

2
EDITION



B R O A D C A S T

TEST

AND

MEASURING

E Q U I P M E N T

for

TELEVISION

AUDIO & VIDEO

FIELD INTENSITY

OSCILLOSCOPES

MONITORING

GENERATORS & METERS

TRANSMITTER

BROADCAST TEST AND MEASURING EQUIPMENT CATALOG

(Second Edition)

PRICE \$1.00



RADIO CORPORATION OF AMERICA

Broadcast & Television Equipment • Camden, N. J.

Page

Typical Test Setups 5

Audio & Video 13

Oscilloscopes 29

Generators & Meters 37

Field Intensity Meters 51

Freq. & Mod. Monitors 55

Sideband Analyzers 61

Demodulators 65

Loads & Wattmeters 71

Index 75

ABOUT THIS CATALOG

This Catalog is devoted solely to information on RCA Test and Measuring equipment designed especially for television station and closed circuit use. Other RCA Broadcast Equipment Catalogs contain similar information on TV camera, film, terminal and audio equipment, AM, FM and TV transmitters, antennas, transmission line equipment and accessories.

The information contained in this catalog is intended to serve as a buying guide for the users of this type of equipment. In the belief that broadcast engineers want facts, rather than generalities, the content has purposely been kept brief and factual. Readers who desire more information or individual bulletins on particular equipment items are invited to write to the RCA Broadcast Representative in the RCA Regional Office nearest them (see opposite page).

OTHER RCA TECHNICAL PRODUCTS

The RCA equipment described in this catalog is specifically designed for broadcast station and closed circuit use. In similar manner RCA builds electronic equipment for many other industries. These include: two-way radio and microwave radio communication equipment; a complete line of equipment for theatres; optical and magnetic film recording equipment; sound systems of all types; 16mm projectors and magnetic recorders; high-fidelity components for home music systems; industrial inspection equipment; scientific equipment, such as the electron microscope; industrial television systems; intercoms; tape recorders; TV Eye; Antenaplex systems; and many types of custom-built equipment for industry and the military services. Information, and catalogs or bulletins, describing these may be obtained from RCA Regional Offices.

HOW TO ORDER

The RCA Test and Measuring Equipment shown in this catalog is sold directly through RCA Broadcast Representatives, who are familiar with broadcast equipment and related problems. One or more of these RCA Represent-

atives are located in each of the RCA Regional Offices listed below. Orders for equipment shown in this catalog, or requests for additional information, should be directed to the nearest one of these offices.

PRICES

The prices of the various equipment units shown in this catalog are given in a separate price list. Prices are listed in the order in which they are shown in the catalog. To determine the price of any equipment first note the page

on which it is shown in the catalog, then consult the price list in accordance with this page number. Equipments are identified by type and MI (Master Item) numbers which are used to identify apparatus on invoices and packing slips.

YOU CAN LOCATE YOUR NEAREST RCA REPRESENTATIVE FROM THIS LIST

REGIONAL OFFICES

Front and Cooper Streets
CAMDEN 2, NEW JERSEY
Woodlawn 3-8000



36 West 49th Street
NEW YORK 20, NEW YORK
Judson 6-3800



7901 Freeway #183
DALLAS 35, TEXAS
Fleetwood 2-3911



1600 Keith Building
CLEVELAND 15, OHIO
Cherry 1-3450

200 Berkeley Street
BOSTON 16, MASSACHUSETTS
Hubbard 2-1700



1121 Rhodes-Haverty Building
134 Peachtree Street, N.W.
ATLANTA 3, GEORGIA
Jackson 4-7703



1006 Grand Avenue
KANSAS CITY 6, MISSOURI
Harrison 1-6480



1560 North Vine Street
HOLLYWOOD 28, CALIFORNIA
Hollywood 9-2154

420 Taylor Street
SAN FRANCISCO 2, CALIFORNIA
Ordway 3-8027



1186 Merchandise Mart Plaza
CHICAGO 54, ILLINOIS
Delaware 7-0700



1625 K Street, N.W.
WASHINGTON 6, D. C.
District 7-1260



2250 1st Avenue, South
SEATTLE 4, WASHINGTON
Main 8350

RECOMMENDED TEST AND MEASURING EQUIPMENT FOR AM, FM, AND TV STATIONS

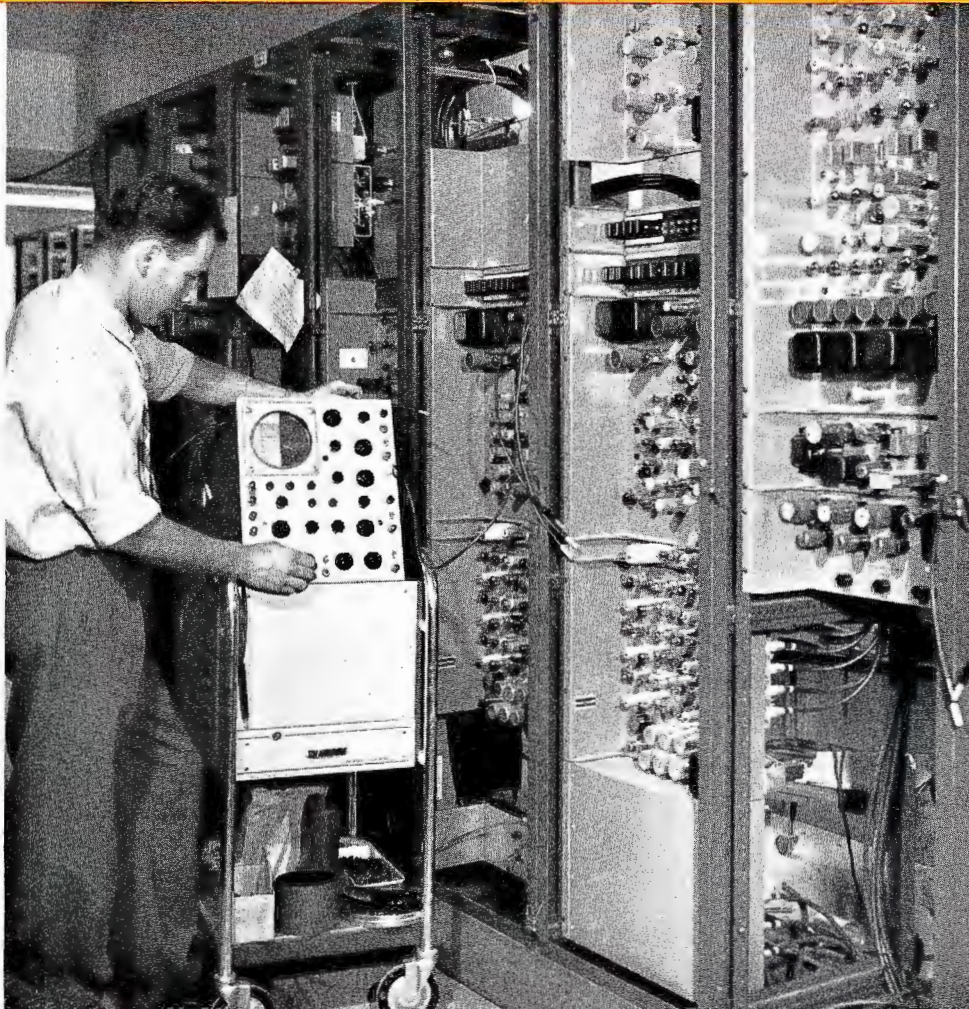

Selection of Test Equipment

High-quality measuring, monitoring, and service test equipment is an important adjunct of AM, FM and Television station and closed circuit facilities; and many items of such equipment are necessary to maintain broadcast operations and assure compliance with FCC standards. A diversified line of equipment is made available by RCA to meet practically every test and measurement requirement. It is recognized by RCA that requirements vary in their scope in relation to the type of operation.

In an effort to assist the Broadcaster in making a proper selection of test and monitoring equipment, several typical equipment lists and station rack layouts are presented. These lists, for the most part, are basic minimum equipment requirements with helpful suggestions regarding optional and additional items. Test and monitoring equipment listings are provided under two different categories—audio and video facilities for broadcasting. The latter listing is further sub-divided into video studio facilities and transmitter test and monitoring equipment. Further differentiation is made to meet the varying needs of TV stations

telecasting black-and-white and color signals. Rack layouts are suggested for the important monitoring equipment, also portable test and service units required for color broadcasting. No layouts are shown for the TV studio test units and portable service and measuring devices, such as field intensity meters, oscilloscopes, voltOhmysts, and similar items since it is felt that each station can best make proper disposition for them among their facilities.

Information in this section is offered only as a general guide, since individual requirements will dictate the final selection to be made. The minimum test and measurement equipment suggested for a single AM, FM or television station will permit the station to perform most all the required measurements. Multiple studio and control rooms, remote transmitter location, transmission link equipment and other facilities may demand a greater variety and/or additional items of the same equipment. RCA Broadcast Sales Engineers will gladly assist in planning equipment lists to handle the particular maintenance and test requirements for any station, large or small.

Audio Test Facilities for Broadcasting Systems

Test instruments required by the AM, FM, or Television station to measure audio facilities are largely dictated by the "proof-of-performance" measurements required by the Federal Communications Commission. Such equipment must be sufficient to measure AM and/or FM output noise level, the audio frequency harmonic distortion, and the audio frequency response under normal program operation as defined by the FCC. In addition, the broadcast station will undoubtedly be equipped to make other measurements such as power output, carrier frequency stability, carrier shift, carrier noise level, output voltage, and other systems tests.

The major items of test equipment required to adequately make the above measurements are listed in Table II. It is assumed that the station has complete transmitter audio input and monitoring equipment (see Table I). It is essential to have a good modulation monitor which provides a low-distortion, audio output with sufficient level for feeding a noise and distortion meter.

An integrated test equipment system for performing audio measurements is shown in the accompanying block diagram. The FCC specifies that "all measurements shall be made with the equipment adjusted for normal program operation and shall include all circuits between the main studio microphone terminals and the antenna output, including telephone lines, pre-amplifier circuits and any equalizers employed except for microphones, and without compression, if a compression (limiting) amplifier is installed." The diagram presents such audio elements in the system immediately following the transmission line measuring set and preceding the transmitter.

As an audio oscillator in the system, RCA offers the Type WA-28A Low Distortion Push Button Oscillator which is capable of providing a quality tone source for distortion measurements and a power source for bridge measurements at audio frequencies. It features convenient push-button frequency selection, providing 27 frequencies between 20 and 15,000 cycles recommended by the FCC for distortion measurements on broadcast transmitters. Three output impedances are available, and the output voltage may be adjusted.

The Type BI-11A Transmission Measuring Set serves in the audio system as a calibrated adjustable attenuator. It is a simplified instrument capable of reading directly such system measurements as gain, loss, mismatch loss, frequency response, and measurements on bridging and matching devices, and complex circuits. It meets FCC accuracies and can be a useful device either in the master control room or at the transmitter.

RCA's Type WM-71A Distortion and Noise Meter measures audio frequency distortion in modulators, speech amplifiers, a-f generators, receivers and other devices employing audio frequencies in the range of 50 to 15,000 cycles. Hum and noise components are able to be measured from 30 to 45,000 cycles. This instrument when used with an oscilloscope identifies individual hum and distortion components, and with linear detectors such as the BW-66F AM monitor or GR-1184-A and HP-335-ER FM and TV modulation and frequency monitor measures distortion and noise characteristics of broadcast transmitters.

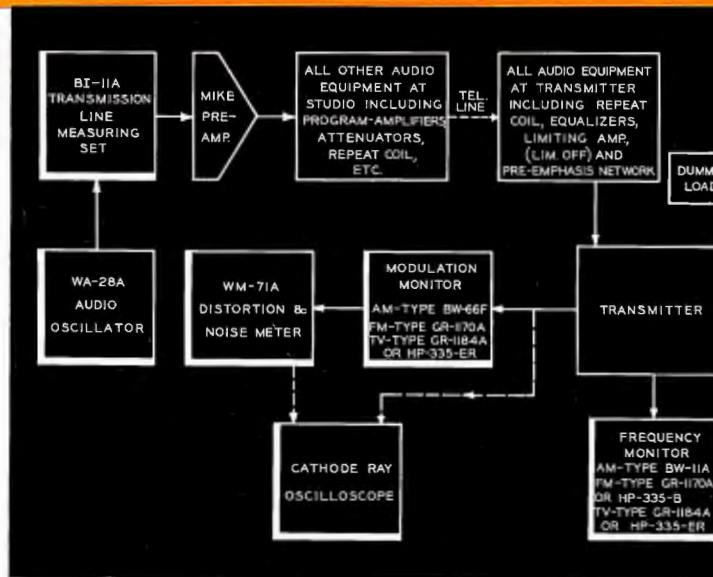

Test set-up for transmitter aural measurements.

It will be noted that the AM, FM and TV services require different frequency and modulation monitors, which must be selected with regards to the varying frequencies at which they are designed to operate. A suitable cathode-ray oscilloscope is also useful in making the audio measurements. The RCA Type WO-91A scope is recommended for the AM or FM station, but the larger, more versatile TO-524AD oscilloscope is strongly recommended for the TV station since it will generally find use in the video circuits as well as the audio. The scope is required for making measurements at the output of the transmitter as well as following the noise and distortion meter.

While many stations will rely on their consultant or an outside engineering service to run field intensity surveys, some stations may wish to include a good field intensity meter to sample signal strength in their area, and to per-

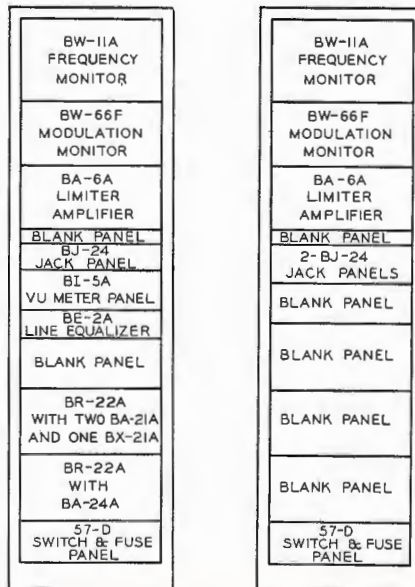

XMTR AT LOCATION
REMOTE FROM STUDIO

XMTR AND STUDIO
AT SAME LOCATION

form their own measurements on spurious emissions and magnitude of r-f harmonics. A clamp-on ammeter or wattmeter, vacuum tube voltmeter, dummy loads, and r-f signal generator may also find a useful place in the station for making other audio measurements. The RCA Type WV-77C Junior VoltOhmyst is a must for the station test bench and it will be useful for the TV station with such accessories as the Type WG-264 Crystal-Diode Probe, Type WG-289 High Voltage Probe, Type WG-291 Crystal-Diode Demodulator Probe and a set of Multiplier Resistors for the high voltage probe.

I. Transmitter Audio and Monitoring

| Item No. | Quantity | | MI Number | Description |
|----------|----------|--------|---------------|---|
| | Studio | Remote | | |
| 1. | 1 | 1 | 30951-B84 | Type BR-84B Cabinet Rack |
| 2. | 2 | 2 | 30566-G84 | Single Trim Strip for BR-84B |
| *3. | 1 | 1 | 30011-A | Type BW-11A AM Freq. Monitor |
| *4. | 1 | 1 | 30066-B | Type BW-66F Mod. Monitor |
| 5. | 2 | 1 | 11645-A | Type BJ-24 Double Jack Panel |
| 6. | 1 | — | 11647-2 | Double Jack Panel Mat |
| 7. | — | 1 | 11647-1 | Single Jack Panel Mat |
| 8. | 1 | 1 | 11225 | Type BA-6A Limiting Amplifier |
| 9. | 1 | 1 | 11289 | Tube Kit for BA-6A |
| 10. | 1 | 1 | 11599 | Shelf for BA-6A |
| 11. | 1 | 1 | 4395-G | Type 57-D Switch and Fuse Panel |
| 12. | 1 | 1 | 4570-A | Terminal Board Mount. Bracket |
| 13. | 1 | 1 | 4568 | Terminal Power Strip |
| 14. | 1 | 1 | 4569 | Terminal Audio Block |
| 15. | 1000' | 1000' | 33 | Inter. Cable (rack wiring) |
| 16. | 1000' | 1000' | 35 | Inter. Cable (a-c and fil. circuits) |
| 17. | 3 | — | 4594-B | Blank Panel, 8¾" |
| 18. | 1 | — | 4592-B | Blank Panel, 5¼" |
| 19. | 1 | — | 4590-B | Blank Panel, 1¾" |
| 20. | — | 1 | 11247 | Type BA-24A Monitoring Amp. |
| 21. | — | 1 | 11481 | Tube Kit for BA-24A |
| 22. | — | 2 | 11244-A | Type BA-21A Pre-amplifier and Isolation Amplifier |
| 23. | — | 2 | 11482 | Tube Kit for BA-21A |
| 24. | — | 2 | 11597 | Type BR-22A Panel and Shelf |
| 25. | — | 1 | 11752 | Type BE-2A Var. Line Equalizer |
| 26. | — | 1 | 11265-F | Type BI-5A VU Meter Panel |
| 27. | — | 1 | 4593-A | Blank Panel, 7" |
| 28. | — | 3 | 4652-2B | 2' Patch Card |
| 29. | — | 1 | 11007 | Type BK-1A Pressure Microphone |
| 30. | — | 1 | 11008 | Type KS-11A Desk Stand |
| 31. | — | 1 | 4630-B | Microphone Cable Plug |
| 32. | — | 1 | 4624-A | Microphone Wall Receptacle |
| 33. | — | 1 | 11833-B | Type BQ-2B Trans. Turntable |
| 34. | — | 1 | 11885-A | Lightweight Tone Arm |
| 35. | — | 1 | 11874-4 | 1 mil Lightweight Pickup |
| 36. | — | 1 | 11874-5 | 2.5 mil Lightweight Pickup |
| 37. | — | 1 | 11888 | Pickup Equalizer |
| 38. | — | 1 | 11406/11411-A | Type LC-1A Monitoring Speaker |
| 39. | — | 1 | 11317 | BX-21A Power Supply |

* When used for FM-TV, space occupied will be utilized for FM frequency and modulation monitor, Type GR-1184-A or HP-335-ER.

II. Broadcast Audio Test and Measuring

| Item No. | Quan. | Type | MI Number | Description |
|----------|-------|--------|-----------|---|
| | | No. | | |
| 1. | 1 | WA-28A | 30028-A | Audio Push Button Oscillator |
| 2. | 1 | BI-11A | 11350 | Transmission Measuring Set |
| 3. | 1 | WM-71A | 30071-A | Distortion and Noise Meter |
| 4. | 1 | | | *Cathode-Ray Oscilloscope |
| 5. | 1 | WV-77C | | Junior VoltOhmyst |
| † 6. | 1 | WG-264 | | Crystal-Diode Probe |
| † 7. | 1 | WG-289 | | High-Voltage Probe |
| † 8. | 1 | WG-291 | | Crystal-Diode Demodulator Probe |
| † 9. | 1 set | | | Multiplier Resistors for High Voltage Probe |

† Items 6 through 9 are not required for AM testing and service.

Test Facilities for Television Systems

The needs of television have led to the development of numerous new test and measurement devices. Many of them have highly specialized functions, and most of them incorporate new and unique design. Moreover, the rigid performance specifications for transmitters and other TV equipment make the use of this test equipment a necessity. Color telecasting has introduced a whole series of new and additional requirements in the way of measuring equipment.

To assist in choosing the proper equipment, two tables have been prepared. Table III lists TV test and measurement equipment for evaluating the studio installation. This selected group of equipment is capable of providing sufficient information to insure that the installation meets the operating standards established by the FCC. Table IV lists the equipment required to test the performance of television transmitters. Both tables have been sectionalized to meet the varying needs of the many TV stations. In each table, section (a) outlines the needs of the standard monochrome station; and section (b) provides a list of test equipment desirable for color stations planning to re-broadcast network programs. Test equipment required by stations who have the necessary equipment to originate their own color signal falls into section (c). Items starred may be considered as optional test devices useful for performing highly specialized tests or equipment made necessary by special services such as microwave, remote facilities, etc.

To meet telecasting standards, precision monitoring equipment is required of all stations, particularly facilities for monitoring the frequency and percentage modulation of the aural and visual transmitters. Care should, therefore, be shown in the selection of such equipment. In Table V will be found a complete list of requirements for a monochrome station monitoring system and Table VI lists Color TV Monitoring needs. Typical rack mounting arrangements for both type TV stations are also included. Provision is made in the Color Monitor racks for housing both the Low and the High Frequency Phase Equalizers and the Low Pass Filter for the color transmitter.

The facilities required for operation and monitoring of the color transmission are nearly the same as for monochrome except for the obvious desirability of a Type TM-21A Color Monitor. This monitor must be fed from a high-quality demodulator such as the RCA Type BW-4B or BWU-4B. A point to be observed in color monitoring is that the input monitoring precedes the phase and amplitude equalizers, since monitoring at any other point between the signal source and the output monitor would contain a certain amount of signal pre-distortion.

TV Studio Test Equipment

Most video signal tests can be performed in the station studio by means of standard monitoring equipment. For the monochrome TV station a few standard items of test equipment provide the other requisites. These include a Type TO-524AD cathode-ray oscilloscope, one or two RCA VoltOhmysts, a test meter and a tube checker. The EIA standard test charts for correcting linearity, resolution and other signal defects should also be available. Many stations will find a video sweep generator useful, for measuring amplitude vs. frequency response characteristic.

At least three additional test units are required for the color TV studio. These are the linearity checker, color signal analyzer, and color-bar generator. All the equipment recommended can easily be housed within a single equipment rack, but in practice it would generally be housed in several racks along with other color TV station

equipment. Some stations have it mounted in a mobile equipment rack. The individual functions and integrated test equipment system for video studio facilities is outlined in the series of block diagrams.

The Linearity Checker, Type WA-7C, generates step-wave form for measuring differential gain, and, in conjunction with the Signal Analyzer, differential phase. It can be used for determining the amount of white stretch necessary to the non-linear transfer characteristic attributable to grid modulation in the transmitter. Supplied with the Linearity Checker is a Hi-lo filter which is used at the input to the oscilloscope. By switching the filter between high, low and normal positions, the subcarrier step-wave or composite signal can be viewed separately and the waveforms interpreted accordingly.

The WA-6A Color Signal Analyzer is a device used for measuring differences in phase at the subcarrier frequency.

- 1** Linearity Checker and Oscilloscope test for differential gain.

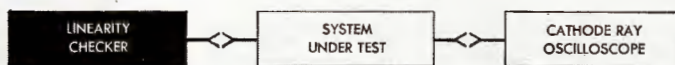

- 2** Addition of Color Signal Analyzer makes it possible to check differential gain and differential phase.

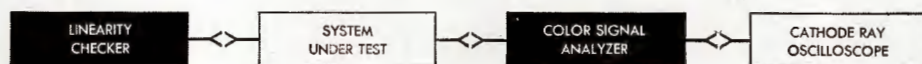

- 3** The Color Bar Generator shown is used with origination equipment for supplying test signal to system. The Color Bar Generator in conjunction with the Color Signal Analyzer is used for precise alignment of the Colorplexer.

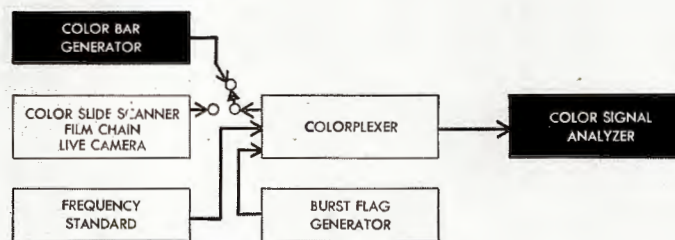

- 4** Integrated Test Equipment System for color broadcasting. This includes all situations depicted above.

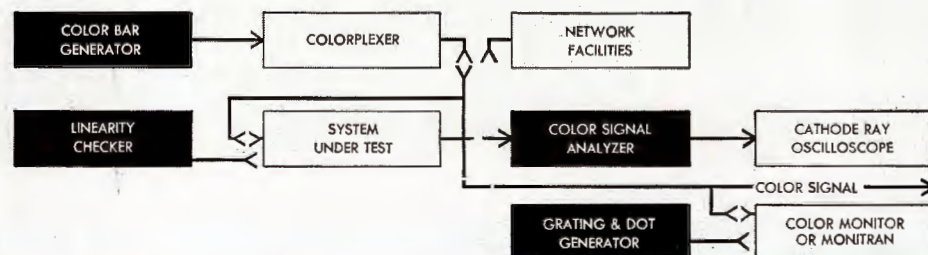

It is used in conjunction with a color bar generator to align the colorplexer. With the linearity checker it is used for making differential phase measurements. In all cases a source of subcarrier must be used in the operation of the color signal analyzer. The linearity checker has an internal generator at subcarrier frequency for this purpose. The output of the frequency standard may also be used. The color signal analyzer is a null-indicating type of instrument with the inherent stability and accuracy, plus the ease of adjustment of such instruments. It contains self-calibrating features which make unnecessary auxiliary calibrating instruments. It is capable of measuring phase differences of the order of 0.5 degrees.



Using MicroMhoMeter to check electron tube performance.

The Type WA-1E Color Bar Generator supplies a synthetic signal which permits exact alignment of the colorplexer. It provides a standard signal against which the performance of the cameras can be measured. The usefulness of its signal for color television is analogous to that of the monoscope in monochrome. The unit is capable of providing a split field color bar pattern with standard color bars at the top of the raster, and two special "Q" and "I" test bars, and a white bar in the bottom of the raster. This field splitting is accomplished by electronic switching. The special "Q" and "I" pulses are provided to simplify phase adjustment of the subcarrier signals.



Making test measurements on TV transmitter.

Checking overall receiver alignment.

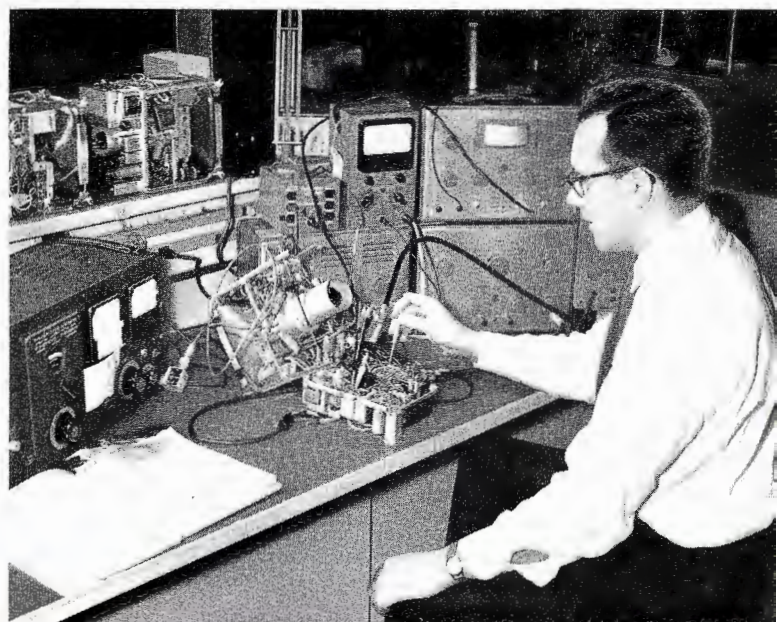



Running performance Test on TV Transmitter.

TV Transmitter Test Equipment

Of the tests and measurements specified for monochrome video transmitters, the majority can be performed with the aid of the RCA Type BW-5A or BWU-5A Sideband Response Analyzer, the BW-4B or BWU-4A Visual Sideband Demodulator, and a suitable R-F Load and Wattmeter. This assumes, of course, that the station is equipped with complete input and monitoring rack equipment, a quality Oscilloscope, one or two VoltOhmysts, and meters capable of reading a-c and d-c currents. In addition a good Field Intensity Meter may often come in handy for field measurements.

Characteristics which must be measured as a routine matter of visual transmitter adjustment include linearity, sideband attenuation, waveform, and amplitude vs. frequency. A composite diagram shows a typical arrangement of the above test equipment capable of carrying out three of the required measurements.

RCA's Type BW-5A Sideband Response Analyzer for VHF channels and the BWU-5A model for UHF channels provide for the display on an oscilloscope of the entire frequency and sideband response capabilities of any TV transmitter or sideband filter without laborious point-to-point curve plotting. The units facilitate the video transmitter adjustments by indicating the effectiveness of the adjustments as they are made. The equipment is equally effective when used in adjusting video amplifiers, modulators, etc. The analyzer includes a video sweep oscillator which makes it unnecessary to provide extra video sweep generators for measurement purposes.

The Visual Sideband Demodulators, Type BW-4B for VHF channels and the Type BWU-4A for the UHF channels should have a place in every station monitoring rack. It may be connected where desired in the transmission line to produce a signal for monitoring and checking the transmitter output. It provides important information on waveform characteristics, such as wave shape, percent sync, depth of modulation, resolution and transient response, as well as a composite picture of the TV signal to serve as a basis for checking compliance with FCC standards.

The R-F Loads and Wattmeters are useful in measuring the power output of both the aural and visual sections of the TV transmitter. The RCA series permits choice of a suitable load and meter for any channel frequency and power level. All meet FCC standards, and may be used to properly terminate the output when measuring the r-f power. This unit also is used as a dummy antenna for transmitter tuning.

The test equipment requirements for the color video transmitter are almost identical to those of the monochrome video transmitter, as will be noted below. Three optional test items may be added to the transmitter equipment for convenience. A Type WA-7C Linearity Checker and a WA-6A Color Signal Analyzer may be required at the transmitter where the studio and transmitter control centers are widely separated. The Linearity Checker is used in making subcarrier amplitude checks and linearity measurements, and both the checker and analyzer are used in the system test for differential phase. A square-wave generator is a handy test device that is also recommended. When available an envelope delay sweep should also be included among the testing facilities. Adjustments of the transmitter for best frequency response are accomplished in the same manner regardless of whether the transmitter is intended for monochrome transmission or color. Particular

Test set-up for transmitter video measurements.

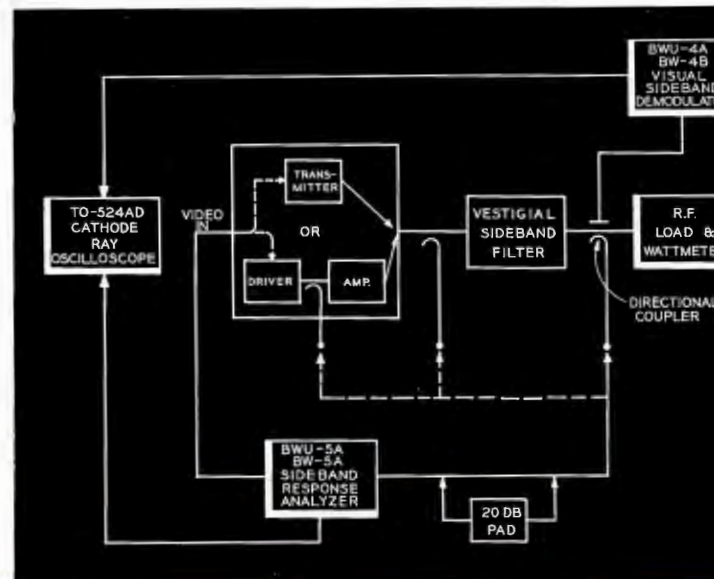



Monitoring TV picture at a typical console.

III. Studio TV Test and Measuring Equipment

(a) FOR STANDARD MONOCHROME OPERATION

| Item No. | Quan. | Type No. | MI Number | Description |
|----------|-------|----------|-----------|--------------------------|
| 1. | 1 | TO-524AD | 26500-A | Cathode-Ray Oscilloscope |
| * 2. | 1 | TO-500 | 26501 | Scope-mobile |
| 3. | 2 | WV-98A | | VoltOhmysts |
| 4. | 1 | 21200-C1 | | Test Meter |

(b) FOR NETWORK PARTICIPATING COLOR TV STATIONS

(All items listed above in section (a) plus the following equipment):

| Item No. | Quan. | Type No. | MI Number | Description |
|----------|-------|----------|-----------|--|
| 5. | 1 | WA-7C | 34017-B | Linearity Checker |
| 6. | 1 | WA-6A | 34016-A | Color Signal Analyzer |
| * 7. | 1 | WR-61B | | Service Type Color Bar Generator |
| * 8. | 1 | BW-11AT | 34040-A | Subcarrier Frequency Monitor, including MI-7962-C Crystal Unit |
| * 9. | 1 | WA-8A | 40214 | Color Stripe Generator |

(c) FOR COLOR ORIGINATING TV STATIONS

(All items listed above in sections (a) and (b) plus the following equipment):

| Item No. | Quan. | Type No. | MI Number | Description |
|----------|-------|----------|-----------|-----------------------------|
| 10. | 1 | WA-1E | 34001-F | Color Bar Generator |
| 11. | 1 | WA-9A | 26070 | Calibration Pulse Generator |

* Optional Equipment.

attention must be paid with color transmission to maintain a flat frequency response to 4.18 mc. The best tools to use are the BW-5A or BWU-5A Sideband Response Analyzer in conjunction with an oscilloscope.

To facilitate transmitter linearity adjustment the Type TA-7C Linearity Checker is recommended. The signal from this device, consisting of a stepped wave with superimposed subcarrier, may be applied to the input of the stabilizing amplifier or substituted for the normal signal source preceding the phase equalizer. The output of the diode demodulator is then displayed on an oscilloscope. The same test apparatus plus the WA-6A Color Signal Analyzer may be employed to observe the subcarrier phase vs. amplitude.

To adjust the phase equalizers, a square wave generator is used as the signal source and the signal should be passed through all the equipment except the stabilizing amplifier. The transmitter should be set for a-c operation at a power level half-way between pedestal and white level. The output should be viewed on a TO-524AD Cathode-Ray Oscilloscope connected to the output of a receiver-type demodulator (such as the BW-4B or BWU-4A) with sound notches removed.

IV. Video Transmitter Test and Measurement Equipment

(a) FOR STANDARD MONOCHROME STATIONS

| Item No. | Quan. | Type No. | MI Number | Equipment |
|----------|-------|----------|-----------|--|
| 1. | 1 | BW-5A | ES-34010 | VHF Sideband Response Analyzer |
| | | | | OR |
| | | BWU-5A | ES-34009 | UHF Sideband Response Analyzer |
| 2. | 1 | | † | R-F Load and Wattmeter |
| * 3. | 1 | TO-524AD | 26500-A | Cathode-Ray Oscilloscope |
| * 4. | 1 | TO-500 | 26501 | Scope-mobile |
| * 5. | 2 | VR-98A | | VoltOhmysts, including WG-264 Probe |
| * 6. | 1 | | 21200-C1 | Test Meter |
| 7. | 1 | BW-7A | 19384 | VHF Field Intensity Meter and Test Set |

(b) FOR NETWORK PARTICIPATING COLOR TV STATIONS

(All items listed above in section (a) plus the following equipment):

| Item No. | Quan. | Type No. | MI Number | Equipment |
|----------|-------|----------|-----------|---------------------------------|
| * 8. | 1 | WA-7C | 34017-B | Linearity Checker |
| * 9. | 1 | WA-6A | 34016-A | Color Signal Analyzer |
| 10. | 1 | 105 | | Tektronix Square-Wave Generator |

(c) FOR COLOR ORIGINATING TV STATIONS

(All items listed above in section (a) and (b).)

† See page 71 for choice of proper equipment to suit frequency and power level of transmitter.

* If TV studio and transmitter locations are at same site item may be omitted as it is listed under required Studio TV Test and Measuring Equipment in Table III. Where studio and transmitter site are remote it is advisable to maintain duplicate equipments for testing and measuring.

Color TV Transmitter Input and Monitoring Equipment

| Item No. | Quan. | MI Number | Equipment | Item No. | Quan. | MI Number | Equipment |
|----------|-------|-----------|--|----------|-------|------------|---|
| 1. | 1 | 30951-B84 | BR-84 Cabinet Rack (Wired) Consisting of: 1 rack, 1 rear door, and 2 side panels | 20. | 1 | ES-34010 | BW-5A VHF Sideband Response Analyzer (with one set of tubes) |
| 2. | 1 | 30951-D84 | BR-84 Cabinet Rack (Wired) Consisting of: 1 rack and 1 rear door | | 1 | ES-34009 | BWU-5A UHF or Sideband Response Analyzer (with one set of tubes) |
| 3. | 2 | 30546-G28 | Electrical Shield | 21. | 3 | 4652-2B | Audio Patch Cord |
| 4. | 1 | 30546-G21 | Electrical Shield | 22. | 6 | 26771 | Video Patch Cord |
| 5. | 2 | 30566-G84 | Single Trim Strip | 23. | 23 | 26784 | Video Dual Connector Plug |
| 6. | 1 | 30568-G84 | Double Trim Strip | 24. | 2 | 30526-G84 | Pair of Panel Mounting Angles |
| 7. | 1 | 4593-B | Blank Panel 7" | 25. | 3 | 4570-A | Terminal Board Brackets |
| 8. | 2* | 4591-B | Blank Panel 3 1/2" | 26. | 1 | 4569 | Audio Terminal Blocks |
| 9. | 1 | 11225 | BA-6A Limiting Amplifier (includes panel but less shelf and tubes) | 27. | 6 | 4568 | Power Terminal Blocks |
| 10. | 1 | 11289 | Tube Kit for BA-6A Amplifier | 28. | 1 | 11645-A | BJ-24 Double Jack Panel |
| 11. | 1 | 11599 | BR-2A Shelf for BA-6A Amplifier | 29. | 1 | 11647-2 | Jack Mat for BJ-24 |
| 12. | 1 | 11247 | BA-24A Monitoring Amplifier (less tubes) | 30. | 2 | 30590-2 | Interlock Switch |
| 13. | 1 | 11481 | Tube Kit for BA-24A Amplifier | 31. | 1 | ES-34034-B | High and Low Frequency Phase Correction Network |
| 14. | 1 | 11597 | BR-22A Shelf for BA-24A Amplifier | 32. | 2 | 26157-B | TA-3B Distribution Amplifier (with one set of tubes) |
| 15. | 1 | 26087 | WP-15 Regulated Power Supply (Rectifier) | 33. | 1 | 27407 | Program Line Selector |
| 16. | 1 | 26088 | Regulator for WP-15 Power Supply (with one set of tubes) | 34. | 1 | 26240 | Circuit Breaker Chassis |
| 17. | 1 | 40222 | TA-9 Stabilizing Amplifier (with one set of tubes) | 35. | 2 | 26764-1 | Circuit Breaker |
| 18. | 2 | 26219 | Video Jack Panel | 36. | 1 | 26764-2 | Circuit Breaker |
| 19. | 1 | ES-34048 | BW-4B VHF Visual Demodulator (with one set of tubes) | 37. | 1 | 27861 | Resistor for WP-15 Regulator |
| | | | or | 38. | 1 | 27862 | Mounting Hardware |
| | 1 | ES-34007 | BWU-4A UHF or Visual Demodulator (with one set of tubes) | §39. | 1 | 1184-A | General Radio Type Station Monitor (complete with one set of tubes) |

§ The Type 335-ER Hewlett-Packard TV Monitor may be specified in lieu of General Radio Equipment shown in table. When ordering the Hewlett-Packard Monitor also order 1 MI-4596-A Blank Panel 12 1/4" and 2 MI-4593-A Blank Panels 7".

* A quantity of 1 blank panel (item 8) is supplied in Monitoring equipment racks for UHF Stations.

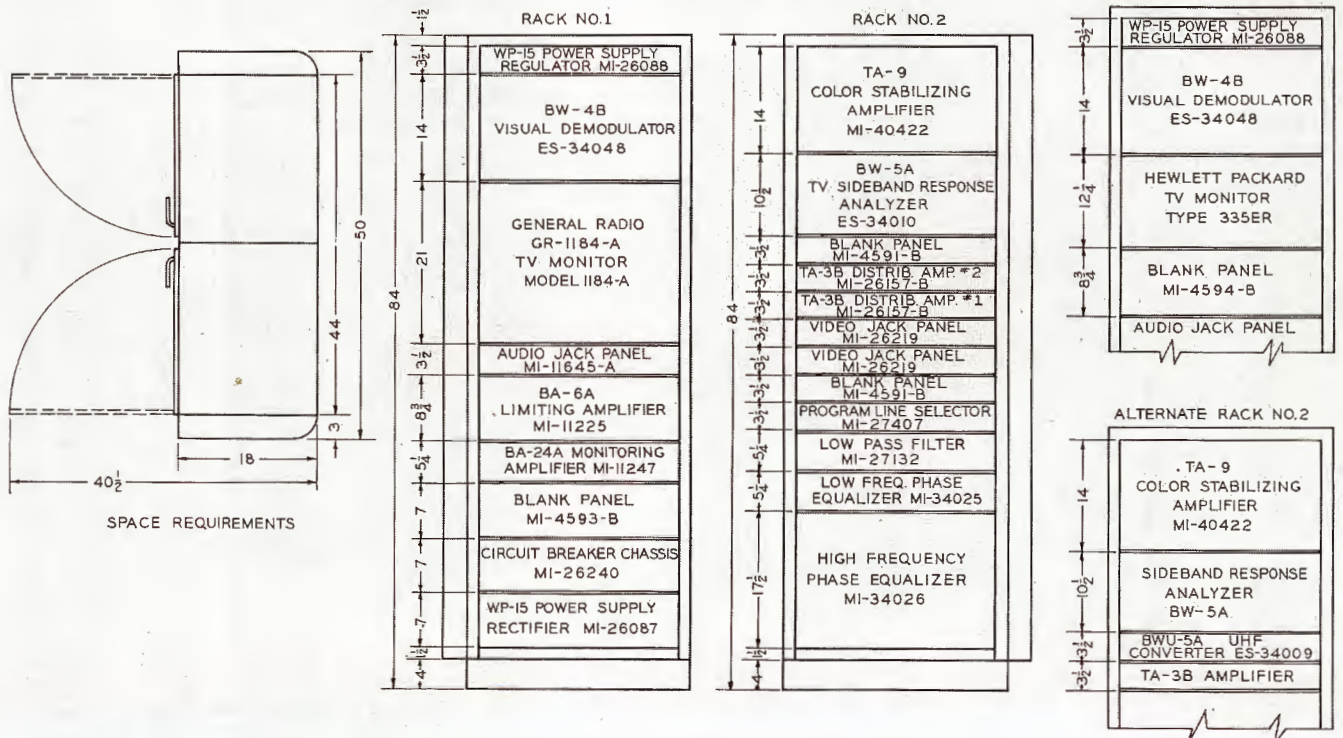

DISTORTION AND NOISE METER

TYPE WM-71A

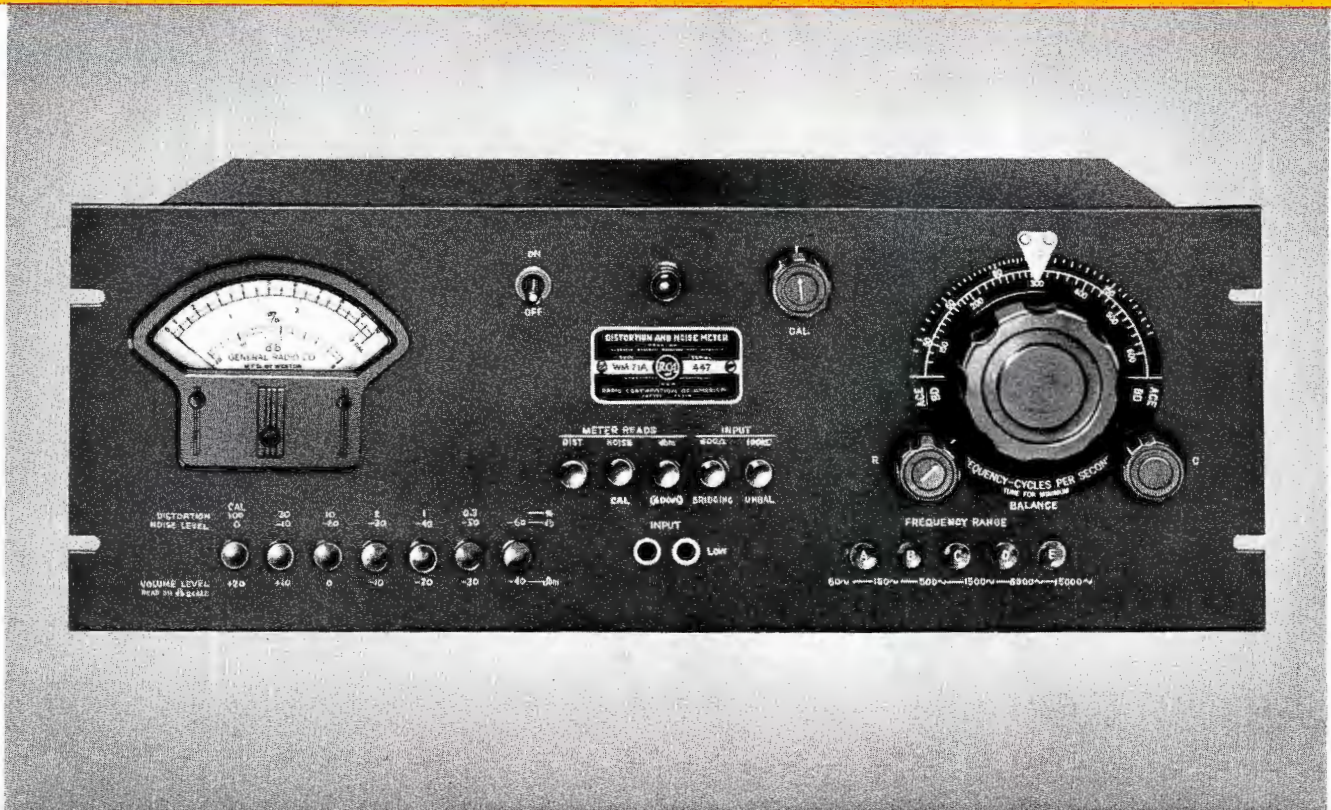

FEATURES

- Quick frequency selection
- Can be used as a wide range highly sensitive voltmeter or VU meter
- Distortion measurements, as low as 0.1%, quickly and easily made by one tuning adjustment
- Requires no direct connection to audio oscillator
- Audio oscillator distortion can be measured
- Tapped power transformer permits operation on either 105-125 volts or 210-250 volts
- Audio frequency range 50 to 15,000 cycles for distortion measurements; 30 to 45,000 cycles for noise and hum measurements

USES

Distortion and Noise Meter, RCA Type WM-71A, is a compact precision instrument for measuring the total distortion and the level of noise and hum in audio-frequency circuits. It permits continuous coverage of the audio frequency range, indicating directly the percentage of a-f distortion in modulators, speech amplifiers, a-f generators, receivers and other equipment employing audio frequencies. The instrument will give full-scale readings for distortion percentages as low as 0.3%, and is capable of measuring noise components at frequencies from 30 to 45,000 cycles.

The instrument has many uses in the communications laboratory and in the production testing of radio receivers as a wide-range, highly sensitive voltmeter for such measurements as signal-to-noise ratio, AVC characteristics and hum level. With the aid of an oscilloscope, individual hum and distortion components can be identified. When used with a linear detector such as the RCA Type BW-66F Amplitude-Modulation Monitor, the distortion and noise characteristics of broadcast and other radio-telephone transmitters can be measured.

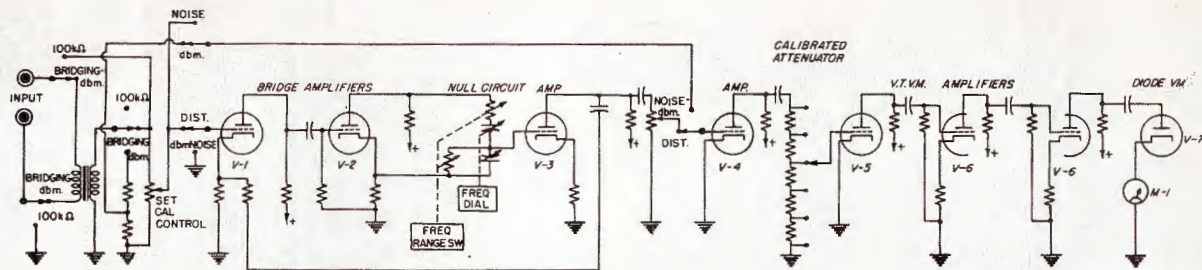

Elementary schematic circuit diagram of the WM-71A Distortion and Noise Meter.

DESCRIPTION

The WM-71A Distortion and Noise Meter consists essentially of a high-gain amplifier, an r-c interstage coupling unit, a calibrated attenuator for adjusting the sensitivity, and a panel meter to indicate amplifier output.

The r-c interstage coupling unit balances to a sharp null at the frequency to which it is tuned, the null frequency being continuously variable and controlled from the panel. Degeneration is employed to maintain high stability in the amplifier and to provide flat transmission characteristics except within an octave of the null point.

In measuring distortion the audio-frequency signal is applied to the instrument and the null point is obtained to balance out its fundamental frequency, leaving only its harmonics and other distortion components which are indicated in percentage directly on the panel meter. When the modulated output of a radio transmitter is to be measured, a linear rectifier is required to produce the audio envelope. Any linear detector system having an undistorted output of 1.5 volts can be used.

A switch on the front panel provides for switching out the null circuit so that the instrument can be used as an extremely sensitive voltmeter for measuring hum and noise levels. Since the WM-71A has only one tuning control plus a small trimmer, it can be quickly set to any frequency over its range. This is a time-saving feature in making a series of measurements. Two input circuits are provided: a transformer for bridging a 600-ohm line, and a direct connection to the 100,000-ohm gain control. Input terminals are provided at the rear of the instrument for direct connection to the modulation monitor.

The instrument is relay rack mounted. All essential controls are located on the front panel. A large meter with an easily read, illuminated scale is provided, and percentage, decibel and dbm calibrations are included. The power supply is voltage regulated so that line surges have no appreciable effect on the instrument.

SPECIFICATIONS

Performance Specifications

- Distortion Range.....Full scale deflections for 0.3%, 1%, 3%, 10% or 30% distortion
- Noise Measurement Range....-80 db below reference calibration level, or 80 db below an audio-frequency signal of zero dbm level, at maximum sensitivity.
- Audio-Frequency Range.....50 to 15,000 cycles (fundamental), for distortion measurements; 30 to 45,000 cycles for noise and hum measurements.
- Dbm Range.....Power-level range is from +20 to -60 dbm (0 dbm is one milliwatt in 600 ohms)
- Input Voltage Range.....1.2 to 30 volts for the 100-kilohm input, and 0.8 to 30 volts for the 600-ohm bridging input
- Accuracy.....For distortion measurements ±5% of full scale for each range ± residual distortion as noted below; for noise and dbm measurements, ±5% of full scale.
- Residual Distortion Level:
 - 100-kilohm Input.....0.05%, max., below 7500 c. 0.10%, max., above 7500 c.
 - Bridging Input.....0.10%, max., between 50 and 70 c. 0.05%, max., between 70 and 7500 c. 0.10%, max., above 7500 c.
- Residual Noise Level.....Less than -80 db
- Input Impedance.....100,000 ohms unbalanced, and 600-ohm bridging input (10,000 ohms), balanced or unbalanced
- Power Line.....Tapped primary provides for operation on a-c line voltages of 105-125 volts, 50/60 cycles, single phase, or 210-250 volts, 50/60 cycles, single phase.
- Power Consumption.....65 watts

Tube Complement

- 4-6J5
- 1-6H6
- 1-6SN7-GT
- 1-6X5-GT
- 1-6K6-GT
- 2-OD3/VR150
- Dimensions.....19" wide, 7" high, 12" deep
- Weight37¾ lbs.
- Finish.....Umber gray lacquer

Equipment Supplied

- WM-71A Distortion and Noise Meter.....MI-30071-A Including electron tubes, line connector, interconnecting cable, instruction book (IB-4071-1), and spare fuses.

Optional and Accessory Equipment

- WA-28A Low Distortion Oscillator.....MI-30028-A
- BI-11A Transmission Measuring Set.....MI-11350

AUDIO PUSH-BUTTON OSCILLATOR

TYPE WA-28A



FEATURES

- Very low distortion
- A high degree of frequency stability which makes this oscillator particularly adaptable for use with distortion meters employing r-c null networks
- Push-button selection of any one of 27 frequencies from 20 to 15,000 cycles
- Any other desired frequency within the normal range can be obtained by the use of plug-in resistors
- Duplicate output terminals on rear for relay-rack installation
- Chassis designed for mounting in standard equipment racks
- Ease of operation from front panel controls

USES

The Type WA-28A Oscillator was designed particularly for use as a tone source for distortion measurements and as a power source for bridge measurements at audio frequencies. It is also satisfactory for use as a general-purpose laboratory oscillator.

The output frequencies include those recommended by the FCC for distortion measurements on broadcast transmitters. This oscillator is thus ideal for use with the Type WM-71-A Distortion and Noise Meter for rapid distortion measurements. The unusually pure waveform delivered by this oscillator at low frequencies makes distortion measurements possible at low frequencies.

DESCRIPTION

The WA-28A oscillator is of the resistance-capacitance type and uses an inverse feedback. Separate feedback networks control the frequency and amplitude independently, thus providing high stability and low distortion. The degenerative feedback which controls the frequency is obtained by means of a parallel-T network including mica capacitors and wire-wound resistors. The regenerative network includes an automatic control system whereby a high

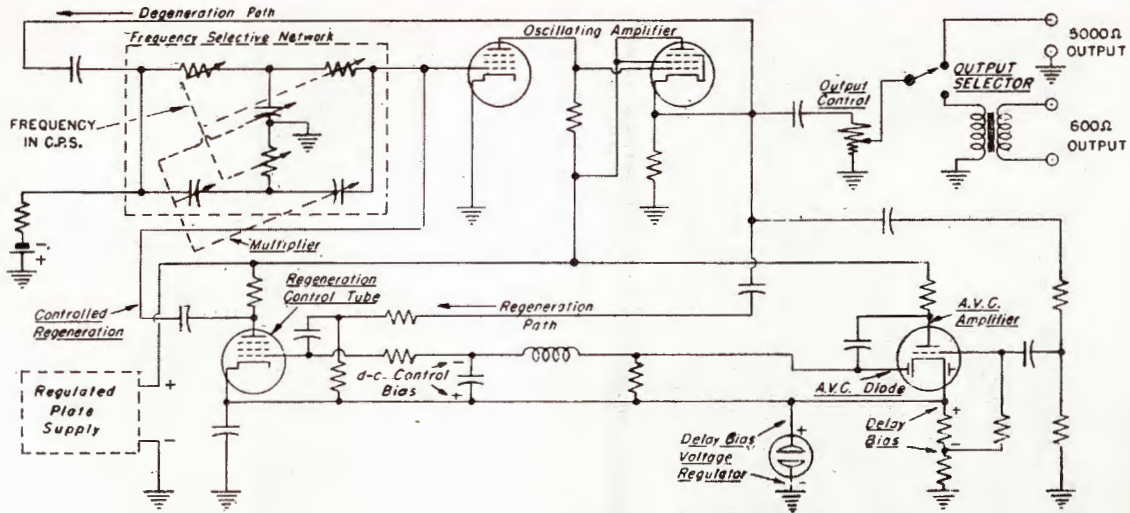

Elementary schematic circuit diagram of the WA-28A Low Distortion Oscillator.

degree of stability is obtained together with low harmonic distortion, without requiring any manual feedback adjustments.

The instrument is mounted on a chassis fitting standard equipment racks. Controls on the front panel include ten frequency push-button switches. Three other push-buttons select the output impedance and a control is provided for adjusting the output voltage. Three frequency multiplier switches and two output jacks are also provided. Terminals are located inside the instrument which permit any specific frequency between the limits of 20 and 15,000 cycles to be obtained by insertion of a set of three calibrated resistors. The values of these resistors for any frequency may be obtained from the chart.

The output impedances available are: a constant 600-ohms balanced to ground, a 600-ohms unbalanced, and a 5000-ohm unbalanced. The 600-ohm output positions use transformer coupling and therefore can be operated either into a balanced line or a grounded line. The internal impedance is essentially constant at 600 ohms. The 5000-ohm output position can be operated unbalanced only. The output control is a potentiometer, and consequently the output impedance is not constant. The total harmonic distortion of any of the outputs will not exceed 0.1% when operating between 40 and 7500 cycles, and is never more than 0.25% when operating at extreme frequencies. The operation of the instrument is substantially independent of climatic changes in temperature and humidity.

Jack-top binding posts with standard 3/4-inch spacing and standard Western Electric double output jack are provided on the panel. A ground terminal is also provided. A standard multipoint connector provides duplicate output terminals on the rear of the instrument for relay-rack

installation. These terminals are disconnected when a plug is inserted in the Western Electric-type panel jack. The instrument is provided with power cord, multipoint connector and spare fuses.

SPECIFICATIONS

Performance Specifications

- Frequency Range.....27 fixed frequencies between 20 and 15,000 cycles
- Frequency Calibration.....Adjusted within 1 1/2% ±0.1 cycle
- Frequency Stability.....Less than 0.02% frequency drift per hour after the first 10 minutes of operation
- Output Power.....18 milliwatts into 600 ohms load, or 6.6 volts open circuit; 100 milliwatts into 5000 ohm load, or 30 volts open circuit; constant within ±1 db throughout frequency range.
- Output Impedances.....600-ohm balanced to ground
600-ohm unbalanced
5000-ohm unbalanced
- Waveform Distortion:
 - 5000-ohm Output.....Less than 0.1% between 40 and 7500 cycles
Less than 0.15% at other frequencies
 - 600-ohm Output.....Less than 0.1% between 40 and 7500 cycles
Less than 0.25% between 20 and 40 cycles
Less than 0.15% above 7500 cycles
- Power Supply.....105 to 125 (or 210 to 250) volts, 50/60 cycles, single phase
- Power Consumption.....45 watts

Tube Complement

- | | | |
|---------|-----------|-------------|
| 1-6Y6-G | 1-6SJ7 | 1-6SK7 |
| 1-NE-17 | 1-6SQ7 | 1-6X5 |
| 1-6B4-G | 1-6SL7-GT | 1-OD3/VR150 |

- Dimensions.....19" wide, 7" high, 12" deep
- Weight32 1/2 lbs.
- Finish.....Light amber gray

Equipment Supplied

- WA-28A Low-Distortion Oscillator, complete.....MI-30028-A
- Including electron tubes, line connector, multiple point connector, instruction book (IB-4028-1) and spare fuses.

Optional and Accessory Equipment

- Noise and Distortion Meter, Type WM-71A.....MI-30071-A
- Transmission Measuring Set, Type BI-11A.....MI-11350

TRANSMISSION MEASURING SET

TYPE BI-11A

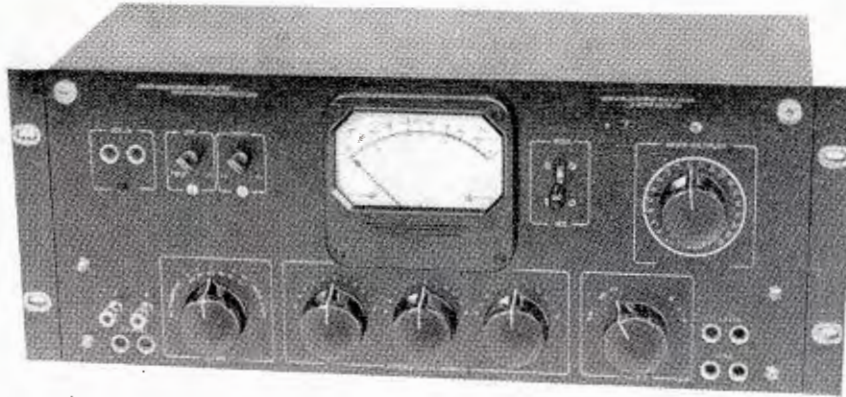

FEATURES

- Simplifies measurement of transmission characteristics of audio systems and their components
- Eliminates lengthy calculations—direct reading
- ± 0.1 db accuracy over frequency range of 20 to 20,000 cycles
- Automatic correction for changes in load impedance
- Output impedance switch for matching
- Wide range of load levels handled
- Hinged panel permits easy access to all components

USES

The Transmission Measuring Set, Type BI-11A, is a simplified, accurate and direct-reading instrument designed for use in the following applications: (1) audio gain measurements; (2) audio loss measurements; (3) measurements of matching and bridging devices; (4) complex circuit measurements; (5) measuring mismatch loss and frequency response measurements. The instrument also may be used as an independent volume level indicator.

The instrument facilitates overall system measurements and may be used with the WA-28A Low Distortion Push-button Oscillator and the WM-71A Distortion and Noise Meter. It eliminates lengthy calculations and intricate setups. It is designed to provide accuracies conforming to FCC regulations and is particularly useful for broadcast stations in the master control room or at the transmitter.

DESCRIPTION

The BI-11A Transmission Measuring Set consists of a volume indicator meter, input and output attenuators, an impedance matching system and jacks for convenient connections. A meter multiplier, which is geared to the load impedance shaft, provides an automatic correction for changes in load impedance. Convenient switches allow the volume indicator to be connected to the input of the attenuator system or to jacks for external connection. An output impedance switch allows matching to 600-250-150-16-8-4 ohm circuits.

Level controls, switches, jacks and VI meter are located on the front of a standard 19 inch rack-type panel. The panel hinges forward to provide ready access to attenuators, jacks, switches and other components. Unit type assemblies (individual sections, such as source, attenuation and load) are readily removable for servicing. Each section is a complete assembly with its own jacks and terminal block.

COLOR BAR GENERATOR

TYPE WA-1E

FEATURES

- Supplies color bar signals for use in set-up, maintenance and operation of color system
- Provides ideal signal for color parameter measurements
- Self-contained regulated power supply
- Special Q and I pulses provided to simplify phase adjustment of the Colorplexer modulator circuits
- Color bars occur in descending order of luminance—white, yellow, cyan, green, magenta, red, blue
- Limiting action insures a constant output level of all bar signals of 0.7 or 1.0 volt peak-to-peak
- Bar Signals interlocked so that each succeeding bar is triggered by the preceding bar, providing improved stability
- Sharper rise times reduce color edging effects at the color bars
- A special white pulse is provided to facilitate white balance adjustments

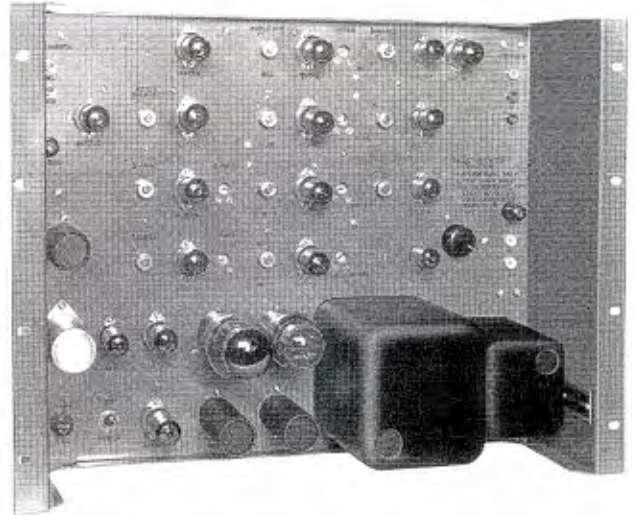

USES

The Color Bar Generator is designed to facilitate adjustment of the Colorplexer and with it to supply a color test signal for general maintenance and measurements in a color broadcasting installation. It generates rectangular pulses which, when fed to the green, red and blue input circuits of the Colorplexer result in the formation of a color bar test signal at the output of the Colorplexer.

In addition, it is capable of providing a split field color bar pattern with standard color bars in the upper three quarters of the raster, and two special "Q" and "I" test bars, and a white bar in the bottom quarter of the raster as recommended by EIA. This field splitting is accomplished by electronic switching. The special "Q" and "I" pulses are provided to simplify phase adjustment of the subcarrier signals, and a white signal is provided to facilitate white balance adjustments in the Colorplexer.

DESCRIPTION

The Color Bar Generator, Type WA-1E, is assembled upon a bath-tub type chassis 14 inches high and designed to mount in a standard 19-inch wide rack. Input and output connectors are mounted on brackets in the rear of the chassis. A self-contained regulated power supply and stabilized circuit design insure stability of operation of the unit.

In operation, the trailing edge of the horizontal blanking pulse triggers the green multivibrator; the firing of the green multivibrator trips the red multivibrator, and the firing of the red multivibrator trips the blue multivibrator. In this manner, the first pulse for each of the primary colors is produced in each color circuit. The trailing edge of the red pulse initiates the second blue pulse; the trailing edge of the green pulse triggers the second red and the third blue pulse, and the trailing edge of the second red pulse triggers the fourth blue pulse.

The trailing edge of the horizontal blanking pulse initiates the "I" pulse, the trailing edge of the "I" pulse triggers the white pulse and the trailing edge of the white pulse triggers the "Q" pulse. Field splitting is accomplished by electronic switching, triggered by the leading edge of the vertical drive, so that the color bars will appear in the top 3/4 of the picture while the test bars appear in the lower 1/4, whenever the pattern selector switch is in either position 3 or 4.

The equipment is so designed that the color bars occur in the descending order of their luminance content, i.e., white, yellow, cyan, green, magenta, red, and blue. Limiting action insures a constant output level for all of the color bar signals, of 0.7 or 1.0 volt, peak to peak.

All connections are made at the rear of the unit. Input connections are made to four bracket mounted connectors on the right hand side of the chassis—rear view. Blanking lines are connected to the upper pair of connectors, and vertical drive lines to the lower pair. Five output connectors are bracket mounted on the left side of the chassis. These outputs are connected to the corresponding receptacles on the Colorplexer. A two pronged male connector connects the unit to any 117 volt, 60 cycle, single-phase current.

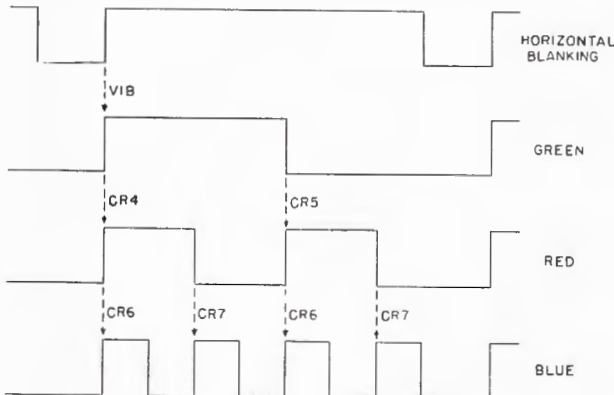

Color Bar Pulses and Pattern.

A-88 63 822

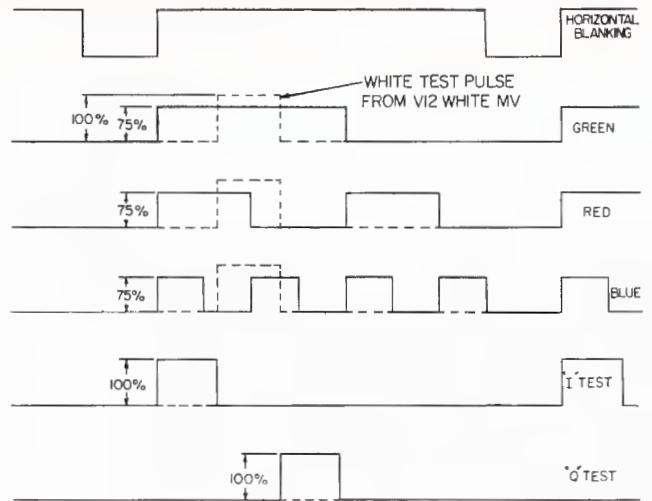

| | | | | | | |
|----------|----------|----------|-------|---|---|---|
| W | Y | C | G | M | R | B |
| I | WHITE | Q | BLACK | | | |
| TEST BAR | TEST BAR | TEST BAR | | | | |

A-8940173

Composite Color Bar, Test Pulses, and Pattern.

The generator may be turned on and off by a power switch, conveniently mounted at the lower left side, on the front of the chassis. A four position pattern selector switch, mounted on the right side of the chassis, provides the four differing types of outputs described below.

SPECIFICATIONS

Performance Specifications

- Power Input.....117 volts a-c, 60 cycle, single phase, 135 watts
- Signal Voltage Required:
 - Inputs (high impedance, bridged):
 - Mixed Blanking.....4 volts, peak-to-peak, neg.
 - Vertical Drive4 volts, peak-to-peak, neg.

Outputs:

- A four position selector switch provides outputs as follows:
 - Pos. 1: Full raster—red, blue, green output pulses at a 0.7 or 1.0 volt level.
 - Pos. 2: Full raster Q and I pulses at 0.7 or 1.0 volt level from separate output jacks and a pulse of 0.7 or 1.0 volt level from each of the red, blue and green output jacks producing white.
 - Pos. 3: Split pattern consisting of the outputs provided by Pos. 1 and Pos. 2.
 - Pos. 4: Same as Pos. 3 except red, blue and green outputs reduced to 75% level. (Note: The reduced level of Color Bars is provided to prevent overmodulation of the transmitter when using the Bar Pattern. (Saturated yellow would exceed 100% modulation.)

Tube Complement

- 1—5V4
- 1—6AS7
- 1—OB2
- 1—12AX7
- 1—6CL6
- 4—6AL5
- 1—5678
- 6—6U8
- 3—12AT7

Dimensions (Unit for rack mounting):

- Height14"
- Width19"
- Depth9"
- Weight30 lbs.

Equipment Supplied

- WA-1E Color Bar Generator.....MI-34001-F
- (Complete with tubes in place and Instruction Book IB-24957-2)

COLOR SIGNAL ANALYZER

TYPE WA-6A

FEATURES

- Precision instrument for accurate alignment of Colorplexer encoder circuits
- Measures differential phase distortion to an accuracy of less than one degree
- Measurements for matching phase of burst between two or more signal sources at input to signal distribution systems
- Measurements read directly in degrees of phase shift at 3.58 mc
- Null adjustment of cathode ray oscilloscope display provides fool-proof measurements
- Internal calibration circuits
- Built-in power supply

USES

Utilizing color bar signals from the Colorplexer, the WA-6A Color Signal Analyzer is the basic phase measuring instrument for adjusting the Colorplexer matrixing and encoder circuits. The various color components of the color bar signal can be phased to an accuracy of less than 1.0° with respect to the phase of the 3.58 mc. burst.

The Linearity Checker, Type WA-7C, supplies a 3.58 mc. modulated step-signal which is used by the Color Signal Analyzer for measuring differential phase distortion either through a single amplifier or an entire system. Measurements are made to an accuracy of less than 1.0 degree.

The WA-6A can also be used for matching the phase of the bursts between two or more color signal sources, at the input of a switching system. Color burst phasing between two color signals must be matched as closely as possible so that in lap-dissolves and super-impositions there will be no undesirable hue shift. The WA-6A measures the phase difference between the burst signals so that the proper phasing can be established.



DESCRIPTION

The Color Signal Analyzer is supplied in a bench type cabinet from which it can be removed, if desired, for standard cabinet rack mounting. When rack mounted, the analyzer occupies $17\frac{1}{2}$ " or 10 units of rack space. It consists of three units: The Phase Shift Panel, the Control Panel, and the Regulated Power Supply. All connections are made to the rear of the control panel except the output to the cathode ray oscilloscope which is on the front panel. Both binding post and coaxial jack type outputs are provided.

Two inputs are provided:

1. A color signal input either from a Color Bar Generator/Colorplexer combination or from a Linearity Checker.
2. A 3.58 mc. sub-carrier input.

The 3.58 mc. sub-carrier is amplified and applied to a calibrated phase shift network which consists of precise lengths of coaxial cable (RG-59/U). The total phase shift of this network is 210° in increments of 90° , 50° , 30° , 20° , 10° , 5° and plus or minus 5° in steps of 1° . By selecting

the proper delay combination by means of the switches on the front panel of the phase shifter, any desired phase shift between -5° and $+215^\circ$ can be established.

The sub-carrier is again amplified and applied to another phase shift circuit capable of a full 360° of phase shift. This second delay network is uncalibrated since it is used only for establishing a zero reference for subsequent measurements, thus the WA-6A Signal Analyzer is self-calibrating.

The sub-carrier is then amplified for the third time and applied to the suppressor grid of a synchronous demodulator. The color video signal from the circuit being analyzed is applied to the control grid of the demodulator. The uncalibrated phase shifter described above is adjusted until the output of the demodulator is zero for the burst interval as observed on a cathode ray oscilloscope. This establishes the zero reference described above.

If the test signal is a color bar signal, selecting the proper phase combination with the calibrated phase shifter to give a null indication on the oscilloscope for each color component gives a precise direct reading in degrees on the phase shifter panel for each color in the bar signal. Conversely, by pre-setting the calibrated phase shifter to the phase prescribed by FCC color standards for the colors in the bar signal, the I and Q demodulators of the colorplexer can be accurately aligned by adjusting them for a null on the oscilloscope.

The Linearity Checker supplies a step-wave on which is super-imposed the 3.58 mc. sub-carrier. By the above procedure, (i.e., by bringing each successive step in the signal to a null with the calibrated phase shifter) differential phase distortion can be read directly in degrees for the entire dynamic range of the video signal. The WA-7C Linearity Checker has provisions for varying the duty cycle of the step-signal from 10% to 90% so that measurements can be made describing the complete differential phase response of the amplifiers or systems under test.

In order to provide a complete signal analysis, there are five output signals available for display on the oscilloscope as selected by a 5-position switch on the control panel. These signals are:

1. Video Signal passed directly through the analyzer without any intervening circuitry.
2. Video Signal through a low-pass filter which removes all sub-carrier components. The response of the circuit is flat to 1 mc.; down 50% at 2 mc.; and essentially zero at 3.58 mc.
3. Video Signal through a hi-pass filter which removes all low-frequency components of the video signal.

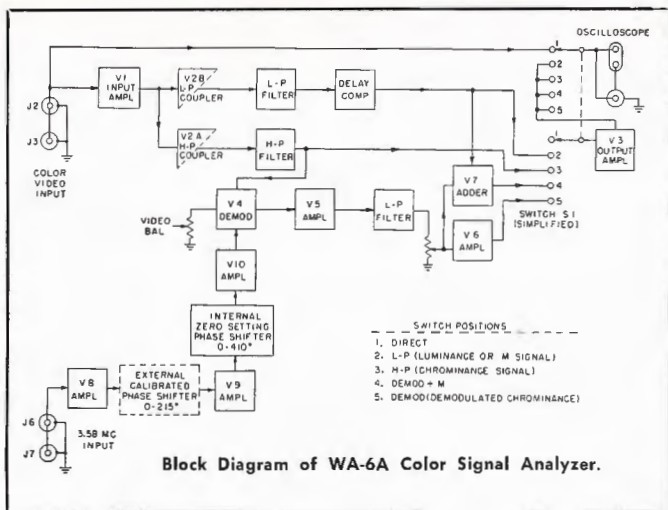

- The response observed on this position is flat from 2.8 to 4.5 mc. and is essentially zero at 1.9 mc.
4. The Demodulated Color Signal added to the signal passed by the low-pass filter.
 5. The output of the Synchronous Demodulator which is the chrominance or color signal. This position of the switch is the one from which the phase measurements are made.

SPECIFICATIONS

Electrical Specifications

| | |
|---|---|
| Plate Power Requirements..... | 280 volts, 110 milliamperes |
| Filament Power Requirements..... | 6.3 volts a-c, 3.25 amperes |
| Input Signals: | |
| Composite Color Bar Video..... | 1 volt p/p (white) |
| Color Subcarrier 3.579545 mc..... | 1-3 volts p/p |
| Output Signals for Composite Input of 1 volt p/p: | |
| Direct..... | 1 volt p/p (white) |
| L-P Luminance (M)..... | Approx. equal to this component of input |
| H-P Chrominance..... | Approx. equal to this component of input |
| Demodulator + M..... | 2 volts p/p approx. |
| Demodulator..... | 4 volts p/p approx. |
| Phase Shift Impedance..... | 73 ohms |
| Power Requirements..... | 105-125 volts, 50/60 cycles, single phase |
| Power Input..... | 140 watts |

Tube Complement

| | |
|---------|-------------|
| 1-5Y4-G | 1-6SJ7 |
| 2-6Y6-G | 1-OA3/VR-75 |
| 1-12AT7 | 1-12AU7 |
| 1-6CL6 | 4-6AU6 |
| 1-6AS6 | 2-6BQ7A |

Overall Mechanical Specifications

| | |
|-----------------|---|
| Dimensions..... | 19 1/2" high, 21 3/4" wide, 15 1/2" deep, overall |
| Weight..... | 80 lbs. |
| Finish: | |
| Cabinet..... | Umber gray wrinkle |
| Panels..... | Umber gray plain |

Equipment Supplied

| | |
|---|------------|
| WA-6A Color Signal Analyzer..... | ES-40950 |
| Including: | |
| 1 Color Signal Analyzer, including phase shifter unit, power supply, control panel, coaxial and power cables, mounting hardware, tubes in place and Instruction Book MI-34016-A | |
| 1 Cabinet..... | MI-26720-9 |

LINEARITY CHECKER

TYPE WA-7C



FEATURES

- Generates synthetic television signal with horizontal sync and blanking
- Duty cycle of test signal variable over range of 10% to 90%
- Permits high sensitivity measurements of differential gain
- Provision for optional external triggering
- External video sweep input for amplitude vs. frequency measurements
- Can be used with Color Signal Analyzer to make differential phase measurements
- Provision for external R-F input (10 kc to 9 mc)
- Optional internally generated R-F output (3.579545 mc or 1 mc)
- Gated sweep output passes through conventional clamp circuits

USES

The RCA WA-7C Linearity Checker provides a test signal which facilitates rapid measurements of differential gain and differential phase distortion in video amplifiers and transmission systems. This instrument is especially useful for testing equipment intended to handle compatible color television signals to assure that color signals can be handled without distortion. Differential gain measurements can be made with the Linearity Checker alone, and differential phase measurements can be made by employing a Color Signal Analyzer (RCA MI-34016-A) to serve as a phase detector to analyze the Linearity Checker signal at the output of the device under test.

In addition, connections are provided for introducing a video sweep signal into the linearity checker in such a manner that the sync and blanking signals are added to the sweep signal. Such a signal is very useful in making amplitude vs. frequency measurements since any clamp circuit through which the signal passes need not be disabled.

DESCRIPTION

The linearity checker is actually a signal generator providing a simulated color video signal. In use, this signal is fed through the device under test and a filter unit supplied with the checker to an external oscilloscope. The filter has a three position switch that makes it possible to connect it as a high pass or low pass filter, or to by-pass the filter entirely.

The output signal of the Linearity Checker consists of four components, (1) sync occurring at a nominal 15,750 cycle repetition rate, (2) an adjustable blanking signal occurring for 4 out of 5 lines, (3) the stair-step signal consisting of ten steps of equal height between black and white level, occurring one line in five, (4) an r-f sine wave at 3.58 mc color subcarrier frequency or 1 mc (10 kc to 9 mc also available from external input) superimposed on the stair-step signal. Adjusting the blanking from 0 to 100% enables the operator to vary the duty cycle of the picture portion of the composite signal from approximately 10% to 90%.

If the circuit under test is linear between black level and white level, the amplitude of the r-f envelope as seen on the oscilloscope will be the same on each step. If the circuit is non-linear, the r-f amplitude will vary. To permit accurate comparison between the r-f heights, the step signal can be filtered out by placing the filter switch in the Hi position. All the sections of the sine wave will then be on the same horizontal axis. To observe very bad non-linearities, the r-f signal can be filtered out by placing the filter switch in the Low position. Non-linearity will then show up as variations in step height.

To measure phase intermodulation, an MI-34016-A Color Signal Analyzer is required in addition to the linearity checker. This instrument makes it possible to observe the phase difference between two r-f signals of the same frequency.

To produce the composite output signal, the WA-7C Linearity Checker contains circuits that generate the r-f, blanking, sync, and step signals separately, and gating circuits that remove the adjustable blanking signal and replace it with the combined step and r-f signals every fifth line. Provision is also made for using the step and r-f signal on every line if so desired. The WA-7C may also be used to gate and add blanking and sync to an r-f oscilloscope sweep signal for frequency response tests in circuits containing clamps.

The Linearity Checker has a self-contained regulated power supply and is designed for either table top or rack mounting. It is normally furnished in a table model cabinet. For rack mounting the panel space required is 8¾ by 19 inches, and standard relay-rack mounting slots are provided in the panel. Both housings are finished in standard umber gray. Controls are located on the front panel and the input and output connectors are on the rear of the equipment. Each equipment is provided with a cross filter, MI-34021, which is necessary for making differential gain measurements, without a color signal analyzer.

The crossover filter supplied with the linearity checker permits filtering out either the step or r-f signals as explained before. The filter is contained in a small rectangular box with a coaxial jack on one end and a coaxial plug on the other end. A three-position lever switch on the top of the box permits bypassing the filter completely or connecting it as a high- or low-pass filter. It is effective only at an r-f frequency of 3.58 mc.

SPECIFICATIONS

Performance Specifications

- Input Signals:
 - Horizontal Drive (optional).....4 volts peak-to-peak negative (Internal Drive—nominal 15.75 kc may be used if desired)
 - R-F Signal (optional).....100 kc to 5 mc (2 volt max.)
 - Video Sweep Signal (optional).....1.0 volt max.
- Output Signals:
 - Composite Signal.....Sync Blanking, Step Signal (1 line in 5), White Signal (9 lines in 10) R-F superimposed on Blanking and Step Signal. Adjustable levels 0 to 1 volt except Sync Level 0 to 0.5 volt. It can also be adjusted to have sync and step only every line.
 - R-F Output2 volts
 - Sync Output for Oscilloscope.....15 volts
- Power Requirement.....117 volts, 60 cycle, 210 watts

Tube Complement

| | |
|---------|---------|
| 2—6AU6 | 2—6AL5 |
| 2—6AS6 | 1—6AS7 |
| 3—5687 | 1—6SJ7 |
| 8—12AT7 | 1—5R4GY |
| 2—12AU7 | 1—OC3 |
| 1—6CL6 | 1—6BA6 |
| 1—6AH6 | 1—6AQ5 |

- Dimensions (Unit only for cabinet or rack mounting):
 - Height8¾"
 - Width19"
 - Depth14"
 - Weight40 lbs.
 - FinishUmber gray

Equipment Supplied

- WA-7C Linearity Checker.....MI-34017-B
- Linearity Checker Chassis, including all tubes in place, one Cross-over Filter, Termination and Coaxial Plugs, five RG-59/U Adaptors, and Instruction Book

COLOR STRIPE GENERATOR

TYPE WA-8A

FEATURES

- Provides inexpensive means of broadcasting test color signal to determine if home receivers are picking up color picture
- Broadcasts color test signal along with regular Monochrome signal
- Crystal controlled oscillator maintains extreme frequency stability
- Accessible front-panel controls
- Self-contained power supply
- Separate controls to adjust color burst width, amplitude, and position with respect to sync

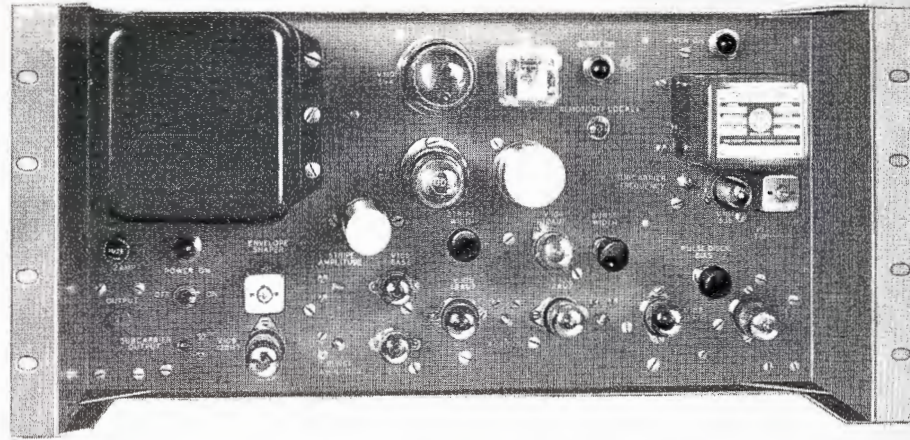

USES

The RCA WA-8A Color Stripe Generator is an inexpensive color signal generating device providing an unobtrusive color test stripe on home receivers. It makes it possible to determine that a particular color receiver installation will be able to reproduce color programs from a specific TV station when no actual color program is being broadcast. Under certain conditions of multipath reception or improper orientation of the receiver antenna it is quite possible to pick up a satisfactory monochrome picture but to have the color subcarrier almost completely cancelled. The WA-8A prevents such faulty home receiver installations.

The Color Stripe Generator is designed to be loosely coupled to the video line feeding the television transmitter in such a way that the normal system operation is not changed in any way. Any TV station which is equipped to transmit network color can use it to add a narrow color stripe to its regular black and white television signal. This stripe is practically unnoticeable on ordinary black and white receivers, but produces a greenish-yellow color at the right hand edge of the color receivers when the horizontal oscillator controls are adjusted slightly off horizontal frequency.

DESCRIPTION

The WA-8A Color Stripe Generator is a completely self-contained instrument designed to be loosely coupled to the video line feeding the television transmitter. The normal signal at this point in the system is the composite (video and sync) monochrome signal. The inserted color stripe generator does not change this basic signal at all but simply adds to it a small amount of color information. This information consists of two "bursts" of subcarrier frequency (3.58 mc). The first "burst" is positioned immediately following horizontal blanking (or $9.2 \begin{matrix} +0.6 \\ -0 \end{matrix}$

microseconds following the leading edge of horizontal sync). This is the information used to "lock-in" the color receiver to the proper phase as does the standard color synchronizing burst in a standard color television signal. The second "burst" is positioned such that its leading edge is 3 microseconds preceding the leading edge of horizontal picture blanking. This "burst" will produce a greenish yellow stripe on the right hand edge of the kinescope on a properly adjusted color receiver. Since they are not generated with any luminance component, they ride up or position themselves on the average of the luminance value present in the monochrome signal at that particular time.

Circuit Description

The circuitry of the WA-8A Stripe Generator is indicated in the block diagram. The first block indicates the sync separator and pulse discriminator. Its purpose is to "strip" the sync from the composite monochrome signal. An additional function has been added, however. No bursts or stripes should appear for 9 lines during the vertical blanking interval, so a "burst eliminate" circuit has been added to prevent the separation of pulses during the vertical sync and equalizing pulse intervals. The output of this stage, therefore, is a series of pulses at horizontal rate with a 9-line gap during the vertical interval. This information is differentiated and applied to the burst position multivibrator which in turn drives the burst width multivibrator. Its output is the positive pulse necessary to trigger the burst gating amplifier. A second output drives the stripe position multivibrator which in turn drives the stripe width multivibrator. Its output is also a positive pulse necessary to trigger the stripe gating amplifier. The subcarrier signal at 3.579545 mc, necessary for the gating amplifiers, is produced by a stable oven-controlled crystal oscillator. Its output is supplied to the gating amplifiers. The outputs of the gating amplifiers are fed to the mixer and output stage. Its output is in turn fed back to the video line. The video line is never broken. If failure of the stripe generator should occur the monochrome signal would not be affected. Coupling of the output signal to the video line is so loose that the monochrome signal is essentially unaffected but the color bursts or envelopes are added or superimposed on it.

The WA-8A color stripe generator is built on an 8¾-inch high bathtub chassis designed for standard rack mounting. It employs 11 tubes, 2 of which are used in the self-contained power supply. The only unusual component involved is the thermostatically controlled oven for the oscillator crystal. Two video jacks are provided on the rear of the

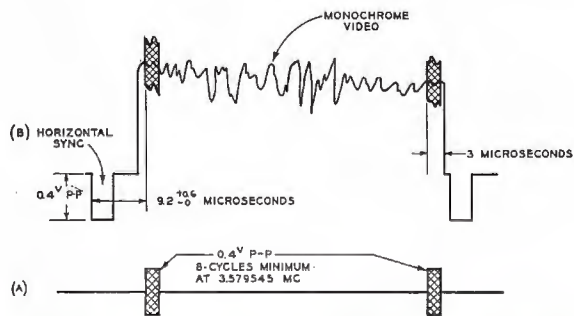
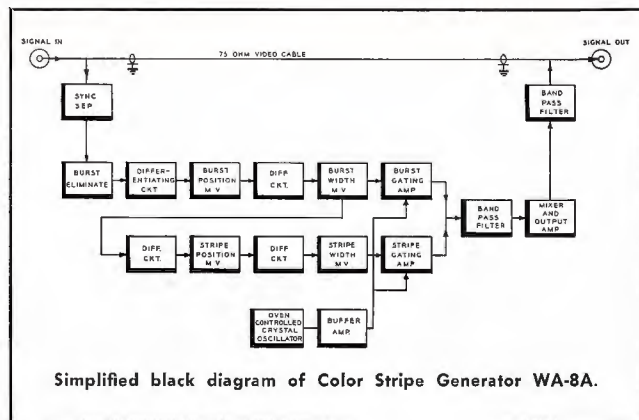

Diagram of signal produced by the Color Burst Generator. Line (a) represents color bursts of sub-carrier frequency, and line (b) is composite signal from stripe generator.



Simplified block diagram of Color Stripe Generator WA-8A.

chassis for video input and output. The only power connection required is to a standard 117 volt, 60 cycle a-c line through a six-pin Jones plug. Two pins of this same plug are used for connection to a remote switch for adding or removing the color bursts from the monochrome signal at some location remote to the actual stripe generator. The unit weighs approximately 20 pounds and is finished in standard umber gray comparable to other RCA equipments.

SPECIFICATIONS

Performance Specifications

| | |
|------------------------------|---|
| Signal Input Frequency..... | Composite monochrome video |
| Signal Input..... | 1.4 volts, peak-to-peak; 0.4 volt peak-to-peak sync |
| Input Impedance..... | 75 ohms |
| Signal Output Frequency..... | Composite monochrome video with added color sync burst and stripe |
| Signal Output Voltage..... | 1.4 volts, peak-to-peak; 0.4 volt, peak-to-peak sync 0.4 volt, peak-to-peak color synchronizing burst 0.4 volt, peak-to-peak color stripe |
| Output Impedance..... | 75 ohms |
| Power Line Requirements..... | 105-125 volts, 50/60 cycles, single phase |
| Power Input..... | 125 watts at 0.9 PF |
| Operating Conditions: | |
| Ambient Temperature..... | 5° C to 45° C |
| Humidity..... | 0 to 95% relative |

Tube Complement

| | |
|---------|---------|
| 1-12AT7 | 1-12BH7 |
| 4-12AU7 | 1-5V4 |
| 2-6AS6 | 1-OD3 |
| 1-6J6 | |

| | |
|-----------------|------------------------------|
| Dimensions..... | 19" wide, 8¾" high, 7¾" deep |
| Weight..... | 20 lbs. |
| Finish..... | Light umber gray |

Equipment Supplied

| | |
|---|----------|
| WA-8A Color Stripe Generator..... | MI-40214 |
| Complete with tubes in place, 2 type PL-259 connectors, 1 Cinch-Jones connector, and Instruction Book | |

CALIBRATION PULSE GENERATOR

TYPE WA-9A



FEATURES

- Precise calibration of studio video signal voltages
- Low output impedance
- Signal readily passes through clamp circuits
- Self-contained power supply
- Provides calibration pulse for processing amplifier in color camera chains
- Choice of 0.7 or 1 volt output
- Output voltage stabilized by feedback

USES

The RCA Type WA-9A Calibration Pulse Generator is designed for the precise calibration of studio video signal voltages. The output signal can be used for accurately calibrating all waveform monitors so that video signal amplitudes can be established against a known reference level. The 0.7 volt output is for calibrating non-composite video signal and the 1.0 volt output is for composite signals.

In color camera chains such as the 3-vidicon film equipment and the TK-41 and TK-45 Live Color Camera chains, the calibrated voltage output is used for set-up of the processing amplifier.

By making the fixed voltage output available at jack panels and in switching systems the entire distribution system may be aligned for the proper video signal levels.

DESCRIPTION

The WA-9A Calibration Pulse Generator provides a square pulse at horizontal frequency the amplitude of which is stabilized at 1.0 volt or 0.7 volt level. Its output impedance is approximately 0.6 ohms, sufficiently low so that several outputs can be provided at the same time without appreciable change of output level. In addition, the square wave is timed so that this positive half-cycle is centered in the period between horizontal sync pulses, thus the signal will readily pass through any clamp circuits in the system without the need for disabling them. Horizontal drive from the sync generator is amplified and used to trigger a stabilized cathode-coupled multivibrator for the delay needed to place the calibrated pulse between the horizontal sync pulses. The delayed pulse triggers a square-wave multivibrator which produces the output pulse. The output of this multivibrator is clipped by a current-regulating circuit whose output level is controlled by a 5651 voltage-reference tube. This accurately-controlled pulse drives a low-impedance output feed-back amplifier having precisely unity gain.

The circuits of the WA-9A are extremely stable. As the line voltage of the WA-9A is changed from 110 volts to 125 volts, the output level will not change more than 1%. Rapid changes of line voltage of 5 volts will not cause noticeable bouncing of the output signal. Output voltage level change in going from no termination to one 75-ohm termination, or from one to two 75-ohm terminations is never more than 0.5%. The square wave has a pulse width of 31.75 μ sec. with positive polarity. Rise time is less than 1.0 microsecond. The tilt is less than 1%.

The unit is mounted on a standard 5¼" bathtub chassis suitable for standard rack mounting. All connections are on the rear of the chassis. Controls are provided on the front of the chassis for the following functions: pulse position, pulse width, voltage calibration, 0.7/1.0 volt selector switch, on-off switch. The output level is controlled by a potentiometer in the form of a locking-type screwdriver control on the front panel.

SPECIFICATIONS

Performance Specifications

- Input Requirements:
- Power Source.....105 to 125 volts, 60 cycles, 50 watts
 - Horizontal Drive Pulse.....3.5 to 5.0 volts, negative polarity, bridging input
- Output Requirements:
- Output Impedance.....Approx. 0.6 ohms
 - Output Voltage Level.....Less than 0.5% change in going from no termination to one 75-ohm termination, or from one to two 75-ohm terminations.
 - Output Voltage.....Square wave, adjustable to 0.7 volt and 1.0 volt, P/P; leading edge adjustable for nominal 21.5 μ sec. from leading edge of horizontal drive pulse; width nominally 31.75 μ sec.

Tube Complement

- 3—12AT7
- 1—6AL5
- 1—5651
- 1—6U8
- 1—6CL6
- 1—5R4GY

- Dimensions.....19" wide, 5¼" high, 9" deep
- Weight14 lbs.
- FinishUmber gray

Equipment Supplied

- WA-9A Calibration Pulse Generator complete, including tubes in place and instruction book.....MI-26070

Block Diagram of the WA-9A Calibration Pulse Generator.

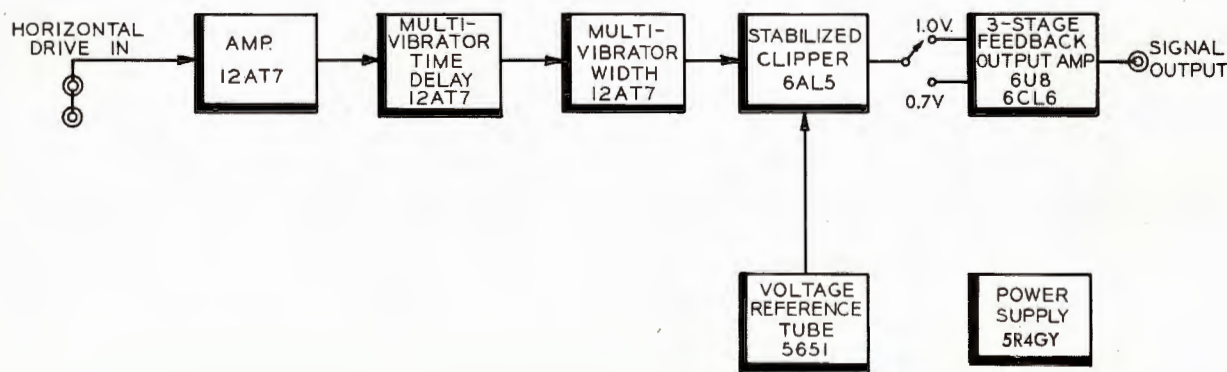

TELEVISION OSCILLOSCOPE

TYPE TO-1

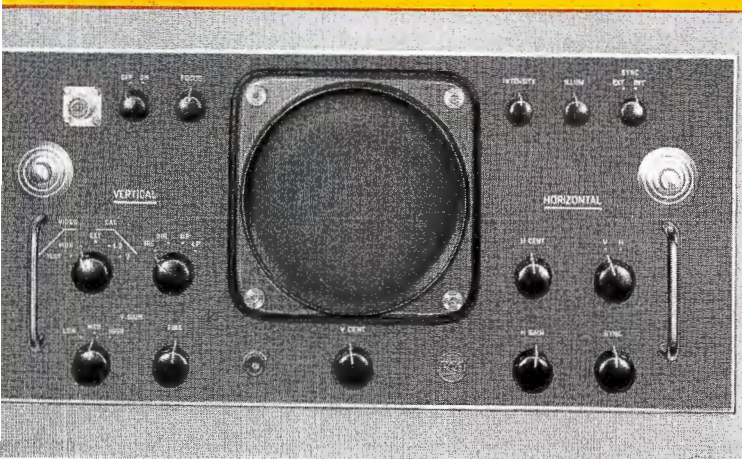

FEATURES

- Only 8 $\frac{3}{4}$ " rack or console space for a full 5" television monitor
- Slide mounting for rapid maintenance
- Open chassis construction does not block air circulation in rack or console
- Minimum number of operating controls logically grouped and located
- CRT in center of front panel
- A color standard—flat frequency response within 0.5 db from 60 c to 5 mc; approximately 3 db down at 10 mc
- Vertical gain distortion less than 2% with 7 cm deflection
- Vertical amplifier stabilized by 24 db feedback

USES

The RCA TO-1 Oscilloscope is a high quality, wide band instrument designed to continuously monitor both monochrome and color signals at (1) studio camera control position, (2) in the terminal equipment racks, (3) at patch panels, and (4) in the master control room. A high input impedance jack conveniently located on the front panel converts the waveform monitor into a television oscilloscope in the above locations and in the maintenance shop. Facilities have also been provided for use of the oscilloscope in color installations to automatically produce three line or frame displays of red, green, and blue camera outputs.

DESCRIPTION

The Type TO-1 Oscilloscope is compactly housed on a drawer-type chassis. The traditional horizontal chassis in the oscilloscope has been replaced by two vertically mounted chassis which do not block air circulation in rack or console mountings and eliminates the requirement for forced air cooling.

The vertical height of the oscilloscope is 8 $\frac{3}{4}$ inches, and the unit fits into a cabinet rack or the RCA 22-inch Console Housing, MI-26787. The cathode-ray tube is located in the center of the front panel allowing equally convenient viewing from either left or right side. Operating controls are kept to a minimum and arranged in "vertical function" and "horizontal function" groupings. Tests have shown this layout to be most convenient from an operating standpoint. Logical positioning of the centering controls has dictated placement of the vertical centering control below and the horizontal centering control to the right of the CRT.

A heavy gauge front panel and sturdy viewing-hood are features of the oscilloscope which enable mounting of a recording camera on the panel. Two catches located on the front panel provide a secure positioning of the oscilloscope in the rack or console and at the same time are positioned and designed to permit rapid removal of the unit from its closed position.

The basic mounting of the TO-1 is on a slide assembly (MI-26891). This is recommended for both rack and console mounting. The oscilloscope, mounted on slides, and the Color Camera Processing Amplifier make an excellent combination in a color installation. The slides are constructed of heavy gauge aluminum, which lock in the extended position allowing convenient access to tubes, components, and wiring. Requirement for release of the locking mechanism on both slides provides a safety factor against accidental release. An additional safety feature is inherent in the "negator" spring on the far end of the slides which act against the weight of the chassis.

A case which provides forced air-cooling can be used to house the TO-1 when a bench or dolly set-up is preferred to rack or console mounting of the oscilloscope. This case is an accessory equipment which may be ordered separately as MI-26890 in place of the set of slides (MI-26891). The oscilloscope case is rack mountable, but it is not recommended in any application where air circulation must be maintained in the racks for cooling purposes.



Type TO-1 Oscilloscope mounted with Color Camera Processing Amplifier in standard 22-inch console housing. The oscilloscope is compactly housed on a drawer-type chassis which glides in or out on heavy gauge aluminum slides which lock in the extended position.

This oscilloscope features advanced circuitry which produces an ultra-stable CRT calibration. Well regulated power supplies combined with 24 db feedback in the vertical amplifier result in the stable calibration which permits the operator to "set and forget." A minimum number of tubes is used which contributes to oscilloscope reliability.

Selection of the following inputs is accomplished by the left-hand vertical selector switch: *Video Test*—high impedance jack on front panel; *Video Mon*—bridging input jacks on rear of chassis; *Cal Ext*—bridging input jacks on rear of chassis available for calibration of oscilloscope vertical circuitry by a "station-wide" calibration signal or for use as a second video monitor position; *Cal 1.0*—1.0 volt peak to peak internal signal automatically inserted into vertical input; *Cal 0.7*—0.7 volt peak to peak internal signal automatically inserted into vertical input. The vertical response selector switch adjusts the frequency response of the vertical amplifier to one of the following: *IRE* roll off; *DI*Rect or flat from 60 cps to 5 mc; high pass filter with slope approaching 12 db per octave below 1.0 mc; and low pass filter with slope approaching 12 db per octave above 1.0 mc.

The horizontal sweep circuit can be triggered from an internal or external source selectable by only one control on the front panel. The operating convenience and the simplicity of the sweep selectors cannot be overempha-

sized. The sweep rate is controlled by only one control on the front panel and is either at television horizontal or vertical rates. Speed of line, one-half line or frame can be selected to display two lines or fields or three lines or fields when used with Color Camera Processing Amplifier (MI-40520 Series). This latter display enables simultaneous viewing of red, blue and green camera outputs. The horizontal gain control is adjustable from a condition of normal viewing of two lines or fields to viewing of the eight cycles of color burst (easily counted) on horizontal rate, or equalizing pulses (easily counted) on vertical rate. The horizontal centering may be used as a line selector in the vertical sweep speed position.

SPECIFICATIONS

Power Requirements.....105-128 volts, 50/60 cycles, 295 watts

Input Impedance:

Monitor Video Input.....Bridging

Test Video Input.....High impedance

Sync InputBridging

Calibrate InputBridging

Vertical Sensitivity.....20 millivolts per centimeter max.

Differential Gain (on face of CRT).....Less than 3% at 1 volt DP and 5% APL input for 7 cms of deflection

Sweep Range.....Adjustable to produce horizontal, vertical, 1/2 horizontal, 1/2 vertical time base rate. Provisions for automatically producing sequential display of red, green, and blue camera outputs when used with the RCA MI-40520-A Processing Amplifier.

Frequency Response.....Flat within 0.5 db 60 cps to 5 mc, down approximately 3 db at 10 mc

Synchronization.....Internal, with provision for external synchronization selectable from the front panel

Tube Complement

Monitor:

| | | | |
|--------------|--------|--------|---------|
| 1—5AQP/1 CRT | 3—6AW8 | 2—6CL6 | 5—6BQ7A |
| 1—6AL5 | 2—OA2 | 1—6U8 | 2—6AN8 |

Power Supply:

| | | | |
|---------|--------|------------|---------|
| 1—5U4GB | 1—6AN8 | 1—6AS7 | 1—12AX7 |
| 1—5651 | 1—2X2A | 1—VXR-2500 | 1—6X4 |
| 1—OA2 | | | |

Mechanical Specifications

Dimensions (overall):

Height8 23/32"

Width19"

Depth17 1/4"

Weight.....35 lbs., less slides

Finish.....Dark umber gray

Equipment Supplied

TO-1 Television Oscilloscope Complete.....ES-40903

Consists of the following units:

1 Oscilloscope complete with tubes in place and instruction book.....MI-26800-A

1 Set of slides for rack or console mounting.....MI-26891

Accessory Equipment

22-inch Console Housing.....MI-26787

Left Panel Assembly and Side Cover.....MI-26788-1

Right Panel Assembly and Side Cover.....MI-26788-2

Upper Left Side Cover Only.....MI-26789-1

Upper Right Side Cover Only.....MI-26789-2

Oscilloscope CaseMI-26890

TELEVISION OSCILLOSCOPE

TYPE TO-524AD

FEATURES

- Sync separator and adjustable sweep delay permitting any portion of a composite signal to be viewed at any of the sweep speeds
- Field selector switch permitting sweep delay circuit to lock on either field of a frame
- New sweep magnifier, 3x and 10x, with expanded portion remaining centered on the screen
- 60 cycle sine wave sweep with phasing control
- Time mark generator providing up to 200 pips per TV line
- Variable duty cycle square wave amplitude calibrator
- Flat faced cathode ray tube
- 4 kv accelerating potential
- High vertical sensitivity
- Vertical amplifier flat to 5 mc; down 3 db at 10 mc

USES

The Tektronix Type TO-524AD is a portable, self-contained cathode-ray oscilloscope specifically designed for maintenance and adjustment of television transmitter and studio equipment.

With this oscilloscope, any portion of the television picture may be observed—from complete frames to small portions of individual lines. Any one of the 525 lines in the picture can be located and observed in minute detail. Accurate time markers greatly facilitate sync pulse timing. The wide-band vertical amplifier is provided with networks that can be switched in to provide a flat response of 60 cycles to 5 mc and to limit the high frequency response to that recommended by the IRE.

DESCRIPTION

With a 10-megacycle bandwidth and excellent transient response, the Type TO-524AD easily accomplishes accurate presentation of all video waveforms encountered in television broadcast installations. A triggered linear sweep

system, with adjustable delay and suitable sweep magnification, permits any portion of the television composite signal to be observed, and to be magnified, if desired, for closer scrutiny.

The 10-megacycle vertical amplifier with a maximum sensitivity of 0.15 v/cm direct coupled and 0.015 v/cm capacitively coupled provides an accurate presentation of the video signal. For applications requiring a vertical-amplifier response flat within 1% from 60 cycles to 5 mc, a switch on the access panel of the TO-524AD inserts special peaking coils in series with the vertical deflection plates of the cathode ray tube to provide this response in the main amplifier. The same access-panel switch can be used to limit the vertical-amplifier response to that recommended by the IRE for the television level measurements.

The oscilloscope is equipped with two UHF input connectors. Selection of either input is made by the vertical-input selector. This feature offers a convenient method of making a rapid comparison of two separate signals. The



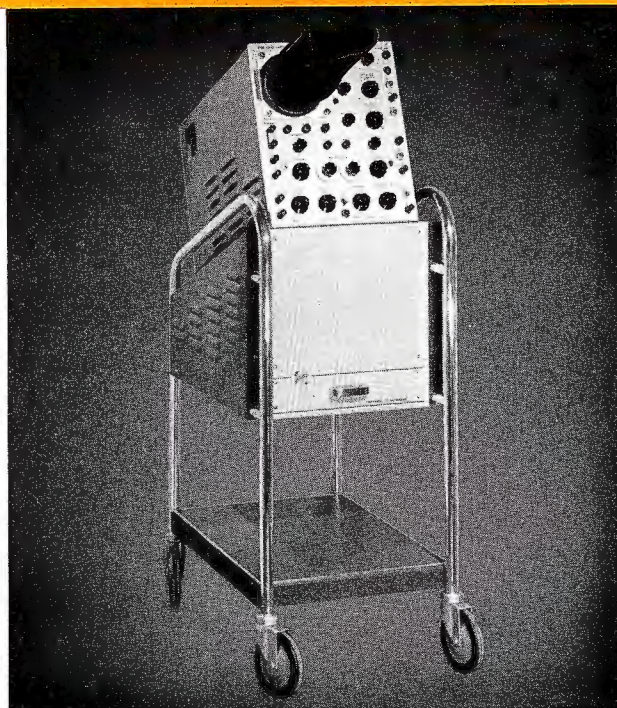

The Type TO-500 "Scope-Mobile" provides portable mounting for the oscilloscope.

constant input impedance of the instrument permits the use of r-c input probes. A high impedance probe on a 42-inch cable is supplied with the instrument. The probe is frequency compensated and has an attenuation of ten times.

A variable-duty-cycle square-wave calibration voltage is provided. It is continuously variable from 0 to 50 volts in seven ranges. The duty cycle of the calibrator can be matched with the duty cycle of the observed signal, thus minimizing error in amplitude calibration of an a-c coupled signal due to change in amplifier bias with the duty cycle of the signal.

The Type 524AD has a continuously variable, linear, triggered time base covering the range of 0.01 sec/cm to 0.1 μ sec/cm. A seven-position sweep-time selector switch provides five sweep-time positions, an internal 60-cycle sine-wave sweep, and an external sweep position. Dual sweep-time multiplier dials cover the range between steps.

By delaying the start of the sweep until the picture has progressed to the desired portion and then triggering the sweep with one of the line sync pulses, any individual portion of the picture may be observed. The sweep delay introduced in the TO-524AD is adjustable with a 3-turn potentiometer through about one and one-half fields, and operates at the frame rate of 30 cps so that only one interlaced line is observed at any time. A field-shift button permits switching to the corresponding inter-laced lines in the outer field.

The oscilloscope can provide either 3 or 10 times magnification of any detail positioned to the center of the screen. With the magnifier on, the operator may explore the entire trace by slowly turning the 3 turn horizontal-position control. The position of any detail with respect to the entire sweep may be determined by turning off the magnifier and observing which part of the trace is centered on the screen.

Time markers are inserted as intensification pips on the cathode ray tube trace at varying intervals. These markers provide a means of accurately timing the sync pulses of a composite signal. Pips spaced at 40 or 200 per television line are useful for adjusting both color and monochrome equipment. A phasing control permits markers to be positioned on any desired point of the waveform under observation.

SPECIFICATIONS

Performance Specifications

- Sweep Circuit.....Hard tube type, triggered or recurrent operation as desired.
- Sweeps.....Continuously variable, 0.01 sec/cm to 0.1 μ sec/cm. Calibration accuracy 5%.
- Trigger Requirements.....0.5 to 50 v. (peak). Pulses as short as 0.05 μ sec. Signal under observation producing 0.5 cm deflection or more. Composite television signal—1 v. peak to peak external or 0.05 v. to vert. amp.
- Sweep Magnification.....Magnifier expands the sweep to left and right of center. Either 3 times or 10 times magnification is available.
- External Sweep Input.....Coupled via 100k potentiometer, sweep magnifier, and direct coupled sweep amplifier. Maximum deflection sensitivity, 0.25 v/cm d-c or a-c peak to peak.
- Time Markers.....Five markers 0.05 μ sec, 0.1 μ sec, 1.0 μ sec, 40 pips and 200 pips per Television line. Accurate within 2%.
- Vertical Amplifier.....5 stage. 3rd, 4th, and 5th stage direct coupled push-pull. Distributed output (5th) stage.
- A-c Vertical Deflection Sensitivity.....Continuously variable from 0.015 v/cm to 50 v/cm, peak to peak.
- D-c Vertical Deflection Sensitivity.....Continuously variable from 0.15 v/cm to 50 v/cm, peak to peak.
- Input Impedance.....1 megohm shunted by 40 μ mf. With probe, 10 megohms shunted by 14 μ mf.
- Vertical Amplifier Response.....D-c to 10 mc (3 db down) sensitivity of 0.15 v/cm; 2 cps to 10 mc (3 db down) sensitivity of 0.015 v/cm.
- Vertical Amplifier Transient Response.....Rise time (10%-90%) 0.04 μ sec.
- Signal Delay Network.....Provides 0.25 μ sec signal delay. Permits observation of the waveform that triggers sweep.
- Calibrating Voltage.....Variable duty cycle square wave. Seven ranges, 0.05 v. to 50 v. full scale, continuously variable, accurate within 3%. Duty cycle variable from 1% to 99%.
- Cathode Ray Tube.....A 5ABP1 cathode-ray tube is furnished with the Type 524-AD. An accelerating potential of 4 kv is used (+2.5 and -1.5 kv).
- Construction.....Completely self-contained, cabinet and chassis made of electrically welded aluminum. Photo etched front panel.
- Dimensions.....13" high, 16" wide, 24 1/2" deep
- Weight61 lbs.
- Power Requirements.....105-125 or 210-250 volts, 50-60 cycles, 500 watts
- FinishDark amber gray

Equipment Supplied

- TO-524-AD OscilloscopeMI-26500-A
(Complete with set of tubes, viewing hood, high impedance probe, and instruction book)

Accessories

- Type TO-500 "Scope-mobile".....MI-26501
- High Impedance Probe.....P-5000-F

5-INCH CATHODE-RAY OSCILLOSCOPE

Type WO-88A



FEATURES

- Frequency response flat within 3 db from 0 to 500 kc, useful to 1.0 mc
- Sweep frequency 15 cps to 30 kc
- 60-cycle sweep with wide angle phasing control
- Frequency-compensated attenuator
- 1-volt peak-to-peak calibrating voltage
- Complete shielding eliminates hum and noise pick-up
- Direct-coupled vertical amplifier
- Lightweight, portable instrument

USES

The WO-88A 5" Oscilloscope is a general purpose instrument for use in broadcasting and television closed circuit applications. This instrument combines the advantages of large screen size, compactness, portability and ease and convenience of operation. The instrument provides large pictures of small-voltage waveforms such as those produced by microphones, tape-recorder heads, phototubes, phono pickups, and single stages in TV sets. High frequency response of the 88A is adequate for monitor and receiver servicing as well as most audio, radio and industrial applications. Modification Kit WG-388A adapts the instrument for color television testing.

The direct-coupled vertical amplifiers in the WO-88A make possible observation of both a-c and d-c phenomena. Measurements can be made of tube "drift," the effect of excitation on d-c operating parameters of tubes, voltage drop in thyatron circuits, the relationship of a-c and d-c levels in avc or afc circuits, and, with a demodulator probe, the percentage modulation of amplitude modulated r-f carriers.

DESCRIPTION

The WO-88A 5-inch Cathode-Ray Oscilloscope displays with unusual fidelity square waves over the frequency range of low "motor-boating" rates up to 1 mc. Peak-to-peak voltage measuring facilities permit simultaneous voltage measurement and display of waveform.

The instrument features "plus" and "minus" sync for positive lock-in on complex waveshapes such as vertical and horizontal sync pulses. Depending upon the number of video amplifier stages, and whether the kinescope is grid-driven or cathode-driven, the picture detector will be either a "positive-peak" or "negative-peak" rectifier. When sync and composite waveforms must be observed, sync action will be good only when scope polarity is correct. Sync polarity may be reversed instantly by a front-panel switch in order to correct the scope polarity as required for observation of sync and composite waveform.

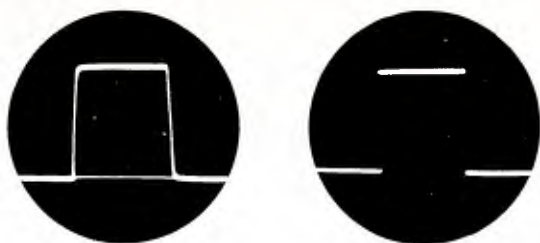

Excellent square-wave reproduction on WO-88A as shown on left by unretouched photo of 50 kc square wave and photo on right of 60 cps square wave.

High input resistance is required for the 'scope. The grid of the vertical oscillator tube is highly sensitive to external loading. Excess loading can cause a shift of the oscillator frequency beyond range of the "hold" control, change the normal waveshape, and cause other detrimental effects. With the sliding switch on the WG-300B probe set to "Locap," the effective input resistance of the WO-88A is raised to 10 megohms and the resistance loading, consequently, is greatly reduced. Low capacitance is also essential as the output circuit of the horizontal sweep oscillator is especially sensitive to capacitive loading. The addition of 75 to 100 $\mu\mu\text{f}$ (average 'scope and cable capacitance) at this point can reduce the voltage by as much as 50%. With the sliding switch on the WG-300B set to "Locap," the loading capacitance is only 12.5 $\mu\mu\text{f}$. Receiver operation remains essentially unaffected. The instrument has a 5-inch cathode-ray tube with magnetic shield. Complete shielding of cable and input circuit eliminates hum and noise pick-up. A green graph screen provides clear readings. It is marked directly in peak-to-peak volts per inch. The WO-88A comes complete with WG-300B Direct/Low Capacitance Probe and Cable, Ground Cable, slip-on alligator clip, graph screen, clip insulator, and instruction booklet.

SPECIFICATIONS

Electrical Specifications

Frequency Response:

Vertical Amplifier:

| | |
|-----------------------|---------------------------|
| From 0 to 100 kc..... | flat |
| At 500 kc..... | within -3 db |
| At 1 mc..... | within -10 db |
| Rise Time..... | 0.5 microsecond or better |

Horizontal Amplifier: (Reference frequency 1000 cps)

| | |
|----------------|--------------|
| At 10 cps..... | within -1 db |
| At 200 kc..... | within -6 db |

Deflection Sensitivity: Volts per inch

| | | |
|--------------------------------|-------|------|
| Vertical Amplifier: | rms | pp |
| At Input Connector..... | 0.025 | 0.07 |
| With WG-300B set to "Dir"..... | 0.025 | 0.07 |
| With 300B set to "Lo Cap"..... | 0.25 | 0.7 |
| Horizontal Amplifier: | | |
| At Input Terminals..... | 0.6 | 1.7 |

Input Resistance and Capacitance:

Vertical Amplifier:

| | |
|-----------------------------------|--|
| With WG-300B set to "Lo Cap"..... | 10 megohms |
| | shunted by 12.5 $\mu\mu\text{f}$ |
| At input terminals..... | 1 megohm shunted by $\mu\mu\text{f}$ |
| With WG-300B set to "Dir"..... | 1 megohm shunted by 75 $\mu\mu\text{f}$ |
| Horizontal Amplifier: | |
| At Input Terminals..... | 2.2 megohms shunted by 55 $\mu\mu\text{f}$ |

Sweep-Circuit Frequency (four ranges).....15 cps to 30 kc

Power Requirements.....105-125 volts, 50/60 cps, 40 watts

Tube Compliment

| | | |
|-------|---------|--------|
| 1-6X4 | 1-12AU7 | 2-6AU6 |
| 1-1V2 | 2-12AT7 | 1-5UP1 |

Mechanical Specifications

Overall Dimensions:

| | |
|----------------------------|--|
| Height | 13 1/2" |
| Width | 9" |
| Depth | 16 1/2" |
| Weight | 25 lbs. |
| Finish..... | Blue-gray hammeroid case, satin-aluminum panel |
| Stock Identification | WO-88A |

DIRECT/LOW CAPACITANCE PROBE AND CABLE

The RCA Type WG-300B Direct/Low Capacitance Probe and Cable is designed for use with the RCA WO-91A or WO-88A 'Scopes. The cable is 48" long, completely shielded from microphone connector to probe tip to minimize hum and stray field pick-up. A built-in switch provides instant selection of direct or low-capacitance operation. The probe has an input characteristic of 10 megohms resistance, less than 12.5 $\mu\mu\text{f}$ capacitance in the low capacitance position. It comes complete with ground lead and clip. A convenient "slip-on" type high-frequency probe is available for use with the WG-300B Probe to permit visual signal tracing for rapid isolation of trouble in r-f, i-f, and v-f stages. It is the WG-302 RF/IF/VF Signal Tracing Probe.

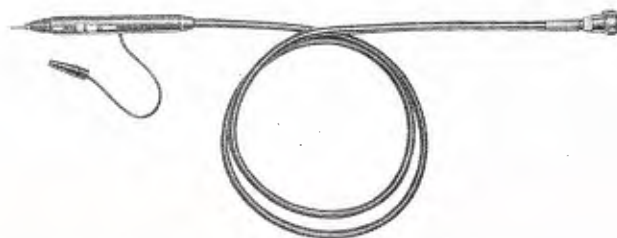

5-INCH CATHODE-RAY OSCILLOSCOPE

TYPE WO-91A

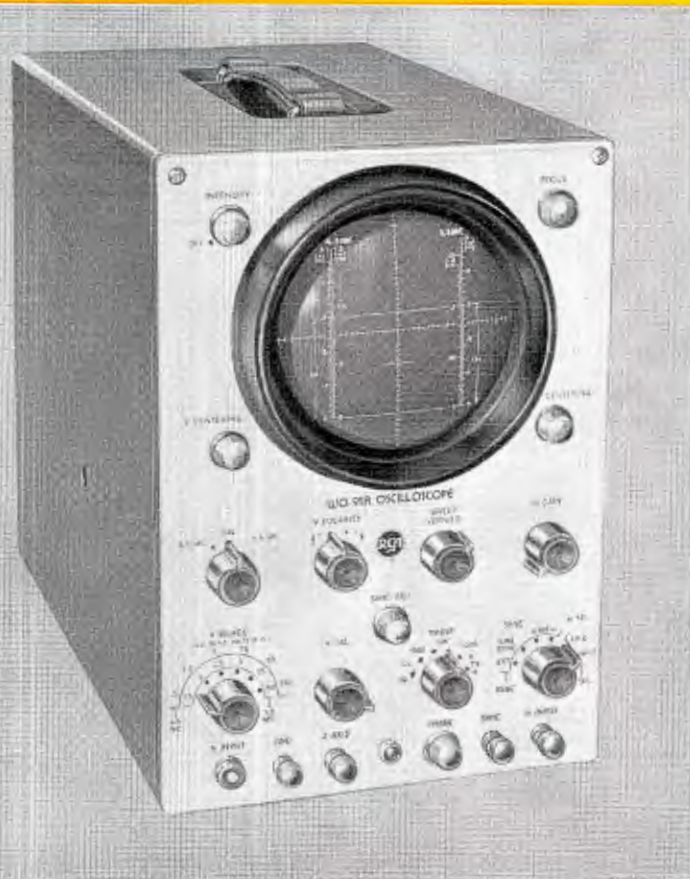

FEATURES

- Preset "V" and "H" sweep positions for speedy, automatic lock-in at vertical and horizontal frequencies
- Voltage-calibrated, frequency-compensated, 3-to-1 step attenuator for vertical amplifier
- Simplified, semi-automatic voltage calibration for simultaneous voltage measurement and waveshape display
- Vertical-polarity reversal switch for "up-right" or "inverted" trace display
- Sturdy, single-unit, low-capacitance direct probe minimizes circuit loading
- Shielded vertical-input connector and shielded cable for minimizing hum and stray-field pick-up
- Positive-lock internal sync
- Z-Axis input facilities permit direct modulation of the cathode-ray-tube grid

USES

The RCA WO-91A 5-inch Cathode-Ray Oscilloscope is a new, low-cost instrument for use in production and servicing of both black-and-white and color television monitors and receivers. The general construction of the WO-91A makes it a readily portable instrument, useful in such applications as studio maintenance and trouble-shooting, general waveform analysis, adjustments of radio receivers and transmitters, square-wave and general testing of audio equipment, peak-to-peak voltage measurements and observation of vacuum-tube characteristics. The new oscilloscope is a versatile and reliable instrument, well-suited to applications which require a dependable 'scope for extended operating periods.

DESCRIPTION

The WO-91A 5-inch Oscilloscope incorporates several circuit and operational features which greatly increase its versatility and help to speed up TV test and service operations. A primary feature is a front-panel bandwidth selector switch which changes the bandpass of the vertical-amplifier section from wide-band to narrow-band (high-sensitivity) operation. A voltage-calibrated, frequency-compensated vertical-input attenuator, an internal calibrating-voltage source, and a graph screen scaled directly in volts make it possible to use the WO-91A as a visual voltmeter. The unique system of calibrating the graph screen provides for scaling voltages directly from the screen. The measurement procedure is similar to that employed with a vacuum-tube voltmeter.

DESCRIPTION (Cont'd)

A feature of special value in television work is the pre-setting of the sweep positions to provide automatic lock-in on vertical- and horizontal-frequency signals. The sweep-frequency control also is continuously adjustable from 10 cps to 100 kc. The sweep oscillator has excellent stability at high sweep rates, a fast retrace, and adequate linearity throughout its frequency range. The overall frequency range of the oscillator is divided into four basic ranges; a vernier adjustment, which overlaps the basic sweep ranges, provides exact adjustment of the sweep frequency. The amount of sync signal fed to the sweep oscillator may be adjusted by means of a front-panel control. Sweep synchronization is exceptionally stable throughout the sweep range of the oscillator.

A Z-Axis input terminal is provided on the front panel of the WO-91A to permit direct modulation of the control grid of the cathode-ray tube. This is useful in special applications requiring trace blanking and time calibration of the sweep trace. A control switch is also provided for reversing the vertical polarity of the trace. By means of this control, the trace may be displayed in an upright or inverted position.

To facilitate its use, the oscilloscope is equipped with a specially designed single-unit probe and input cable. This WG-300B Direct/Low-Capacitance Probe and Cable is provided with a sliding switch in the probe housing which permits its use in circuits which would not function properly if loaded down by a conventional oscilloscope. A WG-302 RF/IF/VF Signal Tracing Probe is a useful accessory for rapid isolation of trouble in r-f, i-f, and video stages.

New Graph Screen with "VTVM"-type scales simplifies voltage measurement. Here's how:

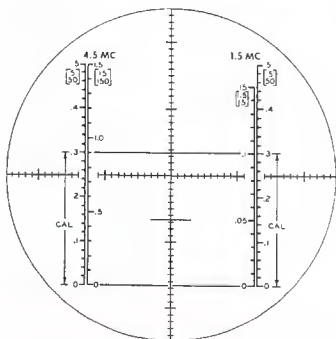

"Zero" base line corresponds to "Zero" on VTVM scales.

Vertical scales are multipurpose; full-scale points correspond to switch settings of "V" range control.

Scales are linear and are subdivided into voltage values.

SPECIFICATIONS

Performance Specifications

Frequency Response (reference frequency 10 kc):

Vertical Amplifier:

- Wide-Band Positions 10 cps to 4.5 mc.....Within ± 1 db
- High-Sensitivity Positions 10 cps to 0.5 mc.....Within -1 db
- High-Sensitivity Positions 10 cps to 1.5 mc.....Within -6 db
- Horizontal Amplifier 10 cps to 500 kc.....Within -6 db

Deflection Sensitivity:

| Vertical Amplifier: | Wide-Band Positions | | High-Sensitivity Positions | | |
|---|---------------------|------|----------------------------|------|---------|
| | rms | p/p | rms | p/p | |
| At V INPUT Connector..... | 0.053 | 0.15 | 0.018 | 0.05 | volt/in |
| With WG-300B set to "DIRECT" | 0.053 | 0.15 | 0.018 | 0.05 | volt/in |
| With WG-300B set to "LOW CAP" | 0.53 | 1.5 | 0.18 | 0.5 | volt/in |
| Horizontal Amplifier at H INPUT terminal..... | 0.15 rms | | | | volt/in |

Average Rise Time (Vertical Amplifier):

- 4.5 MC Positions.....0.1 μ sec
- 1.5 MC Positions.....0.5 μ sec

Maximum A-C Input Voltage (in presence of 600 volts d-c).....

- 600 p/p volts

Input Resistance and Capacitance:

Vertical Amplifier:

- At V INPUT Connector.....1 megohm shunted by 40 μ mf
- With WG-300B set to "DIRECT".....1 megohm shunted by 75 μ mf
- With WG-300B set to "LOW CAP".....10 megohms shunted by 11 μ mf

Horizontal Amplifiers (at H INPUT terminal).....

- 10 megohms shunted by 30 μ mf
- Sync Input Terminal.....0.5 megohm shunted by 35 μ mf

Sweep-Circuit Frequency (variable).....10 to 100,000 cps

Z-Axis Input:

- Minimum Input Voltage for Blanking.....12 rms volts
- Frequency Response.....3 cps to 500 kc

Tube Complement

| | | | |
|--------|---------|----------|--------|
| 1-6AN8 | 1-12AT7 | 1-12AX7 | 1-1V2 |
| 2-6J6 | 1-12AU7 | 1-5Y3-GT | 1-5UP1 |

Power Supply.....105-125 volts, 50/60 cycles

Power Input.....65 watts

Dimensions.....13 1/2" high, 9" wide, 16 1/2" deep Weight.....30 lbs.

Finish.....Blue-gray hammeroid case, brushed-aluminum panel

Equipment Supplied

- 5" Cathode-Ray Oscilloscope.....WO-91A
- Including tubes in place, direct/low-capacitance probe and cable, alligator clip, clip insulator, ground cable, green graph screen, and instruction book.

VIDEO DOT/CROSSHATCH GENERATOR

TYPE WR-46A

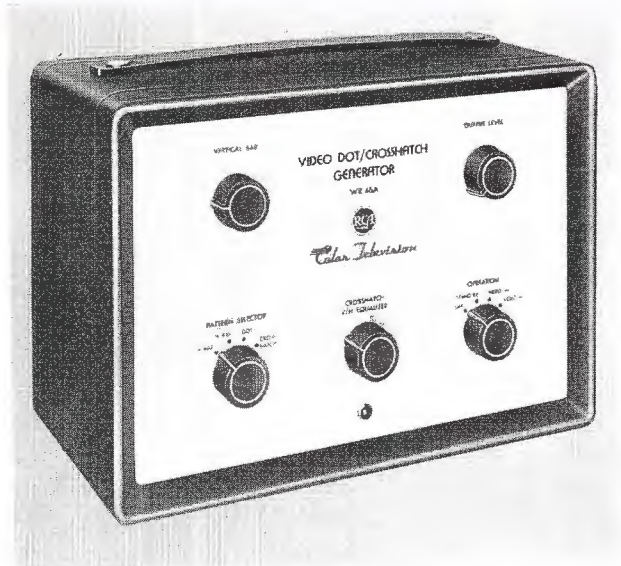

FEATURES

- Sharp, clean, exceptionally stable patterns
- Accurate interlace assured by positive sync-lock
- Output polarity reversal
- "Front panel" compensation for frequency-discrimination effects
- All output leads d-c isolated
- High-level output enables direct connection to picture tube

USES

The RCA Type WR-46A Video Dot and Crosshatch Generator is a compact, portable, dependable, pattern generator which greatly facilitates set-up of d-c and dynamic-convergence adjustments in color monitors and receivers and vertical and horizontal linearity adjustments on both color and black-and-white TV equipment. The instrument generates four different, sharp, clean, exceptionally stable patterns: dots, vertical bars, horizontal bars, or crosshatch. The amplitude of the output is continuously adjustable on all patterns. It is more than sufficient to drive a picture tube directly.

DESCRIPTION

The Video/Dot Crosshatch Generator consists of four basic sections: vertical-bar channel, horizontal-bar channel, output section, and power supply. The vertical and horizontal-bar sections generate, shape, and amplify the signals which produce the output patterns. These are synchronized by a signal taken from the horizontal deflection output circuit of the receiver under test, and they positively lock the generator pattern to the TV-receiver sync pulses.

A sample of the horizontal sync signal is fed to the "V"-bar and "H"-bar channels of the WR-46A where, after frequency multiplication in the "V" channel and frequency division in the "H" channel, the signals are properly formed, shaped, and amplified. Thus the output of the instrument is always "in step with" the monitor or receiver under test and with the TV station or camera chain to which it is tuned.

All output leads are d-c isolated and permit connection to any section of the video amplifier. The output polarity may be reversed at the flip of a switch. Equalizer control for "V" and "H"-bar brightness enables "front-panel" compensation for frequency-discrimination effects. High-level output enables direct connection to the picture tube. This eliminates pattern-distorting effects of r-f bandpass circuits. The instrument is contained in a compact, lightweight case with carrying handle. It is built to withstand hard daily use.

SPECIFICATIONS

Electrical Specifications

| | |
|-------------------------|--|
| Patterns: | |
| Vertical Bars..... | 10 to 25, approx.; continuously adjustable |
| Horizontal Bars | 15 |
| Dots..... | Total number variable 150 to 375 |
| Crosshatch..... | variable in aspect ratio |
| Video Output..... | Continuously adjustable, 0 to 50 volts peak across 4000-ohm load |
| Polarity..... | Positive or negative |
| Power Requirements..... | 117 volts, 60 cps, 95 watts |

Mechanical Specifications

| | |
|----------------------------|---|
| Dimensions (overall): | |
| Height | 10" |
| Width | 13 1/2" |
| Depth | 8" |
| Weight | 17 lbs. |
| Finish..... | Blue-gray hammeroid, satin aluminum panel |
| Stock Identification | WR-46A |



FEATURES

- Provides overall check on operations of color receivers and monitors
- Color phasing is inherently accurate
- Color sub-carrier, picture carrier, sound carrier, horizontal sync and bar frequencies are crystal controlled to insure utmost accuracy and stability
- Pedestal amplitude enables direct comparisons of relative gains of chrominance channels—eliminates complex computations and need for "saturated" color bar signals
- Provides color video signals of either positive or negative polarity for both low and high impedance circuits

USES

The RCA WR-61B Service Color-Bar Generator is a compact, lightweight instrument designed for use in checking the overall operation of color television receivers and monitors, and for adjusting their color phasing and matrixing circuits. It is not to be confused with the RCA Type WA-1E Color-Bar Generator which is used to supply a color test signal for general maintenance and measurements in a color television station.

DESCRIPTION

The WR-61B Color-Bar Generator generates the signals for producing the bar patterns needed in testing receivers or monitors and provides a separate video output of either positive or negative polarity. The instrument permits removal of the sound carrier from the output signal. This provides quick identification of sound interference in the bar pattern. A built-in rectifier circuit, for use with an external VoltOhmyst, facilitates measurement and adjustment of sync and subcarrier amplitudes. Luminance signals are provided to check the "fit" or registration of the luminance and chrominance signals. A new pedestal feature eliminates complex computations by enabling direct comparisons of relative gains of chrominance channels. Circuitwise, the WR-61B feeds a 189-kc signal from the crystal-controlled bar oscillator through the shaper tube to the keyer stage, which keys the 3.56-mc oscillator to produce an output signal composed of 8-cycle blocks. The 189-kc oscillator also controls the repetition rate of the horizontal sync generator. The horizontal sync waveform from the horizontal sync multivibrator is shaped to have a time duration of approximately 5 microseconds. The pulse then is fed into the mixer. The subcarrier blocks and pedestal signals from the cathode of the 6U8 subcarrier keyer stage also are fed into the mixer. The output of the mixer in turn is fed into a modulator, which modulates the picture carrier. The modulated picture carrier and the unmodulated sound carrier are both fed into the r-f output circuit. A metering circuit is provided for use in setting correct sync and subcarrier signal levels. A clamp stage serves to eliminate every twelfth block of the subcarrier signal, and the horizontal-sync pulse occupies the resultant gap.

SPECIFICATIONS

| | |
|---|---|
| R-F Output: | |
| Frequencies..... | 61.25 mc, 65.75 mc (TV Channel 3) |
| Voltage..... | At least 0.01 volt peak-to-peak |
| Composite Picture Signal.... | 61.25-mc picture carrier; 15,750-cps horizontal sync pulses; 3563.795-kc color subcarrier keyed at 189 kc |
| Sound Carrier Frequency..... | 65.75 mc, unmodulated |
| Impedance (at end of r-f output cable)..... | Approx. 300 ohms |
| Video Output Voltage: | |
| HI Terminal..... | 8 volts peak-to-peak across 4700 ohms |
| LO-Connector..... | 0.25 volt peak-to-peak across 75 ohms |
| Number of Color Bars..... | 10 |
| Power Supply..... | 105-125 volts, 60 cycles, single phase |
| Power Input..... | 50 watts |
| Tube Compliment: | |
| | 1-6AS7, 1-6BQ7-A, 1-6X4, 3-6U8, 1-6X8, 2-12AT7 |
| Dimensions..... | 13 1/2" wide, 10" high, 7 1/2" deep |
| Weight..... | 13 lbs. |
| Finish..... | Blue-gray hammeroid case, brushed-aluminum panel |
| WR-61A Service Color-Bar Generator..... | RCA WR-61B |
| | Complete with tubes, 4 control crystals, 1 r-f output cable, 1 TV input adapter, 1 video output cable, registration card, and instruction book. |

TV/FM SWEEP GENERATOR

Type WR-69A

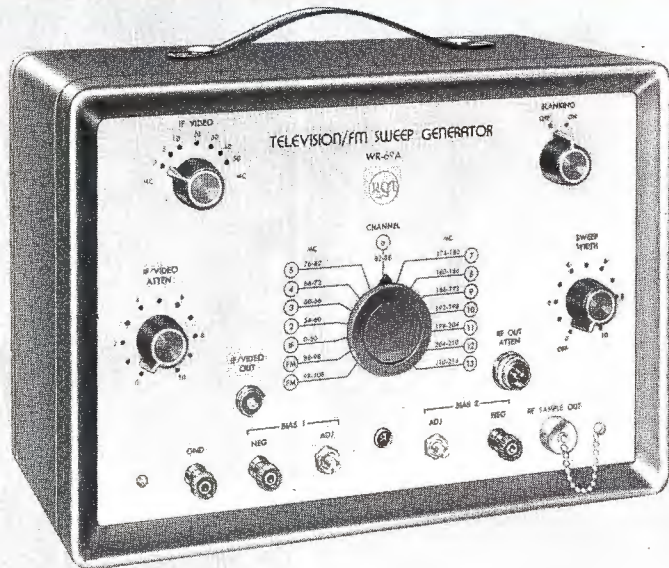

DESCRIPTION

The TV/FM Sweep Generator, RCA Type WR-69A, is designed for visual alignment and trouble-shooting of TV tuners, sound and picture i-f amplifiers, trap circuits, and video amplifiers. Combining such outstanding features as preset switch positions for all VHF TV channels, and continuous tuning from 50 kc to 50 mc (essential requirement for alignment of color TV video and chrominance circuitry), the WR-69A has full coverage of the FM Band. It has a high output voltage, which is flat and free from spurious responses. Fundamental signals are generated on all channels by a push-pull oscillator. The width of the sweep can be controlled on each channel.

New features provide double shielding of the oscillator compartment eliminating leakage to a point far below the fully attenuated signal and providing complete and accurate control of the output down to the noise level of TV receivers. The WR-69A has two built-in d-c negative bias-voltage supplies, both fully adjustable from 0 to 12 volts by means of front panel controls.

Other features include a special blanking circuit for producing a zero reference line on an oscilloscope for quantitative gain measurements and for balancing discriminator circuits; a phase-controlled sweep voltage at power-line frequency for scopes lacking sweep and phase controls; and a dual-piston attenuator with a range down to 5 microvolts. The instrument is housed in a lightweight but

FEATURES

- Produces visual pattern representing the response curve of circuit under test on an oscilloscope screen
- Provides a signal essentially flat over all sweep ranges, output free from spurious responses and other frequency components
- Preset switch positions for all VHF TV channels
- Continuous tunable operation
- Built-in precision harmonic crystal oscillator
- Lightweight portable unit

sturdy case with convenient carrying handle. It comes complete with 300-ohm r-f output cable, resistance terminated i-f/v-f-output cable, and instruction booklet.

SPECIFICATIONS

Performance Specifications

| | |
|--|---|
| R-F..... | TV Channels 2 to 13 preset, maximum sweep frequency not less than 12 mc |
| I-F..... | 50 kc to 50 mc, continuous tuning |
| Sweep Width..... | Continuously variable for both I-F and R-F ranges |
| Output Voltage (rms)..... | 0.1 volt min. |
| Cable Termination: | |
| R-F Positions..... | 300 ohms balanced |
| I-F Position..... | 100 ohms |
| Maximum Attenuator Ratio: | |
| R-F Positions..... | 20,000 to 1 |
| I-F Position..... | 5,000 to 1 |
| Horizontal Sweep for Oscilloscope: | |
| Phase Adjustment Range..... | 160° |
| Frequency | Power line |
| Maximum Amplitude Variation of Sweep Envelope (at maximum rated sweep width).....All positions less than ± 1 db | |

Tube Complement

| | | |
|-------------------|--|-------|
| 2—6J6 | 1—6AS6 | 1—6X4 |
| 1—6C4 | 1—6AT6 | |
| Power Supply..... | 105-125 volts, 50/60 cycles, single phase | |
| Dimensions..... | 13¾" wide, 10" high, 7¼" deep | |
| Weight | 16 lbs. | |
| Finish..... | Blue-gray hommeroid case, satin-aluminum panel | |

Equipment Supplied

| | |
|---|--------|
| Television Sweep Generator..... | WR-69A |
| Complete with tubes, pin plugs, I-F/V-F Output Cable, R-F Output Cable, and Instruction Book | |

Optional and Accessory Equipment

| | |
|--------------------------------|---------|
| Cathode-Ray Oscilloscope | WO-88A |
| Video Multi-Marker | WG-295B |

RF/IF/VF MARKER ADDER

Type WR-70A

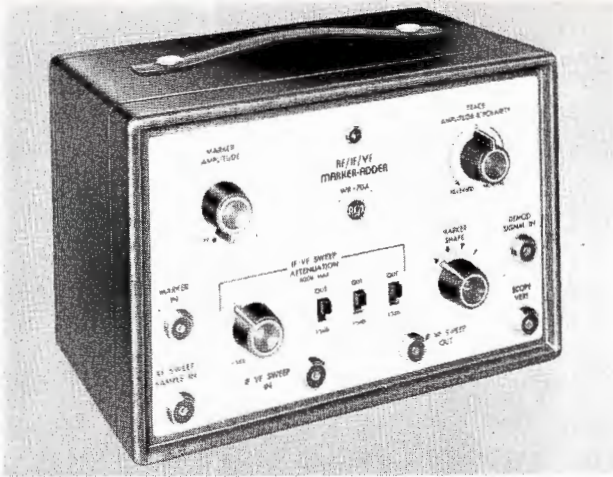

FEATURES

- Choice of four distinct marker shapes
- Provides very high-Q markers of high amplitude and narrow width
- Special voltage—stabilizing circuit provides steady trace display and assures freedom from jitter and bounce
- Permits simple and precise alignment of trap circuits without the possibility of marker "suckout"

USES

The RCA WR-70A RF/IF/VF Marker Adder provides a new technique for aligning video sweep frequency, radio frequency, and intermediate frequency of either color or monochrome monitors and receivers. It is used with existing TV marker generators such as the RCA WR-99A and with sweep generators such as the RCA WR-69A.

During alignment, the marker signal from the WR-70A is added to the sweep-response curve after the sweep signal is taken out of the equipment under test. This new system of adding markers eliminates distortion of the marker and distortion of the sweep curve by the marker due to overloading or clipping in the television monitor or receiver circuits.

The WR-70A provides four different marker shapes so sharply defined that they provide instant identification of trace-shape and frequency. The shapes include: a "wide-band" diamond marker at picture carrier frequency; a "narrow-band" diamond marker at zero point on FM discriminator curve; a positive-clipped marker for trap adjustment; and a negative-clipped marker at picture carrier frequency. The facility for different marker shapes permits selection of a marker that neither obscures the trace nor becomes obscured by the trace.

DESCRIPTION

The WR-70A RF/IF and VF Marker Adder is a lightweight, portable instrument with complete front panel control of all test functions. These include instant selection of one of the four types of markers available as well as control of marker amplitude. Sweep-trace polarity and amplitude may also be adjusted by a front-panel control. The functional grouping of these controls greatly simplifies the alignment procedure.

Included in the WR-70A is a built-in attenuator for use during i-f and video alignment. The attenuator provides for continuous adjustment of the sweep signal over a range of approximately 60 db. The Marker Adder utilizes a special electron-tube regulator circuit to stabilize the B+ voltage and thus insure exceptional trace stability and freedom from trace jitter and bounce.

Four coaxial cables are provided with the WR-70A to facilitate easy connection to the sweep and marker generators, the oscilloscope, and to the input and output circuits of the TV receiver under test. The equipment is housed in an attractive blue hammeroid case which measures 7½" high by 10½" wide and 6¼" deep. The panel is brushed aluminum.

SPECIFICATIONS

Electrical Specifications

| | |
|--|------------------------------------|
| Input Frequencies: | |
| IF/VF Sweep In Connectors..... | 50 kc to 50 mc |
| RF-Input Connectors..... | 50 mc to 250 mc |
| Minimum Input Voltages: | |
| IF/VF Sweep In Connector..... | 0.1 min. volt (rms) |
| RF Sweep Sample In Connector..... | 0.005 min. volt (rms) |
| Marker In Connector..... | 0.1 min. volt (rms) |
| Maximum Input Voltage at Demod. Signal In..... | 8 p-p volts |
| Maximum Output Voltages (Measured at Scope Vert. connector): | |
| Marker Signal..... | 2.5 rms volts |
| Demodulated Sweep Signal..... | 10 p-p volts |
| Input Impedances: | |
| RF Sweep Sample In Connector..... | 100 ohms |
| Marker In Connector..... | 100 ohms |
| IF/VF Sweep In Connector..... | 100 ohms |
| Demod Signal In Connector..... | 0.5 megohm |
| Output Impedance at IF/VF Sweep Out Connector..... | 100 ohms |
| Power Requirements..... | 105-125 volts, 50/60 cps, 25 watts |
| Tube Complement: | |
| 1—12AX7 | 2—12AU7 |
| | 1—6X4 |

Mechanical Specifications

| | |
|-----------------------|---|
| Dimensions (overall): | |
| Height | 7½" |
| Width | 10½" |
| Depth | 6¼" |
| Weight | .8 lbs. |
| Finish..... | Blue-gray hammeroid case; etched aluminum panel |

Equipment Supplied

WR-70A RF/IF/VF Marker Adder complete with tubes, 3 jumper cables, 1 pickup cable, registration card and instruction booklet.

Accessory Equipment

WR-99A Crystal-Calibrated Marker Generator
 WR-69A TV/FM Sweep Generator
 WR-86A UHF Sweep Generator



USES

The RCA Type WR-86A UHF Sweep Generator permits alignment and trouble-shooting of either color or monochrome UHF monitors, receivers, converters, turners, filters, antennas, transmission lines and other equipment operating in the range from 300 to 950 mc. The instrument has a 50-ohm output and will work into a 50-ohm unbalanced load. A padded balun, WG-296 is provided with the generator which permits use into a 300 -ohm balanced load. When used with the accessory WG-298A UHF Demodulator, the sweep generator permits visual observation and measurement of standing-wave ratio of termination on 300-ohm line.

DESCRIPTION

The RCA Type WR-86A UHF Sweep Generator employs a UHF oscillator triode in a specially designed sweep circuit to provide excellent sweep linearity and a maximum amplitude variation of 0.1 db/mc combined with a large sweep width. Amplitude modulation is kept at a minimum over the swept frequency range by means of a shunt regulator circuit. The oscillator compartment and its associated components are especially designed and sturdily constructed for stability and reliable performance over extended operating periods. Critical parts are silver plated for maximum electrical efficiency.

The oscillator is frequency modulated by an electrical-mechanical vibrator of special construction which insures proper alignment of the vibrator capacitor plates. In addition, sweep widths of at least 10% of center frequency are available up to 750 mc; and a sweep width of at least 75 mc is available at any center frequency between 750-950 mc. The entire oscillator section is enclosed in a special silver plated case to minimize leakage. A capacitance adjustment is accessible from outside the oscillator case to correct for amplitude variations which may occur should it become necessary to replace the oscillator tube.

FEATURES

- Wide Frequency range, continuously variable from 300 to 950 mc
- Electro-mechanical sweep of rugged time-tested design
- Phased blanking circuit provides essential zero-reference base line
- Stable Colpitts oscillator with precision quarter-wave tuned line
- RF leakage and radiation minimized by thorough shielding of entire oscillator section, attenuator, and output cable
- Compact, lightweight, portable unit

The WR-86A incorporates a retrace blanking circuit which provides a reference line on the oscilloscope. When the "Removing Blanking" button is pressed, the blanking circuit is incapacitated so that precise adjustment of the Horizontal Phase control may be made. The horizontal sweep frequency for the oscilloscope can be obtained from front-panel terminals. The instrument is contained in a lightweight portable case with all controls on a satin brushed aluminum panel.

SPECIFICATIONS

Electrical Specifications

| | |
|---|---|
| Output Frequency..... | Continuously variable 300-950 mc |
| Output Voltage (rms) across 50-ohm load | |
| or 300-ohm padded balun..... | at least 0.6 volt |
| Maximum Sweep Width..... | Continuously variable, 10% of indicated dial frequency up to 750 mc; 75 mc from 750 mc to 950 mc. |
| Output Impedance..... | 50 ohms |
| Maximum Attenuator Ratio..... | 60 db |
| Maximum Amplitude Variation of Sweep Envelope | |
| at Maximum Sweep Width..... | 0.1 db/mc max. |
| Sinusoidal Sweep Output for Oscilloscope: | |
| Output Voltage (rms)..... | 1 volt |
| Phase Adjustment Range..... | 150 degrees |
| Frequency | Power-Line Frequency |
| Power Requirements..... | 105-125 volts, 60 cps, single phase, 60 watts |
| Tube Complement: | |
| 1-6AF4 | 1-6AQ5 |
| 2-6AV6 | 1-6X4 |

Mechanical Specifications

| | |
|-----------------------|--|
| Dimensions (overall): | |
| Width | 13 1/2" |
| Height | 9 3/4" |
| Depth | 7 1/2" |
| Weight | 15 lbs. |
| Finish..... | Blue-gray hammeroid case, satin-aluminum panel |

Equipment Supplied

| | |
|--|--------|
| UHF Sweep Generator..... | WR-86A |
| Complete with Type WG-296 r-f output cable, 50 to 300 ohm padded balun and instruction book. | |

Accessory Equipment

| |
|--|
| WG-298A UHF Demodulator |
| WO-91A Cathode-Ray Oscilloscope |
| WO-88A 5-Inch Cathode-Ray Oscilloscope |

CRYSTAL-CALIBRATED MARKER GEN. TYPE WR-99A



The RCA Type WR-99A Crystal-Calibrated Marker Generator will furnish an r-f carrier of crystal accuracy for use in alignment of television receivers, both monochrome and color, communications equipment, and other electronic equipment operating in the frequency range of 19 to 260 megacycles. A built-in crystal-controlled oscillator also provides a fixed output signal at 4.5 megacycles for use in aligning intercarrier i-f amplifiers and discriminators. In TV servicing the instrument can be used

to check alignment and bandpass of r-f and i-f circuits and the scanning linearity of both horizontal and vertical circuits. It can also be used as a rebroadcast transmitter, at which time the r-f output is modulated by a video signal from an operating receiver to provide an r-f carrier complete with video and sync information. The output signal can then be used to check picture performance of other VHF TV receivers on any channel.

When the instrument is used as a heterodyne frequency meter, the frequency of an external signal can be determined quickly by feeding the signal into the instrument, zero-beating it with the vfo signal, and reading the frequency directly from the dial. Two variable-frequency oscillators are used to cover the two vfo tuning ranges. Output is on fundamental frequencies, and no beat notes or harmonics are used.

SPECIFICATIONS

| | | | |
|---|---|---------|--------|
| Variable-Frequency Oscillators: | | | |
| Frequency Range (on fundamentals)..... | 19-55 mc, 55-260 mc | | |
| Output Voltages: | | | |
| On VFO Ranges..... | 0.1 rms volt or more | | |
| On 4.5 mc..... | 0.1 rms volt or more | | |
| R-F Attenuation Range..... | .60 db or more | | |
| Output Cable Impedance..... | Approx. 95 ohms | | |
| 2.5-MC Crystal Calibrator: | | | |
| Accuracy..... | ±0.01% | | |
| Total Number of Check Points..... | 96 | | |
| 4.5-MC Crystal Oscillator Accuracy.....±0.02% | | | |
| Internal Modulation..... | 4.5 mc, 4.5 mc and 600 cps, 600 cps, 100-150 kc | | |
| External Modulation Frequency..... | Up to at least 10 mc | | |
| Tube Complement: | | | |
| 1-OA2 | 1-6J6 | 1-6X8 | 1-6CB6 |
| 1-6AS6 | 1-6U8 | 1-12AT7 | 1-6X4 |
| Power Supply..... | 105-125 volts, 50/60 cycles, single phase | | |
| Power Input..... | 55 watts | | |
| Dimensions..... | 13¾" wide, 10" high, 7¼" deep | | |
| Weight..... | 17 lbs. | | |
| Finish..... | Blue-gray hammeroid case, satin-aluminum panel | | |
| Stock Identification..... | WR-99A | | |

VIDEO MULTIMARKER, TYPE WG-295B

The WG-295B Video Multimarker is designed for convenience, accuracy and speed in marking video response curves. It is able to provide five simultaneous absorption type markers accurately preset at the following frequencies in color receivers: 0.5 mc for Q filter, 1.5 mc for I filter, 2.5 mc for pass-band filter, 3.58 mc for color sub-carrier frequency, and 4.5 mc for sound-trap frequency.

Each of the marker frequencies in the WG-295B may be definitely and quickly identified on the response curves simply by touching the corresponding contact on the Multimarker; this has the effect of reducing the amplitude and shifting the position of the particular marker notch. It is connected between the i-f/v-f output on the sweep generator and the regular video output cable.

This absorption-type marker consists of a tuned circuit



loosely coupled to the output of the sweep generator. The tuned circuit absorbs a small amount of the sweep signal, thus producing a dip or notch in the response curve at a point corresponding to the resonant frequency of the tuned circuit.

MASTER VOLTOHMYST

TYPE WV-87B



FEATURES

- Direct readings of peak-to-peak values of complex waves for signal-tracing in TV receivers and other electronic devices employing pulse trigger and timing circuits
- Tracking error of meter less than $\pm 1\%$
- Negative-feedback bridge circuit for good scale linearity and freedom from effects of line-voltage variations
- Fully enclosed metal case for strength and for stability in r-f fields
- Direct-current readings as low as 10 microamperes for applications requiring extremely high meter sensitivity

USES

The WV-87B Master VoltOhmyst is a deluxe instrument useful for television, radar, and other types of pulse work. It has facilities for the direct measurement, on separate scales, of peak-to-peak voltage values of complex waveforms and the rms voltage values of sine waves. It also reads d-c voltage, resistance, and direct current. Vacuum tubes are employed in all functions except current measurement to assure excellent sensitivity and stability.

DESCRIPTION

The WV-87B VoltOhmyst is encased in metal to provide stability in r-f fields and features a negative-feedback bridge circuit for good scale linearity and freedom from effects of line-voltage variations, a 200-microampere meter movement having a tracking error of no more than plus or minus one per cent, and a ratio increase of approximately 3 to 1 in the full-scale voltage points. The meter is electronically protected against burn-out on all a-c and d-c voltage and resistance ranges. It has a large, full-view $8\frac{1}{2}$ " meter which makes it especially useful as a permanently mounted instrument, though it is lightweight and has a carrying handle for easy portability.

Furnished with the instrument is a Type WG-299C DC/AC-ohms probe, and cables for use in making a wide variety of accurate electrical measurements, alligator clip insulator and instruction booklet. The instrument has portable carrying handle and is suited for permanent rack-mounting.

SPECIFICATIONS

| | |
|--------------------------------------|---|
| D-C Voltmeter: | |
| Ranges..... | 0 to 1.5, 5, 15, 150, 500, 1500 volts |
| Input Resistance..... | 11 megohms at all ranges |
| Sensitivity..... | 7.3 megohms/volt on 1.5-volt range |
| Overall Accuracy..... | $\pm 3\%$ of full scale |
| A-C Voltmeter: | |
| Peak-to-Peak Ranges.... | 0 to 4, 14, 42, 140, 420, 1400 and 4200 volts |
| RMS Ranges (for Sine Wave)..... | 0 to 1.5, 5, 15, 50, 150, 500 and 1500 volts |
| Overall Accuracy..... | $\pm 3\%$ of full scale |
| Input Resistance and Capacitance.... | 0.83 megohm shunted by $85 \mu\text{mf}$ (with direct probe and cable at 1.5, 5, 15, 50 and 150-volt ranges) |
| Frequency Response.... | 30 cps to 3 mc up to and including the 500-volt range for source impedance of approximately 100 ohms or lower |
| Ohmmeter..... | 0 to 1000 megohms in 7 ranges |
| Direct Current Meter: | |
| Nine Ranges..... | 0 to 0.5, 1.5, 5, 15, 50, 150, 500 milliamperes; 0 to 1.5, 15 amperes |
| Overall Accuracy..... | $\pm 3\%$ of full scale |
| Tube and Battery Complement: | |
| | 2-6AL5 1-12AU7 |
| Power Line Requirements..... | 105-125 volts, 50/60 cycles, 5 watts |
| Dimensions..... | 10" high, $13\frac{1}{2}$ " wide, 7" deep |
| Weight | 8 lbs. |
| Finish..... | Blue-gray hammeroid case, satin-aluminum panel |
| Stock Identification | WV-87B |

VACUUM TUBE VOLTMETER

Type LV-10



FEATURES

- Excellent stability
- Specially balanced and rugged meter movement
- Measurements to 700 MC
- High input impedance
- AC measurements to 1,500 v.
- DC measurements to 30,000 v.
- Resistance measurements to 1,000 meg-ohms
- Storage space for cables

USES

The LV-10 Vacuum Tube Voltmeter is designed for precise measurement of a-c or d-c voltages and general high impedance circuit measurements. It is extremely useful for laboratory development work in general electronic circuitry.

DESCRIPTION

The RCA LV-10 Vacuum Tube Voltmeter is extremely versatile, combining in a single precision instrument an a-c voltmeter covering a range from audio to UHF frequencies, a db range, a d-c voltmeter with 100 megohms input resistance, and an ohmmeter capable of measuring resistances from zero to 1,000 megohms.

The RCA Model LV-10 has been developed for use wherever highly precise measurements are required, emphasis having been placed on maximum stability. Stability has been achieved by eliminating as many variables as possible and compensating the remainder. The input resistance of 100 megohms on all d-c ranges prevents overloading, and measurements may be taken without disturbing the operation of the circuits under test. The same a-c probe is used for measuring all frequencies from 18 cps to 700 mc. Because the indicating movement of the LV-10 Meter is balanced for all positions, it may be used lying flat, standing vertically, or inclined.

SPECIFICATIONS

| | |
|--|---|
| DC Volts..... | 7 ranges: 1, 3, 10, 30, 100, 300, 1000 |
| Accuracy | ±3% FSD |
| Input resistance..... | 100 megohms ±2% on all ranges |
| AC Volts..... | 6 ranges: 1, 3, 10, 30, 100, 300 |
| Sine Wave Accuracy..... | ±3% FSD |
| Input Impedance..... | Less than 2 μf in parallel with 15 megohms |
| Frequency Response..... | ±1.0 db, 18 cps to 700 MC |
| Relative measurements..... | possible to 1000 MC |
| Resistances: | |
| 0 to 1000 megohms in 7 ranges: | |
| 1 K ohms fullscale, 20 ohms centerscale | |
| 10 K ohms fullscale, 200 ohms centerscale | |
| 100 K ohms fullscale, 2 K ohms centerscale | |
| 1 M ohm fullscale, 20 K ohms centerscale | |
| 10 M ohms fullscale, 200 K ohms centerscale | |
| 100 M ohms fullscale, 2 M ohms centerscale | |
| 1000 M ohms fullscale, 20 M ohms centerscale | |
| Accuracy..... | ±5% between divisions 10 and 100 on the scale |
| DB Range..... | -10 to +52 dbm in 6 ranges |
| Zero dbm = 1mW in 600 ohms | |
| Stability: | |
| Excellent for 1.5% power line change on the 1 volt range it is | |
| ±2% AC and 1.5% DC. Other ranges negligible | |
| Power Required..... | 115 v, 50-60 cps, 12 watts |
| Tube Complement: | |
| 1-57Y1, 1-2-01C, 1-6X4, 1-6AL5 | |
| Dimensions: | |
| Case..... | 12 $\frac{3}{8}$ " high, 7 $\frac{1}{2}$ " wide, 5 $\frac{1}{8}$ " deep |
| AC Probe..... | diam. 1 $\frac{1}{2}$ ", length 4" |
| Weight..... | 13 lbs., net |

Equipment Supplied

| | |
|-------------------------------------|------------|
| Vacuum Tube Voltmeter..... | Type LV-10 |
| Complete with one set of test leads | |

Accessory Equipment

| | |
|---|----------|
| Probe 30 KV DC..... | MI-30403 |
| Adaptor 1500 V AC..... | MI-30404 |
| Adaptor Type N, Probe to Coaxial Cable..... | MI-30402 |

TEST METER

Type LM-1



FEATURES

- Instantaneous overload protection
- High sensitivity—20,000 ohms per volt, AC and DC
- One range-selector switch
- Accurate, rugged meter movement
- Batteries replaceable without opening case
- Easy vision case design

USES

The RCA Type LM-1 Test Meter is a useful instrument in all phases of industry where highly accurate measurement of resistance a-c and d-c voltages and d-c current are encountered. It is particularly suitable for portable applications.

Preliminary work on new circuits can be carried out with the LM-1 whose accuracy is sufficiently high to give required results and whose overload protection circuit eliminates the necessity for laborious calculations and careful use of the circuit. It is particularly welcome for use in broadcast workshops, and laboratories as well as schools and general radio and TV servicing.

DESCRIPTION

The RCA LM-1 Test Meter answers the need for an accurate and highly sensitive (20,000 ohms per volt) instrument with complete protection against the overloads that frequently damage this type of instrument. The system is composed of: a semi-magnetic circuit breaker which acts in the majority of cases and which is reset by a push button; and a fuse which complements the action of the circuit breaker.

The overload cut-out system protects not only the meter movement but also the precision resistors and the shunts which are used in the circuit. The protection is instantaneous and completely isolates the instrument from the overloading source.

The meter is designed with a slightly inclined dial for easy vision. Reading accuracy is assured by a set-zero adjustment, a knife-edge needle and an anti-parallax mirror. The high accuracy movement is particularly rugged and the coil moves in a field provided by a specially oriented magnet.

The switch is a single moulded piece and most ranges are available on one control. It is designed to give long service life.

The battery box is accessible from the exterior and there is no need to open the instrument to change the batteries.

SPECIFICATIONS

| | |
|-------------------------|---|
| DC Volts..... | 7 ranges: 3, 10, 30, 100, 300, 1000, 5000 v. |
| Accuracy..... | ±1.5% FSD, ±3% for the 5,000 v. range |
| AC Volts..... | 7 ranges: 3, 10, 30, 100, 300, 1000, 5000 v. |
| Accuracy..... | ±2.5% FSD |
| Sensitivity..... | 20,000 ohms per volt for both AC and DC |
| Output Meter..... | 3, 10, 30, 100, 300 volts: series capacity 0.1 μf |
| Frequency error..... | 2.5% 50 to 2,000 cps and 100 v. |
| | 5% 2,000 to 5,000 cps and 100 v.; 5% 50 to 2,000 cps for the 300 v. range |
| Decibel Ranges..... | -5 to +11; +5 to +21; +15 to +31; +25 to +41; +35 to +51; |
| | Zero reference = 1 mw in 600 ohms |
| Resistances..... | 0 to 2,000 ohms, center scale reading, 12 ohms; 0 to 200,000 ohms, center scale reading 1,200 ohms; 0 to 20 Megohms, center scale reading 120,000 ohms |
| DC Currents..... | .50 μa, 1 ma, 10 ma, 1A, 10A., 100 ma |
| Accuracy..... | 1.5% FSD |
| Dimensions overall..... | 3 1/8" high, 5 7/8" wide, 8 1/4" deep |
| Weight..... | 3 lbs., 13 oz., net |

Equipment Supplied

Test Meter.....Type LM-1
Complete with two test probes, five RCA Type VS-034 batteries, carrying handle and instruction.

Accessory Equipment

High voltage probe for DC Measurements
up to 30,000 volts. Accuracy: ±3%.....MI-30401

ELECTRON-TUBE MICROMHOMETER

TYPE WT-100A



FEATURES

- Measures true transconductance to an accuracy of better than $\pm 3\%$
- Built-in short circuit test for any combination of tube elements
- Measures transconductance up to 100,000 micromhos in 6 ranges—measures heater currents including 600-ma series-string TV types
- Built in calibrating circuit—no null meters or extra devices required
- Single, precision-type meter used for all measurements
- Regulated power supplies for all d-c voltages—250-ma d-c supply for filaments of battery-operated tube types
- Accommodates wide variety of tubes having sockets with up to 14 pins

USES

The RCA Type WT-100A Electron-Tube MicroMhoMeter is an instrument of laboratory precision which brings a reliable concept of tube-testing technique to users of tubes in broadcast and closed circuit systems, as well as in general electronic applications. A uniquely designed, compact, self-contained unit, the WT-100A offers versatility and accuracy comparable to that of more elaborate and complex laboratory equipment used for measuring transconductance.

The WT-100A tube tester makes it possible to test tubes under actual voltage and current conditions and to obtain test results in terms of actual performance, which can be evaluated against original specifications. Transconductance readings can be obtained simply and quickly on a single, direct-reading meter.

In addition to testing tubes at published ratings, the instrument can also be set up to provide the operating voltage for a circuit of specific design to determine the performance of the tube under the desired circuit conditions. The wide range of controls, the flexibility, and the accuracy of the WT-100A make this instrument an invaluable tool for testing tubes where accuracy and proper evaluation of test results are required.

DESCRIPTION

The RCA WT-100A Electron-Tube MicroMhoMeter is an extremely versatile, self-contained tube testing instrument contained in a lightweight portable chassis with convenient sloping panel containing all controls. A single, precision-type meter is used for all measurements. No patch cords or external null indicators are required. The unique metering circuit provides linear deflection in all functions and ranges. Meter multipliers and shunts are automatically switched when the ranges are changed. The meter is protected electronically against burn-out on current measurements. Mechanical and electrical interlocking of switches protect the meter on all other functions.

The unique calibrating circuit of the WT-100A permits direct measurement of true transconductance to an accuracy better than ± 3 percent without the need for external null indicators. It is quickly calibrated by simply depressing the calibrate control and adjusting it for full-scale deflection of the meter. When the calibrate control is depressed, the metering circuit is switched to the calibrate circuit. The meter indicates the voltage which is developed across the calibrating network by the oscillator signal. Adjustment of the calibrate control for full-scale deflection compensates for the loading effect of the tube

AUTOMATIC ELECTRON-TUBE TESTER

TYPE WT-110A

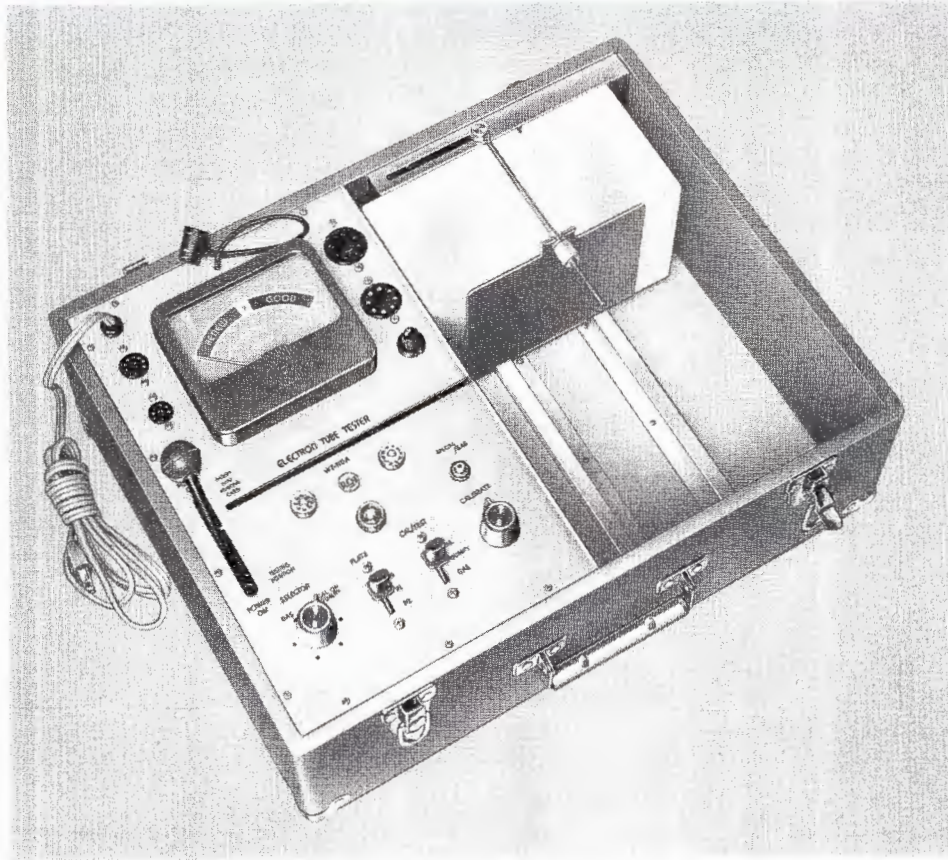

FEATURES

- Provides rapid check for all popular receiving type tubes for general quality, including interelectrode shorts and leakage
- Tube-pin and test-voltage connections automatically set up by use of individual punched card for each tube type
- Cards for new tube types can be prepared by user
- Front panel calibration control permits compensation for above or below normal line voltage
- Easily replaceable screw-mounted tube sockets
- Lightweight, portable instrument housed in plastic covered case

USES

The RCA WT-110A Automatic Electron-Tube Tester is designed to give a rapid check of a tube's usability by checking transconductance, gas, shorts between elements, and balance between sections of twin type tubes. In a matter of seconds readings are provided on a 4½" meter in terms of "Renew — ? — Good" for all popular receiving type tubes. Other tube types can be included merely by preparing punched cards for those types of special interest. The gas condition of the tube is also indicated on the meter.

The outstanding feature of the WT-110A is the use of an individual punched card for each different type tube to automatically set up all tube-pin and test-voltage connections when the card is inserted into the panel slot of the tester. It is not necessary to adjust external switches or other controls to set up pin and operating-voltage connections for the tube. The WT-110A is designed for general service and testing use by skilled or unskilled personnel.

DESCRIPTION

The WT-110A Automatic Electron-Tube Tester is a modern high-speed test device utilizing methods of automation. The "brain" or control-center of the instrument consists of a matrix made up of two gold plated printed circuit boards interconnected by gold plated pins, springs and eyelets. The matrix is activated by inserting a punched card and slipping the power lever into operating position. This simple process immediately sets-up a combination of from 15 to 20 circuits which permit: socket connections to as many as ten pins, 220 combinations of heater voltage, 10 bias voltages, 5 plate voltages, 11 values of cathode resistors, 2 screen voltages and 50 quality sensitivity ranges. In a matter of seconds the tester gives a true indication of a tube's usability by checking transconductance, gas, shorts between elements and balance between sections of twin type tubes. It also tests each section of multi-section type tubes with no paralleling of sections.

A set of pre-punched cards for 7-pin and 9-pin miniature, octal- and loctal-type receiving tubes is supplied with the WT-110A. The cards, made of durable plastic, are permanently hinged in the case adjacent to the tester and are indexed in numerical-alphabetical sequence by tube type. The punched-card system accommodates the popular receiving-tube types employed in television and radio receivers, including diodes, triodes, tetrodes, pentodes, and multiunit receiving tubes which have similar and dissimilar units. The instrument can also be used to check certain industrial type tubes. Cards may be pre-

pared for additional tube types. Card punching information is obtainable from the Radio Corporation of America.

The Automatic Electron-Tube Tester has a front panel calibration control to permit compensation for above- or below-normal line voltage, easily replaceable screw-mounted tube sockets, and steel pin-straighteners mounted on the front panel. Special provisions are included for making high-resistance interelectrode leakage and low-value gas-current tests on certain tube types. These special provisions make possible a better evaluation of tube types used in applications having critical leakage or gas limitations.

The WT-110A is housed in an attractive blue plastic-covered case with detachable cover. The panel is satin-finished aluminum. A 4½" clear-reading meter scaled 0-100 μamps indicates tube condition at a glance. Weight of the instrument, with cards, is approximately 25 pounds. The unit measures 17¼" wide, 13¼" deep and 6⅝" high. Power consumption is approximately 50 watts.

Certain tube types which have bases and pin arrangements different from those provided for on the WT-110A may be tested if an appropriate tube-socket adapter is used. These adapters, which plug into the octal socket on the WT-110A panel, are available as accessory equipment. One set accommodates tubes with small 4-pin, 5-pin, 6-pin or 7-pin bases and medium 7-pin bases; another set is available for testing 7-lead in-line subminiature tubes; and there is a set to accommodate testing of 8-lead circular subminiature tubes.

SPECIFICATIONS

Electrical Specifications

| | |
|-------------------------|--|
| Power Requirements..... | 117 volts, a-c, 60 cycles, single phase |
| Power Consumption..... | 50 watts |
| Circuits..... | Automatic matrix activated by punched card with provisions for: 220 combinations of heater voltage; 10 bias voltages; 5 plate voltages; 11 values of cathode resistors; 2 screen voltages; 50 quality sensitivity ranges |

Mechanical Specifications

| | |
|-------------------------|--|
| Socket connections..... | Up to ten pins |
| Dimensions: | |
| Width | 17¼" |
| Depth | 13¼" |
| Height | 6⅝" |
| Weight | 25 lbs. |
| Finish..... | Satin-finished aluminum panel, blue plastic covered case |

Equipment Supplied

| | |
|---|---------|
| Automatic Electron-Tube Tester..... | WT-110A |
| Including Tube Tester with 1 set of punched cards, one master punched card, one test card, warranty registration card, and instruction booklet. | |

Accessory Equipment

| | |
|--|---------|
| Tube Socket Adapter Set..... | WG-337A |
| 4 adapters for testing tubes with small 4-pin bases, small 5-pin bases, small 6-pin bases, and small and medium 7-pin bases in WT-110A | |
| Tube Socket Adapter..... | WG-338A |
| For testing 7-Lead In-Line Subminiature Tubes in RCA WT-110A | |
| Tube Socket Adapter..... | WG-339A |
| For testing 8-Lead Circular Subminiature Tubes in WT-110A | |

FIELD INTENSITY METER AND TEST SET

BW-7A



FEATURES

- Continuous tuning—no band changing necessary
- Combined lab-quality signal generator and receiver in one convenient case
- Sufficient power to excite antenna under test over long transmission line lengths
- Eliminates "setting-up" separate transmitters, receivers, bridges, etc.
- Output for a standard Esterline-Angus Recorder
- Measures either "average" or "peak-of-sync" value of television signals
- Operates either from 6 volt battery or 115 volt, 50/60 cycle supply

USES

The Type BW-7A R-F Test Set and Field Intensity Meter is especially designed to provide an accurate, self-contained, easy-to-operate instrument for the measurement of radio-frequency field intensities in the range of 54 to 240 megacycles. It is suitable for AM, FM and Television measurement use. The frequency range covers those frequencies assigned to VHF television and FM broadcasting—as well as frequencies, lying within the limits of 54 to 240 mc, that are assigned to aeronautical and other public services.

DESCRIPTION

The Type BW-7A R-F Test Set is designed to fill a very definite place in the VHF measurement field. It combines in one instrument a field intensity meter which is more accurate and more convenient to use than any heretofore available, a standard signal generator of laboratory quality, and a laboratory quality receiver continuously tunable from 54 to 240 megacycles.

The combination of an accurate signal generator in the same case with a fine receiver results in a test instrument of exceptional utility. For example, in making impedance measurements with a slotted line or r-f bridge, there is

available in one self-contained package both the exciter for the line or bridge and a supersensitive receiver for use as a detector. Another example of the utility and flexibility of this instrument would be its use in measuring the characteristics of antennas within its frequency range. The signal generator has sufficient power to excite the antenna under measurement over a very considerable length of transmission line with the receiver being used in conjunction with a simple antenna to receive the radiated signal and measure it in known values over a very wide range. Engineers doing antenna work, who have heretofore found it necessary to set up transmitters, receivers, bridges, etc., with their attendant weight, inconvenience, and lack of flexibility, will appreciate the convenience of operation of the Type BW-7A R-F Test Set and the time and money that will be saved because of the more expeditious way in which their work can be carried out.

Since means are available for standardizing the gain of the receiver and varying this gain in known increments, the test set constitutes an r-f voltmeter for general laboratory work. Likewise, engineers engaged in receiver work will find the wide range and accuracy of the signal-generator portion of the test set of particular advantage in their work.

When used for field intensity measurements the calibrated dipole receiving antenna is connected to the receiver portion of the test set and the gain and step attenuators adjusted until the reading on the output meter is, for example, full scale. The input of the receiver is then switched to the signal generator adjusted until the same reading is obtained. The field strength is then known from the effective height of the antenna and the output of the signal generator. Special provision is made to insure that such variables as the attenuation of the antenna transmission line with frequency, the absolute value of the receiver input termination, and other factors affecting the accuracy as a field strength meter are compensated for. It has long been recognized that a substitution type of field strength measurement could, when the proper precautions are taken, be made the most accurate of any known method of measuring this quantity. The BW-7A R-F Test Set has set a new standard of accuracy for field strength measurements in the VHF region. Additional features of the BW-7A R-F Test Set are provision for operating, without auxiliary equipment, a 1-ma Esterline-Angus recorder; provision for measuring in terms of either the average or the peak-of-sync value of television signals; and provision for aural monitoring of either AM or FM signals. The test set operates either from a 6-volt storage battery or from a 115-volt 50- or 60-cycle supply without any changes whatever; all that is necessary is to attach the proper power cable. The set occupies only 215 sq. in. of bench space.

SPECIFICATIONS

Performance Specifications

Frequency Range.....54 mc to 240 mc
 Type of Tuning.....Continuous. No coil changing necessary in either the receiver or the signal generator.
 I-f Frequency.....21.4 mc
 Image Rejection.....Not less than 37 db anywhere in the tuning range. Typical values are 49 db at 60 mc and 37 db at 240 mc.
 Signal Generator.....Output metered and continuously variable from 1.0 μ v to 100,000 μ v.
 Field Intensity Range.....1.5 μ v/m to 10 v/m at 54 mc;
 6.0 μ v/m to 10 v/m at 220 mc

Tube Complement

| | | | |
|--------|--------|--------|---------|
| 1 6J4 | 1 6AB4 | 1 6AL5 | 2 12AU7 |
| 1 6AK5 | 5 6BH6 | 1 6J6 | 1 6SN7 |

Power Supply.....110-120 volts a-c, 50/60 cycles, single phase
 6 volts d-c, 10 amperes
 Weight.....Test Set, 47.5 lbs. Accessories and case, 20 lbs.
 Dimensions.....Length, 20 in.; width, 11 in.; height, 15 in.

Equipment Supplied

BW-7A R-F Test Set and Field Intensity Meter.....MI-19384
 (Complete with tubes in place and including power cord, battery cable, coaxial lead, antenna carrying case containing: tripod, mast section and tee, extension mast section, two low-frequency dipole elements, 35-foot antenna cable and a 40 db attenuator, and Instruction Book IB-30229)

Optional and Accessory Equipment

1 ma Esterline-Angus Recorder
 Type 110 Mobile Recording Drive Assembly

Circuit block diagram of the BW-7A Field Intensity Meter.

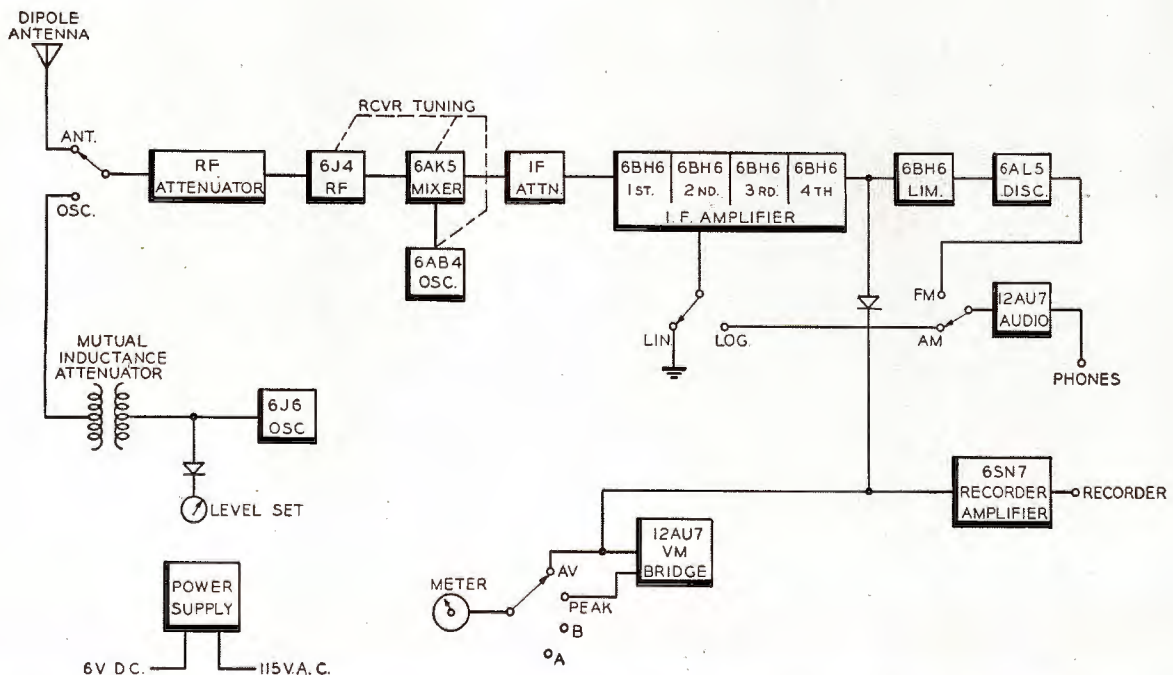

FIELD INTENSITY METER

TYPE WX-2D

FEATURES

- Truly portable—weight, approximately 12½ lbs. including batteries—size approximately 12" x 8½" x 5½"
- Reads directly in microvolts per meter—no correction factor charts are needed
- Stable in operation—calibrates readily in presence of strong fields
- Wide sensitivity range—10 $\mu\text{v}/\text{m}$ meter to 10 volts/meter
- Accurate—built-in calibrating oscillator



USES

The type WX-2D Intensity Meter is a small, accurate and truly portable instrument, especially adapted for field use by Broadcast Station Engineers and Consultants. Designed for battery operation, it provides for a wide range of measurement (10 v/meter to 10 $\mu\text{v}/\text{meter}$) in conducting broadcast band (540 to 1600 kc) field intensity surveys. It makes possible close-in measurements on high-powered directional arrays, as well as interference studies where very low signal strengths are encountered.

DESCRIPTION

The Type WX-2D Field Intensity Meter is direct reading in microvolts per meter without the aid or necessity of charts, curves, correction factors, or computations of any kind. In the WX-2D, a statically shielded, unbalanced loop is used as an integral part of the instrument cover. The loop has only a few turns, thus the natural resonant frequency is very much higher than the highest frequency in the operating range. The high side of the loop is loaded with

a high "Q" coil to provide the total inductance required for the operating range. Injection of the calibrating voltage into the loop circuit is by means of a small toroidal-wound inductance. The "Q" of the loop circuit is approximately 100 at one megacycle. This high "Q", plus the use of a stage of radio frequency amplification, results in a very high order of image rejection. This feature is desirable since the large increase in the number of stations in some localities has made impractical the use of field intensity meters having insufficient front-end selectivity. By careful design, other spurious responses, such as i-f harmonics, have been greatly reduced. The use of crystal diodes for metering purposes eliminates the meter errors due to varying cathode voltages on thermionic rectifiers. The crystals are used in special circuits which swamp out variations due to temperature, etc. The meter will indicate accurately with filament voltages as low as one volt and plate voltages as low as 45 volts.

Ordinary flashlight cells, obtainable everywhere, are used for the filament. A 67-volt battery of the size in common use in small camera-type radios is used for plate supply. The total plate drain of the receiver is 8 ma. The filament drain is 300 ma. Separate batteries are used for the calibrating oscillator. All batteries are carried in a compartment accessible through a door in the rear of the instrument. Provision is made for checking battery voltages with the same meter as used for field intensity indication.

All tubes are quick-heating filamentary types so that the WX-2D stabilizes within a few seconds, thus it is not necessary to keep the instrument operating between readings. The direct reading feature of the WX-2D simplifies field intensity measurements and eliminates the needs of the usual attenuator readings, meter readings and multiplication factors. A wide sensitivity range, 10 volts per meter to 10 microvolts per meter, permits maximum flexibility of operation within the range of 540 to 1600 kc.

Despite its small size and compactness, nothing has been sacrificed in the way of quality or workmanship. Com-

ponents of the highest quality are used throughout. The design is such that all components are accessible. Broadcast Station Engineers and Consultants will find that it offers extreme flexibility in use and fills a long-felt need for a light-weight, portable instrument.

SPECIFICATIONS

Performance Specifications

| | |
|--|---|
| Frequency Range..... | 540-1600 kc |
| Sensitivity..... | 10 μ v/m to 10 v/m (all frequencies) |
| Power Supply (not supplied with equipment)..... | 2 67½ VB-5 1½ unit cells (RCA VS016)—(RCA VS001) |
| Antenna..... | Built in loop with electro-static shield |
| Dimensions..... | 9" high, 13" wide, 5¾" deep |
| Weight | 12.6 lbs. |

Tube Complement

| | |
|-------|-------|
| 4-1T4 | 2-1R5 |
|-------|-------|

Equipment Supplied

| | |
|---|------------|
| WX-2D Field Intensity Meter..... | MI-30002-D |
| (Including electron tubes in place, Instruction Book IB-4002-4 and Instruction Book Addenda IB-4002-4A) | |

Accessory Equipment

Type 121 Recording Amplifier

Block diagram, Field Intensity Meter, Type WX-2D.

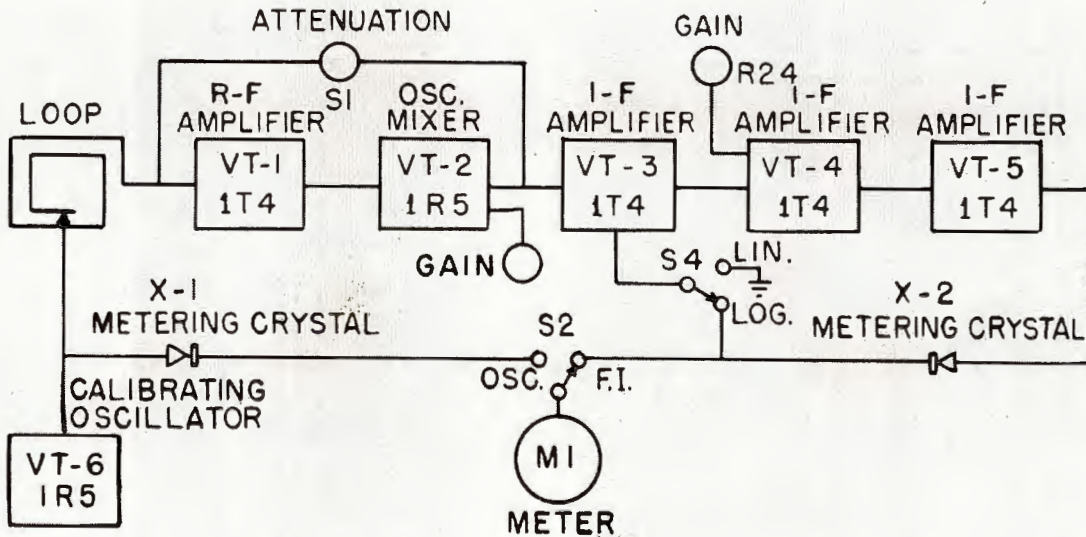

FREQUENCY MONITORS

AM TYPE BW-11A AND COLOR TV SUB-CARRIER TYPE BW-11AT

FEATURES

- Continuous reading deviation meter
- Wide input range
- Minimum accuracy at subcarrier frequency ± 1 cycle for 30 days and ± 5 cycles for 1 year
- Protected trimmer adjustments for frequency calibration
- Warning lamp system indicates failure of either transmitter carrier or monitor crystal oscillator
- Reliable—minimum of attention required from operating staff
- Provision for simultaneous operation of remote indicating or recording meter

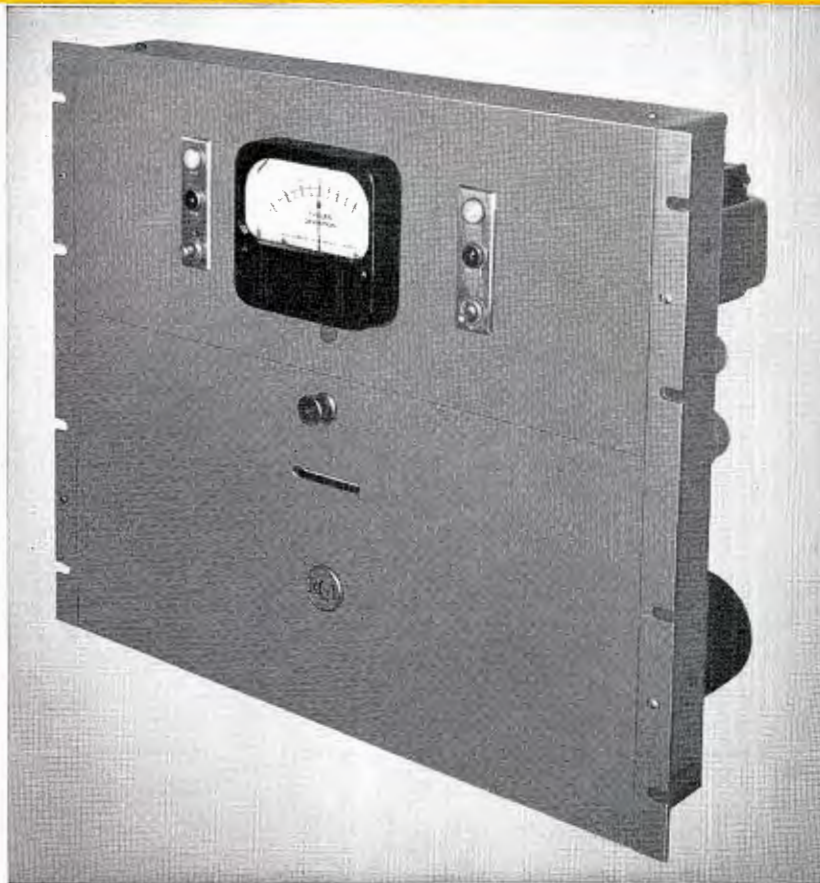

USES

The RCA Frequency Deviation Monitors BW-11A and BW-11AT indicate continuously, and directly in cycles-per-second the magnitude and direction of any departure of the carrier signal from its proper frequency. The two models are used as follows:

1. Type BW-11A for AM broadcast stations to measure departure of the carrier from its assigned channel frequency.
2. Type BW-11AT for TV broadcast stations to measure departure of the color subcarrier from 3.579545 mc standard frequency.

The BW-11A monitor bears FCC approval for use in standard broadcast stations. The BW-11AT more than meets FCC requirement for subcarrier accuracy of ± 10 cycles maximum and will provide an accurate and convenient method of calibrating and monitoring the color frequency standard now used by stations originating color programs.

DESCRIPTION

The circuit arrangement of the BW-11A/11AT is shown in the accompanying block diagram. Voltage from a temperature-controlled piezo-electric oscillator (frequency $f - 1000$ cycles) and the carrier to be monitored (frequency $f \pm \Delta f$) are amplified and fed to a converter tube from which their difference frequency ($1000 \pm \Delta f$) is obtained. This audio-frequency is converted to a constant amplitude square wave by means of a limiter amplifier and then restored to a constant amplitude sine wave of frequency ($1000 \text{ cycles} \pm \Delta f$) by a filter stage. After power amplification the audio frequency is applied to a discriminator and rectifier circuit, from which d-c is obtained. The amplitude and polarity of the d-c is determined by the deviation from 1000 cps. Deviation is indicated on a linearly calibrated zero-center meter with a scale calibration of ± 30 cps. A jack is provided for a remote indicating or recording meter, which can be operated simultaneously with the panel meter.

The monitor is a-c operated and is mounted on a single relay rack panel. Coupling of the BW-11A Monitor to the

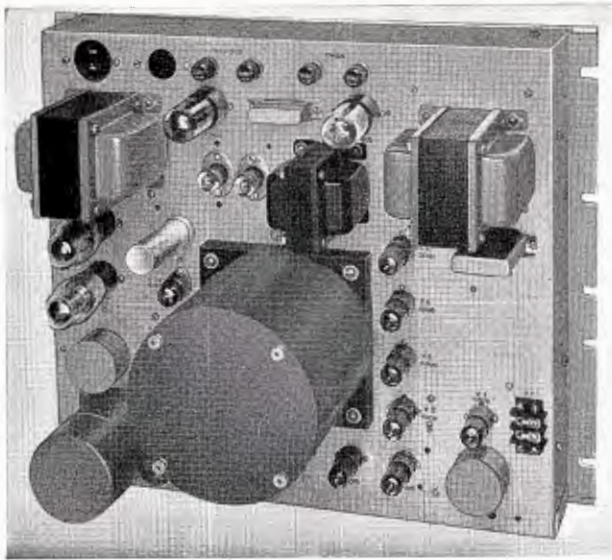

Rear view of BW-11A Frequency Monitor.

transmitter is obtained from a short length of wire attached to the input terminals to act as an antenna. The BW-11AT Monitor's input voltage is obtained by "looping through" a coaxial cable circuit carrying a subcarrier signal.

The oscillator crystal is maintained at a constant temperature by means of a mercury thermostat-controlled oven. Additional isolation against external influences is effected by the use of low heat conductivity wire to the crystal circuits and thermal cutout. No tuning adjustments are required other than the setting of a single capacitor. A wideband amplifier increases the crystal signal uniformly over the frequency range.

Circuits are designed so that wide variations in tube characteristics and line voltage cause negligible error in deviation indications. Negative feedback is used on the power amplifier, and in other circuits, limiting and voltage regulation minimize these effects.

Since the equipment is designed to operate continuously without adjustment, only two switches are provided on the front panel, the monitor toggle switch, and the check push-button switch. The monitor switch controls power for all

circuits except the oven heater which is thermostatically controlled and functions whenever the power cable is connected to the a-c power source. The check pushbutton switch permits a quick check on all circuits. When the monitor is working normally, and this button is pressed, the meter deflection increases by approximately 5 cps. A change appreciably different from 5 cps indicates a defective circuit.

The oven thermometer is visible through a slot in the lower section of the front panel and it is illuminated for easy reading. Tubes and crystal oven, located on the back of the chassis, are easily accessible for servicing. The monitor is contained in a single unit which occupies a 15¼-inch vertical space in a standard 19-inch cabinet rack. To facilitate maintenance, the bottom section of the front panel may be lowered and the upper section raised. Lowering the bottom section exposes most of the monitor circuits for continuity checks, and all the routine maintenance controls. The equipment is shipped with all components in place except the crystal. An MI-7982-B Crystal Unit specially ground to 1000 cycles below the transmitter frequency is provided for the BW-11A, and MI-7962-C Crystal Unit especially ground for the subcarrier frequency is specified for the BW-11AT Monitor.

SPECIFICATIONS

Performance Specifications

| | Model BW-11A | Model BW-11AT |
|--|---|---|
| Frequency Range | 500 to 2000 kc | 3.579545 |
| Frequency Deviation Range (readable to 1 cycle)..... | ±30 cycles | ±30 cycles |
| Accuracy | ±10 parts per million | ±1 cy. for 30 days ±5 cy. for 1 year |
| R-F Input Voltage..... | Approx. 10 mv to 25 volts | Approx. 0.15 to 25 volts |
| Power Supply..... | 105-130 volts, 50/60 cycles, single phase | |
| Power Input..... | | 120 watts |
| Dimensions..... | 19" wide, 15¾" high, 9½" deep | |
| Weight | | .60 lbs. |
| Finish | | Umber gray |
| FCC Approval Number for BW-11A..... | | 1471 |

Tube Complement

| | |
|----------|-------------|
| 5-6AU6 | 2-2D21 |
| 1-6BE6 | 1-5Y3-GT |
| 1-6V6-GT | 2-OC3/VR105 |
| 3-6AL5 | |

Equipment Supplied

- BW-11A AM Broadcast Frequency Monitor.....ES-34042
Including Frequency Monitor (MI-30011-B), complete with tubes in place, 8-foot power cord with plugs, fuses, tuning tool, thermometer, thermostat, Crystal Unit, Type TMV-135L, (MI-7962-B) and instruction booklet.
- BW-11AT Color TV Sub-Carrier Frequency Monitor.....ES-34040-A
Including Frequency Monitor (MI-30011-B), complete with tubes in place, 8-foot power cord with plugs, fuses, tuning tool, thermometer, thermostat, Crystal Unit, Type VC-1-NS, (MI-7962-C) and instruction booklet.

Optional and Accessory Equipment

- Remote MeterMI-93688
- Tube Kit for BW-11A/11AT.....MI-8295

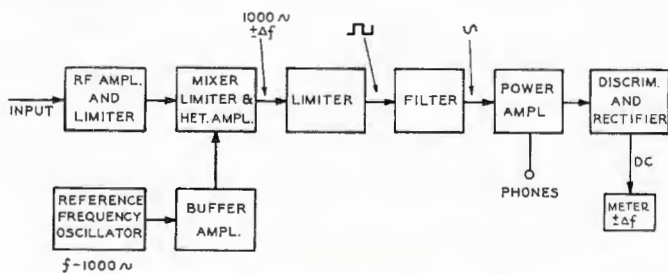

Schematic block diagram of Type BW-11A/11AT Frequency Deviation Monitor.

FREQUENCY AND MODULATION MONITOR

MODEL 335-ER

FEATURES

- Provides accurate check that TV transmitter is operating within FCC specifications
- Operates reliably over long periods of time
- Covers all TV channels, 2 to 83
- Compact size, requires minimum rack space
- External meters may be remotely located
- Simplified operation, all adjustments made from front panel of the monitor
- Forced air cooling system

USES

The Model 335-ER Hewlett Packard Frequency Monitor and Modulation Meter monitors the carrier frequencies of both the aural and visual TV transmitters, and measures the degree of aural modulation. Through the use of the pulse counter-type frequency meter circuit, it provides reliable, accurate operation over long periods of time and requires no adjustment during use. Because of the unit's compact size, a minimum amount of relay rack space is required for its installation.

Three panel meters on the equipment monitor the frequencies of the visual and aural carriers and the percent modulation on the aural carrier with 100% modulation equal to 25 kc deviation. All indications are presented simultaneously. The monitor can be used with any one of the TV channels for either color or monochrome applications. The circuit arrangement also accommodates stations that may have off-set carriers. Full provision is made for the use of a remote peak modulation lamp as well as remote indicating meters. All operating adjustments can be made on the front panel of the monitor.

In addition to its primary function of indicating the percentage modulation of the aural carrier and monitoring the frequencies of both carriers, the 335-ER is also arranged so that it provides the necessary output voltages for measuring the FM and AM noise levels and for determining the frequency response and distortion characteristics of the aural transmitter.

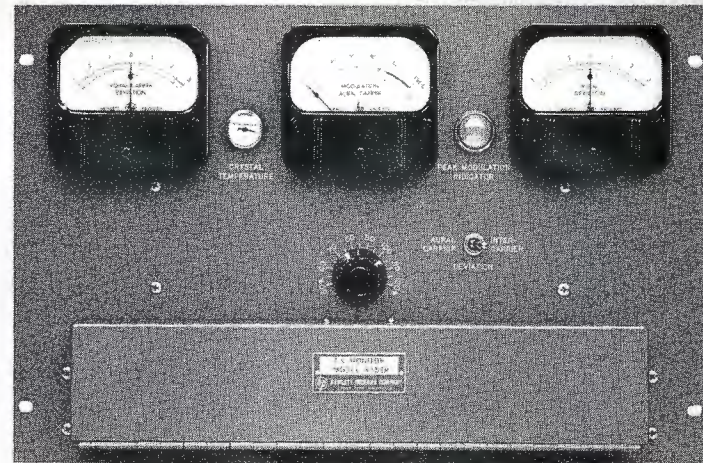

DESCRIPTION

The Model 335-ER Frequency Monitor and Modulation Meter features a master oscillator, controlled by a crystal operating in the 20-30 megacycle region. The crystal is mounted in a carefully-designed oven that controls temperature to within approximately 0.10° C. Oven temperature is indicated by a thermometer readable at the front panel. The master oscillator is provided with a vernier knob adjustment for correcting long time drift.

Highest quality components are used throughout. All filter capacitors are oil-filled. A forced air cooling system assures low operating temperature for long-life and stable performance.

A cathode-coupled type oscillator circuit has been selected because of the exceptionally small effect varying stray capacities have on the frequency of the crystal used in this arrangement. As a further precaution, a constant-voltage type transformer is provided to regulate the master-oscillator filaments.

The master oscillator drives a tuned multiplier which feeds into the separate multipliers for the visual and aural channels of the monitor. In the visual channel the output of the first multiplier is multiplied until it is 4.35 mc above the assigned visual carrier frequency of the station. The output of the visual mixer is then a frequency of 4.35 mc when the visual carrier is exactly at its assigned frequency. The 4.35 mc output of the first visual mixer is then mixed

TELEVISION TRANSMITTER MONITOR

GR TYPE 1184-A

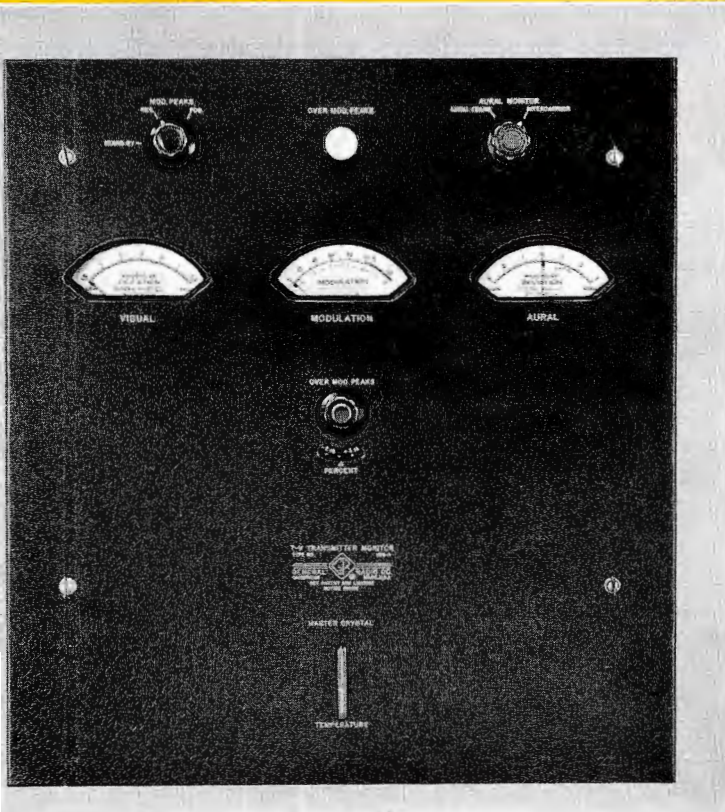

USES

The General Radio Type 1184-A Television Transmitter Monitor is a monitoring system for TV stations operating in either UHF or VHF channels, and broadcasting either color or monochrome signals. The instrument gives a continuous indication of center-frequency and percentage modulation (frequency deviation) from FCC assigned values of visual carrier, aural carrier or intercarrier separation. It also furnishes a high-fidelity output for measuring distortion and noise, and a 600-ohm output for audio monitoring.

The 1184-A also has provisions for complete audio-fidelity tests and residual AM and FM noise measurements on aural and visual transmitters respectively. An external distortion and noise meter may be used to measure the audio fidelity of the aural transmitter as required for FCC proof-of-performance tests. An output signal of 10.8 volts at 100% modulation is available for this purpose. No external detector is required for measurement of the existing mixer stage. Modulation distortion can be measured at any frequency from 0 to 15,000 cycles at 100% modulation. By operating the station-monitoring speaker from this system, an audible warning for loss of either carrier is constantly available.

FEATURES

- Operates on any TV channel (50-890 mc)
- Indicates continuously frequency deviations from FCC assigned values of visual carrier, aural carrier or intercarrier separation
- Accuracy for visual or aural carrier better than ± 500 cycles over 30-day period in VHF band, 10 days at UHF
- Provision for complete audio-fidelity tests and residual AM and FM noise measurements on aural and visual transmitters respectively
- Unique mechanical design gives complete accessibility to interior while instrument is operating without need for removal from relay rack
- Monitors aural frequency modulation

DESCRIPTION

The Type 1184-A Television Transmitter Monitor is designed to mount in standard EIA relay-racks. All circuits are mounted on chassis behind a quickly removable panel plate. As it is mounted on sliders, the instrument can be withdrawn to a position forward of the relay rack where all components are accessible for servicing and adjustment. Components are housed on two large vertical shelves parallel with the front panel. On the front shelf are the major r-f components, along with the aural i-f amplifier and the audio discriminators. On the rear shelf are the audio amplifiers, intercarrier sections, circuits associated with the visual transmitter metering, and, at the bottom, dual, regulated power supplies.

External connections are brought in by cables toward the center of the instrument, where they plug into their respective sockets. When the monitor is drawn forward on slides, connection cables slide on rollers at the rear of the cabinet, so that the instrument can be withdrawn to its fully extended position while in normal operation. In addition, latch buttons on either side permit the monitor to be pivoted forward or backward for accessibility of other components. As a further aid to service and adjustment, all tubes and adjustments are labeled, and the

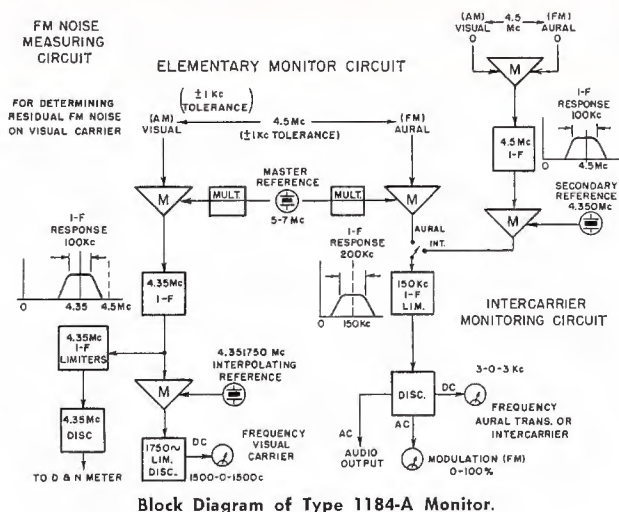

Block Diagram of Type 1184-A Monitor.

route of signal flow through successive stages is plainly marked by arrows. All controls and adjustments are color-coded for easy identification.

The 1184-A Transmitter Monitor employs a single master-reference frequency, a harmonic of which is heterodyned with both the visual and aural carriers. This harmonic is chosen so that it is 150 kc below the aural channel and 4.35 mc above the visual-transmitter frequency. The 4.35 mc beat is used to operate circuits pertaining to the visual transmitter, and the 150 kc beat is used to operate circuits pertaining to the aural transmitter. The aural transmitter system employs single conversion; the visual transmitter dual conversion, where a second heterodyne action is obtained by reference to a 4.351750 mc local crystal oscillator. The resulting low-frequency beat at 1750 cycles is fed to a limiter-discriminator operating at this low frequency and then to a d-c meter calibrated in terms of the visual carrier frequency.

The monitor may be mounted in the rack at any convenient level. Forced air cooling is not normally necessary, but if the temperature of the rack exceeds 40°C. It is suggested that the rack be provided with forced-air circulation. The monitor is completely electrostatically shielded, and will neither interfere with low-level audio equipment nor be influenced by stray fields associated with normal transmitter locations.

The monitor is intended for use with a standard EIA transmitter monitoring output connection. Selectivity is adequate so that an attenuator may be used, if desired, in the monitoring line to reduce effects of standing waves, especially at the UHF frequencies. Two separate individually adjustable inputs are provided, one for use in connection with the visual transmitter and one for use in connection with the aural transmitter.

SPECIFICATIONS

Electrical Specifications

- Frequency Range.....50-890 mc (TV channels 2-83)
- RF Input:
 - Impedance.....Low-impedance, loop coupling
 - Level.....For use with standard EIA transmitter monitoring outputs (10 volts, 50 ohms)
- Sensitivity.....One volt for all functions except the measurement of residual AM noise on the aural transmitter, which requires a minimum of 4 volts r-f input and the visual transmitter input which requires 2 volts
- Indication.....Direct indication on front panel meter
- Frequency (Crystal Stability):
 - Master Reference.....±1.4 ppm/30 days or ±0.35 ppm/10 days
 - Secondary reference.....±5 ppm/30 days (= 21.5 cycles)
 - Interpolating reference oscillator.....±5 ppm/30 days (= 22.5 cycles)
- Accuracy (overall):
 - Aural and Visual.....500c/30 days VHF or 500c/10 days UHF
 - Intercarrier.....250c/30 days at all frequencies

Aural Modulation (FM):

- Meter Scale.....0 to 100% + 3 db, full scale
- Meter Ballistics.....As required by FCC specifications
- Meter Calibration.....100% = 25 kc deviation; selection switch for 100% = 50 kc to permit wide-deviation type tests.
- Polarity Response.....Panel switch for positive or negative peaks, for both meter and flashing lamp
- Peak Indicator.....Flashing lamp indicates peaks in excess of dial setting
- Dial.....Calibrated from 0 to 100% and to +3 db above 100%
- Meter Frequency Response.....±0.25 db from 50 to 15,000 cycles; ±0.5 db from 30 to 20,000
- Peak Indicator Freq. Response.....0.5 db from 100 to 15,000 cycles

Aural FM Transmitter Fidelity Measurements:

- Audio Outputs (at low frequencies with 100% modulation).....10.8 volts into 100 ohms or 0 db into 600 ohms
- Residual Distortion (50 to 15,000 cycles).....0.15% for 25 kc modulation deviation and 0.25% for 50 kc deviation
- Residual FM Noise.....-70 db below 25 kc modulation deviation
- Audio Response.....follows 75-μsec de-emphasis curve within ±0.5 db from 50 to 15,000 cycles, ±3 db from 15 to 30 kc
- AM Noise Reference Level (at low frequencies).....4 volts into 100 ohms
- Residual Noise AM.....-70 db below carrier level

Visual AM Transmitter Fidelity Measurements:

- Noise (FM) Measuring Output (at low frequencies and 25 kc deviation).....1.5 volts into 100 ohm load, 75-μsec de-emphasis circuit included
- Residual (FM) Noise.....-65 db below 25 kc deviation with normal video modulation on transmitter (-70 db without video modulation)

Intercarrier Fidelity Measurements:

- Same as for aural transmitter except Residual (FM) noise is -63 db below 25 kc deviation of aural transmitter with video modulation applied to visual transmitters.

Power Supply:

- Standby Operation.....15 watts, with master crystal oven operating 115/230 volts; 50/60 cycles
- Normal Operation.....Max. demand 265 watts, with all thermostats on. Min. demand 240 watts, with all thermostats off. 115/230 volts; 50/60 cycles.

Mechanical Specifications

- Dimensions (overall).....19" wide, 21" high, 16" deep
- Weight 75 lbs.
- Finished (Panel).....Umber gray or available in other colors to match station equipment
- Ambient Temperature Range.....10-45°C

Equipment Supplied

- General Radio Type 1184-A Television Transmitter MonitorGR-1184-A
- Monitor complete with one set of tubes and instruction booklet. (Specify channel and offset if any.)

TV SIDE BAND RESPONSE ANALYZERS

VHF TYPE BW-5B, and UHF TYPE BWU-5B



FEATURES

- Accurately measures overall transmitter frequency response without necessity for internal connections and with transmitter at normal power output
- Visually separates and presents upper and lower sideband response
- Provides immediate evaluation of transmitter tuning adjustments and their effect upon sidebands
- New high quality video sweep oscillator
- Includes blanking which provides base line for measuring relative amplitudes
- Marker with a dial calibrated in $\frac{1}{4}$ mc intervals for frequencies above and below carrier frequency

USES

The sideband response analyzer is a device for measuring the overall "amplitude versus frequency" characteristic of a VHF television transmitter. In conjunction with an oscilloscope it visually presents and separates both the upper and lower sideband response. Its primary use is for tuning the over-coupled broadband r-f circuits of television transmitters and measuring their amplitude response characteristic. Since it includes a video sweep oscillator, it can also be used in adjusting video amplifiers, modulators, etc.

The type of analyzer required for a TV station is listed below:

FOR VHF
Type BW-5B

FOR UHF
Type BWU-5B

DESCRIPTION

The BW-5B and BWU-5B Sideband Response Analyzers provide for the display, on a suitable oscilloscope, of the entire sideband frequency response capabilities of any TV transmitter including its sideband filter. Such visual presentation permits immediate evaluation of transmitter adjustment without laborious point-to-point curve plotting, and facilitates the adjustments by indicating the effectiveness of the adjustments as they are made.

The BW-5B analyzer consists of video sweep generating circuits to provide transmitter modulation; calibrated marker circuits to develop a continuously variable frequency marker; synchronized receiver circuits to develop

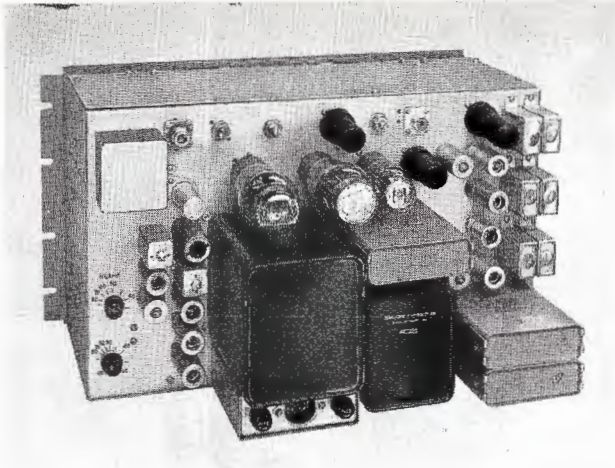

Top-of-chassis view of the Sideband Response Analyzer, BW-5B.

vertical deflection for the oscilloscope and to insure a narrow passband for a high definition sideband response presentation; sweep generating circuits, which include retrace, blanking, and phasing facilities, to develop horizontal deflection for the oscilloscope; and power supply circuits all assembled on a recessed box chassis suitable for assembly in a relay rack. Operating controls for the unit are all mounted on the front panel which is held in position by two captive knurled screws at the top edge.

The panel can be swung down to give access to the interior for ease of maintenance. A three-contact connector on the panel provides connection to an oscilloscope. Other connections to the unit are made at the rear of the chassis. The necessary output cable, power cord, and connectors are all supplied with the equipment.

The BWU-5B includes all the equipment furnished by the BW-5B and in addition has an r-f input section, MI-34005, built on a 3½-inch panel and chassis designed to mount in a standard 19-inch rack. The r-f unit with tubes in place, power cord, and output cable, are required to modify the BW-5B for operation on the UHF television channels. The BWU-5B also provides a special UHF Housing Unit, Directional Coupler, MI-19396-1, and connectors. Except for the frequency ranges covered, the BW-5B and the BWU-5B equipments function similarly.

Basically the analyzer, both BW-5B and BWU-5B, provides modulation for the transmitter by mixing the output of a 130-mc fixed oscillator with the output of a sweep oscillator, which varies in frequency above and below 130 mc to the amount required (see block diagram). The mixer provides a video signal swept at twice power line frequency which is amplified and applied as modulation to the transmitter. The output voltage of this circuit is indicated on a push-to-read meter.

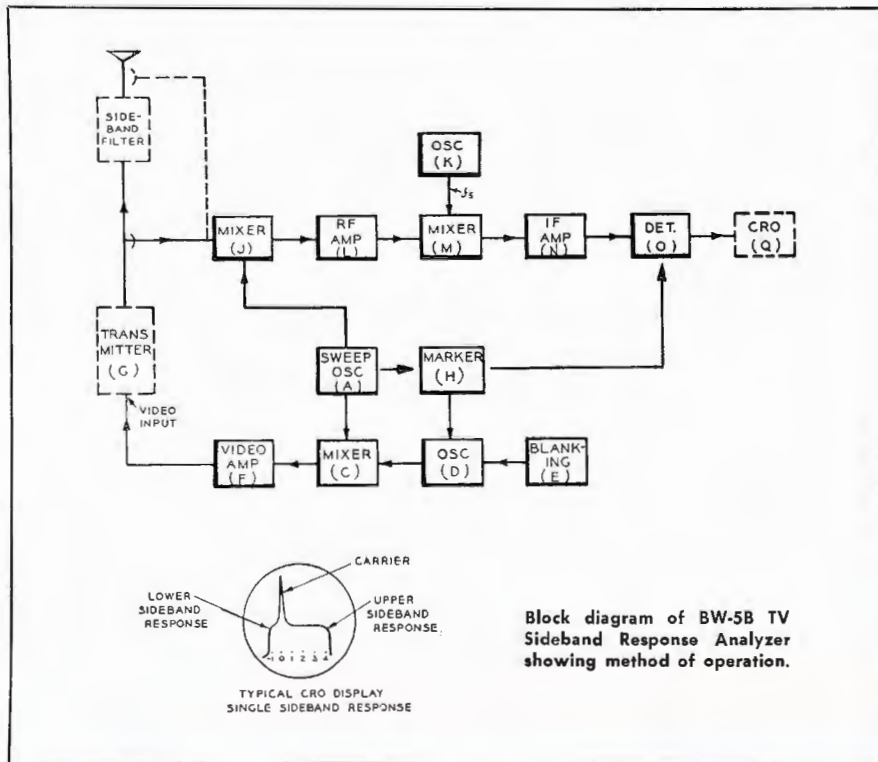

The transmitter modulated output is sampled and mixed with the sweep oscillator output. Among the many sum and difference frequencies that occur in the output of the R-F Mixer, a constant frequency component will exist due to the combination of the instantaneous sweep frequency with one of the transmitter sideband frequencies. This component is selected by the fixed-tuned receiver and the output of the receiver is fed to an oscilloscope, the sweep of which is properly phased to agree with the sweep frequency variations. The resultant pattern displays the transmitter sideband response over the range of modulation frequencies employed.

Circuits are included that develop a marker pulse which can be adjusted to indicate the frequency at any point on the pattern by means of a calibrated dial and knob. Blanking is provided to eliminate pattern retrace but can be cut off by means of a panel mounted switch. Power supply circuits in the chassis provide heater and regulated plate voltages for the equipment.

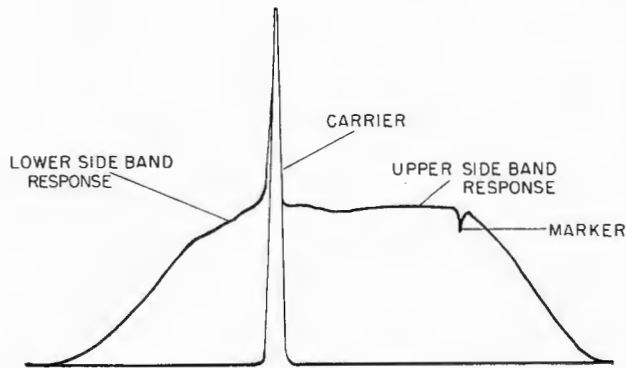

Typical response pattern of the BW-5B Sideband Analyzer, illustrating the wave shape of lower and upper sidebands.

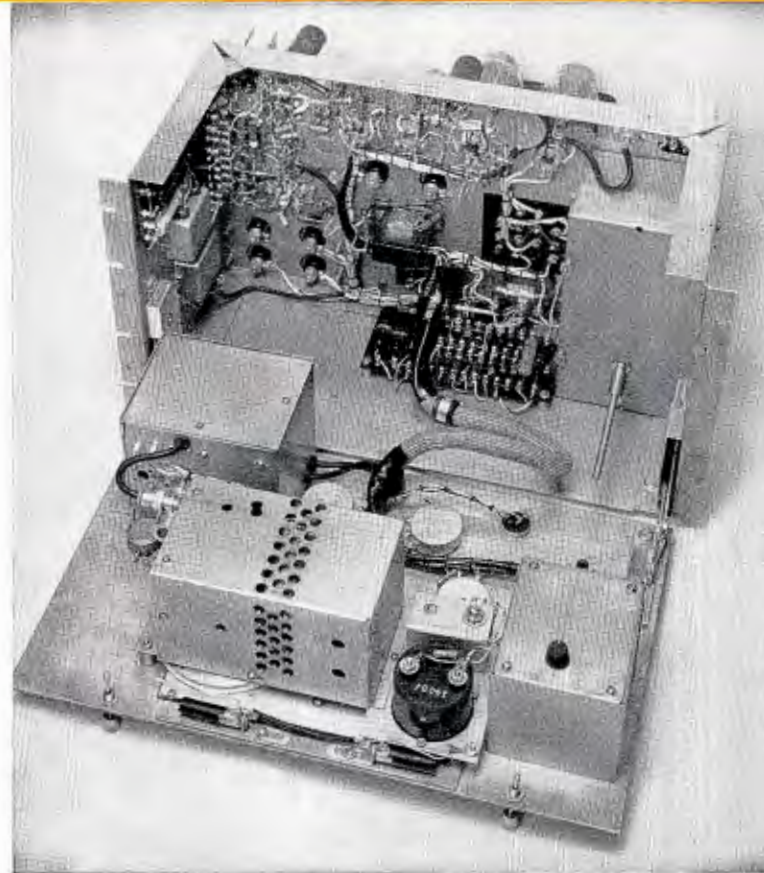

BW-5B with door open and cover removed.

the sampled output frequency of a UHF television transmitter to a channel 7 frequency, within the normal range of the BW-5B analyzer. The r-f input section which functions as this conventional superheterodyne converter has power switch, indicator lamps, and fuses mounted on a sub panel behind a cutout in the front door. Most of the operating controls are located behind this hinged door which may be opened when adjustments are required.

To provide maximum utility, a portable type oscilloscope is recommended for use with the analyzer. A 35-foot cable is supplied which allows the indicator to be readily moved to any vantage point within the limit of cable length. Other additional equipment necessary to make a complete installation, but not supplied except by separate order include, RG-11U coaxial cable, MI-83, and RG-8/U coaxial cable, MI-74 as required. In some installations a directional coupler, MI-19396-1 and section of 3 1/8", 51.5-ohm coaxial transmission line with 1 1/2-inch hole for the directional coupler, MI-19396-3, may be necessary.

Operation on the UHF channels is made possible through the use of a wide-band frequency converter which changes

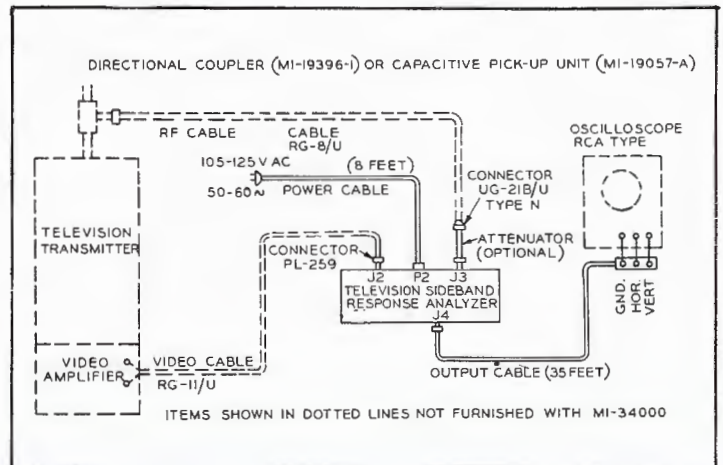

VISUAL SIDEBAND DEMODULATOR

VHF Type BW-4B

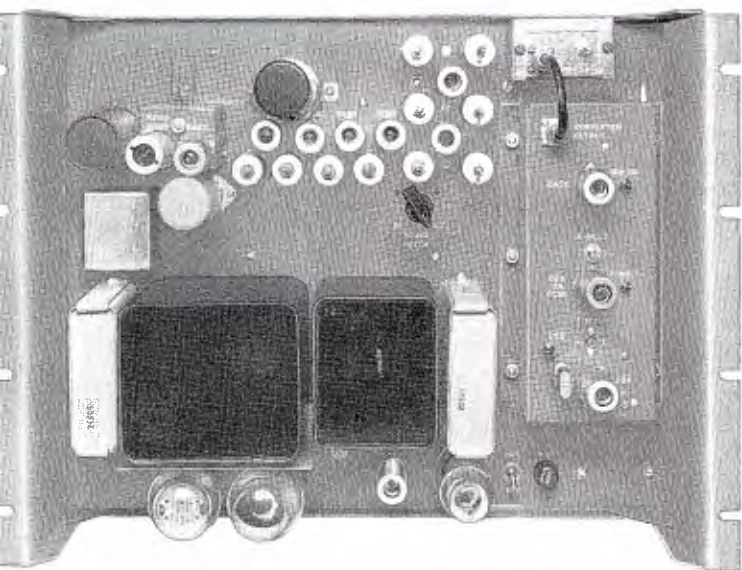

PH-83574-1

USES

The BW-4B Visual Sideband Demodulator is designed for use with Television Master Monitors to permit a visual quality observation of either monochrome or color signals delivered to the antenna of a VHF television transmitter. The picture information supplied by the instrument is equivalent to that which would be obtained from an ideal television receiver located remotely from the station. This signal is free from interference by the accompanying aural transmitter.

The BW-4B provides the following information: (1) waveform characteristics such as wave shape, percent sync, white compression, depth of modulation, resolution and transient response, envelope delay, and (2) a composite picture of the radiated TV signal to serve as a basis for checking compliance with EIA and FCC standards.

A directional coupler, MI-19396-1B, designed to mount in a 3/8-inch transmission line, is included as part of the demodulator equipment. This coupler samples the transmitter output and supplies the resultant signal to the converter unit. This coupler may be inserted into the transmission line at any of several points between the vestigial sideband filter and the antenna. If a filterplexer is used, the directional coupler must be installed between the filterplexer and the antenna.

FEATURES

- Monitor transmitter output any channel 2 to 13
- Directional coupler may be mounted anywhere in transmission line
- Complete sound rejection monitoring at any point
- Remote operation of modulation base line reference
- Insensitive to stray r-f fields
- Affords accurate measurement of phase delay
- Transient response comparable to ideal 4.2 mc filter

DESCRIPTION

The BW-4B demodulator is basically a superheterodyne receiver designed for vestigial sideband reception and includes a crystal-controlled r-f to i-f frequency converter, a sound rejection circuit, a wing trap, four stages of i-f amplification, a video detector, a video amplifier, and a delay equalizer. The frequency conversion circuits are assembled on a small, separate chassis which is mounted on the main i-f and power supply chassis.

The demodulator is provided with a very sharp notch type filter to remove sound from a video signal required for program monitoring when the r-f input signal to the demodulator may have both signals present. A mechanical 50/60 cycle chopper, which may be controlled from a remote location, is included as part of the i-f section. When this chopper is energized, it will apply a negative cut-off bias to tubes in the i-f section at a 50/60 cycle rate, and thereby provide a zero level base line on the monitor oscilloscope screen. The video output level is dependent on the level of the r-f input signal which should be adjusted to produce a peak of sync level of video of two volts across a 75-ohm termination. A switchable six db pad is provided in the output circuit to reduce the output to one volt peak of sync.

The demodulator is compensated for its delay when used without the sound notch. When used with a program as a monitor, the delay introduced by the addition of the sound notch is reasonably corrected by the receiver delay equal-

izer which is normally used in the video circuit preceding the transmitter input to compensate for high frequency cut-off of the average color receiver. The Type BW-4B equipment is used to monitor television channels, 2 to 13.

SPECIFICATIONS

Electrical Specifications

- Power.....105-125 volts, 50/60 cycles, 200 watts
- Operating Conditions.....5°C to 45°C ambient temperature
0-95% relative humidity
- R-F Input
 - Frequency.....55.25-83.25 mc (channels 2 to 6)
175.25-211.25 mc (channels 7 to 13)
 - Voltage.....less than .5V RMS direct for 14V carrier pip
less than 1.0V RMS with 6 db R-F attenuator
 - Impedance51 ohms
- Outputs
 - Receiver Signal
 - Output Termination.....high impedance oscilloscope input
 - Linearity.....error referred to 14V carrier pip

| | |
|-----------|-----------------|
| Indicated | Actual Response |
| -25 db | -24 db |
| -30 db | -28 db |
| -35 db | -33 db |
 - Noise Level.....greater than 50 db below 14V
 - Receiver Gain Control Range.....10 db
- Video Sweep
 - Voltage.....0 to 2V peak-to-peak
 - Frequency.....10-0-10 mc sweep width continuously adjustable
 - Center Frequency.....Adjustable ± 2 mc
 - Sweep Rate.....Power line frequency
 - Repetition Rate.....2X power line frequency
 - Frequency Response..... $\pm .5$ db 70 KC to 5 mc
 ± 1.0 db 50 KC to 7 mc
 - Distortion.....less than 3% at 2V p.p.
- Oscilloscope Sweep
 - Open Circuit Voltage.....4.5V p.p.
 - Frequency.....same as power line
 - Wave Form.....same as power line
 - Internal Impedance.....12,000 ohms
 - Phase Adjustment $\pm 70^\circ$

Tube Complement

- I-F, Video and Power Supply Unit:

| | |
|----------|--------|
| 2-6C4 | 1-1N64 |
| 4-6CB6 | 1-6AS7 |
| 1-5R4-GY | 1-OC3 |
| 1-6AK7 | 1-6197 |
| 1-6485 | |
- VHF Converter Unit:

| | |
|---------------------|--------|
| 1-6J6 | 1-6AS6 |
| 1-6CB6 (Chan. 7-13) | |

Mechanical Specifications

- Dimensions (overall):
 - I-F, Video and Power Supply Chassis.....19" wide, 14 1/2" high, 10 1/2" deep
 - VHF R-F Converters.....9 1/2" long, 4 1/2" wide, 4 1/2" high
 - Directional Coupler.....3" long, 2" wide, 2" high
 - VHF Coupler Housing (MI-19396-3).....12" long, unflanged to fit 3 1/8" 51.5 ohm VHF transmission line
- Weight58 lbs.
- Finish.....Dark umber gray

Equipment Supplied

- VHF Type BW-4B Visual Sideband Demodulator.....MI-34057
- Complete with tubes in place and including housing (MI-19396-3), Directional Coupler (MI-19396-1B), Channel Frequency Crystal (MI-34008-A) for operating channel specified in sales order and instruction book.

Optional and Accessory Equipment

- Senior VoltOhmystWV-98A
- Plate Current Meter.....MI-21200-C1
- Wideband Oscilloscope, Type TO-524AD.....MI-26500-A
- Marker GeneratorWR-99A
- Television Sweep Oscillator.....WR-69A
- Chopper RelayMI-26567
- Complete Spare Tube Kit for BW-4B.....MI-34014-A
- VHF Monitoring Diode.....MI-19051-B
- WA-6A Color Signal Analyzer.....ES-40950
- WA-7C Linearity Checker.....MI-34017-B
- BW-5B Sideband Response Analyzer.....ES-34010-A

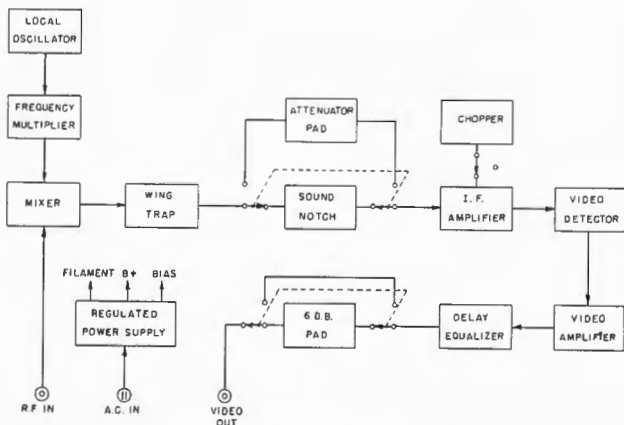

Block diagram of BW-4B Demodulator.

VISUAL SIDEBAND DEMODULATOR

UHF Type BWU-4A

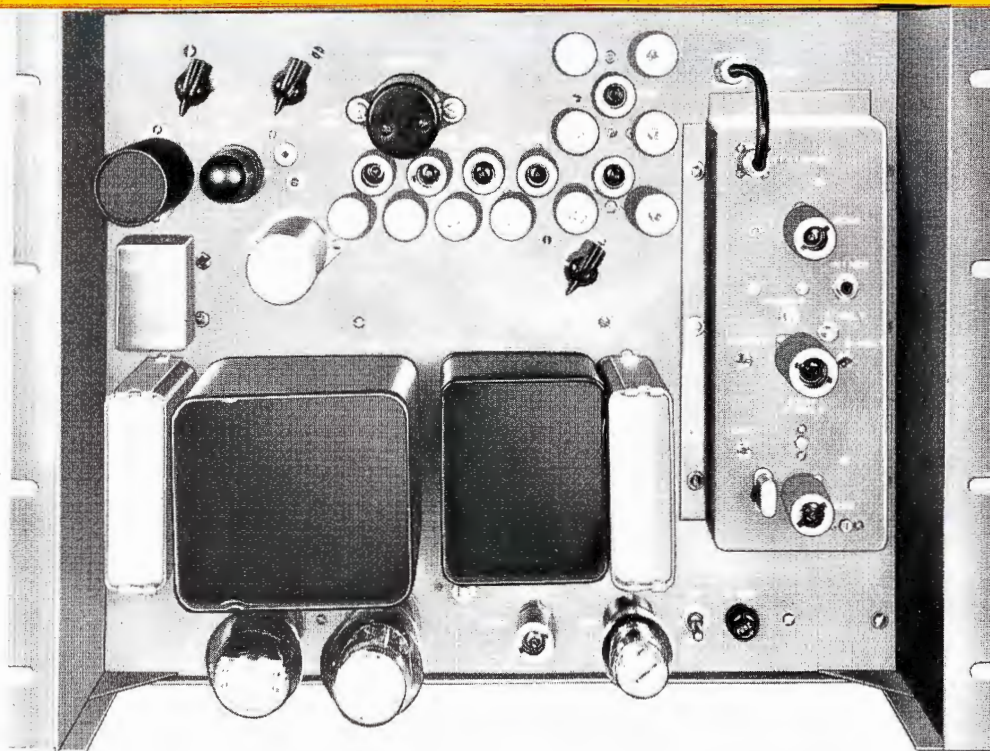

FEATURES

- Monitor any channel 14 to 83
- Directional coupler may be mounted anywhere in transmission line
- Complete sound rejection monitoring at any point
- Remote operation of modulation base line reference
- Switchable phase compensation for VSB reception
- Insensitive to stray r-f fields
- Diode monitoring with envelope detection using directional coupler
- Facilitates a complete, continuous signal quality check

USES

The Visual Sideband Demodulator, Type BWU-4A, is designed for use with Television Master Monitors to permit a visual, quality observation of the signal delivered to the antenna by a UHF TV transmitter. The picture information supplied by the instrument is equivalent to that which would be obtained from an ideal television receiver located remotely from the station. This signal is free from interference by the accompanying aural transmitter.

The BWU-4A provide the following information: (1) waveform characteristics such as wave shape, percent sync, white compression, depth of modulation, resolution and transient response, and (2) a composite picture of the radiated TV signal to serve as a basis for checking compliance with EIA and FCC standards.

DESCRIPTION

The TV demodulator is basically a superheterodyne receiver designed for vestigial sideband reception and includes a crystal-controlled r-f to i-f frequency converter, a sound rejection circuit, four stages of i-f amplification, a video detector, and a video output stage. The frequency conversion circuits are assembled on a small, separate chassis which is mounted on the main i-f and power supply chassis.

A directional coupler, MI-19396-1, designed to mount in a 3/8-inch transmission line, is included as part of the demodulator equipment. This coupler samples the transmitter output and supplies the resultant signal to the converter unit. This coupler may be inserted into the transmission line at any of several points between the vestigial side-

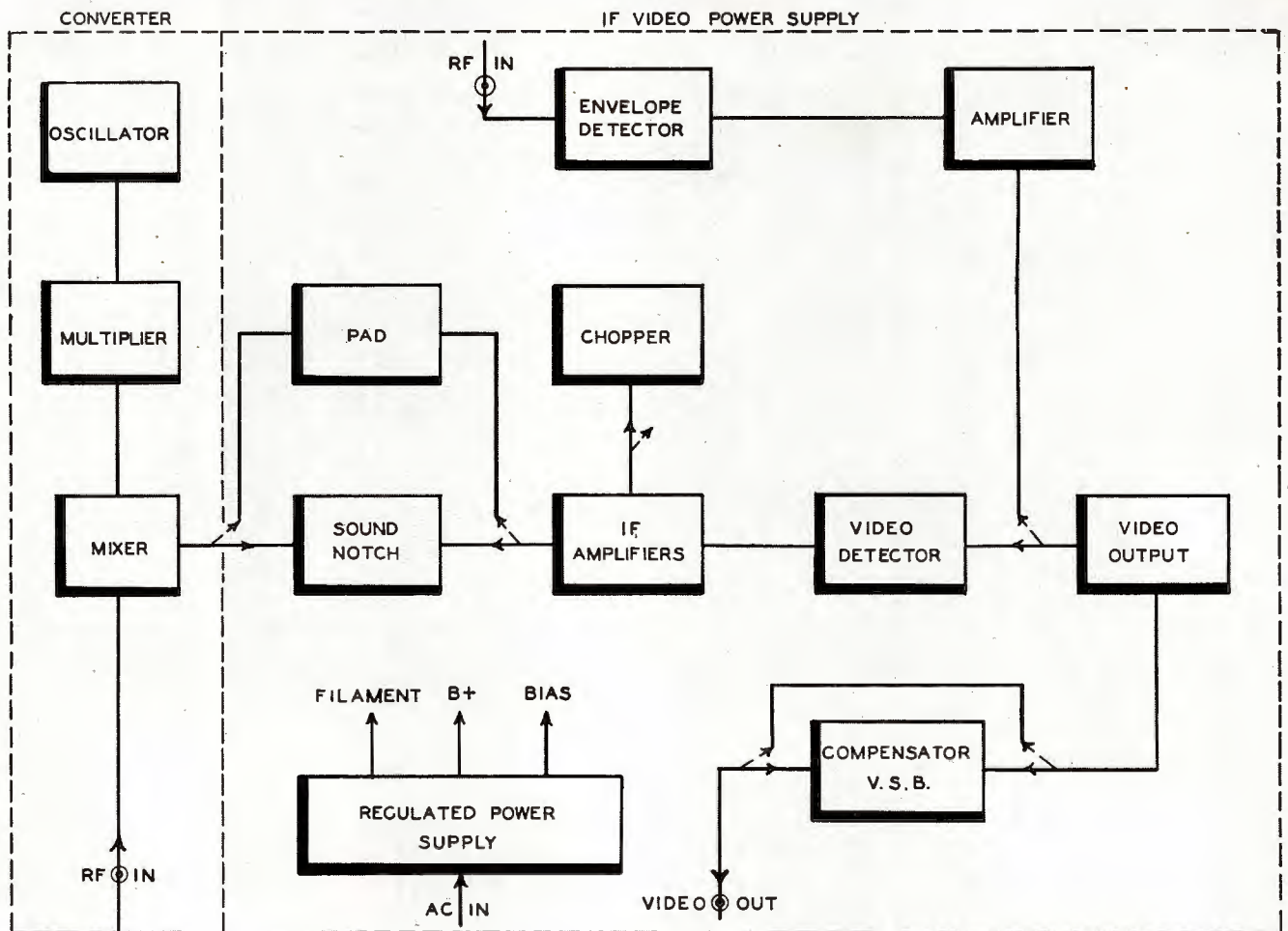

Block diagram of BWU-4A Demodulator.

band filter and the antenna. By installing it in one of the feed lines between the diplexer and the antenna, mismatches in the line being monitored will be readily evident. With this installation, however, mismatches may not be detected in the second antenna feed line unless provision is made for sampling the signal in this line also.

Alternatively, the directional coupler may be inserted into the transmission line between the sideband filter and the diplexer. This location will not be as sensitive to antenna mismatch as the antenna feed line installation. If a filterplexer is used, the directional coupler must be installed between the filterplexer and the antenna. Monitoring next to the antenna, however, places a more stringent requirement upon the sound rejection notch in the demodulator due to the presence of full sound carrier power in the transmission line.

When tests are to be made of the video transmitter outside of regular program periods, the aural transmitter may be shut down and the sound notch on the TV demodulator switched out of the circuit. This gives a wider amplitude response and an improved high frequency phase characteristic. Such characteristics are useful in monitoring the transient response of the transmitter.

Vestigial sideband transmission of television signals introduces a characteristic phase distortion into the detected video signal. Although not usually discernible during regular program telecasting, this distortion will be clearly evidenced by leading whites and trailing smears when a test pattern is used. To correct this distortion, a phase compensating network which may be switched into the video output circuit is provided. This corrects the low frequency phase error of the demodulator.

A mechanical 50/60 cycle chopper, which may be controlled from a remote location, is included as part of the i-f section. When this chopper is energized, it will apply a negative cut-off bias to tubes in the i-f section at a 50/60 cycle rate, and thereby provide a zero level base line on the monitor oscilloscope screen.

The output signal from the TV demodulator includes synchronizing pulses and video from the transmitted signal, and is intended to be coupled to the master monitor through a 75-ohm coaxial line.

The envelope detector is used to enable observation of the overall response envelope of the television transmitter when the transmitter is being modulated by a video sweep generator. For this application, the lead from the directional coupler, normally connected to the converter unit at the converter r-f input jack, is connected to the diode input jack. When the video output is connected to the vertical terminals of an oscilloscope the swept response of the transmitter may be observed.

SPECIFICATIONS

Performance Specifications

R-F CONVERTER UNIT

| | |
|----------------------|--|
| Frequency Range..... | Channels 14-83 |
| Input Required..... | Approximately 1 to 2 volts r-f |
| Output..... | Video sound carrier i-f frequency, 25 mc Sound carrier i-f frequency, 20.5 mc |
| Stability..... | Crystal frequency deviation less than $\pm 0.002\%$ |

I-F AND VIDEO UNIT

| | |
|-----------------------------|---|
| I-F Bandwidth..... | -1.5 db at 4 mc with sound notch -1.5 db at 5 mc without sound notch |
| Low Frequency Response..... | Less than 2% tilt to 60 cycle square wave |
| Sound Rejection..... | More than 50 db to aural signal at ± 25 kc deviation from carrier frequency |

Transient Characteristics:

Tested with 100 kc Square Wave,

| | |
|--|---|
| Anticipatory Undershoot..... | 18% of axis separation |
| Rise Time..... | With sound notch .13 microseconds Without sound notch .09 microseconds |
| Ringing Frequency..... | 4.5 mc with sound notch |
| Amplitude of First Positive Overshoot..... | 10% of axis separation |
| Amplitude of First Negative Overshoot..... | 6% of axis separation |
| Axis of Cutoff Transient..... | Does not deviate more than -10% or +3% of axis separation |
| Sensitivity..... | Approximately 0.05 volts input for 1.5 volts peak sync output across 75 ohms |
| Output Voltage..... | Maximum 1.5 volts peak of sync across 75 ohms output impedance; sync negative |

ENVELOPE DETECTOR

| | |
|-------------|---|
| Input..... | Maximum available (up to 5 volts). Input connector terminated by external pad. Transmitter to be modulated with video sweep signal. |
| Output..... | Varies with input (may be observed on any standard oscilloscope) |

Electrical Specifications

| | |
|--------------------------|--|
| Power Source..... | 105-125 volts a-c, 50/60 cycles, single phase |
| Power Input..... | .250 watts (3 amp. slo-blo fuse) |
| D-C Output Voltages..... | .250 volts regulated; -10 and -3 volts unregulated |
| Ambient Temperature..... | -15° C to 45° C |

Tube Complement

I-F, Video and Power Supply Unit:

| | |
|--------|--------|
| 2-6C4 | 1-1N64 |
| 4-6CB6 | 1-6AS7 |
| 1-5V4 | 1-OC3 |
| 2-6AK6 | 1-1N72 |
| 1-6AG7 | |

UHF Converter Unit:

| | |
|----------|--------|
| 1-6J6 | 1-6CB6 |
| 1-6BQ7-A | 1-1N72 |

Mechanical Specifications

I-F, Video and Power Supply Chassis:

| | |
|-----------------|-----------------------------|
| Dimensions..... | 19" wide, 14" high, 9" deep |
| Weight | 30 lbs. |

UHF R-F Converters (mounts on I-F, Video and Power Supply Chassis):

| | |
|-----------------|---------------------------------------|
| Dimensions..... | 9 1/2" long, 4 1/2" wide, 4 1/2" high |
| Weight | 2 lbs. |

Directional Coupler:

| | |
|-----------------|---------------------------|
| Dimensions..... | 3" long, 2" wide, 2" high |
| Weight | 2 3/8 lbs. |

UHF Coupler Housing (MI-19362-2).....

6" long, flanged each end to fit 3 1/8" 50 ohm UHF transmission line

Equipment Supplied

| | |
|---|-------------|
| UHF Demodulator, Type BWU-4A..... | ES-34007 |
| Including the following: | |
| 1 I-F, Video, and Power Supply Chassis..... | MI-34002 |
| 1 UHF R-F Oscillator Converter..... | MI-34004 |
| 1 Directional Coupler..... | MI-19396-1 |
| 1 Housing | MI-19396-2 |
| 1 Channel Frequency Crystal..... | MI-34008-A* |
| (*Supplied for specific operating channel) | |
| 1 Cable Kit..... | MI-34013 |
| 1 Instruction Book..... | IB-36160 |

Optional and Accessory Equipment

| | |
|---|-------------|
| Senior VoltOhmyst | WV-98A |
| Plate Current Meter..... | MI-21200-C1 |
| Wideband Oscilloscope TO-524AD..... | MI-26500-A |
| Morker Generator | WR-99A |
| Television Sweep Oscillator..... | WR-69A |
| Chopper Relay | MI-26567 |
| Complete Spare Tube Kit for BWU-4A..... | MI-34015 |
| UHF Monitoring Diode..... | MI-19364 |

VHF MONITORING DIODE MI-19051-B

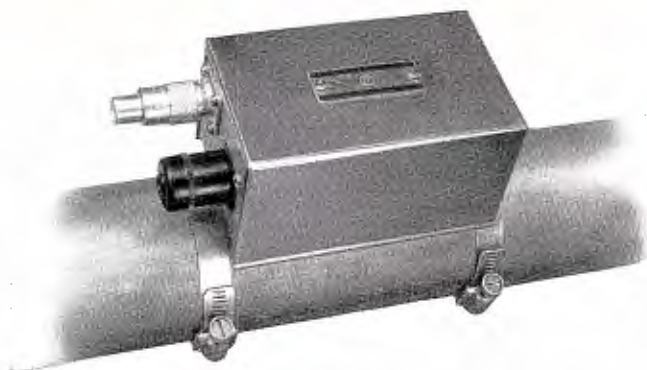

FEATURES

- Requires no external power supply
- Requires no maintenance or periodic adjustment
- Will fit either 3 1/8" or 1 5/8" line without changes in unit
- Input circuit compensated for uniform r-f pickup over the 12 VHF channels

USES

The Monitoring Diode, Type MI-19051-B, is a completely self-contained unit designed for mounting on the r-f transmission line between the output of the visual TV transmitter and the sideband filter. The video output of the Monitoring Diode when fed to a master monitor, or equivalent unit, will permit observation of the picture delivered by the TV transmitter. The diode unit has excellent frequency and linearity response and is designed for use on TV channels 2 to 13.

DESCRIPTION

MI-19051-B consists of a double section diode whose cathodes are capacity coupled by a probe to the transmission line inner conductor. The plates are connected through a load resistor network to the 75-ohm output circuit. The output network provides a 75-ohm output impedance to match coaxial cable impedance and provides optimum performance in color TV systems. Filament voltage for the diode is supplied by a self-contained transformer which requires 115 volts a-c supply. The unit is designed for 3 1/8" and 1 5/8" transmission line.

SPECIFICATIONS

| | |
|----------------------------------|--|
| Frequency Range..... | Channels 2-13 inclusive |
| Output Impedance..... | 70 ohms |
| Output Voltage..... | .75 v.—1.0 v. (adjustable by varying pickup) |
| Dimensions (overall)..... | 7 5/8" long, 3 1/8" wide, 3 3/8" high |
| Weight..... | 3 lbs. approximate |
| Tube Complement, 1 RCA 6AL5..... | Diode Rectifier |
| Stock Identification | MI-19051-B |

UHF MONITORING DIODE MI-19364

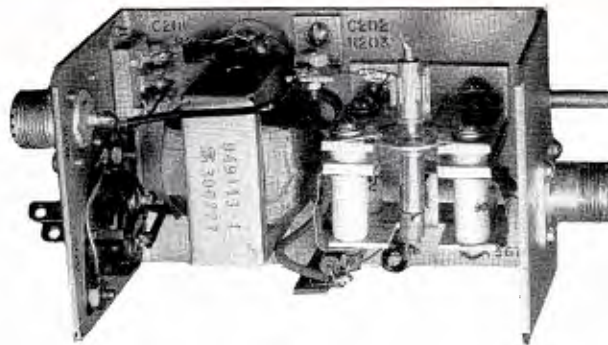

FEATURES

- Permits CRO display of Modulation envelope in conjunction with video sweep input to the transmitter in L position
- Input circuit compensated for uniform r-f pickup over all UHF channels
- Automatically energized whenever monitoring equipment is in operation

USES

The UHF Monitoring Diode, MI-19364, is designed for mounting at any point on the visual transmission line between the transmitter and the filterplexer. The video output of the unit when fed to the master monitor or equivalent unit will permit observation of the picture delivered by the TV transmitter. It is designed for use on UHF channels 14-83.

DESCRIPTION

The MI-19364 UHF Monitoring Diode consists of a triode serving as a diode whose cathodes are capacity coupled by a probe to the transmission line inner conductor. The plates are connected through a load resistor to the 75-ohm output circuit. Filament voltage for the triode is supplied from a 115-volt a-c supply. A directional coupler, is required for use with the diode, and RG-11/U cable is run to the control console, where it can be located in any position on the console. The unit is designed together with its coupler for mounting on 3 1/8-inch or 6 1/8-inch coaxial transmission line.

SPECIFICATIONS

| | |
|------------------------------|-----------------------------------|
| Frequency Range..... | Channels 14-83 |
| Output Impedance..... | 75 ohms |
| Output Voltage..... | 1 volt peak-to-peak |
| Tube Complement, 1—5675..... | Pencil triode |
| Dimensions (overall)..... | 6 1/4" long, 3" wide, 2 1/2" high |
| Weight | 3 lbs. approximate |
| Stock Identification | MI-19364 |

ACCESSORY EQUIPMENT

| | |
|---|----------|
| Directional Coupler for 3 1/8" Transmission Line 51.5 ohm..... | MI-27379 |
| Directional Coupler for 6 1/8" Transmission Line 75 ohm..... | MI-27382 |
| Directional Coupler for 3 1/8" Universal Transmission Line 50 ohm..... | MI-27385 |
| Directional Coupler for 6 1/8" Universal Transmission Line 75 ohm..... | MI-27387 |

R-F LOADS AND WATTMETERS

FEATURES

- Combines dummy TV antenna and r-f power-measurement functions
- Easily installed—occupies little space
- Power indications given directly in watts
- Meets FCC standards
- Wide choice of ratings (300 w, to 50 kw) at any VHF or UHF frequency

USES

The R-F Loads and Wattmeters are designed for use in measuring the power output of the aural and visual sections of television transmitters. The load properly terminates the output of either the visual or aural transmitter and gives a measurement of the average r-f power as required by FCC standards. It is also used as a dummy antenna for transmitter tuning. A choice of ratings is available for any frequency between 54 mc and 890 mc and for any power level.

DESCRIPTION

The RCA Series of R-F Loads and Wattmeters consists of a resistor element for terminating a transmission line in its characteristic impedance, and a current indicating meter for measuring power dissipated. The power dissipating section consists of a resistor unit immersed in a coolant liquid, which is cooled by air in the low power units, by tap water in the medium power units, and by forced water in high power loads. In order to prevent excessive use of tap water during the time the r-f power is at a low level, a water saver is used in most cases. This consists of a thermostatically controlled solenoid valve which allows the water to flow only when needed.

The power measuring section consists of a short length of transmission line (Thru-line), a meter, and a wattmeter

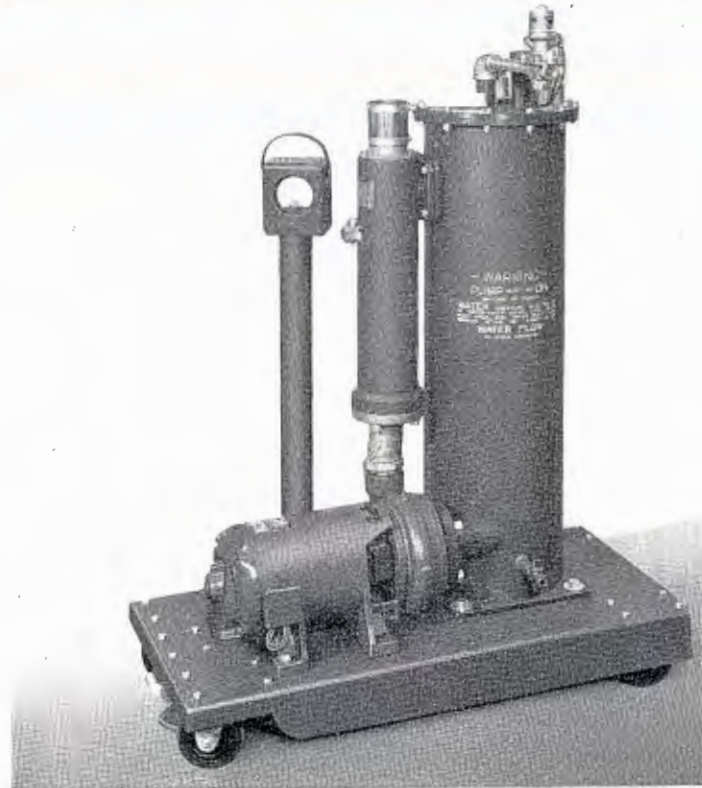

MI-19193-L/H R-F Load and Wattmeter (see p. 4 for Specifications)

element. A socket is provided on the side of the transmission-line-coupling section to accommodate a calibrated wattmeter element, which, when coupled to the transmission line, develops a d-c current approximately proportional to the forward wave voltage across the load resistor. This current is supplied to a remote meter calibrated to indicate directly the power dissipated in the load.

The wattmeter element is a reflectometer which consists of a coupling loop, a crystal detector, and a filter network. The wattmeter element may be rotated 180° in the transmission line housing. This permits it to indicate the incident power to the load, or the reflected power from the load. The MI-19198-A and MI-19024-A models differ in important respects from the above, and are described hereafter.

R-F Loads and Wattmeters for TV Transmitters

| MI Number | Frequency | Ave. Power | Usable Range | Input Imped.* | Type of Cooling |
|-----------|-----------|------------|---------------|---------------|---------------------------------|
| 19196-L/H | Ch. 2-13 | 1200 W VHF | 0 to 1200 W | 50/51.5 ohms | Natural Air Convection |
| 19197 | Ch. 14-83 | 1200 W UHF | 0 to 1200 W | 50 ohms | Natural Air Convection |
| 19024-A | Ch. 2-13 | 3 KW VHF | 1.0 to 5 KW | 50/51.5 ohms | Tap Water (1 GPM) |
| 27396 | Ch. 2-13 | 7.5 KW VHF | 1.0 to 7.5 KW | 50/51.5 ohms | Tap Water (4 GPM) |
| 19198-A2 | Ch. 14-83 | 25 KW UHF | 0.1 to 25 KW | 50 ohms | Tap Water (5.5 GPM) |
| 19193-L/H | Ch. 2-13 | 25 KW VHF | 0 to 25 KW | 50/51.5 ohms | Water & Pumped Coolant (10 GPM) |
| 19191-L/H | Ch. 2-13 | 50 KW VHF | 0 to 50 KW | 50/51.5 ohms | Water & Pumped Coolant (20 GPM) |

* Specify 50 or 51.5 ohms impedance as required for channels 2-13.

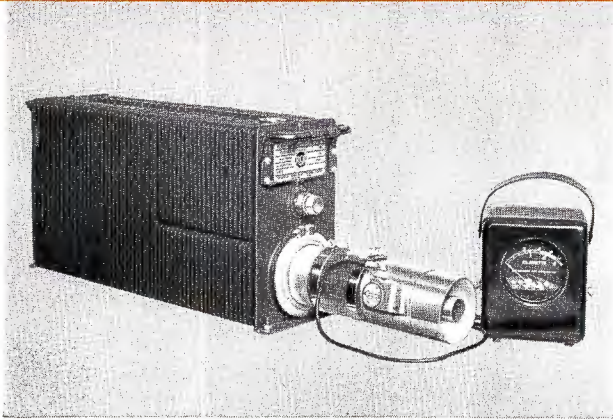

The MI-19196-L/H is a natural air-convection-cooled portable unit, which may be connected to either the transmitter output, the sideband filter output, or either output of the diplexer.

MI-19196-L/H

The RCA 300/1200-Watt R-F Load and Wattmeter (2 kw peak picture power) is an air-cooled, termination type unit for operation in either the 54 to 108 mc (MI-19196-L) or 108 to 216 mc (MI-19196-H) frequency range. It is equipped with unflanged fitting for 3 1/8"–50/51.5 ohm line and is designed for use with TT-500A/B and TT-2AL/AH RCA VHF transmitters. The equipment's power dissipating section consists of the load resistor and a liquid coolant which are contained in a finned radiator structure. The power measuring section consists of a short length of transmission line (ThruLine), a meter, and two wattmeter elements which provide 0 to 375-watt or 0 to 1500-watt full-scale meter deflection. Connection between the power measuring section and the power dissipating section is made by means of an inner conductor connector and a straight coupling.

Equipment Supplied

1 R-F Load Assembly, 1 Straight Coupling, 1 Inner Conductor Connector, 2 Hose Clamps, 1 ThruLine Section, 1 Meter Assembly, and 2 Wattmeter ElementsMI-19196-L/H

Accessory Equipment

Adapter, Inner for MI-27912.....MI-27912-10
 Adapter, Inner for MI-19313 Coaxial Line.....MI-19313-10
 Coupling, StraightMI-19113-8
 Reducer, 3 1/8" to 1 5/8" Coaxial Line.....MI-19112-7

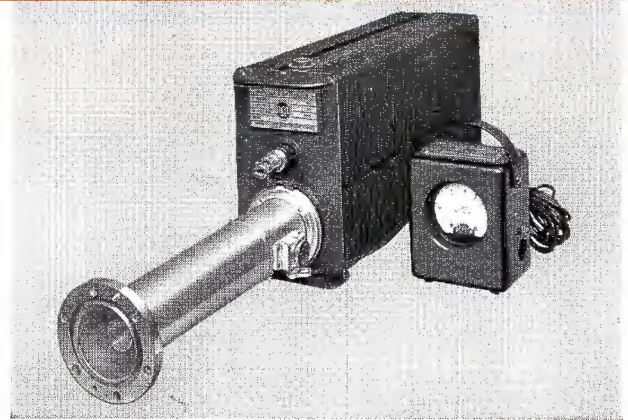

The low-power UHF MI-19197 Load and Wattmeter shown above is the companion unit to the MI-19196 VHF equipment which it resembles in appearance and operation.

MI-19197

The RCA 1200-Watt R-F Load and Wattmeter (2 kw peak picture power) is similar to the MI-19196 VHF Equipment, but designed for operation in the 470 to 890 mc UHF frequency range. It is equipped with flanged fitting for 3 1/8"–50 ohm line, and is specified for use with RCA's type TTU-1B UHF transmitter.

The MI-19197, in addition to functioning as a load, serves as the reject load resistor on the RCA MI-19086 Filter-diplexer. In this application, the inner conductor of the transmission line coupling is surrounded by a specially made sleeve, the coupling forming a matching section which will give a VSWR of 1.02 or better for the operating channel.

Equipment Supplied

1 R-F Load, 1 Meter, 1 Wattmeter Element (0-1500 watts), and 1 Wattmeter Element (0-150 watts).....MI-19197

Accessory Equipment

Reducer, 50 ohm 3 1/8" to Type N.....MI-19089-17
 Adapter, Type N to Type HN.....MI-19089-19
 Connector (anchar insulation).....MI-19089-10
 Adapter, EIA to Universal female.....MI-27791-31
 Adapter, EIA to Universal male.....MI-27791-32

MI-19024-A

The RCA 3-KW R-F Load and Wattmeter (5 kw peak visual power) is designed for use with VHF transmitters with up to 5 kw picture ratings. It is a termination type unit supplied for operation in the 54 to 216 mc frequency range. Channel frequency must be included in ordering information since the equipment is calibrated and adjusted at the factory for a particular channel. The unit may be connected to either the transmitter output, the sideband filter output, or either diplexer output. The power dissipating section consists of the load resistor, an intermediate coolant, a heat exchanger, and a flexible RG-19/U cable which

fits a 1 5/8"–51.5 ohm transmission line. The unit is cooled with tap water which enters and leaves the top of the unit through special 1/2" I.P.S. union connections. The unit is designed for wall or rack mounting.

Equipment Supplied

1 R-F Load Assembly, 1 Wattmeter, and 1 Cable, 10 feet long.....MI-19024-A

Accessory Equipment

Reducer, 3 1/8" to 1 5/8" Coaxial Line.....MI-19112-7

MI-27396

The RCA 7.5-KW R-F Load and Wattmeter (10 kw peak visual power) is a water-cooled, termination type unit for the 54 to 216 mc frequency range. A special film resistor, arranged as the center conductor of a tapered coaxial line to give an almost reflectionless termination, is used as the load resistance. This fixed or portable floor-mounting unit is equipped with unflanged fitting for 3 7/8"—50/51.5 ohm line. It is designed for use with the RCA type TT-10AL/AH VHF transmitter.

The MI-27396 Equipment employs water instead of air to cool the intermediate coolant, which has been chosen for chemical inactivity to prevent damage to the resistor. The cooling coil is a double helix of finned copper tubing which circulates water between the inner and outer helix. A water saver valve is provided to minimize water flow. It is controlled by an automatic thermostwitch so that water flows only when the intermediate coolant temperature reaches a certain maximum limit.

Equipment Supplied

- 1 R-F Load Assembly, 1 Transport, 1 Straight Coupling, 2 Hose Clamps,
- 1 Inner Conductor Assembly, 1 ThruLine Section, 1 Meter Assembly,
- 1 Water Saver Valve, and 1 Wattmeter Element.....MI-27396

Accessory Equipment

- Adapter, Inner for MI-27912.....MI-27912-10
- Adapter, Inner for MI-19313 Transmission Line.....MI-19313-10
- Coupling, StraightMI-19113-8

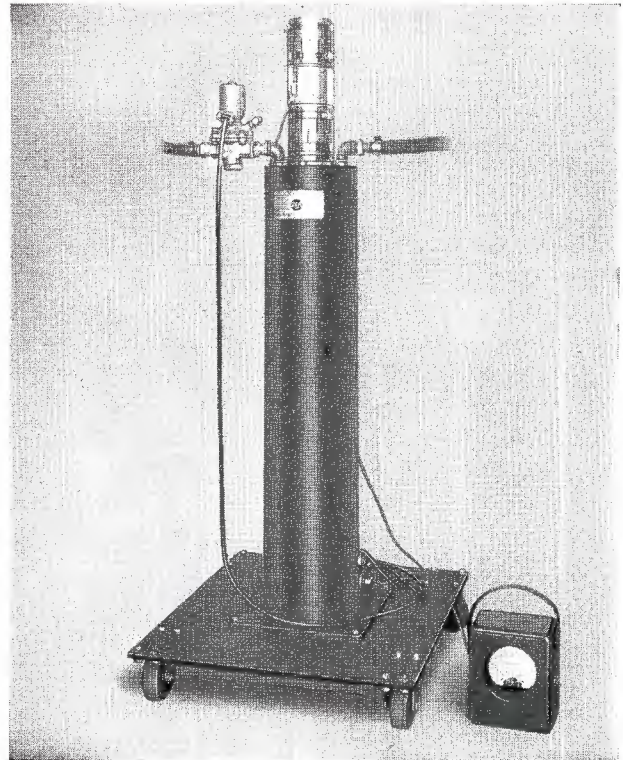

The MI-27396 7.5-kw VHF load is mounted on a wheeled truck to aid in changing connections.

MI-19198-A2

The RCA 15/25-KW R-F Load (40 kw peak visual power) is a termination type unit for operation in the 470 to 890 mc UHF frequency range. It is recommended for use with the RCA type TTU-12A and TTU-25B transmitters. Unit may be connected to either the transmitter outputs, or the output of the filterplexer. The unit is equipped with a 3 7/8"—50 ohm flanged fitting and thermostwitch.

The load utilizes a column of tap water for power dissipation rather than a liquid cooled load resistor. The input of the load consists of a polyethylene transformer section to provide a correct impedance match to the connecting line. The opposite end of the line is short circuited and contains the input and output water connections. The water flows through the inner conductor and enters the space between the inner and outer conductor through small perforations in the inner conductor adjacent to the transformer section. The water flow then continues to the output drain connection. Broadband wattmeters with scale ranges of 0 to 15 kw or 0 to 25 kw can be provided as accessory equipment with a ThruLine unit and Wattmeter element which allows direct incident power readings, or with a 180° turn, a reading of the reflected power.

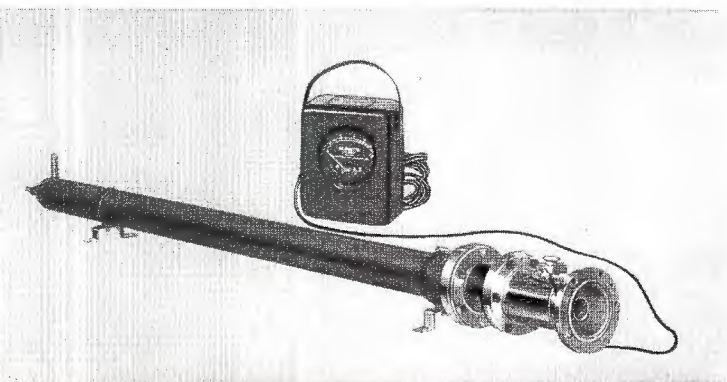

The MI-19198-A2 UHF high power load operates on the "direct-power-dissipation" principle rather than the liquid-cooled load resistor. Shown with the load is R-F Wattmeter (0-15 kw), MI-27350.

Equipment Supplied

- 1 15/25 kw R-F Load Assembly.....MI-19198-A2

Accessory Equipment

- Connector (anchor insulator).....MI-19089-10
- ThruLine R-F Wattmeter (0-15 kw).....MI-27350
- ThruLine R-F Wattmeter (0-25 kw).....MI-27363
- Adapter, to Universal female.....MI-27791-31
- Adapter, to Universal male.....MI-27791-32

MI-19193-L/H

The unit is illustrated on page 1.

The RCA 25-KW R-F Load and Wattmeter (40 kw peak visual power) is also a water-cooled termination type unit for operation in the 54 to 108 mc (MI-19193-L) or 108 to 216 mc (MI-19193-H) frequency range. It is equipped with 3 1/8"–50/51.5 ohm unflanged fitting and designed for use with RCA type TT-25-AL/AH or TT-25-BL/BH VHF transmitters.

The power dissipating sections consist of the load resistor, an intermediate coolant, a heat exchanger (cooling coil) and a motor-driven pump assembly which are mounted on a wheeled truck. Two upright steel cylinders, joined at top through a conduit, and at bottom through a motor-driven centrifugal pump, house the load resistor, coolant and cooling coil. Cooling water is forced through the helix system as in the MI-19199 model. A 115/230 volt a-c motor with a self-contained thermal overload switch drives the circulating pump. The MI-19193, -L and -H loads are equipped with 60 cps motors.

Equipment Supplied

1 Heat Exchanger, 1 R-F Load Unit Assembly, 1 Coupling, 1 Thruline Section, 1 Meter Assembly and 1 Wattmeter Element.....MI-19193-L/H

Accessory Equipment

Adapter, Inner for MI-27912.....MI-27912-10
 Adapter, Inner for MI-19313 Coaxial Line.....MI-19313-10
 Coupling, StraightMI-19113-8

MI-19191-L/H

The RCA 50-KW R-F Load and Wattmeter (84 kw peak visual power) for VHF transmitters is supplied for operation in either the 54 to 108 mc (MI-19191-L/AL) or 108 to 216 mc (MI-19191-H/AH) frequency range. It has a 6 1/8" flanged 50/51.5 ohm fitting and is designed for use with the RCA type TT-50-AH transmitter.

This forced water cooled unit is almost identical to the MI-19193 model. The power measuring section consists of a short length of transmission line (ThruLine), a meter, and a wattmeter element which reads average and not peak power values. The a-c motor used to drive the circulating pump is supplied for either 60 or 50 cps operation. The entire equipment is mounted on a wheeled truck, and is similar in appearance to the MI-19193 unit.

Equipment Supplied

1 Heat Exchanger, 1 R-F Load Unit Assembly, 1 Coupling, 1 Thruline Section, 1 Meter Assembly, 1 Wattmeter Element, 2 Hoses....MI-19191-L/H

Accessory Equipment

Coupling, StraightMI-19314-7
 Reducer, 6 1/8" to 3 1/8" for MI-19113 Transmission Line.....MI-19314-13
 Adapter, Inner for MI-27912.....MI-27912-10
 Adapter, Inner for MI-19313 Transmission Line.....MI-19313-10
 Reducer, 6 1/8" to 3 1/8" for MI-19313 Transmission Line.....MI-19313-13

SPECIFICATIONS

| Electrical Specifications | | MI-19196-L/H | MI-19197 | MI-27396 | MI-19193-L/H | MI-19191-L/H | MI-19024-A | MI-19198-A2 |
|--|--|-------------------------------|----------------------|------------------------------|---|---|----------------------------|-------------------------------------|
| Frequency Range | | 54 to 108 mc 108 to 216 mc | 470 to 890 mc | 54 to 216 mc | 54 to 108 mc 108 to 216 mc | 54 to 108 mc 108 to 216 mc | 54 to 216 mc | 470 to 890 mc |
| Power Rating (Ave.) (5000 ft. max. elev.) | | 1200 watts | 1200 watts | 7.5 kilowatts | 25 kilowatts | 50 kilowatts | 3 kw | 25 kw |
| R-F Input Impedance | | 50/51.5 ohms | 50 ohms | 50/51.5 ohms | 50/51.5 ohms | 50/51.5 ohms | 51.5 ohms | 50 ohms |
| A-c Power Input..... | | ----- | ----- | ----- | 115/230 volts, 50/60 cycles, single phase | 115/230 volts, 50/60 cycles, single phase | None (tap water cooled) | None (tap water cooled) |
| Power Consumption | | ----- | --- | --- | 1.125 kw | 1.125 kw | ----- | ----- |
| Ambient Air Temp.: | | | | | | | | |
| Maximum | | 45° C | 45° C | 45° C | 45° C | 45° C | 45° C | 45° C |
| Minimum | | 15° C | 15° C | 15° C | 15° C | 15° C | 15° C | 15° C |
| Mechanical Specifications | | | | | | | | |
| Mounting | | Horizontal | Horizontal | Floor (fixed or portable) | Floor (fixed or portable) | Floor (fixed or portable) | Vertical surface | Horizontal, water output up |
| Coolant Capacity | | 1.7 gallons | 1.7 gallons | 4 gallons | 15 gallons | 26 gallons | 2 gallons | None |
| Water Required | | None (air cooled) | None (air cooled) | 4 gpm (30° C max.) | 10 gpm (30° C max.) | 20 gpm (30° C max.) | 1 gpm (30° C max.) | 1.5 to 5.5 gpm (40° C max.) |
| Water Connections.. | | None | None | 1/2" hose | Inlet 3/4" std. pipe Outlet 1 1/4" std. pipe | 1 1/4" hose | 1/2" std. pipe | Input 3/4" O.D. Output 7/8" O.D. |
| Weight | | 48 lbs. | 48 lbs. | 175 lbs. | 750 lbs. | 1000 lbs. | 46 lbs. | 50 lbs. |
| Dimensions, Overall: | | | | | | | | |
| Length | | 32 3/16" | 36 5/8" | 24" | 42 1/2" | 45 5/8" | ----- | 89 1/16" |
| Width | | 6 3/8" | 6 3/8" | 20" | 20 1/2" | 24 5/8" | 5" dia. | 5 3/4" dia. |
| Height | | 10 3/4" | 10 3/4" | 46 5/8" | 57 1/8" | 64" | 33 1/2" | ----- |

| <i>Page</i> | <i>Type Number</i> | <i>Description</i> | <i>MI Number</i> |
|------------------------------|--------------------|--|------------------|
| TYPICAL TEST SETUPS | | | |
| 5-12 | | Recommended Test and Measuring Equipment for AM, FM, and TV Stations | |
| 6 | | Audio Test Facilities for Broadcasting Systems | |
| 7 | | Table of Audio Test and Measuring Equipment | |
| 7 | | Test Facilities for Television Systems | |
| 8 | | TV Studio Test Equipment | |
| 10 | | TV Transmitter Test Equipment | |
| 11 | | Table of Studio TV Test and Measuring Equipment | |
| 11 | | Table of Video Transmitter Test and Measurement Equipment | |
| 12 | | Table of Color TV Transmitter Input and Monitoring Equipment | |
| AUDIO TEST EQUIPMENT | | | |
| 13-14 | WM-71A | Distortion and Noise Meter..... | MI-30071-A |
| 15-16 | WA-28A | Audio Push-Button Oscillator..... | MI-30028-A |
| 17-18 | BI-11A | Transmission Measuring Set..... | MI-11350 |
| 18 | | Plate Current Meter..... | MI-21200-C1 |
| VIDEO TEST EQUIPMENT | | | |
| 19-20 | WA-1E | Color Bar Generator..... | MI-34001-F |
| 21-22 | WA-6A | Color Signal Analyzer (complete with case)..... | ES-40950 |
| 21-22 | WA-6A | Color Signal Analyzer (less case)..... | MI-34016-A |
| 22 | | Cabinet for housing WA-6A..... | MI-26720-9 |
| 23-24 | WA-7C | Linearity Checker | MI-34017-B |
| 25-26 | WA-8A | Color Stripe Generator..... | MI-40214 |
| 27-28 | WA-9A | Calibration Pulse Generator..... | MI-26070 |
| OSCILLOSCOPES | | | |
| 29-30 | TO-1 | Television Oscilloscope | ES-40903 |
| 29-30 | TO-1 | Television Oscilloscope (less slide mounting)..... | MI-26800-A |
| 30 | | Set of Slides for rack or console mounting TO-1..... | MI-26891 |
| 30 | | Oscilloscope Case for TO-1..... | MI-26890 |
| 31-32 | TO-524AD | Television Oscilloscope | MI-26500-A |
| 32 | TO-500 | Scope-mobile | MI-26501 |
| 32 | P-5000F | High Impedance Probe | |
| 33-34 | WO-88A | 5-Inch Cathode-Ray Oscilloscope | |
| 34 | WG-300B | Direct/Low Capacitance Probe | |
| 35-36 | WO-91A | 5-Inch Cathode-Ray Oscilloscope | |
| GENERATORS AND METERS | | | |
| 37 | WR-46A | Video Dot/Crosshatch Generator | |
| 38 | WR-61B | Service Color-Bar Generator | |
| 39 | WR-69A | TV/FM Sweep Generator | |
| 40 | WR-70A | RF/IF/VF Marker Adder | |
| 41 | WR-86A | UHF Sweep Generator | |
| 41 | WG-298A | UHF Demodulator | |
| 42 | WR-99A | Crystal-Calibrated Marker Generator | |
| 42 | WG-295G | Video Multimarker | |
| 43 | WV-87B | Master VoltOhmyst | |
| 44 | WV-98A | Senior VoltOhmyst | |
| 44 | WV-77C | Junior VoltOhmyst | |
| 44 | WG-301A | Crystal Diode Probe | |
| 44 | WG-289 | High-Voltage VoltOhmyst Probe | |
| 44 | WG-206 | Multiplier Resistor for VoltOhmyst Probe | |
| 45 | LV-10 | Vacuum Tube Voltmeter | |
| 45 | | 30 KV DC Probe..... | MI-30403 |
| 45 | | 1500-Volt AC Adaptor..... | MI-30404 |
| 45 | | Adaptor Type N, Probe to Coaxial Cable..... | MI-30402 |
| 46 | LM-1 | Test Meter | |
| 46 | | High Voltage Probe for DC Measurements..... | MI-30401 |

| Page | Type Number | Description | MI Number |
|--|-------------|---|--------------|
| GENERATORS AND METERS (Con't) | | | |
| 47-48 | WT-100A | Electron-Tube MicroMhoMeter | |
| 49-50 | WT-110A | Automatic Electron-Tube Tester | |
| 50 | WG-337A | Tube Socket Adapter Set (for testing tubes with small 4-pin, 5-pin and 6-pin bases, and small and medium 7-pin bases) | |
| 50 | WG-338A | Tube Socket Adapter (for testing 7-Lead In-Line Subminiature Tubes) | |
| 50 | WG-339A | Tube Socket Adapter (for testing 8-Lead Circular Subminiature Tubes) | |
| FIELD INTENSITY METERS | | | |
| 51-52 | BW-7A | Field Intensity Meter and Test Set..... | MI-19384 |
| 52 | | 1 MA Esterline-Angus Recorder | |
| 52 | 110 | Mobile Recording Drive Assembly | |
| 53-54 | WX-2D | Field Intensity Meter..... | MI-30002-D |
| 54 | 121 | Recording Amplifier | |
| FREQUENCY & MODULATION MONITORS | | | |
| 55-56 | BW-11A | AM Type Frequency Monitor..... | ES-34042 |
| 55-56 | BW-11AT | TV Type Frequency Monitor..... | ES-34040-A |
| 56 | | Remote Meter | MI-93688 |
| 56 | | Spare Tube Kit for BW-11A/11AT..... | MI-8295 |
| 57-58 | 335-ER | Frequency and Modulation Monitor | |
| 59-60 | CR1184-A | Television Station Monitor | |
| SIDEBAND RESPONSE ANALYZERS | | | |
| 61-64 | BW-5A | VHF Sideband Response Analyzer..... | ES-34010-B |
| 61-64 | BWU-5A | UHF Sideband Response Analyzer..... | ES-34009-B |
| 64 | | Set of Spare Tubes for BW-5A..... | MI-34012-B |
| 64 | | Set of Spare Tubes for R-F Input Unit only..... | MI-34020 |
| 64 | | Directional Coupler (BW-5A or BWU-5A)..... | MI-19396-1 |
| 64 | | Coupling Unit (BW-5A)..... | MI-19057-A |
| 64 | | VHF Line Section for Mounting MI-19396-1 Directional Coupler..... | MI-19396-3 |
| 64 | | UHF Line Section for Mounting MI-19396-1 Directional Coupler..... | MI-19396-2 |
| 64 | "N" | R-F Connector for MI-19396-1 Coupler..... | MI-34011 |
| DEMODULATORS | | | |
| 65-66 | BW-4B | VHF Visual Sideband Demodulator..... | MI-34057 |
| 66 | | Chopper Relay | MI-26567 |
| 66 | | Complete Spare Tube Kit for BW-4B..... | MI-34014-A |
| 67-69 | BWU-4A | UHF Visual Sideband Demodulator..... | ES-34007 |
| 69 | | Complete Spare Tube Kit for BWU-4A..... | MI-34015 |
| 70 | | VHF Monitoring Diode..... | MI-19051-B |
| 70 | | UHF Monitoring Diode..... | MI-19364 |
| 70 | | Directional Coupler for 3 1/8"-51.5 Ohm Line..... | MI-27379 |
| 70 | | Directional Coupler for 6 1/8"-75 Ohm Line..... | MI-27382 |
| 70 | | Directional Coupler for 3 1/8" Universal Line..... | MI-27385 |
| 70 | | Directional Coupler for 6 1/8" Universal Line..... | MI-27387 |
| R-F LOADS AND WATTMETERS | | | |
| 71 | | General Description | |
| 72 | | VHF 1200-Watt R-F Load and Wattmeter..... | MI-19196-L/H |
| 72 | | UHF 1200-Watt R-F Load and Wattmeter..... | MI-19197 |
| 72 | | VHF 3-KW R-F Load and Wattmeter..... | MI-19024-A |
| 73 | | VHF 7.5-KW R-F Load and Wattmeter..... | MI-27396 |
| 73 | | UHF 15/25-KW R-F Load..... | MI-19198-A2 |
| 73 | | ThruLine R-F Wattmeter (0-15 KW)..... | MI-27350 |
| 73 | | ThruLine R-F Wattmeter (0-25 KW)..... | MI-27363 |
| 74 | | VHF 25-KW R-F Load and Wattmeter..... | MI-19193-L/H |
| 74 | | VHF 50-KW R-F Load and Wattmeter..... | MI-19191-L/H |

RCA REGIONAL OFFICES

Atlanta 3, Ga.

1121 Rhodes-Haverty Bldg., Jackson 4-7703

Boston 16, Mass.

200 Berkeley Street, Hubbard 2-1700

Camden 2, N. J.

Front & Cooper Streets, Woodlawn 3-8000

Chicago 54, Ill.

1186 Merchandise Mart Plaza, Delaware 7-0700

Cleveland 15, Ohio

1600 Keith Bldg., Cherry 1-3450

Dallas 35, Texas

7901 Freeway #183, Fleetwood 2-3911

Hollywood 28, Calif.

1560 N. Vine Street, Hollywood 9-2154

Kansas City 6, Mo.

1006 Grand Avenue, Harrison 1-6480

New York 20, N. Y.

36 W. 49th Street, Judson 6-3800

San Francisco 2, Calif.

420 Taylor Street, Ordway 3-8027

Seattle 4, Wash.

2250 First Avenue, South, Main 8350

Washington 6, D. C.

1625 K Street, N. W., District 7-1260



RADIO CORPORATION OF AMERICA
BROADCAST AND TELEVISION EQUIPMENT
CAMDEN, NEW JERSEY