

Moseley



Product Catalog

AURAL STUDIO-TRANSMITTER LINKS



Studio-Transmitter Link Systems offer significant long term savings over the costs of leased telephone circuits. The PCL-606 and PCL-505 STL Systems give the broadcaster complete control of station facilities as well as superior response, distortion and transient char-

PCL-606 Crowded RF environments are natural to the PCL-606 and PCL-606/C Aural Studio-Transmitter Links. A rugged all-new design, using the latest techniques and components, gives the user ultra-low noise and distortion, excellent selectivity and outstanding frequency stability. Furthermore, the balance between distortion and selectivity can be optimized with a user-selected bandwidth.

acteristics. Completely wireless remote control can be integrated with the STL for even greater returns on investment. 148-174, 215-240, 300-330, 370-470, 890-960 MHz and 1.5-1.71 GHz bands are standard. Other frequencies available on special request.

The PCL-606/C transmits composite stereo over a single RF carrier, while two monaural PCL-606's may be used in the "split channel" method to provide a stereo signal. Both are equipped with built-in automatic transfer circuitry to prevent carrier interruption. They have extensive built-in switch-selectable diagnostic metering capabilities in transmitter and receiver, and all normal service adjustments are easily accessible through the module and unit tops.



PCL-505 The Model PCL-505 and PCL-505/C Aural Studio-Transmitter Links offer superior program handling capabilities. Stripline techniques and direct FM provide dependable performance. Solid-state integrated circuitry and continuous-duty design make for easy operation and maintenance.

The PCL-505/C transmits composite stereo on a single RF carrier. Two monaural PCL-505's in a dual configuration provide "split channel" stereo transmission. Optional automatic transfer panels assure continuous stereo broadcast in case of carrier interruption, a system pioneered by Moseley.

COMMUNICATIONS LINK



CL-100 The Model CL-100 Control/Telemetry Link allows you to transmit telemetry or control data on the 450 MHz band to or from your control point. The CL-100 Receiver and Transmitter have been built for continuous-duty

and unattended service. An optional MCW Identifier is available, and a separate microphone input for voice communication is also provided. A 10W output is optional.

STL-CTL/TSL-ACCESSORIES



TPT-2 The Model TPT-2 Transfer Panel Transmitter monitors RF power output of the operating transmitter, and automatically switches RF output and program input to the alternate transmitter in the event of a carrier failure.

TPR-2 The Model TPR-2 Transfer Panel Receiver provides automatic switching of program and multiplex outputs from aural studio-transmitter link receivers. The TPR-2 can handle monaural or composite audio signals.



ECP-5 The Model ECP-5 Extension Control Panel functions with Models PCL-505 and PCL-505/C STL Transmitters. Control of carrier and metering of forward power and AFC voltage are provided on an extension basis by the ECP-5.

ICU The Model ICU-(1D/2D/3D/5D) Isocoupler series facilitates the connection of an STL, RPU, or CTL/TSL Transmitter or Receiver to an antenna mounted on an ungrounded standard AM broadcast tower.

MICROPROCESSOR REMOTE CONTROL

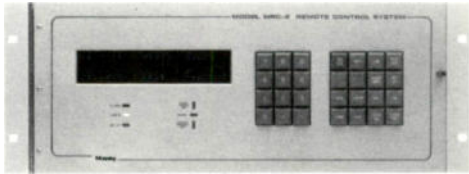

MRC-2 Microprocessors mean that the MRC-2 can be tailored precisely to your needs. Up to 256 command lines, 256 status channels and 256 telemetry channels can be specified in groups of 16 for each of up to 99 sites. Multiple Control Terminals allow a flexible hierarchy of control, with multiple data interconnection links over dedicated or dial-up wire or radio. The MRC-2 can be keyboard calibrated. Two level nested, upper and lower event and/or alarm telemetry tolerances can be set. Status and command lines can be momentary or latching, and status

display can be direct or inverted. In case of power failure, all programming data is stored intact, automatically.

MRC-2 options increase its flexibility. The CRT option can display 32 channels simultaneously with plain English prompting, and can duplicate all command functions. The Automatic Logging option provides a hard copy record of events. Also available are Multiple Direct Command, Multiple Status Display, Automatic Control Unit, Digital Telemetry Input, Rohde & Schwarz UVF Video Analyzer Interconnection, Telco Dial-up capability, and a Personal Computer Interface.

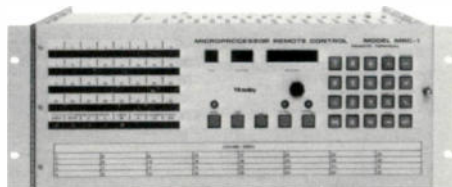

MRC-1 The MRC-1 provides capabilities and features only available before in much more elaborate and expensive systems. Up to 32 channels of status, 32 channels of telemetry and 64 command lines can be specified at each of up to nine sites.

The MRC-1 features keyboard telemetry calibration in three different modes, programmable assignment of control, upper and lower telemetry tolerance alarms with alarm muting, and status and command channels may be momentary or latching. Automatic Logging, CRT, Multiple Direct Command and Moseley Memory are optionally available.

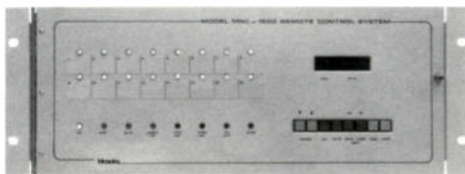

MRC-1600 The MRC-1600 provides sophisticated yet simple remote control operation for the AM or FM broadcaster. It features 16 digital metering channels, 16 status channels, and 16 raise/lower control channels. MRC-1600 calibration and setup are via front-panel keyboard and include programmable upper and lower tolerance alarm limits on metering input, as well as status muting for "no-alarm" changeover of redundant/standby equipment.

Subcarrier terminal interconnection and sub-audible telemetry options are available, eliminating telephone line interconnection and allowing stations to use their AM carrier or FM SCA channel for telemetry return if desired.

All status and telemetry data, with user-selected field titles, is displayed on the optional CRT; an Automatic Logging Option is also available to operate in conjunction with the CRT.

AUDIO SWITCHERS

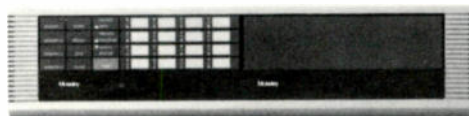

SMART SWITCHER 256 The Moseley Smart Switcher 256 is a computer controllable audio routing/mixing system designed for broadcast and post production applications. Up to 256 cross-points with typical matrices of 8 X 8, 16 X 8, 16 X 16, etc., may be configured into a system.

External control is possible through standard GPI and RS232C ports. Use of standard X-Y controllers either on a front panel casting or desktop wedge enables the user to set up an entire matrix. Four system memories are provided to store complete matrix configurations. Outstanding audio performance and multiple source summing capabilities provide flexibility.

Specifications subject to change without notice.

Printed in U.S.A. 1/87

Moseley

Moseley
Associates
Incorporated

111 Castilian Drive
Santa Barbara, CA
93117-3093

a
Flow General
Company

Phone 805 968 9621
Telex 658448
Cable: MOSELEY

▼
MISC.

The Model PD-1000 Power Divider facilitates coupling two STL, RPU, or CTL/TSL Receivers to a common antenna.

Connector kit includes two Type N female connectors and two 3-foot RG-8/U pigtails. One kit required per antenna.

Mobile and rack mount RF power

amplifiers to boost output of STL or CTL/TSL.

Andrew Heliax low-loss foam dielectric coaxial transmission line.

Scala and Anixter Mark Antennas are suggested for use with Moseley STL or CTL/TSL equipment.

▼
STEREO GENERATOR, DEMODULATOR



SCG-9A The Model SCG-9A Stereo Generator is all solid-state, using integrated circuits. Close attention to design has produced minimal quadrature error and phase difference between channels with excellent channel separation.

SCD-9 The Model SCD-9 Stereo Demodulator transforms a composite stereo waveform into discrete left and right channels for AM stereo and FM broadcast. Complementary to the SCG-9A Stereo Generator, it includes de-emphasis circuitry, 16 kHz low pass filters, and front panel and stereo indication, with an SPDT relay for external control.

▼
SUBCARRIER GENERATOR, DEMODULATOR



SCG-8 The SCG-8 Multiplex FM Subcarrier Generator offers extreme stability, excellent sound quality and simplicity of operation. A peak reading audio meter and all electronic muting are included.

SCD-8 The Model SCD-8 Multiplex FM Subcarrier Demodulator is the companion to the SCG-8 Generator. Front-panel metering, all electronic squelch, and audio low-pass filter are standard. The operating frequency of the SCG-8/SCD-8 is easily changed with plug-in filters.

▼
AUDIO LIMITERS



TFL-280B For FM monaural, FM stereo, FM SCA, TV aural, the TFL-280B delivers loudness and clarity without compromise. Modulation levels of FM transmission systems are precisely controlled by this frequency-conscious limiter. Clipping and its attendant products are essentially eliminated through the use of agile circuitry.

TAL-320 The TAL-320 AM Audio Limiter brings high quality broadcast sound to AM by clearly maximizing the modulation of a standard AM broadcast transmitter. The TAL-320 incorporates an efficient all-pass network, treble equalizer and positive peak adjustable clipper. AM stereo operation is a primary benefit, easily accommodated by two Model TAL-320 Audio Limiters.

▼
AUDIO GAIN RIDER



TGR-340 The Model TGR-340 Audio Gain Rider is designed to automatically ride gain on a program line, providing maximum modulation on a long-term basis with a minimum of audible of measurable by-products. STL, tape, and

satellite program circuits are protected from overload. A switch-defeatable multistage all-pass network is provided to increase signal symmetry, a feature especially useful in TV and FM.

Audio Routing Switcher

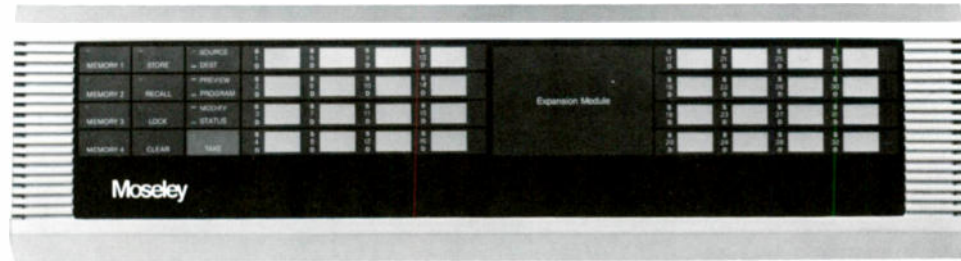

ARS-256

Features

- Up to 256 Crosspoints Configured in Groups of 8 Inputs/Outputs
- 4 System Memories for Preset Matrices
- Multiple-Source Summing Capability
- RS-232 Control Port
- Superior Audio Performance

Options

- X-Y Front-Panel Controller
- X-Y Desktop Wedge Controller
- X-Y Rack-Mount Controller
- VDT Controller

The ARS-256 Audio Routing Switcher is an advanced audio routing/mixing system with a highly versatile control interface. This switcher will operate with, and/or slave to, most industry standard equipment for audio-follow-video or automation directed systems.

External control is possible through a number of standard or optional ports. The standard GPI, RS-232, and RS-422 ports provide outboard control interface capabilities for signal processing and post-production requirements. Optional interfaces, for most popular routers, allow the addition of multilevel high-quality audio routing to a plant's existing switcher. Manual control panels interconnected via a party

line control system permit the ARS-256 to be accessed from as many remote locations as desired.

A single ARS-256 can contain up to 256 crosspoints in 3 rack units. Typical matrices can include 8×8 , 16×8 , 16×16 , etc. in groups of eight. The system can be configured in multilevels, (i.e. stereo, SAP, time code, etc.) Units can be easily stacked and there is no limit to expansion.

All Moseley switchers are designed for maximum reliability and serviceability. Careful selection of components, multiregulated power supply and ultrareliable DIN connectors insure long term durability and maintainability.

Moseley

Moseley
Associates
Incorporated

111 Castilian Drive
Santa Barbara, CA
93117-3093

a
Flow General
Company

Phone 805 968 9621
Telex 658448
FAX: 805 685 9638

Control

As multichannel, multilevel protocol demands grow, the bank switchable CPU controller with 96K of memory has the power to meet the most demanding interface and performance requirements.

Manual Control

The Moseley party line control system enables the use of up to 32 remote control stations. Microprocessor-control provides instantaneous communications. A "take" command is executed at the next vertical interval allowing true real time use during production or post production. Standard controllers include relegendable X-Y crosspoint-oriented switch panels. The party line system has a matrix scratch pad allowing the user to set up an entire matrix and either store it off-line or "salvo" take it to the program at any time. Four system memories are provided to store complete matrix configurations.

GPI Control

The GPI port allows communications with such external device as a real time clock,

an automation system, or an editor-synchronizer. For radio stations this means that network feeds can be switched with millisecond accuracy. Complex audio assignments can be preprogrammed and done instantly under editor control or synchronizer event control for production.

RS-232 Control

An RS-232 port provides a VDT approach to displaying and/or modifying current matrix configurations, as well as system diagnostics. All Moseley Smart Switcher systems feature a standard ASCII terminal interface, which provides the capabilities to communicate with commonly available computer terminals. The ASCII terminal interface allows you to preset the next matrix, setup and salvo the matrix at the right moment, check matrix status at any time, and change one or all of the input/output combinations individually or in groups. The RS-232 port will also allow more sophisticated software control via the use of microcomputers.

SPECIFICATIONS

Frequency Response	± 0.2 dB 10 Hz-30 kHz, ref 1 kHz
Crosstalk	- 80 dB, 15 kHz worst-case crosstalk
Input/Output Isolation	- 80 dB
Common Mode Rejection	- 80 dB, 50-120 Hz
Signal-to-Noise Ratio	- 100 dB re. +24 dBu
THD	<.01% 20 Hz-20 kHz re. max input <.01% 20 Hz-20 kHz re + 8 dBu* op. level
IMD (SMPTE)	<.005% re. max. input
Maximum Input Level	+ 28 dBu* balanced or unbalanced
Maximum Output Level	+ 24 dBu* balanced
Channel Gain/Loss	± 3 dB adjustable
Input Impedance	>20 k ohm
Output Impedance	< 100 ohms balanced
Minimum Load Impedance	600 ohms
Dimensions	5.25" (13.3 cm) H \times 19" (48.3 cm) W \times 18" (45.7 cm) D
Gross Weight	45 lbs (20.5 kg)
Power Requirements	150 watts *O dBu = .775 volts

Specifications subject to change without notice.

Printed in USA 10/87

Moseley

Moseley
Associates
Incorporated

111 Castilian Drive
Santa Barbara, CA
93117-3093

a
Flow General
Company

Phone 805 968 9621
Telex 658448
FAX: 805 685 9638

Aural
Studio
Transmitter
Links

Moseley

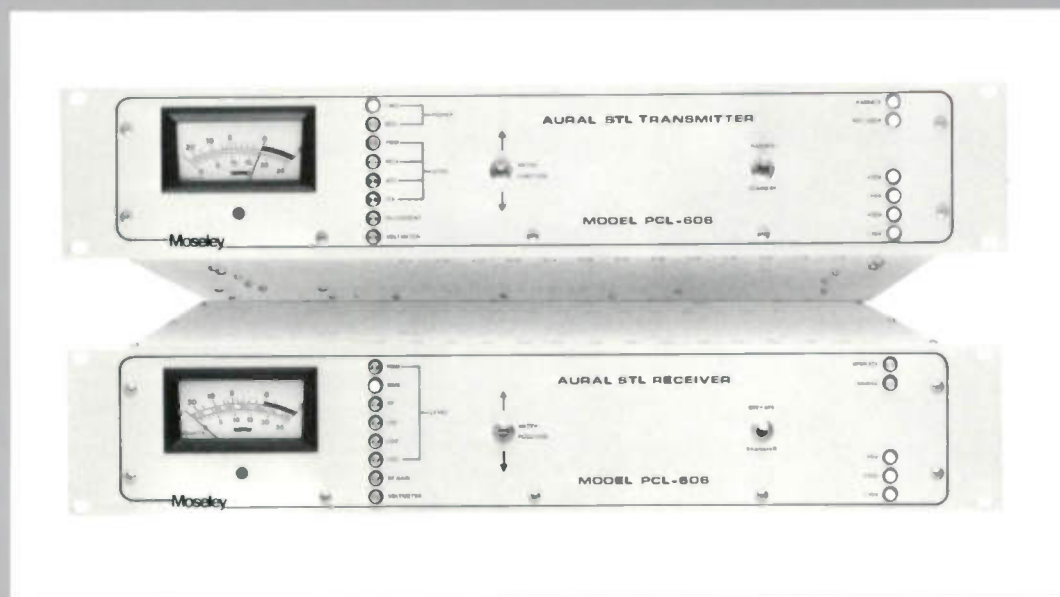

PCL-606 AND PCL-606/C

For:
300-330 MHz
450-470 MHz
890-960 MHz
1.5-1.71 GHz

PCL-606 AND PCL-606/C

WHY STL?

Telephone line charges have increased dramatically over the past few years while line reliability and ultimate audio quality have either degraded or stayed the same. Studio-transmitter link (STL) systems provide broadcasters with an alternative to leased telephone lines for conveying program information from the studios to a remote transmitter location. They offer complete control over program carriage as well as excellent reliability, two factors very important in today's broadcasting. Studio-transmitter links will also convey a program subcarrier, such as an SCA feed, and remote control information over the same economical link.

WHY PCL-606?

The PCL-606 and PCL-606/C Studio-Transmitter Links provide the broadcast and industrial user alike with the highest quality program conveyance service currently available in equipment of this type. Use of the latest technology has achieved significantly improved specifications and performance, even in areas

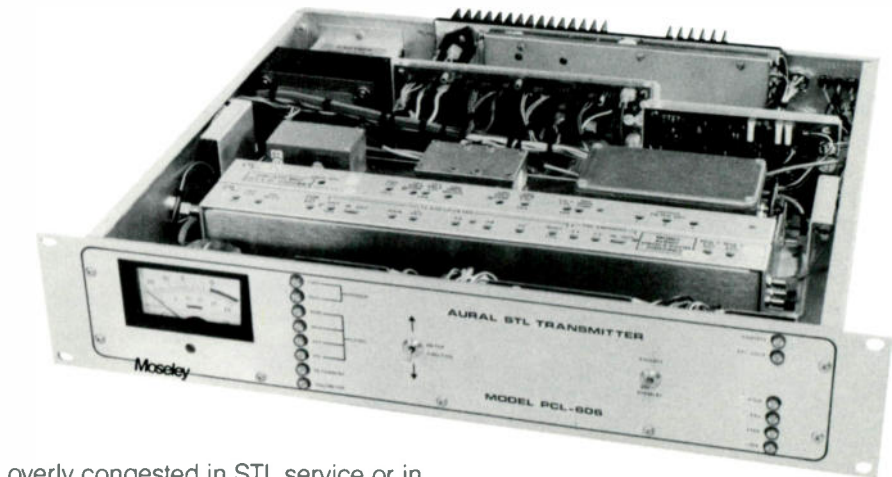

overly congested in STL service or in areas presenting high density RF environments. The PCL-606, designed for highest quality monaural audio service, may be used in a dual configuration for stereo service where composite stereo is not desired. The PCL-606/C, the composite stereo version, conveys the composite stereo waveform with virtually no degradation, neither adding to nor taking away from the stereo waveform, for virtual transparency of sound.

Extensive field testing of the PCL-606 and PCL-606/C Transmitter and Receiver

was done (at such high RF locations as One Shell Plaza and Mt. Wilson) to ensure the highest performance in hostile RF environments. Enclosed module construction is used to reduce the possibility of RFI as well as allow easy service access to each printed circuit board. All normal service tuning adjustments are easily yet securely accessible through the tops of the modules and unit top covers, and extensive internal metering capabilities are standard in both the Transmitter and Receiver.

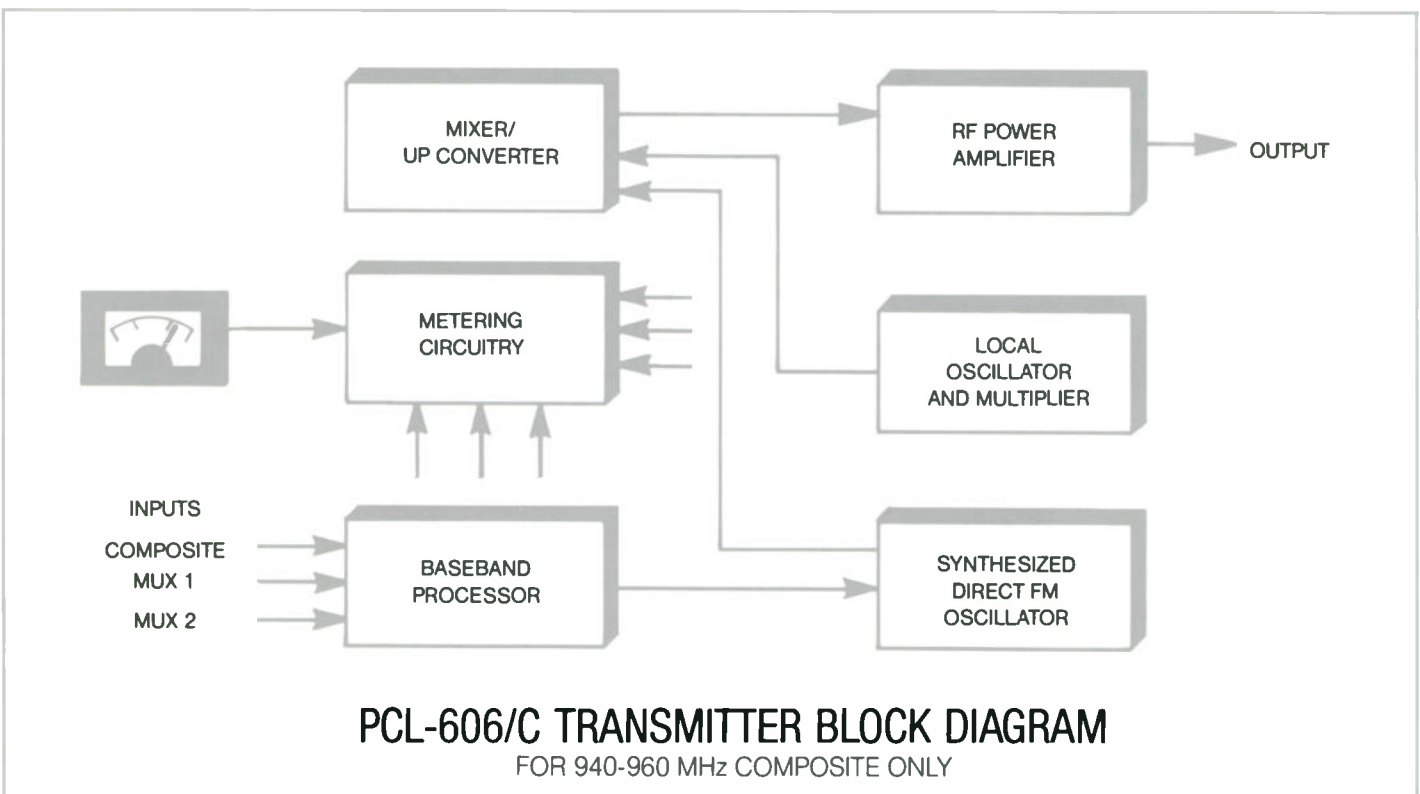

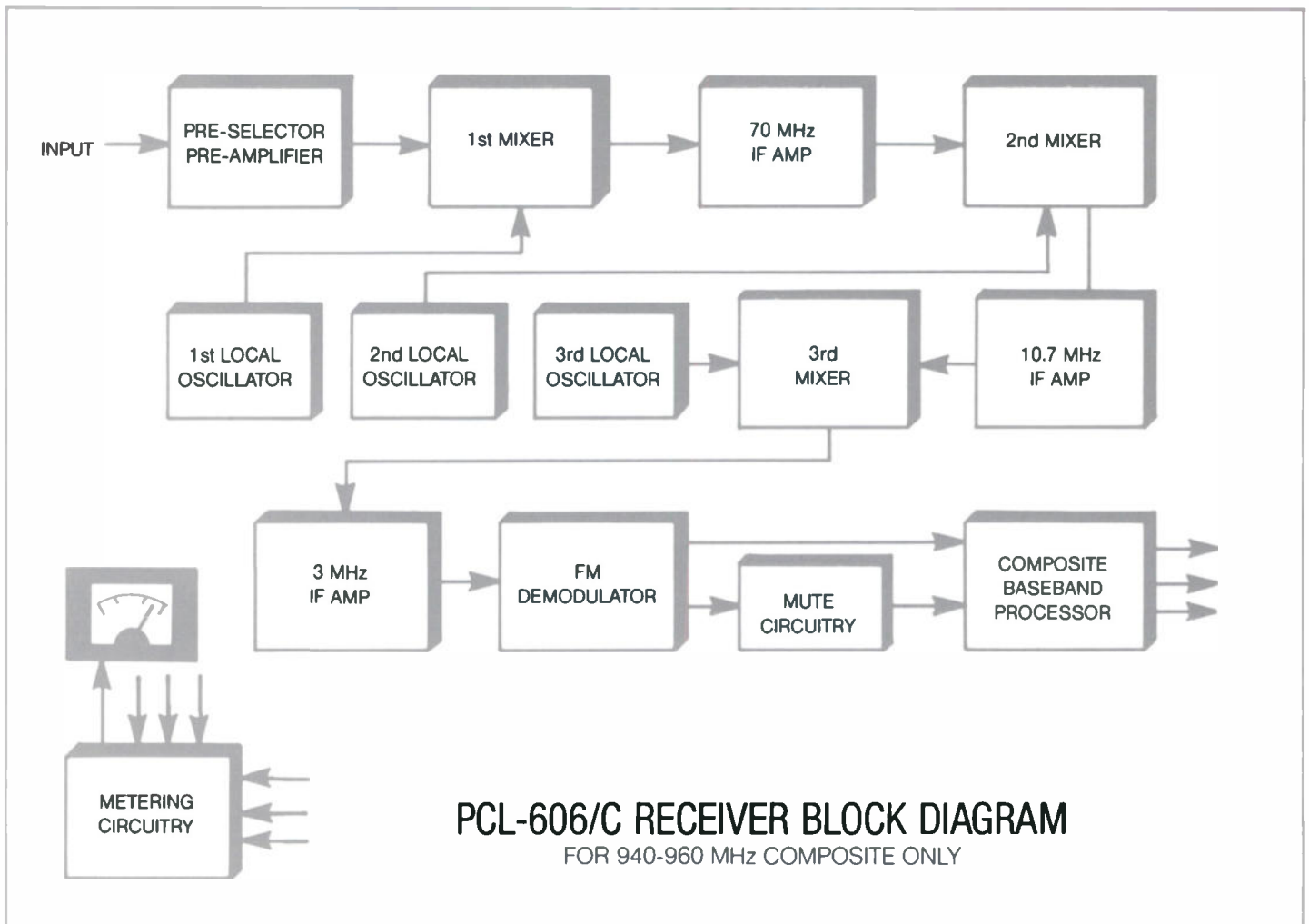

TRANSMITTER

The PCL-606 and PCL-606/C Transmitters employ direct FM modulation techniques. A synthesized reference oscillator is used for frequency and phase control of the direct FM oscillator. Transmitter FM modulated oscillator frequency conversion is done via a double balanced mixer instead of the usual frequency multiplication of the modulated RF signal.

The transmitter includes a front-panel meter with step-switch input selection to allow the metering of important parameters, such as RF forward output, RF reflected output, input levels and AFC voltage. The metering system even includes built-in absolute value peak responding voltmeter capability, with an internal LED to indicate DC polarity.

RECEIVER

The PCL-606 and PCL-606/C Receiver designs were the first to incorporate several important performance and user-controlled features. A PIN diode attenuator circuit is supplied for user adjustment of overall system signal-to-noise ratio. The PIN diode attenuator circuit reduces adjacent signal intermodulation products caused by input signal overloads.

The receiver IF bandwidth may be changed by the user to optimize the tradeoff between distortion and selectivity. The wideband mode yields highest performance in uncongested areas with 500 kHz channel spacings. In high density areas, the narrowband mode, utilizing 300 kHz channel spacings, allows for optimum performance.

The receiver demodulator offers extremely

low distortion and noise characteristics. The demodulator is broadband and adjustment-free, using digital pulse counting techniques for maximum fidelity.

The receiver includes a front-panel meter with step-switch input selection to allow the metering of several parameters, including audio output level, subcarrier level and RF input level in microvolts. The metering system includes built-in absolute value peak responding voltmeter capability with polarity indication. The metering circuit output appears on a back panel connector for remote metering.

Built-in transfer circuitry is standard in the PCL-606 and PCL-606/C Receivers to allow automatic changeover to a standby receiver in the event of a detected malfunction.

SPECIFICATIONS

PCL-606	SYSTEM	PCL-606/C
300-330 MHz, 450-470 MHz 890-960 MHz, 1.5-1.71 GHz Specify exact operating frequency.	Frequency Range	300-330 MHz, 450-470 MHz 890-960 MHz, 1.5-1.71 GHz Specify exact operating frequency.
250 kHz	Channel Spacing Wide (Narrow) Band	500 kHz (300 kHz)
Monophonic audio: ± 0.25 dB or better 30 Hz to 15 kHz	Frequency Response Wide (Narrow) Band	Composite: ± 0.1 dB (± 0.2 dB) or better 30 Hz to 53 kHz, ± 0.3 dB (± 1.0 dB) or better 53 kHz to 73 kHz.
0.20% or less 30 Hz to 15 kHz, typically better than 0.1% at 1 kHz	THD and IMD Wide (Narrow) Band	Stereo demodulated THD and IMD: 0.2% (0.3%) or less 30 Hz to 7.5 kHz, typically better than 0.1% at 1 kHz. Convolved stereo demodulation products: greater than 53 dB (50 dB) below the 400 Hz, 100% modulation ref. level from 7.5 kHz to 15 kHz.
Not applicable	Stereo Separation Wide (Narrow) Band	48 dB (43 dB) or better 50 Hz to 15 kHz, typically 50 dB (45 dB) or better
Not applicable	Nonlinear Crosstalk, Subchannel to Main Channel: Wide (Narrow) Band	53 dB (50 dB) or better
Not applicable	Nonlinear Crosstalk, Main Channel to Subchannel: Wide (Narrow) Band	53 dB (50 dB) or better
73 dB or better, typically 76 dB, below 100% modulation	Signal-to-Noise Ratio Wide (Narrow) Band	73 dB (70 dB) or better, typically 76 dB (73 dB) below 100% modulation, de-modulated, de-emphasized left or right.
3.5" (8.9 cm) high 16.5" (41.9 cm) deep 0° C to +50° C	Dimensions, Operating Temperature Range: Transmitter & Receiver	3.5" (8.9 cm) high 16.5" (41.9 cm) deep 0° C to +50° C
TRANSMITTER		
10 Watts maximum, 5 Watts minimum 12 Watts maximum, 8 Watts minimum	RF Power Output 890 MHz-1.71 GHz 300-470 MHz	10 Watts maximum, 5 Watts minimum 12 Watts maximum, 8 Watts minimum
Type N female, 50 ohm	RF Output Connector	Type N female, 50 ohm
± 40 kHz	Deviation for 100% Modulation Wide (Narrow) Band	± 50 kHz (± 30 kHz)
Better than 0.00025% 0° C to +50° C	Frequency Stability	Better than 0.00025%, 0° C to +50° C
More than 60 dB below carrier level	Spurious and Harmonic Emission	More than 60 dB below carrier level
One program and two subcarrier channels	Modulation Capability	One program and two subcarrier channels.
Monophonic: +10 dBm, 600 ohm, balanced, floating, barrier strip screw input. Multiplex: 1.5 V peak-to-peak, 4 k ohms unbalanced, type BNC female connectors (2), frequency range 22-85 kHz.	Modulation Inputs Wide (Narrow) Band	Composite: 3.5 V peak-to-peak 6 k ohms unbalanced, type BNC female connector. Multiplex: 1.5 V peak-to-peak 4 k ohms unbalanced, type BNC female connectors (2), frequency range 110-185 kHz (110 kHz)
100/120/220/240 VAC, $\pm 10\%$, 50/60 Hz, 70 Watts	Power Source	100/120/220/240 VAC, $\pm 10\%$, 50/60 Hz, 70 Watts
RECEIVER		
Type N female, 50 ohm	RF Input Connector	Type N female, 50 ohm
20 μ V or less required for 60 dB SNR	Sensitivity Wide (Narrow) Band	150 μ V (210 μ V) or less required for 60 dB SNR, left or right channel de-emphasized, demodulated
3 dB I.F. bandwidth, ± 90 kHz 60 dB I.F. bandwidth ± 400 kHz 80 dB I.F. bandwidth, ± 1 MHz	Selectivity Wide (Narrow) Band	3 dB I.F. bandwidth ± 100 kHz (± 75 kHz) 60 dB I.F. bandwidth ± 450 kHz (± 350 kHz) 80 dB I.F. bandwidth, ± 1 MHz (± 1 MHz)
Monophonic: +10 dBm, 600 ohm, balanced, floating, barrier strip screw output. Multiplex: 1.5V peak-to-peak, 4K ohms unbalanced, type BNC female connectors (2)	Modulation Outputs	Composite: 3.5 V peak-to-peak 100 ohm unbalanced, type BNC female connector. Multiplex: 1.5 V peak-to-peak 100 ohm unbalanced, type BNC female connectors (2)
100/120/220/240 VAC, $\pm 10\%$, 50/60 Hz, 30 Watts	Power Source	100/120/220/240 VAC, $\pm 10\%$, 50/60 Hz, 30 Watts

Specifications subject to change without notice.

Printed in U.S.A. 1/87



Moseley
Associates
Incorporated

111 Castilian Drive
Santa Barbara, CA
93117-3093

a
Flow General
Company

Phone 805 968 9621
Telex 658448
Cable: MOSELEY

Aural Studio-Transmitter Link Accessories

Automatic Transfer Panels

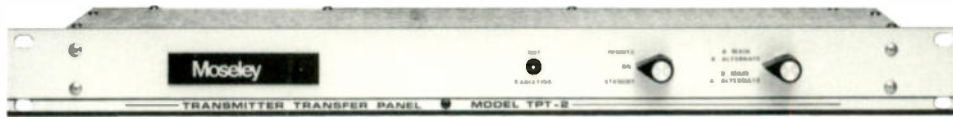

THE TPT-2 TRANSFER PANEL TRANSMITTER enables automatic transfer from a main to an alternate STL transmitter. The TPT-2 senses the RF power output of the operating

transmitter and automatically switches RF output and program input to the alternate transmitter in the event of a carrier failure. Front-panel selection of "Main" and "Alternate" status allows alternating operation of the two

transmitters. Remote control provisions are incorporated in the TPT-2 to remove the transmitters from the radiate mode. The panel is 4.4 cm (1.75") high, 48.4 cm (19") wide, and 12.7 cm (5") deep. Power requirements are 120/240 VAC, 50-60 Hz, or + 13.5 VDC. When ordering the Model TPT-2 Transfer Panel Transmitter, please specify the model of Moseley STL transmitters to be used with the panel.

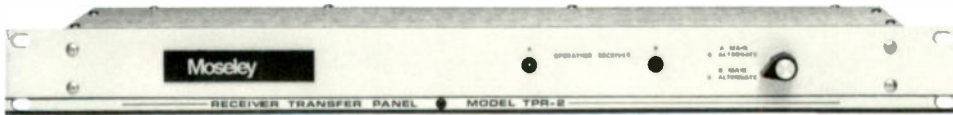

THE TPR-2 TRANSFER PANEL RECEIVER provides automatic switching of program and multiplex outputs from aural studio-transmitter link receivers. Monitoring the carrier-

operated squelch relays in the main and alternate receivers, switching occurs with a carrier failure. Monaural program audio or composite signals can be accommodated by the unit. Because both receivers must be

active to allow use of the TPR-2, separate receiving antennas or a power divider are required. If separate antennas are not used, the PD-1000 or PD-2000 Power Dividers allow operation of both receivers from one common antenna. The panel is 4.4 cm (1.75") high, 48.4 cm (19") wide, and 12.7 cm (5") deep. Power requirements are 120/240 VAC, 50-60 Hz or + 13.5 VDC.

Control Panel



THE ECP-5 EXTENSION CONTROL PANEL functions with the PCL-606,

PCL-606/C, PCL-505 and PCL-505/C STL transmitters. Control of carrier and metering of forward power and

AFC voltage are provided on an extension basis by the ECP-5. A five-conductor cable is required to interconnect the ECP-5 and the transmitter. The panel is 48.4 cm (19") wide, 4.4 cm (1.75") high and 12.7 cm (5") deep.

Power Dividers, Transmission Line, Connector Kits

THE SERIES PD-1000 AND PD-2000 POWER DIVIDERS are passive, broadband devices intended to couple two STL, TSL, or RPL receivers to a single antenna. They are supplied with two 3-foot RG-8/U pigtail assemblies. The power dividers are equipped with Type N RF connectors.

Specifications	PD-1000	PD-2000
Frequency Range	10 MHz- 1,000 MHz	1.0- 2.0 GHz
Insertion Loss	10-500 MHz: 0.4 dB max. 500-1000 MHz: 0.6 dB max.	1.0-2.0 GHz, 0.6 dB max.
Amplitude Balance	0.2 dB max	0.2 dB max.
Maximum Power Capacity	2.5 watts	10 watts
Temperature Range	- 50° C to + 85° C	- 55° C to + 100° C
Manufacturer	Amteq Microwave	Mini Circuits

Specifications subject to change without notice

Moseley

Moseley
Associates
Incorporated

111 Castilian Drive
Santa Barbara, CA
93117-3093

a
Flow General
Company

Phone 805 968 9621
Telex 658448
Cable: MOSELEY

ANDREW HELIAX® low-loss foam dielectric coaxial transmission line. Attenuation: LDF4-50 ½", 2.4 dB; LDF5-50 7/8", 1.4 dB (per 100 feet at 950 MHz).

CONNECTOR KIT includes two Type N female connectors and two 3-foot RG-8/U pigtails. One kit required per antenna. For LDF4-50, use KTL-6; for LDF5-50, use KTL-7.

Studio-Transmitter Link Accessories



THE ISOCOUPLER SERIES is designed to facilitate the connection of a remote pickup transmitter or receiver, a transmitter-studio link transmitter or receiver, a communications link transmitter or receiver, a cellular radio transmitter, or an aural studio-transmitter link transmitter or receiver to an antenna mounted on an ungrounded standard AM broadcast tower. As the capacitive loading presented to the broadcast tower is minimal, the effect on the base impedance will be negligible. The isocoupler eliminates the need to

employ a quarter-wave-length insulated transmission line section when installing radio transmitter or receiver antennas on a standard broadcast tower. The isocouplers are rated to withstand an instantaneous 15,000 volt peak. (Caution: In computing the electrical stress across the isocoupler, use the peak value, not rms, and allow a margin for overmodulation peaks.) They are housed in rugged polyvinyl chloride tubes and the end plates are sealed. Type N female RF connectors used on all isocouplers.

Model	Frequency Range	Power Loss	Capacity	Breakdown	Length	Diameter	Weight
ICU-1D	800-1000 MHz	0.5 dB	8 pF	15 kV	6.5" (16.5 cm)	3.5" (8.9 cm)	1.5 lbs (.68 kg)
ICU-2D	410-530 MHz	0.5 dB	14 pF	15 kV	6.0" (15.5 cm)	3.5" (8.9 cm)	1.6 lbs (.73 kg)
ICU-3D	145-180 MHz	0.5 dB	17 pF	15 kV	6.5" (16.5 cm)	3.5" (8.9 cm)	1.4 lbs (.65 kg)
ICU-5	1.5-1.7 GHz	0.75 dB	7 pF	15 kV	5.5" (14.0 cm)	3.5" (8.9 cm)	1.4 lbs (.65 kg)

All isocouplers are designed to carry a maximum of 100 watts continuous power at rated frequency. Specifications subject to change without notice. Capacitance is measured between ends of isocoupler with center pin of UG-58A/U connector shorted to body.

PRECISION ANTENNAS by Scala Electronic Corporation are suggested for use with the Moseley Aural STL equipment. Weighing only 25 pounds, the PR-450U antenna mounts easily and is ruggedly built. An exclusive balun feed assures equal distribution of current in the driven element. The PR-450U is anodized and dichromate dipped for increased protection against corrosive environments. Impedance is 50 ohms, and a Type N RF female connector is used.

Gain

Physical Aperture

Beamwidth

(½ power points)

Mounting

Wind Thrust

Shipping Information

ANTENNA – SCALA PR-450U

18.0 dB over dipole radiator (950 MHz)
15.5 dB over dipole radiator (450 MHz)

36" × 67" (91.4 cm × 107.2 cm)

E-plane 25°, H-plane 14° (950 MHz)

E-plane 30°, H-plane 22° (450 MHz)

Antenna fastens to a 2" circular support – mounting hardware included

304 pounds at 100 mph with ¼" radial ice

70 1/8" × 37 1/8" × 20 3/8" (178.1 cm × 94.9 cm × 51.8 cm);
30.6 cubic feet (8.7 m³); 75 lbs. (27.9 kg)

Specifications subject to change without notice

Other Accessories

- Yagi Antennas for 148 MHz to 470 MHz
- Receiver Multicouplers
- Transmission Line and Connectors
- Grid and Solid Parabolic Antennas
- Transmitter Multicouplers and Duplexers

Printed in USA 2/87.



Moseley Associates Incorporated

111 Castilian Drive
Santa Barbara, CA
93117-3093

a Flow General Company

Phone 805 968 9621
Telex 658448
Cable: MOSELEY

REMOTE PICKUP LINKS AND RF POWER AMPLIFIERS



BULLETIN 241A

FOR MOBILE, PORTABLE, AND OUTSIDE BROADCAST SERVICE

MODEL RPL-3 FOR 148-174 MHz

MODEL RPL-4 FOR 450-470 MHz

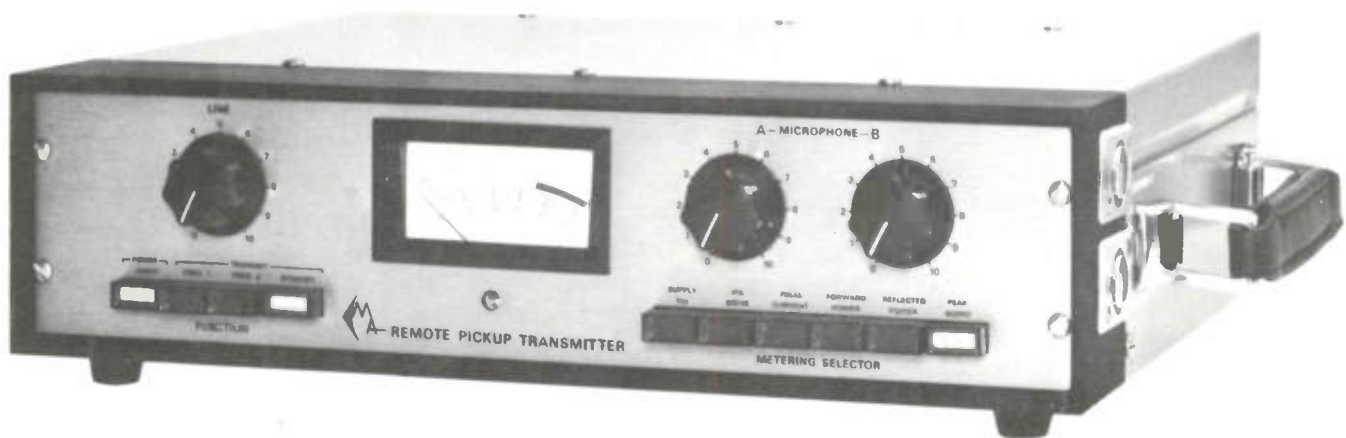

TRANSMITTER



RECEIVER

**MODELS AMP-3 AND
AMP-4 RF POWER
AMPLIFIERS**



MOSELEY ASSOCIATES, INC.

PROFESSIONAL PRODUCTS FOR PROFITABLE BROADCASTING

featuring a low-profile transmitter, including . . .

- Two-frequency operation
- AC and DC operation
- 3-channel audio mixer
- Audio limiter to prevent overmodulation
- All solid-state circuitry

and companion receiver with . . .

- Minimum rack height requirements
- S-meter for input monitoring
- Remote selection of operating frequency

Compactness and portability characterize the Moseley Associates Models RPL-3 and RPL-4 Remote Pickup Links. The transmitter weighs a mere 16 pounds, and is only 4 inches high — including three-channel audio mixing. The companion receiver occupies only 1 3/4 inches of rack space.

Two full-time microphone input channels and one high-level line input channel are provided by the audio portion of the RPL-3/RPL-4 Transmitter. All input connectors are conveniently located near the front panel of the transmitter. Each microphone preamplifier has its own input transformer, eliminating ground loops and enhancing signal-to-noise ratio. A newly designed peak audio limiter is included in the transmitter to prevent overmodulation. Attack time of the limiter is one millisecond, with release time of 700 milliseconds. Unique circuitry reduces distortion at even the lowest audio frequencies. The limiter has a typical control range greater than 25 dB, relieving the operator from constant varying of audio levels with the changing audio levels associated with remote broadcasts.

Full metering of all important parameters is provided on the transmitter. For monitoring audio levels, a peak audio position is provided. Also, forward power, reflected power, final current, RF drive, and power supply voltage may be observed. Selection is accomplished by unique, color-keyed, front-panel push buttons.

All solid-state circuitry is used throughout the RPL-3/RPL-4 systems. The transmitter employs direct FM voltage-controlled crystal oscillators (VCXO) — circuitry pioneered by Moseley Associates in remote pickup equipment. Two separate oscillators are provided, simplifying dual-frequency operation of the transmitter. The transmitter is comprised of four basic modules; audio, VCXO, multiplier/driver, and RF power amplifier. These may be seen in the photograph below and to



Rear view of Transmitter. Separate fuses and input connectors are provided for AC and DC operation. Note protective cap on DC input. RF output is shown at left.

the right. The RF amplifiers of the RPL-3 and RPL-4 use microstrip techniques. Further, the RPL-4 Transmitter uses a hybrid RF power amplifier module. This single module represents the entire final RF amplifier. For applications requiring higher RF output, please refer to the overleaf, which describes the Model AMP-3/AMP-4 RF Power Amplifiers.

The RPL-3/RPL-4 Receivers are of the superheterodyne design and employ double conversion. I.F. frequencies employed are 30 MHz and 10.7 MHz. An all solid-state squelch circuit is employed and has an adjustable threshold.

Optionally, a carrier-operated relay can be supplied for external control purposes. As with the transmitter, the receiver can be operated on dual frequencies. Provisions are incorporated for remote selection of receiver frequency. The RPL-3/RPL-4 Receiver occupies only 1 3/4 inches of rack space.

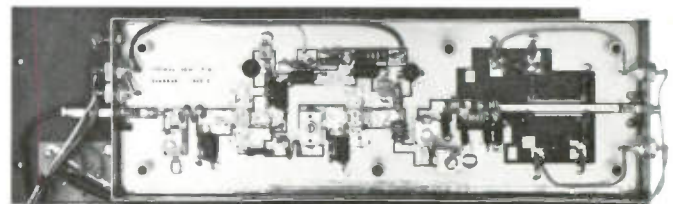

Interior view of the RPL-3 Transmitter RF Amplifier showing microstrip printed circuit technique used. The 450-470 MHz RF Amplifier of the RPL-4 uses the latest hybrid RF amplifier. This single unit amplifies the 450 MHz signal from 100 milliwatts to 10 watts to 13 watts.



Rear view of Receiver. Barrier strip provides for remote selection of operating frequencies and audio output.

RPL-SERIES TRANSMITTER

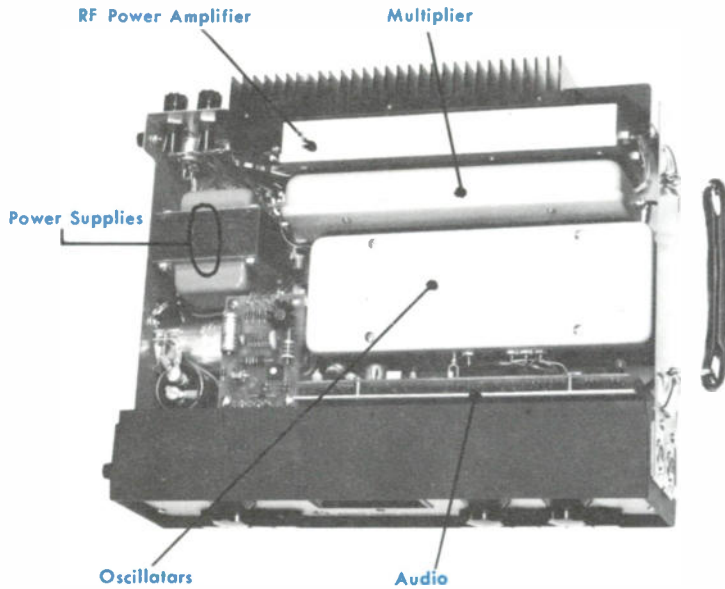

RPL-SERIES RECEIVER

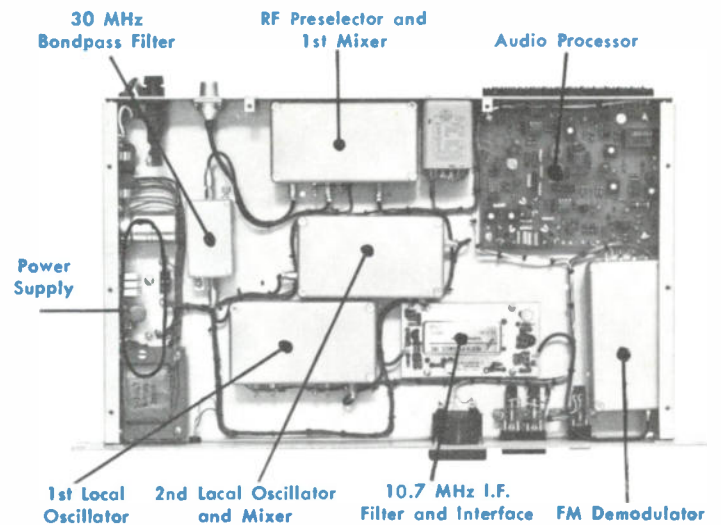

Top view — RPL-3 Transmitter and Receiver. Note individual module concept. Each subassembly is completely shielded from all others. Easy access is afforded to all circuitry.

specifications

system

Audio Response	± 1.5 dB, 30 Hz - 10,000 Hz *
Distortion	Less than 1.3 %, 30 Hz - 10,000 Hz
Signal-to-Noise Ratio	55 dB below 100 % (60 dB typical)

transmitter

RF Output	13 watts maximum, 10 watts minimum, into 50 ohm load. Output connector Type BNC female.
VSWR Protection	Withstands infinite VSWR at all phase angles.
Emission RPL-3 RPL-4	30F3 (± 5 kHz for 100 % modulation) 44F3 (± 12 kHz for 100 % modulation)
Frequency Stability	0.0005 % (-20°C to 60°C)
Harmonic Spurious Output	Better than 60 dB below carrier
Operating Temperature Range	-20°C to 60°C
Audio Inputs	3 independent channels (2 microphone, 1 line)
Audio Input Impedances Line Microphone	-15 dBm to +10 dBm from 600Ω source -60 dBm to -40 dBm
Audio Peak Limiter	Control range greater than 25 dB, attack time one millisecond, release time 700 milliseconds.
Metering	Peak Audio, Forward RF Power, Reflected RF Power, Final Amplifier Current, I.P.A. RF Drive, and Power Supply Voltage.
Power Requirements AC	120/240 VAC, 50-60 Hz, 45 watts maximum
DC	13.5 VDC, negative ground, 2A maximum; 15 VDC maximum, 11 VDC minimum
Size	4" (10.2 cm)H x 14 1/2" (36.8 cm)W x 11" (27.9 cm)D
Weight (Net)	16 pounds (7.2 kg)

Frequency Range

RPL-3
RPL-4

148-174 MHz
450-470 MHz
Two-frequency operation within 2 MHz spacing. One set of crystals supplied with link; order second set of crystals for two-frequency operation.

Audio Monitoring

Utility output with internal adjustable gain control for feeding headphones, telephone line, or other monitor audio amplifiers. Output 600Ω, unbalanced, +10 dBm nominal.

Sensitivity

RPL-3
RPL-4

0.7 microvolt for 20 dB quieting
1.0 microvolt for 45 dB quieting
1 microvolt for 20 dB quieting
1.5 microvolts for 45 dB quieting

Selectivity

RPL-3
RPL-4

-6 dB at ± 22 kHz
-60 dB at ± 42 kHz
-6 dB at ± 44 kHz
-60 dB at ± 75 kHz

All Spurious Response

Frequency Stability

RF Input

Audio Output

Squelch

Operating Temperature Range

Power Requirements

Size

Weight (Net)

65 dB below carrier
0.0005 % (-20°C to 60°C)
50Ω, unbalanced, input connector Type UHF female for RPL-3, Type N for RPL-4
+10 dBm @ 100 % modulation, 600Ω, balanced
Automatic and adjustable, electronic. Carrier-operated relay output (Form C contacts) optionally available.

-20°C to 60°C

120/240 VAC, 50-60 Hz, 10 watts

1 3/4" (4.5 cm)H x 19" (48.4 cm)W x 10" (25 cm)D

10 pounds (4.5 kg)

* Audio response extended to 15,000 Hz on special order. RF bandwidths similar to RPL-4 requiring a minimum of 50 kHz channel spacing.

Specifications subject to change without notice

MODELS AMP-3 and AMP-4 POWER AMPLIFIERS

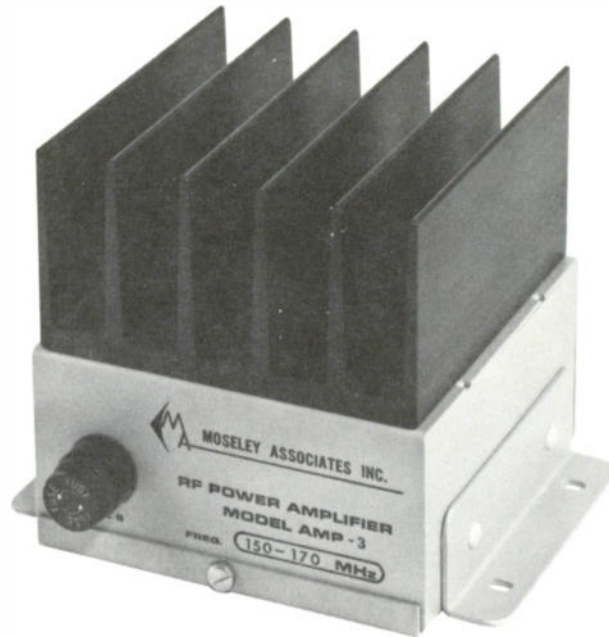

When greater RF outputs are required from the RPL-3 and RPL-4 transmitters to extend their operational range, the Models AMP-3 and AMP-4 RF Power Amplifiers may be added. These fully self-contained amplifiers will increase the RF output nominal gain of their companion remote pickup transmitter. Power gains provided by the AMP-3 and AMP-4 are typically 6 dB and 5 dB, respectively. The only power requirement is 13.5 VDC. No direct control is required. The application

of RF drive activates the RF power amplifier, with less than 5 ma current drawn during non-operating periods. No adjustments are provided or required in the AMP-3 or AMP-4. Both units are constructed using wideband microstrip techniques. If it is desired to monitor the output of either RF power amplifier, the Moseley Associates Type 5478 Relative Power Monitor is suggested. See Bulletin 245 for further information on the Type 5478.

specifications

	AMP-3	AMP-4
Frequency Range	148-174 MHz	450-470 MHz
RF Power Input, Maximum	13 watts	10 watts
RF Input Connector	Type BNC, female	Type BNC, female
Nominal Gain	6 dB (@ 13.5 VDC)	5 dB (@ 13.5 VDC)
RF Output Connector	Type UHF, female (SO-239 Series)	Type N, female
RF Output Impedance	50Ω, unbalanced	50Ω, unbalanced
VSWR	Withstands infinite VSWR at all phase angles	Withstands infinite VSWR at all phase angles
Efficiency	60% minimum	60% minimum
Harmonic Suppression	57 dB below carrier	57 dB below carrier
Spurious Output	60 dB below carrier	60 dB below carrier
Power Requirement	11-15 VDC, negative ground	11-15 VDC, negative ground
Duty Cycle	Continuous at 10 watts input - 60°C ambient	Continuous at 10 watts input - 60°C ambient
Mounting	Not critical. Position unit so as to provide adequate ventilation, with heat sink fully exposed (not inverted).	Not critical. Position unit so as to provide adequate ventilation, with heat sink fully exposed (not inverted).
Size	4" (10.2 cm) H x 5.5" (14 cm) W x 4.5" (11.4 cm) D	4" (10.2 cm) H x 5.5" (14 cm) W x 4.5" (11.4 cm) D
Weight (Net)	3 lbs. (1.4 kg)	5 lbs. (2.3 kg)

Specifications subject to change without notice



MOSELEY ASSOCIATES, INC.
SANTA BARBARA RESEARCH PARK

111 CASTILIAN DRIVE
GOLETA, CALIFORNIA 93017
(805) 968-9621
TELEX: 658448 CABLE: MOSELEY

COMPOSITE STL

MODEL PCL-303/C



BULLETIN 222X

For the stereo FM broadcaster wanting reliable Studio-Transmitter Link equipment, Moseley Associates, the pioneer in stereo STL's, offers a choice of either a dual aural STL or a Composite aural STL. The model PCL-303/C Composite Aural STL gives faithful transmission of the composite stereophonic signal from a studio to the remote FM transmitter. In order to help in determining which Moseley Solid-State stereo STL system will give your station the greatest benefit, the following information is offered. These questions and answers are presented as a supplement to Bulletin 222.

Question: *What is the Model PCL-303/C Composite Aural STL?*

Answer: It is an STL of advanced design that transmits the complete FM composite stereophonic waveform from a studio location to a remote FM broadcast transmitter.

Question: *How does the PCL-303/C differ from the conventional dual STL system for stereo?*

Answer: Only one basic RF link is utilized to transmit the composite stereo waveform including the 19 kHz pilot subcarrier. This differs from the common practice of employing two aural STL systems to convey the unmatrixed LEFT and RIGHT audio signals. The use of the PCL-303/C results in cost savings, but lacks the redundancy of a dual system

MOSELEY ASSOCIATES, INC.

PIONEERS OF STEREO STL'S

Question: *What are the specifications for the PCL-303/C System?*

Answer: The following specifications apply to the composite STL. All others are the same as the PCL-303 (see Bulletin 222).

L+R Frequency Response	±0.5 db, 50 Hz to 15 kHz
L+R Distortion	Less than 0.75%, 50 Hz to 15 kHz
L+R SNR	65 db for 35 μ v input signal
Stereo Separation	Greater than 35 db, 50 Hz to 15 kHz (assuming input stereo signal has separation in excess of 38 db)
Deviation for 100% Modulation	±70 kHz
Maximum Available Composite Output Signal	6 volts peak-to-peak 1,000 Ω minimum load impedance (can be adjusted at the factory for proper interface with your direct FM exciter)
Composite Input	1.5V to 6V peak-to-peak, adjustable. 10 K Ω unbalanced for 100% modulation of STL transmitter
Multiplex Inputs	Two BNC connectors are provided for subcarrier channels, approximately 1.0 volts rms for 20% deviation of STL transmitter
Emission Symbols	
Stereo	246F9, 255 kHz bandwidth
Stereo & 67 kHz SCA	290F9, 300 kHz bandwidth

PROFESSIONAL PRODUCTS FOR PROFITABLE BROADCASTING



MOSELEY ASSOCIATES, INC.
SANTA BARBARA RESEARCH PARK

111 CASTILIAN DRIVE
GOLETA, CALIFORNIA 93017
(805) 968-9621

TOLERANCE ALARM UNIT

MODEL TAU-3



BULLETIN 254

reliable . . . versatile

Using high gain integrated circuit comparators, the Model TAU-3 Tolerance Alarm Unit is designed with the utmost possible accuracy and dependability.



featuring

As An Out-of-Tolerance Unit

Designed to be used with the Moseley Associates Automatic Logging Systems, the TAU-3 functions as an out-of-tolerance alarm system. The DC samples used for the logging system are paralleled with the TAU-3 inputs, and the outputs from the TAU-3 fed to the logging system. When a metered parameter exceeds the preset limits, a relay is activated, indicating an alarm condition.

As A Ratio Alarm Unit

By utilizing an external reference voltage, the TAU-3 becomes a Ratio Alarm. Connectors are provided on the back of the TAU-3 for feeding an external reference voltage to each comparator module. For a 4-tower directional AM array, only three plug-in comparator modules are needed. The DC sample from the reference tower is utilized as an external reference voltage. The three remaining DC samples are each fed to the inputs of the comparator modules. When a change occurs in the ratio of the DC samples, the TAU-3 signals an alarm.

Remote Indication

The TAU-3 can be utilized in conjunction with Moseley Associates status systems when a remote indication is desired.

VERSATILITY

Up to eight independent plug-in comparator modules per main frame.

VISUAL INDICATION

Long-life, front-panel, light-emitting diodes (LED).

FLOATING INPUTS AND OUTPUTS

Fully isolated, up to 300 volts from ground.

EASY CALIBRATION

Multiturn potentiometers for setting tolerance points.

MANY USES

Out-of-tolerance unit or ratio alarm and more.

MOSELEY ASSOCIATES, INC.

PROFESSIONAL PRODUCTS FOR PROFITABLE BROADCASTING

MODEL TAU-3 TOLERANCE ALARM UNIT

With cover removed, easy access is gained to all components. Eight independent plug-in comparator modules are identical, offering easy servicing. Multi-pin connectors are used on these comparator modules for all inputs and outputs. The mating cable-mount connector is supplied with each comparator module.

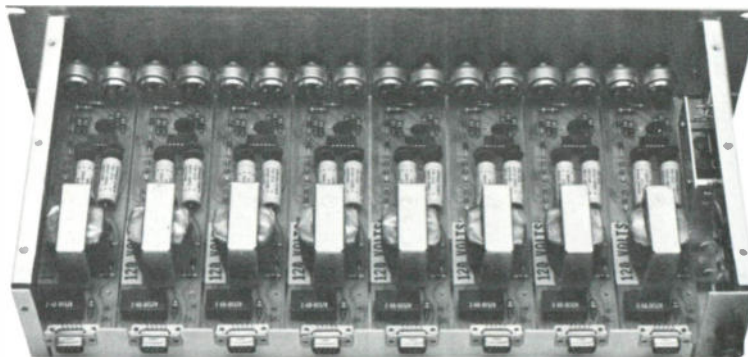

THEORY OF OPERATION

The Model TAU-3 Tolerance Alarm Unit provides a simple and accurate means of electrically determining if a telemetering sample voltage exceeds preset limits. Two independent high gain integrated circuit comparators, fabricated on a single monolithic device, are employed in each plug-in comparator module.

A DC telemetering sample voltage is fed to each of these comparators. One comparator serves for upper limit determination, the other for lower limit determination. A stable internal reference voltage or externally supplied reference voltage is fed via the upper limit potentiometer to the upper limit comparator. The same process is duplicated for the lower limit. Here, the sample voltage is compared to the reference voltage. If the sample voltage is beyond the upper or lower preset limits, one of the comparator outputs, connected in parallel, will sink to ground activating the associated

relay and front-panel light-emitting diode (LED) indicator.

The front-panel LED provides immediate visual indication of an out-of-tolerance condition. Separate and isolated Form C relay contacts (SPDT) from each comparator module are also activated. These contacts can be used for signaling an out-of-tolerance alarm to a Moseley Associates Automatic Logging System. Alternate uses could include any external circuitry requiring a signal level contact closure or break.

The TAU-3 can be custom tailored to fulfill your exact requirements. The main frame contains primary AC distribution, and rack mount housing for up to eight plug-in comparator modules. Simply order a main frame and as many plug-in comparator modules as are needed to fulfill your requirements.

SPECIFICATIONS

Number of Channels	Up to 8; plug-in modules.	External Reference Input Impedance	50K Ω , floating, one lead shared with input signal.
External Connectors	Sub-miniature 9-pin connectors, mating connector supplied with each plug-in comparator module.	Ambient Operating Temperature Cycle	-20 $^{\circ}$ C to +60 $^{\circ}$ C
Input Requirements	0.1 VDC minimum, 4 VDC maximum, floating.	Duty Cycle	Continuous
Input Impedance	100K Ω , floating.	Power Requirements	120/240 VAC, $\pm 10\%$, 50-60 Hz, 2 watts per channel, 16 watts maximum.
Out-of-Tolerance Indicator	Front-panel, light-emitting diode (LED) for each channel. Illuminated when parameter is out-of-tolerance.	Dimensions	3 1/2" H (8.9 cm) x 19" W (48.3 cm) x 9" D (22.9 cm).
Output	Relay Contacts, Form C (SPDT).	Weight	Net—6 pounds (2.7 kg) approx. Shipping—15 pounds (6.8 kg) approx.
External Reference Voltage (If Used)	Greater than the DC voltage presented to the input, not to exceed 8 VDC.		Specifications subject to change without notice.



MOSELEY ASSOCIATES, INC.
SANTA BARBARA RESEARCH PARK

111 CASTILIAN DRIVE
GOLETA, CALIFORNIA 93017
TELEPHONE: (805) 968-9621
TELEX: 658448 CABLE: MOSELEY

TOLERANCE ALARM UNIT

MODEL TAU-2



BULLETIN 233

reliable . . . versatile

Using a carefully chosen combination of integrated circuits and discrete components, the Model TAU-2 Tolerance Alarm Unit is designed with the utmost possible accuracy and dependability.

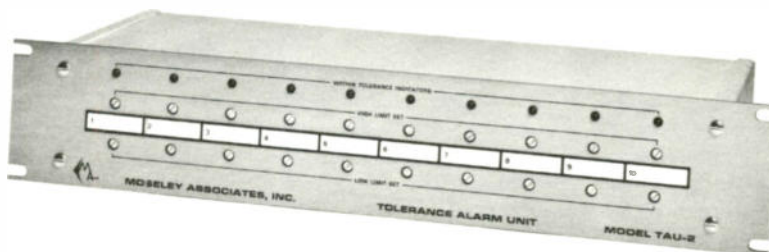

As An Out-of-Tolerance Unit

Designed to be used with the Moseley Associates Automatic Data Printers, the TAU-2 functions as an out-of-tolerance alarm system. The DC samples used for the Data Printer system are paralleled with the TAU-2 inputs, and the outputs from the TAU-2 fed to the Data Printer. When a metered parameter exceeds the preset limits, a transistor switch is activated, indicating an alarm condition.

As A Ratio Alarm Unit

By utilizing an external reference voltage, the TAU-2 becomes a Ratio Alarm. Input terminals are provided on the rear apron for feeding an external reference voltage to each comparator module. For a 4-tower directional AM array, only three plug-in comparator modules are needed. The DC sample from the reference tower is utilized as an external reference voltage. The three remaining DC samples are each fed to the inputs of the comparator modules. When a change occurs in the ratio of the DC samples, the TAU-2 signals an alarm.

Remote Indication

The TAU-2 can be utilized in conjunction with the SCS-2 Status System when a remote indication is desired.

featuring

EXCELLENT ACCURACY

± 5 millivolts from input voltage

VERSATILITY

Up to 10 plug-in comparator modules per main frame.

VISUAL INDICATION

Long-life, front-panel-mounted, light-emitting diodes (LED).

NO MOVING PARTS

Transistor switches used as relays.

EASY CALIBRATION

Multiturn potentiometers for setting tolerance points.

MANY USES

Out-of-tolerance unit or ratio alarm and more.

MOSELEY ASSOCIATES, INC.

PROFESSIONAL PRODUCTS FOR PROFITABLE BROADCASTING

MODEL TAU-2 TOLERANCE ALARM UNIT

With cover removed, easy access is gained to all components. Ten plug-in comparator modules are identical, offering easy servicing.

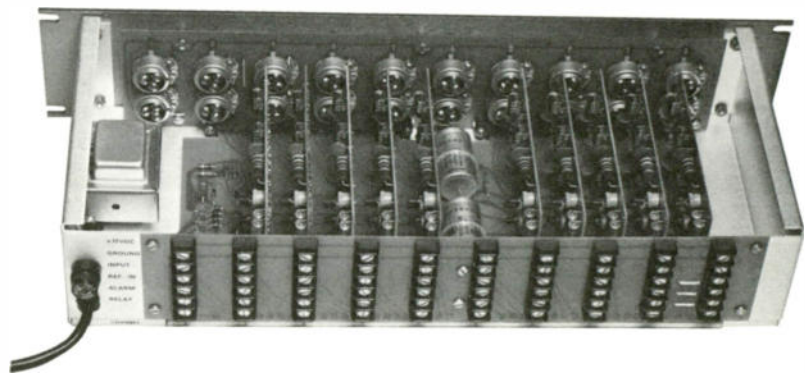

THEORY OF OPERATION

The Model TAU-2 Tolerance Alarm Unit provides a simple and accurate means of electrically determining if a telemetering sample voltage exceeds preset limits. Linear operational amplifiers are employed as voltage comparators. Each plug-in comparator module consists of two of these amplifiers and an "OR" gate.

A DC telemetering sample voltage is fed to each of these amplifiers. One amplifier serves for upper limit determination, the other for lower limit determination. An extremely stable internal reference voltage, or externally supplied reference voltage is fed via the upper limit potentiometer to the upper limit amplifier. The same process is duplicated for the lower limit. Here, the sample voltage is compared to the reference. If the sample voltage is beyond the upper or lower preset limit, the "OR" gate will produce an output.

When this happens, three things occur. First, the front panel LED indicator is extinguished signifying an out-of-tolerance condition. Additionally, two separate and isolated outputs from each comparator module are activated. One output is used for signalling an out-of-tolerance condition to the Moseley Associates Data Printer. Where contact closures are required, the second output may be used to drive an external relay.

The TAU-2 can be custom tailored to fulfill your exact requirements. The main frame contains power supply, sockets, indicators, and calibration potentiometers for a 10-channel system. You simply order a main frame and as many plug-in comparator modules as are needed to fulfill your requirements.

SPECIFICATIONS

NUMBER OF CHANNELS . . .	Up to 10; plug-in modules	EXTERNAL REFERENCE INPUT IMPEDANCE . . .	22,000 Ω
TRIP POINT HYSTERESIS . . .	± 5 millivolts, centered on input	SEMICONDUCTORS . . .	Main frame — 7 diodes, includes 4 rectifiers, 2 regulators, and 1 precision voltage source.
INPUT REQUIREMENTS . . .	-3 VDC to +3 VDC, referenced to ground		Each comparator — 2 integrated circuits, 3 transistors and 5 diodes.
INPUT IMPEDANCE . . .	30,000 Ω	AMBIENT OPERATING TEMPERATURE RANGE . . .	0 $^{\circ}$ to 140 $^{\circ}$ F
OUT-OF-TOLERANCE INDICATOR . . .	Front-panel, solid-state (LED) indicator for each channel. Illuminated when parameter is within tolerance.	DUTY CYCLE . . .	Continuous
OUTPUT . . .	A. Alarm Transistor switch driven to saturation with out-of-tolerance condition	POWER REQUIREMENTS . . .	120/240 VAC, 50-60 Hz, 30 watts maximum
	B. Relay Power supplied to drive external relay (600 Ω 16 volt coil — not supplied)	DIMENSIONS . . .	3 $\frac{1}{2}$ "H x 19"W x 7 $\frac{1}{2}$ "D
EXTERNAL REFERENCE VOLTAGE (If used) . . .	Twice the DC voltage presented to the input, positive only, not to exceed +8 VDC	WEIGHT . . .	Net — 6 pounds (approx.) Shipping — 15 pounds (approx.)
			Specifications subject to change without notice.



MOSELEY ASSOCIATES, INC.
SANTA BARBARA RESEARCH PARK

111 CASTILIAN DRIVE
GOLETA, CALIFORNIA 93017
(805) 968-9621

Aural
Studio-
Transmitter
Links



PCL 6020 System



PCL 6030 System



PCL 6000 Series

PCL 6030 System Specifications

MONAURAL	SYSTEM	COMPOSITE
300-330 MHz, 440-470 MHz, 890-960 MHz. Specify exact operating frequency.	Frequency Range	300-330 MHz, 440-470 MHz, 890-960 MHz., 1.5-1.9 GHz. Specify exact operating frequency.
Monophonic: ± 0.3 dB or better, 30 Hz-15 kHz	Frequency Response	Composite: ± 0.2 dB or better, 30 Hz to 53 kHz; ± 0.3 dB or better 30 kHz to 75 kHz.
0.2% or less, 30 Hz to 15 kHz, typically better then 0.15% at 1 kHz.	THD and IMD	Stereo demodulated :0.1% or less, 30 Hz to 7.5 kHz, typically better than 0.10% at 1 kHz. Convolved stereo demodulation products: > 50 dB below the 400 Hz, 100% mod. ref. level from 7.5 kHz to 15 kHz.
Not applicable.	Stereo Separation	51 dB or better, 50 Hz to 15 kHz, typically 55 dB or better.
Not applicable.	Nonlinear Crosstalk Subchannel/Main Channel	51 dB or better.
75 dB SNR; 0.1 dB frequency response.	IF Repeater	75 dB SNR, 50 dB stereo separation; 0.1 dB frequency response.
75 dB or better, typically 77 dB below 100% modulation.	Signal-to-Noise Ratio	75 dB or better, typically 77 dB below 100% modulation, demodulated, de-emphasized left or right.
120/240 Vac $\pm 10\%$, 50/60 Hz, 100 watts 12-24 Vdc optional.	Power Source	120/240 Vac, $\pm 10\%$, 50/60 Hz, 100 watts 12-24 Vdc optional.
19" (48.3 cm) wide; 3.5" (8.9 cm) high; TX 16" (40.6 cm) deep; RX 13.75" (34.9 cm) deep.	Dimensions	19" (48.3 cm) wide; 3.5" (8.9 cm) high; TX 16" (40.6 cm) deep; RX 13.75" (34.9 cm) deep.
6010	TRANSMITTER	6010
7 watts, maximum, 5 watts minimum. 15 watts maximum, 10 watts minimum.	RF Power Output 890-960 MHz 300-470 MHz	7 watts maximum, 5 watts minimum. 15 watts maximum, 10 watts minimum.
Type N female, 50 ohm.	RF Output Connector	Type N female, 50 ohm.
± 40 kHz; other deviation optional.	Deviation for 100% Modulation	± 50 kHz; other deviation optional.
Better than 0.00025%, 0°C to +50°C.	Frequency Stability	Better than 0.00025%, 0°C to +50°C.
More than 60 dB below carrier level.	Spurious and Harmonic Emission	More than 60 dB below carrier level.
One program and two subcarrier channels.	Modulation Capability	One program and two subcarrier channels.
Monophonic: +10 dBm, 600 ohms, balanced, floating, barrier strip screw input. Two multiplex inputs.	Modulation Inputs User-Switchable Monaural/Composite	Composite: 3.5 V p-p, 6 k ohms unbalanced, type BNC female connector. Two multiplex inputs.
6030	RECEIVER	6030
Type N female, 50 ohm.	RF Input Connector	Type N female, 50 ohm.
20 μ V or less required for 60 dB SNR.	Sensitivity	100 μ V or less required for 60 dB SNR left or right channel de-emphasized, demodulated
3 dB IF bandwidth, ± 90 kHz. 80 dB IF bandwidth, ± 1.0 MHz. 250 kHz channel spacing.	Selectivity 100-500 kHz Channel Spacing	3 dB IF bandwidth, ± 100 kHz. 80 dB IF bandwidth, ± 1.0 MHz. 500 kHz channel spacing.
An adjacent signal 20 dB higher than desired signal will degrade SNR by less than 3 dB.	Adjacent Channel Rejection	An adjacent signal 20 dB higher than desired signal will degrade SNR by less than 3 dB.
Monophonic: +10 dBm, 600 ohms, balanced, floating, barrier strip screw output. Two multiplex inputs.	Modulation Outputs User-Switchable Monaural/Composite	Composite: 3.5 V p-p, 200 ohms unbalanced, type BNC female connector. Two multiplex inputs.

Specifications subject to change without notice.

Printed in the USA 2/89.

Moseley

▼
Moseley
Associates
Incorporated

111 Castilian Drive
Santa Barbara
93117-3093

a
GRC International
Company

Phone 805 968 9621
Telex 658448
Fax 805 685 9638

Moseley

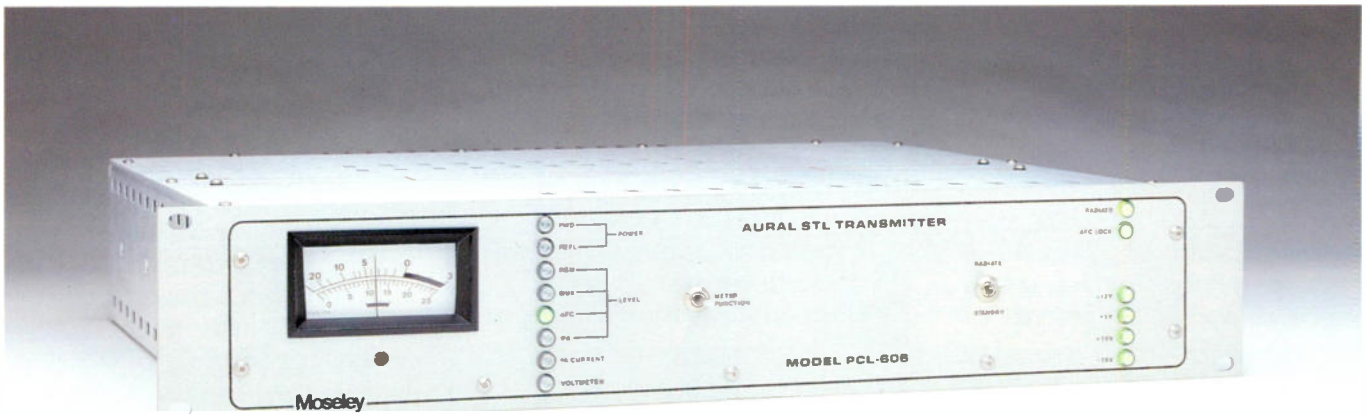

PCL-606 Aural Studio-Transmitter Link

Specifications

MONAURAL	SYSTEM	COMPOSITE
300-330 MHz, 450-470 MHz, 890-960 MHz, 1.5-1.71 GHz. Specify exact operating frequency.	Frequency Range	300-330 MHz, 450-470 MHz, 890-960 MHz, 1.5-1.71 GHz. Specify operating frequency.
250 kHz	Channel Spacing Wide (Narrow) Band	500 kHz (300 kHz)
Monophonic: ± 0.25 dB or better, 30 Hz-15 kHz	Frequency Response Wide (Narrow) Band	Composite: ± 0.1 dB (± 0.2 dB) or better, 30 Hz to 53 kHz; ± 0.3 dB (± 1.0 dB) or better, 53 kHz to 73 kHz
0.2% or less, 30 Hz to 15 kHz, typically better than 0.1% at 1 kHz	THD and IMD Wide (Narrow) Band	Stereo demodulated: 0.2% (0.3%) or less, 30 Hz to 7.5 kHz, typically better than 0.1% at 1 kHz Convolved stereo demodulation products: > 50 dB below the 400 Hz, 100% modulation ref. level from 7.5 kHz to 15 kHz
Not applicable	Stereo Separation Wide (Narrow) Band	52 dB (45 dB) or better, 50 Hz to 15 kHz, typically 57 dB (50 dB) or better
Not applicable	Nonlinear Crosstalk Subchannel/Main Channel Wide (Narrow) Band	53 dB (50 dB) or better
75 dB or better, typically 78 dB below 100% modulation	Signal-to-Noise Ratio Wide (Narrow) Band	75 dB (72 dB) or better, typically 78 dB (75 dB) below 100% modulation, demodulated, de-emphasized left or right
19" (48.3 cm) wide; 3.5" (8.9 cm) high; 16.5" (41.9 cm) deep	Dimensions Transmitter/Receiver	19" (48.3 cm) wide; 3.5" (8.9 cm) high; 16.5" (41.9 cm) deep
0°C to +50°C	Operating Temperature	0°C to +50°C

MONAURAL	TRANSMITTER	COMPOSITE
10 watts, maximum, 5 watts minimum 12 watts maximum, 8 watts minimum	RF Power Output 890 MHz-1.71 GHz 300-470 MHz	10 watts maximum, 5 watts minimum 12 watts maximum, 8 watts minimum
Type N female, 50 ohm	RF Output Connector	Type N female, 50 ohm
± 40 kHz	Deviation for 100% Modulation Wide (Narrow) Band	± 50 kHz (± 35 kHz)
Better than 0.00025%, 0°C to +50°C	Frequency Stability	Better than 0.00025%, 0°C to +50°C
More than 60 dB below carrier level	Spurious and Harmonic Emission	More than 60 dB below carrier level
One program and two subcarrier channels	Modulation Capability	One program and two subcarrier channels
Monophonic: +10 dBm, 600 ohms, balanced, floating, barrier strip screw input Multiplex: 1.5 V p-p, 4k ohms unbalanced, type BNC female connectors (2), 22-85 kHz	Modulation Inputs Wide (Narrow) Band	Composite: 3.5 V p-p, 6 k ohms unbalanced, type BNC female connector Multiplex: 1.5 V p-p 4 k ohms unbalanced, type BNC female connectors (2), 110-185 kHz (110 kHz)
100/120/220/240 Vac, $\pm 10\%$, 50/60 Hz, 70 watts	Power Source	100/120/220/240 Vac, $\pm 10\%$, 50/60 Hz, 70 watts

MONAURAL	RECEIVER	COMPOSITE
Type N female, 50 ohm	RF Input Connector	Type N female, 50 ohm
20 μ V or less required for 60 dB SNR	Sensitivity Wide (Narrow) Band	130 μ V (200 μ V) or less, typically 120 μ V (170 μ V) required for 60 dB SNR left or right channel de-emphasized, demodulated
3 db IF bandwidth, ± 90 kHz 60 dB IF bandwidth, ± 400 kHz 80 dB IF bandwidth, ± 1.0 MHz	Selectivity Wide (Narrow) Band	3 dB IF bandwidth, ± 100 kHz (± 75 kHz) 60 dB IF bandwidth, +460 kHz (± 350 kHz) 80 dB IF bandwidth, +1 MHz (± 1 MHz)
An adjacent signal 20 dB (10 dB) higher than desired signal degrades SNR by less than 3 dB.	Adjacent Channel Rejection	An adjacent signal 20 dB (10 dB) higher than desired signal degrades SNR by less than 3 dB.
Monophonic: +10 dBm, 600 ohms, balanced, floating, barrier strip screw output Multiplex: 1.5 V p-p, 4 k ohms unbalanced, type BNC female connectors (2)	Modulation Outputs	Composite: 3.5 p-p, 100 ohms unbalanced, type BNC female connector Multiplex: 1.5 V p-p, 4 k ohms unbalanced, type BNC female connectors (2)
100/120/220/240 VAC, $\pm 10\%$, 50/60 Hz, 30 watts	Power Source	100/120/220/240 Vac, $\pm 10\%$, 50/60 Hz, 30 watts

Specifications subject to change without notice.

Printed in USA 8/88



Moseley
Associates
Incorporated

111 Castilian Drive
Santa Barbara, CA
93117-3093

a
Flow General
Company

Phone 805 968 9621
Telex 658448
FAX: 805 685 9638

DSP 6000 SYSTEM

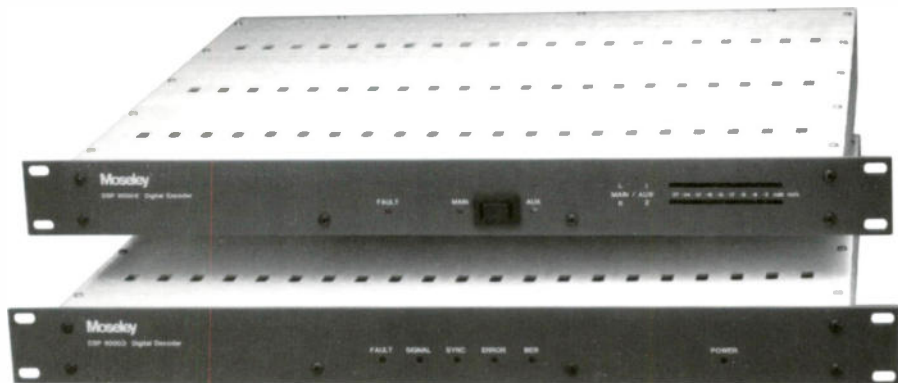

New Transmission Technology

In the past, excessive bandwidth requirements have made transmission of digitized, high quality program material using narrow band (500 kHz or less) studio-to-transmitter links impractical. The DSP 6000 is a new spectrum efficient digital STL that not only transmits CD-quality audio over existing channel allocations but also offers substantial transmission benefits.

DSP 6000 System

The DSP 6000 Digital STL system consists of the DSP 6000E source and channel encoder, the DSP 6000D source and channel decoder and any Moseley digital-ready STL transmitter and receiver.

Encoder and Decoder

Digital transmission of the audio is made possible by the DSP 6000 Digital Encoder and Decoder. Using a combination of source and channel coding, the encoder converts audio program and auxiliary data channels into a shaped digital baseband. The STL transmitter then generates a spectrally compact digital FM signal that is compatible with existing analog FM services. At the receiver end, the source and channel decoder perform the inverse of the encoding operation.

The standard system comes equipped with two (left and right) audio channels and one data channel with provisions for up to two auxiliary program and one additional data channel. When used with the optional built-in digital stereo generator, composite stereo can be delivered directly to the FM exciter.

Direct digital input/output allows for future digital interconnection.

The DSP 6000 Encoder and Decoder can also be interfaced to existing PCL 6000 and PCL 606 STLs already in operation. A digital-ready kit is available for this configuration.

Transmitter and Receiver

The Moseley digital-ready PCL 6000 or PCL 606 transmitter and receiver are available in a number of bands in the 140 MHz to 1.7 GHz frequency range and are now capable of either analog and/or digital modulation.

Value

By delivering true digital audio quality and simultaneously reducing transmission costs, the DSP 6000 System offers broadcasters the digital transmission advantage.

The DSP 6000 continues a proud Moseley tradition of technical innovation, advanced manufacturing, reliability and most of all, value.

The Digital Advantage

■ CD-Quality Audio

Signal-to-noise ratio (SNR) is 90 dB with .01% distortion.

■ Higher System Gain

The DSP 6000 transmission requires 25 dB less system gain than analog STLs. Higher system gain substantially reduces antenna and transmission line costs.

■ Constant SNR

In analog systems, SNR depends on received carrier power. The DSP 6000 delivers its full SNR all the way down to the digital threshold. Fades have no effect on SNR.

■ Spectrally Efficient

The DSP 6000 can operate in existing channel allocations from 100 to 500 kHz coexisting with already established analog radios.

■ No Crosstalk

Left, right and auxiliary audio program channels are multiplexed digitally eliminating crosstalk.

■ Multiple Hops

Multiple analog re-transmission adds noise and distortion with each hop. With the DSP 6000, digital regeneration makes the last hop as good as the first.

Specifications

Frequency Response

Main Wide	20 Hz to 15 kHz +/-0.2 dB.
Main Narrow	20 Hz to 7.5 kHz +/-0.2 dB.
Aux Wide	20 Hz to 14 kHz +/-0.2 dB.
Aux Narrow	20 Hz to 7 kHz +/-0.2 dB.

Distortion < .01%.

Dynamic Range > 90 dB static.

Channel Crosstalk < -80 dB.

Level Stability < 0.2 dB.

Data Coding Method Sub-band ADPCM, others optional.

Sample Rate 32 kHz.

Time Delay < 3.8 ms (2-channel).

Bit Error Immunity > 10⁴ for no subjective loss in audio quality.

Sensitivity -93 dBm at 10⁻⁴ BER (PCL 6000 at 256 kb/s).

Spectral Efficiency 1 bps/Hz standard.

Data Channels

Data 1 RS-232, selectable baud rates from 4800, 2400, 1200, 300 baud.

Data 2 (Optional) RS-232, selectable baud rates from 9600, 4800, 2400, 1200, 300 baud.

Program Channels 1-4 channels. Channels programmable as 15/7.5 kHz for main and 14/7kHz for Aux. Two 15 kHz channels standard.

Power Requirements 115/230 VAC ± 10%, 50/60 Hz.

Transmitter and Receiver

STL Choice of either a digital-ready Moseley PCL 6000 or PCL 606 STL transmitter and receiver.

Frequency Range 140-176, 200-240, 300-330, 440-470, 890-960 MHz, 1.5 - 1.7 GHz.

Power Source 120/240 VAC, ± 10%, 50/60 Hz 100 watts, 12/24 Vdc optional.

RF Output

890-960 MHz 7 watts maximum, 5 watts minimum.

140-470 MHz 15 watts maximum, 7 watts minimum.

RF Output Connector Type N female, 50 ohm.

Frequency Stability Better than 0.00025%, 0°C to + 50°C.

Spurious and Harmonic Emission More than 60 dB below carrier level.

Modulation Capability Analog, digital or combined.

RF Input Connector Type N female, 50 ohm.

Sensitivity See system specs.

Channel Spacing User specified 100-500 kHz Depends on data rate.

Adjacent Channel Rejection (500 kHz) Digital to digital 10 dBc. Digital to analog 25 dBc. Analog to digital 10 dBc.

DSP 6000E Encoder

Audio Input Active balanced input. XLR type. CMRR > 60 dB.

Audio Level Each channel adjustable from -10 dBu to +14 dBu, rear panel accessible.

Data Inputs

Data 1 RS-232, 9-pin "D" type.

Data 2 RS-232, 9-pin "D" type.

Repeater/PCM Inputs

Data BNC; TTL or CMOS input levels. Input for regenerated data from decoder in repeater mode. Input for unformatted linear 16-bit PCM or other source coders in PCM mode.

Clock BNC; TTL or CMOS input levels. Input for synchronous data clock in repeater mode and PCM mode.

Status Output 15-pin D type provides active-low indication of system, clock, modem, encoder, power supply and mux faults.

Indicators

Peak Program Bargraph Dual ten LED display indicates peak level relative to 0 dB A/D overload level for right and left channels.

Fault System fault alarm.

Main Indicates bargraph is displaying main program levels.

Aux Indicates bargraph is displaying auxiliary program levels.

DSP 6000D Decoder

Audio Output Active balanced output. XLR type.

Audio Level Each channel adjustable from -10 dBm to +10 dBm into 600 ohms, rear panel accessible.

Data Outputs

Data 1 RS-232 9-pin "D" type.

Data 2 RS-232 9-pin "D" type.

Repeater Outputs

Data BNC, CMOS levels. Regenerated data in repeater mode. Formatted or unformatted 16-bit linear PCM in PCM mode.

Clock BNC, CMOS levels. Synchronous clock for regenerated data in repeater or PCM mode.

Status Output 15-pin "D" type provides active low indication of system, loss of data, data sync, loss of incoming signal, clock, modem, decoder, BER, power supply and demux faults.

Indicators

Peak Program Bargraph Dual ten LED display indicates peak relative to 0 dB D/A overload level for right and left channels.

Fault System fault alarm.

Main Indicates bargraph is displaying main program levels.

Aux Indicates bargraph is displaying auxiliary program levels.

Sync Indicates decoder is out of sync with received signal.

Error Displays each received bit error.

BER Alarm condition when received bit error rate surpasses preset level (selectable from 10⁻³ to 10⁻⁷).

Signal Indicates input signal present.

Specifications subject to change without notice.



Moseley Associates Incorporated

111 Castilian Drive Santa Barbara, CA 93117-3093

a GRC International Company

Phone 805-968-9621 Telex 658448 Fax 805-685-9638

PRICING

DSP 6000

DSP 6000E 1	One audio and one data channel encoder	\$2,495.00
DSP 6000D 1	One audio and one data channel decoder	\$2,495.00
DSP 6000E 2	Two audio and one data channel encoder	\$2,995.00
DSP 6000D 2	Two audio and one data channel decoder	\$2,995.00
DSP 6000E 3	Three audio and two data channel encoder	\$4,230.00
DSP 6000D 3	Three audio and two data channel decoder	\$4,230.00
DSP 6000E 4	Four audio and two data channel encoder	\$4,950.00
DSP 6000D 4	Four audio and two data channel decoder	\$4,950.00
DSP 6000E R	Digital repeater encoder	\$2,295.00
DSP 6000D R	Digital repeater decoder	\$2,295.00
DSP 6000 SG	Digital stereo generator for decoder	\$1,495.00

*DSP 6000/
PCL 6020 DSP 6000E 2 and DSP 6000D 2
with PCL 6010 TX and PCL 6020 RX \$12,995.00

*DSP 6000/
PCL 6030 DSP 6000E 2 and DSP 6000D 2
with PCL 6010 TX and PCL 6030 RX \$13,995.00

FT1 3000

FT1 3000E 1	One audio and one data channel encoder	\$2,495.00
FT1 3000D 1	One audio and one data channel decoder	\$2,495.00
FT1 3000E 2	Two audio and one data channel encoder	\$2,995.00
FT1 3000D 2	Two audio and one data channel decoder	\$2,995.00
FT1 3000E 3	Three audio and two data channel encoder	\$4,230.00
FT1 3000D 3	Three audio and two data channel decoder	\$4,230.00
FT1 3000E 4	Four audio and two data channel encoder	\$4,950.00
FT1 3000D 4	Four audio and two data channel decoder	\$4,950.00

DigiMux

DigiMux Mainframe with one two-program module \$1,995.00
Additional two-program module \$995.00

Musicode 56/64

Musicode portable unit for ISDN or switched 56 telco lines \$1,995.00

*This post-NAB special discount pricing is good for orders placed up until June 30, 1991.

Moseley

the subcarrier frequency on the program module which is fully synthesized from 1 kHz to 200 kHz. In this case, we select 110 kHz. Dip switch selections, also on the program modules, determine whether the card is a transmit or receive, and the audio bandwidths required for each channel. Audio can be in 7.5, 10 or 15 kHz increments with 60 db uncompanded SNR with companding expect up to 80 db per channel. Because the system is single sideband AM modulated, it is spectrally very efficient. However, the price to pay for this is that it is practically impossible to gain and phase match a stereo pair.

To convey the second set of audio channels, another program module is inserted in the main frame at 150 kHz. Up to 12 transmit and/or receive modules can be added to the mainframe.

Musicode 56/64

As the phone company continues to offer more flexible and less expensive line configurations, remote broadcasts using telcos have become popular again. The Musicode allows for transmission of full duplex high quality program material over switched 56 kbps or 64 kbps lines. A broadcaster can have these lines installed and do a quality remote using the Musicode. Taking advantage of the fact that such lines are bi-directional, a user can use a DTMF tone encoder to key a command to a tape recorder at the end of the line and tape his message for playback at a later time. A status LED flashes in the center of the unit letting the user know the command has been executed.

Shipment

As far as shipment schedules are concerned, the DSP 6000 and FT1 3000 systems are scheduled to begin shipping in July and August. The DigiMux will be a production item in July. The Musicode 56/64 is still under development and will be available by the end of this year.

The fantastic response that we have had from these products will no doubt bring plenty of inquiries. If you need any additional information, please give us a call.

Sincerely,



Dave Chancey
National Sales Manager

We have also included a copy of the technical paper presented by Moseley during a Sunday morning session. The paper contains interesting information on how the technology was developed, and more importantly, how it is used to solve STL problems.

FT1 3000

For decades now, Moseley has marketed products that allow broadcasters to avoid using leased telephone lines. All that has changed with the FT1 3000, a new system that facilitates running digital audio on fractional T1 lines. FT1 service employs a format which divides a T1 line into 24 channels with each channel representing a bandwidth or time slot of 64 kbps. Current equipment using T1 utilizes the full 24 channel 1.544 Mbps capabilities of the line. The FT1 3000 will only use the number of channels that the user actually needs. *By only using part of the line, users will significantly reduce their phone bill costs.* If it all sounds complicated, remember that the FT1 3000 uses 128 kbps for a 15 kHz audio channel or two time slots. Using that formula, you can configure a two channel stereo system using 256 kbps or four time slots. Because we are using the same technology in the DSP 6000, we can easily add two additional audio channels for a total occupied data rate of 512 kbps or eight time slots.

According to Communications News, a telecommunication magazine, rates for a 512 kbps line from 1 to 50 miles are in the order of \$538 per month plus a \$21 charge per mile for a 128 kbps line the rate drops to \$283 per month plus \$11 per mile. The lines are typically bi-directional so a broadcaster can utilize an FT1 3000 Encoder and Decoder to send and receive digital audio to his transmitter site and another system to return his RPU or satellite audio programs.

It should be noted the FT1 3000 provides a standard V.35/RS-422 output. Consequently, interface must be made with a fractional T1 CSU modem that can be purchased/leased from your common carrier or other commercially available sources. The FT1 3000 and DSP 6000 can also be integrated, linking phone lines to our STL systems without having to come back to analog baseband.

DigiMux

Designed to replace our SCG 8 and SCD 8 subcarrier systems, the DigiMux permits the user of any analog STL to use his subcarrier capability to full advantage. The system consists of a mainframe shelf which is effectively a card cage that accepts program modules that can be set-up to carry or receive two audio channels.

To illustrate this, a customer may want to carry four audio channels from his transmitter to studio over a composite PCL 6000 on an ICR license. To satisfy his requirements, he needs two DigiMux mainframes which comes with one two-channel program module. He selects



June 20, 1991

WHA-TV
Thomas C. Smith
821 University Ave.
Madison, WI 53706

Dear Mr. Smith:



The reality of the digital era is certainly upon us. As you attend trade shows or even pick up a trade journal, "digital" pops out of every article and new product front panel. At broadcaster's largest trade show, NAB, Moseley introduced an integrated series of digital products designed to take us from being a manufacturer of analog composite STL links to a company dealing with program conveyance of all types. Here are the highlights of our product introductions and a brief description of their applications.

DSP 6000 Encoder & Decoder

By allowing the user to convert his existing composite STL (either PCL 606 or PCL 6000) to a digital discrete system, we created one of the most talked about products at the show, the *DSP 6000 System*. In addition to the left and right audio and 9600 baud data channels on a standard system, options allow up to two more program channels of 15 kHz or 7.5 kHz bandwidths and one more data channel per system. *Advantages include increased SNR and dynamic range with a 26 db improvement in system gain. Digital transmission has greater immunity from crosstalk, fades and intermod. When the system is used in a digital repeat configurations, multiple hop STLs are free of the degradation in audio specifications normally associated with analog signal regeneration.* An article in the attached Moseley News Express gives more detailed information.

A digital stereo generator that provides 90 db SNR and 70 db stereo separation is also optionally available for the decoder. At a price of \$1,495, it offers the same specifications as digital stereo generators that are available at well over \$5,000.

At NAB, we demonstrated a system getting 90 db SNR with only 10 microvolts of signal. Besides the sonic improvements, if you review the attached Digital vs. Analog Antenna Costs matrix, you can see where significant cost savings in antennas and transmission line for longer STL paths can be realized.

One of the highlights of the show was the realization by the industry that we have thoughtfully provided direct digital inputs and outputs into the system. These input/outputs permit the broadcast chain to be transmitted digitally without unnecessary digital to analog conversions. A block diagram of the system interface is included.

FT1 3000 SYSTEM

A digital CD-quality Fractional T1 system offering the highest quality audio along with all the advantages of digital transmission.

New Transmission Technology

In the past, excessive data rates have made transmission of digitized, high quality program material using Fractional T1 impractical. The FT1 3000 is a new data rate efficient digital encoder and decoder that transmits CD-quality audio over FT1 lines.

FT1 3000 System

The FT1 3000 system consists of the FT1 3000E and FT1 3000D source encoder and decoder.

Encoder and Decoder

Digital transmission of the audio is made possible by the FT1 3000 Digital Encoder and Decoder. Using source coding, the FT1 3000E converts audio program and auxiliary data channels into a digital signal that occupies two 64 kpb/s time slots per 15 kHz channel. The FT1 3000E has a V.35/RS-422 driver interface for a customer supplied CSU. At the receive end, the FT1 3000D performs the inverse of the encoding operation.

The standard system comes equipped with two (left and right) audio channels and one data channel with provisions for expansion for two more program and one additional data channels.

Direct digital input/output allows for future digital interconnection.

Fractional T1 CSU

Any fractional T1 CSU that adheres to the T1 trunk format (with or without ESF) can be used to access the T1 network. Multiport CSUs can be used for routing different channels.

Value

By delivering true digital audio quality and simultaneously reducing phone line costs, the FT1-3000 System offers broadcasters the digital transmission advantage.

The FT1 3000 continues a proud Moseley tradition of technical innovation, advanced manufacturing, reliability and most of all, value.

The Digital Advantage

■ CD-Quality Audio

Signal-to-noise ratio (SNR) is 90 dB with .01% distortion.

■ Lower Transmission Costs

The FT1 3000 transmission requires one-fourth of the data rate of standard digital systems. Lower data rate offers substantial savings on leased line costs and more efficient use of the FT1 line.

■ Constant SNR

The FT1 3000 delivers its full SNR all the way down to the digital threshold. Noise problems normally associated with telephone lines have no effect on SNR.

■ Spectrally Efficient

The FT1 3000 uses 64 kpb/s per 7.5 kHz audio channel or 128 kpb/s per 15 kHz audio channel. A fully expanded system uses only 512 kpb/s for four 15 kHz audio channels.

■ No Crosstalk

Left, right and auxiliary audio program channels are multiplexed digitally eliminating crosstalk.

■ Multiple Hops

With the FT1 3000, digital or analog drop off of the program can be made at a mid point. Digital regeneration makes each receive point as good as the first.



Moseley
Associates
Incorporated

111 Castilian Drive
Santa Barbara
93117-3093

a
GRC International
Company

Phone 805 968 9621
Telex 658448
Fax 805 685 9638

Specifications

Frequency Response	
Main Wide	20 Hz to 15 kHz +/-0.2 dB.
Main Narrow	20 Hz to 7.5 kHz +/-0.2 dB.
Aux Wide	20 Hz to 14 kHz +/-0.2 dB.
Aux Narrow	20 Hz to 7 kHz +/-0.2 dB.
<hr/>	
Distortion	< .01%.
<hr/>	
Dynamic Range	> 90 dB static.
<hr/>	
Channel Crosstalk	< -80 dB.
<hr/>	
Level Stability	< 0.2 dB.
<hr/>	
Data Coding Method	Sub-band ADPCM, others optional.
<hr/>	
Sample Rate	32 kHz.
<hr/>	
Time Delay	< 3.8 ms (2-channel).
<hr/>	
Bit Error Immunity	> 10 ⁴ for no subjective loss in audio quality.
<hr/>	
Sensitivity	-93 dBm at 10 ⁻⁴ BER (PCL 6000 at 256 kb/s).
<hr/>	
Data Rate	64 kbps/7.5 kHz, 128 kbps/15 kHz
<hr/>	
Data Channels	
Data 1	RS-232, selectable baud rates from 4800, 2400, 1200, 300 baud.
<hr/>	
Data 2 (Optional)	RS-232, selectable baud rates from 9600, 4800, 2400, 1200, 300 baud.
<hr/>	
Program Channels	1-4 channels. Channels programmable as 15/7.5 kHz for main and 14/7kHz for Aux. Two 15 kHz channels standard.
<hr/>	
Power Requirements	115/230 VAC ± 10%, 50/60 Hz.

FT1-3000E Encoder

Audio Input	Active balanced input, XLR type. CMRR > 60 dB.
<hr/>	
Audio Level	Each channel adjustable from -10 dBu to +14 dBu, rear panel accessible.
<hr/>	
Data Inputs	
Data 1	RS-232, 9-pin "D" type.
Data 2	RS-232, 9-pin "D" type.

Repeater/PCM Inputs	
Data	BNC; TTL or CMOS input levels. Input for regenerated data from decoder in repeater mode. Input for unformatted linear 16-bit PCM or other source coders in PCM mode.
<hr/>	
Clock	BNC; TTL or CMOS input levels. Input for synchronous data clock in repeater mode and PCM mode.
<hr/>	
Digital Interface	V.35 or RS-422

Clock	BNC; TTL or CMOS input levels. Input for synchronous data clock in repeater mode and PCM mode.
-------	--

Digital Interface	V.35 or RS-422
-------------------	----------------

Status Output	15-pin D type provides active-low indication of system, clock, modem, encoder, power supply and mux faults.
---------------	---

Indicators Peak Program Bargraph	Dual ten LED display indicates peak level relative to 0 dB A/D overload level for right and left channels.
----------------------------------	--

Fault	System fault alarm.
-------	---------------------

Main	Indicates bargraph is displaying main program levels.
------	---

Aux	Indicates bargraph is displaying auxiliary program levels.
-----	--

FT1-3000D Decoder

Audio Output	Active balanced output, XLR type.
--------------	-----------------------------------

Audio Level	Each channel adjustable from -10 dBm to +10 dBm into 600 ohms, rear panel accessible.
-------------	---

Data Outputs	
Data 1	RS-232 9-pin "D" type.
Data 2	RS-232 9-pin "D" type.

Repeater Outputs	
Data	BNC, CMOS levels. Regenerated data in repeater mode. Formatted or unformatted 16-bit linear PCM in PCM mode.

Clock	BNC, CMOS levels. Synchronous clock for regenerated data in repeater or PCM mode.
-------	---

Digital Interface	V.35 or RS-422
-------------------	----------------

Status Output	15-pin "D" type provides active low indication of system, loss of data, data sync, loss of incoming signal, clock, modem, decoder, BER, power supply and demux faults.
---------------	--

Indicators Peak Program Bargraph	Dual ten LED display indicates peak relative to 0 dB D/A overload level for right and left channels.
----------------------------------	--

Fault	System fault alarm.
-------	---------------------

Main	Indicates bargraph is displaying main program levels.
------	---

Aux	Indicates bargraph is displaying auxiliary program levels.
-----	--

Sync	Indicates decoder is out of sync with received signal.
------	--

Error	Displays each received bit error.
-------	-----------------------------------

BER	Alarm condition when received bit error rate surpasses preset level (selectable from 10 ⁻³ to 10 ⁻⁷).
-----	--

Signal	Indicates input signal present.
--------	---------------------------------

Specifications subject to change without notice.

Digital Transmission Advantage

Digital vs. Analog Antenna Costs

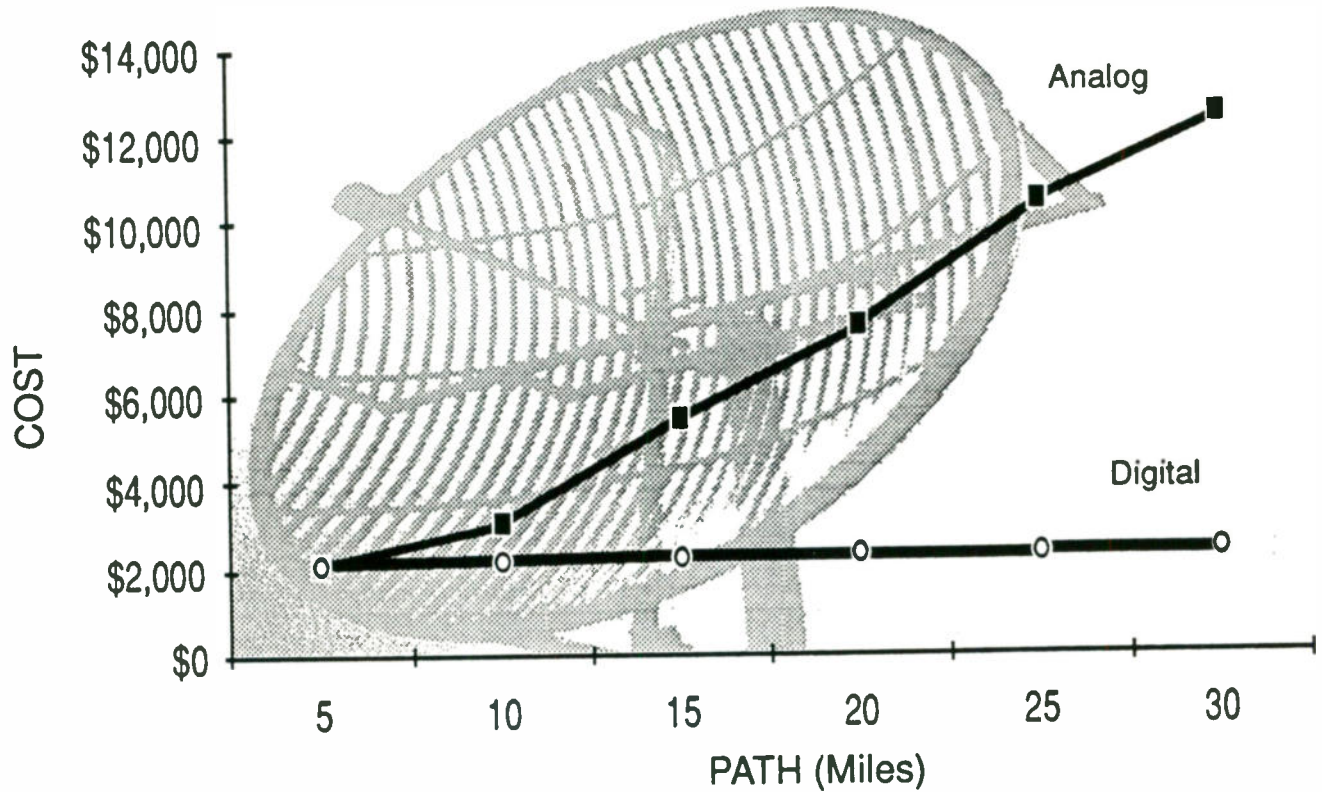

Path	TX Antenna	RX Antenna	TX Cable	RX Cable	Total \$ Analog	Total \$ Digital	Total \$ Savings
5	4	4	200	200	\$2,100	\$2,100	N/A
10	4	6	220	220	\$3,080	\$2,190	\$890
15	8	8	240	240	\$5,500	\$2,280	\$3,220
20	10	10	250	250*	\$7,628	\$2,325	\$5,033
25	10	12	260*	260*	\$10,476	\$2,370	\$8,106
30	10	12	270*	270*	\$12,441	\$2,415	\$10,026

All antenna sizes for digital are 4' dish and cable size is 1/2" except where * = 7/8" cable.

Distance	Path Loss	Loss Due to Additional Cable*	Fade Margin for 99.99% ^o	Antenna Gain Required
5	110	0	8.2	24
10	116.2	1.0	17.2	40
15	119.7	2.0	22.6	50
20	122.1	2.0	26.2	56
25	124.1	3.0	29.2	62
30	125	3.0	30.6	65

*Additional loss due to increase cable runs required to overcome Fresnel zone clearance. This loss, in addition to 10 dB (400'), is cable loss.

^oAssumes climate factor 0.5, terrain factor 0.4. Uses Barnett and Vigilants formula. Formula calculated for 950 MHz band.

Repeater Configurations

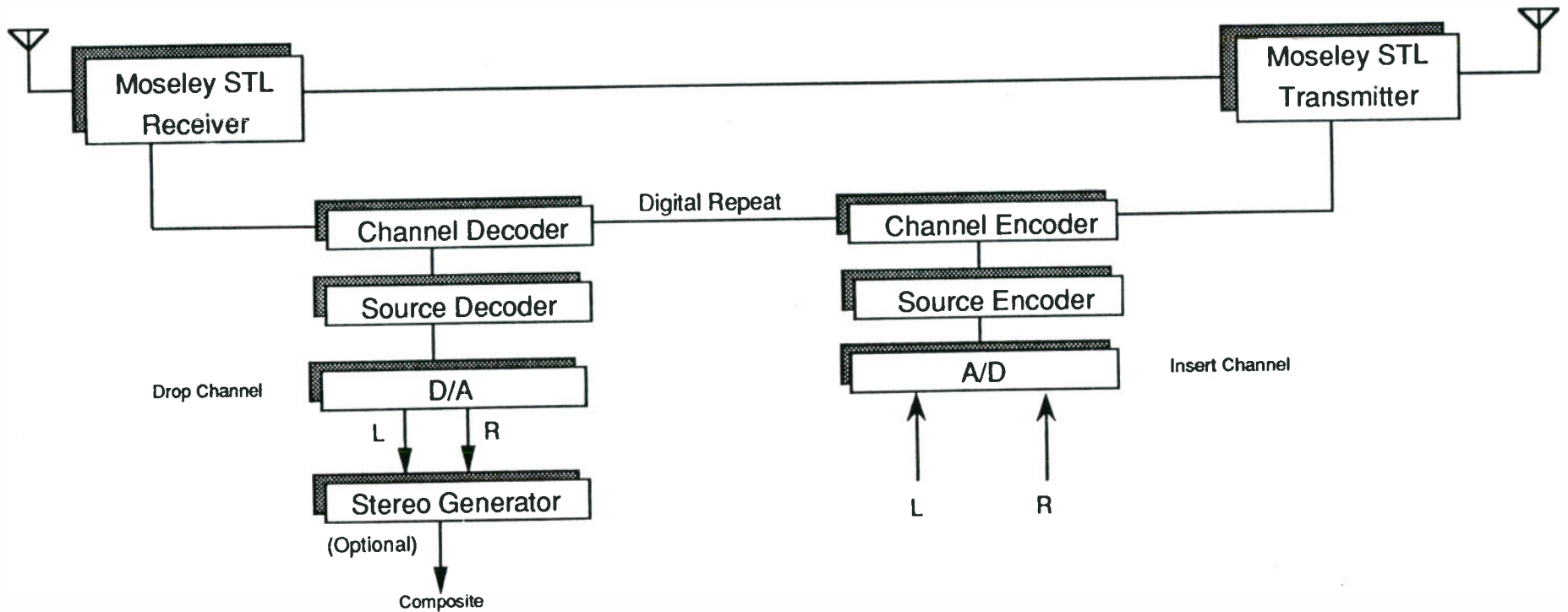
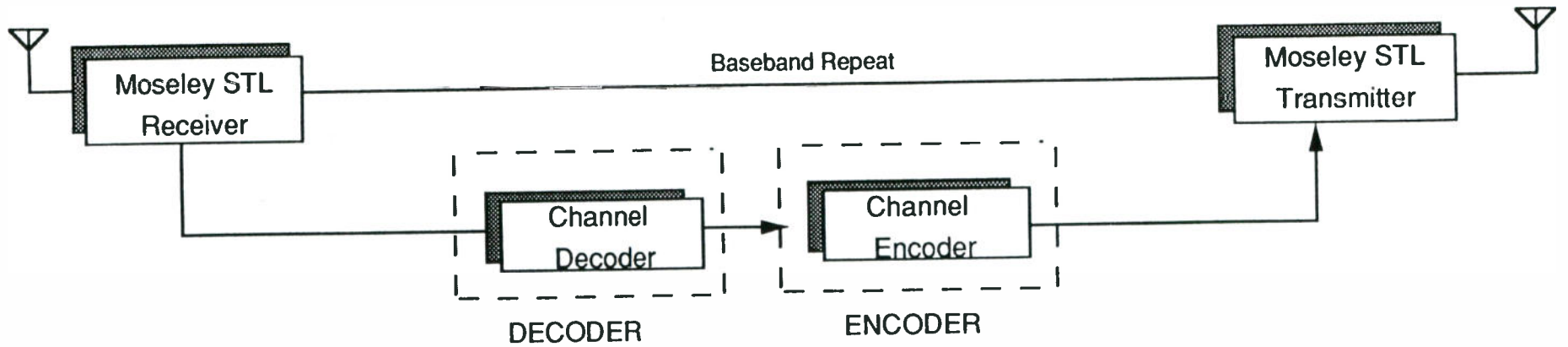

INPUTS

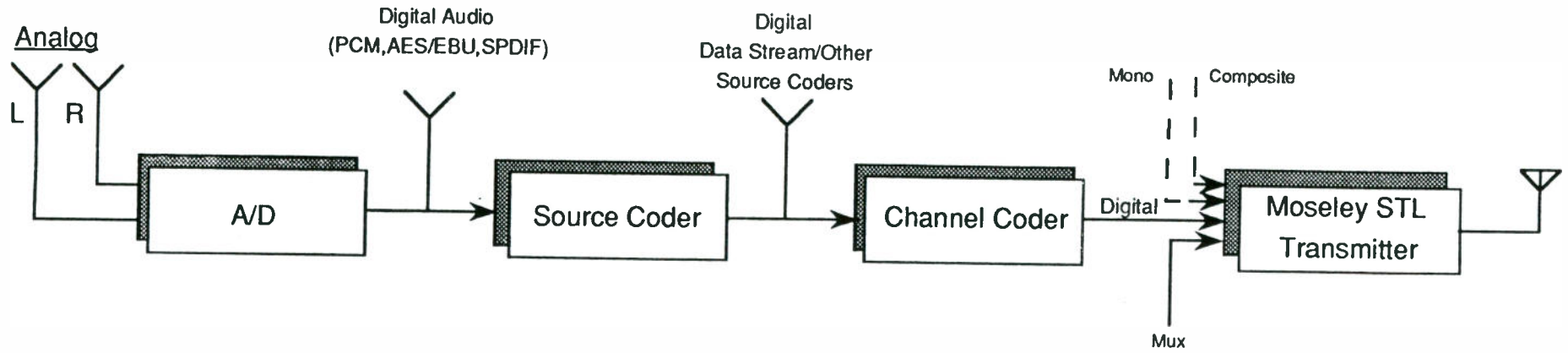

DSP 6000 ENCODER

OUTPUTS

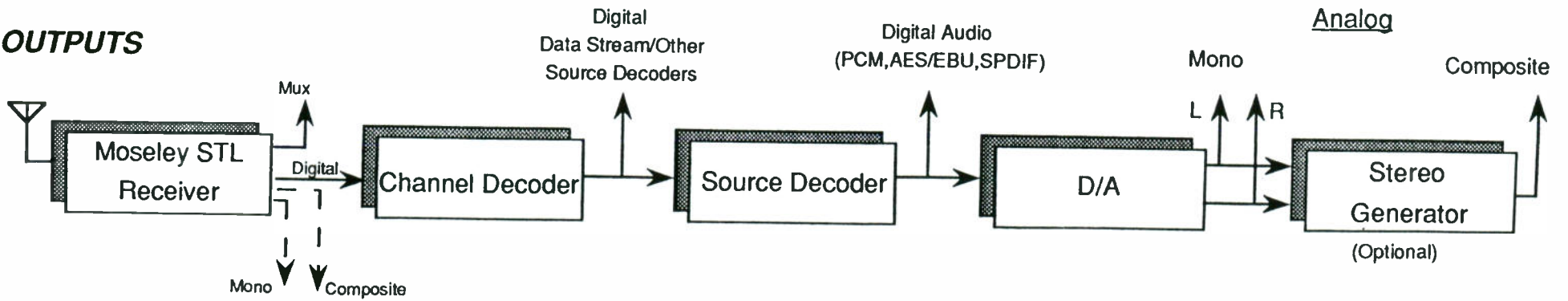

DSP 6000 DECODER

COMPARISON OF ANALOG, COMPOSITE AND DIGITAL TRANSMISSION

Moseley

	Dual Mono Stereo	Composite Stereo	Digital Stereo
Radios required	2	1	1
SNR Ultimate	72dB	72dB	90dB
SNR 400uV	72dB	72dB	90dB
SNR 100uV	72dB	60dB	90dB
SNR 20uV	60dB	43dB	90dB
SNR 7uV	50dB	33dB	90dB
Dynamic Range 1 Khz	72dB	72dB	90dB
Dynamic Range 15 Khz	55dB	55dB	90dB
Stereo Separation	70dB	50dB	80dB
Main SCA Crosstalk	60dB	60dB	80dB
SCA Main Crosstalk	70dB	70dB	80dB
Response	0.3dB	0.2dB	0.2dB
THD 1kHz	0.2%	0.1%	0.01%
Phase gain match	Needed	N/A	Perfect
Multihop degradation	Yes	Yes	No
AES/EBU Digital I/O	No	No	Yes
Stere Gen Location	TX	Studio	TX
Audio Processing	Studio/TX	Studio	Studio/TX
Occupied Bandwidth (Stereo)	500kHz	500kHz	250kHz

AN ALL DIGITAL CD QUALITY STUDIO-TRANSMITTER LINK FOR THE 950 MHz BAND

Howard Friedenberg and Jamal Hamdani
Moseley Associates, Inc.
Santa Barbara, California

Abstract - A new digital modem has been developed which converts CD-quality audio to a spectral-efficient digital signal that is ready for transmission over standard analog FM STLs. Excessive bandwidth requirements have in the past made transmission of digitized high-quality program material incompatible with 950 MHz Studio-Transmitter Link radio usage. Performance tests have shown the resulting digital FM signal to be compatible with existing analog services. This paper describes the considerations that drove the development of this modem as well as performance and compatibility tests.

INTRODUCTION

Digital Audio Tapes (DATs), Compact Discs (CDs), digital cassettes and other digital storage media have made significant inroads toward the culmination of the "all digital" radio station. The benefits of this metamorphosis are generally appreciated and accepted. The digital media is inherently more robust and avoids the noise and distortion accumulation that accompanies analog stages in the audio chain. This trend toward digital component replacement of their analog counterparts has initially targeted the weak spots in the processing chain. One stage in that chain that could benefit from digital

quality is the Studio-Transmitter Link (STL). Resting at the end of the processing chain, it sets many of the crucial chain characteristics. But digital improvements in STL technology have been limited by the current investment in 950 MHz analog FM STLs. Also, the large bandwidth required by digital audio obviates the use of this band when using conventional STL technology.

Recent advances in digital signal processing have solved this dilemma and fueled the development of a 16-bit digital stereo STL that operates through existing 950 MHz analog STL equipment. Figure 1 illustrates the typical configuration using the digital modem over an STL radio link. The digital encoder converts audio program and auxiliary data channels into a shaped digital baseband signal. From this, the STL transmitter can generate a spectrally compact digital FM signal that is compatible with existing analog FM services. At the receiver, an inverse operation is performed to recover the original program information with perfect digital accuracy. The digital link delivers audio with exceptional transparency that has not been attainable with strictly analog links. Direct PCM inputs and outputs facilitate a 100% digital processing chain.

This report describes the benefits, technology considerations and performance requirements that lead to the development of the Moseley DSP-6000 digital STL system.

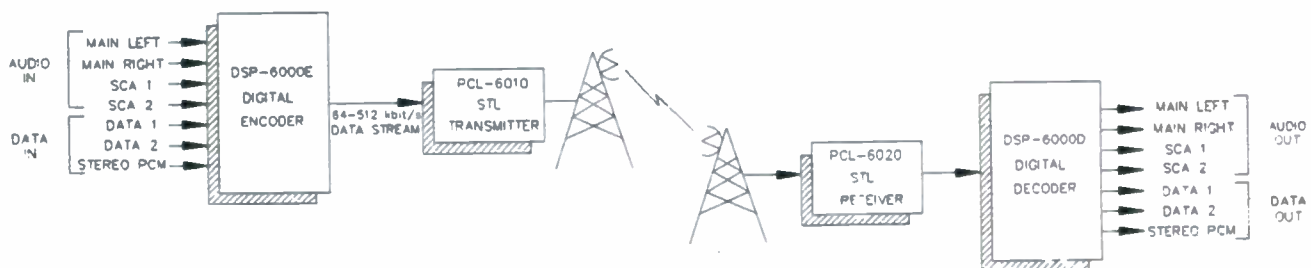

Figure 1
Digital STL in Retrofit Configuration.

BENEFITS OF DIGITAL TRANSMISSION

Degradation-free multiple hops

A standard analog STL system adds a certain amount of noise to the audio program (though these contributions may be acceptable in a well designed system). For multiple STL repeater hops, these noise and distortion products add. The signal-to-noise ratio (SNR) can never be better than the first hop and will continue to worsen with each hop. In a digital system, so long as there is sufficient SNR to regenerate the data accurately, the last hop will produce the same data as the first without degradation of the SNR distortion or frequency response. The 20th hop will be as clean as the first.

Constant audio SNR during fades

Audio program SNR is approximately proportional to the received carrier power in analog radio transmission. In digital transmission, so long as the data is received cleanly, SNR remains constant at its maximum level. Fades have no effect on SNR.

Higher system gain

Most analog signals are considered unacceptable when their Carrier-to-Noise (CNR) reaches 30 dB. Most digital systems will continue to regenerate data correctly at a CNR ratio of 15 dB. Their audio SNR will remain constant until that threshold is reached.

No crosstalk

Because left, right and auxiliary audio program channels are multiplexed digitally rather than in an analog fashion, there is no crosstalk between any of these channels. Thus, concerns for STL effects on composite stereo generators or SCA subcarriers are eliminated.

No background chatter

During those periods of the day when your signal has faded and your neighbor's hasn't, adjacent or co-channel interference may be a problem. The digital system will operate cleanly and quietly under these conditions in contrast to the analog system which may generate audible background chatter or birdies.

No phase distortion

The extreme phase linearity associated with the use of linear PCM encoding techniques and phase-linear FIR filters results in negligible phase distortion. Thus, peak overshoot is minimized allowing for safe use of maximum carrier deviation. Also, zero differential channel phase eliminates the phase synchronization problems normally associated with stereo or dual mono transmission.

SOURCE AND CHANNEL CODING

Linear 16-bit PCM for broadcasting (15 kHz audio) requires 512 kbit/s/channel at 32 kHz sample rate. A typical STL configuration might require two 15 kHz channels for stereo and one 7.5 kHz SCA channel yielding an aggregate data rate of 1280 kbit/s. It is this high data rate that has made previous attempts at digital STL usage in the 500 kHz (and 300 kHz) bandwidths of the 950 MHz band impractical. The required spectral efficiency suggests that coding techniques of greater complexity than conventional FSK with binary signaling are necessary to squeeze the data into standard broadcast channels. Such coding may be partitioned between source and channel encoding techniques to reduce the burden of complexity on either. Currently, state-of-the-art source coding hardware offers bit rate reduction by a factor of four. Channel coding formats yielding spectral efficiency of 1 bit/s/Hz will allow 320 kbp/s transmission in 500 kHz bandwidths.

Source coding

For high quality audio, there are three kinds of source coders— transform coders, sub-band coders and hybrids.^{1,2,3} Choice of source coder is governed by requirements for quality, bit rate, delay, bit error protection, post processing capabilities and hardware implementation complexity. The relative importance of each of these parameters is very application-specific. For 'live' transmission purposes, the coding delay is a critical parameter. The maximum tolerable delay for these applications is on the order of 10 milliseconds. Longer delays present problems for off-air monitoring such as when using IFB or cueing channels.

Transform coders involve the conversion of a block of consecutive samples into the frequency domain. This strategy enables a reduction in the redundancy of the audio signals. Transform coders rely heavily on the computationally intensive FFT algorithm for frequency analysis of the signal. A certain amount of error protection overhead must also be included to enhance performance in poor environments due to the unforgiving nature of the coding. Though very effective at bit rate reduction, transform coders have long coding delays, typically greater than 50 ms, making them impractical for our application. Sub-band coders divide the broad-band signal into a number of sub-band signals with a suitable filter band. This method avoids time-frequency-time conversion and therefore, reduces the degree of signal processing complexity. Depending on the implementation complexity, coding delays are between 1 ms and 20 ms.

Currently, the DSP-6000 digital modem is based on an implementation of sub-band ADPCM with linear prediction and backward adaptive quantization. Like the afore mentioned coding schemes, sub-band ADPCM exploits the con-

siderable natural redundancies of voice and music to achieve the substantial 4-to-1 reduction in bit rate (for further details see [4]). This system satisfied the critical design considerations for our needs. Complexity is moderate. Coding delay is 3.8 ms which is quite reasonable for this application. Transparency was exceptional. Also, an important by-product of sub-band coding is excellent bit error immunity and gentle error handling which offers great benefit in broadcast radio transmission.

Channel Coding

Efficient spectrum utilization is a primary consideration for the choice of modulation format. The format must co-exist favorably in the primarily analog frequency-modulated 950 MHz band. Thus, the out-of-band spectral energy must be well suppressed to avoid interference of the digital carrier with existing analog services. Linear modulation formats such as QPSK or QAM will regenerate sideband energy when confronted with non-linear Class-C amplification found in conventional FM STLs thereby limiting their usefulness. In contrast, continuous-phase frequency shift keying (CPFSK), a broad class of digital frequency modulation, is particularly well suited to FM transmission with non-linear amplification due to its constant-envelope property.

Spectral efficient schemes, such as tamed FM, partial response FM and GMSK, belong to a class of CPFSK known as correlated or partial response CPFSK. This class may be thought of as binary FM that has been very heavily band-limited prior to modulation. The result is a controlled amount of intersymbol interference (ISI) in pulse shapes that last a few bit periods. The pulse value at a given time becomes correlated to the value of previous pulses producing a composite multilevel FM signal.

The simplest form of partial response FM is known as duobinary FM. This scheme gives rise to intersymbol interference from only one previous pulse to yield a baseband signal that has three levels at the sampling instants. Duobinary signaling provides a 2:1 band width compression relative to bi-level or binary signaling. The Nyquist criteria places the maximum symbol packing rate for bi-level binary signaling at 2 symbols/s/Hz but practical filter realization sets this rate closer to 1 symbol/s/Hz. With duobinary signaling, the ideal Nyquist rate of 2 symbols/s/Hz can once more be attained with practical filters that are tolerant of production, temperature and time variations. The price for this increased signaling efficiency is a small loss in robustness for adding the third signalling level. (For comparison, to produce the same spectral efficiency as duobinary, a corresponding zero memory or full-response multi-level signal would require 4 signalling levels thereby further reducing system robustness.) Using duobinary baseband signaling with the FM modulator's peak deviation set for one quarter of the data rate ($h=0.5$), an RF

spectrum is created with a spectral efficiency of 1 bit/s/Hz. It is should be emphasized that spectral efficiency, as generally defined, does not refer to the 3 dB bandwidth that is considered by Carson's rule but to the "infinite attenuation" bandwidth which is more practically taken to be the 20 dB to 50 dB attenuation points depending on the interference requirements of the application.

Along with high spectral efficiency, duobinary signaling has been shown to have good error performance⁵ and speed tolerance. Speed tolerance is defined as the amount of increase in signaling speed that will just cause overlap between adjacent levels (eye pattern closure). For ordinary duobinary, this speed tolerance is 43%. This translates to robustness in withstanding circuit and channel perturbations such as filter variations and unintentional intersymbol interference due to co-channel and adjacent channel interference and transmission channel distortions. This robust quality has been proven in several long haul communication links over the years and proven to be very reliable.

Another benefit of duobinary signaling is that error detection may be readily obtained without introducing redundancies into the data stream. This is accomplished by monitoring the received data for violations in its correlation properties. This error signal aids in determining the quality of the overall transmission path.

Error detection ability, constant envelope, high data rate packing, perturbation tolerance and efficient spectral shape have made duobinary signaling an appropriate technique for use in this modem to compliment existing STL technology.

DSP-6000 IMPLEMENTATION

Source Coding

The source coder portion of the modem is shown in Figure 2. The modem accepts up to four audio program inputs (main left and right and two SCAs) in 15 kHz or 7.5 kHz bandwidths. All audio inputs and outputs are active balanced XLR type. The audio program is converted to 16-bit linear PCM data by a 64 times oversampling dual A/D converter with digital linear-phase anti-alias filtering capable of 95 dB dynamic range. Alternately, the encoder accepts direct 16 bit linear PCM data from a digital source for contiguous digital transmission of the main program channels. On the decoder side, the PCM signal is output as either AES/EBU formatted or unformatted serial data. Analog outputs are also available by use of a 4 times oversampling dual D/A convertor. Two low speed asynchronous data channels (up to 9600 baud) allow for supervisory functions, low data rate services, and other possible applications. All timing and control functions are handled by field programmable gate-array (FPGA) logic (not shown in figure) which greatly reduces parts count to enhance reliability and allows for future upgrades.

Channel Encoding

The duobinary channel encoder is illustrated in Figure 3. Note the simplicity of the encoder. The encoder accepts data from the digital audio encoder or from an external data source. The external data input allows the modem to be configured as a repeater. It also allows transmission of any external data source from 64 kbits/s to 512 kbits/s thereby facilitating the transmission of low data rate services such as basic rate ISDN, Musicam source coders, etc.

A scrambler is the first operation that the input data encounters. The FCC requires that all digital radios randomize their carriers to prevent spectral lines, caused by particular data formats, from interfering with adjacent channels. The next block performs precoding of the data which is necessary to prevent error propagation in the receiver due to the correlative properties of each received bit. The data is Nyquist shaped by a raised cosine low-pass filter with 100% roll-off which is well known to minimize ISI distortion. The shaped data drives the frequency modulated oscillator of the STL transmitter.

Baseband Recovery

At the STL receiver, discriminator detection is used for baseband demodulation since it is best aligned with present

hardware. Also, it avoids the carrier synchronization problem associated with coherent detection. Though coherent recovery does a good job against ISI and provides better static BER performance by 2 to 4 dB, it requires complex hardware and has been found to be problematic in multipath environments such as those that characterize terrestrial communications⁶. Other attractive features of discriminator detection are that it offers immunity to center frequency drift⁷ and can handle arbitrary values of modulation index without realignment.

Channel Decoding

The tri-level baseband is recovered at the discriminator output. This signal enters the channel decoder, as displayed in Figure 4. Here it is first noise averaged by raised cosine shaped low-pass filtering. Ideally, optimal data detection requires a matched filter system to maximize the ratio of output signal power to output noise power. The filtering would be partitioned equally such that the transmitter and receive filter characteristics are identical. But since spectral efficiency is of greater importance than optimal data detection, most of the filtering is performed during the data shaping process in the encoder. Receiver filtering is set to approximately 1.5 times the cutoff of the transmit filtering to band-limit channel noise while avoiding additional eye pattern

FIG 2A DIGITAL AUDIO ENCODER

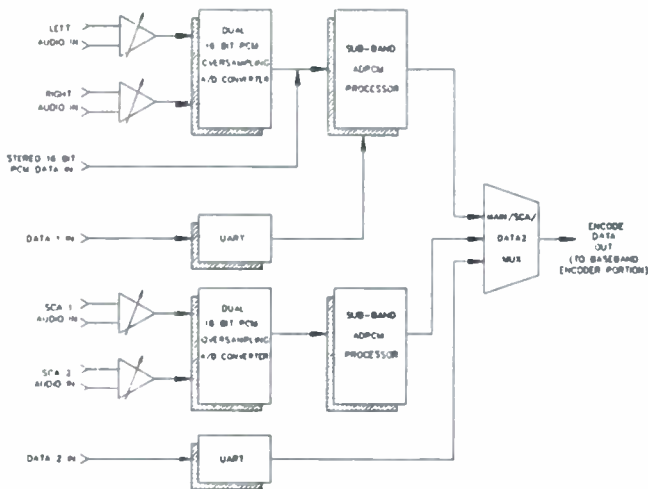

FIG 2B DIGITAL AUDIO DECODER

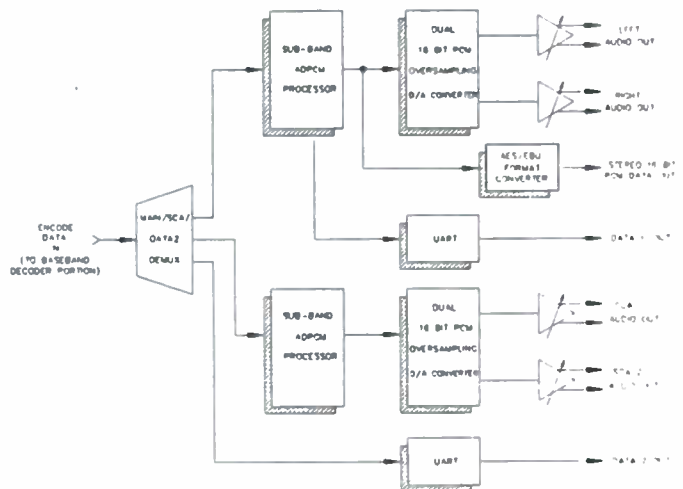

Figure 2 Digital Source Coder Portion of Modem showing a) encoder and b) decoder.



Figure 3 Duobinary Channel Encoder Portion of Modem.

distortion. The loss in C/N performance is only about 1 dB for this filter partitioning versus optimal partitioning⁸.

Clock Recovery

From the recovered tri-level baseband signal at the discriminator output, both bit clock and data recovery are accomplished. The bit clock synchronizes the rest of the system to the recovered data. The duobinary signal is similar to NRZ data in that it contains no significant spectral energy at the clock frequency. A non-linear circuit is used to generate the necessary clock information. The resulting signal has been corrupted by pattern related jitter due to ISI and channel noise jitter. This signal is pre-filtered to 6 kHz and synchronized by a narrowband 2nd order phase-lock loop. The prefilter greatly improves the input SNR to the PLL allowing continuous clock synchronization in the face of deep channel fading behavior to error rates less than 1E-1. An extra pole was placed in the loop to reduce the effect of high frequency or "infinite variance" jitter which may result in potential cycle slips. The locked loop band width of 206 Hz and damping factor of 0.8 provide a lock time of 63 milliseconds. These loop dynamics attenuate the jitter component for a tracking error less than 0.5 degrees rms after 10 repeater hops.

Data Recovery

Bit-by-bit detection is performed on the filtered baseband signal by means of a digital sample-and-hold. This method was judged the most effective for data recovery yielding adequate BER performance with the least amount of circuitry complexity. Following data sampling, decode logic reconstructs and descrambles the data for output to the digital audio processor. Bit-error and BER threshold detection are also provided by the decoder for signal quality indication as described above.

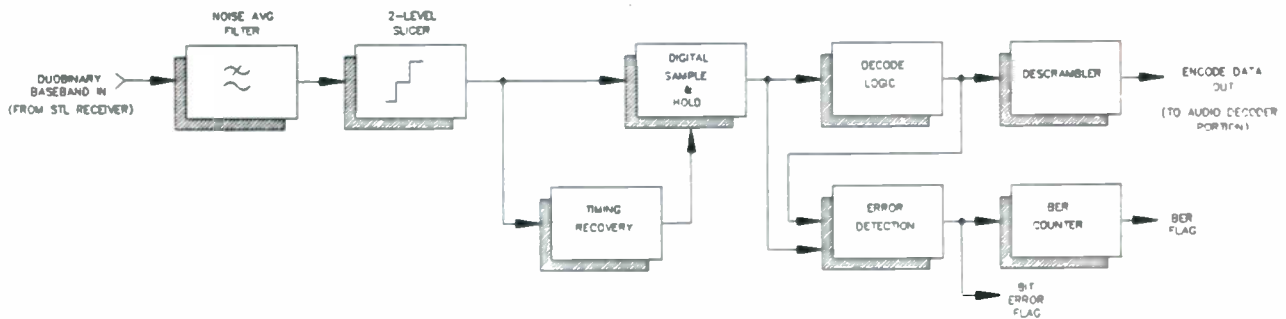

Figure 4
Duobinary Channel Decoder Portion of Modem.

PERFORMANCE TESTS

Spectral Occupancy

Figure 5 shows the RF spectrum produced by the digital STL transmitter for 256 kbits/s and peak deviation of 64 kHz ($h=128/256=0.5$) measured in a 3 kHz bandwidth. Two FCC compliance masks are overlaid on this spectrum. The hatched overlay mask represent the emission boundaries for FM aural STL transmission under Part 74.535 in 500 kHz spacings. The dashed line overlay represents the emission boundaries for digital microwave transmission (Docket No. 19311, FCC Rules Part 21.106) for 500 kHz channels. In this docket, a measurement bandwidth of 4 kHz is specified. The correction for the 1 kHz difference in bandwidth is to add 1.24 dB to the spectrum shown in the figure. In any case, the spectrum falls well within either emission mask.

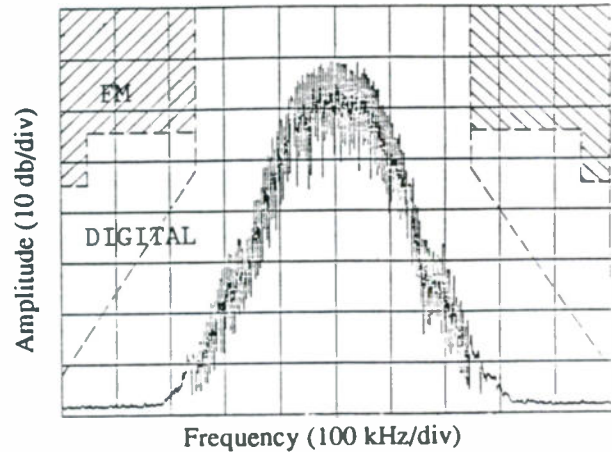

Figure 5
Digital STL Emission with FCC Emission Masks.

Transparency

Back-to-back performance measurements were taken on the digital STL. Most of these tested the limits of our measurement equipment. Frequency response was ± 0.1 dB from 10 Hz to 15 kHz. Static SNR was greater than 90 dB. Stereo separation was greater than 80 dB over the entire 15 kHz bandwidth. Differential phase and amplitude deviation between left and right channels were negligible. Group delay was 1.89 ms ± 0.001 ms over the bandwidth. Several critical listening tests were performed using A-B comparison to a CD source. Experienced impartial listeners certified the high sonic quality of the overall system.

Threshold Performance

Sensitivity is an important measure of overall coding efficiency of this system. A baseline configuration with two main channels was selected for this test. Data rate was 256 kbits/s and $h=0.5$. Since no perceivable degradation in audio quality occurs for $BER < 1E-4$, this level was chosen as the system threshold. For a receiver IF bandwidth of 500 kHz, this threshold was reached for a measured RF input level of 5 microvolts or -93 dBm. For comparison, a composite STL would produce a de-emphasized SNR of 32 dB at this received signal level.

Compatibility With Existing Analog STL Radios

a. Digital STL with adjacent digital STL interferer.

In gauging the effects that digital STLs have on adjacent digital STLs, the digital receiver BER threshold was examined in the presence of an adjacent fully modulated digital carrier. The encoder was configured for two main channels (256 kbit/s data rate). The reference STL carrier was set for a modulation index of 0.5 at 950 MHz. The interfering digital

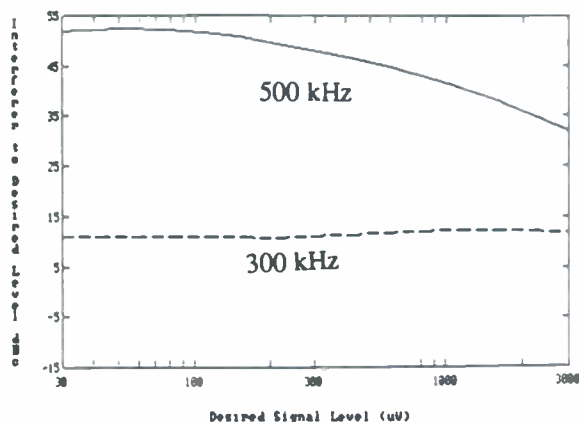

Figure 6

I/C_d for a Digital STL with Digital STL Interferer.

STL was configured similarly. Its carrier was placed at 500 kHz and 300 kHz offsets from the reference carrier. The adjacent signal was increased until the $1E-4$ BER threshold was reached. The difference between the two carrier levels (in dB) at this point is the Interferer-to-Desired-Carrier (I/C_d) ratio. The results are displayed in Figure 6.

The results show that the adjacent signal power needs to be at least 30 dB higher for all input levels (500 kHz spacing) to degrade the BER threshold noticeably. As expected, I/C_d is lower for the narrower 300 kHz spacing yet BER degradation still requires an adjacent carrier level 11 dB above the reference signal level. This was judged to be more than adequate margin for most applications.

b. Digital STL with adjacent composite STL interferer.

In this case a composite FM STL was used as the interfering STL to the digital reference STL. The digital STL was configured as previously described. The interfering composite carrier was modulated by 2 kHz tone (i.e., L+R and L-R channels) at 50 kHz peak (100%) deviation. The results are displayed in Figure 7.

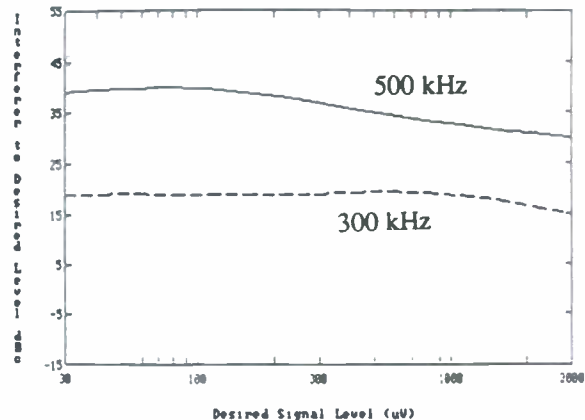

Figure 7

I/C_d for a Digital STL with Composite STL Interferer.

The results show that I/C_d remains relatively constant for both channel spacings. In 500 kHz channels, an adjacent composite FM signal must be at least 30 dB larger than the digital STL's level. In 300 kHz spacing, BER degradation requires an adjacent composite signal 15 dB above digital carrier level. These results are considerably better than for an analog STL with a similar analog interferer. Thus, the digital carrier appears very capable in face of adjacent analog STL interference.

c. Analog STL with adjacent digital STL interferer.

This test is essentially reversed from the preceding test. The test parameters were identical to those previously described. Monitoring the composite SNR, the adjacent interfering signal was increased until the composite SNR dropped by 3 dB. The results are displayed in Figure 8.

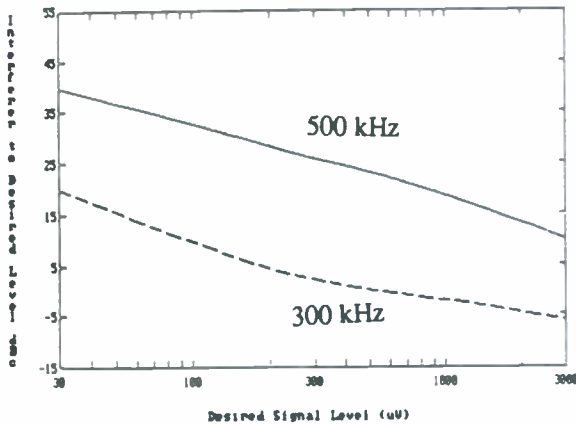

Figure 8

I/C_d for a Composite STL with Digital STL Interferer.

The I/C_d dependence on the composite carrier level results from SNR degradation with lower carrier levels (i.e., composite SNR drops from 76 dB at 3.2 mV to 52 dB at 32 uV). In essence, it requires more interference noise from an adjacent signal to swamp the channel noise.

At a typical received power of 1 mV for 500 kHz spacing I/C_d is +19 dBc which is approximately comparable for a composite FM STL with a similar composite FM interferer. By extension, this suggests that the digital STL is compatible with existing analog STLs in 500 kHz spacings.

For 300 kHz spacing, I/C_d is lowered to -2 dBc at 1 mV received level. This might suggest that an adjacent 300 kHz digital channel must always be lower in power than the primary analog FM carrier. This is not an unreasonable assumption, however. Under normal conditions, a given STL channel will exhibit an RF signal level about 10 to 20 dB stronger than the adjacent channels on either side. This is mainly due to the effects of alternating the antenna polarization from one channel to the next and assumes the use of similar equipment (i.e., transmitter power, antenna gain, etc.) and similar path lengths. This certainly seems to be the case for the majority of users in large metropolitan areas and is a

result of their frequency coordinating committees. However, during the course of time the common path will take fades, and because of the space diversity between users, the effect will not be uniform. The desired signal will take 18 dB fades 1% of the time while the adjacent interfering signals will remain unaffected. It would therefore stand to reason that an adjacent digital carrier, as configured, could co-exist next to a composite FM carrier in 300 kHz spacing without much problem if proper planning of channels and signal levels has been done.

CONCLUSION

Digital transmission of CD quality audio over a 950 MHz studio-transmitter link is now a reality. The benefits of robust digital transmission and the reliability of radio STLs are married in one system. The digital modem as described and tested solves several inadequacies that presently exist in analog FM STL transmission. The digital quality may be obtained even using an existing analog STL. The system has proven to be very robust and flexible. Spectrally speaking, it co-exists admirably with analog FM transmission.

We would like to acknowledge Dr. Douglas Hogg and Dan Barnett for their guidance and assistance during the course of the work and writing of this paper.

References

- [1] G. Davidson, L. Fielder, and M. Antill, "High-Quality Audio Transform Coding at 128 kbits/s," *Proceedings of Int. Acoustics, Speech and Signal Processing*, April 1990.
- [2] S. Smyth and J. McCanny, "High-Fidelity Music Coding at 4 Bits," *Electronics Letters*, vol. 24, No.8, April 1988.
- [3] K. Brandenburg and D. Seitzer, "Low Bit Rate Coding of High Quality Digital Audio: Algorithms and Evaluation of Quality." *Presented at the 7th AES International Conference, "Audio in Digital Times," May 1989.*
- [4] _____, "apt-X 100 Digital Audio Data Compression System," Audio Processing Technology report
- [5] G. L. Deshpande and P. Wittke, "Correlative Encoded Digital FM," *IEEE Trans. Commun.*, vol. COM-29, pp. 1634-1643, Nov. 1981.
- [6] T. Tjhung, K. Kong Yee, and P. Wittke, "Effects of Pulse Shaping and Soft Decisions on the Performance of Digital FM with Discriminator Detection," *IEEE Trans. Commun.*, vol. COM-34, pp. 1116-1122, Nov. 1986.
- [7] J. L. Osterholz and M.K. Klukis, "Spectral Efficient Digital Transmission Using Analog FM Radios," *IEEE Trans. Commun.*, vol. COM-27, pp. 1837-1841, Dec 1979.
- [8] K. Feher, *Advanced Digital Communications, Systems and Signal Processing Techniques*, Prentice Hall, Englewood Cliffs, N. J., 1987.

MUSICODE 56/64

Broadcast Quality Digital Audio Terminal

The *Moseley Musicode 56/64* is a cost effective digital audio terminal that implements the CCITT G.722 ADPCM for wide band audio. The full duplex digital audio terminal can operate in all three G.722 modes and is capable of combined transmission of wide band audio, data and fax.

The *Musicode 56/64* has a built-in two-channel audio mixer and has provision for remote control and status reporting. These unique feature can save broadcast and teleconferencing users more time and money.

FEATURES

- Full duplex
- Combined wideband audio/data/fax
- Self diagnostics
- CCITT G.722 compatible
- Capable of mode 1, 2, 3 switching
- High error immunity
- Built in 2 channel mixer for mic/line levels
- Full remote control and status reporting capability

APPLICATIONS

- Switched 56 kbps
- Terrestrial transmission
- Fibre optic transmission
- ISDN
- DSO/64 kbps use
- Satellite transmission

SPECIFICATIONS

Wide Band Audio

- Frequency response - 20-750Hz down 3db at 750Hz
- THD - 0.8% at 1 kHz
- SNR - 66db referred to +8dBm
- Crosstalk - less than -80dBm
- Max input/output levels - +18dBm or +10dBm
- Nominal input/output levels - +8dBm or 0dBm
- Output impedance - 20 ohms balanced
- Input impedance - 20K or 600 ohms balanced
- AD converter resolution - 16 bits - 16 times oversampling
- DA converter resolution - 16 bits - 8 times oversampling
- Analog input connectors - Female XLR (2)
- Analog output connectors - Male XLR (2)

Physical

- Framing display - Green LED
- Peak display - Yellow LED
- Status display -Green, Red and Yellow LEDs
- Digital connector - V.35 (female)
- Two RS232 connectors - 10 way female
- Keypad input
- Power supply - external wall mounted transformer

Data

- Asynchronous interface 1:
2400, 4800, 9600 baud rates
- Asynchronous interface 2:
2400 (remote controller)

Digital

- Data rate - 48 Kb/s, 56 Kb/s,
65 Kb/s
- Coding - CCITT G.722
(mode 1, 2, 3)
- Digital interface - V.35 (DTE)

Status/Remote Control

- Status indications - 2 channel
- Contact closure - 2 channel
- Status TTL level
- Command: relay closure

Specifications subject to change without notice.



Moseley
Associates
Incorporated

111 Castilian Drive
Santa Barbara
93117-3093

a
GRC International
Company

Phone 805 968 9621
Telex 658448
Fax 805 685 9638

DIGIMUX

The DigIMux is a fully synthesized digital program multiplexer which is user-programmable. Program channels can be centered in 1 kHz step sizes anywhere from 1 kHz to 200 kHz. A spectrum-efficient modulation technique is used to allow inter-channel spacing to be as low as 100 Hz. Available in a housing that can carry 6 full duplex programs.

Features

- User-programmable for audio bandwidths of 3, 5, 7.5, 10 and 15 kHz
- Center frequency programmable in 1 kHz steps from 1 to 20 kHz
- 80 dB signal-to-noise ratio, ± 0.5 dB response, 0.5% distortion
- Optional dual channel transmit and receiver
- Optional Duplex cards

Specifications



Transmitter Card

Audio Bandwidth	30 Hz to 20 kHz
User defined choices	3, 3.4, 7, 7.5, 10, 15, 20 kHz
Center Frequency	1 to 200 kHz
Step size	1 kHz
Frequency response	$\pm .5$ dB 30Hz- audio bandwidth
Distortion	0.5%
Sideband	User-selectable upper/lower
Inter-channel spacing	1 kHz
Signal-to-noise ratio	60 dB; 80 dB with 2:1 compression
Crosstalk	> 55 dB; >65 dB with 2:1 compression
Housing	12 channel per 3RU chassis with individual receive and transmit cards
Power	12/24 V or 110/220 V



Receiver Card

Audio Bandwidth	30 Hz to 20kHz
User defined choices	3, 3.4, 7, 7.5, 10, 15, 20 kHz
Center Frequency	1 Hz to 200 kHz
Step size	1 kHz
Frequency response	$\pm .5$ dB 30Hz audio bandwidth
Distortion	0.5%
Sideband	User-selectable upper/lower
Inter-channel spacing	1 kHz
Signal-to-noise ratio	60 dB; 80 dB with 2:1 compression
Crosstalk	> 55 dB; >65 dB with 2:1 compression
Housing	12 channel per 3RU chassis with individual receive and transmit cards
Power	12/24 V or 110/220 V

CDQ 2000 SYSTEM

A digital CD-quality digital audio for video system offering the highest quality audio along with all the advantages of digital transmission.

New Transmission Technology

In the past, excessive bandwidth requirements have made transmission of digitized, high quality program material using audio subcarriers impractical. The CDQ 2000 is a new spectrum efficient digital unit that transmits CD-quality audio in less than current channel bandwidth and also offers substantial transmission benefits.

CDQ 2000 System

The CDQ 2000 Digital STL system consists of the CDQ 2000 source and channel encoder and either a built-in Moseley or external Subcarrier Generator or Demodulator.

Encoder and Decoder

Digital transmission of the audio is made possible by the CDQ 2000 Digital Encoder and Decoder. Using a combination of source and channel coding, the encoder converts audio program and auxiliary data channels into a shaped digital baseband. The STL transmitter then generates a spectrally compact digital FM signal that is compatible with existing analog FM services. At the receiver end, the source and channel decoder perform the inverse of the encoding operation.

The standard system comes equipped with two (left and right) audio channels and one data channel with provisions for up to two auxiliary program and one additional data channel.

Direct digital input/output allows for future digital interconnection.

The CDQ 2000 Encoder and Decoder can also be interfaced to audio subcarriers already in operation. A digital-ready kit is available for this configuration.

Subcarrier Generator and Demodulator

The built-in Moseley Subcarrier Generator and Demodulator operate in 10 kHz steps in the 4 to 10 MHz frequency range and are capable of either analog and/or digital modulation.

Value

By delivering true digital audio quality and simultaneously reducing transmission costs, the CDQ 2000 System offers broadcasters the digital transmission advantage.

The CDQ 2000 continues a proud Moseley tradition of technical innovation, advanced manufacturing, reliability and most of all, value.

The Digital Advantage

■ *CD-Quality Audio*

Signal-to-noise ratio (SNR) is 90 dB with .01% distortion.

■ *Higher System Gain*

With injections as low as 17 dB below video, the digital threshold for this is the same as the video threshold. This totally eliminates the standard "audio crash before video crash" problem associated with most analog systems and substantially transmission costs.

■ *Constant SNR*

In analog systems, SNR depends on received carrier power. The CDQ 2000 delivers its full SNR all the way down to the digital threshold. Fades have no effect on SNR.

■ *Spectrally Efficient*

The CDQ 2000 occupies only 128 kHz per 15 kHz audio compared to 300 kHz for analog systems and 1 MHz for other digital systems.

■ *No Crosstalk*

Left, right and auxiliary audio program channels are multiplexed digitally eliminating crosstalk.

■ *Multiple Hops*

Multiple analog re-transmission adds noise and distortion with each hop. With the CDQ 2000, digital regeneration makes the last hop as good as the first.

Moseley
Associates
Incorporated

111 Castilian Drive
Santa Barbara
93117-3093

a
GRC International
Company

Phone 805 968 9621
Telex 658448
Fax 805 685 9638

Specifications

Frequency Response

Main Wide	20 Hz to 15 kHz +/-0.2 dB.
Main Narrow	20 Hz to 7.5 kHz +/-0.2 dB.
Aux Wide	20 Hz to 14 kHz +/-0.2 dB.
Aux Narrow	20 Hz to 7 kHz +/-0.2 dB.

Distortion < .01%.

Dynamic Range > 90 dB static.

Channel Crosstalk < -80 dB.

Level Stability < 0.2 dB.

Data Coding Method Sub-band ADPCM, others optional.

Sample Rate 32 kHz.

Time Delay < 3.8 ms (2-channel).

Bit Error Immunity > 10⁻⁴ for no subjective loss in audio quality.

Sensitivity -93 dBm at 10⁻⁴ BER (PCL 6000 at 256 kb/s).

Spectral Efficiency 1 bps/Hz standard.

Data Channels

Data 1 RS-232, selectable baud rates from 4800, 2400, 1200, 300 baud.

Data 2 (Optional) RS-232, selectable baud rates from 9600, 4800, 2400, 1200, 300 baud.

Program Channels 1-4 channels. Channels programmable as 15/7.5 kHz for main and 14/7kHz for Aux. Two 15 kHz channels standard.

Power Requirements 115/230 VAC ± 10%, 50/60 Hz.

Subcarrier Generator and Demodulator

System Choice of either a Moseley Subcarrier Generator or Demodulator or external units.

Frequency Range Both subcarrier generator and demodulator are fully synthesized 4 to 10 MHz, 10 kHz step size.

Power Source 120/240 VAC, ± 10%, 50/60 Hz 100 watts, 12/24 Vdc optional.

RF Subcarrier Output

Modulation FM

Level (P-P) 100 mV, nominal

Adjustable (P-P) 50 to 350 mV.

Impedance High Z Bridging approximately 1.5k.

RF Subcarrier Input

Level (P-P) 100 mV, nominal.

Impedance High Z Bridging approximately 1.5k

Frequency Stability Better than 0.00025%, 0°C to + 50°C.

Modulation Capability Analog, digital or combined.

Sensitivity See system specs.

Channel Spacing User specified 100-500 kHz Depends on data rate.

CDQ 2000E Encoder

Audio Input Active balanced input, XLR type. CMRR > 60 dB.

Audio Level Each channel adjustable from -10 dBu to +14 dBu, rear panel accessible.

Data Inputs

Data 1 RS-232, 9-pin "D" type.

Data 2 RS-232, 9-pin "D" type.

Repeater/PCM Inputs

Data BNC; TTL or CMOS input levels. Input for regenerated data from decoder in repeater mode. Input for unformatted linear 16-bit PCM or other source coders in PCM mode.

Clock BNC; TTL or CMOS input levels. Input for synchronous data clock in repeater mode and PCM mode.

Status Output 15-pin D type provides active-low indication of system, clock, modem, encoder, power supply and mux faults.

Indicators

Peak Program Bargraph Dual ten LED display indicates peak level relative to 0 dB A/D overload level for right and left channels.

Fault System fault alarm.

Main Indicates bargraph is displaying main program levels.

Aux Indicates bargraph is displaying auxiliary program levels.

CDQ 2000D Decoder

Audio Output Active balanced output, XLR type.

Audio Level Each channel adjustable from -10 dBm to +10 dBm into 600 ohms, rear panel accessible.

Data Outputs

Data 1 RS-232 9-pin "D" type.

Data 2 RS-232 9-pin "D" type.

Repeater Outputs

Data BNC, CMOS levels. Regenerated data in repeater mode. Formatted or unformatted 16-bit linear PCM in PCM mode.

Clock BNC, CMOS levels. Synchronous clock for regenerated data in repeater or PCM mode.

Status Output

15-pin "D" type provides active low indication of system, loss of data, data sync, loss of incoming signal, clock, modem, decoder, BER, power supply and demux faults.

Indicators

Peak Program Bargraph Dual ten LED display indicates peak relative to 0 dB D/A overload level for right and left channels.

Fault System fault alarm.

Main Indicates bargraph is displaying main program levels.

Aux Indicates bargraph is displaying auxiliary program levels.

Sync Indicates decoder is out of sync with received signal.

Error Displays each received bit error.

BER Alarm condition when received bit error rate surpasses preset level (selectable from 10⁻³ to 10⁻⁷).

Signal Indicates input signal present.

Specifications subject to change without notice.

Moseley

Moseley
Associates
Incorporated

111 Castilian Drive
Santa Barbara, CA
93117-3093

a
GRC International
Company

Phone 805-968-9621
Telex 658448
Fax 805-685-9638

PRICING

DSP 6000

DSP 6000E 1	One audio and one data channel encoder	\$2,495.00
DSP 6000D 1	One audio and one data channel decoder	\$2,495.00
DSP 6000E 2	Two audio and one data channel encoder	\$2,995.00
DSP 6000D 2	Two audio and one data channel decoder	\$2,995.00
DSP 6000E 3	Three audio and two data channel encoder	\$4,230.00
DSP 6000D 3	Three audio and two data channel decoder	\$4,230.00
DSP 6000E 4	Four audio and two data channel encoder	\$4,950.00
DSP 6000D 4	Four audio and two data channel decoder	\$4,950.00
DSP 6000E R	Digital repeater encoder	\$2,295.00
DSP 6000D R	Digital repeater decoder	\$2,295.00
DSP 6000 SG	Digital stereo generator for decoder	\$1,495.00

*DSP 6000/
PCL 6020 DSP 6000E 2 and DSP 6000D 2
with PCL 6010 TX and PCL 6020 RX \$12,995.00

*DSP 6000/
PCL 6030 DSP 6000E 2 and DSP 6000D 2
with PCL 6010 TX and PCL 6030 RX \$13,995.00

FT1 3000

FT1 3000E 1	One audio and one data channel encoder	\$2,495.00
FT1 3000D 1	One audio and one data channel decoder	\$2,495.00
FT1 3000E 2	Two audio and one data channel encoder	\$2,995.00
FT1 3000D 2	Two audio and one data channel decoder	\$2,995.00
FT1 3000E 3	Three audio and two data channel encoder	\$4,230.00
FT1 3000D 3	Three audio and two data channel decoder	\$4,230.00
FT1 3000E 4	Four audio and two data channel encoder	\$4,950.00
FT1 3000D 4	Four audio and two data channel decoder	\$4,950.00

DigiMux

DigiMux	Mainframe with one two-program module	\$1,995.00
	Additional two-program module	\$995.00

Musicode 56/64

Musicode portable unit for ISDN or switched 56 telco lines	\$1,995.00
--	------------

*This post-NAB special discount pricing is good for orders placed up until June 30, 1991.

Moseley



AURAL STUDIO-TRANSMITTER LINKS

Bulletin 278A

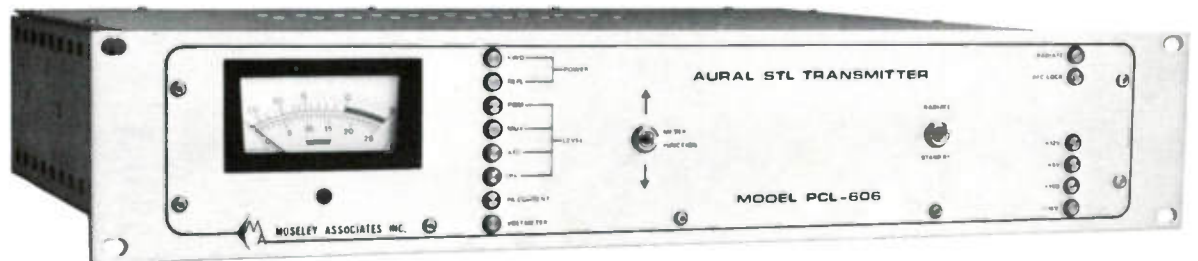

PCL-606 and PCL-606/C

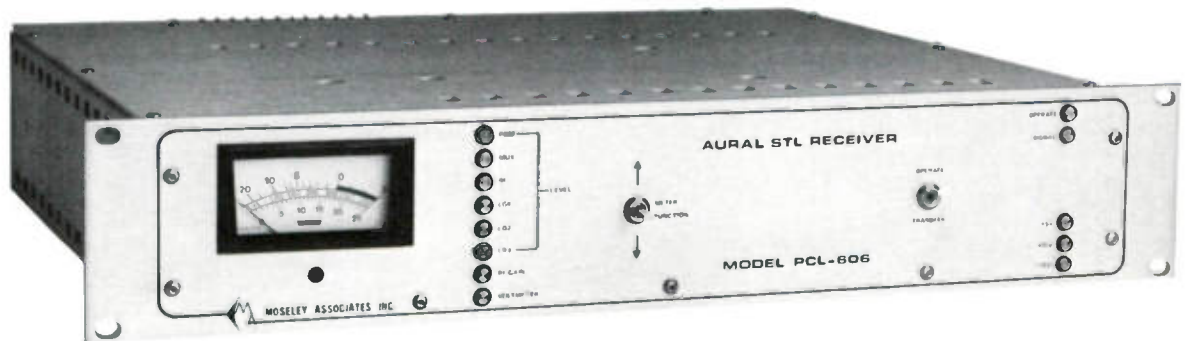

FOR 148 - 174 MHz
215 - 240 MHz
450 - 470 MHz
890 - 960 MHz

MOSELEY ASSOCIATES, INC.

A FLOW GENERAL COMPANY

PCL-606 and PCL-606/C

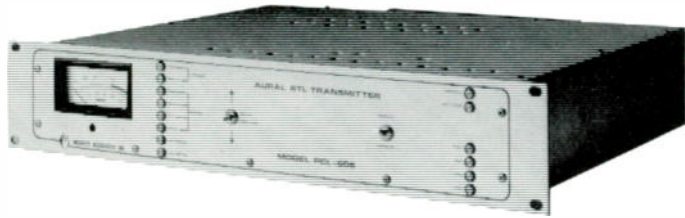

WHY STL?

Studio-transmitter link (STL) systems have traditionally offered broadcasters an alternative to leased telephone lines for conveying program information from the studios to a remote transmitter location. Telephone line charges have increased dramatically over the past few years, while line reliability and ultimate audio quality have either degraded or stayed the same. Studio-transmitter links offer the broadcaster complete control over program carriage with excellent reliability, two factors very important in today's broadcasting. Studio-transmitter links will also convey a program subcarrier, such as an SCA feed, as well as remote control information over the same economical link.

WHY PCL-606?

The PCL-606 and PCL-606/C Studio-Transmitter Links provide the broadcaster and industrial user alike with the highest quality program conveyance service currently available in equipment of this type. By the use of the latest technology available in today's market, significantly improved specifications and performance are achieved, even in areas overly congested in STL service or in areas presenting high density RF environments. The PCL-606, designed for highest quality monaural audio service, may be used in a dual configuration for stereo service where composite stereo is not desired. The PCL-606/C, the composite stereo version, conveys the composite stereo waveform with virtually no degradation, neither adding to nor taking away from the stereo waveform.

The PCL-606 and PCL-606/C Transmitter and Receiver are of an all-new design, using techniques and components heretofore unavailable. Extensive field testing was done on this new STL system to ensure highest performance in hostile RF environments. Enclosed module construction is used to reduce the possibility of RFI as well as allow easy service access to each printed circuit board. All normal service tuning adjustments are easily, yet securely, accessible through the tops of the modules and unit top covers, while extensive internal metering capabilities are standard in both the Transmitter and Receiver.

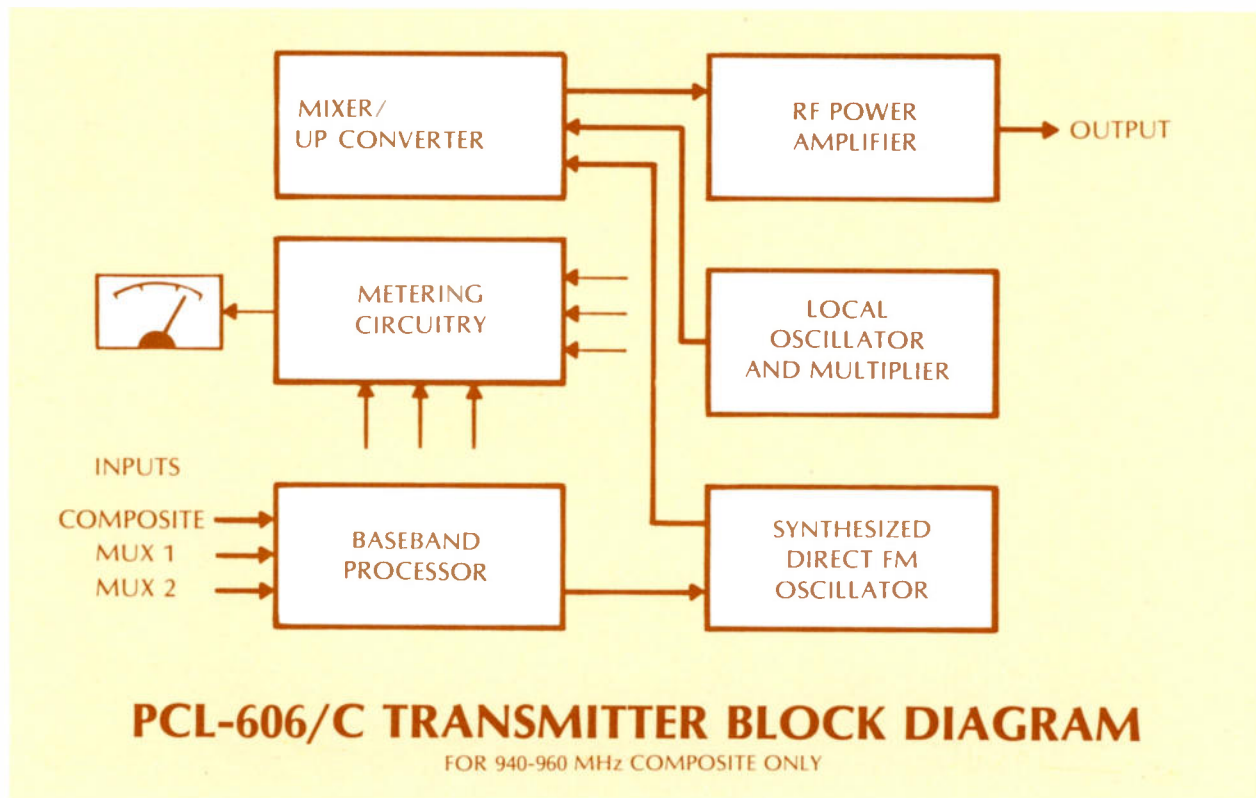

PCL-606 and PCL-606/C

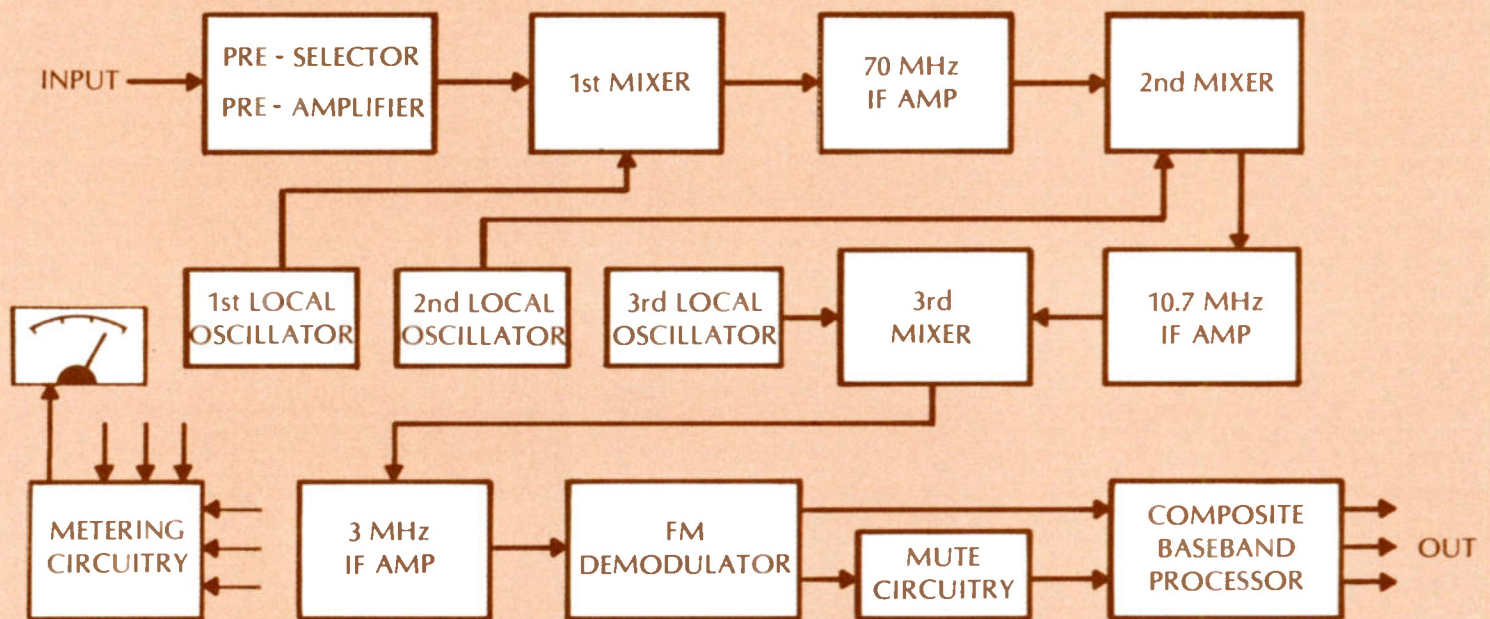

PCL-606/C RECEIVER BLOCK DIAGRAM

FOR 940-960 MHz COMPOSITE ONLY

TRANSMITTER

The PCL-606 and PCL-606/C Transmitters employ a direct FM modulation concept never used before in STL equipment. A synthesized reference oscillator is used for frequency and phase control of the direct FM oscillator. Transmitter FM modulated oscillator frequency conversion is done via a double balanced mixer, instead of employing the usual frequency multiplication of the modulated RF signal.

The transmitter includes a front panel meter with step-switch input selection to allow the metering of important parameters, such as RF forward output, RF reflected output, input levels, and AFC voltage. The metering system even includes built-in absolute value peak responding voltmeter capability, with internal LEDs to indicate DC polarity.

RECEIVER

The PCL-606 and PCL-606/C Receiver designs incorporate several performance and user-controlled features never before seen in point-to-point audio distribution equipment of this type. A PIN diode attenuator circuit is supplied for user adjustment of

overall system signal to noise ratio. The PIN diode attenuator circuit reduces adjacent signal intermodulation products caused by input signal overloads.

The receiver IF bandwidth may be changed by the user to optimize the tradeoff between distortion and selectivity. All specifications shown are with the IF system in the "narrow" position, providing maximum selectivity.

The receiver demodulator is of an all-new design, offering extremely low distortion and noise characteristics. The demodulator is broadband and adjustment free, using digital pulse counting techniques for maximum fidelity.

The receiver includes a front panel meter with step-switch input selection to allow the metering of several parameters, including audio output level, subcarrier level, and RF input level in microvolts. The metering system includes built-in absolute value peak responding voltmeter capability with polarity indication. The metering circuit output appears on a back panel connector for remote metering.

Built-in transfer circuitry is standard in the PCL-606 and PCL-606/C Receivers to allow automatic changeover to a standby receiver in the event of a detected malfunction.

SPECIFICATIONS

PCL-606	SYSTEM	PCL-606/C
148-174 MHz, 215-240 MHz, 450-470 MHz, 890-960 MHz Specify exact operating frequency	Frequency Range	148-174 MHz, 215-240 MHz 450-470 MHz, 890-960 MHz Specify exact operating frequency
Monophonic audio: ± 0.25 dB or better 30 Hz to 15 kHz	Frequency Response	Composite: ± 0.1 dB or better 30 Hz to 53 kHz, ± 0.3 dB or better 53 kHz to 73 kHz
0.25% or less 30 Hz to 15 kHz (typically better than 0.1% at 1 kHz)	THD & IMD Distortion: Narrow (Wide) I.F. Filter	0.3% (0.2%) or less 30 Hz to 53 kHz, typically better than 0.1% (0.07%) at 1 kHz
Not applicable	Stereo Separation	48 dB or better, 50 Hz to 15 kHz (typically 50 dB or better)
Not applicable	Nonlinear Crosstalk, Subchannel to Main Channel: Narrow (Wide) to I.F. Filter	50 dB (54 dB) or better
Not applicable	Nonlinear Crosstalk, Main Channel to Subchannel: Narrow (Wide) I.F. Filter	50 dB (54 dB) or better
72 dB or better (typically 75 dB) below 100 % modulation	Signal-to-Noise Ratio	72 dB or better (typically 75 dB) below 100 % modulation, demodulated, de-emphasized left or right
3.5" (8.9 cm) high, 19" (48.3 cm) wide, 0°-50°C 16" (40.6 cm) deep	Dimensions, Operating Temperature Range: Transmitter and Receiver	3.5" (8.9 cm) high, 19" (48.3 cm) wide, 0°-50°C 16" (40.6 cm) deep
TRANSMITTER		
10 Watts maximum, 5 Watts minimum 15 Watts maximum, 10 Watts minimum	RF Power Output 890-960 MHz 148-470 MHz	10 Watts maximum, 5 Watts minimum 15 Watts maximum, 10 Watts minimum
Type N Female, 50 ohm	RF Output Connector	Type N Female, 50 ohm
± 40 kHz	Deviation for 100% Modulation	± 50 kHz
Better than 0.00025% 0°C to 50°C	Frequency Stability	Better than 0.00025%, 0°C to 50°C
More than 60 dB below carrier level	Spurious and Harmonic Emission	More than 60 dB below carrier level
One Program and Two Subcarrier Channels	Modulation Capability	One Program and Two Subcarrier Channels
Monophonic: +10 dBm, 600 ohm, balanced, floating, barrier strip screw input. Multiplex: 1.5 V peak-to-peak 4 K ohms unbalanced, type BNC female connectors (2), frequency range 22-85 kHz	Modulation Inputs	Composite: 3.5 V peak-to-peak, 6 K ohms unbalanced, type BNC female connector. Multiplex: 1.5 V peak-to-peak, 4 K ohms unbalanced, type BNC female connectors (2), frequency range 110-185 kHz
100/120/220/240 VAC $\pm 10\%$, 50/60 Hz, 70 Watts	Power Source	100/120/220/240 VAC $\pm 10\%$, 50/60 Hz, 70 Watts
RECEIVER		
Type N female, 50 ohm	RF Input Connector	Type N Female, 50 ohm
15 μ V or less required for 60 dB SNR	Sensitivity	30 μ V or less required for 60 dB SNR, broadband de-emphasized. 150 μ V or less required for 60 dB SNR left or right channel de-emphasized demodulated,
3 dB I.F. bandwidth ± 90 kHz 60 dB I.F. bandwidth ± 400 kHz 80 dB I.F. bandwidth ± 1 MHz	Selectivity: Narrow (Wide) I.F. Filter	3 dB I.F. bandwidth ± 100 kHz (± 150 kHz) 60 dB I.F. bandwidth ± 450 kHz (± 850 kHz) 80 dB I.F. bandwidth ± 1 MHz (± 2 MHz)
Monophonic: +10 dBm, 600 ohm, balanced, floating, barrier strip screw output. Multiplex: 1.5 V peak-to-peak, 100 ohms, unbalanced, type BNC female connectors (2)	Modulation Outputs	Composite: 3.5 V peak-to-peak, 100 ohm, unbalanced, type BNC female connector. Multiplex: 1.5 V peak-to-peak, 100 ohms unbalanced, type BNC female connectors (2)
100/120/220/240 VAC $\pm 10\%$, 50/60 Hz, 30 Watts	Power Source	100/120/220/240 VAC $\pm 10\%$, 50/60 Hz, 30 Watts

FOR FURTHER INFORMATION PLEASE
CONTACT OUR MARKETING DEPARTMENT

MOSELEY ASSOCIATES, INC.
 A Flow General Company . Santa Barbara Research Park
 111 Castilian Drive Goleta, California 93117
 (805) 968-9621 Telex: 658-448 Cable: MOSELEY

SHORT FORM CATALOG



PROFESSIONAL PRODUCTS FOR
UNCOMPROMISING BROADCAST
PERFORMANCE

MOSELEY ASSOCIATES, INC.

A FLOW GENERAL COMPANY

MOSELEY

AURAL STUDIO-TRANSMITTER LINKS

PCL-606

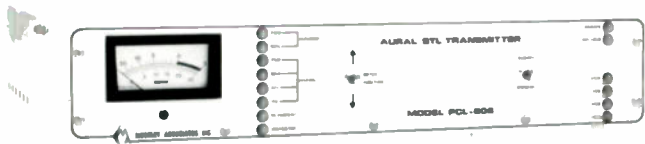

Crowded RF environments are natural to the PCL-606 and PCL-606/C Aural Studio-Transmitter Links. A rugged all-new design using the latest techniques and components gives the user ultra-low noise and distortion, excellent selectivity and outstanding frequency stability. Furthermore, the balance between distortion and selectivity can be optimized with a user-selected bandwidth.

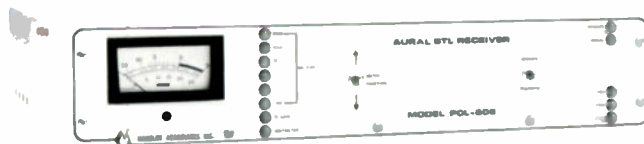

The PCL-606/C transmits composite stereo over a single RF carrier, while two monaural PCL-606's may be used in the "split channel" method to provide a stereo signal. Both are equipped with built-in automatic transfer circuitry to prevent carrier interruption. They have extensive built-in switch-selectable diagnostic metering capabilities in transmitter and receiver, and all normal service adjustments are easily accessible through the module and unit tops.

PCL-505



The Model PCL-505 and PCL-505/C Aural Studio-Transmitter Links offer superior program handling capabilities. State-of-the-art stripline techniques and direct FM provide dependable performance. Solid-state integrated circuitry and continuous duty design make for easy operation and maintenance.



The PCL-505/C transmits composite stereo on a single RF carrier. Two monaural PCL-505's in a dual configuration provide "split channel" stereo transmission. Optional automatic transfer panels assure continuous stereo broadcast in case of carrier interruption, a system pioneered by Moseley.

PCL-101

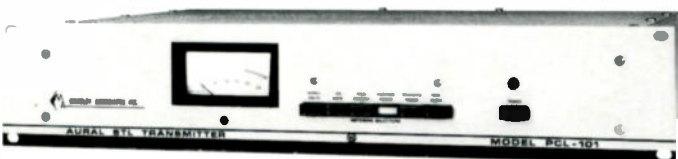

Designed for continuous service, the PCL-101 provides high quality audio performance. The PCL-101 STL is ideal for AM and shortwave broadcasters. Two Model PCL-101 Systems operated in the "split channel" method provide excellent AM stereo service. Request Technical Notes 225 for more information on AM stereo STL service.



The PCL-101 STL System features all solid-state circuitry, modular-type construction, direct frequency modulation, front panel metering, full convection cooling, subcarrier capability, compactness and serviceability.

Studio-Transmitter Link Systems offer significant long term savings over the costs of leased telephone circuits. The PCL-606, PCL-505 or PCL-101 STL Systems give the broadcaster complete control of station facilities as well as superior response, distortion and transient characteristics. Completely wireless remote control can be integrated with the STL for even further returns on investment. 148-174, 214-240, 300-330, 370-470, 890-960 MHz bands are standard. Other frequencies available on request.

MOSELEY

STEREO GENERATOR

SCG-9A



The Model SCG-9A Stereo Generator is all solid-state, using integrated circuits. Close attention to design has produced minimal quadrature error and phase difference between channels with excellent channel separation.

STEREO DEMODULATOR

SCD-9



The Model SCD-9 Stereo Demodulator transforms a composite stereo waveform into discrete left and right channels for AM stereo and FM broadcast. Complementary to the SCG-9A Stereo Generator, it includes de-emphasis circuitry, 15 kHz low pass filters, and front panel and stereo indication, with an SPDT relay for external control.

SUBCARRIER GENERATOR

SCG-8



The SCG-8 Multiplex FM Subcarrier Generator offers extreme stability, excellent sound quality and simplicity of operation. A peak reading audio meter and all electronic muting are included.

AUDIO LIMITER

TFL-280B



For FM monaural, FM stereo, FM SCA, TV aural, the TFL-280B Audio Limiter delivers loudness and clarity without compromise. Modulation levels of FM transmission systems are precisely controlled by this frequency-conscious limiter. Clipping and its attendant products are essentially eliminated through the use of agile circuitry.

SUBCARRIER DEMODULATOR

SCD-8



The Model SCD-8 Multiplex FM Subcarrier Demodulator is the companion to the SCG-8 generator. Front panel metering, all electronic squelch, and audio low-pass filter are standard. The operating frequency of the SCG-8/SCD-8 is easily changed with plug-in filters.

AM AUDIO LIMITER

TAL-320



The TAL-320 AM Audio Limiter brings high quality broadcast sound to AM by clearly maximizing the modulation of a standard AM broadcast transmitter. The TAL-320 incorporates an efficient all-pass network, treble equalizer and positive peak adjustable clipper. AM stereo operation is a primary benefit, easily accommodated by two Model TAL-320 Audio Limiters.

SUBCARRIER MAINFRAME

SCM-1

The SCM-1 allows a combination of two FM subcarrier generators and/or demodulators to be mounted adjacent to or physically removed from the remote control system for wireless operation. It may be used on Moseley Aural STL, video STL aural shelves or FM/TV aural broadcast transmitters.

AUDIO GAIN RIDER

TGR-340



The Model TGR-340 Audio Gain Rider is designed to automatically ride gain on a program line, providing maximum modulation on a long term basis with a minimum of audible or measurable by-products. STL, tape, and satellite program circuits are protected from overload. A switch defeatable multistage all pass network is provided to increase signal symmetry, a feature especially useful in TV and FM.

MICROPROCESSOR REMOTE CONTROL

MRC-2

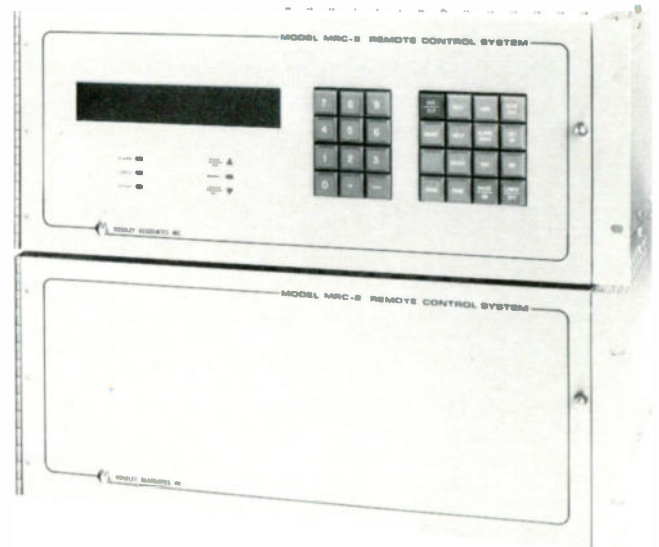
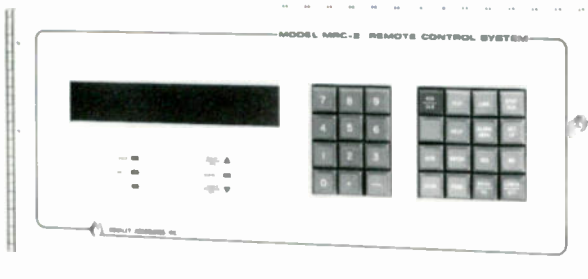

Microprocessors mean that the MRC-2 can be tailored precisely to your needs. Up to 255 command lines, 255 status channels and 255 telemetry channels can be specified in groups of 16 for each at up to 99 sites. Multiple Control Terminals allow a flexible hierarchy of control, with multiple data interconnection links over wire or radio. The MRC-2 can be keyboard calibrated. Two level nested, upper and lower event and/or alarm telemetry tolerances

can be set. Status and command lines can be momentary or latching, and status display can be direct or inverted. In case of power failure, all programming data is stored intact, automatically.



MRC-2 options increase its flexibility. The CRT option can display 32 channels simultaneously with plain English prompting, and can duplicate all command functions. The Automatic Logging option provides a hard copy record of events. Also available are Multiple Direct Command, Multiple Status Display, Automatic Control Unit and Digital Telemetry Input.

MRC-1

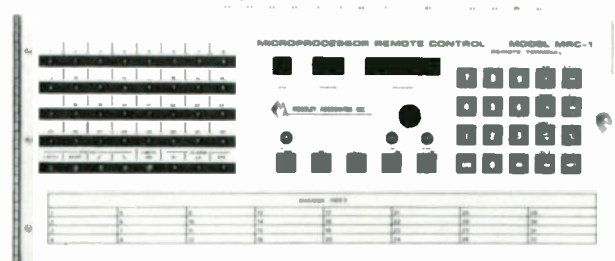
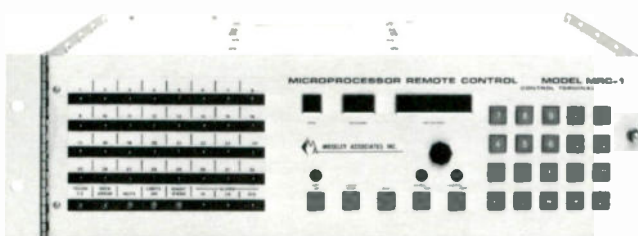

In step with technology, the MRC-1 provides capabilities and features only available before in much more elaborate and expensive systems. Up to 32 channels of status, 32 channels of telemetry and 64 command lines can be specified at each of up to nine sites.

The MRC-1 features keyboard telemetry calibration in three different modes, programmable assignment of control, upper and lower telemetry tolerance alarms with alarm muting, and status and command channels may be momentary or latching. Automatic Logging, CRT, Multiple Direct Command, and Moseley Memory are optionally available.

Effective 1 October 1987

Moseley

*Domestic
Price Schedule*

Table of Contents

Aural Studio-Transmitter Links	1
PCL-606	1
PCL-600	1
PCL-505	1
Aural STL Accessories	1
Telemetry Return Link	3
Telemetry Return Link Accessories	3
Multiplex Equipment	3
Audio Processing Equipment	4
Audio Routing Switchers	4
Microprocesor Based Remote Control	5
MRC-1600 System	5
MRC-2 System	5
MRC-2 System Expansion	6
MRC-2 Remote Terminal Expansion	6
MRC-2 Options	7
Remote Control and Logging Accessories	8

Aural Studio-Transmitter Links

150 MHz, 220 MHz, 300 MHz, 450 MHz, 950 MHz, 1.5 to 1.71 GHz bands

Specify operating frequency when ordering.

PCL-606 STL Transmitter and Receiver with self-contained power supplies and crystals. Tuned and tested on operating frequency. Shp Wt 66 lbs./30.0 kg.

300-330 MHz, 440-470 MHz, 890-960 MHz **10,490.00**

1.5 GHz-1.71 GHz* **13,890.00**

PCL-606/C Composite STL Transmitter and Receiver with self-contained power supplies and crystals. Tuned and tested on operating frequency. Transmits composite stereo waveform over single STL. Shp Wt 66 lbs./30.0 kg.

300-330 MHz, 440-470 MHz, 890-960 MHz **10,490.00**

1.5 GHz-1.71 GHz* **13,890.00**

PCL-600 STL Transmitter and Receiver with self-contained power supplies and crystals. Tuned and tested on operating frequency. Shp Wt 50 lbs./23 kg.

300-330 MHz** 440-470 MHz,** 890-960 MHz** **5,850.00**

PCL-600/C Composite STL Transmitter and Receiver with self-contained power supplies and crystals. Tuned and tested on operating frequency. Transmits composite stereo waveform over single STL. Shp Wt 50 lbs./23 kg.

300-330 MHz** 440-470 MHz**, 890-960 MHz **5,850.00**

PCL-505 STL Transmitter and Receiver with self-contained power supplies and crystals. Tuned and tested on operating frequency. Shp Wt 35 lbs./15.9 kg.

148-174 MHz, 215-240 MHz, 300-330 MHz, 370-430 MHz, 450-470 MHz **7,350.00**

PCL-505/C Composite STL Transmitter and Receiver with self-contained power supplies and crystals. Tuned and tested on operating frequency. Transmits composite stereo waveform over single STL. Shp Wt 35 lbs./15.9 kg.

148-174 MHz, 215-240 MHz, 300-330 MHz, 370-430 MHz, 450-470 MHz **7,350.00**

Extended Baseband Module permits composite STL to carry 92 kHz SCA channel in baseband radio. Replaces standard baseband module.

When ordered with PCL-606/C System **no charge**

Ordered separately **850.00**

NOTE: 110 kHz SCA cannot be used with Extended Baseband Module.

● **Spare Crystal Set** consists of frequency-determining crystals; includes one transmitter and one receiver crystal. Shp Wt 1 lb./450 g. **130.00**

Spare Semiconductor Kits

● **ST-42** for PCL-606 and PCL-606/C, 890-960 MHz. Shp Wt 5 lbs./2.3 kg. **490.00**

● **ST-40** for PCL-606 and PCL-606/C, 300-470 MHz. Shp Wt 5 lbs./2.3 kg. **665.00**

● **ST-43** for PCL-606 and PCL-606/C, 1.5-1.71 GHz. Shp Wt 5 lbs./2.3 kg. **855.00**

● **ST-100** for PCL-600 and PCL-600/C, 300-470 MHz. Shp Wt 5 lbs./2.3 kg. **475.00**

● **ST-112** for PCL-600 and PCL-600/C, 890-960 MHz. Shp Wt 5 lbs./2.3 kg. **490.00**

● **ST-33** for PCL-505 and PCL-505/C, 450-470 MHz. Shp Wt 5 lbs./2.3 kg. **180.00**

● **ST-32** for PCL-505 and PCL-505/C, 300-330 MHz. Shp Wt 5 lbs./2.3 kg. **210.00**

● **ST-30** for PCL-505 and PCL-505/C, 148-240 MHz. Shp Wt 5 lbs./2.3 kg. **135.00**

Aural STL Accessories and Antennas

TPR-2 Transfer Panel Receiver provides automatic changeover to standby STL receiver, carrier operated. Use with PD-1000 Power Divider. For use with PCL-505, PCL-505/C, PCL-600, PCL-600/C. Shp Wt 7.25 lbs./3.3 kg. **700.00**

TPT-2 Transfer Panel Transmitter provides automatic changeover to standby STL transmitter, carrier operated. Includes coaxial relay to switch active transmitter to single antenna. For use with PCL-505, PCL-505/C, PCL-600, PCL-600/C, PCL-606, PCL-606/C. Shp Wt 7.25 lbs./3.3 kg. **1,195.00**

*Export license required for sales outside North America under current regulations.

**Call Moseley Marketing Department for availability.

<p>ECP-5 STL Extension Control Panel provides carrier control and metering of relative RF power output and AFC for PCL-505, PCL-505/C, PCL-600, PCL-600/C, PCL-606, PCL-606/C. Shp Wt 4 lbs./1.8 kg.</p>	325.00	<p>● P-9A120G Antenna. Manufactured by Mark Antenna Products. Ten-foot Grid Parabolic dish, for 890-960 MHz, with type N female termination, universal mounting hardware for horizontal or vertical polarization. (Gain: 27.0 dBi @ 950 MHz.) Shp Wt 500 lbs./227 kg.</p>	2,376.00
<p>MAD-1 Monaural Adaptor for composite STL; consists of transmitter and receiver panels. Shp Wt 10 lbs./4.6 kg.</p>	750.00	<p>● PR-450U Antenna. Manufactured by Scala. Paraflector for 300-960 MHz, with type N female termination, universal mounting hardware for horizontal or vertical polarization, fully anodized, for STL. (Gain: 20.1 dBi gain at 950 MHz.) Shp Wt 75 lbs./34.1 kg.</p>	550.00
<p>● TBD-800-2 Transmitter Combiner (806-1000 MHz.) Manufactured by Celwave Associates. Facilitates coupling two STL transmitters to a common antenna. Provided with type N female connectors. 4.2 dB insertion loss. Shp Wt 25 lbs./11.4 kg.</p>	1,589.00	<p>● MF-960 Antenna. Manufactured by Scala. Miniflector for 940-960 MHz, with type N female termination, universal mounting hardware for horizontal or vertical polarization, fully anodized, for STL. Not recommended for congested areas. (Gain: 16.1 dBi gain at 950 MHz.) Shp Wt 16 lbs./7.3 kg.</p>	300.00
<p>● PD-1000 Power Divider (10-1000 MHz.) Manufactured by American Microwave. Broadband, in-phase two-way with N type female connectors. Facilitates coupling two receivers from a common antenna. Supplied with two 3' RG-8/U pigtail assemblies, 3.5 dB insertion loss. Shp Wt 2 lbs./910 g.</p>	285.00	<p>● LDF4-50A Helix © Manufactured by Andrew Corporation. Low-loss Coaxial Transmission Line, 1/2" foam dielectric, 50 ohm, jacketed. (2.4 dB/100 ft. at 950 MHz; 1.5 dB/100 ft. at 450 MHz) Shp Wt 30 lbs./100 ft.; 45 kg./100 m.</p>	1.73/ft 5.68/m
<p>● SH-5A72GN Antenna. Manufactured by Mark Antenna Products. Grid Parabolic Section, for 350-675 MHz, with type N female termination, universal mounting hardware for horizontal or vertical polarization. (Gain: 14.8 dBi @ 450 MHz.) Shp Wt 30 lbs./13.6 kg.</p>	530.00	<p>● KTL-6 Connector Kit for LDF4-50A, includes two type N female connectors and two 3' RG-8/U pigtail assemblies. ONE KIT REQUIRED PER ANTENNA. Shp Wt 2.5 lbs./1.1 kg.</p>	150.00
<p>● SH-6A72GN Antenna. Manufactured by Mark Antenna Products. Grid Parabolic Section, for 675-960 MHz, with type N female termination, universal mounting hardware for horizontal or vertical polarization. (Gain: 19.0 dBi @ 950 MHz.) Shp Wt 30 lbs./13.6 kg.</p>	530.00	<p>● LDF5-50A Helix © Manufactured by Andrew Corporation. Low-loss coaxial Transmission Line, 7/8" foam dielectric, 50 ohm, jacketed. (1.4 dB/100 ft. at 905 MHz; .85 dB/100 ft. at 450 MHz) Shp Wt 80 lbs./100 ft.; 119 kg./10 m.*</p>	4.52/ft. 14.83/m
<p>● P-9A48G Antenna. Manufactured by Mark Antenna Products. Four-foot Grid Parabolic dish, for 890-960 MHz, with type N female termination, universal mounting hardware for horizontal or vertical polarization. (Gain: 18.9 dBi @ 950 MHz.) Shp Wt 200 lbs./90.9 kg.</p>	734.00	<p>● KTL-7 Connector Kit for LDF5-50A, includes two type N female connectors and two RG-8/U pigtail assemblies. ONE KIT REQUIRED PER ANTENNA. Shp Wt 2.5 lbs./1.1 kg.</p>	220.00
<p>● P-9A872G Antenna. Manufactured by Mark Antenna Products. Six-foot Grid Parabolic dish, for 890-960 MHz, with type N female termination, universal mounting hardware for horizontal or vertical polarization. (Gain: 22.0 dBi @ 950 MHz.) Shp Wt 287 lbs./130.5 kg.</p>	1,082.00	<p>● RG-8/U 3' Pigtail Assembly, type N male connector on each end. Shp Wt 1 lb./450 g.</p>	50.00
<p>● P-9A96G Antenna. Manufactured by Mark Antenna Products. Eight-foot Grid Parabolic dish, for 890-960 MHz, with type N female termination, universal mounting hardware for horizontal or vertical polarization. (Gain: 25.0 dBi @ 950 MHz.) Shp Wt 525 lbs./238.6 kg.</p>	1,649.00	<p>ICU-1D Isocoupler (800-1000 MHz) facilitates mounting STL antenna on ungrounded AM tower. Shp Wt 2 lbs./910 g.</p>	375.00
		<p>ICU-2D Isocoupler (410-530 MHz) facilitates mounting STL antenna on ungrounded AM tower. Shp Wt 2 lbs./910 g.</p>	325.00
		<p>ICU-3D Isocoupler (145-180 MHz) facilitates mounting STL antenna on ungrounded AM tower. Shp Wt 2 lbs./910 g.</p>	325.00
		<p>ICU-5 Isocoupler (1.5-1.71 GHz) facilitates mounting STL antenna on ungrounded AM tower. Shp Wt 2 lbs./910 g.</p>	620.00

*Export license required for sales outside North America under current regulations.

Telemetry Return Link

450-512 MHz; Other frequencies on Special Order.

Specify exact operating frequency when ordering.

CL-100 Communications Link Transmitter and Receiver with self-contained power supplies and crystals. Tuned and tested on operating frequency. Nominal ONE-WATT transmitter output. Shp Wt 40 lbs./18 kg.

450-512 MHz

3,980.00

Optional MCW Identifier Module installs internally to CL-100 Transmitter. Nominally transmits ID every 20 minutes. Specify call letters/ID when ordering.

275.00

• **Optional Microphone Kit.**

60.00

CL-100 Communications Link Transmitter and Receiver with self-contained power supplies and crystals. Tuned and tested on operating frequency. Nominal TEN-WATT transmitter output. Shp Wt 40 lbs./18 kg.

450-512 MHz

4,980.00

Spare Semiconductor Kit

• **ST-188A** for CL-100. Shp Wt 1 lb./450 g.

188.00

Telemetry Return Link Accessories and Antennas

• **CA5-150H Antenna.** Manufactured by Scala. Five-element Yagi, horizontally polarized, 9 dBd gain, 140-230 MHz. Shp Wt 12 lbs./5.5 kg

175.00

• **CA5-450 Antenna.** Manufactured by Scala. Five-element Yagi, H or V polarization, 120 dBd gain, 230-500 MHz. Shp Wt 7 lbs./3.2 kg.

180.00

• **PR-450U Antenna.** Manufactured by Scala. Paraflector, H or V polarization, 15.5 dBd gain, 450-570 MHz. Shp Wt 75 lbs./34.1 kg.

550.00

• **CA7-460 Antenna.** Manufactured by Scala. Broadband, seven-element Yagi, H or V polarization, 10 dBd gain, 450-570 MHz. Shp Wt 7.5 lbs./3.4 kg.

180.00

ICU-2D Isocoupler (410-530 MHz) facilitates mounting remote pickup or telemetry return antenna on ungrounded AM tower. Shp Wt 2 lbs./910 g.

325.00

• **RG-8/U 3' Pigtail Assembly,** type N male connector on each end. Shp Wt 1 lb./450 g.

50.00

• **LDF4-50A Heliax[®]** Manufactured by Andrew Corporation. Low-loss Coaxial Transmission Line, 1/2" foam dielectric, 50 ohm, jacketed. (2.4 dB/100 ft. at 950 MHz; 1.5 dB/100 ft. at 450 MHz) Shp Wt 30 lbs./100 ft.; 45 kg./100m.

1.73/ft

5.68/m

• **KTL-6 Connector Kit** for LDF4-50A, includes two type N female connectors and two 3' RG-8/U pigtail assemblies. ONE KIT REQUIRED PER ANTENNA. Shp Wt. 2.5 lbs./1.1 kg.

150.00

• **LDF5-50A Heliax[®]** Manufactured by Andrew Corporation. Low-loss Coaxial Transmission Line, 7/8" foam dielectric, 50 ohm, jacketed. (1.4 dB/100 ft. at 950 MHz; .85 dB/100 ft. at 450 MHz) Shp Wt 80 lbs./100 ft.; 119 kg./100 m.*

4.52/ft

14.83/m

• **KTL-7 Connector Kit** for LDF5-50A, includes two type N female connectors and two RG-8/U pigtail assemblies. ONE KIT REQUIRED PER ANTENNA. Shp Wt 2.5 lbs./1.1 kg.

220.00

*Export license required for sales outside North America.

Multiplex Equipment for Stereo, SCA and STL Applications

SCG-9A FM Stereo Generator includes power supply and peak-reading deviation meter. Shp Wt 11.5 lbs./5.2 kg.

2,095.00

SCD-9 FM Stereo Demodulator includes power supply. Demodulates composite stereo signal into discrete left and right channels. Shp Wt 10.5 lbs./4.8 kg.

1,695.00

SCG-8 Subcarrier Generator with automatic muting and front-panel peak-deviation meter, includes self-contained power supply. Available for operation at any standard frequency in the 26-185 kHz spectrum. Specify operating frequency when ordering. Shp Wt 10.5 lbs./4.8 kg.

995.00

SCD-8 Subcarrier Demodulator with automatic muting and front-panel peak-deviation meter, includes self-contained power supply. Available for operation at any standard frequency in the 26-185 kHz spectrum. Specify operating frequency when ordering. Shp Wt 10.5 lbs./4.8 kg.

995.00

SCM-1 Subcarrier Mainframe accommodates two subcarrier modules. System includes one generator or demodulator module. Specify generator or demodulator, subcarrier frequency, and STL model when ordering for utility, control, telemetry service. Shp Wt 8 lbs./3.6 kg.

895.00

Additional Subcarrier Generator for SCM-1. 26-185 kHz. Shp Wt 2 lbs./910 g.

350.00

Additional Subcarrier Demodulator for SCM-1. 26-185 kHz. Shp Wt 2 lbs./910 g.

350.00

Spare Semiconductor Kits

• **ST-73** for SCG-9A, Shp Wt 5 lbs./2.3 kg.

25.00

• **ST-74** for SCD-9. Shp Wt 5 lbs./2.3 kg.

43.00

• **ST-70** for SCG-8. Shp Wt 5 lbs./2.3 kg.

12.00

• **ST-71** for SCD-8. Shp Wt 5 lbs./2.3 kg.

20.00

Audio Processing Equipment

TFL-280B Audio Limiter includes switchable 75 μ second pre-emphasis and de-emphasis, plug-in 15 kHz audio low-pass filter, power supply and front-panel calibrated meter. Other time-constants and audio low-pass filters available on special order. For FM, FM SCA, and TV aural service. Shp Wt 11.25 lbs./5.1 kg. **1,795.00**

TFL-280B Stereo Pair consists of two TFL-280B Audio Limiters. Matched channel performance characteristics for FM stereo service. (May involve consideration of present and/or future stereo generators.) Shp Wt. 18.5 lbs./5.1 kg. **3,595.00**

TAL-320 Audio Limiter includes all-pass network, compressor, adjustable clipper, output low-pass filter, power supply and front-panel calibrated meter. For AM and AM stereo service. Shp Wt 10.25 lbs./4.7 kg. **1,695.00**

TAL-320 Stereo Pair consists of two TAL-320 Audio Limiters. Matched channel performance characteristics for AM stereo service. (May involve consideration of present and/or future stereo generators.) Shp Wt 16.5 lbs./7.5 kg. **3,150.00**

TGR-340 Audio Gain Rider includes compressor, adjustable recovery-enable, adjustable recovery delay, clipper control, switchable low-distortion triple AGC, power supply and front-panel calibrated meter. An all-purpose automatic level controller and compressor for AM-FM-TV-STL-Satellite feed and production service. Shp Wt 10.25 lbs./4.7 kg. **1,995.00**

TGR-340 Stereo Pair consists of two TGR-340 Audio Gain Riders. Matched in performance characteristics for AM-FM-TV-STL-Satellite feed and production service. Shp Wt 17.25 lbs./7.8 kg. **3,895.00**

Spare Semiconductor Kits

- **ST-15** for TFL-280B Audio Limiter. Shp Wt 5 lbs./2.3 kg. **42.00**
- **ST-14** for TAL-320 Audio Limiter. Shp Wt 5 lbs./2.3 kg. **51.00**
- **ST-16** for TGR-340 Audio Gain Rider. Shp Wt 5 lbs./2.3 kg. **52.00**

Audio Routing Switchers*

ARS-256 Audio Routing Switcher. Basic system equipped for 8 audio inputs, 8 audio outputs and 64 crosspoints. Each unit includes RS-232C, GPI and RS-422 control ports and four system memories for preset matrices. Shp Wt 40 lbs./18 kg. **3,725.00**

ARS-1024 Audio Routing Switcher. Basic system equipped for 16 audio inputs, 16 audio outputs and 256 crosspoints. Each unit includes RS-232, GPI and RS-422, with four system memories with preset matrices. **7,960.00**

16-Channel Expansion Unit for above X-Y Front Panel. Shp Wt. 5 lbs./2.3 kg. **515.00**

16 x 16 Desktop Wedge Controller. Shp Wt. 5 lbs./2.3 kg. **785.00**

Rack Mount Kit for X-Y Panel Controller includes hardware, 50' of cable, and power supply. Allows front-panel casting to be remoted from an ARS-256 Main Frame. Shp Wt 5 lbs./2.3 kg. **240.00**

- **Video Display Terminal (VDT)** duplicates and allows control of X-Y matrices. Shp Wt 30 lbs./13.5 kg. **935.00**

EXPANSION ASSEMBLIES

8 Input, 8 Output, 64 Crosspoints. **1,075.00**
8 Input, 64 Crosspoints **920.00**
8 Output, 64 Crosspoints **920.00**
64 Crosspoints **815.00**

ACP-1 Audio Connection Panel provides convenient XLR interface connections for ARS products 19" Rack Panel. Configured with 8 audio inputs and 8 audio outputs. **490.00**

OPTIONS

16 x 16 X-Y Front Panel Controller. Relegendable X-Y crosspoint-oriented switch panel. Shp Wt 10 lbs./4.5 kg. **890.00**

ACP-2 Audio Connection Panel used in conjunction with ACP-1. Configured with 8 audio inputs. **365.00**

ACP-3 Audio Connection Panel used in conjunction with ACP-1. Configured with 8 audio outputs. **365.00**

*Note the ARS-256 System architecture permits 256 crosspoints per system. The ARS-1024 allows 1,024 crosspoints per system.

Microprocessor-Based Remote Control

MRC-1600 SYSTEM

MRC-1600 Microprocessor Remote Control System consists of one Control Terminal and one Remote Terminal. The System is equipped with 32 command relays, 16 status channels (TTL contact closure) and 16 digital telemetry channels. FCC acceptable for AM, FM and TV broadcast transmitter remote control includes audible telco/telco data interface on each terminal. Shp Wt 40 lbs./18.2 kg. **4,595.00**

▲ **Option for Cathode-Ray Tube (CRT) Terminal** duplicates all panel functions of the MRC-1600 Control Terminal. Allows simultaneous display of data for 16 channels, including telemetry readings, status conditions, time of day, operation and error-oriented messages. Supplied with 15' (4.57m) cable, standard; 50' (15.24m) or 100' (30.48m) cable optionally available at extra cost. Shp Wt 40 lbs./18.2 kg. **1,095.00**

▲ **Option for Automatic Logging** includes I/O modules, firmware and Texas Instruments Model 850 Desktop Printer. Log headings and commands are entered through CRT keyboard. Requires option for CRT Terminal. Supplied with 15' (4.57m) cable, standard. Shp Wt 50 lbs./22.7 kg. **995.00**

Option for Cathode-Ray Tube (CRT) Terminal and Automatic Logging Less CRT and Logger includes firmware, cables and implementation guide. **495.00**

Option for Subcarrier Generator Module for use with MRC-1600 Control Terminal or Remote Terminal. Displaces telco output module. Available at standard subcarrier frequencies between 26-185 kHz. Advise STL or radio link and subcarrier frequency when ordering. Per terminal, per module (ordered with MRC-1600 System) **no charge**

Per terminal, per module (ordered separately) **195.00**

Option for Subcarrier Demodulator Module for use with MRC-1600 Control Terminal or Remote Terminal. Displaces telco input module. Available at standard subcarrier frequencies between 26-185 kHz. Advise STL or radio link and subcarrier frequency when ordering. Per terminal, per module (ordered with MRC-1600 System) **no charge**

Per terminal, per module (ordered separately) **195.00**

Option for subaudible telemetry for MRC-1600 System, replaces two audible telemetry modules. Allows carriage of telemetry along with AM programming or FM SCA programming. Ordered with MRC-1600 System (includes 2 modules) **no charge**

Ordered separately (includes 2 modules) **790.00**

Spare Semiconductor Kit
● **ST-55** for MRC-1600 Microprocessor Remote Control. Shp Wt 5 lbs./2.3 kg. **358.00**

MRC-2 SYSTEM

MRC-2 Microprocessor Remote Control System with stand-alone Remote Terminal, consisting of one Control Terminal, and one Remote Terminal. Remote Terminal includes data acquisition/command capability, precludes CRT, MDC, MSD capability for terminal. System is configured with 16 command lines (open collector electronic switching), 16 status channels (TTL contact closure), and 16 analog telemetry channels, indicated as 16/16/16. System includes two sets of modems for dedicated main/backup wire interconnections. Shp Wt 60 lbs./27.3 kg. **12,850.00**

Semiconductor Spares Kit
● **ST-60** for MRC-2 Microprocessor Remote Control. **536.00**

MRC-2 Control Terminal Only. Up to two standard Control Terminals can be used with any single standard Remote Terminal. Up to four Control Terminals can be used with any single standard Remote Terminal by the use of additional modems (listed below). In standard configuration, system expansion of up to nine additional expansion/option modules is possible. Shp Wt 30 lbs./13.6 kg. **7,090.00**

MRC-2 Stand-Alone Remote Terminal Only. Includes data acquisition/command capability, precludes CRT, MDC, MSD capability for terminal. Configured with 16 command lines (open collector electronic switching), 16 status channels (TTL/contact closure), and 16 analog telemetry channels, indicated as 16/16/16. Terminal includes two modems for dedicated main/backup wire interconnections. Shp Wt 30 lbs./13.6 kg. **7,980.00**

MRC-2 Microprocessor Remote Control System with Data Acquisition Remote Terminal, consisting of one Control Terminal, One Remote Terminal, and one standard Data Acquisition/Command Unit (DACU-1). System is configured with 32 command lines (open collector electronic switching), 32 status channels (TTL/contact closure), and 32 analog telemetry channels, indicated as 32/32/32. System includes two sets of modems for dedicated main/backup wire interconnections. Shp Wt 90 lbs./40.9 kg. **17,995.00**

● **Spare Semiconductor Kit ST-60** for MRC-2 Microprocessor Remote Control. Shp Wt 5 lbs/2.3 kg. **536.00**

MRC-2 Remote Terminal Only. Incorporates individual programmable site code for multiple Remote Terminals per system. Requires use of one standard Data Acquisition/Command Unit, as listed below. Shp Wt 30 lbs./13.6 kg. **7,090.00**

DACU-1 MRC-2 Standard Data Acquisition/Command Unit Only. One unit required for use with each MRC-2 Remote Terminal. Equipped as MRC-2 system above (32/32/32). Allows for system expansion of up to four additional expansion/option modules. Shp Wt 30 lbs./13.6 kg. **7,180.00**

MRC-2 SYSTEM EXPANSION

DACU-1E MRC-2 Data Acquisition/Command Expansion Unit Only consists of one expansion chassis, equipped with one CPU module, one 96K ROM module, one 32K RAM module, one File Memory Controller module, and one General Purpose Interface Bus (GPIB) module. Allows for system expansion of up to ten additional expansion/option modules. Equipped as 0/0/0. Shp Wt 30 lbs./13.6 kg. **4,270.00**

Command capabilities can be expanded to a maximum of 256 lines per remote site, in groups of 16 lines, by the addition of Command Line (open collector) Expansion modules, in the Remote Terminal, DACU-1 or DACU-1E. Per 16-line module. **415.00**

Status Channel capabilities can be expanded to a maximum of 256 channels per remote site, in groups of 16 channels, by the addition of Status Channel (TTL/contact closure) Expansion modules, in the Remote Terminal, DACU-1 or DACU-1E. Per 16-line module. **415.00**

Analog Telemetry Channel capabilities can be expanded to a maximum of 256 channels per remote site, in groups of 16 channels, by the addition of Telemetry Channel Expansion modules, in the Remote Terminal, DACU-1 or DACU-1E. Per 16-line module **625.00**

CEU-1 Communications Expansion Unit (Control Terminal), allows for up to nine communications expansion/option modules to be used with the MRC-2 Control Terminal. Includes General Purpose Interface Bus (GPIB), below. Shp Wt 30 lbs./13.6 kg **5,995.00**

General Purpose Interface Bus (GPIB) used as a standard interface throughout the MRC-2 System and required for interfacing specific expansion/option features. Includes GPIB and interconnecting cable. Shp Wt 2 lbs./910 g. **605.00**

MRC-2 OPTIONS

▲ **Cathode-Ray Tube (CRT) Terminal** duplicates all panel control functions of the MRC-2 Control Terminal (or Remote Terminal), and allows full display of all status and telemetry channels, in 32-channel-per-display-page blocks. Enhances MRC-2 front-panel display with full alphanumeric capability. First CRT option site must be used in conjunction with File Memory module(s) option.* Shp Wt 40 lbs./18.2 kg. **2,995.00**

Cathode-Ray Tube (CRT) Terminal Less CRT. Includes firmware, cable and implementation guide. **1,795.00**

▲ **Automatic Logging** includes I/O modules, software and Genicom desktop printer. Logger option must be used in conjunction with File Memory module(s) option.* Shp Wt 50 lbs./22.7 kg. **2,995.00**

Automatic Logging Less Logger includes firmware, I/O modules, cable and implementation guide. **1,795.00**

File Memory Expansion Module supplies an additional 8K of EAROM memory. Shp Wt 2 lbs./910 kg. Per 8K module. **695.00**

Optically Isolated Command Lines, if ordered with MRC-2 System, replaces the Open Collector Electronic Switching provided as standard. Per 16 channels, add to system or expansion prices. Shp Wt 2 lbs./910 g **210.00**

CIP-2 Option for Relay Isolated Command Lines includes 19" (48.3) rack panel, 16 relay sockets and power supply. Barrier strip terminals. Relays not included. Shp Wt 4.5 lbs./2.0 kg. **495.00**

● **Relay for CIP-2** contacts rated at 5A, SPDT **9.00**

*For File Memory requirements exceeding the standard 32/32/32 system configuration or for multiple CRT and/or Logger options, contact Moseley Marketing Department.

BSP-1 Barrier Strip Interface Panel. 19" rack panel provides convenient interface connections for 16 command lines, 16 status channels, or 16 telemetry channels. Includes ribbon cable with plug for MRC-2 Remote Terminal. Accepts up to 3 additional expansion modules, described below. Shp Wt 2 lbs./910 kg.	195.00	MDC-2 Multiple Direct Command provides 165 individually programmable push-button switches with tally back accessing any command line accessible by the associated terminal. Includes 19" (48.3) rack mount chassis, interconnecting cable and interface modules. Shp Wt 15 lbs./6.8 kg.	2,495.00
BSP-1 Expansion. Per 16 lines or channels. Shp Wt 2 lbs./910 kg.	150.00	MDC-2E Multiple Direct Command Expansion provides 16 individually programmable push-button switches with tally back accessing any command line accessible by the associated terminal. Includes 19" (48.3 cm) rack mount chassis and interconnecting cable to interface to previously installed MDC-2 or MSD-1 connected to same terminal. Multiple units may be stacked. Shp Wt 15 lbs./6.8 kg	1,995.00
Optically Isolated Status Channels. If ordered with MRC-2 system, replaces TTL/contact closure provided as standard. Per 16 channels, add to system or expansion prices.	210.00	MSD-1 Multiple Status Display allows continuous LED display of two blocks of 16 status channels. Includes 19" (48.3 cm) rack mount chassis, interconnecting cable, and interface modules. Shp Wt 15 lbs./6.8 kg.	2,595.00
Digital Telemetry Input. Allows direct input of BCD telemetry into DACU-1, DACU-1E, or stand-alone Remote Terminal.	495.00	MSD-1E Multiple Status Display Expansion allows continuous LED display of two blocks of 16 status channels. Includes 19" (48.3 cm) rack mount chassis and interconnecting cable to interface to previously installed MDC-2 or MSD-1 connected to same terminal. Multiple units may be stacked. Shp Wt 15 lbs./6.8 kg.	1,695.00
Telemetry Fail-Safe Module provides full compliance with FCC Rules and Regulations for telemetry fail-safe operation. Monitors up to six transmitters at any single remote site.	550.00	Personal Computer Interface allows interconnection of any personal computer capable of communications in ASCII over RS-232C port. Includes firmware, interconnecting cable and protocol guide. All user programming is responsibility of end-user. Use or ability to use computer in RF environments is responsibility of end-user.	2,495.00
Expansion Modem for installation at either Control Terminal or Remote Terminal. Used for providing additional system data links. Must be used in conjunction with Data Link Interfaces listed below. Telco In/Telco Out Interface provided as standard. Per terminal, per module	695.00	Video Analyzer Interface allows connection of Rohde & Schwarz UVF Video Analyzer to any MRC-2 Remote Terminal.	2,395.00
Wireless Operation Option. FM subcarrier generator/demodulator module (available at standard subcarrier frequencies, 26 kHz-185 kHz) mounts internally to MRC-2 and displaces audible telco module. Standard FM subcarrier/ telco combinations can also be provided: (Must be used with a modem)		• UVF Video Analyzer. Manufactured by Rohde & Schwarz	**
TELCO IN/SUBCARRIER OUT INTERFACE SUBCARRIER IN/TELCO OUT INTERFACE SUBCARRIER IN/SUBCARRIER OUT			
Ordered with MRC-2 (Per terminal, per module)	225.00		
Ordered separately (Per terminal, per module)	385.00		
▲ Dial-Up Option includes software, firmware, external Hayes Modem and cable. Note: One option is required for each Control, Remote or stand-alone Terminal in the system using a non-dedicated telco line.			
Ordered with MRC-2	890.00		
Ordered separately*	1,030.00		

*Contact Moseley Marketing Department for ordering details.

**Contact Moseley Marketing Department for current pricing.

Remote Control and Logging Accessories

<p>CIP-1 Control Interface Panel provides for use of slave or repeating relays with Moseley Remote Control Systems. Accepts up to seven relays. Relays not included. Shp Wt. 4.5 lbs./2.0 kg.</p>	275.00	<p>MIU-2 Metering Insertion Unit enables mixing of subaudible metering signal with program audio. For AM broadcast and FM SCA operation. Shp Wt 8 lbs./3.6 kg.</p>	1,090.00
<ul style="list-style-type: none"> ● Type 5480DC Relay, DPDT, momentary closure, coil for 24 VDC. Shp Wt 1 lb./450 g. 	15.00	<p>PVK-1A Plate Voltage Sampling Kit for plate voltages through 3kV. Specify normal operating plate voltage. Shp Wt 1 lb./450 g.</p>	225.00
<ul style="list-style-type: none"> ● Type 5480AC Relay, DPDT, momentary closure, coil for 120 VAC. Shp Wt 1 lb./450 g. 	16.00	<p>PVK-1B Plate Voltage Sampling Kit for plate voltages 3kV through 10kV. Specify normal operating plate voltage. Shp Wt 1 lb./450 g.</p>	225.00
<ul style="list-style-type: none"> ● Type 5481DC Relay, SPDT, magnetic latching, coil for 24 VDC. Shp Wt 1 lb./450 g. 	39.00	<p>PVK-2 Plate Voltage Sampling Kit for plate voltages 10kV through 20kV. Specify normal operating plate voltage. Shp Wt 2 lbs./910 g.</p>	345.00
<ul style="list-style-type: none"> ● Type 5481AC Relay, SPDT, magnetic latching, coil for 120 VAC. Shp Wt 1 lb./450 g. 	46.00	<p>PVK-3 Plate Voltage Sampling Kit for plate voltages 15kV through 30kV. Specify normal operating plate voltage. Shp Wt 2 lbs./910 g.</p>	590.00
<p>DCA-3A DC Amplifier provides low-level telemetry amplification, and isolation. Shp Wt 5 lbs./2.3 kg.</p>	635.00	<p>RFK-1 AM RF Transmission Line Voltage Sampling Kit. Shp Wt 2 lbs./910 g.</p>	195.00
<p>DCA-3B DC Amplifier provides low-level telemetry amplification. Shp Wt 5 lbs./2.3 kg.</p>	450.00	<p>RFK-2 FM RF Transmission Line Voltage Sampling Kit, for 3/8" line. Shp Wt 2 lbs./910 g.</p>	195.00
<ul style="list-style-type: none"> ● DCP-1 DC Power Supply, 24 VDC, 1A into seven parallel terminals. For use with CIP-1 Control Interface Panel, rack mount; 120/240 VAC, 50-60 Hz input. Shp Wt 5 lbs./2.3 kg. 	295.00	<p>RFK-3 FM RF Transmission Line Voltage Sampling Kit, for 1/8" line. Shp Wt 2 lbs./910 g.</p>	195.00
<ul style="list-style-type: none"> ● DCP-2 With Two DC Power Supplies in common rack mount, 24 VDC, 2A into 14 (2x7) parallel terminals. For use with CIP-1 Control Interface Panel; 120/240 VAC, 50-60 Hz input. Shp Wt 7.5 lbs./3.4 kg. 	495.00	<p>RMK-1 Reversible Motor Kit with adjustable clutch. Shp Wt 3 lbs/1.4 kg.</p>	275.00
<p>LVK-3 Line Voltage Sampling Kit (120 VAC to 400 VAC, 50-60 Hz) Shp Wt 2 lbs./910 g.</p>	130.00	<p>TLK-2 Tower Light Sampling Kit. Shp Wt 2 lbs./910 g.</p>	225.00
<p>MBB-1 Universal Plate Circuit (1_p or E_{bb}) Sampling Kit. Used when sampling points are either above or below ground potential. (Requires external shunt or series resistor. Resistor not supplied.) Shp Wt 2 lbs./910 g.</p>	295.00	<p>TSK-4 Temperature Sensing Kit, remoteable sensor. Includes power supply for operation for 120/240 VAC, 50-60 Hz. Shp Wt 2 lbs./910 g.</p>	225.00

WARRANTY

All equipment designed and manufactured by Moseley Associates, Inc. is warranted against defects in workmanship and material that develop under normal use within a period of (2) years from the date of original shipment, and is also warranted to meet any specifications represented in writing by Moseley Associates, Inc., so long as the purchaser is not in default under his contract of purchase and subject to the following additional conditions and limitations:

1. The sole responsibility of Moseley Associates, Inc. for any equipment not conforming to this Warranty shall be, at its option:

A. to repair or replace such equipment or otherwise cause it to meet the represented specifications either at the purchaser's installation or upon the return thereof f.o.b. Santa Barbara, California, as directed by Moseley Associates, Inc.; or

B. to accept the return thereof f.o.b. Santa Barbara, California, credit the purchaser's account for the unpaid portion, if any, of the purchase price, and refund to the purchaser, without interest, any portion of the purchase price theretofore paid; or

C. to demonstrate that the equipment has no defect in workmanship or material and that it meets the represented specification, in which event all expenses reasonably incurred by Moseley Associates, Inc., in so demonstrating, including but not limited to costs of travel to and from the purchaser's installation, and subsistence, shall be paid by purchaser to Moseley Associates, Inc.

2. In case of any equipment thought to be defective, the purchaser shall promptly notify Moseley Associates, Inc., in writing, giving full particulars as to the defects. Upon receipt of such notice, Moseley Associates, Inc. will give instructions respecting the shipment of the equipment, or such other manner as it elects to service this Warranty as above provided.

3. This Warranty extends only to the original purchaser and is not assignable or transferable, does not extend to any shipment which has been subjected to abuse, misuse, physical damage, alteration, operation under improper conditions or improper installation, use or maintenance, and does not extend to equipment or parts not manufactured by Moseley Associates, Inc. and such equipment and parts are subject to only adjustments as are available from the manufacturer thereof.

4. No other warranties, express or implied, shall be applicable to any equipment sold by Moseley Associates, Inc. and no representative or other person is authorized by Moseley Associates, Inc. to assume for it any liability or obligation with respect to the condition or performance of any equipment sold by it, except as provided in this Warranty. This Warranty provides for the sole right and remedy of the purchaser and Moseley Associates, Inc. shall in no event have any liability for consequential damages or for loss, damage or expense directly or indirectly arising from the use of equipment purchased from Moseley Associates Inc.



Moseley
Associates
Incorporated

111 Castilian Drive
Santa Barbara, CA
93117-3093

a
Flow General
Company

Phone 805 968 9621
Telex 658448
Cable: MOSELEY

PCL-600 and PCL-600/C

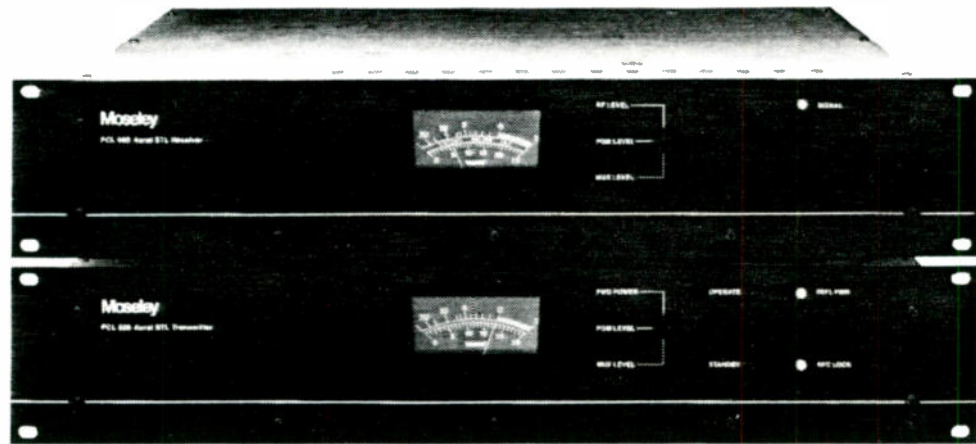

From the pioneers of the Studio-Transmitter Link industry comes a new generation of STLs that blend technology and innovative engineering to provide excellent performance at an economical price. Introducing the monaural PCL-600 and composite stereo PCL-600/C, the first truly cost-effective STL designed to operate in most RF environments with low distortion and low noise characteristics.

The PCL-600/C meets the discerning broadcaster's demand for uniformly flat frequency response, exceptional stereo separation and minimal non-linear crosstalk for transmission of, for example, compact disc recording.

The PCL-600/C has a wideband input that transmits the complete stereo waveform over a single STL. This allows the stereo generator and all audio processing equipment to be located at the studio, far from intense RF radiation, but well within reach for adjustments. When used in conjunction with an SCD-9 Stereo Demodulator, the PCL-600/C is an excellent choice for AM stereo broadcast.

The PCL-600 has a 16 kHz lowpass filter so that two PCL-600s, used in the split channel method, can transmit right and left programs with no measurable crosstalk.

Both the PCL-600 and PCL-600/C can transmit two subcarrier frequencies for SCA and/or remote control as well as the program. The PCL-600 and PCL-600/C set new standards for adjacent channel rejection,

selectivity and signal-to-noise ratio performance within their price range. Both units are fully backed by quality service and support and a two-year, no-nonsense warranty.

TRANSMITTER

The PCL-600 and the PCL-600/C Transmitters use true direct modulation techniques. A synthesized reference oscillator is used for frequency and phase control of the direct FM oscillator. Transmitter FM modulated oscillator frequency conversion is done via an upconverter mixer scheme instead of the usual frequency multiplication of the modulated signal.

The transmitter includes a front-panel meter with switch-selection for forward power, program and multiplex level, etc. Transmitter operation, reflected power and FM lock status are shown by a green/red LED.

RECEIVER

The dual-conversion PCL-600 and PCL-600/C Receivers use well-proven circuitry. Excellent selectivity characteristics let the receiver ignore adjacent channels. A digital pulse counting discriminator offers low distortion and low noise characteristics for maximum fidelity.

The Receiver includes a front-panel meter with switch selection for true RF input level in microvolts, program output level and subcarrier level. Operational/Received signal status is indicated by a green/red LED.

PRELIMINARY SPECIFICATIONS

PCL-600

SYSTEM

PCL-600/C

300-330 MHz, 450-470 MHz, 890-960 MHz Specify exact operating frequency	Frequency Range	300-330 MHz, 450-470 MHz, 890-960 MHz Specify exact operating frequency
Monophonic audio: ± 0.3 dB or better, 30 Hz to 15 kHz	Frequency Response	Composite: ± 0.2 dB or better, 30 Hz to 53 kHz, ± 0.3 dB or better, 30 Hz to 75 kHz
0.2% or less, 30 Hz to 15 kHz (typically better than 0.15% at 1 kHz)	THD and IMD Distortion:	Stereo demodulated THD and IMD: 0.2% or less 30 Hz to 7.5 kHz, typically better than 0.15% at 1 kHz Convolved stereo demodulation products: greater than 50 dB below the 400 Hz, 100% modulation ref. level from 7.5 kHz to 15 kHz
Not applicable	Stereo Separation	50 dB or better, 50 Hz to 15 kHz; typically 55 dB or better
Not applicable	Nonlinear Crosstalk Subchannel to Main Channel	50 dB or better
Not applicable	Nonlinear Crosstalk Main Channel to Subchannel	50 dB or better
72 dB or better below 100% modulation typically 75 dB below 100%	Signal-to-Noise Ratio	72 dB or better, typically 75 dB below 100% modulation, demodulated, de-emphasized left or right
19" (48.3 cm) wide TX 3.5" (8.9 cm) high, RX 3.5" (4.5 cm) high, 16" (40.6 cm) deep 13.75" (34.9 cm) deep	Dimensions Transmitter and Receiver	19" (48.3 cm) wide TX 3.5" (8.9 cm) high, RX 3.5" (4.5 cm) high, 16" (40.6 cm) deep 13.75" (34.9 cm) deep

TRANSMITTER

7 Watts maximum, 5 Watts minimum 15 Watts maximum, 10 Watts minimum	RF Power Output 890-960 MHz 300-470 MHz	7 Watts maximum, 5 Watts minimum 15 Watts maximum, 10 Watts minimum
Type N Female, 50 ohm	RF Output Connector	Type N Female, 50 ohm
± 40 kHz	Deviation for 100% Modulation	± 50 kHz
Better than 0.00025%, 0°C to +50°C	Frequency Stability	Better than 0.00025% 0°C to +50°C
More than 60 dB below carrier level	Spurious and Harmonic Emission	More than 60 dB below carrier level
One Program and Two Subcarrier Channels	Modulation Capability	One Program and Two Subcarrier Channels
Monophonic: +10 dBm, 600 ohm balanced, floating, barrier strip screw input. Multiplex: 1.5 V peak-to-peak, 2K ohms unbalanced, type BNC female connectors (2), frequency range 22-85 kHz	Modulation Inputs	Composite: 3.5 V peak-to-peak, 6K ohms unbalanced, type BNC female connector Multiplex: 1.5 V peak-to-peak, 4K ohms unbalanced, type BNC female connectors (2), frequency range 100-200 kHz
120/240 VAC $\pm 10\%$, 50/60 Hz, 80 Watts	Power Source	120/240 VAC $\pm 10\%$, 50/60 Hz, 80 Watts

RECEIVER

Type N Female, 50 ohm	RF Input Connector	Type N Female, 50 ohm
20 μ V or less required for 60 dB SNR	Sensitivity	140 μ V or less required for 60 dB SNR, left or right channel de-emphasized demodulated
3 dB I.F. bandwidth, ± 90 kHz 80 dB I.F. bandwidth ± 1.2 MHz	Selectivity	3 dB I.F. bandwidth, ± 125 kHz 80 dB I.F. bandwidth, 1.2 MHz
An adjacent signal 10 dB higher than the desired signal will degrade SNR by less than 3 dB	Adjacent Channel Rejection	An adjacent signal 10 dB higher than the desired signal will degrade SNR by less than 3 dB
Monophonic: +10 dBm, 600 ohm balanced floating, barrier strip screw output Multiplex: 1.5 V peak-to-peak, 100 ohms unbalanced, type BNC female connectors (2)	Modulation Outputs	Composite: 3.5 V peak-to-peak, 200 ohm unbalanced, type BNC female connector Multiplex: 1.5 V peak-to-peak, 100 ohms unbalanced, type BNC female connectors (2)
120/240 VAC $\pm 10\%$, 50/60 Hz, 20 Watts	Power Source	120/240 VAC $\pm 10\%$, 50/60 Hz, 20 Watts

NOTE: Specifications subject to change without notice.
Printed in U.S.A. 6/87

Moseley

Moseley
Associates
Incorporated

111 Castilian Drive
Santa Barbara, CA
93117-3093

a
Flow General
Company

Phone 805 968 9621
Telex 658448
Cable: MOSELEY

Dial Access/Voice Response for MRC-1600.

The MRC-1600 Dial Access Option connects a standard MRC-1600 Remote Control System to the public telephone network, providing cost-effective, multi-point monitoring and control of unattended equipment sites. To provide maximum flexibility, the Dial Access Option can be

located at either the MRC-1600 Control Terminal or Remote Terminal. For applications requiring multiple command points, the MRC-1600 Remote Terminal with Dial Access Option will operate without a Control Terminal in a stand-alone configuration.

Features:

- Accessible through any DTMF telephone
- Digitally-Recorded Voice Reporting
- Security Code Prohibits Unauthorized Control
- Real Time Clock
- 32 Relay-Isolated Command Lines
- 16 Status Input Channels
- 16 Telemetry Input Channels
- Automatic Alarm Reporting to Five Different Telephone Numbers
- Immediate Confirmation of Control Action
- Non-volatile Memory
- Can be Interfaced with Any Personal Computer

Option:

- Custom Voice Response in Any Language, Voice and Words of Your Choice

*Specifications subject to change without notice.
Printed in USA 3/87*

compliance with current FCC Regulations, the MRC-1600 has full fail-safe provisions. Remote Terminals are also equipped with a Maintenance Override mode which, when activated, ignores Control Terminal commands but continues to update status and telemetry data. LEDs and auxiliary contacts at the Remote Terminal are provided to enable warnings to personnel that the system is in the override mode.

Options

The CRT Option for the MRC-1600 gives the user full control of the transmitter from the keyboard at the Control Terminal. All status and telemetry data are displayed simultaneously on an ADDS VP+ terminal. Status and telemetry field titles can be up to 14 characters long and may be changed at any time. Seven characters each are allotted for telemetry units, Status On and Status Off displays. The CRT also indicates time of day, data link status, and Remote Terminal Maintenance Override.

An Automatic Logging Option can be added to the CRT Option to provide a printed log of station operation. A Texas Instruments Model 850 printer records

status and telemetry data at user-specified intervals from one minute to twenty-four hours.

MRC-1600 LOGGER
AUTOMATIC DATA

THE HEADER, LOGGED CHANNELS, AND LOGGING INTERVALS ARE USER PROGRAMMABLE.

TIME	FILAMENT VOLTAGE	PLATE VOLTAGE	PLATE CURRENT	OUTPUT POWER	REFL. POWER	INTAKE TEMP.	EXHAUST TEMP.	ALARM SYSTEM	TUNER LIGHTS
09:40	6.3	7.45	2.12	101.4	78.	27.5	56.6	0n	0n
09:50	6.3	7.45	2.12	101.4	78.	27.5	56.6	0n	0n
10:00	6.3	7.45	2.12	101.4	78.	27.5	56.6	0n	0n
10:10	6.3	7.45	2.12	101.4	78.	27.5	56.6	0n	0n
10:20	6.3	7.45	2.12	101.4	78.	27.5	56.6	0n	0n
10:30	6.3	7.45	2.12	101.4	78.	27.5	56.6	0n	0n
10:40	6.3	7.45	2.12	101.5	78.	27.5	56.6	0n	0n
10:50	6.3	7.45	2.12	101.5	78.	27.5	56.6	0n	0n
11:00	6.3	7.45	2.12	101.4	78.	27.5	56.6	0n	0n
11:10	6.3	7.45	2.12	101.4	78.	27.5	56.6	0n	0n
11:20	6.3	7.45	2.12	101.4	78.	27.5	56.6	0n	0n



MRC-1600

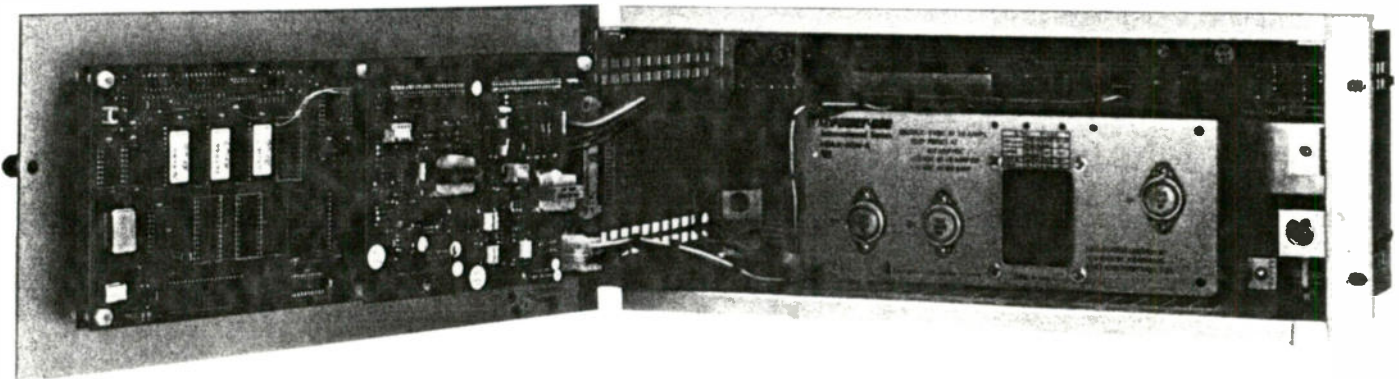

The MRC-1600 Microprocessor Remote Control System offers microprocessor flexibility and sophistication in an economical and dependable package for general remote control applications. It comes equipped with 16 status inputs, 16 telemetry inputs, 16 raise command outputs and 16 lower command outputs. Each command output is relay-isolated. Adapting the MRC-1600 to current system interconnections is easy. Plug-in modules can be ordered to accommodate almost any communication system, from standard 2-wire to 4-wire telephone lines to FM subcarriers, subaudible telemetry, or a combination of any of these.

The MRC-1600 is suitable for such applications as AM, FM, TV, LPTV, and facility control. Telemetry limit checking and status alarm capability help ensure

that an unmanned facility operates at peak efficiency while any alarm conditions, such as fire or intrusion, are quickly relayed to an operating position so that appropriate action can be taken.

Setup and Operation

System setup and calibration are done at the Remote Terminal with eight color-coded buttons. For each channel, upper and lower telemetry limits may be set or disabled independently, and telemetry data may be calibrated in one of four modes: power, indirect power, linear or millivolt. Status inputs may be set to display direct or inverted and may be programmed to trigger an alarm on rising, falling or rising and falling waveforms. Both telemetry and status channels may be muted.

Nonvolatile memory is standard on the MRC-1600. In the event of a power-down, all setup data, calibration information and limits are stored on electrically-erasable, programmable read-only memory (EEPROM) for up to ten years.

The MRC-1600 front panel is simple to operate and easy to understand. All status channels are displayed simultaneously on a set of 16 LEDs. Alpha-numeric LEDs give readouts of selected channel number and telemetry data while eight color-keyed LEDs indicate operation mode, alarms, and other system parameters.

MRC-1600 operation is straightforward. The system constantly checks telemetry data for each channel against assigned upper and lower limits. Any channel exceeding its limits immediately sets off audible and visible alarms. Pressing the ACKnowledge button displays the relevant channel number, telemetry information, and upper or lower limit LED so the operator can push either the RAISE or LOWER key to bring telemetry values for that channel back within limits.

The MRC-1600 operates two special system test channels. One checks A/D conversions and provides an alarm when tolerance exceeds factory set limits. The other gives the user readouts of conditions for both Control-to-Remote and Remote-to-Control data links. In

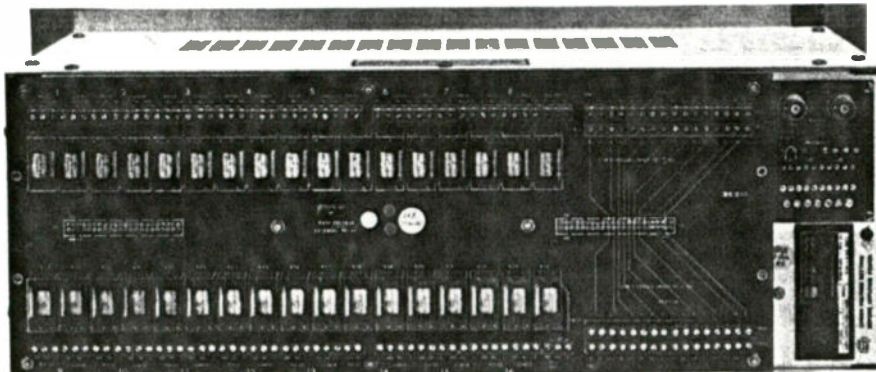

SPECIFICATIONS

Type of System

Microprocessor based Control Terminal and Remote Terminal

Types of Memory Used

Programmable Read Only Memory for system firmware
Random Access Memory for user programmed functions

Moseley Memory

Retains data for ten year minimum or electrically erasable programmable read only memory (EEPROM)
Holds calibration factors, status and command assignments
With CRT, or CRT and Logger options, stores CRT text and logger setups

System Configuration

One Control Terminal, one Remote Terminal per system

Command Lines

Two (one "raise," one "lower") per channel, momentary, total of 16 "raise," 16 "lower"
Command response time: 400 ms to implementation, nominal
Form C relay (SPDT) output standard, up to 2A, 30 VDC or 120 VAC (non inductive) per relay

Telemetry Channels

16 channels, unbalanced input
One person digital calibration, via Remote Terminal keyboard
Fully tolerance alarmed, one high and one low limit
Status muting
Linear, power to linear conversion, indirect power millivolt calibration
Full four digit LED display with decimal point and polarity sign
Resolution: one part in 4096
Overall measurement accuracy: better than 0.5%
Response time: 500 ms, nominal, with audible data
Full scale input level: 0.25 V minimum, 1 V minimum recommended, 4.5 VDC maximum

Status Channels

16 channels, each displayed by individual LEDs on Control Terminal and Remote Terminal front panels
User programmable NO/NC, momentary or latching alarm on rising and/or falling waveform
Status muting
Status response time: 400 ms, nominal, with audible data
TTL compatible input standard (+5 VDC switched by external contacts)

Aural Alarms

Control and Remote Terminals, defeatable and remoteable

Fail Safe

Complies with current FCC requirements for AM, FM and TV

Maintenance Override

Remote Terminal front panel button
Provides Remote Terminal "go home" relay closure, Control Terminal and Remote Terminal LED notification

Number of Data Interconnection Links

One

Data Transmissions

Eight bit plus parity
300 baud standard (audible)
9.4 baud telemetry with subaudible telemetry option
Two way, simultaneous via FSK

Wire Interconnections

Two wire or four wire, 600 ohm balanced
Series 3002 unconditioned data channel per Bell System Technical Reference Publication 4-0004 (FCC Part No. 260)
Nominal send level: 0 dBm, Minimum receive level: -30 dBm

Radio Interconnection

Single or duplex, internal subcarrier systems
Available on standard frequencies between 26 and 185 kHz
Nominal send level: 1.5 V p p at 2.2 k ohm
Nominal receive level: 0.25 V p p at 2.2 k ohm
Specify frequency and exact radio link when ordering

Remote Terminal Connectors

Terminal strip connectors for status telemetry inputs, common outputs

Operating Temperature Range

0 - 50 C

Power Requirements

120/240 VAC, 50/60 Hz, 30 W typ cal (per terminal)

Physical Size

Control Terminal: 17.8 cm H x 48.3 cm W x 21.6 cm D (7"H x 19"W x 8.5"D), depth less connectors
Remote Terminal: 17.8 cm H x 48.3 cm W x 22.9 cm D (7"H x 19"W x 9"D), depth less connectors

OPTIONS

CRT Terminal

ADDS Viewpoint terminal with full keyboard and 12 inch CRT
15 foot cable and software
1200 baud (120 character/second)
Installs at Control Terminal
User programmable text stored in available memory

Automatic Logging

Requires installation of Model B50 printer
15 foot cable, interface to AUX port of CRT terminal at Control Terminal
1200 baud (120 character/second)
User programmable character file to be stored in available memory
(total of non-volatile memory)
Available only if CRT is also present
Will not operate with CRT Modem Option

Subcarrier and Subaudible

26, 39, 41, 67, 92, 94, 110, 152, 185 kHz available
May be purchased in combination with Telex Modem Option

CRT Modem Option

Extends CRT Option to remote location over dial up phone lines
Modems: 15 foot cables
1200 baud
Connects Control Terminal and CRT Modem to remote location, auto answer, auto dial
Will not operate with Telex Modem Option

Specifications subject to change without notice

Printed in U.S.A. 1987

Moseley
Associates
Incorporated

111 Castilian Drive
Santa Barbara, CA
93117-3093

a
Flow General
Company

Phone 805/968-9621
Telex 658448
Cable: MOSLEY

Microprocessor
Remote
Control

Moseley

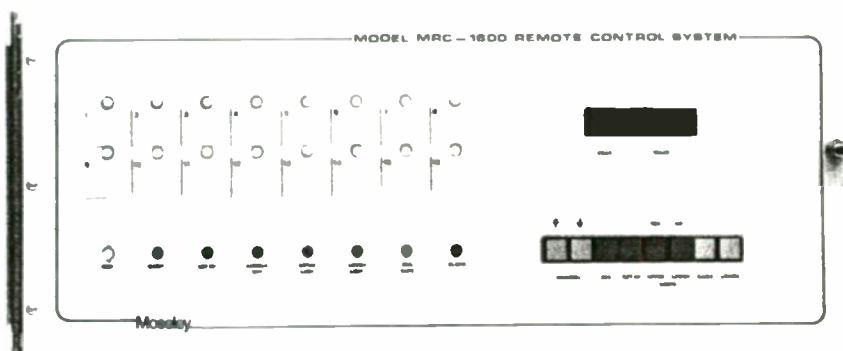

MRC-1600

Audio
Routing
Switcher

ARS-256

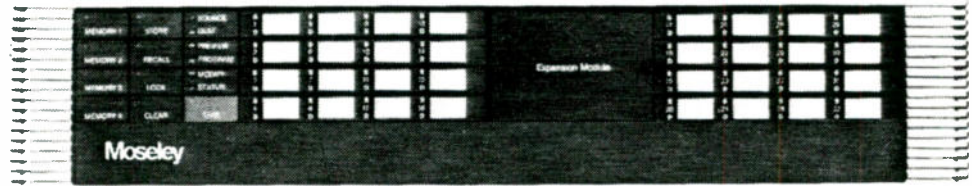

Features

- Up to 256 Crosspoints Configured in Groups of 8 Inputs/Outputs
- 4 System Memories for Preset Matrices
- Multiple-Source Summing Capability
- RS-232 Control Port
- Superior Audio Performance

Options

- X-Y Front-Panel Controller
- X-Y Desktop Wedge Controller
- X-Y Rack-Mount Controller
- VDT Controller

The ARS-256 Audio Routing Switcher is an advanced audio routing/mixing system with a highly versatile control interface. This switcher will operate with, and/or slave to, most industry standard equipment for audio-follow-video or automation directed systems.

External control is possible through a number of standard or optional ports. The standard GPI, RS-232, and RS-422 ports provide outboard control interface capabilities for signal processing and post-production requirements. Optional interfaces, for most popular routers, allow the addition of multilevel high-quality audio routing to a plant's existing switcher. Manual control panels interconnected via a party

line control system permit the ARS-256 to be accessed from as many remote locations as desired.

A single ARS-256 can contain up to 256 crosspoints in 3 rack units. Typical matrices can include 8 x 8, 16 x 8, 16 x 16, etc. in groups of eight. The system can be configured in multilevels, (i.e. stereo, SAP, time code, etc.) Units can be easily stacked and there is no limit to expansion.

All Moseley switchers are designed for maximum reliability and serviceability. Careful selection of components, multiregulated power supply and ultrareliable DIN connectors insure long term durability and maintainability.

Control

As multichannel, multilevel protocol demands grow, the bank switchable CPU controller with 96K of memory has the power to meet the most demanding interface and performance requirements.

Manual Control

The Moseley party line control system enables the use of up to 32 remote control stations. Microprocessor-control provides instantaneous communications. A "take" command is executed at the next vertical interval allowing true real time use during production or post production. Standard controllers include relegendable X-Y crosspoint-oriented switch panels. The party line system has a matrix scratch pad allowing the user to set up an entire matrix and either store it off-line or "salvo" take it to the program at any time. Four system memories are provided to store complete matrix configurations.

GPI Control

The GPI port allows communications with such external device as a real time clock,

an automation system, or an editor-synchronizer. For radio stations this means that network feeds can be switched with millisecond accuracy. Complex audio assignments can be preprogrammed and done instantly under editor control or synchronizer event control for production.

RS-232 Control

An RS-232 port provides a VDT approach to displaying and/or modifying current matrix configurations, as well as system diagnostics. All Moseley Smart Switcher systems feature a standard ASCII terminal interface, which provides the capabilities to communicate with commonly available computer terminals. The ASCII terminal interface allows you to preset the next matrix, setup and salvo the matrix at the right moment, check matrix status at any time, and change one or all of the input/output combinations individually or in groups. The RS-232 port will also allow more sophisticated software control via the use of microcomputers.

PRELIMINARY SPECIFICATIONS

Frequency Response	± 0.2 dB 10 Hz-30 kHz, <i>ref 1 kHz</i>
Crosstalk	-80 dB, 15 kHz worst-case crosstalk
Input Output Isolation	-80 dB
Common Mode Rejection	-80 dB, 50-120 Hz
Signal-to-Noise Ratio	-100 dB re. +24 dBu
THD	<.01% 20 Hz-20 kHz re. max input < 01% 20 Hz-20 kHz re +8 dBu* op. level
IMD (SMPTE)	<.005% re. max. input
Maximum Input Level	+28 dBu* balanced or unbalanced
Maximum Output Level	+24 dBu* balanced
Channel Gain/Loss	± 3 dB adjustable
Input Impedance	>20 k ohm
Output Impedance	<100 ohms balanced
Minimum Load Impedance	600 ohms
Dimensions	5 25" (13.3 cm) H \times 19" (48.3 cm) W \times 18" (45.7 cm) D
Gross Weight	45 lbs (20.5 kg)
Power Requirements	150 watts *0 dBu = 775 volts

Specifications subject to change without notice
Printed in USA 3:87

MOSELEY FINANCING PROGRAM

Moseley provides you with the financial vehicle to acquire the equipment your business needs today. Our Finance/Leasing program allows you to conserve working capital and leave existing lines of credit undisturbed. Financing affords your operation the opportunity to acquire needed equipment and provides other features as well:

Overcomes capital budget restrictions

Establishes a new credit source

Provides 100% financing

Allows for flexible terms of purchase to 60 months

Only one month's advance payment required

Minimum purchase \$10,000

The terms of the program require participation in our extended maintenance service program after the normal warranty period has ended. The monthly payment will include a pro rata portion of the service program.

The table below reflects payment information for the current rate effective June 1987.

\$10,000 Purchase	3 yrs (36 mo)	4 yrs (48 mo)	5 yrs (60 mo)
Lease Payment/mo.	@\$ 341.78	@\$ 273.26	@\$ 232.68
Extended Maintenance Service/mo.	5.55	8.33	10.00
Total Payment/mo.	347.33	281.59	242.68

Submit CREDIT APPLICATION to Qualify.

After all requested information on the Credit Application has been submitted, notification of approval will follow in no longer than five working days.



Moseley
Associates
Incorporated

111 Castilian Drive
Santa Barbara, CA
93117-3093

a
Flow General
Company

Phone 805 968 9621
Telex 658448
Cable: MOSELEY

SPECIFICATIONS

SYSTEM

Frequency Deviation For Rated Specifications	CL-100 Data CL-100 Voice	± 1 kHz ± 3 kHz
Frequency Response	CL-100 Data CL-100 Voice	± 3 dB, 20 Hz to 3200 Hz (-10 dB @ 3825 Hz) ± 3 dB, 20 Hz to 3000 Hz
Harmonic Distortion	CL-100 Data CL-100 Voice	2% nominal 5% nominal
Signal-to-Noise Ratio	CL-100 Data CL-100 Voice	Better than 45 dB @ 60 μ V (-71.2 dBm) Better than 12 dB SINAD @ 0.5 μ V (112.9 dBm) Better than 20 dB SINAD @ 1 μ V (-106.9 dBm)
Carrier Frequencies		FCC Group P (CL-100 Data) N2 and 450-512 MHz, specify exact operating frequency
Channel Spacing	CL-100 Data CL-100 Voice	USA: 10 kHz, 12.5 kHz; International: 20 kHz 20 kHz; 25 kHz

TRANSMITTER

FCC Type Approval		Parts 21, 74 and 90
Emission	1.5 kHz Deviation:	9K0F3E, 9K0FID
Designators	5 kHz Deviation:	16K0F3E, 16K0FID
Type		Direct FM (VCXO)
Frequency Range		450 MHz-470 MHz 470 MHz-512 MHz (crystal select operating frequencies)
Frequency Stability		0.00025% after 2 minutes
Input Levels	Line Microphone	-16 dBm to $+7$ dBm, adjustable -60 dBm, adjustable
Input Impedance	Line Microphone	600 ohm balanced High Z
Input Connectors		Terminal Strip plus microphone input
Metering		Bar graph peak modulation indicator
Indicators		RF LED, Power on LED (on modulation indicator)
RF Output		1-Watt nominal, Type N connector, 10-Watt option available (factory installed)
RF Output Impedance		50 ohms
Spurious Output		Better than 60 dB below carrier at transmitter output
Keying		Rear panel RF carrier keying
Temperature Range	Specifications Operating	-30° to $+50^{\circ}$ C -30° to $+70^{\circ}$ C
Power Requirements	Line Battery	120/220 VAC, 50/60 Hz, 30 watts (60 watts with 10 watt RFA) 13.6 V, 1.5 amps nominal (3.5 amps with 10 watt RFA)
Dimensions	1-Watt 10-Watt	8.9 cm (3.5") H \times 48.3 cm (19") W \times 35.6 cm (14") D 8.9 cm (3.5") H \times 48.3 cm (19") W \times 40.6 cm (16") D
Net Weight	1-Watt 10-Watt	9 kg. (19 lbs.) 10 kg. (21 lbs.)

RECEIVER

Type		Single-conversion Superheterodyne
Frequency Range		450 MHz-512 MHz (crystal select operating frequency)
RF Input Connector		Female Type N
RF Input Impedance		50 ohms
Sensitivity	CL-100 Data CL-100 Voice	45 dB SNR @ 60 μ V (-71.2 dBm) 12 dB SINAD @ 0.5 μ V (112.9 dBm) 20 dB SINAD @ 1 μ V (-106.9 dBm)
Selectivity	CL-100 Data CL-100 Voice	-3 dB bandwidth: ± 3 kHz or greater, -40 dB bandwidth: ± 12 kHz or less; down approx 30 dB at adjacent Group P carrier (± 10 kHz) -3 dB bandwidth: ± 6 kHz or greater; -80 dB bandwidth: ± 20 kHz or less
Line Outputs		0 dB nominal, -16 dBm to $+7$ dBm adjustable, balanced 600 ohm
Output Connectors		Terminal strip
Line Output Monitor		Front-panel speaker (level adjustable). Connections for external speaker available on terminal strip
Received Signal Level LED		Carrier-operated, adjustable; normally green SNR above 25 dB Open-collector output on rear for hot standby/remote control use
Temperature Range	Specifications Operating	0° C to $+50^{\circ}$ C -20° C to $+70^{\circ}$ C
Power Requirements		120/220 VAC, 50/60 Hz, 15 watts nominal
Dimensions		8.9 cm (3.5") H \times 48.3 cm (19.4") W \times 35.6 cm (14") D
Net Weight		8 kg. (17 lbs.)

Specifications subject to change without notice.
Printed in U.S.A. 2/87



Moseley
Associates
Incorporated

111 Castilian Drive
Santa Barbara, CA
93117-3093

a
Flow General
Company

Phone 805 968 9621
Telex 658448
Cable: MOSELEY



CL-100

Features:

- Telemetry or Voice Transmission
- Superior Adjacent Channel Rejection
- AC/DC Operation
- 1-Watt or 10-Watt Options
- Data and Voice Versions

Options

- Microphone (hand-held) with push-to-talk cutting data circuit.
- I.D. with station license in code, separate power-fail message.
- 10-Watt Transmitter output.

CL-100 System

The CL-100 Communications Link gives the broadcaster an alternative to subcarriers and telephone lines for conveying control and telemetry data between the studio and transmitter locations.

CL-100 systems provide the broadcaster with independent control and telemetry circuits, while freeing the STL or program subcarrier channels for other uses. CL-100 system data transmission is extremely reliable, even over a path length of 50 miles (line of sight).

The CL-100 comes in Data and Voice versions. The Data version has increased audio bandwidth and controlled group delay characteristics to allow 9600 baud data rates. In highly congested RF environments, the improved selectivity and sensitivity of the Voice version can be used, providing data rates up to 4800 baud.

The CL-100 system consists of a 1-Watt or 10-Watt Transmitter and companion Receiver in the 450-512 MHz range and is type-accepted for use under parts 21, 74, and 90 by the FCC. Audio inputs are provided on the Transmitter rear panel, with a microphone input for voice communication on the front panel. The CL-100 Receiver is supplied with audio outputs and internal or external speaker drive.

An optional MCW Identifier for Transmitter identification and power-fail identification and optional provision for external transmitter battery for operation during power failure are available. When both are used, the ID module identifies the Transmitter continuously, providing power failure indication. Antennas, transmission line, isocouplers and connector kits are available to complete a CL-100 installation.

Moseley

Moseley
Associates
Incorporated

111 Castilian Drive
Santa Barbara, CA
93117-3093

a
Flow General
Company

Phone 805 968 9621
Telex 658448
Cable: MOSELEY

SOLID-STATE **AURAL** STUDIO-TRANSMITTER LINK **MODEL PCL-404**

FOR 890 — 960 MHz



BULLETIN 232



PCL-404 RECEIVER



PCL-404 TRANSMITTER

featuring

- **direct frequency modulation**
- **all solid-state circuitry**
- **serviceable construction**
- **outstanding performance**
- **5 watts RF output**

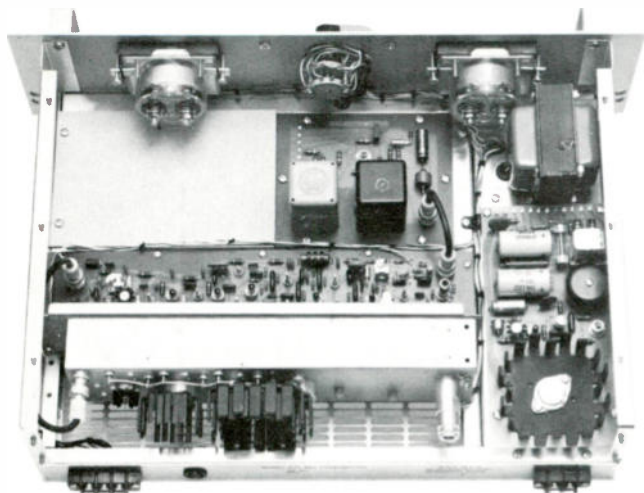

Top view of PCL-404 Transmitter with top and rear covers removed. Note easy access to components and brass subchassis for high-level RF circuits. Glass epoxy-base material is used for printed circuits.

High-quality audio performance and increased savings characterize the Moseley Associates, Inc., Model PCL-404 Aural Studio-Transmitter Link. All solid-state circuitry and advanced techniques enable excellent performance of the PCL-404. Pre-emphasis and de-emphasis are not standard in the PCL-404, making this STL particularly well-suited to AM applications.

Following in the footsteps and complementing the current Moseley Associates PCL-303 and PCL-303/C Aural STL equipment, the PCL-404 offers reliable performance with a modest investment. The PCL-404 is a thrifty STL for any broadcaster wanting long-term savings that result from the elimination of telephone line rental charges. Possessing subcarrier capabilities, the PCL-404 may be used in conjunction with Moseley Associates Wireless Remote Control Systems, resulting in further savings.

AM Wireless Remote Control is easily accomplished with the PCL-404 STL and the Moseley Associates Model RRC-10T or Model PBR-30AR Remote Control Systems. Working as companion systems, the PCL-404 provides an excellent program feed and the Moseley Remote Control Systems enable accurate metering and control of an AM broadcast transmitter. ... all without the use of leased telephone circuits! FM broadcasters, of course, may also enjoy total wireless remote control. Contact our Marketing Department for quotations on complete STL and remote control systems to fulfill your requirements.

FOR AM-FM-TV-INTERCITY SERVICE

MOSELEY ASSOCIATES, INC.

PROFESSIONAL PRODUCTS FOR PROFITABLE BROADCASTING

MODEL PCL-404 AURAL STUDIO-TRANSMITTER LINK

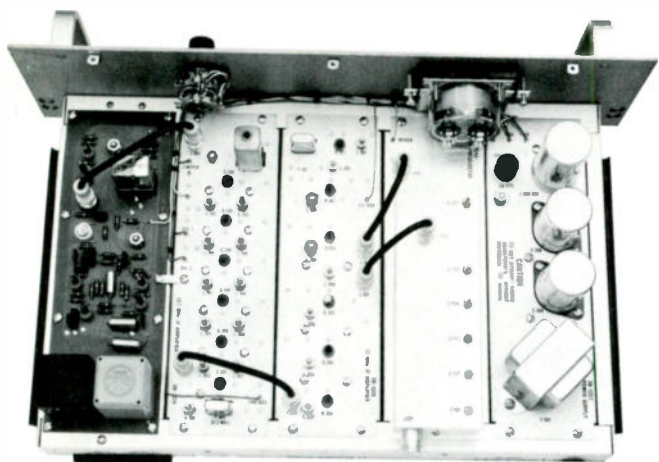

Top view of PCL-404 Receiver, covers removed. Modular-type construction is used in PCL-404 Transmitter and Receiver. Slide-out rack rail mounting allows quick access and removal.

Direct frequency modulation of the PCL-404 Transmitter assures flatter frequency response over a wider range with uniformly low distortion. Excellent carrier stability is accomplished through the use of a voltage-controlled crystal oscillator (VCXO). Modulation occurs in the VCXO through the use of variable capacitance (varicap) diodes. Low-pass elliptical audio filters in the transmitter and receiver remove extraneous signals. A series of RF multipliers amplifies the VCXO output to approximately 10 watts at 315 MHz. The 315 MHz signal is applied to a varactor diode stage which triples this signal to the desired output frequency. A highly selective three-section filter precedes the RF output connector of the transmitter to assure a sinusoidal RF output waveform. Metering of relative RF output and a multimeter for monitoring important operating parameters are provided on the PCL-404 Transmitter.

The PCL-404 Receiver is a superheterodyne design employing double-conversion. A five-cavity preselector rejects signals at the image frequency and precedes the first mixer (Schottky barrier-type). This mixer is a low-noise, diode-type mixer. The first I.F. amplifier utilizes three stages operating at 72 MHz with field-effect transistors (FET) and automatic gain control (AGC). Four stages and a 10-pole filter provide excellent selectivity in the second I.F. amplifier operating at 10.7 MHz. Low-distortion to high-frequency modulation components are insured by this design. A limiter follows this I.F. amplifier and drives the ratio detector. The audio stage provides a +10 dbm output into 600 ohms from the PCL-404 Receiver.

specifications

system

Frequency Response	±1 db, 30 Hz to 15,000 Hz
Distortion	Less than 0.8% from 50 Hz to 15,000 Hz
Signal-to-Noise Ratio	Better than 66 db below 100% modulation, unweighted. Better than 66 db below 100% modulation with optional weighting.
Modulation Capability	One program channel and multiplex subcarrier channels.
Primary Power Source	120/240 VAC, ±10%, 50-60 Hz

transmitter

Type	Direct FM of voltage-controlled crystal oscillator (VCXO).
RF Output	6.5 watts maximum; 5 watts minimum into nominal 50 ohm load — Type N female connector. Mates with UG-21/BU.
Frequency Stability	Better than 0.001% (−10° C to +55° C).
AM Noise Deviation	Better than 70 db below carrier reference. ±40 kHz for 100% modulation.
Spurious Emissions	More than 68 db below carrier.
Audio Input	600 ohms balanced, +10 dbm for 100% modulation.
Multiplex Input	10,000 ohms, unbalanced, 1.5 V p-p nominal.
Solid-State Devices	All silicon: 14 transistors (JEDEC registered), 11 diodes, 3 varicaps, 1 integrated circuit, 1 varactor.
Power Supply	Fully regulated, self-contained.
Cooling	Convection
Operating Temperature Range	−10° C to +55° C.
Dimensions	5 1/4" high x 19" wide x 13" deep.

receiver

Type	Superheterodyne, double-conversion and crystal-controlled.
Antenna Input	Nominal 50 ohm impedance, Type N female connector. Mates with UG-21/BU.
Sensitivity	SNR Weighted Unweighted
	20 db 1.5 μV 3 μV
	60 db 35 μV 55 μV
Selectivity	200 kHz @ −6 db; 450 kHz @ −60 db.
Audio Output	600 ohms balanced, +10 dbm.
Multiplex Outputs	600 ohms unbalanced, 1.8 V p-p nominal.
Solid-State Services	All silicon: 19 diodes, 19 JEDEC registered transistors (18 bi-polar, 3 FET), 1 integrated circuit.
Power Supply	Zener regulated, self-contained.
Dimensions	5 1/4" high x 19" wide x 12" deep.
Operating Temperature Range	−10° C to +55° C.



MOSELEY ASSOCIATES, INC.
SANTA BARBARA RESEARCH PARK

111 CASTILIAN DRIVE
GOLETA, CALIFORNIA 93017
(805) 968-9621

Remote Control System

MODEL PBR-15A

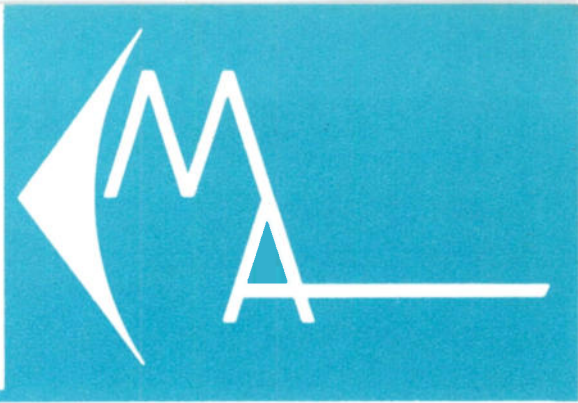

BULLETIN 235

15 METERING CHANNELS
30 INDIVIDUAL CONTROL FUNCTIONS

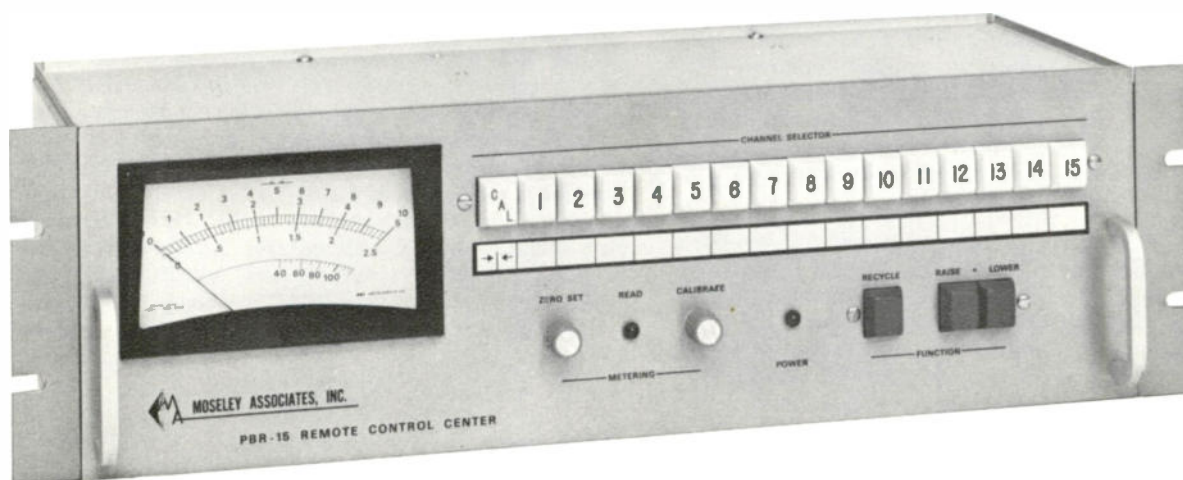

**FOR WIRE OR WIRELESS
OPERATION IN BROADCAST
AND INDUSTRIAL APPLICATIONS**

MOSELEY ASSOCIATES, INC.

MODEL PBR-15A for Wire a

DESCRIPTION

With 15 metering channels and 30 individual control functions, the all SOLID-STATE Model PBR-15A Remote Control System has sufficient versatility to fulfill current requirements and future needs. Flexibility and adaptability are easily obtained with the PBR-15A. Two separate wire versions and one wireless version are selected by plug-in printed circuit modules. These three versions are the Models PBR-15AD, PBR-15AW, and PBR-15AR. A single DC telephone line is required for operation of the PBR-15AD. The only interconnection requirement of the PBR-15AW is any duplex, voice-grade circuit. True wireless remote control can be accomplished with the PBR-15AR. Control subcarrier equipment is standard in this version for multiplexing control information on a Moseley Aural Studio-Transmitter Link. Field conversion to any of these configurations is possible without rewiring . . . simply plug in the appropriate modules.

The circuitry of the PBR-15A is of modular construction, using carefully chosen combinations of integrated circuits and discrete components. Only one stepper relay, located in the Transmitter Unit, is used. Binary numbers generated by the front-panel push-button assembly of the Studio Unit are encoded to command the actual stepper relay position. As no stepper relay is used in the Studio Unit, it is virtually noiseless.

Several features of the PBR-15A are of special interest. Channel selection is simplified by the use of push buttons on the Studio Unit. Optional external meters for display of any selected channel are simply connected to the appropriate barrier terminals. One external meter may be driven from each of the 15 channels, allowing use of up to 15 external meters. Long-life, light-emitting diodes (LED) are used as visual indicating devices on the PBR-15A. The Transmitter Unit contains an LED indicator which is illuminated when the LOCAL button is depressed. This indicator signifies that control from the Studio Unit has been overridden. Auxiliary power supply voltages are available from the rear apron of the Transmitter Unit to power Moseley telemetry accessories.

Unique cabinetry gives full access to all circuitry in the PBR-15A. Front panels of both the Studio Unit and Transmitter Unit simply pull out and fold down. This pull-out, fold-down concept provides full and complete access to the interior of both units. Front-panel handles simplify this operation. Full-width printed circuit mother boards containing the plug-in modular circuitry are directly exposed in the open position. Applicable integrated circuits and transistors are socket-mounted.

In the communications field, the PBR-15A is ideal for the remote control and monitoring of drilling sites, pipeline pump stations, utility substations, municipal water systems, two-way radio base stations, environmental systems, and specialized industrial applications. Only one duplex, voice-frequency radio or wire channel is required for proper operation. Accurate remote controlling and monitoring of such things as temperature, pressure, flow rates, circuit breakers, starting or stopping motors, building security, and other control or verification functions are possible.

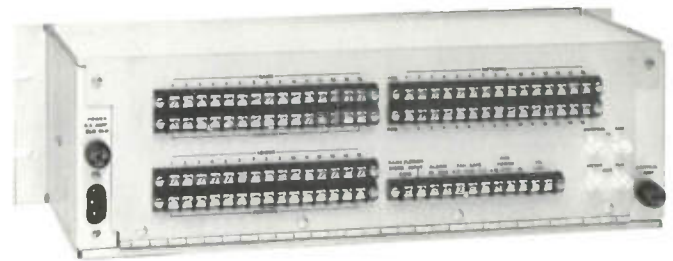

Rear view, Transmitter Unit. Individual terminals for all inputs and outputs are provided for ease of installation. Rear panel hinges open for even greater access.

CONTROL

Fail-safe provisions in the PBR-15A meet all existing FCC requirements and will function with the loss of primary power, interconnecting circuit failure, or an actual malfunction of the equipment itself. The actual fail-safe detector in the Transmitter Unit senses the presence of an audio tone between 335 Hz and 460 Hz. An interruption of approximately 15 seconds will trip the fail-safe circuitry. A carrier of 415 Hz is generated in the Studio Unit as long as power is applied. This 415 Hz carrier maintains fail-safe integrity. For actual control functions, this carrier is frequency-shift keyed (FSK). To advance the stepper relay in the Transmitter Unit, the carrier is keyed to 460 Hz. The number of 460 Hz pulses generated in the Studio Unit signifies the number of positions the stepper is advanced. Two functions, designated RAISE and LOWER, can be performed on each channel selected. In the case of the RAISE function, the carrier is shifted to 375 Hz. For the LOWER function, the carrier is shifted in frequency to 335 Hz. While performing a RAISE or LOWER control function, a parameter can be monitored simultaneously. As frequency shift to 460 Hz is preferential, RAISE and LOWER functions cannot be activated while the stepper relay is advancing.

TELEMETRY

Telemetry is accomplished by one of two different possible techniques. The first approach utilizes the DC continuity of a telephone circuit to obtain a meter deflection at the control point. The second approach is conversion of the DC sample voltages to an audio tone in the Transmitter Unit. This signal is then relayed to the Studio Unit and converted back to a DC voltage proportional to the input sample voltage for display on the 4-inch taut-band, panel-mounted meter. Either of two audio spectrums may be used for conveying this information. These spectrums are 20 Hz to 30 Hz, or 800 Hz to 1200 Hz. Multiturn calibration controls for each channel are provided on the Transmitter Unit for ease of calibration.

nd Wireless Remote Control

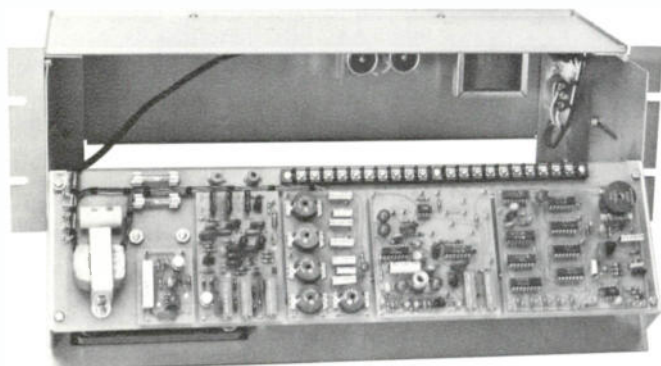

Front view, panel open, Studio Unit. Full access to both units is gained by simply pulling out the front panel and folding it over.

FRONT PANEL ACCESSIBILITY



PULL-OUT



FOLD-DOWN

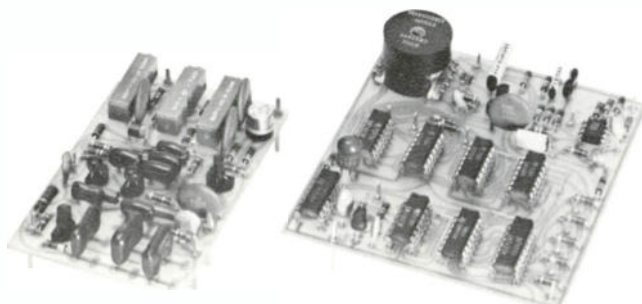
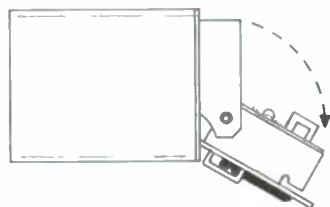

Plug-in printed circuit modules, as shown above, enable field conversion of the PBR-15A to meet future needs.

THREE VERSIONS

Three basic versions of the PBR-15A are available: the PBR-15AD, PBR-15AW, and PBR-15AR. With plug-in modules, field conversion between these configurations is possible.

PBR-15AD

The PBR-15AD is designed for operation over a single two-wire telephone circuit possessing DC continuity with limited audio-response capability. DC continuity provides the path for telemetry return. With DC sample voltages of 2V DC or above, a loop resistance of up to 25,000 ohms will enable a full-scale meter deflection. Audio response between 335 Hz and 460 Hz is required for the FSK control tone. Attenuation in the 335 Hz to 460 Hz spectrum should not exceed 30 dB.

PBR-15AW

Only a full-duplex, voice-grade circuit is necessary for operation of the PBR-15AW. DC continuity is not required. Telemetry is accomplished with an audio tone in the 800 Hz to 1200 Hz spectrum. With the control FSK signal, overall spectrum requirements are 335 Hz to 1200 Hz. The interconnecting circuit should not attenuate this spectrum by more than 30 dB.

PBR-15AR

For wireless service, the PBR-15AR is designed to mate with Moseley aural STL equipment. Control information is transmitted to the Transmitter Unit on a subcarrier multiplexed on the STL. Included in the PBR-15AR are a control subcarrier generator and detector. A 26 kHz control subcarrier is used for monaural STL systems, and for the Model PCL-303/C Composite stereo STL system, a 110 kHz subcarrier is utilized. Telemetry information is subaudible, 20 Hz to 30 Hz. The return path for the telemetry information can be an SCA channel of an FM transmitter, AM carrier, or other radio circuit capable of handling 20 Hz to 30 Hz. An internal telemetry SCA subcarrier generator for conveying only the metering information is available as an option in the PBR-15AR.

Audible telemetry information, as described for the PBR-15AW, is available on special order for voice-radio circuits.

Contact the Marketing Department of Moseley Associates for information on special versions to fulfill individual requirements. Block diagrams of the PBR-15AD, PBR-15AW, and PBR-15AR are available on request.

Model PBR-15A Remote Control System

OPTIONS

ALARM

With a response time under 0.5 second, the optional Alarm Modules for the PBR-15A enable an almost instantaneous alarm indication at the remote control point. Unauthorized entry, high and low temperatures, and emergency generator operation are just some of the possible alarm functions. As this option consists of plug-in printed circuit modules housed within the PBR-15A, it may be added at any time. The Alarm Generator located in the Transmitter Unit is encoded by opening a set of normally closed dry contacts. Any reasonable number of contact sets may be placed in series. When any one of these contacts is opened, the Alarm Generator applies a 2100 Hz tone to the telemetry return circuit. The telemetry return path must not attenuate this 2100 Hz signal by more than 30 dB. The Alarm Detector located in the Studio Unit contains a relay which is activated upon receipt of the 2100 Hz signal. This relay

provides a set of Form C contacts for energizing external alarm indicators such as lamps, bells, or buzzers.

TELEMETRY SUBCARRIER (SCA) GENERATOR

Where an FM subcarrier is to be utilized for telemetry return, the Telemetry Subcarrier (SCA) Generator is available with the PBR-15A. This generator is mounted internally in the Transmitter Unit. The normal operating frequency of this generator is 67 kHz, but other frequencies from 26 kHz to 100 kHz are available on special order.

SAMPLING KITS

Other optional telemetry accessories include a linear-readout temperature sensing kit, AM and FM RF diode sampling kits, chopper-stabilized DC amplifier, and many more. Request Bulletin 217 for further information on these telemetry and remote control accessories.

SPECIFICATIONS

Metering Functions	_____ 15 telemetry channels, plus calibration
Control Functions	_____ 15 RAISE, 15 LOWER (30 total)
Control Output	_____ Momentary contact closure or redistribution of externally-supplied control voltage up to 120V AC or DC. Maximum load 50 watts non-inductive.
Meter	_____ 1, taut-band with carefully controlled ballistics, 100 microamperes F.S. Provisions for 15 external meters.
Metering Stability	_____ Better than 1% with weekly checks
Metering Accuracy	_____ 2% or better of full scale
Telemetry Input Requirements	_____ + or - 1V to 10V DC for full-scale deflection. With PBR-15AD, 2V DC for full-scale deflection with 25,000 ohm loop resistance (1V DC with 12,500 ohm loop resistance). All inputs fully isolated from ground. Maximum 350V potential to ground. Input impedance 20,000 ohms.
Telemetry Frequencies	
Audible	_____ 800 - 1200 Hz
Subaudible	_____ 20 - 30 Hz
Alarm (Optional)	_____ 2100 Hz
Control Frequencies	_____ Stepper Control — 460 Hz Fail-safe — 415 Hz On/Raise — 375 Hz Off/Lower — 335 Hz
Interconnection Requirements	
PBR-15AD	_____ Single telephone pair, DC continuity, loop resistance not to exceed 25,000 ohms with 2V DC telemetry input. Response from 335 Hz to 460 Hz (335 Hz to 2100 Hz with alarm option), 30 dB maximum attenuation.
PBR-15AW	_____ Voice-grade, data-channel telephone circuit (Interstate FCC Tariff 260, type 3002 channel), 600 ohms, 30 dB allowable loss from 335 Hz to 1200 Hz (335 Hz to 2100 Hz with alarm option). DC continuity not required.

PBR-15AR	
Control Circuit	_____ Control subcarrier generator and detector provided internally.
	Studio Unit Output and Transmitter Unit Input: 0.5V rms, 2,000 ohms, nominal, unbalanced. Nominal subcarrier operating frequencies 26 kHz or 110 kHz.
Telemetry Circuit	_____ Telemetry return path capable of handling 20-30 Hz (20 Hz to 2100 Hz with alarm option).
	Transmitter Unit Output: -0 dBm, 500 ohms, unbalanced.
	Studio Unit Input: -0 dBm, bridging, unbalanced.
Optional Telemetry Subcarrier (SCA) Generator	_____ 26 kHz to 100 kHz, internally mounted, 0.5V rms, 2,000 ohms, unbalanced, nominal
Operating Temperature Range	_____ -10°F to 140°F
Power Requirements	_____ 120/240 VAC, ±10%, 50-60 Hz
	Studio Unit: 15 watts, nominal
	Transmitter Unit: 25 watts, nominal
Size	
Studio Unit	_____ 5¼" H x 19" W x 6½" D
Transmitter Unit	_____ 5¼" H x 19" W x 10½" D
Shipping Information	_____ 30 lbs., 1.9 cu. ft. (approx.)
Alarm Option	
Input	_____ External normally closed dry contacts, single input, open to alarm. External contacts in any reasonable number may be connected in series.
Output	_____ Form C relay contacts, maximum load 50 watts, non-inductive.
Response Time	_____ 400 milliseconds, nominal

Specifications subject to change without notice.



MOSELEY ASSOCIATES, INC.
SANTA BARBARA RESEARCH PARK

111 CASTILIAN DRIVE
GOLETA, CALIFORNIA 93017
(805) 968-9621

Remote Control System

MODEL TRC-15A



BULLETIN 239A

15 METERING CHANNELS
30 INDIVIDUAL CONTROL FUNCTIONS



FOR WIRE OR WIRELESS OPERATION

MOSELEY ASSOCIATES, INC.

MODEL TRC-15A for Wire and

DESCRIPTION

With 15 metering channels and 30 individual control functions, the all SOLID-STATE Model TRC-15A Remote Control System has sufficient versatility to fulfill current requirements and future needs. Flexibility and adaptability are easily obtained with the TRC-15A. Two versions of the TRC-15A Remote Control System are available. These are Models TRC-15AW and TRC-15AR. The only interconnection requirement of the TRC-15AW is any duplex, voice-grade circuit. True wireless remote control can be accomplished with the TRC-15AR. Control subcarrier equipment is standard in this version for multiplexing control information on a Moseley Aural Studio-Transmitter Link. Field conversion to either configuration is possible without rewiring . . . simply exchange the appropriate modules.

The circuitry of the TRC-15A is of **modular construction**, using carefully chosen combinations of integrated circuits and discrete components. The system is noiseless in operation . . . employing no stepper relay. Binary numbers generated by the front-panel push-button assembly of the Studio Unit are encoded to command channel selection. The use of **individual relays** in the Transmitter Unit makes system operation noiseless.

Unique cabinetry provides full access to all circuitry in the TRC-15A. All active circuitry in the Studio Unit is housed in a slide-out drawer assembly. A similar slide-out drawer and swing-away door are used in the Transmitter Unit. See the photographs to the right. Front-panel pulls simplify access. All applicable solid-state devices are socketed.

Several features of the TRC-15A are of special interest. Channel selection is simplified by the use of push buttons on the Studio Unit. Optional external meters for display of any selected channel are simply connected to the appropriate barrier terminals. Four external meters may be used with the TRC-15A. Long-life, light-emitting diodes (LED) are used as visual indicating devices on the TRC-15A. Indicators are provided on the Transmitter Unit to show the selected channel. Auxiliary power supply voltages are available from the rear apron of the Transmitter Unit to power Moseley telemetry accessories.

FULL FRONT PANEL

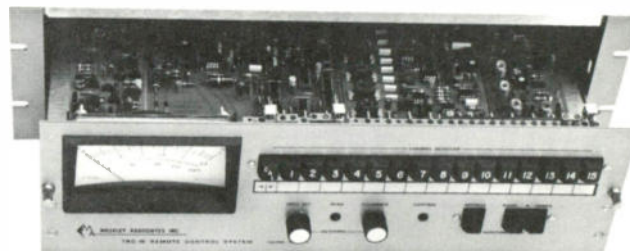

Front View, slide-out drawer partially extended, Studio Unit. Total access is afforded to active circuitry.

CONTROL

Fail-safe provisions in the TRC-15A meet all existing FCC requirements and will function with the loss of primary power, interconnecting circuit failure, or an actual malfunction of the equipment itself. The actual fail-safe detector in the Transmitter Unit senses the presence of an audio control tone carrier. An interruption of approximately 15 seconds will trip the fail-safe circuitry. This 300 Hz carrier is generated in the Studio Unit as long as power is applied and maintains fail-safe integrity. For actual control functions, this carrier is frequency-shift keyed (FSK) to approximately 375 Hz. The duration of the shift to 375 Hz determines the function to be accomplished. Channel selection is accomplished with the front-panel push button. Two functions, designated RAISE and LOWER, can be performed on each channel selected. While performing a RAISE or LOWER control function, a parameter can be monitored simultaneously. As only one shift rate can be accomplished at any point in time, RAISE and LOWER functions cannot be activated while a channel relay is being selected.

TELEMETRY

Telemetry is accomplished through the use of an additional tone. DC sample voltages representing parameters to be remotely observed are converted to an audio tone in the Transmitter Unit. This signal is then relayed to the Studio Unit and converted back to a DC voltage proportional to the input sample voltage for display on the 4-inch, taut-band, panel-mounted meter. Either of two audio spectrums may be used for conveying this information. These spectrums are 20 Hz to 30 Hz, or 800 Hz to 1200 Hz. Multiturn calibration controls for each channel are provided on the Transmitter Unit for ease of calibration.

and Wireless Remote Control

EL ACCESSIBILITY

ORDERING INFORMATION



Front View, Transmitter Unit, showing full access. Note LED channel indicators in lower-left of front panel.

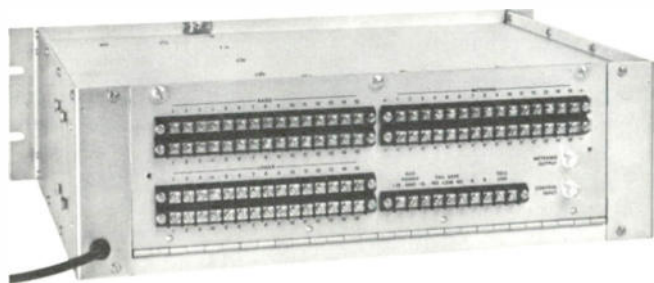

Rear View, Transmitter Unit. Individual terminals for all inputs and outputs are provided for ease of installation. Rear-panel hinges open for greater access.

NO STEPPER RELAY

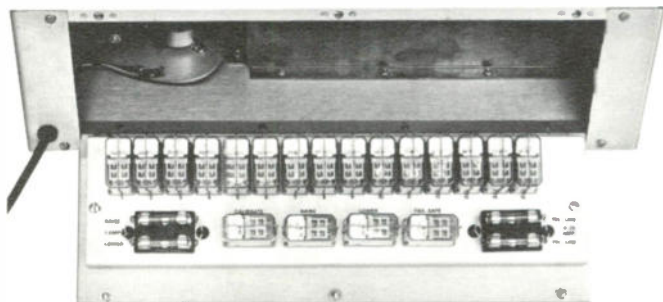

Rear panel hinged open, Transmitter Unit. With panel open, all relays are accessible. Relays are socketed for easy maintenance.

TRC-15AW

Only a half-duplex, voice-grade telephone circuit is necessary for operation of the TRC-15AW. DC continuity is not required. Telemetry is accomplished with an audio tone in the 800 Hz to 1200 Hz spectrum. With the control FSK signal, overall spectrum requirements are 300 Hz to 1200 Hz. The interconnecting circuit should not attenuate this spectrum by more than 30 dB.

TRC-15AR

For wireless service, the TRC-15AR is designed to mate with Moseley aural STL equipment. Control information is transmitted to the Transmitter Unit on a subcarrier multiplexed on the STL. Included in the TRC-15AR are a control subcarrier generator and detector. A 26 kHz control subcarrier is used for monaural STL systems, and for the Model PCL-505/C Composite stereo STL system, a 110 kHz subcarrier is utilized. Telemetry information is subaudible, 20 Hz to 30 Hz. The return path for the telemetry information can be an SCA channel of an FM transmitter, AM carrier, or other radio circuit capable of handling 20 Hz to 30 Hz.

Audible telemetry information, as described for the TRC-15AW, is available on special order for voice-radio circuits.

Contact the Marketing Department of Moseley Associates for information on special versions to fulfill individual requirements.

OPTIONS

When an FM subcarrier is to be utilized for telemetry return, the Telemetry Subcarrier (SCA) Generator is available with the TRC-15A. This generator is mounted internally in the Transmitter Unit. Likewise a Telemetry Subcarrier (SCA) Demodulator for mounting in the Studio Unit is available. See the block diagram on the rear of this bulletin for placement of these options.

ACCESSORIES

Telemetry accessories including a linear-readout temperature-sensing kit, AM and FM RF diode sampling kits, chopper-stabilized DC amplifier and more. Request Bulletin 248 for further information.

Model TRC-15A Remote Control System

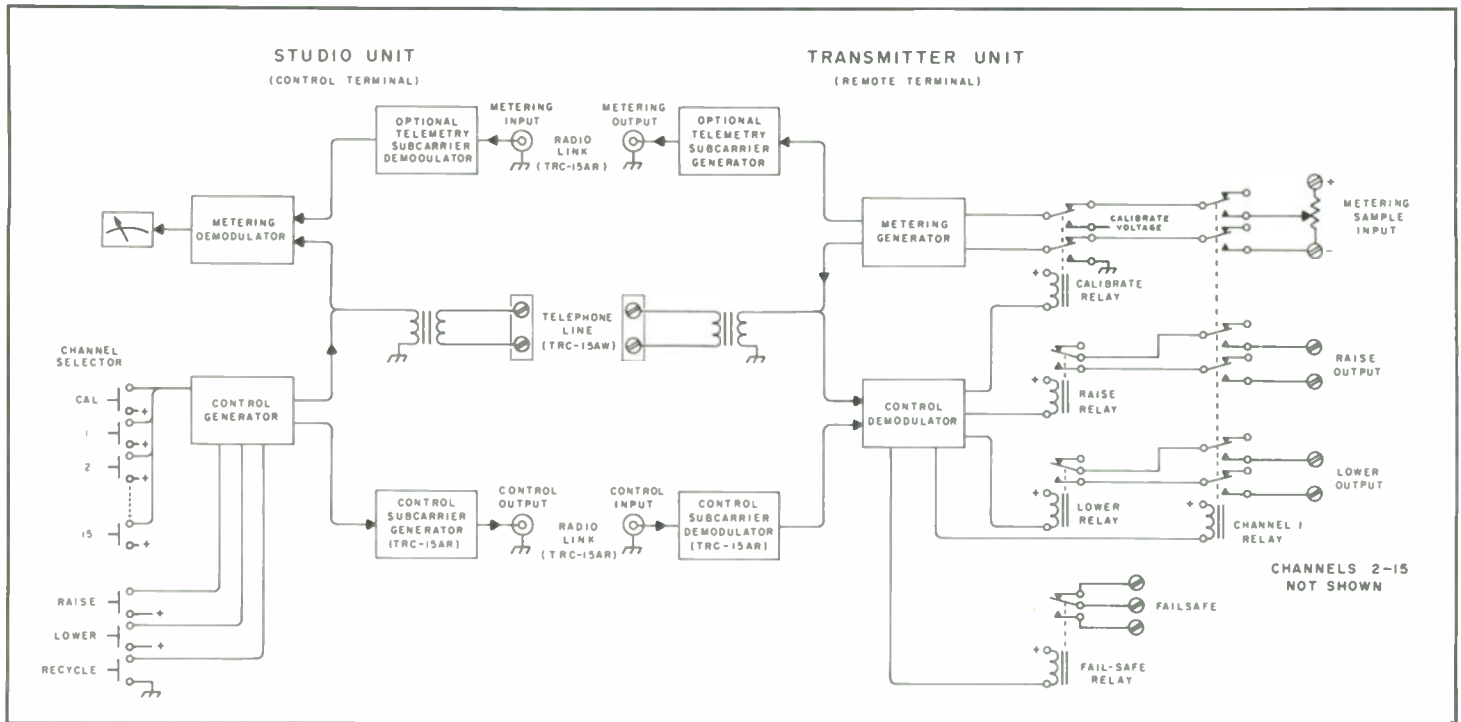

SPECIFICATIONS

- Metering Functions** _____ 15 telemetry channels, plus calibration
- Control Functions** _____ 15 RAISE, 15 LOWER (30 total)
- Control Output** _____ Momentary contact closure or redistribution of externally-supplied control voltage up to 120V AC or DC. Maximum load 50 watts non-inductive.
- Meter** _____ 1, taut-band with carefully controlled ballistics, 100 microamperes F.S. Provisions for 4 external meters.
- Metering Stability** _____ With weekly transmitter-unit checks and daily studio-unit checks, better than 1% exclusive of operator setting or reading error.
- Metering Accuracy** _____ 2% or better of full scale.
- Telemetry Input Requirements** _____ + or -1V to 10 VDC for full-scale deflection. All inputs fully isolated from ground. Maximum 350V potential to ground. Input impedance 20,000 ohms.
- Telemetry Frequencies**
- Audible _____ 800 Hz to 1200 Hz
- Subaudible _____ 20 Hz to 30 Hz
- Control Frequencies** _____ 300 Hz and 375 Hz, nominal
- Interconnection Requirements**
- TRC-15AW _____ Voice-grade, data-channel telephone circuit (Interstate FCC Tariff 260, type 3002 channel), 600 ohms, 30 dB allowable loss from 300 Hz to 1200 Hz. DC continuity not required.

TRC-15AR

- Control Circuit** _____ Control subcarrier generator and detector provided internally. Studio Unit Output and Transmitter Unit Input: 0.5V rms, 2,000 ohms, nominal, unbalanced. Nominal subcarrier operating frequencies 26 kHz to 110 kHz.
- Telemetry Circuit** _____ Telemetry return path capable of handling 20 Hz to 30 Hz.
- Transmitter Unit Output: Up to 6V P-P (adjustable) behind 600 ohms, unbalanced.
- Studio Unit Input: 1.5V P-P, bridging, unbalanced.
- Optional Telemetry Subcarrier (SCA) Generator** _____ 26 kHz to 100 kHz, internally mounted, 0.5V rms, 2,000 ohms, unbalanced, nominal.
- Operating Temperature Range** _____ 20°F (-30°C) to 160°F (70°C)
- Power Requirements** _____ 120/240 VAC, ±10%, 50-60 Hz
- Studio Unit: 20 watts, nominal
- Transmitter Unit: 20 watts, nominal
- Size**
- Studio Unit _____ 5¼"H x 19"W x 13⅝"D (133mm x 483mm x 345mm)
- Transmitter Unit _____ 5¼"H x 19"W x 13⅝"D (133mm x 483mm x 345mm)
- Shipping Weight (approx.)** _____ 65 lbs. (29.5 kg), 5.7 cubic ft. (0.16 cu.m)

Specifications subject to change without notice.



MOSELEY ASSOCIATES, INC.
SANTA BARBARA RESEARCH PARK

111 CASTILIAN DRIVE
GOLETA, CALIFORNIA 93017
(805) 968-9621
TELEX: 658448 CABLE: MOSELEY

AM MODULATION MONITOR

MODEL AMR-1



BULLETIN 234



FCC Type Approval 3-183

True Off-Air Operation

Superb Selectivity

Subaudible Telemetry

Recovery

Excellent Audio Monitor

All Solid-State Circuitry

FCC Type Approved

Removable rack mounting brackets allow versatile use of the AMR-1 AM Modulation Monitor. With brackets removed, the attractive styling of the AMR-1 lends itself to table-top or cabinet installation . . . even at home.

Created specially for off-air operation, the all solid-state Model AMR-1 AM Modulation Monitor provides an accurate display of modulation. Employing a new application of the time-proven superheterodyne technique, the AMR-1 will operate at a remote control point without an RF amplifier. A carefully chosen ceramic ladder filter yields excellent selectivity. This outstanding selectivity enables recovery of the desired signal while rejecting unwanted nearby signals. A sharp 10 kHz notch filter can be switched into audio outputs to remove any undesirable beat notes caused by an adjacent channel signal.

Large antenna arrays are not required for true off-air operation of the AMR-1. A limited-size antenna is all that is required to produce reliable operation. Instructions for a simple, easy-to-construct loop antenna which will serve adequately in most applications are included in the manual. The optional Type 2-1152 Ferrite-rod Antenna may also be used with the AMR-1.

Designed explicitly for use in totally wireless remote control applications, the AMR-1 will recover subaudible telemetry information from the AM carrier. Internal, highly selective filtering separates telemetry information from program modulation for use by a Moseley remote control system. Two separate audio outputs provide excellent off-air program monitoring. These outputs provide a high-quality audio signal for feeding studio or home speaker systems.

MOSELEY ASSOCIATES, INC.

PROFESSIONAL PRODUCTS FOR PROFITABLE BROADCASTING

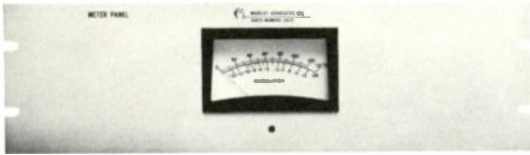

Rear view of AMR-1 with cover removed.

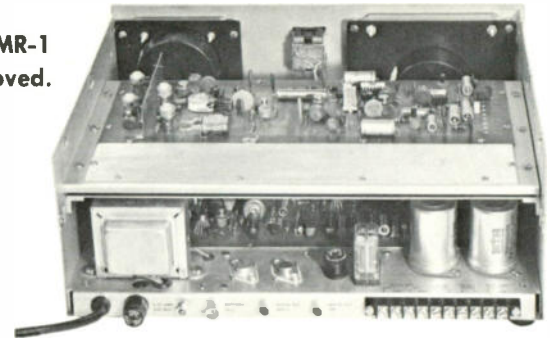

Optional EMP-1 Extension Meter Panel and rack mounting brackets

GENERAL DESCRIPTION

The superheterodyne concept employed by the AMR-1 AM Modulation Monitor provides excellent selectivity for recovery and faithful display of modulation. A field-effect transistor (FET), protected from damage by back-to-back diodes, serves as the first RF amplifier. A signal of only 3 mV at the RF input to the AMR-1 will produce an SNR of 45 dB. Integrated circuits and an additional FET are used in the I.F. amplifier and converter stages. The I.F. frequency utilized is 500 kHz, except at select frequencies where 455 kHz is employed. A ceramic ladder filter provides the basic selectivity of the monitor, making it ideal to use in the presence of nearby stations.

With a dynamic range of 20 dB, AGC circuitry overcomes normal variations in input level. The monitor sensitivity can be manually controlled or set for automatic gain operation with a front-panel control. A unique, extremely linear, active detector employing an integrated

circuit requires only a minimal input to reproduce the transmitted information. The phase and amplitude relationship between the carrier and sidebands applied to the input of the AMR-1 must be unaltered for an accurate indication of modulation.

Percentage of modulation is displayed on the large front-panel meter. The smaller front-panel meter provides an indication of the signal level presented to the AMR-1 and can be used to make carrier-shift measurements. An output enables the extension of the peak flasher. Alternatively, this output will serve as a carrier on-air indicator. Two program audio outputs provide excellent off-air audio monitoring. Additionally, a 40 Hz low-pass filter and associated amplifier circuitry provide for the recovery of a subaudible metering signal. Remote indications of modulation can be displayed on the optional EMP-1 Extension Meter Panel.

SPECIFICATIONS

FCC TYPE APPROVAL NUMBER . . .	3-183	OUTPUTS	
TYPE OF RF CIRCUITRY . . .	Superheterodyne	AUDIO . . .	600 ohms, unbalanced, 0 dBm 10,000 ohms, unbalanced, 2.5 V p-p
FREQUENCY RANGE . . .	540 kHz - 1600 kHz	SUBAUDIBLE . . .	2,000 ohms, unbalanced, 1.5 V p-p (telemetry) at 5% modulation. (40 Hz low-pass filter restricts output to normal 20-30 Hz metering information)
SENSITIVITY . . .	3 mV for 45 dB SNR	AUDIO RESPONSE . . .	20 Hz to 10 kHz ± 0.5 dB 20 Hz to 15 kHz ± 1.5 dB
OVERALL RF SELECTIVITY . . .	-6 dB at 36 kHz BW -80 dB at 45 kHz BW	HARMONIC DISTORTION . . .	Less than 1% at 100% modulation
SIGNAL-TO-NOISE RATIO . . .	55 dB at 5 mV input	OPTIONAL EXTENSION METER PANEL (Type EMP-1) . . .	Operates with external loop resistances through 680 ohms
INPUT IMPEDANCE . . .	50 ohms nominal, unbalanced	DUTY CYCLE . . .	Continuous
INPUT LEVEL . . .	Up to 1 V rms. Higher levels with external pad.	OPERATING TEMPERATURE RANGE . . .	0°C to 50°C
AGC DYNAMIC RANGE . . .	20 dB with less than 1 dB variation in output.	OVERALL DIMENSIONS . . .	5 1/4" W x 11" D x 14" W (19" W with rack mounting brackets)
MODULATION METER . . .	0 - 133% scale, with accuracy better than $\pm 2\%$ for 100% modulation. Positive or negative polarity — switchable.	POWER REQUIREMENTS . . .	120/240 VAC $\pm 10\%$, 50-60 Hz, 15w
PEAK FLASHER . . .	Calibrated in 5% steps from 50% to 100%, negative polarity.	SHIPPING INFORMATION . . .	18 lbs., 1.25 cu. ft. (approx.)

SPECIFICATIONS SUBJECT TO CHANGE WITHOUT NOTICE.



MOSELEY ASSOCIATES, INC.
SANTA BARBARA RESEARCH PARK

111 CASTILIAN DRIVE
GOLETA, CALIFORNIA 93017
(805) 968-9621

D Series Remote Control Equipment



BULLETIN 238-P

AN ALL DIGITAL SYSTEM FOR
REMOTE CONTROL
AUTOMATIC LOGGING
STATUS



MOSELEY ASSOCIATES, INC.

MODEL DCS-1 ALL DIGITAL

'D' SERIES REMOTE CONTROL EQUIPMENT

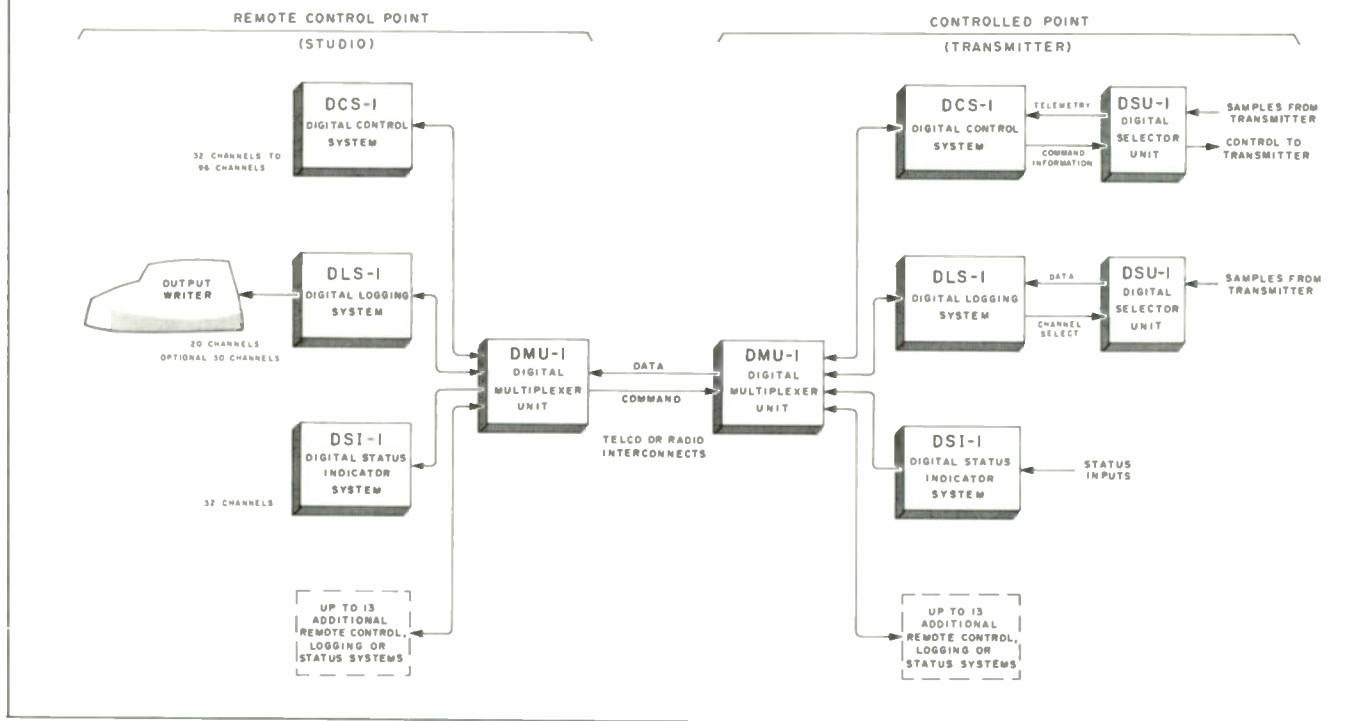

- FULLY INTEGRATED SYSTEM CONCEPT
- REMOTE CONTROL—TO 96 CHANNELS
- AUTOMATIC LOGGING—TO 30 CHANNELS
- STATUS INDICATIONS—32 CHANNELS
- UP TO 16 INDIVIDUAL SYSTEMS OPERATING SIMULTANEOUSLY OVER INTERCONNECTING CIRCUITS
- ALL READOUTS LIGHT-EMITTING DIODE (LED) TYPE
- OVERALL TELEMETRY ACCURACY—0.1 %
- EXTREMELY FAST RESPONSE TIME WITH FULL TALLY
- WIRE OR RADIO LINK OPERATION

A totally new concept for operation of a remotely located broadcast transmitter is offered by the "D" Series Remote Control Equipment. All digital techniques are used throughout the system assuring outstanding accuracy. The "D" Series design includes large-scale (LSI) and medium-scale (MSI) TTL integrated circuits. Individual systems provide remote control and telemetry, automatic parameter logging, and status indications. The Model DCS-1 Digital Control System provides remote control and telemetry; automatic parameter logging is provided by the Model DLS-1 Digital Logging System, and status indications by the Model DSI-1 Digital Status Indicator System. With this concept, operation of one system is not dependent upon another, thus providing greater flexibility and reliability. As shown in the above block diagram, the Model DMU-1 Digital Multiplexer Unit provides interface between the various systems and the interconnecting circuits. Additional systems are currently under design by our Engineering Department. One such system is an individual telemetry and command system with automatic control option. This option includes adjustable upper and lower limits for automatic parameter control.

REMOTE CONTROL SYSTEM

DCS-1 CONTROL PANEL OPERATION

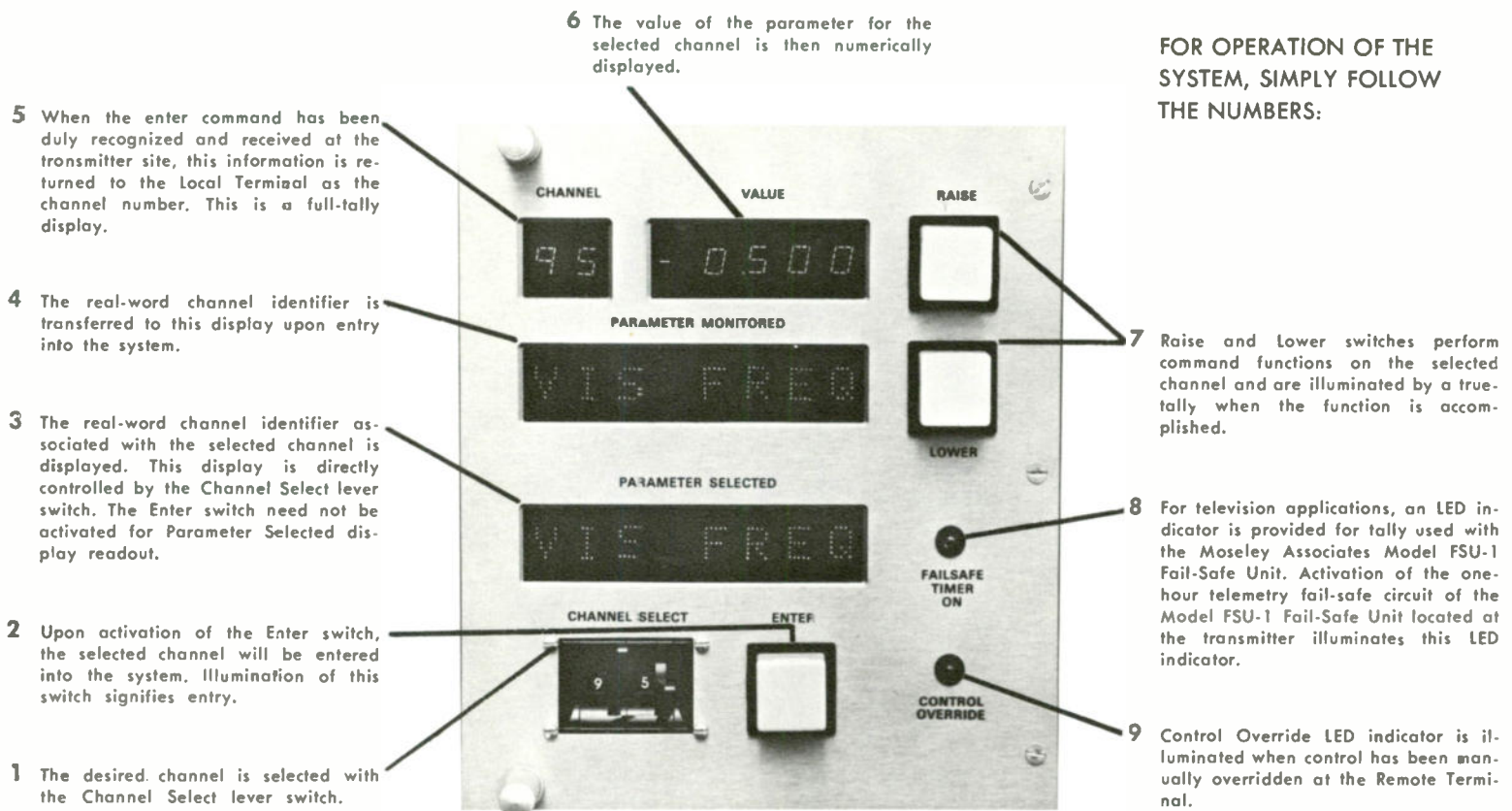

The Model DCS-1 Digital Control System provides the remote control and telemetry system of the "D" Series Remote Control Equipment. In the design of the DCS-1, special emphasis has been placed on operator convenience and fool-proof operation. Up to 96 parameters may be remotely displayed and 192 individual command functions accomplished with each DCS-1 Digital Control System. The basic system provides 32 channels (32 parameters displayed and 64 command functions). This basic system is easily expanded to 64 or 96 channels with the addition of plug-in modules. Each DCS-1 consists of a Local Terminal, Remote Terminal, and Model DSU-1 Digital Selector Unit. The Local Terminal is located at the studio or control point. The Remote Terminal and DSU-1 Digital Selector Unit(s) are positioned at the transmitter site. Each DSU-1 Digital Selector Unit contains relays for 32 channels. Field expansion of the DCS-1 is accomplished by the addition of plug-in modules within the Local Terminal and the addition of Model DSU-1 Digital Selector Unit(s).

Absolute operation of the desired function from the control point is assured by a number of features in the

DCS-1. A full tally function gives positive identification in real numbers of the remote control channel selected at the transmitter site. Parity check and double-message integrity decoding guarantee activation of the desired function.

Parameter presentation is accomplished with a full, four-digit light-emitting diode (LED) display on the Local Terminal. With the DCS-1, resolution is 0.01% with an overall accuracy from input to actual display of 0.1%. As the system is bipolar, when a negative sample is observed, a minus (-) sign is shown preceding the parameter. Decimal points can be pre-programmed for each channel allowing for readings in real units for parameters commonly associated with the operation of a remotely located broadcast transmitter. Provisions are incorporated in the DCS-1 to accept external BCD data.

The Model DCS-1 Digital Control System contains provisions allowing compliance with all current FCC fail-safe requirements. For television transmitter remote control, the Model FSU-1 Fail-Safe Unit is required for telemetry fail-safe. See Bulletin 237 for further information on the Model FSU-1 Fail-Safe Unit.

D Series Remote Control Equipment

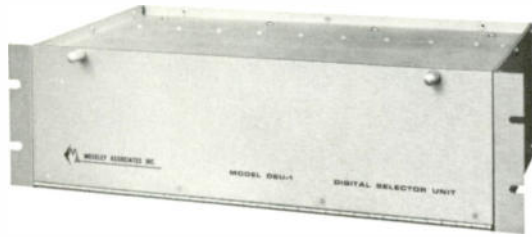

Front View, Model DSU-1 Digital Selector Unit

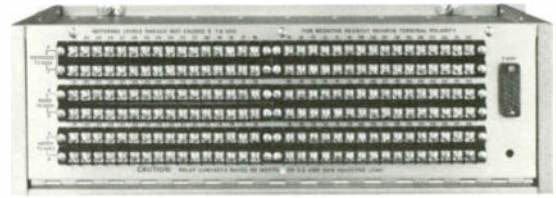

DSU-1 Digital Selector Unit — Rear View

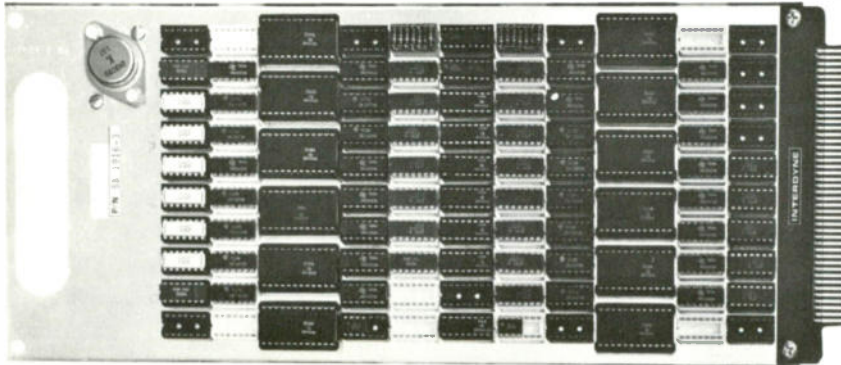

Wire-wrapped module from DCS-1 Digital Control System. These modules are accurately produced by computer-controlled wire-wrapping equipment — a type of construction actually used to produce some computers.

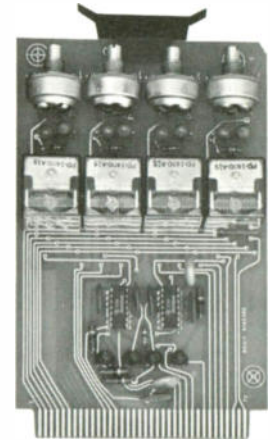

Selector Module from DSU-1. Each module accommodates four channels.

MODEL DLS-1 DIGITAL LOGGING SYSTEM

Transmitter operating parameters and other data may be automatically recorded at predetermined intervals by the Model DLS-1 Digital Logging System. The printed log appears in the familiar columnar format as with other Moseley Associates automatic logging systems with entries listed as full, four-digit numbers. When used with the companion Tolerance Alarm Unit, a parameter, when above or below predetermined limits, will be printed in red and an aural alarm sounded to alert operating personnel. Actual log entries are made by an IBM typewriter.

Overall accuracy of the system is 0.1% or better. Provisions are incorporated to enable selective muting of any channel at any time. Such muting produces an extremely efficient log format and allows for easy insertion of a standby transmitter or other intermittent-duty entries. The system may be programmed for automatic entries at any 10-minute increment within a one-hour time period. Positive or negative DC sample voltages may be used as input sources to the DLS-1. Optionally, BCD information may be fed to pre-selected channels. When used with the Digital Data Option for the Receiver Unit, BCD information from a TV frequency monitor located at the studio or control point may be recorded by the DLS-1.

MODEL DSI-1 DIGITAL STATUS INDICATOR SYSTEM

Monitoring 32 functions continuously, the Model DSI-1 Digital Status Indicator System provides reliable status as well as fault alarm indications. Light-emitting diode (LED) indicators for each channel allow for easy channel location and identification. Each channel may be pre-selected to respond to a fault only as long as that fault exists, or it may be latched and remain latched until manually reset at the Local Unit.

In addition to the LED indicators provided on the Local Unit, each channel is also equipped with an output for activation of external circuitry. Such circuitry may be indicator lamps or relays. Moseley Associates can supply, on special order, custom panels for display or other use of these outputs. As an example, it may be desirable to have a flow-chart display to depict equipment such as exciters, transmitters, STL's, etc., which are in service.

For an independent control system, the DSI-1 System may simply be reversed with the Local Unit situated at the transmitter site and the Remote Unit at the studio site. As all 32 channels operate independently of each other, the system enables simultaneous control for each channel. When combined with a second DSI-1 System, operating in the reverse direction, a 32-channel control system with full tally is obtained.



111 CASTILIAN DRIVE
GOLETA, CALIFORNIA 93017
(805) 968-9621

Solid-State
STEREO GENERATOR
MODEL SCG-9



BULLETIN 252

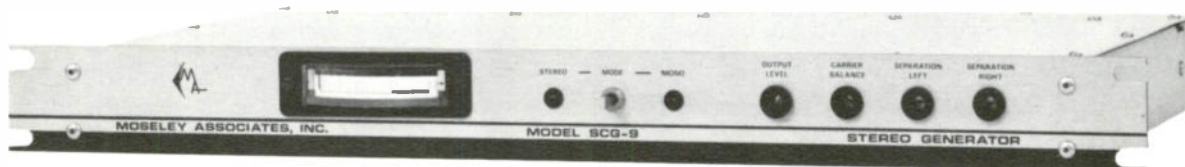

The Model SCG-9 Stereo Generator provides a composite stereo signal of the highest quality. Although this all solid-state generator is intended primarily as a companion to the Moseley Associates composite STL (a single link for stereo), it may be used with most direct FM exciters. The SCG-9 easily meets the requirements of Section 73.322 of the FCC Rules and Regulations. A minimum of adjustments and rigid manufacturing tolerances promise excellent quality and dependable performance.

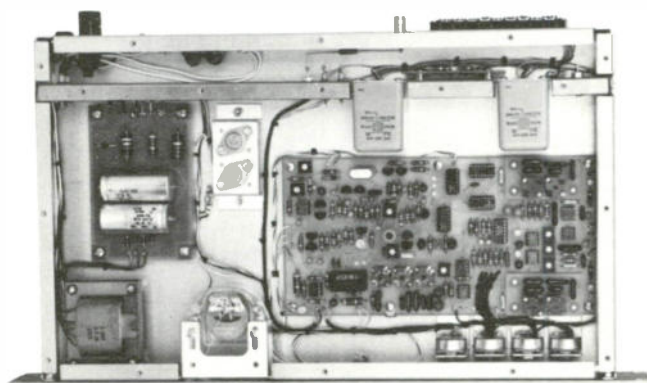

Interior view — SCG-9 Stereo Generator. Note complete shielding techniques utilized in construction.

featuring

RESERVE PERFORMANCE

Designed to greatly exceed FCC requirements — in every respect.

ADVANCED SOLID-STATE CIRCUIT TECHNIQUES

Employs silicon integrated circuits and semiconductors in a logical design assuring a pure stereo waveform.

PEAK-READING dB METER

Accurately reads TOTAL output of the generator.

MODE SELECTION

Stereo/Monaural modes available from front-panel switch or remotely selectable.

COMPACT

1 3/4" rack-panel mounting with self-contained power supply.

EASY MAINTENANCE

Ample test points and a minimum of adjustments.

MOSELEY ASSOCIATES, INC.

PROFESSIONAL PRODUCTS FOR PROFITABLE BROADCASTING

MODEL SCG-9 STEREO GENERATOR

In the design of the SCG-9 Stereo Generator, one of the major objectives was a generator that would produce an inherently pure stereophonic waveform which would have unwanted signal byproducts reduced to the vanishing point with no sacrifice of stability and dependability. This goal has been achieved by using advanced design techniques and components. For example, operational amplifiers are utilized for active pre-emphasis and signal amplification. Integrated circuits are utilized for buffering, pilot, and switching signal generation. Each audio input contains low-pass filters to reduce unwanted program components to a minimum level, thus enabling 19 kHz pilot extraction in the home receiver to be accomplished with ease. Further, these filters also remove ultrasonic components present on some quadrasonic recordings.

Identical LEFT and RIGHT audio signals are applied to an electronic switch operating at a 38 kHz rate. The 38 kHz switching signal and the 19 kHz pilot are obtained from binary dividers driven by a stable crystal-controlled oscillator. This method of stereo signal generation is time proven and provides an inherently fine waveform. The signal is then processed and sinusoidalized by a phase linear low-pass filter to remove harmonics of the stereo waveform, resulting in a pure stereo signal. The electronic switch, operating in a push-pull mode with square-wave signals from the dividers, has excellent suppression of unwanted even harmonics falling in the 67 kHz SCA region. This, in addition to the earlier low-level audio channel low-pass filters, assures minimum cross talk (stereo to SCA) for complete compatibility with SCA program service.

SPECIFICATIONS

AUDIO INPUT	... 600 Ω resistive, balanced, floating; +10 dBm \pm 2 dB
FREQUENCY RESPONSE	... \pm 1 dB, 30 Hz to 15 kHz
PRE-EMPHASIS	... 75 μ second standard, field convertible for other values including flat
HARMONIC DISTORTION	... Less than 0.4%, stereo or mono
NOISE LEVEL	... Better than 68 dB below normal output
COMPOSITE OUTPUT	... 3.5 volts peak-to-peak, 5 volts maximum; 5000 Ω minimum resistive load shunted with 1000 pf maximum capacity
PILOT CARRIER STABILITY	... Less than 1 Hz drift in 6 months
CHANNEL SEPARATION LEFT AND RIGHT	... 35 dB minimum, 45 dB typical
CROSS TALK, MAIN AND SUBCHANNELS	... 43 dB minimum, 50 dB typical including the built-in 16 kHz low-pass program filters, exclusive of external vector error.

SUBCARRIER SUPPRESSION	... 50 dB minimum, typical 55 dB with or without modulation.
SWITCHING SIGNAL HARMONICS	... Better than 45 dB below normal output
STEREO/MONO SWITCHING	... Front-panel momentary-action switch or remote momentary contact closure to ground; modulation level is the same in stereo and mono modes.
METERING	... Full-wave peak-reading meter calibrated in dB to read total output.
POWER REQUIREMENTS	... 120/240 VAC, 50-60 Hz, 10 watts
OPERATING TEMPERATURE RANGE	... -20 $^{\circ}$ C to +60 $^{\circ}$ C (-4 $^{\circ}$ F to +140 $^{\circ}$ F)
SIZE	... 1 $\frac{3}{4}$ "H (4.5 cm), 19"W (48.4 cm), 11"D (28 cm)
WEIGHT	... Net 9 pounds (4.1 kg); domestic shipping weight 12 pounds (5.5 kg)

Specifications subject to change without notice



MOSELEY ASSOCIATES, INC.
SANTA BARBARA RESEARCH PARK

111 CASTILIAN DRIVE
GOLETA, CALIFORNIA 93017
TELEPHONE: (805) 968-9621
TELEX: 658448 CABLE: MOSELEY

Solid-State
STEREO GENERATOR
MODEL SCG-3T



BULLETIN 223A

• • • FOR PROFITABLE BROADCASTING • • •

PROFESSIONAL PRODUCTS

pure stereo

The Model SCG-3T Solid-state Stereo Generator will provide a composite stereo signal of the highest quality. Although intended primarily as a companion to the Moseley Associates Composite single link stereo STL, it may be used with most direct FM exciters. The SCG-3T easily meets the requirements of Section 73.322 of the FCC Rules and Regulations. A minimum of adjustments and rigid manufacturing tolerances promise excellent quality and dependable performance.



featuring

SUPERB STEREO SOUND

Listeners get better sound — even with the less expensive receivers.

RESERVE PERFORMANCE

Designed to greatly exceed FCC requirements — in every respect.

ADVANCED SOLID-STATE CIRCUIT TECHNIQUES

Employs silicon integrated circuits (IC's) and semiconductors in a logical design assuring a pure stereo waveform.

PEAK-READING dB METER

Accurately reads LEFT, RIGHT or TOTAL output.

PUSH-BUTTON (OR REMOTE) MODE SELECTION

Stereo - Monaural.

COMPACT

3½" rack-panel mounting with self-contained power supply.

• • • • • **EASY MAINTENANCE**

Slide-out modules do not require extenders. Ample test points and a minimum of adjustments.



MOSELEY ASSOCIATES, INC.

PROFESSIONAL PRODUCTS FOR PROFITABLE BROADCASTING

CIRCUIT COMMENTS

A major design objective was to produce an inherently pure stereophonic signal which would have unwanted signal by-products reduced to the vanishing point with no sacrifice of stability and dependability.

This goal has been accomplished by using advanced design techniques and components. For example, computer-type direct-coupled operational amplifiers (IC's) are used for active pre-emphasis and output signal amplification. IC's are also used for buffering and pilot and switching signal generation. Additionally, sharp cut-off low-pass filters (over 50 dB down at 19 kHz and above) are used in each audio channel to reduce unwanted program components to a minimal level, thus enabling 19 kHz pilot extraction in the home receiver to be accomplished with ease.

Identical LEFT and RIGHT audio signals are applied to an electronic switch operating at a 38 kHz rate. The 38 kHz switching signal and the 19 kHz pilot

are obtained from binary dividers driven by a stable 76 kHz crystal-controlled oscillator. This method of stereo signal generation provides an inherently fine waveform with which to start. This signal is processed and sinusoidalized by a phase linear low-pass filter to remove unwanted harmonics of the stereo waveform, resulting in a pure stereo signal.

The electronic switch, operating in a push-pull mode with square-wave signals from the dividers, has excellent suppression of unwanted even harmonics falling in the 67 kHz SCA region. This, in addition to the earlier low-level audio channel low-pass filters, assures minimum cross talk (stereo to SCA) for complete compatibility with SCA program service.

SPECIFICATIONS

<p>AUDIO INPUT... 600Ω resistive, balanced, floating; +10 dBm ± 2 dB</p> <p>INPUT PROGRAM FILTERS... Better than 50 dB down at 18.5 kHz and above</p> <p>FREQUENCY RESPONSE... ± 1 dB, 30 Hz to 15 kHz</p> <p>PRE-EMPHASIS... 75 μsecond standard, field convertible for other values including flat</p> <p>HARMONIC DISTORTION... Less than 0.4%, stereo or mono</p> <p>NOISE LEVEL... Better than 68 dB below normal output</p> <p>COMPOSITE OUTPUT... 3.5 volts peak-to-peak, 5 volts maximum; 5000Ω minimum resistive load shunted with 1000 pf maximum capacity</p> <p>PILOT CARRIER STABILITY... Less than 1 Hz drift in 6 months</p> <p>CHANNEL SEPARATION LEFT AND RIGHT... 35 dB minimum, 45 dB typical</p>	<p>CROSS TALK, MAIN AND SUBCHANNELS... 43 dB minimum, 50 dB typical including the built-in 17 kHz low-pass program filters</p> <p>SUBCARRIER SUPPRESSION... 48 dB minimum, typical 85 dB with or without modulation</p> <p>SPURIOUS OUTPUTS BELOW 90 kHz... Better than 55 dB below normal output</p> <p>SPURIOUS OUTPUTS ABOVE 90 kHz... Better than 60 dB below normal output</p> <p>STEREO MONO SWITCHING... Front pane illuminated push-button or remote momentary contact closure to ground; modulation level is the same in stereo and mono modes</p> <p>METERING... Peak-reading meter calibrated in dB, switchable to read LEFT, RIGHT, or TOTAL OUTPUT</p> <p>POWER REQUIREMENTS... 120/240 volts AC, 50-60 Hz, 10 watts</p> <p>OPERATING TEMPERATURE RANGE... 30°F to 140°F</p> <p>PHYSICAL INFORMATION... 3½"H, 19"W, 11"D; net 20.5 pounds; shipping weight 27 pounds</p>
--	--

Specifications subject to change without notice



MOSELEY ASSOCIATES, INC.
SANTA BARBARA RESEARCH PARK

111 CASTILIAN DRIVE
GOLETA, CALIFORNIA 93017
(805) 968-9621

DIGITAL REMOTE SYSTEM MODEL DRS-1A



Bulletin 249

ALL DIGITAL SYSTEM-

□ COMMAND □ TELEMETRY □ STATUS

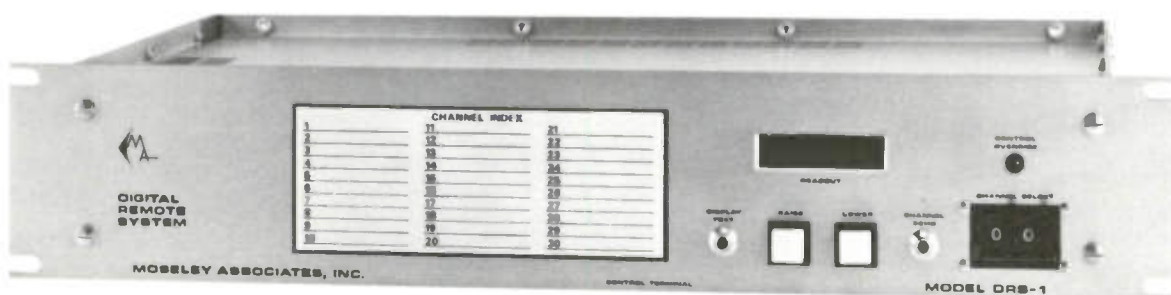

Control Terminal

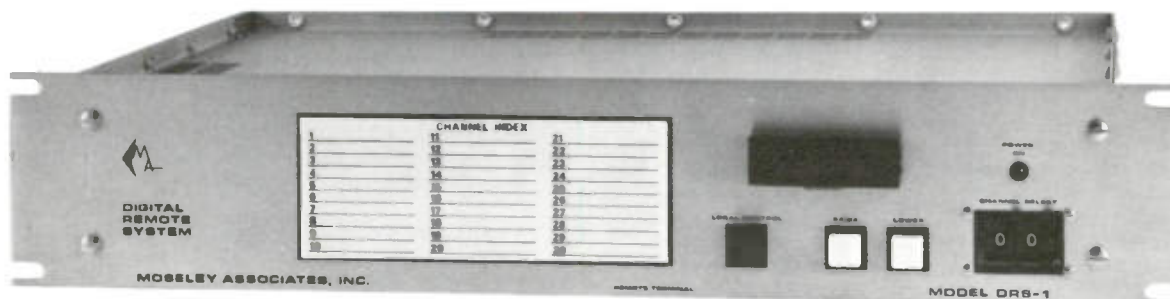

Remote Terminal

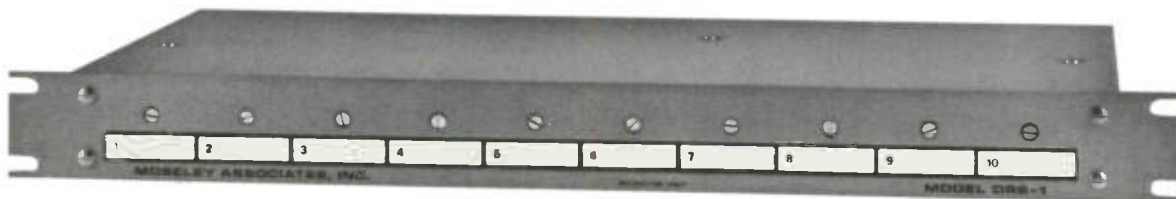

10-Channel Selector Unit



Optional — Status Panel-Control Terminal



Optional — Status Panel-Remote Terminal

FOR BROADCAST AND INDUSTRIAL SERVICE

MOSELEY ASSOCIATES, INC.

MODEL DRS-1A

- Completely Integrated System Concept
- Field Expandable
- Remote Control — to 30 Channels
- Status/Alarm — 24 Channels
- Companion Automatic Parameter Logging
- Internal Data Modems Provided
- Wire or Wireless Operation

Totally digital command, telemetry, status/alarm and automatic parameter logging are supplied, at an affordable price, by the Moseley Associates Model DRS-1A Digital Remote System and its associated units. The basic DRS-1A System provides command and telemetry capability. The Status Subsystem of the DRS-1A enables display and transmission of status/alarm functions. Automatic recording of telemetered parameters is available with the companion Model DLS-1 Digital Logging System.

The basic DRS-1A Digital Remote System is divided into three units — Control Terminal, Remote Terminal and Selector Unit(s). The Control Terminal is located at the remote control point, normally the studio location in broadcast transmitter remote control. The Remote Terminal and Selector Units are situated at the transmitter site, or location of equipment being controlled. Positioning can be seen in the block diagram on the rear of this bulletin. Each Selector Unit provides 10 telemetry/command channels, which allows for field expansion or tailoring of the DRS-1A to fulfill specific channel requirements. A maximum of 30 channels (3 Selector Units) may be used.

Each telemetry/command channel provides a single telemetry function and two command functions. These command or control functions are individual Form A, isolated dry contact closures and are typically identified as Raise and Lower. The Raise and Lower command outputs can switch external loads of up to 50 watts, non-inductive at potentials of 120V AC or DC. Telemetry inputs accept a DC sample voltage representing the desired analog parameter. This DC voltage is typically in the 1 VDC to 10 VDC range.

Every telemetry channel is displayed digitally as a 3 or 3½ digit numeric presentation. With an input of 2 VDC, a maximum numeric display of "1999" is possible. A display of "999" can be obtained with an input of 1 VDC. Individual calibration potentiometers, provided on each telemetry chan-

nel, enable calibration of the numeric display to be identical to the value of the selected parameter. Digital numeric light-emitting diode (LED) displays are located on both Control and Remote Terminals. One-man system calibration is afforded by the digital numeric display on the Remote Terminal. For calibration, it is only necessary to adjust the calibration potentiometer until the digital numeric display shows a value equal to the selected parameter.

Operation of the DRS-1A Digital Remote System is greatly simplified allowing even unskilled operators to efficiently control and observe a remotely located transmitter plant. The front panel of the Control Terminal contains channel select and command controls as well as telemetry display. Telemetry/command channels are selected with centrally-located lever-wheel assemblies. These assemblies provide direct-reading channel numbers. After channel selection, the parameter being telemetered is automatically displayed. Raise and Lower buttons enable activation of command functions. When the command function is accomplished, the Raise or Lower button is illuminated as a true-tally signifying activation of the Raise or Lower relay. This tally-back gives operator confidence previously not available in a system in this price range. For even greater confidence, the channel echo capability allows tally-back and display of the selected channel.

All controls and the telemetry display are duplicated on the Remote Terminal. Local control at the transmitter site is seized by the Remote/Local switch. When depressed, command information, including channel selection, can only be accomplished from the Remote Terminal. When in the local mode, an indication is sent to the Control Terminal illuminating the "Control Override" LED to inform the operator that he has lost command capability. Further, an additional set of controls on the Remote/Local switch is terminated on the rear apron of the Remote Terminal and can be used for an external indication of switch position. These contacts are commonly referred to as "go home" indicators, and can prevent maintenance personnel from leaving the Remote Terminal in the Local mode.

Interconnection between the Control Terminal and Remote Terminal can be by either wire or wireless means. For wire or telephone line operation, the system is identified as the DRS-1AW. Radio link, or wireless operation, is provided by the DRS-1AR. FM subcarrier modules can be mounted in both Remote and Control Terminals. Refer to the Ordering Information section and the block diagram on the rear of this bulletin for further information on subcarrier modules.

Digital techniques are used in the DRS-1A for all functions. DC sample voltages are converted in the Remote Terminal

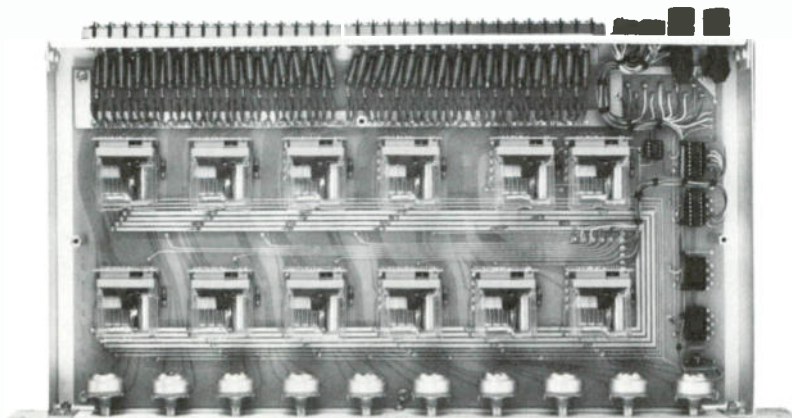

Interior View — DRS-1A Selector Unit. Individual relays provide for channel selection. Each relay is socketed for easy replacement. Telemetry calibration potentiometers for each channel are shown at the bottom. All external inputs and outputs pass through L/C filters, shown at the top.

DIGITAL REMOTE SYSTEM

to serial digital information by an analog-to-digital (A-D) converter. Both telemetry and command information is organized into 8-bit serial digital words. Modems (modulators/demodulators) in the Remote and Control Terminals enable transmission of the digital words. These modems convert the digital words to frequency-shifted keyed (FSK) audio tones which can be transmitted over telephone or radio circuits. Error checking is included to assure absolute accuracy of telemetry and command information. These techniques, when combined with the various true-tally functions, virtually guarantee error-free operation with proper interconnection circuits.

Fail-safe circuitry in the DRS-1A complies with current Federal Communications Commission requirements for broadcast transmitters. For the control fail-safe requirements of standard, FM and TV service, the presence of correct command information is continuously sensed in the Remote Terminal. Should command information not be received for a period of 20 seconds, the control fail-safe relay in the Remote Terminal is de-activated. For telemetry fail-safe with television transmitters, the DRS-1A functions with the Model FSU-1 Fail-Safe Unit. See Bulletin 237 for further information on the FSU-1. The Control Terminal provides a unique indication of telemetry return failure. With an interconnection interruption, or other telemetry failure, the digital numeric display flashes on and off at a one-Hertz rate. Further, an output is provided on the rear apron of the Control Terminal for an external alarm indication.

The Status Subsystem of the DRS-1A provides for 24 status/alarm (go/no-go) indications. Typically, applications include the sensing of illegal entry, fire and smoke alarms, over/under temperature, transmitter status, tower lights, or any similar go/no-go condition or function. The subsystem consists of the Status Panel-Control Terminal and the Status Panel-Remote Terminal. Both panels operate from the power supplies and modems in the DRS-1A Control and Remote Terminals. Each status channel is encoded from external normally-open dry contacts. Closing of these contacts illuminates a light-emitting diode (LED) on both status panels. The subsystem is of the latching type. When a channel is activated, the LED remains illuminated until manually reset at either Remote or Control Terminal.

An additional feature is provided by the Status Panel-Control Terminal. A transistor sink to ground is provided for each channel which is activated when a channel is encoded. These sinks will switch an external load of 200 ma, 24 VDC, enabling the use of external alarms, relays, warning lamps, or similar devices.

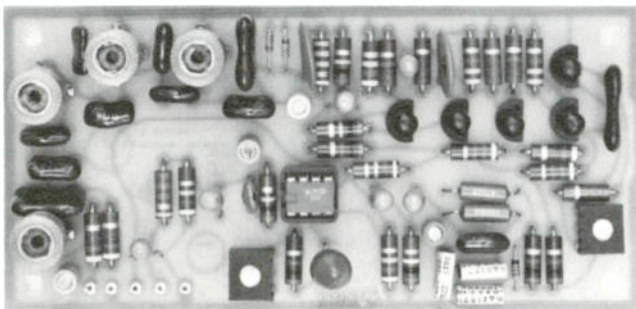

Subcarrier equipment for totally wireless operation is available as modules with the DRS-1A.

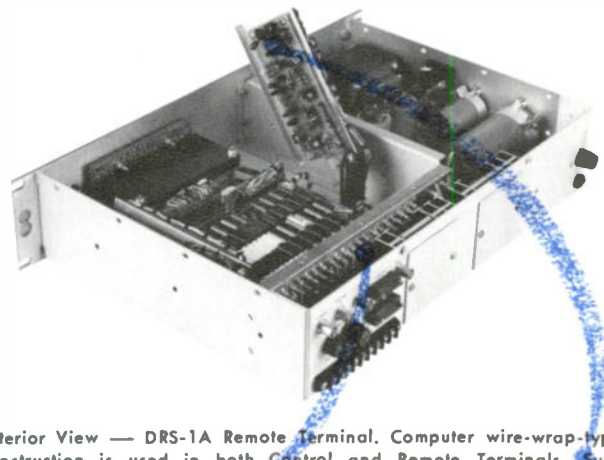

Interior View — DRS-1A Remote Terminal. Computer wire-wrap type construction is used in both Control and Remote Terminals. Subcarrier and modem modules are mounted on unique fold-out assemblies for easy servicing. All active electronics, except for power supply components, are mounted in a totally shielded enclosure. All connections are routed through feed-through filters for isolation from nearby high-energy RF fields.

ORDERING INFORMATION

DRS-1AW

Only a single voice-grade telephone circuit is required for operation of the DRS-1AW. Frequency-shift keyed (FSK) audio tones are utilized for command and telemetry information. Maximum attenuation of the interconnecting circuit is 30 dB. Ten-channel capacity is standard. Order one additional Selector Unit for 20 channels or two additional Selector Units for 30 channels.

DRS-1AR

For wireless service, the DRS-1AR is designed to function with Moseley Aural STL equipment. Control information is transmitted to the Remote Terminal via an FM subcarrier multiplexed on the STL. A control FM subcarrier generator and demodulator are standard in the DRS-1AR. For monaural STL's, a 26 kHz subcarrier frequency is utilized. For the composite STL system, the subcarrier frequency becomes 110 kHz. Audible telemetry (1300-1500 Hz) is standard. Subaudible telemetry (18.75-37.5 Hz) is available on special order for return via an SCA channel of an FM transmitter. Ten-channel capacity is standard. Order one additional Selector Unit for 20 channels or two additional Selector Units for 30 channels. Contact Moseley Associates' Marketing Department for information on special versions to fulfill individual requirements.

Status Subsystem

The Status Subsystem provides 24 status/alarm, or go/no-go type indications. It functions as an integral part of the DRS-1AW or DRS-1AR.

Options

The Model DLS-1 Digital Logging System provides for automatic recording of operating parameters. Up to 20 parameters may be recorded with this system. For further details, refer to Product Bulletin 251.

When an FM subcarrier is to be utilized for telemetry return, the DRS-1A has the capability of accepting a subcarrier generator module and subcarrier demodulator module. See the block diagram on the rear of this bulletin for placement of these modules. These modules are identified as Telemetry Subcarrier (SCA) Generator for DRS-1A and Telemetry Subcarrier Demodulator for DRS-1A.

Accessories

Telemetry accessories, including linear-readout temperature sensing kit, AM and FM RF diode sampling kits, power-to-linear converter, and control interface items are available. Request Bulletin 248 for further information.

MODEL DRS-1A DIGITAL REMOTE SYSTEM

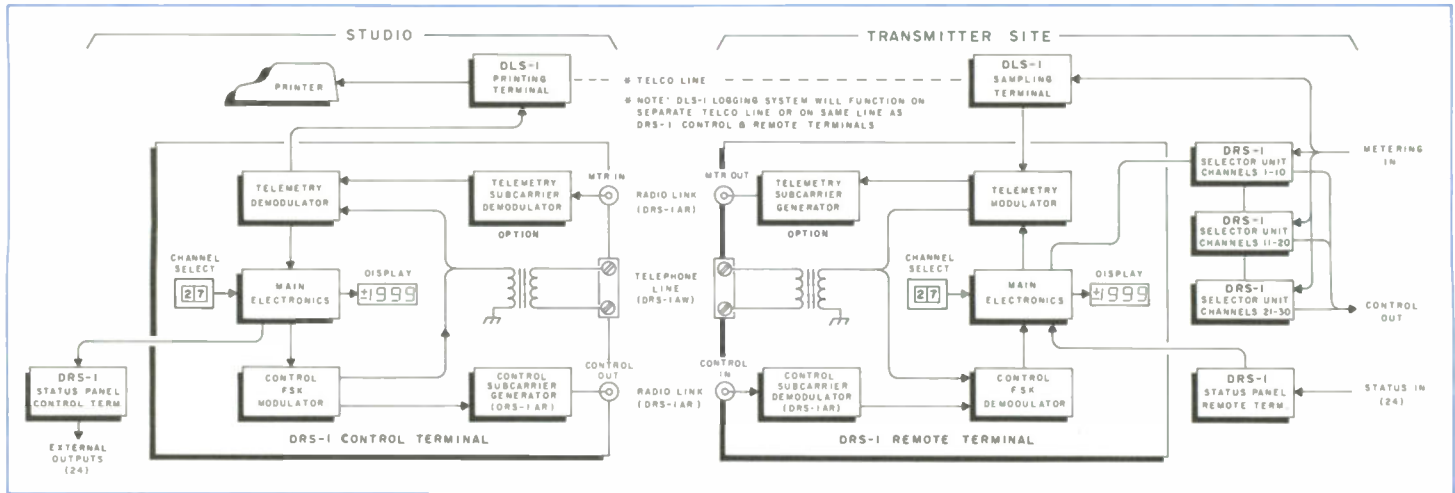

SPECIFICATIONS

Type	Digital command and telemetry
Channel Capability	10 minimum, expandable to 20 or 30 total. Each channel provides one telemetry function and two command or control functions.
Control Output	Relay contact closure, isolated and floating. Contacts rated for maximum load of 50 watts, non-inductive, 120V AC or DC.
Telemetry Input	1 VDC (nominal) differential for full scale (± 999) display. Full 100% over-range capability with 2 VDC (nominal) differential required for display of ± 1999 . Each input fully floating. Input impedance 100K Ω .
Telemetry Display	Digital LED display, 3 1/2-digit, with polarity.
Telemetry Accuracy	0.1% of full scale
Telemetry Response Time	Audible telemetry — 270 milliseconds. Subaudible telemetry — 1.3 seconds. Subaudible, with Status — 1.6 seconds.
Fail-Safe — Control	Relay contact closure (SPDT), closed in energized (operational) position. De-energized (opened) 20 seconds after control failure to Remote Terminal.
Fail-Safe — Telemetry	Provisions for use with independent Model FSU-1 Fail-Safe Unit, complying with current FCC broadcast requirements for television telemetry fail-safe operation.
Interconnection Requirements DRS-1AW	2-wire, voice-grade telephone circuit, 600 Ω balanced, (Reference Series 3002 Data Circuit), 300-3000 Hz, maximum permissive attenuation 30 dB, send level 0 dBm, composite. All functions accomplished via FSK signals. Command 2300-2500 Hz; Telemetry 1300-1500 Hz; Optional DLS-1 Digital Logging System 750-900 Hz.

DRS-1AR

Control FM subcarrier generator and demodulator included as standard. Subcarrier send/receive level 1.5 volts peak-to-peak; input/output impedance, 2000 Ω , nominal, unbalanced. Subcarrier frequency 26 kHz for monaural STL, 110 kHz for composite STL; other frequencies 26 kHz to 185 kHz on special order. Audible telemetry (1300-1500 Hz) standard. Subaudible telemetry (18.75-37.5 Hz) on special order. Telemetry send level, 1.5V peak-to-peak, 2000 Ω nominal, unbalanced. Telemetry receive level, 0.1V to 2V peak-to-peak, 2000 Ω , nominal, unbalanced for audible or subaudible telemetry. Optional telemetry subcarrier generator and detector modules available on special order. Operating levels and impedance same as control subcarrier equipment. Typical frequency — TV 39 kHz; FM 67 kHz.

Operating Temperature Range	-20°C to +70°C
Power Requirements — (30-channel configuration, including Status Subsystem with all channels activated)	
Control Terminal	120/240 VAC, 50-60 Hz, 30W
Remote Terminal	120/240 VAC, 50-60 Hz, 35W
Size	
Control Terminal	3 1/2 inches high, 19 inches wide, 12 inches deep (8.9 cm x 48.4 cm x 30.5 cm)
Remote Terminal	3 1/2 inches high, 19 inches wide, 10 inches deep (8.9 cm x 48.4 cm x 25.4 cm)
Selector Unit	1 3/4 inches high, 19 inches wide, 9 1/2 inches deep (4.4 cm x 48.4 cm x 24.1 cm)

STATUS SUBSYSTEM

Type	Digital, latching, functions with DRS-1A System
Channel Capability	24
Input	External normally-open dry contacts. Closure activates channel.
Status Display	Light-emitting diode (LED) for each channel on both Control and Remote Terminals. Display is latched following activation until cleared at either Remote or Control Terminals.
Output	Independent transistor sink to ground for each channel on Control Terminal. Each sink capable of switching maximum load of 200 ma, 24V.

Interconnection Requirements	Functions with modems in DRS-1A Remote and Control Terminals.
Operating Temperature Range	-20°C to +70°C
Power Requirements	Derived from companion DRS-1A System
Size	
Status-Control Terminal	1 3/4 inches high, 19 inches wide, 2 1/2 inches deep (4.4 cm x 48.4 cm x 6.4 cm)
Status-Remote Terminal	1 3/4 inches high, 19 inches wide, 6 inches deep (4.4 cm x 48.4 cm x 15.2 cm)

Specifications subject to change without notice



MOSELEY ASSOCIATES, INC.
SANTA BARBARA RESEARCH PARK

111 CASTILIAN DRIVE
GOLETA, CALIFORNIA 93017
(805) 968-9621
TELEX: 658448 CABLE: MOSELEY

Aural
Studio
Transmitter
Links

Moseley

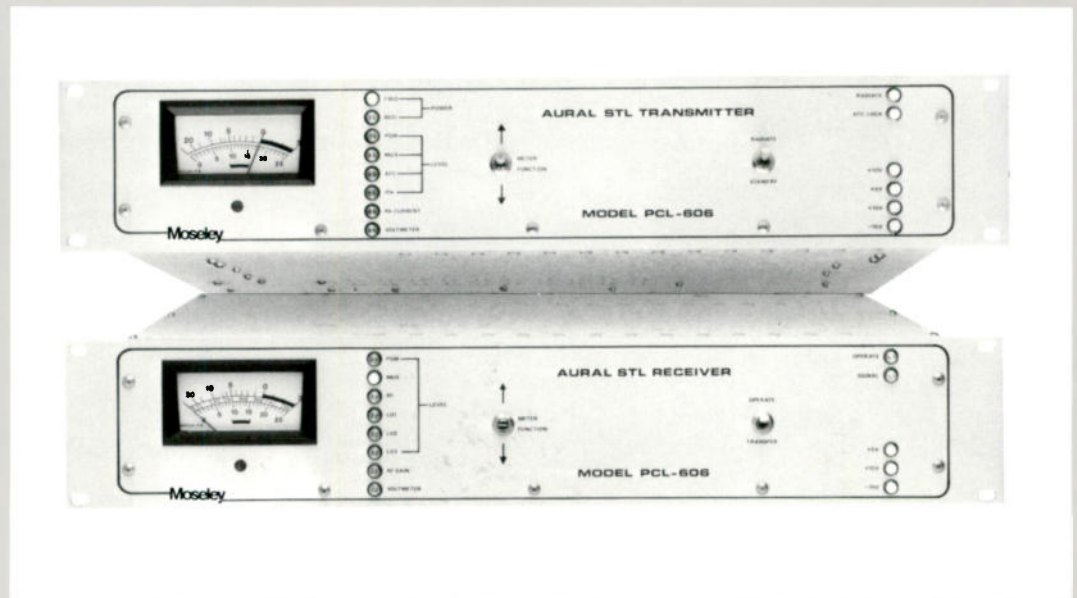

PCL-606 AND PCL-606/C

For:
300-330 MHz
450-470 MHz
890-960 MHz
1.5-1.71 GHz

PCL-606 AND PCL-606/C

WHY STL?

Telephone line charges have increased dramatically over the past few years while line reliability and ultimate audio quality have either degraded or stayed the same. Studio-transmitter link (STL) systems provide broadcasters with an alternative to leased telephone lines for conveying program information from the studios to a remote transmitter location. They offer complete control over program carriage as well as excellent reliability, two factors very important in today's broadcasting. Studio-transmitter links will also convey a program subcarrier, such as an SCA feed, and remote control information over the same economical link.

WHY PCL-606?

The PCL-606 and PCL-606/C Studio-Transmitter Links provide the broadcast and industrial user alike with the highest quality program conveyance service currently available in equipment of this type. Use of the latest technology has achieved significantly improved specifications and performance, even in areas

overly congested in STL service or in areas presenting high density RF environments. The PCL-606, designed for highest quality monaural audio service, may be used in a dual configuration for stereo service where composite stereo is not desired. The PCL-606/C, the composite stereo version, conveys the composite stereo waveform with virtually no degradation, neither adding to nor taking away from the stereo waveform, for virtual transparency of sound.

Extensive field testing of the PCL-606 and PCL-606/C Transmitter and Receiver

was done (at such high RF locations as One Shell Plaza and Mt. Wilson) to ensure the highest performance in hostile RF environments. Enclosed module construction is used to reduce the possibility of RFI as well as allow easy service access to each printed circuit board. All normal service tuning adjustments are easily yet securely accessible through the tops of the modules and unit top covers, and extensive internal metering capabilities are standard in both the Transmitter and Receiver.

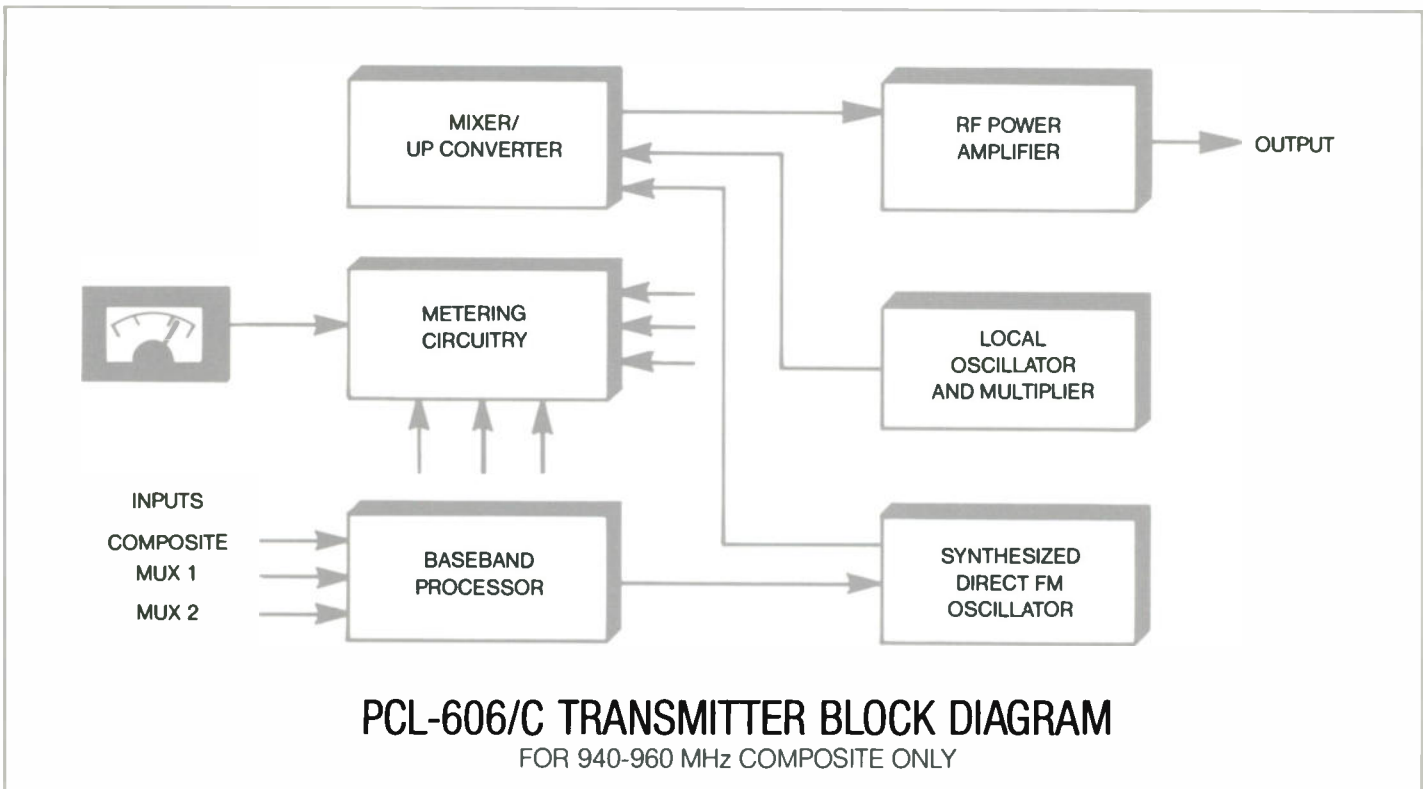

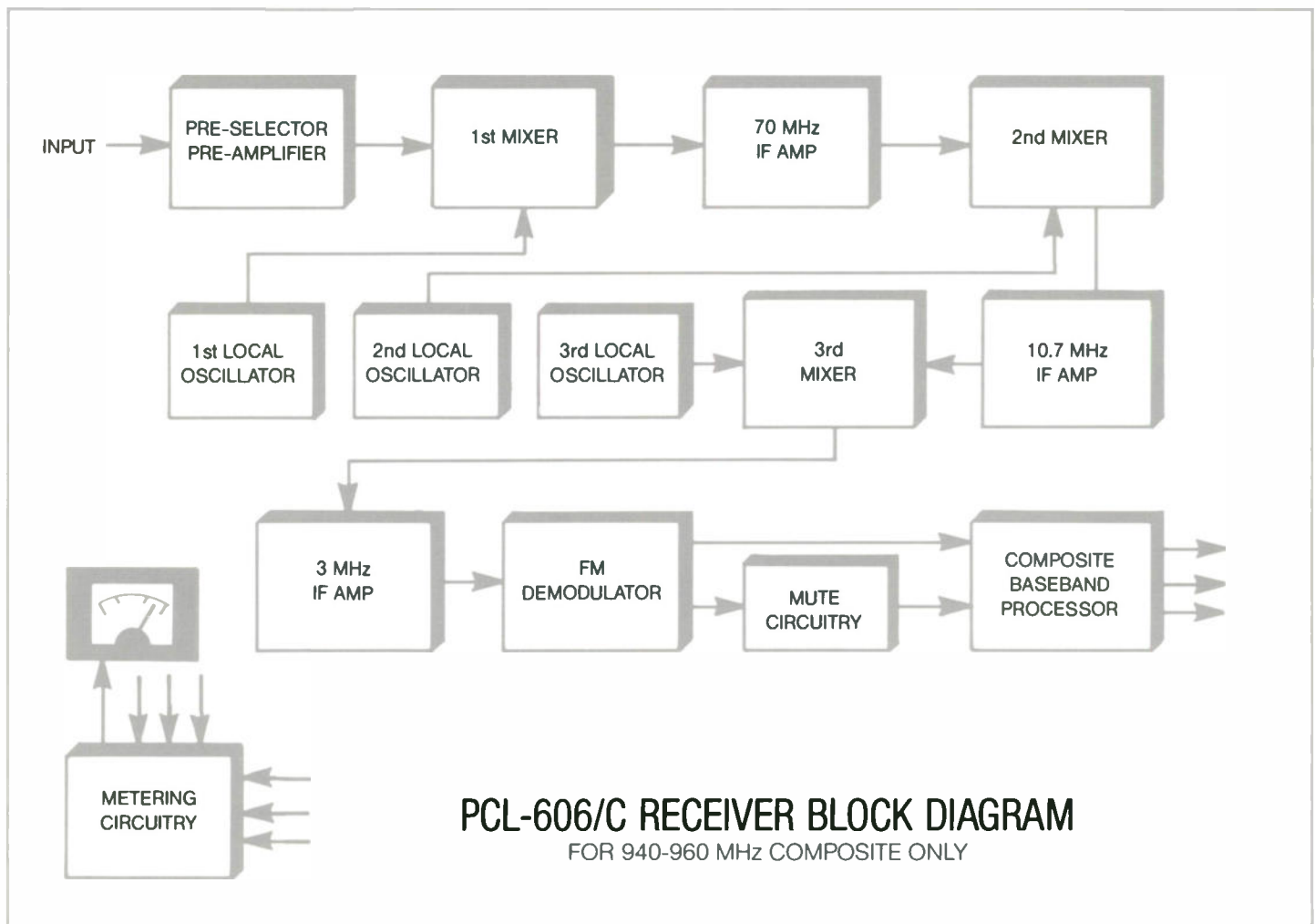

TRANSMITTER

The PCL-606 and PCL-606/C Transmitters employ direct FM modulation techniques. A synthesized reference oscillator is used for frequency and phase control of the direct FM oscillator. Transmitter FM modulated oscillator frequency conversion is done via a double balanced mixer instead of the usual frequency multiplication of the modulated RF signal.

The transmitter includes a front-panel meter with step-switch input selection to allow the metering of important parameters, such as RF forward output, RF reflected output, input levels and AFC voltage. The metering system even includes built-in absolute value peak responding voltmeter capability, with an internal LED to indicate DC polarity.

RECEIVER

The PCL-606 and PCL-606/C Receiver designs were the first to incorporate several important performance and user-controlled features. A PIN diode attenuator circuit is supplied for user adjustment of overall system signal-to-noise ratio. The PIN diode attenuator circuit reduces adjacent signal intermodulation products caused by input signal overloads.

The receiver IF bandwidth may be changed by the user to optimize the tradeoff between distortion and selectivity. The wideband mode yields highest performance in uncongested areas with 500 kHz channel spacings. In high density areas, the narrowband mode, utilizing 300 kHz channel spacings, allows for optimum performance.

The receiver demodulator offers extremely

low distortion and noise characteristics. The demodulator is broadband and adjustment-free, using digital pulse counting techniques for maximum fidelity.

The receiver includes a front-panel meter with step-switch input selection to allow the metering of several parameters, including audio output level, subcarrier level and RF input level in microvolts. The metering system includes built-in absolute value peak responding voltmeter capability with polarity indication. The metering circuit output appears on a back panel connector for remote metering.

Built-in transfer circuitry is standard in the PCL-606 and PCL-606/C Receivers to allow automatic changeover to a standby receiver in the event of a detected malfunction.

SPECIFICATIONS

PCL-606	SYSTEM	PCL-606/C
300-330 MHz, 450-470 MHz, 890-960 MHz, 1.5-1.71 GHz. Specify exact operating frequency	Frequency Range	300-330 MHz, 450-470 MHz, 890-960 MHz, 1.5-1.71 GHz. Specify exact operating frequency.
250 kHz	Channel Spacing Wide (Narrow) Band	500 KHz (300 kHz)
Monophonic audio ± 0.25 dB or better 30 Hz to 15 kHz	Frequency Response Wide (Narrow) Band	Composite ± 0.1 dB (± 0.2 dB) or better 30 Hz to 53 kHz, ± 0.3 dB (± 1.0 dB) or better 53 kHz to 73 kHz
0.20% or less 30 Hz to 15 kHz, typically better than 0.1% at 1 kHz	THD and IMD Wide (Narrow) Band	Stereo demodulated THD and IMD; 0.2% (0.3%) or less 30 Hz to 7.5 kHz, typically better than 0.1% at 1 kHz Convolved stereo demodulation products: greater than 53 dB (50 dB) below the 400 Hz, 100% modulation ref. level from 7.5 kHz to 15 kHz
Not applicable	Stereo Separation Wide (Narrow) Band	52 dB (45 dB) or better 50 Hz to 15 kHz, typically 57 dB (50 dB) or better
Not applicable	Nonlinear Crosstalk Subchannel to Main Channel: Wide (Narrow) Band	53 dB (50 dB) or better
Not applicable	Nonlinear Crosstalk, Main Channel to Subchannel: Wide (Narrow) Band	53 dB (50 dB) or better
75 dB or better, typically 78 dB, below 10% modulation	Signal-to-Noise Ratio Wide (Narrow) Band	75 dB (72 dB) or better, typically 78 dB (75 dB), below 100% modulation, de-modulated, de-emphasized left or right.
3.5" (8.9 cm) high 16.5" (41.9 cm) deep	Dimensions, Operating Temperature Range: Transmitter & Receiver	3.5" (8.9 cm) high 16.5" (41.9 cm) deep
19" (48.3 cm) wide 0°C to +50°C		19" (48.3 cm) wide 0°C to +50°C
TRANSMITTER		
10 Watts maximum, 5 Watts minimum 12 Watts maximum, 8 Watts minimum	RF Power Output 890 HMz-1.71 GHz 300-470 MHz	10 Watts maximum, 5 Watts minimum 12 Watts maximum, 8 Watts minimum
Type N female, 50 ohm	RF Output Connector	Type N female, 50 ohm
± 40 kHz	Deviation for 100% Modulation Wide (Narrow) Band	± 50 kHz (± 30 kHz)
Better than 0.00025%, 0°C to +50°C	Frequency Stability	Better than 0.00025%, 0°C to +50°C
More than 60 dB below carrier level	Spurious and Harmonic Emission	More than 60 dB below carrier level
One program and two subcarrier channels	Modulation Capability	One program and two subcarrier channels
Monophonic +10 dBm, 600 ohm, balanced, floating, barrier strip screw input. Multiplex 1.5 V peak-to-peak, 4 K ohms unbalanced, type BNC female connectors (2), frequency range 22-85 kHz	Modulation Inputs Wide (Narrow) Band	Composite: 3.5 V peak-to-peak 6 k ohms unbalanced, type BNC female connector. Multiplex: 1.5 V peak-to-peak 4 k ohms unbalanced, type BNC female connectors (2), frequency range 110-185 kHz (110 kHz)
100/120/220/240 VAC, $\pm 10\%$, 50/60 Hz, 70 Watts	Power Source	100/120/220/240 VAC, $\pm 10\%$, 50/60 Hz, 70 Watts
RECEIVER		
Type N female, 50 ohm	RF Input Connector	Type N female, 50 ohm
20 μ V or less required for 60 dB SNR	Sensitivity Wide (Narrow) Band	130 μ V (200 μ V) or less, typically 120 μ V (170 μ V), required for 60 dB SNR, left or right channel de-emphasized, demodulated
3 dB I.F. bandwidth, ± 90 kHz 60 dB I.F. bandwidth ± 400 kHz 80 dB I.F. bandwidth, ± 1 MHz	Selectivity Wide (Narrow) Band	3 dB I.F. bandwidth ± 100 kHz (± 75 kHz) 60 dB I.F. bandwidth ± 460 kHz (± 350 kHz) 80 dB I.F. bandwidth, ± 1 MHz (± 1 MHz)
A 20 dB (10 dB) higher than desired signal will degrade SNR by less than 3 dB	Adjacent Channel Rejection	A 20 dB (10 dB) higher than desired signal will degrade SNR by less than 3 dB
Monophonic +10 dBm, 600 ohm, balanced, floating, barrier strip screw output Multiplex 1.5 V peak-to-peak, 4 K ohms unbalanced, type BNC female connectors (2)	Modulation Outputs	Composite: 3.5 peak-to-peak 100 ohm unbalanced, type BNC female connector Multiplex: 1.5 V peak-to-peak 100 ohm unbalanced, type BNC female connectors (2)
100/120/220/240 VAC, $\pm 10\%$, 50/60 Hz, 30 Watts	Power Source	100/120/220/240 VAC, $\pm 10\%$, 50/60 Hz, 30 Watts

Specifications subject to change without notice.

Printed in USA 10/87

Moseley

Moseley
Associates
Incorporated

111 Castilian Drive
Santa Barbara, CA
93117-3093

a
Flow General
Company

Phone 805 968 9621
Telex 658448
FAX: 805 685 9638

S S
AURAL STUDIO — TRANSMITTER LINK
L A
I T
D E

Inter - City Relay

AM • FM • MONO • STEREO
950 MHZ.

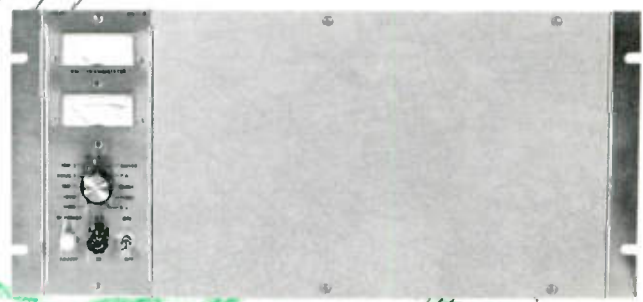

MARTI *Electronics, Inc.*

P.O. Box 661 • 1501 N. Main • Cleburne, Texas 76031 • 817/645-4091

General

Most of the following statements will be of interest to Management as well as Engineering. They should because you have one common stake, a profitable future, which also means job security.

Marti Electronics, Inc., has now been actively engaged in the design and manufacturing of Studio-Transmitter Link equipment for both AM and FM Broadcast, and Inter-City Relay Systems, for the past 7 years. Having well over 300 systems on the air and operating throughout the 50 United States and many more Internationally, soundness of design, reliability and sound quality are a matter of record.

It is our earnest opinion that the only logical answer to increased telephone line costs, minimum "lost air" time, improved sound quality and a general reduction in operating costs lies in the use of STL, Remote Control and Telemetry equipment. An additional consideration, which is ever present in today's society, is the added threat of riots and demonstrations which could cause the Radio Broadcast Industry many hours of "lost air" time. Of prime consideration is the matter of Security. Wire Line Program and Control circuits have many points of possible disruption, while STL Systems require security only at the terminals. Additionally, complete control of the system is exercised by station Engineering personnel, requiring no dependency on outside sources for restoration of circuits.

Based on present day telephone line costs for program, metering and control lines, the average system, whether AM, FM or FM Stereo, would pay out over a period of from 3 to 5 years, depending upon the extent of the equipment required and the amount of backup protection deemed necessary. After this period of time, an immediate reduction of operating overhead could be expected.

The STL and Remote Control equipment currently being manufactured by Marti Electronics is the most reliable and maintenance-free equipment that we have ever produced. Use is made of the latest technology when clear advantages are realized, but unproven or marginal concepts and components are never used. Exhaustive time and testing is devoted to all MARTI products to insure that each design represents the simplest and most reliable answer to providing the necessary performance.

Due to the advancements made in the present day "state of the art" techniques relating to printed circuits, integrated circuits, solid-state components, and improved manufacturing methods, there is no reason whatever that this equipment could not be depended upon to operate reliably and satisfactorily for many years.

In this new line of solid-state equipment, Marti Electronics, has endeavored to present to Engineering the most advanced line of equipment available under present day standards, nor have we forgotten future day standards. A close inspection of the many features of the new solid-state STL system will reveal a Direct FM Modulator for extremely low Noise and Distortion characteristics and RF Sensing for Automatic Changeover to a "hot standby" system. Plug-in or bolt-in Modular construction allows fast and accurate diagnosis of circuit or component failure and is a means of quick replacement of the defective module from a limited number of spares.

Additionally, we have made every effort to design *all* of our new, solid-state equipment around the same basic modules. For example, the LA-20 Plug-in Program Amplifier Module is used not only in the STL Receiver, but it is also used in such other Marti equipment as the RMC-2AX Remote Control System, the CLA-40A Compressor/Limiter Amplifier, the PGM-20 Program/Line Amplifier and several others.

This concept of high performance, maximum reliability and sensible cost is reflected in our "Dual" or "Split" channel approach to FM Stereo, whereby two transmitters and two receivers are used, each being combined into a common antenna system. This method assures two identical FM Broadcast-quality channels with 65 db. Separation, maximum Signal-To-Noise Ratio, Phase Linearity, extremely Low Distortion and Flat Frequency Response.

These outstanding performance characteristics of the MARTI Stereo STL System, when coupled with the REDUNDANCY factor presented by the "Dual" channel system, make this the logical approach to STL. Program transmission and Control Circuits can be maintained, even though in a Mono mode of operation, and precious "lost air" time is no longer a consideration.

Finally, the "Dual" channel concept allows the Stereo Generator to remain at the FM transmitter site, preventing continual adjustment from unauthorized and uninstructed personnel and eliminates the need for expensive interface equipment between the STL System and the FM Broadcast Transmitter. In addition, such problems as Separation can be more easily diagnosed when the Stereo Generator is not combined with the STL system.

Marti Electronics has done extensive laboratory and field experiments employing the use of passive antenna systems for both Relay applications as well as highly critical directional AM antenna arrays. Several such systems are now in use with very satisfactory results, and the pictures on the back page of this brochure will provide some insight as to Marti's capability in this area.

In summary, we welcome your particular problem. For those of you who have clear un-obstructed microwave paths, you have only to purchase the necessary equipment for your particular application to immediately realize the benefits of STL, Remote Control, and Telemetry equipment. To those who have a path problem, we have the capability to help you work it out so that you too can reap the profits by using STL.

Marti Electronics, Inc., operating from modern facilities in Cleburne, Texas, is less than 50 miles from the all new Dallas-Ft. Worth Regional Airport, affording parts and equipment support to all parts of the world in a matter of hours. In addition, all major carriers, including United Parcel Service, Motor Freight Transportation, Rail Express and the U.S. Government Postal Service, are available on a daily basis.

Present day economic factors make STL, Remote Control and Telemetry, well worth looking at, particularly for the AM or FM Broadcaster who looks toward Broadcasting as an interesting and profitable future.

SYSTEM

Specifications For AM Application:

Frequency Response: + or - 1.0 db. from 50 Hz to 12,500 Hz.
 Distortion: 1% or less, 50 Hz to 12,500 Hz.
 Signal to Noise: - 60 db. or better. Ref. 400 Hz. Mod. 100%
 Carrier Frequency Stability: + or - .0005%
 Temperature Range: -30 Degree C to +60 Degree C.

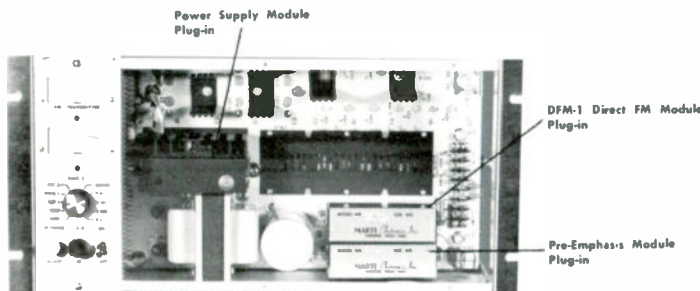

STL-8 Series Transmitter
 Horizontal Mount With Front Cover Removed

SYSTEM

Specifications For FM Application:

Frequency Response: + or - .5 db. from 40 Hz to 15,000 Hz.
 Distortion: 0.6% or less, 50 Hz to 15,000 Hz.
 Signal To Noise: - 65 db. or better. Ref. 400 Hz. Mod. 100%
 Carrier Frequency Stability: + or - .0005%
 Temperature Range: -30 Degree C to +60 Degree C.

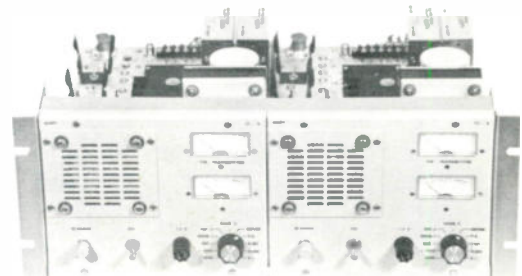

STL-8 Series Transmitter
 Vertical Mount - Stereo Configuration Pictured

Features . . .

- ★ Direct FM Modulator
- ★ All Solid-State
- ★ Field Proven Varactor Final
- ★ Plug-in Modular Construction

- ★ Solid-State Ovens and Hi-Accuracy Crystals
- ★ Automatic Change-over to Standby Transmitter
- ★ RF Sensing for "Out of Status" Alarm Indication
- ★ Current Limiting in Regulated Power Supply

STL-8A SOLID STATE TRANSMITTER SPECIFICATIONS

For AM Broadcast Application

Application	Studio-Transmitter Link (AM) and Inter City Relay
Carrier Frequency Range	942-960 MHz.
RF Power Output	Maximum Licensed power 8 watts, nominal 6 watts. Set at factory
Output Impedance	Nominal 50 ohms
RF Carrier Connector	UG-58A/U (Type N Female)
Carrier Frequency Stability	+ or - .0005% -30°C +60°C (+25°C Ref.)
Type of Modulation	Direct FM 200F3. (200 F9 with remote control and/or Sub Carrier)
Deviation	+ or - 52.5 KHz. (at 400 Hz)
Audio Input	Balanced 600 ohms, + 10DBM (+ or -2DB) for 100% modulation.
Multiplex Inputs	Two BNC Connectors, for Remote Control and Sub Carrier inputs. .5V RMS for 20% Carrier Deviation. 50 to 600 ohms max. unbalanced.
Audio Response	+ or - 1DB, 50 Hz-12,500 Hz.
Distortion	Less than 1% THD, 50 Hz-12,500 Hz.
FM Noise	Better than -60DB below 100% Modulation (400 Hz Ref.)
AM Noise	Better than -55DB below carrier reference.
Power Requirements	115/230 Volts 50-60 Hz. 110 watts.
AC Power Supply	Precision electronically regulated integrated circuit power supply with current limiting. Regulator circuitry contained in plug-in module.
Spurious Emissions	More than 60DB below carrier.
Output Failure Alarm	Adjustable RF output sensing provides fail-safe contact closure for alarm or automatic switching as standard equipment.
Remote Location	Terminals provide for simple remote off-on control of transmitter. Built in RF sensing relay provides remote indication of transmitter status.
Metering	Precision taut-band meters for RF power and circuit testing.
Cooling	Advanced thermal design provides conduction, convection and forced air cooling from high quality fan.
Solid-State Devices	38 Solid-state silicon devices; 11 transistors, 3 varactor diodes, 21 diodes, 2 IC, 1 solid-state proportional temperature control oven.
Dimensions	(Vertical) Panel 7" high x 8 1/2" wide (half rack) x 15" deep. (Horizontal) 8 3/4" x 19" x 8 1/4"
Weight	(Vertical) Transmitter 15.5 lbs. plus 10 lbs. for rack shelf adapter. Rack shelf adapter is 7" x 19". (Horizontal) 20 lbs.

STL-8F SOLID STATE TRANSMITTER SPECIFICATIONS

For FM Broadcast Application

Application	Studio-Transmitter Link, (FM)
Carrier Frequency Range	942-960 MHz.
RF Power Output	Maximum Licensed power 8 watts, nominal 6 watts. Set at factory
Output Impedance	Nominal 50 ohms
RF Carrier Connector	UG-58A/U (Type N Female)
Carrier Frequency Stability	+ or - .0005% -30°C +60°C (+25 C Ref.)
Type of Modulation	Direct FM 200F3. (200 F9 with remote control and/or Sub Carrier)
Deviation	+ or - 52.5 KHz.
Audio Input	Balanced 600 ohms, + 10DBM (+ or -2DB) for 100% modulation.
Multiplex Inputs	Two BNC Connectors, for Remote Control and Sub Carrier inputs. .50, RMS for 20% Carrier Deviation. 50 to 600 ohms unbalanced.
Audio Response	+ or - 0.5 DB, 40 Hz-15000 Hz.
Distortion	Less than 0.6% THD, 50 Hz-15000 Hz.
FM Noise	Better than -65DB below 100% Modulation (400 Hz Ref.)
AM Noise	Better than -55DB below carrier reference.
Power Requirements	115/230 Volts 50-60 Hz. 110 watts.
AC Power Supply	Precision electronically regulated integrated circuit power supply with current limiting. Regulator circuitry contained in plug-in module.
Spurious Emissions	More than 60DB below carrier.
Output Failure Alarm	Adjustable RF output sensing provides fail-safe contact closure for alarm or automatic switching as standard equipment.
Remote Location	Terminals provide for simple remote off-on control of transmitter. Built in RF sensing relay provides remote indication of transmitter status.
Metering	Precision taut-band meters for RF power and circuit testing.
Cooling	Advanced thermal design provides conduction, convection and forced air cooling from high quality fan.
Solid-State Devices	38 Solid-state silicon devices; 11 transistors, 3 varactor diodes, 21 diodes, 2 IC, 1 solid-state proportional temperature control oven.
Dimensions	(Vertical) Panel 7" high x 8 1/2" wide (half rack) x 15" deep. (Horizontal) 8 3/4" x 19" x 8 1/4"
Weight	(Vertical) Transmitter 15.5 lbs. plus 10 lbs. for rack shelf adapter. Rack shelf adapter is 7" x 19". (Horizontal) 20 lbs.

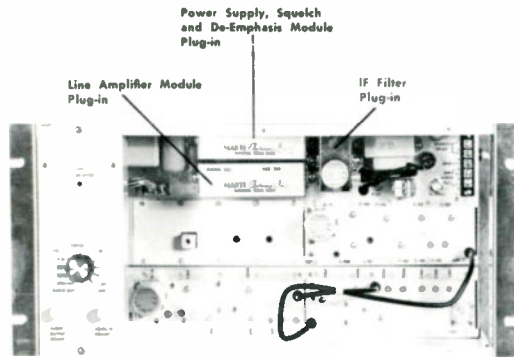

R-200/950 Series Receiver
Horizontal Mount With Front Cover Removed

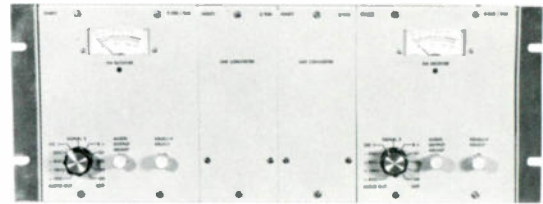

R-200/950 Series Receiver
Vertical Mount - Stereo Configuration Pictured

FOR SYSTEM SPECIFICATIONS, SEE TRANSMITTER DATA SHEET

Features . . .

- ★ All Solid-State
- ★ Plug-in Modular Construction
- ★ Solid-State Ovens and Hi-Accuracy Crystals
- ★ Automatic Change-over to Standby Receiver
- ★ Current Limiting in Regulated Power Supply

R-200/950A SOLID STATE RECEIVER SPECIFICATIONS

For AM Broadcast Application

Application	Crystal controlled, double conversion FM receiver for STL. Companion to STL-8A Transmitter.
Frequency Range	942-960 MHz
Sensitivity	2uv for 20 db S/N ratio 10uv for 50 db 32uv for 60 db
RF Input Impedance	50 ohms UG-58A/U (Type N Female)
Frequency Stability	.0005%—30°C + 60°C (+25°C Ref.) Solid state proportional temperature controlled ovens. 200 KHz for acceptance of 200 F9 modulation.
Selectivity	—70 db
Spurious Response	Balanced 600 ohms. +18 DBM Maximum level
Audio Output	Two type BNC connectors for sub-carrier and/or remote control
Multiplex Output	Adjustable squelch provides N/O and N/C relay contacts for audio muting, fail safe shut-down and alarm circuits as required.
Squelch/Fail Safe/Alarm	115/230 volts 50-60 Hz. 30 watts
Power Requirements	Precision electronically regulated integrated circuit power supply with current limiting protection.
AC Power Supply	Precision taut-band meter with front panel test selector switch
Metering	20 transistors, 23 diodes and 2 integrated circuits.
Solid State Devices	Panel 7" high x 8½" wide (half rack) x 15" deep
Dimensions	(Horizontal) 8¾" x 19" x 8¼"
Weight	(Vertical) Receiver 9 lbs. plus 10 lbs. for rack shelf adapter. Rack shelf adapter is 7" x 19". (Horizontal) 16 lbs.

R-200/950F SOLID STATE RECEIVER SPECIFICATIONS

For FM Broadcast Application

Application	Crystal controlled, double conversion FM receiver for STL. Companion to STL-8F Transmitter.
Frequency Range	942-960 MHz
Sensitivity	2uv for 20 db S/N ratio 10uv for 50 db 32uv for 60 db
RF Input Impedance	50 ohms UG-58A/U (Type N Female)
Frequency Stability	.0005%—30°C + 60°C (+25°C Ref.) Solid state proportional temperature controlled ovens. 200 KHz for acceptance of 200 F9 modulation.
Selectivity	—70 db
Spurious Response	Balanced 600 ohms. +18 DBM Maximum level
Audio Output	Two type BNC connectors for sub-carrier and/or remote control
Multiplex Output	Adjustable squelch provides N/O and N/C relay contacts for audio muting, fail safe shut-down and alarm circuits as required.
Squelch/Fail Safe/Alarm	115/230 volts 50-60 Hz. 30 watts
Power Requirements	Precision electronically regulated integrated circuit power supply with current limiting protection.
AC Power Supply	Precision taut-band meter with front panel test selector switch
Metering	20 transistors, 23 diodes and 2 integrated circuits.
Solid State Devices	Panel 7" high x 8½" wide (half rack) x 15" deep
Dimensions	(Horizontal) 8¾" x 19" x 8¼"
Weight	(Vertical) Receiver 9 lbs. plus 10 lbs. for rack shelf adapter. Rack shelf adapter is 7" x 19". (Horizontal) 16 lbs.

RMC-2AX Radio Remote Control & Telemetry

10-CHANNEL or 24-CHANNEL



RMC-2AX/S STUDIO UNIT

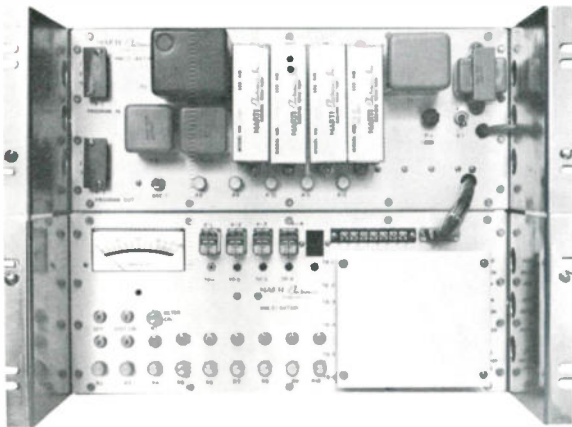

RMC-2AX/T TRANSMITTER UNIT

TO PROVIDE SMOKE AND FIRE ALARM AND UNAUTHORIZED ENTRY DETECTION, SEE PRICE LIST FOR REQUIRED ACCESSORIES.

- ★ Proven Reliability in many installations.
- ★ Solid-State Modular Plug-In Construction
- ★ Proven AM and FM telemetry capability.
- ★ Ten-Turn Vernier Potentiometers for precise adjustment.
- ★ 1% Mirror Scale Taut Band Meters for maximum accuracy.
- ★ Signal Light Channel Indication.
- ★ Auxiliary Control Transmitter Unit.

GENERAL

Designed and approved for AM and FM Sub-Audible Telemetry, the RMC-2AX Remote Control System requires no interface equipment to meet the FCC Rules and Regulations, pertaining to the mixing of the sub-audible telemetry, filtering and prevention of over modulation. These circuits and components are an integral part of the basic studio and transmitter units.

Of all solid-state design and employing modular construction techniques, the RMC-2AX is available as a 22 function system having 10 metering positions, or for the more complex installation, an optional 50 function system with 24 metering positions is available.

Sub-Audible Telemetry is accomplished through the use of a Voltage Controlled Oscillator, with a frequency shift of from 22 to 28 Hz. at a low percentage of modulation, and a Hi-pass filter to prevent the program audio component from modulating the metering channel. Automatic compensation is provided to limit the total modulation to 100% while telemetering.

This same system can be used to meter an FM transmitter, except the FM 67 KHz. Sub-carrier is modulated with the metering information, through a Sub-Carrier Generator, such as the MARTI SCG-8 and is usually recovered at the studio on a Sub-Channel Frequency-Modulation Monitor or on a Multiplex Receiver. The Sub-Carrier may also be used for background music.

SPECIFICATIONS

REMOTE CONTROL FUNCTIONS:

Model RMC-2AXT(10) 10 Raise Commands
10 Lower Commands
Model RMC-2AXT(25) 25 Raise Commands
25 Lower Commands

METERING:

Model RMC-2AXT(10) 10 Telemetering channels including calibration
Model RMC-2AXT(25) 25 Telemetering channels including calibration

METERING INPUT REQUIREMENTS:

1.6 to 2.5 Volts DC, either polarity to ground or referenced above ground not to exceed ± 200 Volts DC. Metering input resistance greater than 12K ohms.

METERING CALIBRATION:

Calibration voltage derived from double regulated Zener Diode, oven temperature controlled. Ten-turn vernier potentiometers provided for all metering adjustments. Four inch mirror scale taut-band 1% accuracy meters provided.

REMOTE CONTROL FREQUENCIES:

For STL: 20 KHZ Dial Function
22.5 KHZ Lower Function
25 KHZ Reset Function
27.5 KHZ Raise Function

TELEMETRY TONE FREQUENCIES:

22 Hz to 28 Hz corresponding to metering sample voltages of 0 to 120% of normal (100%)

TELEMETRY TONE PURITY:

Less than 2% THD at 27 Hz (10 DBM)

TELEMETRY ACCURACY:

$\pm 2\%$ of full scale

TELEMETRY TONE OUTPUT LEVEL:

Adjustable from -35 DBM to +10 DBM

IMPEDANCES:

Program in, program out and telemetry input are all 600 ohms

OPERATING ENVIRONMENT AIR TEMPERATURE RANGE:

-10 C to +40 C

POWER REQUIREMENT:

110 to 125 Volts, 50/60 HZ

DIMENSIONS AND WEIGHT:

RMC-2AXS Studio Unit - 5" x 19" panel, 6 1/4" behind panel
Weight: 14 pounds

RMC-2AXT(10) Transmitter Unit - (2) 7" x 19" panels, 9" behind panel
Total weight: 26 pounds

RMC-2AXT(25) Transmitter Unit - (1) 7" x 19" and (1) 10 1/2" x 19" panel, 9" behind panels
Total weight: 30 pounds

SCA Equipment

SCG-8 SERIES SUB-CARRIER GENERATOR

SCR-8 SERIES SUB-CARRIER RECEIVER



SCG-8 SUB-CARRIER GENERATOR SPECIFICATIONS

Frequency	39 or 67 kHz
Frequency Stability	+ or -500 Hz
Sub-Carrier Purity	Less than 1% THD
Modulation	Direct FM
Modulation Distortion	Less than 1.5%
AF Response	50 Hz. to 6 kHz. + or -1 db
FM Noise	-55 db for + or -5 kHz dev., -50 db for + or -3 kHz dev.
AM Noise	Better than -50 db
Normal Deviation	+ or -3 kHz @ 39 kHz, + or -5 kHz @ 67 kHz.
Pre-Emphasis	75 uSEC
Input Impedance	600 ohm. balanced.
Input Level	Plus 10 DBM, for 100% modulation at 400 Hz.
Output Impedance	Less than 300 ohms, BNC Connector
Output Level	Adjustable up to 1.5 volts RMS
Mute Adjustment	Mute delay adjustable .5 sec. to 5 sec. approx.
Metering	Sub-carrier output, sub-carrier deviation, B+
Sub-Carrier Control	Automatic muting (electronic), manual on-off
RF Filtering	Designed for use in high RF fields.
Power Requirements	120/240 VAC, 50/60 Hz. 10 watts
Temperature Range	-20°C to +50°C
Size	3 1/2"x19" (Standard rack mount) 5 1/2" deep
Weight	7 1/2 pounds net

SCR-8 SUB-CARRIER RECEIVER SPECIFICATIONS

Frequency	39 to 67 kHz
Type of Reception	FM sub-carrier (+ or -3 kHz at 39 kHz, + or -5 kHz at 67 kHz.)
Input Impedance	5000 ohms unbalanced
Input Level	20 MV minimum 39 or 67 kHz
Audio Output Impedance	600 ohms balanced
Audio Output Level	+18 DBM Maximum
Metering	Output Level +4 VU, +10 VU, B+
Sub-Carrier Control	Automatic muting, manual on-off, mute level adjust (Pot.)
Squelch Relay	Auxiliary contacts terminated for sub-carrier control of other equipment.
RF Filtering	Designed for use in high RF fields
Power Requirements	120/240 VAC, 50/60 Hz. 10 watts
Temperature Range	-20°C to +50°C
Size	3 1/2"x19" (Standard rack mount) 5 1/2" deep
Weight	7 1/2 pounds net

39 kHz SYSTEM SPECIFICATIONS

Response	+ or -1 db, 50 Hz. to 6 kHz.
Distortion2% THD
Noise45 db below. + or -3 kHz dev. @ 400 Hz. ref.

The SCG-8 Sub-Carrier Generator and the SCR-8 Sub-Carrier Receiver are intended to be used in conjunction with the 950 MHz. Aural STL, to transmit any type of auxiliary program material from the studio to the transmitter location, via one of the sub-channels of the Link. Used primarily to transmit Background Music material, they can be used equally as well to provide a telephone communications circuit to the transmitter, with the proper auxiliary equipment.

The SCG-8 Sub-Carrier Generator can also be used with most FM Broadcast Transmitters, to inject either Background Music onto the 41 or 67 KHz. FM Sub-Carrier. Many stations which are using Radio Remote Pickup

equipment, prefer to move their Base Receiving Antenna and Remote Pickup Receiver, to the FM Transmitter site and feed the RPU audio back to the studio via the 67 KHz., in order to achieve maximum tower height for the RPU antenna. When using the SCG-8 Generator to feed the RPU audio to the studio, the audio is recovered on a Sub-Channel Frequency-Modulation Monitor for re-processing.

Both Generator and Receiver are supplied with an extremely sharp 6 KHz. Low-Pass Filter to prevent sub to main crosstalk. Extreme care has been exercised to insure extensive shielding and filtering, for operation in high RF fields.

STUDIO-TRANSMITTER LINK & INTER-CITY RELAY — 950 MHZ.**TRANSMITTERS & ACCESSORIES**

STL-8A/H Transmitter, 8 watt, complete with crystal and tuned to frequency. 120 VAC. 8¾" x 19" Horizontal Rack construction. Complete with Low-Pass Filter. For AM Broadcast application.	\$1228.50
STL-8A/V Transmitter. Same as above except Vertical chassis construction for mounting in 7" x 19" Rack Shelf. Rack Shelf is included as part of Transmitter.	1228.50
STL-8F/H Transmitter, 8 watt, complete with crystal and tuned to frequency. 120 VAC. 8¾" x 19" Horizontal Rack construction. Complete with Low-Pass Filter. For FM Broadcast application.	1395.00
STL-8F/V Transmitter. Same as above except Vertical chassis construction for mounting in 7" x 19" Rack Shelf. Rack Shelf is included as part of Transmitter.	1395.00
ASO-8A Automatic Switchover Unit for "hot Standby" switching between two STL-8 Series transmitters. 120 VAC. Rack mount. 3½" x 19".	280.00
CLA-40A Compressor/Limiter Amplifier. 120 VAC. Rack Mount, 3½" x 19".	445.00
HRC-8 Transmitter Combiner. For combining the outputs of two STL-8 Series transmitters into common antenna system. Furnished complete with inter-connect cables to transmitters.	175.00
DCK-8 DC Interface Panel to allow two STL-8 Series transmitters to operate from a 24 volt DC source. Batteries, relay and any battery charging equipment is not included. Rack mount 3½" x 19"	115.00

RECEIVERS & ACCESSORIES

R200/950A/H Receiver, complete with crystal and tuned to frequency. 120 VAC. Complete with Low-Pass Filter. 8¾" x 19" Horizontal Rack construction. For AM Broadcast application. Includes Down Converter.	\$845.00
R-200/950A/V Receiver. Same as above except Vertical chassis construction for mounting in 7" x 19" Rack Shelf. Rack Shelf is included as part of Receiver.	845.00
R200/950F/H Receiver, complete with crystal and tuned to frequency. 120 VAC. Complete with Low-Pass Filter. 8¾" x 19" Horizontal Rack construction. For FM Broadcast application. Includes Down Converter.	875.00
R-200/950F/V Receiver. Same as above except Vertical chassis construction for mounting in 7" x 19" Rack Shelf. Rack Shelf is included as part of Receiver.	875.00
ASO-200A Automatic Switchover Unit for "hot standby" switching between two R-200/950 Series receivers. 120 VAC. Rack mount. 3½" x 19".	250.00
MTS-1 Matching "T" Section. For combining the inputs of two R-200/950 Series receivers from a common antenna system.	75.00
MRA-1 RF Pre-Amplifier. 120 VAC & 12 VDC.	175.00
DCK-200 DC Interface Panel to allow two R-200/950 Series receivers to operate from a 24 volt DC source. Batteries, relay and any battery charging equipment is not included. Rack mount 3½" x 19".	79.50

REMOTE CONTROL & ACCESSORIES

RMC-2AX(10) Remote Control System, 10-channel, solid-state. Complete with Studio & Transmitter units. Rack mount. 120 VAC.	\$1295.00
RMC-2AX(24) Remote Control System, 24-channel, solid-state. Complete with Studio & Transmitter units. Rack mount. 120 VAC.	1645.00
RBS-2 Security Monitor Unit. For Interfacing Unauthorized Entry Detection, Fire & Smoke Detection. To RMC-2AX Remote Control System.	135.00
#2736 Rangaire Smoke & Heat Detector. Actuates when heat of 135° or smoke is detected. Use with RBS-2.	79.90
#2728 False Entry Magnetic Alarm Switch. For use on doors & windows. Use with RBS-2.	4.80
NOTE: Please specify number of doors and windows to be protected.	
#2735 Entrance Delay Control. Delays alarm while leaving or entering building.	19.00
#2731 Key Shunt Switch. Used to activate #2735 Delay Control while making authorized entry to building.	9.00
DA-1 DC Operational Amplifier. Complete with AC power supply. Used to increase meter sampling voltage to Remote Control System.	125.00

SUB-CARRIER GENERATORS & RECEIVERS

SCG-8H Sub-Carrier Generator, solid-state, tuned to 39 or 67 khz. 120 VAC. Complete with Mute Module. 3½" x 19" Horizontal Rack construction.	\$395.00
SCG-8V Sub-Carrier Generator. Same as above except Vertical chassis construction for mounting in 7" x 19" Rack Shelf. Rack Shelf must be purchased additionally. See Accessories.	395.00
SCR-8H Sub-Carrier Receiver, solid-state, tuned to 39 or 67 khz. 120 VAC. 3½" x 19" Horizontal Rack construction.	250.00
SCR-8V Sub-Carrier Receiver. Same as above except Vertical chassis construction for mounting in 7" x 19" Rack Shelf. Rack Shelf must be purchased Additionally. See Accessories.	250.00

MONITOR, PROGRAM AND RF AMPLIFIERS

PGM-20 Program Amplifier. 120 VAC. 3½" x 19" Rack mount.	\$142.45
MA-10 Monitor Amplifier. 120 VAC. 3½" x 19" Rack mount. Complete with Speaker Muting Relay.	95.20
TRF-1AGC Wilkinson AM RF Amplifier, Rack mount, 120 VAC.*	475.00
RFA-4 National Electrolab Associates AM RF Amplifier. Rack mount, 120 VAC.*	750.00
RFA-2 Belar AM RF Amplifier. Rack mount. 120 VAC.*	450.00
RFA-1 Belar FM RF Amplifier. Rack mount. 120 VAC.*	400.00
TBM-2500C FM RF Amplifier. Rack mount. 120 VAC.*	485.00
A-72-SF5 Yagi Antenna, 5-element. For use with TBM-2500C.	14.95
TBM-2000A Sub-Channel Frequency-Modulation monitor. Rack mount, 120 VAC.*	1200.00
SCM-1 Belar Sub-Channel Frequency-Modulation monitor. Rack mount, 120 VAC.*	1250.00

NOTE: *Advise main channel frequency where applicable.

ADDITIONAL ACCESSORIES

RMH-1 Rack Mounting Shelf. To house vertical type chassis equipment.	\$25.00
---	---------

ANTENNAS & ACCESSORIES

Mark Products MG-944GN Cylindrical Parabolic Antenna, multi-element grid construction, 13.5 db. gain (over isotropic). Complete with mounting clamps. Type N Female termination.	\$117.00
Decibel Products DB-496 Cylindrical Parabolic Antenna, screen grid construction, 13.5 db. gain (over isotropic). Complete with mounting clamps. Type N Male termination.	125.00

Mark Products P-948G Parabolic Antenna, 4' multi-element grid construction, 18.9 db. gain (over isotropic). 7/8" EIA Flange termination. Pressurized Feed.	300.00
Andrew P4-9C Parabolic Antenna, 4' spun aluminum solid construction, 19 db. gain (over isotropic). 7/8" EIA Flange termination. Pressurized Feed.	330.00
Scala PR-450 Paraflector Antenna, grid construction, 17.5 db. gain (over dipole). Type N Female termination. Complete with mounting clamps.	290.00
Mark Products P-972G Parabolic Antenna, 6' multi-element grid construction, 22 db. gain (over isotropic). 7/8" EIA Flange Termination with 90 degree Mitre Elbow. Pressurized Feed.	450.00
Andrew P6-9C Parabolic Antenna, 6' solid spun aluminum construction, 22 db. gain (over isotropic). 7/8" Flange termination. Pressurized Feed.	420.00
Mark Products P-996G Parabolic Antenna, 8' multi-element grid construction, 25 db. gain (over isotropic). 7/8" Flange termination with 90 degree Mitre Elbow. Pressurized Feed.	750.00
Mark Products P-9120G Parabolic Antenna, 10' multi-element grid construction, 27 db. gain (over isotropic). 7/8" EIA Flange termination with 90 degree Mitre Elbow. Pressurized Feed.	900.00
Andrew P10-9C Parabolic Antenna, 10' solid spun aluminum construction, 26.8 db. gain (over isotropic). 7/8" Flange termination. Pressurized Feed.	1290.00
Mark Products K-9629 Universal Tilt Mount Kit for P-948G Antenna.	30.00
Mark Products K-9631 Universal Tilt Mount Kit for P-972G Antenna.	78.00
Mark Products K-9632 Universal Tilt Mount Kit for P-996G and P-9120G Antennas.	96.00
Andrew T6 Vertical Mount Kit for P4-9C and P6-9C Antennas.	113.00
Andrew T10A Vertical Mount Kit for P10-9C Antenna.	205.00
Decibel Products DB-4096 Duplexer, 6-cavity. For combining Transmitter & Receiver into common antenna and transmission line. 3.6 MHz., minimum separation required.	375.00
Phelps Dodge Selective Cavity Resonator, single section.	85.00

TRANSMISSION LINE & ACCESSORIES

Foam Transmission line, 1/2", 50 ohm, jacketed.	PER FT.	\$ 0.72
Type N Jack (Female) Connector for 1/2" foam line.		7.20
Type N Plug (Male) Connector for 1/2" foam line.		7.20
Splice for 1/2" foam line.		26.00
Foam Transmission Line, 7/8", 50 ohm, jacketed.	PER FT.	1.84
Type N Jack (Female) Connector for 7/8" foam line.		19.50
Type N Plug (Male) Connector for 7/8" foam line.		19.50
Splice for 7/8" foam line.		30.00
Air Dielectric Transmission Line, 7/8", 50 ohm, jacketed.	PER FT.	2.26
Mitre Elbow, 90 degree, with EIA Flanges, 7/8".		39.00
EIA Flange, 7/8". Without Gas Barrier.		30.00
EIA Flange, 7/8". With Gas Barrier.		49.00
Type N Jack (Female) Connector for 7/8" Air line.		25.00
Type N Plug (Male) Connector for 7/8" Air line.		30.00
Splice for 7/8" Air line.		33.00
PG-4B Jumper Cable. 4' RG-8U with Type N Male (UG-21C/U) Connectors.		6.45

Prices of those items not manufactured by Marti Electronics, Inc., are subject to change without notice and will be invoiced at prices in effect at time of shipment.

All prices quoted are FOB, Cleburne, Texas or Point of Shipment.

Typical Packages – AM & FM

A—MONO PROGRAM ONLY— AM

(Not to exceed 12 Airmiles)

- 1 — STL-8A Transmitter
- 1 — CLA-40/A Compressor/Limiter Amplifier
- 1 — R-200/950A Receiver
- 2 — MG-944 Cylindrical Parabolic Antenna
- 4 — 44AN Type N Jack, 1/2", Female
- 4 — PG-4B Jumper Cable
- PLUS NECESSARY 1/2" FOAM TRANSMISSION LINE

B—MONO PROGRAM ONLY— FM

(Not to exceed 20 Airmiles)

- 1 — STL-8F Transmitter
- 1 — CLA-40/A Compressor/Limiter Amplifier
- 1 — R-200/950A Receiver
- 2 — P-948G Parabolic Antenna
- 2 — K-9629 Tilt Mount Kit
- 2 — 1060 Mitre Elbow
- 2 — 75AR EIA Flange
- 2 — 75AN Type N Jack
- 2 — PG-4B Jumper Cable
- PLUS NECESSARY HJ5-50 TRANSMISSION LINE

C—STEREO PROGRAM ONLY— FM

(Not to exceed 15 Airmiles)

- 2 — STL-8F Transmitters
- 2 — CLA-40/A Compressor/Limiter Amplifier
- 2 — R-200 950F Receivers
- 2 — P-948G Parabolic Antenna
- 2 — K-9629 Tilt Mount Kit
- 1 — HRC-8 Transmitter Combiner
- 1 — MTS-1 Matched Precision "T" Section
- 2 — 1060 Mitre Elbow
- 2 — 75AR EIA Flange
- 2 — 75AN Type N Jack
- 2 — PG-4B Jumper Cable
- PLUS NECESSARY HJ5-50 TRANSMISSION LINE

To Add Remote Control and Telemetry to Package "A", "B" or "C"

- 1 — RMC-2AX Remote Control, 10 channel. (24-channel optional.) (Note 1)

To Add an SCA or Auxiliary Program Channel to Package "A," "B" or "C"

- 1 — SCG-8H Sub-Carrier Generator
- 1 — SCR-8H Sub-Carrier Receiver
- 1 — CLA-40/A Compressor/Limiter Amplifier.

NOTE 1: Where additional metering and control functions are required in Remote Control application, a 24-channel system is also available.

NOTE 2: Main channel modulation cannot be remotely metered, therefore it is necessary to move the Modulation Monitor to the studio and drive it with an RF Amplifier. This applies to both AM & FM.

NOTE 3: Additional items are required to complete the Telemetry circuit on either the AM Carrier or the 41 or 67 KHz. FM Sub-Carrier. These items have not been listed as part of the equipment package as in many cases, they are already on hand and need not be purchased. These would include an AM RF Amplifier for AM Sub-Audible Telemetry, an FM RF Amplifier & Antenna, FM Sub-Channel Frequency-Modulation Monitor and a Sub-Carrier Generator for SCA Telemetry.

In some cases, Program Amplifiers and Matching Transformers are also required, depending upon the type of Modulation Monitor used.

SIMPLIFIED SYSTEM DIAGRAM FOR FM STEREO, SCA, REMOTE CONTROL & TELEMETRY

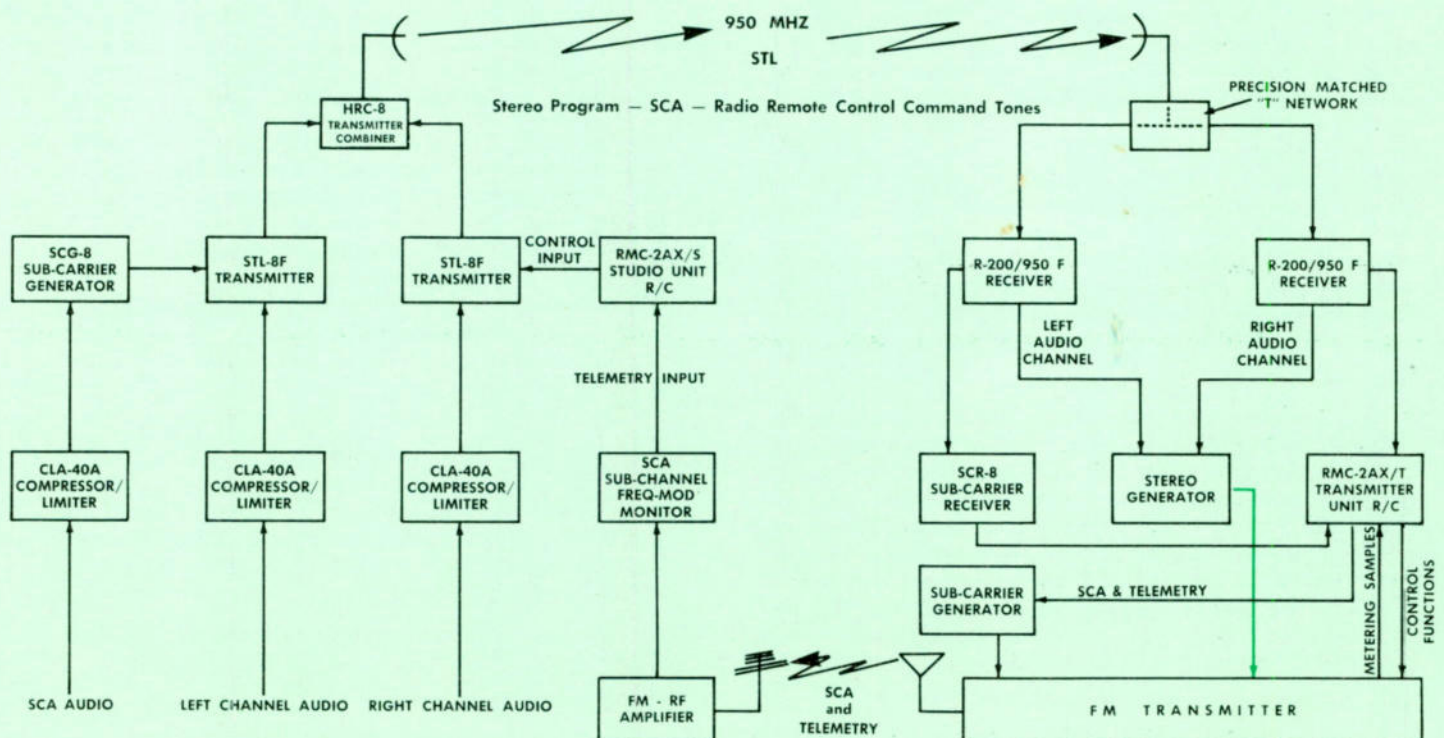

Engineering Information

TRANSMISSION LINE LOSSES PER 100' AT 950 MHZ.

Type of Line	Loss in DB.
1/2" Foam	3.2
1/2" Air	2.7
7/8" Foam	1.9
7/8" Air	1.2
1 1/8" Air	.65

FADE ALLOWANCE RELIABILITY

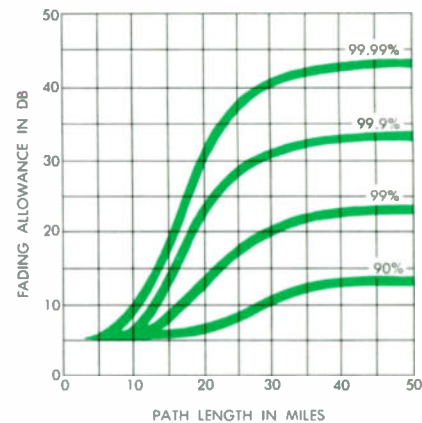

THE FOLLOWING INFORMATION WILL PROVIDE A PREDICTED SIGNAL-TO-NOISE RATIO WITH RESPECT TO A SIGNAL LEVEL IN DB ACROSS 50 OHMS, WHEN COMPARED WITH A SIGNAL STRENGTH IN VU.

Signal Level in DBW across 50 Ohms	Signal Strength in Microvolts	Signal to Noise Ratio
-78 DB.	1000.0	Better than -60 DB.
-83 DB.	500.0	Better than -60 DB.
-87 DB.	320.0	Better than -60 DB.
-97 DB.	100.0	Better than -60 DB.
-107 DB.	32.0	Minus 60 DB.
-117 DB.	10.0	Minus 50 DB.
-127 DB.	3.2	Minus 40 DB.
-131 DB.	2.0	Minus 30 DB.

The Engineering Information shown above will be of value in a preliminary determination of predicted transmission line losses with the various types of transmission line, the fade allowance required over a given path with a predetermined Reliability Factor, and will provide some insight as to the quality that could be expected from the audio program channel under various factors. Complete engineering information is available from Marti Electronics simply by asking for Engineering Bulletin #103. This bulletin contains extensive information relative to the computation of the 0.6 Fresnel Zone Clearance over varying path lengths, Free Space Attenuation charts and graphs, Translation of Received Power to Microvolts, Related Power Outputs of Transmitters, 4/3 Earth Curvature Profile Maps and other pertinent information relative to the complete evaluation of a microwave path.

A word about clearance—The amount of clearance required and which is dictated by the 0.6 Fresnel Zone computations will vary with path distance. This is not to be misconstrued as to be clearance over ground elevations along the path, but it is to be considered as clearance above all obstructions. Of particular importance are heavily forested areas, water towers, grain elevators, hi-rise buildings and paths over water. Such factors as grazing loss, temperature inversion and multipath require serious consideration.

A word about Reliability Factor — When a system is engineered by Marti Electronics, particular attention is paid to path distance, clearance, transmission line loss, antenna gain, transmitter gain, combiner losses, and most important, RELIABILITY. We do not believe that the same size of antenna and the same type of transmission line will be adequate for all path distances. Experience has proven otherwise.

The application of a Studio-Transmitter Link takes on an entirely different approach from an Inter-City Relay system for example, which only feeds a program for a limited time. When designing an STL system, we program a Reliability Factor of 99.99%. This means that out of a 24-hour program day (86,400 Sec.), the signal **could** deteriorate to something just less than the **normal** program quality for a period of 9 seconds, and this 9-second period would not necessarily have to occur all at one time but could be accumulative over the 24-hour period.

Inter-City Relay, on the other hand, requires less of a Reliability Factor. Still, we program an Inter-City Relay system to have a 99.9% Reliability Factor, which means that out of a 24-hour period, some 87 seconds might be expected to produce something just less than normal program quality.

In both cases this is not UNACCEPTABLE PROGRAM QUALITY; it is less than normal program quality.

PLEASE WRITE OR CALL MARTI ELECTRONICS FOR ENGINEERING BULLETIN #103

Antennas

P-SERIES PARABOLA 950 MHZ



MARK PRODUCTS offers a full line of MULTI - ELEMENT GRID PARABOLAS for point to point relay operation in the 950 MHz. frequency range. The patented construction techniques allow for an extremely

rigid and strong parabolic structure having low weight and low wind loading characteristics. Standard units of the grid parabolas are 4, 6, 8, 10, and 15 feet in diameter. Most models can be supplied with either pressurized or non-pressurized feed.

MODEL	P-948G	P-972G	P-996G	P-9120G	P-9180G
FREQ. RANGE MHz.*	890-960	890-960	890-960	890-960	890-960
DIAMETER	4 feet	6 feet	8 feet	10 feet	15 feet
GAIN OVER ISOTROPIC	18.9 DB	22 DB	25 DB	27 DB	30 DB
BEAM WIDTH: H-Plane	17.8-deg.	10-deg.	9-deg.	7-deg.	4.7-deg.
3 DB Points E-Plane	19.8-deg.	11-deg.	10-deg.	8-deg.	5.2-deg.
FRONT-TO-BACK RATIO	28 DB	28 DB	29 DB	30 DB	30 DB
MAXIMUM SIDE LOBE	-21 DB	-22 DB	-22 DB	-22 DB	-22 DB
WIND THRUST 100 MPH	110 lbs.	250 lbs.	500 lbs.	700 lbs.	1200 lbs.
NET WEIGHT	25 lbs.	46 lbs.	83 lbs.	120 lbs.	330 lbs.
CONSTRUCTION	Multi-Element Open Grid Parabolic Design				

* Specify operating frequency. All gains listed for parabolic antennas are relative to isotropic radiator at midband.

NOTE 1: The above specifications all apply to grid type antennas as pictured. Solid spun aluminum antennas also available on request for specific applications. Weight and windloading specifications will increase for solid antennas.

NOTE 2: Heaters and radomes also available for above antennas on request.

NOTE 3: 90 degree mitre elbows are furnished as part of 6, 8, 10 and 15' antennas but must be purchased separately for 4' antenna.

NOTE: Antennas, mounts and radomes from other manufacturers such as Andrew, Decibel Products, Communications Products, and Scala, available upon request.

MG - 944GN CYLINDRICAL PARABOLIC

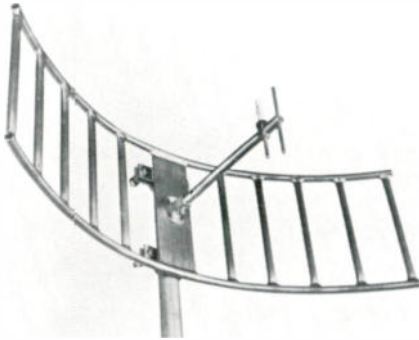

SPECIFICATIONS

Electrical:

Frequency: 940 - 960 MHz.
 Gain: 13.5 dbi
 Max. Minor Lobe Ratio: 15 db
 Impedance: 50 Ohm
 VSWR: 1.3:1 Max. across band
 Horizontal Beam Width (1/2 Power): 18° Max.
 F/B Ratio: 20 db.
 Maximum Power: 100 Watts
 Termination: "N" Female (UG-58)

Mechanical:

Weight:
 Net: 7 lbs.
 Domestic Pack: 12 lbs.
 Export Pack: 31 lbs.

Dimensions:

Width: 44"
 Height: 13 1/2"
 Depth (incl. feed and mounting): 17"
 Wind Survival: 150 MPH
 Wind, operational (w/1/2" radial ice): 100 MPH

Simplified "U" bolt mounting makes for quick, easy installation to round members up to 2 3/8" diameter.

VSWR is better than 1.3:1 across the band

The Mark "Mini-Grid" provides a low cost installation for "short haul" applications

Mark Products Company offers this new Heliarc-welded aluminum Multi-element grid parabolic section antenna in the 940 to 960 Mhz. frequency range.

The unique grid construction is patterned after the patented grid construction used on all Mark full-sized grid parabolas. The "Mini-Grid" is very light weight, yet extremely strong and rigid. Wind loading is less than 25% of a comparable solid parabolic section.

Feed components are constructed of heavily plated solid brass, and the active element of the radiator is protected by a durable Teflon feed housing to assure long life with trouble-free non-pressurized operation.

Transmitter Combiner

HRC-8



This device is commonly used for combining two STL transmitters into a common antenna and transmission line system. While used primarily for FM Stereo application in the "Split" or "Dual" channel system, it can also be used in "Hot Standby" application. The combiner presents a 3 db. loss to the system, but in most cases is less expensive than using separate antenna and transmission line systems. More than adequate isolation is maintained between transmitters and the combiner has a 20 watt resistive load built in. A special Precision cut "T" matching section is available for receivers, also presenting a 3 db. loss.

Engineering Information

CHART #1 — TYPICAL STL SYSTEMS — AM. (Based on Minimum 0.6 Fresnel Zone Clearance)

	5 MI.	10 MI.	15 MI.	20 MI.	30 MI.
Path Loss (Isotropic) in DB.	-109.0	-115.0	-118.0	-121.0	-124.0
Total Line Loss in DB.	6.4	7.25	4.75	5.75	5.0
Total Antenna Gain in DB.	27.0	27.0	38.0	41.0	44.0
Transmitter Gain in DBW.	8.0	8.0	8.0	8.0	8.0
Type of Transmission Line.	1/2" Foam	1/2" Foam	7/8" Foam	7/8" Foam	7/8" Air
Length of Transmission Line. (Estimated)	200'	230'	250'	300'	400'
Normal Signal at Receiver in DBW.	-80.4	-87.25	-76.75	-77.75	-77.5
Equivalent in Microvolts.	725.0	280.0	1100.0	900.0	950.0
Fade Allowance for 99.99% Rel. in DB.	6.0	10.0	20.0	32.0	41.0
Signal at Receiver in DBW. with Fade.	-86.4	-97.25	-96.75	-109.75	-118.50
Equivalent in Microvolts.	350.0	90.0	110.0	25.0	*9.0
Safety Factor in DB., for 50 DB, S/N.	30.6	19.75	20.25	7.25	*None

***NOTE #1:** Generally, a 30 mile microwave circuit is used principally for Inter-City Relay Service, where a 99.99% Reliability Factor is not required. Inter-City Relay Service requires only a 99.9% Reliability Factor which reduces the required Fade Allowance. If it is actually an STL application, additional antenna gain, or a reduction in transmission line loss would have to be provided. In such a case, Marti Electronics should be consulted for engineering information relative to a proper antenna and transmission line system.

CHART #2 TYPICAL STL SYSTEMS - FM - MONO. (Based on Minimum 0.6 Fresnel Zone Clearance)

	5 MI.	10 MI.	15 MI.	20 MI.	30 MI.
Path Loss (Isotropic) in DB.	-109.0	-115.0	-118.0	-121.0	-124.0
Total Line Loss in DB.	2.5	2.75	3.0	3.5	5.0
Total Antenna Gain in DB.	34.0	38.0	38.0	44.0	47.0
Transmitter Gain in DBW.	8.0	8.0	8.0	8.0	8.0
Type of Transmission Line.	7/8" Air	7/8" Air	7/8" Air	7/8" Air	7/8" Air
Length of Transmission Line. (Estimated)	200'	230'	250'	300'	400'
Normal Signal at Receiver in DBW.	-69.5	-71.75	-75.0	-72.5	-74.5
Equivalent in Microvolts.	2250.0	1800.0	1250.0	1725.0	1350.0
Fade Allowance for 99.99% Rel. in DB.	6.0	10.0	20.0	32.0	41.0
Signal at Receiver in DBW. with Fade.	-75.5	-81.75	-95.0	-104.5	-115.5
Equivalent in Microvolts.	1200.0	550.0	125.0	42.5	*11.5
Safety Factor in DB., for 60 DB, S/N.	31.5	25.25	12.0	2.5	*None

*See Note #1

CHART #3 - TYPICAL STL SYSTEMS - FM STEREO. (Based on a Minimum 0.6 Fresnel Zone Clearance)

	5 MI.	10 MI.	15 MI.	20 MI.	30 MI.
Path Loss (Isotropic) in DB.	-109.0	-115.0	-118.0	-121.0	-124.0
Total Line Loss in DB.	2.5	2.75	3.0	3.5	5.0
Total Combiner Loss in DB.	6.0	6.0	6.0	6.0	6.0
Total Antenna Gain in DB.	38.0	38.0	41.0	47.0	50.0
Transmitter Gain in DBW.	8.0	8.0	8.0	8.0	8.0
Type of Transmission Line.	7/8" Air	7/8" Air	7/8" Air	7/8" Air	7/8" Air
Length of Transmission Line. (Estimated)	200'	230'	250'	300'	400'
Normal Signal at Receiver in DBW.	-71.5	-77.75	-78.0	-75.5	-77.5
Equivalent in Microvolts.	1850.0	900.0	890.0	1175.0	950.0
Fade Allowance for 99.99% Rel. in DB.	6.0	10.0	20.0	32.0	41.0
Signal at Receiver in DBW. with Fade.	-76.5	-87.75	-98.0	-107.5	-118.5
Equivalent in Microvolts.	1050.0	280.0	85.0	32.0	*9.0
Safety Factor in DB., for 60 DB, S/N.	30.5	19.25	9.0	None	*None

*See Note #1

EXAMPLE OF SYSTEM COMPUTATION — FM STEREO. (Based on a Minimum 0.6 Fresnel Zone Clearance)

Path Loss (Isotropic) — 12 Airmiles	-116.50 DBI
Transmission Line Loss — 250' (Estimated) 7/8" Air	3.00 DB
Combiner Loss	6.00 DB.
Total System Loss (Before Fade Allowance)	-125.50 DB.
Antenna Gain — 2 (Two) P-948G @ 18.9 DB. each	37.80 DB.
Transmitter Gain — STL-8 Series, 8 watt (Compared to 1 watt)	8.00 DB.
Total System Gain	+45.80 DB.
Net Signal Strength at Receiver Terminals (Loss Minus Gain)	-79.70 DBW.
Interpolation — -79.70DB equals	725.00 UV.
Recommended Fade Allowance for 99.99% Reliability	15.00 DB.
Net Signal Strength at Receiver Terminals With Fade (-79.70 + 15.0)	-94.70 DBW.
Interpolation — -94.70 DB. equals	130.00 UV.

NOTE: The Marti R-200 950 Receiver requires only 32 microvolts to maintain a 60 DB. or better Signal-To-Noise Ratio Program Channel. Since a -107.00 DBW is the equivalent of 32 microvolts, even with a 15 DB fade, the signal would only fade to a -94.70 DBW which would leave a Safety Margin in the system of 12.30 DB. (107.0-94.7), which could be considered as **additional** fade margin, over and above the required fade margin.

Accessories

CLA-40/A Compressor/Limiter Amplifier

Recommended for use between the output of the audio control console and the input to the STL transmitter to prevent over modulation of the Link, the CLA-40/A Compressor/Limiter, is perhaps the most versatile audio processing device to be found on the market today. Combining the functions of Limiting, Compression, Expansion and Automatic Gain Control, the CLA-40/A fills a variety of requirements formerly accomplished by several different devices. Compatible with either AM or FM broadcast application, it can be used in either mode of operation, simply by switch selection. For stereo application, two CLA-40/A Amplifiers are strapped together and checked out as a stereo device. The amplifier may be operated in either the symmetrical or asymmetrical limiting mode. A switch is provided on the front panel for defeating the compress-limit action for proof of performance tests.



ASO-8 Automatic Switchover Unit

The ASO-8 and ASO-200 Automatic Switch-Over Units have been designed and are in use for complete back-up protection in "Hot-Standby" application, where "lost air time" is of major importance. These units, designed around power sensing and squelch relays, will automatically switch to a standby transmitter or receiver, in case of a malfunction in either or both units. Front panel controls allow selection of "Alternate" or "Main" transmitters or receivers, for maintenance or "off air" testing. The ASO-8 is designed for use with the STL-8 series transmitter, while the ASO-200 is for use with the R-200/950 series receiver.

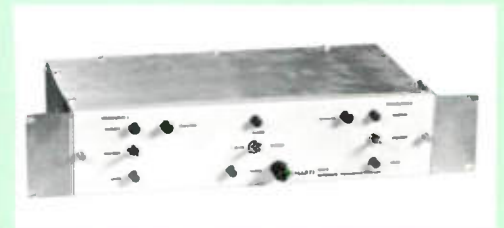

MRA-1 RF Pre-Amplifier

Where a small amount of additional gain is desirable in the overall STL system, the MRA-1 RF Pre-amplifier is ideal. A two-stage solid-state pre-amplifier, it will provide approximately 12 db. additional gain to any STL receiver. Usually mounted either at the receiving antenna, or just ahead of the receiver itself, the pre-amp operates from either a 120 VAC or 12 VDC source of power. For marginal paths and where fade allowances are not quite adequate, the MRA-1 provides an inexpensive means of adding additional signal to the receiver. When used at the antenna, weatherproof enclosures and AC or DC power facilities must be provided.



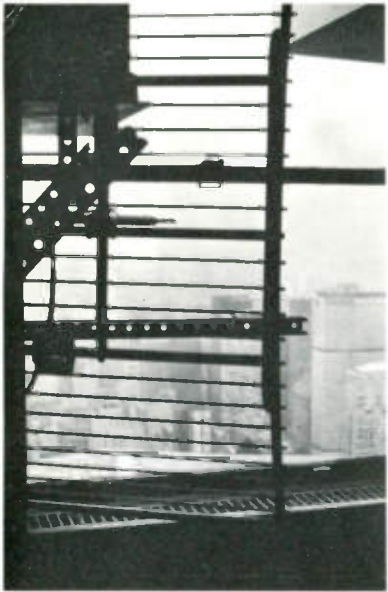

WNBC, New York City. Scala Paraflector mounted inside Empire State Building to AM transmitter site. With "Hot Standby."



WFAA, Dallas, Texas. FM Stereo to Cedar Hill (18 airmiles) to TV-FM site. Using 7 GHz. Passive Reflector.



WBAP - Fort Worth - WFAA - Dallas. Isolation techniques on 3-tower Directional AM Northlake Texas site. WBAP, 50 KW Non-Directional, WFAA, 5 KW DA-2. Sharing same antenna system. Both with "Hot Standby."



KLIF-AM - KNUS-FM - Dallas. Relay facilities using passively Coupled Antenna system to Chalk Hill. FM Stereo Program dropped at Chalk Hill. AM program split at Chalk Hill with 7 watts going to Rockwall, daytime 50 KW site and 1 watt going to Irving, 5 KW Nitetime site. AM Program with "Hot Standby" all the way through system.

REMOTE PICKUP AMPLIFIER MODEL RPA-1



The Model RPA-1 Remote Pickup Amplifier is designed to operate in conjunction with the RPL-2 series Transmitter. Functioning as an audio mixer and control head, the RPA-1 Remote Pickup Amplifier simplifies remote broadcasts using the RPL-2 Remote Pickup Link. As audio mixing is not accomplished in the Transmitter, the RPL-2T can be situated at any convenient location. One single multiconductor cable is required to interconnect the RPA-1 and RPL-2T. The low profile of the RPA-1 does not obstruct the field of vision of operating personnel. An internal audio limiter assists in level control and prevention of overmodulation of the RPL-2T Transmitter. Control and metering functions of the RPL-2T Transmitter are also accomplished with the RPA-1. A meter switch enables the monitoring of the RPL-2T internal power supplies, collector voltage of the final RF stage transistors, and relative RF power output. Request Bulletin 230 for full details on the RPA-1 Remote Pickup Amplifier.

specifications

Mixing Channels	3 (2 microphones and 1 line input)
Frequency Response	+0.4 db to -0.8 db, 50 Hz to 15,000 Hz
Distortion	Less than 0.5% at normal output, 50 Hz to 15,000 Hz
Signal-to-Noise Ratio	Better than 60 db
Peak Limiter	Control range approximately 20 db, attack time 1 millisecond
Power Requirements	120 VAC, 50 — 60 Hz; 11.5 VDC to 16 VDC; or internal battery holder
Size	3 3/4 inches high, 12 inches wide, 11 inches deep

Specifications subject to change without notice

ORDERING INFORMATION

When ordering, please specify operating frequency.

RPL-2T/150 All Solid-State Remote Pickup Transmitter, with internal AC and DC power supplies, for operation in the 160 MHz band. Tuned and tested on one operating frequency.

RPL-2T/450 All Solid-State Remote Pickup Transmitter, with internal AC and DC power supplies, for operation in the 450 MHz band. Tuned and tested on one operating frequency.

RPL-2R/150 All Solid-State Remote Pickup Receiver, with internal AC power supply, for operation in the 160 MHz band. Tuned and tested on one operating frequency.

RPL-2R/450 All Solid-State Remote Pickup Receiver, with internal AC power supply, for operation in the 450 MHz band. Tuned and tested on one operating frequency.

For two-frequency operation, order additional crystal set. Frequencies must be spaced less than 120 kHz apart for the RPL-2/150, and less than 360 kHz apart for the RPL-2/450.

Antenna and transmission line available to fulfill individual requirements. Horizontally and vertically polarized, fixed and mobile, directional and non-directional antennas available. All standard transmission lines available. Please advise your requirements, and we will assist in antenna and transmission line selection.

RPA-1 Remote Pickup Amplifier, provides audio mixing, metering, and control facilities for RPL-2T series Transmitters.



MOSELEY ASSOCIATES, INC.
SANTA BARBARA RESEARCH PARK

111 CASTILIAN DRIVE
GOLETA, CALIFORNIA 93017
(805) 968-9621

REMOTE PICKUP LINK MODEL RPL-2



BULLETIN 229

ALL SOLID-STATE



30 watts — 160 MHz
20 watts — 450 MHz
13.5 VDC / 120 VAC OPERATION

MOSELEY ASSOCIATES, INC.

PROFESSIONAL PRODUCTS FOR PROFITABLE BROADCASTING

MARTI

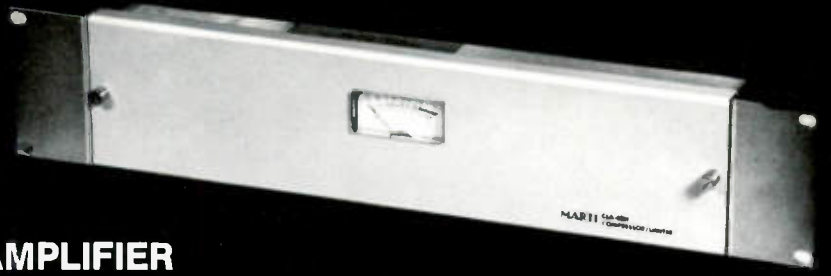

CLA-40A COMPRESSOR/LIMITER AMPLIFIER

FEATURES: \$445.00

- ★ Symmetrical or Asymmetrical Peak Limiting — Switchable
- ★ Pre-emphasized or Flat Audio Response — AM or FM — Switchable
- ★ Compress/Limit, Compress Only, Compress Limit Off — Switchable
- ★ Well Shielded and Filtered for Strong RF Fields
- ★ Plug-In, Modular Construction
- ★ Illuminated, Taut-Band Meter reads Gain Reduction or Output Level in VU
- ★ 40 DB Dynamic Range with less than 1% Distortion
- ★ Automatic Gain Control Built In
- ★ Solid-State
- ★ Selectable Release Times

See reverse side for specifications

The CLA-40A Compressor/Limiter, is perhaps the most versatile audio processing device to be found on the market today.

Compatible with either AM or FM broadcast application, it can be used in either mode of operation, simply by switch selection. For stereo application, two CLA-40A Amplifiers are strapped together and checked out as a stereo device. The amplifier may be operated in either the symmetrical or asymmetrical limiting mode and when operating asymmetrically, it often produces a significant rise in average modulation.

Any type of program format is adequately handled by the CLA-40A from "Middle of the Road" to "Hard Rock," with maximum Dynamic Range and minimum Distortion. With switch selectable release times of as high as 5 seconds, the unit also finds application as an Automatic Gain Control Amplifier and is ideal for use between the output of a Production Console and the input to the Record Amplifier of Cartridge Tape Systems.

Fully accessible controls, permit its use as a Compressor, Compressor/Limiter or as a "Straight Through" amplifier for Proof of Performance measurements. The CLA-40A is supplied with a meter, reading in Gain Reduction, + 4 VU or + 10 VU.

AUDIO PROCESSING SUGGESTIONS USING CLA-40A

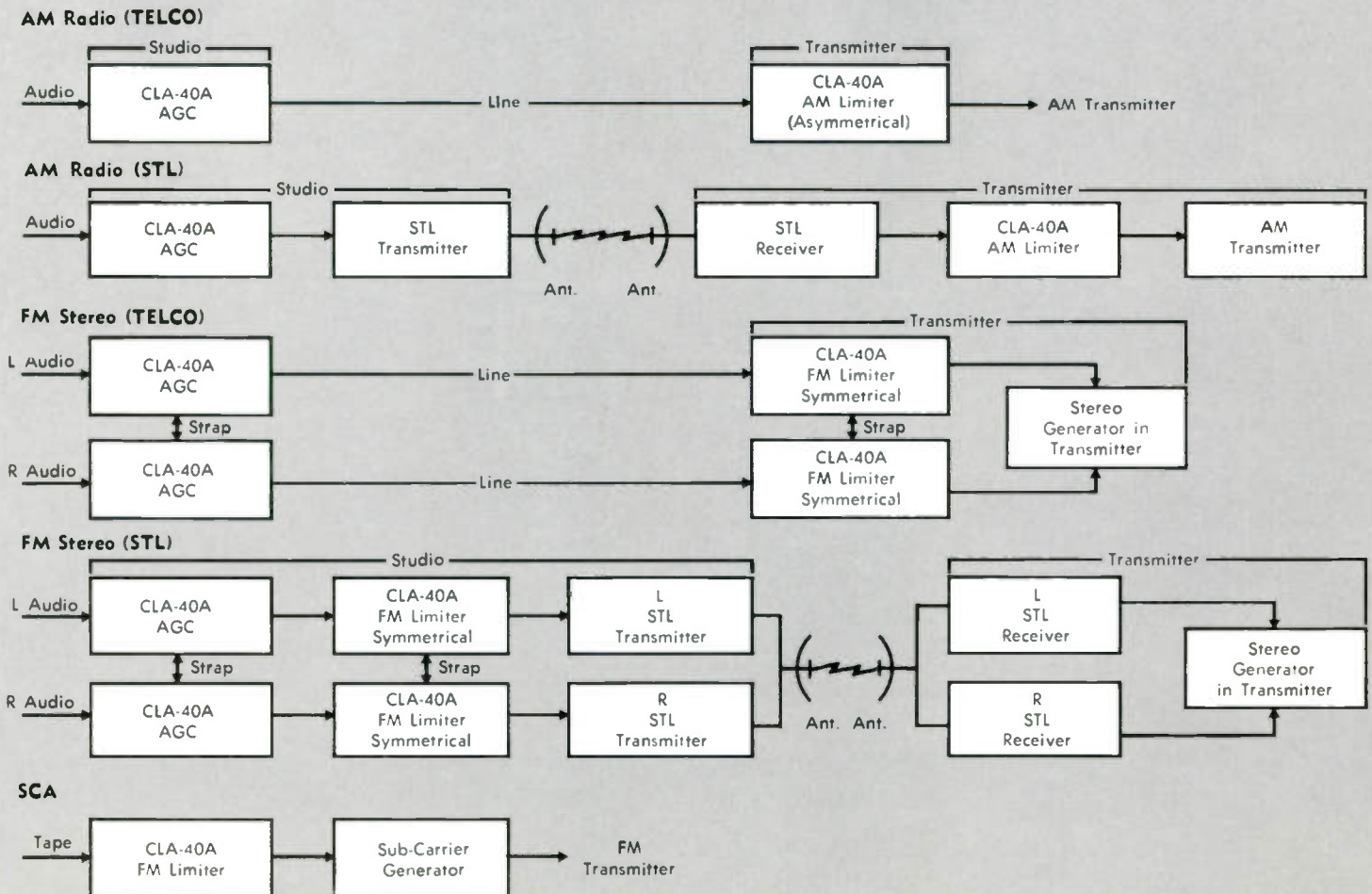

SPECIFICATIONS FOR CLA-40A AMPLIFIER

Application	AM or FM (Characteristics selectable). Strap two together for stereo. For high performance FM limiting, the CLA-40A should be driven by another CLA-40A operating as a wide-range AGC amplifier.
Peak Limiting	Three control systems used. Symmetrical peak limiting for FM, selectable asymmetrical or symmetrical peak limiting for AM. Peak limiting level adjustable.
Input and Output Impedances	600 ohms balanced or unbalanced.
Input Level	-15 to +20 DBM.
Maximum Output Level	+20 DBM RMS.
Frequency Response	50 Hz. to 15 KHz flat within 0.5 DB in AM or FM mode.
Maximum Gain	40 DB.
Noise Level	-66 DB Ref. +10 DBM output (FM Mode).
Distortion	Less than 1% THD at all compression levels. (Symmetrical limiting)
Compression Ratio	Better than 10:1.
Automatic Gain Control Range	40 DB dynamic.
Release Time	Adjustable 800 milliseconds., 2 sec., 5 sec. approx.
Attack Time	Less than 1 microsecond in compress-limit mode.
Metering	Gain reduction, output level +4 VU, +10 VU.
AM-FM Operation	Both. Standard 75 microsecond pre-emphasis/de-emphasis used in FM operation.
Shielding and RF Filtering	For use in high RF fields.
Operating Temperature	-20° C to +50° C.
Physical Dimensions	8.9cm x 48.5cm x 14cm. (3 1/2" x 19" x 5 1/2") rack panel.
Power Requirements	115/230 volts 50-60 Hz., 10 watts.
Weight	2.4 kg. (6 lbs.)

\$225.00

OTHER QUALITY AMPLIFIERS BY MARTI

\$ 186.00

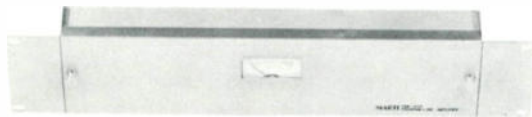

PGM-20A Series Program/Line Amplifier

SPECIFICATIONS

Input Impedance	600/4200 ohms, balanced.
Input Level	-40 DBM to +10 DBM.
Input Attenuator	0-15-30 DB.
Metering	Taut Band Metering of output level ranges +20, +10 or +4 VU.
Gain	60 DB gain when connected 600 to 600 ohms. 43 DB gain when using bridging input of 4200 ohms.
Output Impedance	600 ohms balanced or unbalanced, 75 ohms unbalanced.
Maximum Output Level	+20 DBM RMS.
Distortion at Maximum Output Level	0.5% or less.
Frequency Response	±0.5 DB from 30 to 15,000 cycles
Temperature	-20° C to +50° C.
Output Noise	-60 DB or less referred to a +4 DBM output level.
Power Requirements	115/230 volts, 50-60 cycles, 5 watts. Self contained power supply.
Controls	Input pad, output level, meter switch.
Mounting	8.9cm x 48.5cm x 14cm. (3 1/2" x 19" x 5 1/2") rack panel.
Weight	2.2 kg. (5 lbs.).



MA-10 Series Monitor Amplifier

SPECIFICATIONS

Maximum Output	10 watts RMS.
Input Impedance	600 ohms balanced or 4200 ohms balanced.
Gain	-40 DBM across 600 ohms will produce 4 watts output approx.
Output Impedance	8 ohms.
Terminals	600 ohms input, 4200 ohms input, relay control, relay contacts.
Power Requirements	115/230 volts, 50-60 cycles, 16 watts.
Frequency Response	±1 DB from 30 to 20,000 cycles.
Distortion	Less than 1% THD at rated output (10 watts RMS).
Temperature	-10° to +50° C.
Adjustments	Gain control, input pad 0-15-30 DB.
Muting	Plug in relay optional. (Internal relay power provided.)
Mounting	8.9cm x 48.5cm x 14cm. (3 1/2" x 19" x 5 1/2") rack panel.
Weight	2 kg. (4.5 lbs.).

MARTI *Electronics, Inc.*

P.O. Box 661 • 1501 N. Main • Cleburne, Texas 76031 • 817/645-9163

Aural Studio-Transmitter Links



PCL-600 and PCL-600/C

From the pioneers of the Studio-Transmitter Link industry comes a new generation of STLs that blend technology and innovative engineering to provide excellent performance at an economical price. Introducing the monaural PCL-600 and composite stereo PCL-600/C, the first truly cost-effective STL designed to operate in most RF environments with low distortion and low noise characteristics.

The PCL-600/C meets the discerning broadcaster's demand for uniformly flat frequency response, exceptional stereo separation and minimal non-linear crosstalk for transmission of, for example, compact disc recording.

The PCL-600/C has a wideband input that transmits the complete stereo waveform over a single STL. This allows the stereo generator and all audio processing equipment to be located at the studio, far from intense RF radiation, but well within reach for adjustments. When used in conjunction with an SCD-9 Stereo Demodulator, the PCL-600/C is an excellent choice for AM stereo broadcast.

The PCL-600 has a 16 kHz lowpass filter so that two PCL-600s, used in the split channel method, can transmit right and left programs with no measurable crosstalk.

Both the PCL-600 and PCL-600/C can transmit two subcarrier frequencies for SCA and/or remote control as well as the program. The PCL-600 and PCL-600/C set new

standards for adjacent channel rejection, selectivity and signal-to-noise ratio performance within their price range. Both units are fully backed by quality service and support and a two-year, no-nonsense warranty.

TRANSMITTER

The PCL-600 and the PCL-600/C Transmitters use true direct modulation techniques. A synthesized reference oscillator is used for frequency and phase control of the direct FM oscillator. Transmitter FM modulated oscillator frequency conversion is done via an upconverter mixer scheme instead of the usual frequency multiplication of the modulated signal.

The transmitter includes a front-panel meter with switch-selection for forward power, program and multiplex level, etc. Transmitter operation, reflected power and FM lock status are shown by a green/red LED.

RECEIVER

The dual-conversion PCL-600 and PCL-600/C Receivers use well-proven circuitry. Excellent selectivity characteristics let the receiver ignore adjacent channels. Superior linearity provides low noise characteristics for maximum fidelity.

The Receiver includes a front-panel meter with switch selection for true RF input level in microvolts, program output level and subcarrier level. Operational/Received signal status is indicated by a green/red LED.

Moseley

Moseley
Associates
Incorporated

111 Castilian Drive
Santa Barbara, CA
93117-3093

a
Flow General
Company

Phone 805 968 9621
Telex 658448
FAX: 805 685 9638

SPECIFICATIONS

PCL-600	SYSTEM	PCL-600/C
300-330 MHz, 450-470 MHz, 890-960 MHz, Specify exact operating frequency.	Frequency Range	300-330 MHz, 450-470 MHz, 890-960 MHz, Specify exact operating frequency.
Monophonic audio: ± 0.3 dB or better 30 Hz to 15 kHz	Frequency Response	Composite: ± 0.2 dB dB or better 30 Hz to 53 kHz, ± 0.3 dB or better kHz to 75 kHz.
0.20% or less 30 Hz to 15 kHz, typically better than 0.15% at 1 kHz	THD and IMD	Stereo demodulated THD and IMD, 0.2% or less 30 Hz to 7.5 kHz, typically better than 0.15% at 1 kHz. Convolved stereo demodulation products: greater than 50 dB below the 400 Hz, 100% modulation ref. level from 7.5 kHz to 15 kHz.
Not applicable	Stereo Separation	50 dB or better 50 Hz to 15 kHz, typically 55 dB dB) or better
Not applicable	Nonlinear to Crosstalk Subchannel to Main Channel:	50 dB or better
Not applicable	Nonlinear Crosstalk, Main Channel to Subchannel:	50 dB or better
72 dB or better, typically 75 dB, below 100% modulation	Signal-to-Noise Ratio	72 dB or better, typically 75 dB below 100% modulation, de-modulated, de-emphasized left or right.
19" (48.3 cm) wide TX 3.5" (8.9 cm) high 16" (40.6 cm) deep RX 3.5" (4.5 cm) high, 13.75" (34.9 cm) deep	Dimensions Transmitter and Receiver	19" (48.3 cm) wide TX 3.5" (8.9 cm) high, 16" (40.6 cm) deep RX 3.5" (4.5 cm) high, 13.75" (34.9 cm) deep
TRANSMITTER		
7 Watts maximum, 5 Watts minimum 15 Watts maximum, 10 Watts minimum	RF Power Output 890 HMz-960 MHz 300-470 MHz	7 Watts maximum, 5 Watts minimum 15 Watts maximum, 10 Watts minimum
Type N female, 50 ohm	RF Output Connector	Type N female, 50 ohm
± 40 kHz	Deviation for 100% Modulation	± 50 kHz
Better than 0.00025%, 0°C to +50°C	Frequency Stability	Better than 0.00025%, 0°C to +50°C
More than 60 dB below carrier level	Spurious and Harmonic Emission	More than 60 dB below carrier level
One program and two subcarrier channels	Modulation Capability	One program and two subcarrier channels.
Monophonic: +10 dBm, 600 ohm, balanced, floating, barrier strip screw input. Multiplex: 1.5 V peak-to-peak, 2 K ohms unbalanced, type BNC female connectors (2), frequency range 22-85 kHz.	Modulation Inputs	Composite: 3.5 V peak-to-peak 6 K ohms unbalanced, type BNC female connector. Multiplex: 1.5 V peak-to-peak 4 K ohms unbalanced, type BNC female connectors (2), frequency range 110-200 kHz
120/240 VAC, $\pm 10\%$, 50/60 Hz, 80 Watts	Power Source	120/240 VAC, $\pm 10\%$, 50/60 Hz, 80 Watts
RECEIVER		
Type N female, 50 ohm	RF Input Connector	Type N female, 50 ohm
20 μ V or less required for 60 dB SNR	Sensitivity	140 μ V or less required for 60 dB SNR left or right channel de-emphasized, demodulated
3 dB I.F. bandwidth, ± 90 kHz 80 dB I.F. bandwidth, ± 1.2 MHz	Selectivity	3 dB I.F. bandwidth ± 125 kHz 80 dB I.F. bandwidth, ± 1.2 MHz
An adjacent signal 10 dB higher than the desired signal will degrade SNR by less than 3 dB	Adjacent Channel Rejection	An adjacent signal 10 dB higher than the desired signal will degrade SNR by less than 3 dB
Monophonic: +10 dBm, 600 ohm, balanced, floating, barrier strip screw output. Multiplex: 1.5 V peak-to-peak, 100 ohms unbalanced, type BNC female connectors (2)	Modulation Outputs	Composite: 3.5 peak-to-peak 200 ohm unbalanced, type BNC female connector. Multiplex: 1.5 V peak-to-peak 100 ohm unbalanced, type BNC female connectors (2)
120/240 VAC, $\pm 10\%$, 50/60 Hz, 20 Watts	Power Source	120/240 VAC, $\pm 10\%$, 50/60 Hz, 20 Watts

Specifications subject to change without notice.

Printed in USA 10/87



Moseley
Associates
Incorporated

111 Castilian Drive
Santa Barbara, CA
93117-3093

a
Flow General
Company

Phone 805 968 9621
Telex 658448
FAX: 805 685 9638

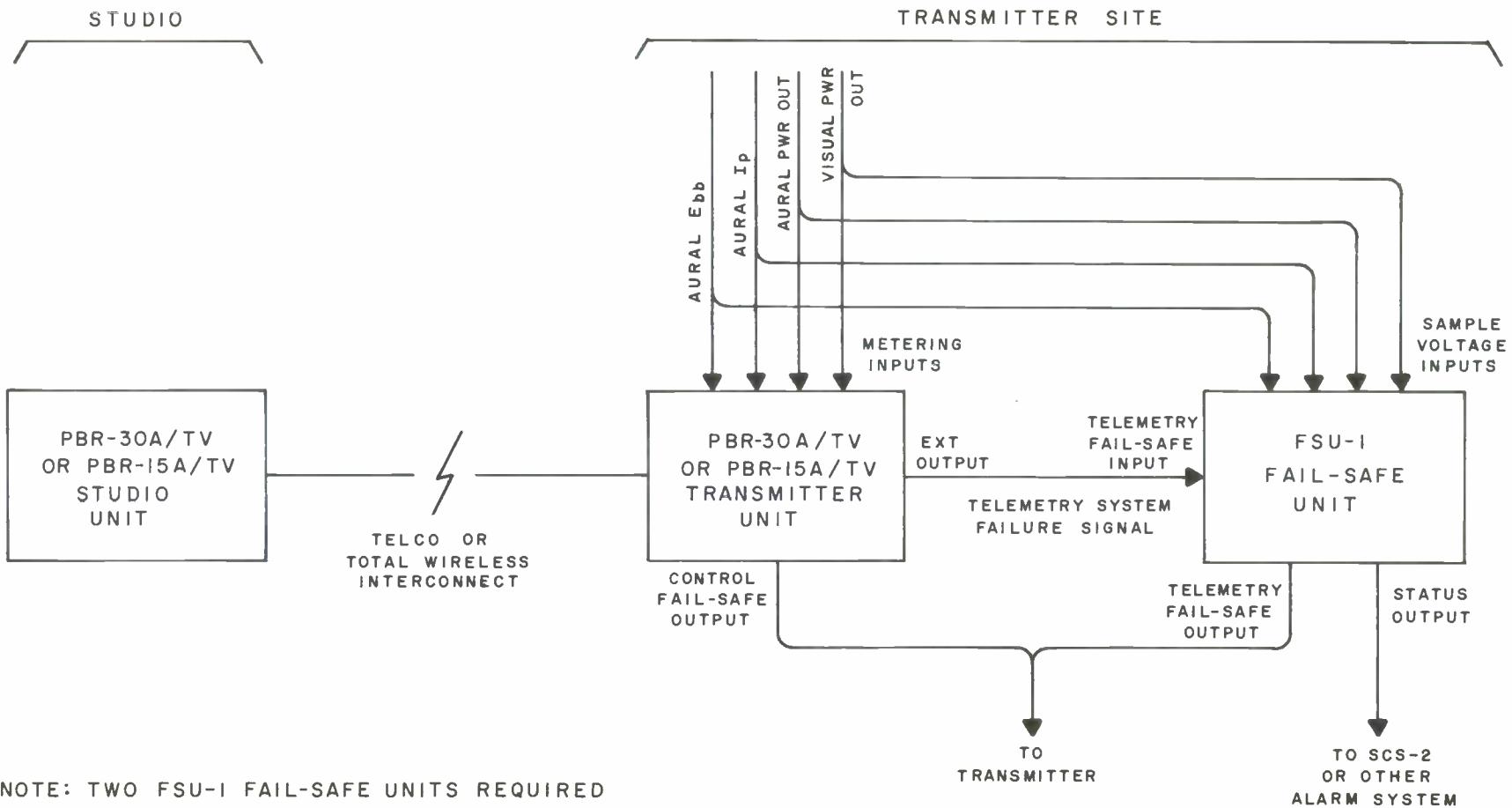

NOTE: TWO FSU-I FAIL-SAFE UNITS REQUIRED FOR PARALLEL TRANSMITTERS.

BLOCK DIAGRAM OF TYPICAL MODEL FSU-I FAIL-SAFE UNIT INSTALLATION

FAIL-SAFE UNIT

MODEL FSU-1



Bulletin 237P

The Model FSU-1 Fail-Safe Unit assures compliance with the FCC's Rules and Regulations for television remote control telemetry fail-safe when used with Moseley Associates Models PBR-15A/TV or PBR-30A/TV Remote Control Systems. Four inputs are provided for sensing the DC sample voltages representing the parameters required to be logged by Section 73.671(a). In the FSU-1, a failure of these sample voltages is defined as an output of less than 0.25V. A fifth input accepts a voltage provided from the companion remote control signifying the loss of the telemetry signal at the studio site. Any input will activate a one-hour integrated circuit timer housed within the FSU-1. Should all four DC sample voltages fail, the unit will assume the transmitter has been removed from the air. Two relay contact outputs are provided by the FSU-1 - Status and Fail-Safe. The Status Output may be programmed to trip at 4.8 or 48 seconds after the timer has started. This output may be used to alert studio personnel that the one-hour time period has begun. The Fail-Safe Output would be placed in series with the control fail-safe of the remote control system to automatically remove the transmitter from the air one hour after a failure. For parallel transmitters, two FSU-1 Units are required.

SPECIFICATIONS

Inputs

DC Sample Voltage	100K Ω or greater, isolated and floating (350V insulation).
Telemetry Fail-Safe	24 VDC from affiliated remote control system upon failure of telemetry at studio.

Outputs

Fail-Safe	SPST relay contacts, one-hour internal time delay.
Status	SPDT, to status or alarm system if desired; operates 4.8 or 48 seconds (selectable) after failure detected.

Failure Detection Method

Stable integrated circuits and simple relay interconnection.

Adjustments

None

Maintenance

Minimal; nearly all circuitry is plug-in and serviceable by substitution.

Duty Cycle

Continuous

Operating Temperature Range

0° to 140° Fahrenheit

Power Requirements

120/240 VAC, 50/60 Hz, 30 watts

Required Rack Space

3 $\frac{1}{2}$ " vertical, 7" depth

Specifications subject to change without notice

MOSELEY ASSOCIATES, INC.

Microprocessor
Remote
Control

Moseley

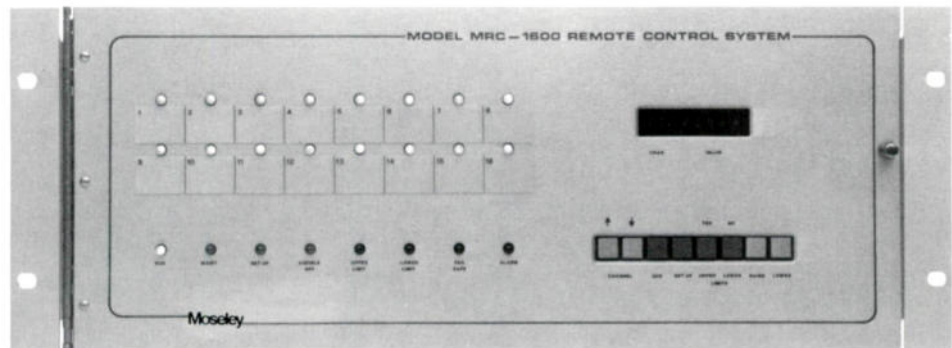

MRC-1600

MRC-1600

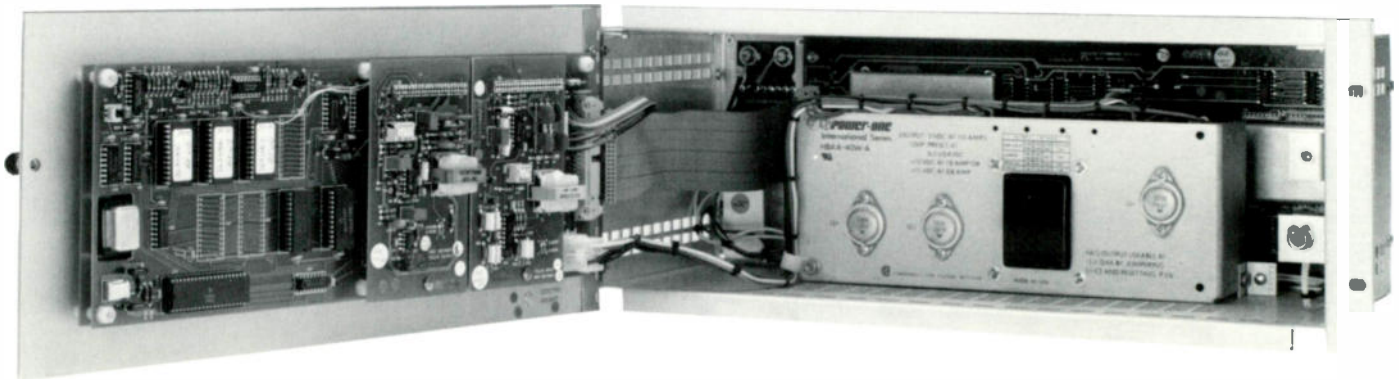

The MRC-1600 Microprocessor Remote Control System offers microprocessor flexibility and sophistication in an economical and dependable package for general remote control applications. It comes equipped with 16 status inputs, 16 telemetry inputs, 16 raise command outputs and 16 lower command outputs. Each command output is relay-isolated. Adapting the MRC-1600 to current system interconnections is easy. Plug-in modules can be ordered to accommodate almost any communication system, from standard 2-wire to 4-wire telephone lines to FM subcarriers, subaudible telemetry, or a combination of any of these.

The MRC-1600 is suitable for such applications as AM, FM, TV, LPTV, and facility control. Telemetry limit checking and status alarm capability help ensure

that an unmanned facility operates at peak efficiency while any alarm conditions, such as fire or intrusion, are quickly relayed to an operating position so that appropriate action can be taken.

Setup and Operation

System setup and calibration are done at the Remote Terminal with eight color-coded buttons. For each channel, upper and lower telemetry limits may be set or disabled independently, and telemetry data may be calibrated in one of four modes: power, indirect power, linear or millivolt. Status inputs may be set to display direct or inverted and may be programmed to trigger an alarm on rising, falling or rising and falling waveforms. Both telemetry and status channels may be muted.

Nonvolatile memory is standard on the MRC-1600. In the event of a power-down, all setup data, calibration information and limits are stored on electrically-erasable, programmable read-only memory (EEPROM) for up to ten years.

The MRC-1600 front panel is simple to operate and easy to understand. All status channels are displayed simultaneously on a set of 16 LEDs. Alpha-numeric LEDs give readouts of selected channel number and telemetry data while eight color-keyed LEDs indicate operation mode, alarms, and other system parameters.

MRC-1600 operation is straightforward. The system constantly checks telemetry data for each channel against assigned upper and lower limits. Any channel exceeding its limits immediately sets off audible and visible alarms. Pressing the ACKnowledge button displays the relevant channel number, telemetry information, and upper or lower limit LED so the operator can push either the RAISE or LOWER key to bring telemetry values for that channel back within limits.

The MRC-1600 operates two special system test channels. One checks A/D conversions and provides an alarm when tolerance exceeds factory set limits. The other gives the user readouts of conditions for both Control-to-Remote and Remote-to-Control data links. In

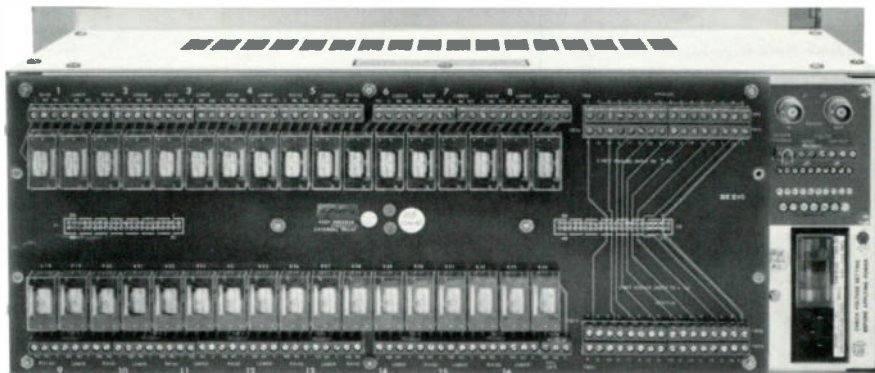

compliance with current FCC Regulations, the MRC-1600 has full fail-safe provisions. Remote Terminals are also equipped with a Maintenance Override mode which, when activated, ignores Control Terminal commands but continues to update status and telemetry data. LEDs and auxiliary contacts at the Remote Terminal are provided to enable warnings to personnel that the system is in the override mode.

Options

The CRT Option for the MRC-1600 gives the user full control of the transmitter from the keyboard at the Control Terminal. All status and telemetry data are displayed simultaneously on an ADDS VP+ terminal. Status and telemetry field titles can be up to 14 characters long and may be changed at any time. Seven characters each are allotted for telemetry units, Status On and Status Off displays. The CRT also indicates time of day, data link status, and Remote Terminal Maintenance Override.

An Automatic Logging Option can be added to the CRT Option to provide a printed log of station operation. A Texas Instruments Model 850 printer records

status and telemetry data at user-specified intervals from one minute to twenty-four hours.

MRC-1600 LOGGER
AUTOMATIC DATA

THE HEADER, LOGGED CHANNELS, AND LOGGING INTERVALS ARE USER PROGRAMMABLE

TIME	FILAMENT VOLTAGE	PLATE VOLTAGE	PLATE CURRENT	OUTPUT POWER	REFL. POWER	INTAKE TEMP.	EXHAUST TEMP.	ALARM SYSTEM	TOWER LIGHTS
09:40	6.3	7.45	2.12	101.4	98.	27.5	56.6	On	On
09:50	6.3	7.45	2.12	101.4	98.	27.5	56.6	On	On
10:00	6.3	7.45	2.12	101.4	98.	27.5	56.6	On	On
10:10	6.3	7.45	2.12	101.4	98.	27.5	56.6	On	On
10:20	6.3	7.45	2.12	101.4	98.	27.5	56.6	On	On
10:30	6.3	7.45	2.12	101.4	98.	27.5	56.6	On	On
10:40	6.3	7.45	2.12	101.5	99.	27.5	56.6	On	On
10:50	6.3	7.45	2.12	101.5	98.	27.5	56.6	On	On
11:00	6.3	7.45	2.12	101.4	98.	27.5	56.6	On	On
11:10	6.3	7.45	2.12	101.4	98.	27.5	56.6	On	On
11:20	6.3	7.45	2.12	101.4	98.	27.5	56.6	On	On



SPECIFICATIONS

Type of System

Microprocessor-based Control Terminal and Remote Terminal

Types of Memory Used

Programmable Read-Only Memory for system firmware
Random Access Memory for user-programmed functions

Moseley Memory

Retains data for ten years minimum, on electrically-erasable, programmable read-only memory (EEPROM)
Holds calibration factors, status and command assignments
With CRT, or CRT and Logger options, stores CRT text and logger setups

System Configuration

One Control Terminal, one Remote Terminal per system

Command Lines

Two (one "raise," one "lower") per channel, momentary, total of 16 "raise," 16 "lower"
Command response time: 400 ms to implementation, nominal
Form C relay (SPDT) output standard, up to 2A, 30 VDC or 120 VAC (non-inductive) per relay

Telemetry Channels

16 channels, unbalanced input
One-person digital calibration, via Remote Terminal keyboard
Fully tolerance alarmed, one high and one low limit
Status muting
Linear, power-to-linear conversion, indirect power, millivolt calibration
Full four-digit LED display with decimal point and polarity sign
Resolution: one part in 4096
Overall measurement accuracy: better than 0.5%
Response time: 500 ms, nominal, with audible data
Full-scale input level: 0.25 V minimum, 1 V minimum recommended, 4.5 VDC maximum

Status Channels

16 channels, each displayed by individual LEDs on Control Terminal and Remote Terminal front panels
User-programmable N.O./N.C., momentary or latching, alarm on rising and/or falling waveform
Status muting
Status response time: 400 ms, nominal, with audible data
TTL-compatible input standard (+5 VDC switched by external contacts)

Aural Alarms

Control and Remote Terminals, defeatable and remoteable

Fail Safe

Complies with current FCC requirements for AM, FM and TV

Maintenance Override

Remote Terminal front-panel button
Provides Remote Terminal "go home" relay closure, Control Terminal and Remote Terminal LED indication

Number of Data Interconnection Links

One

Data Transmissions

Eight-bit plus parity
300 baud standard (audible)
9.4 baud telemetry with subaudible telemetry option
Two-way, simultaneous via FSK

Wire Interconnections

Two-wire or four-wire, 600 ohm balanced
Series 3002 unconditioned data channel per Bell System
Technical Reference Publication 41004 (FCC tariff No. 260)
Nominal send level: 0 dBm; Minimum receive level: -30 dBm

Radio Interconnection

Single or duplex, internal subcarrier systems
Available on standard frequencies between 26 and 185 kHz
Nominal send level: 1.5 V p-p at 2.2 k ohm
Nominal receive level: 0.25 V p-p at 2.2 k ohm
Specify frequency and exact radio link when ordering

Remote Terminal Connectors

Terminal strip connectors for status, telemetry inputs, command outputs

Operating Temperature Range

0° - 50°C

Power Requirements

120/240 VAC, 50/60 Hz, 30 W typical (per terminal)

Physical Size

Control Terminal: 17.8 cm H x 48.3 cm W x 21.6 cm D (7"H x 19"W x 8.5"D), depth less connectors
Remote Terminal: 17.8 cm H x 48.3 cm W x 22.9 cm D (7"H x 19"W x 9"D), depth less connectors

OPTIONS

CRT Terminal

ADDS Viewpoint terminal with full keyboard and 12-inch CRT
15-foot cable and software
1200 baud (120 characters/second)
Installs at Control Terminal.
User-programmable text (stored in nonvolatile memory)

Automatic Logging

Texas Instruments Model 850 printer
15-foot cable, attaches to AUX port on CRT terminal at Control Terminal
1200 baud (120 characters/second)
User-programmable channel list, header text, and log intervals (stored in nonvolatile memory)
Available only if CRT is also present
Will not operate with CRT Modem Option

Subcarrier and Subaudible

26, 39, 41, 67, 92, 94, 110, 152, 185 kHz available
May be purchased in combination with Telco if desired

CRT Modem Option

Extends CRT Option to a remote location over dial-up phone lines
Modems, 15-foot cables
1200 baud
Connects Control Terminal and CRT
Choice of manual or auto-answer modems
Will not operate with Automatic Logging Option

Specifications subject to change without notice.

Printed in U.S.A. 1/87



Moseley
Associates
Incorporated

111 Castilian Drive
Santa Barbara, CA
93117-3093

a
Flow General
Company

Phone 805 968 9621
Telex 658448
Cable: MOSELEY

Microprocessor
Remote
Control

Moseley

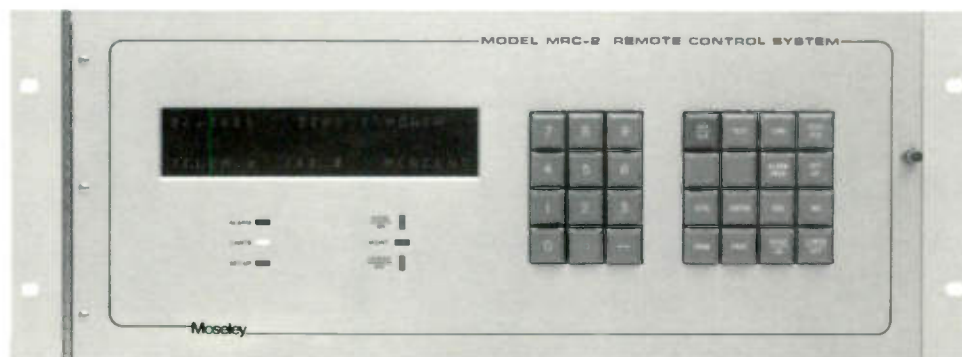

MRC-2

MRC-2

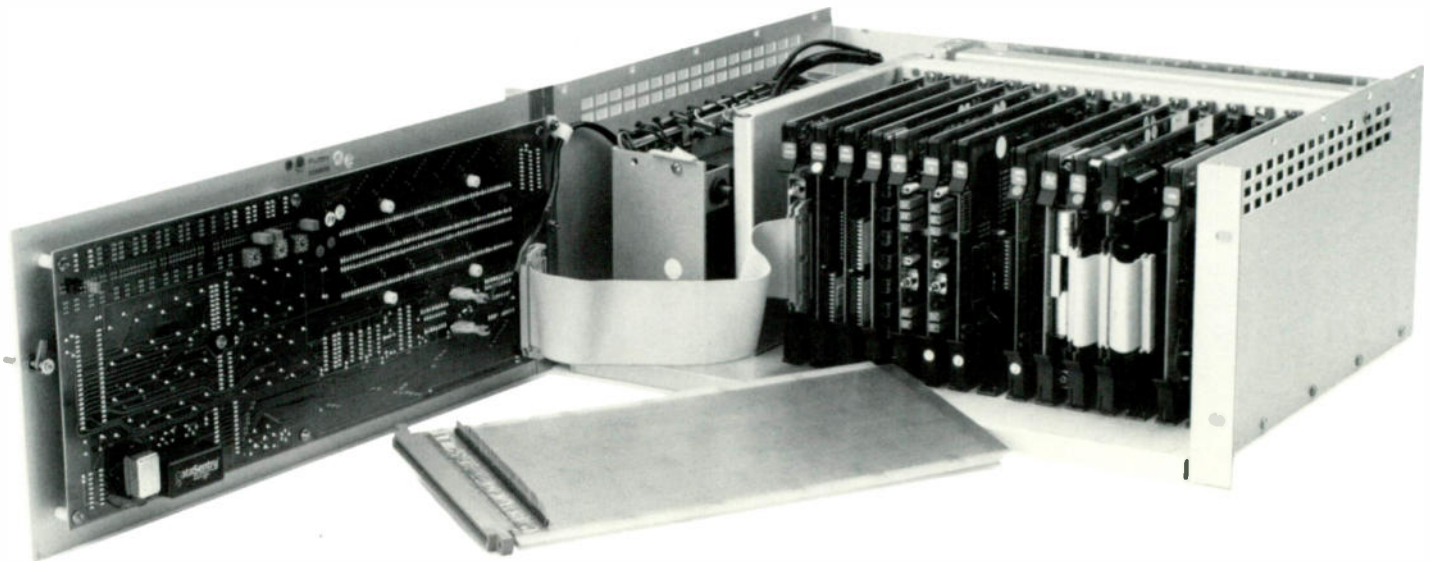

WHY REMOTE CONTROL?

The MRC-2 Microprocessor Remote Control System brings a new level of sophistication to remote control, telemetry and status acquisition. System size and operational capabilities have been expanded over previously available remote control systems, and the use of the CRT option enhances operator interfacing with the system by providing a plain-English display of all desired transmitter plant parameters. This display is user-programmed, allowing maximum flexibility in CRT setup. The Automatic Logging option relieves the operator from the necessity of keeping a manual log by routinely recording all desired parameters as well as automatically printing any alarm conditions. In addition, the Automatic Control Unit option can reduce or eliminate the monitoring of the transmitter plant by the operator while providing quicker response.

These and other features translate into greater transmitter plant control and security at lower cost, two very important factors in today's complex broadcast operations. The MRC-2 System provides the broadcaster with greater control of the transmitter and peripheral equipment through quick, positive monitoring and control of all desired parameters. Critical parameters, such as transmitter power output, can be constantly monitored for compliance with user pre-programmed tolerance limits, allowing

maximum performance within regulatory and safe operating limits. The use of dual limits allows the operator (or the system itself, with the optional Automatic Control Unit) to adjust parameters before a critical limit is reached. Plant security is improved by the ability of the MRC-2 to continuously monitor the transmitter facility for intrusion, fire, or any other occurrence that could endanger the transmitter or its surroundings. Multiple communications links may be easily used to improve system integrity.

The MRC-2 does not only move the technical operations of the transmitter site to the studio; it also frees technical personnel from the need to operate the transmitter, reducing or eliminating human intervention from transmitter plant operation. This is accomplished by a highly sophisticated, well-integrated control system described below and on the following pages.

WHY MRC-2?

The MRC-2 is a true building block system. The basic MRC-2 System consists of one Control Terminal, normally located at a broadcast studio facility, along with one stand-alone Remote Terminal or one Remote Terminal with Data Acquisition/Command Unit, normally located at a broadcast transmitter facility. This is only the beginning; multiple Remote Terminals may be added to the system, with each Remote Terminal

designated as a site, either in stand-alone configuration or equipped with one or more Data Acquisition/Command Units. A stand-alone Remote Terminal may be equipped with up to eight input/output modules, including telemetry failsafe. A typical maximum configuration would be 64 command lines, 32 status channels, and 32 telemetry channels.

At a given site, Multiple Data Acquisition/Command Units may be equipped with as many as 256 command lines, 256 status inputs, and 256 analog telemetry inputs. These capacities can be independently expanded to the maximum in increments of 16. Multiple Control Terminals may also be used, with a pre-established hierarchy enabling the delegation of control capability between Control Terminals.

All Control Terminals are not required to have access to all Remote Terminals in this system, so installations may be configured exactly as the user desires. Multiple Control Terminals may be used in AM/FM or AM/FM/TV operations where it is desirable to shift control from one location to another. This may also be useful for systems where a particular Control Terminal is located in a control room that is not manned 24 hours a day. In addition, it would prevent failsafe shutdown in the event of a control data link failure, which would normally disable a transmitter receiving commands from only a single Control Terminal.

Operator control of MRC-2 System is simple, whether the standard Control Terminal or the optional CRT terminal is used for operator interface. Site selection and channel selection may be accomplished in either case by a simple keyboard entry, while commands are implemented by pressing the raise or lower button on the keyboard. The Control Terminal alphanumeric LED display indicates the selected channel number as well as the type and value of the selected parameter. The CRT display is considerably more extensive, and is described in the options section.

COMMAND, STATUS, TELEMETRY SETUP AND OPERATION

Command, status, and telemetry setup is straightforward on the MRC-2 System. Using the Remote Terminal keyboard and 48-character alpha-numeric LED display, the system provides plain-English prompting and "menu" pages for setup selection. Similar procedures are used at the Control Terminal to set up and verify telemetry limits, assign data links, and to set up controlled access for restricted functions.

Each command line output may be designated latched, pulsed, or momentary and is assigned or "mapped" to one or more telemetry and/or status channels by keyboard entries, again on the Remote terminal. In the MRC-system, command lines are not pre-assigned to channels but are associated with the desired channel or channels via keyboard entries. With this approach, status or telemetry channels that do not require control functions do not result in unnecessarily tying up unused command lines. In addition, a command line or pair of command lines (each command line is designated as either a raise or lower function) may be assigned to more than one status and/or telemetry channel. For example, two command lines (one "raise" and one "lower") associated with raising or lowering the power output of an FM or aural TV transmitter may be assigned to the

telemetry channels monitoring plate current, direct power, and indirect power. This results in a savings in the number of command lines used. Standard command outputs are via transistor switch closures, with optically isolated and relay isolated command line outputs optionally available.

Each status channel may be displayed direct or inverting and functions in a momentary or latching mode as user selected. Status inputs can be programmed to initiate an event or alarm indication on a rising waveform (on), falling waveform (off), or both. Status channels may also be assigned to disable limit checking on selected telemetry channels. This is useful for avoiding alarms when a transmitter is not being used, either in a single or multiple (alternate/main) transmitter.

For further user convenience, analog telemetry inputs to the MRC-2 Data Acquisition/Command Unit may be calibrated in one of six ways: millivolt, linear, power, product, ratio, or digital word. Millivolt calibration reads the input in millivolts, while linear calibration consists of a keyboard entry corresponding to the desired reading for the input sample. This allows linear tracking above and below the entered value. Power calibration is similar, but the displayed reading varies with the square of the input voltage. Product and ratio calibration both use telemetry inputs to two channels to provide a third reading, which is scaled by a keyboard-entered value as above. Product calibration may be used for indirect transmitter power reading, while ratio calibration may be used to balance parameters such as dual transmitter output power or AM antenna currents. Using the Digital Telemetry Input option, the digital word calibration mode is used for direct digital input to the MRC-2 System.

A wide selection of words and symbols for telemetry units is available (22 total), including volts, kilovolts, amperes, watts, kilowatts and degrees. The selected unit word or symbol appears on the Control

Terminal and Remote Terminal LED display.

Single or dual, upper and/or lower tolerance limits may be programmed for each telemetry channel. Any excursion beyond the limit will initiate an event and/or alarm indication, depending on how the tolerance limits are programmed during setup. The use of dual upper and lower limits allows the taking of corrective action before a parameter reaches a critical level.

A telemetry tolerance excursion or status change that has been user-designated as an alarm will cause audible and visible indications to the operator at the Remote Terminal, Control Terminal, and optional CRT, with optional logging at an Automatic Logging option. Tolerance excursions and/or status changes programmed as events are routine indications of a change in a parameter of interest, and will generate an entry on the printed log. Returning of a telemetry input within tolerance limits may also be logged at the user's discretion.

FAIL-SAFE PROVISIONS

The MRC-2 System includes control fail-safe operation which causes a relay contact to open at the remote site after loss of control to the site from all applicable Control Terminals.

The telemetry fail-safe option is available to monitor four user programmed telemetry parameters of up to six transmitters for each Remote Terminal. The option includes a three-hour internal timer that will display the time until automatic shutdown if a telemetry fail-safe condition is in progress.

MAINTENANCE OVERRIDE

MRC-2 Remote Terminals are equipped with a Maintenance Override button for locking out command capability by all Control Terminals and their CRTs. Auxiliary contacts are provided at the Remote Terminal to enable the warning of maintenance personnel that the unit is still in an override condition.

OPTIONS



AUTOMATIC CONTROL UNIT

The MRC-2 Automatic Control Unit (ACU-1) option adds both feedback-oriented and time-oriented command functions to the system. Programming for this feature is done by the user at the Automatic Control Unit keyboard which comes with a built-in CRT. A BASIC-like language allows the programmer to set up system control algorithms, tailored to the specific needs of the user. In operation, the system will monitor selected parameters and cause a command or sequence of commands and parameter checking to occur upon user-initiated commands and/or status changes and/or telemetry value changes. The sequence may also be initiated by time of day and/or date. Time delays may be programmed to allow parameter settling time or sufficient time for certain functions, such as coaxial switch changes, to occur. The user may also program internal telemetry tolerance values into the Automatic Control Unit for initiating control sequences.

Time-oriented functions may be implemented at an exact time, or used to provide a warning to the operator that a pre-programmed amount of time is allowed to manually implement the desired function or functions, such as day/night pattern changes for an AM transmitter. The system can automatically implement the function or functions if the operator has not done so within the allotted time.

The Automatic Control Unit is capable of multiple steps with logic branching

at many levels to accommodate control and switching of multiple transmitters, antennas, etc. User programming as well as factory system programming is stored on diskette and loaded into RAM automatically upon system startup.

The user is cautioned to be certain that all applicable FCC rules are followed in the use of this option. Contact a Moseley Associates representative for details.

CRT TERMINAL

The MRC-2 CRT option makes the system even more versatile and easy to operate. Each CRT option, with full keyboard, duplicates either all control functions of the Control Terminal or all control functions of the Remote Terminal, depending on where installed. Multiple

CRTs may be installed with each Control Terminal and/or Remote Terminal. The CRT will display 32 channels of status, 32 channels of telemetry or a mixture of both on a master page as shown in the photographs. Command lines may also be displayed on the CRT for "housekeeping" purposes.

Each CRT option installed with a Control Terminal may be used to display information from any site accessible to the associated Control Terminal. A CRT option installed with a Remote Terminal has access to all data generated at that terminal and may implement control functions if the Remote Terminal has been placed in the maintenance override condition. Control Terminal CRTs may exercise command functions by implementing the "take control" function, which transfers command capability to one CRT at a time in compliance with the FCC remote control rules. An automatic time-out ensures that a CRT will not take control and be left in that condition, inadvertently locking out control access by other CRTs. The Control Terminal itself always takes command priority over its associated CRTs.

The CRT option is extremely easy to program. Initial page setup is accomplished by answering a series of questions on the CRT screen. Display programming is accomplished by typing

Site 01, Page 01: KW41-TV TRANSMITTER REMOTE CONTROL				03 Mar 1982 14:20:22	
Channel	Value	Channel	Value		
SQ65 SYSTEM STATUS	STATUS	SQ67 OVERLOAD INDS			
SQ01 XMTR In Use	MAIN	SQ11 Vis Plate Ovd	No		
SQ02 Duplexr In Use	A	SQ14 Aur Plate Ovd	No		
SQ03 Antenna In Use	Main	SQ21 Aux Vis Ovd	No		
		SQ22 Aux Aur Ovd	No		
SQ66 MAIN XMTR		SQ68 AUX XMTR			
TQ01 MAIN Vis Fils	6.33 Volts	TQ17 AUX Vis Fils	[0.] Volts		
TQ02 Vis Plate Volt	7.55 KVolts	TQ18 Vis Plate Volt	[0.] KVolts		
TQ03 Visual Current	4.35 Amperes	TQ20 Visual Power	[0.] Percent		
TQ04 Visual Power	100.0 Percent	TQ21 Aural Filament	[0.] Volts		
TQ15 Vis Refl Power	234. Watts	TQ22 Aur Plate V	[0.] KVolts		
TQ08 Aural Filament	6.29 Volts	TQ24 Aural Power	[0.] Percent		
TQ09 Aural Plate V	5.53 KVolts				
TQ10 Aural Current	2.36 Ampere	SQ24 Front Door	Closed		
TQ11 Aural Power	102.2 Percent	SQ26 Fire Alarm	No		
TQ16 Aur Refl Power	75.2 Watts				
On raise: Xmtr Select	<input type="checkbox"/>	Restricted functions	ENABLED		
On lower: Xmtr Select	Aux	Limit checking	DISABLED		
		Maintenance override	DISABLED		

descriptors in plain English for parameters, telemetry units, and status conditions. These descriptors, along with telemetry values, are displayed on the CRT along with system status, site status, and alarm conditions. Data link conditions are also displayed on a separate page.

The selected telemetry or status channel on a given page is normally displayed in full intensity video, which changes to reverse video when the CRT is enabled for command functions

AUTOMATIC LOGGING

The MRC-2 Automatic Logging option provides a printed record of any or all telemetry and/or status channels from one or several sites in a 13 column format. The system will print user-defined header lines, which may be programmed to print at various times of the day. Multiple headers may be used, with each one programmed to print at different times to allow for shift changes as well as the beginning and end of a broadcast day.

Use of the CRT option in conjunction with the Automatic Logging option adds the CRT descriptors to the Automatic Logging option for alarm and event descriptions. The MRC-2 Logging

ROSELEY ASSOCIATES, INC. 111 CASTILIAN DRIVE GOLETA, CALIFORNIA 93117										CONTROL TERMINAL AUTOMATIC LOGGING SYSTEM									
										OPERATOR OFF					OPERATOR ON				
-----MAIN TRANSMITTER-----					-----AUX TRANSMITTER-----					Key	Outside	Tower	Rain	Aux					
Site	Chan	Stat	Event	Value	Site	Chan	Stat	Event	Value	Switch	Light	Lights	Fan	Fan					
0525	SITE 01	6.216								OFF	ON	ON	OFF	OFF					
0525	SITE 01	6.293																	
0527	SITE 01	CHANNEL 005	STATUS EVENT:	RISING EDGE DETECTED					Visual Plate	On									
0527	SITE 01	CHANNEL 007	STATUS EVENT:	RISING EDGE DETECTED					Aural Plate	On									
0527	SITE 01	6.203	7.531	4.740	099.9					OFF	ON	ON	ON	OFF					
0527	SITE 01	6.202	5.093	2.350	099.9														
0530	SITE 01	6.206	7.534	4.742	099.0					OFF	ON	ON	ON	OFF					
0530	SITE 01	6.202	5.093	2.350	100.0														
0600	SITE 01	6.206	7.534	4.742	093.2<					OFF	ON	ON	ON	OFF					
0600	SITE 01	6.202	5.093	2.350	100.0														
0617	SITE 01	CHANNEL 004	ANALOG ALARM:	EXCEEDED LOWER RED LIMIT					Main Vis Power										
0617	SITE 01	6.200	7.536	4.743	000.6<<					OFF	ON	ON	ON	OFF					
0617	SITE 01	6.205	5.095	2.359	100.0														
0618	SITE 01	CHANNEL 004	ANALOG EVENT:	RETURN TO LOWER RED LIMIT					Main Vis Power										
0618	SITE 01	6.209	7.536	4.744	099.9					OFF	ON	ON	ON	OFF					
0618	SITE 01	6.207	5.095	2.359	100.0														
0700	SITE 01	6.212	7.542	4.747	100.0					OFF	ON	ON	ON	OFF					
0700	SITE 01	6.209	5.095	2.359	100.0														
0722	SITE 01	CHANNEL 027	STATUS EVENT:	FALLING EDGE DETECTED					Outside Lights	Off									
0722	SITE 01	CHANNEL 028	STATUS EVENT:	FALLING EDGE DETECTED					Tower Lights	Off									

option is available for use with Control and Remote Terminals (specify when ordering). Up to eight Automatic Logging options may be used with a single terminal, subject to card slot availability.

MULTIPLE DIRECT COMMAND

Site selection, channel selection, and function (raise or lower) may be accomplished with a single button with the addition of the Multiple Direct Command

option. This pre-programmed panel contains 16 buttons with true tally-back lamps to indicate that a control function has been implemented. This is especially useful for simplified operations of frequently needed or seldom used functions, such as transmitter switching.

MULTIPLE STATUS DISPLAY

Some applications of the MRC-2 require the ability to simultaneously monitor a number of status channels at either a Control Terminal or Remote Terminal. The optional MRC-2 Multiple Status Display panel permits presentation of a block of 32 status channels from a site in the form of LEDs with user-produced labeling. A status output driver for indicators external to the panel is included.

DIGITAL TELEMETRY INPUT

Digital telemetry may be input to the MRC-2 System in the form of four BCD digits or 14-bit binary input with sign, bypassing conversion from analog to digital data. This digital data will be displayed directly on the MRC-2 Control Terminal, Remote Terminal, and CRTs. Each plug-in conversion card will accommodate one digital input.

Site 01, Page 02: KMAI-TV TELEMETRY DISPLAY				03 Mar 1982 14:29:56			
Channel	Value	Channel	Value				
T001 MAIN Vis Fils	6.33 Volts	T017 AUX Vis Fils	[0.] Volts				
T002 Vis Plate Volt	7.55 KVolts	T018 Vis Plate Volt	[0.] KVolts				
T003 Visual Current	4.35 Amperes	T019 Visual Current	[0.] Ampere				
T005 Visual Drive	4.9 Rel.	T020 Visual Power	[0.] Percent				
T006 Vis Driver Pl	2459. Volts	T021 Aural Filament	[0.] Volts				
T007 Vis Dr Current	1.03 Amperes	T022 Aur Plate V	[0.] KVolts				
T008 Aural Filament	6.29 Volts	T023 Aural Current	[0.] Amperes				
T009 Aural Plate V	5.53 KVolts	T024 Aural Power	[0.] Percent				
T010 Aural Current	2.36 Ampere	T025 AC Phase 1	237.0 Volts				
T011 Aural Power	102.3 Percent	T026 AC Phase 2	237.3 Volts				
T012 Aural Drive	75. Rel.	T027 AC Phase 3	241.5 Volts				
T013 Aur Driver Pl	2396. Volts	T028 Reject Power	1.234 KWatts				
T014 Aur Dr Current	1.10 Amperes	T029 Diplexer Temp	92.4 Deg F				
T015 Vis Refl Power	234. Watts	T030 Intake Temp	75.3 Deg F				
T016 Aur Refl Power	75.2 Watts	T031 Exhaust Temp	88.4 Deg F				
		T032 Outside Temp	72.7 Deg F				

On raise: Visual Drive	Raise	Restricted functions	ENABLED
On lower: Visual Drive	Lower	Limit checking	DISABLED
		Maintenance override	DISABLED

BARRIER STRIP INPUT/OUTPUT PANEL

A Barrier Strip Input/Output Panel is available to simplify the connection of telemetry and status inputs as well as open collector or optically-isolated command outputs. Each rack-mounted panel includes an interconnecting cable with plug for 16 input or output connections with grounds and may be expanded up to a total of 64 lines or channels per panel.

COMMAND INTERFACE PANEL

A Command Interface Panel option is available for providing relay-isolated command lines for inter-connecting to transmitter or plant control circuits not suitable for standard transistor switching. Each CIP-2 Panel provides 16 relay sockets and power supply with ribbon cable for direct connection to the MRC-2 standard command outputs. The relays are available separately to allow configuring as required.

VIDEO ANALYSER INTERFACE

A user-supplied Rohde & Schwartz UVF Video Analyser can be used with the MRC-2 to remotely monitor video signals. The UVF appears to the MRC-2 as a block of 16 telemetry channels. The Video Analyser interface can be used with up to eight UVFs at any remote terminal.

PERSONAL COMPUTER INTERFACE

Some applications require a simple interface to a user-supplied personal computer. The personal computer interface allows serial access to virtually any data which is available at the Remote or Control Terminal where the Interface is installed. This includes analog data, status data and command data. All programming of the personal computer is the responsibility of the user.

CRT MODEMS

In those cases where it is desirable to extend the CRT option great distances

from its associated control or remote terminal, modems may be used to connect the CRT and terminal dial phone lines. Manual or auto-answer

modems are available. This can be used as an alternate control point, since all the functions of the CRT are maintained.

SPECIFICATIONS

Optically Isolated Command Outputs

16 output lines per module, optical isolators driving high-current Darlingtons
Switches up to 250 mA, 48 VDC, at up to +50 VDC from ground, user-supplied

Relay Isolated Command Outputs (Model CIP-2)

16 output lines per panel, one SPDT relay per command line
Barrier Strip outputs
Up to 5A, 240 VAC per relay

Optically Isolated Status Inputs

16 lines per module, LED optical isolator
Input 10-48 VDC (3-15V strappable), 5-30 mA current, user-supplied voltage
Maximum voltage to ground +50 VDC

CRT Display/Control

ADDS VP60+ terminal with full ASCII keyboard and 12-inch CRT
15-foot cable, interface cards and software
9600 baud (960 characters/second)
Installs at Control Terminal or Remote Terminal used with DACU-1

Automatic Logging

Genicom 2030 KSR printer with full keyboard
15-foot cable, interface cards and software
Logs in "plain-English" with addition of CRT option
Logs parameters from attached Remote Terminal or any sites accessed by an attached Control Terminal

Automatic Control Unit

User-programmed with CRT on Automatic Control Unit
Programming in BASIC-like language allows complex algorithms involving commands, status, telemetry, time and date
May also be programmed in BASIC
Installs at Control Terminal or Remote Terminal used with DACU-1

Multiple Direct Command

16 buttons per unit with LED tally-back
Each switch individually programmable for site and command line, includes external command input
May be "daisy chained" for additional display capability (up to 13 units)

Multiple Status Display

32 LEDs per unit
Displays two blocks of 16 status channels, includes external display output
May be "daisy chained" for additional display capability (up to 13 units)

Digital Telemetry Input

Input: Four BCD digits with sign or 14-digit binary
One input per module
Card and software

Barrier Strip Input/Output Panel (BSP-1)

16 input channels or output lines per panel standard, expandable to 64 in groups of 16
Panel with 16 barrier strip(s) and interconnecting cable(s)

Personal Computer Interface

User-supplied computer and programming
Installs at remote or control terminal
15-foot cable interface cards and software
Allows access to MRC-2 protocols and variables

Video Analyser Interface

User-supplied Rohde & Schwartz UVF Video Analyser
1-meter cable, interface cards and software
Installs at remote terminal

Dial-up Communications

Hayes Smart modem each terminal standard
Remote cables, interface cards, and software

*Nominal response times based on basic system with 2 modems and no options.

NOTE: Specifications subject to change without notice.

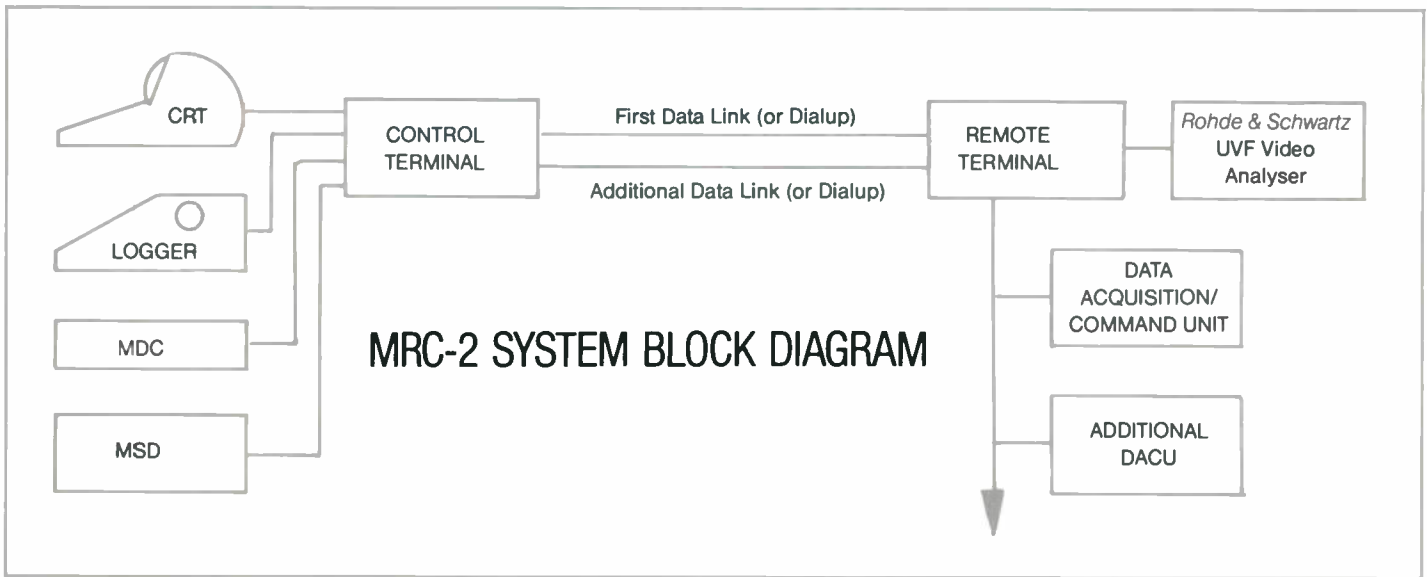

SYSTEM INTERCONNECT

The MRC-2 System allows maximum flexibility in interconnecting Control Terminals and Remote Terminals. The basic system (one Control Terminal, one Remote Terminal) is provided with two wire-line modems on each Terminal. This type of interconnection is intended for use with suitable telephone lines or radio links conveying baseband audio in the 300-3,000 Hz range. Optional FM subcarrier generators and demodulators are available to replace the standard interface on the input and/or output for each modem. These units are available in the 26 kHz to 185 kHz range on standard frequencies for conveyance over aural studio-transmitter links as well as FM or aural TV carriers. An RS-232 option is also available for users desiring to integrate their own modems or specialized forms of transmission into the MRC-2 System.

A dial-up configuration is available to take advantage of the public telephone network in those instances where continuous communication is not required. Control terminals can automatically dial a Remote Terminal per user-set intervals. Remote terminals can dial Control terminals when alarm conditions occur. The dial-up configuration does not preclude use of dedicated circuits.

MRC-2 Systems employing two data links between a given pair of terminals

will make use of both data links to enhance system speed as well as reliability. Up to six modems (8 with dial-up) may be used in a Control Terminal, and up to four modems (8 with dial-up) may be used in a Remote

Terminal, allowing up to two modems per Control Terminal/Remote Terminal interconnect. As transmission is non-simultaneous within a given subsystem, Remote Terminals may be paralleled to a Control Terminal modem.

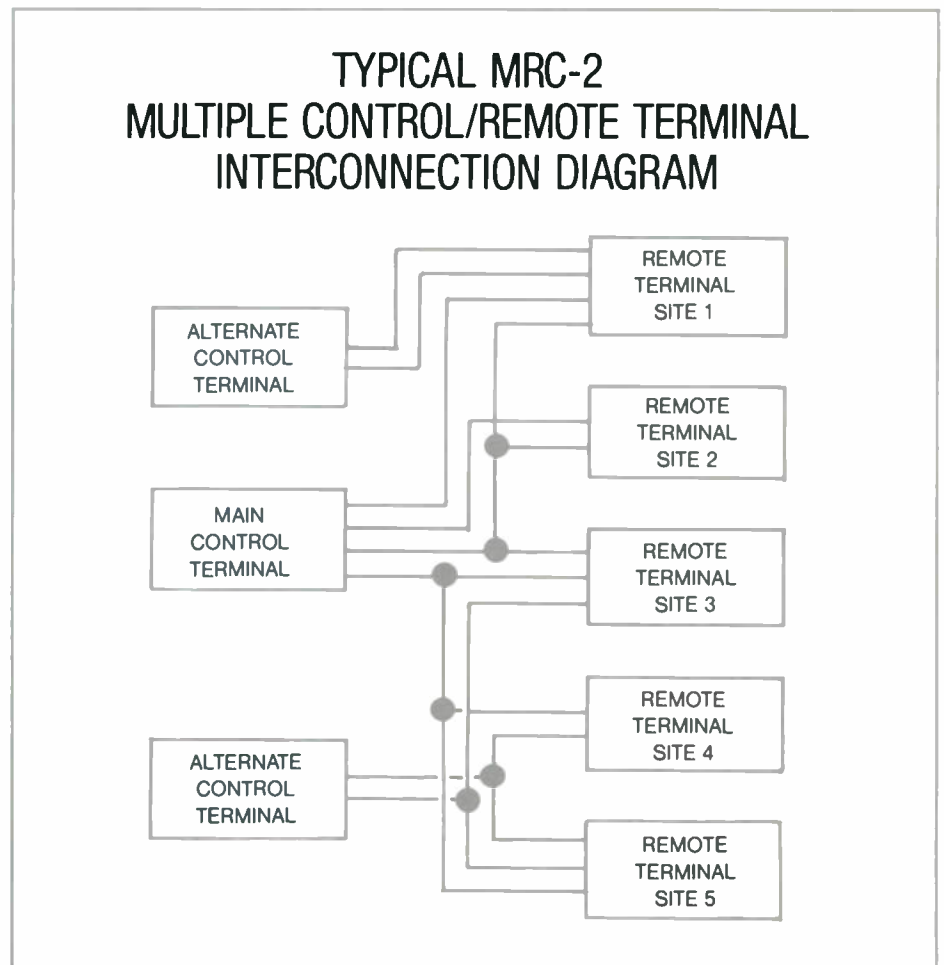

SPECIFICATIONS

Type of System

Microprocessor-based, distributed intelligence

Types of Memory Used

*Programmable Read-Only Memory for system firmware
Electrically-Alterable Read-Only Memory for user programmed functions
Firmware and user-programming non-volatile, kept intact during power failure, no battery backup required.*

Real-Time Clock

Crystal-controlled with battery backup for power failure duration of up to one year

Remote Site Capability

One to 99 sites, coded protocol

Control Terminal Configuration

Up to four per Remote Terminal, one functioning as master Control Terminal

Command Lines

*Programmable momentary, momentary pulse, or latching
Command response time: 750 ms to implementation, nominal*
Momentary pulse duration: 0.1 to 6.4 seconds
Open collector output standard (will switch up to 250 mA at 48 VDC, user-supplied voltage)
Front-panel tally-back LED indicators
0 to 256 lines per site in 16 line increments, 32 lines per DACU-1 supplied standard, 16 lines per stand-alone Remote Terminal supplied standard
Optically isolated and relay interfaces optional*

Status Channels

*User-programmable N.O./N.C., momentary or latching, alarm or event indication
Status, response time: 500 ms, nominal* Command Unit
TTL-compatible input standard (+5 VDC switched by external contacts)
0 to 256 channels per site in 16 channel increments, 32 channels per DACU-1 supplied standard, 16 channels per stand-alone Remote Terminal supplied standard*

Telemetry Channels

*One person digital calibration, via Remote Terminal keyboard
Fully tolerance alarmed, dual high and dual low limits
Absolute, linear, power-to-liner conversion, indirect power, ratio, digital word calibration
Full four-digit LED display with decimal point and polarity
Resolutions: one part in 1024
Overall measurement accuracy: better than 0.5%
Response time: 500 ms, nominal*, independent of channel load
Up to 64 channels per Data Acquisition/Command Unit
Full scale input level: ± 300 mV minimum, ± 1 V minimum recommended, ± 4.5 VDC maximum (field-alterable to ± 10 VDC maximum)
0 to 256 channels per site in 16 channel increments, 32 channels per DACU-1 supplied standard, 16 channels per stand-alone Remote Terminal supplied standard
Digital telemetry input optional*

Aural Alarms

Control and Remote Terminals, defeatable and removable

Fail-Safe

*Control relay relaxes after 3 minutes of no control
Telemetry: optional, includes internal three hour timer for up to six transmitters*

Maintenance Override

*Remote Terminal front-panel button
Provides Remote Terminal "go home" relay closure and Control Terminal LED alert indication*

Number of Data Interconnection Links

*Up to four per Remote Terminal (8 with Dialup)
Up to eight per Control Terminal (8 with Dialup)
Two per Terminal supplied standard
Up to two per Control Terminal/Remote Terminal pair*

Data Transmissions

*Seven bit ASCII with parity plus Longitudinal Redundancy Character Check
1200 baud each direction standard
Two-way, non-simultaneous, via FSK, 1200/2200 Hz*

Wire Interconnection

*Two-wire or four-wire, 600 ohm, balanced
Series 3002 basic unconditioned data channel per Bell System Technical Reference Publication 41004 (FCC tariff No. 260) for 1200 baud (standard)
Two-way, non-simultaneous
Nominal send level: 0 dBm, minimum receive level: -30 dBm
RS-232 interconnection optional*

Radio Interconnection

*Single or duplex, internal subcarrier systems available on standard frequencies between 26 and 185 kHz
Nominal Level: 1.5 V P-P at 2k ohms
Specify frequency and exact radio link when ordering*

Operating Temperature Range

0° - 50°C

Power Requirements

Control Terminal Remote Terminal, Data Acquisition/Command Unit (each): 120/240 VAC, 50/60 Hz, 100 Watts, nominal

Physical Size

Control Terminal, Remote Terminal and Data Acquisition/Command Unit: 17.8 cm H x 48.3 cm W x 39.4 cm D (7-H x 19-W x 15.5-D), depth less connectors

NOTE: Specifications subject to change without notice.

Printed in U.S.A. 11/86



Moseley
Associates
Incorporated

111 Castilian Drive
Santa Barbara, CA
93117-3093

a
Flow General
Company

Phone 805 968 9621
Telex 658448
Cable: MOSELEY
FAX 805 685 9638



MICROPROCESSOR REMOTE CONTROL

BULLETIN 283

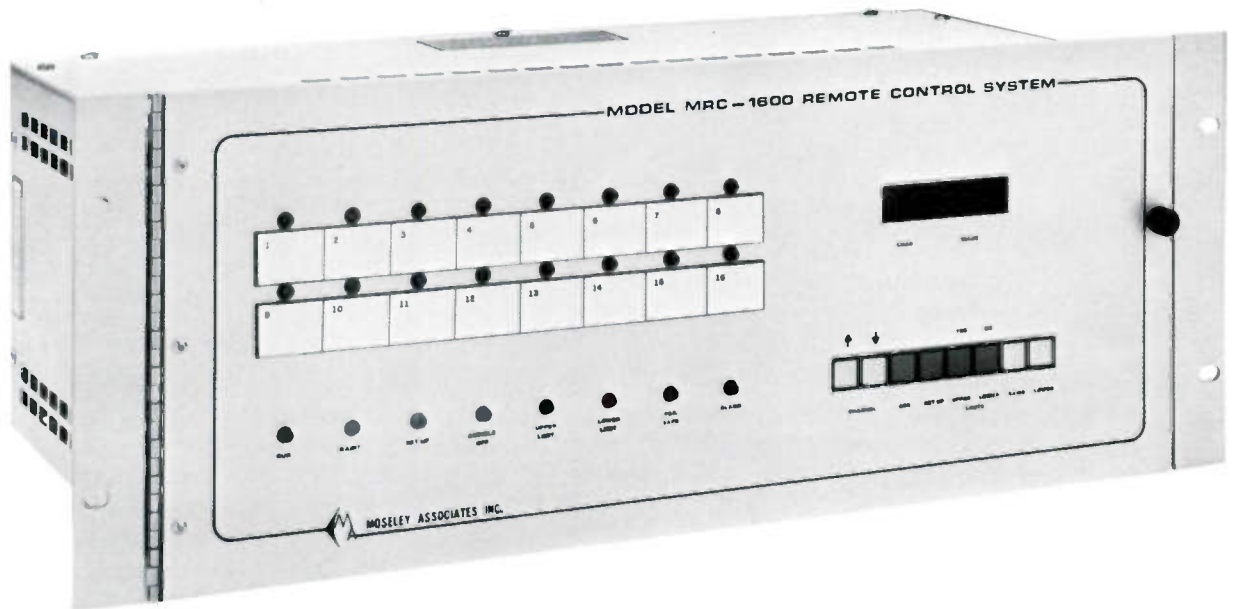

MRC-1600



**ALLIED BROADCAST
EQUIPMENT**
5097 N. Elston Ave., Suite 303
Chicago, IL 60630
Phone (312) 794-0224

MOSELEY ASSOCIATES, INC.

A FLOW GENERAL COMPANY

MRC-1600

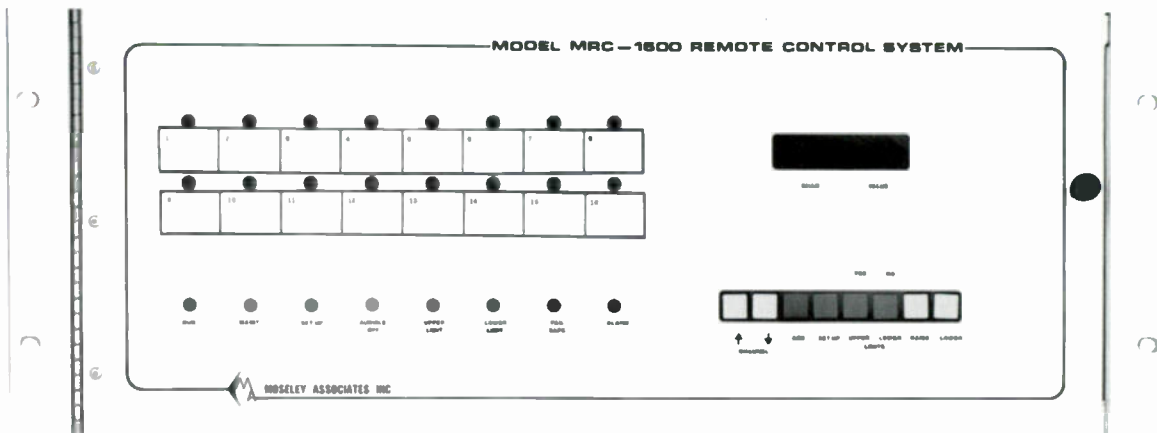

The MRC-1600 Microprocessor Remote Control offers microprocessor flexibility and sophistication in an economical and dependable package for general AM-FM remote control applications. It comes equipped with 16 status inputs, 16 telemetry inputs, 16 raise command outputs and 16 lower command outputs. Each command output is relay-isolated. Adapting the MRC-1600 to current system interconnections is easy. Plug-in modules can be ordered to accommodate almost any interconnection system, from standard 2-wire or 4-wire telephone lines to FM subcarriers, subaudible telemetry, or a custom combination of any of these.

The MRC-1600 is also suitable for other applications where television telemetry failsafe is not required, like low power television (LPTV) facility control. Telemetry limit checking and status alarm capability help ensure that an unmanned facility operates at peak efficiency while any alarm conditions, such as fire or intrusion, are quickly relayed to an operating position so that appropriate action can be taken. The user is cautioned to be certain that any applicable FCC Rules regarding fail-safe operation are followed in the use of this system.

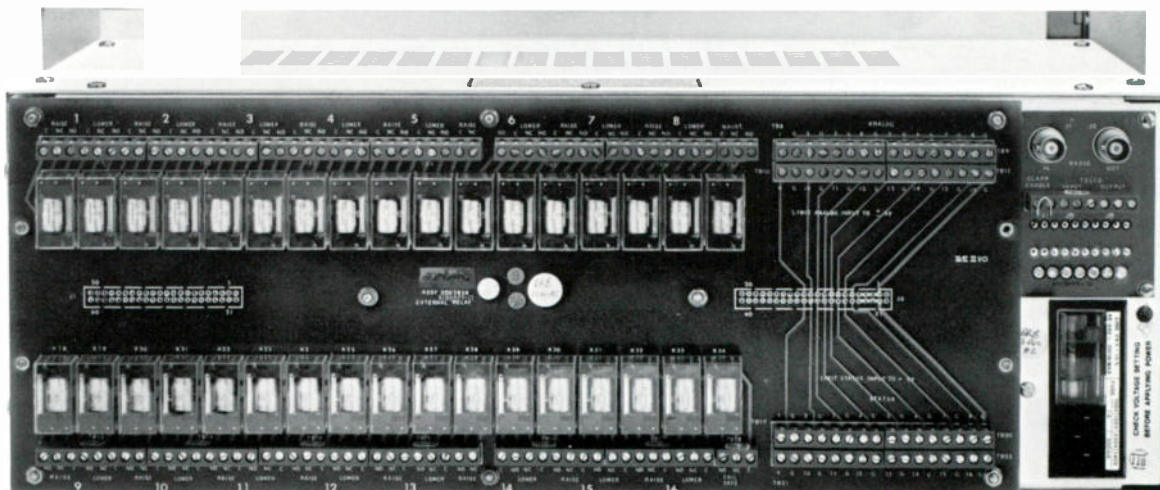

MRC-1600



CRT TERMINAL

The CRT option for the MRC-1600 gives the broadcaster full control of the transmitter from the keyboard at the Control Terminal. All status and telemetry data are displayed simultaneously on an ADDS Viewpoint A2 terminal. It also indicates time of day, data-link status and Maintenance Override mode at the Remote Terminal.

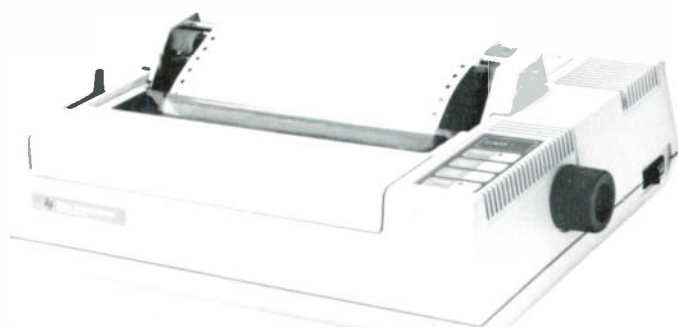

AUTOMATIC LOGGER

An Automatic Logging option can be added to the CRT option to provide a printed log of station operation. A Texas Instruments Model 850 printer records status and telemetry data at user-specified intervals from one minute to twenty-four hours.

MOSELEY MEMORY

Moseley Memory is standard on the MRC-1600. In event of power down, all setup data, calibration information and limits are stored on electrically-alterable read-only memory (EAROM) for up to ten years. This ensures fast system restart after power is restored.

SPECIFICATIONS

Moseley Memory:

- Retains data for ten years minimum, on electrically-alterable read-only memory (EAROM).
- Holds calibration factors, status and command assignments.
- With CRT, or CRT and Logger options, stores CRT text and logger setups.

CRT Terminal:

- ADDS Viewpoint A2 CRT terminal with full keyboard and 12-inch CRT.
- 15-foot cable and software.
- 1200 baud (120 characters/second).
- Installs at Control Terminal.

Automatic Logging:

- Texas Instruments Model 850 printer.
- 15-foot cable, attaches to AUX port on CRT terminal at Control Terminal.
- 1200 baud (120 characters/second).
- User-programmable channel list header text, and log intervals (stored in non-volatile memory).
- Available only if CRT is also present.

Subcarrier and Subaudible:

- 26, 39, 41, 67, 92, 94, 110, 152, 185 kHz available.
- May be purchased in combination with Telco if desired.

MRC-1600

SETUP AND OPERATION

System setup and calibration are done at the Remote Terminal with eight color-coded buttons. For each channel, during setup, upper and lower telemetry limits may be set or disabled independently, and telemetry data may be calibrated in one of four modes: power, indirect power, linear, or millivolt. Status inputs may be set to display direct or inverted and may be programmed to trigger an alarm on rising, falling, or rising and falling waveforms. Once setup and calibration are complete, all data is copied to the Control Terminal, ensuring that recalibration and setup will not be necessary should either terminal be shut down temporarily.

The MRC-1600 operates two special system test channels. One checks A/D conversions and provides an alarm when tolerance exceeds factory set limits. The other gives the user readouts of conditions for both control to remote, and remote to control data links. In compliance with current FCC Regulations, the MRC-1600 has full control fail-safe provisions. Fifteen seconds after loss of control contact between terminals, aural and visual alarms are initiated.

After 45 seconds, the RUN LEDs will extinguish and the control fail-safe relay at the Remote Terminal will relax. MRC-1600 Remote Terminals are also equipped with a Maintenance Override mode which, when

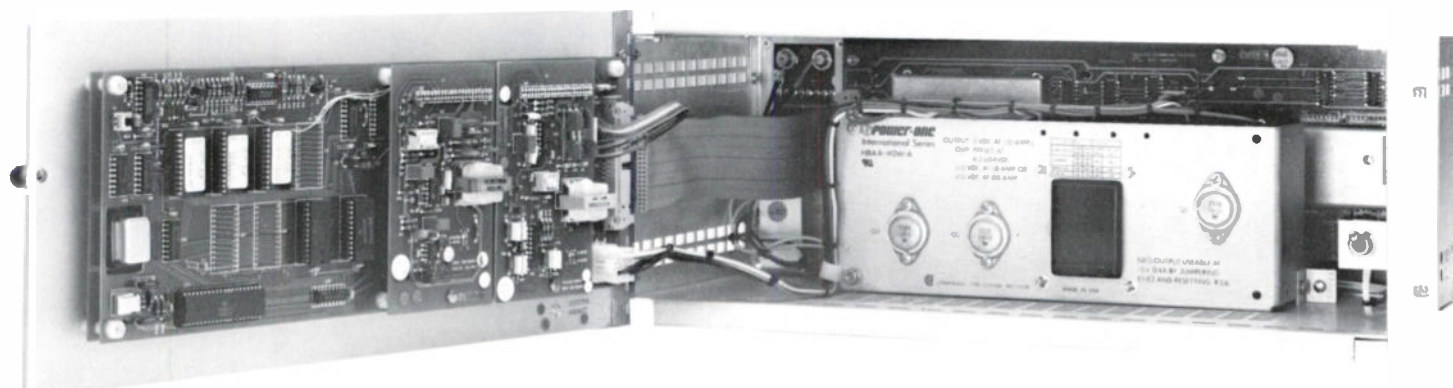

The MRC-1600 front panel is simple to operate and easy to understand. All status channels are displayed simultaneously on a set of 16 LEDs. Alphanumeric LEDs give readouts of selected channel number and telemetry data while eight color-keyed LEDs indicate system operation mode, alarms, etc.

MRC-1600 operation is straightforward. The system constantly checks telemetry data for each channel against assigned upper and lower limits. Any channel exceeding its limits immediately sets off audible and visible alarms. Pressing the ACKnowledge button displays the relevant channel number, telemetry information, and upper or lower limit LEDs so the operator can push either the raise or lower key to bring telemetry values for that channel back within limits.

activated, ignores Control Terminal commands but continues to update status and telemetry data. LEDs and auxiliary contacts are provided to enable warnings to personnel that the Remote Terminal is in the override mode.

SPECIFICATIONS

Type of System:

- Microprocessor-based Control Terminal and Remote Terminal

Types of Memory Used:

- Programmable Read-Only Memory for system firmware
- Random Access Memory for user-programmed functions

System Configuration:

- One Control Terminal, one Remote Terminal per system

Command Lines:

- Two (one raise, one lower) per channel, momentary, total of 16 "raise", 16 "lower"
- Command response time: 400 ms to implementation, nominal
- Form C relay (SPDT) output standard, up to 2A, 30 VDC or 120 VAC (non-inductive) per relay

Telemetry Channels:

- 16 channels, unbalanced input
- One-person digital calibration, via Remote Terminal keyboard
- Fully tolerance alarmed, one high and one low limit
- Linear, power-to-linear conversion, indirect power, millivolt calibration
- Full four-digit LED display with decimal point and polarity sign
- Resolution: one part in 4096
- Overall measurement accuracy: better than 0.5%
- Response time: 500 ms, nominal, with audible data
- Full-scale input level: 0.25V minimum, 1V minimum recommended, 4.5 VDC maximum

Status Channels:

- 16 channels, each displayed by individual LEDs on Control Terminal and Remote Terminal front panels
- User-programmable N.O./N.C., momentary or latching, alarm on rising and/or falling waveform
- Status response time: 400 ms, nominal, with audible data
- TTL-compatible input standard (+5 VDC switched by external contacts)

Aural Alarms:

- Control and Remote Terminals, defeatable and remoteable

Fail-Safe:

- Control: Complies with current FCC requirements for AM and FM radio station operation

Maintenance Override:

- Remote Terminal front-panel button
- Provides Remote Terminal "go home" relay closure, Control Terminal and Remote Terminal LED indication

Number of Data Interconnection Links:

- One

Data Transmissions:

- Eight-bit ASCII plus parity
- 300 baud each direction standard (audible)
- 9.4 baud telemetry with subaudible telemetry option
- Two-way, simultaneous via FSK

Wire Interconnection:

- Two-wire or four-wire, 600 Ω , balanced
- Series 3002 unconditioned data channel per Bell System Technical Reference Publication 41004 (FCC tariff No. 260) for 300 baud (standard)
- Two-way simultaneous
- Nominal send level: 0 dBm; Minimum receive level: -30 dBm

Radio Interconnection:

- Single or duplex, internal subcarrier systems
- Available on standard frequencies between 26 and 185 kHz
- Nominal send level: 1.5V p-p at 2.2 k Ω
- Nominal receive level: 0.25V p-p at 2.2 k Ω
- Specify frequency and exact radio link when ordering

Remote Terminal Connectors:

- Terminal strip connectors for status, telemetry inputs, command outputs

Operating Temperature Range:

- 0° - 50°C

Power Requirements:

- 120/240 VAC, 50/60 Hz, 30W typical (per terminal)

Physical Size:

- Control Terminal: 17.8 cm H x 48.3 cm W x 21.6 cm D (7"H x 19"W x 8.5"D), depth less connectors
- Remote Terminal: 17.8 cm H x 48.3 cm W x 22.9 cm D (7"H x 19"W x 9"D), depth less connectors

FOR FURTHER INFORMATION

PLEASE CONTACT OUR MARKETING DEPARTMENT

 **MOSELEY ASSOCIATES, INC.**
A Flow General Company . Santa Barbara Research Park
111 Castilian Drive Goleta, California 93117
(805) 968-9621 . Telex: 658-448 . Cable: MOSELEY