

# AEL Total RF Transmission Systems

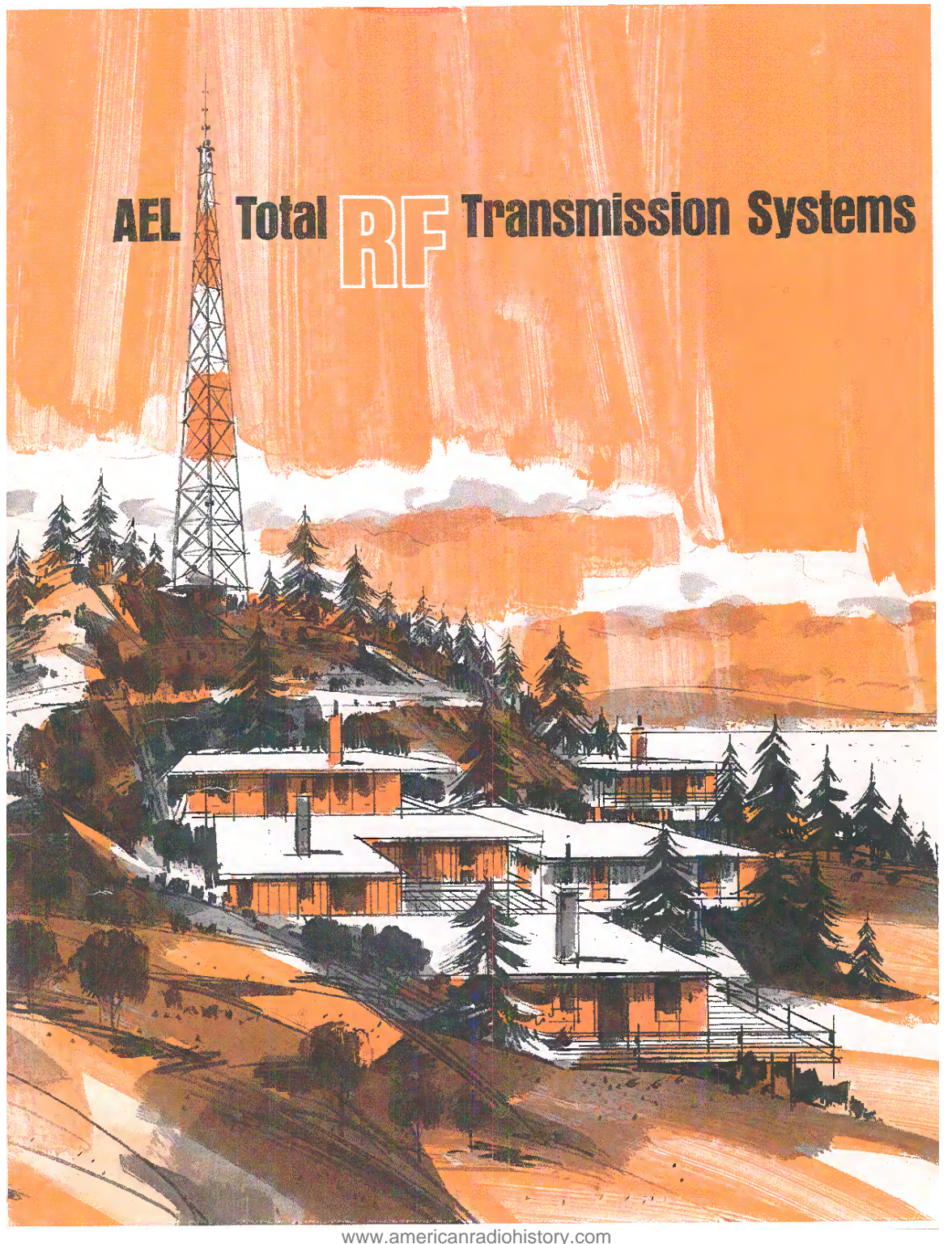

## TABLE OF CONTENTS

	Page No.
Model AM-5KD • 5,000W	6
Model AM-10KD • 10,000W	10
Model AM-50KD • 50,000W	14
Model FM-2.5KE • 2,500W	22
Model FM-5KE • 5,000W	24
Model FM-10KE • 10,000W	24
Model FM-15KE • 15,000W	26
Model FM-25KE • 25,000W	28
Model FM-25/25KE • 40,000W-50,000W	30
Model FM-20E Exciter	36
Model FM-20E/SG Stereo Generator	37
Model FM-20E/SC SCA Generator	37
Model FM-15QE Exciter	38
Model FM-15QE/SG Stereo Generator	39



AMERICAN ELECTRONIC LABORATORIES, Inc.

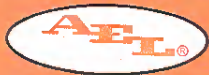

## *A QUARTER CENTURY OF TECHNOLOGICAL GROWTH*

American Electronic Laboratories, Inc. was founded in 1950 by two engineers on the staff of the Moore School of Electrical Engineering at the University of Pennsylvania . . . Dr. Leon Reibman and Conrad J. Fowler.

The modern plant, with the state-of-the-art equipment and facilities, is located on a 55-acre tract in historic Montgomery County, Pennsylvania

The AEL Broadcast Division is part of a responsive and efficient organization, geared to meet the challenges of scientific research, design, development, manufacturing and service.

Throughout the free world numerous customers have benefited from the success of AEL's innovative endeavors: the Department of Defense, the National Aeronautics & Space Administration, many industrial organizations . . . and especially commercial broadcasters.

The requirements of the broadcaster are served throughout the United States, as well as internationally, with marketing representatives dedicated to serve management and the broadcast engineer.

For additional information, contact the Broadcast Marketing Manager at our headquarters in Colmar, PA.

American Electronic Laboratories, Inc.  
P.O. Box 552, Lansdale, PA 19446  
(215) 822-2929 TWX: 510-661-4976

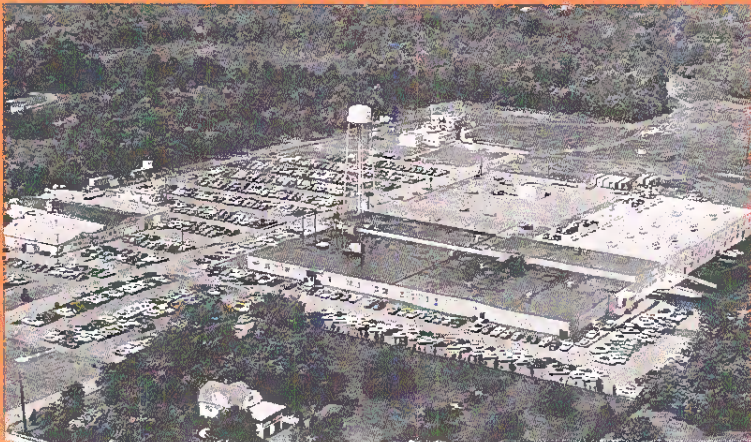



Lee DeForest (1873-1961), an American inventor, pioneered in wireless telegraphy and radio broadcasting. He obtained patents on more than 300 inventions. He patented a vacuum tube called a triode, or audion, in 1907. It often is described as an invention as great as radio itself. The tube, which amplifies weak sounds, is basic to long-distance radio and television communication.





# 5,000W



## FEATURES

- Excellent Fidelity
- Easy Maintenance
- Semi-Automatic Operation
- High Level Modulation
- Solid State Control Circuitry
- 125% Modulation Capability
- Central Control Panel

The Model AM-5KD is a completely self-contained 5,000 Watt AM transmitter. It is FCC Type Accepted for service in the 535 to 1605 kHz broadcast band

This transmitter was designed for the professional AM broadcaster and features all solid state control circuits, excellent audio fidelity, and semi-automatic start-up features.

## FIDELITY

The low level audio section of the AM-5KD is completely solid state. The program input line drives a dual 100 Watt solid state preamplifier whose output provides grid drive to a pair of low distortion 4CX3000A class AB-1 modulators. Negative feedback is used around the complete audio section to reduce distortion and assure high fidelity performance. The overall performance of this transmitter that is of particular interest to the broadcast engineer includes:

- Frequency Response 50 — 7500 Hz ( $\pm 1.5$  dB)
- Low Distortion 1.5% (typical)
- Low Noise —55dB (unweighted)

## Model AM-5KD Broadcast Transmitter

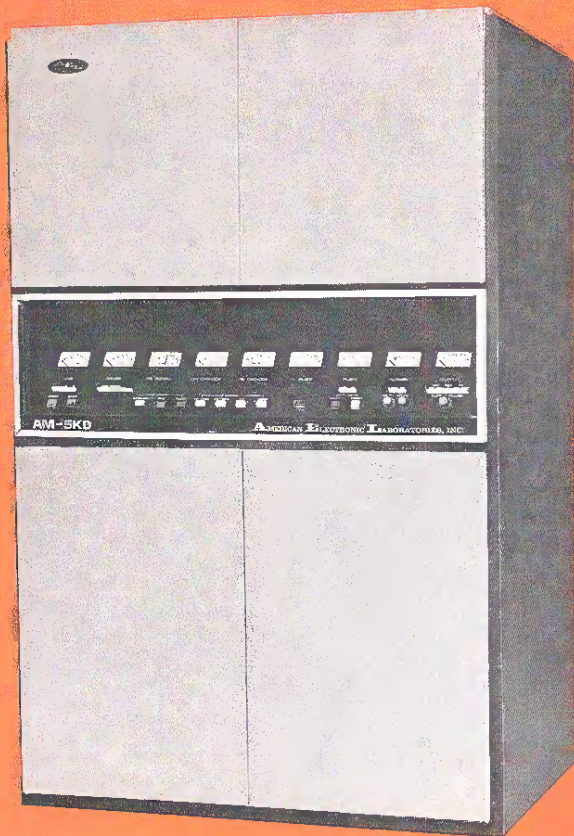

### RF OUTPUT CIRCUITRY (Front View)

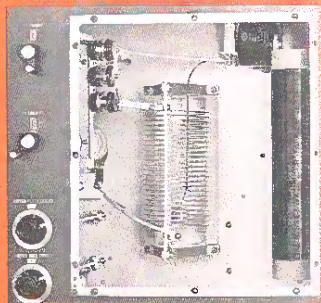

RF choke and plate tank coil. Notice the convenient PA and driver tuning controls.



**EASY MAINTENANCE**

The transmitter is housed in a single self-contained modern cabinet including the AEL Center Line Control Panel concept. This places all metering, control, and indicator functions at the normal reading level position for easy operation while making tuning or operation adjustments.

The meter panel is front-end hinged for easy access to all control and logic circuits.

All High Power circuits and components are located in the rear of the cabinets

The entire chassis maintains a positive cabinet air pressure which prevents intrusion of dust and dirt; this feature significantly increases the life of the high-voltage components and reduces the need for maintenance.

**TUBES**

The RF output stage uses one (1) high gain, high reliability 4CX3000A Tetrode; the RF driver stage utilizes a single 8121 high performance Tetrode which operates at one third of maximum output capabilities; the modulator stage uses two (2) 4CX3000A's operating class AB1.

There are only two tube types (4 tubes total in this 5,000W transmitter).

**SEMI-AUTOMATIC OPERATION**

This transmitter has several semi-automatic controls that are of interest to the broadcaster. These include automatic re-start, automatic re-cycle, and power cut-back; all control functions are accomplished by solid state logic circuits; each operates from a 24 Vdc regulated power supply. The interlock and sequence relays are also operated from this low voltage source for safety and convenience. Push button start/stop operation is used. Operating and fault status lights are placed in the center-mounted control panel.

**AUTOMATIC RE-CYCLING—Overload Protection**

Any abnormal condition that might cause an overload condition in the Driver Tube, the Power Amplifier Tube, or the high voltage section of the amplifier immediately initiates a 1 second shut down. The plate voltage is removed automatically from these tubes to protect them from permanent damage. It is automatically returned after this one second interval; after three consecutive shut downs the plate voltage can be restored only by a manual re-set.

*(Continued on page 8)*

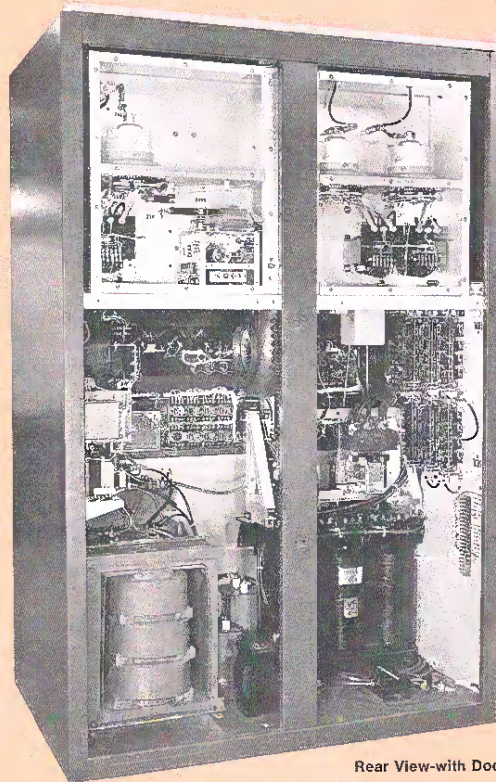

Rear View-with Doors and Air Filters removed.

**RF OUTPUT CIRCUITRY  
(Rear View)**

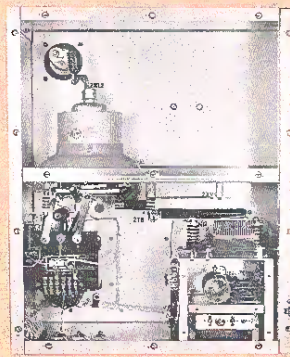

At the top of this RF section is the RF power amplifier and below is the solid state exciter.



# 5,000W

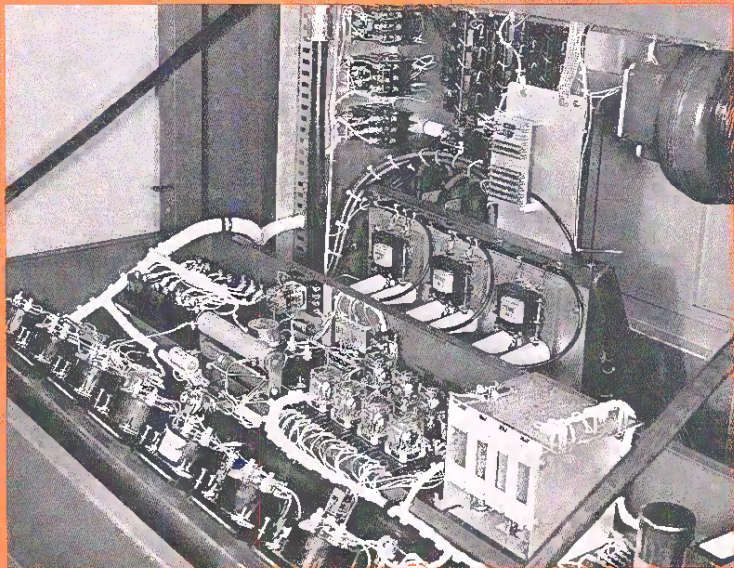

AEL Design Meter Panel Hinged For Quick Access



## Model AM-5KD Broadcast Transmitter

### **AUTO RESTART—Power Interrupt**

If the primary power to the transmitter is interrupted for less than 5 seconds the transmitter automatically shuts down; this protects sensitive tubes and circuits. It is automatically returned to full power immediately upon return of primary power. As long as the interrupt is less than 5 seconds this sequence will continue indefinitely. If primary power to the transmitter is interrupted for more than 5 seconds the transmitter is automatically shut down. When full power is restored, a 3 minute restart cycle is automatically instituted after which normal operation of the transmitter resumes. This 3 minute delay is required to protect the sensitive high power tubes.

### **SELF-CHECK CIRCUITS**

In order to assist the broadcast engineer in routine maintenance procedures, and overload Status Board is incorporated in this transmitter. This provides a visual indication whenever one of the following circuits become overloaded:

- High Voltage Supply
- Final Amplifier Driver
- Modulator
- Low Voltage Supply

### **REMOTE CONTROL**

Terminals for connecting remote control and remote metering functions are built into the transmitter, permitting interface with any conventional remote control system.

### **POWER CUT-BACK**

A single button control with automatic built-in sequencing controls the cut-back from 5,000 Watts to 1,000 or 500 Watts.

### **MECHANICAL/ENVIRONMENTAL**

SIZE: 77-1/4"H x 48"W x 36"D (overall)  
77-1/4"H x 48"W x 33"D (trim and doors removed)

WEIGHT: 2360 lbs. (approx.)

FLOOR LOADING: 215 lbs./sq. ft. (approx.)

CABINET STYLE: Enclosed single steel cabinet; access through front doors and quickly removable panels, swing-down centrally located meter and control panel, rear doors.

OPERATING AMBIENT TEMPERATURE RANGE: 20°F to 113°F

STORAGE TEMPERATURE RANGE: 20°F to 120°F

### **PROTECTIVE FUNCTIONS**

Extra circuit protection is provided by both multiple circuit breakers and fuses. All access doors and hatches are provided with interlocks for protection of personnel. A high voltage shorting stick is provided with each transmitter.

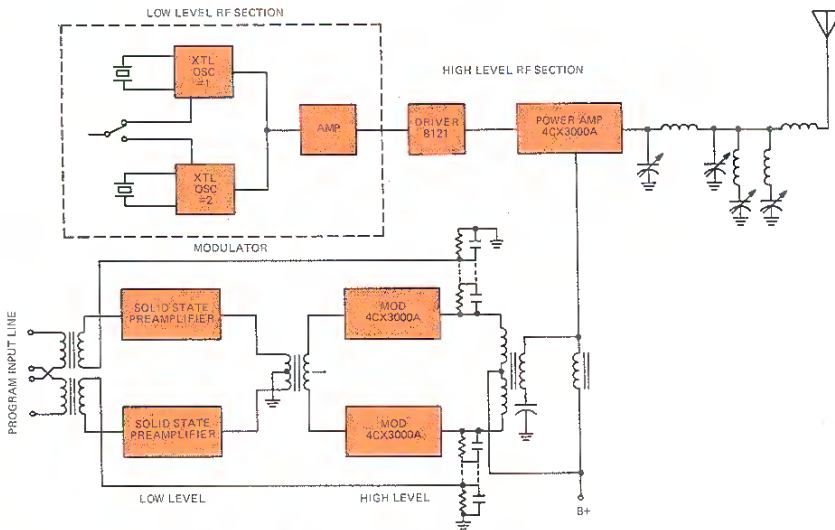

Simplified Block Diagram, AEL AM-5KD Transmitter

**SPECIFICATIONS**

**ELECTRICAL CHARACTERISTICS**

Frequency Range:	535 to 1605 kHz.
Frequency Stability:	±5 Hz.
Audio Frequency Input Impedance:	150/600 ohms balanced.
Audio Frequency Input Level:	+10 dBm ±2 dB for 100% modulation.
Audio Frequency Response:	±1 dB 50 Hz to 8 kHz.
Audio Frequency Distortion:	Less than 2.5% 50 Hz to 8 kHz at 95% modulation.
Noise Unweighted:	(referenced 100% modulation at 400 Hz): -55 dB.
Power Output Capability:	5.5 kW.
Modulation:	High level plate modulation.
Type of Emission:	A3
Output Impedance:	50 ohms unbalanced standard; other impedances available on special order.
Carrier Shift:	(100% modulation): Less than 3%.
Monitor Output:	5 V to RMS into 50/75 ohms.
Line Voltage:	208 to 240 Vac 60 Hz, 3 phase, 4 wire (others available on special order).
Power Consumption:	0% modulation — 11 kW. 30% modulation — 12 kW. 100% modulation — 14 kW.
Power Factor:	90%
Voltage Variation and Regulation:	±5%.
Spurious RF Emission:	(2nd harmonic & higher): -80 dB.

*Prices and specifications subject to change without notice*



# 10,000W



## FEATURES

- Excellent Fidelity
- Easy Maintenance
- Semi-Automatic Operation
- High Level Modulation
- Solid State Control Circuitry
- 125% Modulation Capability
- Central Control Panel

The Model AM-10KD is a completely self-contained 10,000 Watt AM transmitter. It is FCC Type Accepted for service in the 535 to 1605 kHz broadcast band.

This transmitter was designed for the professional AM broadcaster and features all solid state control circuits, excellent audio fidelity, and semi-automatic start-up features.

## FIDELITY

The low level audio section of the AM-10KD is completely solid state. The program input line drives a dual 100 Watt solid state preamplifier whose output provides grid drive to a pair of low distortion 4CX3000A class AB-1 modulators. Negative feedback is used around the complete audio section to reduce distortion and assure high fidelity performance. The overall performance of this transmitter that is of particular interest to the broadcast engineer includes:

- Frequency Response 50 — 7500 Hz ( $\pm 1.5$  dB)
- Low Distortion 1.5% (typical)
- Low Noise  $\pm 55$  dB (unweighted)

## Model AM-10KD Broadcast Transmitter

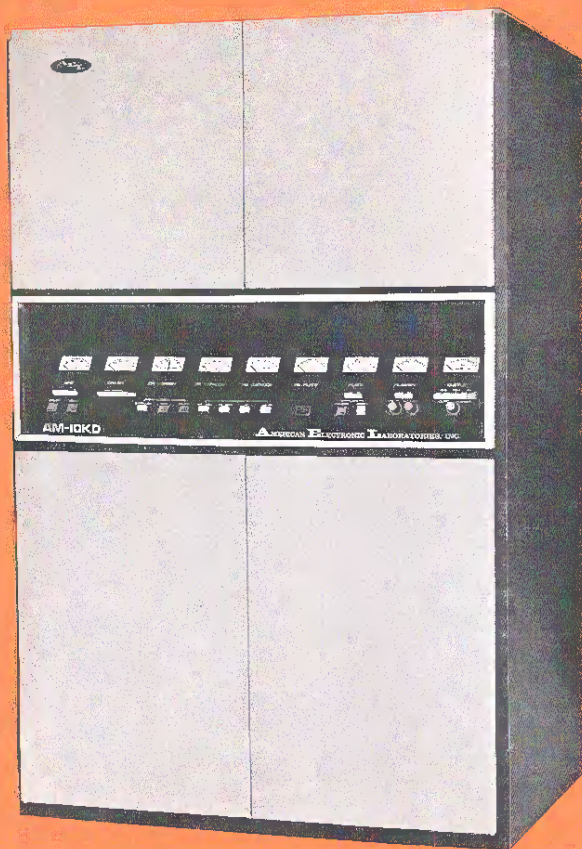

### RF OUTPUT CIRCUITRY (Front View)

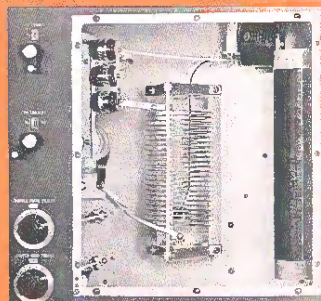

RF choke and plate tank coil. Notice the convenient PA and driver tuning controls.



### EASY MAINTENANCE

The transmitter is housed in a single self-contained modern cabinet including the AEL Center Line Control Panel concept. This places all metering, control, and indicator functions at the normal reading level position for easy operation while making tuning or operation adjustments.

The meter panel is front-end hinged for easy access to all control and logic circuits.

All High Power circuits and components are located in the rear of the cabinets.

The entire chassis maintains a positive cabinet air pressure which prevents intrusion of dust and dirt; this feature significantly increases the life of the high-voltage components and reduces the need for maintenance.

### TUBES

The RF output stage uses two (2) high gain, high reliability 4CX3000A Tetrodes; the RF driver stage utilizes a single 8121 high performance Tetrode which operates at one half of maximum output capabilities; the modulator stage uses two (2) 4CX3000A's operating class AB1.

There are only two-tube types (5 tubes total) in this 10,000 W transmitter.

### SEMI-AUTOMATIC OPERATION

This transmitter has several semi-automatic controls that are of interest to the broadcaster. These include automatic re-start, automatic re-cycle, and power cut-back; all control functions are accomplished by solid state logic circuits; each operates from a 24 Vdc regulated power supply. The interlock and sequence relays are also operated from this low voltage source for safety and convenience. Push button start/stop operation is used. Operating and fault status lights are placed in the center-mounted control panel.

### AUTOMATIC RECYCLING—Overload Protection

Any abnormal condition that might cause an overload condition in the Driver Tube, the Power Amplifier Tube, or the high voltage section of the amplifier immediately initiates a 1 second shut down. The plate voltage is removed automatically from these tubes to protect them from permanent damage. It is automatically returned after this one second interval; after three consecutive shut downs the plate voltage can be restored only by a manual re-set.

*(Continued on page 12)*

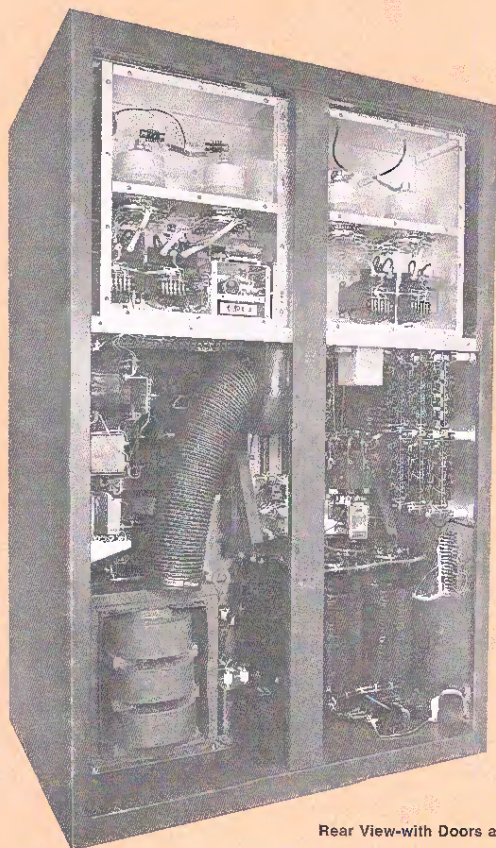

Rear View-with Doors and Air Filters removed.

### RF OUTPUT CIRCUITRY (Rear View)

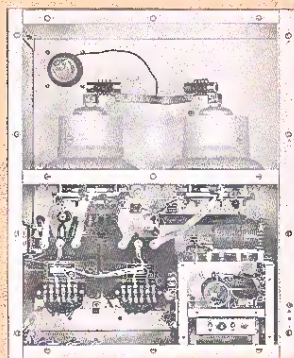

At the top of this RF section is the RF power amplifier and below is the solid state exciter.



# 10,000W

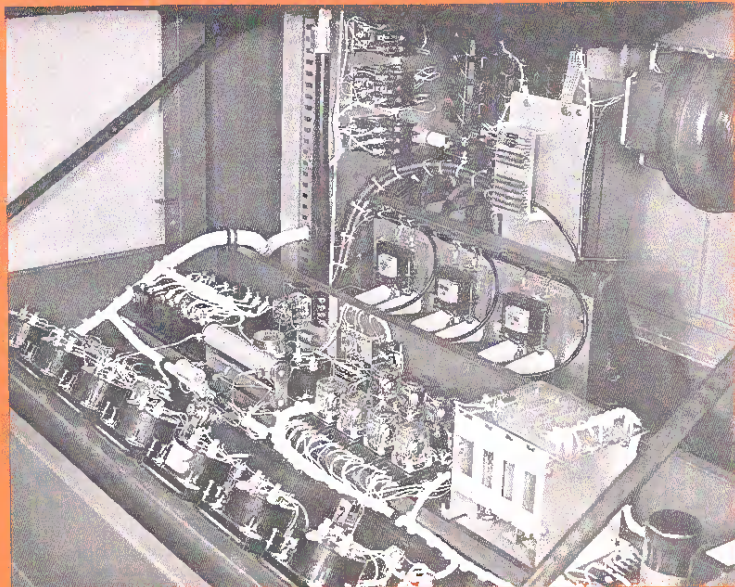
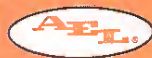

AEL Design Meter Panel Hinged For Quick Access

## Model AM-10KD Broadcast Transmitter

### **AUTO RESTART—Power Interrupt**

If the primary power to the transmitter is interrupted for less than 5 seconds the transmitter automatically shuts down; this protects sensitive tubes and circuits. It is automatically returned to full power immediately upon return of primary power. As long as the interrupt is less than 5 seconds this sequence will continue indefinitely. If primary power to the transmitter is interrupted for more than 5 seconds the transmitter is automatically shut down. When full power is restored, a 3 minute restart cycle is automatically instituted after which normal operation of the transmitter resumes. This 3 minute delay is required to protect the sensitive high power tubes.

### **SELF CHECK CIRCUITS**

In order to assist the broadcast engineer in routine maintenance procedures, an overload Status Board is incorporated in this transmitter. This provides a visual indication whenever one of the following circuits become overloaded:

- High Voltage Supply
- Final Amplifier Driver
- Modulator
- Low Voltage Supply

### **REMOTE CONTROL**

Terminals for connecting remote control and remote metering functions are built into the transmitter, permitting interface with any conventional remote control system.

### **POWER CUT-BACK**

A single button control with automatic built-in sequencing controls the cut-back from 10,000 Watts to 5,000 or 1,000 Watts.

### **MECHANICAL/ENVIRONMENTAL**

**SIZE:** 77-1/4"H x 48"W x 36"D (overall)  
77-1/4"H x 48"W x 33"D (trim and doors removed)

**WEIGHT:** 2360 lbs. (approx.)

**FLOOR LOADING:** 215 lbs./sq. ft. (approx.)

**CABINET STYLE:** Enclosed single steel cabinet; access through front doors and quickly removable panels, swing down centrally located meter and control panel, rear doors.

**OPERATING AMBIENT TEMPERATURE RANGE:**  
20°F to 113°F.

**STORAGE TEMPERATURE RANGE:**  
-20°F to 120°F.

### **PROTECTIVE FUNCTIONS**

Extra circuit protection is provided by both multiple circuit breakers and fuses. All access doors and hatches are provided with interlocks for protection of personnel. A high voltage shorting stick is provided with each transmitter.

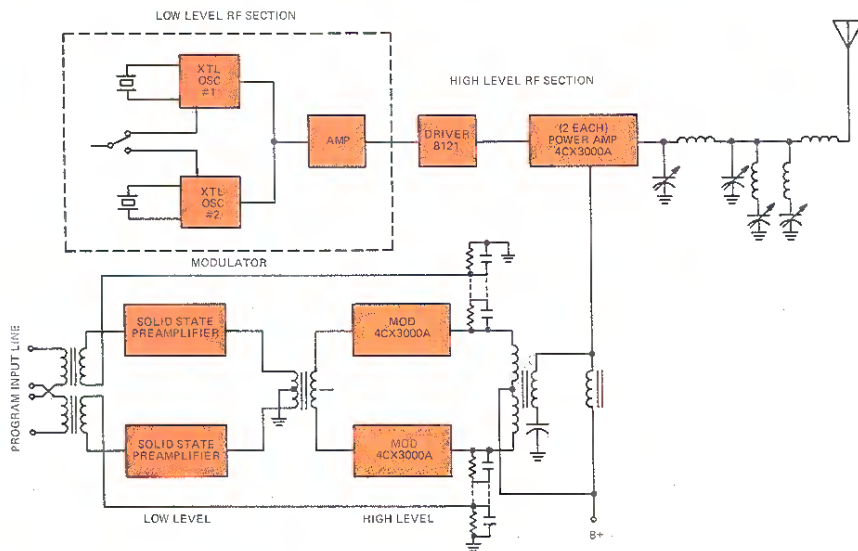

Simplified Block Diagram AEL AM-10KD Transmitter

**SPECIFICATIONS**

**ELECTRICAL CHARACTERISTICS**

Frequency Range: .....	535 to 1605 kHz.
Frequency Stability: .....	± 5 Hz.
Audio Frequency Input Impedance: .....	150/600 ohms balanced.
Audio Frequency Input Level: .....	+10 dBm ± 2 dB for 100% modulation.
Audio Frequency Response: .....	± 1 dB 50 Hz to 8 kHz.
Audio Frequency Distortion: .....	Less than 2.5% 50 Hz to 8 kHz at 95% modulation.
Noise Unweighted .....	(referenced 100% modulation at 400 Hz): -55 dB.
Power Output Capability: .....	11.5 kW.
Modulation: .....	High level plate modulation.
Type of Emission: .....	A3
Output Impedance: .....	50 ohms unbalanced standard; other impedances available on special order.
Carrier Shift .....	(100% modulation): Less than 3%.
Monitor Output: .....	5-10 V RMS into 50/75 ohms.
Line Voltage: .....	208 to 240 Vac 60 Hz, 3 phase, 4 wire (others available on special order).
Power Consumption: .....	0% modulation — 10 kW. 30% modulation — 22 kW. 100% modulation — 31 kW.
Power Factor: .....	90%
Voltage Variation and Regulation: .....	± 5%.
Spurious RF Emission .....	(2nd harmonic & higher): - 80 dB.

Prices and specifications subject to change without notice



# 50,000W

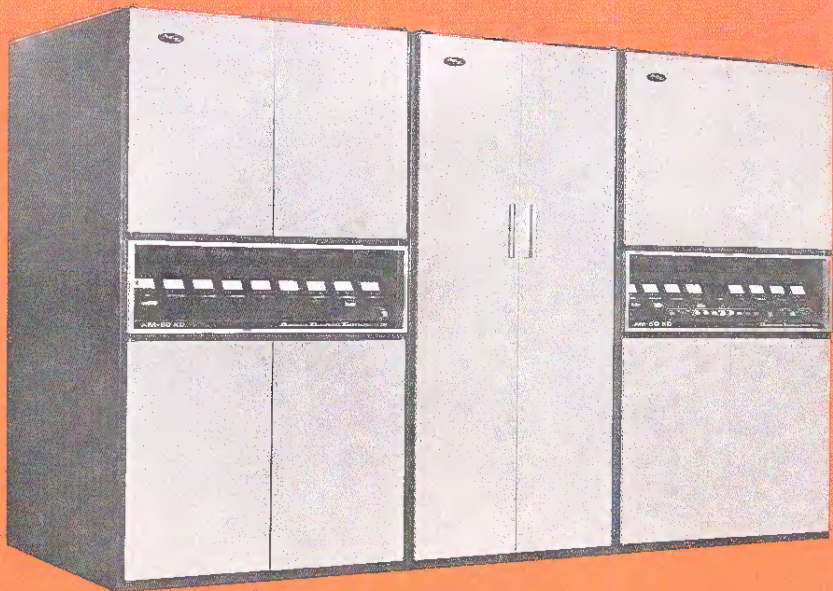

## Model AM-50KD Broadcast Transmitter

### FEATURES

- Excellent Fidelity
- Easy Maintenance
- Semi-Automatic Operation
- High Level Modulation
- Solid State Control Circuitry
- 125% Modulation Capability
- Central Control Panels

*The Model AM-50KD is a high level modulated 50,000 Watt AM transmitter. It is FCC Type Accepted for service in the 535 to 1605 kHz broadcast band.*

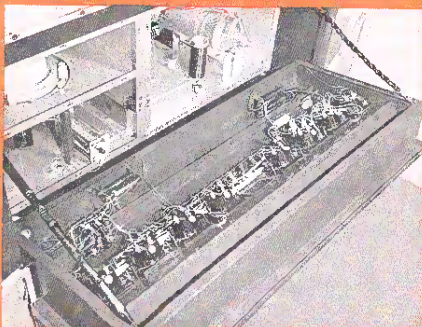

Easy Access Drop-Down Meter and Control Panel

*This transmitter was designed for the professional AM broadcaster and features all solid state control circuits, excellent audio fidelity, and semi-automatic start-up features.*

### FIDELITY

The low level audio section of the AM-50KD is completely solid state. The program input line drives a dual 100 Watt solid state preamplifier whose output provides grid drive to a pair of low distortion 4CX15000A class AB-1 modulators. Negative feedback is used around the complete audio section to reduce distortion and assure high fidelity performance. The overall performance of this transmitter that is of particular interest to the audio engineer includes:

- Frequency Response 50 — 7500 Hz ( $\pm 2$  dB)
- Low Distortion 1.5% (typical)
- Low Noise -55 dB (unweighted)

### EASY MAINTENANCE

This air cooled transmitter is housed in a three section modern cabinet with a separate Power Vault and includes the AEL Center Line Control Panel concept. This places all metering, control, and indicator functions at the normal reading level position for easy operation while making tuning or operation adjustments.

The meter panels are front-end hinged for easy access to all control and logic circuits.

All High Power circuits and components are located in the rear of the cabinets.

All necessary chassis sections maintain a positive cabinet air pressure which prevents intrusion of dust and dirt; this feature significantly increases the life of the high-voltage components and reduces the need for maintenance.

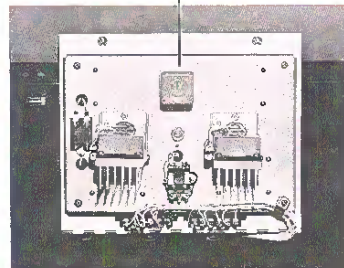
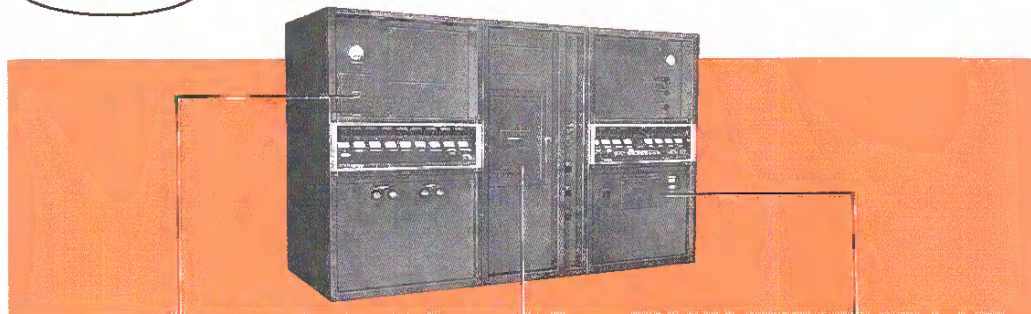

Solid State Audio Amplifier

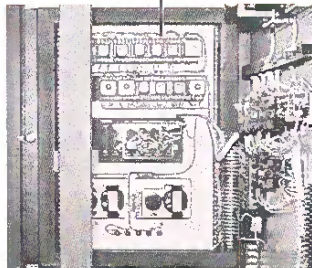

Solid State Control Circuitry

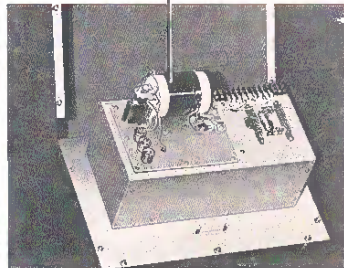

Exciter

**TUBES**

The RF output stage uses one (1) high gain, high reliability 4CX35000C Tetrode; the RF driver stage utilizes a single 4-400A high performance Tetrode which operates at one half of maximum output capabilities; the modulator stage uses two (2) 4CX15000A's operating class AB1.

**SEMI-AUTOMATIC OPERATION**

This transmitter has several semi-automatic controls that are of interest to the broadcaster. These include automatic re-start, automatic re-cycle, and power cut-back features; all are accomplished by solid state logic circuits. All operate from 24 Vdc regulated power supplies. The Interlock and sequence relays are also operated from this low voltage source for safety and convenience. Push button start/stop operation is used. Operating and fault status lights are placed in the center-mounted control panels. Solid state VSWR protection is a standard feature.

**AUTOMATIC RECYCLING—Overload Protection**

Any abnormal condition that might cause an overload condition in the Driver Tube, the Power Amplifier Tube, or the high voltage section of the amplifier immediately initiates a 1 second shut down. The plate voltage is removed automatically from these tubes to protect them from permanent damage. It is automatically returned after this one second interval; after three consecutive shut downs the plate voltage can be restored only by a manual re-set.

**AUTO RESTART—Power Interrupt**

If the primary power to the transmitter is interrupted for less than 5 seconds the transmitter automatically shuts down; this protects sensitive tubes and circuits. It is automatically returned to full power immediately upon return of primary power. As long as the interrupt is less than 5 seconds this sequence will continue indefinitely. If primary power to the transmitter is interrupted for more than 5 seconds the transmitter is automatically shut down. When full power is restored, a 3 minute restart cycle is automatically instituted after which normal operation of the transmitter resumes. This 3 minute delay is required to protect the sensitive high power tubes.

**SELF-CHECK CIRCUITS**

In order to assist the broadcast engineer in routine maintenance procedures, we have incorporated an overload Status Board in this transmitter. This provides a visual indication whenever one of the following circuits become overloaded:

- High Voltage Supply
- Final Amplifier Driver
- Modulator
- Low Voltage Supply

**REMOTE CONTROL**

Terminals for connecting remote control and remote metering functions are built into the transmitter, permitting interface with any conventional remote control system.

**POWER CUT-BACK**

A single button control with automatic built-in sequencing controls the cut-back from 50,000 Watts to 25,000 or 10,000 Watts.

(Continued on page 16)



**AEL AM-50KD**  
Rear View — Driver and PA Cabinet  
(Doors Removed)

View With Interlocked  
Hatch Cover Removed

Heavy Duty Plate  
Tank Coil

Oil-Filled  
Modulation  
Reactor

Second Harmonic Trap

Tuning Control

Third Harmonic Trap

Tuning Control

High Efficiency  
PA Compartment  
Blower 1500 CFM

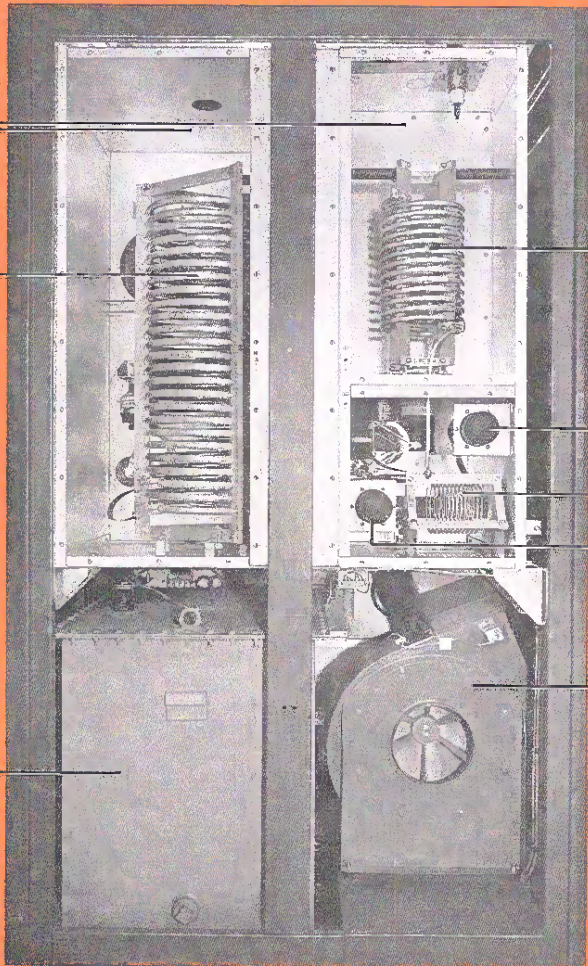



**AEL AM-50KD**  
**Rear View — Modulator Cabinet**  
**(Doors Removed)**

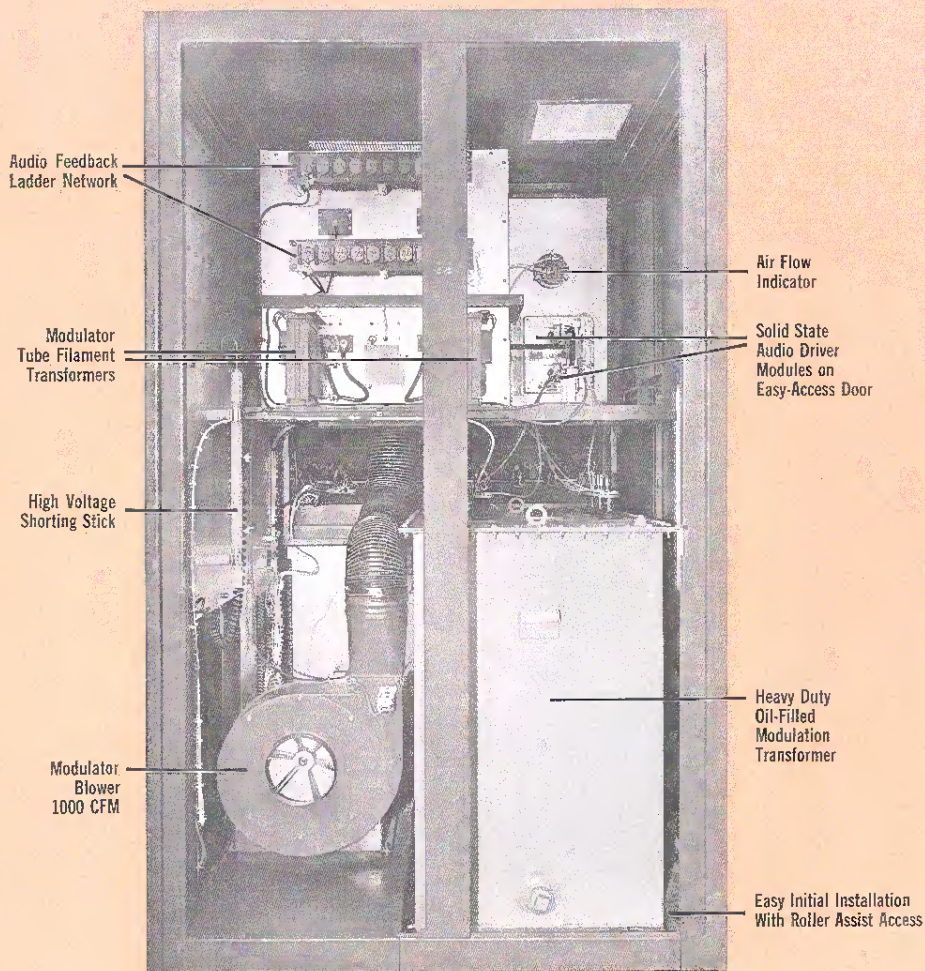



AEL AM-50KD  
Front View — High Voltage Power Vault  
(Door Removed)

- Main Circuit Breaker
- High Voltage Step-Start Control
- High Voltage Three-Phase Bridge Rectifier Stacks
- Low Voltage Circuit Breaker
- High Voltage Shorting Stick
- Positive Pressure Cabinet Fans 1000 CFM Each
- High Voltage Plate Transformer
- High Voltage Power Supply Filter Choke

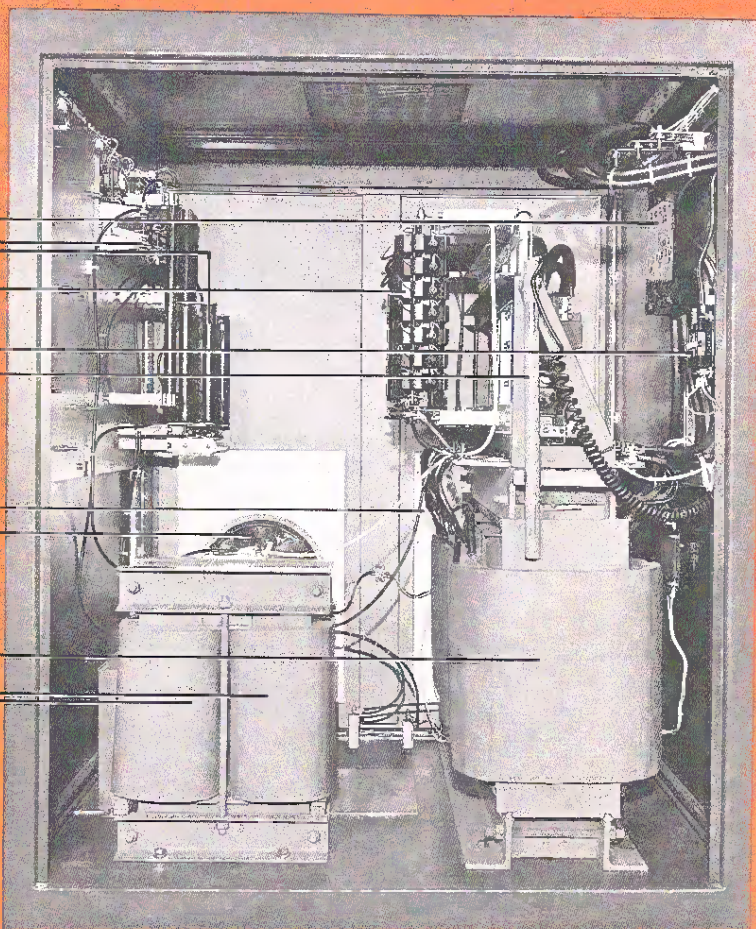





**AEL AM-50KD**  
Rear View — Control Cabinet

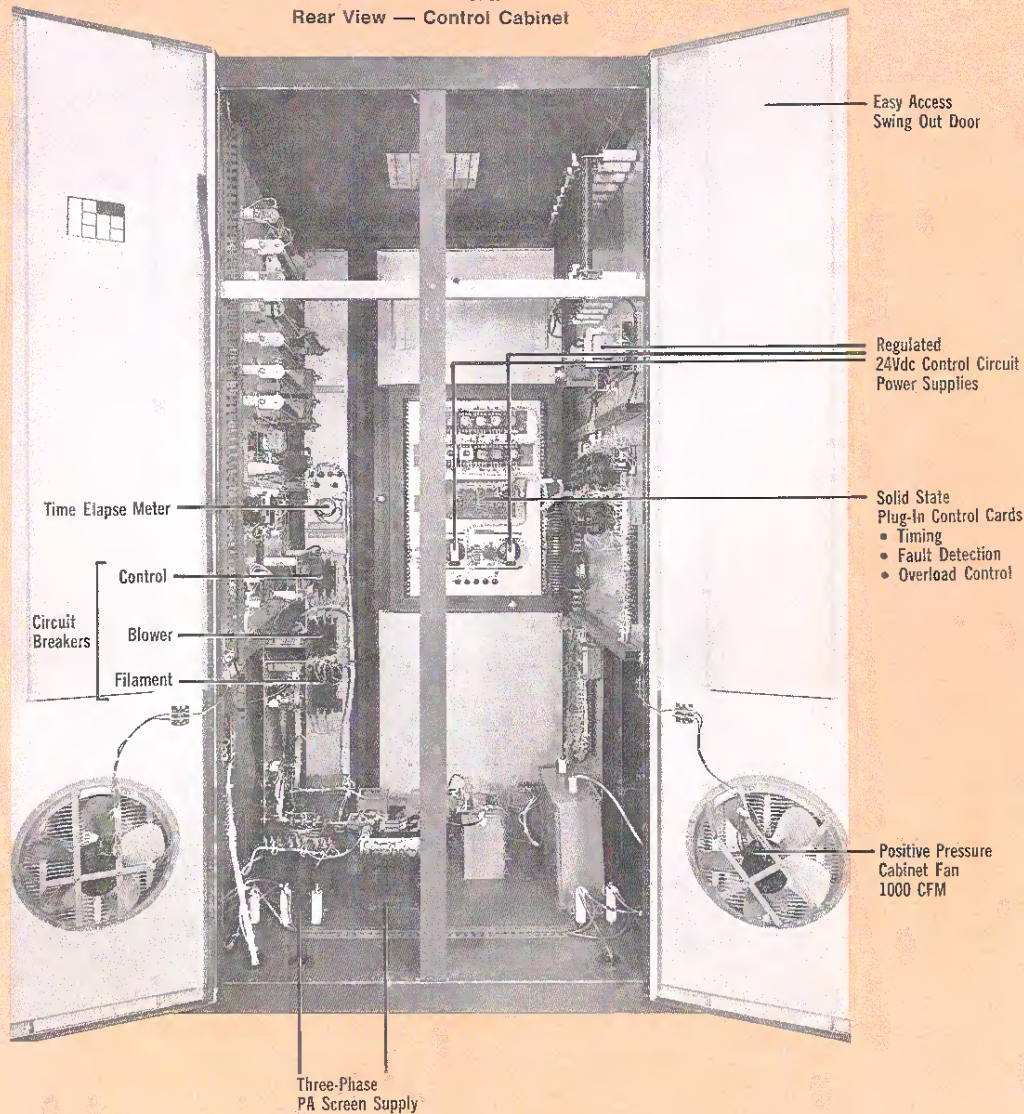



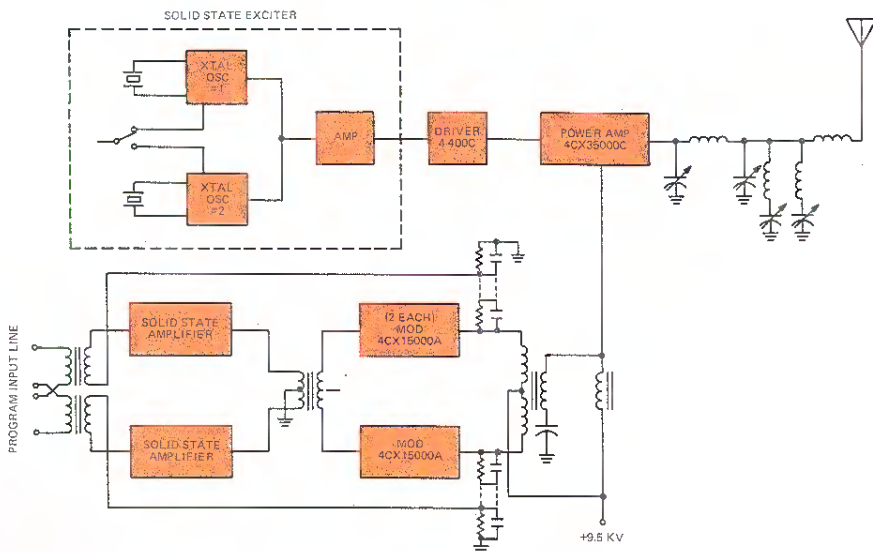

**Simplified Block Diagram, AEL AM-50KD Transmitter**

## SPECIFICATIONS

### ELECTRICAL

Power Output	55 kW max
Frequency Range	530-1640 kHz
Emission	A3
Modulation	High level Class AB,
Frequency Stability	$\pm 5$ Hz
Carrier Shift at 100% Mod	3% max
Output Impedance	50-230 ohms
Audio Response	50-10,000 Hz; $\pm 2$ dB
Audio Distortion	50-7500 Hz, 3% max
Noise (ref 100% mod)	-55 dB max
Spurious Outputs	-80 dB max
Power Line Requirement	380/460 Vac, 3 phase, 60 Hz
Power Consumption (approx)	
0% Modulation	99 kW
30% Modulation	112 kW
100% Modulation	150 kW
Power Factor	0.9

### MECHANICAL

Main Cabinet Size	84" H x 136" W x 48" D
Transformer Vault	48" H x 48" W-x 48" D
Weight (approx)	13,000 lbs
Operating Temperature	0 to 45°C
Operating Altitude	6,000 ft. max

### TUBE COMPLEMENT

1 ea 8121
1 ea 4-400C
1 ea 4CX35000C
2 ea 4CX15000A

Prices and specifications subject to change without notice.

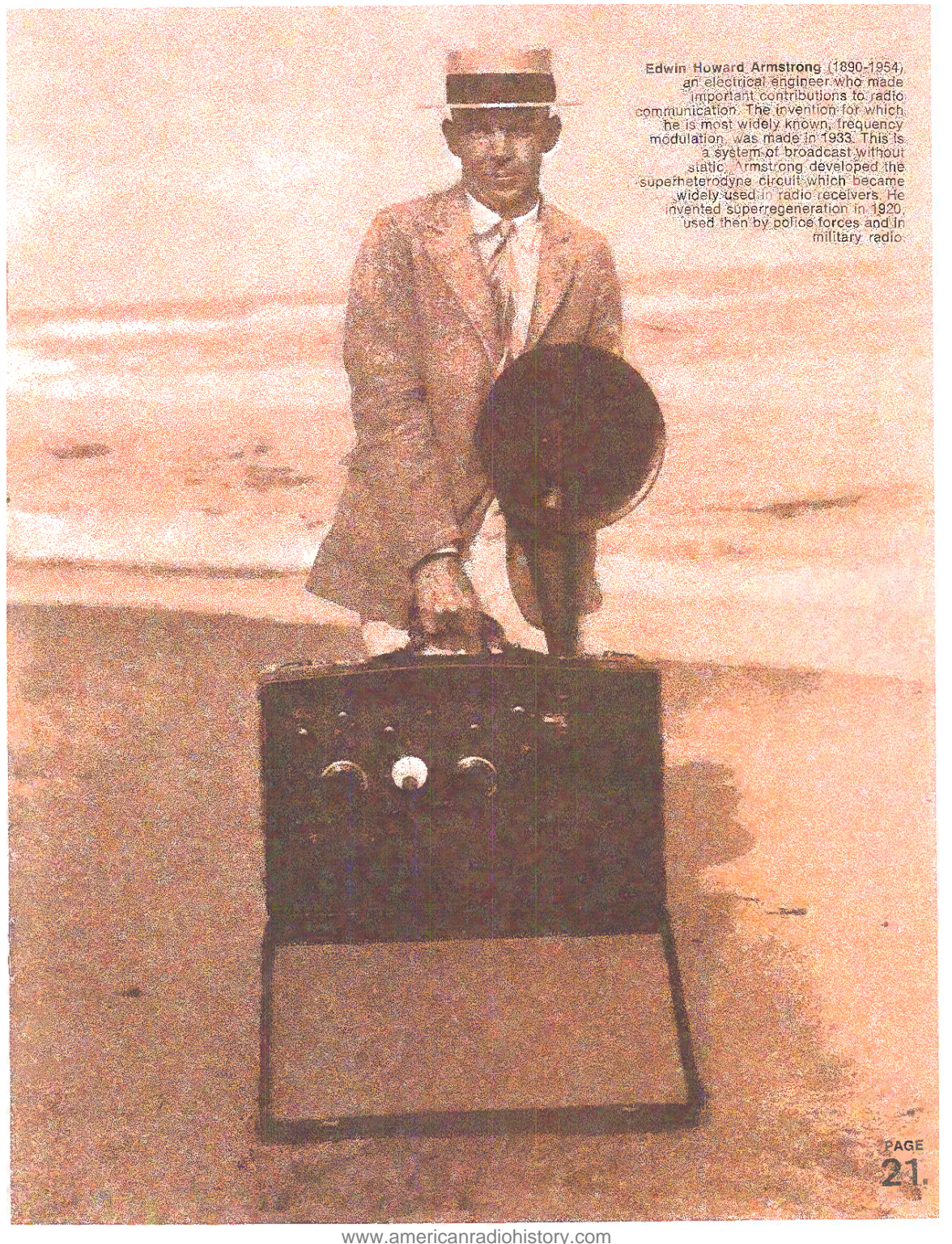

A black and white photograph of Edwin Howard Armstrong, an electrical engineer, standing outdoors. He is wearing a suit, a tie, and a hat, and is holding a large, dark, rectangular radio receiver. The receiver has several knobs and a speaker on the front. The background is a bright, open field.

**Edwin Howard Armstrong** (1890-1954), an electrical engineer who made important contributions to radio communication. The invention for which he is most widely known, frequency modulation, was made in 1933. This is a system of broadcast without static. Armstrong developed the superheterodyne circuit, which became widely used in radio receivers. He invented superregeneration in 1920, used then by police forces and in military radio.



# 2,500W



## Model FM-2.5KE Broadcast Transmitter

### FEATURES

- Superior Performance
- Reliability
- Ease of Maintenance
- Automatic Re-Cycling
  - Overload Protection
  - Power Interrupt
  - Auto Restart (Option)
- Mid-Panel Metering
- Remote Control Interface
- VSWR Protection (Option)
- Elapsed Time Indicator (Option)
- Remote Control Power Adjust (Option)

The FM-2.5KE is a completely self-contained 2500W FM Broadcast Transmitter. It operates at any fixed frequency between 88 and 108 MHz in monaural or stereo, and SCA mode.

It is supplied with a complete set of operating tubes and harmonic filter and is factory pre-tuned and tested to the individual customer's frequency.

### SUPERIOR PERFORMANCE

The overall frequency stability of the FM-2.5KE is typically maximum  $\pm 300$  Hz (See Exciter, page 38). Excellent linearity, 0.5% total harmonic distortion (THD), and  $\pm 1.0$  dB frequency response result in the faithful reproduction of all natural sound.

This outstanding performance is obtained principally by four factors:

- 0.35% IM distortion
- FM noise of  $-70$  dB
- Bandwidth of 250 kHz
- Less than  $4^\circ$  phase shift

### RELIABILITY

AEL is a major supplier of militarized RF systems. The same technology and reliability used in these sophisticated systems is designed into our commercial transmitters.

All critical components are operated at 50% below their manufacturer's suggested ratings. The grounded grid final amplifier stage eliminates the need for the usual screen voltage supply, the bias voltage supply, and all tuned input circuits. The conservatively rated IPA uses a 4X150A tube input which operates at only half of the rated power of 250 watts.

The pressurized cabinet reduces dirt and dust intrusion. This significantly increases the operating life of all major high voltage components.

All transmitters are operated at Station TPO and frequencies for a minimum of 100 hours at AEL before shipment to the customer.

### EASE OF MAINTENANCE

The estimated mean-time-to-repair of the FM-2.5KE is less than 30 minutes.

All doors and panels are easily removed to give immediate access to all major sub-assemblies. Standard components are used wherever possible and most are mounted in easily reached plug-in modules.

Twenty-four hour parts and technical assistance is available from AEL.

### AUTOMATIC RE-CYCLING—Overload Protection

Any abnormal condition that might cause an overload condition in the Driver Tube, the Power Amplifier Tube, or the high voltage section of the amplifier immediately initiates a 1 second shut down. The plate voltage is removed automatically from these tubes to protect them from permanent damage. It is automatically returned after this one second interval; after three consecutive shut downs the plate voltage can be restored only by a manual re-set.

### AUTO RESTART—Power Interrupt

If the primary power to the transmitter is interrupted for less than 5 seconds the transmitter automatically shuts down; this protects sensitive tubes and circuits. It is automatically returned to full power immediately upon return of primary power. As long as the interrupt is less than 5 seconds this sequence will continue indefinitely. If primary power to the transmitter is interrupted for more than 5 seconds the transmitter is automatically shut down. When full power is restored, a 3 minute restart cycle is automatically instituted after which normal operation of the transmitter resumes. This 3 minute delay is required to protect the sensitive high power tubes.

### MISCELLANEOUS

The Model FM-2.5KE contains many other features of interest to the professional broadcast engineer and technicians. These include a mid-panel metering system for easy viewing. Remote control interface connections are standard. Optional features include VSWR protection, an elapsed time indicator, Automatic level controls, and a remote control power adjust system.



FM-15QE Exciter

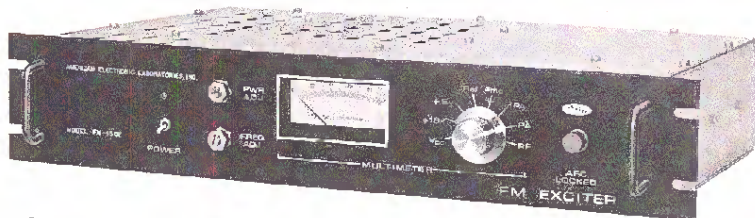

**SPECIFICATIONS Model FM-2.5KE**

**GENERAL**

Frequency Range ..... .88 to 108 MHz  
 Rated Power Output ..... .500 to 2500 watts  
 Type of Emission ..... .F3, F9  
 RF Load Impedance ..... .50 ohms  
 Output Termination ..... .1 1/2" EIA flange  
 Frequency Stability ..... .±300 Hz  
 Modulation Capability ..... .±100 kHz  
 Temperature Range ..... .-10 to 55°C  
 Altitude Above Sea Level ..... .10,000 ft. max.  
 Power Line Requirements  
 Voltage ..... .200/240 Vac  
 Frequency ..... .60 Hz  
 Phase ..... .single  
 Consumption at 250CW ..... .6 kW  
 Power Factor (Mex) ..... .0.9  
 Overall Dimensions ..... .76" H x 28" W x 26" D  
 Net Weight ..... .800 lbs. (approx.)

**MONAURAL**

Audio Input Impedance ..... .600 ohms balanced  
 Audio Input Level  
 400 Hz at 100% Modulation ..... +10 ±2 dBm  
 Audio Harmonic Distortion  
 50 to 15,000 Hz ..... .0.5% maximum  
 Audio Frequency Response ..... ±1 dB  
 Standard 75 microsecond pre-emphasis  
 50 to 15,000 Hz  
 FM Noise (Ref 400 Hz at 100% Mod) ... -70 dB  
 AM Noise (Reference Carrier AM  
 Modulation 100%) ..... -55 dB

**STEREO**

Audio Input Impedance ..... .600 ohms balanced  
 (right and left)  
 Audio Input Level (right and left)  
 400 Hz at 100% Modulation ..... +10 ±2 dBm  
 Audio Frequency Response ..... ±1 dB  
 (right and left)  
 Standard 75 Microsecond  
 Pre-Emphasis, 50 to 15,000 Hz  
 FM Noise ..... -63 dB  
 (Reference 400 Hz at 100% Mod)  
 AM Noise ..... -55 dB  
 (Reference Carrier AM Mod. 100%)  
 Stereo Separation  
 50 to 15,000 Hz ..... .40 dB min.  
 Stereo Pilot Stability ..... .19 kHz ±1 Hz  
 Cross-talk  
 (L + R to L-R, L-R to L+R) ..... -46 dB max.

**SCA**

Frequency Range ..... .30 to 75 kHz  
 Frequency Stability ..... .±400 Hz  
 Audio Input Impedance ..... .600 ohms  
 Audio Input Level ..... -15 dBm to 10 dBm  
 adjustable  
 Muting Delay ..... .0.5 to 5 second adjustable  
 FM Noise ..... -63 dB  
 AM Noise ..... -55 dB  
 Pre-Emphasis ..... .75 microsecond\*

\*Standard; otherwise specify

*Prices and specifications subject to change without notice.*

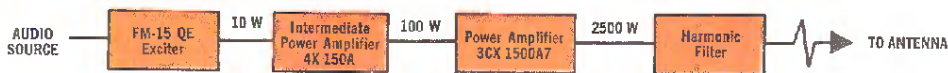

Simplified Block Diagram AEL FM-2.5KE Transmitter



5,000W  
AEL  
10,000W

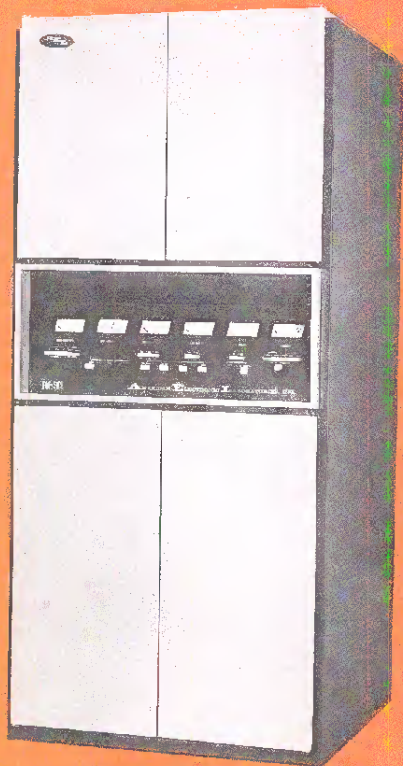

The FM-5KE and FM-10KE are completely self-contained Broadcast Transmitters that operate at 5000W and 10000W respectively. They operate at any fixed frequency between 88 and 108 MHz in monaural or stereo, and SCA mode.

They are supplied with an AEL FM-15QE Exciter, a complete set of operating tubes and harmonic filter and are factory pre-tuned and tested to the individual customer's frequency.

#### SUPERIOR PERFORMANCE

The overall frequency stability of these transmitters are typically  $\pm 300$  Hz (See Exciter page 38). Excellent linearity, maximum 0.5% total harmonic distortion (THD), and  $\pm 1.0$  dB frequency response result in the faithful reproduction of all natural sound.

This outstanding performance is obtained principally by four factors:

- 0.35% IM distortion
- FM noise of  $-70$  dB
- Bandwidth of 250 kHz
- Less than 4% phase shift

#### RELIABILITY

AEL is a major supplier of militarized RF systems. The same technology and reliability used in these sophisticated systems is designed into our commercial transmitters.

All critical components are operated at 50% below their manufacturer's suggested ratings. The grounded grid final amplifier stage eliminates the need for the usual screen voltage supply, the bias voltage supply and all-tuned input circuits.

The pressurized cabinet reduces dirt and dust intrusion. This significantly increases the operating life of all major high voltage components.

All transmitters are operated at Station TPO and frequencies for a minimum of 100 hours at AEL before shipment to the customer.

## Model FM-5KE & FM-10KE Broadcast Transmitters

#### FEATURES

- Superior Performance
- Reliability
- Ease of Maintenance
- Automatic Re-Cycling
  - Overload Protection
  - Power Interrupt
  - Auto Restart
- Mid-Panel Metering
- Remote Control Interface
- VSWR Protection (Option)
- Elapsed Time Indicator
- Remote Control Power Adjust

#### EASE OF MAINTENANCE

The estimated mean-time-to-repair of these transmitters is less than one hour.

All doors and panels are easily removed to give immediate access to all major sub-assemblies. Standard components are used wherever possible and most are mounted in easily reached plug-in modules.

Twenty-four hour parts and technical assistance is available from AEL.



Simplified Block Diagram AEL FM-5KE Transmitter



**SPECIFICATIONS**

**FM-5KE and FM-10KE with FM-15QE Exciter**

**GENERAL**

Frequency Range	88 to 108 MHz
Rated power output	FM-5 3000 to 6000 watts FM-10 6000 to 11,000 watts
Type of emission	F3, F9
RF load impedance	50 ohms
Output termination	FM-5 1 1/4" FM-10 3 1/4"
Temperature range	-10 to 55°C
Altitude above sea level	10,000 ft max
Power line requirements:	
Voltage	180/260 Vcc
Frequency	50-60 Hz
Phase	3
Power connection	4-wire, Star with grounded neutral
Power consumption	FM-5 9kW FM-10 18kW
Power factor	0.9
Overall dimensions	76" H x 34" W x 35" D
Net weight	FM-5 Approx. 1100 Lbs. FM-10 Approx. 1500 Lbs.

**MONAURAL**

Audio input impedance	600 ohms balanced
Audio input level	+10 ±2 dBm (400 Hz @ 100% modulation)
Audio harmonic distortion	0.5% max. (50-15,000 Hz)
Audio frequency response	±1 dB (75 microsecond pre-emphasis, 50-15,000 Hz)
FM Noise	-70 dB (Ref. 400 Hz @ 100% modulation)
AM Noise	-55 dB (Ref. carrier AM modulation 100%)
Frequency stability	±500 Hz
Intermodulation distortion	Typical 0.25% (S.M.P.T.E.)

**STEREOPHONIC**

Audio input impedance	600 ohms balanced (Right and left channels identical)
Audio input level	+10 ±2 dBm (Right and left channels identical)— 400 Hz @ 100% modulation
Audio frequency response	±0.5 dB (Right and left channels identical)— 75 microsecond pre-emphasis, 50-15,000 Hz)
FM noise	-63 dB (Ref. 400 Hz @ 100% modulation)
Stereo separation	-40 dB 50-15,000 Hz
Stereo pilot stability	19 kHz ±1 Hz
Cross talk	
(L+R) into (L-R)	-46 dB
(L-R) into (L+R)	-46 dB
Composite input level for 100% modulation	4 Vpp

**SCA**

Sub-carrier frequency range	30-75 kHz
Sub-carrier frequency stability	±400 Hz
Audio input impedance	600 ohms balanced
Audio input level	-15 dBm to -10 dBm (adjustable)
Muting delay	0.5 to 5 seconds (adjustable)
S/N ratio	-63 dB
Pre-emphasis	75 microsecond standard (otherwise specify)

Prices and specifications subject to change without notice

**AUTOMATIC RE-CYCLING—Overload Protection**

Any abnormal condition that might cause an overload condition in the Driver Tube, the Power Amplifier Tube, or the high voltage section of the amplifier immediately initiates a 1 second shut down. The plate voltage is removed automatically from these tubes to protect them from permanent damage. It is automatically returned after this one second interval; after three consecutive shut downs the plate voltage can be restored only by a manual re-set.

**AUTO RESTART—Power Interrupt**

If the primary power to the transmitter is interrupted for less than 5 seconds the transmitter automatically shuts down; this protects sensitive tubes and circuits. It is automatically returned to full power immediately upon return of primary power. As long as the interrupt is less than 5 seconds this sequence will continue indefinitely. If primary power to the transmitter is interrupted for more than 5 seconds the transmitter is automatically shut down. When full power is restored a 3-minute restart cycle is automatically instituted after which normal operation of the transmitter resumes. This three-minute delay is required to protect the sensitive high power tubes.

**MISCELLANEOUS**

These transmitters contain many other features of interest to the professional broadcast engineer and technicians. These include a mid-panel metering system for easy viewing. Remote control interface connections are standard. Optional features include VSWR protection.



Simplified Block Diagram AEL FM-10KE Transmitter



# 15,000W



## FEATURES

- Superior Performance
- Reliability
- Ease of Maintenance
- Automatic Re-Cycling
  - Overload Protection
  - Power Interrupt
  - Auto Restart
- Mid-Panel Metering
- Remote Control Interface
- VSWR Protection (Option)
- Elapsed Time Indicator
- Remote Control Power Adjust

The FM-15KE is a completely self-contained 15,000W FM Broadcast Transmitter. It operates at any fixed frequency between 88 and 108 MHz in monaural or stereo, and SCA mode.

It is supplied with an AEL FM-15QE Exciter, a complete set of operating tubes and harmonic filter and is factory pre-tuned and tested to the individual customer's frequency.

## SUPERIOR PERFORMANCE

The overall frequency stability of the FM-15KE is typically  $\pm 300$  Hz (See Exciter, page 38). Excellent linearity (0.5% total harmonic distortion (THD)) and  $\pm 1.0$  dB frequency response result in the faithful reproduction of all natural sound.

This outstanding performance is obtained principally by four factors:

- 0.35% IM distortion.
- FM noise of  $-70$  dB
- Bandwidth of 250 kHz
- Less than 4° phase shift

## RELIABILITY

AEL is a major supplier of militarized RF systems. The same technology and reliability used in these sophisticated systems is designed into our commercial transmitters.

All critical components are operated at 50% below their manufacturer's suggested ratings. The grounded grid final amplifier stage eliminates the need for the usual screen voltage supply, the bias voltage supply and all tuned input circuits. The conservatively rated IPA uses a 4CX1000A tube input which operates at only half of the rated power of 1600 watts.

# Model FM-15KE Broadcast Transmitter

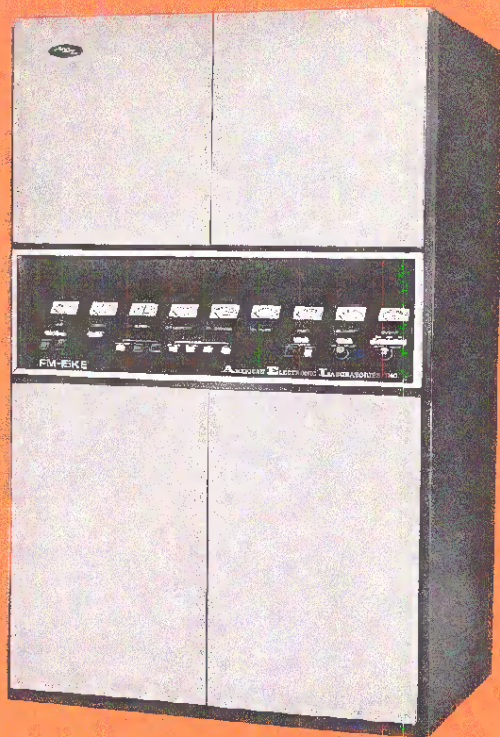

The pressurized cabinet reduces dirt and dust intrusion. This significantly increases the operating life of all major high voltage components.

All transmitters are operated at Station TPO and frequencies for a minimum of 100 hours at AEL before shipment to the customer.

## EASE OF MAINTENANCE

The estimated mean-time-to-repair of the FM-15KE is less than 1 hour.

All doors and panels are easily removed to give immediate access to all major sub-assemblies. Standard components are used wherever possible and most are mounted in easily reached plug-in modules.

Twenty-four hour parts and technical assistance is available from AEL.

## AUTOMATIC RE-CYCLING— Overload Protection

Any abnormal condition that might cause an overload condition in the Driver Tube, the Power Amplifier Tube, or the high voltage section of the amplifier, immediately initiates a 1 second shut-down. The plate voltage is removed automatically from these tubes to protect them from permanent damage. It is automatically returned after this one second interval; after three consecutive shut-downs the plate voltage can be restored only by a manual re-set.



FM-15QE Exciter

**AUTO RESTART—Power Interrupt**

If the primary power to the transmitter is interrupted for less than 5 seconds the transmitter automatically shuts down; this protects sensitive tubes and circuits. It is automatically returned to full power immediately upon return of primary power. As long as the interrupt is less than 5 seconds this sequence will continue indefinitely. If primary power to the transmitter is interrupted for more than 5 seconds the transmitter is automatically shut down. When full power is restored a 3-minute restart cycle is automatically instituted after which normal operation of the transmitter resumes. This 3-minute delay is required to protect the sensitive high power tubes.

**MISCELLANEOUS**

The Model FM-15KE contains many other features of interest to the professional broadcast engineer and technicians. These include a mid-panel metering system for easy viewing. Remote control interface connections are standard. Optional features include VSWR protection.

**SPECIFICATIONS FM-15KE with FM-15QE Exciter**

**GENERAL**

Frequency Range	88 to 108 MHz
Rated Power Output	5,000 to 15,000 watts
Type of Emission	F3, F9
RF Load Impedance	50 ohms
Output Termination	3 1/4" EIA Jange
Frequency Stability	±300 Hz
Modulation Capability	±100 kHz
Temperature Range	-10 to 55°C
Altitude Above Sea Level	10,000 ft. max.
Power Line Requirements	
Voltage	208/240 Vac
Frequency	60 Hz
Phase	3
Consumption at 15 kW	25 kW
Power Factor	0.9
Overall Dimensions (less filter)	76"Hx48"Wx35"D
Net Weight	1800 lbs. (approx.)

**STEREO**

Audio Input Impedance	600 ohms balanced (right and left)
Audio Input Level (right and left)	400 Hz at 100% Modulation +10 ±2 dBm
Audio Frequency Response	±1 dB (right and left)
	Standard 75 Microsecond
	Pre Emphasis, 50 to 15,000 Hz
FM Noise	-63 dB (Reference 400 Hz at 100% Mod.)
AM Noise	-55 dB (Reference Carrier AM Mod. 100%)
Stereo Separation	
50 to 15,000 Hz	40 dB min.
Stereo Pilot Stability	19 kHz ±1 Hz
Cross-talk (L+R to L-R, L-R to L+R)	-46 dB max.

**MONAURAL**

Audio Input Impedance	600 ohms balanced
Audio Input Level	
400 Hz at 100% Modulation	+10 ±2 dBm
Audio Harmonic Distortion	
50 to 15,000 Hz	0.5% maximum
Audio Frequency Response	±1 dB
	Standard 75 microsecond pre-emphasis
	50 to 15,000 Hz
FM Noise (Ref 400 Hz at 100% Mod.)	-70 dB
AM Noise (Reference Carrier AM Modulation 100%)	-55 dB

**SCA**

Frequency Range	30 to 75 kHz
Frequency Stability	±400 Hz
Audio Input Impedance	600 ohms
Audio Input Level	-15 dBm to +10 dBm adjustable
Muting Delay	0.5 to 5 second adjustable
FM Noise	-63 dB
AM Noise	-55 dB
Pre Emphasis	75 microsecond**
	*33"D without trim **Standard; otherwise specify

Prices and specifications subject to change without notice.



Simplified Block Diagram AEL FM-15KE Transmitter



# 25,000W



## FEATURES

- Superior Performance
- Reliability
- Ease of Maintenance
- Automatic Re-Cycling
  - Overload Protection
  - Power Interrupt
  - Auto Restart
- Mid-Panel Metering
- Remote Control Interface
- VSWR Protection
- Elapsed Time Indicator
- Remote Control Power Adjust

The FM-25KE is a completely self-contained 25,000W FM Broadcast Transmitter. It operates at any fixed frequency between 88 and 108 MHz in monaural or stereo, and SCA mode.

It is supplied with a complete set of operating tubes, FM-20E Exciter and harmonic filter and is factory pre-tuned and tested to the individual customer's frequency.

## Model FM-25KE Broadcast Transmitter

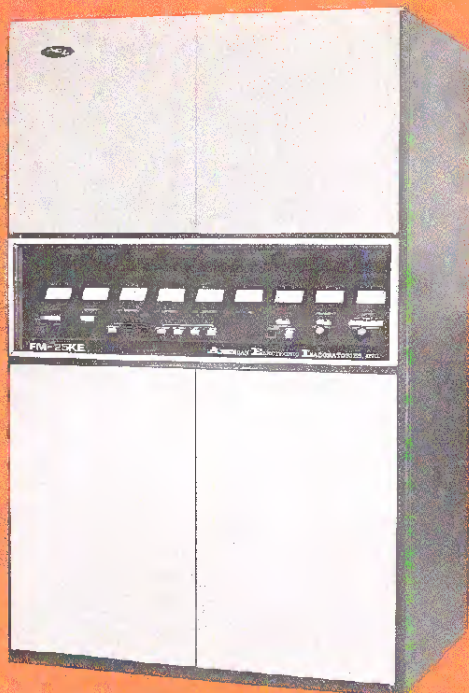

## SUPERIOR PERFORMANCE

The overall frequency stability of the FM-25KE is typically  $\pm 200$  Hz (See Exciter, page 36). Excellent linearity, 0.5% total harmonic distortion (THD), and  $\pm 1.0$  dB frequency response result in the faithful reproduction of all natural sound.

This outstanding performance is obtained principally by four factors:

- 0.35% IM distortion
- FM noise of  $-70$  dB
- Bandwidth of 250 kHz
- Less than  $1^\circ$  phase shift

## RELIABILITY

AEL is a major supplier of militarized RF systems. The same technology and reliability used in these sophisticated systems is designed into our commercial transmitters.

All critical components are operated at 50% below their manufacturer's suggested ratings. The grounded grid final amplifier stage eliminates the need for the usual screen voltage supply, the bias voltage supply and all tuned input circuits.

The pressurized cabinet reduces dirt and dust intrusion. This significantly increases the operating life of all major high voltage components.

All transmitters are operated at Station TPO and frequencies for a minimum of 100 hours at AEL before shipment to the customer.

## EASE OF MAINTENANCE

The estimated mean-time-to-repair of the FM-25KE is less than 1 hour.

All doors and panels are easily removed to give immediate access to all major sub-assemblies. Standard components are used wherever possible and most are mounted in easily reached plug-in modules.

Twenty-four hour parts and technical assistance is available from AEL.

## AUTOMATIC RE-CYCLING— Overload Protection

Any abnormal condition that might cause an overload condition in the Driver Tube, the Power Amplifier Tube, or the high voltage section of the amplifier immediately initiates a 1 second shut down. The plate voltage is removed automatically from these tubes to protect them from permanent damage. It is automatically returned after this one second interval; after three consecutive shut downs the plate voltage can be restored only by a manual re-set.

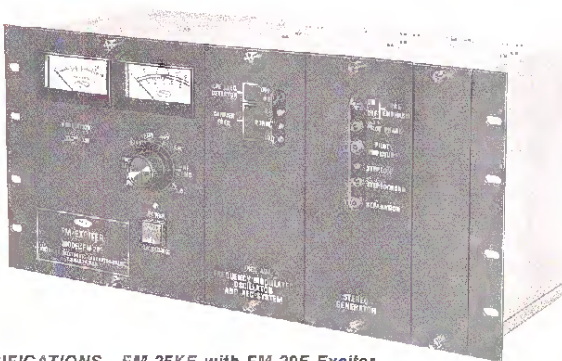

FM-20E Exciter

**AUTO RESTART—Power Interrupt**

If the primary power to the transmitter is interrupted for *less* than 5 seconds the transmitter automatically shuts down; this protects sensitive tubes and circuits. It is automatically returned to full power immediately upon return of primary power. As long as the interrupt is less than 5 seconds this sequence will continue indefinitely. If primary power to the transmitter is interrupted for *more* than 5 seconds the transmitter is automatically shut down. When power is returned a 3 minute restart cycle is automatically instituted after which normal operation of the transmitter resumes. This delay is required to protect the sensitive high power tubes.

**MISCELLANEOUS**

The Model FM-25KE contains many other features of interest to the professional broadcast engineer and technicians. These include a mid-panel metering system for easy viewing. Remote control interface connections, VSWR protection, an elapsed time indicator, automatic level controls, and a remote control power adjust system are standard items.

**SPECIFICATIONS FM-25KE with FM-20E Exciter**

**GENERAL**

Frequency Range ..... 88 to 108 MHz  
 Rated Power Output ..... 3,000 to 25,000 watts  
 Type of Emission ..... F3, F5  
 RF Load Impedance ..... 50 ohms  
 Output Termination ..... 3/4" EIA flange  
 Frequency Stability ..... ±300 Hz  
 Modulation Capability ..... ±100 kHz  
 Temperature Range ..... -10 to 55°C  
 Altitude Above Sea Level ..... 10,000 ft. max.  
 Power Line Requirements  
 Voltage ..... 208/240 Vac  
 Frequency ..... 60 Hz  
 Phase ..... 3  
 Consumption at 25 kW ..... 39 kW  
 Power Factor ..... 0.9  
 Overall Dimensions (less filter) 76"Hx48"Wx35"D  
 Net Weight ..... 2200 lbs. (approx.)

**STEREO**

Audio Input Impedance ..... 600 ohms balanced (right and left)  
 Audio Input Level (right and left) 400 Hz at 100% Modulation ... +10 ±2 dBm  
 Audio Frequency Response ..... ±1 dB (right and left)  
 Standard 75 Microsecond Pre-Emphasis, 50 to 15,000 Hz  
 FM Noise (Reference 400 Hz at 100% Mod.) ..... -63 db  
 AM Noise (Reference Carrier AM Mod. 100%) ..... -55 dB  
 Stereo Separation ..... 40 dB min.  
 Stereo Pilot Stability ..... ±19 kHz  
 Cross-talk (L+R to L-R, L-R to L+R) ..... -46dB max.

**MONAURAL**

Audio Input Impedance ..... 600 ohms balanced  
 Audio Input Level 400 Hz at 100% Modulation ... +10 ±2 dBm  
 Audio Harmonic Distortion 50 to 15,000 Hz ..... 0.5% maximum  
 Audio Frequency Response ..... ±1 dB Standard 75 microsecond pre-emphasis 50 to 15,000 Hz  
 FM Noise (Ref 400 Hz at 100% Mod) ..... -70 dB  
 AM Noise (Reference Carrier AM Modulation 100%) ..... -55 dB

**SCA**

Frequency Range ..... 30 to 75 kHz  
 Frequency Stability ..... ±400 Hz  
 Audio Input Impedance ..... 600 ohms  
 Audio Input Level ..... -15 dBm to +10 dBm adjustable  
 Muting Delay ..... 0.5 to 5 second adjustable  
 FM Noise ..... -63 dB  
 AM Noise ..... -35 dB  
 Pre-Emphasis ..... 75 microsecond\*\*  
 \*33°D without trim. \*\*Standard; otherwise specify

*Prices and specifications subject to change without notice.*



Simplified Block Diagram AEL FM-25KE Transmitter



# 40,000W/50,000W



The FM25/25KE is a completely self-contained 40,000 or 50,000W FM Broadcast Transmitter. It operates at any fixed frequency between 88 and 108 MHz, in monaural or stereo, and SCA mode.

It is supplied with a complete set of operating tubes and harmonic filter and is factory pre-tuned and tested to the individual customer's frequency.

The AEL FM-25/25KE is designed for very high power broadcasting service and provides a high degree of redundancy and reliability. This transmitter consists basically of two AEL FM-25KE 25kW FM transmitters whose outputs are connected through a hybrid combiner for a total output capability of up to 50 kW.

The basic configuration comprises two standard FM-25KE transmitters and a control and interface cabinet placed between the two transmitter units. A standard 40 kW 3-1/8" hybrid combiner is normally supplied for external mounting depending on individual station layouts. A larger combiner for use with 6-1/8" line is also available for power level requirements over 40 kW. Additionally, various patching and switching functions can be provided to suit individual station requirements.

A true 90° hybrid combiner accepts the output of both transmitters, adds the two outputs together and delivers the combined output to the antenna. In the event one of the transmitter units shuts down, the remaining transmitter continues to deliver power through the combiner to the antenna. In this case, however, the combiner operates as a power divider with half the power going to the antenna and half being dissipated in a

reject load connected to the combiner. A high degree of isolation is maintained between the transmitters so that service may be performed on the off unit.

A single width matching rack cabinet between the two transmitter units provides metering and control functions for the system as well as a common interface for connection to remote control and monitoring requirements. The exciter, buffer and phasing controls are also in the control cabinet. Meters for all important combiner functions and individual transmitter start, stop and plate voltage control are provided.

A single FM-20E Exciter provides drive to a solid state dual buffer amplifier, the outputs of which provide excitation to the individual 25 kW amplifiers. (See page 36).

Each 25 kW amplifier is connected through its individual harmonic filter to the inputs of the hybrid combiner.

The standard 40 kW output level requires that each 25 kW amplifier operate at only 20 kW, thus providing sufficient reserve and conservative operation.

Each 25 kW amplifier retains all of its individual metering and remote control functions. In addition, in the control cabinet, meters are provided for reading total forward power and reflected power in the antenna system, power in the reject load, power in a dummy load (optional) if used, and power from each transmitter. Also provided are parallel control functions for turning each amplifier on and off and control of plate voltage.

## Model FM-25/25KE Broadcast Transmitter

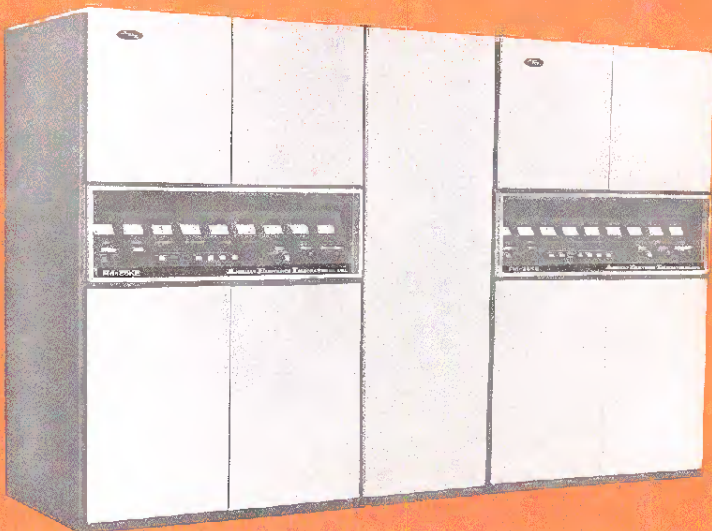



## FEATURES

- Superior Performance
- Reliability
- Ease of Maintenance
- Automatic Re-Cycling
  - Overload Protection
  - Power Interrupt
  - Auto Restart
- Mid-Panel Metering
- Remote Control Interface
- VSWR Protection
- Elapsed Time Indicator
- Remote Control Power Adjust

## SUPERIOR PERFORMANCE

The overall frequency stability of the Model FM-25/25KE is typically  $\pm 200$  Hz (See FM-20E Exciter, page 36). Excellent linearity, 0.5% total harmonic distortion (THD), and  $\pm 1.0$  dB frequency response result in the faithful reproduction of all natural sound.

This outstanding performance is obtained principally by four factors:

- 0.35% IM distortion
- FM noise of  $-70$  dB
- Bandwidth of 250 kHz
- Less than  $1^\circ$  phase shift

## RELIABILITY

AEL is a major supplier of militarized RF systems. The same technology and reliability used in these sophisticated systems is designed into our commercial transmitters.

All critical components are operated at 50% below their manufacturer's suggested ratings. The grounded grid final amplifier stage eliminates the need for the usual screen voltage supply, the bias voltage supply and all tuned input circuits.

The pressurized cabinet reduces dirt and dust intrusion. This significantly increases the operating life of all major high voltage components.

All transmitters are operated at Station TPO and frequencies for a minimum of 100 hours at AEL before shipment to the customer.

## EASE OF MAINTENANCE

The estimated mean-time-to repair of the Model FM-25/25KE is less than 1 hour.

All doors and panels are easily removed to give immediate access to all major sub-assemblies. Standard components are used wherever possible and most are mounted in easily reached plug-in modules.

Twenty-four hour parts and technical assistance is available from AEL.

## AUTOMATIC RE-CYCLING—Overload Protection

Any abnormal condition that might cause an overload condition in the Driver Tube, the Power Amplifier Tube, or the high voltage section of the amplifier immediately initiates a 1 second shut down. The plate voltage is removed automatically from these tubes to protect them from permanent damage. It is automatically returned after this one second interval; after three consecutive shut downs the plate voltage can be restored only by a manual re-set.

## AUTO RESTART—Power Interrupt

If the primary power to the transmitter is interrupted for less than 5 seconds the transmitter automatically shuts down; this protects sensitive tubes and circuits. It is automatically returned to full power immediately upon return of primary power. As long as the interrupt is less than 5 seconds this sequence will continue indefinitely. If primary power to the transmitter is interrupted for more than 5 seconds the transmitter is automatically shut down. When power is returned a 3 minute restart cycle is automatically instituted after which normal operation of the transmitter resumes. This delay is required to protect the sensitive high power tubes.

## MISCELLANEOUS

The Model FM-25/25KE contains many other features of interest to the professional broadcast engineer and technicians. These include a mid-panel metering system for easy viewing. Remote control interface connections, VSWR protection, an elapsed time indicator, automatic level controls, and remote control power adjust system are standard items.





### AEL FM-25/25KE Custom Control Cabinet

Front View—Door Removed

Rear View—Door Removed

Individual Power and Total Power Output Meters

Controls and Status Indication of Coax Switching

Control System Transmitters "A" and "B"

Dual Buffer Amplifier for Transmitters "A" and "B"

AEL FM-20E Exciter

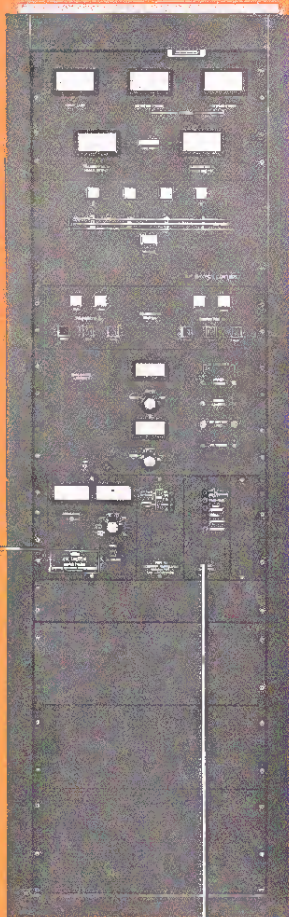

AEL FM-20E/SG Stereo Generator

Rear View Individual Power and Total Power Output Meters

Remote Control Function Connection Panel

Rear View Coax Switching Control Relays

Rear View Dual Buffer Amplifier Assembly

Regulated 24Vdc Control Circuit Power Supply

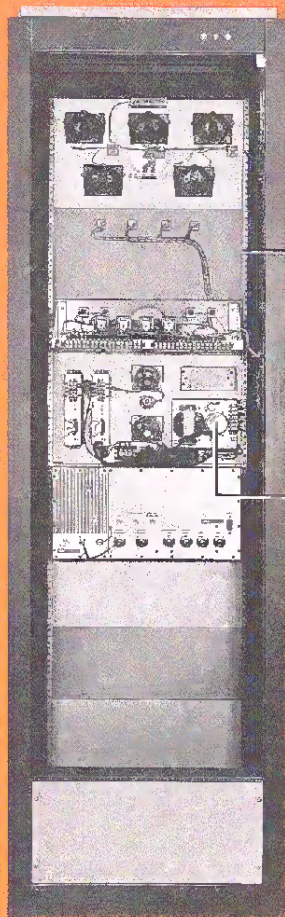

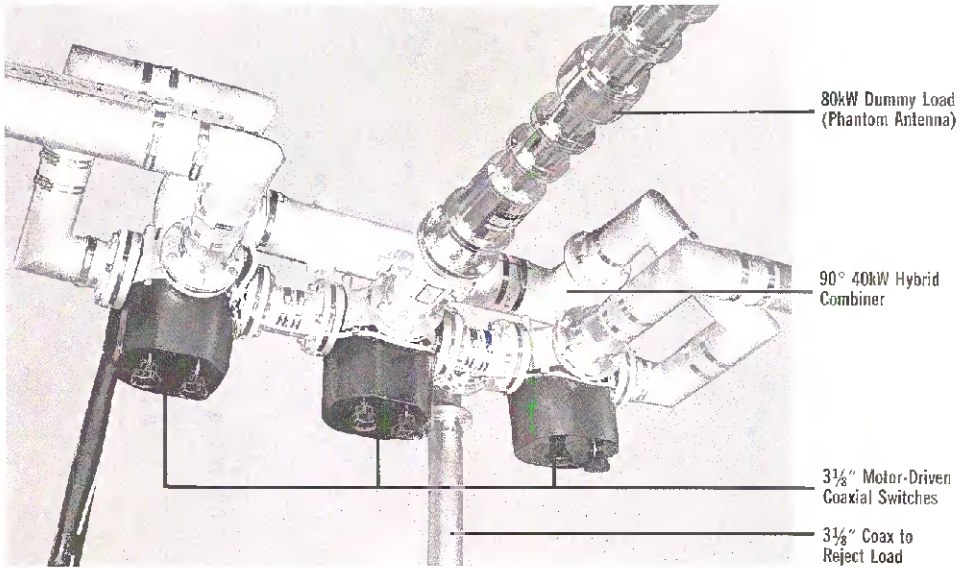

**FM-25/25KE 40KW Combiner with Remote Control Coax Switching**

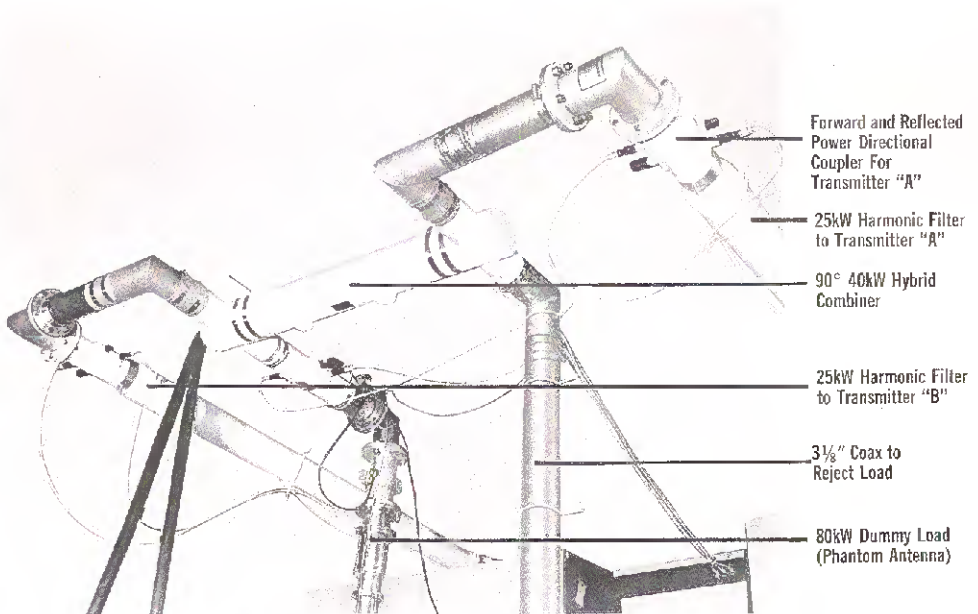

**FM-25/25KE 40KW Combiner**





**SPECIFICATIONS FM-25/25KE**

**ELECTRICAL**

Power Output .....	40 kW max with 3 1/8" line 50 kW max with 6 1/8" line
Frequency Range .....	88 to 108 MHz
Emission .....	F3, F9
Load Impedance .....	50 ohms; VSWR 1.5: 1 max
Output Termination .....	3 1/8" or 6 1/8" EIA flange
Frequency Stability .....	±200 Hz
Modulation Capability .....	±100 kHz
Audio Input Impedance .....	600 ohms balanced
Audio Input Level .....	10 ± 2 dBm for 100% mod at 400 Hz
Audio Response .....	±1 dB, 50-15000 Hz
Audio Distortion .....	0.5% max, 50-15000 Hz
FM Noise .....	-70 dB max
AM Noise .....	-55 dB max
Power Line .....	208/240 Vac, 3 phase, 60 Hz
Power Factor .....	0.9

**MECHANICAL**

Overall Dimensions (main cabinets) .....	76"H x 120"W x 34"D (less filters and combiner)
Net Weight .....	4600 lbs (approx)
Operating Altitude .....	10,000 ft max
Operating Temperature .....	0° to 45° C

**TUBE COMPLEMENT**

- 2 ea 4CX1000A
- 2 ea 3CX15000A7

*Prices and specifications subject to change without notice.*

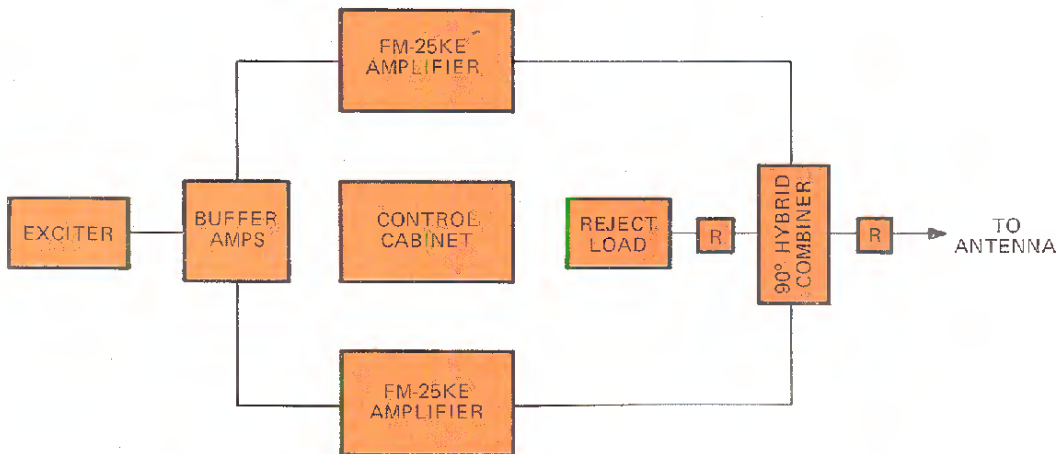

**Basic System Block Diagram AEL FM-25/25KE**



A black and white portrait of Guglielmo Marconi, an Italian inventor and electrical engineer. He is shown from the chest up, wearing a dark suit jacket, a white shirt with a high collar, and a dark tie. He has short, dark hair and is looking slightly to the right of the camera with a neutral expression. The background is dark and indistinct, possibly showing some equipment or a desk.

Guglielmo Marconi (12-4-1874-1937) Marconi, an Italian inventor and electrical engineer, won recognition for his work in developing wireless telegraphy or radio. This led to present-day radio broadcasting. He produced a practical wireless telegraph system in 1895, one has credited as the first had previously been made in wireless telegraphy. He produced the first transatlantic wireless signal in history on Dec. 12, 1901, and patented his powerful directional aerial in 1906. Marconi invented the beam system of wireless for long-distance communication.



# FM-20E EXCITER



The AEL Model FM-20E, FM Exciter, nucleus of the AEL FM-25KE Transmitter, is a totally solid state unit employing Direct Carrier Frequency Modulation. The exciter's capabilities allows exceptional performance over a wide frequency range with negligible phase shift and provides good stereo separation, extremely low distortion and noise.

The AFC and FMO circuitry provides long term frequency stability. The modular construction of the AEL FM-20E permits the integration in a single rack mounted unit the Power Supply and Metering Module, the Frequency Modulated Oscillator, the Monaural Module, the Stereo Generator, and the SCA Generator.

## FEATURES

- 25 Watt RF output
- 88 — 108 MHz without tuning
- Superior Audio Performance
- Ease of Maintenance
- Military type construction
- Minimum alignment adjustments

## SUPERIOR AUDIO PERFORMANCE

This exciter offers superior performance for the professional FM broadcaster. The 25W output provides sufficient reserve power for most installations. Other outstanding performance specifications include:

- Low Intermodulation Distortion  
0.35% (typical)
- Frequency Stability  
 $\pm 200$  Hz
- Phase Linearity  
 $\pm 3^\circ$  at 75kHz deviation

## EASE OF MAINTENANCE

All critical circuits are mounted on three readily accessible and replaceable modules. All sensitive circuits located on these boards are measured and displayed on front panel meters. Replacing any one of these plug-in modules will correct most failures that might occur in this exciter. This feature reduces potential down-time to an absolute minimum.

## MINIMUM ALIGNMENT ADJUSTMENTS

Most modern exciter designs require from 7 to 14 separate adjustments to maintain frequency stability, distortion, and RF output power. The AEL Model FM-20E exciter requires only 3 alignment adjustments to control these functions. In normal operation, these adjustments will never have to be made unless a component failure occurs.

## MILITARY TYPE CONSTRUCTION

These exciters have been designed, manufactured, and tested in conformance to the most rigorous electrical and mechanical requirements. This results in years of trouble-free operation. Only AEL offers these outstanding construction features:

- MIL Spec IC's
- Double-Rail mechanical mountings
- Short circuit-proof power supply
- Heavy gauge steel construction
- PC boards electrically shielded

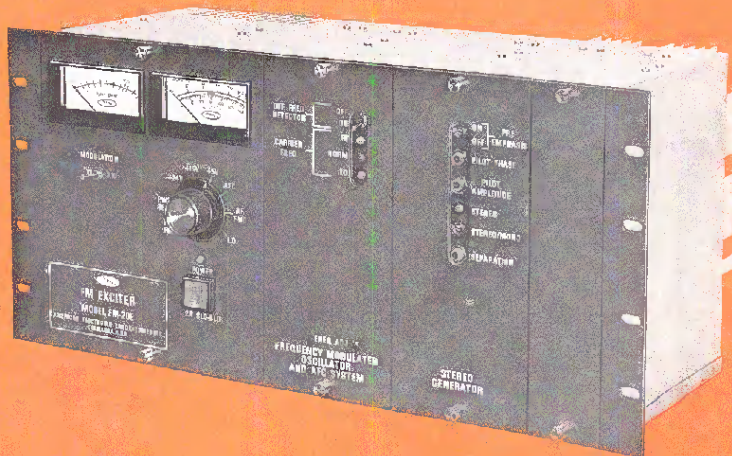



**STEREO GENERATOR**

The AEL FM-20E/SG stereo generator exceeds its published specifications by a considerable margin. These specifications are by far more exacting than the minimum FCC requirements.

The AEL FM-20E/SG utilizes an all silicon monolithic design which offers unprecedented reliability and performance. A special digital chain for the sub-channel carrier offers extreme stability of frequency and phase. A similar modulation technique assures a separation in excess of 40 dB at any frequency from 50 Hz to 15,000 Hz.

**SCA GENERATOR**

The AEL FM-20E/SC Generator provides an SCA carrier for the exciter. A digital monolithic circuitry provides excellent stability, performance and reliability. The standard AEL FM-20E/SC provides a 67 kHz sub-carrier (10% modulation,  $\pm 6.7$  kHz); a 41 kHz version is also available upon request.

**MONAURAL MODULE**

The Monaural Module of the FM-20E exciter provides the necessary circuitry for driving the FMO with a 30-15000 Hz  $\pm .5$ dB signal, it has an isolation transformer and pre-emphasis and has provision for altering it to any value that may be desired.

**SPECIFICATIONS**

**GENERAL**

Frequency Range	88 to 108 MHz
Power Output	5-20 watts (cont. variable)
Load Impedance	50 ohms
AFC	Phase Locked Loop
Type of Modulation	Direct FM
Modulation Capability	$\pm 100$ kHz minimum
Altitude	10,000 feet
Temperature Range	-10 to 55°C
Overall Dimensions	8 1/2" x 19" x 8 1/2" deep
Net Weight	16 1/2" rack—FMO—P.S.—20 lbs. Monaural module —2.5 lbs. Stereo module —7.0 lbs. SCA module —5.0 lbs.
VSWR	Will withstand an open or a short circuited output indefinitely

**MONAURAL OPERATION**

Input Impedance	150/600 ohms balanced
Input Level	0 dBm to +20 dBm for 100% modulation
Frequency Response	30-15,000 Hz $\pm 0.5$ dB
Pre-Emphasis	Standard 75 $\mu$ sec with provision to change
FM Noise	better than -70 dB
AM Noise	-55 dB
Distortion	0.5% max. (I.M.D. & T.H.D)

**STEREO OPERATION**

Input Impedance	600 ohms balanced
Input Level	+10dBm $\pm 2$ dB for 100% modulation
Stereo Response	50-15,000 $\pm 1$ dB
Stereo Pre-Emphasis	75 $\mu$ sec standard with provision to change
Distortion	0.5% max. (I.M.D. & T.H.D)
FM Noise	-63 dB
Stereo Pilot Stability	$\pm 1$ Hz
Stereo Separation	40 dB 50-15,000 Hz

**SCA SUB-CHANNEL**

Frequency Range	30-100 kHz
Frequency Stability	$\pm 400$ Hz
Input Impedance	600 ohms balanced
Input Level	-15 to +10 dBm adjustable
Muting Delay	0.5 to 5 seconds adjustable
FM Noise	-63 dB
Cross-Talk	-45 dB

Prices and specifications subject to change without notice.

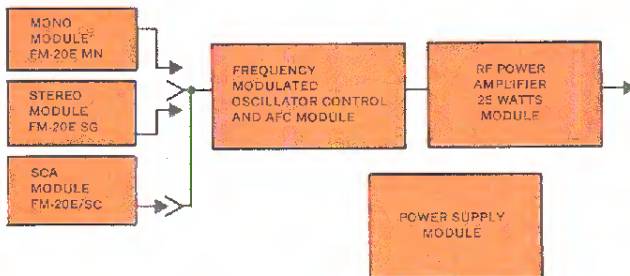

FM-20E Exciter





AMERICAN ELECTRONIC LABORATORIES, Inc.

P.O. Box 552, Lansdale, PA 19446 • (215) 822-2929 TWX 510-861-4976

Copyright © 1976 by American Electronic Laboratories, Inc. All rights reserved.

