

broadcast

MC MARTIN

250-1,500 WATT FM TRANSMITTER

BF-1M

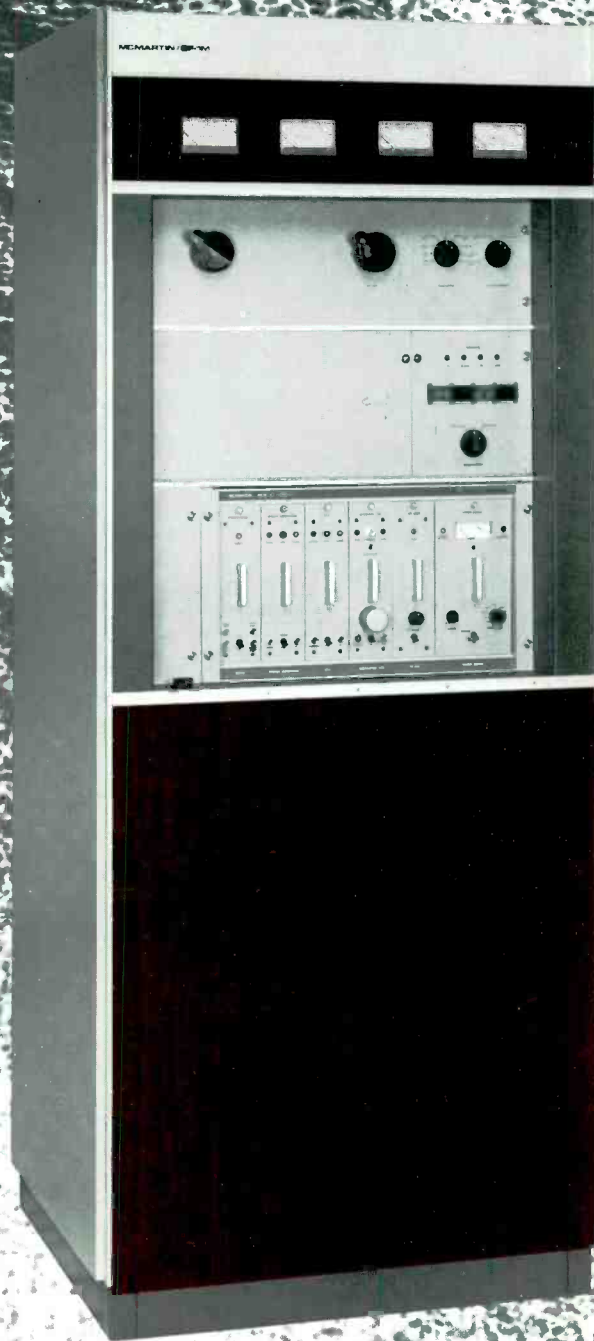

MCMARTIN

McMARTIN BF-1M TRANSMITTER

EXCELLENT PA EFFICIENCY — 70– 80%

VERY STABLE OPERATION — GROUNDED GRID

OVERLOAD-STATUS LIGHTS BUILT-IN

**EASILY REMOTE CONTROLLED.
NO INTERFACE ADAPTERS NEEDED**

AUTOMATIC RECYCLING

**CONSERVATIVELY RATED —
USES 40% OF PA DISSIPATION**

PA-OVERLOAD AND VSWR SENSING BUILT-IN

**PROTECTIVE CIRCUIT FOR LOSS OF AIR
PRESSURE AND EXCESSIVE TEMPERATURE**

NO NEUTRALIZATION REQUIRED

Topnotch performance at output levels in the .25 to 1.5 kW range is assured by the McMartin Model BF-1M FM Broadcast transmitter. The BF-1M is FCC Type Accepted at these power ranges.

Designed for operation on any specified frequency from 88 to 108 MegaHertz, the BF-1M, with its grounded grid Class C PA stage, assures excellent bandwidth characteristics essential to the stringent demands of stereophonic and SCA multiplex transmission today.

The power amplifier stage uses a ceramic/metal, zero-bias, hi- μ triode — the 3CX1500/A7. As a grounded grid Class C amplifier, this tube requires no neutralization, nor grid bias and screen grid power supplies. The elimination of these many components, required for power tetrode PA stages, contributes both to long-term reliability and stability and a remarkably simple and straightforward power output RF stage design.

The PA tube is driven by a solid-state intermediate power amplifier stage following the field-proven, high-performance McMartin Model BFM-15 solid state exciter, of modular plug-in design. Stereo or SCA multiplex capability is easily attained by use of the optional modular stereo and SCA generator assemblies.

The heart of the BF-1M is the advanced McMartin BFM-15, high performance, fully modular FM exciter. Optional plug-in circuit cards allow the user to add SCA, stereo and audio processing functions within the exciter cabinet.

The audio processor is McMartin's Exclusive *Maxi-I*, an exceptionally responsive design which assures maximum program loudness and limits overshoot to less than 2%.

The BFM-15 replaces the McMartin B-910 exciter used in the "K" series FM transmitters and provides superior performance that includes improved stereo separation, lower SCA distortion, and extremely low SCA crosstalk into the main channel; lower, in fact, than the noise floor. The BFM-15 is also unaffected by line voltage transients and is extremely stable under a wide range of environmental conditions.

The BF-1M is easy to operate. Simple pushbutton start-stop switching, eye-level metering and convenient operating controls emphasize the "designed-for-humans" approach. Maintenance and servicing is simple — all components are readily accessible. Where remote control operation is employed, the BF-1M is ready. Terminations are provided for interface with all standard remote control systems. In addition to start-stop functions and motor driven power output control, telemetry sampling voltages of the major operating parameters, including VSWR indication, are standard.

The BF-1M has an automatic recycling system, backed up by a memory-type LED status indicator panel. Exciter output, IPA and PA overloads and VSWR values are monitored continuously. If a fault occurs, it is displayed on the LED status indicator associated with that portion of the transmitter circuit where it occurred. Three "start" pulses spaced about one second apart are automatically initiated. If the fault is corrected during the three-pulse sequence the BF-1M is returned to its normal operation; however, the status indicator remains energized until manually reset. If the fault persists, the BF-1M reverts to its "standby" condition. The status indicator localizes the fault and remains on until reset manually. The automatic recycling/status indicator combination immediately alerts engineering personnel to intermittent faults which are normally extremely difficult to isolate.

The BF-1M is completely self-contained in an attractively-styled cabinet.

Positive pressure cabinet cooling, coupled with conservative operating levels for all components results in outstandingly cool operation, contributing to excellent, long-term reliability.

Large, eye-level meters display PA plate voltage and current, VSWR, filament and line voltage, plus a ten-position multimeter readout of auxiliary operating voltages and currents.

The BF-1M is delivered to you, pretuned and tested, on your frequency, complete with engineering test data. Installation is strictly a matter of connecting primary power, audio input and monitor cables and the antenna transmission line.

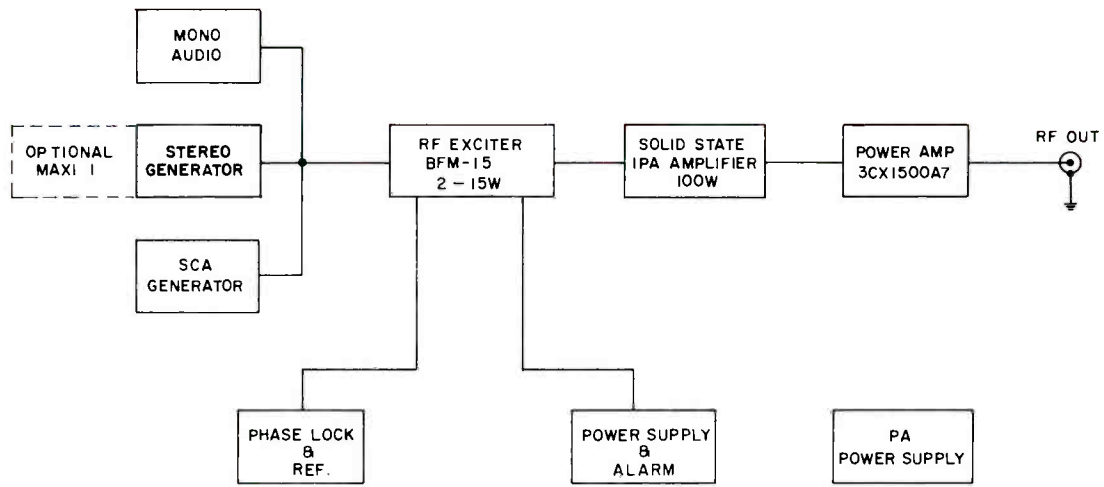

Block diagram

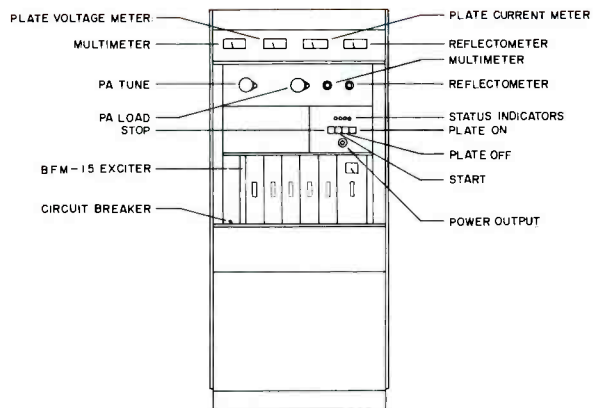

Front panel description

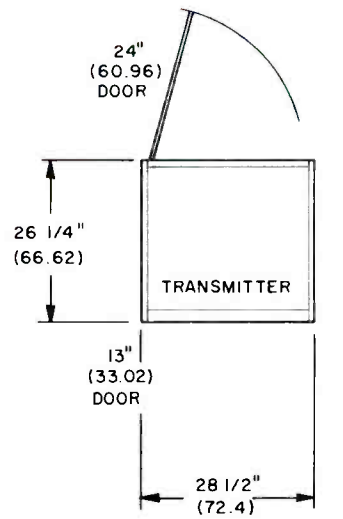

DIMENSIONS IN ()
GIVEN IN CENTIMETERS

Floor plan

SPECIFICATIONS

OPERATING RANGE88 to 108 MegaHertz
RF POWER OUTPUT1,500 watts maximum
RF OUTPUT IMPEDANCE50 ohms
CENTER FREQUENCY STABILITY	±500 Hz
MODULATION CAPABILITY	±150 kHz
AUDIO INPUT IMPEDANCE600 ohms, balanced
AUDIO INPUT LEVEL	+10, ±2, dBm
AUDIO FREQUENCY RESPONSE	±0.75 dB, 30-15,000 Hz (Std. FCC 75 usec preemphasis)
TOTAL HARMONIC DISTORTION0.3% or less, 30-15,000 Hz, 100% mod.
IM DISTORTION0.2% or less 60 Hz/7 KHz, 4:1 ratio
FM NOISE	>65 dB below 100% modulation (typical 70 dB)
AM NOISE	>55 dB below carrier level
POWER REQUIRED208/230/240 Vac, 50/60 Hz, single phase, 3-wire.
POWER CONSUMPTION1,500W output, 2,600W 1,000W output, 1,700W 250W output, 850W
OPERATING TEMPERATURE0° to 50° Celsius
ALTITUDE7,500 feet above mean sea level
DIMENSIONS	width .28 1/4" (71.8 cm) height .70 1/2" (179 cm) depth .25 3/4" (65.4 cm) rear door swing .30" (76.2 cm)
WEIGHT	actual .590 lbs (267.3 kg) crated .670 lbs (303.5 kg)
FINISHMcMartin beige w/wood-grain trim

STEREO OPERATION (with BFM-1521 Stereo Assembly)

AUDIO INPUT IMPEDANCE600 ohms balanced, each channel
AUDIO INPUT LEVEL	+10, ±2, dBm
AUDIO FREQUENCY RESPONSE	±0.75 dB, 30-15,000 Hz, Std FCC 75 usec, preemphasis, each channel

TOTAL HARMONIC DISTORTION0.5% or less, 30-15,000 Hz
IM DISTORTION0.2% or less 60 Hz/7 KHz, 4:1 ratio
STEREO SEPARATION40 dB or greater, 50-15,000 Hz typically 50 dB or greater at mid-range
FM NOISE60 dB or greater below 100% modulation
PILOT STABILITY	±1.0 Hertz over rated temperature range
SUBCARRIER SUPPRESSION55 dB or greater
CROSSTALK (L+R to L-R, L-R to L+R)40 dB or greater below 90% modulation

SCA OPERATION (with BFM-1531 SCA Generator Module)

AUDIO INPUT IMPEDANCE600 ohms, balanced
AUDIO INPUT LEVEL	+10, ±2, dBm
CARRIER FREQUENCY41 or 67 KHz standard (others available on request)
CARRIER STABILITY	±500 Hz
MODULATION CAPABILITY	±7.5 kHz
PREEMPHASIS150 usec standard, 50 or 75 usec available on request
FREQUENCY RESPONSE	±1.5 dB, 50-5000 Hz
CROSSTALK (main to sub, sub to main)60 dB or lower
DISTORTION (50-5000 Hz)0.75% or less with LP output filter 2.5% or less with BP output filter
S/N NOISE60 dB or greater

ORDERING INFORMATION

Model	Description	Product Code
BF-1M25-1.5KW FM broadcast transmitter, complete with exciter and tubes, 208/230/240 VAC, 50/60 Hz, single phase 3-wire (grounded neutral)	.10-01-090
STF-1K	Spare tube kit for BF-1M Spare rectifier diode stack RS 1.5-12-12M (Requires 2)	.10-01-094 210015

1,500-3,500 WATT FM TRANSMITTER

BF-3.5M

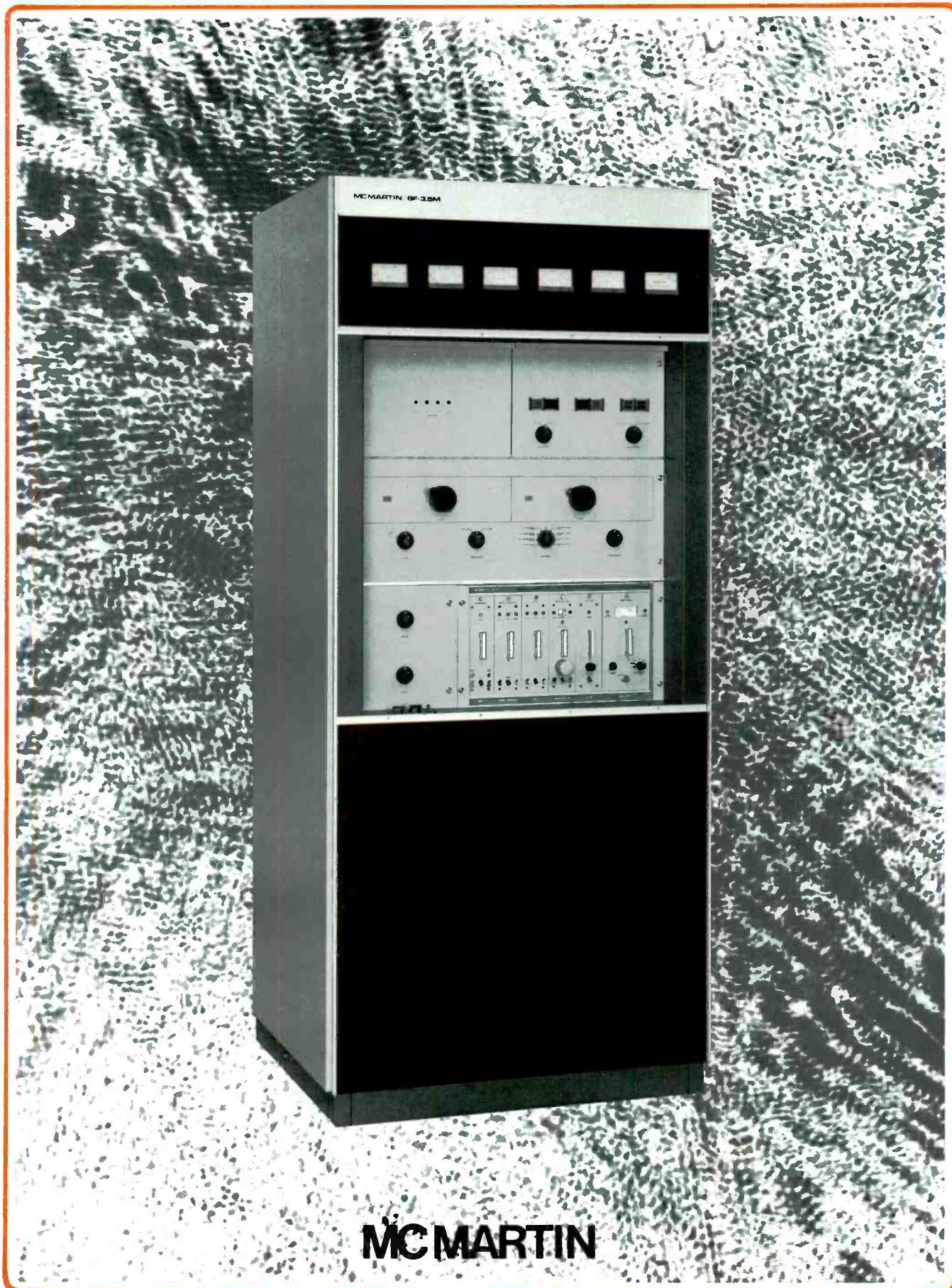

MCMARTIN

MC MARTIN BF-3.5M TRANSMITTER

EXCELLENT PA EFFICIENCY — 70– 80%

OVERLOAD-STATUS LIGHTS BUILT-IN

AUTOMATIC RECYCLING

PA-OVERLOAD AND VSWR SENSING BUILT-IN

NO NEUTRALIZATION REQUIRED

VERY STABLE OPERATION — GROUNDED GRID

**EASILY REMOTE CONTROLLED.
NO INTERFACE ADAPTERS NEEDED**

**CONSERVATIVELY RATED —
USES 40% OF PA DISSIPATION**

**PROTECTIVE CIRCUIT FOR LOSS OF AIR
PRESSURE AND EXCESSIVE TEMPERATURE**

The McMartin BF-3.5M FM Broadcast Transmitter is an extremely stable, high performance unit meticulously designed for many years of reliable service.

The BF-3.5M design is simple and straightforward. It uses only two tube types. To provide the stability and bandwidth characteristics, essential to modern broadcast fidelity requirements, the BF-3.5M power amplifier stage employs a type 3CX3000A7 high mu, zero-bias power triode operating in grounded-grid Class C mode. The need for control grid bias, and screen voltage power supplies is eliminated. No neutralization is required.

Excellent plate efficiencies, in excess of 70% across the entire 88 to 108 MHz range and at power output levels from 2,000 to 3,500 watts, result in an extremely conservative transmitter. The BF-3.5M is FCC Type Accepted at these power ranges.

The intermediate power amplifier stage uses a pair of rugged radial beam power tetrodes, 4CX250B's, operated in parallel. The BF-3.5M power output is adjusted by motor-driven control of screen voltage applied to the IPA stage.

The heart of the BF-3.5M is the advanced McMartin BFM-15, high performance, fully modular FM exciter. Optional plug-in circuit cards allow the user to add SCA, stereo and audio processing functions within the exciter cabinet.

The audio processor is McMartin's exclusive *Maxi-1*, an exceptionally responsive design which assures maximum program loudness and limits overshoot to less than 2%.

The BFM-15 replaces the McMartin B-910 exciter used in the "K" series FM transmitters and provides superior performance that includes improved stereo separation, lower SCA distortion, and extremely low SCA crosstalk into the main channel; lower, in fact, than the noise floor. The BFM-15 is also unaffected by line voltage transients and is extremely stable under a wide range of environmental conditions.

The BF-3.5M includes as standard equipment, many features available in competitive models only as add-ons. Automatic recycling, with a memory-type LED fault indicator, forward-reverse reflectometer, plus full remote-control capability are built into the BF-3.5M.

A quiet, centrifugal blower maintains positive air pressure through the compartmentized IPA and PA stages, and is supplemented by a cabinet exhaust fan. This air system greatly reduces thermal aging of components.

The BF-3.5M satisfies the management, program and technical personnel of today's FM broadcast station. Reasonable initial and operating cost, a high quality sound, trouble-free operating and ease of maintenance are but a few of the design objectives met by the newest — and best — FM broadcast transmitter you can buy!

The electronic integrity is supplemented by rugged mechanical design in a style which is strikingly attractive.

The powerfully proud BF-3.5M is a pleasure to own . . . a pleasure to maintain . . . a pleasure to listen to . . . another new breed of McMartin broadcast products.

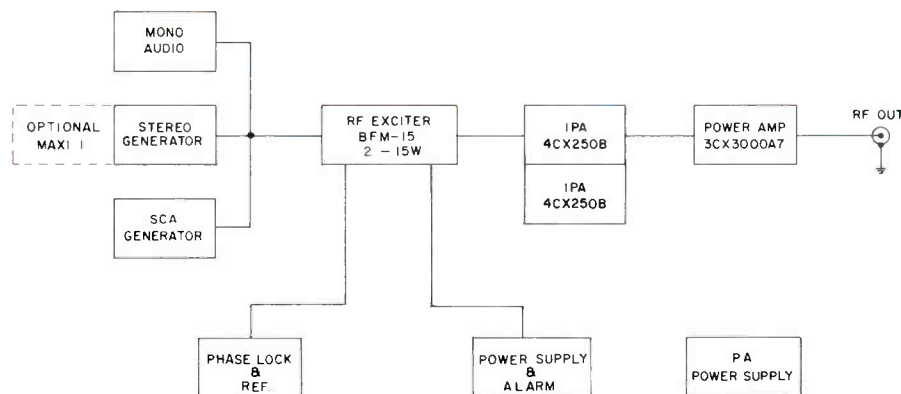

Block diagram

Built-in low pass filter and directional coupler

Rugged PA tuning

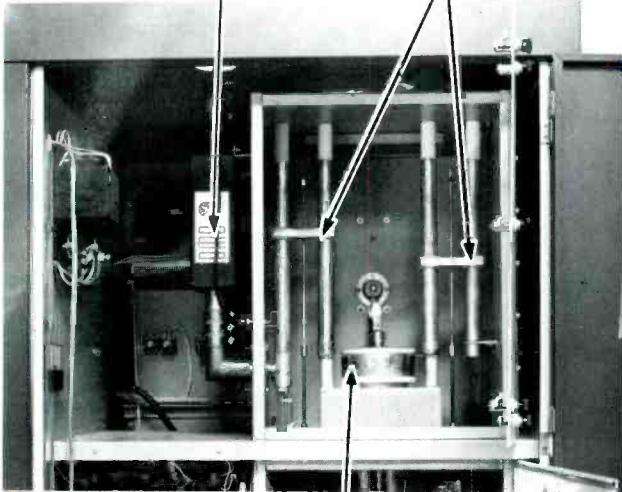

Conservative final amplifier tube 3CX3000A7

Rear view, top section of BF-3.5M

All control relays easily accessible

Rectifier diodes individually replaceable. Rated 4 times working voltage

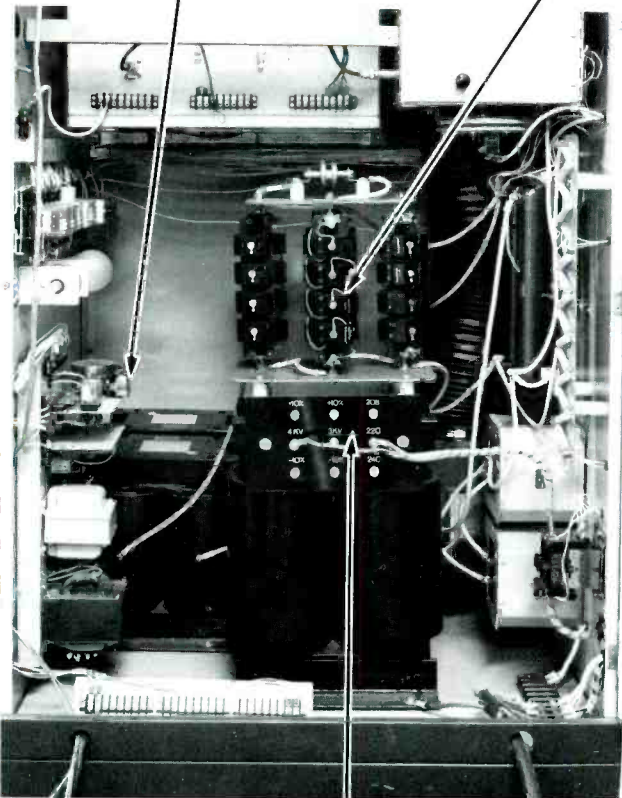

Multi-tap power transformer for any AC input configuration three phase or single phase

Rear view, base section of BF-3.5M

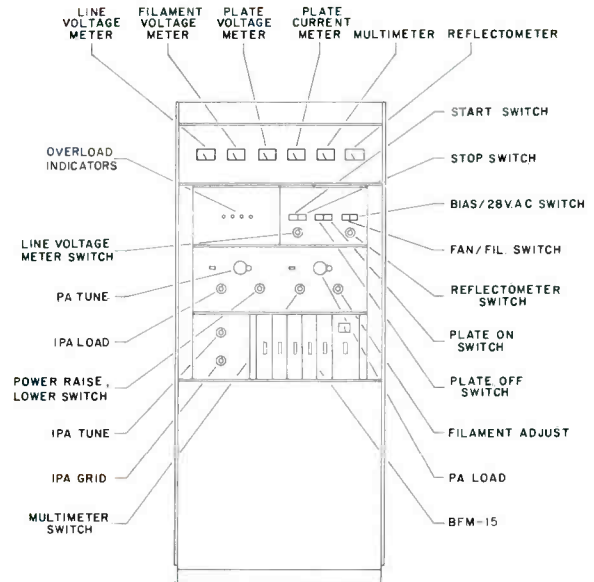

Front panel description

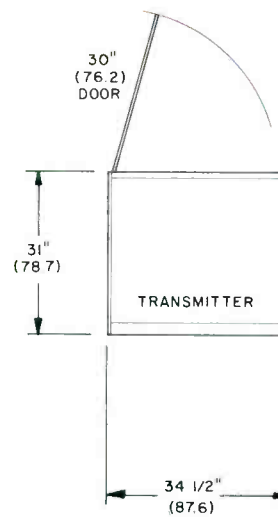

DIMENSIONS IN () GIVEN IN CENTIMETERS

Floor plan

SPECIFICATIONS

OPERATING RANGE88 to 108 MegaHertz
RF POWER OUTPUT3,500 watts maximum
RF OUTPUT IMPEDANCE50 ohms (supplied with 1 $\frac{1}{2}$ " elbow and flange)
CENTER FREQUENCY STABILITY \pm 500 Hz
MODULATION CAPABILITY \pm 150 kHz
AUDIO INPUT IMPEDANCE600 ohms, balanced
AUDIO INPUT LEVEL+10, \pm 2, dBm
AUDIO FREQUENCY RESPONSE \pm 0.75 dB, 30-15,000 Hz (Std. FCC 75 usec pre-emphasis)
TOTAL HARMONIC DISTORTION0.3% or less, 30-15,000 Hz, 100% mod.
IM DISTORTION0.2% or less 60 Hz/7 KHz, 4:1 ratio
FM NOISE65 dB below 100% modulation (typical 70 dB)
AM NOISE55 dB below carrier level
POWER REQUIRED208/230/240 Vac, 50/60 Hz single phase standard 208/230/240 Vac, 3-phase optional
POWER CONSUMPTION (Approx.)2,000 watt output, 4,400 watts 2,500 watt output, 5,200 watts 3,000 watt output, 5,900 watts 3,500 watt output, 6,500 watts
OPERATING TEMPERATURE0° to 50° Celsius
ALTITUDE7,500 feet above mean sea level
DIMENSIONS	width34 $\frac{1}{2}$ " (87.6 cm) height85" (219.9 cm) depth31" (78.7 cm) rear door swing30" (76.2 cm)
WEIGHT	actual920 lbs (417.8 kg) crated1020 lbs (463.1 kg)
FINISHMcMartin beige w/wood-grain trim

STEREO OPERATION (with BFM-1521 Stereo Assembly)

AUDIO INPUT IMPEDANCE600 ohms balanced, each channel
AUDIO INPUT LEVEL+10, \pm 2, dBm

AUDIO FREQUENCY RESPONSE \pm 0.75 dB, 30-15,000 Hz, Std FCC 75 usec, pre-emphasis each channel
TOTAL HARMONIC DISTORTION0.5% or less, 30-15000 Hz
IM DISTORTION2% or less 60 Hz/7 kHz, 4:1 Ratio
STEREO SEPARATION40 dB or greater, 50-15000 Hz
FM NOISE60 dB or greater below 100% modulation
PILOT STABILITY \pm 1.0 Hertz over rated temperature range
SUBCARRIER SUPPRESSION55 dB or greater
CROSSTALK (L + R to L - R, L - R to L + R)40 dB or greater below 90% modulation

SCA OPERATION (with BFM-1531 SCA Generator Module)

AUDIO INPUT IMPEDANCE600 ohms, balanced
AUDIO INPUT LEVEL+10, \pm 2, dBm
CARRIER FREQUENCY41 or 67 kHz standard (others available on request)
CARRIER STABILITY \pm 500 Hz
MODULATION CAPABILITY \pm 7.5 kHz
PREEMPHASIS150 usec standard, 50 or 75 usec available on request
FREQUENCY RESPONSE \pm 1.5 dB, 50-5000 Hz
CROSSTALK (main to sub, sub to main)60 dB or lower
DISTORTION (50-5000 Hz)0.75% or less with LP output filter 2.5% or less with BP output filter
S/N NOISE60 dB or greater

ORDERING INFORMATION

Model	Description	Product Code
BF-3.5M	1.5-3.5KW FM transmitter, complete with exciter and tubes, 208/230/240 VAC, 50/60 Hz, single phase — or optional (208/230/240 VAC 3 phase)	10-01-026
STF-3.5K	Spare tube kit for BF-3.5M (complete set)	10-01-027
	Spare Rectifier Diode Stack RS 3.5-24-12S (Requires 4)	210016

3,500-5,500 WATT FM TRANSMITTER

BF-5M

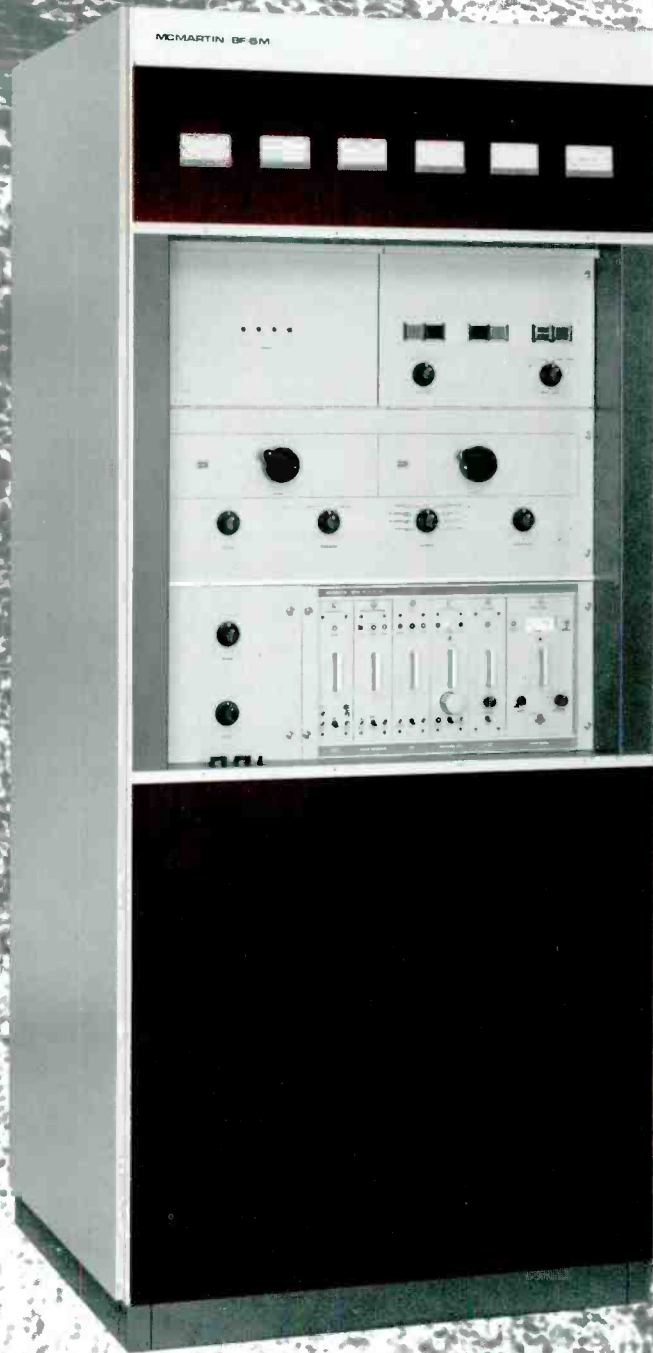

MCMARTIN

McMARTIN BF-5M TRANSMITTER

EXCELLENT PA EFFICIENCY — 70– 80%

OVERLOAD-STATUS LIGHTS BUILT-IN

AUTOMATIC RECYCLING

PA-OVERLOAD AND VSWR SENSING BUILT-IN

NO NEUTRALIZATION REQUIRED

VERY STABLE OPERATION — GROUNDED GRID

**EASILY REMOTE CONTROLLED.
NO INTERFACE ADAPTERS NEEDED**

**CONSERVATIVELY RATED —
USES 40% OF PA DISSIPATION**

**PROTECTIVE CIRCUIT FOR LOSS OF AIR
PRESSURE AND EXCESSIVE TEMPERATURE**

The McMARTIN BF-5M transmitter is designed for FM broadcast service, operating on a specific frequency in the range of 88 to 108 MHz, and power output levels from 3.5 to 5.5 KW. The BF-5M is FCC Type Accepted at these power ranges.

The BF-5M utilizes the high-performance McMARTIN BFM-15 solid state exciter. The RF output of the exciter drives an intermediate power amplifier stage consisting of paralleled Type 4CX250B radial beam tetrodes. These supply RF excitation to a ceramic/metal, zero-bias, hi- μ triode tube, Type 3CX3000/A7 operating as a grounded-grid Class C amplifier. This configuration is well-recognized as optimum for the wide-band characteristics essential to superior stereo and SCA multiplex operation today — and for quadrasonic sound, tomorrow.

In addition, the elimination of grid-bias and screen-voltage power supplies and the need for neutralization, essential to transmitter designs using power tetrode output tubes, contributes to long-term, stable operation.

The heart of the BF-5M is the advanced McMARTIN BFM-15, high performance, fully modular FM exciter. Optional plug-in circuit cards allow the user to add SCA, stereo and audio processing functions within the exciter cabinet.

The audio processor is McMARTIN's Exclusive *Maxi-1*, an exceptionally responsive design which assures maximum program loudness and limits overshoot to less than 2%.

The BFM-15 replaces the McMARTIN B-910 exciter used in the "K" series FM transmitters and provides superior performance that includes improved stereo separation, lower SCA distortion, and extremely low SCA crosstalk into the main channel; lower, in fact, than the noise floor. The BFM-15 is also unaffected by line voltage transients and is extremely stable under a wide range of environmental conditions.

The BF-5M is controlled by simple pushbutton start-stop switch operation, with terminations provided for interface with standard remote control systems, including telemetry sampling voltages.

Automatic recycling and memory-type LED status indication is standard. The status system senses and displays the source of any carrier interruption. The exciter output; IPA and PA stage overloads; and transmission line VSWR are monitored continuously. Any fault is detected and displayed on the LED indicator panel and can be "cleared" only by manual reset. The recycling circuitry upon a fault occurrence, automatically initiates three "start" pulses, spaced about one second apart. If the fault persists, the BF-5M will revert to its "standby" condition, and the LED status indicator associated with that portion of the transmitter within which the fault occurred will be illuminated.

For output operating levels up to 4KW, the BF-5M is completely self-contained. For 4.0 to 5.5 KW output, an external RF harmonic filter is supplied. This mounts horizontally above the BF-5M cabinet.

Positive-pressure air cooling, in conjunction with conservative operating levels for all components results in unusually cool operation of the BF-5M. This contributes to excellent long-term component reliability.

All major parameters are displayed on large front panel meters, including PA plate voltage and current; VSWR; filament and line voltages and a ten-position multimeter readout. Three-phase primary power is standard. Single phase operation when requested will be supplied at no additional cost.

Where redundant or combined transmitter systems are desired, dual BF-5M units may be used. McMARTIN will gladly furnish quotations for specialized systems of this type, engineering-tailored to your specifications.

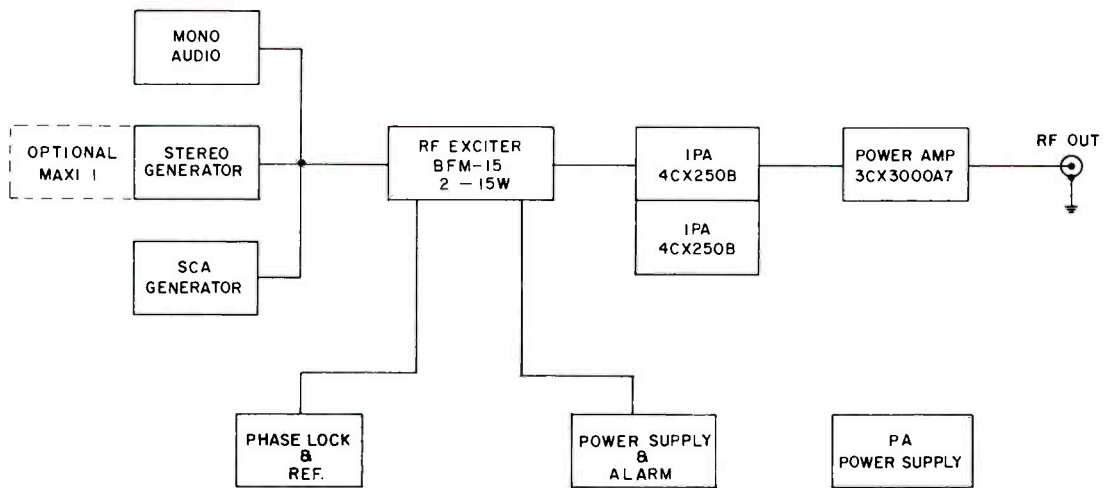

Block diagram

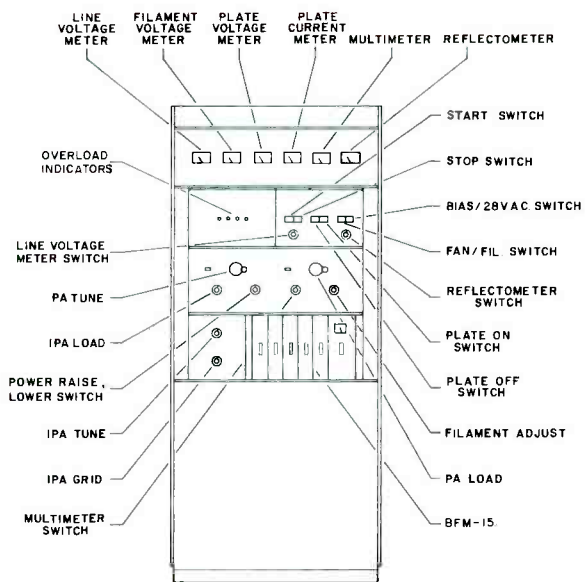

Front panel description

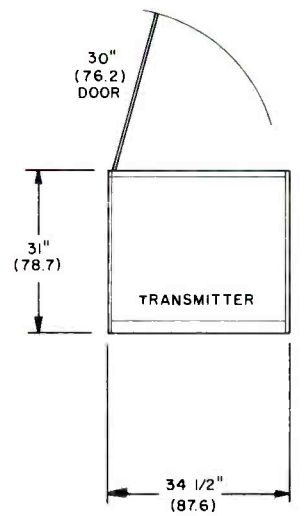

DIMENSIONS IN ()
GIVEN IN CENTIMETERS

Floor plan

SPECIFICATIONS

OPERATING RANGE88 to 108 MegaHertz
RF POWER OUTPUT5,500 watts maximum
RF OUTPUT IMPEDANCE50 ohms
CENTER FREQUENCY STABILITY	±500 Hz
MODULATION CAPABILITY	±150 kHz
AUDIO INPUT IMPEDANCE600 ohms, balanced
AUDIO INPUT LEVEL	+10, ±2, dBm
AUDIO FREQUENCY RESPONSE	±0.75 dB, 30-15,000 Hz (Std. FCC 75 usec preemphasis)
TOTAL HARMONIC DISTORTION0.3% or less, 30-15,000 Hz, 100% mod.
IM DISTORTION0.2% or less 60 Hz/7 KHz, 4:1 ratio
FM NOISE	>65 dB below 100% modulation (typical 70 dB)
AM NOISE	>55 dB below carrier level
POWER REQUIRED208/230/240 Vac, 3-phase or single phase
POWER CONSUMPTION (Approx.)3500 watt output, 7200 watts 4500 watt output, 10,000 watts 5000 watt output, 11,250 watts 5500 watt output, 12,500 watts
OPERATING TEMPERATURE0° to 50° Celsius
ALTITUDE7,500 feet above mean sea level
DIMENSIONS	width .34½" (87.6 cm) height .78½" (199 cm) depth .31" (78.7 cm) rear door swing .30" (76.2 cm)
WEIGHT	actual .970 lbs (439 kg) crated .1070 lbs (485 kg)
FINISHMcMartin beige w/wood-grain trim

STEREO OPERATION (with BFM-1521 Stereo Assembly)

AUDIO INPUT IMPEDANCE600 ohms balanced, each channel
AUDIO INPUT LEVEL	+10, ±2, dBm

AUDIO FREQUENCY RESPONSE	±0.75 dB, 30-15,000 Hz, Std FCC 75 usec, preemphasis, each channel
TOTAL HARMONIC DISTORTION0.5% or less, 30-15,000 Hz
IM DISTORTION0.2% or less 60 Hz/7 KHz, 4:1 ratio
STEREO SEPARATION40 dB or greater, 50-15,000 Hz typically 50 dB or greater at mid-range
FM NOISE60 dB or greater below 100% modulation
PILOT STABILITY	±1.0 Hertz over rated temperature range
SUBCARRIER SUPPRESSION55 dB or greater
CROSSTALK (L+R to L-R, L-R to L+R)40 dB or greater below 90% modulation

SCA OPERATION (with BFM-1531 SCA Generator Module)

AUDIO INPUT IMPEDANCE600 ohms, balanced
AUDIO INPUT LEVEL	+10, ±2, dBm
CARRIER FREQUENCY41 or 67 KHz standard (others available on request)
CARRIER STABILITY	±500 Hz
MODULATION CAPABILITY	±7.5 kHz
PREEMPHASIS150 usec standard, 50 or 75 usec available on request
FREQUENCY RESPONSE	±1.5 dB, 50-5000 Hz
CROSSTALK (main to sub, sub to main)60 dB or lower
DISTORTION (50-5000 Hz)0.75% or less with LP output filter 2.5% or less with BP output filter
S/N NOISE60 dB or greater

ORDERING INFORMATION

Model	Description	Product Code
BF-5M	3.5-5.5KW FM broadcast transmitter, complete with exciter and tubes, 208/230/240 VAC, 50/60 Hz, 3-phase — or — optional (208/230/240 VAC, single phase)	10-01-040
STF-5K	Spare tube kit for BF-5M Spare Rectifier Diode Stack RS 3.5-24-12S (Requires 4)	10-01-027 210016

5,500-15,000 WATT FM TRANSMITTER

BF-10M



MCMARTIN

MC MARTIN BF-10M TRANSMITTER

EXCELLENT PA EFFICIENCY — 70– 80%

OVERLOAD-STATUS LIGHTS BUILT-IN

AUTOMATIC RECYCLING

PA-OVERLOAD AND VSWR SENSING BUILT-IN

NO NEUTRALIZATION REQUIRED

VERY STABLE OPERATION — GROUNDED GRID

**EASILY REMOTE CONTROLLED.
NO INTERFACE ADAPTERS NEEDED**

**CONSERVATIVELY RATED —
USES 40% OF PA DISSIPATION**

**PROTECTIVE CIRCUIT FOR LOSS OF AIR
PRESSURE AND EXCESSIVE TEMPERATURE**

For optimum performance and long-term reliability in FM broadcast installations requiring transmitter power output in the range of 5.5 to 15.0 kW, the McMartin Model BF-10M FM Broadcast Transmitter is the finest choice. The BF-10M is FCC Type Accepted at these power ranges.

The BF-10M meets today's stringent requirements for monaural, stereophonic and SCA multiplex operation — and is ready for the mode of tomorrow — quadraphonic sound.

The excellent wideband characteristics of the BF-10M have been designed into the unit by the use of grounded-grid circuitry in its high-power RF driver and power amplifier stages. Both stages use ceramic/metal, zero-bias, high- μ triodes; a Type 3CX1500/A7 for the driver and a Type 3CX10,000/A7 in the PA stage. Widely-recognized for their broadband characteristics in the grounded grid configuration, the use of these tube types also eliminates the need for neutralization and the many components required for grid bias and screen voltage power supplies. This results in an outstandingly simple and straightforward design approach in the critical high-power RF stages.

One additional tube, a Type 4CX250B serves as an intermediate power amplifier between the solid-state BFM-15 exciter and the driver stage. Motor-driven screen voltage adjustment of the 4CX250B screen grid voltage insures extremely smooth control of the BF-10M power output level.

The heart of the BF-10M is the advanced McMartin BFM-15, high performance, fully modular FM exciter. Optional plug-in circuit cards allow the user to add SCA, stereo and audio processing functions within the exciter cabinet.

The audio processor is McMartin's Exclusive *Maxi-I*, an exceptionally responsive design which assures maximum program loudness and limits overshoot to less than 2%.

The BFM-15 replaces the McMartin B-910 exciter used in the "K" series FM transmitters and provides superior performance that includes improved stereo separation, lower SCA distortion, and extremely low SCA crosstalk

into the main channel; lower, in fact, than the noise floor. The BFM-15 is also unaffected by line voltage transients and is extremely stable under a wide range of environmental conditions.

The BF-10M is controlled by simple push-button start-stop switching, with terminations for remote control operation, including telemetry sampling voltages, for interface with all standard remote control systems.

Automatic recycling and memory-type LED status indication is standard. The latter system senses and displays the source of any carrier interruption. The exciter RF output; IPA, driver and PA stage overloads; and transmission line VSWR are continuously monitored. Any fault is detected and displayed on the LED indicator panel and can be "cleared" only by manual reset. The recycling circuitry automatically reverts to a standby condition, and the LED status indicator for that portion of the transmitter in which the fault occurred will be illuminated.

The BF-10M is completely self-contained in an attractively-styled dual-section cabinet, with the exception of the RF harmonic filter which is externally mounted above the BF-10M cabinet.

Positive pressure air cooling, in conjunction with conservative operation of the high-power RF stages results in unusually cool operation of the BF-10M. This contributes to excellent long-term component reliability.

All major parameters are monitored on large-size front panel meters. Driver and PA plate voltages and currents are metered separately. In addition VSWR, input line voltages, driver/PA filament voltages and a ten-position multimeter readout occupy the upper front meter panel.

The electrical and mechanical design of the BF-10M provides for easy field installation of optional power output feed at an approximately 1000 watt level directly from the 3CX1500/A7 driver stage.

Dual BF-10M units may be combined for redundant 10 to 13.5 KW, or combined 20 to 27 KW output operation. McMartin will gladly furnish quotations for special systems of this type, engineered and tailored to your specifications.

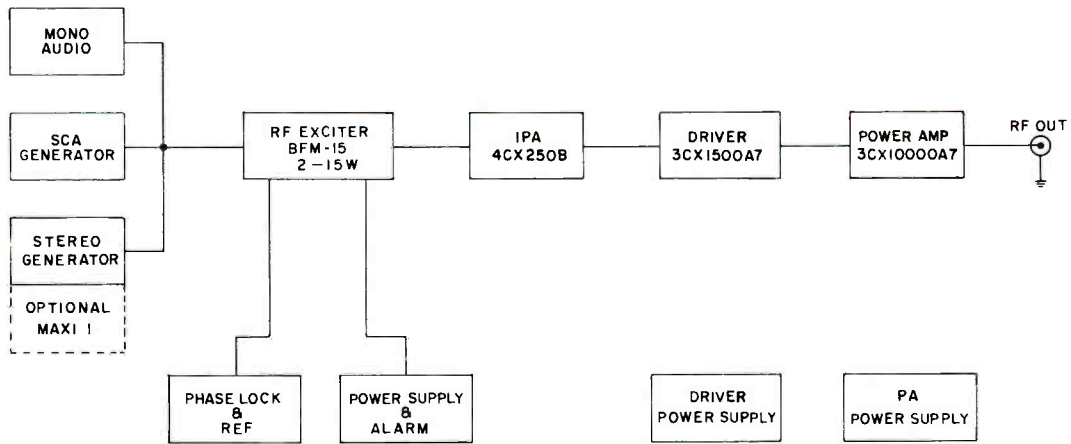

Block diagram

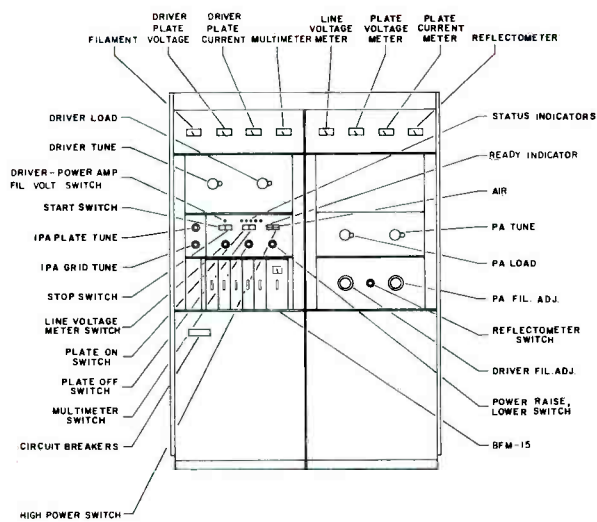

Front panel description

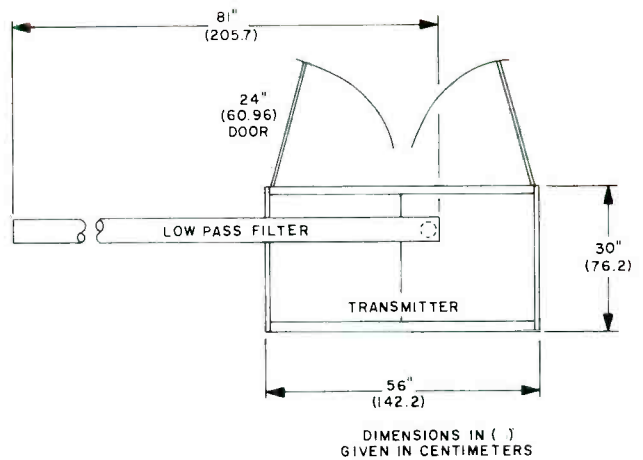

Floor plan

SPECIFICATIONS

OPERATING RANGE	88 to 108 MegaHertz
RF POWER OUTPUT	15.0 kW maximum
RF OUTPUT IMPEDANCE	50 ohms
CENTER FREQUENCY STABILITY	±500 Hz
MODULATION CAPABILITY	±150 kHz
AUDIO INPUT IMPEDANCE	600 ohms, balanced
AUDIO INPUT LEVEL	+10, ±2, dBm
AUDIO FREQUENCY RESPONSE	±0.75 dB, 30-15,000 Hz (Std. FCC 75 usec preemphasis)
TOTAL HARMONIC DISTORTION0.3% or less, 30-15,000 Hz, 100% mod.
IM DISTORTION0.2% or less 60 Hz/7 KHz, 4:1 ratio
FM NOISE	>65 dB below 100% modulation (typical 70 dB)
AM NOISE	>55 dB below carrier level
POWER REQUIRED208/230/240 Vac, 3-phase
POWER CONSUMPTION (Approx.)	5.5kW output, 12 KVA 7.5 kW output, 15 KVA 10.0 kW output, 18 KVA 15.0 kW output, 27 KVA
OPERATING TEMPERATURE0° to 50° Celsius
ALTITUDE7,500 feet above mean sea level
DIMENSIONS	width56" (142.2 cm) height79" (200.7 cm) depth30" (76.2 cm) rear door swing24" (60.7 cm)
WEIGHT	actual1600 lbs (724.8 kg) crated1730 lbs (784.0 kg)
FINISHMcMartin beige w/wood-grain trim

STEREO OPERATION (with BFM-1521 Stereo Assembly)

AUDIO INPUT IMPEDANCE	600 ohms balanced, each channel
AUDIO INPUT LEVEL	+10, ±2, dBm
AUDIO FREQUENCY RESPONSE	±0.75 dB, 30-15,000 Hz, Std FCC 75 usec, preemphasis, each channel

TOTAL HARMONIC DISTORTION0.5% or less, 30-15,000 Hz
IM DISTORTION0.2% or less 60 Hz/7 KHz, 4:1 ratio
STEREO SEPARATION40 dB or greater, 50-15,000 Hz typically 50 dB or greater at mid-range
FM NOISE60 dB or greater below 100% modulation
PILOT STABILITY	±1.0 Hertz over rated temperature range
SUBCARRIER SUPPRESSION55 dB or greater
CROSSTALK (L+R to L-R, L-R to L+R)40 dB or greater below 90% modulation

SCA OPERATION (with BFM-1531 SCA Generator Module)

AUDIO INPUT IMPEDANCE	600 ohms, balanced
AUDIO INPUT LEVEL	+10, ±2, dBm
CARRIER FREQUENCY41 or 67 KHz standard (others available on request)
CARRIER STABILITY	±500 Hz
MODULATION CAPABILITY	±7.5 kHz
PREEMPHASIS150 usec standard, 50 or 75 usec available on request
FREQUENCY RESPONSE	±1.5 dB, 50-5000 Hz
CROSSTALK (main to sub, sub to main)60 dB or lower
DISTORTION (50-5000 Hz)0.75% or less with LP output filter 2.5% or less with BP output filter
S/N NOISE60 dB or greater

ORDERING INFORMATION

Model	Description	Product Code
BF-10M	5.5-15KW FM broadcast transmitter, complete with exciter and tubes, 208/230/240 VAC, 50/60 Hz, 3-phase10-01-045
STF-10K	Spare tube kit for BF-10M Spare Rectifier Diode Stack, Low Voltage RS 1.5-12-12M (Requires 2)10-01-048 .210015
	Spare Rectifier Diode Stack, High Voltage RS 3.5-24-12S (Requires 6)210016

10,000-27,500 WATT FM TRANSMITTER

BF-25M

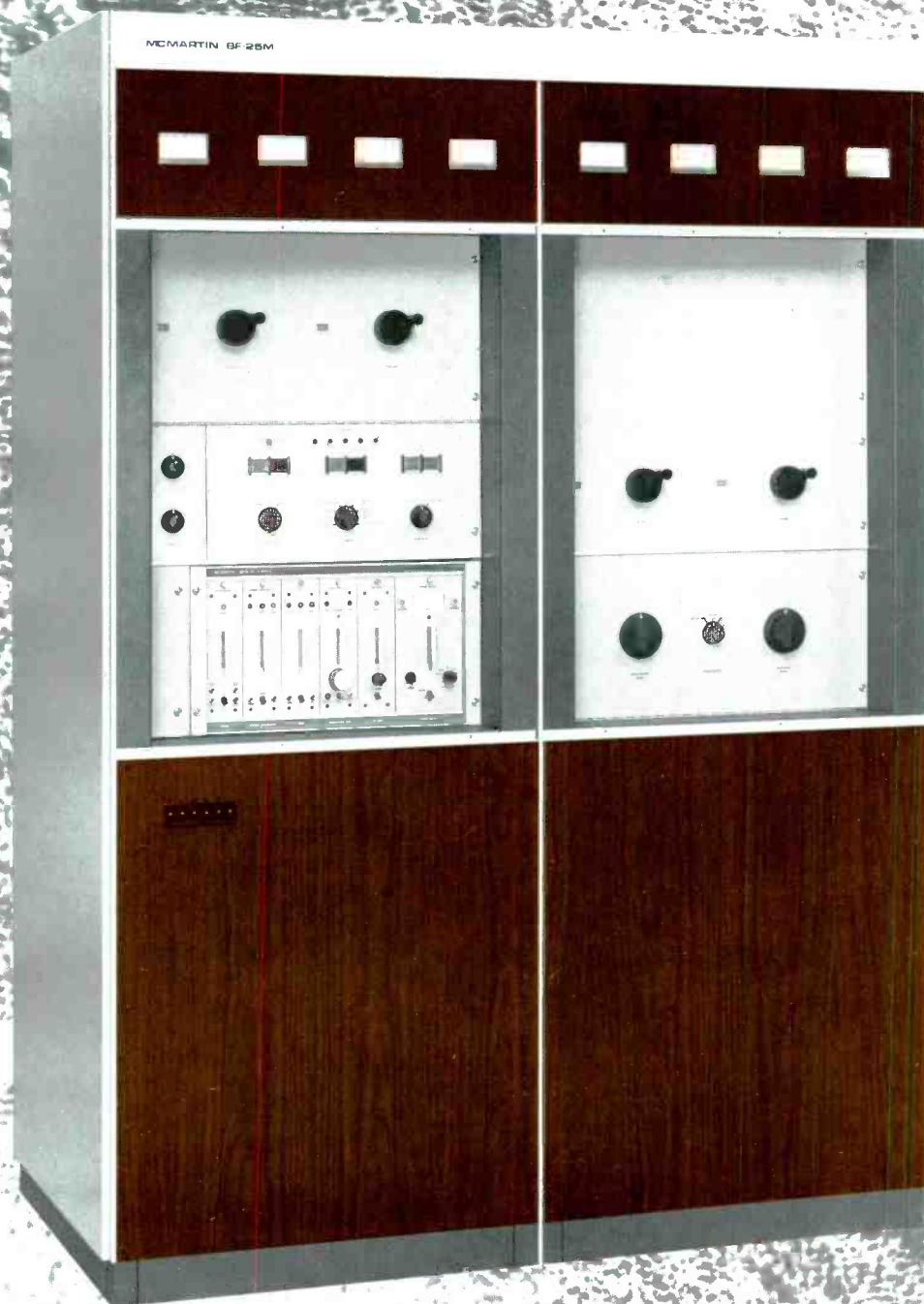

MC MARTIN

McMARTIN BF-25M TRANSMITTER

EXCELLENT PA EFFICIENCY — 70– 80%

OVERLOAD-STATUS LIGHTS BUILT-IN

AUTOMATIC RECYCLING

PA-OVERLOAD AND VSWR SENSING BUILT-IN

NO NEUTRALIZATION REQUIRED

The McMARTIN BF-25M FM broadcast transmitter satisfies FM broadcast station installations requiring transmitter output levels from 10 to 27.5 kW. The BF-25M is FCC Type Accepted at these power ranges.

The BF-25M meets today's stringent requirements for stereo and SCA multiplex operation — and is ready for the mode of tomorrow, quadrasonic sound.

Selected for its widely recognized superior wide band characteristics, McMARTIN has incorporated grounded-grid Class C designs in the high-level driver and PA stages of the BF-25M. Both stages employ ceramic/metal, zero/bias, high- μ triodes; a 3CX3000/A7 for the driver and a 3CX20,000/A7 in the power amplifier output stage. The latter tube, with rated 20,000 watt plate dissipation, when operated at the 27.5 KW maximum BF-25M output level utilizes less than 40% of its plate dissipation capability. This conservative operation is typical of the overall design of the BF-25M. Emphasis has been placed on circuit simplicity, long-term reliability and ease of maintenance.

By the grounded-grid design approach, grid bias and screen-grid power supplies — essential to tetrode-tube type amplifiers, are completely eliminated. The sometimes touchy and troublesome neutralization problems are gone. The BF-25M RF amplifier stages do not require neutralization. The grounded-grid approach delivers another little bonus. A portion of the "drive" power appears in the PA output circuit. This results in outstanding PA efficiency.

One additional tube, a Type 4CX250B, is used as the intermediate power amplifier between the solid-state exciter and the driver stage. Extremely smooth adjustment of the RF power output of the BF-25M is controlled by motor driven adjustment of the screen voltage applied to the 4CX250B tube.

The heart of the BF-25M is the advanced McMARTIN BFM-15, high performance, fully modular FM exciter. Optional plug-in circuit cards allow the user to add SCA, stereo and audio processing functions within the exciter cabinet.

The audio processor is McMARTIN's Exclusive *Maxi-I*, an exceptionally responsive design which assures maximum program loudness and limits overshoot to less than 2%.

VERY STABLE OPERATION — GROUNDED GRID

**EASILY REMOTE CONTROLLED.
NO INTERFACE ADAPTERS NEEDED**

**CONSERVATIVELY RATED —
USES 40% OF PA DISSIPATION**

**PROTECTIVE CIRCUIT FOR LOSS OF AIR
PRESSURE AND EXCESSIVE TEMPERATURE**

The BFM-15 replaces the McMARTIN B-910 exciter used in the "K" series FM transmitters and provides superior performance that includes improved stereo separation, lower SCA distortion, and extremely low SCA crosstalk into the main channel; lower, in fact, than the noise floor. The BFM-15 is also unaffected by line voltage transients and is extremely stable under a wide range of environmental conditions.

Interlocked control logic permits simple pushbutton switching of all start-stop functions. Termination for remote control operation, including telemetering sampling voltages, permit interface of the BF-25M with all standard remote control systems.

Automatic recycling and a memory-type LED status indicator display, sense and indicate the source of carrier interruptions. The exciter output, IPA, driver and PA stages, high-voltage overload and VSWR are monitored continuously. Any fault is sensed and displayed on the LED indicator panel and can be cleared only by manual reset. The recycling circuitry automatically initiates three "start" pulses, spaced approximately one second apart. If the fault persists, the recycling detection circuit illuminates the LED, indicating that portion of the transmitter system where the fault occurred.

The BF-25M is housed in an attractively styled dual-section cabinet with the power amplifier stage occupying one section and all other circuitry in the other. The two halves of the assembly are individually cooled. The electrical and mechanical design arrangement permits easy field installation of optional antenna transmission line switching to the output of the driver stage at a power level of approximately 2500 watts.

The high-voltage power transformer and associated silicon rectifier stacks for PA plate supply are housed in a separate assembly. The RF harmonic filter mounts horizontally above the main transmitter cabinet.

Driver and PA plate voltages and currents are separately metered. These parameters along with VSWR, line voltage, driver/PA filament voltages and a ten-position multimeter readout, are shown on the upper front-panel meter panel.

Dual BF-25M units are also available for redundant 27.5 or paralleled 55 KW output operation. McMARTIN would be pleased to furnish quotations on systems of this type, engineered and tailored to your specific situations.

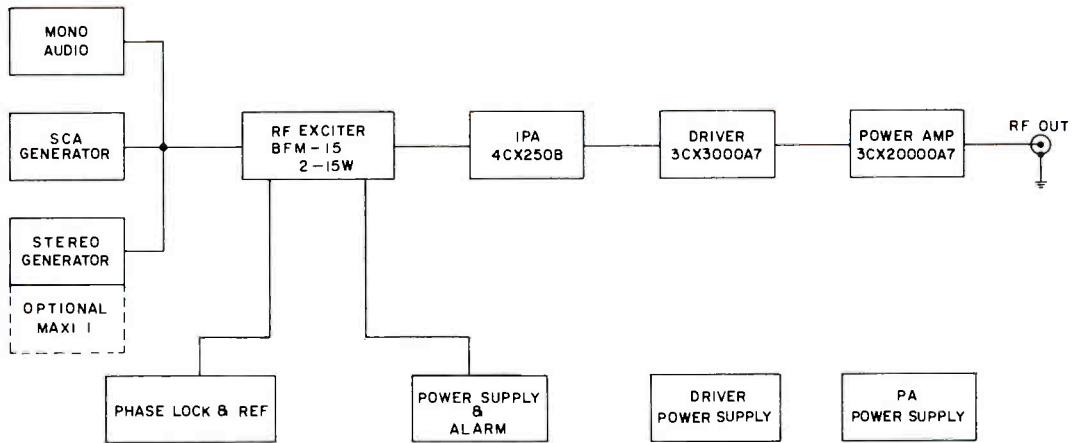

Block diagram

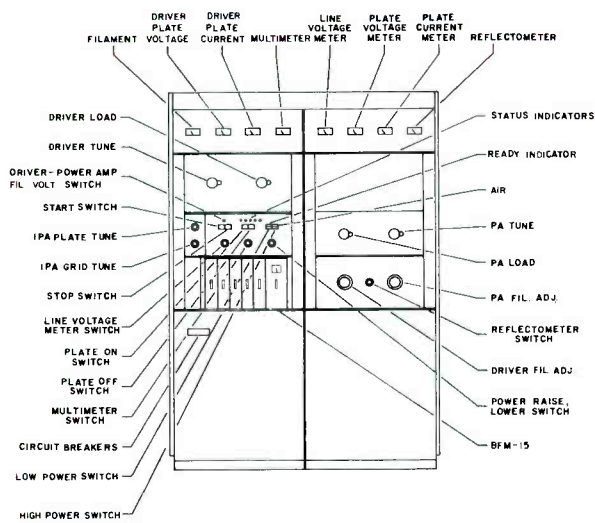

Front panel description

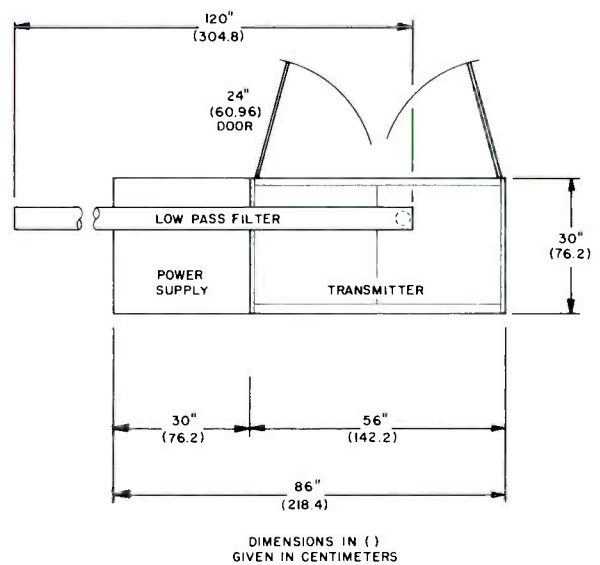

Floor plan

SPECIFICATIONS

OPERATING RANGE	88 to 108 MegaHertz
RF POWER OUTPUT	27,500 watts maximum
RF OUTPUT IMPEDANCE	50 ohms
CENTER FREQUENCY STABILITY	±500 Hz
MODULATION CAPABILITY	±150 kHz
AUDIO INPUT IMPEDANCE	600 ohms, balanced
AUDIO INPUT LEVEL	+10, ±2, dBm
AUDIO FREQUENCY RESPONSE	±0.75 dB, 30-15,000 Hz (Std. FCC 75 usec preemphasis)
TOTAL HARMONIC DISTORTION	0.3% or less, 30-15,000 Hz, 100% mod.
IM DISTORTION	0.2% or less 60 Hz/7 KHz, 4:1 ratio
FM NOISE	>65 dB below 100% modulation (typical 70 dB)
AM NOISE	>55 dB below carrier level
POWER REQUIRED	208/230/240 Vac, 3-phase
POWER CONSUMPTION (Approx.)	10,000 watt output, 21 KVA 15,000 watt output, 28.5 KVA 20,000 watt output, 32 KVA 25,000 watt output, 38 KVA
OPERATING TEMPERATURE	0° to 50° Celsius
ALTITUDE	7,500 feet above mean sea level
DIMENSIONS:	
Main Cabinet	width 56" (142.2 cm) height 79" (200.7 cm) depth 30" (76.2 cm) rear door swing 24" (60.7 cm)
Power Supply Assembly	width 30" (76.2 cm) height 29" (73.7 cm) depth 30" (76.2 cm)
WEIGHT:	
Main Cabinet	actual 1500 lbs (679.5 kg)
Power Supply Assembly	actual 700 lbs (317.1 kg) crated 2140 lbs (969.0 kg)
FINISH	McMartin beige w/wood-grain trim

STEREO OPERATION (with BFM-1521 Stereo Assembly)

AUDIO INPUT IMPEDANCE	600 ohms balanced, each channel
AUDIO INPUT LEVEL	+10, ±2, dBm
AUDIO FREQUENCY RESPONSE	±0.75 dB, 30-15,000 Hz, Std FCC 75 usec, preemphasis, each channel

TOTAL HARMONIC DISTORTION	0.5% or less, 30-15,000 Hz
IM DISTORTION	0.2% or less 60 Hz/7 KHz, 4:1 ratio
STEREO SEPARATION	40 dB or greater, 50-15,000 Hz typically 50 dB or greater at mid-range
FM NOISE	.60 cB or greater below 100% modulation
PILOT STABILITY	±1.0 Hertz over rated temperature range
SUBCARRIER SUPPRESSION	.55 dB or greater
CROSSTALK (L+R to L-R, L-R to L+R)	40 dB or greater below 90% modulation

SCA OPERATION (with BFM-1531 SCA Generator Module) STEREO OPERATION (with BFM-1521 Stereo Assembly)

AUDIO INPUT IMPEDANCE	600 ohms, balanced
AUDIO INPUT LEVEL	-10, ±2, dBm
CARRIER FREQUENCY	41 or 67 KHz standard (others available on request)
CARRIER STABILITY	±500 Hz
MODULATION CAPABILITY	±7.5 kHz
PREEMPHASIS	150 usec standard, 50 or 75 usec available on request
FREQUENCY RESPONSE	±1.5 dB, 50-5000 Hz
CROSSTALK (main to sub, sub to main)	60 dB or lower
DISTORTION (50-5000 Hz)	0.75% or less with LP output filter 2.5% or less with BP output filter
S/N NOISE	60 dB or greater

ORDERING INFORMATION

Model	Description	Product Code
BF-25M	10-27.5KW FM broadcast transmitter, complete with exciter and tubes, 208/230/240 VAC, 5C/60 Hz, 3-phase	10-01-046
STF-25K	Spare tube kit for BF-25M (complete set)	10-01-047
	Spare Rectifier Diode Stack, Low Voltage RS 1.5-12-2S (Requires 4)	210016
	Spare Rectifier Diode Stack, High Voltage RS 3.5-24-15S (Requires 6)	210017

10,000-55,000 WATT TRANSMITTER

BF-55M

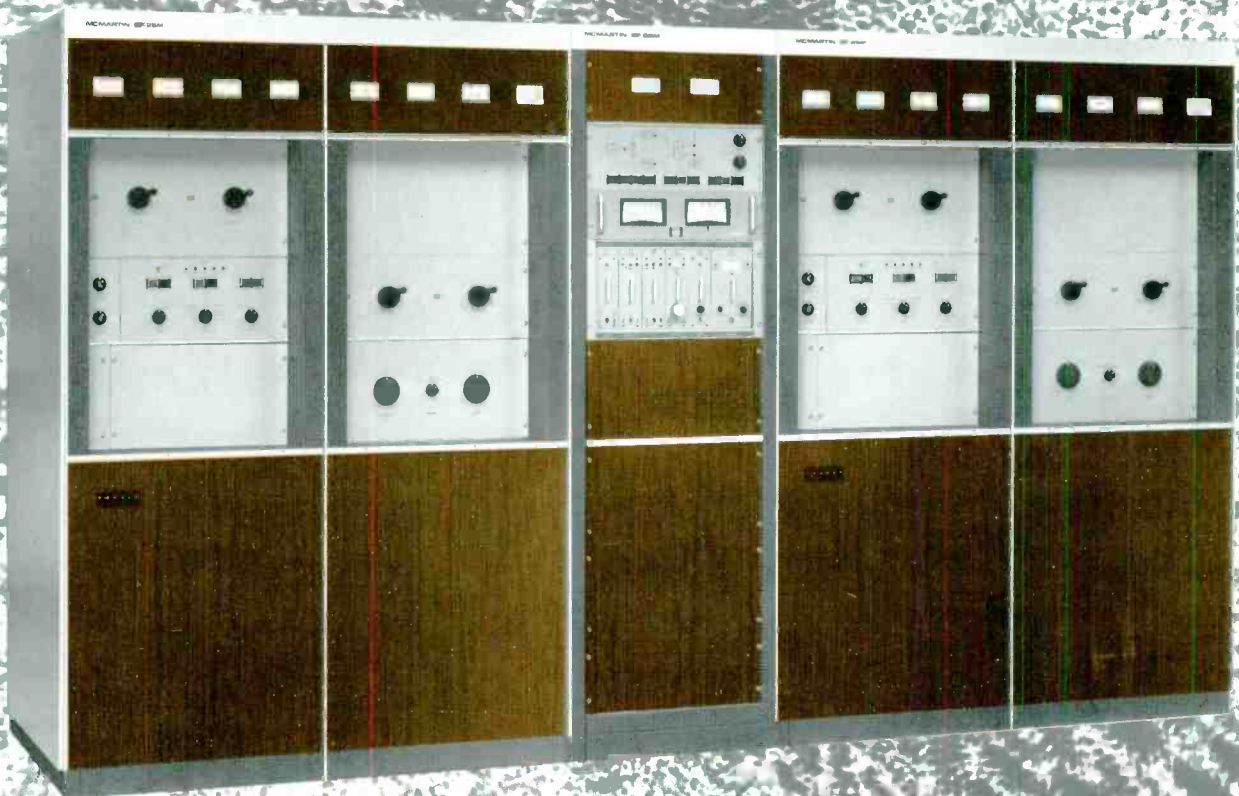

MC MARTIN

McMARTIN BF-55M TRANSMITTER

EXCELLENT PA EFFICIENCY — 70– 80%

OVERLOAD-STATUS LIGHTS BUILT-IN

AUTOMATIC RECYCLING

PA-OVERLOAD AND VSWR SENSING BUILT-IN

NO NEUTRALIZATION REQUIRED

VERY STABLE OPERATION — GROUNDED GRID

**EASILY REMOTE CONTROLLED.
NO INTERFACE ADAPTERS NEEDED**

**CONSERVATIVELY RATED —
USES 40% OF PA DISSIPATION**

**PROTECTIVE CIRCUIT FOR LOSS OF AIR
PRESSURE AND EXCESSIVE TEMPERATURE**

The McMartin Model BF-55M 55 KW FM Broadcast Transmitter consists of a single exciter which drives two identical 27.5 KW RF transmitter assemblies, the outputs of which are combined to provide a single RF output termination delivering up to 55 kilowatts of power.

The 55-kilowatt output capability of the BF-55M has the advantage over competitive transmitters of 40 to 45 KW output capability, since the higher output power frequently permits the use of a less-complex, lower cost antenna array. This generally effects not only a lower investment in the antenna system itself but also lower total antenna windloading characteristics which are an important element in support tower costs.

In the event of a malfunction of one of the 27.5 KW RF power units, transmission continues uninterrupted at a power level equal to one-quarter of the 55 KW output level, or 13,750 watts. An equivalent amount of power is dissipated in an air-cooled reject load.

The heart of the BF-55M is the advanced McMartin BFM-15, high performance, fully modular FM exciter. Optional plug-in circuit cards allow the user to add SCA, stereo and audio processing functions within the exciter cabinet.

The audio processor is McMartin's Exclusive *Maxi-1*, an exceptionally responsive design which assures maximum program loudness and limits overshoot to less than 2%.

The BFM-15 replaces the McMartin B-910 exciter used in the "K" series FM transmitters and provides superior performance that includes improved stereo separation, lower SCA distortion, and extremely low SCA crosstalk into the main channel; lower, in fact, than the noise floor. The BFM-15 is also unaffected by line voltage transients

and is extremely stable under a wide range of environmental conditions.

The output of the exciter is fed to a power divider network to provide equal RF drive to each of the 27.5 KW RF power amplifier assemblies. These each are the McMartin Model BF-25M broadcast transmitter, less exciter. The control circuitry for these BF-25M units is such that intermediate power amplifier stages and the RF power amplifier stages and associated power supplies may be controlled independently. This greatly facilitates servicing and maintenance. The RF power assemblies are independently powered so that full redundancy is insured beyond the exciter portion of the system.

The individual RF power outputs feed low pass harmonic filters, the outputs of which are combined to produce a single 6 $\frac{1}{8}$ " EIA coaxial output termination.

There is considerable latitude in the physical configuration of the transmitter system which can be adapted to the most convenient arrangement for an individual transmitter plant installation. The equipment will be housed in the cabinetry used for two Model BF-25M units, plus an auxiliary matching cabinet enclosure which will house the output combiner control circuitry, exciter and reject load monitoring panel. All coaxial line, fittings and associated hardware required to mechanically interconnect the harmonic filter, combining networks, etc., are included.

The guaranteed electrical operating specifications, except for those obviously relating to power output, etc., for the McMartin Model BF-55M are identical to those shown for the individual McMartin Model BF-25M transmitters.

The center combining cabinet incorporates the required control circuitry to operate either or both transmitters locally or by remote control.

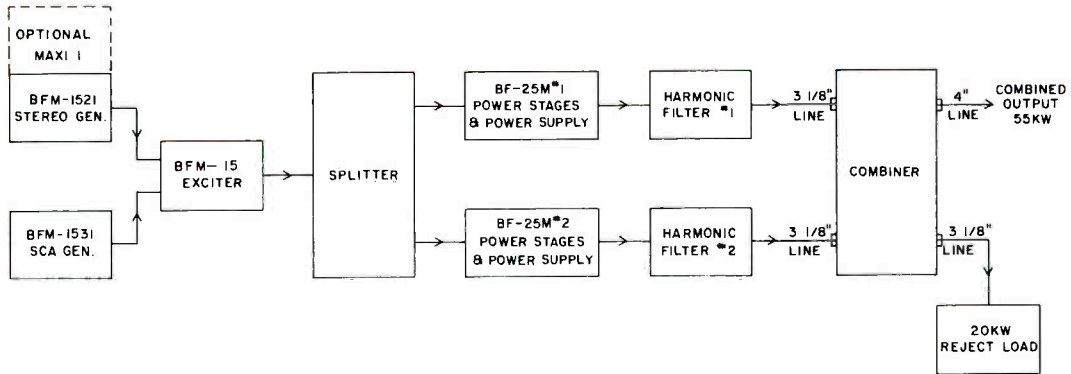

Block diagram

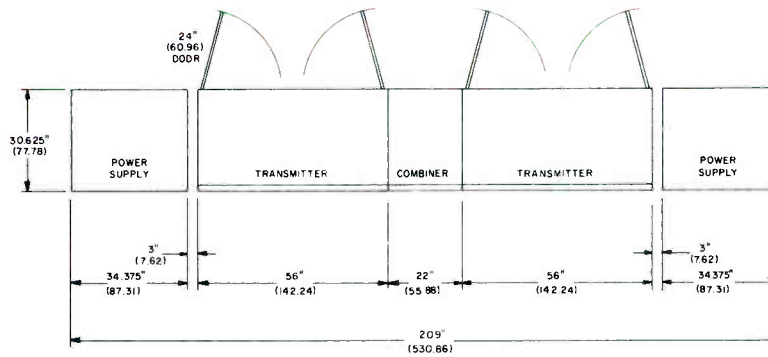

DIMENSIONS IN ()
GIVEN IN CENTIMETERS

Floor plan

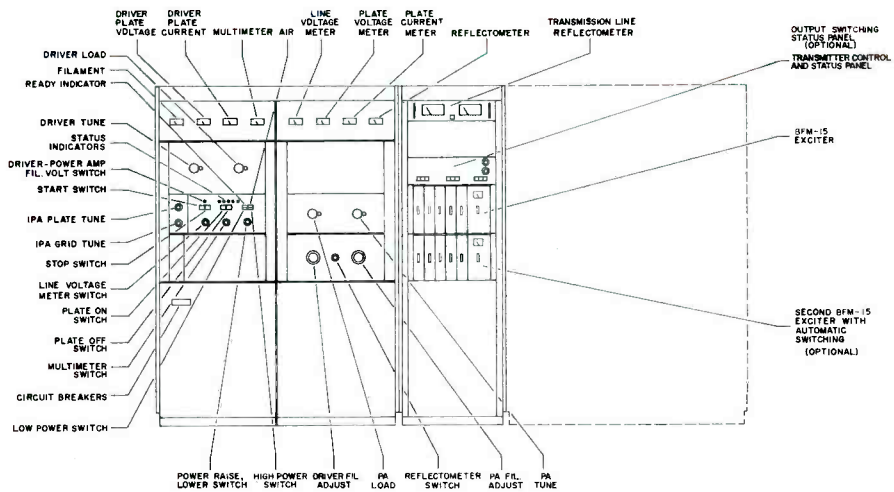

Front panel description

SPECIFICATIONS

OPERATING RANGE88 to 108 MegaHertz
RF POWER OUTPUT55,000 watts maximum
RF OUTPUT IMPEDANCE50 ohms
CENTER FREQUENCY STABILITY	±500 Hz
MODULATION CAPABILITY	±150 kHz
AUDIO INPUT IMPEDANCE600 ohms, balanced
AUDIO INPUT LEVEL	+10, ±2, dBm
AUDIO FREQUENCY RESPONSE	±0.75 dBm, 30–15,000 Hz (Std. FCC 75 usec pre-emphasis)
TOTAL HARMONIC DISTORTION0.3% or less, 30-15,000 Hz, 100% modulation
IM DISTORTION0.2% or less 60 Hz/7 KHz, 4:1 ratio
FM NOISE	>65 dB below 100% modulation (typical 70 dB)
AM NOISE	>55 dB below carrier level
POWER REQUIRED208/230/240 Vac, 3-phase
POWER CONSUMPTION (Approx.)30,000 watt output, 54 KVA 40,000 watt output, 72 KVA 50,000 watt output, 90 KVA 55,000 watt output, 98 KVA
OPERATING TEMPERATURE0° to 50° Celsius
ALTITUDE7,500 feet above mean sea level
DIMENSIONS:	
Main Cabinet	width140" (355.6 cm) height79" (200.7 cm) depth30" (76.2 cm) rear door swing24" (60.7 cm)
Power Supply Assembly (Two cabinets)	width30" (76.2 cm) height29" (73.7 cm) depth30" (76.2 cm)
WEIGHT:	
Main Cabinet	actual2560 lbs (1160 kg) crated2760 lbs (1250 kg)
Power Supply Assemblies	actual1460 lbs (661 kg) crated1540 lbs (698 kg)
Combiner	actual200 lbs (90 kg) crated250 lbs (113 kg)
FINISHMcMartin beige w/wood-grain trim

STEREO OPERATION (with BFM-1521 Stereo Assembly)

AUDIO INPUT IMPEDANCE600 ohms balanced, each channel
AUDIO INPUT LEVEL	+10, ±2, dBm
AUDIO FREQUENCY RESPONSE	±0.75 dB, 30-15,000 Hz, Std FCC 75 usec, preemphasis, each channel

TOTAL HARMONIC DISTORTION0.5% or less 30-15,000 Hz
IM DISTORTION2% or less 60 Hz/7 kHz, 4:1 Ratio
STEREO SEPARATION40 dB or greater, 50–15,000 Hz typically 50 dB or greater at mid-range
FM NOISE60 dB or greater below 100% modulation
PILOT STABILITY	±1.0 Hertz over rated temperature range
SUBCARRIER SUPPRESSION55 dB or greater
CROSSTALK (L+R to L-R, L-R to L+R)40 dB or greater below 90% modulation

SCA OPERATION (with BFM-1531 SCA Generator Module)

AUDIO INPUT IMPEDANCE600 ohms, balanced
AUDIO INPUT LEVEL	+10, ±2, dBm
CARRIER FREQUENCY41 or 67 KHz standard (others available on request)
CARRIER STABILITY	±500 Hz
MODULATION CAPABILITY	±7.5 kHz
PREEMPHASIS150 usec standard, 50 or 75 usec available on request
FREQUENCY RESPONSE	±1.5 dB, 50-5000 Hz
CROSSTALK (main to sub, sub to main)60 dB or lower
DISTORTION (50-5000 Hz)0.75% or less with LP output filter 2.5% or less with BP output filter
S/N NOISE60 dB or greater

ORDERING INFORMATION

Model	Description	Product Code
BF-55M	30–55KW FM broadcast transmitter, complete with one exciter (combined output of two BF-25M transmitters), 208/230/240 VAC, 50/60 Hz, 3-phase	10-01-071

OPTIONAL ACCESSORIES

AES	Automatic exciter switching for dual FM systems (provides complete exciter redundancy)	10-01-072
AOS	Automatic RF output switching for dual FM systems (first transmitter — to feed antenna and transmitter; second transmitter — to be fed to dummy load for maintenance)	10-01-073
APC	Automatic power control for FM transmitter	10-01-074
AS-3	Three phase AC detector with auto restart	10-01-075
TCP-1	Transmitter control panel for remote control for AM/FM transmitter	10-01-076

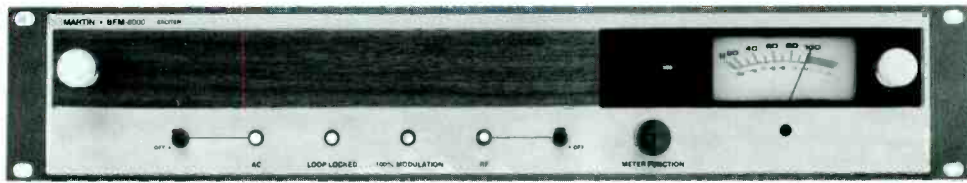

BFM-8000T BFM-8000 fm exciter
10 watt fm transmitter

MCMARTIN

BFM-8000 FM EXCITER BFM-8000T 10 WATT FM TRANSMITTER

**DIRECT FM
NO CRYSTAL OVEN
REMOTE CONTROL PROVISIONS
SUPERIOR STEREO SEPARATION
SELF CONTAINED WITH INTERNAL POWER SUPPLY
PHASE-LOCKED AFC PROVIDES ± 500 Hz STABILITY
UNIT CAN BE USED AS EXCITER OR LOW POWER TRANSMITTER
FULL METERING INCLUDING FORWARD POWER, REFLECTED POWER, AND MODULATION PERCENTAGE**

The McMartin BFM-8000 is designed to function either as an exciter for a higher power FM broadcast transmitter, or as a 10-watt FM broadcast transmitter.

The BFM-8000 employs a unique C-MOS phase locked direct FM modulator. This provides ultra stable and precise frequency control.

All circuitry for the BFM-8000 FM Exciter/Transmitter is housed in a single drawer-type cabinet which provides excellent accessibility for servicing and maintenance. Front panel metering of necessary operating parameters is provided. Monitoring and full remote control provisions are included.

The BFM-8000 also has been designed to provide the cleanest, most crisp sounding FM main channel signal and, when so equipped, multiplex stereo and SCA subchannel signals.

There are four units, each designed for rack mounting, for use with the BFM-8000 Exciter/Transmitter:

**BFM-1531R SCA Generator
BFM-1521R Stereo Generator
BFM-1514R "Maxi-1" Stereo Audio Processor
BFM-1515R "Maxi-1" Monaural Audio Processor**

The BFM-1521R Stereo Generator is equipped with 15 kHz input filters and a 53 kHz low-pass filter to assure that there is no interference with a 67 kHz SCA channel.

The BFM-1531R SCA Generators at 67 kHz are provided with optimum filtering depending on whether they are used with monaural or stereo exciters. When utilized with a monaural exciter, a 7.5 kHz band pass input filter is used; and a 90 kHz low pass output filter is used (this assures lowest distortion SCA and main channel reception). This filter combination assures the cleanest monaural and SCA signals, with objec-

tional interference and "birdies" totally eliminated. When a 67 kHz SCA Generator is used with an exciter equipped with a BFM-1521R Stereo Generator, the SCA generator's output filter is a 67 kHz band pass, thus assuring that no interference with the stereo (L-R) signal will occur.

The BFM-1531R SCA Generators at 41 kHz are equipped with 7.5 kHz input filters and a 60 kHz low pass output filter, which assures total non-interference with the main channel and the 67 kHz SCA channel.

BFM-1531R SCA Generators are factory equipped for ± 6 kHz deviation with the 7.5 kHz input filter. For ± 4 kHz SCA deviation requirement, a 5 kHz input filter is optionally available.

This care in providing optimum filtering is just another example of the quality and care that comes with a BFM-8000, assuring clean signals with no possible subchannel to main channel interference.

PHASE LOCK DIRECT FM MODULATOR

The heart of the BFM-8000 is the Direct FM modulator, with a phase lock AFC circuit providing ± 500 Hz frequency stability. The frequency-modulated oscillator itself utilizes a free running oscillator at the operating frequency. This frequency is modulated by both the main and all sub-channel audio signals (stereo and/or SCA), and is buffered and amplified in the next stage. This on-carrier frequency signal is then digitally divided first by 11, then by 512, and compared in the phase/frequency comparator with a similarly divided signal from a highly stable temperature-compensated crystal oscillator. The phase comparator operates at about 20 kHz. Any phase difference detected between the two signals represents a frequency difference between the modulated oscillator and reference source and con-

sequently an off-frequency condition of the FMO. A correction voltage is then derived, which serves as an AFC voltage to maintain the FMO at its precise frequency.

A front panel LED indicator is provided to confirm proper phase lock. At the same time, FM power is automatically available from the output connector.

Special emphasis is placed on obtaining the highest possible degree of reliability while maintaining the performance characteristics equal to or better than competing equipment. As a result of this emphasis, our tentative failure analysis indicates a Mean Time Between Failure (MTBF) of nearly 1,000 hours, almost three times that of a typical competitive exciter, for a reliability of .990 (monaural operation).

EASE OF OPERATION AND MAINTENANCE

The BFM-8000 is designed for simple and easy operation with operational controls held to a minimum.

Full front panel metering is provided to allow monitoring of operating voltages total modulation and other parameters.

Tuning the BFM-8000 is a very easy procedure and is accomplished in minutes utilizing the front panel meter to give an indication of a phase lock condition between the frequency modulated oscillator and the reference oscillator. Once phase lock is achieved, the RF chain is optimized for maximum indication on the panel meter completing the tuning.

BFM-1521R STEREO GENERATOR

The optional BFM-1521R Stereo Generator provides the 19 kHz pilot and the composite stereo signals (L + R and L - R). The stereo generator utilizes a switching mode oscillator employing a temperature stabilized crystal at four times the 19 kHz pilot frequency (76 kHz). This 76 kHz signal is digitally divided to derive the 19 kHz pilot and the 38 kHz square wave signal used to alternately switch between the left and right channel audio signals. The circuitry is precisely designed to assure that 38 kHz subcarrier suppression is 55 dB below the modulated signal. Use of the square wave switching mode eliminates the need for troublesome carrier balance adjustments. This simplifies adjustment, and additionally provides for excellent stereo separation (40 dB through the entire exciter or transmitter). Adjustments for the BFM-1521R Stereo Generator are held to a minimum. Only Pilot Level and Pilot Phase adjustments (for setting proper timing of the pilot and L - R signal) are provided on the front panel.

Local and remote stereo/mono mode switching are provided for with front panel indication of stereo operation. A remote indicator may be connected.

BFM-1514R AUDIO PROCESSOR

The BFM-1514R dual channel audio processor has

been designed to precisely control the modulation of the FM stereo or mono transmission system preventing over-modulation with varying audio input levels.

Pre-emphasis may be switched in or out as desired. The processor is frequency conscious and follows the pre-emphasis curve, thereby assuring that the problems associated with pre-emphasis are controlled. This is accomplished by an extremely fast AGC circuit and not by diode clippers which produce undesired interference problems, especially in stereo transmissions. These circuits provide limiting of overshoot to 2%.

Approximately 20 dB of gain reduction at low frequencies, and 30 dB gain reduction at high frequencies (pre-emphasis in), produce optimum compression and gain reduction without the use of other signal processing devices.

A front panel release time control is adjustable in order to optimize the system for maximum loudness - using the fast setting (counterclockwise) - or for the best quality - using the slow setting (fully clockwise).

The recovery time will always be short for transients regardless of the setting of the control. Under sustained gain reduction, the recovery time will automatically lengthen depending on the program material content.

BFM-1515R MONAURAL PROCESSOR

The BFM-1515R Monaural Audio Processor is designed for use with a monaural main channel or for improving the loudness of an SCA channel. Its design and features are approximately the same as the BFM-1514R.

BFM-1531R SCA GENERATOR

The BFM-1531R SCA Generator is optionally available to provide for a 67 kHz subchannel in an exciter equipped with a stereo generator. For use with a monaural exciter, either a 67 kHz and/or a 41 kHz SCA Generator is available (other frequencies 20-75 kHz are available on special order).

The BFM-1531R is an ultra stable SCA generator utilizing a new internally compensated direct FM oscillator providing ultra stable operation even over widely varying temperature conditions. Manual or automatic SCA muting is provided and the mute circuitry is adjustable, both for modulation level and delay time (which is continuously adjustable 1/2 to 8 seconds).

Unique to the BFM-1531R is the ability to remotely disable the automatic mute. This circuit provides a ready means of obtaining the necessary signal when making measurements at the studio requiring an unmodulated SCA subcarrier.

BFM-1531R SCA Generators are factory equipped for

±6 kHz deviation with a 7.5 input filter. For ±4 kHz SCA deviation requirement, a 5 kHz input filter is an option.

The BFM-1531R also has provision to allow the SCA subcarrier to be switched on and off locally and remotely.

BFM-8000T FM TRANSMITTER

The BFM-8000 is also designed to serve as a 10 watt transmitter for low power educational FM stations, or as a 3-15 watt STL (studio to transmitter link) or relay transmitter in those countries where the 88 to 108 MHz band is available for such use. When the BFM-8000 is ordered as a 10 watt transmitter (model BFM-8000T), a low pass filter is placed in the RF output line. The "FWD Power" meter is calibrated to read 100% for 10 watts into a 50Ω load. An attractive dustproof matching cabinet for use in applications where rack mounting is not desired is available.

STANDARD SCA FILTER COMBINATIONS

SCA	INPUT FILTER 4 KHz • DEVIATION • 6 kHz		OUTPUT FILTER
41 kHz	5 kHz	7.5 kHz	80 kHz LP
67 kHz monaural	5 kHz	7.5 kHz	80 kHz LP
67 kHz stereo	5 kHz	7.5 kHz	80 kHz LP

SPECIFICATIONS:

BFM-8000 EXCITER/TRANSMITTER

PERFORMANCE:

Type of Emission	F3/F9
Frequency Range	88-108 MHz
RF Power Output	3-15 watts continuously adjustable
RF Output Impedance	50 Ω, unbalanced
(Type BNC connector)		
Carrier Frequency		
Stability	± 500 Hz over rated temperature range
Frequency Deviation	± 75 kHz
for 100% Modulation		
Modulation Capability	± 150 kHz
Method of Modulation	Direct FM
Audio Input		
Impedance	600 Ω balanced
Audio Input Level	+ 10, ± 2, dBm
Audio Frequency		
Response	± 0.5 dB, 30-15,000 Hz
(Monophonic)		
Pre-Emphasis Net-		
work Time Constant	75 μs pre-emphasis, 50 μs available
Composite		
Input Level	1 V _{rms}
Total Harmonic		
Distortion	less than 0.3%, 30-15,000 Hz
FM Noise	68 dB below 100% modulation
AM Noise	65 dB below carrier level
Crosstalk	55 dB below 100% modulation
Power Required	120/240 VAC, 50/60 Hz
Power Consumption	50 Watts
Ambient Temperature	- 20° to 50°C (- 4° to 122°F)

DIMENSIONS	height	3½" (8.9 cm)
	width	19" (48.3 cm)
	depth	14¼" (36 cm)

WEIGHT	actual	18 lbs. (8.2 kg)
	shipping	23 lbs. (10.4 kg)

FINISH	McMartin Beige
--------	-------	----------------

STEREO OPERATION (with BFM-1521R Stereo Generator)

AUDIO INPUT		
IMPEDANCE	600 Ω balanced, each channel
AUDIO INPUT LEVEL	+ 10, + 2, dBm
AUDIO FREQUENCY		
RESPONSE	± 0.5 dB, 30-15,000 Hz, Std FCC 7.5 μs pre-emphasis, each channel
TOTAL HARMONIC		
DISTORTION	0.5% or less, 30-15,000 Hz
IM DISTORTION	0.2% or less, 60 Hz/7 kHz, 4:1 ratio
STEREO SEPARATION	40 dB or greater, 50-15,000 Hz typically 50 dB or greater at mid-range
FM NOISE	65 dB or greater below 100% modulation
PILOT STABILITY	± 1.0 Hz over rated temperature range
SUBCARRIER		
SUPPRESSION	55 dB or greater
CROSSTALK	40 dB or greater below 90% modulation
(L + R to L - R, L - R to L + R)		

SCA OPERATION (with BFM-1531R SCA Generator)

AUDIO INPUT		
IMPEDANCE	600 Ω, balanced
AUDIO INPUT LEVEL	+ 10, ± 2, dBm
CARRIER FREQUENCY	41 or 67 kHz standard (others available on request)
CARRIER STABILITY	± 500 Hz
MODULATION		
CAPABILITY	± 7.5 kHz
PRE-EMPHASIS	150 μs standard, 50 or 75 μs available on request
FREQUENCY		
RESPONSE	± 1.5 dB, 50-5,000 Hz
CROSSTALK (main to sub, sub to main)	60 dB or lower
DISTORTION	0.75% or less with LP output filter 2.5% or less with BP output filter
(50-5,000 Hz)		
S/N NOISE	60 dB or greater

STEREO GENERATOR

BFM-1521R



COMPLETE RFI SHIELDING

BUILT-IN 15 kHz LP FILTERS

REMOTE SELECTION OF MONO/STEREO

SWITCHING METHOD SIGNAL GENERATION

PROGRAM SEPARATION OF 50 dB OR GREATER

FRONT PANEL MODE SELECTION TO SPEED PROOF MEASUREMENTS

The BFM-1521R is a completely self-contained, rack-mount unit capable of generating a high-quality stereo composite signal. It is intended primarily for stereophonic mode broadcasting where the composite stereo signal originates at a studio location and composite STL equipment is used for relaying the program material to a remote transmitter site. Separate inputs are provided for either standard audio or highly processed, peak limited, audio. The processed audio input bypasses the input filters, pre-emphasis, transformers, etc.

The BFM-1521R includes local mono/stereo operating mode switching with provision for remote control.

Each channel includes built-in 15 kHz low pass filtering. Separate switches are provided for pilot disable and easy selection of L, R, L + R, L - R.

Separate audio and stereo generator modules are mounted within the 3½" rack-mounted package.

SPECIFICATIONS

FREQUENCY RESPONSE	± 0.5 dB, 30-15,000 Hz
HARMONIC DISTORTION	0.5% or less, 30-15,000 Hz
SEPARATION	40 dB or greater, 30-15,000 Hz (typically 50 dB)
CROSSTALK	40 dB, 30-15,000 Hz
FM S/N RATIO	65 dB or greater
PRE-EMPHASIS	75 μ seconds standard
PILOT STABILITY	± .5 Hz over rated temperature range
38 kHz SUPPRESSION	60 dB minimum
AF INPUT IMPEDANCE	600 ohms, balanced (L and R channel)
AF INPUT LEVEL	+ 10 dBm, ± 2 dB

COMPOSITE OUTPUT LEVEL	0-3 volts, P/P	
OUTPUT IMPEDANCE	Low (suitable for driving 10' of coax)	
POWER REQUIRED	115/230 VAC, 50/60 Hz, 10 watts	
OPERATING TEMPERATURE	- 20° to 50° C	
DIMENSIONS	height	1¾" (4.5 cm)
	width	19" (48.3 cm)
	depth	11" (27.9 cm)
WEIGHT	actual	8 lbs. (3.6 kg)
	shipping	10 lbs. (4.5 kg)
FINISH		McMartin beige

ORDERING INFORMATION

Model	Description	Product Code
BFM-1521R	Stereo generator, self-contained	10-01-131

AUG/80

SCA GENERATOR

BFM-1531R



- AUTOMATIC MUTING**
- VARIABLE MUTE DELAY**
- ULTRA STABLE VCO DESIGN**
- FRONT PANEL SCA FREQUENCY TEST JACK**

- DC TELEMETRY INPUT**
- RACK MOUNT, SELF-CONTAINED**
- INTEGRAL INPUT/OUTPUT FILTERS**

The BFM-1531R SCA Generator is a completely self-contained unit designed for the generation of high quality subchannel information for use in FM or TV broadcast SCA applications.

The BFM-1531R is available with input/output filter combinations to insure optimum compatibility with either monaural or stereophonic main channel operation.

Electronic muting, adjustable to respond to levels from 3% to 100% modulation and muting delay from 1/2 to 5 seconds, is standard.

Local/remote switching is provided with front panel level control.

The BFM-1531R is designed for rack mounting.

SPECIFICATIONS

CARRIER FREQUENCY	(26 - 114 kHz) 67 kHz standard, other frequencies on special order
CARRIER STABILITY	0.25%
AF RESPONSE	± .5 dB, 30-5,000 Hz
DISTORTION	less than .5% at 400 Hz, ± 6kHz, 67 kHz
AF INPUT LEVEL	+ 10, ± 2 dBm
AF INPUT IMPEDANCE	600 Ω, balanced
OUTPUT LEVEL	0-6 V P/P, adjustable
PRE-EMPHASIS	150 μ seconds (50 or 75 μ seconds special order)
MODULATION CAPABILITY	± 12% of subchannel carrier frequency

S/N RATIO	65 dB or greater
MUTE DELAY	0.2 to 2 seconds
OPERATING TEMPERATURE	- 20° to + 50° C
POWER REQUIRED	115/230 Vac, 50/60 Hz
DIMENSIONS	height..... 1 3/4" (4.5 cm) width..... 19" (48.3) depth..... 11" (27.9 cm)
WEIGHT	actual..... 6 lbs. (2.7 kg) shipping..... 8 lbs. (3.6 kg)
FINISH	McMartin beige

ORDERING INFORMATION

Model	Description	Product Code
BFM-1531R	SCA Generator, self-contained	10-01-132

Consult factory for other than 67 kHz operation.

JAN/80

50 WATT FM AMPLIFIER
50 WATT FM TRANSMITTER

B-950
BFM-50

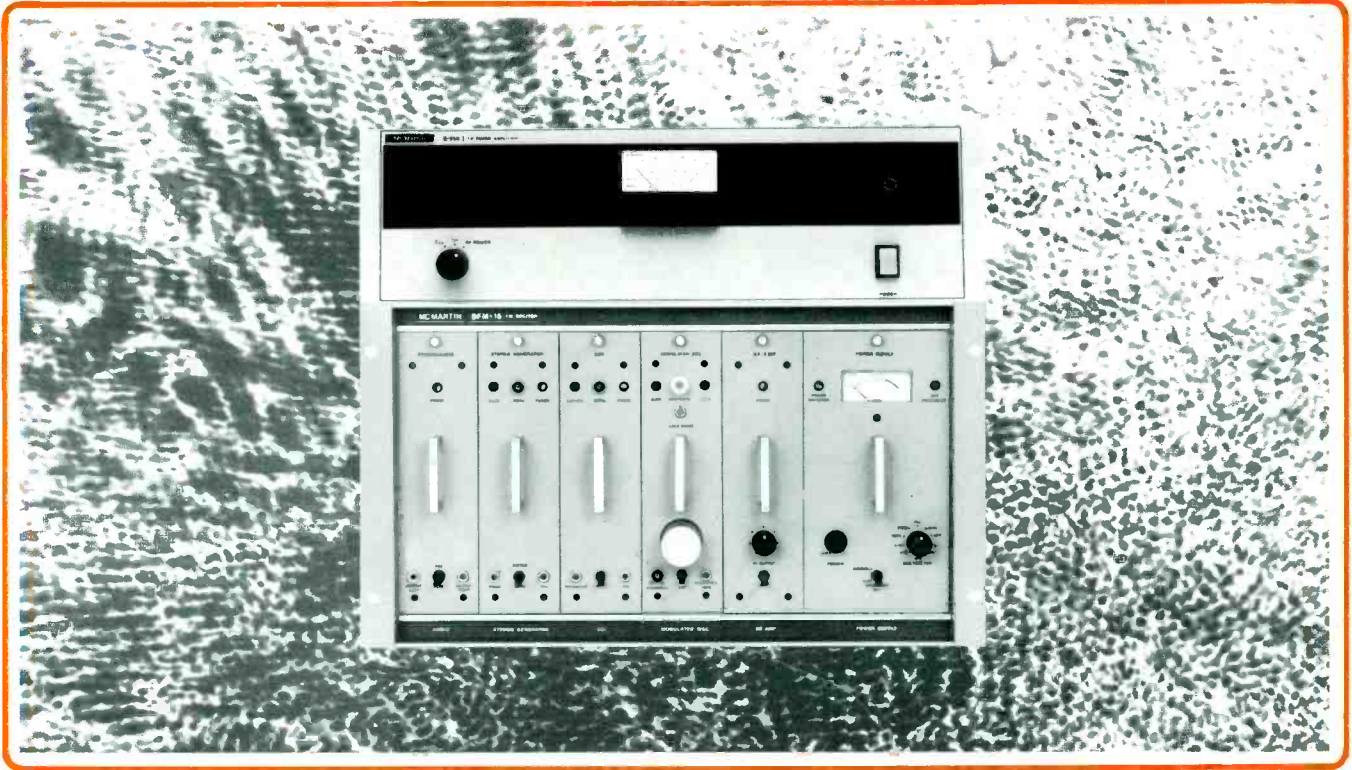

100 WATT FM AMPLIFIER
100 WATT FM TRANSMITTER

B-9100
BFM-100



MC MARTIN AMPLIFIERS/TRANSMITTERS

B-950 / BFM-50

SINGLE STAGE FOR POWER EFFICIENCY

COMPLETELY SOLID STATE

NO VSWR PROTECTION REQUIRED

FULL METERING

TRANSMITTER VERSION AVAILABLE MONO OR STEREO
WITH AUDIO PROCESSING AND SCA OPTIONS

The McMartin B-950 is a 50 watt FM amplifier designed to be coupled with any FM exciter to produce a 50 watt FM transmitter. The B-950 is also available with a McMartin BFM-15 exciter as a complete 50 watt FM transmitter package. The complete transmitter is designated "BFM-50."

The B-950, 50 watt power amplifier, utilizes a single high reliability RF power transistor and easily achieves 50 watts of output power when driven by an exciter producing 10 watts of power. Designed for 70-watt output capability, the B-950 operates very conservatively at its rated 50 watt output level.

By using a single stage solid state design, the B-950 reduces power supply requirements. A single +28 volt

dc supply is utilized. The power transistor requires no VSWR protection. It is capable of sustaining either open or direct short circuit conditions.

Front panel metering on the B-950 displays power supply voltage, PA collector current, and RF power output. No tuning controls are required or necessary as the power amplifier is drive limited and broadbanded. All tuning and power control is accomplished in the FM exciter used with the amplifier.

When coupled with a McMartin BFM-15 FM exciter to make a BFM-50 complete 50 watt FM transmitter, the output specifications for the complete transmitter are the same as those for the exciter alone, except for power consumption and output power.

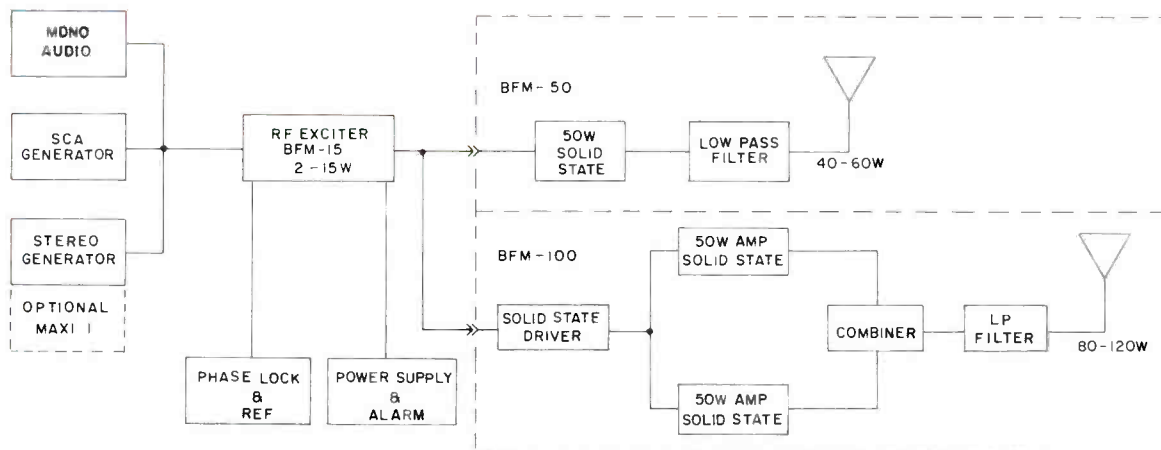

Block diagram

B-9100 / BFM-100

DUAL POWER AMPLIFIERS ASSURE 25% POWER IF ONE POWER AMP FAILS

COMPLETELY SOLID STATE

FULL METERING

TRANSMITTER VERSION AVAILABLE MONO OR STEREO
WITH AUDIO PROCESSING AND SCA OPTIONS

The McMartin B-9100 is a 100 watt FM power amplifier designed to be coupled with any FM exciter to produce a 100 watt FM transmitter. The B-9100 is also available with a McMartin BFM-15 exciter as a complete 100 watt FM transmitter package. The complete transmitter is designated "BFM-100."

The BFM-100 provides a 100 watt FM broadcast signal in the 88 to 108 MHz frequency range, and is well suited to low power broadcast applications and as an emergency standby transmitter for higher powered FM stations. The B-9100 amplifier is ideally suited to upgrading ten watt educational stations to 100 watts.

The B-9100 consists of a basic 100 watt FM power amplifier and internal harmonic filter, and may be used in conjunction with any FM exciter capable of at least

5 watts output. The unit is designed for standard 19" rack mounting. The antenna is connected directly to the output jack.

The B-9100 features a combined solid-state two stage amplifier in which the driver output is coaxially split and used to drive two 50 watt amplifiers, which in turn are coaxially combined by a hybrid combiner. A resistive reject load is used to absorb excess RF power if one of the final amplifiers should fail. In this situation, one-quarter power, i.e. 25 watts, will appear at the antenna terminal.

The use of redundant RF amplifiers provides unusual reliability in a low powered unit, making it an excellent choice for remotely located low power installations and for use as an emergency back-up unit.

A state-of-the-art exciter for the BFM-50/BFM-100

The heart of both the BFM-100 and BFM-50 is the advanced McMartin BFM-15, high performance, fully modular FM exciter. Optional plug-in circuit cards allow the user to add SCA, stereo and audio processing functions within the exciter cabinet.

The audio processor is McMartin's exclusive *Maxi-1*, an exceptionally responsive design which assures maxi-

mum program loudness and limits overshoot to less than 2%.

The BFM-15 replaces the McMartin B-910 exciter used in previous FM transmitters and provides superior performance that includes improved stereo separation, lower SCA distortion, and extremely low SCA crosstalk into the main channel. The BFM-15 is also unaffected by line voltage transients and is extremely stable under a wide range of environmental conditions.

SPECIFICATIONS — BFM-50, BFM-100

PERFORMANCE

Type of Emission	F3/F9
Frequency Range	88-108 MHz
RF Power Output	BFM-50 50 Watts BFM-100 80-120 Watts
RF Output Impedance	.50 ohms, unbalanced
Carrier Frequency Stability	±500 Hz over rated temperature range
Frequency Deviation for 100% Modulation	±75 kHz
Modulation Capability	±150 kHz
Method of Modulation	Direct FM

Audio Input Impedance	600 ohms balanced
Audio Input Level	+10, ±2 dBm
Audio Frequency Response	±0.5 dB 30-15,000 Hz
Pre-Emphasis Network Time Constant	.75 μ sec pre-emphasis, 50 μ sec avail.
IM Distortion	0.2% or less 60 Hz/7KHz, 4:1 ratio
Total Harmonic Distortion	less than 0.3% 30-15,000 Hz
FM Noise	>65 dB below 100% modulation typically 70 dB
AM Noise	65 dB below carrier level

SPECIFICATIONS

ELECTRICAL:

Power Required	100-135 (200-270), VAC 50/60 Hz
Power Consumption (With Stereo and SCA Generator)	BFM-50 175 watts BFM-100 275 watts
Ambient Temperature	-20° to 50°C (-4° to 122°F)

DIMENSIONS

BFM-15 Exciter	height	.10½" (27 cm)
	width	.19" (48.3 cm)
	depth	.14¼" (36 cm)
B-950 Amplifier	height	Rack Mount 15¾" (40 cm)
	width	.19" (48.3 cm)
	depth	.17¾" (45.1 cm)
	Cabinet	height19" (48.3 cm) width20" (50.8 cm) depth22" (55.9 cm)
B-9100 Amplifier	height	.8¾" (22.2 cm)
	width	.19" (48.3 cm)
	depth	.14½" (36.8 cm)

WEIGHT

BFM-15 Exciter	actual	.34 lbs. (15.4 kg)
B-950 Amplifier	actual	.25 lbs. (11.3 kg)
B-9100 Amplifier	actual	.37 lbs. (11.8 kg)
BFM-15 Exciter	shipping	.44 lbs. (19.3 kg)
B-950 Amplifier	shipping	.35 lbs. (15.9 kg)
B-9100 Amplifier	shipping	.47 lbs. (21.3 kg)

FINISH McMartin beige with wood grain trim front access panel

OUTPUT CONNECTOR REQUIRED

..... PL 259

SCA OPERATION (with BFM-1531 SCA Generator Module)

AUDIO INPUT IMPEDANCE 600 ohms, balanced

AUDIO INPUT LEVEL +10, ±2, dBm

CARRIER FREQUENCY 41 or 67 KHz standard (others available on request)

CARRIER STABILITY ±500 Hz

MODULATION CAPABILITY ±7.5 kHz

PREEMPHASIS150 usec standard, 50 or 75 usec available on request

FREQUENCY RESPONSE ±1.5 dB, 50-5000 Hz

CROSSTALK (main to sub, sub to main)60 dB or lower

DISTORTION (50-5000 Hz)0.75% or less with LP output filter
2.5% or less with BP output filter

S/N NOISE60 dB or greater

All specifications for monaural, stereo and SCA operation are for the entire BFM-50 or BFK-100.

STEREO OPERATION (with BFM-1521 Stereo Assembly)

AUDIO INPUT IMPEDANCE 600 ohms balanced, each channel

AUDIO INPUT LEVEL +10, ±2, dBm

AUDIO FREQUENCY RESPONSE ±0.75 dB, 30-15,000 Hz, Std FCC 75 usec, preemphasis, each channel

TOTAL HARMONIC DISTORTION0.5% or less, 30-15,000 Hz

IM DISTORTION0.2% or less 60 Hz/7 KHz, 4:1 ratio

STEREO SEPARATION40 dB or greater, 50-15,000 Hz typically 50 dB or greater at mid-range

FM NOISE >60 dB or greater below 100% modulation

PILOT STABILITY ±1.0 Hertz over rated temperature range

SUBCARRIER SUPPRESSION55 dB or greater

CROSSTALK (L+R to L-R, L-R to L+R)40 dB or greater below 90% modulation

ORDERING INFORMATION

Model	Description	Product Code
B-950	50 watt FM amplifier only	10-01-025
BFM-50	Complete 50 watt transmitter, rack mount (includes BFM-15 and B-950)	10-01-135
BFM-50	Complete 50 watt transmitter, as above, with B-123 cabinet	10-01-135
B-9100	100 watt FM amplifier only	10-01-002
BFM-100	Complete 100 watt transmitter, rack mount only, includes BFM-5 exciter	10-01-136

PLUG-IN MODULES FOR BFM-15, 15 watt exciter

BFM-1501	Blank panel	10-01-130
BFM-1511	Mono audio amplifier	10-01-128
BFM-1512	Stereo audio amplifier	10-01-129
BFM-1514	Maxi-I stereo audio processor module	10-01-127
BFM-1521	Stereo generator	10-01-125
BFM-1531	SCA generator	10-01-124
BFM-1541	Modulation oscillator/AFC	10-01-123
BFM-1551	RF amplifier	10-01-122
BFM-1561	Power supply/Alarm	10-01-121

Note: Stereo operation with audio processor requires both BFM-1514 and BFM-1521. Stereo operation without audio processor requires BFM-1512 and BFM-1521.

PORTABLE REMOTE PICKUP TRANSMITTER

RPU-1103



**RECHARGEABLE BATTERY
DUAL FREQUENCY OPERATION (ONE SUPPLIED)
DESIGN EXCEEDS ALL NEW F.C.C. REQUIREMENTS
150 MHz 3 W PORTABLE REMOTE PICKUP TRANSMITTER
RUGGED LIGHTWEIGHT CONSTRUCTION
ALL SOLID STATE**

The McMartin RPU-1103 Portable Remote Pickup Transmitter is a completely self-contained 150 MHz, three watt battery operated transmitter. The transmitter is designed to be used by today's on-the-go newsman. When carrying the unit on the shoulder strap, the RPU-1103 allows instant viewing of the controls and indicators. Along with the unique styling, the transmitter provides a degree of audio and RF performance never before available in a portable RPU. The transmitter incorporates the latest in solid state circuit technology. Only the highest quality circuit components, silver mica and tantalum capacitors, are used wherever possible.

Optional two frequency operation is available from the factory or can be added later in the field simply by plugging in the second channel element. Two channel operation with up to 1 MHz separation will not deteriorate performance.

Two high quality audio inputs are provided. The microphone input, located on the front panel, offers 25 dB of compression along with an L.E.D. indicator to display proper operation. A front panel switch is provided to key the transmitter when using the rear mounted line input. This eliminates a live

microphone condition if the "push-to-talk" button is used to key the transmitter while using the line input. The audio compressor functions on both the line and microphone allowing simple talk over line operation.

A rear compartment provides quick easy access to the battery. A charger jack is located on the rear of the RPU to allow charging of the battery without removal from the transmitter. A fully charged battery is capable of operating the unit on a continuous basis for about one and one half hours, and correspondingly longer on an intermittent basis. If desired, a field battery change can be quickly accomplished. Spare batteries are available as an option.

The microphone input jack mates with either a GC-18-092 or Amphenol 88-870 or equivalent, one of which is included with each unit. The standard whip antenna provides increased gain and transmitting range over the optional rubber duck type antenna.

The durable aluminum construction complimented by the small size offers an extremely attractive portable transmitter weighing only six pounds, including battery.

AUG/80

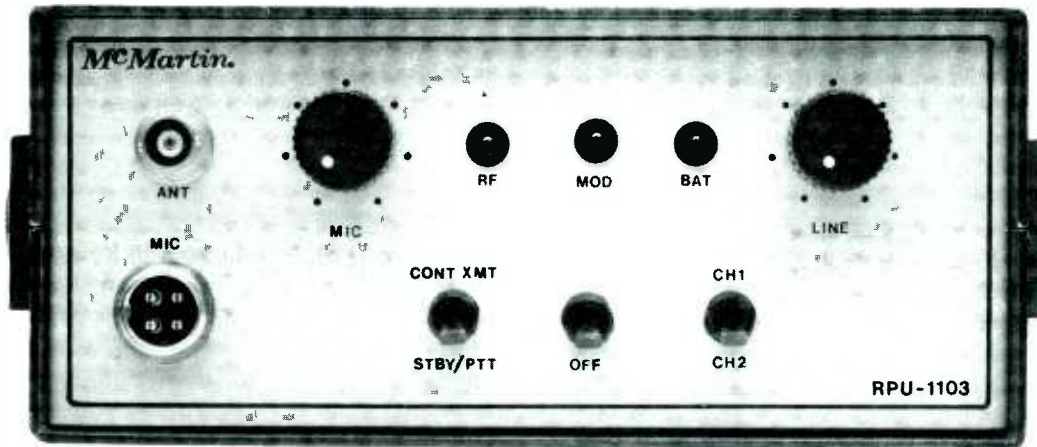

Control panel (top view) of RPU-1103

SPECIFICATIONS

FREQUENCY	150-172 MHz	AUDIO INPUT LEVEL	Microphone - 65 dBm to - 30 dBm Line - 20 dBm to + 18 dBm
CRYSTAL MULTIPLICATION	Times 12	AUDIO INPUT IMPEDANCE	Mic 50/150/600, Line 8 Ω /600 Ω
DUAL FREQUENCY OPERATION	Front panel switch selectable (crystal optional)	MIC INPUT CONNECTOR	Amphenol 4 pin type 80-871
SPURIOUS EMISSIONS	>60 dB below rated output	LINE INPUT CONNECTOR	RCA type Phono Jack
RF OUTPUT	3 W nominal	POWER REQUIREMENTS	2.5 AH battery, 10-13 V battery internally mounted for quick change. Battery drain 80 MA standby, 600 MA transmit
VSWR PROTECTION	No damage incurred by excessive VSWR	DIMENSIONS	height 9 $\frac{3}{4}$ " (24.8 cm) width 7" (17.8 cm) depth 3" (7.6 cm)
RF OUTPUT CONNECTION	Type BNC	ORDERING INFORMATION	
TEMPERATURE RANGE	- 20° to 50°C (0° to 120°F)	Model	Description
MODULATION	30F3 adjusted for \pm 5 kHz deviation	RPU/BAT	Replacement 12 V battery
NOISE	>50 dB below 100% modulation	RPU/BC	Battery Charger
AUDIO INPUTS	2 provided, 1 mic input push-to-talk, 1 unbalanced high level input	RPU/ANT	Antenna, Duck-1-BNC
AUDIO RESPONSE	\pm 0.75 dB, 50-7,500 Hz (75 μ s pre-emphasis)	RPU/ZCH	Second Channel Module
DISTORTION	1.5% 100-7,500 Hz, 1% typical	RPU/MIC	Microphone 350D, push to talk
			Product Code
			10-01-115
			10-01-111
			10-01-112
			10-01-114
			10-01-113

PORTABLE REMOTE PICKUP TRANSMITTER

RPU-1403-40F3
RPU-1403-20F3



RECHARGEABLE BATTERY
DUAL FREQUENCY OPERATION (ONE SUPPLIED)
DESIGN EXCEEDS ALL NEW F.C.C. REQUIREMENTS
450 MHz 3 W PORTABLE REMOTE PICKUP TRANSMITTER
AVAILABLE FOR BOTH WIDE AND NARROW F.C.C. RPU CHANNELS

The McMartin RPU-1403 Portable Remote Pickup Transmitter is a completely self-contained 450 MHz, three watt battery operated transmitter. The transmitter is designed to be used by today's on-the-go newsman. When carrying the unit on the shoulder strap, the RPU-1403 allows instant viewing of the controls and indicators. Along with the unique styling, the transmitter provides a degree of audio and RF performance never before available in a portable RPU. The transmitter incorporates the latest in solid state circuit technology. Only the highest quality circuit components, silver mica and tantalum capacitors, are used wherever possible.

Optional two frequency operation is available from the factory or can be added later in the field simply by plugging in the second channel element. Two channel operation with up to 2 MHz separation will not deteriorate performance.

Two high quality audio inputs are provided. The microphone input, located on the front panel, offers 25 dB of compression along with an L.E.D. indicator to display proper operation. A front panel switch is provided to key the transmitter when using the rear mounted line input. This eliminates a live micro-

phone condition if the "push-to-talk" button is used to key the transmitter while using the line input. The audio compressor functions on both the line and microphone allowing simple talk over line operation.

A rear compartment provides quick easy access to the battery. A charger jack is located on the rear of the RPU to allow charging of the battery without removal from the transmitter. A fully charged battery is capable of operating the unit on a continuous basis for about one and one half hours, and correspondingly longer on an intermittent basis. If desired, a field battery change can be quickly accomplished. Spare batteries are available as an option.

The microphone input jack mates with an Amphenol 88-870 plug, or equivalent, which is included with each unit. A 6" "Rubber Duck" antenna is furnished, however a whip or fixed mounted external antenna can be used.

The durable aluminum construction complimented by the small size offers an extremely attractive portable transmitter weighing only six pounds, including battery.

AUG/80

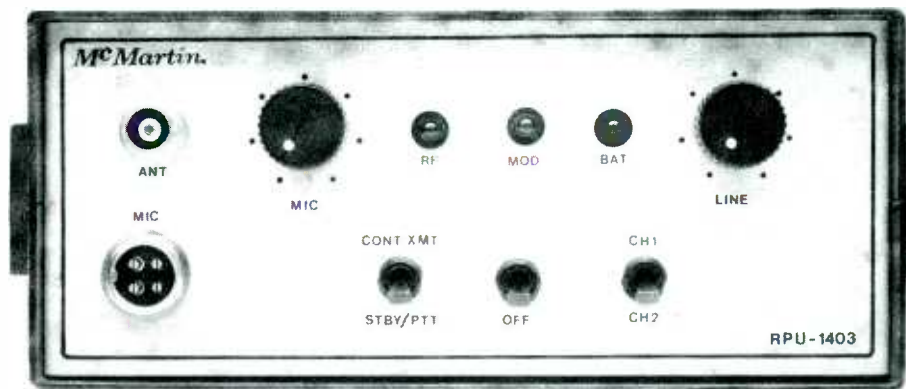

Control panel (top view) of RPU-1403

SPECIFICATIONS

FREQUENCY RANGE450-456 MHz
OSCILLATOR MULTIPLICATION Times 36
FREQUENCY STABILITY0005%
DUAL FREQUENCY OPERATION Front Panel Switch Selectable, max. separation 2 MHz. (Second crystal optional)
SPURIOUS EMISSIONS >60 dB below rated output
RF OUTPUT3W nominal
VSWR PROTECTION No damage incurred by excessive VSWR
RF OUTPUT CONNECTIONType BNC
TEMPERATURE RANGE-30 to +50° C-20 to +120° F
AUDIO INPUT IMPEDANCE Mic 50/150/600 Balanced Line 8 ohm/600 Unbal.
MIC INPUT CONNECTOR Amphenol 4 pin type 80-871 (Push-to-Talk)
LINE INPUT CONNECTOR RCA type Phono Jack
AUDIO INPUT LEVEL Microphone -65 dBm to -30 dBm Line -20 dBm to +18 dBm
FM NOISE>50 dB below 100% modulation-55 dB typical
DISTORTION Less than 1.5% within audio bandpass; 0.75% typical

	RPU-1403-40F3	RPU-1403-20F3
Channel Desig.	N1, R (50 KHz)	N2 (25 KHz)
Audio Response	30-10 KHz ± 1 dB	30-5 KHz ± 1dB
Carrier Dev.	± 10 KHz	± 5 KHz

PRE-EMPHASIS75 microsecond, standard

LED INDICATORS Rectified RF output
..... 3 dB audio 'Peak Flasher'
..... Battery Condition

POWER REQUIRED .. .2.5 AH battery, 10-13 volt battery internally mounted for quick change. Battery drain 80 MA standby, 800 MA transmit

DIMENSIONS9³/₄" (24.77 cm) height
..... 7" (17.78 cm) width
..... 3" (7.62 cm) depth

FINISH McMartin beige and bronze with simulated leather exterior. Rugged shoulder strap.

WEIGHT77 lbs. (3.5 kg)

ORDERING INFORMATION

MODEL	DESCRIPTION	PRODUCT CODE
RPU-1403	Portable Remote Pick-up Transmitter10-01-087
RPU/BAT	Battery 12 volts, replacement10-01-115
RPU/BC	Battery Charger10-01-111
RPU/ANT 450 MHz	Antenna (rubber duck), replacement10-01-118
RPU/2CH	Second Channel Module10-01-114
RPU/MIC	Microphone 350D, push to talk10-01-113

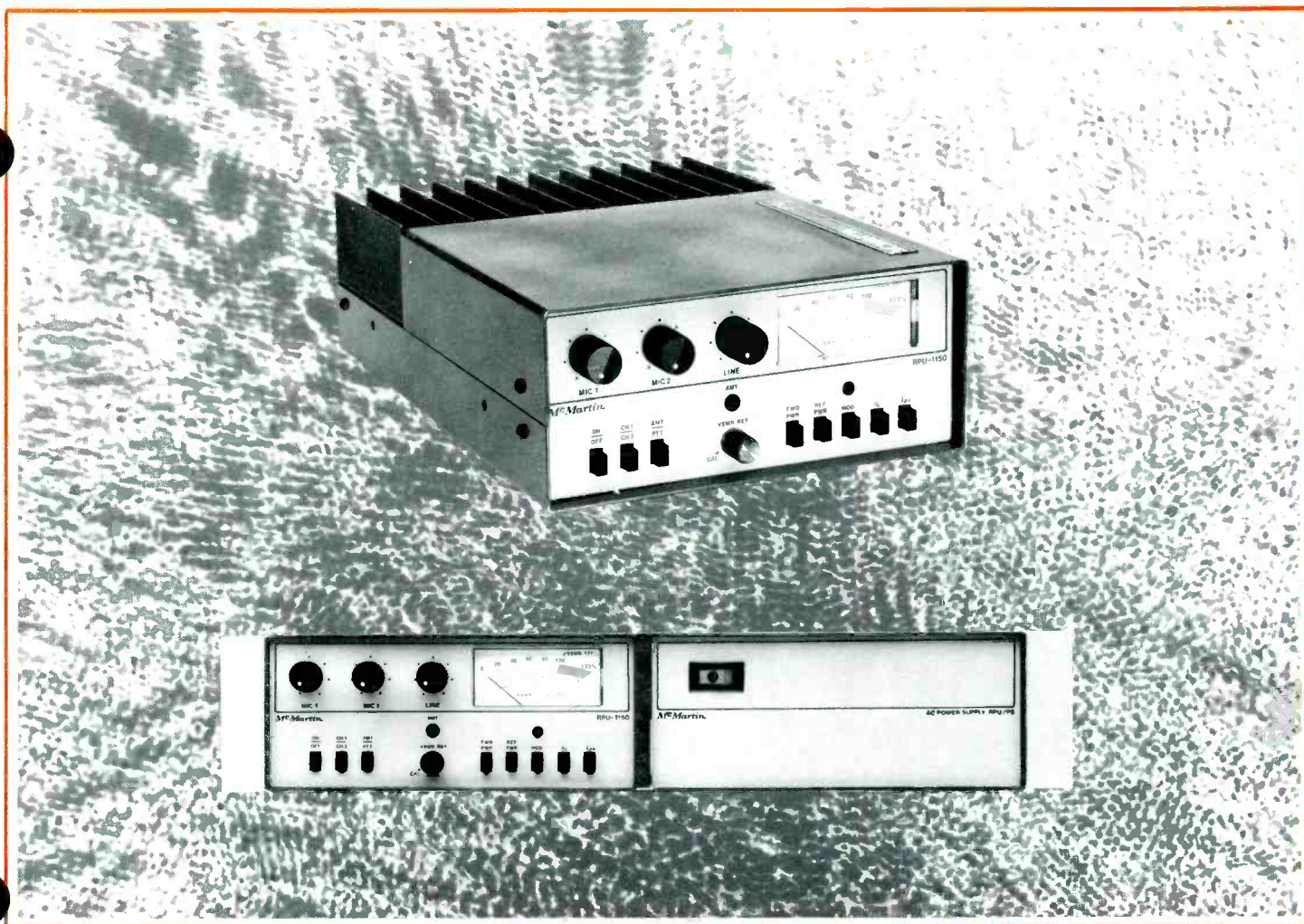

150 MHz / 450 MHz remote broadcast transmitters

MCMARTIN

150-170 MHz and 450-455 MHz broadcast quality remote pick-up transmitters.
Mobile or Fixed Base Operation.
Front panel multimeter indicates modulation, forward, and reflected power, Vc, IPA
Dual frequency operation
Microphone and line transformer inputs.
Compressor limiter operates on both line and mic inputs.
Talk over line input capability.
Latest design exceeds all new F.C.C. requirements.
Rugged lightweight construction (weighs only 8 lbs.).
All solid state; High VSWR and Thermal Overload protected.
Use of highest quality components.
**Full-line of accessories available including 120/240 VAC power supply, rack mount
frame, antennas, etc.**
Superior serviceability.

The McMartin RPU-1150 and RPU-1430 Remote Broadcast transmitters incorporate the latest in FM solid state technology and are designed for high audio quality remote broadcast program origination. The RPU-1150 operates on a specified frequency in the range of 150-170 MHz with a continuous power output rating of 50 watts.

The RPU-1430 operates on a specified frequency in the 450-455 MHz range with a continuous power output of 30 watts. The units are identical in size and appearance and utilize the same accessories except for antennas.

The basic unit is designed for 13.5 VDC mobile power sources but can also be operated from 115 or 230 VAC, 50-60 Hz with an optional companion power supply. The supply can be mounted separately or side-by-side with the transmitter in an optional rack-mount cabinet. By removing the de-mountable rack ears and attaching a carrying handle (supplied), the cabinet doubles as a smart portable carrying case.

The unit is equipped with a full complement of front panel-mounted controls and has provisions for a remote control head. A combination under-dash/floor mount cradle is furnished as standard for mobile operation.

A switch-selected multimeter allows the user to read forward and reflected RF power, modulation level, supply voltage and power amplifier current.

The RPU-1150 and RPU-1430 employ a direct FM modulation process employing a crystal oscillator operating at 1/12 or

1/36 the output frequency. The transmitter has built-in two channel capability. All that is required to expand the operation to two channels is install the second plug-in channel element. The frequency is then determined by the front panel or remote channel select switch. Both frequencies must be in the same FCC channel grouping.

The audio processing circuitry provides excellent limiting characteristics with minimum distortion. Excellent overload and dynamics range characteristics are ensured by the use of two section microphone gain controls. This permits the use of either high performance or close talking microphones with nominal output levels over the range of -60 to -30 dBm.

The RF power amplifier is a completely solid state design, conservatively rated for continuous RF output. It is capable of withstanding infinite VSWR conditions at rated supply voltage and drive levels and is thermostatically protected against long-term mismatch or overload conditions.

All interstage and output impedance matching is accomplished with broadband microstrip techniques and there are no amplifier tuning adjustments to be made.

A convenient built-in VSWR bridge enables the user to check or adjust the antenna system for a favorable match to effect maximum radiated power.

The transmitters utilize harmonic and spurious suppression techniques that attenuate all undesired signals well below present FCC and international standards.

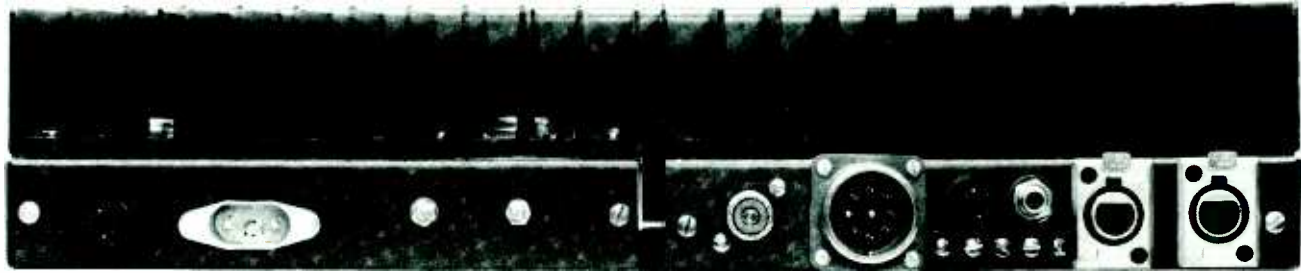

Rear View of RPU 1150 with Power Supply (RPU/PS)

EMISSION/FREQUENCY AVAILABILITY

RPU-1150

GROUP	FREQUENCY MHz	EMISSION DESIG.	AUDIO B.W.	FREQUENCY DEVIATION
K ₁	152.87-153.35 (9 ch.)	25F3	7.5 kHz	±5 kHz
K ₂	161.64-161.76 (5 ch.)	25F3	7.5 kHz	±5 kHz
L	166.25 (1 ch.)	20F3	5.0 kHz	±5 kHz
M	170.15 (1 ch.)	20F3	5.0 kHz	±5 kHz

RPU-1430

N ₁	450 (6 ch.)	455 (6 ch.)	40F3/40F3A *	10.0 kHz	±10 kHz
N ₂	450 (12 ch.)	455 (12 ch.)	20F3/20F3A *	5.0 kHz	±5 kHz
R	450 (5 ch.)	455 (6 ch.)	40F3/40F3A *	10.0 kHz	±10 kHz

- NOTE:**
- Standard carrier frequency stability required is $\pm .0005\%$.
 - Group N₁ and R channels may only be used for program material and cues. All other groupings listed can be used for program, cues and communications.
 - * 3. The (A) versions of the RPU-1430 designate frequency tolerance of $\pm .0002\%$ required when these units are used as base stations or mobile repeaters.
 4. For dual frequency operation, both operating frequencies must be in the same channel group. Additionally, the maximum channel spacing at 455 MHz should be less than 2 MHz.



RPU/MC Mobile Control Head

SPECIFICATIONS

	RPU-1150	RPU-1430
OPERATING FREQUENCY RANGE	148-172 MHz	450-456 MHz
RF OUTPUT POWER	50 watts (Minimum continuous @ 13.5 VDC into 50 ohms.)	30 watts
POWER REQUIRED	10 A transmit 100 MA Standby @ 13.5 VDC. (12.5 to 14.5 VDC operating range)	7 A transmit 100 MA Standby
OSCILLATOR MULTIPLICATION	X12	X36
TEMPERATURE RANGE	-20 to 120° F. (-30 to 50° C)	
SPURIOUS EMISSIONS	Greater than 65 dB below rated output	
MODULATION	Direct FM VCXO; See table for licensed frequencies and bandwidths.	
FREQUENCY STABILITY	± .0005% STD ± .0002% for 450 MHz fixed stations.	
FM and AM NOISE	Better than -50 dB below 100% modulation -55 dB typical	
FREQUENCY RESPONSE*	30 Hz to 5 kHz, 7.5 kHz, or 10 kHz ± 1 dB depending on licensed channel BW. 75 microsecond pre-emphasis is standard on all units.	
* see NOTE		
AUDIO DISTORTION	.0.8% typical 1.5% maximum, 50-7500 Hz	
MODULATION CONTROL	By means of audio filter and compressor-limiter	
AUDIO LIMITING	25 dB at 2 millisecond attack time. 300 millisecond delay	
AUDIO INPUTS	.3 independent, 2 mic input push-to-talk, 1 high level line input	
AUDIO INPUT LEVEL	Microphone -65 dBm to -30 dBm. Line -20 dBm to +18 dBm	
AUDIO INPUT IMPEDANCE	Mic 50/150/600 balanced, Line 8 to 600 ohm balanced or unbalanced.	
MIC INPUT CONNECTORS	Amphenol 4 pin type XLR-31	
LINE INPUT CONNECTION	Phone Jack, unbalanced; term strip, balanced	

RF OUTPUT CONNECTION	Type SO-239
DIMENSIONS	height3½" (9 cm) width8½" (20 cm) depth13" (33 cm)
WEIGHT	actual7.7 lbs. (3.5 kg) shipping11 lbs. (5 kg)
FINISH	McMartin Beige & Bronze, on heavy-duty aluminum cabinet

NOTE: Unless otherwise specified, unit will be supplied with audio filter and carrier deviation adjusted as follows:

CHANNEL GROUP	AUDIO BANDWIDTH	CARRIER DEVIATION	EMISSION DESIG.
K1, K2	7.5 kHz	±5 kHz	25F3
L, M	5.0 kHz	±5 kHz	20F3
N2	5.0 kHz	±5 kHz	20F3
N1, R	10.0 kHz	±10 kHz	40F3

75 microseconds Pre-emphasis is standard in all units.

ORDERING INFORMATION

MODEL	DESCRIPTION	PRODUCT CODE
RPU-1150	50 watt 150 MHz remote pickup transmitter. Includes mobile mount, requires 13.5 volt DC @ 10 amps transmit. (Specify frequency)	10-01-088
RPU-1430	30 watt 450 MHz remote pickup transmitter. Includes mobile mount, requires 13.5 volt DC @ 7 amps transmit. (Specify frequency)	10-01-089
RPU/PS	AC power supply	10-01-095
RPU/RmCc	Rack mount and carrying case provides convenient carrying case and rack mounting for both the power supply and 50 or 30 watt transmitter. (Not required for mobile installations)	10-01-096
RPU/MC	Mobile control head for use when unit is trunk mounted. Includes cable from control head to transmitter.	10-01-098

150 & 450 MHz CUE RECEIVERS

RPU-1150Q
RPU-1450Q



shown adapted to the RPU-1103

**FOUR CHANNEL,
TWO BAND CAPABILITY**

**ADDITIONAL CHANNELS FOR POLICE,
FIRE, & COMPETITION**

SWITCHING DIODE TR SWITCH STANDARD

PIGGY-BACK TO RPU TRANSMITTER

McMartin's New Breed, the RPU cue receiver, is a piggy-back receiver which can be added to McMartin's RPU transmitters, the RPU-1103 and RPU-1403. These receivers come in two basic versions, one a 150 MHz unit with two channels and the other, a 450 MHz unit with two channels. The second channel is an additional cost item.

Provision has been made to incorporate into either version an additional front end circuit board which will

extend coverage by two channels to four channels. You may order either version with four channels, and it is possible to have cross band operation with two channels on 150 and two channels on 450. This allows the ENG crew to monitor any one of four different frequencies in either low band or high band channels. You can monitor local police, fire department channels, and competitor's RPU channels as well. This greatly adds to the versatility of the RPU transmitters with the addition of the RPU cue receiver.

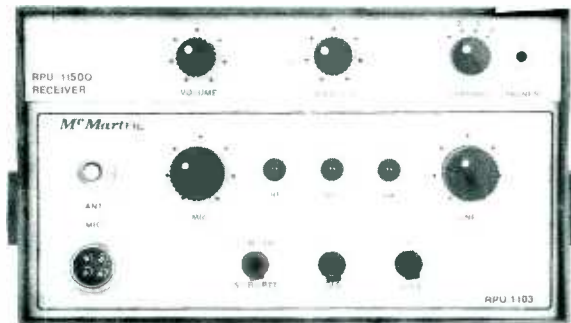

Receiver section

Transmitter section

top view, adapted to the RPU-1103

DEC/78

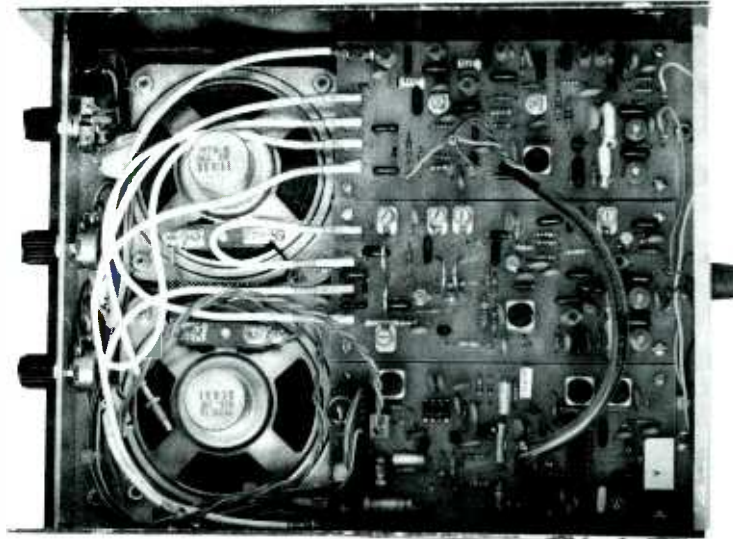

interior view of RPU-1150Q Receiver

SPECIFICATIONS

APPLICATION	Sensitive, crystal controlled dual-conversion receiver with excellent voice quality and high audio output power intended for on-the-scene cueing (not for program material). An add-on piggy-back receiver for McMartin 3 watt transmitters.	AUDIO OUTPUT2 watts into internal speaker; external 8 ohm output jack provided for phones or external speaker.
FREQUENCY RANGE	RPU-1150Q: 150-172 MHz with 2 channel capability. RPU-1450Q: 450-456 MHz with 2 channel capability.	DISTORTION	Less than 5% @ 5 kHz deviation and 1 watt audio output.
SENSITIVITY	1 μ v for 20 dB quieting 150 MHz 2 μ v for 20 dB quieting 450 MHz	POWER REQUIREMENT35 MADC at 12 volts idle, 100 MADC average at normal listening levels derived from RPU transmitter battery pack.
SELECTIVITY6 dB @ \pm 10 kHz, 45 dB @ \pm 20 kHz; 1 volt on adjacent channel will not produce interference.	ANTENNA	Uses transmitter antenna by means of a solid-state pin-diode antenna switching network.
IF STAGES10.7 MHz and 455 kHz with 455 kHz limiter and bandpass ceramic ladder filter.	CIRCUITRY3 IC's, 5 transistors (including 2 MOS FET's)
AUDIO RESPONSE50-5000 Hz \pm 2 dB (75 microsecond de-emphasis standard)	CONTROLS	Volume, squelch, channel select, external output jack.
SQUELCH	Smooth but positive acting RF level squelch with hysteresis to prevent jitter; no noise bursts	WEIGHT	Adds approximately 10 ounces to the RPU transmitter.
AGCD-MOS FET RF amplifier provides the ultimate in low noise reception and provides 50 dB AGC range. Accommodates signal levels from .3 μ v to greater than one (1) volt without overloading.	DIMENSIONS	Replaces top cover of the RPU-1103 or 1403, adding 1" (2.54 cm) depth to the transmitter. Easy to field install on existing units
ORDERING INFORMATION			
MODEL	DESCRIPTION	PRODUCT CODE	
RPU 1150Q	150 MHz Cue Receiver10-03-054	
RPU 1450Q	450 MHz Cue Receiver10-03-055	

REMOTE PICK-UP RECEIVERS

RPU-1150R
RPU-1450R

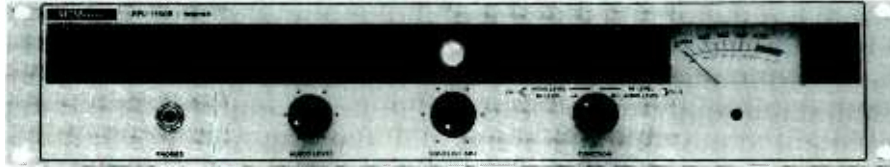

150-175 MHz & 450-470 MHz RPU RECEIVER

BALANCED 600 OHM OUTPUT

6 HIGH "Q" TUNED RF CIRCUITS

ALL SOLID STATE

**PROVISION FOR DUAL FREQUENCY
OPERATION WITHIN 1 MHz**

FULLY METERED

HIGH SENSITIVITY

4 BANDWIDTHS AVAILABLE

IMPROVED NOISE SQUELCH

CARRIER OPERATED RELAY

The McMartin RPU-1150R (150-175 MHz) and RPU-1450R (450-470 MHz) are rack mounted, dual channel, (optional) crystal-controlled receivers with high sensitivity and selectivity. Remote channel switching allows the receiver to be placed close to the receiving antenna for optimum performance.

The receiver utilizes dual conversion. The RF signal is amplified and converted to a 10.7 MHz, first IF frequency to provide good image frequency rejection. The 10.7 MHz signal is converted to the second IF frequency of 455 kHz where the signal is amplified hard limited and demodulated with the new PTD, precise tracking decoder circuit.

The front end of the RPU-1150R and RPU-1450R utilized diode protected dual gate D MOS-FET RF amplifier. This device has a very linear AGC control providing greater than 50 dB gain reduction without any detuning effect of the high "Q" RF tuned circuits.

A noise squelch is used to mute the receiver at the desired S/N output and is controlled by a recessed front panel control.

A carrier-operated relay provides either normally open or normally closed contacts in the absence or presence of an RF carrier. This is independently controlled and not related to the noise squelch circuit but to the RF input level.

The selectivity can be tailored to the desired bandwidth by inserting the proper bandpass filter.

A front panel meter is used to indicate the relative RF input and modulation levels. A front panel function switch selects the desired channel. RF input and modulation levels. The sensitivity of the RF metering circuitry allows indication of RF as low as 1 microvolt or less.

MAY/79

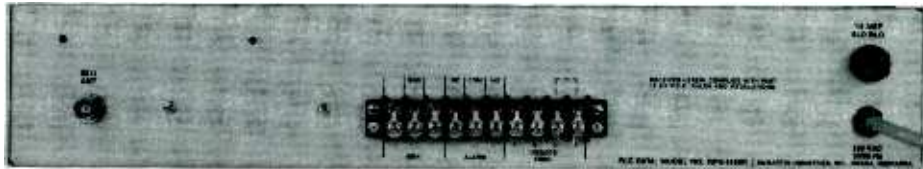

Rear view of RPU-1450R

SPECIFICATIONS

	RPU-1150R	RPU-1450R
CARRIER FREQUENCY RANGE	150-175 MHz	450-470 MHz
DUAL FREQUENCY OPERATION	Two frequency operation with 1 MHz spacing. Second channel operation optional.	Two frequency operation with 2 MHz spacing. Second channel operation optional.
INPUT IMPEDANCE	50 ohm BNC connector	50 ohm BNC connector
SENSITIVITY	0.5 microvolts for 20 dB quieting referenced from ± 5 kHz deviation @ 400 Hz	0.5 microvolts for 20 dB quieting referenced from ± 5 kHz deviation @ 400 Hz
SELECTIVITY	± 15 kHz @ 6 dB ± 40 kHz @ 60 dB. Determined by deviation specified	± 15 kHz @ 6 dB ± 60 kHz @ 60 dB. Optional filters available. Determined by deviation specified
S/N RATIO	.55 dB below 100%, 60 dB typical	
SPURIOUS RESPONSE	At least -65 dB	
AUDIO OUTPUT	Balanced 600 ohm +10 dBm	
SQUELCH	Adjustable up to 20 μ volts	

RF FILTERING	Double shielding of RF and oscillator circuits
METERING	2 Channels — RF input level and modulation
POWER REQUIREMENTS	120 VAC 50/60 Hz, 25 watts
DIMENSIONS	Standard rack mount: Width — 19" (48.3 cm) Height — 3½" (8.9 cm) Depth — 11" (27.9 cm)
WEIGHT	actual10 lbs. (4.5 kg) shipping13 lbs. (5.9 kg)
FINISH	McMartin beige with woodgrain trim

ORDERING INFORMATION

Model	Description	Product Code
RPU-1150R	Receiver, 150 MHz, rack mount, 2 channel (specify frequency)	10-03-032
RPU-1450R	Receiver, 450 MHz, rack mount, 2 channel (specify frequencies)	10-03-033



1082V Stereo Console

1000 series audio consoles

MCMARTIN

- 5 Channel Stereo / vertical attenuators**
- 8 Channel Stereo or Mono / vertical attenuators**
- 8 Channel Stereo or Mono / rotary attenuators**
- Gold plated PCB contacts**
- All channels convertible to MIC or HI level inputs**
- 15 watts • Monitor amplifier output**
- Headphone amplifier with volume control**
- Cue amplifier**
- External power supply**
- 10 inputs into 5 mixer (5 channel consoles)**
- 18 inputs into 8 mixer (8 channel consoles)**
- Audition output usable as 2nd program output**
- Cassette Input Jack 8-Channel Models**

The McMartin B-1000 Series of audio consoles is a new breed of human-engineered, easy-to-live-with consoles that last and last. Clean design keeps board operations tight and accurate. Clean construction and internal lay-out makes service, when required, fast and easy. Clean engineering assures you of a clean signal.

FIVE OR EIGHT CHANNELS

Plenty of inputs are provided for a variety of broadcast production needs. The eight channel models have 18 inputs while the five channel models provide for 10. This affords sufficient input selection for most of today's broadcast requirements.

VERTICAL OR ROTARY ATTENUATORS

Both mono and stereo versions come with either vertical, recording studio type slide attenuators or the more commonly used rotary attenuators. Either style provides the operator with the precision control necessary to meet the demands of today's broadcasting.

ALL CHANNELS CONVERTIBLE

All channel positions can be converted to mic. or line inputs, the line inputs either balanced or unbalanced. Check the ordering information for the standard configuration of mic. and line inputs.

STEREO OR MONO

The design of the B-1000 Series was conceived with stereo performance in mind. Mechanically both stereo and mono units are the same. Many of the functional parts in the monaural units are the same as those used in the stereo versions. This similarity of parts provides greater value per dollar than is found in some units costing considerably more.

Monaural stations contemplating conversion to stereo at a later date will find the 1000 series stereo console an excellent investment in future growth.

HEADPHONE AMPLIFIER WITH VOLUME CONTROL

Headphone amplifier can be switched to monitor several console functions. Check the picture for the versatility provided.

FIFTEEN WATT MONITOR OUTPUT AMPLIFIER

Enough power for almost any monitor speaker is provided without requiring the use of an external monitor amplifier. The hybrid amplifier modules easily provide up to 15 watts per channel output.

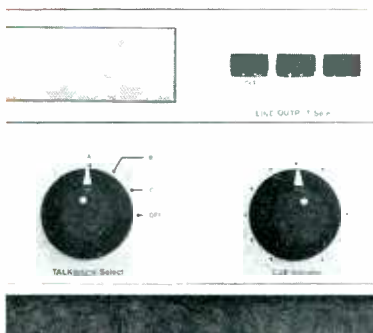

Cue and talkback controls

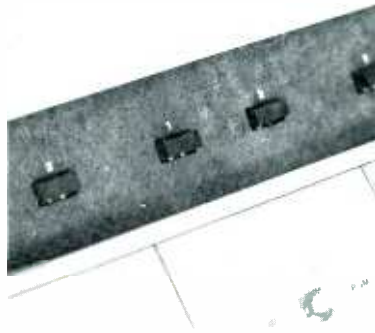

Pushbutton input select switches

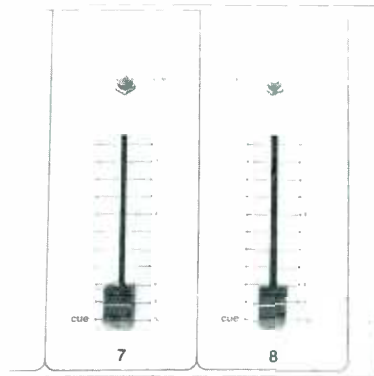

Slide attenuators, rotaries also available

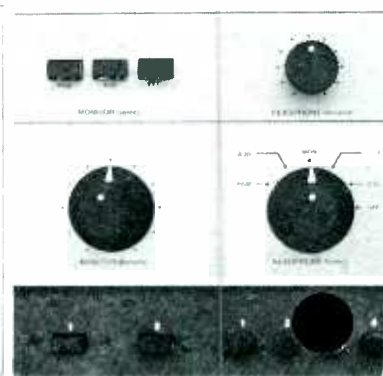

Monitor and headphone select controls

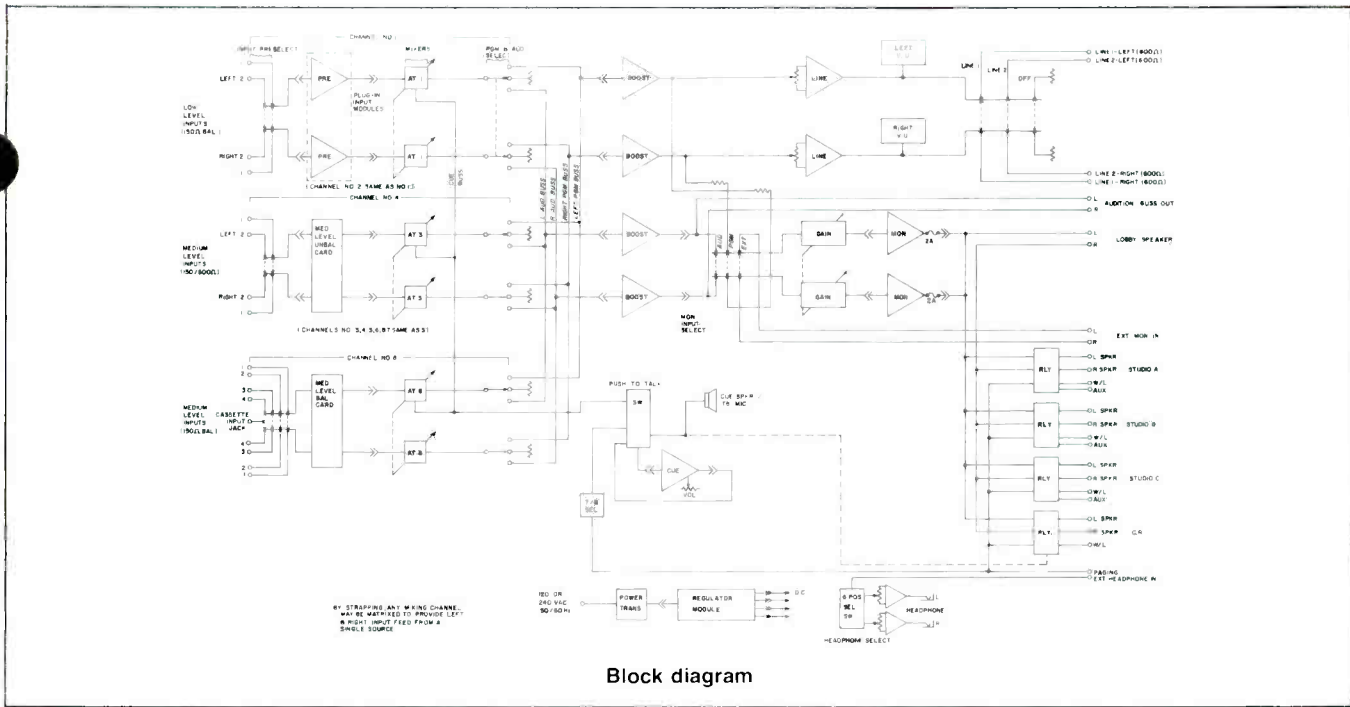

McMartin's B-1000 Series consoles offer plain and simple performance and reliability, but without gadgets, complexity or exotic appearance. The McMartin plain and simple philosophy makes McMartin consoles more versatile, easier to learn, and faster to service. They become a total tool for effective broadcasting, not a machine to be reckoned with. You don't have to worry about performance or reliability. McMartin engineering is state-of-the-art, plain and simple.

CUE AMPLIFIERS

Built in cue amplifier provides adequate volume for cueing purposes and cue is available on all channels.

AUDITION OUTPUT USEABLE AS SECOND PROGRAM OUTPUT

The audition output could be used as a program amplifier in an emergency situation. This makes your McMartin console more versatile.

PUSH-BUTTON INPUT SWITCHING

Pre-select from two input sources on each channel (channel eight has four inputs). On channels one, two and three, push-buttons can also assign control of speaker muting/warning light relays to the correct studio.

LOW PROFILE DESIGN

The industrial design of the B-1000 was conceived with the operator in mind. It is both attractive and yet easy to see and work with.

SIMPLE MODULAR DESIGN

Plain and simple design makes servicing simple and fast. Easy inter-changeability can keep you on the air.

GOLD PLATED CONTACTS AND TANTALUM CAPACITORS USED WHERE IT COUNTS

McMartin has chosen to use high quality components throughout the B-1000 Series. Gold plated contacts on printed circuit board plugs and sockets and tantalum capacitors show that this unit has been designed with quality in mind.

EXTERNAL POWER SUPPLY

The heavy duty external power supply has five separate fused lines. One AC primary line fuse, the four other separately fusing individual circuit groups. Should a failure occur in the monitor or cue amplifiers, program circuits will continue to function.

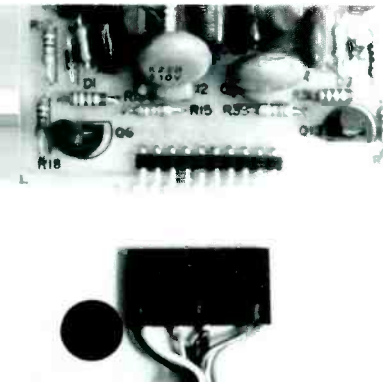

Quality components—
gold plated plug & sockets

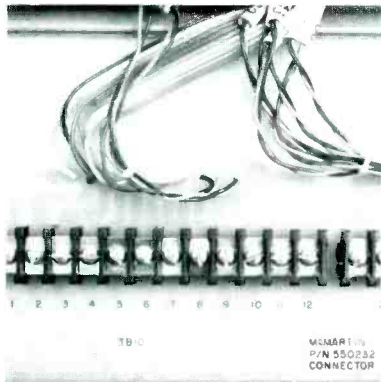

Terminal strip wiring of all inputs

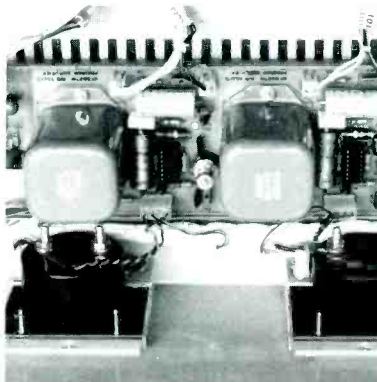

Program amplifier—
IC amplifiers quality transformers

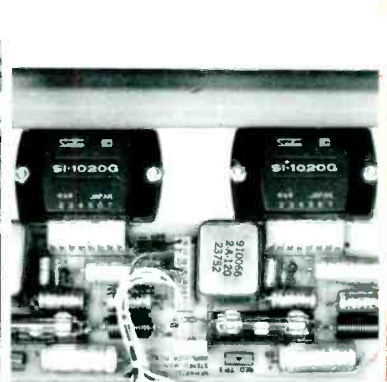

15 watt per channel
monitor amplifier

SPECIFICATIONS

PROGRAM CHANNELS (Mono, Left or Right)

FREQUENCY RESPONSE: ± .5 dB, 30 to 15,000 Hz
 ± 1 dB, 20 to 20,000 Hz

DISTORTION: 0.5% or less, 30 to 15,000 Hz
 1.0% or less 20 to 20,000 Hz @
 +18 dBm Output, produced by a -50
 dBm signal fed to any microphone input.

S/N RATIO: 74 dB or greater below +18 dBm output,
 produced by a -50dBm signal fed to
 any microphone input with channel
 mixer and master gain control each
 set for approx. 12 dB attenuation.

OVERALL GAIN:95 dB±3 dB microphone input to
 line output

OUTPUT LEVEL: +8 dBm nominal, +28 dBm maximum

OUTPUT IMPEDANCE: 600 ohms balanced

INPUT LEVELS: MICROPHONE CHANNELS: -60 dBm
 nominal, -22 dBm maximum
 MEDIUM LEVEL CHANNELS: -15 dBm
 nominal, +20 dBm maximum

INPUT IMPEDANCES: MICROPHONE CHANNELS: 150 ohms
 balanced (50 or 600 ohms available
 by strapping) Unbalanced medium
 level channels: 600 ohms Balanced
 Medium Level Channels: 150 ohms
 balanced (600 ohms by strapping)

CROSSTALK: Below noise level

AUDITION BUS OUTPUT: +10 dBm unbalanced 600 ohms

MONITOR CHANNEL (Mono, Left or Right)

FREQUENCY RESPONSE: ± .5 dB, 50 to 15,000 Hz

HARMONIC DISTORTION: 0.5% or less 50 to 20,000 Hertz
 at full 15 watt output

S/N RATIO: 80 dB below full output

OUTPUT IMPEDANCE: 4/8/16 ohms unbalanced

OUTPUT LEVEL: 15 watts rms

HEADPHONE AMP: 1 watt, 0.25% Distortion,
 Mono/Stereo

CUE AMPLIFIER: 1 watt - Mono only

FINISH: Upper and lower control panels are
 textured McMartin beige; center control
 panel and aluminum end panels have
 dark brown leather trim.

DIMENSIONS

8 Channel: width 30" (76.2 cm)
 depth 19½" (49.5 cm)
 height 10" (25.4 cm)

5 Channel: width 19½" (49.5 cm)
 depth 19½" (49.5 cm)
 height 10" (25.4 cm)

Power Supply: 8" (20.32 cm) width
 13" (33.02 cm) depth
 5¼" (13.3 cm) height

WEIGHT

8 Channel: actual 34.5 lbs (15.6 kg)
 shipping 50.0 lbs (22.5 kg)

5 Channel: actual 24.5 lbs (11.1 kg)
 shipping 35.0 lbs (15.75 kg)

Power Supply: actual 9.5 lbs (4.3 kg)
 shipping 10.0 lbs (4.5 kg)

ORDERING INFORMATION

Model	Description	Product Code
1052V	5 Channel Stereo Vertical Attenuators CH 1, Microphone Input CH 2, 3, 4, HI Level Unbalanced Input CH 5, HI Level Balanced Input	10-02-146
1081	8 Channel Mono Rotary Attenuators CH 1, 2, Microphone Input CH 3, 4, 5, 6, 7 HI Level Unbalanced Input CH 8, HI Level Balanced Input	10-02-120
1081V	8 Channel Mono Vertical Attenuators CH 1, 2, Microphone Input CH 3, 4, 5, 6, 7, HI Level Unbalanced Input CH 8, HI Level Balanced Input	10-02-119
1082	8 Channel Stereo Rotary Attenuators CH 1, 2, Microphone Input CH 3, 4, 5, 6, 7, HI Level Unbalanced Input CH 8, HI Level Balanced Input	10-02-118
1082V	8 Channel Stereo Vertical Attenuators CH 1, 2, Microphone Input CH 3, 4, 5, 6, 7, HI Level Unbalanced Input CH 8, HI Level Balanced Input	10-02-117

REPLACEMENT PRINTED CIRCUIT CARDS for 1000 SERIES CONSOLES

Cue/Talkback Amplifier	10-02-124
Program Amplifier	10-02-125
Monitor Amp Stereo	10-02-126
Monitor Amp Mono	10-02-134
SANKEN Hybrid Module for use with MONITOR AMPS, Requires 1 Mono, 2 Stereo	
Stereo Mic PreAmp	10-02-130
Mono Mic PreAmp	10-02-135
Headphone Amplifier	10-02-129
Stereo HI Level Balanced Input	10-02-131
Mono HI Level Balanced Input	10-02-136
Mono or Stereo HI Level Unbalanced Input	10-02-132

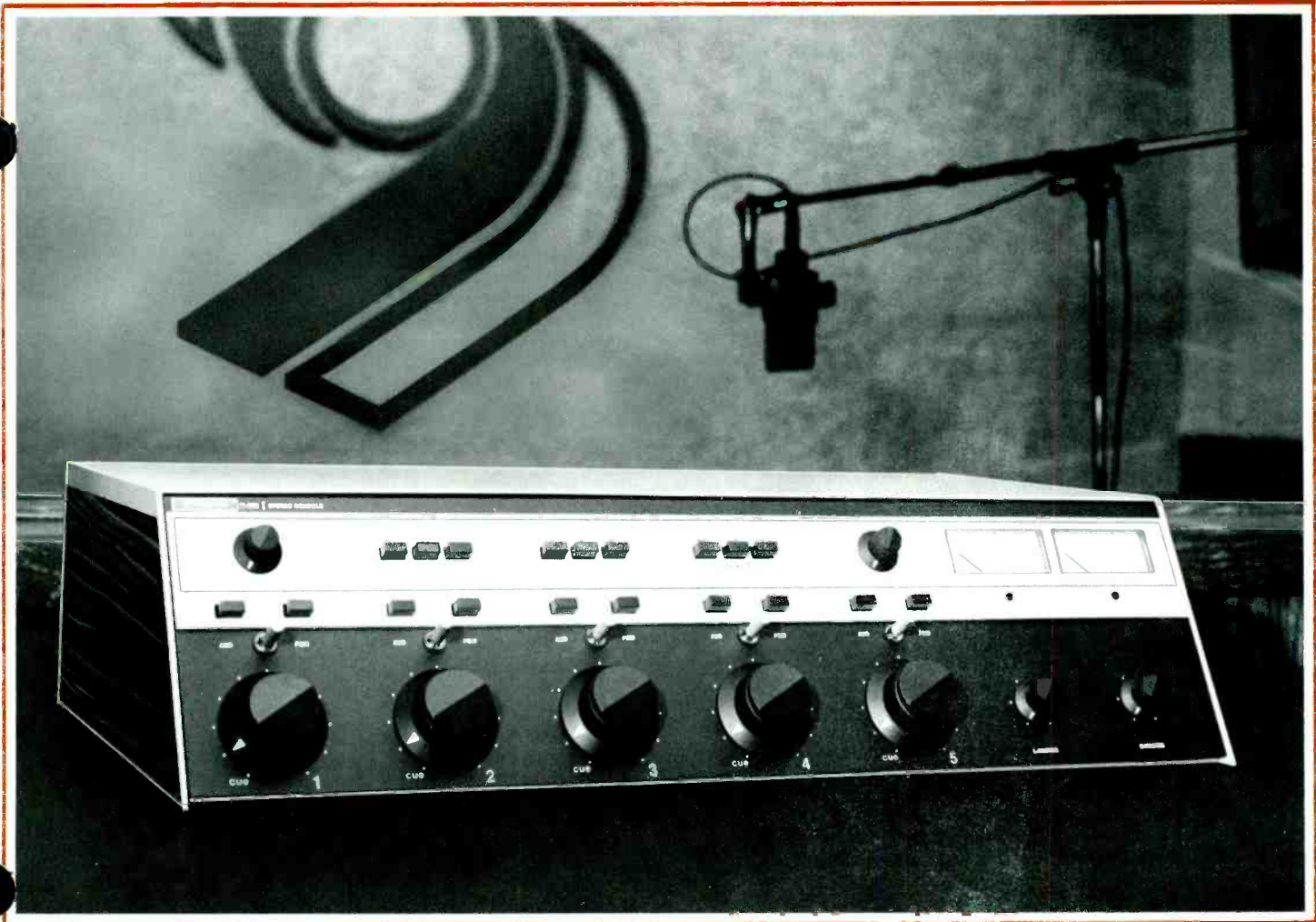

500 series audio consoles

MCMARTIN

**Compact Design Ideal for Production and
Small On-Air Studios As Well As Mobile Units**

Excellent Performance Specifications

Plug-in Modular Design

**Input Modules Available for:
Microphone and Balanced High-Level**

Standard Configuration One Microphone, Four Balanced High Level Inputs

Other Input Combinations by Simple Plug-in Module Substitution

Two Preselect Inputs Per Mixer

Four Watt rms Monitor Amplifier

Cue on All Mixers

Built-in Cue-Amplifier and Speaker

Speaker Muting for One Studio, Muting for Second Studio Optional

Functional, Large, Well Located Controls

Monaural, and Stereo Models

The McMartin B-500 series five-mixer audio consoles have been designed to provide for audio mixing and control for production and broadcasting application. Two models in the B-500 series are available, the B-501 monaural console and the B-502 stereo console.

B-500 series consoles provide five mixing channels, with switch selection of two inputs per mixer (a total of 10 inputs are provided). Each mixer output may be switched to the program or the audition busses of the console. Each mixer is provided with a detented counter-clockwise cue switch, to allow aural monitoring of any input channel by means of an integral 2-watt cue amplifier and built-in cue speaker. A front panel cue gain control is provided.

The five mixers are precision molded composition triple wiper attenuators which will typically operate for over 5 million operations without mechanical or electrical degradation. B-500 series five mixer consoles are available with step attenuators. These are identified by the basic model number plus the suffix "SA" for the step attenuator models.

Plug-in modules are used in the program and audition channels of the B-500 consoles. Input cards are available for microphone and for balanced high level inputs.

The use of these plug-in cards permits the user to tailor the console to his specific operating requirement. The standard models are supplied with one microphone preamplifier and four balanced high level input modules. Numerous other combinations are available as original purchase options or may be changed in the field at any time simply by unplugging one card, and plugging in the desired type input card.

The microphone preamplifiers accept low impedance balanced microphones of 150 ohm or 250 ohm impedance.

Balanced high level input cards are factory wired to accept 600 ohm balanced line inputs. Additional transformer taps accommodate 150 ohm or 50 ohm balanced inputs.

Each console is provided with a speaker muting/warning light relay for one location that operates in conjunction with the A input of mixer #1. Switching of that input to either the audition or the program bus will activate the relay. A prewired socket accepts an optional second relay for an additional location. It is connected to operate in conjunction with the B input of mixer #1. Spare contacts are available on all channel lever key switches, and on input select pushbuttons to allow extension of the muting/warning light relay control wiring to any or all other mixing channels.

All wiring connections to B-500 consoles are by means of rear panel mounted barrier type screw terminal strips. Space and cutouts are provided to allow field installation of two XLR-3 microphone connectors.

Convenient headphone jacks for monitoring are provided on both models, with front panel switch selection of the program, audition or cue busses.

The console outputs may be switched to two output lines or to an internal terminating load.

Program outputs are for 600 ohm balanced lines, and are at a + 8 dBm output level. Audition output levels, available to feed recording equipment, are 1.5V rms and can feed unbalanced 2.5K ohm loads.

B-500 series consoles represent the ultimate in flexibility, in a compact and attractive cabinet. They reflect the extensive, professional-quality, audio experience of McMartin in the design and manufacture of broadcast audio consoles.

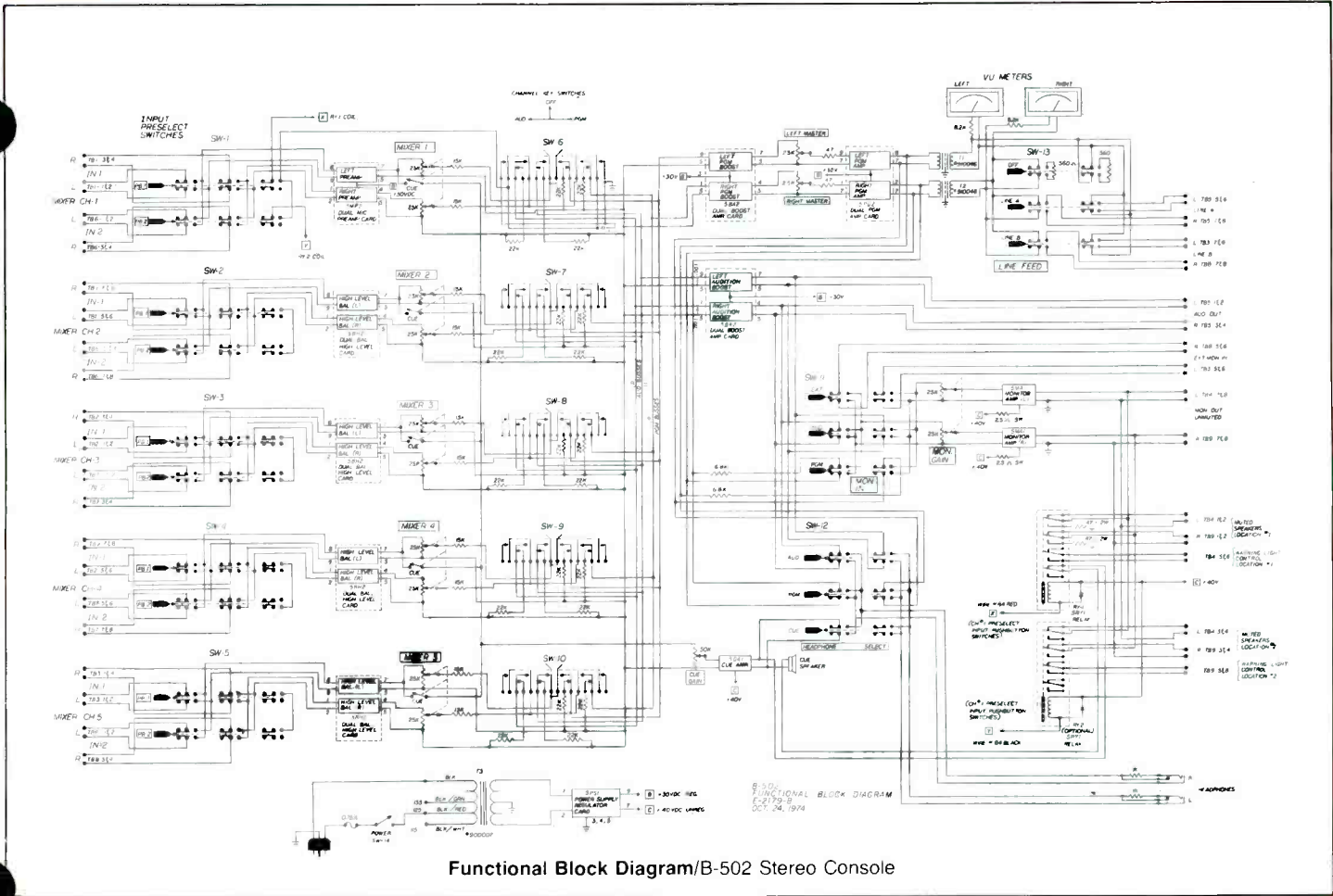

Functional Block Diagram/B-502 Stereo Console

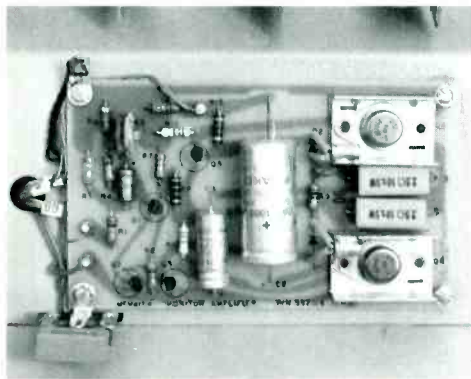

Monitor amplifier



Attenuator, input and program audition select switches

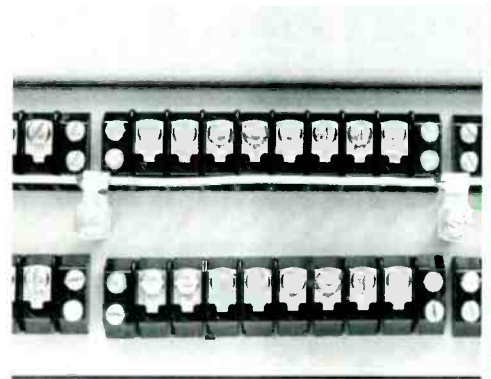

Screw terminal wiring of all inputs—no solder connections

Plug in printed circuit cards

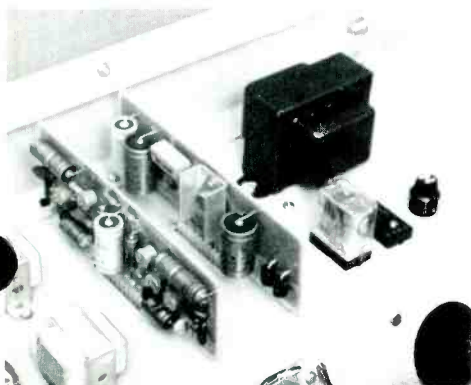

High quality switches used throughout

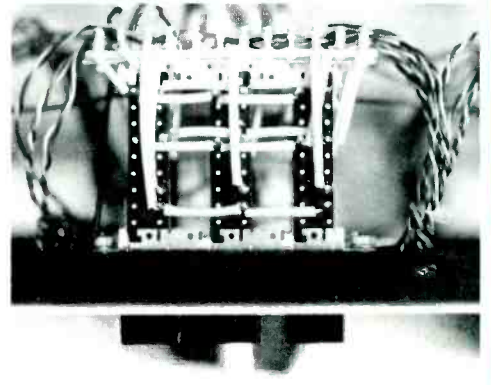
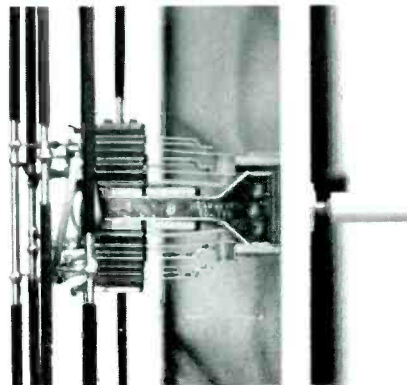

SPECIFICATIONS

PROGRAM CHANNEL(S)

Frequency response ±0.5 dB, 30-15,000 Hz
 Harmonic Distortion 0.5% or less, 30-15,000 Hz @ +18 dBm output
 S/N Ratio 72 dB or greater below +18 dBm output with -50 dBm signal fed to microphone input

Crosstalk B501
 Monaural below noise level
 (audition to program)

B-502

Stereo below noise level
 (left channel to right channel to audition channel)
 Overall Gain 100 ±2 dB
 Output Level +8 dBm for 0 VU meter reading +18 dBm capability

Input Levels

Microphone channels -60 dBm nominal, -34 dBm maximum
 High level channels -15 dBm nominal, +10 dBm maximum

Input Impedances

Microphone channels 150/250 ohms balanced
 High level 50/150/600 ohms balanced
Output Impedances 600 ohms balanced

AUDITION CHANNEL(S)

Output Impedance 2,500 ohms unbalanced
 Level 1.5 volts rms

MONITOR CHANNEL(S)

Frequency Response 1.0 dB, 30-15,000 Hz
 Harmonic Distortion 1.0% or less, 30-15,000 Hz @ 4 watts rms output
 S/N60 dB below 4 watts rms output (through program input)
 Output Level 4 watts rms continuous; 8 watts normal program content

Output Impedance 4-16 ohms unbalanced

TERMINATIONS Barrier screw terminals on rear; space and cutouts to mount two XLR-3 microphone connectors, McMartin Part Number 173003

POWER REQUIRED 115/125/135 VAC 50/60 Hz (230 VAC on special order)
 B-501 40 watts, B-502 50 watts

DIMENSIONS 16" (40.6 cm) deep
 7" (17.8 cm) high
 27" (68.6 cm) wide

WEIGHT 64 lbs.
 Shipping Weight 67 lbs.

FINISH McMartin beige with matte black in mixer control area, wood grain end panels

ORDERING INFORMATION

- B-501** 5 Mixer Monaural Audio Console (one mic, four hi-bal input cards standard) **10-02-041**
- B-501SA** B-501 equipped with step attenuators **10-02-044**
- B-502** 5 Mixer Stereophonic Audio Console (One dual mic, four dual hi-bal input cards standard) **10-02-042**
- B-502SA** B-502 equipped with step attenuators **10-02-045**

Plug-in Input Cards for B-501;

- 5MP1** Plug-in Microphone Preamplifier **10-02-056**
- 5BH1** Plug-in Balanced High Level Input Card **10-02-054**

Plug-in Input Cards for B-502:

- 5MP2** Plug-in Balanced High Preamplifier **10-02-060**
- 5BH2** Plug-in Dual Balanced High Level Input Card **10-02-058**
- 5RY1** Speaker Muting Relay **10-02-064**

FIVE MIXER AUDIO CENTRAL CONTROL UNIT

ACCU-FIVE

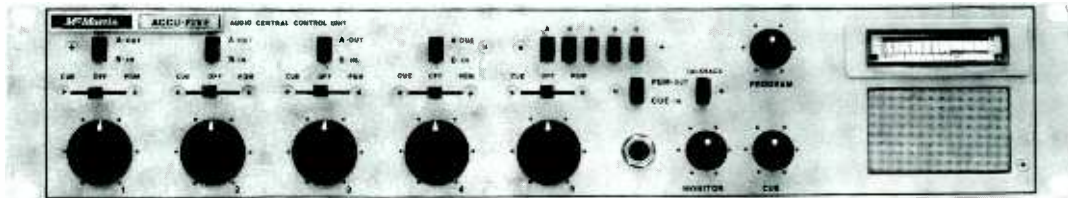

**FULL PROGRAM, MONITOR & CUE FACILITIES
ACCOMMODATES UP TO 13 MICROPHONE INPUTS
HIGH/LOW LEVEL INPUT SWITCHING ON 3 CHANNELS**

**ALL INPUTS TRANSFORMER ISOLATED
COMPLETELY SILICON SOLID STATE
CUE/TALKBACK CAPABILITY**

The McMartin "Accu-Five" five channel mini-console is completely self-contained in a 3½-inch rack-mount unit.

Mixers 1 and 2 are designed to control low level microphone inputs with panel selection of two sources per channel. Loudspeaker muting associated with channel switching for these two mixers is provided.

Mixers 3 and 4 may accommodate either microphone or high level (as from tape devices, turntables, etc.) inputs by means of rear chassis switching. Mixer 5 accommodates five similar type inputs through pre-select pushbutton selection.

All input sources may be previewed by cue bus switching for each channel without disturbing the mixer control positions. A panel mounted cue speaker is driven by the internal cue amplifier. The latter also performs a second function. It serves as a talkback amplifier, permitting communication between the control room and studio. Provision is made for headphone monitoring of program or cue material. When the latter function is used, the cue speaker is muted.

The "Accu-Five," in spite of its compactness, retains truly professional operating parameters. Program output capability is +18dBm with ± 1.0 dB response and 0.5% or lower harmonic distortion, 30-15,000Hz.

The monitor amplifier delivers 4.0 watts rms into an 8-ohm load with ± 1.5 dB response and 1.0% or less THD at full output, 50-15,000Hz.

XL type microphone connectors are used for one each of the two microphone-level inputs to Mixers 1 & 2. All remaining input and output connections are made to screw-type terminals on the rear of the unit.

An illuminated VU meter calibrated for zero-VU deflection when +8dBm appears at the program channel output terminals, permits visual monitoring of the program material.

The "Accu-Five" is ideally suited for broadcast remote or production applications, educational broadcast or training purposes or as the audio complement to closed circuit TV operations.

APR/79

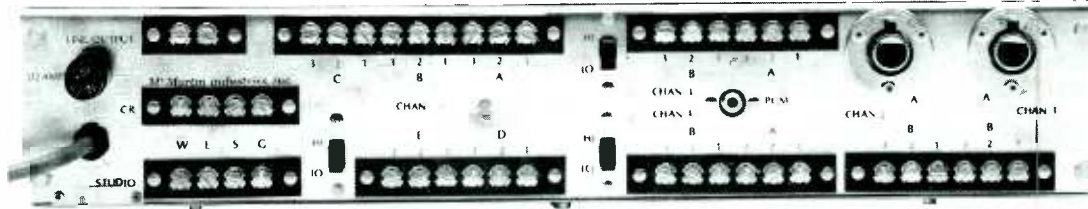

Rear View of ACCU-FIVE

SPECIFICATIONS

PROGRAM CHANNEL

Frequency response: ± 1.0 dB, 30-15,000 Hz

Harmonic distortion: 0.5% or less, 30-15,000Hz @ +18 dBm output and -50dBm signal to any low-level input

S/N ratio: 60dB below +8dBm output produced by -50dBm signal to any low-level input

Overall gain: 100, ± 2 dB

Input impedances: Low level mode: 150-ohms, balanced
High level mode; 600-ohms, balanced

Input levels: Low level mode: -60dBm nom;
-35dBm max.
High level mode: -20dBm nom;
+5dBm max.

Output: 600-ohms balanced (transformer isolated) +8dBm nom; +18dBm max.

CROSSTALK

(Cue to Program Channels): Below system noise

MONITOR CHANNEL:

Frequency response: ± 1.5 dB, 50-15,000 Hz

Harmonic distortion: 1.0% or less, 50-15,000 Hz @ full output

Output level: 4 watts, rms

Output impedance: 8 ohms, unbalanced

POWER

REQUIRED: 120/240 VAC, 60 Hz, 30 Watts

DIMENSIONS: width EIA Standard 19" rack mount, (48 cm)
height 3 1/2", (8.9 cm)
depth 10" overall (25.4 cm)

WEIGHT: actual 12 pounds (5.4 kg)
shipping 16 lbs. (7.2 kg)

FINISH: McMartin Beige

ORDERING INFORMATION

Model	Description	Product Code
ACCU-FIVE	5 Channel rack mount mini-console	10-02-080

DTC-1	Cabinet for desk mounting	30-02-026
-------	---------------------------	-----------

4-CHANNEL REMOTE AMPLIFIER

BR-400

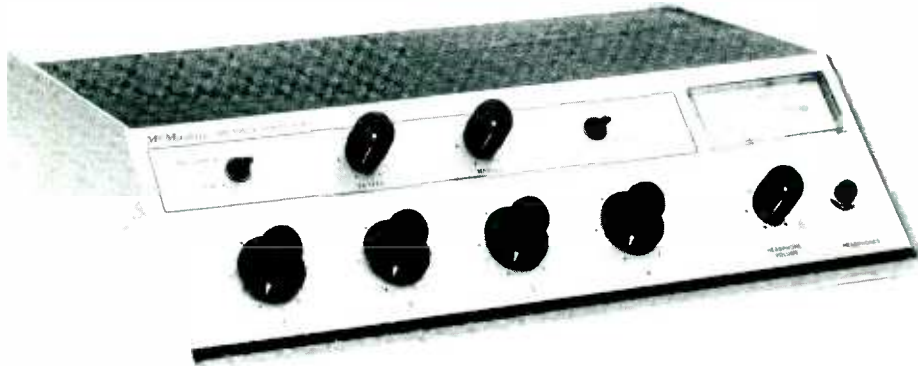

AC LINE/BATTERY OPERATION
RIAA PHONO OPTION — MIXERS #3 & #4
INBUILT TONE GENERATOR

PA FEED
COMPACT, LIGHTWEIGHT
HEADPHONE AMPLIFIER

DESCRIPTION

The McMartin Model BR-400 four-channel broadcast remote amplifier incorporates extreme flexibility in a lightweight portable package and meets today's stringent requirements for high quality remote broadcasting.

Basically, a four-channel, balanced low-impedance microphone mixer, two of the mixing channels are field convertible to RIAA equalized phono operation, or alternatively, to accommodate balanced line-level inputs. In addition to +8 dBm 600-ohm balanced output, visually-monitored by a front panel VU meter, a PA feed output with independent level control is provided. The BR-400 includes an internal 1000 Hz tone generator for presetting levels.

An isolated headphone amplifier with independent level gain control will accommodate low- as well as high-impedance headphones. This amplifier is

switchable to the incoming telephone line where used for remote "cueing" purposes.

The BR-400 is normally powered from 115 Vac power; however, it is designed to house an internal battery power supply with automatic changeover to battery operation in the event of a power line failure. The BR-400 dc supply consists of nine readily-available D-type cells. When rechargeable types are used, the BR-400 provides the means of recharging these by switch operation. Battery life permits approximately 100 hours of continuous operation, with half this time if the VU meter lamp, which may be switched off, is used continuously.

The complete assembly is housed in a durable aluminum enclosure. Ready access to batteries and circuitry is afforded by the hinged top cover/front panel construction.

MAR/76

SPECIFICATIONS

FREQUENCY RESPONSE	± 2.0 dB, 20-20,000 Hz (mic or line level input) (± 2.0 dB RIAA curve phono service)
TOTAL HARMONIC DISTORTION	0.5% or less, 20-20,000 Hz @ +8 dBm output
INPUT IMPEDANCES	150/250 ohms, balanced. Mixers #3 and #4 switchable to 47K-ohm RIAA mag. phono or 600 ohm balanced input.
INPUT LEVELS	-60 dBm (microphone input) -20 dBm (line input) 2.0 mV, equalized phono input
OUTPUTS	
Line out	+8 dBm nominal (+18 dBm max) 600 ohms balanced
PA Feed	0.5 volts rms max (adjustable) 5K-ohms unbalanced. (1.0 V into 25K-ohm or higher-Z load)
Headphone	+8 dBm max (adjustable) 600 to 20K-ohms unbalanced
HUM & NOISE	62 dB or greater below +8 dBm output (equivalent input noise -122 dBm)
OVERALL GAIN	90, ±2, dB

POWER REQUIREMENTS	115 Vac, 50/60 Hz -or- 13 Vdc, 30 milliamperes, (80 ma with meter illuminated), from internal battery pack (nine D-type cells) or external supply
FRONT PANEL CONTROLS	A. Mixer #1 through Mixer #4 B. Master gain control C. PA feed gain control D. Headphone level control E. Cue/program switch F. Power switch
REAR PANEL CONTROLS	A. Tone generator on/off B. RIAA Eq./flat response (Mixers #3 & #4) C. Mic/Line impedance (Mixers #3 & #4) D. Battery on/off charge E. Meter lamp on off F. Battery test button
DIMENSIONS	14" W x 3.5" H x 10.5" D (35.6 x 8.9 x 26.7 cm)
WEIGHT	6.5 pounds, 8.0 pounds with batteries
FINISH	McMartin beige with woodgrain trim
ORDERING INFORMATION	
Model BR-400	4-channel remote amplifier (Supplied less D-cell batteries, which are readily available in the field)

RIAA EQUALIZED PHONO PREAMP

B-200B

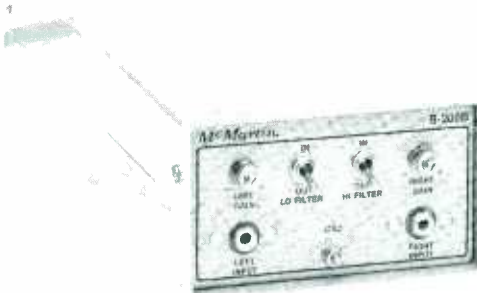

- MONO OR STEREO
- HI/LO FILTERS

- BALANCED OUTPUT

DESCRIPTION

The McMartin B-200 turntable preamplifier for use with either mono or stereo magnetic phono cartridge inputs is suitable for professional, high-performance applications.

The B-200 is completely self-contained. Its frequency response characteristics conform, within 1 dB, with the standard RIAA curve.

Its excellent stereo crosstalk performance is such

that a single B-200 unit may be used for preamplification of two separate mono sources. Both "high" and "low" filters may be switch selected. The "high" filter produces 15 dB attenuation at 20 kHz. The "low" filter attenuates 20 Hz signals by 10 dB.

Individual RCA phono input jacks are provided, with individual channel preset level controls. The outputs are terminated on barrier-type screw terminals.

SPECIFICATIONS

FREQUENCY RESPONSE	± 1.0 dB of RIAA curve
DISTORTION	less than 0.25% at +8 dBm output; (20-20,000 Hz)
NOISE LEVEL	108 dBm equivalent input noise at 1,000 Hz
CROSSTALK	55 dB @ 15,000 Hz 65 dB or greater @ 1,000 Hz
INPUT IMPEDANCE	47 K-ohms, resistive
INPUT SENSITIVITY	2.5 mV @ 1,000 Hz for +8 dBm output (overload: 20 dBV @ 1,000 Hz)
OUTPUT IMPEDANCE	600 ohms, balanced

OUTPUT LEVEL	+ 18 dBm, max.
HIGH FILTER ATTENUATION	- 15 dB @ 20,000 Hz
LOW FILTER ATTENUATION	- 10 dB @ 20 Hz
POWER REQUIREMENTS	115 Vac, 50/60 Hz, 5 watts
DIMENSIONS	2 ³ / ₈ " H x 4 ¹ / ₈ " W x 11 ¹ / ₂ " D (6 x 10.5 x 29.2 cm)
SHIPPING WEIGHT	4 pounds

SEP 76



FOUR MICROPHONE & ONE PROGRAM INPUT CHANNEL

BUILT IN TONE GENERATOR

The McMartin Model MX-5 five-channel mixer/pre-amplifier is a high-quality, high performance unit offering excellent flexibility in the choice of input mixing functions required either for subsequent amplification in sound distribution systems, or for premixing for recording equipment with "line-level" input requirements.

Four balanced, low-level, low impedance inputs, terminated in female, XL-type connectors accommodate 150 ohm microphones. Any of these inputs, by change in internal jumper-plug orientation, may be modified to accept high-impedance, unbalanced microphones. In addition, two of the inputs may be modified for magnetic phono, RIAA equalized, service. By operation of a rear-panel slide switch, the first microphone input channel is converted to a 1000-Hertz tone generator. This permits prechecking of overall system operating levels.

The program-level input mixer accepts either low impedance balanced sources through rear-chassis screw terminals, or unbalanced 25K-ohm input through an RCA phono jack.

The level of the premixed inputs is controlled by a front-panel Master gain control. Output level from the MX-5 is monitored by an illuminated VU meter,

JUN/78

OPERABLE FROM EXTERNAL DC SUPPLY

TWO MIC CHANNELS CONVERTIBLE TO RIAA MAG PHONO SERVICE

with front-panel switching for "zero VU" meter indication of either +4 dBm or +8 dBm line level output levels.

600-ohm, transformer-isolated, balanced line output appears on rear-panel screw terminals. In addition, microphone level, at nominally -40 dBm, is terminated in a male XL-type connector; unbalanced 5K-ohm output appears on an RCA phono jack; and an isolated +18 dBm signal is brought out to a rear, standard ¼-inch phone jack for headphone monitoring. Where desired, the MX-5 may be powered from a 36-volt 70-milliampere, external dc power supply — in lieu of the normal built-in MX-5 power supply which operates from a 120 Vac, 60 Hz power source.

The versatility of the MX-5 operation is enhanced by its compact packaging. The MX-5 is completely self-contained in an attractively-finished blue and silver gray, aluminum housing which is only 12¾" wide, 7½" deep, with a low 2¾" profile.

The MX-5 is a quality instrument, using high-grade, long-life components, most of which are mounted on a single grade G-10, glass epoxy base, printed circuit board for ease of maintenance and servicing.

The MX-5 satisfies the requirement for professional, high quality and reliability sound installations.



Rear View of MX-5

SPECIFICATIONS

INPUTS

Microphone Four (4) Total: Channel #1 switchable to operate as 1 kHz tone generator. Channels #3 and #4 switchable to RIAA equalized magnetic phono service, by simple internal plug reversal

Program One

INPUT IMPEDANCES

Mic Channels 50-150 ohms balanced; switchable to 25K-ohms unbalanced by internal jumper plug. Channels #3 and #4 switchable to 47K-ohms for magnetic phono service by internal plug reversal

Program Channel 600 ohms, balanced (matching) 10K-ohms, balanced (bridging); or 25K-ohms, unbalanced (bridging)

INPUT LEVELS

Mic Channels -60 dBV balanced; -28 dBV overload point; -55 dBV, unbalanced. Channels 3 & 4 in magnetic phono mode: 2 millivolts @ 1 kHz

Program Channel 600 ohms matching; or 10K-ohm bridging; or 100 millivolts, 25K-ohms, unbalanced

FREQUENCY RESPONSE

Mic Channels ±1.0 dB, 50-20,000 Hz, ±2.0 dB, 20-20,000 Hz; Channels #3 & 4 in magnetic phono mode: within 2.0 dB of RIAA curve

Program Channel ±0.5 dB, 50-20,000 Hz; ±1.0 dB, 20-20,000 Hz

NOISE

Mic Channels65 dB (wide band) and 72 dB (with 15 kHz low pass filter) below +8 dBm output, with 3.0 mV input signal. Equivalent Input Noise: -122 dBm. Channels #3 & 4 in magnetic phono mode: -55 dB.

Program Channel80 dB (wide band) and 85 dB (w/15 kHz LP filter) below +18 dBm output.

OUTPUT IMPEDANCES & LEVELS

A) 600 ohms balanced: +4 dBm or +8 dBm nominal by front panel switching; +18 dBm maximum into 600-ohm load.
B) 5K-ohms, unbalanced (isolated) @ 3.0 volts, rms
C) 50/150 balanced: -45 dBm
D) Headphone jack: 600 ohms, unbalanced (isolated) @ +18 dBm

TOTAL HARMONIC & INTERMODULATION DISTORTION

..... 0.5% or less, 20-20,000 Hz @ +8 dBm output level; 1.0% or less, 20-20,000 Hz @ +18 dBm output level

FRONT PANEL CONTROLS

..... Mic #1/tone generator, Mic #2 level, Mic #3 & 4/equalized phono levels, Program level and Master gain

FRONT PANEL SWITCHES

..... Output level, +4 or +8 dBm; power on/off.

REAR PANEL SWITCHES:

..... Mic #1/Tone generator.

REAR PANEL TERMINATIONS

..... Channel #1 to #4 inputs, C1F connectors; Mic Level Output, C1M connector; Balanced program input and balanced 600-ohm output, screw terminals; unbalanced program input and 5K-ohm unbalanced output, RCA phono jack; 36-volt dc external power, two-pin Cinch Jones socket.

POWER REQUIREMENTS

..... 105/125 Vac, 50/60 Hz, 3 watts (Fuse: 1/8 ampere, slow-blow)

DIMENSIONS

..... 12 3/4" (32.4 cm) wide
2 3/4" (7.0 cm) height
7 3/4" (19.7 cm) deep

SHIPPING WEIGHT

..... .6 pounds

FINISH

..... McMartin blue and silver gray

ORDERING INFORMATION

Model	Description	Product Code
MX-5	5 channel mixer/preamplifier	.20-04-045

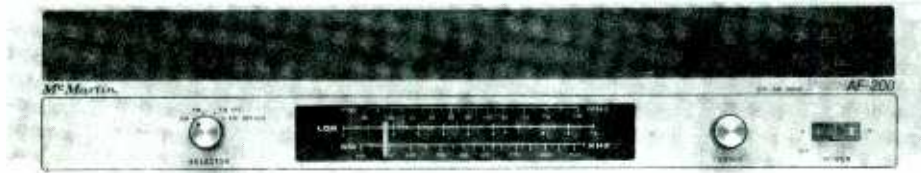

FM AFC
BETWEEN STATION FM SQUELCH
INDEPENDENT MONO/STEREO OUTPUTS
INTEGRATED CIRCUIT FM STEREO DECODER
INTEGRATED CIRCUIT FM IF AND DETECTOR WITH 10.7 MHz BLOCK FILTER

The AF-200 is a high performance, AM/FM/FM stereo, tuner. All silicon transistor and integrated circuit design insures long life and trouble-free performance over a wide range of ambient operating conditions. The FM AFC, regulated power supply and wide-range AGC circuits provide long term stability without readjustment regardless of signal, temperature, or line voltage variations.

The RF amplifier front-end on both the AM and FM sections of the tuner provides excellent selectivity, sensitivity, and rejection of spurious signals.

The high quality, 10.7 MHz IF filter, together with the integrated circuit 10.7 MHz IF amplifier and quadrature detector, provides not only excellent selectivity but also a very linear passband. This results in true high fidelity audio and excellent stereo separation.

The FM and AM mono signal audio output from the tuner board is fed through an additional amplifier and emitter follower stage to provide a high level 600 ohms output. The FM stereo audio outputs are fed through a 38 KHz LC filter after de-emphasis to eliminate any residual switching components from the stereo composite signal.

The AF-200 is attractively packaged in an all-aluminum chassis with 3½" E.I.A. standard rack mount front panel. The front panel is finished in McMartin beige textured enamel, with vinyl leather grain trim.

The AF-200 may also be housed in the McMartin DTC-1 cabinet for desk top mounting.

Front panel controls consist of an illuminated "on-off" rocker switch, function selector, tuning control, and a calibrated slide rule dial with logging and AM /FM frequency scales.

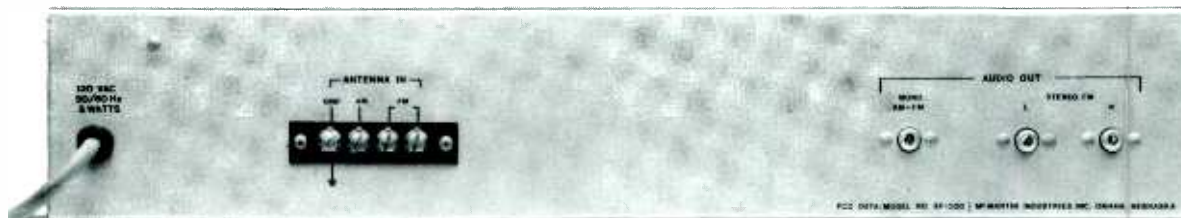

Rear view of AF-200

SPECIFICATIONS

	FM	AM
TUNING RANGE	88-108 MHz	540-1605 KHz
ANTENNA INPUT	300 ohms balanced (screw terminals)	High Impedance, unbalanced (screw terminals)
SENSITIVITY	3 μ V/30dB quieting	30 μ V/20dB S/N @ 30% modulation
SELECTIVITY	-3dB @ 200 KHz -35dB min @ 400 KHz	-10dB @ \pm 10 KHz
IMAGE REJECTION ..	-55dB	-35dB
SPURIOUS RESPONSE	-60dB	-30dB
HARMONIC DISTORTION	1% or less @ 100% modulation	3% or less @ 90% modulation 400 Hz
S/N RATIO	-55dB below 100% modulation with full limiting	-40dB below 30% modulation 5000 μ V input
AF RESPONSE	\pm 1dB 100-15,000 Hz	\pm 2dB 20-5000 Hz
AF OUTPUT (Mono)	1V rms @ 100% modulation 600 ohm load	0.5V rms @ 90% modulation 600 ohm load

	FM	AM
MUTE DEPTH (Squelch)	-50dB	—
AF OUTPUT (Stereo)	0.15V rms @ 100% modulation 5000 ohm load	—
STEREO SEPARATION	30dB minimum @ 1 KHz	—
POWER REQUIRED ..	120V 50/60Hz, 5 watts	—
DIMENSIONS	19 inches (48.3 cm) wide 3 1/2 inches (8.9 cm) high 8 1/2 inches (21.5 cm) deep	—
REAR CHASSIS TERMINATIONS	Audio pin jacks Antennas screw terminals	—
FINISH	McMartin beige with vinyl leather grain trim	—
SHIPPING WEIGHT ..	5 pounds (2.2 kilograms)	—

ORDERING INFORMATION

AF-200	AM/FM/FM Stereo Tuner (Rackmount)	30-01-013
DTC-1	Desk Top Cabinet	30-02-026

TRANSISTOR AMPLIFIERS, 10-15 watts

**LT-80C
108C**



LT-80C shown



10-15 WATTS RMS POWER OUTPUT

LOW PROFILE 3½" HIGH

BALANCED LOW Z MICROPHONE INPUT

MICROPHONE/PROGRAM INPUTS

BUILT-IN ELECTRONIC MUTING (LT-80C)

ELECTRONIC SHORT CIRCUIT PROTECTION

ALL SILICON DESIGN

SINGLE/DUAL RACK MOUNT OPTIONS

The LT-80C and 108C are conservatively rated wide power-bandwidth 10-15 watt rms audio amplifiers. They are designed for system sound applications requiring one microphone and one program source. As many as twenty speakers (tapped ½ watt) may be driven from the 25 or 70.7 volt balanced output, or a single four-ohm speaker system may be driven to a full 15 watts rms from the unbalanced output.

The microphone input is standard balanced low impedance 50/150 ohms with -60 dBm input sensitivity and 30 dB dynamic range. The microphone input is also convertible to high impedance unbalanced input. A three pin XL female connector is provided for microphone termination on the LT-80C. Screw terminal input connection is provided on the 108C.

The LT-80C features a fully electronic page mute system. Actuation of a simple single pole, single-throw switch closure at the microphone location automatically mutes the program channel and energizes the microphone channel for paging purposes. This switching operation is completely free of clicks and pops.

The program channel input is unbalanced 25K ohms with 300 millivolt sensitivity. An optional plug-in trans-

former card, Model MT-3, provides for balanced bridging input with sensitivity of -10 dBm. Input termination is either screw terminals or pin connector for the unbalanced inputs, and screw terminals for balanced input.

A 20 dB treble-cut tone control is provided for high-end roll off of the program channel. The microphone input is wired for 10 dB bass roll-off for crisp voice quality and may be field modified for flat response. On the LT-80C, the tone control is on the front panel and in the 108C, it is a front access, recessed screwdriver adjusted control. An optional gain limit control may be field installed to limit the range of the front panel controls.

Screw terminal output termination allows for connection of unbalanced loads from 4 to 16 ohms. Balanced 25 volt (62.5 ohm) and 70.7 volt (500 ohm) outputs are also provided. Continuous short circuit operation of any output will not damage transistors or the power supply.

Attractive, low profile packaging, with the capability of single or dual-unit optional rack mounts, make the LT-80C and 108C even more flexible in application.

FEB/79



Rear View, LT-80C

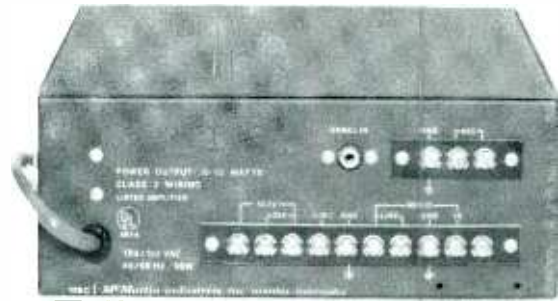

Rear View, 108C

SPECIFICATIONS

POWER OUTPUT:	10 watts rms—16 ohms unbalanced; 25/70.7 volt balanced line 12.5 watts rms—8 ohms unbalanced 15 watts rms—4 ohms unbalanced
FREQUENCY RESPONSE:	± 1 dB, 50-15,000 Hz
DISTORTION:	1% or less, 50-20,000 Hz at 12.5W output
HUM & NOISE:	
MIC:	60 dB below 10 watts output
PGM:	70 dB below 10 watts output
OUTPUTS:	.4/8/16 ohms unbalanced; 25/70.7 volt balanced line
PROGRAM/LINE INPUT:	25K-ohm unbalanced, 600 ohms balanced with optional MT-3 plug-in card
PROGRAM/LINE SENSITIVITY:	300 millivolts, 25K ohm unbalanced input. -10 dBm (balanced 10K ohm bridging with MT-3 plug-in card.) 0 dBm (balanced 600-ohm matching with MT-3 plug-in card.)
OPERATING TEMPERATURE:	to 150°F (66°C)
OVERLOAD PROTECTION:	Solid state protection circuit samples output stage current and disables input signal during excessive loading condition
POWER REQUIRED:	120 Vac, 50/60 Hz, 30 watts (Primary taps for 105 and 125 Vac)
MIC INPUT:	150 ohms balanced
MIC TERMINATION:	
LT-80C	XL Connector
108C	Screw terminals

MUTING:

LT-80C	Electronic muting of microphone and program circuits
108C	None

RESPONSE EQUALIZATION:

LT-80C	Front panel treble cut tone control (-20 dB at 20 kHz) Microphone bass cut (-10 dB at 50 Hz). Flat response possible by change of one capacitor.
108C	Front panel screwdriver adjustment treble cut tone control (-20 dB at 20 kHz); Microphone bass cut (-10 dB at 50 Hz). Flat response possible by change of one capacitor.

DIMENSIONS

height	3½" (8.9 cm)
width	8½" (21.6 cm)
depth	7¼" (18.4 cm)

FINISH:

McMartin Blue and gray

WEIGHT:

actual	4 lbs. (1.8 kg)
shipping	7 lbs. (3.2 kg)

OPTIONAL ACCESSORIES:

MT-3	Plug-in program channel matching/bridging line input card
MRP-3	Single unit rack mounting kit height 3½" (8.9 cm) width 19" (48.3 cm)
MRP-4	Dual unit rack mounting kit (two units racked side by side) height 3½" (8.9 cm) width 19" (48.3 cm)

ORDERING INFORMATION

MODEL	DESCRIPTION	PRODUCT CODE
LT-80C	10-15 watt amplifier	20-04-008
108C	10-15 watt amplifier	20-04-001
MT-3	line input card	20-04-043
MRP-3	single rack mounting kit	30-02-023
MRP-4	dual rack mount kit	30-02-024

25 WATT UNIVERSAL AMPLIFIER

LT-252B



ONE LOW-Z MIC INPUT

ONE LOW-Z MIC/MAG PHONO INPUT

DESK MOUNT

tone compensation

EXCELLENT PERFORMANCE

ONE HI-Z UNBALANCED PROGRAM INPUT CONVERTIBLE TO LOW-Z BALANCED



The McMartin LT-252B is a 25 watt rms silicon solid state amplifier designed for multiple input applications. It is completely self-contained and housed in an attractive cabinet suitable for desk top use.

The LT-252B accommodates two 150 ohm balanced microphone inputs through XLR type connectors and a medium level 25 k ohm unbalanced program input. The program input can accommodate medium level, 600 ohm matching or 10 k ohm bridging signal sources by addition of the optional plug-in MT-3 module.

Front panel tone compensation controls permit ± 15 dB treble and bass boost or cut.

The LT-252B is designed to feed 25 or 70.7 volt balanced; or 4 or 8 ohm unbalanced loads. Where applicable, direct coupled 4 ohm loads by-passing the output transformer provide ± 10 dB frequency response from 50 to 20,000 Hz.

The LT-252B is conservatively designed to provide highly-reliable continuous service.

DEC/80

SPECIFICATIONS

POWER OUTPUT 25 W rms, 35 W music, 50 W peak

FREQUENCY RESPONSE

Microphone Inputs ± 2.0 dB, 200-20,000 Hz, with 10 dB controlled low frequency roll-off. Convertible to ± 21 dB response, 40-20,000 Hz.

Program Input ± 1.0 dB, 50-10,000 Hz; ± 1.0 dB, 50-20,000 Hz with 4 Ω direct-coupled output.

Tone Controls Treble: ± 15 dB at 15,000 Hz.
Bass: ± 15 dB at 50 Hz.

HUM & NOISE

Microphone Inputs 60 dB or greater below RPO with 30 mV reference input signal

Program Input 70 dB or greater below RPO

INPUT SENSITIVITY

Microphone Inputs -60 dBm

Program Input 0.4 V unbalanced. With optional MT-3 plug-in card: 0 dBm, 600 Ω matching; or -10 dBm, 10 k Ω bridging.

INPUTS

Microphone Two (2) 150 Ω balanced.

Program One (1), 25 k Ω unbalanced. Convertible to 600 Ω balanced matching, or 10 k Ω balanced bridging (with optional MT-3 card).

OUTPUTS 25 and 70.7 V balanced; 4 or 8 Ω unbalanced. Unbalanced 4 Ω direct coupled output available on terminal strip.

CONTROLS Two microphone gain; one program gain; one bass boost/cut; one treble boost/cut; illuminated power switch.

OPERATING TEMPERATURE

. Full performance specifications to 150° F (65° C).

POWER REQUIRED 105-115/115-125 VAC, 50/60 Hz, 75 W

DIMENSIONS

height 3 1/2" (8.9 cm)
width 12" (30.5 cm)
depth 8 3/4" (22.3 cm)

WEIGHT

actual 7 1/2 lbs. (3.4 kg)
shipping 10 lbs. (4.5 kg)

FINISH McMartin beige with leather grain trim

ORDERING INFORMATION

Model	Description	Product Code
LT-252B	25 watt amplifier	10-05-003

ACCESSORIES

MT-3	line input card	20-04-043
------	-----------------	-----------

All tests conducted in accordance with EIA Standard SE-101-A where applicable.

ARCHITECTS'S & ENGINEERS' SPECIFICATIONS

The amplifier shall be a McMartin LT-252B, or approved equal. It shall be of all silicon, solid state design and be capable of 25 W rms, 35 W rms music or 50 W peak power output. Only amplifiers meeting all three wattage ratings will be accepted. The amplifier shall have 1.0% or less total harmonic distortion when operated at rated power output level, or below. Frequency response through the microphone inputs shall be ± 2.0 dB or less over the range of 200 to 20,000 Hz with provision by simple field alteration of extending the frequency range to cover 40 to 20,000 Hz. The frequency response of the program input channel shall be within ± 1.0 dB over the spectrum from 50 to 10,000 Hz. The hum and noise level shall be 60 dB or greater below rated power output produced by a 3.0 mV reference input signal through either of the microphone channels. The hum

and noise through the program input channel shall be 70 dB or greater below the rated power output level. The amplifier shall permit ± 5 dB boost/cut at 15,000 Hz and 50 Hz by means of treble/bass front panel controls respectively. The amplifier shall have outputs of 4 and 8 Ω unbalanced and 25 and 70 V balanced configuration. Rear panel termination of a 4 Ω direct coupled output shall be provided.

The amplifier shall be listed by Underwriters Laboratories

The amplifier front panel shall be finished in McMartin beige with leather grain trim, self-contained in an aluminum enclosure of bronze metallic finish, suitable for desk top use.

25 WATT POWER AMPLIFIER

LT-250C



- **LESS THAN 1% DISTORTION**
- **40 - 20,000 Hz FULL POWER FREQUENCY RESPONSE**
- **CURRENT SENSING OVERLOAD PROTECTION**
- **BALANCED 70.7 & 25 VOLT OUTPUTS**
- **BASS CUT SWITCH FOR HORN SPEAKER USE**
- **UNBALANCED 4, 8, & 16 OHM OUTPUTS**

The LT-250C is a 25 watt rms silicon solid-state transistorized amplifier designed for low distortion output over a full power bandwidth of 40-20,000 Hz. The low frequency response of the amplifier can be extended to 20 Hz when operated with the field convertible direct coupled output.

This basic amplifier utilizes plug-connected circuit board construction, with power transistors and power supply components mounted and placed for maximum accessibility. Computer grade capacitors, and conservatively-rated transformers contribute to maximum performance and reliability.

The LT-250C accommodates either an unbalanced high impedance or a 600 ohm balanced program input. The balanced input utilizes a transformer, factory wired for 600 ohms matching. It is easily field modified for 10K ohms bridging without additional components.

The front panel program gain control may be transferred to the rear panel where that location is preferred.

The LT-250C amplifier features an overload protection, fast-acting current-limiting electronic circuit that automatically disables amplifier drive should a potentially harmful overload occur.

The LT-250C amplifier has 70.7 V and 25 V balanced outputs, plus 4, 8, and 16 ohm unbalanced outputs. Input and output connections are on convenient screw terminals.

The amplifier output may be directly coupled to an 8 ohm load. When so operated, the low-end frequency response is extended to 20 Hz.

A rear-panel mounted bass cut switch tailors the amplifier response (14 dB down at 100Hz) in installations where horn speakers are utilized.

The LT-250C, styled in McMartin beige with complementary leather grain accent, is designed for direct mounting in a 19" rack. An attractive desk top cabinet is available.

LT-250C — continuing the excellence in solid-state amplifiers pioneered by McMartin Industries.

JAN/79

SPECIFICATIONS

POWER OUTPUT25 watts rms 35 watts music 50 watts peak
FREQUENCY RESPONSE±1 dB 40-20,000 Hz ±1 dB 20-20,000 Hz direct coupled output
DISTORTIONLess than 1% (40-20,000 Hz) at RPO and below
HUM AND NOISE (Program)85 dB below RPO
PROGRAM INPUTUnbalanced 25K ohms, and balanced 10K ohms bridging or balanced 600 ohms matching
INPUT SENSITIVITY0.4 volts unbalanced 0 dBm 600 ohms matching -10 dBm 10K ohms bridging
OUTPUTSBalanced 70.7 volts and 25 volts; Unbalanced 4, 8, and 16 ohms; Unbalanced 8 ohm direct output
CONTROLSProgram gain; power on/off

ARCHITECTS' & ENGINEERS' SPECIFICATIONS

The amplifier shall be a McMARTIN LT-250C, or approved equal. It shall be of all silicon solid-state construction and capable of 25 watts rms, 35 watts music, 50 watts peak power output. Only amplifiers meeting all three wattage ratings will be accepted. The amplifier shall have less than 1% distortion at rated output and below. The frequency response shall be ±1 dB 40-20,000 Hz with a transformer output, and ±1 dB 20-20,000 Hz with a field strappable direct 8-ohm output. The amplifier noise shall be at least 85 dB below signal at the rated power output. The amplifier shall be designed to operate continuously on line voltages of 105 to 125 Volts, 50/60 Hz over a temperature range of 0° to 150° F. (-18° C to 65° C). The amplifier shall be equipped with a current sensing overload protection circuit that will remove audio drive from the amplifier should an overload or short circuit develop. This protection circuit shall restore the amplifier in one millisecond when the short or overload is removed.

Only amplifiers offering this type of protective circuits shall be acceptable.

The amplifier shall be capable of accepting either a balanced or unbalanced program input without the installation of additional equipment. A transformer shall be permanently installed in the amplifier to accommodate 10K ohm and 600 ohm balanced line inputs, both matching and bridging shall be available. Screw terminals shall be provided for balanced inputs.

POWER REQUIRED105-115 Vac or 115-125 Vac 50/60 Hz 75 watts
DIMENSIONS	height3½" (8.9 cm) width19" (48.3 cm) depth5¾" (14.5 cm)
WEIGHT	actual11 lbs (5 kg) shipping13 lbs (5.9 kg)
OPERATING TEMPERATUREFull performance to 150° F (65° C)
FINISHMcMartin beige with leather grain trim

ORDERING INFORMATION

Model	Description	Product Code
LT-250C	25 watt power amplifier	30-01-002
ACCESSORIES DTC-1	Desk top cabinet height 3½" (8.9 cm) width 19¼" (48.9 cm) depth 9¼" (23.5 cm)	30-02-026

All tests conducted in accordance with EIA Standard SE-101-A where applicable.

The amplifier shall have outputs of 4, 8, and 16 ohms unbalanced, and 70.7 V and 25 V balanced. The balanced circuits shall be capable of being balanced to ground, or floating balanced. A bass cut switch shall be provided that shall attenuate the bass in the output. A 14 dB cut at 100 Hz will be required. Screw type terminals shall be provided for all outputs. A direct coupled 8 ohm output shall be available by strapping the rear panel connector, and the direct coupled output shall provide extended low frequency response down to 20 Hz.

The amplifier shall be equipped with a program gain control, and an illuminated power on/off switch.

The amplifier shall have an unswitched 115 volt 3 wire grounded accessory outlet.

The amplifier shall be listed by Underwriters Laboratories and the Canadian Standards Association.

The amplifier shall be McMartin beige with a leather grain trim.

The amplifier shall be capable of being directly mounted in a 19" relay rack, and shall be supplied with, capable of being housed in a complementary appearing desk top housing.

50 WATT POWER AMPLIFIER

LT-500D

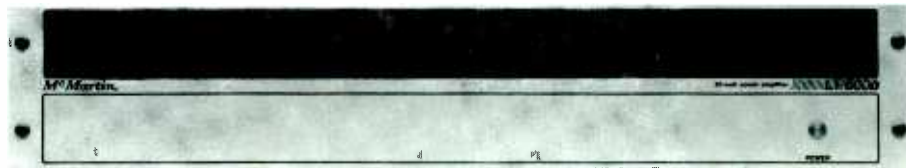

65 WATT RMS EIA RATING
50 WATT RMS CONTINUOUS RATING
DUAL SLOPE LOAD LINE PROTECTION
CONSTANT CURRENT AND THERMAL BIAS STABILIZATION
LESS THAN 0.25% THD AT RATED OUTPUT 20-20,000 Hz ON DIRECT OUTPUT
LESS THAN 1% THD AT RATED OUTPUT 30-20,000 Hz ON 70.7 V LINE.
FULL PERFORMANCE OVER -40°C TO +65°C TEMPERATURE RANGE
SIMPLE, RUGGED CONSTRUCTION FOR LONG TERM RELIABILITY
LOW PROFILE 3½" PANEL HEIGHT

The McMartin LT-500D is a professional quality power amplifier rated for continuous 50 watt rms output. This new D version amplifier is equipped with dual slope load line protection to protect the driver-output components and power supply during output shorts and overload, or input overdrive.

A low-cut filter provides a low frequency roll-off of 10 dB at 100 Hz to protect horn drivers from low frequency transients. Input provisions include a built-in balanced line input transformer for 600 ohm matching input or 10 K ohm bridging input.

Sufficient gain is provided to drive the amplifier to full output from a -20 dBm line level input. A 25 K ohm (nominal) unbalanced input is also provided for direct drive from unbalanced sources. A unique input pad configuration also permits balanced bridging input from balanced line sources up to 100 volts rms. This provides cascading of amplifiers for system expansion as a "booster" amplifier from the 70.7 volt system feed of another amplifier. Sound systems may therefore be expanded as buildings are enlarged without adding a "home run" line back to the central feed point, and without increased loading of the existing system. Removal of the front panel without exposure to live circuitry also permits easy mounting of the LT-500D

amplifier to a structure or enclosure other than a standard E.I.A. rack cabinet. Computer grade electrolytic capacitors and oversized transformers provide safe, full performance operation over a temperature range of -40°C to +65°C.

Circuit design of the power amplifier section is also all new. The use of an integrated circuit predriver and dual slope load line protection network together with a conjugate full complimentary output section provides the ultimate in simplicity, ruggedness, and performance. The constant current biasing used in the predriver also maintains absolute AB₂ bias stabilization over extreme variations in power line voltage and temperature.

Installation and servicing of all "D" version amplifiers provides the ultimate in simplicity. The removable front panel provides ease of handling of the chassis assembly during rack mounting even if other units or panels are installed directly above and below the rack opening. This also provides access to the power supply components and output devices. Removal of the rear panel provides access to the circuit board, input transformer and other circuit components. This panel may be opened and locked in place for tests and servicing.

OCT/78



Rear View of LT-500D

SPECIFICATIONS

POWER OUTPUT

Direct Output	50 watts rms 20-20,000 Hz at less than 0.25% THD (0.15% or less typical)
70.7 V Output	50 watts rms 30-20,000 Hz at less than 1% THD (0.5% or less typical)

FREQUENCY

RESPONSE:

Direct Output	±1 dB 20-20,000 Hz
70.7 V Output	±1 dB 30-20,000 Hz

INPUT SENSITIVITY

Unbalanced	.80 MV for RPO
Balanced 600 ohms or 10 K bridging	-20 dBm

HUM AND NOISE

	-80 dB below RPO (-90 dB typical)
--	--------------------------------------

I.M. DISTORTION

	Less than 0.5% 100 MW to RPO
--	------------------------------

LOW CUT FILTER

	-3 dB @ 300 Hz
	-10 dB @ 100 Hz
	-20 dB @ 40 Hz

REGULATION:

70.7 V Output	.2 dB or less NL to FL (1 dB typical)
---------------	--

OPERATING

TEMPERATURE

	-40°C to +65°C
--	----------------

POWER REQUIRED

	.120 VAC nominal 50/60 Hz 90 W @ RPO, 20 W idle
--	--

INPUTS:

Unbalanced	.25 K ohms nominal
Balanced	.600 ohms matching or 10 K ohms bridging

OUTPUTS:

Unbalanced	.4 and 8 ohms
Balanced	.25 & 70.7 V

CONTROLS:

External	Input level Lo Filter In-Out
Internal	Bias Adjust

INDICATORS

	Power "on"
--	------------

PROTECTION

	Electronic and 1.5 amp fuse
--	-----------------------------

DIMENSIONS

	3.5" (8.9 cm) high
	19" (48.3 cm) wide
	8" (20.4 cm) deep

SHIPPING WEIGHT

	.15 lbs. (6.8 Kgms)
--	---------------------

FINISH

	Beige front panel with leather grain trim; caustic etched aluminum chassis
--	--

ORDERING INFORMATION

MODEL	DESCRIPTION	PRODUCT CODE
LT-500D	50 Watt Power Amplifier	.30-01-014

All tests conducted in accordance with EIA Standard SE-101-A and SE-104 where applicable.

ARCHITECTS AND ENGINEERS SPECIFICATIONS

The power amplifier shall be a McMartin model LT-500D or approved equal, all silicon type, solid state amplifier. The amplifier shall have a continuous power output rating of 50 watts rms at less than 1% THD over the frequency range of 30 to 20,000 Hz with all components operating within safe limits. Reserve power shall be available to produce 65 watts rms from 50 to 15,000 Hz at less than 5% THD for use in commercial and industrial paging applications. The amplifier shall have a frequency response of ±1 dB 30-20,000 Hz and an input sensitivity of 80 MV unbalanced and -20 dBm balanced. Hum and noise shall be at least 80 dB below rated output. Intermodulation distortion from 100 MW to RPO shall be less than 0.5%. A low-cut filter shall provide at least 10 dB attenuation at 100 Hz and 20 dB at 40 Hz. Input impedance shall be unbalanced 25 K ohm and balanced 600 or 10,000 ohm bridging with built-in line

transformer. Output regulation shall be less than 2 dB no load to full load at RPO on the 70.7 V output. Controls for gain, low filter "IN-OUT" and a power "on" indicator shall be provided. Power requirements shall be 105 to 130 VAC, 50/60 Hz single phase and the amplifier shall draw no more than 20 watts with no input signal and 90 watts at 50 watts rms output. Outputs shall be 4 and 8 ohms unbalanced, and 25 and 70.7 volts balanced. Protection shall be load line limiting electronic protection and an AC line fuse for power supply protection. The shipping weight shall be 15 lbs. (6.8 Kgms). The amplifier shall be a standard 19 inch (48.3 cm) rack panel mounted, having a height of 3.5 inches (8.9 cm) and a depth of 8 inches (20.9 cm). Finish shall be McMartin beige with leather grain trim. Access to all components shall be available through removal of the front panel and rear chassis terminal cover.

100 WATT POWER AMPLIFIER

LT-1000D



125 WATT RMS EIA RATING

100 WATT RMS CONTINUOUS RATING

DUAL SLOPE LOAD LINE PROTECTION

CONSTANT CURRENT AND THERMAL BIAS STABILIZATION

LESS THAN 0.25% THD AT RATED OUTPUT 20-20,000 Hz ON DIRECT OUTPUT

LESS THAN 1% THD AT RATED OUTPUT 30-20,000 Hz ON 70.7 V LINE.

FULL PERFORMANCE OVER -40°C TO +65°C TEMPERATURE RANGE

SIMPLE, RUGGED CONSTRUCTION FOR LONG TERM RELIABILITY

LOW PROFILE 3½" PANEL HEIGHT



The McMartin LT-1000D is a professional quality power amplifier rated for continuous 100 watt rms output. This new D version amplifier is equipped with dual slope load line protection to protect the driver-output components and power supply during output shorts and overload, or input overdrive.

A low-cut filter provides a low frequency roll-off of 10 dB at 100 Hz to protect horn drivers from low frequency transients. Input provisions include a built-in balanced line input transformer for 600 ohm matching input or 10 K ohm bridging input.

Sufficient gain is provided to drive the amplifier to full output from a -20 dBm line level input. A 25 K ohm (nominal) unbalanced input is also provided for direct drive from unbalanced sources. A unique input pad configuration also permits balanced bridging input from balanced line sources up to 100 volts rms. This provides cascading of amplifiers for system expansion as a "booster" amplifier from the 70.7 volt system feed of another amplifier. Sound systems may therefore be expanded as buildings are enlarged without adding a "home run" line back to the central feed point, and without increased loading of the existing system. Removal of the front panel without exposure to live circuitry also permits easy mounting of the LT-1000D

amplifier to a structure or enclosure other than a standard E.I.A. rack cabinet. Computer grade electrolytic capacitors and oversized transformers provide safe, full performance operation over a temperature range of -40°C to +65°C.

Circuit design of the power amplifier section is also all new. The use of an integrated circuit predriver and dual slope load line protection network together with a conjugate full complimentary output section provides the ultimate in simplicity, ruggedness, and performance. The constant current biasing used in the predriver also maintains absolute AB₂ bias stabilization over extreme variations in power line voltage and temperature.

Installation and servicing of all "D" version amplifiers provides the ultimate in simplicity. The removable front panel provides ease of handling of the chassis assembly during rack mounting even if other units or panels are installed directly above and below the rack opening. This also provides access to the power supply components and output devices. Removal of the rear panel provides access to the circuit board, input transformer and other circuit components. This panel may be opened and locked in place for tests and servicing.

OCT/78



Rear View of LT-1000D

SPECIFICATIONS

POWER OUTPUT

Direct Output	100 watts rms 20-20,000 Hz at less than 0.25% THD (0.15% or less typical)
70.7 V Output	100 watts rms 30-20,000 Hz at less than 1% THD (0.5% or less typical)

FREQUENCY RESPONSE:

Direct Output	±1 dB 20-20,000 Hz
70.7 V Output	±1 dB 30-20,000 Hz

INPUT SENSITIVITY

Unbalanced	.80 MV for RPO
Balanced 600 ohms or 10 K bridging	-20 dBm

HUM AND NOISE

	-80 dB below RPO (-90 dB typical)
--	--------------------------------------

I.M. DISTORTION

	Less than 0.5% 100 MW to RPO
--	------------------------------

LOW CUT FILTER

	-3 dB @ 300 Hz
	-10 dB @ 100 Hz
	-20 dB @ 40 Hz

REGULATION:

70.7 V Output	.2 dB or less NL to FL (1 dB typical)
---------------	--

OPERATING TEMPERATURE

	-40°C to +65°C
--	----------------

POWER REQUIRED

	.120 VAC nominal 50/60 Hz 190 W @ RPO, 25 W idle
--	---

INPUTS:

Unbalanced	.25 K ohms nominal
Balanced	.600 ohms matching or 10 K ohms bridging

OUTPUTS:

Unbalanced	.4 and 8 ohms
Balanced	.25 & 70.7 V

CONTROLS:

External	Input level Lo Filter In-Out
Internal	Bias Adjust

INDICATORS

	Power "on"
--	------------

PROTECTION

	Electronic and 2.5 amp fuse
--	-----------------------------

DIMENSIONS

	3.5" (8.9 cm) high
	19" (48.3 cm) wide
	8" (20.4 cm) deep

SHIPPING WEIGHT

	.20 lbs. (9.2 Kgms)
--	---------------------

FINISH

	Beige front panel with leather grain trim; caustic etched grain aluminum chassis
--	--

ORDERING INFORMATION

MODEL	DESCRIPTION	PRODUCT CODE
LT-1000D	100 Watt Power Amplifier	30-01-015

All tests conducted in accordance with EIA Standard SE-101-A and SE-104 where applicable.

ARCHITECTS AND ENGINEERS SPECIFICATIONS

The power amplifier shall be a McMartin model LT-1000D, or approved equal, all silicon type, solid state amplifier. The amplifier shall have a continuous power output rating of 100 watts rms at less than 1% THD over the frequency range of 30 to 20,000 Hz with all components operating within safe limits. Reserve power shall be available to produce 125 watts rms from 50 to 15,000 Hz at less than 5% THD for use in commercial and industrial paging applications. The amplifier shall have a frequency response of ±1 dB 30-20,000 Hz and an input sensitivity of 80 MV unbalanced and -20 dBm balanced. Hum and noise shall be at least 80 dB below rated output. Intermodulation distortion from 100 MW to RPO shall be less than 0.5%. A low-cut filter shall provide at least 10 dB attenuation at 100 Hz and 20 dB at 40 Hz. Input impedance shall be unbalanced 25K ohm and balanced 600 or 10,000 ohm bridging with built-in line

transformer. Output regulation shall be less than 2 dB no load to full load at RPO on the 70.7 V output. Controls for gain, low filter "IN-OUT" and a power "on" indicator shall be provided. Power requirements shall be 105 to 130 VAC, 50/60 Hz single phase and the amplifier shall draw no more than 25 watts with no input signal and 190 watts at 100 watts rms output. Outputs shall be 4 and 8 ohms unbalanced, and 25 and 70.7 volts balanced. Protection shall be load line limiting electronic protection and an AC line fuse for power supply protection. The shipping weight shall be 20 lbs (9.2 Kgms). The amplifier shall be a standard 19 inch (48.3 cm) rack panel mounted, having a height of 3.5 inches (8.9 cm) and a depth of 8 inches (20.9 cm). Finish shall be McMartin beige with leather grain trim. Access to all components shall be available through removal of the front panel and rear chassis terminal cover.

200 WATT POWER AMPLIFIER

LT-2000D

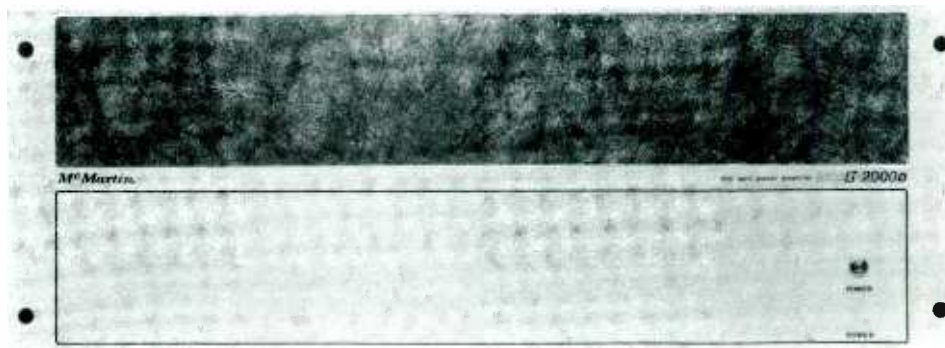

250 WATT rms E.I.A. RATING

200 WATT rms CONTINUOUS RATING

FAILSAFE ELECTRONIC PROTECTION



CONSTANT CURRENT AND THERMAL BIAS STABILIZATION

LESS THAN 1% THD AT RATED OUTPUT 50-10,000 Hz ON 70.7 V LINE

FULL PERFORMANCE OVER -40°C TO +65°C TEMPERATURE RANGE

MODULAR CONSTRUCTION WITH REMOVABLE REAR CIRCUIT ASSEMBLY

The McMartin LT-2000D is a professional quality power amplifier rated for continuous 200 watt rms output. The "D" version amplifiers are all equipped with a new improved instantaneous shutdown, automatic reset, all electronic M-Gard protection network. This circuit prevents damage to the driver-output components and power supply during output shorts and overload or input overdrive.

A low-cut filter provides a low frequency roll-off of 10 dB at 100 Hz to protect horn drivers from low frequency transients. Input provisions include a built-in balanced line input transformer for 600 ohm matching input or 10K ohm bridging. Sufficient gain is provided to drive the amplifier to full output from a -20 dBm line level input. A 25K ohm (nominal) unbalanced input is also provided for direct drive from unbalanced sources. A unique input pad configuration also permits balanced bridging input from balanced line sources up to 100 volts rms. This provides cascading of amplifiers for system expansion as a "booster" amplifier from the 70.7 volt system feed of another amplifier. Sound systems may therefore be expanded as buildings are

enlarged without adding a "home run" line back to the central feed point, and without increased loading of the existing system. Computer grade electrolytic capacitors and oversized transformers provide safe, full performance operation over a temperature range of -40°C to +65°C.

Installation and servicing of all "D" version amplifiers provides the ultimate in simplicity. The removable front panel provides ease of handling of the heavy chassis assembly during rack mounting, even if other units or panels are installed directly above and below the rack opening. This also provides access to the power supply components for servicing. The entire amplifier circuit assembly is mounted on the removable rear panel. The rear panel contains the driver and protection circuit board input-output terminations, and the output stage heatsinks and devices. This panel may either be opened and locked in place for tests and field servicing, or it may be completely unplugged and removed for bench servicing without removing the heavy power supply assembly from the rack installation.

JUNE/79

SPECIFICATIONS

POWER OUTPUT:	
Continuous rms @ less than 1% THD:	
Direct Output200 watts 50-15,000 Hz
70.7 Volt Output200 watts 50-10,000 Hz
E.I.A. Rating less than 5% THD250 watts 50-10,000 Hz
FREQUENCY RESPONSE:	
Direct Output	±1 dB, 30-20,000 Hz
70.7 Volt Output	±1 dB, 30-15,000 Hz
INPUT SENSITIVITY:	
Unbalanced80 MV for Rated Power Output
Balanced 600 ohms or 10K bridging	-20 dBm
HUM & NOISE	-80 dB below RPO
I.M. DISTORTION	Less than 0.5% 100 MV to RPO
LOW CUT FILTER	-3 dB @ 300 Hz -10 dB @ 100 Hz -20 dB @ 40 Hz
REGULATION	
70 V OUTPUT2 dB or less
OPERATING TEMPERATURE	
	-40°C to +65°C

POWER REQUIRED	120 VAC nominal, 50/60 Hz 500 watts @ RPO 45 W idle	
INPUTS:		
Unbalanced25K ohms	
Balanced	600 ohm matching 10K ohm bridging	
OUTPUTS:		
Unbalanced	1.5 and 8 ohms	
Balanced25 and 70.7 V	
CONTROLS:		
External	Input level Lo filter "IN-OUT"	
Internal	Input gain limit Current trip level	
INDICATORS	Power on	
PROTECTION	Electronic and 6.2 amp fuse	
DIMENSIONS	7"(17.8 cm) High 19"(48.3 cm) wide 11"(27.9 cm) depth	
WEIGHT	actual 57.0 lbs (25.8 kg) shipping 60.0 lbs (27.2 kg)	
FINISH:	Beige front panel with leather grain trim; Caustic-etched aluminum chassis	
ORDERING INFORMATION:		
Model	Description	Product Code
LT-2000D200 Watt Power Amplifier	30-01-016

All tests conducted in accordance with E.I.A. Standard SE-101-A and SE-104 where applicable.

ARCHITECTS AND ENGINEERS SPECIFICATIONS

The power amplifier shall be a McMartin model LT-2000D, or approved equal, all silicon type, solid state amplifier. The amplifier shall have a continuous power output rating of 200 watts rms at less than 1% THD over the frequency range of 50 to 10,000 Hz with all components operating within safe limits. Reserve power shall be available to produce 250 watts rms from 50 to 10,000 Hz at less than 5% THD for use in commercial and industrial paging applications requiring only intermittent duty operation. The amplifier shall have a frequency response of 30 to 15,000 Hertz ±1 dB and an input sensitivity of 80 MV unbalanced and -20 dBm balanced. Hum and noise shall be at least 80 dB below rated output. Intermodulation distortion from 100 MW to RPO shall be less than 0.5%. A low-cut input filter shall provide at least 10 dB attenuation at 100 Hz and 20 dB at 40 Hz. Input impedance shall be unbalanced 25K ohm and balanced

600 or 10,000 ohm bridging with built-in line transformer. Regulation shall be better than 2 dB. Controls for gain, filter "IN-OUT" and a power "ON" indicator shall be provided. Power requirements shall be 105 to 130 VAC, 50/60 Hz single phase and the amplifier shall draw no more than 45 watts with no input signal and 500 watts at 200 watts rms output. Outputs shall be 1.5 and 8 ohms unbalanced and 25 and 70.7 V volts balanced. Protection shall be self-resetting electronic shutdown and an AC line fuse for power supply protection. The shipping weight shall be 60 pounds (27 Kgms). The amplifier shall be a standard 19 inch (48.3 cm) rack panel mounted, having a height of 7 inches (17.8 cm) and a depth of 11 inches (48.3 cm). Finish shall be McMartin beige with leather-cut grain trim. Access to all components shall be available through removal of the front panel and rear chassis assembly.

350 WATT POWER AMPLIFIER

LT-3500D

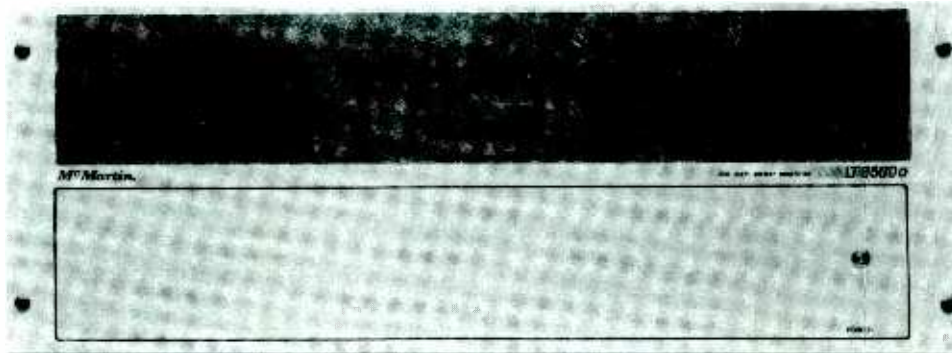

425 WATT rms E.I.A. RATING

350 WATT rms CONTINUOUS RATING

FAILSAFE ELECTRONIC PROTECTION

CONSTANT CURRENT AND THERMAL BIAS STABILIZATION

LESS THAN 1% THD AT RATED OUTPUT 50-10,000 Hz ON 70.7 V LINE

FULL PERFORMANCE OVER -40°C TO +65°C TEMPERATURE RANGE

MODULAR CONSTRUCTION WITH REMOVABLE REAR CIRCUIT ASSEMBLY



The McMartin LT-3500D is a professional quality power amplifier rated for continuous 350 watt rms output. The "D" version amplifiers are all equipped with a new improved instantaneous shutdown, automatic reset, all electronic M-Gard protection network. This circuit prevents damage to the driver-output components and power supply during output shorts and overload or input overdrive.

A low-cut filter provides a low frequency roll-off of 10 dB at 100 Hz to protect horn drivers from low frequency transients. Input provisions include a built-in balanced line input transformer for 600 ohm matching input or 10K ohm bridging. Sufficient gain is provided to drive the amplifier to full output from a -20 dBm line level input. A 25K ohm (nominal) unbalanced input is also provided for direct drive from unbalanced sources. A unique input pad configuration also permits balanced bridging input from balanced line sources up to 100 volts rms. This provides cascading of amplifiers for system expansion as a "booster" amplifier from the 70.7 volt system feed of another amplifier. Sound systems may therefore be expanded as buildings are

enlarged without adding a "home run" line back to the central feed point, and without increased loading of the existing system. Computer grade electrolytic capacitors and oversized transformers provide safe, full performance operation over a temperature range of -40°C to +65°C.

Installation and servicing of all "D" version amplifiers provides the ultimate in simplicity. The removable front panel provides ease of handling of the heavy chassis assembly during rack mounting, even if other units or panels are installed directly above and below the rack opening. This also provides access to the power supply components for servicing. The entire amplifier circuit assembly is mounted on the removable rear panel. The rear panel contains the driver and protection circuit board, input-output terminations, and the output stage heatsinks and devices. This panel may either be opened and locked in place for tests and field servicing, or it may be completely unplugged and removed for bench servicing without removing the heavy power supply assembly from the rack installation.

JUNE/79

SPECIFICATIONS

POWER OUTPUT:	
Continuous rms @ less than 1% THD:	
Direct Output	350 watts 50–15,000 Hz
70.7 Volt Output	350 watts 50–10,000 Hz
E.I.A. Rating less than 5% THD	425 watts 50–10,000 Hz
FREQUENCY RESPONSE:	
Direct Output	±1 dB, 30–20,000 Hz
70.7 Volt Output	±1 dB, 30–15,000 Hz
INPUT SENSITIVITY:	
Unbalanced	80 MV for Rated Power Output
Balanced 600 ohms or 10K bridging	–20 dBm
HUM & NOISE	–80 dB below RPO
I.M. DISTORTION	Less than 0.5% 100 MV to RPO
LOW CUT FILTER	–3 dB @ 300 Hz –10 dB @ 100 Hz –20 dB @ 40 Hz
REGULATION 70 V OUTPUT	2 dB or less
OPERATING TEMPERATURE	–40°C to +65°C

POWER REQUIRED	120 VAC, nominal 50/60 Hz 800 watts @ RPO 45 W idle	
INPUTS:		
Unbalanced	25K ohms	
Balanced	600 ohm matching 10K ohm bridging	
OUTPUTS:		
Unbalanced	1.5 ohms	
Balanced	70.7V	
CONTROLS:		
External	Input level Low filter "IN-OUT"	
Internal	Input gain limit Current trip level	
INDICATORS	Power on	
PROTECTION	Electronic and 10 amp fuse	
DIMENSIONS	height7" (17.8 cm) width19" (48.3 cm) depth11" (27.9 cm)	
WEIGHT	actual65.0 lbs (29.4 kg) shipping70.0 lbs (32.0 kg)	
FINISH	Beige front panel with leather grain trim; Caustic-etched aluminum chassis	
ORDERING INFORMATION:		
Model	Description	Product Code
LT-3500D	350 watt power amplifier	30-01-017

All tests conducted in accordance with E.I.A. Standard SE-101-A and SE-104 where applicable.

ARCHITECTS AND ENGINEERS SPECIFICATIONS

The power amplifier shall be a McMartin model LT-3500D, or approved equal, all silicon type solid state amplifier. The amplifier shall have a continuous power output rating of 350 watts rms at less than 1% THD over the frequency range of 50 to 10,000 Hz with all components operating within safe limits. Reserve power shall be available to produce 425 watts rms from 50 to 10,000 Hz at less than 5% THD for use in commercial and industrial paging applications requiring only intermittent duty operation. The amplifier shall have a frequency response of 30 to 15,000 Hertz ±1 dB and input sensitivity of 80 MV unbalanced and –20 dBm balanced. Hum and noise shall be at least 80 dB below rated output. Intermodulation distortion from 100 MW to RPO shall be less than 0.5%. A low-cut input filter shall provide at least 10 dB attenuation at 100 Hz and 20 dB at 40 Hz. Input impedance shall be unbalanced 25K ohm and balanced 600 or

10,000 ohm bridging with built-in line transformer. Regulation shall be better than 2 dB. Controls for gain, filter "IN-OUT" and a power "ON" indicator shall be provided. Power requirements shall be 105 to 130 VAC, 50/60 Hz single phase and the amplifier shall draw no more than 45 watts with no input signal and 800 watts at 350 watts rms output. Outputs shall be 1.5 ohms unbalanced and 70.7 volts balanced. Protection shall be self resetting electronic shutdown and an AC line fuse for power supply protection. The shipping weight shall be 70 pounds (32 Kgms). The amplifier shall be standard 19 inch (48.3 cm) rack panel mounted, having a height of 7 inches (17.8 cm), and a depth of 11 inches (27.9 cm). Finish shall be McMartin beige with leather grain trim. Access to all components shall be available through removal of the front panel and rear chassis assembly.

AM RF AMPLIFIER

RF-85B



MINIMUM ENVELOPE DISTORTION
AUTOMATIC GAIN CONTROL
REMOTE/LOCAL POWER CHANGE SWITCHING

1.0 MILLIVOLT SENSITIVITY
CARRIER FAILURE ALARM
MOD/FREQ MONITOR OUTPUT

The McMartin Model RF-85B AM RF amplifier is intended for off-air operation of FCC Type Approved AM modulation/frequency monitors.

Special attention has been placed on amplifying the incoming signal with minimum disturbance of the modulation envelope. This includes consideration of providing adequate reserve amplification to accommodate signals with positive modulation peaks in excess of 100%.

The RF-85B uses Class A amplification through the modulation monitor drive circuitry. The frequency monitor output is heavily limited to strip the modula-

tion and produces an approximately square wave output.

The AGC is effective over a 30 dB input signal range and maintains the output level within 0.5 dB for this wide variation in input level.

A high-low panel switch, remotable through an external contact closure, accommodates dual power situations. The RF-85B is equipped with a carrier-failure relay which operates on carrier interruptions of one second or longer duration. The relay contacts are terminated for connection of external visual or aural alerting devices.

JAN/79

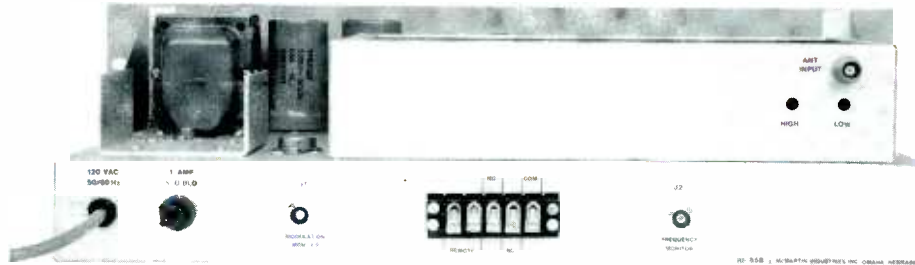

Rear view of RF-85B

SPECIFICATIONS

FREQUENCY RANGE:540-1600 kHz

INPUT SENSITIVITY:1.0 millivolts, minimum

INPUT IMPEDANCE:50 ohms unbalanced, nominal

SELECTIVITY:down 1.0 dB or less, ± 10 kHz
down 40.0 dB or greater, ± 40 kHz

S/N RATIO:50 dB or greater below 100% modulation (with 1.0 millivolt input signal)

AGC RANGE: 30 dB variation in input level produces less than 0.5 dB output level change

OUTPUTS

Modulation Monitor: ...0 to 0.5 watts, unmodulated carrier, 50 ohms

Frequency Monitor: ...5 volts, peak-to-peak, square wave, 1K-ohm

TEMPERATURE RANGE:0° to 50° Celsius

REAR CHASSIS

TERMINATIONS: 1. Input (BNC)
 2. Mod. Mon. out (BNC)
 3. Freq. Mon. out (BNC)
 4. Carrier failure alarm
 5. Remote power level switching

POWER REQUIRED:117 Vac, 50/60 Hz

DIMENSIONS:EIA standard rack,
19" (48.3 cm) width
5 1/4" (13.3 cm) height
10" (25.5 cm) depth

WEIGHT10 lbs. (4.4 kgms)

FINISH: McMartin Beige with woodgrain trim

ORDERING INFORMATION

Model	Description	Product Code
RF-85B	Am RF Amplifier	10-03-104

AM FIXED - FREQUENCY TUNER

AMR - 1



**RACK MOUNT
SELF - CONTAINED
DESIGNED FOR E.B.S. OR OFF-AIR MONITORING**

The McMartin Model AMR - 1 is a low cost, high performance, single channel AM broadcast receiver for use as a reliable off-air source for house monitoring systems.

It is also intended as a companion AM receiver unit for use with the McMartin Model EBS - 2 EBS Decoder.

The AMR - 1 contains a monolithic silicon integrated circuit from which the RF amplifier, IF amplifier, mixer, oscillator, and AGC detector are constructed.

It operates on the superheterodyne principle with a 455 kHz IF frequency. A cascode IF amplifier with

controlled output impedance and negligible Miller-effect eliminates regeneration and selectivity skewing. A discrete diode detector and audio amplifier are also provided from which both 600 ohm balanced output at a 0 dBm level, as well as unbalanced audio at a nominal 1.0 volt level are brought out to rear chassis screw terminals. The latter serves as audio drive for the EBS - 2 monitor. The AMR - 1 circuitry also includes a carrier off relay closure to activate external alarm devices in the event the control system becomes inoperative.

The AMR - 1 is a completely self-contained, rack mount unit occupying 1 3/4" of vertical space. An illuminated front panel power switch is also provided.

SPECIFICATIONS

FREQUENCY RANGE	540-1620 kHz
<i>(specify operating frequency)</i>	
ANTENNA INPUT	75 Ω
<i>(BNC type connector)</i>	
SENSITIVITY	30 μV/20 dB S/N at 30% modulation
SELECTIVITY	6 dB point: ± 10 kHz
HARMONIC DISTORTION	3.0% or less at 90% modulation
S/N RATIO	45 dB below 100% modulation with 10 μV input
AF RESPONSE	± 1.0 dB, 50-5,000 Hz; ± 3.0 dB, 5-10 kHz
AUDIO OUTPUTS	0 dBm, 600 Ω bal., and 1.0 V, 600 Ω unbal.

POWER REQUIRED	120 VAC, 50/60 Hz, 6 watts
DIMENSIONS	height 1 3/4" (4.45 cm)
	width 19" (48.3 cm)
	depth 6" (12.7 cm)
WEIGHT	actual 4.5 lbs. (2 kg)
	shipping 6 lbs. (2.7 kg)
FINISH	McMartin beige with woodgrain trim
REAR CHASSIS TERMINATIONS	Antenna (BNC); Balanced audio out; unbal. audio out; Relay contacts (n.o.)

ORDERING INFORMATION

Model	Description	Product Code
AMR - 1	AM Monitor Receiver	10-04-003

OCT/80

FIXED FREQUENCY FM TUNER

FMR-1D



NEW PTD (PRECISE TRACKING DECODER)

IMPROVED SENSITIVITY

50 dB LINEAR AGC

BALANCED 600 OHM OUTPUT (+ 8 dBm)

ADJUSTABLE NOISE SQUELCH CONTROL

REAR PANEL RELAY CONTACTS (NO) OR (NC)

The FMR-1D utilizes a new concept in tuner design providing space age technology in which the tuner actually tracks the modulated signal from the transmitter. The PTD will "lock on" and accurately recover the main channel signal identical to those originally transmitted. No multisection LC filters are used to disturb the original phase relationship of the transmitted signal reducing distortion. This system also tracks the original signal and reduces the effects of multipath propagation.

The selected 10.7 MHz signal is fed to IC-1 (MOB-605), a special integrated circuit where the signal is highly amplified and hard limited followed by a tracking decoder which converts the frequency modulated into the original composite signal with minimum inter-modulation distortion.

A specially designed mute circuit is incorporated in the integrated circuit to provide noise free muting

and is a function of RF noise rather than RF input level. A relay circuit will provide either contact closure or open contacts in the absence of the RF carrier. The relay threshold is also adjustable from 3-15 microvolts.

An audio integrated circuit is used to drive a transformer providing a balanced 600 ohm output at a level of + 18 dBm at 100% modulation at 400 Hz. A 15 kHz low pass filter eliminates the troublesome 19 kHz stereo pilot signal from the audio output when used for rebroadcast or recording.

The number of components have been greatly reduced due to the use of an integrated circuit IF system. IC's are also used in the audio system; fewer components means greater reliability.

The FMR-1D utilizes only 1 3/4" of vertical rack space. An illuminated front panel power switch is provided.

AUG/81



Rear view of FMR-1D

SPECIFICATIONS

RF INPUT IMPEDANCE	50/72 ohms unbalanced
FREQUENCY RANGE	88-108 MHz
SENSITIVITY	1 mV – 30 dB quieting 3 mV – 50 dB quieting
SELECTIVITY	65 dB alternate channel
DYNAMIC RANGE	Typically 100 dB
CAPTURE RATIO	Typically 1 dB or less
AM REJECTION	60 dB or greater
AGC RANGE	50 dB or greater
DISTORTION	0.5% or less
FREQUENCY RESPONSE	± 1 dB 30-50,000 Hz
SIGNAL TO NOISE RATIO	Typically 65 dB or greater Below 100% modulation (400 Hz)
19 kHz PILOT CARRIER REJECTION	65 dB or greater

AUDIO OUTPUT IMPEDANCE	600 ohm balanced
AUDIO OUTPUT LEVEL	+ 8 dBm 100% modulation @ 400 Hz
RELAY CONTACTS RATING	0.5 A @ 24 V
POWER REQUIRED	120 VAC 50/60 Hz 6 W
DIMENSIONS	height 1 3/4" (4.45 cm) width 19" (48.3 cm) depth 6" (12.7 cm)
REAR CHASSIS TERMINATIONS	Antenna (BNC); balance 600 ohm audio output. Unbalance audio output, relay contacts. Can be either NO or NC by reversing an internal plug.
FINISH	McMartin beige with woodgrain trim

ORDERING INFORMATION

MODEL	DESCRIPTION	PRODUCT CODE
FMR-1D	FM Monitor Receiver	10-04-012
	Monaural, Single Channel	

EBS TWO-TONE MONITOR

EBS-2

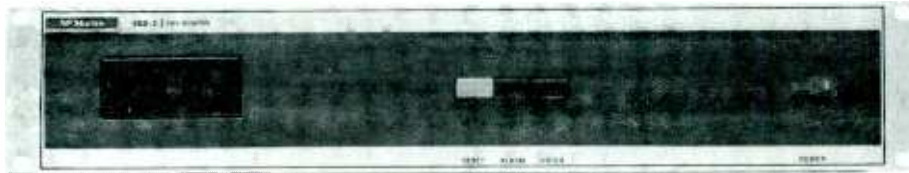

STABLE ± 3 Hz RESPONSE

DUAL RECEIVER INPUTS

STRAIGHT-FORWARD OPERATION

MONITORS NEW 2-TONE EBS SYSTEM

EXTERNAL ALARM CIRCUITRY

REMOTE RESET CAPABILITY

The McMartin Model EBS-2, EBS Monitor is FCC certified and satisfies the need for a reliable, trouble-free method of monitoring the new two-tone Emergency Broadcast Service (EBS). In use, its operation is simple and readily understood by non-technical personnel.

The EBS-2 requires an audio input level of 300 millivolts to 6 volts, rms. It is designed primarily for use with the McMartin FMR-1D (FM) or AMR-1 (AM) fixed frequency receivers. Since the EBS-2 contains its own power supply, it may be used with other receiving equipment which can provide proper audio output level. Two EBS receivers may be connected simultaneously to the EBS-2 audio input.

By using precision tuning-fork techniques, the EBS-2 responds only to the two designated EBS tones of precise frequency tolerances. For example, the transmitted audio tone frequencies are 853 and 960 Hz, plus or minus 0.5 Hz.

When the proper tones are transmitted and received on the AMR-1 or FMR-1D, the EBS-2 decodes the information and automatically switches the transmitted EBS message to its loudspeaker output. The EBS-2 has three front-panel pushbutton switches and a momentary RESET switch. When the OPERATE switch is depressed, the EBS-2 is in its normal, muted, operating condition.

Depressing the LISTEN button by-passes the automatic speaker muting for checking purposes. After an EBS transmission has been received, depressing the RESET momentary switch restores the unit to its normal operating condition.

Audio output level from the loudspeaker is preset by an internal control to avoid loss of speaker output due to tampering or inadvertent misadjustment. Provision is made for the connection of external alarm devices and for remote reset of the EBS-2.

SPECIFICATIONS

AUDIO TONE CONDITION

Response 853 and 960 Hz, ± 3 Hz
 Input level range 300 mV to 6 V rms
 Response time 8-16 s (factory adjusted for 12 s)

FRONT PANEL CONTROLS

..... Interlocked LISTEN/OPERATE;
 Momentary RESET;
 Power on/off, illuminated.

REAR CONNECTIONS

..... Rear chassis screw terminals:
 (1) receiver input #1
 (2) receiver input #2
 (3) ext. alarm relay closure
 (4) remote reset
 (5) ext. speaker

POWER REQUIRED 120 VAC, 50/60 Hz, 6W

DIMENSIONS height 3 1/2" (8.9 cm)
 width 19" (48.3 cm)
 depth 6" (15.3 cm)

WEIGHT actual 4 1/2 lbs. (2 kg)
 shipping 9 lbs. (4 kg)

FINISH McMartin beige with woodgrain trim

ORDERING INFORMATION

Model	Description	Product Code
EBS-2	EBS Decoder	10-04-002

JAN/81

PRECISION TWO-TONE EBS GENERATOR

TG-2/EBS



**MANUAL OR AUTO TIMING
INDEPENDENT TONE LEVEL CONTROLS**

**CRYSTAL-DERIVED TONE BASE
REMOTE START**

The McMartin Model TG-2/EBS Precision Two Tone EBS Generator is FCC Type-Accepted to produce the Two-Tone Attention Signal for the new Emergency Broadcast System (EBS) effective for all AM, FM and TV stations on April 16, 1976.

The regulations specify the two tone frequencies as 853 and 960, ± 0.5 Hz. This stability is provided in the TG-2/EBS by digital logic division from a highly-stable crystal oscillator. The derived audio tones are filtered and combined, with individual level controls to produce a minimum +8 dBm, balanced 600 ohm output for feeding the two-tone information through normal program channels.

The individual tone level controls permit presetting of the output level to meet the 40%, $\pm 5\%$ modulation

requirement of the new rules.

The TG-2/EBS also incorporates an automatic duration timing device. The two tones may be initiated either by manual operation of a front panel CONTINUOUS OUTPUT pushbutton, or may be preset by a TIMED OUTPUT pushbutton switch with automatic transmission of 22 seconds duration by operation of a momentary-action front panel START pushbutton. The latter operation may also be initiated remotely. A front panel LED indicator shows the presence of tones.

The TG-2/EBS includes a self-contained power supply and regulator. It is finished in beige with woodgrain trim.

SPECIFICATIONS

OUTPUT FREQUENCIES	853 and 960 Hz
FREQUENCY STABILITY	± 0.2 Hz
OUTPUT LEVEL	+8 dBm min (each tone level independently adjustable)
OUTPUT IMPEDANCE	600 Ω , balanced
HUM & NOISE	65 dB below +8 dBm outut
DISTORTION	less than 1.5%
TIMED OUTPUT DURATION	22.5, ± 2.5 s

DIMENSIONS	height	3 1/2" (8.9 cm)
	width	19" (48.3 cm)
	depth	6" (15.3 cm)
WEIGHT	actual	4 1/2 lbs. (2 kg)
	shipping	9 lbs. (4 kg)
FINISH McMartin beige with woodgrain trim	

ORDERING INFORMATION

Model	Description	Product Code
TG-2/EBS	Precision two tone EBS Generator	10-04-011

FM FREQUENCY/MODULATION MONITOR

TBM-3700

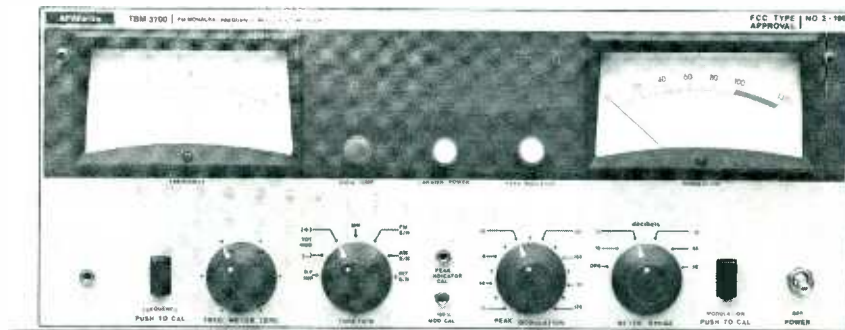

**DIRECT READING AM & FM S/N
REAR ACCESS PLUG-IN CARDS
REMOTE METERING AVAILABLE**

**INDEPENDENT FREQUENCY/MODULATION SECTIONS
BUILT-IN FREQUENCY/MODULATION CALIBRATION
STEREO/SCA ADD-ON CAPABILITY**

DESCRIPTION

The McMartin TBM-3700 combines the frequency deviation and modulation percentage functions in a single rack mount unit.

The TBM-3700 uses silicon solid-state semiconductors. Most circuits are mounted on plug-in, glass epoxy base printed circuit boards accessible from the rear.

The frequency deviation and modulation monitoring functions are independent of each other. Frequency measurements and calibration switching may be performed without interruption of the modulation monitoring or audio feed to house monitor systems. Audio output is automatically muted when RF feed to the TBM-3700 is not present.

The TBM-3700 incorporates circuitry permitting precise calibration of the modulation percentage meter and measurement of inherent internal FM noise of the monitor (typically -75 dB below 100% modulation). Direct reading of AM and FM signal-to-noise ratios is also featured.

Provision is made for remote metering of both frequency deviation and modulation percentage. Accessory kits for this purpose are available.

Two isolated composite signal outputs are provided for driving the McMartin TBM-2200 Stereo Modulation Monitor and/or TBM-2000A SCA Frequency/Modulation Monitor.

The TBM-3700 conforms in all respects with FCC Rules (Approval #3-190).

MAY/78

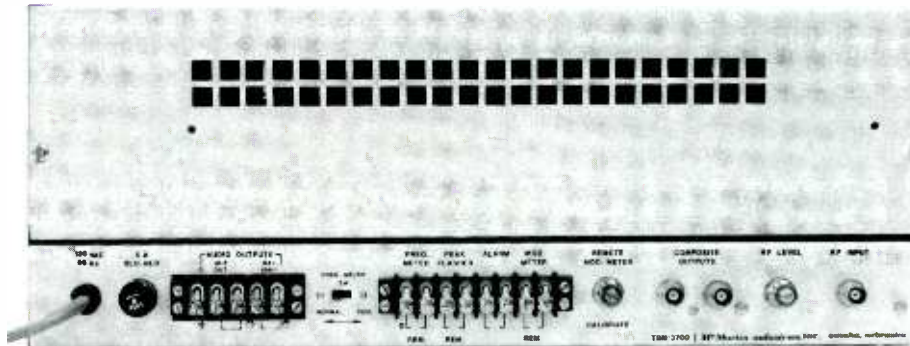

Rear view of TBM-3700

SPECIFICATIONS

OPERATING RANGE 88-108 MHz

INPUT 50 ohms, unbal. 0.1 to 1.0 W. level

OUTPUTS:

Audio monitoring 600 ohms balanced; +2dBm (100% modulation-400Hz) Distortion: less than 0.5% (50-15,000 Hz)

Distortion measurement 10K ohms impedance, unbalanced; 5 volts (100% modulation @ 400 Hz) Distortion: 0.25% (30-15,000 Hz) SNR: 66dB below 100% modulation @ 400 Hz

Composite output Two rear chassis BNC connectors—300 ohms unbalanced; 1.0 volt peak-to-peak ± 0.2 dB (50-100,000 Hz)

MODULATION METER:

Main channel position Accuracy, ± 0.5 dB; Freq. Response: ± 0.5 dB (30-15,000 Hz)

Total modulation position Accuracy, ± 0.5 dB; Freq. Response: ± 0.5 dB (30-75,000 Hz)

Range ± 75 kHz deviation, 100% modulation; ± 100 kHz deviation, 133% modulation (full scale)

FREQUENCY METER:

Scale ± 4 kHz, 100Hz increments

Accuracy Better than ± 500 Hz

REMOTE METERING:

Modulation up to 2,500 ohms external loop resistance may be accommodated. Requires RM-37-T accessory plug-in card and RM-37-R remote meter panel kit

Frequency can accommodate up to 3,000 ohms external loop resistance. Remote meter panel kit available

CARRIER ALARM Monitor automatically mutes at preset muting control level. Rear panel terminals available for external alarm interconnection

POWER REQUIRED 105-125 VAC, 50/60 Hz, 45W

AMBIENT TEMPERATURE RANGE 10° to 50° C

DIMENSIONS 19" width (EIA) standard rack mount) 7" height, 13" depth

FINISH Beige with wood grain trim

ORDERING INFORMATION

MODEL	DESCRIPTION	PRODUCT CODE
TBM-3700	Frequency and monaural modulation monitor	10-03-049

STEREO MODULATION/FREQUENCY MONITOR

TBM-2200A



PLUG-IN MODULAR DESIGN

19 kHz FREQUENCY METERING

19-38 kHz PHASING ADJUSTMENT

LEFT AND RIGHT MODULATION METERS

FULL REMOTE METERING OPTIONS

INTERNAL 19 kHz CALIBRATION

The McMartin TBM-2200A solid state stereo modulation and frequency monitor is designed to operate in conjunction with McMartin base band monitors, TBM-3700, TBM-4000A, TBM-3500A, or TBM-3500B, to provide all stereo monitoring requirements. Three meters are used for simultaneously monitoring the left and right stereo channels and the center frequency deviation of the 19 kHz pilot carrier. The right and left meters are also used as audio voltmeters, which serve a secondary function of measuring separation between right and left channels, crosstalk between main and subchannels, 38 kHz carrier suppression and stereo S/N of each channel.

The various meter functions are incorporated in one switch. Functions read on the left meter are as follows: Calibrate level, pilot injection level, operate, L+R, 19-38 kHz phasing, 38 kHz suppression and stereo signal-to-noise ratio. L-R information is read on the right meter. When the function switch is in the stereo S/N position, the audio is automatically de-emphasized.

A precise 19 kHz signal and additional circuitry are used to accurately calibrate the 19 kHz pilot injection measuring circuits. This allows daily verification of the

accuracy of the monitor and frequency of the 19 kHz pilot.

The metering circuits used in the TBM-2200A are peak-indicating devices capable of accurately measuring composite signals. The meter driving circuits are designed to go into saturation slightly above full scale deflection to protect the meters against severe overload.

An indicator light displays the presence of the 19 kHz pilot carrier. A phasing control, located on the front panel allows adjustments of the 19 and 38 kHz circuits for exact phase coincidence.

A switched front panel termination permits viewing of the pilot carrier, L+R and L-R signals. All critical circuits are on plug-in cards, removable from the rear of the chassis for ease of servicing. The power supply design includes short circuit protection. A squelch circuit disables the 19 kHz frequency metering in the absence of the pilot carrier.

The TBM-2200A has complete facilities for optional remote monitoring of the 19 kHz pilot carrier level, left and right stereo modulation and frequency deviation of the pilot carrier.

JUNE/79

The FCC type approval number is 3-201.

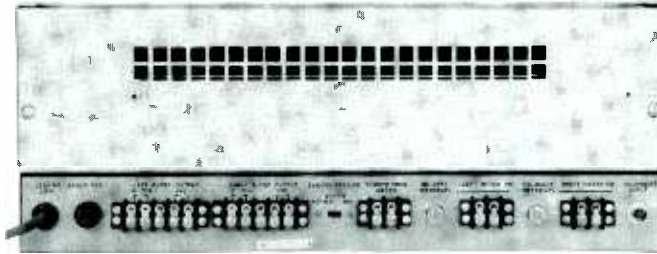

Rear view of TBM-2200A

SPECIFICATIONS

COMPOSITE INPUT

Impedance:5K ohms
Sensitivity:0.9 to 1.5 volts peak to peak

OUTPUTS

(left and right)

Audio output for monitoring circuits

Source impedance:600 ohms balanced
Level:+2 dBm at 100 percent modulation at 400 Hz

Distortion:Less than 0.5 percent (50-15,000 Hz)

Audio output for distortion measurement

Impedance:10K ohms or greater
Level:5 volts at 100 percent at 400 Hz
Frequency response:±0.5 dB, 30-15,000 Hz

DISTORTION

Stereo:0.35 percent, 30-15,000 Hz
Stereo Noise Level:-66 dB below 100 percent modulation at 400 Hz

COMPOSITE OUTPUT

Source Impedance:1000 ohms
Level:0.3 volts rms
Frequency Response:±0.2 dB, 50-75,000 Hz

PILOT INJECTION CIRCUIT

Accuracy:±0.5 percent
Meter Indication:6-12 percent (pilot injection scale)
Indicator:Pilot lamp (operates at 5 percent of greater injection level)

INTERNAL PILOT CALIBRATE

Accuracy:±0.5 percent

MODULATION METERS

(left or right)

Accuracy:±0.5 dB
Frequency Response:±0.5 dB, 30-15,000 Hz

SEPARATION

Left and Right

Channels:-45 dB or better (50 to 10,000 Hz)
.....-40 dB or better (10,000-15,000 Hz)

NOTE: Separation can be measured internally down to 60 dB

MEASUREMENT OF SUPPRESSED 38 kHz CARRIER

Modulated 100% with frequencies above 5 kHz:

.....Better than 50 dB

No Modulation:

.....Better than 60 dB

CROSSTALK

Main into stereo

sub channel:

.....50 dB or better

Stereo subchannel

into main channel:

.....50 dB or better

67 kHz into main or

stereo channel:

.....66 dB or better

PILOT CARRIER

FREQUENCY METER

Deviation Range:

.....±2.5 Hz

Accuracy:

.....±0.25 Hz

REMOTE MONITORING FACILITIES

Modulation:

.....

Optional RM-22 T/R kit available. Left and right meter may be remotely monitored with 2500 ohm external loop resistance. Remote meters are completely independent of internal meters.

Pilot Carrier

Frequency:

.....

Frequency deviation may be remotely monitored with 2500 ohms external loop resistance.

POWER REQUIRED:

.....

105-125 volts AC

AMBIENT TEMPERATURE RANGE:

.....

10-50 degrees C

DIMENSIONS

width

height

depth

19" (48.3 cm)

7" (17.8 cm)

13" (33.0 cm)

WEIGHT

actual

shipping

15 lbs (6.8 kg)

19 lbs (8.6 kg)

FINISH:

.....

McMartin beige with wood grain trim

ORDERING INFORMATION

Model

TBM-2200A

RM-22T

RM-22R

Description

Stereo modulation and

pilot frequency monitor

Remote metering plug-in card

Remote metering rack

mount panel

Product Code

10-03-034

10-03-037

10-03-036

10-03-036

10-03-036

SCA FREQUENCY/MODULATION MONITOR

TBM-2000B

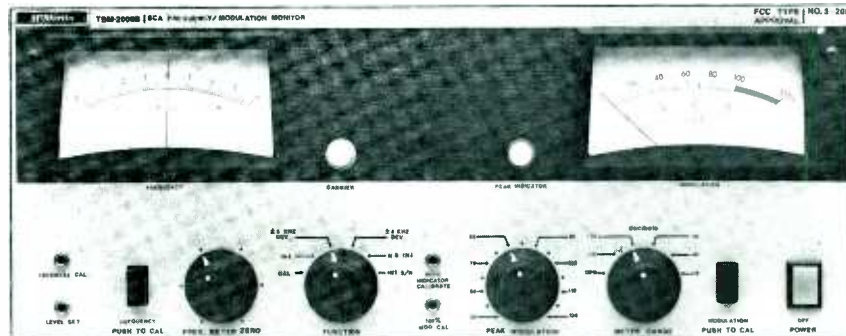

**INTERNAL CALIBRATION
MODULAR PLUG-IN CARD DESIGN**

**REMOTE METERING OPTION
CARRIER-OFF MUTING**

DESCRIPTION

The McMartin TBM-2000B silicon solid-state SCA monitor, in conjunction with the McMartin TBM-3700, TBM-3500B, TBM-3500A, TBM-4000A or TBM-4500A monitors, will monitor all the characteristics of the SCA transmission. The TBM-2000B features the measurement of injection level, modulation, frequency of the SCA carrier, SCA FM signal-to-noise, and crosstalk.

For simplicity of operation, the various metering functions are incorporated in one switch. The functions read on the right meter as follows: Set level-cal., injection level, ± 6 kHz deviation, ± 4 kHz deviation, narrow band injection, and internal signal-to-noise of the monitor. In addition, the TBM-2000B features push-button calibration of the frequency meter, injection level, and modulation meter.

The modulation meter is a peak indicating device capable of measuring true peak value. The meter is also used as an audio voltmeter to measure the FM signal-to-noise of the sub-channel, main to sub-channel crosstalk, crosstalk between two sub-channels and the inherent FM S/N of the monitor. When the meter range switch is in the 'operate' position, the meter ballistics conform to the FCC requirement.

A crystal reference oscillator is used to calibrate the frequency meter. This oscillator and addi-

tional circuitry are used to accurately calibrate the modulation meter and the internal calibrate system. The internal FM noise of the TBM-2000B is typically 70 dB below 100% modulation.

The frequency meter is automatically protected against severe overload. A carrier light indicates presence of the sub-channel. The audio is automatically muted and the frequency meter de-activated in the absence of the subcarrier. The mute threshold is adjustable.

The TBM-2000B has complete facilities for remote monitoring of the modulation, carrier frequency deviation, peak modulation indicator and sub-carrier presence indicator.

Two rear-chassis composite output terminations are available for viewing the wide band output.

A relay is activated when the SCA carrier is muted or falls below a predetermined level. One pair of relay closures are available on the rear chassis for operation of an external signal system for indication of carrier 'On' or 'Off' condition.

All critical circuits have double regulation for added stability. All solid state devices are operated far below their rated voltage for greater reliability.

MAR/74

The FCC type approval number is 3-200.

SPECIFICATIONS

OPERATING RANGE: 67 kHz standard (26, 41, 42 and 65 kHz frequencies optional)

MODULATION RANGE: ±6 kHz deviation—100 percent modulation
 ±4 kHz deviation—100 percent modulation
 Selection is made by front panel function switch

COMPOSITE INPUT

Impedance: 2000 ohms
Level adjustable by front panel level set: 0.3 volts rms or greater

MODULATION METER

Accuracy: ±0.5 dB
Frequency response: 30-7500 Hz ±1 dB (67 kHz)
 30-5000 Hz ±1 dB (41 kHz)

PEAK FLASHER INDICATOR:

Peak light adjustable to read modulation peaks from 50 to 120 percent. Responds to modulation peaks of 0.1 millisecond duration and remains on for 2 to 4 seconds as required by the FCC.

INTERNAL MODULATION CALIBRATION ACCURACY:

±2%

SCA FREQUENCY METER

Deviation range: ±4000 Hz, center zero
Accuracy: Better than ±50 Hz at 67 kHz
Stability: Maintained by crystal with 0.005 percent tolerance

SCA INJECTION CIRCUIT

Accuracy: ±0.5 percent
Meter indication: 0-15 percent in 1 percent increments
 0-30 percent in 1 percent increments

Internal injection calibrator accuracy: ±0.5 percent

OUTPUTS—SCA SUB-CHANNEL

AUDIO OUTPUT FOR MONITORING CIRCUITS

Source impedance: 600 ohms balanced
Level: +2 dBm at ±6 kHz deviation (100 percent modulation -400 Hz)
Distortion: Less than 1 percent (400 Hz)

AUDIO OUTPUT FOR DISTORTION MEASUREMENTS

Impedance: 10K ohms or greater
Level: 4 volts at ±6 kHz deviation (100 percent modulation -400 Hz)
Frequency response: 30-7500 Hz ±1 dB (67 kHz)
Distortion: 1.0 percent, or less -400 Hz
Noise level: 66 dB or greater below ±6 kHz deviation (100 percent modulation -400 Hz)

CROSSTALK (front panel range control measures down to -70 dB)

Main channel (30-15000 Hz) into SCA sub-channel: 66 dB or better
Stereo (23-53 kHz) into SCA sub-channel (67 kHz): 55 dB or better
SCA-1 channel into SCA-2 channel: 66 dB or better

POWER REQUIRED: 105-125 volts AC, 50/60 Hz 35 watts
FUSE: 0.5 amp slo-blo

AMBIENT TEMPERATURE RANGE:

10-50° C

DIMENSIONS:

(w) 19" (EIA standard rack mount)
 (h) 7"
 (d) 13" overall

WEIGHT: 20 pounds

FINISH: McMartin beige with wood grain trim

REMOTE MONITORING FACILITIES

Modulation: (optional) RM-37 T/R kit available. Modulation may be remotely monitored with 2,500 ohm external loop resistance plus remote meter resistance. Remote meter is completely independent of internal meter

Frequency: Subcarrier frequency may be remotely monitored with remote line resistance up to 3,000 ohms

Peak flasher: Termination provided for remote peak flasher installation

Subcarrier presence indicator: Termination provided of relay closure for remote "Subcarrier On" indicator or external carrier failure alarm devices

FM MODULATION MONITOR

TBM-3500B

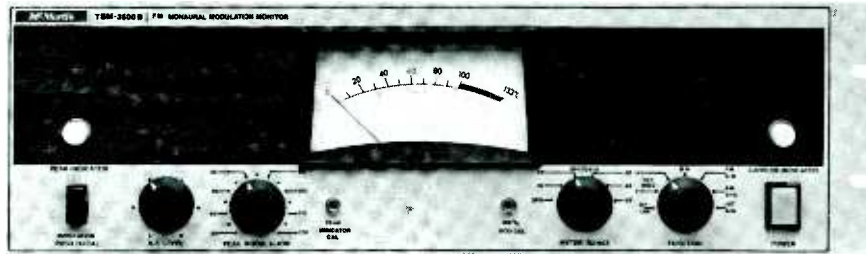

DIRECT READING AM & FM S/N
MODULAR PLUG-IN CONSTRUCTION
OPTIONAL PLUG-IN LOW LEVEL INPUT

INTERNAL CALIBRATION
CARRIER FAILURE ALARM
REMOTE METERING AVAILABLE

The McMartin TBM-3500B monitors the modulation of main-channel FM broadcast stations, and when used with a) the TBM-2200A, all parameters of stereophonic transmission; and/or b) the TBM-2000B, all parameters of SCA multiplex operation.

The TBM-3500B permits metering of total positive and negative modulation and measurement of FM and AM signal-to-noise ratios as low as -70 dB. A peak flasher independent of meter switching indicates the highest positive or negative peak encountered. Threshold is adjustable from 50% to 120%.

The meter functions as a semi-peak reading voltmeter for modulation. When used to read AM or FM noise the meter is damped to improve readability in the presence of noise. Meter positions are provided to read the inherent internal noise (typically -75 dB below 100% modulation) of the monitor and internal calibration. When reading AM, FM or internal noise 75 microsecond de-emphasis is automatically inserted into the measuring circuit.

With the optional plug-in LL-35B low level input card

installed the TBM-3500B will operate with RF signals as low as 350 microvolts. This permits operation from an antenna-derived input signal in most situations and eliminates the need for an external RF amplifier.

Should RF input be interrupted or fall below a preset level, a front panel carrier presence lamp is extinguished, audio output is automatically muted, and a carrier-off relay operates. External alarm devices may be activated by the latter.

The optional Model RM-35B provides for rack-mount remote modulation metering and peak flasher indication. Up to 2,500 ohms of loop and meter resistance can be accommodated in the remote meter circuit.

High impedance audio output for connection of external distortion measurement equipment, and a 600-ohm balanced output for audio monitoring are rear-chassis terminated.

Designed for rack mounting, the TBM-3500B is attractively styled in McMartin beige with woodgrain trim.

The FCC type approval number is 3-219.

JAN/81

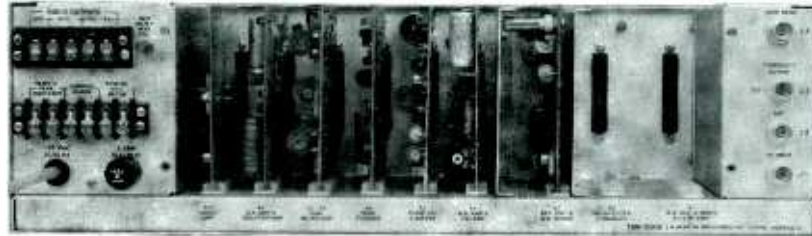

Rear view of TBM-3500B

SPECIFICATIONS

OPERATING RANGE 88-108 MHz

MODULATION RANGE .. 75 kHz deviation-100% modulation
100 kHz deviation-133% modulation

RF INPUT (standard)
Impedance 50 Ω unbalanced
Sensitivity 0.1 to 1 W

RF INPUT (with optional LL-35B low level input card)
Impedance 50 Ω unbalanced
Sensitivity 350 μ V minimum

OUTPUTS

Audio Output for Monitoring Circuits
Source impedance 600 Ω balanced
Level +2 dBm at 100% modulation at 400 Hz
Distortion less than 0.5%, 50-15,000 Hz

Audio Output for Distortion Measurement
Impedance 10 k Ω or greater
Level 5 V at 100% modulation at 400 Hz
Frequency response \pm 0.5 dB, 30-15,000 Hz
Distortion
Monaural 0.2%, 30-15,000 Hz
Noise Level -75 dB below 100% modulation
at 400 Hz

Composite Output (2)
Source impedance 300 Ω
Level Approximately 1 V peak-to-peak
Frequency response \pm 0.2 dB, 30-100,000 Hz
3 dB down at 180 kHz

NOTE: 75 μ s de-emphasis or flat response selectable for measurement purposes.

MODULATION METER (Ballistics meet FCC Requirements)

Main Channel Position
Accuracy \pm 0.5 dB
Frequency response \pm 0.25 dB, 30-15,000 Hz at 100% modulation

PEAK FLASHER Peak light adjustable to read positive and negative peaks from 50% to 120% modulation
FCC Requirements)
Total Modulation (+) or (-) Positions
Accuracy \pm 0.5 dB
Frequency response \pm 0.25 dB, 30-75,000 Hz

INTERNAL CALIBRATION

Accuracy 2% of 100% modulation

POWER REQUIRED .. 105 to 125 VAC, 50/60 Hz, 35 W

AMBIENT TEMPERATURE RANGE 10° to 50° C (50° to 122° F)

DIMENSIONS height 5 1/4" (13.3 cm)
width 19" (48.3 cm)
depth 13" (33 cm)

WEIGHT actual 20 lbs. (9 kg)
shipping 23 lbs. (10.4 kg)

FINISH McMartin beige with woodgrain trim

REMOTE FACILITIES

MODULATION RM-35 meter panel optionally available. Modulation may be remotely monitored with 2,500 Ω external loop resistance plus remote meter resistance. Remote meter is completely independent of internal meter.

PEAK INDICATOR The peak light may be remotely monitored.

ALARM INDICATOR AND MUTE Relay contact closures are available on the rear terminals when the RF carrier fails or falls below a preset value. Audio output from the monitor is muted.

ORDERING INFORMATION

Model	Description	Product Code
TBM-3500B	FM Modulation Monitor	10-03-029
RM-35B	Remote metering rack mount panel	10-03-045
LL-35B	Low level input module	10-03-044

SOLID STATE RF AMPLIFIER

TBM 2500-C series



TBM-2500-C: FM BAND

TBM-2500-CL: TV-CH 2-6

TBM-2500-CH: TV-CH 7-13

FULLY METERED
ULTRASTABLE OPERATION
AGC LEVEL CONTROL

DESCRIPTION

The TBM-2500-C, -CL and -CH are designed to amplify off-air signals in the FM and VHF-TV frequency ranges to a level suitable for driving FCC Type-Approved frequency and modulation monitoring equipment located at sites remote from the transmitter.

Utilizing essentially identical circuitry, the three models perform this function with minimum degradation of the transmitted signal and its sidebands.

Excellent passband and skirt selectivity characteristics of a special IF filter insure optimum response to the desired signal and rejection of interfering signals. A sum and difference oscillator injection technique is used so that a zero operating-frequency error results.

The models incorporate AGC circuitry to maintain constant output signal with input signal variations over a 45 dB range. This, in conjunction with excellent limiter action, minimizes signal amplitude variations resulting from propagation effects or "flutter" generated by signal reflections caused by passing aircraft.

Metering of injection voltage, AGC bus voltage, RF drive and RF output is provided.

0.5 watts output (0.2 for the TBM-2500-CH) is developed with a 500-microvolt input signal, with complete limiting.

Although designed for specific use with the complete McMartin line of FM and VHF-TV FCC Type Approved monitoring equipment, the TBM-2500-C series RF amplifier will drive any of the current monitors regardless of manufacture.

SPECIFICATIONS

OPERATING RANGES:

TBM-2500-C	88-108 MHz
TBM-2500-CL	TV Channels 2-6
TBM-2500-CH	TV Channels 7-13

SELECTIVITY: 290 kHz @ 3 dB points . . 60 dB down at 800 kHz

SENSITIVITY:

TBM-2500-C	500 microvolts at antenna input produces 0.5 watts output and full limiting
TBM-2500-CL	Same as TBM-2500-C
TBM-2500-CH	500 microvolts at antenna input produces 0.2 watts output and full limiting

LEVEL,
Input Overload 100,000 microvolts

LEVEL,
Maximum Output

TBM-2500-C	0.5 watts
TBM-2500-CL	0.5 watts
TBM-2500-CH	0.2 watts

IMPEDANCES:

Input	50 ohms, unbalanced (BNC connector)
Output	50 ohms, unbalanced (BNC connector)

AGC RANGE: 45 dB

POWER REQUIRED 115/230 VAC, 50/60 Hz, 15 watts

DIMENSIONS: 19 (W) x 5 1/4" (H) x 10 (D)

WEIGHT: 10 pounds

CONTROLS,
FRONT PANEL: Power on/off; output level; Metering, (1)OSC; (2)AGC; (3)Drive; (4)Output

FM RELAY RECEIVER

FM range **TBM-1005D**

TV (VHF only) **TBM-1003D**

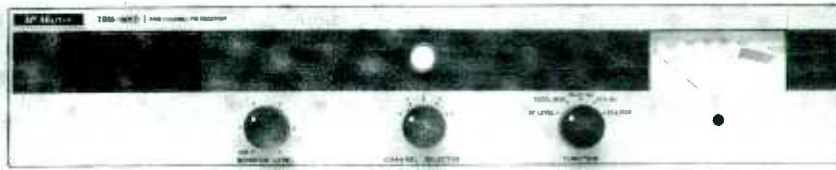

NEW PTD (PRECISE TRACKING DECODER)

IMPROVED SENSITIVITY

GREATER RF DYNAMIC RANGE

STEREO/SCA PLUG-IN OPTIONS

1-5 CHANNEL CAPABILITIES

IMPROVED LINEARITY

FULLY METERED

PANEL MOUNTED MONITORING SPEAKER

The McMartin TBM-1005D is a 1-5 channel crystal controlled FM relay receiver which supercedes the performance proved TBM-1000B series. The McMartin TBM-1003D is available for operation in the VHF-TV aural channels. Channel 2 through 6 and channel 7 through 13 only.

The McMartin TBM-1005D is a high performance FM relay receiver with an accurate wide band composite signal output. The receiver also provides stereo and/or SCA outputs by simple insertion of optional plug-in cards. Two cards may be accommodated. The optional STE-1D stereo plug-in card provides a left and right channel output at a level of +8dbm (600 ohms), and provides accurate measurement of the stereo pilot injection level.

The optional SCA-2-67D or SCA-2-41D SCA plug-in cards will provide an SCA audio output of +8dbm (600 ohms) and provide measurement of the SCA injection level plus monitoring of the modulation level, selectable by the front panel function switch. Two SCA plug-in cards may be used simultaneously with the second SCA card inserted in the mono or stereo socket.

The standard mono card incorporates a 15 kHz low-pass filter to remove the troublesome 19 kHz stereo signal from the audio which can otherwise create problems if the signal is used for rebroadcast or recording.

The TBM-1005D utilizes a new concept in receiver design providing space age technology in which the

receiver actually tracks the modulated signal from the FM transmitter providing accurate composite signals identical to what was originally transmitted.

The front end of the TBM-1005D is crystal controlled and utilizes a diode protected dual gate D-MOS field effect RF amplifier. This device has very linear AGC control providing greater than 50db gain reduction resulting in an overall tuner dynamic range of over 100db with minimum of cross modulation. The AGC does not produce any skewing or detuning of the RF circuits. All RF circuitry switching and tracking is performed by using Varactor tuning techniques. No switch contacts are used in RF circuits and each channel is tuned by a trimpot potentiometer controlled by the front panel function switch.

An entirely new IF system has been designed eliminating the multisection 10.7 mHz IF band-pass filter. The TBM-1005D provides better selectivity to reject unwanted signals and still provide accurate composite signals. Provisions are provided for the addition of an optional filter for exceptional high selectivity.

Adjustable squelch control of main channel and two SCA channels are provided. The two SCA squelch controls are mounted on the rear chassis and are adjustable from 3% to 10% injection levels.

The TBM-1005D and 1003D are rack mounted and styled in beige with wood grain trim.

JUNE/79

SPECIFICATIONS

MAIN CHANNEL:

ANTENNA INPUT IMPEDANCE 50/72 ohm unbalanced

RANGE—

TBM-1005D 88-108 mHz
TBM-1003D VHF-TV channels 2-13
 aural carriers

SENSITIVITY—

TBM-1005D 1 microvolt for 30db quieting
(MONAURAL) 3 microvolts for 50db quieting

TBM-1003D (CH. 2-6) 1.5 microvolt for 30db quieting
(CH. 7-13) 3 microvolts for 30db quieting

SELECTIVITY— 50db alternate channel (Standard)
TBM-1005D 70db with optional filter

CAPTURE RATIO 1.5db or less

COMPOSITE OUTPUT 1.5v (P-P) adjustable

COMPOSITE FREQUENCY RESPONSE ±0.3db 10-75000 Hz

PROGRAM AUDIO OUTPUTS: MONAURAL PLUG-IN CARD (standard)

Audio output impedance 600 ohm balanced

Output level +8dbm @ 100% mod. 400 Hz

Frequency response ±0.5db 30-15000 Hz

De-emphasis 75 microsecond standard
 25 or 50 microsecond available

S/N ratio Typically 65db or greater below
 100% mod. 400 Hz

Distortion THD 0.5% or less (30-15000 Hz)

19 kHz pilot carrier rejection 65db or greater

STEREO PLUG-IN CARD STE-1D (optional)

Audio output impedance 600 ohm balanced right and left channel

Output level +8dbm right and left channel

Frequency response +0.5db 30-15000 Hz

De-emphasis 75 microsecond standard
 25 or 50 microsecond available

S/N ratio 55db or greater below 100%
 Modulation 400 Hz left or right Ch.

Distortion THD 1% or less 30-15000 Hz

Channel separation 40db 30-10000 Hz
 30db 10000-15,000 Hz

Pilot injection metering ±1% accuracy when receiver is
 completely limited.

SCA rejection 65db or greater

SCA PLUG-IN CARD SCA-2-67D (optional)

Audio output impedance 600 ohm balanced

Output level +8dbm 100% modulation (±6 kHz
 deviation) @ 200 Hz

Frequency response ±3db—30-6000 Hz with modified
 150 microsecond de-emphasis

S/N ratio Typical 60db below 100% modulation
 referenced @ 200 Hz

Distortion 1% or less 30-6000 Hz—Typically
 0.5% at 400 Hz

SCA injection metering ±1% accuracy when receiver is
 completely limited

SCA modulation metering Meter is semi-peak reading and
 referenced at ±6 kHz deviation
 for 100% modulation

SCA—PLUG-IN CARD SCA-2-41D (optional)

Specifications are generally the same as for the SCA-2-67 kHz
 plug-in card excepting the 100% modulation is referenced at ±4
 kHz deviation. *NOTE: Other SCA frequencies are available.*

METERING

FUNCTIONS: Relative RF level, total modulation,
 pilot injection, SCA injection and
 SCA modulation

POWER REQUIRED: 120/240 VAC 50/60 Hz—25 watts

DIMENSIONS: width 1.9" (48.3 cm)
 height 3½" (8.9 cm)
 depth 1.2" (30.9 cm)

WEIGHT: actual 7.7 pounds (3.5 kg)
 shipping 12.7 pounds (5.8 kg)

FINISH: McMartin beige with woodgrain trim

PLUG-IN ACCESSORIES:

STE-1D: Stereo demodulator card

SCA-2-67D: 67 kHz SCA demodulator card

SCA-2-41D: 41 kHz SCA demodulator card

*NOTE: Other SCA frequencies available.
 The TBM-1005D and 1003D are
 normally supplied with the plug-in
 mono card.*

NB-1: Optional band-pass filter

REAR CHASSIS

TERMINATION: Antenna (BNC), composite output
 (BNC) monaural or stereo left, SCA-2
 or stereo right, SCA-1 and carrier
 relay contacts (NO) or (NC)

RELAY CONTACTS

RATING: 0.5 am. @ 24 volts

ORDERING INFORMATION:

Model	Description	Product Code
TBM-1005D	5 Channel Relay Runner 88 to 108 mHz (with one crystal) Additional Crystals (specify frequency)	10-03-009
TBM-1003D	TV Aural Receiver Channel 2-13	
STE-1D	Stereo Plug in Demodulator Card	10-03-012
SCA-2-41D	SCA Plug in Demodulator Card 41KH2	10-03-010
SCA-2-67D	SCA Plug in Demodulator Card 67KH2	10-03-011

TV SCA RECEIVER

TVR-1



HIGH SENSITIVITY

MAIN OR SCA OUTPUT

EARPHONE CORD ANTENNA

EXTREMELY RUGGED PLASTIC CASE

NEW LINEAR DIFFERENTIAL DECODER

OPERATION ON CHANNEL 2-6 AND CHANNEL 7-13

CRYSTAL CONTROLLED ON DESIRED CHANNEL

The new McMartin TVR-1, TV SCA pocket receiver is a high performance unit designed for cueing, paging, monitoring, etc., utilizing an SCA carrier on the aural TV carrier. The earphone cord has been RF isolated and designed as an integral part of the antenna system providing high RF pick up and good SCA reception under difficult conditions.

The TVR-1 receiver utilizes a new linear differential decoder to provide greater recovery of weak RF signals.

The RF section of the TVR-1 utilizes a low noise, grounded base RF amplifier which achieves a very low noise figure.

A main or SCA slide switch is provided; also an adjustable volume control is used to set the level of the earphone audio to suit individual requirements.

The TVR-1, TV SCA receiver is designed to be readily attached around the waist by means of a cloth strap supplied.

APR/79

SPECIFICATIONS

TV AURAL CHANNEL

Operating frequency	Channel 2-6 TV Aural Carrier. Channel 7-13 TV Aural Carrier.
Sensitivity:	
Channel 2-6	0.5 microvolts for 20 dB quieting
Channel 7-13	1.0 microvolts for 20 dB quieting
Antenna	Headphone cable RF isolated above ground and audio and tuned to desired channel.

SCA CHANNEL

Frequency Deviation	39.5 kHz or 67 kHz 39.5 kHz, ± 4 kHz deviation 67 kHz, ± 6 kHz deviation
Output Level	Adjustable up to 1 volt across 2000 ohm earphones
Frequency Response	100 to 3500 Hz
Distortion	Less than 2%
De-emphasis	Modified 150 microsecond

SENSITIVITY CHANNEL 2-6

39.5 kHz SCA Carrier:	
10% injection	(± 2.5 kHz dev. of aural carrier) 10 microvolts for 20 dB quieting.
20% injection	(± 5 kHz dev. of aural carrier) 5 microvolts for 20 dB quieting.
67 kHz SCA Carrier:	
10% injection	(± 2.5 kHz dev. of aural carrier) 10 microvolts for 20 dB quieting.
20% injection	(± 5 kHz dev. of aural carrier) 5 microvolts for 20 dB quieting.

SENSITIVITY CHANNEL 7-13

39.5 kHz SCA Carrier:	
10% injection	(± 2.5 kHz dev. of aural carrier) 10 microvolts for 20 dB quieting.
20% injection	(± 5 kHz dev. of aural carrier) 5 microvolts for 20 dB quieting.
67 kHz SCA CARRIER:	
10% injection	(± 2.5 kHz dev. of aural carrier) 15 microvolts for 20 dB quieting.
20% injection	(± 5 kHz dev. of aural carrier) 7.5 microvolts for 20 dB quieting.

POWER SUPPLY REQUIRED

Battery Operated ..	9.6 volts (standard transistor radio battery)
Battery Drain	9 volts 34 ma
DIMENSIONS	Height 5" (12.7 cm) Width 2 3/16" (5.5 cm) Depth 1" (2.54 cm)
WEIGHT	actual 6 oz. (169.8 kg) shipping 12 oz. (339.6 kg)

ORDERING INFORMATION

Model	Description	Product Code
TVR-1	TV/SCA Receiver, 39.5/67 kHz	40-02-011

SCA-PLUS SYSTEM



BSP-2800 Dual Channel SCA Encoder



SPL-2800A Audio Channel Decoding Filter
SPH-2800A Data Channel Decoding Filter



SPL-2800B Audio Channel Decoding Filter
SPH-2800B Data Channel Decoding Filter

TRANSMIT AURAL AND DATA SIGNALS SIMULTANEOUSLY OVER THE SAME FM/SCA CHANNEL
USE ALL EXISTING RECEIVERS AND TRANSMITTING EQUIPMENT
NO CROSSTALK
LOW COST

The McMartin SCA-Plus system allows an audio signal and a digital data signal to be transmitted *simultaneously* over the *same* SCA subchannel of an FM carrier. For example, a background music service and a business information service (feeding Teletype or computer style terminals) can now make use of the same SCA channel.

SCA-Plus makes use of a band-sharing scheme in which those frequencies containing most of the energy of voice and music broadcasts are allocated for aural information, while the less used frequencies are reserved for transmission of specially encoded digital information.

The SCA-Plus system consists of one headend unit, the BSP-2800 encoder, and four decoding filters, each designed for a specific application. All SCA-Plus components are fully compatible with existing FM excitors, monitors, and tuners. The SCA-Plus units are used in conjunction with existing FM/SCA equipment.

The McMartin *BSP-2800* is used to feed the audio and data signals into the SCA input of an FM transmitter. It contains its own power supply and mounts into a standard 19" equipment rack.

Inputs: Audio signal Outputs: Composite output
Data signal

Decoding filters are used in conjunction with standard SCA receivers to separate the desired signal from the composite dual channel SCA signal.

The "SPL" models retrieve the *audio channel* signal, the "SPH" models retrieve the *data channel* signal.

The "A" models are circuit boards designed for internal mounting in an SCA tuner or tuner/amplifier.

The "B" models are each housed in a metal box and contain input/output transformers. They are designed for external connection between the SCA tuner and power amplifier. The "B" model decoding filters allow rapid field conversion to the SCA-Plus system without any modification of existing FM/SCA equipment.

A word about data communications hardware . . .

Most aural FM/SCA operators wishing to expand into SCA data communications will probably carry a franchised data service. The franchiser will usually provide the data signal in a format ready to be inserted into a McMartin BSP-2800 Dual Channel SCA Encoder, and will also make available the necessary display hardware.

If you wish to generate your own digital data, McMartin Industries can provide you with information about equipment requirements.

OCT/78

SATELLITE/MICROWAVE IF MODULATOR AND DEMODULATOR

SMR-1 IF Modulator SDR-1 IF Demodulator

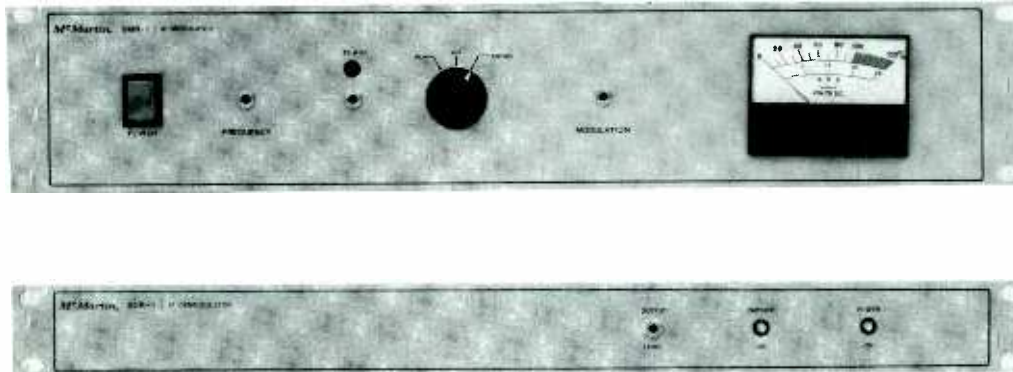

FOR SATELLITE/MICROWAVE IF SYSTEMS REQUIRING 52-88 MHz MODULATORS AND DEMODULATORS

50-5,000 Hz AUDIO BANDWIDTH

SUITABLE FOR AUDIO AND DATA TRANSMISSION

DEMODULATOR TRACKS AND RELOCKS TRANSPONDER FREQUENCY ERROR GREATER THAN ± 50 kHz

The McMartin SMR-1 IF Modulator and SDR-1 IF Demodulator are intended for narrow band FM services using a maximum 5 kHz audio bandwidth in a 52 MHz — 88 MHz carrier frequency range. Although designed for satellite communications, the products are also excellent in terrestrial microwave applications. Possible applications include data and/or aural coordination communications for broadcasters and CATV operators, medium grade aural program communications, and nationwide distribution of digital information services.

The SMR-1 modulator uses a crystal referenced phase lock technique to generate a direct FM modulated signal.

The balanced 600 ohm audio input is pre-emphasized at 75 μ s and band limited to 6 kHz by means of a LC type low pass filter in the modulator. The RF output is adjustable to approximately +10 dBm level and filtered by a multi-section band pass filter.

The modulator produces an audio response of 50-5,000 Hz, ± 1 dB, with a nominal ± 10 kHz frequency deviation. It is capable of an RF output up to +10 dBm into a 50 ohm load, and its signal to noise ratio is 60dB or greater. The unit is available for operation with any FM deviation from ± 10 kHz to ± 75 kHz.

APR/79

The SDR-1 IF Demodulator is designed for continuous duty reception of signals in a 52 to 88 MHz range and utilizes a dual conversion technique for elimination of image responses in this frequency range.

The demodulator consists of a low noise dual gate "D" MOS FET RF amplifier. A discreet first mixer and amplifier feed the single chip second mixer/amplifier/limiter/demodulator and an audio amplifier. The unit is capable of acquiring and tracking, and relocking, a signal even when the transponder frequency error is ± 50 kHz or more. The SDR-1 locks onto the carrier frequency insuring that the signal is precisely centered in the IF pass band.

An automatic sweep circuit is used to reacquire lock in case of carrier failure or AC power loss to the demodulator. The output signal is also muted in the absence of a carrier.

A recessed front panel control allows the program level to be set to the desired level between 0 dBm and +18 dBm across a 600 ohm load. A carrier "on" light is used to indicate the presence of a carrier of suitable level to produce frequency lock. A power "on" indicator light is used to insure that AC power is applied to the demodulator.

The SDR-1 delivers at least 33 dB Signal-to-Noise ratio for a C/KT of 58 dB (or a Carrier-to-Noise ratio of 14 dB in a 25 kHz predetection bandwidth). Its distortion limited performance with high Carrier-to-Noise is greater than -60 dB.

The SMR-1 and SDR-1 are both designed for standard 19" rack mounting. The front panels are finished in McMartin beige.

SPECIFICATIONS

	SMR-1	SDR-1
AUDIO		
Impedance	600Ω	
Pre-Emphasis75 μs	
Deviation	±10 kHz	
Sensitivity	+12 dBm to +24 dBm (+18 dBm nominal)	
OUTPUT		
Frequency	52-88 MHz	
Level	+10 dBm ±1 dB (Adjustable to -10 dBm)	
Impedance	50-75 ohm unbalanced	
Occupied Bandwidth25 kHz	
Spurious	-70 dB	
Harmonics	-30 dB	
FREQUENCY RESPONSE	±1.5 dB (100-5kHz)	
DISTORTION		
ThD	<1% (100-5 kHz)	
IM	<3%	
SIGNAL TO NOISE	Better than 60 dB	
POWER REQUIRED	120 VAC ±10% 50/60 Hz	
DIMENSIONS	height 3½" (8.9 cm) width 19" (48.3 cm) depth 13" (33.0 cm)	
WEIGHT	actual 8.5 lbs. (3.9 kg) shipping 12 lbs. (5.4 kg)	
FINISH	McMartin beige	
FREQUENCY RANGE		Single frequency in range of 52-88MHz crystal controlled
TRACKING RANGE		At least ±50kHz
RF INPUT Z		Nominally 75 ohms unbalanced
RF QUIETING SENSITIVITY		1 Microvolt for greater than 30dB quieting
SELECTIVITY		±12.5kHz at 3dB bandwidth
HUM AND NOISE		Greater than 60 dB below +18 dBm output into a 600 ohm load. (1000 Hz. reference)
FREQUENCY RESPONSE		±1dB 100-5000Hz
DE-EMPHASIS75 microseconds
DISTORTION THD2% or less (100-5000Hz)
IM5% or less
SIGNAL TO NOISE RATIO		High carrier to noise: greater than 60 dB signal to noise ratio. 14 dB carrier to noise in a 25 kHz pre-detection bandwidth (equal to a C/KT of 58 dB) and a ±10 kHz deviation: 33 dB signal to noise ratio.
OUTPUT LEVEL — FRONT PANEL CONTROL		0 to +18dBm across 600 ohm load
TEMPERATURE RANGE		0-50°C
POWER REQUIRED		120V AC ±10% 50/60Hz
DIMENSIONS		height 1¾" (4.4 cm) width 19" (48.3 cm) depth 8" (20.3 cm)
WEIGHT		actual 4 lbs. (1.8 kg) shipping 7 lbs. (3.2 kg)
FINISH		McMartin beige

BROADCAST PROFESSIONAL TURNTABLE

TT-12C



INSTANT START

RUGGED—ONLY 3 MOVING PARTS

STEREO RUMBLE LESS THAN -48 DB

RIM DRIVE

THREE STANDARD SPEEDS (33,45,78)

SYNCHRONOUS MOTOR

BUILT IN 45RPM ADAPTER

SPEED CAN BE CHANGED WITH PLATTER TURNING

ONE YEAR PARTS WARRANTY — LIFETIME WARRANTY ON WORKMANSHIP

The McMartin TT-12C custom turntable is designed to provide the broadcaster, or other discerning user, with a rugged, reliable turntable which can come up to speed in a fraction of a second—less than 1/16th revolution—but can still operate free from rumble, wow and flutter.

This high performance is made possible by the use of precision manufacturing and assembly techniques and by thorough testing.

Freedom from rumble, wow and flutter are further attained by the selection of an acoustic absorbing phenolic for the motor capstan, turning this element on its own motor shaft to achieve perfect concentricity, and by specially designing an idler wheel to transmit the motor torque to the inside rim of a perfectly round concentric platter.

The utilization of outer rim drive has been demonstrated, over the years, as the best method of achieving "instant" start with a minimum of vibration effects. (Center hub drive does not have the mechanical advantage of outer rim drive, it requires a substantial motor with attendant isolation problems.)

The McMartin TT-12C is supplied with a synchronous motor for exact speed and minimum rumble. Most major tone arms can be mounted on the TT-12C baseplate.

JULY/79

SPECIFICATIONS

SPEEDS (RPM) 33 $\frac{1}{3}$, 45 & 78

LINE VOLTAGE 115 volts, 60 cycles, standard
(230V — 50 cycles, optional)

START-UP TIME @ 33 $\frac{1}{3}$ RPM 1/16th of revolution
for Full Speed

RUMBLE (stereo with respect to NAB standard of -36 db) -48 db
WOW AND FLUTTER Less than 0.1%
Speed Regulation99.5%
Concentricity of Platter $\pm .001$ " D
Drive outer rim with idler
Capstan phenolic, ground on motor shaft
Platter $\pm .001$ " ($\pm .0025$ cm) Concentricity,
5.5 lb. (2.5 kg) Aluminum

DIMENSIONS width 15" (38.1 cm)
height (below frame) 5" (12.7 cm)
depth 15 $\frac{1}{2}$ " (39.4 cm)
cubage 1.7 cu. ft. (.48 ds)

WEIGHT actual 21.5 lbs. (9.7 kg)
shipping 25.0 lbs. (11.3 kg)

FINISH McMartin beige with felt pad for "slip" cueing.

ORDERING INFORMATION

Model	Description	Product Code
TT-12C	Turntable	10-02-110

HIGH SPEED TAPE ERASER

**TE-70
TE-105**

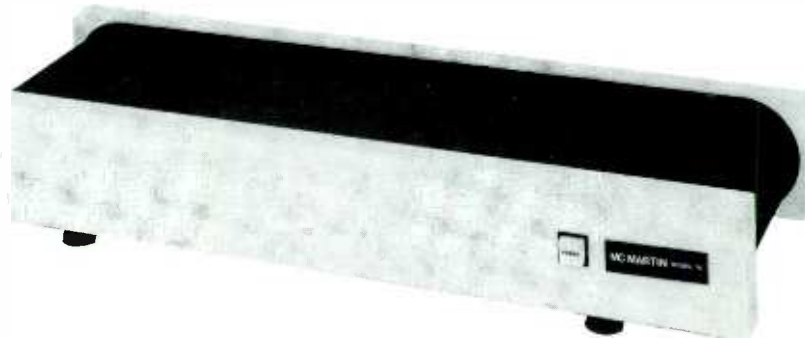

**ERASES CLEAN
SIMPLE "HANDS OFF" OPERATION
SAVES TIME AND IMPROVES QUALITY
FAST — 4 SECONDS FOR MOST TAPES
HANDLES AUDIO / VIDEO REELS AND CARTRIDGES**

The McMartin TE-70 and TE-105 bulk tape erasers are designed to automate your tape erasing operations and to eliminate residual noise problems.

Model TE-70 can handle cartridges and reels up to seven inches in diameter. Model TE-105 can also handle tapes up to 10½ inches in diameter.

Operation is simple and efficient. Just press the

power button and put any reel or cassette on the endless belt. In four seconds it delivers a clean, "no-whump" erasure that will meet stringent recording standards.

With the TE-70 or TE-105, tape erasing is no longer drudgery. Tapes need not pile up because no one wants to tackle hand erasing.

SPECIFICATIONS

POWER 117 VAC, 60 Hz 220 VAC, 50 Hz

ERASER LEVEL -80 dB nominal

METHOD OF OPERATION Tapes are passed on a continuous belt over high flux coils and deposited at end of machine.

THERMAL PROTECTION Overheating is prevented by automatic cut-off switch, which reactivates eraser after cool-down period.

DIMENSIONS
TE-70 height 5" (12.7 cm)
width 27" (68.6 cm)
depth 10" (25.4 cm)
belt width 7½" (19 cm)

TE-105 height 5" (12.7 cm)
width 27½" (69.9 cm)
depth 13¼" (33.7 cm)
belt width 11" (27.9 cm)

WEIGHT
TE-70 actual 60 lbs. (27.2 kg)
shipping 65 lbs. (29.5 kg)

TE-105 actual 80 lbs. (36.2 kg)
shipping 88 lbs. (39.9 kg)

FINISH light tan

ORDERING INFORMATION

Model	Description	Product Code
TE-70	High Speed Tape Eraser	10-02-114
TE-105	High Speed Tape Eraser	10-02-115

FEB/80

FM BROADCAST ANTENNAS

**MLCP
MHCP**

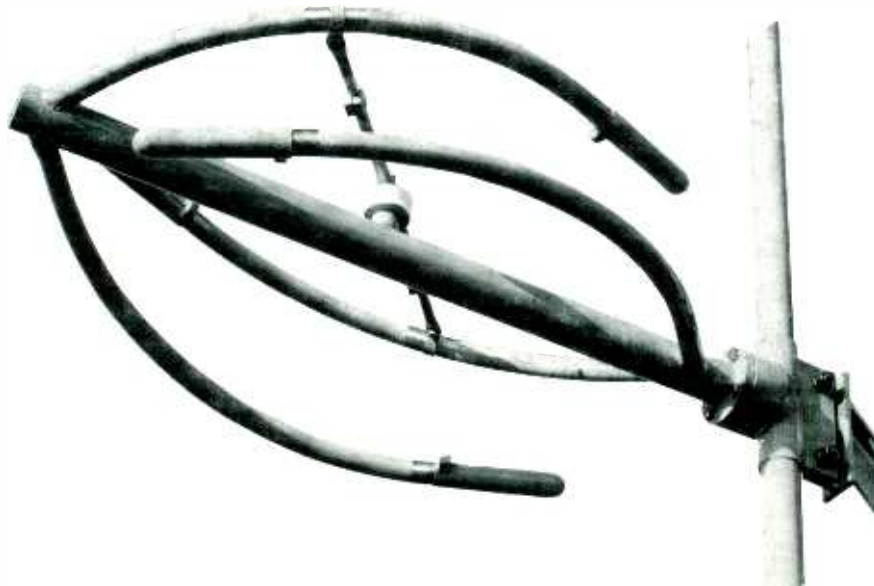

**CIRCULARLY POLARIZED
MADE OF HIGHEST QUALITY WELDED TUBULAR BRASS
PURGE VALVE FOR QUICK REMOVAL OF FEEDLINE MOISTURE
AVAILABLE WITH DE-ICERS OR RADOMES
TWO YEAR WARRANTY**

The radiating surfaces of the McMartin MLCP and MHCP antennas are constructed of the highest quality welded tubular brass with hemispherical corona suppressing adjustable element tips.

The unique curved, interlaced element design provides excellent bandwidth characteristics over the entire 88-108 MHz band. The antennas are factory adjusted to maintain an input standing wave ratio of 1.1:1 or less over a 400 KHz bandwidth, providing excellent stereo, SCA and quadraphonic performance.

Each element has a feed point centrally located on

the main boom. A high quality teflon insulator is used to route the RF to the driven element.

Every antenna is factory tuned on a tower section similar to the customer specified tower to be used.

Antennas include a special purge valve to allow for quick removal of feedline moisture.

Options: Optimization of the pattern is available at additional cost as well as directionalizing. When ordering directionalizing, consult the FCC rules and regulations.

SEP/79

MHCP FM Antenna

TYPE NO. AND BAYS	POWER GAIN RATIO	GAIN IN DB	FIELD GAIN	FS @ 1 MILE 1 KW, MV/M	SAFE POWER RATING	NET WEIGHT WITH MOUNTING BRACKETS	WINDLOAD AT 50/33 PSF (112 MPH) WITH MOUNTING BRACKETS
MHCP-1 w/de-icers w/radomes	0.46	-3.37	0.678	93.2	10 KW	21 lbs. 30 lbs. 51 lbs.	48 lbs. 57 lbs. 128 lbs.
MHCP-2 w/de-icers w/radomes	1.0	0.0	1.0	137.6	20 KW	117 lbs. 135 lbs. 177 lbs.	195 lbs. 219 lbs. 355 lbs.
MHCP-3 w/de-icers w/radomes	1.5	1.76	1.23	168.4	30 KW	187 lbs. 213 lbs. 277 lbs.	320 lbs. 368 lbs. 560 lbs.
MHCP-4 w/de-icers w/radomes	2.1	3.22	1.45	199.2	40 KW	258 lbs. 292 lbs. 378 lbs.	443 lbs. 516 lbs. 763 lbs.
MHCP-5 w/de-icers w/radomes	2.7	4.31	1.64	225.2	40 KW	330 lbs. 373 lbs. 480 lbs.	568 lbs. 664 lbs. 968 lbs.
MHCP-6 w/de-icers w/radomes	3.2	5.05	1.79	246.0	40 KW	474 lbs. 482 lbs. 654 lbs.	730 lbs. 851 lbs. 1210 lbs.
MHCP-7 w/de-icers w/radomes	3.8	5.80	1.95	268.0	40 KW	504 lbs. 563 lbs. 714 lbs.	854 lbs. 999 lbs. 1414 lbs.
MHCP-8 w/de-icers w/radomes	4.3	6.34	2.07	285.2	40 KW	577 lbs. 645 lbs. 817 lbs.	979 lbs. 1148 lbs. 1619 lbs.
MHCP-9 w/de-icers w/radomes	4.9	6.90	2.21	303.8	40 KW	677 lbs. 760 lbs. 989 lbs.	1122 lbs. 1316 lbs. 1842 lbs.
MHCP-10 w/de-icers w/radomes	5.5	7.40	2.35	322.4	40 KW	734 lbs. 819 lbs. 1034 lbs.	1265 lbs. 1483 lbs. 2065 lbs.
MHCP-12 w/de-icers w/radomes	6.6	8.20	2.57	353.2	40 KW	881 lbs. 984 lbs. 1241 lbs.	1514 lbs. 1780 lbs. 2475 lbs.
MHCP-14 w/de-icers w/radomes	7.8	8.92	2.79	383.5	40 KW	995 lbs. 1102 lbs. 1417 lbs.	1760 lbs. 2077 lbs. 2885 lbs.

SUPER HIGH POWER ANTENNA**MSHCP**

Circularly Polarized

**EXTREMELY BROAD BANDWIDTH****CIRCULARITY OF PATTERN ± 1 dB****HEAVY RUGGED BRASS CONSTRUCTION****TWO YEAR WARRANTY**

With a power rating of 30 kW per bay and a total antenna rating of 80 kW, the McMartin super high power antenna will accept the output of any currently produced high power transmitter. An extremely large surface area designed into this antenna virtually eliminates the common problems related to corona and arcing. With the greatly reduced surface potentials, power levels as high as 30 kW per bay are easily handled during the most severe weather conditions. The massive antenna construction provides for an excellent low "Q" condition resulting in a superior broad-band performance characteristic.

The unique antenna design, although simple in construction, provides the best possible radiating system available. The feed system between the bays is $6\frac{1}{8}$ inch diameter line. The attachment of the elements to the line sections is by means of a heavy brass casting. The four elements are constructed of 3 inch diameter heavy duty brass tubing. The center support boom is pressurized to the feed point from the same system which pressurizes the feed line. Each antenna is equipped with an overpressure relief valve allowing easy purging to remove moisture as well as preventing over pressurization due to pressurizing equipment failure.

JUN/80

Bandwidth/VSWR - Over a 400 kHz bandwidth, or ± 200 kHz, the antenna is factory tested to have an input terminal VSWR of 1.1:1 or better. This test is performed while the antenna is mounted on a tower section similar to that used by the customer. This rigid testing procedure minimizes the need for field tuning of the antenna. Under normal conditions the antenna will not require further field tuning. However, for optimum performance, always consult the transmitter manufacturer when matching the antenna to the transmitter.

Signal Pattern - When mounting the antenna on any metallic surface, the circularity of the pattern will be distorted somewhat from an ideal ± 1 dB pattern of the antenna element in free space. When mounted on a typical pole, the pattern will be ± 1.2 dB or less. If the antenna is mounted on the face of a tower with a 30 inch face, the expected non-circularity will be approximately ± 3 dB. When mounting the antenna on a tower, consult the factory to insure that no azimuth pattern null falls within the area of maximum desired signal.

Hardware - Heavy duty galvanized mounting brackets are provided to mount the antenna. The particular type of tower must be specified. Upon special request, at additional cost, the antenna can be adapted to mount on tapered poles, tapered towers, or on the face sides of a tower. When specifying the type of mounting situation, the mounting hardware is included with the mounting brackets.

Directionalizing • Beamtilt • Null Fill - If a directional pattern is required, consult the FCC rules to avoid a

non-compliance. McMartin offers a complete service for directional patterns, including pattern certification.

Details on particular beam tilt and null fill can be supplied on request. Power gain figures in the horizontal plane will be affected by beam tilt and this information is available on request.

De-icing - In geographical areas when icing and sleet conditions exist, it is recommended that de-icers be employed to maintain the low VSWR inherent in the antenna design. One kW of heating is available for each antenna bay; however, this may be operated at 110 VAC instead of the nominal 240 VAC for an effective heating capacity of 250 watts per bay. When de-icers are employed, the inner-bay wiring and junction boxes are included. De-icers are manually operated unless a precision, thermostatically controlled, automatic system is ordered.

Tower Space Requirements - The total number of feet required is:

$$\frac{984}{f_0} (N-1) \quad \begin{matrix} f_0 = \text{frequency in MHz} \\ N = \text{number of bays} \end{matrix}$$

For a 1 bay antenna, the antenna connector is a $3/8$ inch E.I.A. female connector. For 2 thru 6 bays, the feed point is nine feet below the bottom bay and is a $6/8$ inch E.I.A. female connector. For 8 thru 12 bays, the feed point is 13 feet below the antenna center, and is a $6/8$ inch E.I.A. female connector.

Warranty - The two year warranty covers defects in material and workmanship to the original purchaser of the antenna and begins the date of delivery of the antenna.

Technical Data -

Type No. and Bays	Power Gain	Gain in dB	Field Gain	FS @ 1 Mile kW, mV/m	Net Weight	Safe Power Rating	Windload 50/33 PSF
MSHCP-1	.46	-3.37	0.678	93.2	212 Lbs.	30 kW	269 Lbs.
MSHCP-2	1.0	0	1.0	137.6	425 Lbs.	60 kW	540 Lbs.
MSHCP-3	1.6	1.98	1.25	172.	634 Lbs.	60 kW	806 Lbs.
MSHCP-4	2.1	3.30	1.46	201.	1007 Lbs.	80 kW	1254 Lbs.
MSHCP-5	2.7	4.35	1.65	227.	1167 Lbs.	80 kW	1460 Lbs.
MSHCP-6	3.3	5.20	1.82	250.	1320 Lbs.	80 kW	1662 Lbs.
MSHCP-7	3.9	5.90	1.97	271.	1540 Lbs.	80 kW	1970 Lbs.
MSHCP-8	4.5	6.50	2.11	291.	1758 Lbs.	80 kW	2245 Lbs.
MSHCP-10	5.7	7.53	2.38	328.	2202 Lbs.	80 kW	2827 Lbs.
MSHCP-12	6.7	8.26	2.59	356.	2640 Lbs.	80 kW	3410 Lbs.

TERMS AND CONDITIONS OF SALE

1. PRICE: Prices of equipment are based on a cash transaction and are FOB Omaha, Nebraska, or point of shipment. McMMartin may adjust the price of any of the equipment covered by this order to McMMartin's current price in effect immediately prior to shipment except that, in the case of equipment manufactured by McMMartin, if (a) this order is accompanied by a down payment of at least 25% of the total price of the equipment described herein and shipment is made within 90 days after McMMartin's acceptance of this order, or (b) this order is herein designated as contingent upon issuance of a construction permit by the Federal Communications Commission and is accompanied by a down payment of at least 5% of the total price of the equipment described herein and shipment is made within 6 months after McMMartin's acceptance of this order, no price increases shall be made on McMMartin manufactured equipment. All vendor manufactured equipment will be at the price in effect at time order is made firm.

2. CONTINGENT ORDERS: If this order is herein designated as being contingent, Purchaser represents it as pending, or will file, with the F.C.C. an application for a construction permit. If such application as originally filed, or as amended, is denied, revoked, or abandoned, Purchaser upon giving prompt written notice to that effect to McMMartin, may cancel this order with respect to any or all items unshipped at the date of McMMartin's receipt of said notice, whereupon McMMartin shall refund to Purchaser the payments theretofore made for such cancelled items after deducting charges for special or custom-built equipment, if such charges are incurred by McMMartin. If a balance remains payable to McMMartin after deducting the price of such equipment, Purchaser shall pay said balance upon receipt of invoice from McMMartin.

3. ORDERS: All orders must be signed by an officer of the purchasing corporation, partnership, or company, or his designate. All orders, down payment agreements and terms are subject to final acceptance of McMMartin in the Omaha, Nebraska office; and the banking, negotiation, or other use of down payment shall not constitute an acceptance by McMMartin.

4. CREDIT APPROVAL: Shipments and deliveries shall at all times be subject to the approval of our Credit Department.

5. TERMS OF PAYMENT: Terms of payment are cash with order, unless other terms are offered within. Orders are accepted from customer with an established credit rating with a 25% down payment and the balance due net 30 days each invoice for existing stations, balance due net 60 days each invoice for new stations. The prompt payment discount is one percent 10th and 25th, net 30 days. Payment made beyond the 30-day period is subject to a finance charge of 1 1/4 per cent per month (equivalent to an annual percentage rate of 18 per cent). Customers wishing to establish 30-day terms should furnish trade and bank references and current financial information for review by McMMartin's Credit Department. Equipment is available through a lease/purchase option plan. Contact McMMartin's Sales Department for details.

6. INSURANCE: Purchaser shall furnish to McMMartin an insurance policy in such company as McMMartin shall approve on the equipment against All Risk perils in an amount equal to the full value of the equipment, with loss first payable to McMMartin as its interests may appear. If any deductible is involved with the All Risk coverage, such amount shall be borne by the purchaser. Purchaser will maintain such insurance until full payment shall have been made to McMMartin, in default of which McMMartin may obtain the same at Purchaser's expense for which Purchaser shall promptly reimburse McMMartin.

Purchaser agrees to indemnify and hold McMMartin free and harmless from any liability, loss, cost, damage or expense, including attorney's fees, which lessor may suffer or incur as a result of any claims which may be made by any person, including but not limited to Lessee, its agents and employees, that arise out of or result from the manufacture, delivery, actual or alleged ownership, performance, operation, possession, selection, leasing and/or return of the equipment, whether such claims are based on negligence, whether of Lessor or another, breach of contract, breach of warranty, absolute liability or otherwise.

7. DELIVERY: Delivery of the equipment sold hereunder shall be made FOB shipping point. Damage and risk of loss of any kind or nature after delivery to the carrier shall be at purchaser's sole risk. McMMartin will not be liable for any default or delay caused by government directives, priorities, regulations, requests, aides, or requisitions; or by embargoes, fires, strikes, work stoppages, accidents to machinery or any other cause whatsoever impeding production or delivery of the products ordered. Dates of delivery are made in good faith, and every reasonable effort will be made to fulfill them. However, if a scheduled delivery date cannot be met, McMMartin will not be liable to additional transportation charges incurred by customer's request to use a faster means of transportation, or for any penalty charges.

8. WARRANTY: McMMartin products are warranted to be free from defects in materials and workmanship for a period of one year after shipping date, when subjected to normal usage and service. All warranties are void if (a) equipment has been altered or repaired by others without McMMartin's specific prior authorization; or (b) equipment is operated under environmental conditions or circumstances other than those specifically described in McMMartin literature or instruction manuals.

Upon notification within the applicable warranty period, McMMartin agrees without charge, to repair, replace, or supply replacement parts for any properly maintained equipment or parts that are defective as to design, materials or workmanship and that are returned in accordance with McMMartin's instructions to the Buyer. At McMMartin's sole discretion, the Buyer may be requested to return the defective part or equipment to McMMartin, FOB Omaha, Nebraska. Parts or equipment may be returned only with McMMartin's prior authorization and must be identified by a return authorization number previously issued by McMMartin's Customer Service Department. All merchandise so returned must be sent transportation prepaid, at Buyer's risk. Full details of the failure or malfunction should be included so as to expedite repair or replacement. Repair parts or repaired or replaced equipment will be returned to the Buyer, FOB factory.

The above warranty does not extend to equipment manufactured by others, including, but not limited to, tubes, transistors, I.C.'s lamps or fuses manufactured by others, which are subject to only such adjustment as McMMartin may obtain from the suppliers thereof. McMMartin shall not be liable for consequential damages resulting from the use of, or the inability to use, the equipment; nor for any loss, damage or expense incurred thereby; nor from any other cause.

Except as set forth herein, and except as to title, there are no warranties, or any affirmations of fact or promises by McMMartin, with reference to the equipment, or to merchantability, fitness, for particular application, signal coverage, infringement, or otherwise, which extend beyond the description of the equipment on the face hereof.

9. SPECIAL 5 YEAR WARRANTY: The following warranty is applicable solely to the following products. The McMMartin BFM-8000, Exciter, and the BFM-8000T, transmitter, are warranted to be free from defects in materials and workmanship for a period of 5 years from shipping date. In addition, any combination of the BFM-1521R, stereo generator, BFM-1531R, SCA generator, purchased in a package with the BFM-8000 exciter or BFM-8000T transmitter are warranted to be free from defects of materials and workmanship for a period of 5 years from shipping date. However, if the BFM-1521R, stereo generator, or the BFM-1531R, SCA generator, are purchased separately, then the standard one year warranty set forth above in paragraph 8 will apply.

10. INSTALLATION AND MAINTENANCE: Except as set forth on the face hereof, Purchaser is responsible for the prompt installation, and proper maintenance of the Equipment to McMMartin's specifications and accepted engineering practice, and providing an adequate foundation, and employment of sufficient technically qualified personnel, and shall furnish any necessary equipment, materials, services, necessary facilities and utilities, and adequate access to the Equipment and installation site. If a contract so provides, McMMartin will furnish the services of an erection supervisor whose sole responsibility shall be to supervise or check out the installation of McMMartin's equipment furnished hereunder for the number of days required therefor, at McMMartin's published field service charge then in effect.

11. REPAIR OR REPLACEMENT: If a McMMartin product fails during the applicable warranty period, replacement or repair parts will be furnished free of charge. Upon request, and at the discretion of McMMartin, the customer may return the defective part or equipment to McMMartin, FOB Omaha, Nebraska. Parts or equipment may be returned only with McMMartin's prior authorization and must be accompanied by return authorization number issued by McMMartin's Customer Service Department. All merchandise returned for service must be sent freight prepaid at owner's risk, and with appropriate insurance coverage. Full details of the circumstances of the failure or malfunction should be included to expedite repair or replacement. Repaired equipment will be shipped to the customer, FOB, factory.

12. RETURNS: Merchandise manufactured and shipped upon order is not returnable for credit. Merchandise may be exchanged if McMMartin Industries in its sole discretion determines that circumstances warrant such concession. Merchandise for exchange must be of current design and in unopened factory cartons and is subject to a 20 per cent restocking charge, plus a \$30.00 retuning charge for receiver and monitor products with tuned RF stages. McMMartin assumes no responsibility for unauthorized returns.

13. PRODUCT CHANGES: McMMartin reserves the right without-advance notice to make engineering and production changes including substitution of vendor sources for components which may modify the design or specifications of its products, provided said modification will not materially affect the performance of the product.

14. TOWER, ANTENNA AND RELATED SERVICES: Tower and antenna erection work, ground system installation, installation of concrete foundations and anchors, and any services related thereto and provided for herein, will be performed by an independent contractor.

McMartin shall let the contract for erection of any towers and antennas provided for herein to an independent contractor, who shall not be deemed to be an agent of McMMartin, upon the installers Terms and Conditions hereto attached, as accepted by purchaser. Purchaser agrees to supervise and direct such independent contractor in the performance of the work to assure compliance with all applicable specifications, restrictions, ordinances, laws and governmental regulations.

With respect to the erection of the tower, antenna and related services, Purchaser agrees that, (a) prior to shipment of such equipment, Purchaser will have obtained from the Federal Communications Commission, the Federal Aviation Agency, and any other governing bodies having jurisdiction thereof all necessary permits (b) the site will be level, clear and free from obstructions and debris, and staked off prior to arrival of the tower erection crew, (c) the site shall not consist of marshy land, swamps, dumps, rocky soil, peat or frozen soil, and the soil conditions shall be normal and suitable, (d) suitable electrical power will be available for construction work and for testing, and (e) there shall be suitable access to the site by truck and other vehicles for the hauling of all necessary materials and equipment.

If, either before or after the erection crew has begun the work of erection, it is discovered that any of the conditions specified in (a) through (e) do not conform, then the erection crew foreman in his discretion may have the crew, at the expense of the Purchaser, perform such work as may be necessary or appropriate in order that the specified conditions may be brought about, or may delay the beginning of the work, or if already begun may discontinue the work, and, if he considers it impractical to keep the erection crew on the site, may have the crew depart from the site.

Purchaser agrees to pay to McMMartin or its order, upon invoice, all costs of extra material or services required for the performance of work related to the installation of towers, antennas or related equipment including any extra costs incurred by the contractor by reason of failure of compliance by Purchaser with any of the conditions (a) through (e) above or occasioned by inclement weather, labor difficulties, or excess labor costs resulting from requirements of local unions for extra work or stand-by labor.

Upon certification of the completion of the erection work hereunder by the erection crew foreman, Purchaser shall inspect the work, and if it is in conformity with the terms and provisions of this contract shall certify its acceptance by immediately delivering the erection crew foreman a signed statement to that effect. If Purchaser declines to sign such statement, then Purchaser before departure of the crew, shall inform McMMartin in detail by telephone of the reasons for such declination and promptly confirm such reasons in writing. If before departure of the crew, Purchaser fails so to notify McMMartin, or if Purchaser fails to make such inspection, the work shall be conclusively deemed to have been accepted by Purchaser.

15. GENERAL:

A. The preferred shipping method should be specified in your order. When not specified, shipment will be made by a common carrier selected by McMMartin. Generally, shipments will be made transportation charges collect. All materials are shipped F.O.B. Omaha or point of origin and the Purchaser is responsible for any and all damaged goods except shipments by U.P.S.

B. Claims for damage incurred in transit must be made by the customer directly with the carrier except for shipments handled by United Parcel Service (U.P.S.). U.P.S. claims must be filed at the point of origin. In either case, McMMartin must be immediately notified of damage details, dates and McMMartin invoice numbers involved.

C. In no event is McMMartin liable for consequential damages resulting from late or non-delivery, or malfunction or failure of its products, and in no event shall either party be liable to the other for consequential or special damages.

D. We reserve the right to correct clerical or typographical errors at any time without penalty.

MCMARTIN

BROADCAST EQUIPMENT

Effective November 1, 1980 • DOMESTIC PRICE SCHEDULE

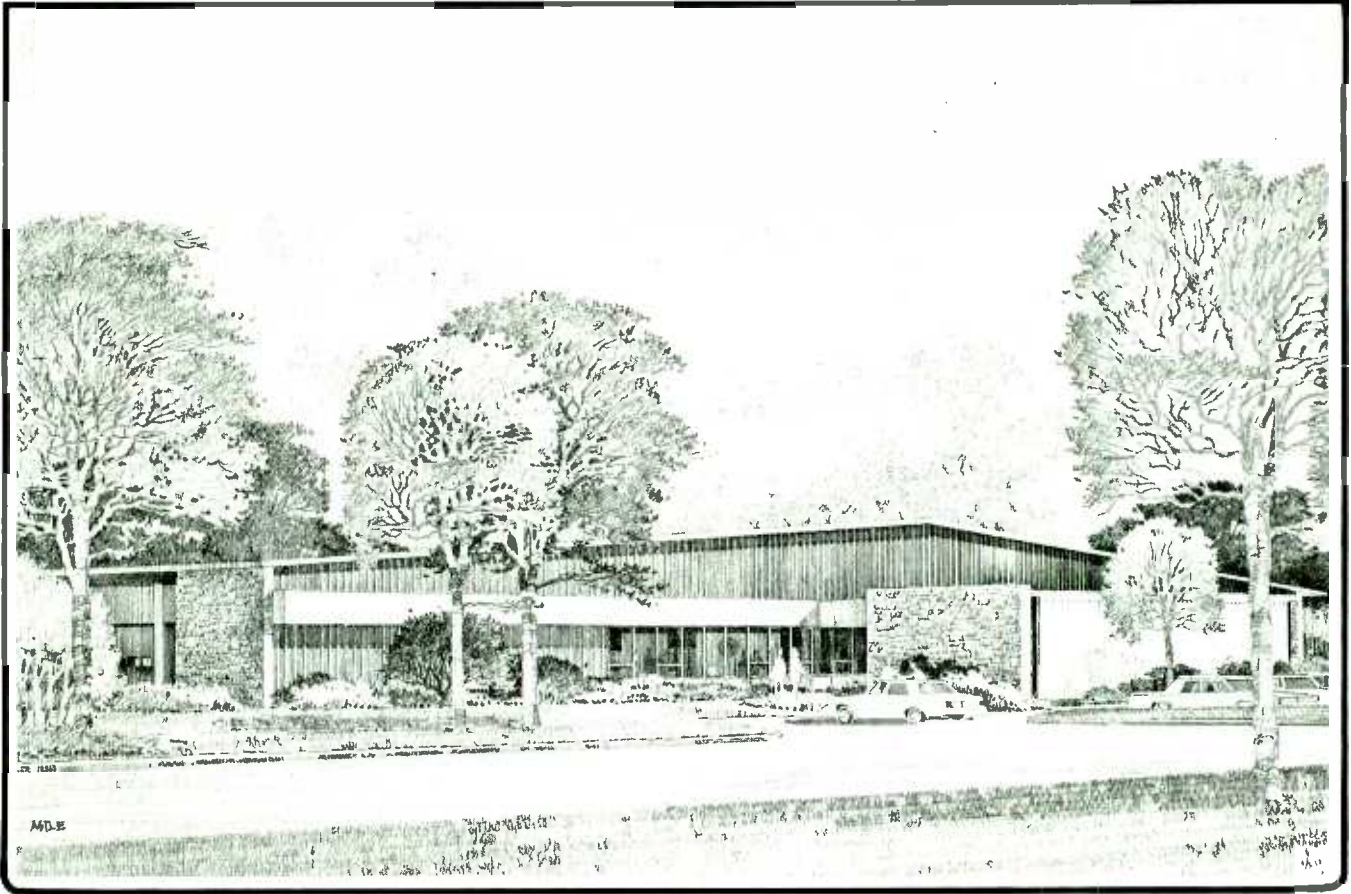

INDEX

	PAGE
AM Transmitters	1
FM Transmitters	2
FM Exciter	3
Remote Pick-Up Equipment, Transmitter & Receivers	4
RPU Accessories	5
RPU Antennas	6
1000 Series Audio Consoles	7
Replacement Printed Circuit Cards for 1000 Series Consoles	7
500 Series Audio Consoles	8
Replacement Printed Circuit Cards for 500 Series Consoles	8
Remote, Production Consoles, Phono Preamp, Tuner & Mixers	8
Tape Erasers	8
Turntables	9
Broadcast Monitor Amplifiers	9
AM Monitors	9
AM/FM Monitor and EBS Equipment	9
FM Monitors	10
FM Rebroadcast Receivers	10
Related FM Antennas	10
SCA-Plus Products	10
Satellite/Microwave Products	10
STL Systems	11
FM Antennas	12
Terms and Conditions of Sale	14

AM TRANSMITTERS

Model	Description	Product Code	Price
BA-1K	1000/500/250 watt AM transmitter, 208/230 VAC, 50/60 Hz, single phase, 3-wire (grounded neutral) For PSA powers below 250 watts, add \$250.00	10-01-061	\$ 12,995.00
SR-1K	Sola filament regulator for BA-1K	10-01-062	425.00
STA-1K	100% spare tubes for BA-1K (4 ea, 4-500 A) Spare Rectifier Diode Stack RS 1.5-12-12M (2 used)	10-01-063 210015	820.00 72.00
SC-AM	Spare vacuum crystal (Specify frequency) for all AM transmitters	10-01-064	104.00
PT-1K	Line transformer for 220/240 VAC, single-phase, 2-wire (for BA-1K)	10-01-065	325.00
SCK-A1K	Spare semi conductor kit (Audio and RF exciter transistor and diodes only)	10-01-093	126.00
BA-2.5K	2500/1000/500 watts AM broadcast transmitter, 208/230 VAC, 50/60 Hz, single phase, 3-wire (grounded neutral)	10-01-066	18,595.00
SR-2.5K	Sola filament regulator for BA-2.5K	10-01-068	495.00
STA-2.5K	100% spare tubes for BA-2.5K (4 ea, 4-1,000 A) Spare Rectifier Diode Stack RS 3.5-24-12S (4 used)	10-01-069 210016	1,808.00 115.00
BA-5K	5000/2500/1000/500 AM broadcast transmitter (combined BA-2.5K), 208/230/240 VAC, 50/60 Hz, single phase, 3-wire (grounded neutral)	10-01-055	38,995.00
BA-5K2	5000/1000 or 5000/2500 AM broadcast transmitter (Single ended) 208/230/240 VAC, 50/60 Hz, 3 phase	10-01-056	33,995.00
STA-5K2	Spare tube kit for BA-5K2, 4CX-5000A (3 ea) Individual spare tube for BA-5K2, 4CX-5000A Spare rectifier diode stack RS 3.5-24-12S (6 used)	10-01-0XX 111123 210017	3,300.00 1,100.00 110.00
BA-10K	10,000/5,000 or 2,500 watt AM transmitter complete with tubes, 208/230/240 VAC, 50/60 Hz, 3 phase 10,000/1,000 watt AM transmitter complete as above with cutback to 1,000 watts	10-01-036 Special	36,995.00 37,695.00
STA-10K	Spare tube kit for BA-10K, 4CX-5000A (4 ea.) Individual spare tube for BA-10K, 4CX-5000A Spare rectifier diode stack RS 3.5-24-12S (6 used)	10-01-037 111123 210016	4,400.00 1,100.00 115.00
BA-20K	20,000 watt AM transmitter consisting of two BA-10K transmitters and central combining unit. Transmitter complete with tubes, crystals, and solid state devices. 208/230/240 VAC, 50/60 Hz, 3 phase.	10-01-038	84,995.00
STA-20K	100% spare tube kit 4CX-5000A (8 ea) Individual spare tube (4CX-5000A) Spare rectifier diode stack RS 3.5-24-12S (12 used)	10-01-039 111123 210016	8,800.00 1,100.00 115.00
BA-50K	50,000 watt AM transmitter high level plate modulated, with 10 kW power cutback consisting of: (1)A four section cabinet which houses all exciter, audio, solid state driver stages, high level modulators, RF amplifiers and all control and measuring circuits, (2)Power control panel, (3)High voltage power supply vaults, (4)Modulation transformer and reactor vault. 380/415/460 VAC, 50/60 Hz, 3 phase (Specify actual)	10-01-058	129,995.00
STA-50K	100% Spare tube kit which consists of four 8990 A tubes		5,380.00
BA-50K TEO	Test equipment option for BA-50K. Consists of Tektronix RTM-506 mainframe, DM502A digital frequency counter, SG-505 function generator, SC502 oscilloscope, AA501 distortion analyzer		9,995.00

FM TRANSMITTERS

Model	Description	Product Code	Price
BF-1M	.25 - 1.5KW FM broadcast transmitter, complete with exciter and tubes, 208/230/240 VAC, 50/60 Hz, single phase, 3-wire (grounded neutral)	10-01-090	\$15,995.00
STF-1K	Spare tube kit for BF-1M (1-3CX1500A7/8877)	10-01-094	466.00
	Spare Rectifier Diode Stack RS 1.5-12-12M (2 used)	210015	72.00
BF-3.5M	1.5 - 3.5 kw FM transmitter, complete with exciter and tubes, 208/230/240 VAC, 50/60 Hz, single phase standard 3 phase (optional at \$1,500.00 additional cost)	10-01-026	18,495.00
STF-3.5K	Spare tube kit for BF-3.5M (2-4CX250BC, 1-3CX3000A7)	10-01-027	807.00
	Spare Rectifier Diode Stack RS 3.5-24-12S (4 used)	210016	115.00
BF-5M	3.5 - 5.5 kw FM broadcast transmitter, complete with exciter and tubes, 208/230/240 VAC, 50/60 Hz, 3-phase standard single phase (optional at \$1,500.00 additional cost)	10-01-040	23,495.00
STF-5K	Spare tube kit for BF-5M (2-4CX250BC, 1-3CX3000A7)	10-01-027	807.00
	Spare Rectifier Diode Stack RS 3.5-24-12S (4 used)	210016	115.00
BF-10M	5.5 - 15 kw FM broadcast transmitter, complete with exciter and tubes, 208/230/240 VAC, 50/60 Hz, 3-phase	10-01-045	32,995.00
STF-10K	Spare tube kit for BF-10M (1-4CX250BC, 1-3CX1500A7, 1-3CX10000A7)	10-01-048	1,959.00
	Spare Rectifier Diode Stack, Low Voltage RS 1.5-12-12M (2 used)	210015	72.00
	Spare Rectifier Diode Stack, High Voltage RS 3.5-24-12S (6 used)	210016	115.00
BF-25M	10 - 27.5 kw FM broadcast transmitter, complete with exciter and tubes, 208/230/240 VAC, 50/60 Hz, 3-phase	10-01-046	44,995.00
STF-25K	Spare tube kit for BF-25M (1-4CX250BC, 1-3CX3000A7, 1-3CX20000A7)	10-01-047	2,474.00
	Spare Rectifier Diode Stack, Low Voltage RS 1.5-12-12S (4 used)	210016	115.00
	Spare Rectifier Diode Stack, High Voltage RS 3.5-24-15S (6 used)	210017	145.00
SR-25M	Sola filament regulator for BF-25M transmitter	920039	730.00
BF-55M	20 - 55 kw FM broadcast transmitter, complete with one exciter (combined output of two BF-25M transmitters), 208/230/240 VAC, 50/60 Hz, 3 phase	10-01-078	99,995.00
ACCESSORIES			
AES	Automatic exciter switching for dual FM systems	10-01-072	5,995.00
AOS	Automatic RF output switching for dual FM systems	10-01-073	12,995.00
APC	Automatic power control for FM transmitter	10-01-074	495.00
AS-3	Three phase AC detector with auto restart	10-01-075	450.00
TCP-1	Transmitter control panel for remote control for AM or FM transmitter (Specify model numbers when ordering)	10-01-076	695.00

FM EXCITER, Low Power 10 - 100 Watt Transmitters, Accessories

Model	Description	Product Code	Price
BFM-8000/T	Exciter/Transmitter, monaural, 15 watt rack mount with rack slides	10-01-150	\$ 3,995.00
BFM-1521R	Stereo generator, self contained, rack mount	10-01-131	1,995.00
BFM-1531R	SCA generator, self contained, rack mount	10-01-132	995.00
BFM-1515R	Maxi-1 Audio Processor, monaural (Specify TV, Mono FM, AM, SCA for correct pre-emphasis and bandwidth)	10-01-138	995.00
BFM-1515/B-910	Adapter kit to operate BFM-1515R with 910 exciter	10-01-139	29.00
BFM-1514R	Maxi-1 Audio Processor, stereo	10-01-134	1,495.00
BFM-1514/B-910	Adaptor kit to operate BFM-1514R with 910 exciter	10-01-137	29.00
B-122	Cabinet, 10½" (H) × 19" (W) × 22" (D), can be used to house exciter and accessories	10-01-016	400.00
B-123	Cabinet, 20" (H) × 19" (W) × 22" (D), can be used to house exciter and accessories	10-01-023	500.00
SPARE CRYSTAL	For BFM-8000, (specify transmitter freq.)	10-01-152	75.00
B-950	50 watt FM amplifier	10-01-025	1,595.00
BFM-50	Complete 50 watt transmitter, rack mount (includes BFM-8000 and B-950)	10-01-135	5,590.00
B-9100	100 watt FM amplifier	10-01-002	2,995.00
BFM-100	Complete 100 watt amplifier, rack mount (includes BFM-8000 and B-9100)	10-01-136	6,990.00
SCK-8000	Spare semi-conductor kit for BFM-8000	10-01-151	500.00
REPLACEMENT PLUG-IN MODULES for B-910, 10 watt exciter			
B-110	Stereo, generator assembly; plug-in module (includes B-111, 112, and filter)	10-01-004	1,895.00
B-110R	Stereo generator, self-contained, rack mount	10-01-017	NLA
B-113	SCA generator	10-01-007	795.00
B-113R	SCA generator, self-contained, rack mount	10-01-018	NLA
B-114	Mono audio amplifier	10-01-008	375.00
B-115	Modulated oscillator	10-01-009	425.00
B-116	Reference oscillator	10-01-010	525.00
B-117	RF power amplifier	10-01-011	550.00
B-118	Alarm and control module	10-01-012	550.00
B-119	Power supply regulator	10-01-013	275.00
B-120	Harmonic filter	10-01-014	325.00
SCK-910	100% spare semiconductor kit for B-910	10-01-019	425.00

NOTE: Check Omaha office for price and availability on used B-910's and modules.

REMOTE PICK-UP EQUIPMENT, TRANSMITTER & RECEIVERS

Model	Description	Product Code	Price
RPU-1103	McMartin portable, 3 watt battery operated remote pickup transmitter 150.87 to 170.15 MHz. Bands K1, K2, L and M. Includes battery and antenna (microphone and battery charger sold separately) Specify frequency	10-01-086	\$ 795.00
RPU-1403	McMartin portable, 3 watt battery operated remote pickup transmitter 450 MHz band. Includes battery and antenna (microphone and battery charger sold separately) Specify frequency	10-01-087	995.00
RPU-1150	50 watt 150 MHz remote pickup transmitter. Includes mobile mount, requires 13.5 volt DC @ 10 amps transmit. (Specify frequency)	10-01-088	1,395.00
RPU-1430	30 watt 450 MHz remote pickup transmitter. Includes mobile mount, requires 13.5 volt DC @ 10 amps transmit. (Specify frequency) For base station use, .0002 frequency tolerance, add \$220.00	10-01-089	1,595.00
RPU-1150R	Receiver, 150 MHz, rack mount, 2 channels (for second channel, add \$25.00)	10-03-038	875.00
RPU-1450R	Receiver, 450 MHz, rack mount, 2 channels (for second channel, add \$25.00)	10-03-033	925.00
RPU-1150Q	150 MHz Cue receiver 1 Channel (Specify frequency) 2 Channel (Specify frequency)	10-03-054	450.00 500.00
RPU-1450Q	450 MHz Cue receiver 1 Channel (Specify frequency) 2 Channel (Specify frequency)	10-03-055	500.00 550.00
150 MHz FE	Additional front end 150 MHz 1 Channel (Specify frequency) 2 Channel (Specify frequency)	10-03-056	200.00 250.00
450 MHz FE	Additional front end 450 MHz 1 Channel (Specify frequency) 2 Channel (Specify frequency)	10-03-057	225.00 275.00

NOTE: The "Cue" receivers mount on the RPU-1103 or RPU-1403 transmitters and work off the transmitter power supply only.

RPU ACCESSORIES

Model	Description	Product Code	Price
FOR RPU-1103 & RPU-1403			
RPU/BAT	Replacement battery, 12 volts Ni-Cad	10-01-115	\$ 49.00
RPU/BC	Battery charger	10-01-111	59.00
RPU/ANT	Rubber duck antenna 150 MHz	10-01-112	22.00
RPU/ANT	Rubber duck antenna 450 MHz	10-10-118	22.00
RPU/2CH	Second Channel frequency module (specify frequency) for RPU-1103, 1403, 1150, and 1430. (450 MHz base station \$200.00)	10-01-114	105.00
RPU/MIC	Turner push-to-talk microphone model 350D	10-01-113	55.00
FOR RPU-1150, RPU-1330, & RPU-1430			
RPU/PS	AC power supply	10-01-095	350.00
RPU/RmCc	Rack mount and carrying case provides convenient carrying case and rack mounting for both the power supply and 50 or 30 watt transmitter. (Not required for mobile installations)	10-01-096	85.00
RPU/MC	Mobile control head for use when unit is trunk mounted. Includes cable from control head to transmitter.	10-01-098	240.00

FIXED BASE



RPU-1150 and RPU/PS Rack mount

PORTABLE



RPU-1103 3 watt portable transmitter

MOBILE



RPU-1150 as for trunk mounting



RPU/MC Mobile control head

RPU ANTENNAS

Model	Description	Product Code	Price
MOBILE (150 MHz)			
DB-702-100	2.5 dB Gain - Roof mount, includes 15' RG/58U cable and PL-259 connector.	10-20-301	\$ 38.00
DB-702-102	Same as above with "no holes" trunk mount.	10-20-302	45.00
BASE (150 MHz)			
DB-264	6 dB circular to 9 dB offset consists of 4 vertical folded dipoles, enclosed feed system, with type N male connector. Length 258" top mounted. (Specify frequency)	10-20-303	300.00
DB-5001	Side mount kit for DB-264	10-20-304	102.00
DB-230	3 element YAGI - 7 dB Gain - Type N male connector supplied.	10-20-305	129.00
DB-230-2	2-DB-230's stacked -10 dB Gain harness and type N male connector supplied.	10-20-306	293.00
DB-230-4	4-DB-230's stacked -13 dB Gain harness and type N male connector supplied.	10-20-307	620.00
MOBILE (450 MHz)			
DB-705-201	5 dB Gain - Roof mount, includes 15' RG/58U cable and PL-259 connector.	10-20-308	36.00
DB-705-203	Same as above with "no holes" trunk mount.	10-20-309	43.00
BASE (450 MHz)			
DB-408	4 bay collinear array 6.6 dB Gain type N male connector supplied, length 9'5". (Specify frequency)	10-20-310	226.00
DB-410	8 bay version of DB-408 (above) 9.2 dB Gain, length 18'1". (Specify frequency)	10-20-311	364.00
DB-5012	Side mount kit for DB-408 or 410.	10-20-312	102.00
DB-436	6 element YAGI antenna 10 dB Gain type N male termination.	10-20-313	114.00
DB-436-2	2-DB-436 stacked 13 dB Gain.	10-20-314	246.00
DB-436-4	4 DB-436 stacked 16 dB Gain.	10-20-315	509.00

NOTE: Vendor items are subject to price change. Various other antennas are also available. Please check Omaha sales office for information.

1000 SERIES AUDIO CONSOLES

Model	Description	Product Code	Price
1052V	5 Channel Stereo Vertical Attenuators CH 1 Microphone Input CH 2,3,4 Hi Level Unbalanced Input CH 5 Hi Level Balanced Input	10-02-146	\$ 2,900.00
1052SA	As above but with rotary step attenuators	10-02-145	2,900.00
1052	As above but with carbon potentiometers	10-02-144	2,700.00
1081	8 Channel Mono Rotary Attenuators CH 1,2 Microphone Input CH 3,4,5,6,7 Hi Level Unbalanced Input CH 8 Hi Level Balanced Input	10-02-120	3,350.00
1081V	8 Channel Mono Vertical Attenuators CH 1,2 Microphone Input CH 3,4,5,6,7 Hi Level Unbalanced Input CH 8 Hi Level Balanced Input	10-02-119	3,550.00
1082	8 Channel Stereo Rotary Attenuators CH 1,2 Microphone Input CH 3,4,5,6,7 Hi Level Unbalanced Input CH 8 Hi Level Balanced Input	10-02-118	4,100.00
1082V	8 Channel Stereo Vertical Attenuators CH 1,2 Microphone Input CH 3,4,5,6,7 Hi Level Unbalanced Input CH 8 Hi Level Balanced Input	10-02-117	4,400.00

REPLACEMENT PRINTED CIRCUIT CARDS for 1000 Series Consoles

Cue/Talkback Amplifier	10-02-124	175.00
Program Amplifier	10-02-125	195.00
Monitor Amp Stereo	10-02-126	250.00
Monitor Amp Mono	10-02-134	150.00
SANKEN Hybrid Module for use with MONITOR AMPS. Requires 1 Mono, 2 Stereo		50.00
Stereo Mic PreAmp	10-02-130	225.00
Mono Mic PreAmp	10-02-135	145.00
Headphone Amplifier	10-02-129	150.00
Stereo Hi Level Balanced Input	10-02-131	145.00
Mono Hi Level Balanced Input	10-02-136	95.00
Mono or Stereo Level Unbalanced Input	10-02-132	35.00
Power Supply	10-02-133	450.00

500 SERIES AUDIO CONSOLES

Model	Description	Product Code	Price
B-501	5 mixer, monaural, 1 mic, 4 hi-bal	10-02-041	\$ 1,425.00
B-501SA	B-501 with step attenuators	10-02-044	1,750.00
B-502	5 mixer, stereo, 1 mic, 4 hi-bal	10-02-042	1,995.00
B-502SA	B-502 with step attenuators	10-02-045	2,495.00

REPLACEMENT PRINTED CIRCUIT CARDS FOR 500 Series Consoles

PLUG-IN CARDS

5MP1	Microphone preamplifier (B-501)	10-02-056	60.00
5MP2	Microphone preamplifier (B-502)	10-02-060	120.00
5BH1	High level balanced input (B-501)	10-02-054	50.00
5BH2	Dual high level balanced input (B-502)	10-02-058	80.00
5BA1	Booster amplifier (B-501)	10-02-055	40.00
5BA2	Dual booster amplifier (B-502)	10-02-059	60.00
5PG1	Program amplifier (B-501)	10-02-057	50.00
5PG2	Dual program amplifier (B-502)	10-02-061	70.00
5PS1	Power regulator (All models)	10-02-053	40.00

WIRE-IN CARDS

5QA1	Cue amplifier	10-02-051	55.00
5MA1	Monitor amplifier	10-02-052	75.00

ACCESSORIES

5RY1	Speaker muting relay (All Models)	10-02-064	30.00
------	-----------------------------------	-----------	-------

REMOTE, PRODUCTION CONSOLES, PHONO PREAMP, TUNER, & MIXERS

ACCU-FIVE	5 channel rack mount mini console	10-02-080	752.00
BR-400	4 channel remote mixer amplifier	10-02-081	425.00
B-200B	Mono/stereo equalized phono preamplifier, balanced 600 ohm output	10-02-076	240.00
MX-5B	5-channel mixer/preamplifier	10-02-084	199.00
MRP-7B	Rack mount adaptor, beige, for MX-5	10-02-085	20.00
AF-200/B	AM/FM stereo tuner	10-05-018	194.00
AF-300/B	AM/FM Stereo tuner amplifier	10-05-023	309.00

TAPE ERASERS

TE-70	High Speed Tape Eraser, 7"	10-02-114	825.00
TE-105	High Speed Tape Eraser, 10½"	10-02-115	1,150.00

TURNTABLES

Model	Description	Product Code	Price
TT-12C	McMartin Broadcast turntable - 3 speed	10-02-110	\$ 360.00
303 Pickup Arm	Micro-trak 12" tone arm	10-02-111	107.00
Stanton 500 AL	Stereo cartridge	10-02-112	35.00
Shure M44-7	Stereo cartridge	10-02-113	39.00

BROADCAST MONITOR AMPLIFIERS

LT-80C/B	12-watt universal amplifier with one mic, 1 program input	10-05-001	94.00
LT-252B/B	25-watt universal amplifier with two mic, 2 program input	10-05-003	194.00
LT-250C/B	25-watt power amplifier	10-05-002	160.00
LT-500D/B	50-watt power amplifier	10-05-004	218.00
LT-1000D/B	100-watt power amplifier	10-05-006	291.00
LT-2000D/B	200-watt power amplifier	10-05-007	437.00
LT-3500D/B	350-watt power amplifier	10-05-008	653.00
MT-3B	Plug-in balanced/bridging transformer	10-05-009	16.00
MS-105/B	5-watt amplifier	10-05-017	65.00
MRP 3B	Rack mount adaptor for LT 80C/108C	10-05-010	12.00
MRP 4B	Rack mount adaptor for dual LT 80C/108C	10-05-011	9.00
MRP 8B	Rack mount kit for MS-105B	10-05-022	24.00

AM MONITORS

RF-85B	AM RF amplifier	10-03-104	795.00
--------	-----------------	-----------	--------

AM/FM MONITOR AND EBS EQUIPMENT

AMR-1	AM monitor receiver, single channel	10-04-003	165.00
FMR-1D	FM monitor receiver, single channel	10-04-013	215.00
EBS-2	EBS decoder for AMR-1 and FMR-1D/FMR-5 (Two-tone system)	10-04-002	195.00
TG-2/EBS	Precision two-tone EBS generator	10-04-011	325.00

FM MONITORS

Model	Description	Product Code	Price
TBM-3700	Frequency and monaural modulation monitor	10-03-049	\$ 2,350.00
RM-37T	Remote metering plug-in card	10-03-052	150.00
RM-37R	Remote metering rack mount panel	10-03-051	375.00
TBM-3500B	Modulation monitor	10-03-043	1,895.00
RM-35B	Remote metering rack mount panel	10-03-045	250.00
LL-35B	Low level input module	10-03-044	350.00
TBM-2200A	Stereo modulation and pilot frequency adaptor (Requires TBM-3700 or TBM-3500)	10-03-034	1,795.00
RM-22T	Remote metering plug-in card	10-03-037	150.00
RM-22R	Remote metering rack mount panel	10-03-036	450.00
TBM-2000B	SCA modulation and frequency adaptor (Requires TBM-3700 or TBM-3500)	10-03-027	1,795.00
RM-20T	Remote metering plug-in card	10-03-030	150.00
RM-20R	Remote metering rack mount panel	10-03-029	350.00
TBM-2500C	RF amplifier	10-03-041	750.00

FM REBROADCAST RECEIVERS

TBM-1005D	Five channel relay receiver (88-108 MHz) with one crystal. Each additional channel crystal	10-03-015	595.00 20.00
TBM-1003D	Aural TV channel 2-13 receiver		750.00
STE-1D	Plug-in stereo demod card for relay receiver	10-03-012	240.00
SCA-2D	Plug-in SCA demodulator card 41 kHz 67 kHz	10-03-010 10-03-011	165.00 165.00
TVR-1	TV/SCA receiver, 39.5/67 kHz	40-02-013	158.00
TR-E7	TV/SCA receiver, 39.5/67 kHz	40-02-010	150.00
TX-200D/B	FM/SCA Field strength meter (less batteries)	40-02-040	450.00
TX-200 XFMR	AC Transformer for TX-200D/B for operation of built-in battery charger	900075	10.00

RELATED FM ANTENNAS

A-72-SF-3	3 element Yagi Antenna cut to band (2 per carton)	20-03-001	20.00
A-72-SF-5	5 element Yagi Antenna cut to band	20-03-002	35.00
AS-1	Stacking harness (for A-72-SF-3/SF-5)	20-03-003	31.00
SPA2-B	Preamp/Attenuator	10-05-024	49.00
PS-13/B	Power Supply	10-05-025	49.00

SCA-Plus PRODUCTS

BSP-2800/B	Dual channel SCA encoder	10-05-026	547.00
SPH-2800A/B	Data channel decoding filter board	10-05-027	29.00
SPH-2800B/B	Data channel decoding filter - stand alone model	10-05-028	44.00
SPL-2800A/B	Audio channel decoding filter board	10-05-029	14.00
SPL-2800B/B	Audio channel decoding filter - stand alone model	10-05-030	44.00

SATELLITE/MICROWAVE PRODUCTS

SDR-1/B	IF Demodulator	10-05-031	650.00
SMR-1/B	IF Modulator	10-05-032	1,150.00

STL SYSTEMS

Model	Description	Product Code	Price
STL-9500-51	STL-all solide state composite transmitter and receiver, including self contained power supplies, crystals and tested to operating frequency.	10-20-505	\$ 5,245.00
STL-9500-52	STL-all solid state composite transmitter and receiver with HOT standby transmitter and receiver with automatic switching, including self contained power supplies crystals, and tested to operating frequency.	10-20-506	11,545.00
STL-9500-53	STL-all solid state single channel transmitter and receiver, including self contained power supplies, crystals, and tested to operating frequency.	10-20-507	4,910.00
STL-9500-54	STL-all solid state single channel transmitter and receiver with HOT standby transmitter and receiver with automatic switching, including self contained power supplies, crystals and tested to operating frequency.	10-20-508	9,990.00
STL-9500-55	STL-all solid state dual single channel transmitters and receivers for separate left and right channel, including self contained power supplies, crystals and tested to operating frequency.	10-20-509	9,820.00
STL-9503	Composite Receiver	10-20-501	2,175.00
STL-5901	Monaural Receiver	10-20-502	1,965.00
STL-9500	Transmitter	10-20-503	3,675.00
STL-9504	Transmitter Automatic Changeover Unit Retrofit Installation Charge	10-20-504	525.00 100.00
MOPT-01	Receiver Automatic Changeover Unit	10-20-601	160.00
MOPT-02	A power splitter for parallel operation of dual receivers	10-20-602	220.00
MOPT-03	A balanced audio output at + 10 dBm (Monaural only)	10-20-603	120.00
MANT-450	Scala Paraflector Antenna for 960 MHz, 19.65 dB gain over dipole, type N female connector, universal mounting for vertical or horizontal polarization, fully anodized.	10-20-701	435.00
MANT-960	Scala Miniflector Antenna for 960 MHz, 16.14 dB gain over dipole, type N female connector, universal mounting for vertical or horizontal polarization, fully anodized. Not recommended for congested areas.	10-20-702	250.00
MCOX-01	Heliax*LDF4-50 Transmission Line 1/2" foam Dielectric, 50 ohm jacketed.	10-20-801	per foot 1.36
MCON-1	Connector Kit for LDF4-50 Heliax consisting of 2 type L44N female connectors. ONE KIT REQUIRED FOR EACH LENGTH OF LDF4-50.	10-20-802	34.00
MCOX-2	Heliax*LDF5-50 Transmission Line 7/8" foam Dielectric 50 ohm jacketed	10-20-901	3.54 per foot
MCON-2	Connector Kit for LDF5-50 Heliax consisting of 2 type L45N female connectors. ONE KIT REQUIRED FOR EACH LENGTH OF LDF5-50.	10-20-902	80.00
MPTL-1	3' pigtail assembly of RG-8/U with type N male connector on each end. TWO REQUIRED FOR EACH ANTENNA	10-20-401	25.00 each

FM ANTENNAS

Model	Description		Product Code	Price
LOW CIRCULAR POWER				
	Bays	Line	Gain	KW Power
MLCP-2	2	1 $\frac{7}{8}$ "	1.0	5
		With Deicers		
		With Radomes		
MLCP-3	3	1 $\frac{7}{8}$ "	1.5	6
		With Deicers		
		With Radomes		
MLCP-4	4	1 $\frac{7}{8}$ "	2.1	8
		With Deicers		
		With Radomes		
MLCP-5	5	1 $\frac{7}{8}$ "	2.7	10
		With Deicers		
		With Radomes		
MLCP-6	6	1 $\frac{7}{8}$ "	3.2	10
		With Deicers		
		With Radomes		
MLCP-7	7	1 $\frac{7}{8}$ "	3.8	10
		With Deicers		
		With Radomes		
MLCP-8	8	1 $\frac{7}{8}$ "	4.3	10
		With Deicers		
		With Radomes		
MLCP-9	9	1 $\frac{7}{8}$ "	4.9	10
		With Deicers		
		With Radomes		
MLCP-10	10	1 $\frac{7}{8}$ "	5.5	10
		With Deicers		
		With Radomes		
MLCP-12	12	1 $\frac{7}{8}$ "	6.6	10
		With Deicers		
		With Radomes		
MLCP-14	14	1 $\frac{7}{8}$ "	7.8	10
		With Deicers		
		With Radomes		
HIGH CIRCULAR POWER				
MHCP-1	1	1 $\frac{7}{8}$ "	0.46	10
		With Deicers		
		With Radomes		
MHCP-2	2	3 $\frac{1}{8}$ "	1.0	20
		With Deicers		
		With Radomes		
MHCP-3	3	3 $\frac{1}{8}$ "	1.5	30
		With Deicers		
		With Radomes		
MHCP-4	4	3 $\frac{1}{8}$ "	2.1	40
		With Deicers		
		With Radomes		
MHCP-5	5	3 $\frac{1}{8}$ "	2.7	40
		With Deicers		
		With Radomes		
MHCP-6	6	3 $\frac{1}{8}$ "	3.2	40
		With Deicers		
		With Radomes		

FM ANTENNAS

Model	Description		Product Code	Price
HIGH CIRCULAR POWER				
	Bays	Line	Gain	KW Power
MHCP-7	7	3 $\frac{1}{8}$ "	3.8	40
		With Deicers		
		With Radomes		
			10-20-057	\$ 12,657.00
			10-20-069	14,862.00
			10-20-081	15,598.00
MHCP-8	8	3 $\frac{1}{8}$ "	4.3	40
		With Deicers		
		With Radomes		
			10-20-058	14,201.00
			10-20-070	16,721.00
			10-20-082	17,561.00
MHCP-9	9	3 $\frac{1}{8}$ "	4.9	40
		With Deicers		
		With Radomes		
			10-20-059	15,818.00
			10-20-071	18,653.00
			10-20-083	19,598.00
MHCP-10	10	3 $\frac{1}{8}$ "	5.5	40
		With Deicers		
		With Radomes		
			10-20-060	17,430.00
			10-20-072	20,580.00
			10-20-084	21,630.00
MHCP-12	12	3 $\frac{1}{8}$ "	6.6	40
		With Deicers		
		With Radomes		
			10-20-061	20,423.00
			10-20-073	24,166.00
			10-20-085	25,426.00
MHCP-14	14	3 $\frac{1}{8}$ "	7.8	40
		With Deicers		
		With Radomes		
			10-20-062	23,787.00
			10-20-074	28,198.00
			10-20-086	29,668.00
SUPER HIGH CIRCULAR POWER				
MSHCP-1	1	6 $\frac{1}{8}$ "	0.48	30
		With Deicers		
			10-20-201	3,037.00
			10-20-211	3,596.00
MSHCP-2	2	6 $\frac{1}{8}$ "	1.0	60
		With Deicers		
			10-20-202	5,465.00
			10-20-212	6,589.00
MSHCP-3	3	6 $\frac{1}{8}$ "	1.6	80
		With Deicers		
			10-20-203	8,132.00
			10-20-213	9,818.00
MSHCP-4	4	6 $\frac{1}{8}$ "	2.1	80
		With Deicers		
			10-20-204	11,288.00
			10-20-214	13,535.00
MSHCP-5	5	6 $\frac{1}{8}$ "	2.7	80
		With Deicers		
			10-20-205	13,655.00
			10-20-215	16,464.00
MSHCP-6	6	6 $\frac{1}{8}$ "	3.3	80
		With Deicers		
			10-20-206	16,201.00
			10-20-216	19,572.00
MSHCP-7	7	6 $\frac{1}{8}$ "	3.9	80
		With Deicers		
			10-20-207	18,874.00
			10-20-217	22,806.00
MSHCP-8	8	6 $\frac{1}{8}$ "	4.5	80
		With Deicers		
			10-20-208	20,874.00
			10-20-218	25,368.00
MSHCP-10	10	6 $\frac{1}{8}$ "	5.7	80
		With Deicers		
			10-20-209	26,093.00
			10-20-219	31,710.00
MSHCP-12	12	6 $\frac{1}{8}$ "	6.7	80
		With Deicers		
			10-20-210	27,909.00
			10-20-220	34,650.00
OPTIONS AND ACCESSORIES				
	Pattern measurement service			
	Tower mount			2,000.00
	Pole Mount			1,500.00
	Beam tilt any amount, any antenna			750.00
	Null fill any percentage, any antenna			750.00
	Combined beam tilt and null fill			1,250.00
	Deicer control - 2 temperature (1-5 bays)			450.00
	Deicer control - 2 temperature (6 or more bays)			600.00
	Deicer control - 1 temperature for MLCP antennas			250.00

This is your price list for McMartin Broadcast products. All prices and specifications are subject to change without notice. Firm quotations are available for specific time periods. All prices are F.O.B. Omaha, Nebraska or point of shipment.

TERMS AND CONDITIONS OF SALE

1. PRICE: Prices of equipment are based on a cash transaction and are FOB Omaha, Nebraska, or point of shipment. McMartin may adjust the price of any of the equipment covered by this order to McMartin's current price in effect immediately prior to shipment except that, in the case of equipment manufactured by McMartin, if (a) this order is accompanied by a down payment of at least 25% of the total price of the equipment described herein and shipment is made within 90 days after McMartin's acceptance of this order, or (b) this order is herein designated as contingent upon issuance of a construction permit by the Federal Communications Commission and is accompanied by a down payment of at least 5% of the total price of the equipment described herein and shipment is made within 6 months after McMartin's acceptance of this order, no price increases shall be made on McMartin manufactured equipment. All vendor manufactured equipment will be at the price in effect at time order is made firm.

2. CONTINGENT ORDERS: If this order is herein designated as being contingent, Purchaser represents it as pending, or will file, with the F.C.C. an application for a construction permit. If such application as originally filed, or as amended, is denied, revoked, or abandoned, Purchaser upon giving prompt written notice to that effect to McMartin, may cancel this order with respect to any or all items unshipped at the date of McMartin's receipt of said notice, whereupon McMartin shall refund to Purchaser the payments theretofore made for such cancelled items after deducting charges for special or custom-built equipment, if such charges are incurred by McMartin. If a balance remains payable to McMartin after deducting the price of such equipment, Purchaser shall pay said balance upon receipt of invoice from McMartin.

3. ORDERS: All orders must be signed by an officer of the purchasing corporation, partnership, or company, or his designate. All orders, down payment agreements and terms are subject to final acceptance of McMartin in the Omaha, Nebraska office; and the banking, negotiation, or other use of down payment shall not constitute an acceptance by McMartin.

4. CREDIT APPROVAL: Shipments and deliveries shall at all times be subject to the approval of our Credit Department.

5. TERMS OF PAYMENT: Terms of payment are cash with order, unless other terms are offered within. Orders are accepted from customer with an established credit rating with a 25% down payment and the balance due net 30 days each invoice for existing stations, balance due net 60 days each invoice for new stations. The prompt payment discount is one percent 10th and 25th, net 30 days. Payment made beyond the 30-day period is subject to a finance charge of 1½ per cent per month (equivalent to an annual percentage rate of 18 per cent). Customers wishing to establish 30-day terms should furnish trade and bank references and current financial information for review by McMartin's Credit Department. Equipment is available through a lease/purchase option plan. Contact McMartin's Sales Department for details.

6. INSURANCE: Purchaser shall furnish to McMartin an insurance policy in such company as McMartin shall approve on the equipment against All Risk perils in an amount equal to the full value of the equipment, with loss first payable to McMartin as its interests may appear. If any deductible is involved with the All Risk coverage, such amount shall be borne by the purchaser. Purchaser will maintain such insurance until full payment shall have been made to McMartin, in default of which McMartin may obtain the same at Purchaser's expense for which Purchaser shall promptly reimburse McMartin.

Purchaser agrees to indemnify and hold McMartin free and harmless from any liability, loss, cost, damage or expense, including attorney's fees, which lessor may suffer or incur as a result of any claims which may be made by any person, including but not limited to Lessee, its agents and employees, that arise out of or result from the manufacture, delivery, actual or alleged ownership, performance, operation, possession, selection, leasing and/or return of the equipment, whether such claims are based on negligence, whether of Lessor or another, breach of contract, breach of warranty, absolute liability or otherwise.

7. DELIVERY: Delivery of the equipment sold hereunder shall be made FOB shipping point. Damage and risk of loss of any kind or nature after delivery to the carrier shall be at purchaser's sole risk. McMartin will not be liable for any default or delay caused by government directives, priorities, regulations, requests, aides, or requisitions; or by embargoes, fires, strikes, work stoppages, accidents to machinery or any other cause whatsoever impeding production or delivery of the products ordered. Dates of delivery are made in good faith, and every reasonable effort will be made to fulfill them. However, if a scheduled delivery date cannot be met, McMartin will not be liable to additional transportation charges incurred by customer's request to use a faster means of transportation, or for any penalty charges.

8. WARRANTY: McMartin products are warranted to be free from defects in materials and workmanship for a period of one year after shipping date, when subjected to normal usage and service. All warranties are void if (a) equipment has been altered or repaired by others without McMartin's specific prior authorization; or (b) equipment is operated under environmental conditions or circumstances other than those specifically described in McMartin literature or instruction manuals.

Upon notification within the applicable warranty period, McMartin agrees without charge, to repair, replace, or supply replacement parts for any properly maintained equipment or parts that are defective as to design, materials or workmanship and that are returned in accordance with McMartin's instructions to the Buyer. At McMartin's sole discretion, the Buyer may be requested to return the defective part or equipment to McMartin, FOB Omaha, Nebraska. Parts or equipment may be returned only with McMartin's prior authorization and must be identified by a return authorization number previously issued by McMartin's Customer Service Department. All merchandise so returned must be sent transportation prepaid, at Buyer's risk. Full details of the failure or malfunction should be included so as to expedite repair or replacement. Repair parts or repaired or replaced equipment will be returned to the Buyer, FOB factory.

The above warranty does not extend to equipment manufactured by others, including, but not limited to, tubes, transistors, I.C.'s lamps or fuses manufactured by others, which are subject to only such adjustment as McMartin may obtain from the suppliers thereof. McMartin shall not be liable for consequential damages resulting from the use of, or the inability to use, the equipment; nor for any loss, damage or expense incurred thereby; nor from any other cause.

Except as set forth herein, and except as to title, there are no warranties, or any affirmations of fact or promises by McMartin, with reference to the equipment, or to merchantability, fitness, for particular application, signal coverage, infringement, or otherwise, which extend beyond the description of the equipment on the face hereof.

9. SPECIAL 5 YEAR WARRANTY: The following warranty is applicable solely to the following products. The McMartin BFM-8000, Exciter, and the BFM-8000T, transmitter, are warranted to be free from defects in materials and workmanship for a period of 5 years from shipping date. In addition, any combination of the BFM-1521R, stereo generator, BFM-1531R, SCA generator, purchased in a package with the BFM-8000 exciter or BFM-8000T transmitter are warranted to be free from defects of materials and workmanship for a period of 5 years from shipping date. However, if the BFM-1521R, stereo generator, or the BFM-1531R, SCA generator, are purchased separately, then the standard one year warranty set forth above in paragraph 8 will apply.

10. INSTALLATION AND MAINTENANCE: Except as set forth on the face hereof, Purchaser is responsible for the prompt installation, and proper maintenance of the Equipment to McMartin's specifications and accepted engineering practice, and providing an adequate foundation, and employment of sufficient technically qualified personnel, and shall furnish any necessary equipment, materials, services, necessary facilities and utilities, and adequate access to the Equipment and installation site. If a contract so provides, McMartin will furnish the services of an erection supervisor whose sole responsibility shall be to supervise or check out the installation of McMartin's equipment furnished hereunder for the number of days required therefor, at McMartin's published field service charge then in effect.

11. REPAIR OR REPLACEMENT: If a McMartin product fails during the applicable warranty period, replacement or repair parts will be furnished free of charge. Upon request, and at the discretion of McMartin, the customer may return the defective part or equipment to McMartin, FOB, Omaha, Nebraska. Parts or equipment may be returned only with McMartin's prior authorization and must be accompanied by return authorization number issued by McMartin's Customer Service Department. All merchandise returned for service must be sent freight prepaid at owner's risk, and with appropriate insurance coverage. Full details of the circumstances of the failure or malfunction should be included to expedite repair or replacement. Repaired equipment will be shipped to the customer, FOB, factory.

12. RETURNS: Merchandise manufactured and shipped upon order is not returnable for credit. Merchandise may be exchanged if McMartin Industries in its sole discretion determines that circumstances warrant such concession. Merchandise for exchange must be of current design and in unopened factory cartons and is subject to a 20 per cent restocking charge, plus a \$30.00 retuning charge for receiver and monitor products with tuned RF stages. McMartin assumes no responsibility for unauthorized returns.

13. PRODUCT CHANGES: McMartin reserves the right without advance notice to make engineering and production changes including substitution of vendor sources for components which may modify the design or specifications of its products, provided said modification will not materially affect the performance of the product.

14. TOWER, ANTENNA AND RELATED SERVICES: Tower and antenna erection work, ground system installation, installation of concrete foundations and anchors, and any services related thereto and provided for herein, will be performed by an independent contractor.

McMartin shall let the contract for erection of any towers and antennas provided for herein to an independent contractor, who shall not be deemed to be an agent of McMartin, upon the installers Terms and Conditions hereto attached, as accepted by purchaser. Purchaser agrees to supervise and direct such independent contractor in the performance of the work to assure compliance with all applicable specifications, restrictions, ordinances, laws and governmental regulations.

With respect to the erection of the tower, antenna and related services, Purchaser agrees that, (a) prior to shipment of such equipment, Purchaser will have obtained from the Federal Communications Commission, the Federal Aviation Agency, and any other governing bodies having jurisdiction thereof all necessary permits (b) the site will be level, clear and free from obstructions and debris, and staked off prior to arrival of the tower erection crew, (c) the site shall not consist of marshy land, swamps, dumps, rocky soil, peat or frozen soil, and the soil conditions shall be normal and suitable, (d) suitable electrical power will be available for construction work and for testing, and (e) there shall be suitable access to the site by truck and other vehicles for the hauling of all necessary materials and equipment.

If, either before or after the erection crew has begun the work of erection, it is discovered that any of the conditions specified in (a) through (e) do not conform, then the erection crew foreman in his discretion may have the crew, at the expense of the Purchaser, perform such work as may be necessary or appropriate in order that the specified conditions may be brought about, or may delay the beginning of the work, or if already begun may discontinue the work, and, if he considers it impractical to keep the erection crew on the site, may have the crew depart from the site.

Purchaser agrees to pay to McMartin on its order, upon invoice, all costs of extra material or services required for the performance of work related to the installation of towers, antennas or related equipment including any extra costs incurred by the contractor by reason of failure of compliance by Purchaser with any of the conditions (a) through (e) above or occasioned by inclement weather, labor difficulties, or excess labor costs resulting from requirements of local unions for extra work or stand-by labor.

Upon certification of the completion of the erection work hereunder by the erection crew foreman, Purchaser shall inspect the work, and if it is in conformity with the terms and provisions of this contract shall certify its acceptance by immediately delivering the erection crew foreman a signed statement to that effect. If Purchaser declines to sign such statement, then Purchaser before departure of the crew, shall inform McMartin in detail by telephone of the reasons for such declination and promptly confirm such reasons in writing. If before departure of the crew, Purchaser fails so to notify McMartin, or if Purchaser fails to make such inspection, the work shall be conclusively deemed to have been accepted by Purchaser.

15. GENERAL:

A. The preferred shipping method should be specified in your order. When not specified, shipment will be made by a common carrier selected by McMartin. Generally, shipments will be made transportation charges collect. All materials are shipped F.O.B. Omaha or point of origin and the Purchaser is responsible for any and all damaged goods except shipments by U.P.S.

B. Claims for damage incurred in transit must be made by the customer directly with the carrier except for shipments handled by United Parcel Service (U.P.S.). U.P.S. claims must be filed at the point of origin. In either case, McMartin must be immediately notified of damage details, dates and McMartin invoice numbers involved.

C. In no event is McMartin liable for consequential damages resulting from late or non-delivery, or malfunction or failure of its products, and in no event shall either party be liable to the other for consequential or special damages.

D. We reserve the right to correct clerical or typographical errors at any time without penalty.

MCMARTIN

NOVEMBER 80 • Printed in U.S.A.

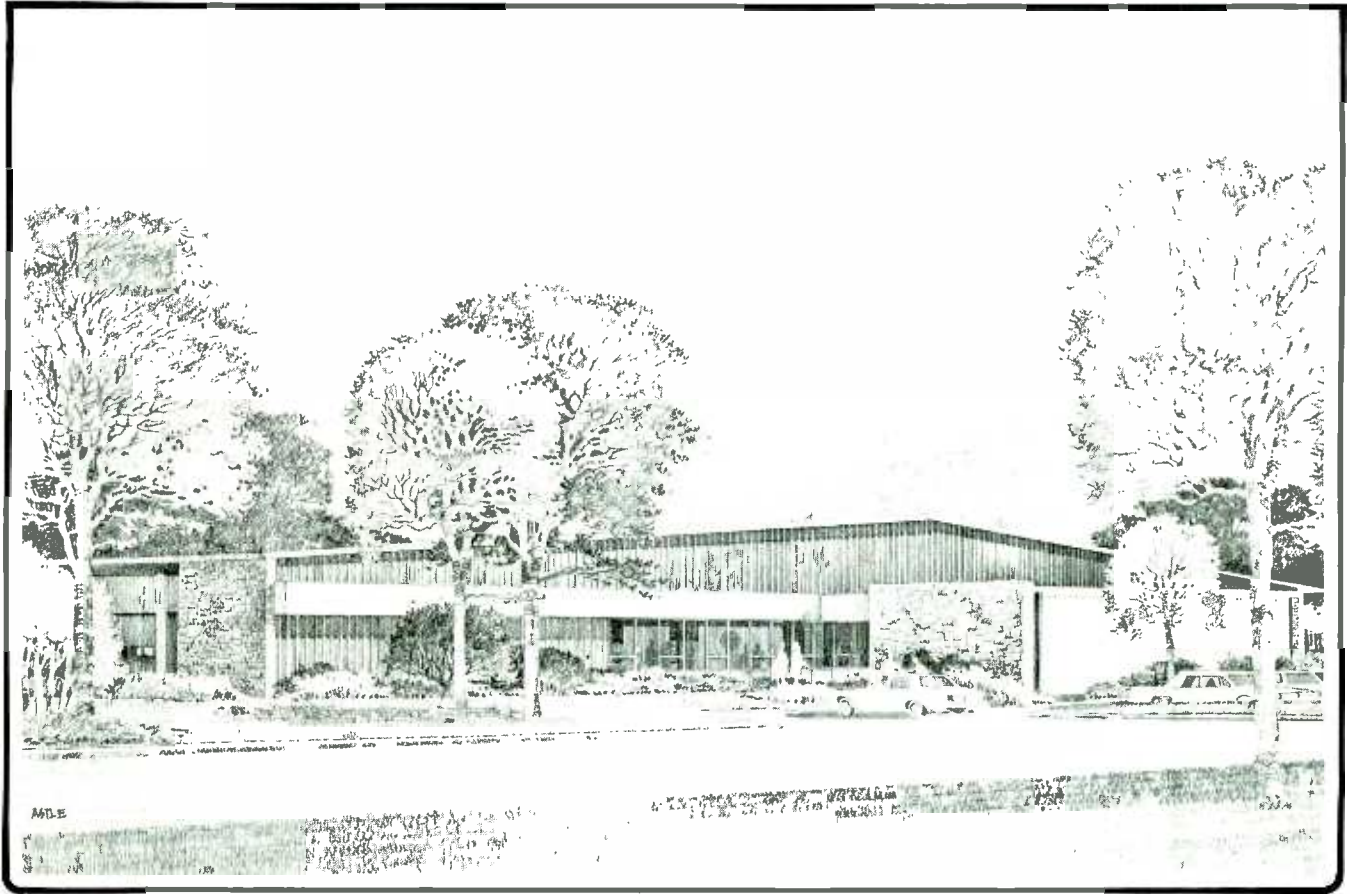

ALL ORDERS MUST USE PRODUCT CODE NUMBERS
ALL PRICES ARE FOB FACTORY AND SUBJECT TO CHANGE WITHOUT NOTICE
MINIMUM ORDER \$15.00

FM TRANSMITTERS USERS LIST BY STATE

FEBRUARY 16, 1981

<u>STATE</u>	<u>CUSTOMER</u>	<u>CITY</u>	<u>MODEL</u>
Alabama	WDJC	Birmingham	BF-25K
	WQHW/WKYD	Andalusia	BF-25K
	WQSB/WAVU	Albertville	BF-25K
Alaska	KRBD	Ketchikan	BF-3.5K
	KSKA	Anchorage	BF-3.5K
	KSRM	Soldotna	BF-3.5K
	KSTK	Wrangell	BF-3.5K
Arizona	KMDX	Parker	BF-3.5k
Arkansas	KABJ/KMCW	Augusta	BF-5K
	KDDA	Dumas	BF-3.5K
	KMAG/KMHE	Ft. Smith	BF-25K
	KSAR	Salem	BF-3.5K
	KUCA	Conway	BF-3.5K
	KADO	Texarkana	BF-3.5K
California	KACE (2)	Inglewood	BF-3.5K
	KAVO	Fallbrook	BF-3.5K
	KCAL	Redlands	BF-3.5K
	KCBS	San Fransico	BF-25K
	KEDY/KSWD	Mt. Shasta	BF-3.5K
	KEWE/KORV	Oroville	BF-3.5K
	KHYE/KHSJ	Hemet	BF-3.5K
	KKIQ	Livermoore	BF-3.5K
	KMAX	Arcadia (Pasadena)	BF-3.5K
	KRWQ	San Luis Obispo	BF-10K
	KSGN/KLLU	Riverside	BF-3.5K
	KBCA	Los Angeles	BF-25K
	TRW	Redondo Beach	BF-25K
	Medallion, TV	W. Hollywood	BF-25K
	IER	LaTolla	BF-10K

Colorado	KMTS KRAI KULE KVRH KWBI KWDE KLMR	Glenwood Springs Craig Gunnison Salida Morrison Montrose Lemar	BF-3.5K BF-10K BF-3.5K BF-3.5K BF-3.5K BF-25K BF-25K
Florida	WEAI WLYF/WGBS WMEZ WPDQ/WKUE WPFM/WWQM WQUH/WGTX WWBA Indian River Comm Lower Keys Broadcasting	Jacksonville Miami Pensacola Jacksonville Panama City DeFuniak Springs St. Petersburg Fort Pierce Ft. Lauderdale	BF-5K BF-25K BF-25K BF-3.5K BF-25K BF-3.5K BF-55K BF-3.5M BF-3.5M
Georgia	WIFO WRFG Roscom	Jessup Atlanta Roswell	BF-5K BF-3.5K BF-1M
Hawaii	KKAI/KBCA	Kailua	BF-55K
Idaho	KGEM/KJOT KRBU	Boise Pocatello	BF-25K BF-3.5K
Illinois	WCSJ WFIW WSPY WVJC WZOE WCCO WRUL	Morris Fairfield Plano Mt. Carmel Princeton Joliet Carmi	BF-3.5K BF-3.5K BF-5K BF-10K BF-3.5K BF-3.5M BF-10M
Indiana	WJCK WBST WRIA	Renssler Muncie Richmond	BF-10K BF-3.5K BF-10K

Iowa	KAYL	Storm Lake	BF-10K
	KCMR	Mason City	BF-3.5K
	KCOB/KIVN	Newton	BF-3.5K
	KLGA	Albia	BF-3.5K
	KOAK	Red Oak	BF-3.5K
	KOSG	Osaga	BF-3.5K
	KQKQ	Council Bluffs	BF-55K
	KLXL	Dubuque	BF-3.5K
Kansas	KCLY/KCTR	Clay Center	BF-3.5K
	KINF	Dodge City	BF-1K
	KWLS	Pratt	BF-3.5M
	KLKC	Parsons	BF-1K
Kentucky	WKOA	Hopkinsville	BF-25K
	WLBJ	Bowling Green	BF-1K
	WMTL/WKHG	Leitchfield	BF-3.5K
	WTCO	Campbellsville	BF-3.5K
	WUOL	Louisville	BF-10K
	WPRT	Prestonburg	BF-3.5M
Louisiana	KRVS	Lafayette	BF-3.5K
	WRKF	Greenwell Springs	BF-10K
Maine	WLOB	Portland	BF-1K
	WTMS/WGEP	Presque Isle	BF-25K
Maryland	WCRH	Williamsport	BF-3.5K
	WGTS	Tocoma Park	BF-10K
	WPGC	Morningside	BF-25K
	KTRX	Tankino	BF-3.5M
Massachusetts	WBMT	Topsfield	BF-1K
Michigan	WLAV	Grand Rapids	BF-25K
	WQON	Grayling	BF-3.5K
	WSHN	Fremont	BF-3.5K
	WVIC	East Lansing	BF-10K

Minnesota	KQAL WJYJ KGHS KTIG KTRF Sterling	Winona Brainerd International Falls Pequot Lake Thief River Falls Rochester	BF-1K BF-25K BF-3.5K BF-5K BF-3.5K BF-5M
Missouri	KAOL KBK/KLEX KCHI KEMM KJEZ KSCF KVCM KDEX KTUI	Carrollton Lexington Chillicothe Marshfield Poplar Bluffs Florissant Montgomery City Dexter Sullivan	BF-25K BF-25K BF-3.5K BF-1K BF-25K BF-25K BF-3.5K BF-3.5M BF-3.5M
Montana	KGCH KEMC KYBS KIKC	Sidney Billings Livingston Forsyth	BF-25M BF-10K BF-25M BF-25K
Nebraska	KBWH KELN/KAHL KHUB KICS KICX KNCY KOWH KRCB KSDZ KSRD KBRX Omaha Public Schools	Blair North Platte Fremont Hastings McCook Nebraska City Omaha Kearney Gordon Seward O'Neill Omaha	BF-3.5K BF-25K BF-3.5K BF-3.5K BF-3.5K BF-3.5K BF-25K BF-25K BF-5K BF-25K BF-25M BF-25M
Nevada	KUDO	Las Vegas	BF-25K
New Hampshire	WLNH	Laconia	BF-3.5K
New Jersey	ELEXCO	Ridgewood	BF-1M
New Mexico	KKQQ XHVH XHIL XHPQ XHCH Media Corp J.L. Empradas KZZX	Clovis Mexico Mexico Mexico Mexico Humble City Mexico Albuquerque	BF-10K BF-10K BF-10K BF-10K BF-10K BF-25K BF-10K BF-10M

New York	KRKT	Albany	BF-25K
	WAQX	Syracuse	BF-1K
	WCBS	New York City	BF-10K
	WDST	Woodstock	BF-3.5K
	WSUL	Monticello	BF-3.5K
	WVCR	Poughkeepsie	BF-1K
	WVOS	Liberty	BF-3.5K
	WCBC	New York City	BF-10K
North Carolina	HYDE	Swan Quarter	BF-1M
North Dakota	KFNW	Fargo	BF-25K
Ohio	WBBY	Westerville	BF-1K
	WDMT	Salon	BF-5K
	WKTL	Struthers	BF-3.5K
	WKTN	Kenton	BF-3.5K
	WWWJ	Johnston	BF-3.5K
	WYPC/WJEH	Gallipolis	BF-25K
Oklahoma	KASX	ADA	BF-1K
	KCLI	Clinton	BF-3.5K
	KGOW	Tulsa	BF-3.5K
	KNID/KCRC	Enid	BF-25K
	KPNC	Ponca City	BF-3.5K
	KTLO	Talequah	BF-3.5K
	KOKF	Edmond	BF-3.5K
Oregon	KRCO	Pineville	BF-3.5M
	KSBC	Redmond	BF-3.5M
	KICR	Salem	BF-3.5K
	KKIC/KEMX	Ashland	BF-3.5K
	KOHU	Hermiston	BF-3.5K
	KOKF	Edmond	BF-3.5K
	KOOS	North Bend	BF-1K
	KYNG	Eastside	BF-3.5K
	KIDO	New Port	BF-3.5M
	KBKR	Baker	BF-3.5M
	KRWQ	Gold Hill	BF-10K
	Pennsylvania	WCUC	Clarion
WGRP		Greenville	BF-3.5K
WHYP		Northeast	BF-3.5K
WTTC		Towanda	BF-3.5K
WVCS		California	BF-3.5K
South Carolina	WAIM	Anderson	BF-25K

Tennessee	WSSQ Sterling Comm WKTA	Athens Chattanooga McKenzzie	BF-3.5K BF-25K BF-25K
Texas	KHBJ KADO KBMF KCOT/KPET KEYE KGRI KHLB KHOC KHYM KIXS KJAK KLLL KLTD/KCLY KOHM KORA/KTAM KPLA KQIZ KSDL/KFIM KSNY KSPL KVRN KWLD KYTX/KZIP KXEO KXXX KATX/KVOP	Canyon Texarkana Spearman Lamesa Perryton Henderson Burnet Levelland Gilmer Killeen Slaton Lubbock Lempasis Lubbock Bryan Brownwood Amarillo El Paso Snyder Lufkin Sonora Plainview Amarillo Dallas Odessa Plainview	BF-5M BF-3.5K BF-3.5K BF-25K BF-3.5K BF-3.5K BF-3.5K BF-25K BF-25K BF-3.5K BF-3.5K BF-3.5K BF-25K BF-25K BF-3.5K BF-3.5K BF-25K BF-25K BF-3.5K BF-3.5K BF-3.5K BF-5K BF-25K BF-25K BF-25K BF-25K
Utah	KJKJ KAYK	Logan Provo	BF-5K BF-25K
Virginia	WIXV WKZZ/WWOD WRVK	Frontroyal Lynchburg Richmond	BF-5K BF-1K BF-10K
Washington	KTRW KAOS KDNA KOMW KONA KPBX KPLU KSXT/KHIT KZUN	East Wanatchee Olympia Yakima Omaha Tri-Cities (Kennwick) Spokane Tacoma Walla Walla Spokane	BF-3.5M BF-1K BF-5K BF-3.5K BF-25K BF-25K BF-25K BF-25K BF-25K
West Virginia	WFGM WWVA/WCPI	Fairmont Wheeling	BF-10K BF-25K

Wisconsin

WJMC
WORT
WWSP

Rice Lake
Madison
Stevens Point

BF-25K
BF-3.5K
BF-1K

Wyoming

KIOZ

Laramie

BF-25K

AM TRANSMITTER USERS LIST BY STATE

February 16, 1981

<u>STATE</u>	<u>CUSTOMER</u>	<u>CITY</u>	<u>MODEL</u>
Alabama	WPCY	Mobile	BA-5K2
	WJMW	Athens	BA-1K
	WKYD	Andalusia	BA-5K2
	WVNA	Tuscumbia	BA-10K
	WCRL	Oneonta	BA-2.5K
Alaska	KBBI	Homer	BA-5K
	KSKO	Mcgrath	BA-5K2
Arizona	KAPR	Douglas	BA-2.5K
	KDAP/KANT	Douglas	BA-1K
	KPIN	Casa Grande	BA-1K
	XEUK	Nogales	BA-1K
Arkansas	Adams Broadcasting	Yellville	BA-1K
	KACJ	Greenwood	BA-1K
	KAMO	Rogers	BA-1K
California	KPCO	Quincy	BA-1K
	Sacramento Army Depot	Sacramento	BA-1K
	KTHO	South Lake Tahoe	BA-2.5K
	IER	LaTolla	BA-1K
	KDAC	Fort Bragg	BA-1K
	KGUD/KOLA	Riverside (Banning)	BA-1K
	KKIO	Santa Barbara	BA-1K
	KLBS	Los Banos	BA-1K
	KPRO	Riverside	BA-1K
	KUDE	Oceanside	BA-1K
	KWSD	Mt. Shasta	BA-1K

Colorado	KCRT KRDZ	Trinidad Wray	BA-1K BA-1K
Florida	WKTX Gen. Conf. of SDA WJNJ WOCN WVCF	Atlanta Beach Coral Gables Atlanta Beach Miami Orlando	BA-2.5K BA-5K2 BA-2.5K BA-1K BA-1K .
Georgia	WCGA WHYD WTIF WWCC	Conyers Columbus Tifton Bremen	BA-1K BA-2.5K BA-2.5K BA-2.5K
Hawaii	KGU	Honolulu	BA-10K
Idaho	KGEM/KJOT KTEE	Boise Idaho Falls	BA-10K BA-2.5K
Illinois	KPCO WINI WJBD	Quincy Murphysboro Salem	BA-1K BA-1K BA-1K
Indiana	WBIW	Bedford	BA-1K

Iowa	KLNG/KRCB	Council Bluffs	BA-1K
	KBAB	Indianola	BA-1K
	KBKB	Fort Madison	BA-1K
	KJAN	Atlantic	BA-1K
	KLBA	Albia	BA-1K
	KNWS	Waterloo	BA-1K
Kansas	KARE	Atchinson	BA-1K
Kentucky	WDXR	Paducah	BA-1K
	WTKY	Thompkinsville	BA-2.5K
	WEZJ	Williamsburg	BA-1K
	WLKS	West Liberty	BA-1K
	WLOC	Munfordville	BA-1K
	WRLV	Salyerville	BA-1K
..	WWKY	Winchester	BA-1K
Maine	WDCS	Portland	BA-5K
Mexico	XELEO	Mexico	BA-1K
	XEACB	Veracruz	BA-1K
Michigan	WCHB	Inkster	BA-1K
	WLEW	Bad Axe	BA-1K
	WSHN	Fremont	BA-1K
	WYGR	Wyoming	BA-1K
Minnesota	KFIL	Preston	BA-1K
	KCUE	Red Wing	BA-1K
	KDAN	Newport	BA-1K
	KTHO	Golden Valley	BA-2.5K
	KTIS	Roseville	BA-2.5K
	KUXL	Golden Valley	BA-2.5K
	WKKQ	Hibbing	BA-1K

Mississippi	WABG	Greenwood	BA-1K
Missouri	KBIN KCMW KXEO	Neosho Warrensburg Mexico	BA-1K BA-1K BA-1K
Montana	KLYC KTXX	Laurel Whitefish	BA-1k BA-1k
Nebraska	KESY KGFW KGMT KTCH KTTT	Omaha Kearney Fairbury Wayne Columbus	BA-1K BA-1K BA-1K BA-2.5K BA-1K
New Jersey	Elexco Daystrong Int'l Lighting Electronics	Redgewood North Bergen Milburn	BA-2.5K BA-1K BA-1K
New Mexico	KAMQ KENN	Carlsbad Farmington	BA-1K BA-10K
New York	World Tronics WBTA WVIN WLIX WXRL	Plainview Batavia Bath Bayshore Lancaster	BA-10K BA-1K BA-1K BA-1K BA-2.5K

North Carolina	WGAI WKBQ WKVO	Elizabeth City Raleigh Havelock	BA-1K BA-1K BA-2.5K
North Dakota	KFNW KTGO KQDJ	Fargo Tioga Jamestown	BA-10K BA-1K BA-1K
Ohio	WGOR WJEH WKOV WKTN	Toledo Gallipolis Wellston Kenton	BA-1K BA-1K BA-1K BA-2.5K
Oklahoma	KTLQ KWOK KWPR	Tahlequah Wagoner Claremore	BA-1K BA-1K BA-1K
Oregon	KCMX/KKIC KDUN	Warrensburg Reedsport	BA-1K BA-2.5K
Pennsylvania	WESA WHJB WHPA WHYP WPAZ WPDC WVLV WWBR WWGO WYJZ WFEC/WPAZ	Charleroi Greensburg Harrisburg North East Pottstown Elizabethtown Lebanon Johnstown Erie Pittsburgh Harrisburg	BA-1K BA-2.5K BA-2.5K BA-1K BA-1K BA-1K BA-1K BA-2.5K BA-1K BA-1K BA-1K

South Carolina	WAIM	Anderson	BA-1K
South Dakota	KVAA	Volga	BA-1K
Tennessee	WYXI Better Communications	Athens Portland	BA-1K BA-1K
Texas	KBAL KXEO LT&T Enterprises KCLW KDDD KEPS KGAS KGRI KIXS KSTV KURV KVMC KXIT KYKR KZIP	San Saba Dallas Odessa Hamilton Dumas Eagle Pass Carthage Henderson Killeen Stephanville Edinburg Colorado City Dalhart Port Arthur Amarillo	BA-1K BA-1K BA-1K BA-1K BA-1K BA-1K BA-2.5K BA-1K BA-1K BA-1K BA-1K BA-1K BA-1K BA-10K BA-1K
Utah	Dart, Inc. KJOT	Price Boise	BA-2.5K BA-10K
Virginia	WPAK	Farmville	BA-1K

Vermont	WSTJ	St. Johnsbury	BA-1K
Washington	KASY KMAS KZUN	Auburn Shelton Spokane (Opportunity)	BA-2.5K BA-2.5K BA-1K
Wisconsin	WATK WCQL WJMC	Antigo Waukesha Rice Lake	BA-1K BA-1K BA-1K
Wyoming	KEVA KUGR	Evanston Green River	BA-1K BA-1K

McMARTIN INDUSTRIES
201 25TH AVENUE
COUNCIL BLUFFS, IA 51501 USA
PHONE: 712/366-1300
FAX: 712/366-2515 TEL: 1-800-1100

ADDENDUM TO NOVEMBER 1, 1982 PRICE SCHEDULE

All of the products listed below have been REDUCED in price by \$1,000. The prices shown are the new (January 18, 1983) correct amounts.

BFM-8000	FM Exciter	\$3,795
BF-1M	.25 to 1.5 kW FM Transmitter	\$17,995
BF-3.5M	1.5 to 3.5 kW FM Transmitter	\$20,995
BF-5M	3.5 to 5.5 kW FM Transmitter	\$27,995
BF-10M	5.5 to 15 kW FM Transmitter	\$37,995
BF-25M	10 to 27.5 kW FM Transmitter	\$52,995
BF-55M	20 to 55 kW FM Transmitter	\$122,995

Effective November 1, 1982

AM TRANSMITTERS

Product Code	Model	Description	Price
10-01-058	BA-50K	50,000 watt AM transmitter high level plate modulated, with 10 kW power cutback consisting of: (1)A four section cabinet which houses all exciter, audio, solid state driver stages, high level modulators, RF amplifiers and all control and measuring circuits, (2)Power control panel, (3)High voltage power supply vaults, (4)Modulation transformer and reactor vault. 380/415/460 VAC, 50/60 Hz, 3 phase (Specify actual)	\$ 159,995.00
10-01-059 300044	STA-50K	100% Spare tube kit which consists of four 4CX20000B individual spare tube:	7,080.00 1,770.00
	BA-50K TEO	Test equipment option for BA-50K. Consists of Tektronix RTM-506 mainframe, DM502A digital frequency counter, SG-505 function generator, SC502 oscilloscope, AA501 distortion analyzer	10,995.00
10-01-038	BA-20K	20,000 watt AM transmitter consisting of two BA-10K transmitters and central combining unit. Transmitter complete with tubes, crystals, and solid state devices. 208/230/240 VAC, 50/60 Hz, 3 phase.	102,995.00
10-01-039 111123 210016	STA-20K	100% spare tube kit 4CX-5000A (8 ea) Individual spare tube (4CX-5000A) Spare rectifier diode stack RS 3.5-24-12S (12 used)	9,920.00 1,240.00 210.00
10-01-036	BA-10K	10,000/5,000 or 2,500 watt AM transmitter complete with tubes. 208/230/240 VAC, 50/60 Hz, 3 phase	47,995.00
Special		10,000/1,000 watt AM transmitter complete as above with cutback to 1,000 watts	48,995.00
10-01-037 111123 210016	STA-10K	Spare tube kit for BA-10K, 4CX-5000A (4 ea.) Individual spare tube for BA-10K, 4CX-5000A Spare rectifier diode stack RS 3.5-24-12S (6 used)	4,960.00 1,240.00 210.00
10-01-181	TCP/BA-10K	Remote control panel for BA-10K	795.00
10-01-056	BA-5K2	5000/1000 or 5000/2500 watt AM broadcast transmitter (Single ended) 208/230/240 VAC, 50/60 Hz, 3 phase	40,995.00
10-01-057 111123 210017	STA-5K2	Spare tube kit for BA-5K2, 4CX-5000A (3 ea) Individual spare tube for BA-5K2, 4CX-5000A Spare rectifier diode stack RS 3.5-24-12S (6 used)	3,720.00 1,240.00 210.00
10-01-066	BA-2.5K	2500/1000/500 watts AM broadcast transmitter, 208/230 VAC, 50/60 Hz, single phase, 3-wire (grounded neutral)	25,995.00
10-01-068	SR-2.5K	Sola filament regulator for BA-2.5K	650.00
10-01-069 210016	STA-2.5K	100% spare tubes for BA-2.5K (4 ea, 4-1,000 A) Spare Rectifier Diode Stack RS 3.5-24-12S (4 used)	2,188.00 210.00
10-01-061	BA-1K	1000/500/250 watt AM transmitter, 208/230 VAC, 50/60 Hz, single phase, 3-wire (grounded neutral) For PSA powers below 250 watts, add \$500.00	15,995.00
918979	SR-1K	Sola filament regulator for BA-1K. 60 Hz	475.00
10-01-063	STA-1K	100% spare tubes for BA-1K (4 ea, 4-500 A)	1,052.00
210015	SRS-1K	Spare Rectifier Diode Stack RS 1.5-12-12M (2 used)	80.00
10-01-064	SC-AM	Spare vacuum crystal (Specify frequency) for all AM transmitters	135.00
10-01-065	PT-1K	Line transformer for 220/240 VAC, single-phase, 2-wire (for BA-1K)	350.00
10-01-093	SCK-A1K	Spare semi conductor kit (Audio and RF exciter transistor and diodes only)	175.00

FM TRANSMITTERS

Product Code	Model	Description	Price
10-01-078	BF-55M	20 - 55 kw FM broadcast transmitter, complete with one exciter (combined output of two BF-25M transmitters), 208/230/240 VAC, 50/60 Hz, 3 phase	\$ 123,995.00
10-01-046	BF-25M	10 - 27.5 kw FM broadcast transmitter, complete with exciter and tubes, 208/230/240 VAC, 50/60 Hz, 3-phase	53,995.00
10-01-047	STF-25K	Spare tube kit for BF-25M (1-4CX250BC, 1-3CX3000A7, 1-3CX2000A7)	2,891.00
210016		Spare Rectifier Diode Stack, Low Voltage RS 1.5-12-12S (4 used)	210.00
210017		Spare Rectifier Diode Stack, High Voltage RS 3.5-24-15S (6 used)	210.00
920039	SR-25M	Sola filament regulator for BF-25M transmitter	1,050.00
10-01-045	BF-10M	5.5 - 15 kw FM broadcast transmitter, complete with exciter and tubes, 208/230/240 VAC, 50/60 Hz, 3-phase	38,995.00
10-01-048	STF-10K	Spare tube kit for BF-10M (1-4CX250BC, 1-3CX1500A7, 1-3CX1000A7)	2,330.00
210015		Spare Rectifier Diode Stack, Low Voltage RS 1.5-12-12M (2 used)	80.00
210016		Spare Rectifier Diode Stack, High Voltage RS 3.5-24-12S (6 used)	210.00
10-01-040	BF-5M	3.5 - 5.5 kw FM broadcast transmitter, complete with exciter and tubes, 208/230/240 VAC, 50/60 Hz, 3-phase standard, single phase (optional at \$1,500.00 additional cost)	28,995.00
10-01-027	STF-5K	Spare tube kit for BF-5M (2-4CX250BC, 1-3CX3000A7)	870.00
210016		Spare Rectifier Diode Stack RS 3.5-24-12S (4 used)	210.00
10-01-026	BF-3.5M	1.5 - 3.5 kw FM transmitter, complete with exciter and tubes, 208/230/240 VAC, 50/60 Hz, single phase standard, 3 phase (optional at \$1,500.00 additional cost)	21,995.00
10-01-027	STF-3.5K	Spare tube kit for BF-3.5M (2-4CX250BC, 1-3CX3000A7)	870.00
210016		Spare Rectifier Diode Stack RS 3.5-24-12S (4 used)	210.00
10-01-090	BF-1M	.25 - 1.5KW FM broadcast transmitter, complete with exciter and tubes, 208/230/240 VAC, 50/60 Hz, single phase, 3-wire (grounded neutral)	18,995.00
10-01-094	STF-1K	Spare tube kit for BF-1M (1-3CX1500A7/8877)	574.00
210015		Spare Rectifier Diode Stack RS 1.5-12-12M (2 used)	80.00
ACCESSORIES			
10-01-074	APC	Automatic power control for FM transmitter	530.00
10-01-079	ARS-1	Single phase AC detector with auto restart	375.00
10-01-075	ARS-3	Three phase AC detector with auto restart	485.00
10-01-078	TCP-1	Transmitter control panel for remote control for AM or FM transmitter (Specify model numbers when ordering)	795.00

FM EXCITER, Low Power 10 - 100 Watt Transmitters, Accessories

Product Code	Model	Description	Price
10-01-150	BFM-8000	Exciter/Transmitter, monaural, 15 watt rack mount with rack slides	\$ 4,785.00
10-01-151	SCK-8000	Spare semi-conductor kit for BFM-8000	535.00
10-01-152	SPARE CRYSTAL	For BFM-8000, (specify transmitter frequency)	105.00
10-01-131	BFM-1521R	Stereo generator, self contained, rack mount	2,135.00
10-01-143	BFM-2001R	SCA generator, selectable compression, self contained, rack mount	995.00
10-05-042	CM-2001	Compandor, self contained, rack mount	195.00
10-01-138	BFM-1515R	Maxi-1 compressor, limiter, AGC audio processor, monaural (Specify TV, Mono FM, AM, SCA for correct pre-emphasis and bandwidth) (unbalanced output). For balanced output use MT-3B items transformer page 8 - transformers are not required when used with McMartin BFM-1531R SCA generator	695.00
10-01-139	BFM-1515/B-910	Adapter kit to operate BFM-1515R with 910 exciter	80.00
10-01-134	BFM-1514R	Maxi-1 Compressor, limiter, AGC audio processor stereo (unbalanced outputs). For balanced outputs use two MT-3B transformers page 8 - transformers are not required when used with McMartin BFM-1521R stereo generator	1,095.00
10-01-137	BFM-1514/B-910	Adaptor kit to operate BFM-1514R with 910 exciter	80.00
10-01-016	B-122	Cabinet, 10½" (H) x 19" (W) x 22" (D), can be used to house exciter and accessories	425.00
10-01-023	B-123	Cabinet, 20" (H) x 19" (W) x 22" (D), can be used to house exciter and accessories	535.00
10-01-025	B-950	50 watt FM amplifier	1,895.00
10-01-002	B-9100	100 watt FM amplifier	3,595.00
10-01-021	B-9100RCI	Remote control interface for B-9100	535.00

REMOTE PICK-UP EQUIPMENT, TRANSMITTER & RECEIVERS 150 MHz

Product Code	Model	Description	Price
3 WATT - 150 MHz TRANSMITTER			
10-01-086	RPU-1103	Portable, 3 watt battery operated remote pickup transmitter 150.87 to 170.15 MHz. Bands K1, K2, L and M. Includes: battery, antenna, microphone and battery charger. Specify AC voltage for battery charger 110 V or 220 V. Specify frequency _____ MHz, Deviation _____ kHz, Audio Bandwidth _____ kHz	\$ 1,125.00
10-01-115	RPU/BAT	Replacement battery, 12 volts	55.00
10-01-111	RPU/BC	Replacement battery charger (specify voltage 110 V or 220 V)	80.00
10-01-113	RPU-MIC	Replacement push-to-talk microphone turner model 350D	65.00
10-01-114	RPU/2CH	Second Channel frequency module (specify frequency) for RPU-1103 and 1150	115.00
10-01-112	RPU/ANT	Replacement antenna 150 MHz	25.00
50 WATT 150 MHz TRANSMITTER			
10-01-088	RPU-1150	50 watt 150 MHz remote pickup transmitter. Includes mobile mount, requires 13.5 volt DC @ 10 amps transmit. Specify frequency _____ MHz, Deviation _____ kHz, Audio Bandwidth _____ kHz	1,495.00
ACCESSORIES FOR RPU-1150			
10-01-095	RPU/PS	AC power supply	395.00
10-01-096	RPU/RmCo.	Rack mount and carrying case provides convenient carrying case and rack mounting for both the power supply and 50 or 30 watt transmitter. (Not required for mobile installations)	95.00
10-01-098	RPU/MC	Mobile control head for use when unit is trunk mounted. Includes cable from control head to transmitter.	265.00
RPU-1150R 150 MHz RECEIVER			
10-03-038	RPU-1150R	Receiver, 150 MHz, rack mount, 2 channels (for second channel, add \$25.00) Specify frequency _____ MHz, Deviation _____ kHz, Audio Bandwidth _____ kHz	950.00

REMOTE PICK-UP EQUIPMENT, TRANSMITTERS & RECEIVERS 450 MHz

Product Code	Model	Description	Price
3 WATT 450 MHz TRANSMITTER			
10-01-087	RPU-1403	Portable, 3 watt battery operated remote pickup transmitter 450 MHz band. Includes battery, antenna, microphone and battery charger. Specify AC voltage 110 V or 220 V. Specify Frequency _____ MHz, Deviation _____ kHz, Audio Bandwidth _____ kHz	\$ 1,295.00
10-01-115	RPU/BAT	Replacement battery, 12 volts	55.00
10-01-111	RPU/BC	Replacement battery charger (Specify 110 V or 220 V)	80.00
10-01-113	RPU/MIC	Replacement push-to-talk microphone turner model 350D	65.00
10-01-114	RPU/2CH	Second Channel frequency module (specify frequency) for RPU-1403 and 1430 (450 MHz base station \$200.00)	115.00
10-01-118	RPU/ANT	Replacement antenna 450 MHz	25.00
30 WATT 450 MHz TRANSMITTER			
10-01-089	RPU-1430	30 watt 450 MHz remote pickup transmitter. Includes mobile mount, requires 13.5 volt DC @ 10 amps transmit. Specify frequency _____ MHz, Deviation _____ kHz, Audio Bandwidth _____ kHz	1,795.00
ACCESSORIES FOR RPU-1430			
10-01-095	RPU/PS	AC power supply	395.00
10-01-096	RPU/RmCc	Rack mount and carrying case provides convenient carrying case and rack mounting for both the power supply and 50 or 30 watt transmitter. (Not required for mobile installations)	95.00
10-01-098	RPU/MC	Mobile control head for use when unit is trunk mounted. Includes cable from control head to transmitter	265.00
RPU-1450R 450 MHz RECEIVER			
10-03-039	RPU-1450R	Receiver, 450 MHz, rack mount, 2 channels (for second channel, add \$25.00) Specify frequency _____ MHz, Deviation _____ kHz, Audio Bandwidth _____ kHz	950.00

1000 SERIES AUDIO CONSOLES

Product Code	Model	Description	Price
10-02-120	1081	8 Channel Mono Rotary Attenuators CH 1,2 Microphone Input CH 3,4,5,6,7 Hi Level Unbalanced Input CH 8 Hi Level Balanced Input	3,795.00
10-02-119	1081V	8 Channel Mono Vertical Attenuators CH 1,2 Microphone Input CH 3,4,5,6,7 Hi Level Unbalanced Input CH 8 Hi Level Balanced Input	3,895.00
10-02-118	1082	8 Channel Stereo Rotary Attenuators CH 1,2 Microphone Input CH 3,4,5,6,7 Hi Level Unbalanced Input CH 8 Hi Level Balanced Input	4,695.00
10-02-117	1082V	8 Channel Stereo Vertical Attenuators CH 1,2 Microphone Input CH 3,4,5,6,7 Hi Level Unbalanced Input CH 8 Hi Level Balanced Input	4,895.00

REPLACEMENT PRINTED CIRCUIT CARDS for 1000 Series Consoles

10-02-124	Cue/Talkback Amplifier	185.00
10-02-125	Program Amplifier	210.00
10-02-126	Monitor Amp Stereo	265.00
10-02-134	Monitor Amp Mono	160.00
	SANKEN Hybrid Module for use with MONITOR AMPS Requires: 1 Mono, 2 Stereo	55.00
10-02-130	Stereo Mic PreAmp	295.00
10-02-135	Mono Mic PreAmp	155.00
10-02-129	Headphone Amplifier	160.00
10-02-131	Stereo Hi Level Balanced Input	155.00
10-02-136	Mono Hi Level Balanced Input	105.00
10-02-132	Mono or Stereo Level Unbalanced Input	40.00
10-02-133	Power Supply	530.00

500 SERIES AUDIO CONSOLES

Product Code	Model	Description	Price
10-02-041	B-501	5 mixer, monaural, 1 mic, 4 hi-bal	\$ 1,795.00
10-02-044	B-501SA	B-501 with step attenuators	2,125.00
10-02-042	B-502	5 mixer, stereo, 1 mic, 4 hi-bal	2,495.00
10-02-045	B-502SA	B-502 with step attenuators	3,025.00

REPLACEMENT PRINTED CIRCUIT CARDS FOR 500 Series Consoles

PLUG-IN

CARDS

10-02-056	5MP1	Microphone preamplifier (B-501)	70.00
10-02-060	5MP2	Microphone preamplifier (B-502)	135.00
10-02-054	5BH1	High level balanced input (B-501)	55.00
10-02-058	5BH2	Dual high level balanced input (B-502)	85.00
10-02-055	5BA1	Booster amplifier (B-501)	50.00
10-02-059	5BA2	Dual booster amplifier (B-502)	70.00
10-02-057	5PG1	Program amplifier (B-501)	55.00
10-02-061	5PG2	Dual program amplifier (B-502)	80.00
10-02-053	5PS1	Power regulator (All models)	45.00

WIRE-IN

CARDS

10-02-051	5QA1	Cue amplifier	60.00
10-02-052	5MA1	Monitor amplifier	80.00

ACCESSORIES

10-02-064	5RY1	Speaker muting relay (All Models)	35.00
-----------	------	-----------------------------------	-------

REMOTE, PRODUCTION CONSOLES, PHONO PREAMP, TUNER, & MIXERS

10-02-080	ACCU-FIVE	5 channel rack mount mini console	1,375.00
10-02-081	BR-400	4 channel remote mixer amplifier	695.00
10-02-076	B-200B	Mono/stereo equalized phono preamplifier, balanced 600 ohm output	295.00
10-05-012	MX-5/B	5-channel mixer/preamplifier	450.00
10-05-044	MHP-7/B	Rack mount adaptor, beige, for MX-5	35.00
10-05-018	AF-200B/B	AM/FM tuner	395.00

BROADCAST MONITOR AMPLIFIERS & ACCESSORIES

10-05-001	LT-80C/B	12-watt universal amplifier with one mic, 1 program input	170.00
10-05-043	LT-252B/B	25-watt universal amplifier with two mic, 2 program input	520.00
10-05-041	LT-250D/B	25-watt power amplifier	290.00
10-05-014	LT-500D/B	50-watt power amplifier	355.00
10-05-015	LT-1000D/B	100-watt power amplifier	475.00
10-05-016	LT-2000D/B	200-watt power amplifier	845.00
10-05-021	LT-3500D/B	350-watt power amplifier	1,140.00
10-05-009	MT-3B	Plug-in balanced/bridging transformer	31.00
10-05-017	MS-105/B	5-watt amplifier	120.00
10-05-010	MRP 3B	Rack mount adaptor for LT 80C/108C	19.00
10-05-011	MRP 4B	Rack mount adaptor for dual LT 90C/108C	15.00
10-05-022	MRP 8B	Rack mount kit for MS-105B	39.00
10-05-035	LR-1000D	Monitor control panel	500.00
10-05-036	LR-1003C	Line amplifier	290.00
10-05-037	LR-100JC	Compressor/Limiter amplifier	345.00
10-05-038	LR-1006	1/3 Octave equalizer	720.00
10-05-039	LR-1008	One Octave equalizer	415.00

AM MONITORS

10-03-104	RF-85B	AM RF amplifier	975.00
-----------	--------	-----------------	--------

AM/FM MONITOR AND EBS EQUIPMENT

10-04-003	AMR-1	AM monitor receiver, single channel	210.00
10-04-013	FMR-1D	FM monitor receiver, single channel	275.00
10-04-002	EBS-2	EBS decoder for AMR-1 and FMR-1D/FMR-5 (Two-tone system)	275.00
10-04-011	TG-2/EBS	Precision two-tone EBS generator	375.00

SATELLITE/MICROWAVE PRODUCTS

60-01-002	SDR-1	IF Demodulator Communications Channel	550.00
60-02-001	SMR-1	IF Modulator Communications Channel	1,115.00
60-01-001	SPR-3	Satellite Program Channel Demodulator (will receive up to 3 channels if within 2 MHz between 52-88 MHz band) 2nd and 3rd channel crystals	615.00 ea. 17.00 ea.
60-01-003	550306	Expander board for SPR-3 (3 x 1)	115.00 ea.
60-01-004	550317	Expander board for SPR-3 (2 x 1)	115.00 ea.
10-05-042	CM-2001/B	Compressor, self contained, rack mount	195.00
60-02-002	SMR-4 (AC)	IF Modulator Communications Channel	1,495.00
60-02-003	SMR-4 (DC)	IF Modulator Communications Channel	1,695.00
60-01-005	SDR-4 (AC)	IF Demodulator Communications Channel	850.00
60-01-006	SDR-4 (DC)	IF Demodulator Communications Channel	850.00
		Extra crystal for SMR-4/SDR-4	25.00

FM MONITORS

Product Code	Model	Description	Price
10-03-049	TBM-3700	Frequency and monaural modulation monitor	\$ 2,750.00
10-03-052	RM-37T	Remote metering plug-in card	215.00
10-03-051	RM-37R	Remote metering rack mount panel	455.00
10-03-043	TBM-3500B	Modulation monitor	2,150.00
10-03-045	RM-35B	Remote metering rack mount panel	270.00
10-03-044	LL-35B	Low level input module	375.00
10-03-034	TBM-2200A	Stereo modulation and pilot frequency adaptor (Requires TBM-3700 or TBM-3500)	2,395.00
10-03-037	RM-22T	Remote metering plug-in card	215.00
10-03-036	RM-22R	Remote metering rack mount panel	535.00
10-03-027	TBM-2000B	SCA modulation and frequency adaptor (Requires TBM-3700 or TBM-3500)	2,250.00
10-03-030	RM-20T	Remote metering plug-in card	215.00
10-03-029	RM-20R	Remote metering rack mount panel	485.00
10-03-041	TBM-2500C	RF amplifier	895.00

FM-TV-SCA RECEIVERS & ACCESSORIES

10-03-015	TBM-1005D	Five channel relay receiver (88-108 MHz) with one crystal.	795.00
		Each additional channel crystal	27.00
10-03-014	TBM-1003D	Aural TV channel 2-13 receiver	950.00
10-03-012	STE-10	Plug-in stereo demod card for relay receiver	270.00
10-03-010	SCA-2D	Plug-in SCA demodulator card 41 kHz	185.00
10-03-011		67 kHz	185.00
40-02-013	TVR-1	TV/SCA receiver, 39.5 kHz (Specify TV channel and SCA frequency)	185.00
40-02-010	TR-E7	TV/SCA receiver, 39.5/67 kHz (Specify TV channel and SCA frequency)	270.00
10-05-040	TX-200D/B	FM/SCA Field strength meter (less batteries)	720.00
900075	TX-200 XFMR	AC Transformer for TX-200D/B for operation of built-in battery charger	16.00
10-05-024	SPA2-A/B	Preamp/Attenuator	52.00
10-05-025	PS-13/B	Power Supply	52.00

SCA-Plus PRODUCTS

10-05-026	BSP-2800/B	Dual channel SCA encoder	585.00
10-05-027	SPH-2800A/B	Data channel decoding filter board (High pass)	33.00
10-05-028	SPH-2800B/B	Data channel decoding filter - stand alone model (High pass)	59.00
10-05-029	SPL-2800A/B	Audio channel decoding filter board (Low pass)	33.00
10-05-030	SPL-2800B/B	Audio channel decoding filter -stand alone model (Low pass)	59.00

ALL ORDERS MUST USE PRODUCT CODE NUMBERS
ALL PRICES ARE FOB FACTORY AND SUBJECT TO CHANGE WITHOUT NOTICE
MINIMUM ORDER \$50.00

**FM / SCA
sound
systems**

McMartin®

