

INSTRUCTION BOOK
FOR
GATES' M6209 PRESIDENT CONSOLE.

IB #888 -0764 001
8/21/62

Gates Radio Company
Quincy, Illinois

GATES' M6209 PRESIDENT CONSOLE

INDEX

| | |
|---|-------|
| SPECIFICATION | 1 - 2 |
| INTRODUCTION | 1 |
| INSTALLATION | 2 |
| Size | 2 |
| Cable and Conduit Layout | 3 |
| Signal Levels | 3 |
| Grounding Circuits | 4 |
| Balanced and Unbalanced Lines | 5 |
| Circuit Impedances | 6 |
| INSTALLATION - WIRING | 6 |
| Power Connections | 6 |
| Studio Intercom Wiring | 7 |
| Monitor Speakers | 7 |
| Monitor Input Circuits | 8 |
| Program Input Connections | 9 |
| Line Output Connections | 10 |
| Utility Switches | 10 |
| OPERATION | 11 |
| Microphone Selector Switches | 11 |
| Medium Level Inputs | 11 |
| PRINCIPLES & THEORY OF OPERATION | 14 |
| Transistor Amplifier Circuitry | 14 |
| Cue-Intercom System | 14 |
| Mixing System | 15 |
| VU Meter & Isolation Pads | 15 |
| Speaker Matching Transformers | 15 |
| Regulated Power Supply & Power Transformer .. | 15 |
| MAINTENANCE | 16 |
| Voltage Measurements | 16 |
| MECHANICAL COMPONENTS..... | 17 |
| MODIFICATIONS..... | 17 |
| Patch Panel Facilities | 17 |
| Ambient Temperatures | 18 |
| WARRANTY | |

PARTS LIST 1 - 4

DRAWINGS:

- 842 3485 001 - Schematic, Regulated Power Supply
- 837 9345 001 - Schematic, Cue-Intercom, M6035
- D-23704 - Overall Schematic

- 842 3687 001 - Functional Block Diagram
- 837 9416 001 - Schematic, M6034 Preamplifier

INSTRUCTION BOOKS:

- M5700A Transistorized Program Amplifier
- M6034 Transistorized Console Preamp
- M6035 Transistorized Cue-Intercom Amplifier
- M6108A Transistorized Monitor Amplifier
- M6108 Modification of Transistorized Monitor
Amplifier for Current Limiting.
- 813 7719 001 - Schematic - Current Limiter
Replacing Component Parts

GATES' M6209 PRESIDENT CONSOLE

SPECIFICATIONS

GAIN: Microphone input to line output: 104 db \pm 2 db.
Turntable input to line output: 62 db \pm 2 db.
Microphone input to speaker
output: 106 db minimum.
Turntable input to speaker output: 64 db minimum.

FREQUENCY RESPONSE:

\pm 1.0 db from 30 to 15,000 cps in all regular
program circuits.
 \pm 1.5 db from 30 to 15,000 cps in all emergency
program circuits.
 \pm 1.5 db from 30 to 15,000 cps in all monitor
speaker circuits.

HARMONIC DISTORTION:

0.5% maximum, 30 to 15,000 cps at + 8 dbm output
in all regular program circuits.
0.5% maximum, 50 to 15,000 cps at + 8 dbm output
in all regular program circuits.
1.0% maximum, 50 to 15,000 cps at + 8 dbm output
in all emergency program circuits.
1.0% maximum, 50 to 15,000 cps at + 39 dbm (8 watts)
in speaker outputs.

IM DISTORTION:

0.5% maximum in program circuits.
1.0% maximum in monitor circuits.

SOURCE IMPEDANCE:

Microphone -- 30/50 or 150/250 ohms.
Turntable/tape/projector/remote/network -- 600 ohms.

LOAD IMPEDANCE:

Program line -- 600 ohms.
Speaker outputs -- 4 to 16 ohms.
Audition output -- 600 ohms.

NOISE:

-122 dbm relative input noise on microphone channels.
-75 dbm relative input noise on turntable channels.

CROSSTALK:

Below noise level, in all channels.

TRANSISTOR COMPLEMENT:

6 Industrial type totaling 56.

SIZE:

52-3/8" long, 11-3/8" high, 17-3/8" deep.

WEIGHT:

114 pounds net.

FINISH:

Satin anodized black nomenclature on natural anodized aluminum background panels on a medium gray cabinet.

M6209 PRESIDENT CONSOLE.

INTRODUCTION

The M6209 President Console is a versatile and efficient dual eight mixer audio control center for AM, FM and TV broadcasting. It is equally proficient for recording and sound distribution systems where a large number of input sources must be flawlessly programmed.

The President provides for the mixing, cueing and monitoring of a variety of program sources. These sources include microphones, turntables, tape recorders, projectors, remote pickups and networks. These signals are fed from the outputs of the console to the program lines in the transmitting system and to the house monitoring speakers and audio circuits.

The M6209 Console is completely transistorized and self-contained except for the power transformer and VU meters. The power transformer has been placed externally to minimize hum pickup in the console amplifiers and internal wiring. The VU meters are in separate housings to permit the flexibility of placing them anywhere along the top of the console, or to set on a desk top by the removal of the bracket for console mounting.

Breaking and jumpering of all major circuits allows full use of the normalling jack fields, with all connections brought out to terminal blocks for ease of installation and future circuit checking. Three speaker muting and warning light relay circuits accommodate the four normal microphone channels for three different areas. They may be jumpered to operate in conjunction with Channel 3 or 8 if these are connected as optional microphone channels.

Compensation of signal levels by the use of fixed attenuators throughout the console minimizes the necessity of readjusting gain controls when switching from one circuit to another. External inputs should be padded to a nominal -15 DBM in all of the medium level circuits to complete this desirable operating feature.

The cue-intercom system provides for the cueing of the turntables and all other inputs except the microphones, as well as the intercom facilities between the control room and studios. It also allows talkback down the remote lines. The entire facilities of the cue-intercom system are interlocked with the speaker muting relays so that cueing and intercom signals can not inadvertently get on the air.

This introduction has touched on some of the more important points of the console to give general information without excessive details. Those concerned with the daily operation should study the section labeled "OPERATION". The installation crew should study their section before actually starting

the work. Each section is broken down to cover different phases so that unnecessary confusion may be eliminated and the answer to any particular question may be easily found. The engineering staff is urged to become acquainted with all sections so they can advise other groups in the best performance of the console, as well as being able to keep it in top operating condition at all times.

INSTALLATION

All of the packing material, including any shipping frames and platforms, should be carefully removed prior to the installation of the M6209 Console. The removable items are as follows:

| | | |
|---|--------------|------------------------------------|
| 4 | 994 6034 001 | Transistor Preamplifier |
| 2 | 994 5700 001 | Transistor Program Amplifier. |
| 1 | 994 6035 001 | Transistor Cue-Intercom Amplifier. |
| 2 | 994 6208 001 | VU meter, in separate housing. |
| 1 | 472 0429 000 | Power Transformer. |
| 1 | 646 0379 000 | Group of Knob Decals. |
| 1 | 888 0764 001 | Instruction Manual. |

If any of the items listed above are missing, search all of the packing material again to determine if they have been overlooked. If still missing, contact the Gates Radio Company for instructions.

SIZE:

The M6209 Console is 52-3/8" long, 11-3/8" high and 17-3/8" deep. The net weight is 114 lbs.

With the plug-in amplifiers removed, place the console on the control desk in the final operating position. Determine the routing of the interconnecting cables into the cabinet and the method of connecting the cables to the control desk. The conduit and/or duct layout should also be considered in the planning of the interconnecting cable runs. If the cables are to come up through the surface of the desk, mark the cable access holes (in the console base) on the desk top so that they may be accurately drilled after removal of the cabinet.

In some cases, it is preferred to elevate the console cabinet sufficiently to permit the cables to lay between the desk top and the console base, making a right-angle turn with the cables to enter the cabinet. The cables are then dressed off the rear of the desk and generally a protective cover is installed on the rear of the desk.

In either type of installation, the console should be fastened securely to the control desk after the wiring is complete. This is facilitated by the holes in the center of several of the large dimples in the cabinet base. The wiring adjacent to the mounting holes should be fully protected during the drilling and fastening operation.

CABLE AND CONDUIT LAYOUT:

This is of utmost importance in the studio installation. Good results, with a minimum of noise and crosstalk, require careful planning and consideration before actually starting the construction. A system hastily installed, without thorough planning, invariably results in continuous trouble until rebuilt.

SIGNAL LEVELS:

Console cables should generally be divided into three groups: Low level cables may include levels from -60 DBM to -20 DBM. Medium level cables may include levels from -20 DBM to +14 DBM. High level cables may include levels from +14 DBM to +40 DBM. The AC and power wiring should always be run in separate cables.

Whenever possible do not run any of the four cables listed in a conduit along with cables of different level classification. If two or more cables must run in a common conduit, never exceed a difference of 40 DB in level between the highest and lowest level in either cable. Use high quality shielded twisted pair, such as Gates catalog number 1261, for all audio wiring. For all microphone wiring, and long medium level cable and conduit runs, the use of rubber, plastic or cloth covered shielded pairs eliminates multiple ground loops and the resultant noise problems. Gates catalog number 8440 microphone cable is recommended.

In parallel cable runs of different levels, the most important aid is physical isolation. Up to six inch spacing is preferred. If there is not room for this isolation, do not lace all of the wires in the same cables. Keep the cables laced separately for the different level classifications even if two or more must lay together. This will give much better isolation than when formed into one cable. The deviations from the preferred methods must not be taken lightly or just for convenience. Use them only as a last resort.

Terminal layout is arranged in the Console to allow adequate separation of cables up to the point of connecting to the terminal block. Low level microphone cables connect to the left of TB1 (located in the left-hand and right-hand cubicles, viewed from the front panel). Most the medium level cables connect into TB2 (located in the left-hand side of the middle cubicle, viewed from the front panel). The high level cables are segregated into part of TB3 (the large 80-terminal block located in

the middle cubicle). The intercom terminals, relay coils, and other miscellaneous connections are also on TB3.

Bring the external cables into the terminal boards in the most direct route while maintaining maximum separation between level classifications. It would be very helpful to make a sketch of the external cables in the vicinity of the console and the console terminal boards to fully plan their routing before starting to connect to the console.

Conduit generally affords enough shielding so that different levels in separate conduit presents no isolation problem even without spacing them apart. Microphone level conduit and speaker level conduit can probably run along together with no crosstalk. However, if practical, it is advisable to maintain physical separation and add to the safety of the installation. Power circuits, especially those with high current, should not be in close proximity with program carrying conduit; electromagnetic shielding is poor in most conduit.

GROUNDING CIRCUITS:

Grounding circuits, like cable layout and most systems work methods, are unpredictable to a certain extent. Therefore, no hard and fast rules apply 100% of the time. In this section it is attempted to cover the things to avoid and to present generally accepted practices that always give good results, or allow good results to be obtained with minor modifications. Entirely different approaches have been used, some with good results, but unless you are an expert on the subject, most are risky.

The console grounding system is based on the one point ground. ~~Different circuit grounds are insulated from the chassis and~~ other grounds except at one point, where they all join together and go to earth ground. This system presents multiple ground loops with the resulting hum pickup from circulating currents and RF pickup and regeneration.

External circuits connected in the console should not destroy this system. Microphone circuits are not grounded in the console. The shields should not be grounded externally except after noise checks. They may then be grounded if better results are obtained. Turntable and tape inputs are balanced, and feed into isolation transformers in the console when switched into the program circuits. When they are not switched into the program circuits, they feed an unbalanced input into the cueing amplifier through two 4700 ohm isolation resistors in each circuit. These resistors are designated as R52 through R75 on the schematic diagram. Since grounding an external circuit would effectively short out one of the 4700 ohm isolation resistors and also create a ground loop between the external equipment and the console grounding system, this should be

avoided. Therefore, none of the medium level inputs into the two banks of pushbutton switches should be grounded, they should always be balanced circuits without even a center tap ground. If the ground cannot be removed on any of these external circuits, or the circuit impedance will not match the 600 ohm input, an isolation transformer should be employed on the external circuit before it enters the console.

In order to prevent connecting transformer to transformer, (the other transformer being the isolation transformer within the console) a minimum of 6 DB resistive isolation pad should be employed with the output of the pad connecting to the input of the console terminals. It might be desired to make this pad even larger in order to attenuate the input signal to approximately -15 DBM to match the output level of the microphone preamplifiers. This will allow all of the channel attenuators to run at approximately the same position and provide optimum operating characteristics. Order Gates Type A-21 line matching and isolation transformer for this purpose.

Thus, a safe rule to follow is: DO NOT ground either side of external circuits. Generally, the shields of the cables should ground at the console only. They may be connected to the ground terminals in the console. There may be exceptions to this rule, especially on microphone input circuits, so the shield grounds should be wired in such a manner that they can be lifted in the console and grounded at the other end. Again, this is part of the test procedure and used to obtain lowest noise.

BALANCED AND UNBALANCED LINES:

If a circuit is ungrounded, it is considered balanced to ground. If one side is grounded, of course, it is unbalanced. If the circuit is center tap grounded with pad or coil, it is balanced to ground. Refer to the sub-chapter "GROUNDING CIRCUITS" for determining proper classification. Twisted shielded pairs should be used for all circuits, whether they are balanced or unbalanced. Cancellation of noise and crosstalk pickup is approximately the same for either when the one point ground system is used. If it is necessary to connect a balanced line to an unbalanced line, or the opposite, an isolation transformer should be used between them. The transformer must have good balance, an electrostatic shield and magnetic shielding sufficient to reduce the hum pickup to at least 65 DB below the signal level. Impedance taps on primary and secondary are important to properly match both circuits. The Gates Radio Company's general catalog lists these transformers. Balanced lines require balanced pads and attenuators, unbalanced lines require unbalanced ones. Mixing them generally results in poor noise, frequency response or other poor operation.

CIRCUIT IMPEDANCES:

The microphone inputs are factory connected for 150 ohms. These are balanced inputs. The impedance can be changed to 50 ohms balanced by changing the connections of the input transformer on the preamplifier board. See the preamplifier schematic diagram included at the back of this book for information on this change.

The turntable and tape inputs are 600 ohms balanced. Since any one of the eleven inputs, as well as the net and remote lines, feed into common isolation transformers; it is necessary that all of these inputs be of one impedance. If it is permissible to run the network, remote lines, turntables, projectors, etc., all at 150 ohms or 50 ohms, then it is permissible to change the impedance taps on the primary of T1 and T2.

The network and remote input lines are 600 ohm balanced circuit. As mentioned previously, all of these medium level inputs must be of one impedance. This impedance can be changed by changing the taps on T1 and T2, the isolation transformers in these circuits. The factory connection is to terminals 1 and 3 and the impedance is 600 ohms. Connect to terminals 1 and 2 for 150/200 ohms, and to terminals 2 and 3 for 30/50 ohms.

INSTALLATION - WIRING

POWER CONNECTIONS:

A 117 volt AC circuit should be connected to terminals TB4-1&2. This furnishes power to the muting relays to energize the warning lights. TB4 is the barrier type terminal strip located in the extreme right-hand rear corner of the middle cubicle locking at it from the front. Of course, 117 volts should be applied to terminals 1 and 3 on the external power transformer. Terminals 1 and 2 should be used if the local AC line voltage is low (105-110 volts). Terminals 1 and 4 should be used where the local AC line voltage is high (120-125 volts).

There are three 28 volts secondary windings on the power transformer. This console requires the use of only two of these three windings. Terminals 5 and 6 on the power transformer should connect into TB5-1&2 in the console. Power transformer terminals 7 and 8 should connect to console terminals TB5-3&4.

In no case should the same windings be used to feed TB5-1&2 at the same time it is feeding TB5-3&4. TB5-1&2 is the 28 volt AC input to the monitoring amplifier power supply. TB5-3&4 feed the main console power supply. If these are fed from the same 28 volt winding, crosstalk will occur between the output of the monitoring amplifier back through the main console power supply into the program circuits.

The 117 volts connected into console terminals TB4-1&2 are the only AC wiring necessary to connect to the studio warning lights. Do not allow any external AC wiring or circuit or earth ground to connect to the warning light wiring external to the console. The warning light for studio A connects to TB4-5&6. The warning light for Studio B connects to TB4-3&4. The warning light for the Control Room connects to TB4-7&8. 117 volts will be switched to these pairs of terminals when the proper microphone key and associated muting relay are operated. The console is factory connected so that operating microphones 1, 3, 5, or 7 will operate relay 1. This means that studio speakers and warning lights which are operated by relay 1 should be in the same studio as the above microphones. Operating microphones 2, 4, 6, or 8 will operate relay 2 and the same placement of speakers and warning lights should be observed. If the additional microphones preamps are used in channels 3 and 8 these channel switches can also be wired to operate the desired muting relay. The above factory installed wiring can also easily be changed to suit individual needs, see the schematic diagram for complete details on the wiring and terminal board information.

WARNING

Warning lights circuits should not be grounded at any point and should not draw more than 2 amperes per relay. Therefore, do not exceed 200 watts warning light power on any one of the three muting relays.

STUDIO INTERCOM WIRING:

When connecting the studio intercom units, the wiring should be kept separated from program circuits. The studio intercom speakers should have a nominal coil impedance of approximately 45 ohms. These may be ordered from Gates Radio Company by #722 0009 000. Connect the Studio A intercom speaker into TB3-3&4. Connect Studio B intercom speaker into TB3-7&8. Since the intercom circuits are at approximately microphone level when talking back from the studio, it is advisable to use twisted shielded pair with insulated jackets for these runs. Since the talkback level into the studio from the control room is speaker level the circuit should never be run with any of the studio microphone circuits. If possible, it is best to physically isolate these intercom circuits from any other power or program circuits in the radio station.

MONITOR SPEAKERS:

All speaker wiring is high level and must run in separate conduit away from low level program circuits. The 8 watt transistor monitoring amplifier has ample power to drive as many as

five speakers. The three muting relays will give muted speaker operation in three different locations. This would generally consist of Studio A, Studio B, and Control Room. A news booth could be used in place of either one of the studios or could be operated in conjunction with one of the studios even though it were in a separate location. Therefore, the same muting relay could mute Studio A and a news booth simultaneously. The output impedance of the monitoring amplifier is nominally 8 ohms. It will put out full power from 4 ohms to 16 ohms load. It is more convenient to operate multiple speakers from a common amplifier by the use of speaker matching/bridging transformers. Gates number A-30601 speaker transformers are recommended for bridging the 8 ohms speaker line into 6-8 ohms speaker voice coils. Connect the 45-60 ohm primary to the output terminals on the console. Connect the 6-8 ohm transformer secondary to the speaker voice coil. The relay deck has 47 ohm backloading resistors across the lines when the speakers are muted. Thus, a constant load is presented to the output of the monitoring amplifier by either the 48 ohm speaker transformer or the 47 ohm backloading resistor.

Speakers connect to the following terminals on TB3: Lobby speaker - TB3-75&76. Any other speakers, such as Managers Office, Reception Room, etc. should also connect to these terminals for unmuted speaker operation. Studio speaker A - TB3-71&72. Studio speakers B - TB3-67&68. Control Room - TB3-79&80. The muted speakers in all three of the major areas will mute when the microphone channel key is thrown to either program or audition bus. The muting can be arranged so that microphone #1 operates a different muting relay than microphone #2. The extra set of contacts shown on the schematic diagram to select microphone #1 or microphone #2 can be used to energize any one of the three relay coils as desired. Rather than go through all the possible combinations, please contact the Gates Radio Company, Engineering Department if you are unable to arrive at the particular combination you desire.

SPEAKER CIRCUITS MUST NOT BE GROUNDED.

MONITOR INPUT CIRCUITS:

The monitor amplifier has a three-position input switch to select the output of program line #1, the output of program line #2, or an external input. The external monitoring input is connected to TB2-5&6 in the console. This input should be padded to match the level of the other two inputs so that the operator can switch to any one of them without changing the monitoring amplifier gain control. This is an ungrounded circuit and may accommodate either a grounded input or a balanced input. The usual sources of external monitoring input include air monitor from the monitoring receiver, sub-master console outputs, etc.

PROGRAM INPUT CONNECTIONS:

The M6209 Console has normal facilities for eight microphones switched into four microphone channels. Microphones 1 through 4 connect in the left-hand cubicle as follows: Microphone 1, TB1-1&2; microphone 2, TB1-3&4; microphone 3, TB1-5&6; microphone 4, TB1-7&8. Microphones 5 through 8 connect in the right-hand cubicle as follows: Microphone 5, TB1-1&2; microphone 6, TB1-3&4; microphone 7, TB1-5&6, microphone 8, TB1-7&8. Two additional microphone preamps may be obtained to convert channels three and eight from high level channels to microphone channels. These changes can be best understood by reference to the console block diagram and schematic. Connections to the third channel of the left-hand cubicle are as follows: Nemo 1, TB1-9&10; Nemo 2, TB1-11&12. Connections to the eighth channel (on the right-hand cubicle) are as follows: Nemo 3, TB1-9&10; Nemo 4, TB1-11&12. The microphone inputs are 150 ohms balanced and the external circuits should not be grounded. See the pre-amplifier schematic if it is desired to change the factory impedance from 150 ohms to 30/50 ohms. See the section "GROUNDING CIRCUITS" for installation techniques.

The medium level inputs connect directly into one of the multi-position pushbutton switches. They normal through S4 into S5, the second pushbutton bank. S4 directs the selected input signal into T1 and into channel attenuator #4. S5 connects the selected program input through T2 into channel attenuator #5. These inputs are normally used for turntables, tape recorders, projectors, etc. The first button on both selector switches connect the output of the network and remote line keys into either channel #4 or #5 as directed. The center position of the network key is an "OFF" position which is also bridged by the "NET" position of the headset selector switch. The upper position of the network key feeds the network into the input of the cueing amplifier for previewing over the cue speaker. The lower position of the network key directs it into the mixing channel which feeds through position #1 in either one of the pushbutton switches into the mixing channels. The four remote keys are directed to the intercom circuit for talkback purposes in the upper position. A two-way conversation can be carried on between a control room operator and the remote operator by simply throwing the press-to-talk key and releasing it. The center position of the remote key feeds the program cue from the output of the monitoring amplifier back down the remote line. The lower position of the remote key feeds the program through the pushbutton keys into either channel #4 or #5 to mix on the program bus. If any of the medium level inputs are grounded or unbalanced, an isolation transformer and isolation pad should be used to present a balanced resistive input to the console terminals. This is covered further in previous chapters.

The eleven medium inputs that connect to the eleven positions of the selector switch are on TB2 and the pairs are as follows: TB2-19&20, TB2-21&22, TB2-23&24, TB2-25&26, TB2-27&28, TB2-29&30, TB2-31&32, TB2-33&34, TB2-35&36, TB2-37&38, TB2-39&40. The network input terminals are TB2-7&8. Remote #1 input terminals are TB2-9&10. Remote #2 input terminals are TB2-11&12. Remote #3 input terminals are TB2-13&14. Remote #4 input terminals are TB4-15&16.

The remote line facilities can be greatly increased by bringing all of the remote lines into patch panels. If the four remote inputs to the console are brought to adjacent jacks on these panels, any pattern may be set up and any number of remote lines handled conveniently and faultlessly.

LINE OUTPUT CONNECTIONS:

Output connections for program line #1 are in the left-hand cubicle on TB1-27&28. Output connections for program line #2 are in the right-hand cubicle on TB1-27&28. An internal 6 DB telephone line isolation pad is built into the console to prevent telephone line reactances from interfering with any of the console circuits. Therefore, the output of the console should be connected directly to the program telephone line to feed to the transmitter site. In cases where the transmitter and console are in the same building, the output of the console should be padded down to connect at the proper level into the peak limiting amplifier. The console should always be operated at the normal output level, which is obtained when VU meter peaks 0 or 100%. Any level adjustment out of the console should be handled by resistive pads for attenuation or booster amplifiers for an increase in level.

The outputs of the console are balanced and ungrounded and the telephone lines should be maintained as balanced and ungrounded lines from the outputs of the console to the inputs of the peak limiter amplifiers.

UTILITY SWITCHES:

Six utility switches are available on the console panel for the special circuits in the particular installation. Each one of these switches are three-positions and may be used for any circuit that does not exceed 115 volts, 60 cycles at 1/10 of an amp. They are high quality program switches and may be used for anything from microphone level to speaker level. The common terminals on these switches are brought out to terminals along with the three switched positions so that they can be used in either direction for maximum flexibility. The connections to the three utility switches on the left-hand panel are brought out to TB1 in the left-hand cubicle. The connections to the three utility switches on the right-hand panel are

brought out to TB2 in the right-hand cubicle. See the schematic diagram for terminal numbering of these switches.

OPERATION

The arrangement of panel controls gives maximum versatility to console operation while keeping actual operating as simple as possible. Control functions are explained in the following sections. In all cases reference to the block diagram of the console, drawing 842-3687-001 will help clarify these functions.

MICROPHONE SELECTOR SWITCHES:

The lever key on the upper panel section directly above each of the mixers 1 through 3 and 6 through 8 is used to direct one of two inputs into that particular channel. Microphone 1 or microphone 2 can be switched into channel 1. Microphone 3 or microphone 4 can be switched into channel 2. In the same way, microphone 5 or microphone 6 can be switched into channel 6 and microphone 7 or microphone 8 can be switched into channel seven. Channel three will accept either Nemo 1 or Nemo 2 or microphone 9 or 10 if the additional microphone preamp is installed. Channel eight will accept either Nemo 3 or Nemo 4 or microphone 11 or 12 if the additional microphone preamp is installed in this channel.

The muting is switched along with the choice of microphone selections (if the console is wired in this manner) so it is not necessary for the console operator to do anything but select the proper microphone and throw the channel key either program bus or audition bus. The three keys located between the input selector key to channel one and channel two are utility keys that may be used for any special circuit in the particular installation. The station engineer will have to explain their operation to the operators.

MEDIUM LEVEL INPUTS:

Eleven medium level inputs such as turntables, tape recorders, projectors, etc. may be connected into pushbutton #2 through #12 on the middle cubicle of the console. These pushbuttons are interlocked so that pushing any one of them will release any other one in a particular string. The top row of pushbuttons feed into channel #4 (to the left). The bottom row of pushbuttons feed into channel #5 (the channel on the extreme right). Channel four has preference over channel five. In the normal installation the same input program will feed channel #2 on either switch, another program input will feed channel #3 on either switch, etc. Therefore, if position #2 is pushed on the channel five bank and also pushed on the channel four bank the input will actually be directed into channel four and not channel five. Only the inputs pushed on channel five selector key that are not simultaneously selected on the channel four key will feed into channel five. The network, remote #1, remote #2, remote #3, and remote #4 switches are ganged

together in the "MIX" position and feed into the pushbutton station #1. Thus, when any one of these five selector keys are pushed to the "MIX" position, the input is fed to position #1 on either selector switch. This gives a total of sixteen inputs that can be selected into either channel #4 or channel five. When the selector switches are not pushed to select one of these sixteen inputs to either channel four or channel five, the inputs are connected into the cue bus and cue amplifier. Thus, the turntables may be cued up at any time that they are not actually being put on the program line, the tape recorders may be cued any time, the network or remote lines may be cued in the "MIX" position as well as their own cue position at any time they are not actually connected into the program amplifier in the console. This means that if there are signals on two or more of these inputs they will actually intermix in the cue speaker. There are large isolation pads between each of the inputs and the possibility of one of them feeding crosstalk back to the other one is unlikely. There is no reason for the necessity of having more than one signal in this cue position at a time so this is really a feature to prevent the selection of various pieces of equipment for cueing in this particular instance.

Each one of the pushbutton stations have a set of contacts to operate the illuminated pushbutton knob. 37 volts DC from the console power supply is used for this purpose. 37 volt relays may be used to start the tape recorders and turntables, if desired. The relay coils will parallel the 37 volt lights in the illuminated pushbutton knobs, therefore, they must not draw over 30 milliamperes or circuit loading will result. The hot side of the relay coils should connect to TB3 terminals 33, 34, 37, 38, 41, 42, 45, 46, 49, 50, 53, 54, 57, 58, 61, 62, 65, 66, 69, 70, 73, 74, 77 or 78. The common side of these relay coils must connect to B- (-37 volts on the regulated power supply in the console). B+ on this regulated power supply actually goes to station ground. However, the switch contacts are connected to B+ so the other side of the relay coil or the coil return must go to B- on the regulated power supply.

The network input is fed into the common of the network key and can be directed to an "OFF" position in the middle position, where it can be bridged and monitored by the headphones in the "NET" position of the headphone switch. The upper position of the network key directs the network into the input of the cueing amplifier. The lower position of the network key directs the network through the pushbutton banks into the program channel attenuators.

The four remote keys are also three-position keys with the individual remote lines connected into the common arms. In the upper position, the remote line is connected for talkback.

The console operator may talk to the remote operator by simply depressing the "TALK" key on the intercom circuit (in the upper center of the panel on the middle cubicle). The control operator may listen to the remote operator by simply releasing this press-to-talk key. In the center position of the remote keys, program cue signals are fed down the remote line from the output of the monitoring amplifier. It is necessary that the monitoring amplifier be connected to the correct program output of the console or "Off-The-Air" monitor so that he receives the program that is actually being broadcast for cueing purposes. The lower position of the remote keys feed the remote line into the mixed position through the pushbutton selectors into the channel attenuators.

The headset key allows a choice of the program output #1, network or program output #2. The monitor input selector switch and monitor gain are located on the upper right-hand corner of the middle control panel. The input selector key allows a choice of program #1 output, program #2 output, or external monitor input. The station engineer will explain the function of the external monitor input position.

The cue-intercom speaker is located on the left of the front panel on the middle cubicle. This speaker is used for both listening in the cue and various other positions, and for talking on studio intercom and remote talkback circuits. It is not necessary to lean over and speak closely into this speaker but it is well to speak clearly in the same manner as when on the microphone and in a normal voice towards this speaker. A few minutes of practice will show the best technique for the individual operator. The input selector switch for the cue-intercom amplifier has a cue position where only the signals fed to the cue bus can be monitored. The cue signals are also bridged across the other four positions of this switch so that the cue may be heard on any position regardless of the status of the selector at any particular time. Thus, the control operator can be talking over the studio intercom to one of the studios and still receive a call from a remote operator or cue a turntable. He may select the spare position for whatever the station engineer has wired into it. This may be used as another intercom position into a third studio or Manager's Office or some other convenient location. The cue-intercom circuits are fully interlocked by the means of the input selector switch and/or the muting relays to prevent any possible interference with programming. The studio intercoms are muted when the studio microphone is on the air, the control room intercom speaker when the control room microphone is on the air. The operator may still cue up records or receive calls on the intercom circuit on his headphones if he will simply plug them into the cue phone jack.

The master gain control for program channel #1 is located on the left-hand cubicle. The master gain control for program channel #2 is located on the right-hand cubicle. They should be adjusted during initial test for optimum signal-to-noise ratio and, except for emergency level changes thereafter, be left in this optimum position. The levels of the input program sources should always be adjusted by means of the step-type channel attenuators on the lower portion of the console panel. It will be noticed that the third input channel from the left and the last input channel to the right have an extra detented position at the extreme counterclockwise position. This is the cue position on these attenuators and connects the input to these attenuators to the cue bus and separates it from the program channel. This is convenient if these channels are used for turntables, tape recorders, etc.

PRINCIPLES & THEORY OF OPERATION

This section is included to give the engineer a better understanding of some of the more unusual features of the console. The various obvious methods of operation will not be covered, since they are common knowledge, or have been covered in previous sections of this instruction book.

TRANSISTOR AMPLIFIER CIRCUITRY

Complete details on the various amplifiers used in the console will be found in the individual instruction books included in the back of this manual. However, a word about the circuitry will aid in explaining overall console setup. The preamps, monitor booster amp, cue-intercom amp and monitor amplifier have transformerless output circuits. Grounding of external wiring is critical for best noise figures and to avoid cross-talk, especially in the high-gain cue-intercom amplifier. If modifications are made on the console, care should be exercised to insure that unwanted grounds do not enter the picture. UNDER NO CIRCUMSTANCES SHOULD THE MONITOR SPEAKER WIRING BE GROUNDED EXTERNALLY.

CUE-INTERCOM SYSTEM:

Reference to the schematic drawing 837 9345 001, of the cue-intercom amplifier and the overall console schematic for the wiring of this system will aid in understanding the operation of the cue-intercom system.

An interstage volume control, remotely mounted on the front panel helps reduce noise at normal operating level. The incoming remote lines normally operate with a signal of +8 VU. This level is padded down to a level sufficiently low to prevent overloading the cue-intercom amplifier when listening to the remote lines. These pads consist of the 620 ohm loading resistor across the input of each remote line and the large building out resistors in series with each side of the line to feed the cue-intercom amplifier. These pads may be built

on the selector switch and not in separate pad assemblies. These pads also give isolation between the various remote lines when more than one line is switched into the cue amp at the same time.

The maximum gain of this amplifier is approximately 90 DB. Since the input and output of the amplifier come in close proximity at the "TALK-LISTEN" switch (S16) wire dress is very important in this area. The grounding of the cue-intercom system is also very critical. Do not allow any part of the external speakers or system to be grounded, they are grounded in the console. Shielding of all external speaker lines is necessary to prevent hum and possible regeneration.

The frequency response of the amplifier is rolled off severely on both ends to provide the best compromise of cueing and intercom functions. Do not attempt to alter it without taking all of the circuit requirements into consideration.

MIXING SYSTEM:

The mixing system consists of an eight channel mixer utilizing step-type ladder controls connected in a parallel, minimum loss type, mixing circuit. D contacts are used on all of the channel lever keys and backloading and building out resistors are used to maintain a constant impedance both ways with any combination of switching on these keys.

VU METER & ISOLATION PADS:

The VU meters are set to read 0 (or 100%) with an audio level of "8 VU on the output telephone line terminals. The isolation pads are 6 DB resistive pads to isolate the telephone line reactance from the internal console circuits.

SPEAKER MATCHING TRANSFORMERS:

All house monitor speakers must have matching transformers. These should be the 45/60 ohms to voice coil type, Gates Type A-30601. The output impedance of the monitoring amplifier is from 4 to 16 ohms (8 ohms nominal). The parallel combination of the speakers should fall in this range. The 47 ohm backloading resistors mounted on the relay deck prevent the load from changing when muting the speakers.

REGULATED POWER SUPPLY & POWER TRANSFORMER:

The power supply has two DC outputs. A 30 volt unregulated output is used for the pushbutton lamps. A 30 volt regulated supply is used to furnish power to all the other console amplifiers except the monitor amplifier, which has its own

power supply. Transistors XQ4, XQ5, XQ6 (in the 30 volt regulated power supply) act to amplify any change in the output voltage. This sensing signal is fed back to XQ2 which in turn controls the voltage drop across XQ1. XQ1 is in series with the output and maintains the voltage constant with varying load. Zener diodes, CR9, CR10 and CR11 provide reference levels for the voltage sensing amplifier.

Overload protection is provided by XQ3 and associated circuitry. Maximum current out of the power supply is limited to approximately 600 milliamperes. R12 allows adjusting the output voltage over a small range to allow for line voltage variations. When installing the console, this voltage should be checked, and if necessary, R12 readjusted to give 30 volts at the output plus and minus bus bars on the top of the regulated power supply. Space is provided for a spare fuse on the front of the power supply for immediate replacement if this becomes necessary. The console power transformer is intended to mount externally. This prevents the high hum fields surrounding the power transformer from inducting a high hum level into the low level console circuits. Two independent 28 volt windings are necessary to provide complete isolation between the monitor amplifier and the console power supply. A third 28 volt winding is not used on this power transformer in this particular console model.

MAINTENANCE

One of the great advantages in the use of transistors is the long life to be expected from semiconductor devices. In this console, high quality components, conservatively rated, have been combined with the latest circuit techniques to give maximum dependability with a minimum of required maintenance. However, even the finest equipment may become erratic or become inoperative if not properly cared for. We strongly recommend that the station engineer plan a routine maintenance schedule and make every effort to follow it carefully.

VOLTAGE MEASUREMENTS

Correct voltage readings are given on the schematic diagrams of the various amplifiers. It is recommended that after the console is installed and operating satisfactorily, these readings be checked and recorded on the schematic. This will provide the station engineer with a record of the actual voltage readings in his installation using his meter. If trouble later develops, he will then be better able to judge whether or not a particular circuit is operating properly since he will have available a record of the various readings with his particular meter at his particular location. DC readings were taken with a 20,000 ohms/volt meter as indicated on the schematic diagrams. RMS signal voltages are given in parenthesis and must

be measured with a vacuum tube voltmeter. If a VTVM is used to measure the DC voltages, slightly higher readings may be obtained.

MECHANICAL COMPONENTS

The channel attenuators are step-type low impedance attenuators. If they are of the sealed type (manufactured by the Langevin Company) they will require no cleaning. If they are of the unsealed type (manufactured by the Daven Company) they will require cleaning on the average of about four times a year. A well air-conditioned room would allow longer periods between cleaning schedules. A very dusty location would require more frequent cleaning. The attenuator contacts should be cleaned and lubricated by using Davenol (sometimes called Daven Oil). A soft, lint-free cloth should be used to remove the dirty accumulation from the contact surfaces. Davenol is inexpensive and may be purchased from the Gates Radio Company.

The relays and channel lever keys were selected for long-life and trouble-free service. The contacts are self-wiping and everyday use will keep them burnished. The contacts on the keys and relays that receive infrequent use can be cleaned by operating the equipment several times. If the trouble persists on these infrequently used contacts, use a contact burnishing tool (Gates Type TM-1). Abrasive papers, files, emery cloth and grease solvents should never be used on these contacts. Grease or oil should not be used on relay or key contacts. This would make them collect dust, get gummy and cause contact burning and possible failure. The Centralab lever keys have excellent wiping action and will probably never require cleaning. If one of these keys becomes damaged, it is better to replace it than to attempt to repair it. Use the parts list for description if it is necessary to order a replacement lever key.

MODIFICATIONS

In the design and construction of the M6209 President Console it was attempted to provide a unit which would give the maximum number of installations adequate operating facilities. Realizing, however, that some users may require facilities that are not common, we have included in this section information about possible modifications which can be made on the console. Plan your modification carefully and allot sufficient time to complete it so that it will be well executed and not a future source of trouble.

PATCH PANEL FACILITIES:

Since the amplifiers are mostly unbalanced outputs and used in critical grounding circuits, they are not brought out to terminals for patching. The use of semiconductors in the amplifiers

preclude the normal routine troubles encountered with tube type amplifiers. Therefore, this internal amplifier patching is not necessary in a console of this type. All of the program amplifiers (preamplifiers, booster amplifier and main program amplifier) are plug-in so that the amplifier can be readily changed should trouble ever develop.

Patch panel use is, therefore, limited to external circuitry. They may be used to expand any section of the input facilities of the console should the occasion demand.

AMBIENT TEMPERATURES:

The transistor amplifiers and the power supply used in the console have been designed for reliable operation at temperatures up to 55° C. or 131° F. No special ventilation is required. However, the long sine wave testing (especially in the monitoring amplifiers) should be avoided to allow heat build-up in the power output transistors to be dissipated. See the instruction books provided at the end of this manual for more information.

GATES' M6209 PRESIDENT CONSOLE

PARTS LIST

| <u>Symbol No.</u> | <u>Gates Stock No.</u> | <u>Description</u> |
|-------------------|------------------------|-----------------------------|
| | 396 0120 000 | Lamp, 28 V. #1819 |
| AT6 | 913 5931 001 | VU Pad Assembly |
| | 630 0105 000 | VU Meter, Model 1349 "B" |
| P3 | 610 0097 000 | Plug, P-304 CCT |
| R81 | 540 0593 000 | Res., 180 ohm, 2W., 5% |
| | 406 0317 000 | Pilot Light Socket #708 |
| T5 | 472 0429 000 | Power Transformer, AP-36766 |
| | 994 6115 001 | "LOW LEVEL" |

SECTION FOR PRESIDENT CONSOLE

| | | |
|---------------|--------------|-----------------------------|
| AL1 | 994 5700 001 | Transistorized Program Amp. |
| AP1, AP2 | 994 6034 001 | Transistorized Preamp |
| AT1, AT2 | 554 0251 000 | Attenuator, 600/600 ohm |
| AT3 | 554 0250 000 | Attenuator, 600/600 ohm |
| AT7 | 994 5484 003 | "H" Pad Assy. 600/600, 6 DB |
| C1, C2, C3 | 506 0005 000 | Cap., .1 uf, 200 V. |
| J3 | 612 0045 000 | Socket |
| R1, R2, R3 | 540 0034 000 | Res., 240 ohm, 1/2 W, 5% |
| R4, R8, R12 | 540 0040 000 | Res., 430 ohm, 1/2 W, 5% |
| R5, R7, R9, | | |
| R11, R13, R15 | 540 0051 000 | Res., 1200 ohm, 1/2 W, 5% |
| R6, R10, R14 | 540 0044 000 | Res., 620 ohm, 1/2 W., 5% |
| R25 | 550 0236 000 | Control, 2500 ohm |
| R80 | 540 0043 000 | Res., 560 ohm, 1/2 W., 5% |
| R85 | 540 0052 000 | Res., 1300 ohm, 1/2 W., 5% |
| S1, S2, S3, | | |
| S22 | 602 0007 000 | Lever Switch |
| S6, S7, S8 | 602 0011 000 | Lever Key |
| S11, S12, S13 | 602 0005 000 | Lever Switch |
| TB1 | 926 7731 001 | Terminal Block, 80 term. |

8/21/52

-1-

M6209 President Console.

994 6116 001 "HIGH LEVEL"
SECTION FOR PRESIDENT CONSOLE

| <u>Symbol No.</u> | <u>Gates Stock No.</u> | <u>Description</u> |
|-------------------|------------------------|--|
| AM1 | 994 6108 002 | Transistorized Mon. Amp. |
| AQ1 | 994 6035 001 | Transistorized Cue Amp. |
| AT4,AT5 | 554 0251 000 | Attenuator, 600/600 ohm |
| J1,J2 | 612 0284 000 | Phone Jack |
| K1,K2,K3 | 572 0072 000 | Relay 2A,2B, AK-12626 |
| LS1 | 722 0009 000 | Speaker, 45 ohm, 3" |
| PS1 | 994 6205 001 | Mon. Amp. Power Supply |
| R16,R20 | 540 0040 000 | Res., 430 ohm, 1/2 W, 5% |
| R17,R19,R21, | | |
| R23,R84 | 540 0051 000 | Res., 1200 ohm, 1/2 W, 5% |
| R18,R22,R24 | 540 0044 000 | Res., 620 ohm, 1/2 W, 5% |
| R26 | 550 0236 000 | Mon. Control, 2500 ohm |
| R27 | 550 0215 000 | Cue Control, 10K ohm |
| R28 | 540 0042 000 | Res., 510 ohm, 1/2 W, 5% |
| R29,R31,R32 | 540 0018 000 | Res., 51 ohm, 1/2 W, 5% |
| R30 | 540 0032 000 | Res., 200 ohm, 1/2 W, 5% |
| R33,R34,R35 | 540 0579 000 | Res., 47 ohm, 2 W, 5% |
| R37,R39,R82, | | |
| R83 | 540 0055 000 | Res., 1800 ohm, 1/2 W, 5% |
| R52 thru | | |
| R75,R86,R87 | 540 0065 000 | Res., 4700 ohm, 1/2 W, 5% |
| R76,R77 | 540 0034 000 | Res., 240 ohm, 1/2 W, 5% |
| R78,R79 | 540 0599 000 | Res., 330 ohm, 2 W, 5% |
| S4,S5 | 604 0204 000 | Illuminated Pushbutton Switch, 13 Station |
| S9,S10 | 602 0011 000 | Lever Key Series 4803 |
| S14 | 600 0218 000 | Rotary Switch |
| S15,S17,S18, | | |
| S19,S20,S21, | | |
| S23 | 602 0005 000 | Lever Switch |
| S16 | 602 0006 000 | Lever Switch |
| T1,T2 | 478 0009 000 | Transformer |
| T3,T4 | 478 0230 000 | Transformer |
| TB2 | 614 0439 000 | Terminal Block, 40 Term. |
| TB3 | 926 7731 001 | Terminal Block, 80 Term. |
| TB4 | 614 0048 000 | Terminal Board |
| TB5 | 614 0054 000 | Terminal Board |

994 6205 001 TRANSISTOR

REGULATED POWER SUPPLY - 30 V. DC AT 40 MA

| <u>Symbol No.</u> | <u>Gates Stock No.</u> | <u>Description</u> |
|---|------------------------|--|
| C1,C2 | 522 0268 000 | Cap., 20 mfd, 100(W) V. |
| C3 | 524 0100 000 | Cap., 1000 uf, 50 V. |
| C4 | 506 0005 000 | Cap., .1 mfd, 200 V. |
| C5 | 522 0297 000 | Cap., 250 mfd, 50 (W) V. |
| C6 | 522 0321 000 | Cap., 500 uf, 50 V. |
| CR1,CR2, CR3,CR4, CR5,CR6, CR7 | 384 0062 000 | Silicon Rectifier, X5A2 |
| CR8,CR10, CR9,CR11 | 386 0019 000 | Zener Diode |
| F1 | 398 0056 000 | Fuse, 1.5 amp., Slo-Blo |
| F2 | 398 0017 000 | Fuse, 1 amp, 250 V. |
| Q1,Q3 | 380 0016 000 | Transistor, 2N1539 |
| Q4 | 380 0013 000 | Transistor, 2N1225 |
| Q2,Q6 | 380 0014 000 | Germanium Transistor, 2N1414 |
| Q5 | 380 0011 000 | Transistor, 2N214 |
| R1,R5, R8,R11 | 540 0073 000 | Res., 10K ohm, 1/2 W, 5% |
| R2 | 540 0066 000 | Res., 5100 ohm, 1/2 W, 5% |
| R3 | 542 0696 000 | Res., .51 ohm, 1 W, 5% |
| R4 | 540 0623 000 | Res., 3300 ohm, 2 W, 5% |
| R6,R7,R9 | 540 0071 000 | Res., 8200 ohm, 1/2 W, 5% |
| R12 | 550 0217 000 | Sub-miniature Potentiometer, 2K ohm, 1/4 W. |
| R13 | 540 0058 000 | Res., 2400 ohm, 1/2 W, 5% |
| R10 | 540 0059 000 | Res., 2700 ohm, 1/2 W, 5% |
| R14 | 540 0570 000 | Res., 20 ohm, 2 W, 5% |
| TB1 | 614 0112 000 | Terminal Board |
| TB2 | | Terminal Board (Part of Mech. Assy.) |
| XCR8,XCR9, XQ2,XCR11, XCR10,XQ4, XQ5,XQ6 | 404 0066 000 | Socket |
| XF1,XF2 | 402 0023 000 | Fuse Holder |
| XQ1,XQ3 | 404 0136 000 | Transistor Mtg. Kit |

7/23/62

-3-

M5564 Ambassador Console
M6209 President Console

994 6108 002 TRANSISTORIZED MONITOR AMPLIFIER

| <u>Symbol No.</u> | <u>Gates Stock No.</u> | <u>Description</u> |
|-------------------------|------------------------|-----------------------------------|
| C1 | 522 0158 000 | Cap., 50 uf, 3 V. |
| C2 | 500 0818 000 | Cap., 50 uuf, 500 V. |
| C3 | 522 0256 000 | Cap., 20 uf, 50 V. |
| C4 | 516 0045 000 | Cap., .0005 uf, 1 KV, <u>+10%</u> |
| C5 | 522 0242 000 | Cap., 25 uf, 25 V. |
| C6 | 522 0160 000 | Cap., 100 uf, 3 V. |
| C7 | 522 0306 000 | Cap., 1000 uf, 25 V. |
| C8 | 506 0006 000 | Cap., .25 uf, 200 V. |
| C9 | 524 0100 000 | Cap., 1000 uf, 50 V. |
| C10 | 508 0076 000 | Cap., .005 uf, 100 V. |
| CR1,CR2, CR3,CR4 | 384 0062 000 | Silicon Rectifier |
| F1 | 398 0054 000 | Fuse, 1 amp, 250 V. Slo-Blo |
| L1 | 494 0135 000 | R.F. Choke, 5 uf. |
| Q1,Q3, Q2 | 380 0014 000 | Transistor, 2N1414 |
| Q4 | 380 0013 000 | Transistor, 2N1225 |
| Q5,Q6 | 380 0011 000 | Transistor, 2N214 |
| Q7,Q8 | 380 0012 000 | Transistor, 2N1183 |
| | 380 0016 000 | Transistor, 2N1539 |
| R2 | 540 0043 000 | Res., 560 ohm, 1/2 W, 5% |
| R3 | 540 0100 000 | Res., 130 K ohm, 1/2 W, 5% |
| R4 | 559 0002 000 | Thermistor, 50 K ohm, 45TG2 |
| R5 | 540 0091 000 | Res., 56 K ohm, 1/2 W, 5% |
| R6 | 540 0039 000 | Res., 390 ohm, 1/2 W, 5% |
| R7 | 540 0073 000 | Res., 10 K ohm, 1/2 W, 5% |
| R8 | 540 0049 000 | Res., 1 K ohm, 1/2 W, 5% |
| R9 | 540 0070 000 | Res., 7.5 K ohm, 1/2 W, 5% |
| R10 | 540 0024 000 | Res., 100 ohm, 1/2 W, 5% |
| R11 | 540 0039 000 | Res., 390 ohm, 1/2 W, 5% |
| R12,R15 | 540 0041 000 | Res., 470 ohm, 1/2 W, 5% |
| R13,R16 | 540 0018 000 | Res., 51 ohm, 1/2 W, 5% |
| R14,R17 | 542 0703 000 | Res., 1 ohm, 1 W, 5%, BW1 |
| R18 | 540 0003 000 | Res., 22 ohm, 1/2 W, 5% |
| R19 | 540 0089 000 | Res., 47 K ohm, 1/2 W, 5% |
| T1 | 478 0137 000 | Input Transformers, AM-1981 |
| TB1 | 614 0218 000 | Terminal Strip 17-7 |
| TB2,TB3 | 624 0213 000 | Terminal Strip 17-2 |
| XCR1,XCR2, XCR3,XCR4 | 402 0059 000 | Diode Board, DB-1 |
| XF1 | 402 0023 000 | Fuseholder |
| XQ1,XQ2,XQ3, XQ4 | 404 0066 000 | Socket, 3303 |
| XQ7,XQ8 | 404 0136 000 | Socket |

7/23/62

-4-

M5564 Ambassador Console
M6200 President Console

GATES

 **—solid statesman line—**

**M 5700
TRANSISTOR
PROGRAM AMPLIFIER**



Fig. 1 - M5700 Transistor Program Amplifier

The Gates Transistor Program Amplifier is available in three versions:

1. The M5700 is designed specifically for use in Gates Transistor Consoles. It is supplied less the interstage level control, and with the input unterminated. The control is mounted externally on the Console panel.
2. The M5700A is designed for rack mounting in system applications, and has the level control mounted internally and the input terminated.
3. The M5700B is identical to the M5700A except that the input is unterminated.

TECHNICAL DATA

| | | |
|-----------------------------|---|---|
| Gain: | 80 db, may be reduced as required with internal volume control. | wave power output, using 40 and 7000 cps., mixed 4:1. Under 1.5% at +24 dbm. |
| Frequency Response: | +1 db from 30 to 15,000 cps. | Noise Level: -115 dbm equivalent input noise. |
| Harmonic Distortion: | Under 0.75% at 30 cps., 0.5% from 50 to 15,000 cps., at +24 dbm output. | Source Impedance: 150/250 ohms, or 500/600 ohms. |
| Intermodulation Distortion: | Under 0.3% at +14 dbm equivalent sine | Input Impedance: Factory connected for 150 ohms. May also be connected for 600 ohms. |

Load Impedance:
 Factory connected for 600 ohms. May also be connected for 150 ohms.

Maximum Input Level:
 -35 dbm.

Maximum Output Level:
 +24 dbm.

Maximum Operating Ambient Temperature:
 55° C. (131° F.)

Maximum Storage Ambient Temperature:
 85° C. (185° F.)

Power Requirements:
 30 volts D.C., 90 ma., 0.1 mv. maximum ripple.

Transistors:
 5 - 2N1414 1 - 2N422
 1 - 2N1183

Finish:
 Cadmium plated cover, black escutcheon plate.

Mounting:
 M6031 Mounting Tray required to mount in M6029 Shelf Assembly. Shelf assembly accommodates seven Program Amplifiers and requires panel space of 3-1/2" X 19".

Size:
 2-7/32" wide, 3-1/8" high, 10-3/4" long, overall.

Weight:
 4-1/4 lbs. net. 8-1/4 lbs. packed.

Cubage:
 0.8 cu. ft. domestic pack.

DESCRIPTION

The M5700 Program Amplifier is completely transistorized, and is designed for use as a line or isolation amplifier in broadcasting and recording applications. Special techniques have been employed to obtain low noise, low distortion, and good temperature stability.

The amplifier is used with the M6031 Mounting Tray which carries a mating receptacle and is supplied with mounting hardware. Up to seven trays may be installed on the M6029 Shelf Assembly, which mounts in a standard Gates rack cabinet, and occupies 3-1/2" of panel space. A keying pin is pro-

vided with the mounting tray to prevent accidental interchange of non-similar plug-in units in the system.

On the front panel of the A and B models is located the interstage level control. The output transformer and receptacle are attached to the frame, and all other components are mounted on the printed wiring boards.

Typical frequency response and distortion curves are shown in Fig. 2. These measurements were taken with all transistors selected at random.

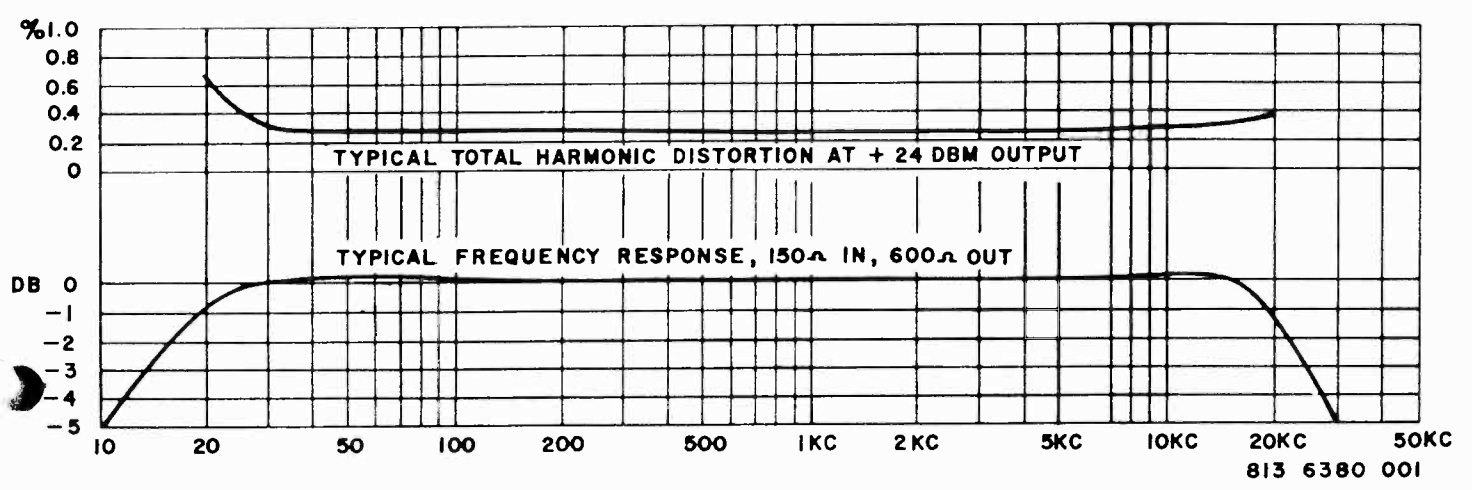

Fig. 2 - Response and Distortion

813 6380 001

INSTALLATION

MOUNTING TRAY AND SHELF ASSEMBLY

Mounting holes have been spaced in the shelf assembly to allow it to be completely filled with trays of any one type for the Gates transistorized units. It is possible, where maximum use of shelf space is not required, to mix trays of different sizes. Thus a program amplifier and preamplifier could be placed at the left and a power supply at the extreme right. Proceed as follows:

1. Locate the first tray at the extreme left or right of the shelf assembly, with the receptacle at the rear. The countersunk holes of the tray will fit into the matching holes in the shelf, when properly located. Leave a 1/16" space between trays.
2. Secure the tray to the shelf with the two #4-40 x 1/4" flat head screws with the two #6 internal-external shakeproof washers under two #4 hex nuts.

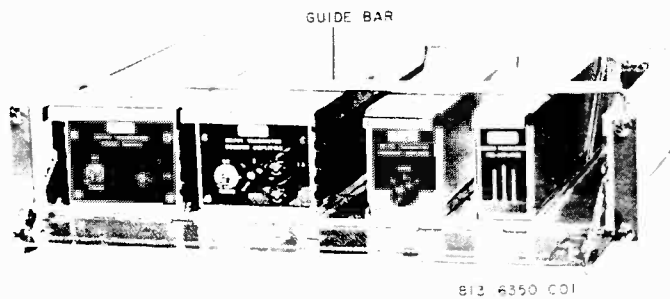

Fig. 3 - Shelf Assembly With Guide Bar

3. Determine whether or not the guide bar, shown in Fig. 3, will be required. The purpose of this bar is to prevent possible damage to the mating connectors when upward pressure is inadvertently applied to the amplifier during withdrawal. The bar will be required only where no other protecting obstruction is present in the rack, or where the shelf is used at a location such as a work bench.

It will not be required where another M6029 Shelf Assembly is mounted directly above,

or where overhead equipment interferes with mounting of the shelf due to the presence of the bar. The mounting screws are located so that they may be removed from within the shelf.

4. Mount the shelf in the rack using hardware supplied with the rack. The two end strips mount under the screw heads, and are to be flush with the drop panel.

INPUT AND OUTPUT TRANSFORMERS

The input transformer is factory connected for 150 ohms primary impedance, as shown on the schematic diagram and on Fig. 4. Refer to Fig. 4 for connections for 600 ohms impedance. Note that the input terminating resistor, R31, must be changed to 620 ohms when making this change.

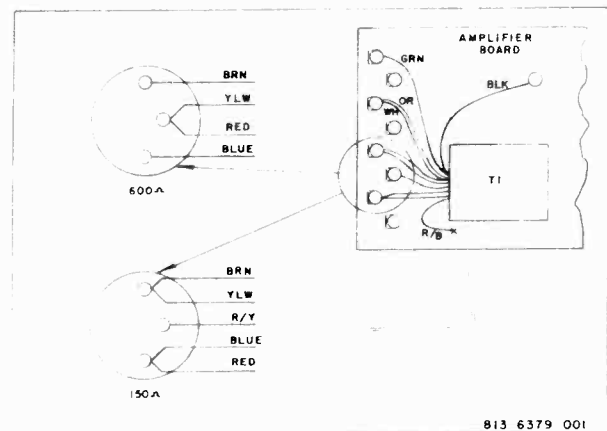

Fig. 4 - Input Transformer Connections

Where it is desired to use the M5700A Program Amplifier with an unterminated input remove R31, which is a 150 ohm resistor connected directly between the input lugs on the preamplifier printed board. Also change R1 from 620 ohms to 240 ohms. Location of these resistors may be determined from the component location drawing, Fig. 6.

Both the M5700 and M5700B models have these changes incorporated.

The output transformer is factory connected

for 600 ohms secondary impedance. To re-connect for 150 ohms refer to the schematic diagram. Remove the green/white and black wires from terminal #7. Connect the black wire to terminal #5 and the green/white wire to terminal #6.

EXTERNAL CONNECTIONS

External connections are made to the mounting tray receptacle as follows:

| <u>Circuit</u> | <u>Terminals</u> |
|---------------------------------------|------------------|
| External Control (Optional) +30 V. | 1, 2, 3 4 |
| Circuit Ground | 4 |
| Output Connections | 5, 6 |
| Output Center-Tap (600 ohms) | 7 |
| Input Connections | 9, 10 |
| Input Center-Tap -30 V. | 11 12 |
| Chassis Ground | 13 |
| No Connection | 8, 14, 15, 16 |

Jumper together all #13 terminals on the shelf, whether program amplifiers or other types, and connect to the rack ground bus. Connection from rack ground to the circuit ground in the program amplifier (B+) should be made at the amplifier (not at the power supply). Make a connection from the rack ground bus to each amplifier terminal #14, SEPARATELY, with at least 18 gauge wire. These circuit grounds must be carried separately to prevent the possibility of interac-

tion (due to mixing of return currents in a common wire). Where other types of amplifiers are mounted on the same shelf, consult their respective Instruction Book for grounding information. Where many amplifiers and power supplies are mounted in a rack, it is preferable to run a vertical rack ground bus-bar, to pick up grounds at each shelf.

Run the D. C. supply leads, output pair, and chassis and circuit ground leads along the rear edge of the shelf. The D.C. supply leads should be at least 18 gauge, and must be run SEPARATELY from each program amplifier to its respective power supply, to prevent the possibility of common coupling in the power wiring. See the power supply Instruction Book for further information.

Run input pairs and external control leads along the shelf brace, above the receptacles.

EXTERNAL VOLUME CONTROL

Reference to the schematic diagram will indicate that the program amplifier is wired to accommodate an external volume control. This feature makes it possible to locate the volume control on an adjacent rack panel, or on a console control panel, when the amplifier is mounted internally. The internal control, R30, must be disconnected when the amplifier is to be used in this way. The (R30) control may be ordered as part number 550 0218 000.

THEORY OF OPERATION

For the purpose of explanation, the program amplifier can be considered to be made up of two parts: the preamplifier, and the high level amplifier.

THE PREAMPLIFIER

The four stage preamplifier has a transformer coupled input and emitter follower output, with direct coupling utilized between Q1 and Q2, and between Q3 and Q4. The first stage transistor is a low noise type de-

signed for use in critical low noise applications.

Biasing is accomplished by a combination of voltage divider and emitter resistance, as with R2, R3, and R5. This method of biasing also insures a high degree of temperature stability. Signal degeneration is provided for Q1 by R6, and for Q3 by R17. A loop feedback network connects from Q3, thru R7 and C5, to Q1. The large amount of feedback and degeneration obtained by these

T1 PRIMARY

| W/P | C T | JOIN | CONNECT TO | R31 |
|-------|-----|------|------------|-------|
| 600 Ω | YEL | RED | BLUE & BRN | 620 Ω |
| 15 Ω | BLK | YEL | BLUE & BRN | 150 Ω |

T2 SECONDARY

| W/P | C T | JOIN | CONNECT TO |
|-------|-----|------|------------|
| 600 Ω | GRN | BLK | GRN & YELW |
| 15 Ω | — | GRN | GRN & YELW |

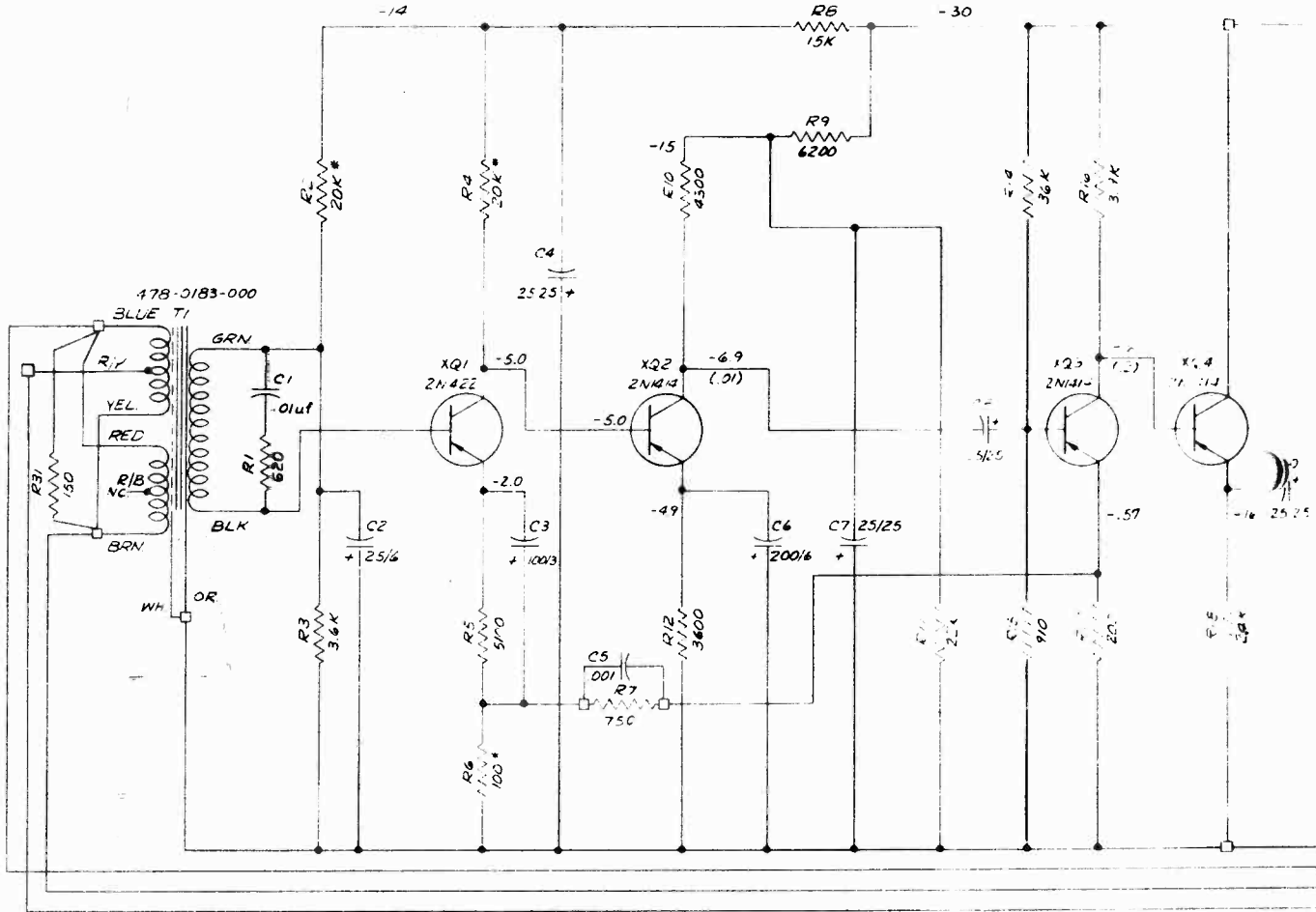

(1) D.C. VOLTAGES MEASURED WITH
 (2) 1 μS SIGNAL VOLTAGE AT
 (3) ALL RESISTORS 1/2 WATT 5%
 (4) ALL CAPACITORS IN MFD. 5%
 (5) DESIGNATES BOARD LUG C
 (6) FOR MS700B MODEL DELETE

Fig. 6 - Schema

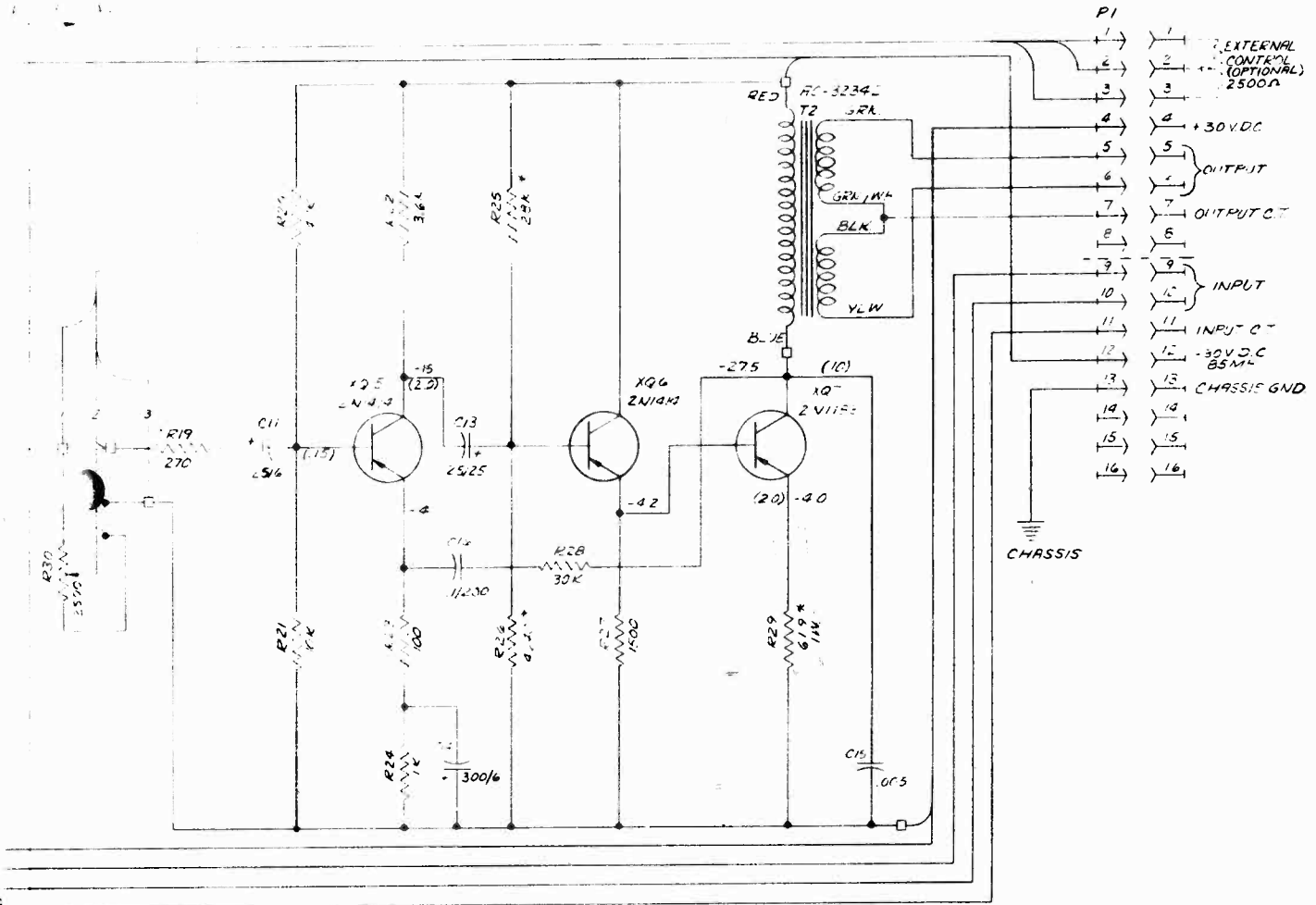

WITH 20K Ω /VOLT METER
 AT 1KΩ, -5% DMM IN, +24.015M OUT
 1% EXCEPT 1% AND WHERE NOTED.
 WITH 0.1WV
 CONNECTION.
 NOTE R31

methods reduces distortion in the preamplifier to an extremely low value, and makes the operation almost completely independent of variations in transistor parameters.

THE HIGH LEVEL AMPLIFIER

The output stage, Q7, is connected in the common emitter configuration, with a series fed output transformer, T2, in the collector circuit. Emitter resistor R29 provides a large amount of degeneration, to reduce

large-signal distortion to a low value.

The low driving impedance required by a stage of this type is obtained from the emitter follower, Q6. The stages are direct coupled, with R25 and R26 establishing the bias on both Q6 and Q7. Q5 provides additional gain for the high level amplifier.

The feedback network, R28 and C16, is used primarily for low frequency response compensation.

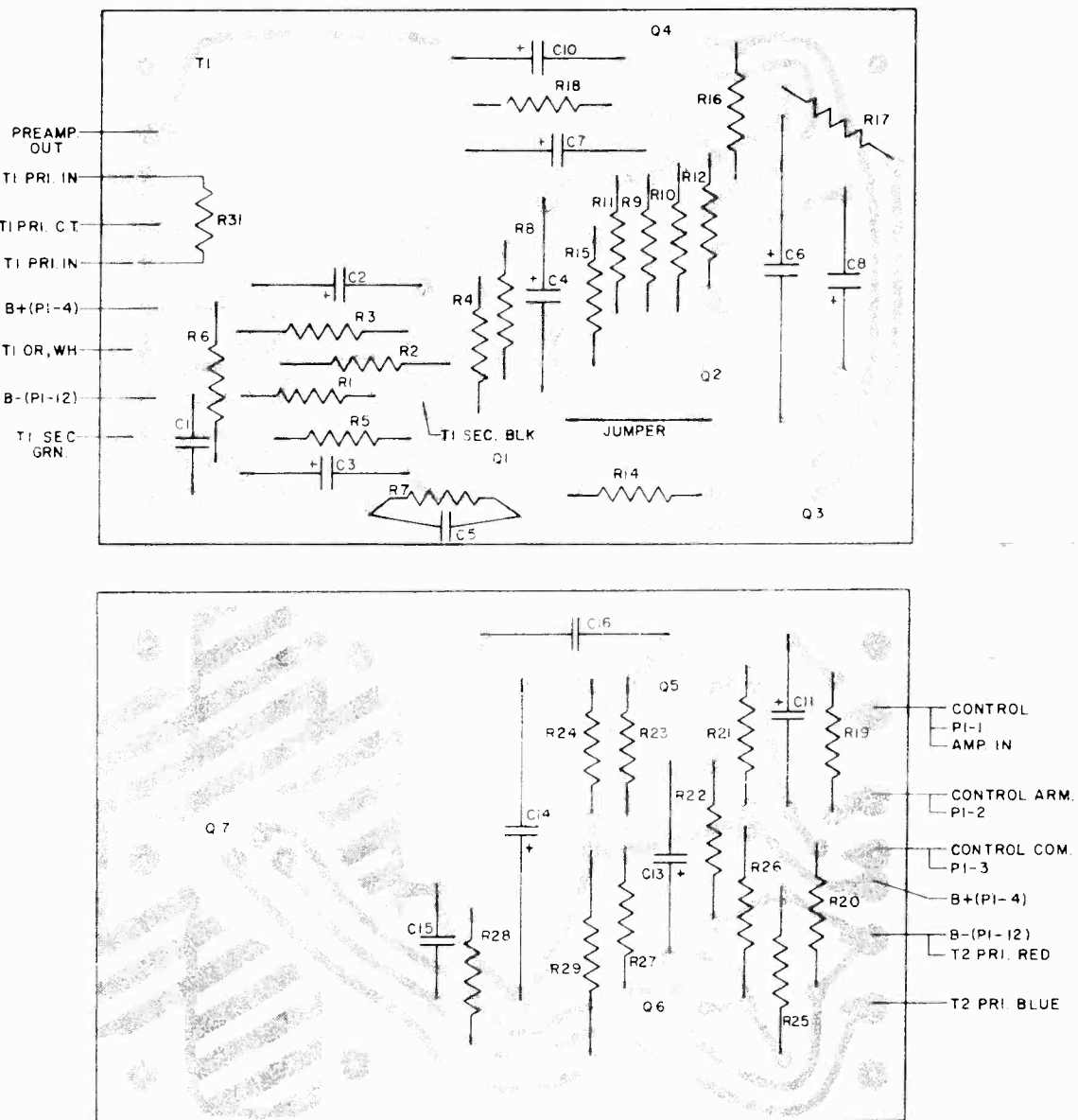

Fig. 6 - Printed Board Component Location, Viewed from Wiring Side.

MAINTENANCE

PREVENTIVE MAINTENANCE

The M5700 Program Amplifier is designed for long, trouble-free service. However, as with all high quality electronic equipment, a regular program of inspection should be followed.

It is recommended that when the amplifier is first placed in operation, D.C. voltage be measured with the same voltmeter that will be used for maintenance and trouble shooting, and that these readings be recorded on the amplifier schematic above the typical voltage shown.

Dust and dirt should be periodically removed with a soft brush.

SERVICING

When servicing the amplifier, the following points should be observed:

1. The condition of the output stages, Q7

and Q6, can be most readily checked by measuring the D. C. voltages associated with these stages.

2. Circuit resistances should be measured only after removing the associated transistor or transistors, to prevent damage due to ohm-meter battery voltage.

3. Do not remove or insert transistors with the power on.

4. Do not probe the printed board with a metal probe with the power on.

5. Circuit voltages are reversed from standard vacuum tube practice, as is the polarity of all the electrolytic capacitors.

6. The location of the positive end of each electrolytic capacitor is indicated by the white dot marked on the top of the circuit board.

PRINTED CHASSIS COMPONENT REPLACEMENT

CHECKING COMPONENTS

1. The components should be carefully checked by measuring circuit voltages and resistances before attempting to remove one of the leads from the printed chassis. Extreme care must be exercised in removing the lead to prevent damage to the board or conductors. This operation should not be considered unless it is the only way the component can be checked. If one lead must be removed without damage to the component, apply a well cleaned and tinned 25 to 60 watt iron to the fillet adjacent to the lead. With small long nose pliers or thin screwdriver, pry the folded portion of the lead in line with the holes. Applying the iron for more than four seconds at a time may damage the chassis base material.

possible. Remove all the kinks in the wire. With heat applied, gently pull the wire through the hole.

RESOLDERING THE COMPONENT

2. If the component is good, replace as follows: Use a metal twist drill (1/8" dia. or less) to clear the hole only in the fillet of solder. Turn with the fingers only remove solder slowly to prevent the drill from tearing the fillet.

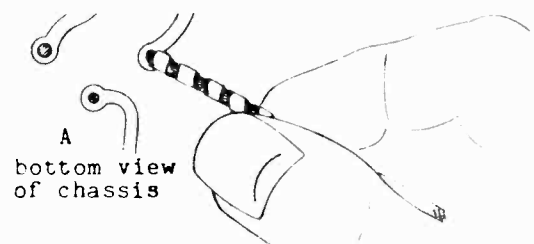

Fig. 7 - Cleaning Holes

Remove as much solder from the lead as

Be sure the component lead is straight and free of solder. Push it gently back through the hole until some of it shows on the other side. Solder carefully but rapidly to prevent chassis damage.

REPLACING COMPONENTS

3. Components can be replaced with less chance of damage to the chassis than the removal and rewiring of one of the leads. Remove as follows: Clip the leads close to the body of the component. Heat the fillet and gently push the wire through until the hook may be clipped off. Clip the hook off (on the soldered side) with sharp cutters.

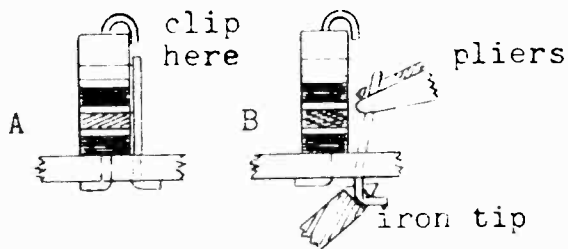

Fig. 9 - Removing Components

With the iron applied to the fillet, pull the wire gently out of the component side of the chassis:

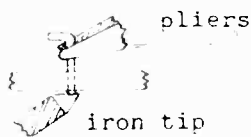

Fig. 8 - Removing Lead

After removing the leads, prepare the chassis for the new component as explained in Fig. 7, paragraph 2.

To replace the component, fold the leads on the new part to the same spacing as the mounting holes. Insert the part and fold the

leads under the chassis to hold the component firmly against it.



Fig. 10 - Installing New Component

Clip off the excess wire. Place the iron on both the component lead and fillet. Solder carefully and rapidly to prevent damage to the chassis base. If one of the conductors is damaged, it is seldom necessary to scrap the printed chassis. Lay a small piece of wire (#18 to 24 ga.) across the break and solder each end to the conductor.

If a fillet is pulled loose, break it off to get rid of the loose end. Fold the new component lead to lay on the conductor and solder. If the component lead is too short, solder in another piece of wire to bridge the gap. Printed chassis construction places no strain on repairs of this nature, thus, soldering alone will provide sufficient mechanical strength even with heavy shock and vibration in almost every case.

The base material used on the printed chassis is the best available for this service. The two oz. copper is twice as heavy as used in average applications of this type of equipment. This assures reliable service and repair, if and when required. If replacement parts are ordered from the Gates Radio Company, please list the Gates stock number given in the parts list, as well as the description of the part. This will assure receipt of the right part immediately.

PARTS LIST

| <u>Symbol No.</u> | <u>Gates Stock No.</u> | <u>Description</u> |
|-------------------|------------------------|--------------------------|
| C1 | 508 0215 000 | Cap., .01 uf., 100 V. |
| C2, C11 | 522 0178 000 | Cap., 25 uf., 6 V. D.C. |
| C3 | 522 0160 000 | Cap., 100 uf., 3 V. D.C. |

| <u>Symbol No.</u> | <u>Gates Stock No.</u> | <u>Description</u> |
|-------------------|------------------------|----------------------------|
| C4, C7, C8 | | |
| C10, C13 | 522 0242 000 | Cap., 25 uf., 25 V. D.C. |
| C5 | 516 0054 000 | Cap., .001 uf., 1 KV |
| C6 | 522 0187 000 | Cap., 200 uf., 6 V. D.C. |
| C14 | 522 0189 000 | Cap., 300 uf., 6 V. D.C. |
| C15 | 508 0076 000 | Cap., .005 uf., 100 V. |
| C16 | 506 0005 000 | Cap., .1 uf., 200 V. D.C. |
| P1 | 610 0244 000 | Plug |
| Q1 | 380 0004 000 | Transistor, 2N422 |
| Q2, Q3, Q4, | | |
| Q5, Q6 | 380 0014 000 | Transistor, 2N1414 |
| Q7 | 380 0012 000 | Transistor, 2N1183 |
| R1 | 540 0034 000 | Res., 240 ohm, 1/2 W., 5% |
| R2, R4 | 548 0050 000 | Res., 20K ohm, 1/2 W., 1% |
| R3, R12, R22 | 540 0062 000 | Res., 3600 ohm, 1/2 W., 5% |
| R5 | 540 0066 000 | Res., 5100 ohm, 1/2 W., 5% |
| R6 | 548 0049 000 | Res., 100 ohm, 1/2 W., 1% |
| R7 | 540 0046 000 | Res., 750 ohm, 1/2 W., 5% |
| R8 | 540 0077 000 | Res., 15K ohm, 1/2 W., 5% |
| R9 | 540 0068 000 | Res., 6200 ohm, 1/2 W., 5% |
| R10 | 540 0064 000 | Res., 4300 ohm, 1/2 W., 5% |
| R11 | 540 0081 000 | Res., 22K ohm, 1/2 W., 5% |
| R14 | 540 0086 000 | Res., 36K ohm, 1/2 W., 5% |
| R15 | 540 0048 000 | Res., 910 ohm, 1/2 W., 5% |
| R16 | 540 0063 000 | Res., 3900 ohm, 1/2 W., 5% |
| R17 | 540 0032 000 | Res., 200 ohm, 1/2 W., 5% |
| R18 | 540 0058 000 | Res., 2400 ohm, 1/2 W., 5% |
| R19 | 540 0035 000 | Res., 270 ohm, 1/2 W., 5% |
| R20 | 540 0089 000 | Res., 47K ohm, 1/2 W., 5% |
| R21 | 540 0073 000 | Res., 10K ohm, 1/2 W., 5% |
| R23 | 540 0025 000 | Res., 100 ohm, 1/2 W., 5% |
| R24 | 540 0049 000 | Res., 1000 ohm, 1/2 W., 5% |
| R25 | 548 0094 000 | Res., 28K ohm, 1/2 W., 1% |
| R26 | 548 0095 000 | Res., 4640 ohm, 1/2 W., 1% |
| R27 | 540 0053 000 | Res., 1500 ohm, 1/2 W., 5% |
| R28 | 540 0084 000 | Res., 30K ohm, 1/2 W., 5% |
| R29 | 548 0093 000 | Res., 61.9 ohm, 1 W., 1% |
| R30 (M5700A,B) | 550 0218 000 | Potentiometer, 2500 ohm |
| R31 (M5700A) | 540 0029 000 | Res., 150 ohm, 1/2 W., 5% |
| T1 | 478 0183 000 | Transformer, Input |
| T2 | 478 0125 000 | Transformer, Output |
| XQ1, XQ2, XQ3, | | |
| XQ4, XQ5, XQ6 | 404 0066 000 | Socket |
| XQ7 | 404 0149 000 | Socket |

MODIFICATION OF THE GATES'

M-6108 TRANSISTOR MONITOR AMPLIFIER

FOR CURRENT LIMITING.

If the output of the M-6108 Monitor Amplifier should be accidentally shorted, or if oscillation in the amplifier should develop, excess current flow through the output stage could damage the 2N1539 output transistors or the emitter resistors in this stage.

A current limiting device has been incorporated in the amplifier to limit the output stage current under such conditions to a safe level, thus preventing damage to the amplifier. This device in no way affects the normal operation of the amplifier.

Refer to drawing 813 6261 001, the schematic of the monitor amplifier and drawing 813 7719 001, the schematic of the current limiter for a better understanding of the operation of this circuit. Transistors XQ9 and XQ10 are connected as a direct coupled amplifier and act to amplify the voltage drop across R17, the emitter resistance for XQ8, one of the output transistors. When the voltage drop across this resistor exceeds a certain predetermined level, (due to excess current flow in the output stage) XQ11 becomes saturated since its base is direct coupled to the collector of XQ10 of the voltage sensing amplifier. The collector of XQ11 is connected to the collector of XQ2. When XQ11 reaches saturation, the effective impedance between collector and emitter becomes very low. Therefore, the collector of XQ2 is effectively grounded through R26. This action pulls the center bus of the single-ended push-pull output stage down, limiting the output stage current to a safe value.

It should be remembered that a full 8 watts of program material can be handled safely by the amplifier. If this limit is exceeded, program peaks will cause the amplifier to go into current limiting as explained above. This is not a fault of the amplifier but simply a result of the current limiting device performing properly.

6/28/62

-1-

Modifications of
M-6108 Monitor
Amplifier

LIST OF PARTS

| 104 | 103 | 102 | 101 | GR. FIRST MADE FOR NO. | REFERENCE | PT. OR G.N. | FIN. | DESCRIPTION | MATL. |
|-----|-----|-----|-----|------------------------|-----------|-------------|------|-------------|-------|
|-----|-----|-----|-----|------------------------|-----------|-------------|------|-------------|-------|

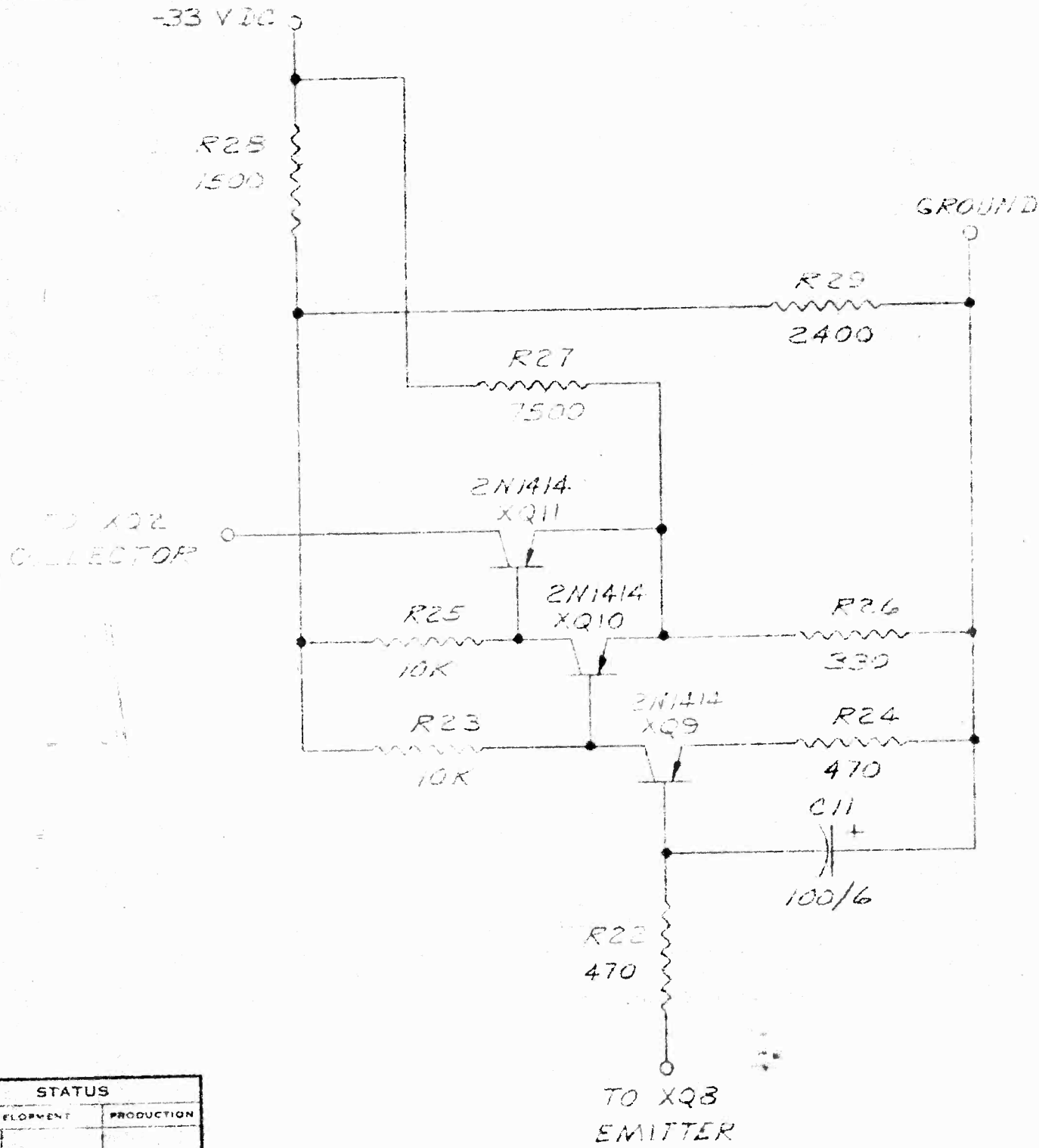

| STATUS | |
|------------------|------------|
| DEVELOPMENT | PRODUCTION |
| MECH. CHK. | |
| PROD. ENG. | |
| PROV. SECTION NY | |

| | | |
|--------|--------|------|
| CH. BY | MTL | |
| DATE | 6-2-60 | |
| DR. BY | ENG | FIN. |
| DATE | 6-2-60 | |

TITLE SCHEMATIC - CURRENT LIMITER
TRANSISTOR MONITOR AMP
M-6108

UNLESS OTHERWISE SPECIFIED,
ALL TOLERANCES PER GATES
SPEC 63M102.

813-7719-001

**M6108 TRANSISTOR
MONITOR AMPLIFIER**

INSTRUCTION BOOK



GATES RADIO COMPANY

A Subsidiary of Harris-Intertype Corporation

QUINCY, ILLINOIS

TECHNICAL DATA

Gain:

53 db (matching 600 ohm).
39 db min. (bridging 6,000 ohm)

Frequency Response:

+ 1.0 db from 20 to 20,000 cps
@ normal output level.

Harmonic Distortion:

Under 1.0% from 30 to 15,000 cps
@ + 38 dbm output (6 watts).
Under 1.0% from 50 to 15,000 cps
@ + 39 dbm output (8 watts).

Intermodulation Distortion:

Under 1.0% at + 38 dbm equivalent
sine wave power output, using 40
and 7000 cps mixed 4:1.

Noise Level:

- 85 db below rated output level
(+ 39 dbm).

Source Impedances:

600 ohms for 600 ohms matching input.
150/600 for 6000 to 10,000 ohm
bridging input.

Input Impedances:

600 ohms matching input, balanced
(transformer input).
6,000 ohms, bridging input, balanced
(bridging pad and transformer input).

Load Impedances:

4 to 16 ohms (8 ohms nominal), un-
balanced (transformerless output,
isolated from AC ground by power
transformer).

Output Impedance:

1.2 ohms, approximately.

Maximum Input Level:

0 dbm.

Maximum Output Level:

+ 39 into 8 ohms (8 watts).

Maximum Operating Ambient Temperature:

55° C. (131° F.)

Maximum Storage Ambient Temperature:

85° C. (185° F.)

Power Requirements:

117 Volts at 50/60 cps., 18 watts.

Transistors:

| | |
|------------|------------|
| 2 - 2N1414 | 1 - 2N1225 |
| 1 - 2N214 | 2 - 2N1539 |
| 2 - 2N1183 | |

Rectifiers:

4 - X5A2 (silicon)

Finish:

Light grey cover, flat black heat
sink chassis.

Mounting:

Two keyhole slots, rubber bumpers on
bottom, permanent or movable mounting
in any position.

Size:

3-1/4" high, 4-5/8" deep, 8-1/2" long.

Weight:

4 lbs., net. 7 lbs., packed.

Cubage:

0.9 cu. ft., domestic pack.

DESCRIPTION

The M6108 Monitor Amplifier is a trans-
istorized, self-contained amplifier de-
signed for use in broadcasting, record-
ing, and general sound reinforcement
applications. Special techniques have
been employed to obtain reliability,

low distortion, and good temperature sta-
bility. The amplifier can be mounted in
any position and does not require ventil-
ation when handling 8 watts of program
material. The input, power, output con-
nections, fuse and input level control
are mounted on end panels of the chassis.

INSTALLATION

MOUNTING

The amplifier has been provided with two keyhole slots for #8 screws for fixed or permanent mounting.

INPUT CONNECTIONS

Provisions are made for changing from 600 ohm matching to 6,000 ohm bridging on the input terminal strip. Fig. 1 shows the connection for 600 ohms. Fig. 2 shows the connection for 6,000 ohm bridging.

In the event that a preamplifier driver is used requiring a minimum load of 10,000 ohms, a 2200 ohm resistor may be added at each bridging input terminal. With this change, 1.5 volts input will be required for full output.

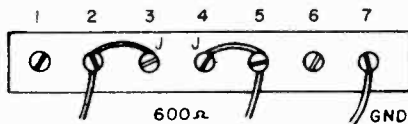

Fig. 1

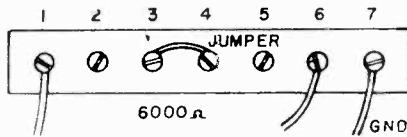

Fig. 2

OUTPUT CONNECTIONS

Output connections are made to the two lug terminal strip on the end plate of the chassis. Groups of speakers may be driven with this amplifier; connected in series, parallel, or series parallel; but the combined impedance should not be less than 4 ohms. With an impedance of more than 12 ohms, the amplifier will not be able to deliver full output power. Speaker matching transformers permit the paralleling of a number of speakers, depending on the unit required. Gates Part No. 813 0601 001 transformer is available, having a primary of 48 ohms and a secondary of 8 ohms for matching purposes.

In wiring speaker loads it should be remembered that 8 watts at 8 ohms represents 1 ampere of audio current. The recommended use of No. 16 gauge twisted and shielded wire will prevent power losses and possible interaction of circuits.

AMPLIFIER PARALLELING

It is not recommended that amplifiers of this type be paralleled at their outputs to obtain higher power. Where more power is required than can be supplied by one amplifier, the speaker load should be divided between several amplifiers which have their inputs bridged across the common signal source.

POWER CONNECTIONS

117 volts A.C., 50/60 cycles is supplied thru the power cord and power plug on the chassis end plate. A power switch is not required due to the low power consumption and heat dissipation.

NOTE

While the amplifier can handle a continuous 8 watts of program material, CAUTION should be exercised during full power sine wave testing to avoid exceeding the thermal capabilities of the chassis heat sink. During these tests it is recommended that a duty cycle of 30 seconds on to 3 minutes off be used to allow heat build-up to dissipate.

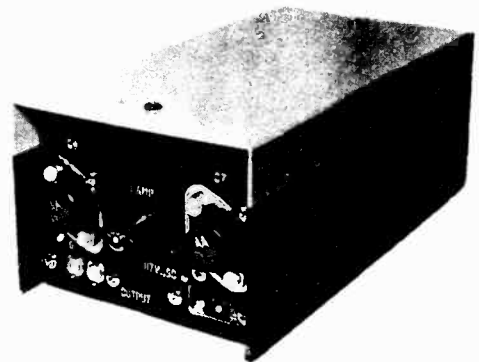

MG109 MONITOR AMPLIFIER

THEORY OF OPERATION

The amplifier is driven by an input transformer which provides for isolation and matching functions in the primary by means of split windings and resistive pads. The input level control provides a constant load to the input transformer secondary while furnishing a gain control function. Transistor Q1 operates as an emitter follower and provides impedance matching from the input to the voltage amplifier, Q2. Note that Q2 is the only stage which has voltage gain. A high frequency transistor is used at this point to improve stability. The output stages of the amplifier operate Class B, and are arranged in the circuit configuration known as "single ended push-pull" or a "followed emitter follower". The upper and lower units are in series across the power supply, and the load is connected at their junction. When the signal at the collector of Q2 goes negative; Q3, Q5, and Q7 conduct; since they are all PNP types. When the

signal goes positive; Q4, Q6, and Q8 all conduct; since Q4 is an NPN type. Thus, the full signal appears at the junction point. Q3, Q5, Q7, and Q6, Q8 are connected in a compound or "Darlington" configuration, a connection which provides extremely high current gain, and improves linearity at high signal levels. General feedback loops are employed in the amplifier including R3, R19, C2, C4, and C5. C2 and C4 provide high frequency feedback while C5 supplies positive feedback from the output to the collector circuit of Q2 to increase the signal handling capacity of this stage.

Thermistor R4 compensates for variations in the amplifier bias due to temperature changes. Choke L1 renders the amplifier insensitive to changes in capacity across the output leads. The power supply is a conventional full wave bridge rectifier with filter capacitor circuit.

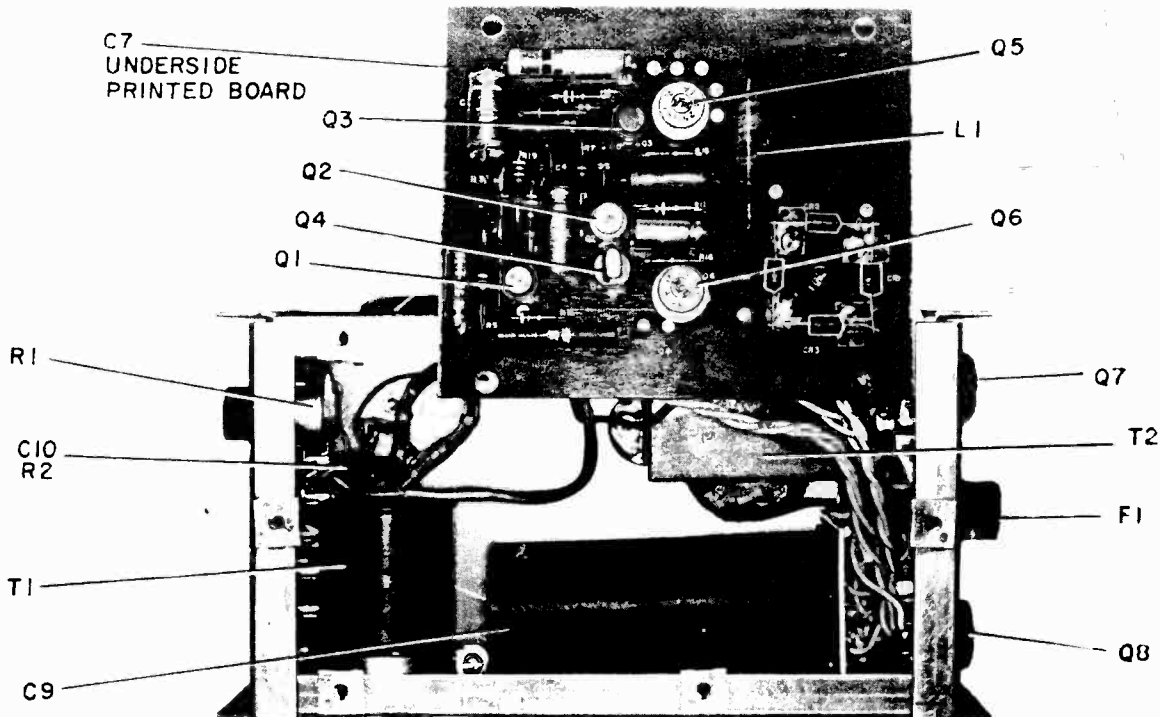

PARTS LOCATION
M6108 TRANSISTOR
MONITOR AMPLIFIER

T1 PRIMARY CONNECTIONS

| PRI. IMP. | JUMPER | CONNECT TO |
|-----------|---------------|------------|
| 600 Ω | 2 TO 3 4 TO 5 | 2 5 |
| 6000 Ω | 3 TO 4 | 1 6 |

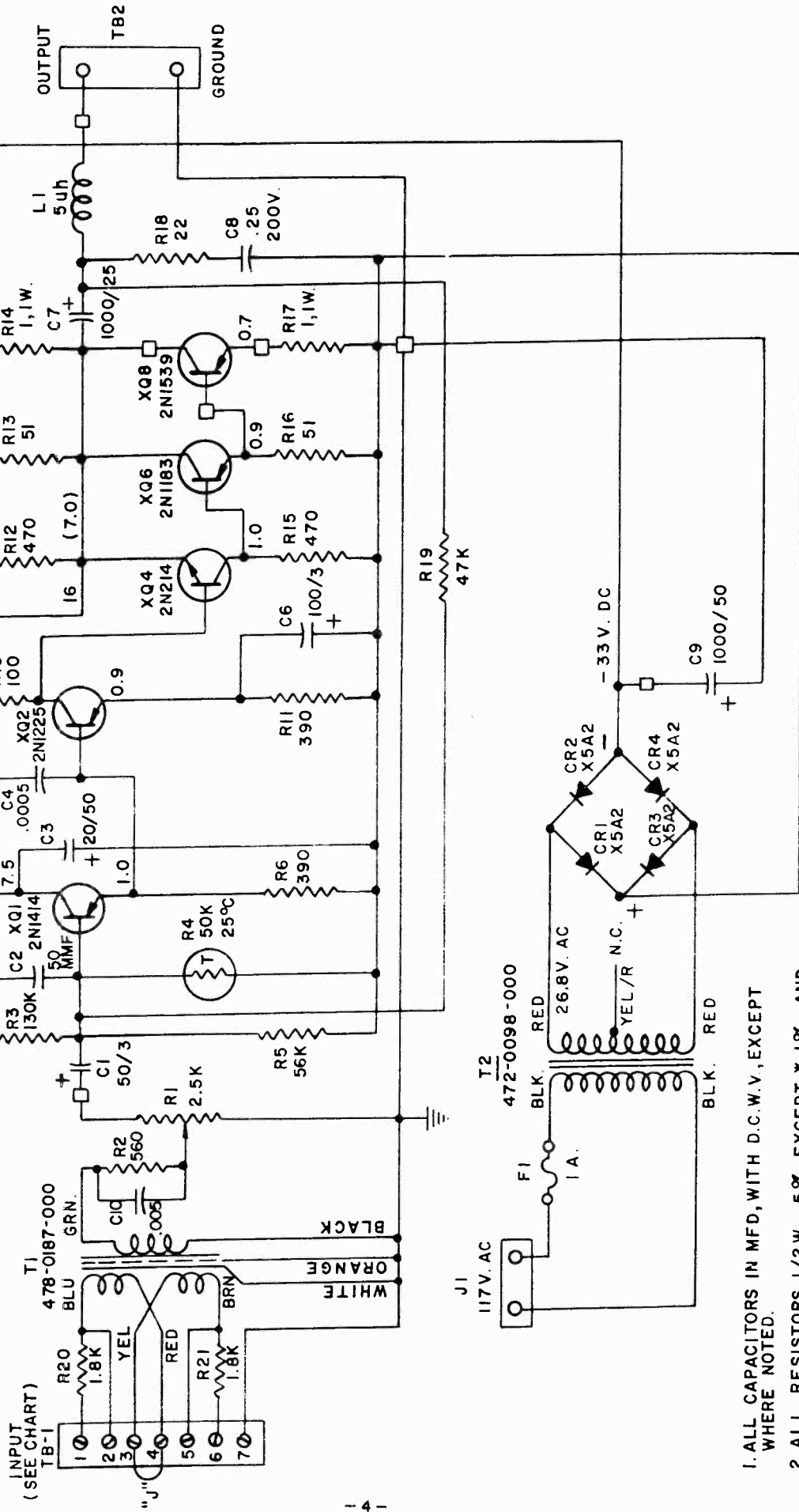

SCHMATIC
M6108 TRANSISTOR
MONITOR AMPLIFIER
6-19-61 813 6261 001

1. ALL CAPACITORS IN MFD, WITH D.C.W.V., EXCEPT WHERE NOTED.
2. ALL RESISTORS 1/2W., 5% EXCEPT * 1%, AND WHERE NOTED.
3. □ DESIGNATES BOARD LUG CONNECTIONS.
4. D.C. VOLTAGES MEASURED AGAINST B+, WITH 20KΩ VOLT METER, AT +38 DBM OUTPUT.
5. () R.M.S. SIGNAL VOLTAGES AT 1KC, -15 DBM INPUT, (600Ω) + 38DBM OUTPUT.

MAINTENANCE

PREVENTIVE MAINTENANCE

The M6108 Monitor Amplifier is designed for long, trouble-free service. However, as with all high quality electronic equipment, a regular program of inspection should be followed. These points should be covered:

1. Check the power amplifier supply voltage at the collector of Q5 or Q7. On the power transistors, such as the 2N1183 and 2N1539, the collector is connected to the case.
2. Check the speaker bus voltage, which appears at the collectors, or cases of Q6 and Q8.
3. Remove dust which collects on the printed board or in the housing, with a soft brush.

It is recommended that when the amplifier is first placed in operation, that D.C. voltages be measured with the same voltmeter that will be used for maintenance and troubleshooting, and that these readings be recorded on the amplifier schematic. The speaker bus and B- voltages should be recorded with an without signal.

SERVICING

When servicing the amplifier, the following points should be observed:

1. The condition of the power supply can be most readily checked by measuring

the D.C. voltage between the chassis and the case of output transistor Q8. (One of the two power transistors mounted on the end of the chassis). This voltage will be much higher or lower than normal if trouble is present in the power amplifier.

2. Voltages may be checked with Q5, Q6, Q7 and Q8 removed, provided that the speaker load is disconnected.
3. Circuit resistances should be measured only after removing the associated transistor or transistors, to prevent damage due to ohm-meter battery voltage.
4. Do not remove or insert transistors with the power on.
5. Do not probe the printed board with a metal probe with the power on.
6. Circuit voltages are reversed from standard vacuum tube practice, as is the polarity of all electrolytic capacitors.
7. The location of the positive end of each electrolytic capacitor is indicated by the white dot marked on top of the circuit board.
8. When replacing either Q7 or Q8, and before turning on the power, check with an ohm-meter between transistor case and chassis to make certain that a short circuit does not exist. Note that insulating washers are placed under the transistors to provide insulation.

PRINTED CHASSIS COMPONENT REPLACEMENT

1. CHECKING COMPONENTS

The components should be carefully checked by measuring circuit voltages and resistances before attempting to remove one of the leads from the printed chassis. Extreme care must be exercised in removing the lead to prevent damage to the board or conductors. This operation

should not be considered unless it is the only way the component can be checked.

If one lead must be removed without damage to the component, apply a well cleaned and tinned 25 to 60 watt iron to the fillet adjacent to the lead. With small long nose pliers or thin screwdriver, pry the folded portion of the lead in line

with the hole. Applying the iron for more than four seconds at a time may damage the chassis base material.

Remove as much solder from the lead as possible. Remove all the kinks in the wire. With heat applied, gently pull the wire through the hole.

2. RESOLDERING THE COMPONENT LEAD

If the component is good, replace as follows: Use a metal twist drill (1/8" dia. or less) to clear the hole only in the fillet of solder. Turn with the fingers only. Remove solder slowly to prevent the drill from tearing the fillet.

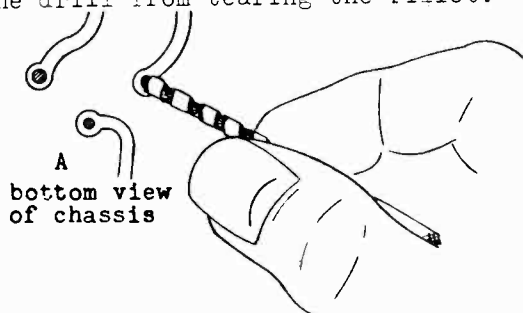

Fig. 3 - Cleaning Holes

With the iron applied to the fillet, pull the wire gently out of the component side of the chassis:

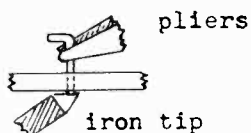

Fig. 4 - Removing Lead

Be sure the component lead is straight and free of solder. Push it gently back thru the hole until some of it shows on the other side. Solder carefully but rapidly to prevent chassis damage.

3. REPLACING COMPONENTS

Components can be replaced with less chance of damage to the chassis than the removal and rewiring of one of the leads. Remove as follows: Clip the leads close to the body of the component. Heat the fillet and gently push the wire thru until the hook may be clipped off. Clip the hook off (on the soldered side) with

sharp cutters.

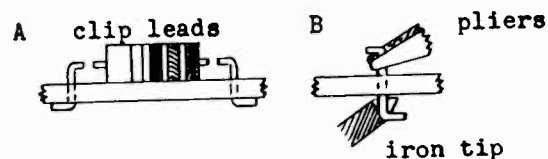

Fig. 5 - Removing Components

After removing the leads, prepare the chassis for the new component as explained in paragraph 2 and Fig. 3.

To replace the component, fold the leads on the new part to the same spacing as the mounting holes. Insert the part and fold the leads under the chassis to hold the component firmly against it:



Fig. 6 - Installing New Component

Clip off the excess wire. Place the iron on both the component lead and fillet. Solder carefully and rapidly to prevent damage to the chassis base. If one of the conductors is damaged, it is seldom necessary to scrap the printed chassis. Lay a small piece of wire (#18 to 24 ga.) across the break and solder each end to the conductor.

If the fillet is pulled loose, break it off to get rid of the loose end. Fold the new component lead to lay on the conductor and solder. If the component lead is too short, solder in another piece of wire to bridge the gap. Printed chassis construction places no mechanical strain on repairs of this nature, thus, soldering alone will provide sufficient mechanical strength even with heavy shock and vibration in almost every case.

The base material used on the printed chassis is the best available for this service. The two ounce copper is twice as heavy as used in average applications of this type of equipment. This assures reliable service and repair.

PARTS LIST

| <u>Symbol No.</u> | <u>Gates Part No.</u> | <u>Description</u> |
|---------------------------|-----------------------|----------------------------------|
| C1 | 522 0158 000 | Cap., 50 ufd., 3 V. |
| C2 | 500 0818 000 | Cap., 50 uufd., 500 V. |
| C3 | 522 0256 000 | Cap., 20 ufd., 50 V. |
| C4 | 516 0045 000 | Cap., .0005 uf., 1 KV. \pm 10% |
| C5 | 522 0242 000 | Cap., 25 ufd., 25 V. |
| C6 | 522 0160 000 | Cap., 100 ufd., 3 V. |
| C7 | 522 0306 000 | Cap., 1000 ufd., 25 V. |
| C8 | 506 0006 000 | Cap., .25 ufd., 200 V. |
| C9 | 524 0100 000 | Cap., 1000 ufd., 50 V. |
| C10 | 508 0076 000 | Cap., .005 ufd., 100 V. |
| CR1, CR2, CR3, CR4 | 384 0062 000 | Silicon Rectifier |
| F1 | 398 0054 000 | Fuse, 1 amp., 250 V. |
| J1 | 250 0025 000 | Receptacle and A.C. Line Cord |
| L1 | 494 0135 000 | Choke, RF, 5 uh. |
| Q1, Q3 | 380 0014 000 | Transistor, 2N1414 |
| Q2 | 380 0013 000 | Transistor, 2N1225 |
| Q4 | 380 0011 000 | Transistor, 2N214 |
| Q5, Q6 | 380 0012 000 | Transistor, 2N1183 |
| Q7, Q8 | 380 0016 000 | Transistor, 2N1539 |
| R1 | 550 0218 000 | Potentiometer, 2500 Ohm |
| R2 | 540 0043 000 | Res., 560 Ohm, 1/2 W., 5% |
| R3 | 540 0100 000 | Res., 130K ohm, 1/2 W., 5% |
| R4 | 559 0002 000 | Thermistor, 50K ohm |
| R5 | 540 0091 000 | Res., 56K Ohm, 1/2 W., 5% |
| R6 | 540 0039 000 | Res., 390 Ohm, 1/2 W., 5% |
| R7 | 540 0073 000 | Res., 10K Ohm, 1/2 W., 5% |
| R8 | 540 0049 000 | Res., 1K Ohm, 1/2 W., 5% |
| R9 | 540 0070 000 | Res., 7.5K Ohm, 1/2 W., 5% |
| R10 | 540 0025 000 | Res., 100 Ohm, 1/2 W., 5% |
| R11 | 540 0039 000 | Res., 390 Ohm, 1/2 W., 5% |
| R12, R15 | 540 0041 000 | Res., 470 Ohm, 1/2 W., 5% |
| R13, R16 | 540 0018 000 | Res., 51 Ohm, 1/2 W., 5% |
| R14, R17 | 542 0703 000 | Res., 1 Ohm, 1 W., 5% |
| R18 | 540 0009 000 | Res., 22 Ohm, 1/2 W., 5% |
| R19 | 540 0089 000 | Res., 47K Ohm, 1/2 W., 5% |
| R20, R21 | 540 0055 000 | Res., 1.8K Ohm, 1/2 W., 5% |
| T1 | 478 0187 000 | Transformer, Input |
| T2 | 472 0098 000 | Transformer, Power |
| TB1 | 614 0218 000 | Terminal Strip, 7 terminal |
| TB2 | 614 0213 000 | Terminal Strip, 2 terminal |
| XCR1, XCR2, XCR3, XCR4 | 402 0039 000 | Diode Board |
| XF1 | 402 0023 000 | Fuseholder |
| XQ1, XQ2, XQ3, XQ4 | 404 0066 000 | Socket |
| XQ7, XQ8 | 404 0136 000 | Socket |

INSTALLATION AND OPERATING INSTRUCTIONS
FOR
M-6034 TRANSISTOR PREAMPLIFIER

TECHNICAL DATA

GAIN: 45 DB \pm 1 DB operated into a 600 ohm load

FREQUENCY RESPONSE: \pm 1 DB, 30 cps to 15,000 cps.

HARMONIC DISTORTION: Under 0.5% from 50 cps to 15 KC at +5 DBM output.
Under 0.5% from 30 cps to 15 KC at -50 DBM output.

INTERMODULATION DISTORTION: Under 0.5% at -5 DBM output level, and under 1.0% at +5 DBM output level. Distortion measured at equivalent sine wave output using 40 cps and 7 KC mixed 4 to 1.

NOISE LEVEL: -122 DBM equivalent input noise.

SOURCE IMPEDANCE: 30/50 and 150/250 ohms.

INPUT IMPEDANCE: Input transformer unloaded, resulting in input impedance being substantially higher than source impedance.

OUTPUT LOAD IMPEDANCE: 600 ohms \pm 10%.

MAXIMUM INPUT LEVEL: -40 DBM.

MAXIMUM OUTPUT LEVEL: +5 DBM.

MAXIMUM OPERATING AMBIENT TEMPERATURE: 55° C. (131° F.)

MAXIMUM STORAGE AMBIENT TEMPERATURE: 85° C. (185° F.)

POWER REQUIREMENTS: -30 V. DC at 15 ma with less than .1 MV ripple.

TRANSISTORS: 1 - 2N422 3 - 2N1414

MOUNTING: Requires M-6039 mounting frame.

SIZE: 3-1/4" Wide X 6-3/8" Long X 1" Thick.

DESCRIPTION

The Gates M-6034 Transistor Preamplifier is a premium quality low noise unit for use in consoles, and is completely temperature compensated using the latest techniques. The amplifier has a gain of 45 DB with a maximum output in unbalanced and transformerless, which is designed to operate into a 600 ohm variable attenuator.

The input is balanced, and is connected for 150/250 ohm source impedance at the factory but may be reconnected for 30/50 ohms.

THEORY OF OPERATION

This amplifier is designed to provide a fixed gain of 45 DB. It is a four-stage amplifier and utilizes a transformerless output. It features negative feedback to reduce distortion to a very low level and minimizes specification changes with transistor changes.

Signal is applied to pins C and E and is fed through transformer, T1, to the base of Q1 (2N422). Q1 is a low noise transistor operated at ideal collector current for minimum noise. It will be noted that the first stage is series fed through T1 to provide the maximum input gain from T1. C1 and R1 are connected across the secondary of T1 to stabilize the amplifier. The value of R1 and C1 were picked to provide a roll off above the audio range to prevent amplification of very high frequency noise.

The signal is then direct coupled from the collector of Q1 to the base of Q2. Q2 is a very high gain stage because the emitter is completely by-passed. The signal is then coupled from the collector of Q2 (thru C8) to Q3. The collector of Q3 is direct coupled to the base of Q4. Q4 is an emitter follower. Emitter followers are very stable and are virtually distortionless. This also provides the low output impedance required to feed a 600 ohm fader. Feedback is applied from R17 through R13 and C9, R7 and C5 to the emitter resistor (R6) of the first stage. R13 and C9 provide a boost of 1 DB at 30 cps to make the response flat in the audio range.

MAINTENANCE

Transistor amplifiers are designed for a long trouble-free life, however, dust and dirt can cause trouble. A monthly dusting with a soft brush should be adequate.

SHOULD TROUBLE OCCUR -

- Step 1 - First check all DC voltages. The DC voltages determine the bias points of the transistors and any departure of 20% or more should be considered a defect. NOTE: Use of the resistance chart will help detect faulty components.
- Step 2 - Before any signal measurements are made, replace any defective parts to make DC voltages correct.
- Step 3 - After all DC voltages are correct, signal tests may be performed. The correct (RMS) voltages are shown on the schematic diagram. Voltages shown are for -40 DBM input @ 150 ohms not terminated.

DO NOT use an ohmmeter on the printed wiring with transistors in their sockets. Excessive current can flow to damage them.

DO NOT remove or insert transistors with the power ON.

REMEMBER - In transistor circuitry B+ is ground, therefore, capacitors have the positive side connected to ground.

DO NOT probe the printed board with the power ON with a metal screwdriver, etc., that could short out wiring.

RESISTANCE CHART

Resistance Chart taken with Q1, Q2, Q3, Q4 from sockets removed. Remove all transistors before making resistance check.

| Measure Resistance From | Q1 | | Q2 | | Q3 | | Q4 | |
|-------------------------|--------|-------|--------|-------|--------|-------|--------|-------|
| | To Gnd | To B- | To Gnd | To B- | To Gnd | To B- | To Gnd | To B- |
| Base | 3200 | 15K | 30K | 30K | 900 | 10K | 14K | 3.5K |
| Emitter | 4700 | 15K | 2.9K | 13K | 175 | 10K | 2.2K | 12K |
| Collector | 30K | 30K | 15K | 9K | 14K | 3.5K | 10K | 0 |

| <u>Symbol No.</u> | <u>Gates Stock No.</u> | <u>Description</u> |
|-----------------------|------------------------|---------------------------|
| C1 | 508 0215 000 | Cap., .01 uf, 100 V. |
| C2 | 522 0178 000 | Cap., 25 uf, 6 V. |
| C3 | 522 0160 000 | Cap., 100 uf, 3 V. |
| C4, C7, C8, C10 | 522 0242 000 | Cap., 25 uf, 25 V. |
| C5 | 516 0054 000 | Cap., .001 uf, 1 KV |
| C6 | 522 0187 000 | Cap., 200 uf, 6 V. |
| C9 | 522 0158 000 | Cap., 50 uf, 3 V. |
| Q1 | 380 0004 000 | Transistor, 2N422 |
| Q2, Q3, Q4 | 380 0014 000 | Transistor, 2N1414 |
| R1 | 540 0035 000 | Res., 270 ohm, 1/2 W, 5% |
| R2, R4 | 548 0050 000 | Res., 20K ohm, 1/2 W, 1% |
| R3 | 540 0062 000 | Res., 3600 ohm, 1/2 W, 5% |
| R5 | 540 0066 000 | Res., 5100 ohm, 1/2 W, 5% |
| R6 | 548 0049 000 | Res., 100 ohm, 1/2 W, 1% |
| R7 | 540 0038 000 | Res., 360 ohm, 1/2 W, 5% |
| R8 | 540 0077 000 | Res., 15K ohm, 1/2 W, 5% |
| R9 | 540 0068 000 | Res., 6200 ohm, 1/2 W, 5% |
| R10 | 540 0064 000 | Res., 4300 ohm, 1/2 W, 5% |
| R11 | 540 0081 000 | Res., 22K ohm, 1/2 W, 5% |
| R12 | 540 0062 000 | Res., 3600 ohm, 1/2 W, 5% |
| R13 | 540 0025 000 | Res., 100 ohm, 1/2 W, 5% |
| R14 | 540 0086 000 | Res., 36K ohm, 1/2 W, 5% |
| R15 | 540 0048 000 | Res., 910 ohm, 1/2 W, 5% |
| R16 | 540 0063 000 | Res., 3900 ohm, 1/2 W, 5% |
| R17 | 540 0032 000 | Res., 200 ohm, 1/2 W, 5% |
| R18 | 540 0058 000 | Res., 2400 ohm, 1/2 W, 5% |
| T1 | 478 0221 000 | Transformer, Input |
| XQ1, XQ2, XQ3, XQ4 | 404 0066 000 | Socket |

Schematic - 837 9416 001

INSTALLATION AND OPERATING INSTRUCTIONS

FOR

M-6035 CUE-INTERCOM AMPLIFIER

TECHNICAL DATA

GAIN: 88 DB +2 DB @ 1 KC
Variable - Requires 10K variable resistor.
(Part of Console).

FREQUENCY
RESPONSE: Peaked for maximum intelligibility.

HARMONIC
DISTORTION: Under 4% at +28 DBM (.6 W) at mid-band
frequencies.

NOISE: -105 DBM equivalent input noise.

SOURCE
IMPEDANCE: 45 Ohms.

OUTPUT LOAD
IMPEDANCE: 45 Ohms. (High Impedance Speaker)

MAXIMUM
INPUT LEVEL: -35 DBM

MAXIMUM
OUTPUT LEVEL: +28 DBM

MAXIMUM OPERATING
AMBIENT TEMPERATURE: 55° C. (131° F.)

MAXIMUM STORAGE
AMBIENT TEMPERATURE: 85° C. (185° V.)

POWER REQUIREMENTS: -36 V. DC (unregulated) 10 - 75 ma.

TRANSISTORS: 2 - 2N214 2 - 2N1183
 3 - 2N1414 1 - 2N1225

SIZE: 3-1/4" Wide X 7-1/2" Long X 1" Thick

DESCRIPTION

The Gates M-6035 Transistor Cue-Intercom Amplifier is designed to be used in transistor consoles for cueing and talkback purposes. The amplifier utilizes a gain control for adjusting to different input levels. The amplifier is designed to be fed from a 45 ohm source and to operate into a 45 ohm speaker or resistive load.

The amplifier is designed to be used with the M-6039 mounting frame, which carries a mating receptacle for the printed card type connection. The connections on the printed wiring board are gold flashed for positive connection with the gold contacts on the mating receptacle.

The amplifier requires a -36 V. DC unregulated power source and requires from 10 ma. (at average power output) to a maximum of 75 ma. (at +28 DBM output).

THEORY OF OPERATION

For the purpose of explanation, the Cue-Intercon Amplifier can be considered to be made up of two distinct parts: the preamplifier, and the power amplifier.

THE PREAMPLIFIER

The two stage preamplifier is driven by an input transformer which is somewhat loaded by the input resistor. This resistor prevents excessive signals from being developed by the speaker at its resonance frequency, which would over-drive the input stage. Both stages are of the common emitter configuration, with direct coupling utilized between the stages. On the schematic, 837 9345 001, it should be noted that Q1 is a NPN type transistor and has its emitter returned to B- for biasing purposes.

Biasing is accomplished by a combination of voltage divider and emitter resistance as with R1, R2 and R5. This method of biasing also insures a high degree of temperature stability. Signal degeneration is also for Q2 by R7.

The volume control, (located on the console) situated between the preamplifier and power amplifier, is connected in reverse, to maintain the high source impedance at all settings that the power amplifier requires.

THE POWER AMPLIFIER

The output stages of the power amplifier operate Class B, and are arranged in the circuit configuration known as "single ended push-pull", or "followed emitter follower". The upper and lower units are in series across the power supply, and the load is connected at their junction when the signal at the collector of Q4 goes negative Q6 and Q8 conduct, since they are all PNP types. When the signal goes positive Q5 and Q7 conduct since Q5 is a NPN type. Thus, the full signal appears at the junction point.

Note that Q4 is the only stage in the power amplifier with this voltage gain. A high frequency transistor is used at this point

to improve stability. Several feedback loops are employed in this circuit, including R10, C7, C10, and C9, C7 and C10 provide high frequency stability, C12 supplies positive feedback from the output to the collector circuit of Q4 to increase the signal handling capability of this stage.

MAINTENANCE

PREVENTIVE MAINTENANCE

The M-6035 Cue-Intercon Amplifier is designed for long, trouble-free service. However, as with all high quality electronic equipment, a regular program of inspection should be followed.

It is recommended that when the amplifier is first received, part of the console, D.C. voltage be measured with the same voltmeter that will be used for maintenance and troubleshooting, and these readings be recorded on the amplifier schematic above the typical voltages shown.

SERVICING

When servicing the amplifier, the following points should be observed.

1. The condition of the output stage measuring the speaker bus voltage at the junction of R21 and the collector of Q8.
2. Circuit resistances should be measured only after removing the associated transistor or transistors, to prevent damage due to ohmmeter battery voltage.
3. DO NOT remove or insert transistors with the power ON.
4. DO NOT probe the printed board with a metal probe with the power ON.
5. Circuit voltages are reversed from standard vacuum tube practice, as is the polarity of all electrolytic capacitors.
6. The location of the positive end of each electrolytic capacitor is indicated by the white dot marked on the top of the circuit board.

PARTS LIST

| <u>Symbol No.</u> | <u>Gates Stock No.</u> | <u>Description</u> |
|--------------------|------------------------|---------------------|
| C1,C2,C3, C4,C9 | 522 0242 000 | Cap., 25 mfd, 25 V. |

6/28/62

-3-

M-6035 Cue-Intercon
Amplifier

| <u>Symbol No.</u> | <u>Gates Stock No.</u> | <u>Description</u> |
|---------------------------------|------------------------|----------------------------|
| C5 | 506 0005 000 | Cap., .1 mfd., 200 V. |
| C6 | 522 0178 000 | Cap., 25 mfd., 6 V. |
| C7,C10 | 516 0054 000 | Cap., .001 mfd., 1 KV, 10% |
| C8 | 522 0256 000 | Cap., 20 mfd., 50 V. |
| C11 | 522 0160 000 | Cap., 100 mfd., 3 V |
| C12 | 522 0246 000 | Cap., 100 mfd., 25 V. |
| C13 | 506 0006 000 | Cap., .25 mfd., 200 V. |
| Q1,Q6 | 380 0011 000 | Transistor, 2N214 |
| Q2,Q3,Q5 | 380 0014 000 | Transistor, 2N1414 |
| Q4 | 380 0013 000 | Transistor, 2N1225 |
| Q7,Q8 | 380 0012 000 | Transistor, 2N1183 |
| R1 | 540 0081 000 | Res., 22K ohm, 1/2 W, 5% |
| R2,R3 | 540 0071 000 | Res., 8200 ohm, 1/2 W, 5% |
| R4 | 540 0076 000 | Res., 13K ohm, 1/2 W, 5% |
| R5 | 540 0075 000 | Res., 12K ohm, 1/2 W, 5% |
| R6 | 540 0057 000 | Res., 2200 ohm, 1/2 W, 5% |
| R7,R17 | 540 0025 000 | Res., 100 ohm, 1/2 W, 5% |
| R8 | 540 0052 000 | Res., 1300 ohm, 1/2 W, 5% |
| R9,R19,R20 | 540 0041 000 | Res., 470 ohm, 1/2 W, 5% |
| R10,R14 | 540 0073 000 | Res., 10K ohm, 1/2 W, 10% |
| R11 | 540 0085 000 | Res., 33K ohm, 1/2 W, 5% |
| R12,R18 | 540 0039 000 | Res., 390 ohm, 1/2 W, 5% |
| R13 | 540 0098 000 | Res., 110K ohm, 1/2 W, 5% |
| R15 | 540 0049 000 | Res., 1K ohm, 1/2 W, 5% |
| R16 | 540 0070 000 | Res., 7500 ohm, 1/2 W, 5% |
| R21,R22,R23 | 540 0017 000 | Res., 47 ohm, 1/2 W, 5% |
| R24 | 540 0023 000 | Res., 82 ohm, 1/2 W, 5% |
| T1 | 478 0221 000 | Transformer, Input |
| XQ1,XQ2, XQ3,XQ4, XQ5,XQ6 | 404 0066 000 | Socket |
| XQ7,XQ8 | 404 0149 000 | Socket |

Schematic - 837 9345 001

6/28/62

-4-

M-6035 Cue-Intercom
Amplifier.

| | | | | | | | | | | |
|---|------|------|-------------|------|----|------|----|------|------|--------------|
| GATES RADIO COMPANY QUINCY, ILLINOIS | | | | | | | | | | 842-3687-001 |
| LIST OF PARTS | | | | | | | | | | SCALE |
| REF. | QTY. | UNIT | DESCRIPTION | DATE | BY | REV. | BY | REV. | DATE | BY |

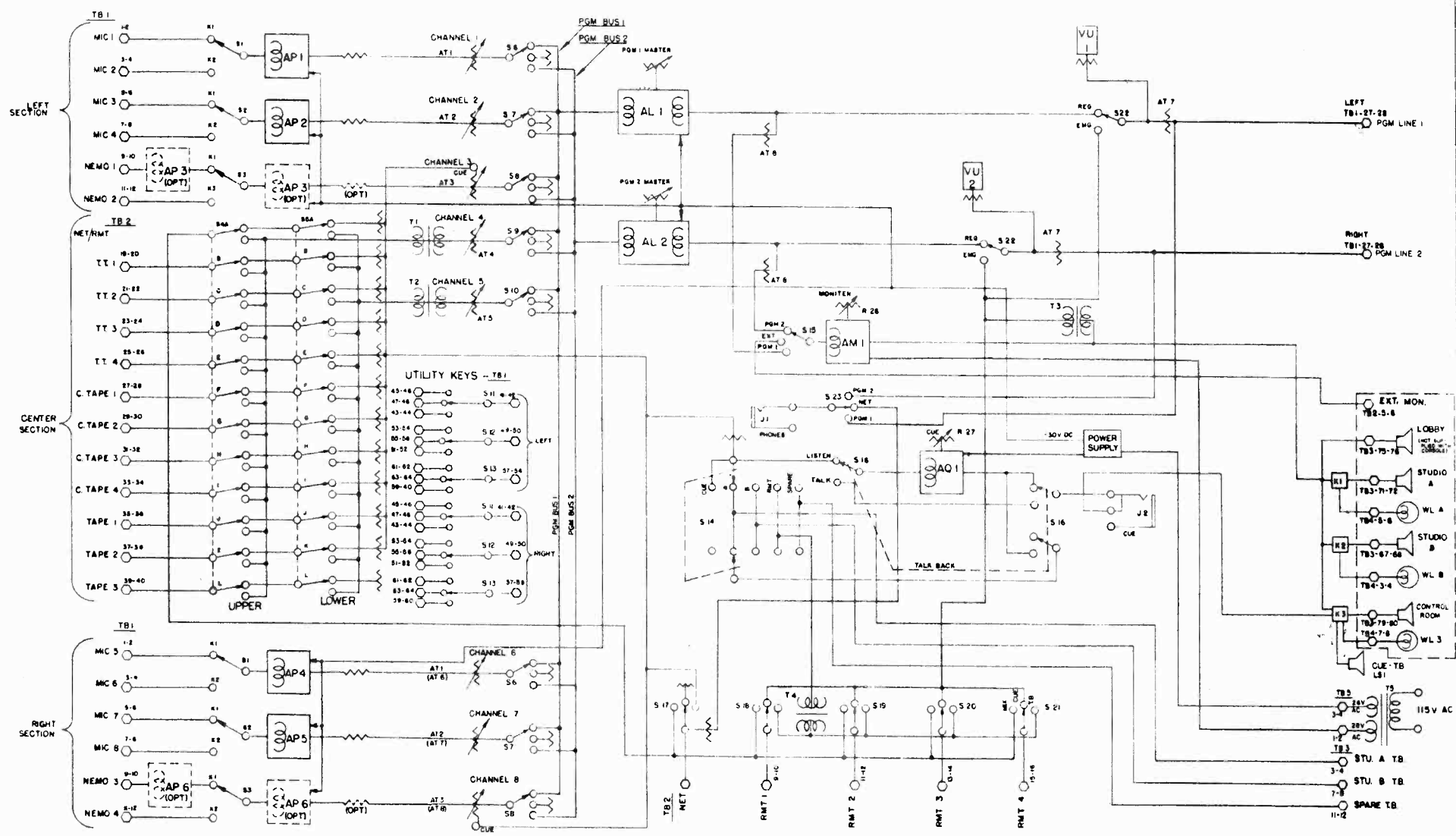

| | | | | | | | | | |
|--|------|------|------|------|------|------|------|--------|------|
| BLOCK DIAGRAM - "PRESIDENT" DUAL CHANNEL CONSOLE | | | | | | | | | |
| M-6209 | | | | | | | | | |
| DATE | BY | CHK | APP | REV. | BY | CHK | APP | DATE | BY |
| 8-1-58 | W.K. | W.K. | W.K. | | W.K. | W.K. | W.K. | 8-1-58 | W.K. |
| DA. P. BOWEN | CHK | W.K. | APP | | W.K. | CHK | APP | | W.K. |
| 842-3687-001 | | | | | | | | | |

FIRST MADE FOR
GATES RADIO COMPANY
 QUINCY, ILLINOIS
C-79416
 SCALE

TI PRIMARY

| IMP. | C.T. | JOIN | CONNECT TO |
|------|------|-----------------------------|-------------|
| 150Ω | Y&R | YEL. TO RED | BLUE & BRN. |
| 50Ω | R/Y | BLUE TO RED YEL. TO BRN. | BLUE & YEL. |

| LIST OF PARTS | | | | | | | REFERENCE | PT. ON G.N. | FIN. | DESCRIPTION | MATERIAL |
|---------------|------|------|------|------|------|------|-----------|-------------|------|-------------|----------|
| 106 | 105 | 104 | 103 | 102 | 101 | Q1 | | | | | |
| QTY. | QTY. | QTY. | QTY. | QTY. | QTY. | ITEM | | | | | |

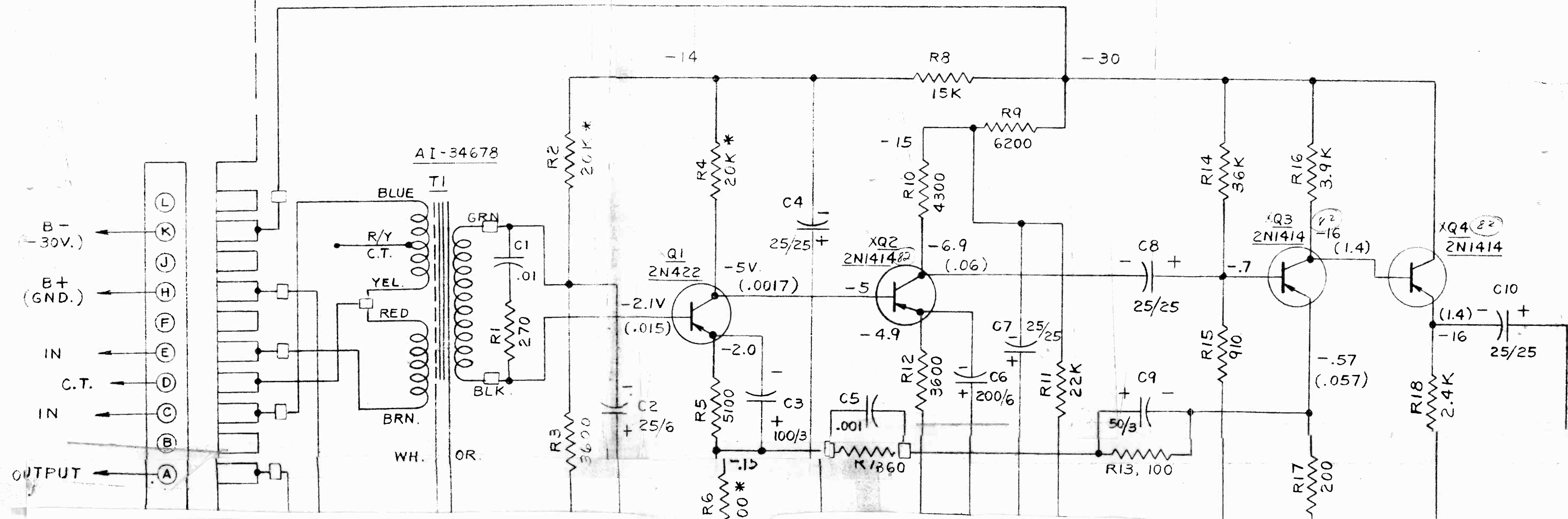

2
3
4
5
6
7
8
9
10

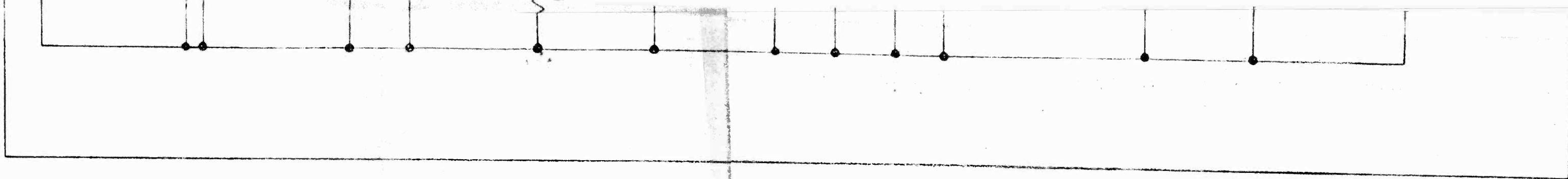

PRINTED BOARD

- 1) DC VOLTAGES ARE TYPICAL AND WERE READ WITH A SIMPSON 260.
- 2) VOLTAGES SHOWN AS (-) RE SIGNAL VOLTAGES.
- 3) ALL RESISTORS 1/2 WATT, % EXCEPT * 1%
- 4) ALL CAPACITORS IN MFD, WH D.C.W.V.
- 5) □ INDICATES SOLDER LUG

| ECN 8584 7-11-61/65. | STATUS | |
|-------------------------|-------------|------------|
| | DEVELOPMENT | PRODUCTION |
| | MECH CNK | |
| | PROJ ENG. | KB |
| APPROV PRODUCTION BY | | |

| | | | |
|---|-------|---------|--|
| TITLE SCHEMATIC, CONSOLE PREAMP M6034 | | | |
| MTL | | FIN. | UNLESS OTHERWISE SPECIFIED ALL TOLERANCES PER GATES SPEC DRAWING |
| DR BY D.L. | CH BY | ENG. KB | SHEET OF |
| DATE 11-23-60 | | | C-79416 |

537 9416 001

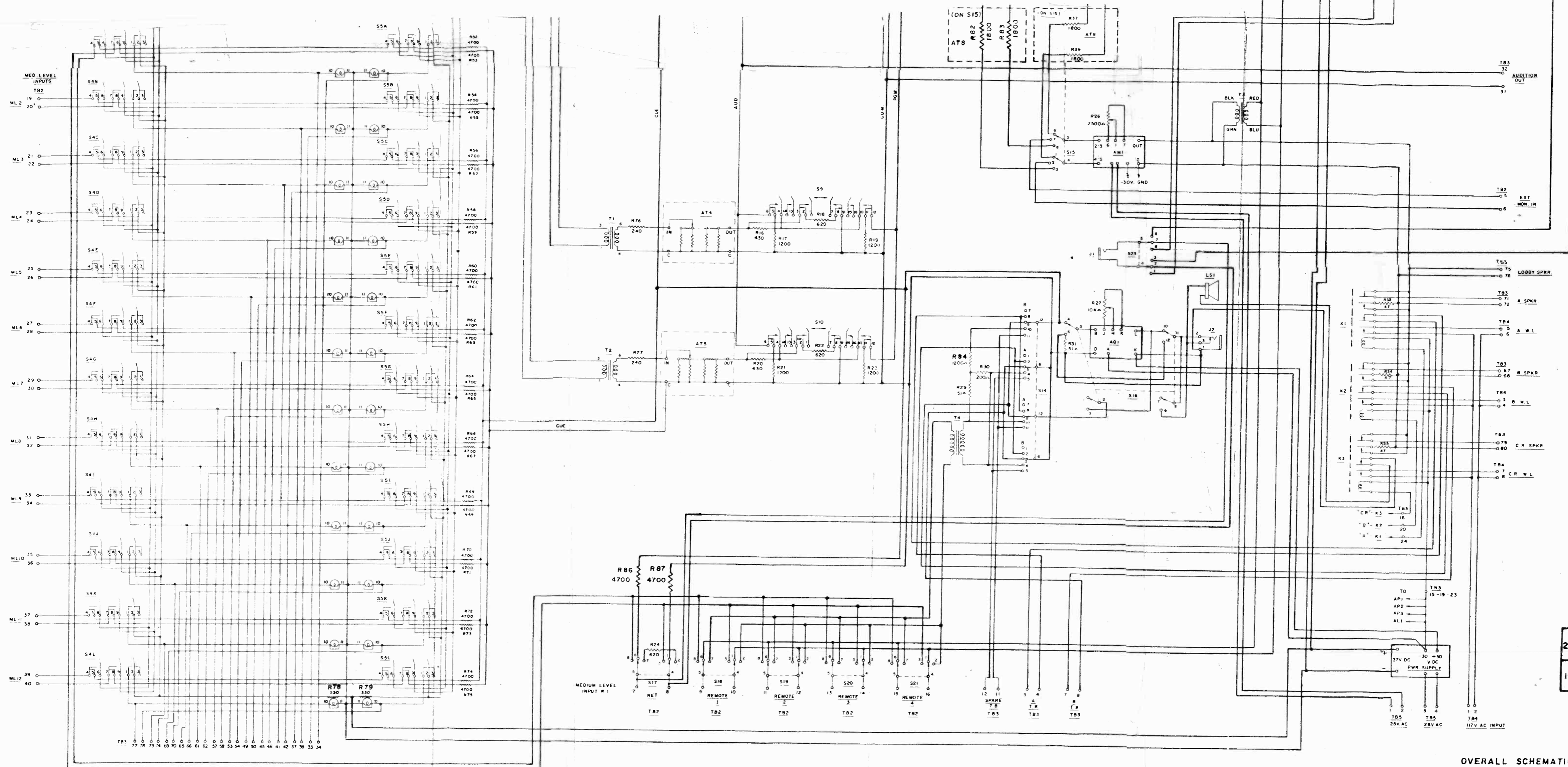

ECN 9349
 2 GWY 12-17-62
 ECN 9315
 1 GWY 10-30-62

OVERALL SCHEMATIC
 TRANSISTORIZED CONSOLE
 "PRESIDENT"
 M6209

LOW LEVEL INPUTS LEFT

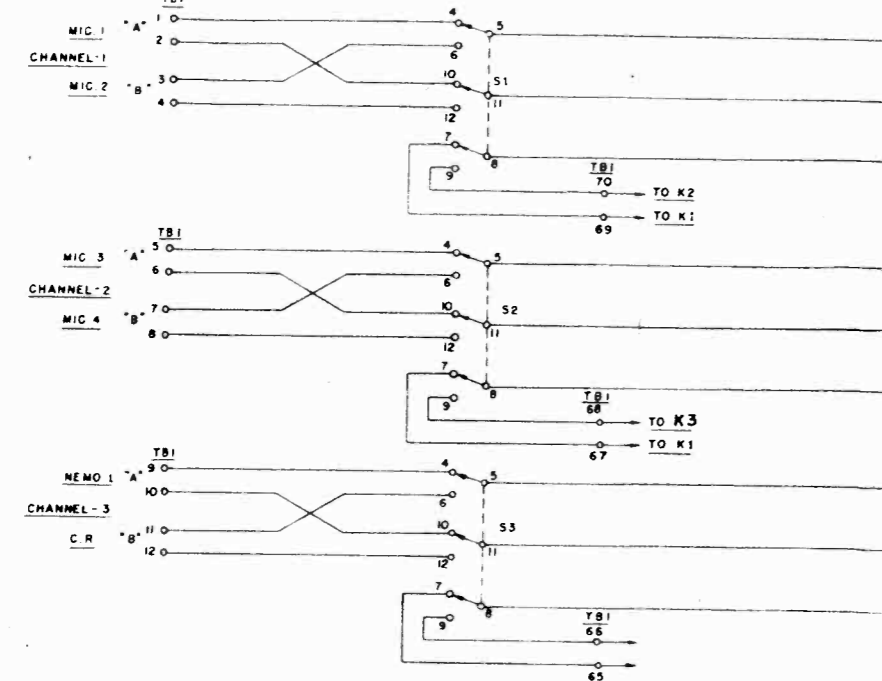

LOW LEVEL INPUTS RIGHT

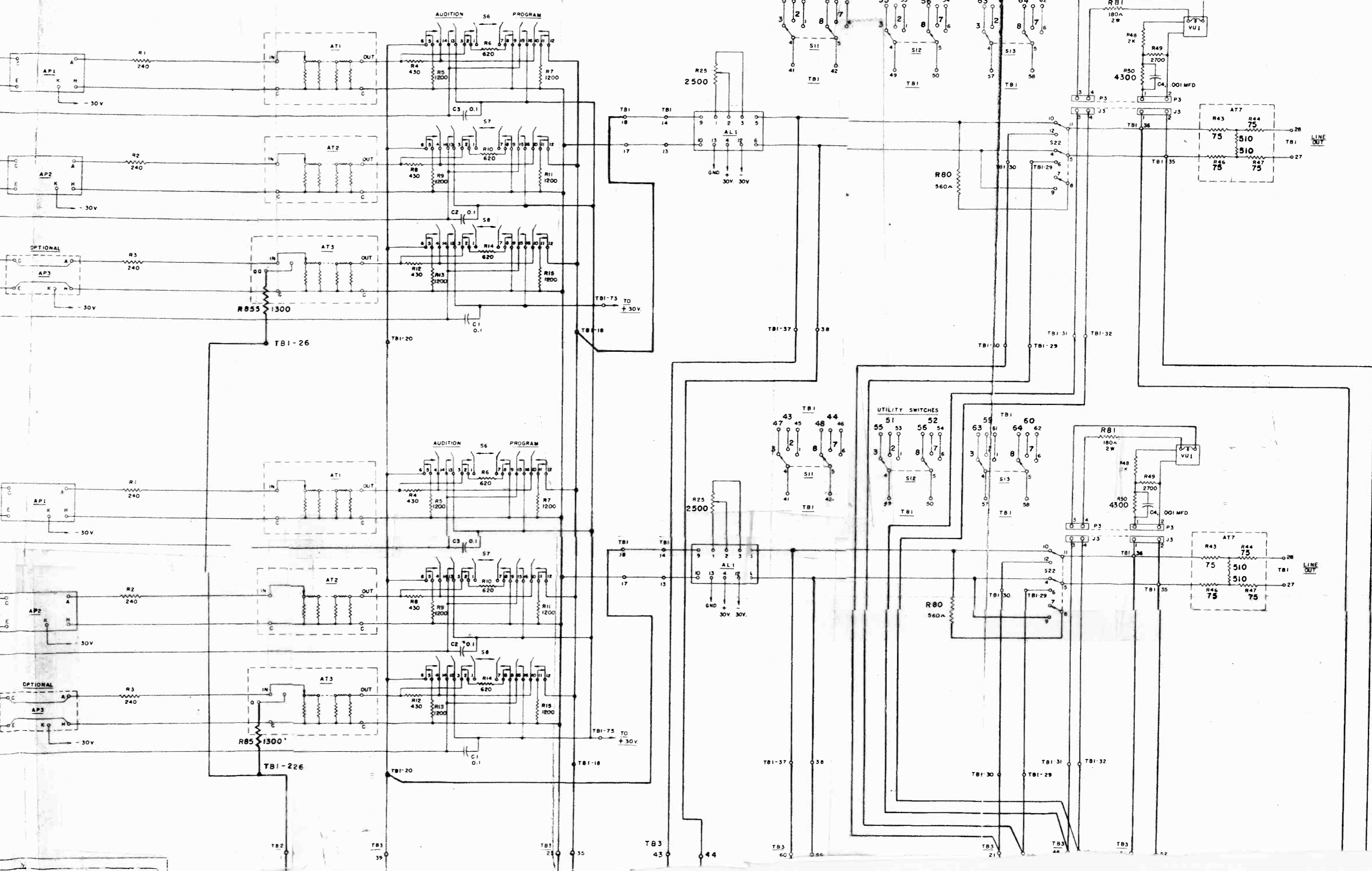
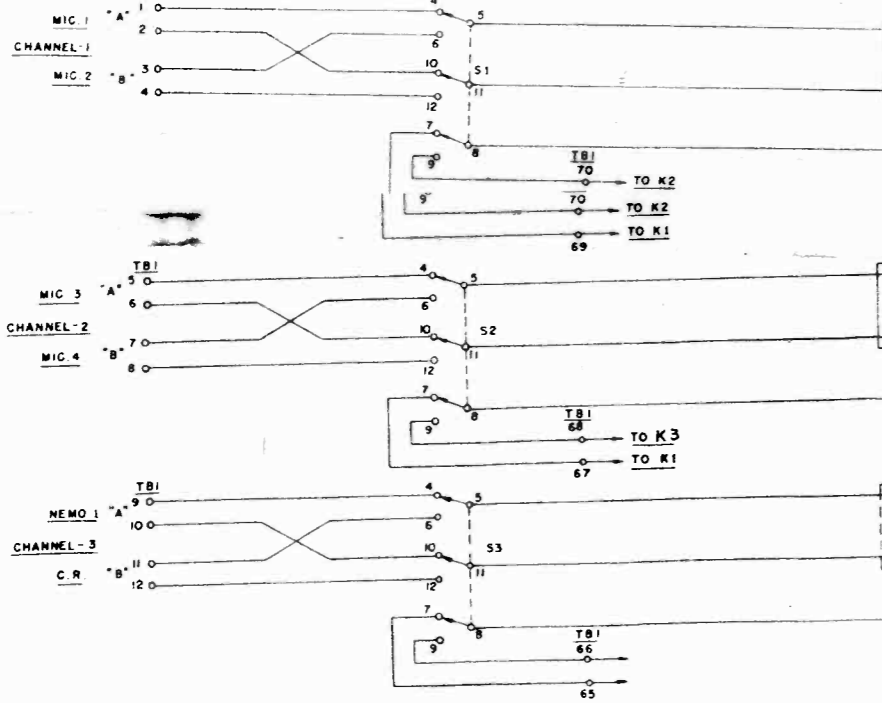

| | | | | | | | | | | | | |
|------|------|------|------|------|------|----------------|---|-------------|--|---------|----------|-------|
| | | | | | | FIRST MADE FOR | GATES RADIO COMPANY QUINCY, ILLINOIS | | | C-11245 | | |
| | | | | | | | LIST OF PARTS | | | | | SCALE |
| 106 | 105 | 104 | 103 | 102 | 101 | PT. OR G.N. | FIN. | DESCRIPTION | | | MATERIAL | |
| QTY. | QTY. | QTY. | QTY. | QTY. | QTY. | ITEM | REFERENCE | | | | | |

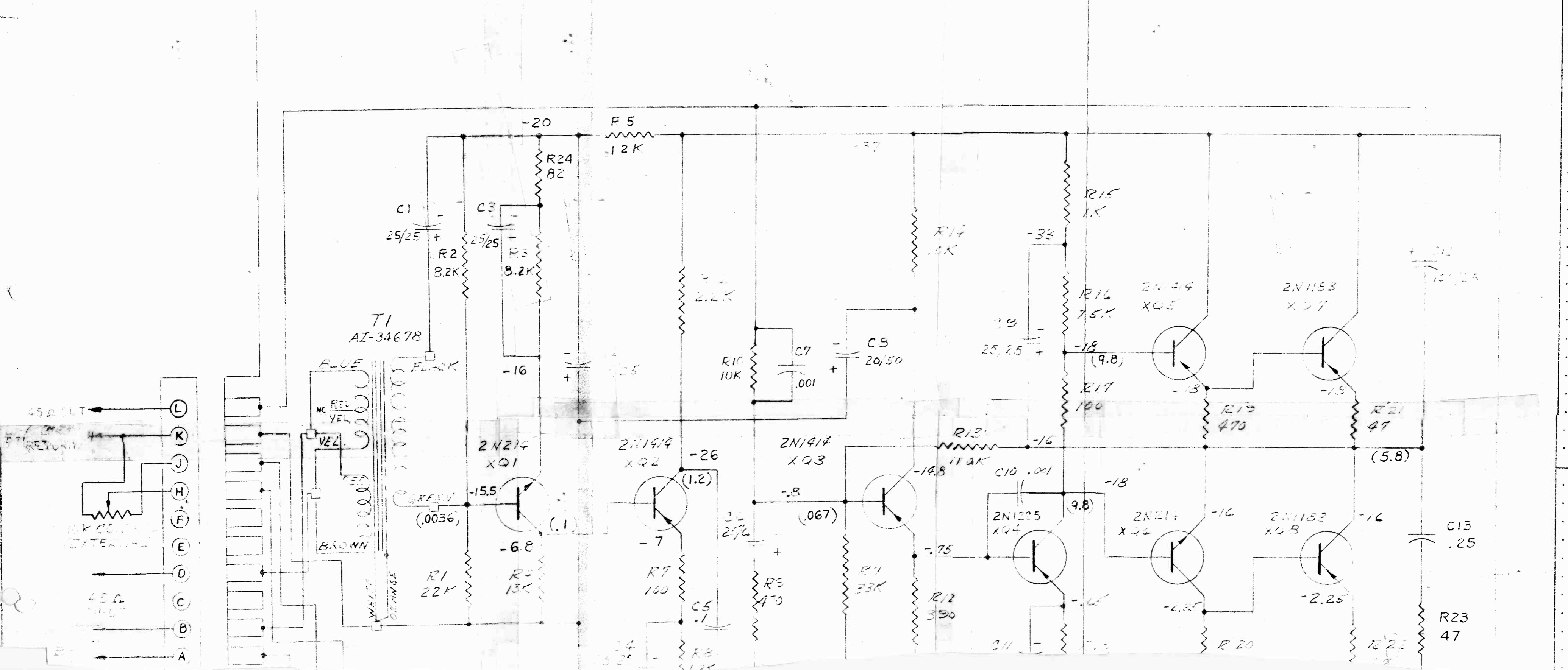

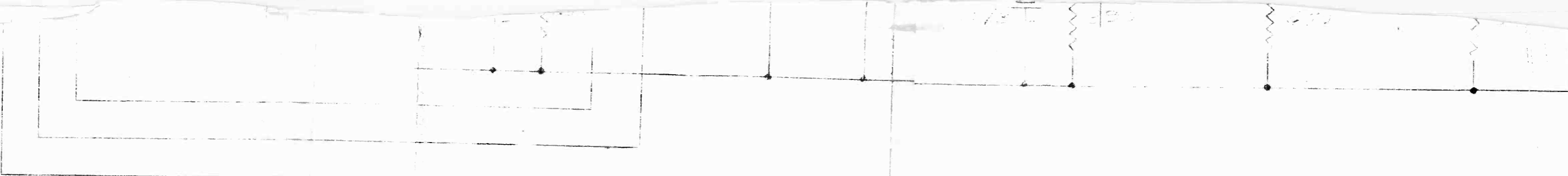

PRINTED BOARD

1. ALL CAP. IN MFD., WITH D.C.W.V.
2. ALL RESISTORS 1/2 W. @ 5%.
3. D.C. VOLTAGES MEASURED AGAINST B+ WITH 20K Ω /VOLT METER.
4. () RMS SIGNAL VOLTAGE AT 1K Ω , -50 DBM IN, +28 DBM OUT.
5. \square INDICATES SOLDER LUG

| | | | |
|-------------------------|-------------|-------------|------------|
| ECN 8921 2-2-62 DL 2 | 1 1/1/62 | STATUS | |
| | | DEVELOPMENT | PRODUCTION |
| MECH. CHK. | | | |
| PROJ. ENG. | | | |
| APPROV. PRODUCTION | | | |

| | | | |
|---|--------------------|----------------|--|
| TITLE TRANSISTOR CUE - INTERIOR AMP SCHEMATIC DIAGRAM | | M-6045 | |
| DR. BY: <i>RJD</i> | CH. BY: <i>RJD</i> | ENG. <i>JR</i> | UNLESS OTHERWISE SPECIFIED ALL TOLERANCES PER GATES SPEC 68102 |
| DATE: 11-21-60 | | SHEET OF | C-79345 |

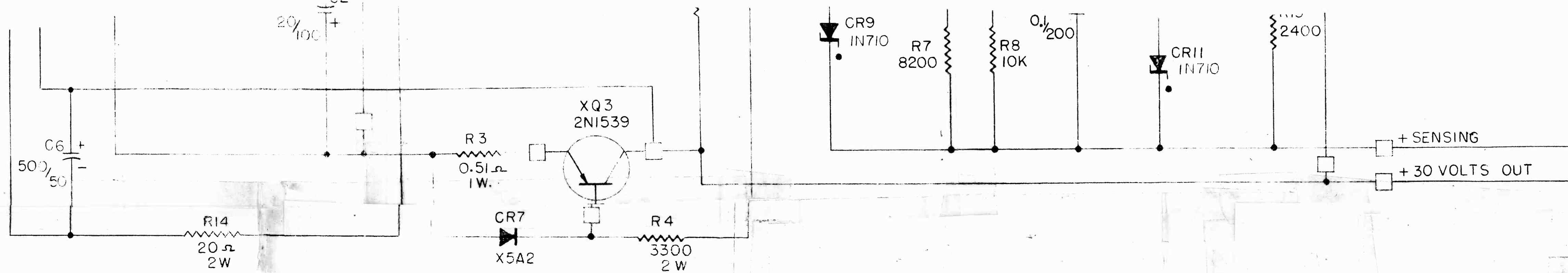

1. ALL RESISTORS 1/2 WATT 5% EXCEPT WHERE NOTED.
2. ALL CAPACITANCE IN MFD., WITH D.C.W.V.
3. D.C. VOLTAGES MEASURED WITH 20K Ω /VOLT METER.
4. R7 IS ADJUSTED TO PROVIDE -30V OUTPUT.
5. \square DESIGNATES BOARD LUG CONNECTIONS.
6. LAST R NO 14
7. LAST C NO 6

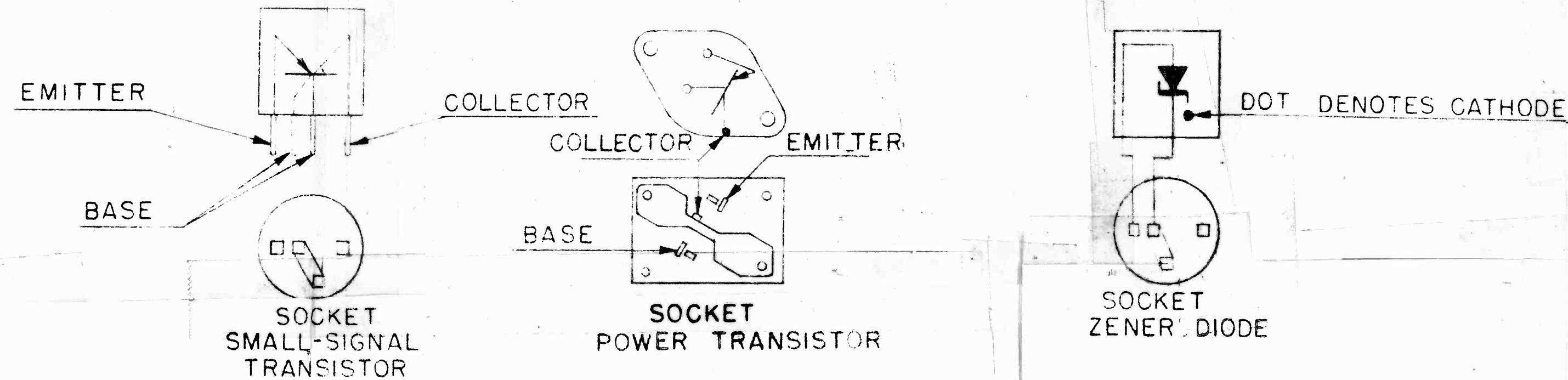

ECN 9377 2
DT 2-1-63
ECN 9369
GMV 12-14-62

| STATUS | |
|---------------|------------|
| DEVELOPMENT | PRODUCTION |
| MECH. CHK. | |
| PROJ. ENG. | |
| APPROV. BY | |
| PRODUCTION BY | |

| | | | | | |
|--------------------|------------------|---|------------------|--|---------------|
| TITLE | | TRANSISTOR REGULATED POWER SUPPLY STEREO CONSOLE | | M6205 | |
| MIL. | | FIN. | | UNLESS OTHERWISE SPECIFIED ALL DIMENSIONS PER MIL-STD-883C SPEC. QM107 | |
| DR. BY: <i>AKC</i> | DATE: <i>2/1</i> | BY: <i>HLA</i> | DATE: <i>2/1</i> | SHEET OF | <i>825-31</i> |

825-31