

C A T A L O G

1
9
9
1



JENISE KNILDSON

BSW

BROADCAST SUPPLY WEST

America's Full-Time Broadcast Supplier

With Technology Accelerating At a Relentless Pace, Broadcasting Success In The 90's Demands a Clear Vision Of The **FUTURE**

As your equipment supplier, we strive to stay ahead of the pack, giving you access to the latest innovations in broadcast gear. Under no circumstances will we ever forget the reason we are in business...to provide you with the best service, support and satisfaction. Here's how we accomplish these goals:

BSW People:

Who take your business personally. Our qualified sales representatives/engineers have experience in the trenches. Like you, they demand timely, efficient, and personal service. As your business partner, your BSW Sales Representative will strive to understand your requirements and respond with solutions which will give you the most value for your investment.

BSW Inventory:

The industry's most extensive. We maintain the largest inventory of items that are crucial to your operation. Our inventory also has "depth" which means we stock substantial quantities of popular items. When the pressures on to get that important product, BSW is the one who comes through for you time and time again.

BSW Systems:

That provide timely, efficient service. To give you the industry's fastest, most reliable delivery, we have developed state-of-the-art order entry and inventory systems enabling us to give you immediate accurate pricing, product availability and delivery you can count on. The bottom line is "we can ship it before our competition can find out if they have it".

BSW FlexLease:

Creative solutions for equipment financing. Quality leasing programs, like quality broadcast equipment, come from specialists. BSW has joined forces with GE Capital to offer exclusively to BSW customers, FlexLease. With FlexLease you are able to choose from a variety of programs that are tailored to meet your individual requirements, all at very competitive rates.

Integrity... Accessibilty... Dependability... Accountability. Four areas we consider to be our most important virtues that sum up our never ending commitment to you.

Open 12 Hours Daily

PACIFIC
6:00 - 6:00

MONDAY THRU FRIDAY

EASTERN
9:00 - 9:00

MOUNTAIN
7:00 - 7:00

CENTRAL
8:00 - 8:00

Nationwide and Canada 800-426-8434

Local and International 206-565-2301

Fax 206-565-8114

Telex 910-441-2617

Prices and specifications shown in catalog are subject to change without notice and should be verified prior to ordering. BSW actual selling prices are routinely discounted below manufacturer suggested list prices. Additional discounts may apply depending on size of order or payment terms.

NO MINIMUM ORDER

FOB: Point of Origin

Actual shipping charges with minimal handling fee will apply to each order.



TERMS:

NET 30 DAYS ON APPROVED CREDIT

Personal checks up to \$1,000.00 accepted with Telecheck approval.



BSW

BROADCAST SUPPLY WEST

America's Full-Time Broadcast Supplier



Copyright © 1991 Broadcast Supply West, Inc.



Sustaining Member

Index Of Products By Type

Type	Page	Type	Page	Type	Page
AM STEREO	73,88	Production	41-44,123	RACKS	
AMPLIFIERS		Remote	46-48	Cartridge	101,102
Distribution	3	COPY HOLDERS	107	Cassette	102
Headphone	55	DAT MACHINES	49,50	Compact Disc	101-103
Interface	56,126	DAT CASSETTES/CLEANER	51	DAT	102,103
Monitor/Power	2,123,126	DAT RACKS	102,103	Equipment	103,104
Preamps, Microphone	68	DIGITAL RECORDERS	49	Reel to Reel	104,75
Preamps, Phono	120	DIGITAL WORKSTATIONS	124,125	RECEIVERS, AM/FM	74
ANTENNAS & ACCESSORIES		DUMMY LOADS	90	RECORD CARE PRODUCTS	121
FM	91	EBS SYSTEMS	71	REEL TAPE AND ACCESSORIES	78
RPU	83	EDITING SUPPLIES	79	REEL TO REEL MACHINES	75-77
STL	86	EFFECTS PROCESSORS		REMOTE CONTROL	80,81
AUDIO PROCESSING		(See AUDIO PROCESSING)		REMOTE PICK-UP EQUIPMENT	82,83
AM	4,6,7,123	ERASERS	20	RF CABLE AND CONNECTORS	92
Composite	5,6	EXCITERS	87,88	ROUTING SWITCHERS (Audio)	58,59
Compressors/Limiters	10-12	FIRE EXTINGUISHERS	109	SATELLITE	94
Delay Units	8	FM CABLE MODULATOR	88	SCA EQUIPMENT	89
Digital Effects	15-17	FREQUENCY EXTENDERS	110-113	SERVICING EQUIPMENT	116-118
Equalizers	13,14,123	FURNITURE, STUDIO	100-104	SKIMMER	126
FM	4-7	HEADPHONES & HEADSETS	52-54	SOUND EFFECTS, CD	34
Microphone	9	HEADPHONE ACCESSORIES	55	SOUND INSULATION	105
Noise Reduction	17	HEADS, Tape Machine	26,79	SPEAKERS	95-98,123
NRSC	8	HEAD CLEANING PRODUCTS	79	SPEAKER ACCESSORIES	98
On Air	4-8,123	INTERCOM	59	SPLICE FINDERS	21-23
Special Effects	15,16	INTERFACE		SPLICING SUPPLIES	79
Stereo Enhancers	7	Amplifiers	56,126	STL EQUIPMENT	
Stereo Generators	4,5,7	Patch Products	60,61	Antennas & Accessories	86
Stereo Synthesizer	7	Relays	57	SCA	89
Voice	9	Switchers	58,59	Transmitters/Receivers	84,85
AUTOMATION	18,19	ISOCOUPERS	90	TRL links	82,84,85
BULK ERASERS	20	LIGHTING/Studio	106,107	STEREO GENERATORS	4,5,7
CABLE, Audio	70,122	LIGHTING/Tower	93	SURGE/TRANSIENT SUPPRESSORS	99
CABLE, RF	92	MASTS, Telescoping	83	SWITCHERS	
CARTRIDGES, Phono	121	METERING, Audio	74	Audio	58,59
CARTRIDGES, Tape	26,27	MICROPHONES	62-67	RF	90
CARTRIDGE MACHINES	21-24	MICROPHONE ACCESSORIES		TELEPHONE EQUIPMENT	
CART MACHINE ACCESSORIES		Adaptors	69	Cellular Interfaces	110
Alignment	25,26	Booms/Arms	70	Couplers	111,113,115
Cleaning Products	79	Cable	70	Frequency Extenders	110-113
Erasers	20	Combiners	69	Hybrids	110-114
Labels	25	Mixers (See CONSOLES)		Mix-Minus	115
Racks	101,102	Phantom Power	68	Phone Systems	111,114
Splice Finders	21-23	Preamps	68	TEMPERATURE GAUGES	109
Tape	26	Splitters	69	TEST EQUIPMENT	116-118
Winders	25	Stands	70	TEST TAPES	25,79
CASSETTE MACHINES	28,29	Windscreens	69	TIMERS, CLOCKS	107,108
CASSETTES & ACCESSORIES	30	MONITORS		TONEARMS	119,120
CASSETTE RACKS	102	Audio Signal	74	TONE SENSORS/GENERATORS	18
CLEANERS		EBS & Weather	71	TOOLS	118
Tape Head	79	Modulation	72,73	TOWERS & ACCESSORIES	93
Electrical Contact	118	Status/Alert	109	TRANSMITTERS & EXCITERS	87,88
CLOCKS & TIMERS	107,108	MONITOR SPEAKERS	95-98,123	TUNERS, AM/FM	74
COMPACT DISC PLAYERS	31,32,123	NOISE REDUCTION	17	TURNTABLES	119
COMPACT DISC ACCESSORIES	33,34	ON AIR LIGHTS	106	TURNTABLE ACCESSORIES	120,121
COMPACT DISC RACKS	101-103	PATCHBAYS, CORDS, PANELS	60,61	UTILITY LIGHT	107
COMPOSITE DISTRIBUTION AMP	93	PHASE CORRECTORS	25	WATT METERS	93,117
CONSOLES		PHONO CARTRIDGES, STYLI	121	WEATHER INSTRUMENTS	109
D.J.	45	PREAMPS, Mic	68	WIRE AND ACCESSORIES	122
Line Mixers	44,126	PREAMPS, Phono	120	WIRELESS MICROPHONES	66,67
On Air	35-40	POWER SUPPLIES	104,110	WORKSTATIONS, Digital	124,125

CROWN



D75 Power Amplifier

Broadcasting's most popular amplifier. 35 watts per channel RMS with harmonic distortion only .05%. The D75 features active balanced inputs and XLR connectors. 3 year warranty.

Mfg. List \$549.00

Call For BSW Price



MT1200 Power Amplifier

Micro-Tech™ series amplifiers from Crown are packed with Crown quality and plenty of power. Model 600 delivers 200 watts per channel into 8 ohms and Model 1200 delivers 350 watts per channel into 8 ohms. 3 year warranty.

Mfg. List \$1,295.00

Call For BSW Price

QSC



1100 Power Amplifier

Boasting 50 watts per channel in 8 ohms, the 1100 provides the added power that is needed for today's reference monitors. The 1100 features two headphone jacks on the front panel with separate volume controls. The back panel, like all of the Series One amplifiers, has XLR, 1/4", and barrier strip inputs to make interface simple.

Mfg. List \$568.00

Call For BSW Price



1200 Power Amplifier

The Model 1200 from QSC is a medium-power amplifier that offers high-performance and reliability. Total output power at 8 ohms is 100 watts per channel. Premium components are used throughout and a wide array of input connections make the Model 1200 an ideal addition to your studio.

Mfg. List \$598.00

Call For BSW Price

TOLL FREE 800-426-8434

RAMSA



WP9055 Power Amplifier

Truly great amplifiers are measured by two standards. Sonic quality and reliability. The Ramsa 9055 power amplifier achieves excellence on both counts. 50 watts per channel, UL listed and an outstanding 5 year warranty. Balanced and unbalanced inputs.

Mfg. List \$540.00

Call For BSW Price

STEWART

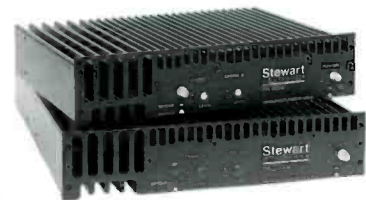

PA SERIES Power Amplifiers

Stewart Electronics makes use of a 100 kHz switching power supply to provide surprising power in a space saving half-rack design. PA series amps feature thermal protection, tamper resistant screw driver level controls, and are available with 25 or 50 watts per channel. (U models = unbalanced, B models = balanced).

PA50U Mfg. List \$249.00

PA50B Mfg. List \$279.00

PA100U Mfg. List \$324.00

PA100B Mfg. List \$359.00

Call For BSW Price

SYMETRIX



A220 Power Amplifier

High performance, low power stereo amplifier. The A220 will develop better than 20 watts per channel into 8 ohms with full power distortion of less than .02 % @ 1 kHz. Typical application includes the powering of headphone distribution boxes and small monitor speakers.

Mfg. List \$349.00

Call For BSW Price

YAMAHA

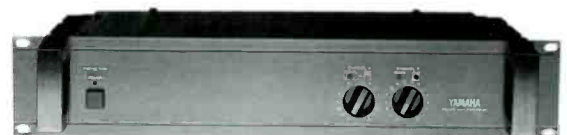

P2075 Power Amplifier

For solid monitoring power at an affordable price choose the Yamaha P2075C. With 50 watts per channel into 8 ohms, balanced inputs and outputs, special overload protection, and recessed input attenuators, the P2075C is perfect for professional monitoring applications.

Mfg. List \$545.00

Call For BSW Price

FAX 206-565-8114

APHEX



120 Distribution Amplifier

The Model 120 is a high performance audio distribution amplifier with a single high impedance input and four low impedance outputs, all electronically servo-balanced. The sturdy steel chassis may be used stand-alone or rack mounted, singly or in pairs. THD is .002% @ +4 dBm, hum and noise better than 90 dB.

Mfg. List \$279.00

Call For BSW Price

ATI



DA208/DA416 Distribution Amplifiers

Two or four inputs, each driving four individually adjustable, active balanced outputs gives you twice the channels for the price. Need more outputs? Just parallel inputs for up to 1 X 16 operation.

DA208 (Dual 1 X 4) Mfg. List \$489.00 Call For BSW Price

DA416 (Quad 1 X 4) Mfg. List \$339.00 Call For BSW Price

HENRY ENGINEERING

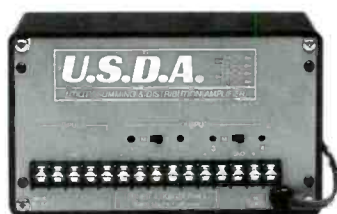

U.S.D.A. Distribution Amplifier

U.S.D.A. ("Utility Summing and Distribution Amplifier") has two inputs (one stereo pair) and four outputs (two stereo pairs), and can be used as a conventional 1x4 or 2x4 distribution amplifier. USDA can also be used to combine a stereo input to a mono output.

Mfg. List \$195.00

Call For BSW Price

Need prices on a major project? Save yourself time and FAX us your equipment list. We'll have a complete price quote back to you in no time.

BSW FAX # 206-565-8114

GENTNER



RDA Routing Distribution Amplifier

RDA's unique design gives you uncompromised versatility with eight inputs and 28 outputs. Any input or combination of inputs can be routed to any output via front panel dip switches. The RDA delivers outstanding aural specifications with 98dB of dynamic range, > 90dB of separation between any channel, and SNR >80dB referenced to +4 out.

Mfg. List \$1,295.00

Call For BSW Price

RADIO DESIGN LABS



STDA3 Distribution Amplifier

This compact, stick-on 1X3 DA will fit almost anywhere. The STDA3 allows the bridging of any audio line, adjusting the gain, and driving up to three isolated outputs. Inputs and outputs can be balanced or unbalanced. Power supply included.

Mfg. List \$99.95

Call For BSW Price

SHURE



FP16 Distribution Amplifier

Rugged, compact, and light weight, this 1-input, 6-output distribution amplifier is specially designed for field production and can be powered via internal batteries or an AC adaptor. All 6 outputs, as well as the input, are individually switchable to mic-or-line level.

Mfg. List \$570.00

Call For BSW Price

RADIX



DA1600 Distribution Amplifier

DA1600 features 8 stereo or 16 mono outputs with front panel level control and selectable pads to accommodate a wide range of input levels. One of the best things about this DA is the removable, plug-in connectors that allow wiring changes to be made quickly and effortlessly with the DA still in the rack. Specifications: THD: .01% max @ +20 dBm out, SNR 90 dB, output separation: 90dB

Mfg. List \$435.00

Call For BSW Price

CRL



FM AUDIO Processing Systems

CRL FM processing systems are modular and are comprised of either two, three or four of the following units:

- SGC800 Stereo Gain Controller. High quality multiband AGC and is designed for use as the first unit in a CRL system. Exclusive to this unit is Dynafex™ noise reduction.
- SEC800 Spectral Energy Compressor. Allows four band EQ. Programmable attack and release times. Switch selectable wideband or multiband limit or compress modes.
- SMP850 Stereo Modulation Processor. Final peak limiter offering maximum performance and fidelity. Unique stereophonic enhancement system can be used to create dramatic stereo sound fields.
- SG800A Stereo Generator. Digitally synthesized providing the ultimate in stereophonic baseband generation.

CRL FM processing can be purchased either as a system or as individual components.

Prices Based On Configuration



AM AUDIO Processing Systems

The CRL AM processing systems are modular and are comprised of either two or three of the following units:

- AGC400 Mono SGC800 Stereo Gain Controller. Designed to be used as the input unit. Offers wideband or multiband processing with Dynafex noise reduction.
- SEC400 Mono SEC800 Stereo Spectral Energy Compressor. Programmable four channel multiband compressor/AGC.
- PMC450A Mono SMP950A Stereo Peak Modulation Controller. Incorporates selectable NRSC preemphasis and bandwidth filtering standards.

CRL AM processing can be purchased as a system or as individual components.

Prices Based On Configuration

TOLL FREE 800-426-8434

CRL



AUDIO SIGNATURE FM/AM Stereo Processor

Audio Signature provides wideband and four band processing in one package. CRL's FT (Friendly Touch) Digital Control system offers the power of digital control in a user friendly, easy to operate format. Even though all major front panel controls feed the microprocessor system, users are provided with a totally "real-time" touch and feel not normally associated with digital equipment. Features:

- Digitally processed user controls
- Separate wideband and Multiband control
- User adjustable Multiband crossovers
- Real time analysis output monitoring
- 8 position audio diagnostic metering
- 4 memory recall sound settings
- PC and automation remote control capability

Mfg. List \$5,995.00

Call For BSW Price

CUTTING EDGE

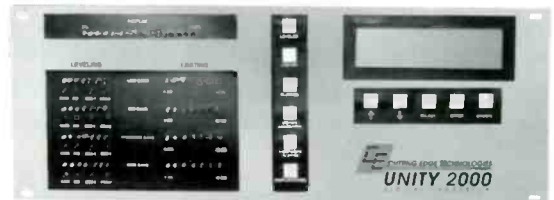

UNITY 2000 Digital Processor

Finally, a complete digital processor that delivers every function in today's audio chain in one chassis!

The Unity 2000 includes the following:

- Selectable low frequency equalizer
- DIGITAL 4 band leveler/processor (feed forward RMS circuitry)
- DIGITAL 4 band limiter (feed forward, multiple time constants)
- Clipper Drive
- DIGITAL stereo generator (better than 50 dB of separation)
- Selectable composite clipper

Both the Preprocessor and the limiter include the revolutionary "intelligent time constant controller" that actually learns the music and adjusts attack and release time accordingly, and in real time. Feed forward technology provides a constant processing ratio giving the user a "sweet spot" at any level of processing. Other features include programmable and savable settings, adjustable time constants and cross over frequencies, an RS232 port for remote access, and a port for ancillary devices.

Mfg. List \$7,995.00

Call For BSW Price

FAX 206-565-8114

CUTTING EDGE

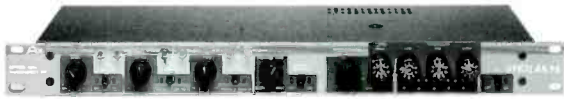

VIGILANTE FM Audio Processor

Now you can use the same secret weapon that helped establish dial dominance for top stations in New York and Los Angeles with the Vigilante. This unit begins as an Aphex Dominator, but with special redesign and circuit modification from Cutting Edge, it creates a full, brilliant and LOUD sound that maintains detailed openness. Extensive front panel controls allow for custom tailoring the Vigilante to your format.

Mfg. List \$3,000.00

Call For BSW Price



DIVIDEND Composite Filter

This unit works in conjunction with your existing composite clipper offering you a "pay off" in terms of performance. The Dividend can actually boost main channel modulation at least 5% and reduce multipath distortion in fringe areas. The Dividend also provides full spectral protection, including SCAs and complete pilot protection with full stereo separation. If you're looking to maximize legal modulation on your main channel and/or provide a clean signal to your SCA customers, then the Dividend is for you.

Mfg. List \$2,495.00

Call For BSW Price

GENTNER



SPECTRUM SYSTEMS Digital FM Audio Processing

Digital technology has changed audio quality standards. Audio is cleaner and more transparent than ever. However, digitally recorded audio, no matter how clear it is, deteriorates through an analog processing chain. So, Gentner has developed the broadcast industry's first all-digital on-air processing chain; Spectrum Systems.

Spectrum Systems products include the LAZER, a digital FM limiter/stereo generator, PRIZM, the all-digital, stereo 4-band audio processor and the Optical Encoder analog-to-digital converter. These systems keep your audio totally in the digital domain from studio output to exciter input, while providing precise control on processing and limiting.

TOLL FREE 800-426-8434

GENTNER



LAZER Digital FM Processor

Lazer provides excellent aural specifications; including maximum stereo separation built-in concise limiting and virtually no noise or RF interference. The result: your music holds its true sound and distortion is a thing of the past. Total digital manipulation allows for consistent precise audio. Tweaking isn't necessary. You can walk away from Lazer and feel confident that your audio processing parameters remain fixed.

Mfg. List \$7,995.00

Call For BSW Price



PRIZM Digital FM Processor

This 4-band completely digital audio processor gives you total modulation control. You can achieve the sound you want by simply specifying precise parameters from a front panel menu. Digital manipulation of audio means that each audio band is phase linear and distortion free so you can increase power without sacrificing audio clarity and still stay within your legal limits.

How about 8 pre-set programs for your different formats? The Digital Prizm's numerical operation parameters allow you to change format sounds and still revert back to precise parameters that you previously designated.

Mfg. List \$6,995.00

Call For BSW Price



OPTICAL ENCODER Digital/Analog Converter

Both the Lazer and Prizm make use of the separate Optical Encoder for analog to digital conversion. Only one unit is required when using the Lazer and Prizm together as a complete system.

Mfg. List \$995.00

Call For BSW Price

DELTA



AMP1 AM Stereo Processor

This high performance AM stereo Tri-Band processor combines state-of-the-art technology with ease of operation and delivers a loud, clean, and bright sound at a reasonable price. The AMP1 features digital control over input audio and a broadband AGC with slow attack and release times. Stations contemplating a move to AM stereo may initially use the AMP1 in a monaural mode to up-grade existing processing, and then convert to AM stereo with a simple jumper change.

Mfg. List \$3,250.00

Call For BSW Price

GENTNER



FM AUDIO PRISM II FM Audio Processor

The Audio Prism from Gentner is giving many stations the extra punch and modulation power required to be competitive in today's aggressive markets. The Prism's four-band parallel layout and digital control provide smooth, predictable gain change and full modulation without fatigue. A broad band safety buffer guards against unusually high input levels, and a single density control simultaneously adjusts attack and release times. Set up is easy with a built in pink noise generator and front panel test points. The Audio Prism is designed to go before a final peak limiter and stereo generator. Two units are required for stereo.

Mfg. List \$1,795.00

Call For BSW Price



PHOENIX AM Audio Processor

The PHOENIX is a complete, monaural, AM processing system. The heart of the PHOENIX is the famous Audio Prism™ multi-band processor used by many FM stations. Digital control insures a clean, bright sound that is sure to please your listeners. Features include:

- Full NRSC compliance
- Internal low-frequency tilt corrector with 80 Hz square-wave generator
- Internal Phase-rotator

Mfg. List \$2,995.00

Call For BSW Price

INOVONICS



250 AM/FM/TV Audio Processor

Inovonics' 250 is a comprehensive multiband stereo audio processor for demanding applications in AM, FM, or TV. Programmability of the 250 enables the user to adapt processing parameters to suit different station formats or dayparts. Features...

- Feed forward PWM control
- Unique "soft knee" compression
- FM/TV stereo, matrix AM-stereo or AM mono
- Manual presets or RS232 control

Mfg. List \$3,050.00

Call For BSW Price



255 FM Audio Processor

Inovonics' 255 is a stereo audio processor with principal utility in the "contemporary music" FM broadcasting format. The 255 allows almost unlimited control over program spectral distribution and density through a series of calibrated wide-range adjustments. Unit includes:

- Gated AGC
- Activity detector masks processing artifacts
- Gated 3-band Compressor/Limiter
- Feedforward PWM control

Mfg. List \$1,990.00

Call For BSW Price

MODULATION SCIENCES



CP803RM Composite Processor

Sharpen your competitive edge by adding the CP803RM to your compressor/limiter/stereo generator to enhance the stereo composite signal. Increase your signal by 6 dB with greater dynamic range without the breathing, pumping or swishing associated with conventional processing.

Mfg. List \$1,495.00

Call For BSW Price

BSW Delivers

BSW's extensive inventory assures you outstanding delivery. Our special discount rate on Federal Express saves you dollars and time.

ORBAN



8100A OPTIMOD FM Processor/Stereo Generator

The standard in FM audio processing. Features:

- Multiband compressor/ limiter/ stereo generator
- Versatile setup controls permit precise "tuning" for different formats
- Freedom from processing artifacts and distortion
- Optimum voice/music balances
- Excellent high frequency power handling for brightest sound
- State-of-the-art stereo generator
- Overshoot compensator permits full modulation at all frequencies, yet doesn't increase low frequency IM distortion
- Dual chassis (studio/transmitter) option
- Plug-in card construction for easy maintenance
- Built-in crosstalk test generator
- True VCA gain control
- True peak reading gain reduction meter.

Mfg. List \$5,550.00

Call For BSW Price

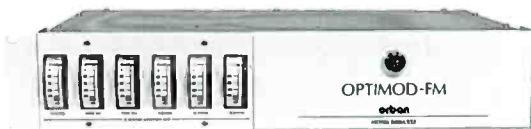

8100A/XT2 FM Multiband Processor

The 8100A/XT2 works with any 8100A OPTIMOD and features two high frequency equalizer controls: Presence and Brilliance. The XT2 also excels in delivering loudness on music while keeping speech from clipping distortion. The XT2 lets you tailor the bass and treble to your taste and format requirements. The XT2 is the next step in upgrading your OPTIMOD™ at an exceptionally reasonable price.

Mfg. List \$2,550.00

Call For BSW Price



9100B AM Audio Processor

Broadcasters are looking for new audio processing not only to increase loudness and coverage but also to noticeably improve AM audio quality. With OPTIMOD-AM, announcers' voices will have presence and impact while still sounding very clean. Music will have real bass, with punch and warmth, not boom. The highs will seem to open up. And loudness and tonal balance will be consistent from source to source.

9100B1 (Mono) Mfg. List \$4,550.00 Call For BSW Price

9100B2 (Stereo) Mfg. List \$6,350.00 Call For BSW Price

MODULATION SCIENCES



STEREOMAXX Spatial Enhancer

Almost all air chain processors work to increase loudness. StereoMaxx makes your station sound bigger, not just louder. No matter what kind of radio your listeners tune, once your station adds the energy and excitement of StereoMaxx, other stations sound rather tired and dull by comparison. Works with all on-air audio processing units.

Mfg. List \$2,889.00

Call For BSW Price

ORBAN



222A Spatial Enhancer

The Orban 222A stereo spatial enhancer can augment your station's spatial image the way your audio processor maximizes loudness and brightness. Highlights:

- Proprietary technique detects and enhances psychoacoustic directional cues.
- Front panel controls allow custom tailoring
- No increase in: FM multipath distortion, unnatural reverberation, or sensitivity to vertical tracing distortion.
- Full mono compatibility.

Mfg. List \$995.00

Call For BSW Price



245F Stereo Synthesizer

The Orban 245F stereo synthesizer has been designed to take any mono signal and create life-like pseudostereo. Unlike many other techniques, the patented Orban stereo synthesis technique causes no change in spectral balance, does not blur the transient definition and adds no audible noise or distortion to the mono original. The stereo output sums back to the original mono for total mono/stereo compatibility.

Mfg. List \$459.00

Call For BSW Price

Customer Service

BSW's "after the sale" support is second to no one. Your complete satisfaction is our only goal and we pay for the call.

Toll Free 1-800-426-8434

AUDIO DIGITAL



TC4 Broadcast Delay

A state-of-the-art advancement in broadcast profanity delay. 6.8 seconds delay time, 15 kHz bandwidth, and 85 dB dynamic range. Optional card allows memory dump as well as catchup feature.

Mfg. List \$1,597.00

Call For BSW Price

EVENTIDE



BD941/942 Broadcast Delay

Now reliable, efficient obscenity protection is so cost-effective, even radio stations that only program occasional live talk shows can afford it. The mono BD941 is available in 6 and 12 second versions—the stereo BD942 offers 3 or 6 seconds of delay. All versions feature full bandwidth and inaudible distortion.

The Eventide BD941 and BD942 provide a simple and practical "one-button" method for eliminating the risk of on-air obscenities. When a "no-no" is uttered, the talent simply hits the delete button on the front panel, or activates a remote closure. This control simultaneously bypasses the delay line and closes a relay contact. The relay contact can be used to start a cart jingle or other filler message. At the end of the message, the BD941/2 automatically go back on line with full delay protection.

Model BD941 (Mono, 6 Second Delay) Mfg. List \$1,795.00

Model BD942 (Stereo, 6 Second Delay) Mfg. List \$2,395.00

Call For BSW Price

INOVONICS



222 AM NRSC Processor

222 incorporates an adaptive preemphasis characteristic to enhance signal intelligibility and presence, and a sharp roll-off to eliminate adjacent channel interference. With a built-in peak limiter, the 222 can act as a stand alone processor, or interface with existing processing.

Mfg. List \$620.00

Call For BSW Price

RADIO DESIGN LABS

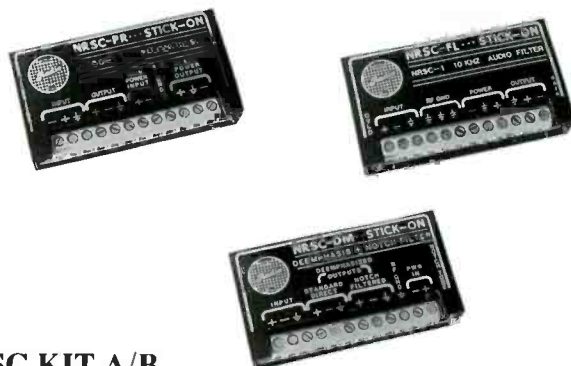

NRSC KIT A/B NRSC Processors

Here's an economical way to gain all the benefits of NRSC compliance with space saving stick-on units. NRSC KIT A includes a preemphasis filter, high frequency roll-off, and a complete manual to NRSC compliance. KIT B includes the preemphasis, roll-off, manual, and a deemphasis module. All modules have terrific specs and come with all the necessary power supplies.

NRSC KIT A Mfg. List \$399.00 Call For BSW Price

NRSC KIT B Mfg. List \$449.00 Call For BSW Price

America's Full-Time Broadcast Supplier

When BSW was founded in 1973, our goal was to establish a single source supply house to serve the needs of America's broadcast professionals. Regional offices solved the problem of time zone but only served to delay delivery of equipment critical to a station's operation.

So we decided to work overtime every day of the week. 12 hours a day, there is a qualified sales engineer on duty who knows your business and your needs. And there's only one number you need to know—toll free across America. 1-800-426-8434 BSW's commitment to service is why we're America's full-time broadcast supplier.

CRL



IPP100 Voice Processor

Powerful equalization and compression circuitry are combined with an advanced microcontroller to give a wide range of programmable preset characteristics in CRL's IPP100.

Anyone who has ever operated a standard equalizer or compressor will find the advanced control and programming power of the IPP100 very easy to manage. 18 memory "pre-sets" can be loaded into the memory so each individual announcer may have their own customized setting. Features:

- Selectable microphone or line level inputs
- Two band parametric equalizer, constant Q
- Two band compressor with gain reduction gating
- 18 memories for all user adjustable controls
- Easy to use "analog" controls
- Quick acquisition of preset information
- Security lock prevents alteration of presets
- Fast switching from one preset to another
- Remote jack for switching of presets

IPP100 Mfg. List \$1,495.00

IPP100R (Remote Panel) Mfg. List \$395.00

Call For BSW Price

ORBAN



787A Voice Processor

Nearly any voice can be made more appealing by the judicious use of mic processing. Each voice at your station or studio can be assigned a permanent setup for each mic/studio combination for instant recall just before the voice airs. The programmable mic processor gives you an important competitive edge by enabling you to get the sound you want quickly and consistently.

The 787A features three band parametric equalizer, compressor, de-esser, noise gate, compressor gate and optional ducker integrated in a compact, powerful system. Stores up to 99 different control setups in memory for instant recall. Designed for DJ mic processing and voice recording, but versatile enough for many other production uses.

Mfg. List \$1,995.00

Call For BSW Price

SYMETRIX



528 Voice Processor

The 528 is a complete, self contained voice processor that performs five separate functions: mic preamp, de-esser, compressor/limiter, downward expander and parametric equalizer/ notch filter. High density packaging allows all five signal processors to fit comfortably in a single rack space.

But, nothing is left out. Each function is served by a full complement of controls, in an easy-to-use layout. As a dedicated single channel voice processor, the 528 delivers the same processing power found in a sophisticated recording studio signal chain. With the 528 Voice Processor you get all the control you need, without the cost or complications of separate units.

Mfg. List \$679.00

Call For BSW Price

VALLEY INTERNATIONAL

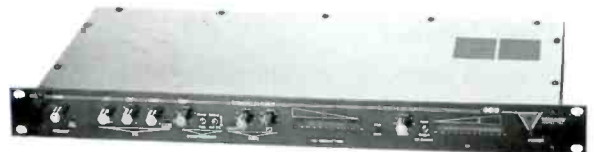

400 Voice Processor

How do you emphasize your on-air personalities' impact? Give them a Model 400 mic processor from Valley International! To begin with, the Model 400 contains a high quality mic preamp, so you can go line level into your console. Other features include:

- 3 band EQ section
- Compressor/expander
- Noise gate
- De-esser

Mfg. List \$679.00

Call For BSW Price

ATI



EM1000-1 Voice Processor

The EM1000-1 Emph'a Sizer is a complete processing system for studio microphones and a powerful tool for broadcast applications. Unit Features:

- Noise gate
- 4 band parametric equalizer with 4 selectable presets
- Compressor/limiter
- Quality mic preamp

Mfg. List \$1,395.00

Call For BSW Price

APHEX



COMPELLOR Compressor/Limiter

The Compellor is a revolutionary audio processor. It delivers invisible compression, leveling and peak limiting simultaneously! The Compellor intelligently varies all the parameters for you. All you need to do is set input level to control the amount of processing, adjust output level, and set the balance between compression and leveling. That's it. The Compellor will then provide complete dynamic control—all automatically.

Compellor (Mono) Mfg. List \$795.00 Call For BSW Price
Compellor (Stereo) Mfg. List \$1,195.00 Call For BSW Price



DOMINATOR II Stereo Peak Limiter

Dominator II represents the ultimate in clean and transparent peak limiting. Based on the popular Aphex Dominator, the Dominator II has even better performance with a dynamic range that has been increased by 24 dB to 104 dB and THD distortion of less than .005%

Mfg. List \$1,350.00 Call For BSW Price

ART



MDC2001 Dynamic Processor

For virtually any application that requires compression, limiting, expansion, noise gating, de-essing, signal enhancement, and sibilance correction, the MDC2001 will perform like nothing else available. Each function can be adjusted independently with over 45 LEDs to precisely monitor all functions and level variations. A revolutionary new VCA offers up to 1.5 dB more dynamic range and 80% less distortion than other VCA's currently available. This stereo unit fits in a single rack space.

Mfg. List \$499.00 Call For BSW Price

Why wait around for your equipment. . . for just a few dollars more we can Federal Express your order. Ask your BSW Sales Rep for details.

DBX



166 Compressor/Limiter

Features:

- Noise gating with switchable release rate • Hardwire bypass
- Variable over-easy compression
- Stereo or dual-mono operation • Side chain monitoring
- Peak stop, for good sounding clipping
- Rack mountable; low profile

Mfg. List \$599.00

Call For BSW Price



160XT Compressor/Limiter

In the world of compressor/limiters, the 160XT is known as the standard and with good reason. It delivers outstanding performance and easy to use operational flexibility in a slimline rack mount package. Its metering system provides an instantaneous picture of the gain reduction of the compressed signal compared with either the input or the output level. The 160XT is a textbook lesson in compression.

The 160XT has all the features a studio operator, broadcast or sound reinforcement engineer, or professional musician would want, as well as outstanding reliability for difficult road and performance conditions. It is the only compressor/limiter that gives you the choice of over-easy or hard-knee operation, irrespective of compression ratio. The unique infinity + compression offers unusual sonic effects, and access to the rms-defector input offers both frequency and time dependent compression. Balanced inputs and outputs.

Mfg. List \$459.00

Call For BSW Price



163X Compressor/Limiter

The 163X provides traditional dbx sonic quality and performance in a rugged, easy to use package at a very untraditional price. It's designed for the working musician, sound contractor, small studio operator, disco DJ, or anyone who needs a low cost, friendly compressor/ limiter/ preamp.

The 163X was designed for simplicity of use at no sacrifice in sonic quality. A single fader, along with the level-set control, provides the flexible combination of compression and gain at a consistent output level. Rear and front panel inputs allow quick and complete system hookup and operation that can be switched over to instrument or microphone just by "plugging in" to the front panel.

Mfg. List \$149.00

Call For BSW Price

ORBAN



424A Dynamic Processor

Here is one of the most complete, multi-function, audio processors available for the studio. The dual channel 424A features a compressor, limiter, and de-esser all in one package. Features:

- Defeatable gate with adjustable threshold
- Compressor has adjustable attack and release time
- Extensive use of VCA's for low distortion
- Better than 25 dB de-ess gain reduction

Mfg. List \$1,095.00

Call For BSW Price



464A Compressor/Limiter

The Orban 464A is a friendly, automatic "assistant operator" that smoothly and unobtrusively rides gain and limits peaks. The Orban 464A provides an unprecedented combination of versatility, audio quality and ease of use. Features:

- Transparent gain riding without overshoots
- Release time and release shape are adjustable to optimize processing
- A defeatable "silence gate" prevents noise rush-up
- Two channels in a space saving, rugged, all metal 1 3/4" package

Mfg. List \$1,195.00

Call For BSW Price



412A Compressor/Limiter

The Orban 412A is a basic, cost effective compressor/limiter with remarkably natural sound and extraordinary ease of use. A streamlined, straight forward front panel offers the most demanded user controls, including attack time, release time, ratio and threshold. This is a no frills unit with all the essentials at a very attractive price.

412A (Single Channel) Mfg. List \$459.00 Call For BSW Price

414A (2 channel) Mfg. List \$849.00 Call For BSW Price

Leasing?

Leasing equipment saves working capital. Talk to your BSW Sales Representative on the advantages of leasing your next equipment purchase from BSW.

RANE



DC24 Dynamic Processor

Features:

- Independent stereo limiter, compressor and expander/gate functions.
- Separate threshold and ratio controls for each operation.
- Built-in 24 dB/octave crossover
- Gain reduction meters, threshold, signal and overload LED indicators.
- Stereo or dual (slave) side chain switch and side chain insert jacks.
- 3-pin balanced/unbalanced connectors with ground lift switch.

Mfg. List \$549.00

Call For BSW Price

RADIO DESIGN LABS



STGCA Gain Controlling Amplifier

The STGCA1 is a high performance AGC that operates like a fast-action compressor/limiter. It has an adjustable level and threshold and can be used anywhere you want to maintain uniform audio levels. The STGCA is part of the Radio Design Labs family of "stick-on" products and comes with it's own power supply.

Mfg. List \$89.95

Call For BSW Price

SYMETRIX



SX206 Dynamic Processor

The SX206 Multi Dynamics Processor is a single channel device that may be used as a compressor/ limiter, gate, downward expander, ducker, or slave (for stereo operation). A full complement of controls is provided for each operating mode. This inventive blend of control techniques, implemented with a precision low-noise VCA, soft-knee transition, ultra stable feedforward control, and +24 balanced output capability, give the SX206 its outstanding sonic integrity.

Mfg. List \$329.00

Call For BSW Price

SYMETRIX



501 Compressor/Limiter

Two processor device with variable ratio compressor and an infinity-to-1 peak limiter for the ultimate in compression limiting. Selectable automatic mode significantly reduces overshoot and distortion. Balanced and unbalanced inputs and outputs. Used in broadcasting, music recording, sound reinforcement and tape duplication. Two units required for stereo.

Mfg. List \$349.00

Call For BSW Price



525 Compressor/Limiter

Features:

- A multi-function dynamic range controller designed for exceptional performance and ease of operation
- Two independent channels which may be ganged for stereo operation
- Simultaneous compress/limit and expand/gate action
- Separate compress/limit and expand/gate side-chains are program dependent to make set-up quick and simple
- Balanced inputs and outputs

Mfg. List \$539.00

Call For BSW Price

JBL



7110 Compressor/Limiter

The JBL/UREI 7110 Limiter/Compressor is built in the tradition that has made UREI limiter/compressors the audio professional's choice world-wide. Incorporating both peak and average gain reduction detectors in a single rack space size, the Model 7110 is equally at home in the small recording studio, the sound contractor's rack, portable sound systems, broadcasting studios or anywhere audio levels need to be automatically controlled. Two units required for stereo.

Mfg. List \$495.00

Call For BSW Price

**All Telephones Lead
To BSW**

*Toll Free from all 50 states including Puerto Rico,
US, Virgin Islands and Canada.*

UREI



LA4 Compressor/Limiter

The Urei LA4 compressor limiter gives you smooth, natural sounding compression with selectable compression ratio. Features:

- Input overload indicator
- Space saving 8 1/2" wide
- Simple stereo coupling
- Two units needed for stereo

Mfg. List \$690.00

Call For BSW Price



1176LN Peak Limiter

The 1176LN is one of the worlds most popular limiters. Pushbutton selection of four compression ratios. Attack time is front panel adjustable from 50 ms to 1.1 seconds. High impedance, balanced, bridging input. Output is transformer balanced.

1176LN Mfg. List \$790.00

Call For BSW Price

1178 (Dual Channel) Mfg. List \$1,290.00

Call For BSW Price

VALLEY INTERNATIONAL

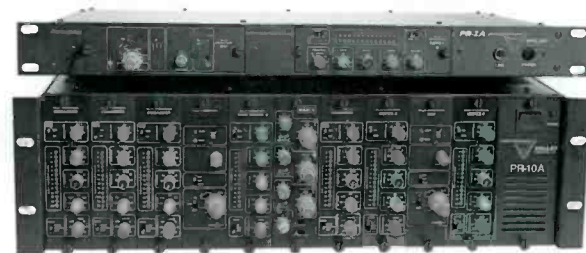

800 SERIES Processing Modules

Some of the most popular Valley processors are offered in part or in total in these small modules to give you the flexibility to configure a processing system to meet your specific requirements. Modules can be housed in two different powered rack frames, the PR10 - 10 space frame (vertical), or the PR2 - 2 space frame (horizontal). PR series rack frames feature improved strength, RFI shielding, and XLR connectors standard. 800 Series modules include the following: 810 kepeX II noise gate/expander, 811 Gain Brain II variable ratio limiter, 812 Maxi-Q 3 band parametric, 815 DSP dynamic sibilance Processor, 816 Leveller intelligent limiter, 817 Comander compressor/expander.

Call BSW For Specifications And Pricing

DAX



3110 Graphic Equalizer

This single channel, single rack space unit EQ offers 31 bands of control (+12 dB boost or cut) plus XLR balanced inputs and outputs. Frequency response is 20Hz to 20KHz, +/-1 dB. THD is < .01% at 1 KHz, 0dB output. SNR is 90 dB at 0dBV output.

Mfg. List \$349.00

Call For BSW Price

DBX



1531X Graphic Equalizer

A rear panel converts the 1531X from a single channel 31-band EQ to a dual-15 band EQ...Now that's versatile! Fader throw is selectable for +/-15 dB or +/-7.5 dB and a high pass filter is selectable via the front panel with a choice of 3 turnover frequencies (20, 60, or 120 Hz).

Mfg. List \$399.00

Call For BSW Price

DIGITECH

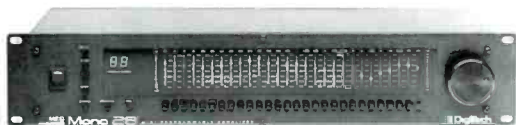

MEQ SERIES Programmable Equalizers

Catalog all your favorite EQ settings for on-air or production with these programmable EQs. Choose from the MEQ DUAL14 dual 14 band or MEQ MONO28 single channel 28 band to match your application. Features:

- 99 memory locations
- THD <.03% at 1 kHz
- Midi access
- +/-12 dB cut/boost
- 90 dB S/N ratio
- Non-volatile memory

MEQDUAL14 Mfg. List \$569.95 Call For BSW Price

MEQMONO 28 Mfg. List \$569.95 Call For BSW Price

ORBAN



672A Equalizer

A cost effective professional quasi-parametric equalizer with the convenience of graphic type EQ controls. Features very low noise and distortion, high slew rate for minimum TIM (SID), front panel gain control with 12 dB gain available, "peak stretching" overload lamp to warn of clipping, active balanced inputs and unbalanced outputs.

Mfg. List \$689.00

Call For BSW Price

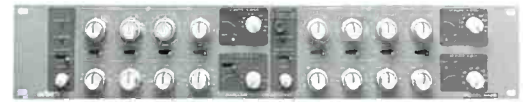

642B Parametric Equalizer

Features:

- 4 band, dual channel parametric equalizer. Each section offers overlapping tuning with a 25:1 frequency range +16 dB boost/-40 dB cut in each band.
- Bandwidth variable from about 5 to 1/4 octaves ("Q": 0.29 to 5.0).
- "Constant-Q" design facilitates precise tuning of notches.
- Tunable 18 dB/octave high pass filter and 12 dB/octave "Automatic Sliding Besselworth low pass filter provide maximum flexibility while preserving musicality.
- Front panel cascade switch permits use as either a two channel 4 band, or one channel 8 band equalizer.
- Noise and distortion specs significantly better than 16 bit digital.
- Active balanced inputs and outputs with optional output transformer.

Mfg. List \$995.00

Call For BSW Price

RANE



MPE SERIES Programmable Equalizers

Whether you employ MIDI control or not, the MPE series programmable EQs offer you maximum flexibility. Both the MPE14 (2 channel 14 band) and the MPE28 (single channel 28 band) are single rack space and include the following features:

- 128 memory locations
- Interpolating constant-Q filters
- Full MIDI access
- Balanced/unbalanced input and outputs
- Two-level access security system
- Non-volatile memory

MPE14 Mfg. List \$799.00

Call For BSW Price

MPE28 Mfg. List \$749.00

Call For BSW Price

RANE



GE30 Graphic Equalizer

The Rane GE30 is a 1/3 octave graphic equalizer that incorporates the best design criteria to yield the highest performance levels.

Features:

- Overload indicator • RFI input filters • Security cover included
- Switchable active or transformer balanced output
- Switchable between +12 dB/-15 dB boost/cut mode
- 3 pin and barrier strip inputs and outputs

Mfg. List \$749.00

Call For BSW Price



SP15 Parametric EQ/Notch Filter

Aimed at critical digital recording, the SP15 guarantees residual noise level below digital recording equipment. Each of the five filters in the SP15 are capable of covering a frequency range of four octaves.

- Specs exceed 16-bit digital audio performance
- +12 dB/-15 dB boost/cut range
- THD less than .005%, 20 Hz-20 kHz
- Balanced/unbalanced XLR inputs and outputs

Mfg. List \$599.00

Call For BSW Price

ART

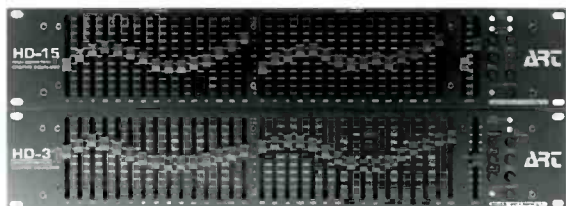

HD31/HD15 Graphic Equalizer

HD series equalizers let you equalize with a new level of precision with little need to worry about phase shift of sound coloration. Constant Q circuitry and the absolute finest electrical components ensure transparent, accurate operation. Both units feature balanced inputs and outputs, 60mm high resolution faders, signal/clip LEDs, switchable and subsonic/ultrasonic filters. Choose the single channel 31 band HD31 or two channel 15 band HD15.

HD31 Mfg. List \$425.00

Call For BSW Price

HD15 Mfg. List \$425.00

Call For BSW Price

TOLL FREE 800-426-8434

SYMETRIX



SX201 Parametric Equalizer

The Model SX201 is a high performance studio quality parametric equalizer/notch filter designed to handle both low level and line level inputs. Three fully parametric bands of equalization are provided, with +15 dB boost and 30 dB cut capability. Overlapping frequency controls cover the entire audio range, from 16 Hz to 20 kHz. Bandwidth is continuously variable from .05 octave (for deep notch filtering), to 3.3 octaves (for smooth tone shaping). Distinguished by its superb sonic integrity, extremely low noise and low distortion performance, the SX201 delivers uncompromising quality in a remarkably compact 1/2 rack package.

Mfg. List \$259.00

Call For BSW Price

UREI



535 Graphic Equalizer

The 535 dual graphic is a studio quality product which offers 12 dB of boost or cut at each of its 10 frequencies. Filter parameters have been optimized for excellent combining action with minimum phase shift. Features:

- Two channels in one complete package
- Ten adjustable equalizers on each channel
- Low distortion, low noise
- Balanced inputs and outputs

Mfg. List \$790.00

Call For BSW Price

JBL

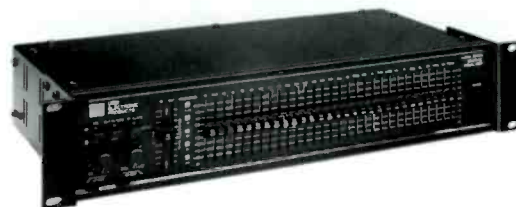

5547A Graphic Equalizer

This rugged, 1/3 octave EQ features unique gain structure controls that optimize headroom and signal to noise ratio for different signal level environments. Continuously variable filters at each end of the frequency spectrum control available bandwidth of the system with a 12 dB per octave slope. XLR, 1/4", and barrier strip connectors are included. Single channel.

Mfg. List \$1,095.00

Call For BSW Price

ART



DRX Effects Processor

This wonder processor features full dynamic processing and special effects and can perform up to 10 audio functions simultaneously with stunning clarity. There are 200 memory locations to store over 60 types of effects including: harmonic exciter, noise gate, programmable EQ, expander, peak limiter, compressor, envelope filter, sampler, pitch transpose, reverb, flange, stereo imaging, chorus, and more.

Mfg. List \$629.00

Call For BSW Price



MULTIVERB III Effects Processor

The most advanced multiverb to date with two full seconds of delay, an internal sampler, four simultaneous studio effects, and new generation reverbs that border perfection. In addition there's over two octaves of pitch shift, stereo chorus, stereo flange, more than 20 different delays, and the most comprehensive midi implementation available. MultiverbIII utilizes 20 bit processing and fits into a single rack space. Fully upgradeable software.

Mfg. List \$529.00

Call For BSW Price



MULTIVERB LT Effects Processor

This unit features many of the quality effects of the Multiverb III in a cost effective, easy to use package. 192 factory presets are included with some patches using 3 effects simultaneously. Chose from rich combinations of chorus, delays, reverbs, flanges, tape delays, gated reverbs, reverse reverbs, stereo panning effects, and much more.

Mfg. List \$299.00

Call For BSW Price

BSW's West Coast Location Allows Late In The Day Shipments. If You Need Equipment Fast, BSW Is Your Supplier.

We Offer Special Discount Rates On Federal Express.

DIGITECH



DSP256 Effects Processor

The new DSP256 adds to the impressive legacy of the DSP128. This new machine expands the capabilities of digital multi-effects processing to a new level of performance. The DSP256 has a full 20 Hz to 20 kHz bandwidth with 16-bit resolution, making it an indispensable tool for stage or studio. Features:

- 4 effects simultaneously
- 24 different effect combinations
- Independent full operation of all effects
- 256 program locations
- Program tilting
- MIDI continuous control of all parameters
- Comprehensive MIDI implementation
- Programmable level controls

Mfg. List \$529.00

Call For BSW Price



IPS33B Pitch Processor

With only one note you can create 2- and 3-note intelligent harmonies in 41 scales. Also included is a stereo pitch detune chorus and 1.5 seconds of delay.

Mfg. List \$899.95

Call For BSW Price

EVENTIDE



H3000B Effects Processor

This stereo, digital effects unit allows broadcasters the ability to create special effects and character voices quickly, at the push of a button. Sound like Max Headroom, Cuzzin It, or a variety of other colorful voices. Capture the attention of your listeners with thundering helicopters, blasting cannons, and tremendous storm-like effects, quickly and easily. This unit also features built-in stereo audio time compression and expansion, and it's completely automatic. Changing the running time of recorded reel-to-reel and cart tapes has never been this easy. You get the capabilities of a stand-alone time compression system which costs five times the price of the H3000B!

For even greater flexibility and creative possibility, order the HS322 internal digital sampler option with 23 second mono, or 11 second stereo sampling.

H3000B Mfg. List \$2,995.00

Call For BSW Price

HS322 Mfg. List \$995.00

Call For BSW Price

LEXICON



LXP SERIES Effects Processors

The Lexicon LXP series are powerful effects units in a compact 1/2 rack size featuring the clean, quiet performance and rich, musical quality that could only come from Lexicon. The LXP5 enhances your arsenal of sounds with an exciting panorama of digital effects, including pitch shift over three octaves, dramatic delay sweeps, flanging, thickening, 64 preset effects in all, from subtle enhancements to wild, space-age sounds. As many as five effects can be used simultaneously. Its 128 user memories allow you to change or expand its sound bank with user customized sounds.

LXP1 provides a wide range of time-based effects with fast, intuitive control. 128 state-of-the-art reverberation programs, including concert halls, rooms, plates, delays, choruses, even inverse and gated reverb give you a wide range of creative possibilities.

LXP1 Mfg. List \$549.00

Call For BSW Price

LXP5 Mfg. List \$549.00

Call For BSW Price



PCM70 Effects Processor

The Lexicon PCM 70 lets you choose from more than 40 imaginative factory programs. Versatile effects programs cover chorus and echo, multiband delays and resonant chords each with six voices. In addition, the PCM 70 offers you Lexicon reverb programs like concert hall, rich chamber and rich plate.

Using these factory programs as a basis, you can create 50 of your own individualized programs and store them in separate registers. That gives you instant access to a total of more than 90 available programs.

Mfg. List \$2,295.00

Call For BSW Price

ORBAN



111B/1 Reverb

The 111B/1 offers two channels of reverb in a single package that combines both electronics and spring delay lines. It is a reverb that combines full Orban quality and reliability with significant advances in cost effectiveness. It's the only choice for anyone needing two channels of fully professional reverb in an economical package.

Mfg. List \$959.00

Call For BSW Price

YAMAHA



SPX1000 Effects Processor

The SPX1000 is a highly sophisticated, full stereo, digital reverb and effects system which offers 40 preset effect programs. These include accurate simulations of natural reverberation and early-reflections, delay and echo effects, gated effects, modulation effects, a versatile compressor, a low-level expander, a harmonic exciter, freeze (sampling) programs and others. The SPX1000 also provides up to 5 effects at one time. With a sampling frequency of 44.1 kHz, it delivers full, flat frequency response from 20 Hz to 20 kHz.

Mfg. List \$1,795.00

Call For BSW Price



SPX900 Effects Processor

The SPX900 is a highly sophisticated, mono in by stereo out, digital reverberation and effects system offering 50 preset effect programs. These include stunning simulations of natural reverberation and early-reflections, delay and echo effects, gated effects, modulation effects, a versatile compressor, a harmonic enhancer, a freeze (sampling) program and more. The SPX900 also provides up to 5 effects at one time! Full-function wired remote control is available.

Mfg. List \$995.00

Call For BSW Price



REV5 Effects Processor

The REV5 is becoming one of the most asked for reverb units in broadcasting. In addition to great sounding reverbs, the REV5 includes choruses, echos, flanges, tremelo, stereo phasing and more.

Mfg. List \$1,995.00

Call For BSW Price

BSW's experienced sales staff is dedicated to meeting the needs of today's broadcasters. Call toll free or Fax us with your equipment requirements.

APHEX

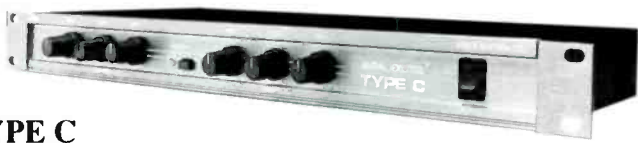

TYPE C Aural Exciter

Apex Aural Exciters are known for their ability to restore natural brightness, clarity, and presence to any audio signal. They use a patented process involving harmonic restoration rather than some form of equalizer filtering or phase scrambling. The Type C is the perfect solution to spice up a dull production room. You really must hear it to believe it. Call for information on how you can demo a unit in your studio.

Mfg. List \$299.95

Call For BSW Price

ORBAN



290RX Adaptive Enhancement Processor

Here is the cure for dull over-processed audio...the 290RX. It contains two independent channels of audio problem solving power, each providing three unique processing functions: harmonic restoration, spectral restoration, and single ended noise reduction. The harmonic restoration circuitry recreates even-order harmonics to add sparkle without introducing IM distortion common in other units. The spectral restoration feature is a program dependent circuit that adds just the right amount of high frequency content to restore shimmer to a dull signal. Separate downward expansion and bandwidth adjustments allow the single ended noise reduction to zero in on unwanted noise.

Mfg. List \$1,200.00

Call For BSW Price

CRL



DX2 Noise Reduction

The DX2 incorporates patent pending Dynafex™ noise reduction circuitry that provides up to 30 dB of noise reduction without the encode/decode process.

The Dynafex™ system has gained wide popularity in the professional audio market because of its ability to remove noise from virtually any audio source. Unit is two channel.

Mfg. List \$820.00

Call For BSW Price

TOLL FREE 800-426-8434

DBX



900 SERIES Signal Processing System

The 900 series modular signal processing system from DBX packs up to 9 processing modules in a single 3 space rack. Fill it up with your choice of noise reduction, de-essers, compressor/limiters, noise gates, and parametric equalizers. Get all the details from your BSW sales representative.

Price Based On Configuration



140X/150X Noise Reduction



Again and again professionals turn to DBX for quality, dependable noise reduction for all their critical recording needs. These compact, 1/2 rack width units give you two channels of encode/decode noise reduction. The 140X is designed to be used with low band-width audio sources, such as cassette recorders or other audio recorders that operate at 7.5 ips or slower. The 150X is perfect for full bandwidth digital systems or analog recorders operating at 15 ips or faster. Both units feature balanced 1/4" TRS inputs and outputs.

140X Mfg. List \$299.00

Call For BSW Price

150X Mfg. List \$299.00

Call For BSW Price

SYMETRIX



511A Noise Reduction

The Model 511A is a two channel, single-ended noise reduction system configured for use in professional and commercial audio systems. With its dynamic high frequency filter and downward expander, up to 30 dB overall reduction of both high frequency and broadband noise is attainable. The dynamic filter reduces high frequency sounds like hiss, RF artifacts and dimmer noise, while broadband and low frequency phenomena like hum, turntable rumble and air conditioning noise are reduced by the expander. A high performance 18 dB/octave rumble filter is included for optimal treatment of low frequencies.

Independent two channel or true stereo operation is front panel selectable. In stereo, the left and right control circuits are tied together, assuring a stable stereo image. In mono, the channels operate independently, so each may be used with a separate source.

Mfg. List \$599.00

Call For BSW Price

IGM



Model EC



Model MC



AUTOMATION CONTROLLERS

Whether you're an international giant, a network affiliate, or a small local station, IGM has a controller for you.

The IGM-EC is the perfect "starter" system. With 12 source audio inputs available, this full-featured PC based system can cover live assist, full automation, or satellite back-up in an economical package.

The MC controller is the next step up with increased monitoring, logging, and metering capabilities.

When you need the maximum control available, the top-of-the-line SC is the system for you. Expandable to 32 channels, this system can grow with you to offer continued service for years to come.

**Call BSW For More Detailed Information,
Pricing, And Configuration.**

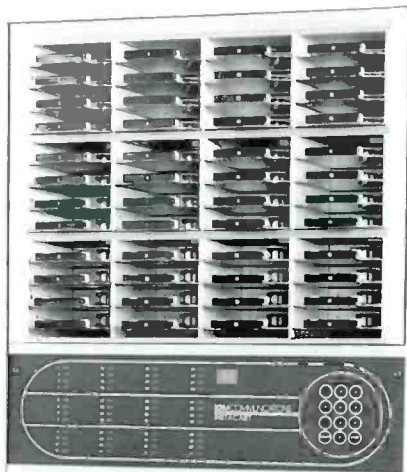

INSTACART Multiple Cartridge Player

IGM Instacarts are the industry standard cartridge playback units used in automation systems worldwide. Modular construction allows 4 different configurations. Choose from 12, 24, 36, or 48 cartridge capacity, mono or stereo. The tape drive system consists of high quality, high torque motors designed for continuous duty operation.

Call For Pricing And Information

TOLL FREE 800-426-8434

IGM



GO-CART 24 Multiple Cartridge Player

This microprocessor controlled unit provides fast reliable service for full, or partially automated operations. Features:

- Exceptionally rugged construction
- Microprocessor based design
- Bi-directional search (less than 8 sec.)
- Self-diagnosing error detectors
- Random or sequential modes

Mfg. List \$4,245.00 (Stereo)

Call For BSW Price

CONEX



CS25B 25 HZ Tone Sensor

The Conex CS25B is a compact and reliable bridging-type 25 Hz tone sensor for use in broadcast automation and tape control systems. The unit features two independent sensors so only one unit is needed for two recorders.

CS25B Mfg. List \$417.00

CS25B11 (With Stereo High-Pass Filter) Mfg. List \$502.00

Call For BSW Price

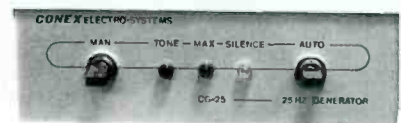

CG25A 25HZ Tone Generator

The CG25A allows you to put 25Hz tones on your own tapes. Use with automation systems or live assist operations. Timing intervals, tone levels adjustable.

Mfg. List \$420.00

Call For BSW Price

BROADCAST AUTOMATION, INC.
LIVE ASSISTANT
Live Assist Controller

Features:

- Allows connection of up to 8 audio sources
- Plays sources in any order with 24 programming events
- Thumbwheel operation lets you see instantly which sources are programmed and their order
- LEDs tell you at a glance which source is on the air and which is next
- Built-in silence sensor and closed-loop fail-safe features
- Reset to first event and auto stop

Options: VU meters, 15' source cable, rack mount kit

Mfg. List \$2,795.00

Call For BSW Price

SENTRY SYSTEMS
FS12C
Automation Controller

The FS12C Format Sentry is the heart of the automation system and will interface with almost any type of audio gear. When you purchase the FS12C you get the controller and software. All you add are the audio sources and a personal computer for a fully automated, live assist or Satellite system. The memory is large enough to offer 50,000 events, 12 sources standard, expandable to 24. The software allows traffic integration and operates with a real time clock. Complete logging is incorporated so record keeping is all automatic.

Mfg. List \$4,900.00 (Basic Controller)

Call For Configurations And Pricing

**With BSW You never Pay
Extra for outstanding service.**

*Place your order by Noon....We'll ship stock items by 5
... or the freight charges are on us !!*

GEFEN SYSTEMS
SOUNDTOUCH/CD SOUND
Automated CD Systems

These systems connect one or more Sony CDK-006 Auto Disc Loader (60 CDs), to a single computer controller. Specially developed Gefen Systems interfaces control the Sony CDK-006s. The software control gives you random access to play any or all of the music tracks on a given CD, as well as random play from all the CDs that are loaded into the CDL-006 trays.

SOUNDTOUCH is a touch screen application program for playback of music on CDs. CDSOUND is a less expensive keyboard oriented program. Either system allows you to create a play list to play all or part of your music. Both systems feature continuous playback, random playback, auto random play, and the ability to handle up to 120 CDs on line at once. In addition, the SOUNDTOUCH system gives you 2400 track storage for each library, logging of all played tracks (can be printed), and selection by music, style, artist name, or CD title.

System Prices Based On Configuration

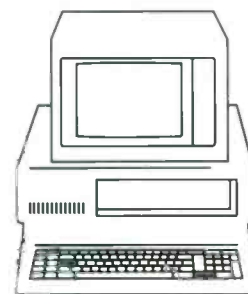
BSW
SATFIRE 1
Digital Audio Storage/Automation System

This PC based Automation System is designed for radio stations programming from a satellite network format. All of your commercial spots can be recorded directly onto the systems digital hard disc and played back in any predetermined order to fill the satellite spot breaks. Standard system will record/play up to 120 minutes of audio

A complete schedule of spot breaks, including all commercials, PSAs, liners, IDs and station promos, as well as talent shifts, can be quickly and easily programmed into Satfire 1. Anyone can master this extremely user friendly program without any previous computer experience.

Everything is done for you, perfectly on cue. You don't even have to worry about pulling out-dated spots. Satfire will automatically pull and replace spots as they pass their pull date.

This incredible system can save you money, headaches, and hassle. Call us Toll Free for more information.

Mfg. List \$8,995.00

Call For BSW Price

Bulk Erasers

AUDIOLAB



TD1B Bulk Eraser

Erases cassettes, cartridges and up to 10 1/2" reels. Automatic thermal protection to avoid burn-out. The complete line of Audiolab erasers is available from BSW.

Mfg. List \$132.00

Call For BSW Price

AVSC



409 Bulk Eraser

Completely erases all audio, video, instrumentation tapes and magnetic films. Audio and video cartridges, as well as tapes on reels or in boxes can be efficiently degaussed. Reel sizes up to 16 inches can be accommodated.

Mfg. List \$1,295.00

Call For BSW Price

FIDELIPAC

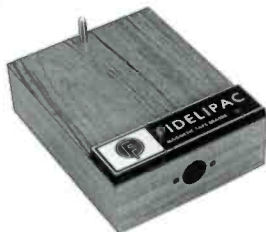

400 Bulk Eraser

The 400 provides over 2000 Gauss of erasure power. Enclosed in a hardwood case with laminate top, removable pivot point, and non-skid rubber feet, it will efficiently erase cartridges, cassettes, and open reel tape 1" wide.

Mfg. List \$125.00

Call For BSW Price

395 Bulk Eraser



Molded in durable plastic, the 395 Blank-It is rugged, light weight, has thermal protection, with a duty cycle of 5 min. on 15 min. off Perfect for erasing cartridges and cassettes.

Mfg. List \$70.00

Call For BSW Price

GARNER



Bulk Erasers

It takes just 4 seconds to erase all sizes and types of audio tape with Garner Degaussers. Just hit the power button and drop any reel or cartridge on the endless belt. You now have a clean, "no whump" erasure. Four models to choose from starting at \$990.00.

GENEVA



PF211 Bulk Eraser

It only takes a few seconds to prepare used tapes for like-new performance. The PF211 generates 2300 Gauss field intensity and is perfect for erasing cassettes, carts, and open reel tapes 1/2" wide.

Mfg. List \$69.95

Call For BSW Price

SONAR



MARK I Bulk Eraser

For audio tape degaussing, the Mark I from Sonar offers outstanding value. For all tape formats from cassettes to carts to open reel, the Mark I is a wise choice.

Mfg. List \$69.00

Call For BSW Price

VP2001 Bulk Eraser



For tough erase jobs, the VP2001 is extremely powerful and will effectively erase up to 1" video tape.

Mfg. List \$190.00

Call For BSW Price

BROADCAST ELECTRONICS



PT90 SERIES Cartridge Machines

PhaseTrak 90's unique phase correction circuit continually monitors and corrects the phase relationship between the playback audio of the right and left channels regardless of the machine used to produce the original cartridge.

Through its microprocessor-assisted automatic tape analysis system, the Phase Trak 90 will completely evaluate a new tape and "learn" all of the bias, level and EQ settings necessary to obtain optimum performance.

The Phase Trak 90 boasts a signal to noise ratio of better than 80 dB, and its excellent frequency response delivers "audiophile" quality in any application.

The Phase Trak 90 is completely modular for the ultimate in servicing convenience. All modules are easily removed from the back of the cabinet. Test points and adjustments are reached by removing the top cover.

PT90RPS (Record/Play Stereo) Mfg. List \$4,395.00

PT90PS (Play Only Stereo) Mfg. List \$2,700.00

Call For BSW Price

Mono Models Available

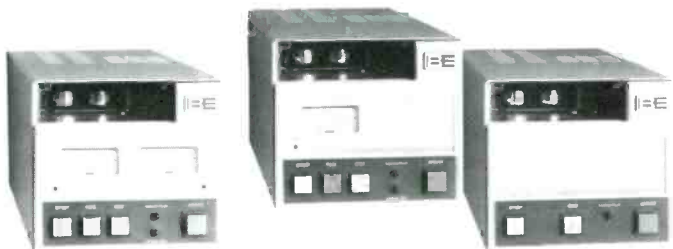

SERIES 2100C Cartridge Machines

No other cart machine combines the value and economy of the 2100C's. For example, the Series 2100C's include two cue tones (1 kHz and 150Hz) as a standard feature. Flat response, long life heads offer superb performance and the direct drive transport ensures maximum reliability. Features include: exclusive mono/stereo switching, precision machined deck with improved cartridge guidance system, direct drive transport, and low-voltage air damped solenoid.

2100CPS (Stereo Play) Mfg. List \$1,625.00

2100CRPS (Stereo Rec./Play) Mfg. List \$2,495.00

Call For BSW Price

Mono Models Available

TOLL FREE 800-426-8434

BROADCAST ELECTRONICS



DT90 SERIES Cartridge Machines

Available in mono and stereo record/play and playback configurations, Dura Trak 90 cart machines offer sparkling audio performance, durability, and all the features broadcasters need most, at an affordable price. Features: Rugged direct drive motor • Three cue tone sensing standard • Fast forward standard • Machined 1/2" thick aluminum deck plate • Cart previously-played lockout • Pressure roller cleaning mode • Balanced inputs and outputs • Front panel 1kHz record defeat • Low voltage, current regulated solenoid

DT90PS Mfg. List \$1,895.00

Call For BSW Price

DT90RPS Mfg. List \$2,795.00

Call For BSW Price

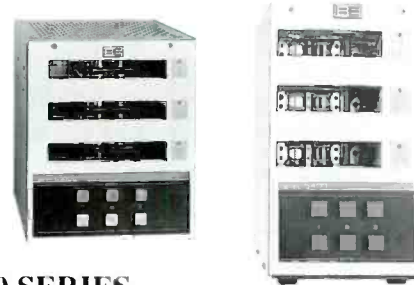

5400/5300 SERIES Multi-Deck Cartridge Machines

These machines provide clean sound reproduction and smooth, consistent performance in a 3 deck format. The 5300C and 5400C are similar in features, but the 5300C is wider and can accommodate larger format carts.

Both the 5300 and 5400 series machines feature plug-in decks for quick, easy servicing, quiet, powerful air damped solenoids, and repeat play lockout. Optional recording amplifiers allow for recording on deck three of both models. Three cue tones are standard on the record modules.

Call For Prices And Specifications



ST90 Eraser/Splice Finder

For fast, reliable erasure and splice detection, you can't beat the ST90 Splice Track. Running at 27.5 ips, it zips through carts providing a minimum of 85 dB of audio erasure. Splice detection is virtually 100% accurate because Splice Track senses the thickness of the splice itself rather than using the less reliable photocell method.

Mfg. List \$1,150.00

Call For BSW Price

FIDELIPAC



CTR 100 SERIES Cartridge Machine

The CTR 100 Series embodies unique features not available in any other machine in today's market. Central to the CTR 100 Series is CARTSCAN™. Now it is possible for you to intermix mono and stereo carts, elevated and standard levels, plus matrix record and playback, using the same machine. Simply attach a CARTSCAN label to your carts and the CTR100 automatically changes the characteristics of the machine electronically. Features:

- Bar graph LED level indicators • Front panel diagnostics
- Secondary and tertiary cue tones
- Fast forward • Two speed played flashing indicator
- Splice finder • Front panel 1 kHz add and defeat
- DC servo drive motor • Audio switcher and mixer
- On-board test oscillator • Played restart disable

CTR112 (Stereo Play) Mfg. List \$2,620.00

CTR124 (Stereo Rec./Play) Mfg. List \$4,390.00

Call For BSW Price



CTR90 SERIES Cartridge Machines

Dynamax has gained the respect and loyalty of broadcasters worldwide by producing extremely durable and functional machines. Now, the designers of Dynamax have achieved even greater versatility and reliability in the CTR90 series, providing all of the features and internal options required for modern radio broadcast applications. Features: 3 cue tones • FSK compatible • Advanced programmable internal logic • Status indicators • Real time min./sec. timer • Fast forward • Cleaning mode • Dolby HX Pro® headroom extension • DNR® dynamic noise reduction • Balanced XLR audio connections • Audio switcher for parallel operation • Bi-directional remote interconnects

CTR91 (Mono play) Mfg. List \$1,895.00

CTR92 (Stereo play) Mfg. List \$2,050.00

CTR93 (Mono Rec./Play) Mfg. List \$2,790.00

CTR94 (Stereo Rec./Play) Mfg. List \$3,050.00

Call For BSW Price

FIDELIPAC



CTR 10 SERIES Cartridge Machines

The Dynamax CTR 10 series of cartridge machines provides unsurpassed audio performance and today's most desired features including: Fast forward • Three cue tones standard • High speed cueing • Selectable front panel metering for audio, phase and cue tones on recorders • On board audio switcher and mixer • Transformerless audio circuitry • Played indicator with selectable restart disable

CTR12 (Stereo Play) Mfg. List \$1,935.00

CTR14 (Stereo Rec./ Play) Mfg. List \$2,890.00

Call For BSW Price

Mono Models Available



CTR 30 SERIES Cartridge Machines

The bottom deck records and plays as a standard feature in this space saving three stack system. All plug in boards are interchangeable with those used in CTR10 series machines. All decks are removable for service without disabling the machine. Audio switcher and mixer are included to permit connection to single console input. Flashing stop lamps warn operators of played cartridges.

CTR33 (Mono) Mfg. List \$4,250.00

CTR34 (Stereo) Mfg. List \$4,600.00

Call For BSW Price



ESD10 Eraser/Splice Finder

Dual, full track heads are incorporated instead of a coil below the deck plate on the ESD10. The result is an erase depth of 85 dB or more and better signal-to-noise ratio when you record your carts. Splice detection is extremely reliable. Tape speed is 27.5 ips.

Mfg. List \$1,150.00

Call For BSW Price

ITC

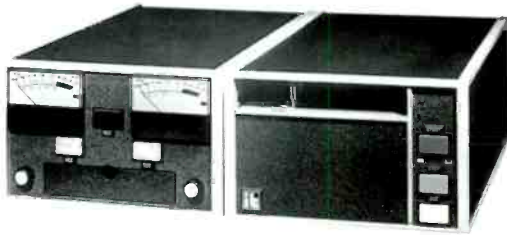

99B SERIES Cartridge Machines

Loaded with features, the 99B series delights the most discriminating user and listener. Central to the 99B series is the patented ELSA feature found in the recorder. The ELSA cartridge preparation feature automatically erases the cartridge, locates the splice and azimuth aligns the record head for maximum phase response performance. The 99B series standard features include: Microprocessor controlled logic, high speed cueing, and three cue tones. Crystal referenced phase lock loop DC brushless servo motor offers precise speed control and low wow and flutter. Plug in P.C. boards have socketed I.C.s with gold edge connectors and microprocessor design virtually eliminates all troublesome relays.

More than just a cartridge machine, the 99 Series from ITC is a complete system for recording and playback.

99B (Stereo record/play) Mfg. List \$6,645.00

Call For BSW Price



DELTA SERIES Cartridge Machines

The DELTA series consistently meets the tough requirements of professionals who demand outstanding audio performance in a reliable, mid-priced mono or stereo cartridge machine. Available as DELTA I single deck or space saving DELTA III triple deck units. DELTA IV recording amplifier converts a DELTA I reproducer or the bottom deck of a DELTA III reproducer into a recorder. Standard features:

- 3 cue tones
- High-speed cue on DELTA I reproducer
- Microprocessor controlled logic
- Crystal referenced phase lock loop DC brushless servo motor

Call For Price And Configuration

TOLL FREE 800-426-8434

ITC



SERIES 1 Cartridge Machines

The newest advances in mechanical and electrical technology have been incorporated in the SERIES 1 to provide premium quality and faultless operation at an affordable price. High speed cue, three cue tones, extra cool operation, and heavy cast aluminum deck are just a few of the features designed into this machine. Available in mono or stereo, record/play or play only, all SERIES 1 machines are individual 1/3 rack width units.

**Prices Start At \$1,795.00 Mfg. List Call For
Price And Configuration**



ESLV Eraser/Splice Finder

The ESLV combines erasing and splice locating in one easy, automatic step, ensuring consistent high quality audio reproduction from cartridge to cartridge. This eliminates the tedious task and inconsistency of manually bulking cartridges and visually locating splices and allows the operator to perform other tasks while the ESLV prepares the carts.

Microprocessor control assures a clean, deep erasure every time, eliminating unwanted program material and noise. Tape speed is 30 ips for splice finding.

Mfg. List \$1,225.00

Call For BSW Price

BSW
BROADCAST SUPPLY WEST

GE CAPITAL

Present
FlexLease

*The fast and easy way to get the equipment you need,
while taking advantage of all the financial benefits
leasing has to offer. Ask your BSW
Sales Rep for all the details.*

OTARI



CTM10 SERIES Cartridge Machines

The CTM10 series cartridge machines are designed for broadcast and audio post-production professionals. The microprocessor-controlled CTM10 offers the high performance, outstanding features, and "workhorse" reliability for which Otari products are known.

The series consists of three models: the CTM10SR stereo record/play deck; the CTM10MR mono record/play deck; and the CTM10 combination mono/stereo playback deck, to which recording capability is a simple conversion.

All CTM10 series units may be rack mounted side-by-side and take only 1/3 width rack space. These machines also feature selectable tape speed (15, 7.5 or 3.5 ips), Dolby HX-Pro bias optimization circuitry, and a wealth of other features.

- CTM10 (Mono/Stereo Play) Mfg. List \$2,195.00
- CTM10M (Mono/Record Play) Mfg. List \$2,445.00
- CTM10S (Stereo/Record Play) Mfg. List \$2,695.00
- CTM10R (Record Electronics) Mfg. List \$1,350.00

Call For BSW Price

CTM10R Required For All Recording Units

TAPECASTER



X701 SERIES Cartridge Machines

Look no further for the best value in cart machines. Tapecaster has long been established for great performance at a pleasing price. Features:

- Precision adjustable head bracket
- Super-torque hysteresis synchronous motor
- Heavy duty air-damped solenoid

- X701P (Playback Mono) Mfg. List \$860.00
- X701PS (Playback Stereo) Mfg. List \$1,035.00
- X701RP (Record/Play Mono) Mfg. List \$1,185.00
- X701RPS (Record/Play Stereo) Mfg. List \$1,345.00
- X701RPD (Mono Delay) Mfg. List \$1,350.00

Call For BSW Price

AUDICORD



S SERIES Cartridge Machines

Audicord's premium cartridge machine line, the S series provides high-end features at realistic prices. Features include:

(Playback) Three cue tones • Hi/Lo playback EQ • Replay lock-out • Automatic motor shut-off for long idle periods • Full cue status lights including un-cued cart indicator • Controls accessible via front panel pull-out drawers • +8dBm output selectable at 600 or 150 ohm • Extremely rugged deck, headblock, and guides.

(Record) Multi-function meter system with automatic switching from record to play • Hi/Lo record EQ • Bias and tone recording indicators • Record shut-off with end of SEC tone • Record timer • Complete remote control facilities (plugs supplied)

- S11 (Mono Play) Mfg. List \$1,120.00
- S16 (Stereo Play) Mfg. List \$1,210.00
- S21 (Mono Rec/Play) Mfg. List \$1,840.00
- S26 (Stereo Rec/Play) Mfg. List \$2,030.00

Call For BSW Price



DL SERIES Cartridge Machines

Here is durability at the lowest cost. The Audicord DL Series stands up to the daily grind of broadcasting and offer features that make the operator's job easier. Features include:

(Playbacks) Replay lock-out to prevent accidental replay errors • Manual or automatic muting of output audio (from SEC cue operation) • Cue tone status indicator lamps • Both SEC and primary • Mute lamp to indicate audio on or off status • Automatic motor turn-off if selected conserves power and heat

(Record-Plays) Full view meters for accurate level monitoring. • Bias and tone presence indicators • Automatic meter switching from record to replay • Optional recording shutoff with the end of SEC tone • Full +8dBm output ability with 12db of headroom • Slide back cover design allows for quick and easy access for cleaning • Complete remote control connections (plugs are furnished)

- DLPM (Playback, Mono) Mfg. List \$920.00
- DLPS (Playback, Stereo) Mfg. List \$1,000.00
- DLRM (Record/Play, Mono) Mfg. List \$1,290.00
- DLRS (Record/Play, Stereo) Mfg. List \$1,480.00

Call For BSW Price
Dual Transport Units Available

TAPECASTER



X100 Automatic Cartridge Loader

The X100 from TapeCaster provides accurate tape length measurement through precision calibrated minute and second face mounted controls. Operation is easy with the use of a single lever which activates the reset, start, and run functions of the X100.

Mfg. List \$620.00

Call For BSW Price

STL



TEST CARTS

BSW carries the complete line of STL tape products. All you need to do when ordering alignment carts is specify your favorite cart shell and bias preference.

BSW



CARTRIDGE LABELS

These labels are removable and are available in six colors (black, red, orange, green, blue, yellow).

Sheet (10 Labels) 1-25 sheets 50¢ per sheet
26+ sheets 40¢ per sheet

Rolls (1000 Labels) \$19.95 per roll

Need prices on a major project? Save yourself time and FAX us your equipment list. We'll have a complete price quote back to you in no time.

BSW FAX # 206-565-8114

BROADCAST DEVICES



APC200 Phase Corrector

It's a fact that stereo phase error drastically affects your mono sound. The smallest phase error can degrade high frequency performance. Larger phase errors are audible in stereo and can affect your stereo image as well. The Rightrack gives you a quick and easy method of making sure that your existing tape equipment provides phase accurate, superior sound—in mono as well as stereo. Both visual and aural indications of phase performance allow you to provide precise phase correction. With a built-in reference oscillator, the Rightrack doubles as a piece of studio test equipment. Easy alignment, verification of tape head azimuth and frequency response makes the Rightrack even more valuable in any production studio.

Mfg. List \$995.00

Call For BSW Price

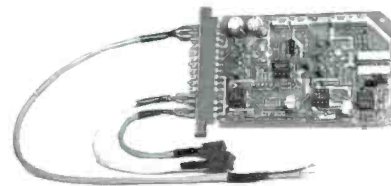

ATF200-2 Replacement Transformer

Replace the input transformers on your ITC Series 99* recorder and improve its performance. Broadcast Devices' ATF200-2 Active Transformer Card offers improved headroom, transient response and frequency response over the original transformer balanced inputs. With an FET differential input, the ATF200-2 is a stereo balanced circuit that mounts on the rear of your existing input connectors. It's simple and quick to install—we supply you with all the parts needed, including a step-by-step manual. The ATF200-2 runs off existing power supply and can be either AC or DC coupled to the audio input. Multiturn controls are provided for gain, offset drift and common mode rejection. *Series 99 is a product of International Tapetronics Corporation.

BSW Price \$159.00

What Has Your Bank Done For You Lately??

When was the last time your bank or credit union offered to give you an equipment loan that covered 100% of the equipment cost, including shipping and installation, that featured low monthly payments and built-in tax advantages, along with insurance to cover the equipment for the duration of the loan, and could be approved in just a few days? Never...Right! If this sounds like the type of financing you might be interested in, call your BSW representative. Toll-Free, to find out how a FlexLease program can offer you all of these benefits.

FIDELIPAC



328
Head Insertion Gauge
BSW Price \$7.90



326
Height Gauge
BSW Price \$28.70

387
Right Angle Zenith
BSW Price \$34.15



Lubricated Tape For Carts



AUDIOPAK

FORMULA 17(605)
Standard Output

- 17918100 (1800' Reel) \$13.30
- 17942605 (4200' Hub) \$16.25
- 17984605 (8400' Hub) \$13.95 (While Supplies Last)

Q17(613)

- 17618613 (1800' Reel) \$15.80

ITC

219
High Output/Low Noise
2191425HPB (2500' Hub) \$24.00

TOLL FREE 800-426-8434

NORTRONICS/VIKRON



TAPE HEADS

When your cart machines need replacement heads BSW is the supplier to call. We are proud to carry both Nortronics and Vikron quality replacement heads.

Nortronics has replacement heads for just about every cartridge and reel-to-reel machine you can name.

Vikron is an approved source for all broadcast cart machines including ITC, Fidelipac, Audicord, SMC, IGM, and BE.

Prices Vary Upon Application.
Call Us With Your Requirements. 1-800-426-8434

AUDIOPAK



AA4
Stereo Cartridge

The key feature of the AA4 is the SGS4 broadcast mastering tape which offers nearly 5dB higher saturation headroom at 16kHz (7 1/2 ips) compared to the HOLN Tape in AA-3 cartridges. No bias adjustment is usually necessary when recording on machines optimized for HOLN or other "hot" tapes.

AA3
Stereo Cartridge

Precision molding provides highly accurate tape guidance inside the cartridge for excellent stereo phase stability. Tough, reinforced plastics resist warping and damage due to even severe mishandling, thus assuring the phase will not change under any use conditions for the life of the cartridge.

AA2
Mono Cartridge

The most popular cartridge on the market for monaural broadcasting. Standard bias tape in the familiar black shell.

If it has to do with carts, BSW is the supplier for you. We stock the largest supply of cartridges, machines, and maintenance supplies in the industry. When you can't afford to wait, call BSW. 12 hours daily 1-800-426-8434.

ITC



**ITC CART II
Stereo Cartridges**

The innovative design of this cart combined with its superior mastering tape formulation offer you performance capabilities far beyond what you have come to expect from broadcast cartridges. 1.5 mil tape and unique padless tape path greatly prolong the usable life of the carts, making them a good investment for your cart dollars.

**Call BSW With Your Cart Requirements
We Offer Competitive Prices And Outstanding Delivery.**

FIDELIPAC

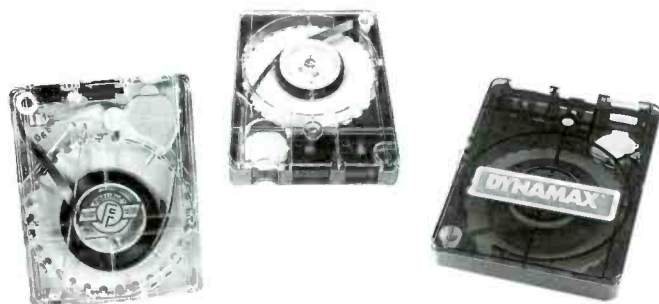

**DYNAMAX COBALT
Stereo Cartridge**

The Dynamax cobalt cartridge is rapidly gaining recognition as something special. A new generation cartridge loaded with broadcasting's first cobalt tape. The Dynamax shell is constructed of high grade engineering plastic for more strength, greater heat stability and dimensional accuracy. The new cobalt tape provides extra headroom necessary when carting CD's.

**MASTERCART
Stereo Cartridge**

The Mastercart provides maximum stereo phase tracking and performance at standard operating levels.

**300 SERIES
Mono Cartridge**

The widely used grey cart has been the workhorse of the industry since 1962.

**Call For BSW Competitive Prices
And Outstanding Delivery.**

TOLL FREE 800-426-8434

**YOU
CAN'T
ORDER...**

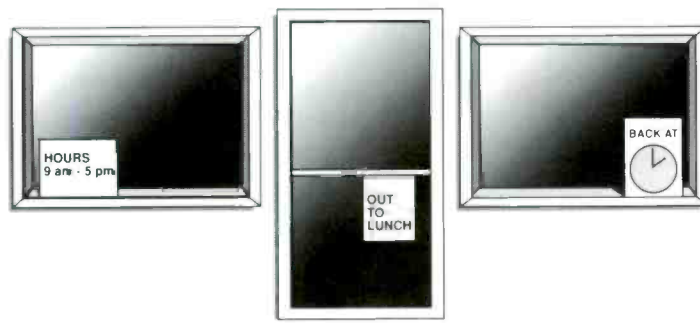

**...From A Company
You Can't Reach**

Accessibility may be the most important quality of a good equipment supplier. A company can offer you a long list of reasons why you should do business with them. Yet, none of these reasons mean a thing if you can't reach them when you need to place an order. At BSW, we work overtime to ensure you immediate access to our qualified sales staff. We're open 12 hours a day (6 a.m. to 6 p.m. Pacific and 9 a.m. to 9 p.m. Eastern) so you can call us when it's convenient for you, morning or evening. With over one million dollars of inventory on hand, chances are we have what you need in stock and can have it in your hands the next day. So the next time you need to reach a supplier, call BSW, America's Full-time Broadcast Supplier.

BSW®

BROADCAST SUPPLY WEST

America's Full-Time Broadcast Supplier

ORDERS • INFORMATION • SPECIFICATIONS
7012 27th Street West Tacoma, WA 98466

Cassette Machines

TASCAM



122MKII Professional Cassette Deck

The 122MKII offers extended durability and reliability features an extremely high standard of audio reproduction quality with a full 3-head system featuring top performance CA (Cobalt Amorphous) record and playback heads. Adding to the strength of this machine are uncompromised electronics, a precision FG-servo direct-drive capstan motor, balanced XLR type inputs and outputs (+ 4 dBm), an accurate cue and review function, and Dolby B/C noise reduction.

Mfg. List \$1,099.00

Call For BSW Price



112/112B Professional Cassette Decks

The 112 is a basic 2-head machine that fully maintains the professional quality performance, stability and reliability of the topline 122MKII. Special care has been taken in the 112 to ensure unfaltering transport reliability, stable circuit operation, low distortion and a wide dynamic range. Dolby HX Pro and Dolby B and C type noise reduction are incorporated. The 112 is available with balanced inputs and outputs.

112 Mfg. List \$679.00

Call For BSW Price

112B Mfg. List \$749.00

Call For BSW Price

YAMAHA



C300 Professional Cassette Deck

Everything about this deck is top notch, from the 12-layer amorphous heads to the dual capstan tape transport, to the fine styling and logical control layout.

Features include: Manual or automatic bias setting • DBX, Dolby B and C noise reduction • Wired remote control • Optional wireless remote allows advanced programming functions • Master fader • Dual speed fast forward/rewind • Music search • Zero to cue repeat play • Balanced +4 dBm input and output • Built-in rack ears

Mfg. List \$1,095.00

Call For BSW Price

MARANTZ



PMD430 Portable Cassette Recorder

The PMD430 provides professional-caliber location recording in stereo and features 3 heads, for true off-the-tape monitoring during the record process. Noise reduction dbx allows the PMD430 to achieve a totally inaudible signal-to-noise ratio of 75 dB, for clear reproduction of low-level speech and music. Dolby B noise reduction has been included for compatibility with other decks. Other features include:

- Illuminated VU meters • 3-Digit tape counter • Built-in speaker
- Memory rewind • Bias fine adjustment • Auto shutoff, Auto replay
- 4-Way power supply • Pitch control • 3-Position mic attenuators (0-5-30db) limiter • 3-Position tape selector (metal, CrO2, normal)

Mfg. List \$599.00

Call For BSW Price



PMD201/221 Portable Cassette Recorders

These are, without a doubt, the most popular portable, mono, cassette recorders used in broadcast. The PMD221 and PMD201 are loaded with features that make life on the road a lot easier. 3 "D" size batteries provide 7 1/2 hours of continuous recording and an AC power supply is provided for longer time requirements. Optional Nicad rechargeable battery pack yields 5 1/2 hours of use.

A modular telephone jack is provided for direct telephone recording and playback. The PMD221 is a 3-head design allowing tape monitoring during the recording process. Other features common to both include:

- Switchable limiter • Anti-roll transport • Built-in monitor speaker
- Vari-speed • 3-Digit tape counter • External speaker jack
- 3-Position mic attenuation • Line input and output jacks
- 3-Position tape selector (normal, CrO2, metal) • Cue and review
- Volume and tone control • Automatic or manual record level
- Built-in electret condenser microphone
- 3-Position automatic noise cancel switch

Accessories: Carry case, Rechargeable battery pack

PMD221 Mfg. List \$369.00

Call For BSW Price

PMD201 Mfg. List \$299.00

Call For BSW Price

SONY



TCD5 PROII Portable Cassette Recorder

The TCD5 PROII is ideally suited to a wide range of professional audio applications. Twin VU meters, LED peak level indicator, built-in monitor speaker, and headphone jack eliminate guess work so you can have great recordings. Peak limiter and mic attenuator eliminate clipping and suppress excess signal levels by 20 dB to prevent distortion. Inputs are mic level XLR connectors. Outputs are unbalanced RCA connectors. Powered by 2 "D" size batteries, the TCD5 PROII allows 4.5 hours of recording time. AC power supply available optionally.

Mfg. List \$869.00

Call For BSW Price

PANASONIC



RQL335 Portable Cassette Recorder

Features: AC/Battery operation • Includes AC adaptor/recharger and Ni-Cad Batteries • Built-in condenser mic with sound level equalizer (SLE) • Three tape speeds • Auto-stop and pause • LED indicator(record/battery and SLE) • One touch and voice activated recording • Cue and review • Tone control (HI/LO) • Tape counter • Jacks: DC-in, ext. mic, monitor

Mfg. List \$54.95

Call For BSW Price

YAMAHA

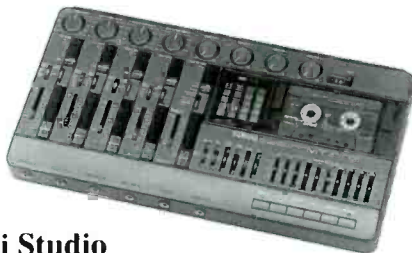

MT100II Cassette Mini Studio

Talk about convenient... Here's a mini production studio you can fit into your briefcase. The MT100II includes a 4-track recorder, 4 channel mixer, extensive patching network, and a graphic EQ all in one compact unit. This is no toy. Features and specs are suitable for professional use.

Mfg. List \$495.00

Call For BSW Price

TECHNICS



RSTR265 Dual Cassette Deck

Features: Auto reverse (both decks) • High speed editing • Synchro start editing • 24 hour playback • Cue/review • L/R record level controls • Dolby B & C noise reduction • Dolby HX Pro frequency extension

Mfg. List \$249.95

Call For BSW Price

AIWA



ADWX777 Dual Cassette Deck

Features: Auto reverse play/record • High speed dubbing • 24 hour continuous playback • Dolby B & C noise reduction • Extremely stable tape transport

Mfg. List \$330.00

Call For BSW Price



ADS37 Cassette Deck

This machine incorporates feather-touch IC logic control, Dolby B & C noise reduction, fine bias adjustment, and cue/review.

Mfg. List \$180.00

Call For BSW Price

TASCAM



102 Cassette Deck

Features: IC logic Control • Dolby B & C noise reduction • Dolby HX Pro frequency extension • Bias fine tuning control • Electronic tape counter with index and tape-run-time modes • Right, left, and master record level controls • Optional RMS-2 rack shelf

Mfg. List \$215.00

Call For BSW Price

BSW



Custom Loaded Cassettes

BSW cassettes are custom loaded at our facility. Get the finest quality cassettes without having to pay for middle man mark up and fancy packaging. Standard lengths are 5, 10, 20, 30, 45, 60, and 90 minutes, with custom lengths available for the asking. Three grades of tape are available: Standard voice quality. Deluxe music quality (HOLN), and Prime quality (high bias chromium compatible) Quantity price breaks are available. Minimum quantity is 25 cassettes.

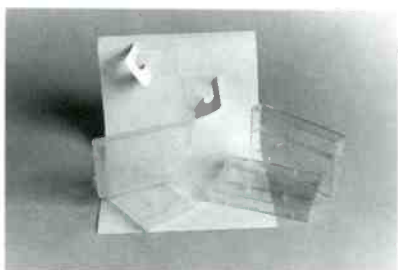

CASSETTE BOXES / LABELS

BSW offers two types of cassette boxes: Clear, hard-shell (Norelco style) and soft semi-clear (poly-box style). Label your cassettes with BSW cart labels. White, 12 per sheet.

- CLEARBOX** BSW Price 14¢ ea 100+ 12¢ ea
- POLYBOX** BSW Price 22¢ ea 100+ 19¢ ea
- CASSSHW** BSW Price 25¢ ea 100+ 20¢ ea (sheet of 12 labels)

DISCWASHER



FG1230



FG1450



FG1230 Cassette Head Cleaner

Perfect Path® safely removes tape oxides and contamination from delicate tape heads.

Mfg. List \$4.99

Call For BSW Price

FG1450 Cassette Demagnetizer

D'Mag™ helps restore high frequency content to tapes.

Mfg. List \$19.95

Call For BSW Price

TOLL FREE 800-426-8434

Broadcast Supply West,



East, North & South

As a company that serves the nation's broadcasters, we have often considered opening regional offices to improve our service or expand our sales. In the final analysis, we determined that regional offices would only serve to retard service and drive our overhead sky high. So here we are in the west, maintaining the most efficient and economical distribution system in the broadcast industry. Regardless of your location, you benefit by saving money, enjoying quick delivery, and receiving exceptional service. We are open 12 hours daily, 9a.m. to 9p.m. east, 6a.m. to 6p.m. west, so you can call us at your convenience for all your audio equipment needs. From any point on the compass, BSW is as close as your telephone.

BSW®

BROADCAST SUPPLY WEST

America's Full-Time Broadcast Supplier

ORDERS • INFORMATION • SPECIFICATIONS
7012 27th Street West Tacoma, WA 98466

DENON



DN950FA



DN970FA

DN950FA/DN970FA CD Cart Players

Denon introduced the world's first CD cart player system at the NAB show in 1987. The concept became an immediate hit and since then has become the leader in high quality professional CD players. An obvious advantage of the CD Cart format is that the CD is permanently stored in a CD Cartridge to protect it from damage resulting from scratches, dust, and fingerprints. Upon loading, a shutter door on the cartridge opens to expose the CD to the laser.

The DN950FA makes use of the same simple design and ease of operation as the first model that was introduced. In addition to simple operation and extreme durability, this machine features a digital display showing remaining or elapsed time in minutes, seconds, and frames, instant cueing aided by a select dial, a simple audition function, single or continuous play, 4-times oversampling, variable output level through XLR connectors, and complete remote accessibility.

The DN970FA goes beyond the DN950FA with advanced features like 3 cue point memory, instantaneous start time, variable speed, digital audio output, track and index search, external synchronization, and more.

DN950FA Mfg. List \$1,499.00 Call For BSW Price
DN970FA Mfg. List \$2,599.00 Call For BSW Price

TECHNICS



SLP1300/SLP1200 Compact Disc Players

Technics developed the SLP1300 to serve as a reference CD player for broadcast and other situations where the highest possible sound quality is demanded. No other player has all these features at this price. Look at the advantages of the 1300 ... 8 times oversampling, 4 digital-to-analog converters, XLR connectors with +8dBm output, vari speed, digital output, cue wheel for precise cueing with audio. In addition, the SLP1300 cues to music automatically. Features:

- High resolution digital filter
- Double isolated anti resonant cabinets
- Search dial cueing - precision pitch control

The SLP1200 is Similar to SLP1300 but with unbalanced outputs.

SLP1300 Mfg. List \$1,699.95 Call For BSW Price
SLP1200 Mfg. List \$1,399.95 Call For BSW Price

TOLL FREE 800-426-8434

TECHNICS



SLPS50 Compact Disc Player

Features:

- MASH PWM 4-DAC system for ultimate fidelity
- Linear motor transport and full anti-resonance construction
- Digital output
- Auto Cue-to-music
- Peak search for optimizing levels
- Ten-key programming

Mfg. List \$187.00

Call For BSW Price



SLP370 Compact Disc Player

Features:

- MASH PWM 4-DAC system for ultimate fidelity
- Linear motor transport and full anti-resonance construction
- Auto Cue-to-music
- Ten-key programming

Mfg. List \$120.00

160
Call For BSW Price



SLP170 Compact Disc Player

Features:

- MASH PWM 4-DAC system for ultimate fidelity
- Linear motor transport and full anti-resonance construction
- Auto Cue-to-music

Mfg. List \$105.00

199.95
Call For BSW Price

Don't Panic... We're Still Open

BSW's extended hours and West Coast location are great for those times when you just have to have that piece of important equipment. We're open 6 a.m. to 6 p.m. Pacific time, 9 a.m. to 9 p.m. Eastern.

CD Players

TASCAM



CD701/RC701 CD Player/Remote Control

The CD701 Player and RC701 system features a full-size turntable and unique disc clamping system that virtually eliminate tracking errors, and "ZD Circuitry" for impeccable CD sound with an absolute minimum of digital noise. Up to four CD701 units can be controlled by the sophisticated RC701 Control Unit. The RC701 offers dial-controlled search with frame accuracy, Auto Cue, event play, link play, +6% pitch control, and more. Should you only need simple transport functions, the CD701 can be programmed for operation without the RC701.

CD701 Mfg. List \$2,199.99

Call For BSW Price

RC701 Mfg. List \$1,249.00

Call For BSW Price



CD401 Compact Disc Player

The CD401 is rack mount ready, and has XLR balanced outputs. It also allows fader-start operation, and has a remote control unit that can be used in either the wired or wireless mode. It has a precision 3-beam pickup controlled by a special track and focus system, 18-bit 4-times oversampling, and dual D/A converters.

Mfg. List \$799.00

Call For BSW Price



CD301 Compact Disc Player

With balanced outputs, built-in rack mounting, and a hard-wired 10-key remote control, this unit is a natural in broadcast on-air studios and production rooms. Notable features on the CD301 are the single play option that automatically stops playback at the end of a cut, and a special link function that allows one unit to start another unit for sequence play. Now you can have a professional CD player that's truly affordable.

Mfg. List \$549.00

Call For BSW Price

TOLL FREE 800-426-8434

STUDER

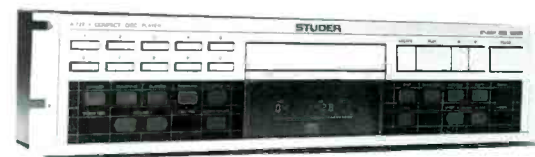

A727 Compact Disc Player

Armed with extensive feedback from CD users in the field, Studer designed this machine to meet the tough demands of professionals by offering the following features:

- Very short access times
- Quick, quiet CD drawer
- Start Review & End Review
- Auto Cue
- Digital output
- Serial port (RS422, SMPTE/EBU) & parallel remote port
- Logically arranged controls with large buttons
- Rack ears included

Mfg. List \$2,695.00

Call For BSW Price



A730 Compact Disc Player

Powerful, rugged, and easy to use, the A730 is perfect for demanding broadcast facilities. This unit can be used on the desk top or flush mounted, for on-air or production. Features include:

- Professional transport mechanism for long life
- High speed CD loading system
- Auto Cue & Auto Pause (end of cut stop)
- Frame accurate cue wheel
- Start Review
- Varispeed (+/-10%)
- Advanced Cue Memory
- Complete remote interface
- Balanced audio outputs & digital output

Mfg. List \$3,795.00

Call For BSW Price

BSW Delivers

BSW's extensive inventory assures you outstanding delivery. Our special discount rate on Federal Express saves you dollars and time.

DENON



**CD TEST
Test Disc**

Turn your compact disc player into a powerful test signal generator. This outstanding CD Test Disc from Denon includes 99 audio tests that include frequency sweeps, tone bursts, pink noise, 1M distortion, square waves, and more.

BSW Price \$32.00

TRACKMATE



**TM301
Disc Shield**

The Disc Shield was designed to protect your CDs from permanent damage. The crystal clear, self-clinging shield is easily installed and will stay in place, protecting your discs during normal handling or accidental dropping. Each package includes 10 shields.

BSW Price \$14.95

DISCWASHER



**CDC
CD Cleaner**

Discwasher's patented rotary technique safely and effectively removes contaminants from your CDs.

Mfg. List \$17.95

Call For BSW Price

DISCWASHER

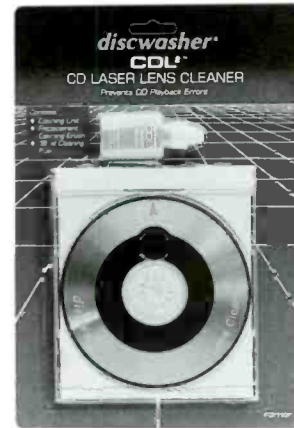

**FG1107
CD Lens Cleaner**

Safely removes contaminants from CD player's laser lens with unique wet/dry cleaning action. Kit includes cleaning solution, cleaning disc, and one replacement cleaning pad.

Mfg. List \$27.95

Call For BSW Price

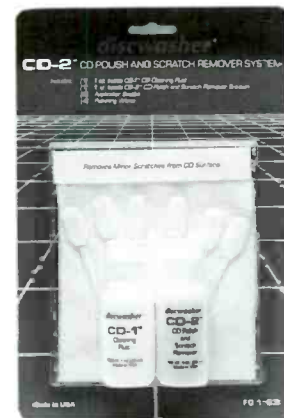

**FG1163
CD Repair Kit**

This handy kit can actually remove small scratches and blemishes in the disc. The kit includes fluid, polish, applicators, and polishing wipes.

Mfg. List \$12.95

Call For BSW Price

FLEX LEASE

Innovative lease programs made available by BSW and GE Capital may be just the right answer for your equipment financing dilemma. Whether you're interested in low monthly payments, 100% financing without the wait, conserving your working capital, or taking advantage of tax incentives there's a Flex Lease program just for you. Call A BSW representative today for more information.

SIMS



SILENCERS

Audio Component Isolators

Sims Silencers are component feet made from a unique energy absorption material called NAVCOM™. NAVCOM was specifically engineered to dampen unwanted vibrations throughout the audio spectrum 10 to 30,000 Hz. Silencers allow your audio components to process pure audio signals without the false input of unwanted vibrations. Silencers can be used on CD players, amplifiers, turntables, or any other sensitive audio equipment. Four silencers to a package.

BSW Price \$59.95

VALENTINO INC.



CD Sound Effects

From the delicate wisps of pages turning in a book to the dynamic roar of a 747 taking off, you'll be amazed at the quality of these digitally recorded and mastered discs.

All Valentino sound effects are grouped together by category for convenience and all sound effects are individually tracked on each CD (no sub-indexing) so cuts are easy to locate in any CD player. There are no additional royalty, clearance or license fees required once a library is purchased. Available as a ten CD set (your choice of volumes) or as an entire 28 volume library.

SFXCD 10 Vol. Set BSW Price \$499.00

28 Vol. Library BSW Price \$1,195.00

TOLL FREE 800-426-8434

BSW

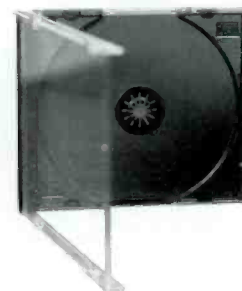

CDBOX

CD Jewel Boxes

Whether you're replacing broken CD cases or trying to protect the CDs music companies send you in a plastic bag, BSW CD boxes are the perfect solution.

Quantity	1-49	50-99	100-499	500+
BSW Price	79¢	69¢	59¢	50¢



CD Organizers

Color code your CDs with our versatile CD labels. Separate discs by format, day parts, new hits ... whatever. Each label has space for you to write in intro and running times, tempo, type of ending, etc. Choose red, blue, green, and yellow. 84 labels per package.

BSW Price \$7.95 per pkg

AUDIO SOURCE



LLC1

Laser Lens Cleaner

A dirty laser lens on your CD player can cause skipping or false cueing. The LLC1 cleaner is an easy and effective solution. Just insert into the CD compartment, hit play, and within seconds your CD lens is clean.

BSW Price \$29.95

ARRAKIS

10,000 SERIES Audio Consoles

The 10,000 series are world class consoles that combine the best features from on-air consoles with features found on multi-track studio consoles in a single mainframe. Features include:

- "On-Air", 4-track and 8-track production capability
- Ten main audio busses, two stereo auxiliary busses, stereo cue buss and stereo solo buss
- "Front of the console" access to all bussing connectors via hydraulic assisted, hinged top.
- Two stereo auxiliary busses for effects/foldback
- External regulated and protected power supply features independent supplies for audio, logic, monitor and phantom power
- Stereo cue system with autocue switching of earphones
- Monitor system provides feeds for console, host, co-host and guest headphones



- Separate control room and studio monitor systems for multiple studios
- Multistation talkback or intercom systems for multiple studios
- Multifrequency test oscillator
- Independent telephone mix-minus module
- Comprehensive remote control logic for each input

Prices Based On Configuration

12,000 SERIES Audio Consoles

The most advanced technology has been incorporated into the new Arrakis 12,000 Series. Four different input modules are available, each with 2 inputs and 3 stereo outputs. Choose from three mainframe sizes to accommodate up to 28 input modules. Extensive metering and timer are standard along with Penny and Giles faders, ITT Schadow switches, gold board connectors and solid oak trim. Features:

- Easy connectorized installation
- Stereo cue system
- VCA controlled faders
- Three stereo output busses
- Universal mainframe buss design - any module can be placed anywhere
- Comprehensive logic system
- Total turret support



- External regulated and protected power supply
- Mic modules available with panning feature
- Line modules available with mode select feature
- Monitor system for control room and two studios
- Two telephone mix-minus busses

Prices Based On Configuration

5,000 SERIES Audio Console

The Arrakis 5000 Series Console is a full featured, modular console accommodating 16 channels plus a channel for accessory modules and a standard control room monitor module. The meter bridge contains a clock, timer and meters for both program and audition stereo outputs. The power supply is external, regulated and protected. The entire modular front panel hinges up to expose the input/output terminal strip connectors. All wiring is performed from the front of the console.

The standard console preamp module features two balanced stereo inputs, program and audition output assignment switches, stereo cue



accessed by detent on the Penny and Giles slide fader, and momentary lighted module on and off switches. Remote start/stop, prefader patch points and remote module controls are standard in the 5000. Dimensions are only 30" wide by 17" deep.

Prices Based On Configuration

ARRAKIS

Arrakis Audio Consoles

Arrakis consoles are exceptionally cost effective without compromising reliability or product features. All Arrakis products are engineered to be reliable first. No expense is spared in the use of quality components, like Penny and Giles slide faders and ITT Schadow switches. Any product that they build must do more for the price than any competitive product. In fact, Arrakis provides features in their consoles that many times aren't available from other manufacturers at twice the price. Features available on all consoles:

- VCA level controls
- DC controlled - no audio pots or switches
- 10 watt per channel monitor amp
- 2 watt cue amp & 2 watt headphone amp
- Solid oak end panels and armrest
- Modular regulated power supply
- Mono mixdown standard
- Telephone mix-minus standard
- Remote start standard (except 150SC)

BACKED BY A 2-YEAR WARRANTY SPECIFICATIONS FOR ALL CONSOLES

INPUTS: 1 or 2 per channel Remote select switches - 7 inputs each
low level - 1000 ohms, -50 dBm typical input level Trim pot adjustable level from -60 to 30 dBm
high level - 100,000, 0 dBm typical input level 30 dB trim adjustable A & B inputs

PROGRAM/AUDITION OUTPUTS: Identical 600 ohms balanced, +27 dBm maximum output. Mono mix and mix-minus busses are the same.

MONITOR AMP: Selectable between Program (Audition) and external inputs. 10 watts at 8 ohms per channel. Line out for external amps.

CUE AMP: Selected by detent on the individual volume pot. 2 watts RMS at 8 ohms per channel.

EARPHONE AMP: Selectable between Program (Audition), Cue and External, 2 watts RMS at 8 ohms per channel.

REMOTE START: Each of the channels has a ground closure for start. Jumpers determine momentary or sustained action. A & B start individually on 2 input per channel models. Remote start not available on the 150SC.

DIMENSIONS: 30"W X 17"D x 7"H.

FREQUENCY RESPONSE: +5 dB 20 Hz to 20 kHz.

HUM AND NOISE:

mic channel: -70 dB below +8 dBm, -50 dBm input, 20 kHz.

line channel: 100 dB below +18 dBm, +18 dBm input, 20 kHz.

TOTAL HARMONIC DISTORTION: .02% typical at +8 dBm.

TOLL FREE 800-426-8434



2100SC12S

2100SC12S

12 channel, 34 inputs, program and audition outputs

Mfg. List \$5,995.00

Call For BSW Price

1500SC8S

same as 2100SC12S, only 8 channels, 28 inputs

Mfg. List \$4,495.00

Call For BSW Price

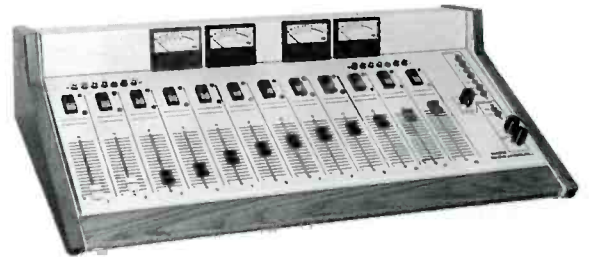

2000SC12S

12 channels, 24 inputs, program and audition outputs

Mfg. List \$4,995.00

Call For BSW Price



500SC8S

8 channels, 25 inputs, program and audition outputs

Mfg. List \$3,595.00

Call For BSW Price

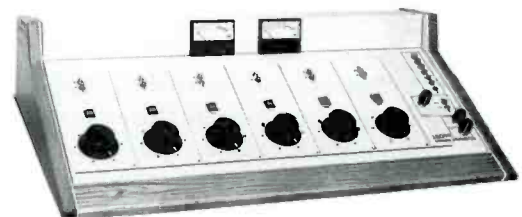

150SC6S

6 channel, 18 inputs, program output

Mfg. List \$2,495.00

Call For BSW Price

AUTOGRAM



R/TV20 Audio Console

When you need mixing flexibility, you'll want the R/TV20 from Autogram. 18 slide faders have a single input, the remaining 2 faders have 8 inputs each to allow multiple auxiliary sources. Total of 34 stereo inputs on 20 channels. Standard features include: VCA level control, Penny and Giles linear conductive plastic pots, shadow selector switches, up to eight patchable microphone preamplifiers, and remote control capability. Optional live assist package plugs into the R/TV Series console and offers full remote control plus four live assist programs, each with 32 step capability.

R/TV20 Mfg. List \$12,995.00

R/TV12 (not shown) Mfg. List \$10,775.00

Live Assist Package Mfg. List \$1,395.00

Call For BSW Price



IC10A Audio Console

The IC10A features high quality step attenuators, 2 inputs per channel with 2 six position remote select switches. Remote start switches, headphone monitor and cue amplifiers standard. 2 stereo outputs with mono mixdown are standard as well.

IC10A (10 Channel Stereo 28 Inputs) Mfg. List \$8,986.00

AC8A (8 Channel Stereo 26 Inputs) Mfg. List \$6,830.00

AC6A (6 Channel Stereo 23 Inputs) Mfg. List \$5,495.00

Call For BSW Price
Transformer Versions Available

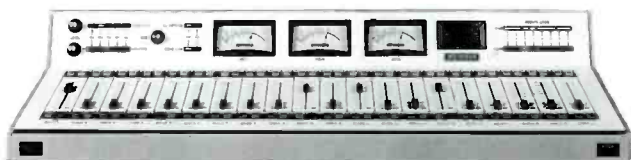

LC10A Audio Console

The LC10A is a ten-pot, linear fader audio console. Features include: push button select switches, engraved front panel ITT Shadow switches, VU meter select, remote select and A/B channel select, remote start. Input and output configurations similar to model IC10A.

Mfg. List \$9,404.00

Call For BSW Price

Pacemaker Series Audio Consoles

Pacemaker consoles offer an incredible amount of flexibility without an enormous price tag.

For newsroom operations, you'll want the Pacemaker 648 and the 618. The 648 features 8 inputs per channel (48 inputs total). On the 618 channels 1-5 have dual inputs, channel 6 has 8 inputs. Machine logic controls are standard on both consoles.

For the control room, the Pacemaker 8-channel 828 or 10-channel 1032 offer additional mixing flexibility. The 828 has 28 stereo inputs, the 1032, 32 stereo inputs. Each console has 2 inputs per channel and 2 banks of remote selectors. Features:

- VCA level controls
- Optional Autoclock or Autocount
- No audio transformers
- Shadow selector switches
- Electronic switching
- Engraved front panel
- Penny and Giles faders
- Pluggable miniature terminal strips

Outputs: 1 Stereo Program, 1 Mix-Minus, 2 Line Monitor, 1 Stereo Audition, 1 Mono, 2 Headphones, 1 Cue

618 Mfg. List \$4,995.00

648 Mfg. List \$6,495.00

828 Mfg. List \$5,995.00

1032 Mfg. List \$7,200.00

Call For BSW Price

618



648

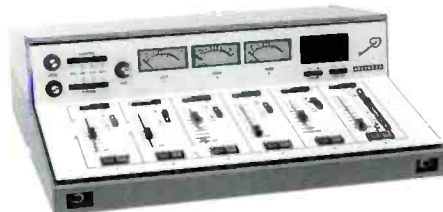

1032

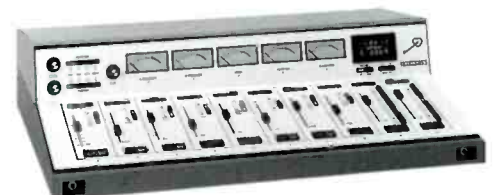

AUDITRONICS

210 SERIES

Audio Consoles

210 Series consoles are available in four mainframe sizes (6, 12, 18, and 24 channel) to meet any application. The large assortment of optional modules permits you to configure the console to meet your particular, and sometimes unique, operating requirements without having to resort to expensive, custom construction. Standard mainframe features:

- Totally modular design • 9 positions for 7" accessory modules • 2 stereo and two mono output busses • Control room monitor module • Stereo headphone out with EQ • Built-in Clock and timer

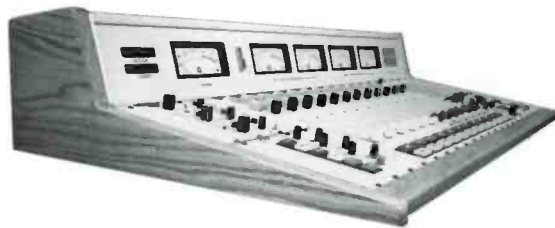

- VCA controlled faders • Built in cue amp, speakers and metering
- Active balanced input/output circuitry • 1 year warranty

Pricing Based On Configuration

AUDIOARTS

A50

Audio Console

Clever engineering and the latest advances in electronic assembly give this console high-end features and quality at a truly affordable price. 8, 12, and 18 channel models are available. Features:

- Any combination of mic and line inputs available • two inputs per channel • Program, audition and telephone outputs
- Remote start switches • Full function event timer • Separate control room and studio source selectors • Full talkback system
- Built-in headphone amplifier • Built-in cue amp and speaker
- Channel on/off remote controllable • On-air tally opto-relay



- Plug-in faders and pots • Fully-enclosed aluminum chassis resists RF
- Six-position line preselector module option
- Digital Clock (18 channel model only)

A50-8 Mfg. List \$4,495.00

A50-12 Mfg. List \$6,495.00

A50-18 Mfg. List \$8,895.00

Call For BSW Price

Call For BSW Price

Call For BSW Price

AUDITRONICS

310 SERIES

Audio Console

Designed as a modular system, the 310 Series is easily expandable in capabilities, without sacrificing performance specifications. All input modules include multiple source selections, and each input has dedicated active balanced input circuitry for optimization of level, noise, common mode rejection, and crosstalk. All output bussing assignments are made via CMOS "Load-Lift" switching, thereby ensuring optimum noise specifications throughout the system. Standard Features:

- 4 or 8 outputs, plus discrete stereo and mono mix
- Mono and/or stereo inputs, with or without equalization
- Hi cut and lo cut filters on each input • VCA level controls
- VCA input grouping • Mute control capability • 4 auxiliary sends
- Built-in monitor mixer

Prices Based On Configuration



BROADCAST ELECTRONICS

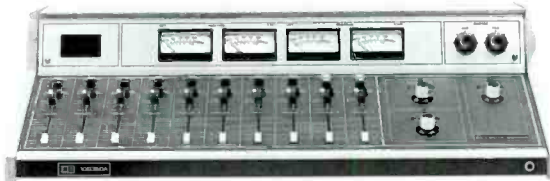

**SERIES 350A
Audio Consoles**

The 350A Series consoles offer the smooth reliability of Penny & Giles precision faders. Each fader features convenient dual cue switching through the use of a detent "drop cue" or Cue/Program Audition/Off switch. The 350A's also offer separate audition and program metering which allows simultaneous monitoring of both channel levels. The stereo 10S350A console provides four meters (audition right and left plus program right and left). It is attired with a two-tone technical white and gray finish and a laminated polycarbonate overlay.

Mfg. List \$6,295.00

Call For BSW Price

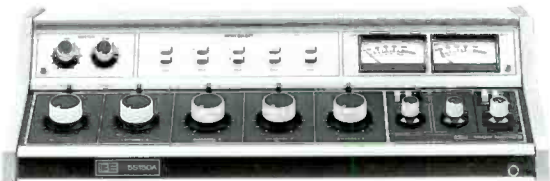

**SERIES 150A
Audio Consoles**

The 150A Series consoles with elegant white and gray finish and solid oak end panels offer full featured versatility without straining your budget. Durable, sealed potentiometers are used in each mixing control with detent cue buss. Each mixing channel accommodates two pushbutton selectable inputs and may be preset for either microphone or high level service. Monitor, headphone and cue amplifiers give you full monitoring capability.

5S150A (5 Mixer Stereo) Mfg. List \$3,095.00

8S150A (8 Mixer Stereo) Mfg. List \$3,795.00

10S150A (10 Mixer Stereo) Mfg. List \$5,395.00

Call For BSW Price



**4S50A
Audio Console**

The 4S50A sets the standard for compact stereo consoles. Featuring excellent stereo performance, the 4S50A lends itself well to either production or on-air use. Each of the first three channels accepts two high or low level stereo inputs. Channel four can be pre-selected for a single high or low level stereo input, or for one of five high level remote/utility stereo inputs. Each channel mixer control incorporates sealed dual-potentiometers fitted with detent cue switches.

Mfg. List \$2,195.00

Call For BSW Price

TOLL FREE 800-426-8434

BROADCAST ELECTRONICS

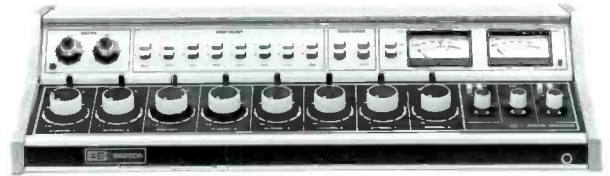

**SERIES 250A
Audio Consoles**

With their two-tone technical white and gray finish and solid oak trim, the 250A Series consoles are sure to accent any studio. But don't let their stylish exteriors fool you. These consoles are tough performers! Broadcast Electronics has specifically designed the 250A Series for rugged, reliable service in any demanding on-air or production application. The quality features of the 250A Series consoles include ladder-type step attenuators (with cue detent) for long life and easy maintenance, and roller-cam key switches to designate individual channel assignments. Each mixer preamplifier offers the flexibility of selecting either microphone or high level input for each channel. Every 250A series console also features separate monitor, headphone and cue channels. (Mono/stereo mode switching is optional on all stereo consoles.) All front panel graphics are protected by a laminated polycarbonate overlay.

5S250A (5 Mixer Stereo) Mfg. List \$3,895.00

8S250A (8 Mixer Stereo) Mfg. List \$4,995.00

10S250A (10 Mixer Stereo) Mfg. List \$6,095.00

Call For BSW Price

**In
Broadcasting,
Time Can Be
Your Toughest
Competitor**

**Put Time On
Your Side With BSW**

Deadlines are a given in broadcasting. When the pressure's on, you need a company you can depend on. Look to BSW. We understand that people who are accustomed to measuring time in seconds, can't wait weeks and months for equipment to arrive from their supplier. That's why we work overtime, everyday, to deliver equipment from our million dollar inventory with unmatched speed and accuracy. Should items ship directly from the factory, our sterling reputation with over 200 manufacturers insures prompt attention to your order. No company is better qualified to put time on your side than BSW, America's Full-Time Broadcast Supplier.

LPB

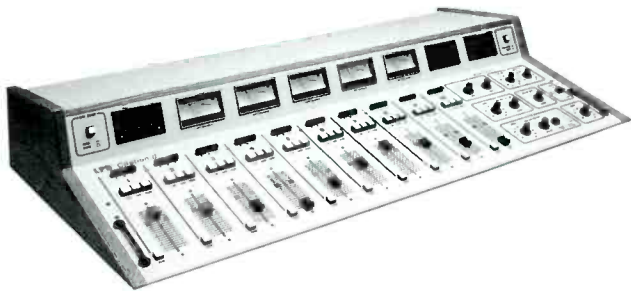

CITATION II SERIES Audio Consoles

Start with one of the longest running success stories in the radio console business: the LPB Citation I. Then add the combined wisdom of ten years of user feedback and make that "wish list" of features standard. Now you've got the idea behind LPB's new low profile Citation II console.

For durability, Citation II's low profile front panel is protected by a tough Lexan® overlay. And the entire console is built for long life and easy maintenance.

For flexibility, the ten-mixer Citation II features three inputs per mixer with lock-out switching, two stereo output busses, mix-minus capability, mono mixdown with independent VU, two user configurable four position auxiliary selectors and programmable monitor and cue muting for the first five mixers.

Mfg. List \$9,995.00

Call For BSW Price

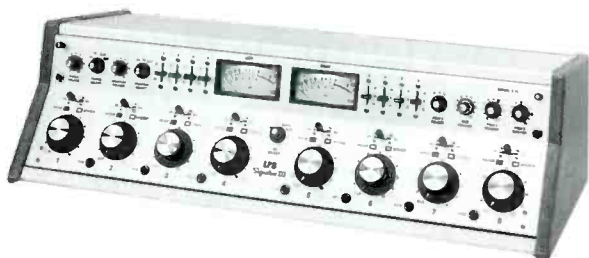

SIGNATURE III SERIES Audio Consoles

These consoles offer 3 inputs per mixer, rotary Shallco step or optional P&G stepless faders, plug-in modules, LED peak indicators, switchable mic gain, all transformer inputs and outputs and demonstrated RFI immunity. Mixers 1 through 4 accept either microphone or high level plug-ins (option available for more), others are fixed high level. Monitor speaker muting and tally relays are provided for mixers 1 through 3. Every fader has a cue position, and the consoles include an internal cue amplifier and S"cue speaker as well as 12/watt channel monitor amplifiers.

S10 (6 Mixer Dual Stereo) Mfg. List \$4,195.00

S13 (8 Mixer Dual Stereo) Mfg. List \$4,995.00

S20 (10 Mixer Dual Stereo) Mfg. List \$5,895.00

S24 (12 Mixer Dual Stereo) Mfg. List \$6,895.00

Call For BSW Price

ATI



VANGUARD SERIES Audio Consoles

Vanguard Series Consoles offer superior performance and long term reliability with low initial cost and minimum maintenance.

DC operated VCAs used on all level controls totally eliminate fader noise and tracking errors. Effective RF protected, punchblock type connections and jumper plug gain matching of input and output levels allow for quick, easy and foolproof installation. Modular, plug-in circuit cards allow fast board substitution troubleshooting by non-technical personnel. Features:

- Headphone amplifier • Muted monitor drivers • Cue amplifier and speaker • Two microphone preamps • Balanced, bridging inputs
- Active balanced outputs • Modular, plug-inboards • External power module • Compact (24" or 32" Wide) • Effective RF Protection

BC8DSL (8 linear faders, 12 stereo inputs) Mfg. List \$3,395.00

BC8DSR (8 rotary faders, 12 stereo inputs) Mfg. List \$3,395.00

BC12DSL (12 linear faders, 24 stereo inputs) Mfg. List \$4,995.00

Call For BSW Price

RUSSCO



505S Audio Console

This five channel stereo mixer can accept hi-level line, microphone or phono signals on input channels 1 thru 4. The 5th channel accepts 5 stereo, hi-level, balanced input lines selected by a push-button switch to give you a total of 9 stereo channels. Cue on any channel can be deactivated by removing a jumper on the P.C. board. Channels 1 thru 4 feature push-button on-air switches with LED indicator lights and monitor muting with an FET switch that can be deactivated. A built-in headphone amplifier with stereo headphone jack allows the use of a monitor headset of high or low impedance. A cue amplifier drives a built-in cue speaker.

Mfg. List \$2,299.00

Call For BSW Price

RAMSA

WR8616 Audio Console

The WR8616, a mixer specifically designed for recording and broadcast applications. It employs a versatile mainframe that can accommodate a variety of modules to meet the user's specific need. Such a design approach facilitates interfacing with a variety of equipment, such as tape cartridge machines, 2 to 16 track tape machines, turntables, or up to 16 microphones. The WR8616 offers a choice of two input modules, a mono mic/line module (WU8101) and a stereo line module (WU8106). Depending upon which modules are used, the WR8616 can accommodate up to 16 mic in signals or 32 line in signals, or any combination of mic and line inputs. Available with remote start switches and equalization, the WR8616 is one of the most versatile consoles available in its price range. Call us toll free for detailed pricing and specifications.



**A Standard 12 Channel Configuration Lists
For Under \$9,000.00 Call For
Specific Price And Configuration**

BIAMP

LEGEND SERIES Audio Consoles

The Biamp Legend in-line mixing console is a highly compact, modular mixing system designed primarily for multitrack recording applications. It's available in three mainframe sizes ranging from 8 to 32 inputs and from 4 to 24 group outputs. Each unit consists of a communications module, a stereo mixdown module and multiple input/output modules. Features include:

- Quality op-amps used throughout for high slew rate, low distortion and low noise
- 3 band EQ (all filters sweepable), EQ bypass and high pass filter
- Four sends per input channel
- Tape returns with complete tape monitoring on each input channel.
- Assignable, 12 segment high intensity meters on all inputs and put puts
- Direct outs and insert patch points on all input channels and group outputs
- Full solo capability on virtually every signal path
- Balanced group outputs and tape returns



LEGEND 2016 (20-Channel, 16 Submaster, 20 Tape Returns) Mfg. List \$9,999.00
LEGEND 3216 (32-Channel, 16 Submaster, 32 Tape Returns) Mfg. List \$15,499.00
LEGEND 3224 (32-Channel, 24 Submaster, 32 Tape Returns) Mfg. List \$15,999.00

Short Loaded Custom Configurations Available

SOUNDCRAFT

200 DELTA Audio Console

Start with an 8, 16, 24, or 32 channel mainframe, add the number of inputs and subgroups you need, and you've got the perfect solution to your production console needs. Choose from four styles of inputs:

The standard input module, featuring wide-range input level control, 3 band EQ, 6 aux sends, and complete routing.

The deluxe input adds an input phase reverse switch, highpass filter, and an extended EQ.

The stereo input allows switching between two stereo input sources with full right/left balance or mono summing on either source.

The dual line input module effectively doubles the number of sources per channel.



You can feed all inputs directly to stereo or choose up to 4 submasters. The 8 channel mainframe can be rack mounted.

**A Standard Input, 16 Channel Console Lists For under \$5,300.00
Call For Specific Pricing And Configuration**

YAMAHA

MR SERIES Audio Consoles

These high quality, feature laden consoles are available in 8, 12, and 16 channel models. Features on all consoles include:

- 4 group mixing busses and a stereo master buss.
- Mic/line or tape input selection on all input channels
- Peak LED's on each input channel
- 3-band equalizer on each channel with (shelving low/ high, sweepable mid)
- Monitor assign switches and talkback facilities.

MR1242 Mfg. List \$1,695.00

Call For BSW Price



PM1200 SERIES Audio Consoles

Here is Yamaha's newest generation production console with professional features that make it perfect for the broadcast production studio. These consoles are available in 16, 24, and 32 channel configurations and offer the following features:

- Adjustable input gain accepts nominal signals from -60 to +10 dB
- Four sub-groups and a stereo buss
- Three band EQ with sweepable mid-band and a high-pass filter
- 4 aux sends (switchable pre/post fader)
- Two stereo input channels standard (additional modules optional)
- Two complete stereo aux returns
- Complete talkback facilities
- All outputs balanced (+4 dBu XLR)

Typical 16 channel Configuration Lists for Under \$6,100.00

Call For Specific Pricing And Information



DMP7/MLA7 Digital Mixing Console

Here is a revolutionary digital mixing console and processor from Yamaha. Features: 8 input x 2 output configuration. • Complete digital signal processing from input to output with 16-bit resolution 44.1-kHz sampling frequency for a full 20Hz to 20kHz frequency response.

- Reliable multi-function motorized faders, with adjustment fade time, that serve as channel level controls and effects send level controls.
- Versatile 3-band equalizer for fine control of any portion of the sound spectrum.
- 3 effect loops, each with a high-performance internal digital multi-effect processor. Access to external effects is provided via the effect send and return jacks on the rear panel.
- Memory storage of 30 scenes, which allow instant recall of all console parameters.
- Internal digital stereo compressor.

Mfg. List \$3,650.00

Call For BSW Price



TASCAM



M3500-24ST Audio Console

To stay competitive, stations are relying on more sophisticated audio production demanding consoles that integrate multiple audio sources, effects units and multitrack recorders. The M3500-24ST from Tascam features 24 mono and 8 stereo inputs, 8 group busses and an "in line" monitor system which allows for complicated productions involving up to 24 recorded tracks. Special features: 4 band, 6 control EQ, 6 aux sends, Slide faders for in-line monitoring and effect returns, Optional LED meter bridge provides metering on all input channels.

Mfg. List \$9,499.00

Call For BSW Price



M312B Audio Console

For sophisticated studio recording, live mixing or production applications, the 300B Series Mixing Consoles offer all the features, signal routing flexibility and audio quality you need. Even complex foldback, effects mixing, subgrouping and monitoring requirements are handled with ease. The 300B Series consoles also deliver clean, dynamic sound thanks to TASCAM's transformerless balanced differential input design, with superior bandwidth and transient response even in the face of signal level or source impedance variations.

Features:

- 48V phantom power supply • Complete talkback system • Defeatable 3-band EQ on each channel (LOW/MID sweep, HIGH shelving)
- 4 program groups, stereo master buss provided w/ balanced outputs
- 3 auxiliary mix systems with 2 effect returns • Sophisticated solo system with PFL and AFL capability • Insertion points on each input channel, PGM buss, stereo buss and mono buss • Transformerless balanced input design • 8 monitor return channels function as effect or tape returns

Mfg. List \$3,399.00

Call For BSW Price

TOLL FREE 800-426-8434

TASCAM



M208 Audio Console

The M208 is versatile, accepting inputs from a wide variety of input sources. It can handle a wide range of applications with maximum convenience, quality, and dependability. Features:

- 3-band EQ on each channel combines shelving and sweep-type EQ
- 2 auxiliary mix systems with 2 effect returns • 4 program groups, each with a master fader and pan control, and a choice of XLR and RCA output connectors • 8 tape return jacks • LED overload indicators on each channel • Trim and pad controls on each input provide broad level matching from -70 to +4 dB • Switchable VU meters with peak-reading LEDs • Optional RM208 Rack Mount Kit

Mfg. List \$1,199.00

Call For BSW Price

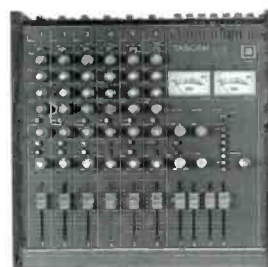

M106 Audio Console

The M106 offers comprehensive input and output facilities in a convenient practical layout. Features: Mic/line inputs on all 6 input channels • 4 phono inputs for use in A/V production or club applications • Group, aux, effect, and monitor outputs • Trim and pad controls on each input provide broad level matching from -70 to +4 dB • 2-band shelving EQ on each channel allow up to 15 dB boost or cue at 10 kHz and 100 Hz • 19" rackmountable using the optional RM106 rackmount kit

Mfg. List \$699.00

Call For BSW Price

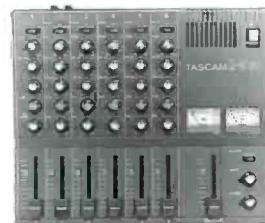

M06ST Audio Console

The M06ST is perfect for small home, or station production rooms. Features: 6 stereo input channels (channels 1 and 2 have stereo phono inputs for direct connection of turntables while channels 3-6 have stereo line inputs) • Mic inputs on each channel accept a wide range of signals from microphones, musical instruments and audio equipment • Stereo AUX inputs with level control provide an extra stereo input • Insert patch points on channels 5 and 6 • Cue send level controls on each channel

Mfg. List \$499.00

Call For BSW Price

RAMSA



WR133 Portable Mixer

This compact, 8 channel portable mixer comes with its own carrying handle and detachable hard cover making it perfect for taking on the road. It comes complete with balanced mic/line and phono inputs, effect, monitor, and mono outputs, and balanced stereo XLR outputs.

Mfg. List \$1,290.00

Call For BSW Price



WRM10 Multiple Source Mixer

22 input connections, 11 output connections, built-in compression, auto-muting and sub-grouping are among the features that make this a most flexible, compact mixer. This unit can be mounted in a number of different ways including: rackmount, wall mount, and flush mount. Cue and remote start are standard features.

Mfg. List \$900.00

Call For BSW Price

RANE



SM26 Splitter/Mixer

Here is an extremely versatile, single rack space mixing tool that performs a number of useful functions. Use it for line mixing, line distribution, or line matching/amplification. Features:

- Combination 6-in/2-out mixer and 2-in/6-out splitter
- Provides mix/pan and level controls
- Transformerless balanced/unbalanced inputs and outputs

Mfg. List \$349.00

Call For BSW Price

BIAMP



RACKMAX II Audio Mixer

The Rackmax II is a unique audio tool... a 16-input, high performance stereo, full-feature mixer in a rackmount unit only 8 spaces high and 3 inches deep (including power supply). Features include:

- 4 sends per channel (selectable pre- or post-fader)
- Mic and line level input channels
- 48 volt phantom power available
- Complete cue/solo system
- 3-band EQ on each input channel
- XLR type mic/line input connectors
- Balanced outputs

Mfg. List \$1,299.00

Call For BSW Price

America's Full-Time Broadcast Supplier

When BSW was founded in 1973, our goal was to establish a single source supply house to serve the needs of America's broadcast professionals. Regional offices solved the problem of time zone but only served to delay delivery of equipment critical to a station's operation.

So we decided to work overtime every day of the week. 12 hours a day, there is a qualified sales engineer on duty who knows your business and your needs. And there's only one number you need to know—toll free across America. 1-800-426-8434 BSW's commitment to service is why we're America's full-time broadcast supplier.

ATUS



**AM300/AM300E
Audio Mixer**

The AM300 is a compact, inexpensive multiple-source mixer suitable for DJ work or simple audio production. The AM300E is the same as the AM300 but contains a built-in echo circuit. Features:

- Rack mountable
- Inputs for: two turntables, six stereo line-level sources, and two microphones.
- A/B fader for phono/CD channels
- Ducker on mic channel
- Monitoring of any input signal
- Output switchable between 0dBu and +4dBu
- Separate left/right 5-band graphic EQ

AM300 Mfg. List \$299.95

Call For BSW Price

AM300E Mfg. List \$415.95

Call For BSW Price

BIAMP



**DJ5500
DJ Mixer**

Conservatively rated components, and sound mechanical design combine to provide reliable, high quality performance for the long run. Features:

- Ultra low noise and distortion throughout system
- Bass boost Circuit
- 3-band EQ on each channel
- Fully muted outputs prevent on/off thump
- A full octave more bass than most DJ mixers
- Variable talkover ducker

Mfg. List \$999.00

Call For BSW Price

RANE

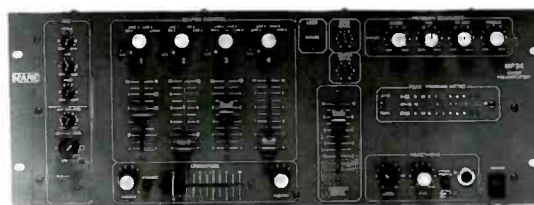

**MP24
Mixer/Preamplifier**

The MP24 is a rugged, high performance, rackmountable mixer for mobile DJ applications, or anywhere you need a multiple source mixer with phono preamp capability. Features:

- 9 stereo inputs - 3 phono & 6 line - assignable to 4 input mixing busses
- Fully assignable crossfade with defeat switch
- Alps 60 mm studio faders and sealed rotary pots
- Separate booth, zone, and light trigger outputs
- Two mic inputs with 3-way EQ and full effects loop
- Flexible headphone section, 2 master effects loops
- 4-way program EQ

Mfg. List \$1,299.00

Call For BSW Price

NUMARK



**MDJS1775A
Mobile DJ System**

Here is everything you need for a complete portable DJ system. Mixer and turntables are housed in a rugged, light weight case. The system includes powered speakers so all you have to do is plug them into the mixer output and you're ready. System includes:

- 1-DM1775A preamp mixer/sampler
 - 2-TT1400 direct drive turntables (with 680EL cartridges and extra styli)
 - 2-PM330C amplified 3-way speakers (225w RMS)
 - 1-UD940A microphone with gooseneck
 - 1-HM5500A broadcast headphones
- All necessary cables, connectors, etc.

Mfg. List \$5,859.00

Call For BSW Price

COMREX



SLX

STLX

SLX/STLX Remote Consoles

Ideal for sports or news, the STLX and SLX consoles are completely self-contained remote broadcast packages. The STLX incorporates a two line Frequency Extender encoder with noise suppression. The SLX has a built-in basic single line Frequency Extender encoder. Features:

- Four mixing channels (2 mic/ line) • Built-in telephone interface
- Custom monitor mix with station talkback available on each head-
phone (4 headphones/STLX) (3 headphones/SLX) • AGC • AUX IN
and OUT for external PA feeds, monitors, etc. • Feeds dial or dedicated
circuits • Requires Comrex dual or single line decoder for frequency
extension. Call BSW for the complete line of Comrex equipment.

SLX Mfg. List \$4,200.00

Call For BSW Price

STLX Mfg. List \$7,750.00

Call For BSW Price

ELECTRO-VOICE



ELX1R Remote Mixer

The Electro-Voice ELX1R is a compact, high-performance audio mixer designed for professional applications where clean audio and reliable operation are important. The ELX1R features four balanced inputs, selectable mic or line level. Switchable output limiter prevents clipping, and low cut filters reduce low frequency background noise. Headphone output has a separate power amp and level control will drive any type of headphones or small speaker. Level setting is easy with the built-in tone oscillator.

Mfg. List \$567.00

Call For BSW Price

GENTNER



CRM Remote Mixer

Have you ever had an application where you wished the mic mixer and headset amplifier were all in one box? Gentner's new Combination Remote Mixer is your answer. It's the perfect one box solution for quick, easy remotes or similar applications. Four mic inputs, plus four individual headset amps are all built into one convenient package. Each headset output can have its own input and/or input from the "master" audio channel. This means your talent can listen to program audio and independently receive cues.

Mfg. List \$1,595.00

Call For BSW Price

RUSSCO



T321 Remote Mixer

Russco's Telemote 321 gives you two low impedance microphone inputs and one medium impedance tape recorder input in a compact, 3 pound package. What makes this mixer so unique is that it requires no batteries or any other external power source except your phone line. The 321 works right off your dial or touch-tone phone line feed. While you're broadcasting that important event, you can supply audio to 3 headsets at once and control their level by a front panel pot. The audio level feeding the telephone line is controlled by a built-in limiter with the limiting action displayed by an LED bar-graph meter. It also incorporates a signal bell that allows calls originating at your station to be received at your remote location.

Mfg. List \$649.00

Call For BSW Price

Why wait around for your equipment--for just a few dollars more we can Federal Express your order. Tell your BSW Sales Rep to "Fed X" it.

SHURE

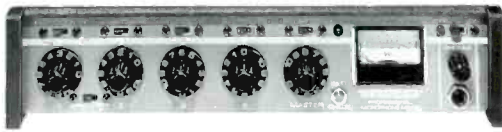

**M267
Microphone Mixer**

The Shure M267 offers performance and capabilities never before available in a modestly priced mixer. It has all the features that made the Shure M67 the industry standard mixer, plus additional features and performance improvements that promise to make it the industry standard. These features include... peak limiter, phantom power, built-in battery pack, LED peak indicator, headphone level control. The M267 has four mic or line switchable inputs. It also includes transformer balanced inputs and outputs, mix buss, VU meter, low RFI and line noise susceptibility.

Mfg. List \$520.00

Call For BSW Price



**M268
Microphone Mixer**

The M268 is a compact, lightweight, five-channel microphone mixer that offers significant improvements in design, performance and versatility over other value-priced mixers including the Shure M68. It is ideal for public address and paging in hotels, schools, community centers, and hospitals, as well as an excellent add-on mixer for expanding current equipment. It is also an excellent mixer for use by the serious tape recording enthusiast.

Mfg. List \$315.00

Call For BSW Price



**FP51
Microphone Mixer**

Broadcast and field production professionals will find the Shure FP51 an invaluable time, labor, and space-saving component. By combining a high quality gated-memory compressor with a four-input, one-output professional mixer, the FP51 gives users a lightweight, compact production unit with remarkable versatility and "hands-free" operation. It rides gain automatically, saves on rack space, and eliminates many adjustment problems. It's an ideal component for ENG trucks, remote broadcasts, on location productions, and sound reinforcement applications. And, like other products in Shure's "FP" Series, the FP51 packs a multitude of useful professional features into an exceptionally space-efficient package.

Mfg. List \$965.00

Call For BSW Price

SHURE



**FP42
Microphone Mixer**

Field production technicians suffering from audio headaches can rejoice. Shure has a cure in the FP42 - an extraordinarily reliable, compact, feature-packed stereo audio mixer. The FP42 combines Shure ruggedness with all the convenient features that made the M267 so popular plus full stereo capability!

Mfg. List \$990.00

Call For BSW Price



**FP32
Microphone Mixer**

Professional users asked for it, and Shure delivered! Shure's FP32 Stereo Mixer definitely answers the demand for a reliable, rugged compact stereo audio mixer. Roughly the stereo equivalent of the FP31, this high quality mixer handles even the most stringent demands.

Mfg. List \$1,395.00

Call For BSW Price



**FP31
Microphone Mixer**

A compact, portable microphone mixer specially designed for electronic news gathering (ENG) and electronic field production (EFP) use. Measuring just 6 5/16" x 5 5/16" x 1 7/8", the FP31 incorporates the features most requested by audio engineers, electronic news professionals, sportscasters, and film and video sound engineers. Three XLR connector inputs and two outputs are provided, each switchable for either microphone or line-level operation. Incorporated in the FP31 is a built-in slate microphone for voice announcements and emergency field use.

Mfg. List \$1,025.00

Call For BSW Price

ZERCOM

Case & Clock



MAX-Z Remote Console

MAX-Z is a remote broadcast console that provides maximum flexibility, utility, and above all, audio quality. When it comes to convenience features that help make a remote broadcast run smoothly and sound professional, the MAX-Z has no equal. Features include: carrying case, built-in rechargeable batteries and charger, clock, stopwatch/timer, V.U. meter, wide range and audio inputs (will match almost anything), cue channel, phone line alarms, memory dialing (tone or pulse), etc.

Mfg. List \$1,095.00

~~\$\$\$~~ 875
Call For BSW Price



MAX-Z II Remote Console

The MAX-Z II is an abbreviated version of the MAX-Z. High quality audio handling is maintained in the two channels of audio input. AC/DC powered, two headphone outputs, cue channel.

Mfg. List \$600.00

Call For BSW Price

TELFAX



CELLULAR ATTACHE Remote Console/Cellular Link

This convenient system combines the Telfax X30 remote mixer with a 3 watt cellular telephone transceiver, a 2 hour battery pack, regulated AC power supply, telescoping antenna, and single-line frequency extension, all in a standard size briefcase. The X30 mixer can be removed from the case and connected to the cellular transceiver via a modular phone cable. "Cel-Link" circuitry is incorporated to allow FAX machines, computer modems and answering machines to be interfaced to the Cellular Attache.

Mfg. List \$3,880.00

Call For BSW Price

TOLL FREE 800-426-8434

TELFAX



X30 Remote Console

The X30 utilizes the latest audio circuitry to make it the lightest (2.75 lbs.) and most compact device of its kind on the market today. It's only 1.5" thick, so you can pack it in a briefcase with room left over. The X30 features 3 Mic inputs, one Tape Input, a Tape Output, and three headphone jacks. The built-in rechargeable Ni-Cad battery pack can be recharged in just 3 hours.

Mfg. List \$895.00

Call For BSW Price



TEN 32 Remote Console

The TEN 32 allows you to mix and send audio, plus communicate with your studio over standard dial telephone lines. The TEN 32 features four low noise Mic inputs, and two tape inputs, line and auxiliary outputs; A headphone amplifier with four jacks, and radio monitor input. Rechargeable Ni-Cads are standard. Other features include: Output level switch, accessory jack and switch for interfacing external audio processors. Optional carrying cases are available.

Mfg. List \$990.00

Call For BSW Price



TEN 44 Remote Console

The TEN 44 has the 32 features shown above, plus: Electronically controlled nicad battery • Digital up/down timer w/alarm and large LCD display • 1/4" isolated mono phone jacks ~ 4 active balanced mic preamps • 1 kHz test tone oscillator • Fused power input • New mini toggle switches for radio monitor switching in headphones • Noise cancelling on/off master audio "kill" switch and spotter channel

Mfg. List \$1,150.00

964
Call For BSW Price

360 SYSTEMS



DCR1000 DIGICART Digital Cartridge Machine

The sonic excellence of CDs in a convenient, user recordable format...it's the DigiCart™ digital audio cart machine. Although it looks and operates like an analog cart machine, DigiCart combines the power and sonic excellence of digital audio storage in a fast, user friendly package. Store up to 10 minutes of stereo audio at 15 kHz or 40 minutes in mono at 10 kHz on a rugged, removable magnetic disc cartridge. With true 16-bit linear encoding, fast access and an unlimited number of cuts per disc, DigiCart offers direct, reliable performance day after day.

If automation is part of your station's business plan, DigiCart can be the key to cost-effective operation. Optional internal (and external) hard disks hold a full day's programming and can be loaded from the removable cartridges at greater than ten times normal speed.

Cue lists can be easily created and stored within DigiCart to speed production. It's even possible to cue up a second spot while the first one is playing in the same machine. Features:

- Random access
- Cue title and time remaining display
- Instant cueing
- No tape head or bias adjustments
- No frequency loss with head wear

Mfg. List \$3,995.00

Call For BSW Price

RAMSA



SV255 Portable Digital Audio Tape Recorder

Ideal for high quality professional on-the-job recording applications, indoors or out, the ultra-compact SV-255 is just 9" wide, 1 1/4" high, and 5 3/8" front to back. And, it weighs only 3.2 lbs. The rechargeable battery delivers 2.2 hours of continuous recording or playback. Other valuable features:

- XLR type mic/line input
- 32-step random access programming
- 2-way power supply accepts AC and rechargeable battery
- High speed search that is 60 times faster than standard record/playback rate
- Wide range level meters with peak hold
- LCD display shows: track number in play, next track number, tape counter/program step, inter-track detection level, battery indication
- Digital output terminal
- Direct access and skip search

Mfg. List \$2,700.00

Call For BSW Price

TOLL FREE 800-426-8434

RAMSA



SV3900 Digital Audio Tape Recorder

The SV3900 is designed for versatility and is compatible with virtually all editing controllers and automation systems. Full remote control capability is available via serial port and can be switched to follow ES-Bus or P-2 protocols. It comes with a full-function wired remote controller that includes a keypad for IDs, a 2-speed shuttle wheel, and all transport controls.

- Push button selectable sampling rate (44.1 and 48 kHz)
- Program, absolute, and time-remaining displays
- Digital and analog inputs and outputs
- Balanced XLR analog inputs and outputs
- Up to 400 times fast-forward/rewind and search speeds
- Quad 18-bit DACs

Call For Pricing And Specifications



SV3700 Digital Audio Tape Recorder

This unit employs the most advanced A-to-D converters and quad 18 bit DACs for reduced distortion and better reproduction at lower signal levels. It features balanced XLR inputs and outputs; multiple function time display, push button sampling rates for 44.1 and 48 kHz via analog or digital inputs, and a horizontal cassette tray for easier loading. Ramsa has also included a shuttle search wheel with 0.5 to 15 times speed range and a push-button fade-in fade-out function. A full function wireless remote is included.

Mfg. List \$1,599.00

Call For BSW Price

Need prices on a major project? Save yourself time and FAX us your equipment list. We'll have a complete price quote back to you in no time.

BSW FAX # 206-565-8114

Digital Audio Recorders

SONY



PCM2500 Digital Audio Tape Recorder

The Sony PCM2500 is the top-of-the-line professional DAT recorder. A wide array of analog or digital input and outputs make the PCM2500 ideal for any professional application. Two remote controls allow wired or infrared control of the transport and programming functions. Front panel keypad allows for quick track location. Instant cueing with standby for instant start up. Each cut recorded can be assigned a track index number automatically or manually by operator. Start codes can be manually edited in .03 second increments for very tight cueing requirements. The audio quality of the PCM2500 is outstanding. What else would you expect from Sony?

Mfg. List \$3,550.00

Call For BSW Price

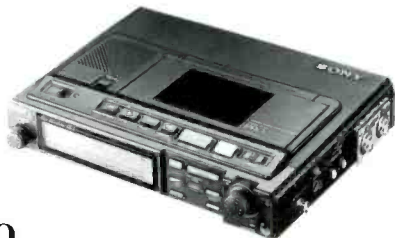

TCD-D10PRO Digital Audio Tape Recorder

This is Sony's smallest DAT machine weighing only 4 lbs. 7 oz even with its internal battery pack. Balanced XLR mic connectors allow proper interface with professional low impedance microphones or +4 line level inputs. Features include: Digital I/O (S/PDIF and AES/EBU type) • Clear, easy-to-read back lit display • Two hour recording time • Switchable limiter • Built-in speaker • Internal battery

Mfg. List \$2,900.00

Call For BSW Price



PCM2000 Digital Audio Tape Recorder

The PCM2000 is equipped with functions necessary for digital outdoor recording and easy connection with studio digital systems. Features: AES/EBU digital I/O • Records and reproduces SMPTE time code • Capable of external sync. • Multipurpose backlit LCD display • mic/line with level, low cut, and phantom power • Two times oversampling in A/D and D/A converters

Mfg. List \$5,000.00

Call For BSW Price

TASCAM



DA30 Digital Audio Tape Recorder

The DA30 is the ideal springboard to launch your sound into the digital age of the '90s. Designed for professionals with features like XLR balanced analog inputs and outputs, and AES/EBU digital interface. State-of-the-art 64X oversampling 16-bit delta-sigma A/D technology and 8X oversampling 18-bit D/A conversion contribute to superior sound quality, while automated features make operation smooth and efficient. An optional wired remote or the 15-pin parallel port allow the DA30s transport controls to be remotely operated.

Mfg. List \$1,499.00

Call For BSW Price

TECHNICS



SVDA10 Digital Audio Tape Recorder

A consumer oriented machine that will undoubtedly find wide acceptance among professionals due to low cost, high quality sound, and advanced features. Copy Code Protection is present in this unit. Features include:

- MASH A/D and D/A conversion
- 2-speed shuttle search dial
- 400 times tape speed for fast search
- Addressable code and program numbers
- 37-key wireless remote included

Mfg. List \$895.00

Call For BSW Price

\$695

Customer Service

BSW's "after the sale" support is second to no one. Your complete satisfaction is our only goal and we pay for the call.

DIC

Quality tape, affordably priced

- DIC30XR (30 min.) Mfg. List \$7.90
- DIC60XR (60 min.) Mfg. List \$8.87
- DIC90XR (90 min.) Mfg. List \$11.25
- DIC120XR (120 min.) Mfg. List \$12.00

Call For BSW Price



SONY



Time tested tape from the Pioneers of digital audio.

- DT60R (60 min.) Mfg. List \$11.00
- DT90R (90 min.) Mfg. List \$13.15
- DT120R (120 min.) Mfg. List \$15.20

Call For BSW Price

RAMSA



Super high quality shell construction and tape composition. Features Roadhandler lifetime warranty.

- RTR60 (60 min.) Mfg. List \$11.00
- RTR90 (90 min.) Mfg. List \$13.00
- RTR120 (120 min.) Mfg. List \$15.00

Call For BSW Price



RTRCLP

DAT Cleaning Cassette

Cleaning your DAT machine's head is as easy as playing a DAT tape with the Ramsa DAT cleaning cassette.

Mfg. List \$13.00

Call For BSW Price

TOLL FREE 800-426-8434

YOU CAN'T ORDER...

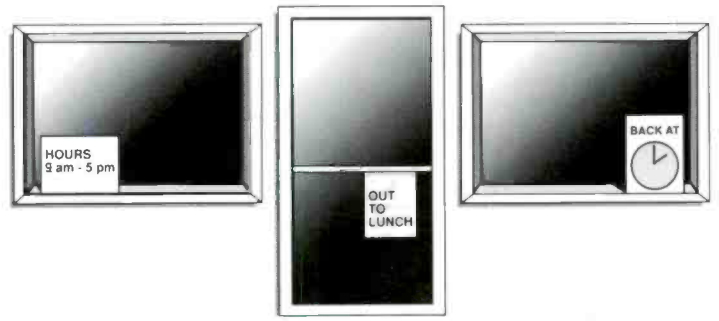

...From A Company You Can't Reach

Accessibility may be the most important quality of a good equipment supplier. A company can offer you a long list of reasons why you should do business with them. Yet, none of these reasons mean a thing if you can't reach them when you need to place an order. At BSW, we work overtime to ensure you immediate access to our qualified sales staff. We're open 12 hours a day (6 a.m. to 6 p.m. Pacific and 9 a.m. to 9 p.m. Eastern) so you can call us when it's convenient for you, morning or evening. With over one million dollars of inventory on hand, chances are we have what you need in stock and can have it in your hands the next day. So the next time you need to reach a supplier, call BSW, America's Full-time Broadcast Supplier.

BSW[®]

BROADCAST SUPPLY WEST

America's Full-Time Broadcast Supplier

ORDERS • INFORMATION • SPECIFICATIONS
7012 27th Street West Tacoma, WA 98466

Headphones

AKG



K240M

The K240M offers accurate reproduction at all listening levels, and extreme comfort with virtually no fatigue with prolonged use. Frequency response 15 Hz to 20,000 Hz. 4-600 ohm impedance.

Mfg. List \$120.00

Call For BSW Price



K141M

A lightweight, semi-open-air headphone with resonance-free characteristics of "open air" designs. Frequency response 20 Hz to 20,000 Hz. 4-600 ohm impedance.

Mfg. List \$100.00

Call For BSW Price

BEYER



DT220

These unusually lightweight, sealed ear headphones feature excellent fidelity and sparkling clarity that satisfies even the most discriminating ear. Frequency response 20 Hz to 20,000 Hz. 600 ohm impedance.

Mfg. List \$129.00

Call For BSW Price



DT320MKII

Lightweight semi-open format headphones with soft, removeable ear cushions. Frequency response 20 Hz to 20,000 Hz. Impedance 40 ohms.

Mfg. List \$82.95

Call For BSW Price

BEYER



DT100

Reliable, comfortable headphones with moderately spacious sound perspective and powerful, but not overemphasized bass response. Frequency response 30 Hz to 20,000 Hz. Impedance 400 ohms.

Mfg. List \$149.95

Call For BSW Price

SENNHEISER



HD250

Sennheiser quality in a closed ear format for minimal sound leakage. Frequency response 10-25,000 Hz. 600 ohm impedance.

Mfg. List \$225.00

Call For BSW Price



HD450S

Successor to the HD414SL series and designed specifically for the professional. Open-air design, HD450 provides higher output and improved accuracy using neodymium-iron magnets. Supplied with 10-ft. stranded steel cable. Frequency response 20-20,000 Hz. Impedance 600 ohms.

Mfg. List \$99.00

Call For BSW Price



HD25

Utilizing dynamic drivers in a closed supraural design, the HD 25 offers a lightweight and comfortable alternative to professionals who spend a great deal of time wearing headphones. An adjustable split headband insures optimum fit and a single side audio cable allows maximum freedom of movement. Unique rotating drivers allow one ear cueing. Frequency response 30-16,000 Hz. 70 ohm impedance.

Mfg. List \$219.00

Call For BSW Price

KOSS



PRO4AAPLUS

Feedback on the air a problem? Koss PRO4AAPLUS is a great solution. Sealed ear cup provides comfort and durability. Frequency response 10-20,000 Hz. Impedance 100 ohms.

Mfg. List \$70.00

Call For BSW Price



PRO4AA

Brought back by popular demand, the PRO4AA has been preferred by professionals for years. Using an oversized diaphragm and voice coil, the PRO4AA delivers an extended range with outstanding sensitivity for precision monitoring. The foam-filled Pneumalite earcushions provide a comfortable and complete seal eliminating outside noise and feedback. Frequency response 10-22,000 Hz. Impedance 230 ohm @ 1 kHz.

Mfg. List \$99.95

Call For BSW Price



PRO450

Koss' finest headphone. Dual element driver with neodymium magnet gives extended frequency response (10-30,000 Hz). 8 foot and 25 foot detachable coiled cords. Superior noise cancellation and comfort.

Mfg. List \$174.95

Call For BSW Price

Place your order by Noon....We'll ship stock items by 5... or the freight charges are on us !!

FOSTEX



T20A

Designed exclusively for professional use, the Fostex T20A headphones are proven performers that can handle high SPL without distortion. The ear pad design is soft and very comfortable in a semi-closed format. The cable is easily removeable for repair. Frequency response 50 Hz to 30,000 Hz.

Mfg. List \$99.00

Call For BSW Price

SONY



MDRV6

The secret is out, Sony MDRV6's are fantastic! They deliver high quality sound along a surprisingly wide frequency range (5 to 30,000 Hz usable) in a comfortable, circum-aural (sealed ear) format providing maximum isolation from external sound.

Mfg. List \$99.00

Call For BSW Price

KOSS



K6XPLUS

This lightweight, semi-open stereophone delivers great sound and is very affordable. Frequency response 10 to 20,000 Hz. 100 ohms.

Mfg. List \$31.95

Call For BSW Price



K20

These ultra lightweight open air headphones are surprisingly durable and good sounding for the price.

Mfg. List \$24.99

Call For BSW Price

Headsets

BEYER



DT109K Headset

A headphone microphone combination for heavy duty use. All parts easily interchangeable. Long wearing comfort. Hyper-cardioid microphone has excellent noise cancelling qualities. Headphone frequency response, 40 Hz to 12,000 Hz; microphone, 30 Hz to 20,000 Hz.

Mfg. List \$232.90

Call For BSW Price



DT329 Headset

A lightweight headset with exceptional sound, the DT329 uses a comfortable dynamic headphone and an electret condenser mic for high fidelity voice reproduction. 400 ohm phones, 700 ohm mic. Phones frequency response is 20 to 20,000 Hz, mic response is 40 to 20,000 Hz.

Mfg. List \$399.95

Call For BSW Price



DT159 Headset

If you like the DT109 you'll love the DT159 which combines DT100 series headphones with the ultra-high quality M560 ribbon mic element for studio sound quality in the convenience of the headset format. Mic frequency response is very flat from 20 to 20,000Hz.

Mfg. List \$479.95

Call For BSW Price

In a hurry? Why not have your shipment Federal Expressed. BSW offers low rates on rush shipments.

SENNHEISER



HMD224X Headset

One of broadcasting's most popular headsets, the HMD224X incorporates a dynamic cardioid microphone specially angled on the boom for optimum speech reception. Sealed ear configuration guards against unwanted crowd noise. Headphone frequency response, 16 Hz to 20,000 Hz; microphone, 50 Hz to 12,000 Hz.

Mfg. List \$295.00

Call For BSW Price

SHURE



SM2 Headset

The Shure SM2 provides maximum comfort, durability and high quality sound reproduction. Headset features include a patent mic boom mount adjusts for left or right side use, a metal boom that is less subject to damage, a rugged, all metal headband with leather-like covering, and "pillow-soft" ear pads for maximum comfort. Headphone frequency response, 100 Hz to 8,000 Hz; mic response 50 Hz to 15,000 Hz.

Mfg. List \$210.00

Call For BSW Price

TELEX



PH91 Headset

The Telex PH91 has long been a favorite of professional announcers. Ideal for studio or on location sports broadcast, from the press box or the high noise environment of the playing field. Both earphone and microphone elements are field replaceable. Headphone response, 50 Hz to 15,000 Hz; microphone, 50 Hz to 15,000 Hz.

Mfg. List \$195.00

Call For BSW Price

BENCHMARK

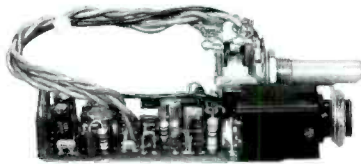

HPA1 Stereo Headphone Amplifier

The Benchmark jack mounted amplifier series has been called brilliant. We call them practical. The HPA1 can be used anywhere - in consoles, at the patch bay, in interview tables and test sets, wherever you need individual level control. The HPA1 is ideal for the "Studio Series" headphones in the 200 to 600 ohm range but will work with 8 ohm devices as well.

BSW Price \$60.00

EDCOR



HA400C Headphone Amplifier

Four independent stereo amplifiers, each with its own volume control. Provides high fidelity reproduction, far surpassing all but the most expensive systems.

Mfg. List \$231.00

Call For BSW Price

GENTNER



6X Headset/speaker Amplifier

The 6X is a six output stereo amplifier delivering up to 2 watts per channel. The flexible input configuration of the 6X makes set-up and operation fast, simple, and adaptable to all applications. The 6X has a master stereo input and individual direct inputs for each of six channels, either mono or stereo.

Mfg. List \$795.00

Call For BSW Price

RADIX



HE20 Headphone Amplifier/EQ

Three bands of EQ and a powerful amplifier allow the listener to customize a headphone mix to his liking while listening in stereo, narrow stereo or mono. The on air signal goes untouched, while announcers hear a custom-tuned signal they like. The HE20 mounting bracket allows it to be conveniently mounted underneath or on top of the counter. Rear panel barrier strip lets you remote-out an external headphone jack.

BSW Price \$249.95

RANE



HC6 Headphone Amplifier

Features:

- Six stereo headphone amplifiers in a single rack chassis
- Main stereo inputs drive all six amps through individual volume controls
- Each headphone amp also has its own separate input which independently by-passes the main stereo input

Mfg. List \$399.00

Call For BSW Price

SHURE



FP12 Headphone Amplifier

The FP12 is a 1-input, 2 output headphone bridging amplifier designed to provide headphone feeds from any type of audio input. The FP12 features two XLR in/out connectors and two 1/4" in/out jacks, Mic/Line input switch, Hi Z/Lo Z headphones switch, headphone level control, and removable belt clip. The FP-12 is powered by one standard 9V battery.

Mfg. List \$255.00

Call For BSW Price

SYMETRIX



SX204 Headphone Amplifier

The SX204 is a 1-in 4-out amplifier utilizing proprietary high voltage converter technology to drive high impedance headphones, while providing more than ample power for low impedance phones.

Mfg. List \$299.00

Call For BSW Price

RADIX



HS160 Headphone Splitter

Headphone signal distribution has never been as easy or inexpensive. Introducing the Radix 1x6 headphone splitter. Simply provide amplified headphone signal and plug in up to six headphones. The Radix 160 features isolation resistors to keep signal constant regardless of how many headphones are plugged in. Heavy duty chassis, excellent for field use. Locking 1/4" jacks prevent accidental unplugging.

BSW Price \$79.95

Interface Amplifiers

APHEX



124 Interface Amplifier

This ApheX unit will easily interface consumer audio equipment with professional studio and broadcast facilities. Active, servo-balanced circuitry converts +4 dBm (or +8 dBm) line levels to -10 dBm (hi-fi) levels, and back again. XLR and RCA type connectors enable quick hook-up. Frequency response:

• 5 Hz to 50 kHz +0, -0.4 dB • THD: 0.005 @ 1 kHz • Crosstalk: -95 dB @ 1 kHz, -78 dB @ 20 kHz • Noise: -95 dBm, 20 Hz to 20 kHz.

Mfg. List \$219.00

Call For BSW Price

ATI

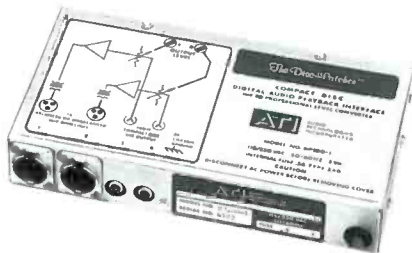

DP100 DISCPATCHER Interface Amplifier

A uni-directional stereo interface for playback only applications. It is designed specifically to convert the unbalanced IHF outputs of digital compact disc players to transformer balanced and isolated 600 ohm line levels with no compromise or degradation of the source audio.

Mfg. List \$219.00

Call For BSW Price

BENCHMARK



DOA1/DOA2 Interface Amplifiers

DOA's provide a professional interface at a very low price. They mount inside equipment where cabling, space, mounting, and AC power problems are eliminated and provide variable gain from off to +26 dB. The DOA-1 uses bipolar power from +6V to +22. The DOA-2 uses single + power from +12V to +44V D.C. Power supplies are user provided.

DOA1 BSW Price \$55.00

DOA2 BSW Price \$55.00

TOLL FREE 800-426-8434

HENRY ENGINEERING



MATCHBOX Interface Amplifier

This is the ideal, inexpensive way to correctly interconnect "HI FI" or semi-pro equipment with professional studio gear. The Matchbox is a bi-directional unit with four independent amplifiers providing full stereo input and output interface. Features adjustable output levels and RF shielding.

Mfg. List \$195.00

Call For BSW Price

RUSSCO



CD100 Interface Amplifier

This little unit can solve your impedance matching problems effectively and inexpensively. The CD100 can be used to interface any high impedance output device to a 600 ohm line; balanced or unbalanced.

Mfg. List \$79.90

Call For BSW Price

TASCAM



LA40 Interface Amplifier

The perfect one rack space solution to the problem of mismatched line levels or impedances. The LA40 is a compact 4-channel unit that establishes instant compatibility between -10 dbv unbalanced inputs and outputs and almost all other equipment. Compatible levels, compatible impedances and balanced/unbalanced operation.

Mfg. List \$450.00

Call For BSW Price

RADIO DESIGN LABS

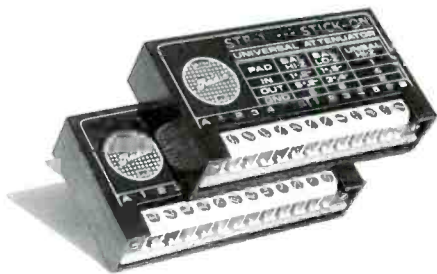

STICK-ON SERIES Interface Devices

Each Stick-On measures only 2.9" W x 1.5"D x 0.5" H and is housed in durable plastic. Stick-On's are so small they can be directly and discretely mounted on equipment or under countertops. Careful attention to audio specifications and durability required by professional audio users are found in every Stick-On.

ACTIVE STICK-ONS

Model	Description	Mfg. List
STA1	Electronic Transformer, Dual Channel w/supply	\$109.95
STA3	Audio Power Amp, 3 watts RMS w/supply	\$79.95
STA6	Audio Power Amp, 6 watts RMS w/supply	\$99.95
STVCA1	Voltage Controlled Amplifier w/supply	\$84.95
STDA3	Distribution Amplifier, mono w/supply	\$99.95
STDA3D	Distribution Amplifier, stereo w/supply	\$149.95
STGCA1	Gain Control Amplifier w/supply	\$89.95
STM1	Microphone Preamp, fixed gain w/supply	\$79.95
STM2	Microphone Preamp, variable gain w/supply	\$109.95
STMDA3	Mic-Level Distribution Amplifier w/supply	\$109.95
STACR	Audio Controlled Relay w/supply	\$84.95
STLCR1	Logic Controlled Relay (momentary pulse) w/supply	\$55.95
STLCR2	Logic Controlled Relay (alternate action switching) w/supply	\$89.95

PASSIVE STICK-ONS

STD1	Divider/Combiner Network, Four Channel (specify 150 or 600 ohm)	\$32.95
STP1	Variable Attenuator, Two Channel	\$32.95

Call For BSW Discounted Prices

All units available without power supplies Call for details.



STICK-ON SERIES RACKING SYSTEM

STR19	19" Rack Kit, (holds 12 Stick-On's), Snaps Included	Mfg. List \$159.00
STR12	Rack Kit Snaps, (additional 12 pack)	Mfg. List \$25.00

Call For BSW Price

TOLL FREE 800-426-8434

JUICE GOOSE



TWELVE PAQ Multi Voltage Power Supply

Now you can power your interface boxes, effects units, or any items requiring lower voltages from a neat, rack mounted, outlet saving unit. Twelve Paq has six separate low voltage outputs, each providing 9 VAC, 18 VAC, 9 VDC, and 12 VDC and 6 - 120 VAC outlets. Both high and low voltage outs have excellent noise filtration and spike protection. Custom cables are available to match Twelve Paq's low voltage outs to your equipments particular inputs.

Mfg. List \$249.00

Call For BSW Price

BROADCAST TOOLS

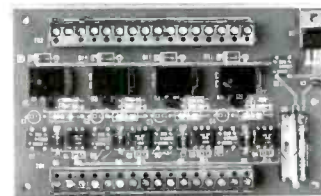

UI4 Relay Interface

Here is an inexpensive interface that facilitates remote control interfacing of transmitters, studio, and remote equipment that is not normally remoteable. The 3" x 5" universal interface creates an SPDT relay and open collector output from an optically isolated 5-28 volt AC or DC input. Four channels of control are included and can operate independently, or may be combined for latched and multiple relay contact operation. Input and output connections are via lugless type terminals. The UI4 is supplied with a plastic bracket for easy mounting using screws, double sided tape, or velcro. A self contained power supply operates from 12 to 48 volts AC or DC. Optional external wall transformer is available.

BSW Price \$129.95

Don't Panic... We're Still Open

BSW's extended hours and West Coast location are great for those times when you just have to have that piece of important equipment. We're open 6 a.m. to 6 p.m. Pacific time, 9 a.m. to 9 p.m. Eastern.

360 SYSTEMS



AM16B Audio Routing Switcher

The basic switcher is a mono16 x16 matrix, but may also be configured as an 8 x 8 stereo unit, or as a 16 x 1 mono or 8 x 1 stereo selector. All inputs and outputs are electronically balanced. Several slave units may operate in parallel to provide more than sixteen simultaneous inputs for 16 x 16 stereo or multi-channel operation. All active power supply elements are fully redundant, so an AM16 B can keep working even if all regulated supplies experience a failure. 100 memory presets are standard.

Mfg. List \$1,495.00

Call For BSW Price

ARRAKIS

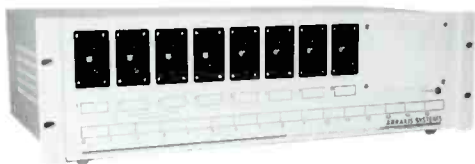

1100ARSS Audio Routing Switcher

Here's a professional alternative to patch panels with an ultra-reliable power supply that has a 10 year meantime before failure. The thumbwheel control switches are 1,000,000 operation. These switchers may be used in most critical sections of the audio chain with total confidence. Features: Control by four 16 position binary thumbwheels. One per output • Remote control • Size - 5 1/4" x 19" rack mount • 16 in by 4 outputs stereo • Expandable

Mfg. List \$1,195.00

Call For BSW Price

CONEX



AS101 Audio Routing Switcher

Allows any one of 10 stereo sources to be switched to the stereo output channel. Switching is accomplished by pressing one of the illuminate buttons on the front panel, or remotely, via the remote control connector on the rear panel. Several remote control devices may be connected in parallel, and all will indicate the selected channel.

AS101 Mfg. List \$895.00

AS401 Remote Control Mfg. List \$150.00

Call For BSW Price

CONEX



UM33 Cue And Monitor Amplifier/Switcher

The UM33 is a stereo, eight channel in, one channel out, general purpose cue, monitor and line amplifier. The UM33 provides the easiest, least expensive, and most compact way of handling a variety of common monitoring, cueing, amplifying, and switching situations in any audio installation. Typical UM33 applications include:

- Network or remote line monitor and buffer amplifier
- Transmitter input selector and monitor
- Automation cue amplifier
- Tape recorder input selector
- Telephone line source selector
- Headphone amplifier
- Intercom, communication system, or multi-media testing
- Console input expander

Mfg. List \$550.00

Call For BSW Price

TITUS TECH LABORATORIES



MLW1 Automatic Stereo Router

This wonder box can automatically identify and correct a number of problems that can occur in any monaural or stereo audio path or can act as a manual router and level matcher.

In the automatic mode MLW1 will sense the loss of a channel and instantly switch both outputs to the channel with audio, or switch in a second or third audio source. It will also bring up a second or third audio source upon loss of signal and create an alarm under any of the above conditions. Reaction time to either channel or signal loss can be user programmed.

In manual mode the MLW1 offers the following modes of operation on two of the three stereo inputs. It can reproduce the stereo input, produce an out of phase stereo source, produce the sum of the inputs on both output channels, produce the difference between the two channels on both output channels, or direct the left or right channel input to both outputs.

All inputs and outputs are balanced. The inputs can be individually set for -10, +4, or +8dBm and the outputs for +4 or +8dBm. Metering is provided for left/right and left+right/left-right.

Mfg. List \$1,800.00

Call For BSW Price

GENTNER



SWITCHER 10/SWITCHER 20
Audio Routing Switchers

Gentner switchers are insensitive to voltage fluctuations. Even if the units lose power, the proper source remains selected. Switchers 10 and 20 use highly dependable magnetically latching relays to route audio, data or control signals through your facility. Because the switching process is passive, with no loads or amplifiers of any kind, it's transparent to your signal. The Signal Switcher 10 selects ten stereo channels to a stereo output; the Signal Switcher 20 selects 20 mono channel signals to a mono channel output.

SWITCHER 10 Mfg. List \$899.00

SWITCHER 20 Mfg. List \$899.00

Call For BSW Price

BROADCAST TOOLS



SMI
Studio Monitor Intercom

Most broadcast consoles, even very high end consoles don't have adequate talkback/intercom or monitor capabilities. The Broadcast Tools SMI (Studio Monitor Intercom) provides an efficient, affordable solution. We all know that communication between studios is vital. The SMI allows you to talk to up to four other studios. Simply buy as many SMI's as you need. Talk with one studio at a time or on an "all call" basis. Each unit has host and guest headphone jacks with bass and treble EQ. The SMI automatically dims studio monitors during talkback. In addition, host headphones split for talkback in the right ear and air signal or program in left ear (defeatable while on air). Other features include:

- Fully remote controllable with tally
- Interconnection via convenient 50 pin telco-type connectors
- Mono/ phase check button
- Front panel talkback mic with adjustable AGC
- Aux input for talkback with level control (for remote feeds etc.).

Mfg. List \$699.00

Call For BSW Price

**All Telephones Lead
To BSW**

*Toll Free from all 50 states including Puerto Rico,
US Virgin Islands and Canada.*

TOLL FREE 800-426-8434

Broadcast Supply West And GE Capital

Working Together For Your Benefit

Never before has an audio equipment supplier and a financial institution developed a series of leasing programs that make it so easy and fast to acquire the equipment you desperately need. With *Flex Lease* you are able to choose from a variety of programs that are tailored to your individual needs.

BSW's exclusive relationship with GE Capital is based on our high volume of business. This means you get the best possible lease rates, together the highest level of service available.

For information on creative solutions to your equipment financing, contact a BSW sales representative today.

BSW[®]

BROADCAST SUPPLY WEST

America's Full-Time Broadcast Supplier

ORDERS • INFORMATION • SPECIFICATIONS
7012 27th Street West Tacoma, WA 98466

ADC

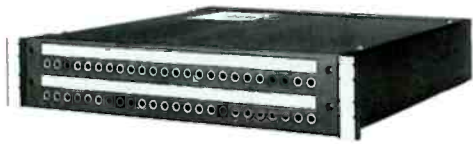

PRO PATCH MARK II Patch Panels

ADC's finest series patch bays are compact and ultra-high quality. In front, circuit designations are neat and convenient; and in back, the terminal layout affords faster installation and more flexibility of configuration. The fully enclosed Pro Patch chassis protects all the internal patchbay wiring as well as eliminating the need for routing and dressing conventional patchbay harnessing. Front panel and rear panels remove easily for service without removing the unit from the rack.

QCP is featured on Pro Patch. QCP provides a "gas tight" connection which means your cable connections are impervious to harmful environments, thereby giving you a connection that will not deteriorate over time.

Call BSW For Price And Configuration



BJF MKII Prewired Patch Panels

The standard BJF MKII patch panels include an Ultra Patch termination (see below) and a four foot cable harness but are available in numerous harness lengths and termination configurations on a special order basis.

Call BSW For Price And Configuration



QB2 Wire Insertion Tool

The insertion tool is used for insertion of wire into ADC patch systems with the QCP split cylinder terminations.

It applies the correct force to the wire by a spring loaded mechanism within the tool. Either of two impact forces can be applied, as selected by the LO-HI thumbwheel on the side of the tool. The impact tool includes 1 removable tip which comes stored in the tool's handle.

QB2 Mfg. List \$70.00

QB2T (Replacement Tip) Mfg. List \$16.00

Call For BSW Price

TOLL FREE 800-426-8434

ADC

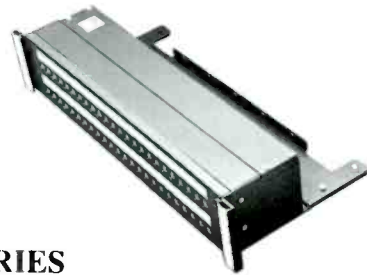

P-KIT SERIES Patch Kits

These money saving kits have many of the features of the pre-assembled patch bays, but in a package designed specifically for the do-it-yourselfer. Simply add your own cable and termination panel.

P-KIT1 Mfg. List \$180.00

1.75" panels with 2X24 array of long frame (1/4") jacks

P-KIT2 Mfg. List \$180.00

3.5" panels with 2X24 array of long frame (1/4") jacks

P-KITB Mfg. List \$240.00

1.75" panels with 2X48 array of Bantam jacks

Call For BSW Prices



ULTRA PATCH Punch Down System

Features:

- Utilizes QCP technology (see description from Pro Patch)
- Full and half normalling available
- Four design configurations to fit your application
- Cable support system insures that your cabling will dress neatly and stay that way, without stressing your connections

Call BSW For Price And Configuration



LONG FRAME 1/4"



BANTAM

LONG FRAME PATCH CORDS

PJ81 1 Foot BSW Price \$16.30

PJ82 2 Foot BSW Price \$17.15

PJ83 3 Foot BSW Price \$17.80

BANTAM PATCH CORDS

PJ712 1 Foot BSW Price \$9.65

PJ714 2 Foot BSW Price \$10.05

PJ716 3 Foot BSW Price \$10.45

Call For Details On Complete Selection
Of ADC Patchcords

GENTNER

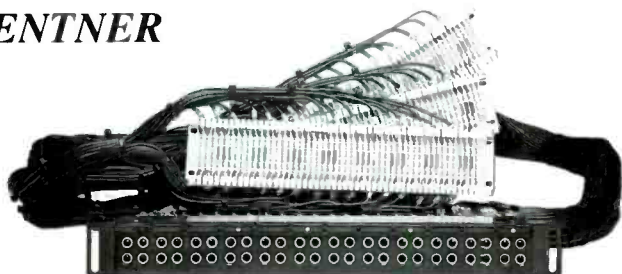

PRE-WIRED SERIES Patch Systems

Hand-wired to your specifications, using the highest quality components. A large variety of bay fronts and terminations are readily available for almost any configuration.

Call For Pricing And Configurations



VERSAPATCH Patch Systems

Chassis-enclosed audio patch panels with the terminations mounted on the rear panel. Eliminates guesswork on bundle length and provides protection against RFI and dust. Offset jack spacing for stereo patching.

Call For Pricing And Configurations

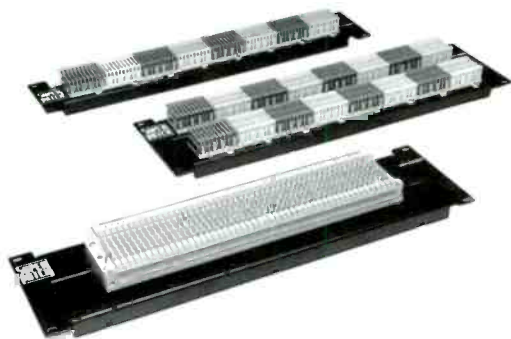

SUPERPATCH Termination Panels

These panel assemblies provide you with a convenient and flexible rack mount termination for your wiring projects. Superpatch is available with one or two rows of Flexiblock terminations or a Telco-type 66 punch block. All three models are secured to a fixed rack mounted aluminum panel to make punchdown connections fast and easy. Superpatch panels can be ordered separately or terminated to any of Gentner's prewired patch panels at the factory.

- SP1** Single Flexiblock (160 terminals-2 rack units) **Mfg. List \$109.00**
- SP2** Two Flexiblocks (320 terminals-3 rack units) **Mfg. List \$139.00**
- SP66** Telco punch block (150 terminals-three rack units) **Mfg. List \$99.00**

Call For BSW Prices

GENTNER

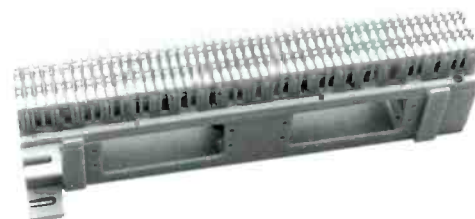

FLEXIBLOCK Termination Panel

A "punch block" for stranded wire. Provides simple, gas-tight connection without cutting strands. Mounting bracket provides easy cable management. 100 terminals configured with 2 rows of 50 terminals; each slot accepts 2 wires. (Split Flexiblock also available; provides 2X50 terminals with 2 wire connections per terminal.)

FBI Mfg. List \$29.00

Call For BSW Price

MOGAMI



Patch Cords

Super high quality cable and nickel plated connectors insure that your audio makes it from patch point to patch point with the absolute minimum loss of signal and maximum clarity with Mogami patch cords.

Prices Based On Size And Connector Type



Why wait around for your equipment---for just a few dollars more we can Federal Express your order. Tell your BSW Sales Rep to "Fed X" it.

Microphones

AKG



C414B/ULS Condenser Mic

The low inherent self-noise and high overload point guarantee a dynamic range in order of 126 dB. Four different polar patterns selectable on mic. All metal housing in black chrome finish. Includes stand adaptor and wind screen.

Mfg. List \$1,045.00 Call For BSW Price

AUDIO TECHNICA



AT815A Shotgun Mic

With the acceptance angle of approximately 40°, the AT815A provides a useful tool to overcome problems of noise or distance. Its flat response and high output insures well balanced, natural sounding pickup. Includes windscreen, battery, case, clamp, and cord.

Mfg. List \$285.00 Call For BSW Price

BEYER



M500 Ribbon Cardioid Mic

High quality ribbon microphone has a rising frequency response curve for optimum voice reproduction and vocal presence. Hyper cardioid pickup pattern offers high gain before feedback. Built-in pop screen. Frequency response 40 Hz to 18,000 Hz.

Mfg. List \$329.95 Call For BSW Price

TOLL FREE 800-426-8434

AUDIO TECHNICA



ATM25 Dynamic Cardioid Mic

Small hyper-cardioid mic with the performance of larger, more expensive studio mics. Minimal off axis coloration and voice tailored response.

Mfg. List \$240.00 Call For BSW Price
Options: Wind Screen AT8112, Shock Mount TM3

BEYER



M59 Cardioid Microphone

The M59 is a rugged mic employing low, a large diaphragm and enhanced-field magnet technology for high output, high sensitivity, startlingly accurate reproduction, and superb off-axis rejection. Includes integral windscreen and shock resistance.

Mfg. List \$214.95 Call For BSW Price
Options: Windscreen WS740

SONY



ECM55B Omni-directional Lavalier Mic

One of the most popular lavalier microphones we sell. It can be powered by AA batteries or external power supply. Comes with mesh windscreen and holder clips.

Mfg. List \$309.00 Call For BSW Price

AKG



D1200E Dynamic Cardioid Mic

An integral B-M-S switch, an AKG exclusive, permits the user to create an almost endless variety of tone control possibilities. Frequency range: 40 Hz to 17,000 Hz.

Mfg. List \$250.00 Call For BSW Price
Optional Wind Screen W29, SA41/1
Stand Adaptor Included

AUDIO TECHNICA



AT813 Condenser Cardioid Mic

Flat response, sensitive pick up, tightly defined pick-up pattern all contribute to the performance of this mic. Includes clamp, case, battery, and cord.

Mfg. List \$153.00 Call For BSW Price

BEYER



M58 Omnidirectional Moving Coil Mic

Specifically designed to satisfy ENG and EFP applications. Its internal shockmount dramatically reduces handling noise. Accurate voice reproduction information with a very high degree of intelligibility. Frequency response 40 Hz to 20,000 Hz. Includes WS58 windscreen and zippered case.

Mfg. List \$199.00 Call For BSW Price

ELECTRO-VOICE



RE27N/D Dynamic Cardioid Mic

A neodymium alloy magnet makes this mic a dynamic that rivals expensive studio condensers in sensitivity, output and clarity. The RE27N/D exhibits very consistent response no matter the distance from the mic with excellent off-axis rejection.

Mfg. List \$625.00 **Call For BSW Price**
Options: Windscreen WS87, Shock Mount 309

ELECTRO-VOICE



RE20 Dynamic Cardioid Mic

One of the most popular microphones used in broadcasting. The RE20 has a warm sound which will please the most discriminating announcers. Frequency response 45 Hz to 18,000 Hz. Output, -57 dB.

Mfg. List \$525.00 **Call For BSW Price**
Options: Windscreen WS87, Shock Mount 309

ELECTRO-VOICE



RE2000 Supercardioid Condenser Mic

The RE2000 features large diaphragm, side-fired format, RF-biasing, and switchable output level and provides wide-range, low-distortion performance with an uncolored natural character. Frequency response: 30 to 20,000 kHz.

Mfg. List \$1,000.00 **Call For BSW Price**



RE45N/D Shotgun Cardioid Mic

Specifically designed for hand-held use. The exclusive N/DYM™ dynamic element has the output level of a condenser microphone without need for battery or phantom power. Frequency response 50 to 15,000 Hz (close), 150 to 15,000 Hz (far). Output -50dB. Includes: clip, case, windscreen, and shock handle

Mfg. List \$429.00 **Call For BSW Price**



RE50 Omnidirectional Dynamic Mic

Features an internal shock and built-in windscreen with voice tailored response and -55dB output. Frequency response 80 to 13,000 Hz

Mfg. List \$207.00 **Call For BSW Price**



635A Omnidirectional Dynamic Mic

The 635A is our largest seller due to extreme durability and low cost. Frequency response 80 Hz to 13,000 Hz. Output, 55 dB.

Mfg. List \$139.00 **Call For BSW Price**
Options: Windscreen 314E, Shock Mount 313A



RE15/RE16 Super Cardioid Dynamic Mic

Features wide, flat response for broadcast applications. Its uniform super-cardioid pattern extends working distances. Frequency response 80 to 15,000 Hz. Output, -57 dB

RE15 Mfg. List \$349.00

RE16 Mfg. List \$365.00 (Same as the RE15 except includes blast filter to reduce "P" pops.)

Call For BSW Price

Options: Windscreens 314, 379 Shock Mount 313A



RE11 Super Cardioid Dynamic Mic

High degree of directional control with minimal off-axis coloration.

- Frequency response 90 to 13,000 Hz
- Output: 56 dB
- Built-in blast filter

Mfg. List \$249.00 **Call For BSW Price**
Options: Windscreen 379, Shock Mount 307



CO90 Omnidirectional Lavalier Mic

Broadcasters' favorite lavalier microphone. Battery power provides 1,000 hours of use. Comes with tie clasp bar, windscreen, zippered pouch, and battery housing with belt clip. Frequency response is 40 to 15,000 Hz. Output, -57 dB.

Mfg. List \$195.00 **Call For BSW Price**

Microphones

SHURE



SM7 Dynamic Cardioid mic

One of the finest studio professional dynamic microphones in use today. It features a wide-range, very smooth frequency response with graphic response tailoring switches to permit the choice of four different microphone response curves. Frequency response 40 to 16,000 Hz. Output, -57 dB. Contains integral shock mounting.

Mfg. List \$550.00 Call For BSW Price

SHURE



SM58LC/SM57LC Dynamic Cardioid Mics

Ideal for studio and remote, and unmatched in performance, ruggedness and reliability. The SM58 features a distinctive vocal presence peak and integral windscreen and the SM57 provides wide range reproduction of music and voice

SM58 Mfg. List \$176.00

SM57 Mfg. List \$137.00

Call For BSW Price

Optional Windscreens: (SM58) A58WS, (SM57) A2WSA

SHURE



SM87LC Cardioid Condenser Mic

An innovative new cartridge element features a highly directional supercardioid polar pattern for a surprising amount of gain before feedback. Shock isolated capsule and built in multistage blast filter. Low susceptibility to RF interference.

Mfg. List \$329.00 Call For BSW Price



SM63LLC Omnidirectional Dynamic Mic

The SM63 is an elegant, rugged microphone with very high output . . . up to 6 dB higher than comparable omnidirectional microphones. Frequency response 50 Hz to 20,000 Hz. Output, -56 dB.

Mfg. List \$145.00 Call For BSW Price



BETA57/BETA58 Dynamic Cardioid Mics

The BETA58 has the low frequency warmth of the popular SM58 with a smoother presence rise, extended top end and greater off-axis rejection. The BETA57 has a greater frequency range than the famous SM57 with a hotter output and greater off-axis rejection.

BETA58 or BETA57 Mfg. List \$258.00

Call For BSW Price

SM89 Shotgun Condenser Mic

The SM89's highly directional polar pattern and fine-tuned frequency response will pick up desired sounds while rejecting of axis ambient noise. Frequency response 60Hz to 20,000Hz. Output, -52dB. Windscreen and carrying case included.

Mfg. List \$900.00 Call For BSW Price

Options: Shock mount A89SM

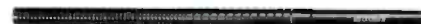

VP88 Stereo Condenser Mic

Select from three stereo modes or direct mid and side output. VP88 offers a wide, natural, uncolored response for stereo imaging, yet is perfectly mono compatible. It Battery or phantom powered and includes windscreen, clip, case, and Y-cable.

Mfg. List \$995.00 Call For BSW Price



SM83CN Omnidirectional Lavalier Mic

Provides superior quality sound reproduction in professional broadcasting and features a wide range frequency response, to provide natural sounding vocal reproduction. Mic is detachable from the preamp. Frequency response 80 to 20,000 Hz.

Mfg. List \$248.00 Call For BSW Price

SM90/SM91 Surface Mount Condenser Mics

Professional, studio-quality, "boundary effect," surface microphones. Ideal for TV settings, news conferences, dramatic productions, choirs or wherever inconspicuous microphone is desired. The SM91 is unidirectional and the SM90 is omnidirectional.

SM91 or SM90 Mfg. List \$310.00

Call For BSW Price



SENNHEISER



MD421U Dynamic Cardioid Mic

One of Sennheiser's most versatile and popular dynamic microphones. For on-air or production use, the MD421U is the natural choice for many stations. Frequency response 30 to 17,000 Hz

Mfg. List \$439.00 Call For BSW Price
Options: Windscreen 421WS, Shockmount TM3/311

NEUMANN



U87A Multi-Pattern Condenser Mic

In the last few decades the U87 has been the premier microphone in studios all over the world. It's smooth characteristics make it a superb vocal mic. Patterns include: omni, cardioid, and figure 8. Frequency response is 40 to 16,000 Hz.

Mfg. List \$2,475.00 Call For BSW Price
Options: Windscreen WS87, Shock Mount (option "Z")

R.D. SYSTEMS



P650EPM Parabolic Mic

One of the most directional microphones ever produced; making it possible to record voices, sounds, practically anything—to professional standards without having the microphone near the subject being recorded. Includes handle and headphones for monitoring.

Mfg. List \$599.00 Call For BSW Price

TOLL FREE 800-426-8434

SENNHEISER



ME80/K3U Short Shotgun Mic

Combination of supercardioid at low frequencies, and shotgun above 2,000 Hz. Excellent on-camera or hand-held interview mike for ENG/ EFP. Use with K3U power module. Frequency range 50-15,000 Hz.

ME80 Mfg. List \$259.00
K3U (Power Supply Module) Mfg. List \$210.00
Call For BSW Price

NEUMANN



TLM170 Multi-pattern Condenser Mic

Capable of handling sound pressure levels up to 140 dB with minimal distortion, with a dynamic range of 126 dB. Choose from: omni, wide cardioid, cardioid, hypercardioid and figure-8. Equipped with a tiltable, elastically suspended mounting bracket.

Mfg. List \$2,295.00 Call For BSW Price
Options: Windscreen WS89

CROWN



SASS-P Stereo Mic

The Crown SASS-P or Stereo Ambient Sampling System™ is a patented, stereo condenser microphone system using PZM technology. The SASS uses two premium-quality Pressure Zone Microphones mounted on boundaries (with a foam barrier between them) to make each microphone directional.

Mfg. List \$899.00 Call For BSW Price

SENNHEISER



MD431U Dynamic Cardioid Mic

Aspringsuspended element, humbucking coil, low frequency interference filter and integral pop filter contribute to the outstanding electro acoustic properties of this hand held cardioid mic. An excellent vocal mic with low handling noise, with a removable on/off switch.

Mfg. List \$449.00 Call For BSW Price

NEUMANN



U89 Multi-pattern Condenser Mic

The U89 houses a newly developed dual-membrane capsule with a particularly linear frequency response for all polar patterns. 5 directional patterns include: omni, cardioid, figure-8, wide-angle cardioid, hypercardioid

Mfg. List \$2,295.00 Call For BSW Price
Options: Windscreen WS89, Shock Mount (option "Z")

CROWN



SOUNDGRABBER Pressure Zone Mic

Crown PZM microphone technology in an inexpensive package. One Soundgrabber in the middle of the table can replace eight conventional microphones for recording. You can understand every word with amazing definition and detail. Comes with mini and 1/4" plug for direct recorder connection. Perfect for news departments.

Mfg. List \$99.00 Call For BSW Price

AUDIO TECHNICA



ATW1031/1032 Wireless Mic System

At the heart of ATW wireless systems is a sophisticated automatic diversity receiver. Two antennas, two complete, independent RF inputs, and a very sophisticated switching system eliminate multipath distortion and dropouts. Two isolated audio outputs permit simultaneous feeds to both unbalanced and balanced inputs. Choose from either a hand-held microphone or a body pack/lavalier transmitter. Transmitters may be operated up to 200 feet from receiver even in congested RF fields.

**System Prices Start At Only \$650.00 Mfg. List.
Call For BSW Pricing And Specifications.**

BEYER



TGX Wireless Mic System

This reliable, high performance, and cost effective system is available in two basic configurations. The hand held system incorporates the new TGX480 mic head with super cardioid pick-up characteristics. The MCE5 lavalier mic gives the body pack system wide frequency response, low noise, and superior intelligibility. Both systems include the NE170 true diversity receiver with balanced /unbalanced outs, adjustable gain, and mute sensitivity control.

Call BSW For Configurations And Pricing

SHURE



L SERIES Wireless Mic System

The L Series gives you a level of reliability and features unsurpassed in its price range. L Series systems are available in diversity and non-diversity versions and feature popular Shure microphone models that are perfectly matched to the system electronics.

**System Prices Start At \$360.00 Mfg. List For Non-Diversity.
Call Toll-Free For Complete Specifications And Prices.**

SAMSON



BROADCAST STD Wireless Mic System

This system features 10 selectable digitally-synthesized channels on both transmitter and receiver. Through the use of the BR3 level LED ladder you can visually scan all 10 channels to select the best channel for operation. Broadcast STD Series also provides improved state-of-the-art RF circuitry and utilizes dbx noise reduction to provide expanded dynamic range and the highest level of audio quality.

Prices Based On System Configuration.



STAGE 2 SERIES Wireless Mic System

Here is our most popular seller in budget priced wireless systems. The Samson Stage 2 Series offers superior VHF non-diversity wireless performance. Dbx noise reduction assures high signal-to noise ratio and quiet reception. This system will operate under adverse RF environments and is stable at distances up to 250 feet. Choose from systems that feature different mic capsules in either hand-held or body pack transmitters.

**Prices Start At Only \$289.00 Mfg. List.
Call For Pricing And Configuration**

*BSW's West Coast Location Allows Late In The Day
Shipments. If You Need Equipment Fast,
BSW Is Your Supplier.*

***We Offer Special Discount Rates On
Federal Express.***

TELEX



FMR50 Wireless System

The FMR50 uses the latest in CMOS electronics for powerful RF rejection. Selectivity is further enhanced by the exclusive use of a computer designed system of low distortion, linear phase IF filters. This narrow selectivity permits the operation of up to seven systems in a single location, simultaneously, without interference. Features:

- Peak reading volume indicator
- Carrier indicator
- Adjustable output control
- Standard Hand-held or Lapel System

Mfg. List \$810.00

Call For BSW Price



FMR25 Wireless Mic System

The most economical Telex wireless system, the FMR25 has less distortion and flatter frequency response than other systems in the same price range. Exclusive compander circuitry improves dynamic range. Line of site working distance is up to 500 feet between transmitter and receiver. Hand-held microphone or lapel/belt pack transmitters are available.

FMR25 Lapel System Mfg. List \$465.00

FMR25 Hand-Held System Mfg. List \$600.00

Call For BSW Price

FMR25 Systems Are Available In Diversity.

VEGA



PRO SERIES Wireless Mic Systems

For years, Vega wireless microphones have been the yardstick by which the rest of the wireless industry is measured. Their outstanding reliability and superior performance have made them the choice systems for broadcast and entertainment professionals. Choose from diversity or non-diversity receivers. Both feature Dynex II audio processing for exceptional audio performance and separate 10 segment LED displays for audio and RF signal strength.

The belt pack transmitter features an audio overload indicator, allowing easy maximization of usable dynamic range, while silent on/off mute switch permits you to turn off the mic without affecting the RF. Of course hand-held transmitters are available with a wide variety of mic capsules.

Non-Diversity Systems Start At \$1600.00 Mfg. List
Call For Complete Systems Configurations And Pricing.



RANGER SERIES Wireless Mic Systems

Here is Vega's answer to competitively priced wireless systems without compromising audio performance. They offer a high signal-to-noise ratio and wide dynamic range by virtue of their exclusive CVX™ audio processing and offer smooth, clear, virtually noise-free audio performance. Ranger is available in both true-diversity and non-diversity configurations, and delivers exceptional RF performance through the transmitter's high radiated power and a sensitive, highly selective receiver. Ranger offers a wide variety of lavalier microphones and hand-held microphone elements, operates on crystal-controlled frequencies in the 169-216 MHz range, and comes with a three year warranty.

System Prices Start At \$1,179.00 Mfg. List For Non-diversity.
Call For Configurations and Pricing.

Microphone Accessories

ATI

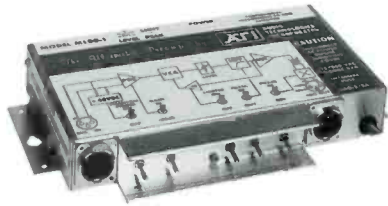

ULTIMIKE M100 Microphone Preamplifier

Eliminate dimmer noise, RF pickup and hum loops by mounting this small, rugged, full featured preamp right near the audio source. The unusually quiet, direct balanced amplifier input has impressive hum and RF rejection and accepts +20 dBm maximum input. Features switchable and adjustable gain, limiter, lo-cut filter, 48 volt phantom power and a phase reversing switch. A unique output driver provides the many advantages of the true transformer isolation with no performance compromises. XLR in and out, dual rack mountable.

Mfg. List \$329.00

Call For BSW Price

SYMETRIX



SX202 Dual Mic Preamp

The SX202 features two ultra clean microphone preamplifiers with variable gain, 15 dB pad, +48 volt phantom powering, left, right, and left + right outputs.

Mfg. List \$289.00

Call For BSW Price

SHURE



FP11 Mic-to-Line Amplifier

The FP11 is a portable, 1-input, 1-output microphone-to-line level amplifier designed for field production. It is ideal for use where long lines must be driven at higher than microphone or auxiliary levels. It can also be used to interface between equipment requiring different signal levels.

The balanced, locking XLR input and output provide for excellent rejection of hum and RF interference. A switchable peak limiter prevents output overload distortion. Additional features include a peak/limiter LED indicator, aux level mini-phone jack input, balanced line-level binding post output, and a removable belt clip. The FP11 is powered by one standard 9V battery.

Mfg. List \$270.00

Call For BSW Price

RADIO DESIGN LABS



STM1/STM2 Microphone Preamps

Ultra compact size makes these units ideal where larger or heavier preamps cannot be used. Both models feature Hi or Lo-Z, RF filtered inputs and balanced Hi or Lo-Z outputs. STM1 Has a single fixed level output - STM2 has two variable level outputs. External phantom power can be supplied to mics through a designated supply input on both models.

STM1 Mfg. List \$79.95

STM2 Mfg. List \$109.95

Call For BSW Price

Call For BSW Price

WHIRLWIND



MICPOWER Phantom Power Supply

For use with most electret condenser microphones this unit supplies +12 to +18VDC under nominal loads at the microphone input. The output is AC coupled. Micpower operates on two 9 volt batteries for approximately 50 hours and includes a battery level LED.

BSW Price \$50.75

STEWART



PM1/PM2/PM4/PM6 Modular Phantom Power Systems

Models of one to six channels are available providing true 48v phantom power. Units feature individual regulation of each channel, short circuit protection, isolated outputs, and very low noise and cross talk. All models require the Stewart PS1 power supply module (300 mA at 24vDC from 110v AC) but models PM1, PM2, and PM4 can be combined to create a system of up to 12 channels using one PS1 power supply. PM6 is a six channel rack mount unit that comes with rack hardware.

PM1 w/PS1 Power Supply Mfg. List \$93.00

PM2 w/PS1 Power Supply Mfg. List \$138.00

PM4 w/PS1 Power Supply Mfg. List \$171.00

PM6 w/PS1 Power Supply Mfg. List \$269.00

Call For BSW Price

PM1, PM2, and PM4 available without PS1

SHURE

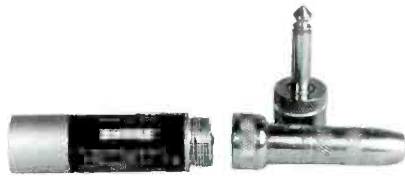

A97A/F Line Matching Transformers

Matches low impedance (150 ohm to 600 ohm) microphone outputs to medium impedance (1k ohm to 10k ohm) inputs. Model A97A converts low-impedance XLR connector to medium-impedance standard 1/4" male and female phone connectors. Model A97F mates low-impedance XLR connector to medium-impedance short cable, terminated by a 9/64" diameter miniature phone plug.

A97A BSW Price \$33.00 A97F BSW Price \$37.00

EFXX

RTS321 3 Wire Adaptor

Five miniature slide switches provide 32 internal wiring schemes for the proper match of a 1/4" TRS connector and an XLR type connector.

BSW Price \$28.45



WHIRLWIND

LITTLE IMP Mic Transformer

Impedance matching transformer XLR type low in to 1/4" high.
BSW Price \$10.30



IMP SPLITTER/IMP COMBINER Microphone Splitters/Combiners

Two models (Splitter 1x2, Splitter 1x3) split 1 low impedance input to 2 or 3 low impedance outputs. Imp Combiner combines 2 low impedance inputs to 1 low impedance out. All units feature transformer isolation and a phase reverse switch.

IMP Splitter 1x2 BSW Price \$53.90
IMP Splitter 1x3 BSW Price \$59.95
IMP Combiner BSW Price \$56.80



NEUTRIK



Audio Connectors

When it comes to quality connectors, choose Neutrik. More than 15 million have been sold over the last 10 years. Easy to disassemble and reassemble. Built-in strain relief system that insures your connection will remain solid under adverse conditions.

Call For Pricing On Specific Connectors

BSW

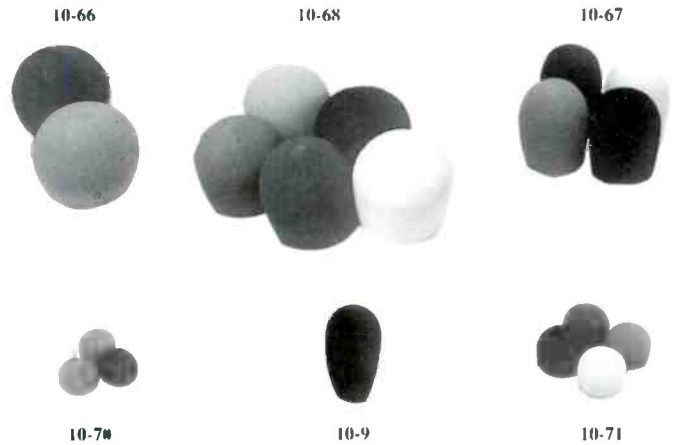

Universal Multi-color Windscreen Sets

Block out unwanted pop, wind, noise and close talking hiss. Made from special soft cut foam, decorative in design. These multicolor screens add beauty to your microphones as well as identify them so no mix up will occur when more than one microphone is used.

10-9 2 3/4" high screen, fits slim models from 3/4" to 1 1/8", black
BSW Price \$2.00

10-66 Contains two 2 3/8" high screens, fits 1 3/4" to 2" diameter mics, 1-red, 1-blue.
BSW Price \$6.60

10-67 Contains four 2 3/4" high screens, fits 1 3/8" to 1 3/4" diameter mics, 1 each: red, blue, yellow, black.
BSW Price \$8.15

10-68 Contains five screens 2 3/8" High for spherical head mics with 1 3/4" to 2" diameter. 1 each: red, blue, yellow, green, black.
BSW Price \$19.85

10-69 Contains four 7/8" high screens, fits 1/4" to 1/2" diameter lavalier type mics. 1 each: red, black, yellow, green.
BSW Price \$6.15

10-70 Contains four 1 1/8" high screens, fits 3/4" to 1" diameter mics. 1 each: red, black, yellow, green.
BSW Price \$7.50

10-71 Contains four 1 1/2" high screens, fits 7/8" to 1 1/8" spherical head mics. 1 each: red, black, yellow, green.
BSW Price \$7.65

AUDIO VISUAL RESOURCES



POPBK Studio Pop Filter

Get maximum protection against P-popping without sound coloration. Order with KM237 clamp and GN13 gooseneck to mount to your studio mic arm.

Mfg. List \$24.00

Call For BSW Price

Microphone / Accessories

LUXO



A.



B.



C.



D.



E. F. G.

Oyster or black color.

G. LM2 26" reach, for 1 lb. microphone. Grey color.

E, F, Or G BSW Price \$59.95

E, F, Or G With 12" Pedestal Pro-Bracket \$72.50

Mounting Brackets For Booms

A. Clamp Mount

B. Wall Mount

C. Desk Mount

A, B, or C Your Choice \$9.50 ea.

D. PRO-BRACKET 12" Pedestal Rugged

all aluminum. Colors: grey, oyster, black and silver.

BSW Price \$24.95

E. LM1-3 41" reach heavy duty model for up to 3 lb. microphones. Oyster or black color.

F. LM1 41" reach, for 1 lb. microphone.

ATLAS



H.



I.



J.



K.



L.



M.



N.

O.

H. DS2

Vibration Isolating Stand

Non-adjustable 3" high chrome tube. Non-reflective 4" X 6" charcoal base.

BSW Price \$24.40

I. DS5

General Purpose Stand

Non-adjustable 4" high chrome tube. 6" diameter cast iron charcoal base.

BSW Price \$12.20

J. DS7

Adjustable Desk Stand

Chrome tube assembly, adjustable height 8" to 13". Grip-action clutch. 6" diameter charcoal base. Black or silver.

BSW Price \$16.80

K. DS14

Contemporary Stand

Non-adjustable 3" high chrome tube. Lightweight charcoal base.

BSW Price \$18.70

L. MS12C

General Purpose Stand

Grip-action clutch. Low-profile charcoal base with added weight for extra stability. Our best seller. Black or silver.

BSW Price \$33.25

M. PB10X

Microphone Boom

Die-cast swivel, tapered counterweight, coordinated hardware. Attaches to any microphone stand terminating in 5/8" diameter tubing or adapter. Grip action clutch. Expandable from 31" to 50". Black or

silver. BSW Price \$39.65

N. SB36W

Heavy Duty Boom Stand

Grip-action clutch with integral air suspension to counterbalance boom weight. Boom length 62". Adjustable vertical height from 48" to 72". Rubber casters for mobility.

BSW Price \$284.50

AKG

O. KM265/KM211/3

Floor Stand/Boom

KM265 lightweight economy stand, available in black, white blue, and red. High quality collapsible construction, adjustable from 34" and 62". Shown with KM211/3 boom.

KM265/KM211/3 Combo

Mfg. Price \$38.65

NEUMANN



NEUMANN Microphone Cable

Neumann, the quality mic manufacturer, also makes some of the finest mic cable available. This cable is extremely durable and flexible and BSW has both bulk lengths and pre-made individual cables in a variety of colors and sizes.

Call Us With Your Requirements.

PROCABLE



RAI125 Mic Cable

Here's an outstanding value in a sturdy 25 ft. cable with XLR connectors.

BSW Price \$22.95

4 Or More \$19.95

BSW



CORDLOX

Handy cable ties that secure your coiled cables so you don't end up with piles of tangled cables to untie. Send them with remote crews to organize their cables and help prolong cable life.

307-0 Package Of 10 BSW Price \$18.00

GORMAN - REDLICH



**CEB
EBS Monitor**

This low cost unit exceeds FCC specifications for EBS requirements and offers uncompromising quality and performance. Features:

- Encoder FCC type accepted • Decoder FCC certified • Provision for remote operation • Programming loop through standard in encoder
- Decoder demutes monitor receiver/and or activates auxiliary alarm
- Decoder can be self-tested • Requires outboard tuner

Mfg. List \$540.00

Call For BSW Price



**CRW
Weather Alert Monitor**

Receive accurate local weather, plus emergency alert messages, weather radar data or marine information. Automatic warning for severe weather or civil defense emergency.

Mfg. List \$540.00

Call For BSW Price

MTS



**3000
EBS/Weather Monitor**

System 3000 incorporates three monitor receivers, and an EBS encoder/decoder into one rack mountable package 3 1/2" high. A single System 3000 can monitor your areas CPCS1, CPCS2, and the local NOAA weather service. Or it can monitor your CPCS1, CPCS2, and an adjacent area CPCS1. Or with 2 or more systems you can monitor EBS and NOAA services over a large area thereby offering your community the best information and protection available. Additional features include:

- Three channel scan • Continuous automatic self test • Manual or automatic operation • Program audio loop through • NOAA weather service receiver • NOAA priority alert decoder • Left and right channel outputs • Remote operation • Built-in monitor speaker

Mfg. List \$1,900.00

Call For BSW Price

TOLL FREE 800-426-8434

MTS

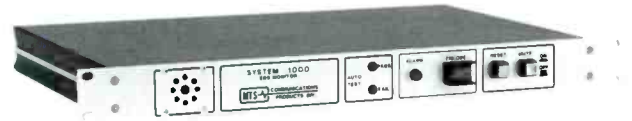

**SYSTEM 1000
EBS System**

This single rack space unit covers all your EBS requirements with EBS encoder, decoder, and receiver built in. Features:

- Continuous automatic self test • Full program audio loop through
- Digital remote control access • Stereo outputs • Independent encoder output • Alarm relay • Hi-Z RX monitor port

Mfg. List \$899.00

Call For BSW Price

TFT



**886/887
EBS Monitor**

The AM receiver, Model 886, and the FM receiver, Model 887, are tunable for their entire respective broadcast bands via front panel push button selectors. Both receivers have built-in two tone decoders for the 853 Hz and 960 Hz EBS signaling tones. Two 2-digit LED displays on the front panels of the receivers show the number of days, up to twelve, since EBS test transmissions were last received and/or sent to help avoid FCC citations.

886 Mfg. List \$2,095.00

Call For BSW Price

887 Mfg. List \$2,020.00

Call For BSW Price

***What Has Your Bank Done
For You Lately??***

When was the last time your bank or credit union offered to give you an equipment loan that covered 100% of the equipment cost, including shipping and installation, that featured low monthly payments and built-in tax advantages, along with insurance to cover the equipment for the duration of the loan, and could be approved in just a few days? Never...Right! If this sounds like the type of financing you might be interested in, call your BSW representative. Toll-Free, to find out how a FlexLease program can offer you all of these benefits.

BELAR

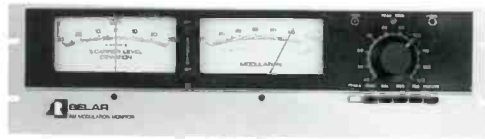

AMM2B AM Modulation Monitor

One of the most popular AM modulation monitors available. Includes the following features: Separate 100% negative peak and 125% positive peak modulation indicator lamps that are independent of carrier level • Adjustable peak modulation indicator, 40 to 130% in less than 1% increments, independent of carrier level • True peak-reading modulation meter responds accurately to the shortest duration program peaks • Built-in carrier-off alarm • Built-in modulation calibrator

Mfg. List \$1,320.00

Call For BSW Price



FMM2 FM Modulation Monitor

The FMM2 sets new standards in accurate FM monitoring the first to incorporate a sample hold peak modulation meter circuit independent of modulation polarity to allow the meter to respond to program peaks of the shortest duration. The heart of the FMM2 is an ultra-linear digital discriminator which provides a distortionless baseband signal for accurate monitoring as well as a precise stereophonic, and SCA decoding. FMM2 required with FMS2 or SCM1.

FMM2 Mono Modulation Monitor Mfg. List \$1,590.00

FMS2 Stereo Modulation Monitor Mfg. List \$1,790.00

SCM1 Subcarrier Modulation Monitor Mfg. List \$1,695.00

Call For BSW Price

QEI

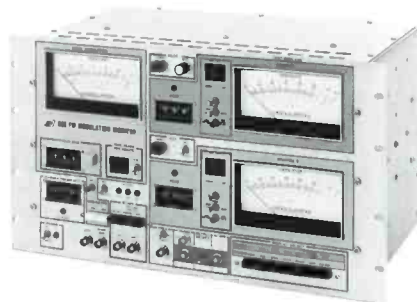

691/01 FM Modulation Monitor/Test Set

The 691/01 is a highly technical, precision instrument employing a combination of test techniques in a versatile, but very compact package. It was designed to be a complete FM test package with facilities for all proof-of-performance measurements and a wide range of trouble-shooting test. Operator convenience and simplicity of use were primary considerations in the design of the 691. 18 tests can be performed in addition to measuring FM and SCA modulation when used with an oscilloscope.

Mfg. List \$6,675.00

Call For BSW Price

TOLL FREE 800-426-8434

TFT

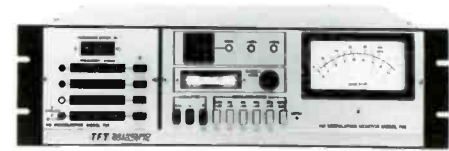

753/755A AM Modulation Monitor/Preselector

In today's competitive AM markets, you need to deliver a strong signal to the widest possible area. But, transmitter power alone isn't enough. You also need all the modulation you can legally achieve. That's the basic purpose behind the TFT Model 753 AM Modulation Monitor. Not only does it make extremely accurate proof-of-performance measurements, but more importantly, it allows you to monitor your transmitter so precisely that you can modulate it to the maximum legal limits in absolute confidence. The optional 755A preselector module allows you to monitor your own, or a competitor's signal off-air.

753 Mfg. List \$1,680.00

Call For BSW Price

755A Mfg. List \$1,765.00

Call For BSW Price



844 FM/Stereo Modulation Monitor

You get everything you need for complete proof-of-performance measurements (for distortion, an external analyzer is needed) right on the front panels, plus accuracy, versatility and convenience no other monitors can match. The 844 FM Monitor combines a tunable RF preselector, a baseband monitor and a stereo monitor in one compact instrument. State-of-the-art design includes the use of linear phase filters, large scale integrated circuits (LSI) and toroidal power transformers to reduce hum and power line noise. Modular PC cards make service and routine calibrations easy.

Mfg. List \$4,550.00

Call For BSW Price



884 FM Stereo Modulation Monitor

A cost effective alternative to TFT's popular Model 844. The 884 allows you to maximize modulation levels while maintaining the highest signal quality. The 884 can be used for transmitter Proof-Of-Performance measurements (with a 40 dB attenuator inserted before the antenna input), or at the studio for off-air monitoring. The frequency synthesized pre-selector can be used to select your own station's signal or the signal of another station for easy and convenient comparison.

Mfg. List \$3,595.00

Call For BSW Price

FAX 206-565-8114

MODULATION SCIENCES



MODMINDER FM Modulation Monitor

Increase modulation with less processing, and still stay within FCC limits. Another "miracle processor"? Not at all, ModMinder™, the unprocessor gives you more accurate measurement of modulation and doesn't alter your signal in any way. By the most recent FCC standard, your modulation monitor is making you set RMS modulation lower than necessary. That's because it registers overmodulation on brief overshoots that it should ignore. FM ModMinder™ registers only those longer "events" that the FCC really cares about. So you can boost modulation up to 3 dB if you use moderate processing. Or you can back off on "nail-it-to-the-wall" processing while keeping loudness at the max. You don't have to junk your current modulation monitor to take advantage of the correct measuring method. ModMinder™ works with any stereo-capable demodulator.

Mfg. List \$2,395.00

Call For BSW Price

BROADCAST ELECTRONICS



AS10 AM Stereo Modulation Monitor

AS10 represents a substantial improvement in C-QUAM® monitoring technology with design innovations and convenience not found in other monitors. Features include: RF AGC for optimum C-Quam® decoder performance • Minimal overshoot for accurate modulation level measurement • Digital pilot detection for excellent long term stability • Rapid carrier shift response • Selectable manual or auto-ranging meters • Front panel audio output for transmitter alignment and proof of performance

Mfg. List \$4,800.00

Call For BSW Price

DELTA



ASM1 AM Stereo Modulation Monitor

The ASM1 helps maintain and ensure AM broadcast system performance. The monitor incorporates a high performance C-QUAM decoder to demodulate the RF sample. It provides all the demodulated signals necessary for annual proof of performance when used with standard AM proof equipment.

Mfg. List \$6,305.00

Call For BSW Price

DELTA



SM1 AM Splatter Monitor

Now you can use the same tool that the FCC uses to measure your station(s) compliance with NRSC and FCC regulations and requirements. It's inexpensive and easy to use and offers the following features: Quick and easy to interpret results • 450 kHz to 1700 kHz phase-locked operation (10kHz or optional 9kHz channel spacing) • Portable operation from external 12 VDC power supply and optional active antenna • measurement of I, Q, I+Q, and external audio signals

SM1 Mfg. List \$2,500.00

Active Whip Antenna Mfg. List \$495.00

Call For BSW Price

RADIO DESIGN LABS



ACM1 Amplitude Component Monitor

The ACM1 is a precise AM noise meter which connects to the RF sample on an FM transmitter. A digital string display with 20 dB of range displays AM noise for precise transmitter tuning. It interfaces with any remote control to sample and then read back a stable indication of AM noise. An adjustable alarm threshold can signal the station operator when AM noise has increased beyond a level you determine will cause reception problems. The nature of AM noise measured can be examined by the engineer with the oscilloscope output. Audio and data outputs are provided.

Mfg. List \$1,295.00

Call For BSW Price

SENTRY SYSTEMS



AIR SENTRY II Audio Signal Monitor

The Air Sentry is designed to constantly monitor the presence of an audio signal to energize a relay when the audio is absent. Activation of the relay is front panel adjustable from 4 to 20 seconds. The relay may be used to activate an external audible or visible alarm to notify station personnel of the absence of broadcast signal. Air Sentry can monitor any stereo or mono audio source such as audio from AM/FM tuner, TV receiver, or modulation monitor. Air Sentry is built to broadcast standards of reliability and is extremely cost-effective.

Mfg. List \$295.00

Call For BSW Price

ATI



VU800 VU Metering System

Know at a glance where your signals are (or are not). Expandable ATI MicroMeters display one, two, three or four stereo lines (eight channels) on bright, two-color vacuum fluorescent bar-graph indicators. Balanced, bridging inputs are switchable for 0 VU at -10, +4, and +8 dBm line levels. Displays -20 to +8 VU with peaks stored for several seconds. Backlit, compact 3 1/2" rack mount.

Mfg. List \$1,249.00 Smaller Versions Available
Call For BSW Price

DORROUGH



40A Loudness Monitor

Dorrough loudness monitors display, in an easy to read format, the actual energy content of the program material while still indicating peak amplitude by displaying both peak and average on the same scale. They allow the operator to adjust all program material for equal perceived loudness while protecting the peak waveform. One Dorrough meter gives you more usable information than any combination of peak hold, VU, and PPM indicators. 40 LEDs in a single scale offer maximum accuracy in signal monitoring.

Mfg. List \$475.00 Call For BSW Price

SYMETRIX



SX205 Precision Audio Meter

To extract the full performance from analog or digital systems, precision metering is essential. The SX205 is convenient, cost effective, and fits the bill perfectly. This precision digital meter is a microprocessor controlled, two channel level display that measures both voltage (VU) and power (watts across 2, 4, or 8 ohms). Each channel can display average level or peak level, both with adjustable peak hold (zero to infinity). SX205's intelligent display driver allows bargraph or dot format to be selected. A 1000 Hz sine wave calibration oscillator is included in this half rack-width unit.

Mfg. List \$339.00 Call For BSW Price

CARVER



PSB11 AM/FM Stereo Tuner

This unit is the successor of the popular TX11B. New rack mountable front panel and improved AM stereo specs make this even more broadcast ready. Features include: Ultra-high performance FM detection circuit for dramatically reduced multipath and noise • 13 AM/FM presets • Preset scan • Best AM stereo specs in the industry (full 20-15 kHz frequency response (+-0.3 dB) • 0.05% THD@ 1 kHz for FM tuner section

Mfg. List \$749.95 Call For BSW Price



TX10 AM/FM Tuner

For an accurate tuner without the frills found in more expensive tuners, take a look at the Carver TX10. Features include 20 AM/FM presets, auto/manual tuning, and LED signal strength meter.

Mfg. List \$299.95 Call For BSW Price



TX12 AM/FM Tuner

This mid-priced tuner provides accurate reproduction of your station's signal. Features: Advanced, logic-controlled asymmetrical charge-coupled FM detection circuit for dramatically reduced multipath and noise • 20 FM/AM presets • Analog signal strength meter • Preset/scan • Multi-function remote control • Auto/manual tuning • Stereo/mono switch • Dual antenna inputs

Mfg. List \$399.95 Call For BSW Price

SOUNDCRAFTSMEN



PROTUNER FOUR AM/FM Stereo Digital Tuner

Soundcraftsmen's advanced technology incorporates sophisticated frequency synthesized tuning with a highly stable quartz crystal oscillator that locks into the broadcast signal and makes station selections precise and drift-free. A 16-station microcomputer memory system, coupled with two-way automatic scanning, provides incredibly simple programming station selection. Rack mountable.

Mfg. List \$379.00 Call For BSW Price

OTARI



5050 SERIES 2, 4, & 8 Channel Recorders

The new generation Otari MX5050 series allows the audio professional to select exactly the right machine for his or her application from a complete range of compact audio recorders. Models include the new MX5050BIII two track, BQIII 4 track, three overhead meter style machines - The MKIV-2 two track, MKIV-4 four track, and MKIV-8 eight track.

All models include the following features: Three-head design • Transformerless balanced inputs and outputs • Front panel record electronics with built-in test oscillator • Gapless, seamless, punch-in/punch-out (on BQIII, MKIV-4, and MKIV-8 only) • Dump edit and cue modes • Reel size selector for take-up and supply reels • Servo controlled direct drive motor • Microprocessor controlled tape handling with dynamic breaking • Built-in mini auto locator with 3 cue point memory, search to zero, and repeat function • Microphone and line mixing on each channel • Tape timer display shows Hrs/Min/Sec as well as tape speed in IPS and % of tape speed • Pitch control (+/-20% in .01% steps) • Time code editing with external synchronizer via 37 pin parallel interface • Extremely rugged construction

Available options: Autolocaters CB119, CB120 • Remote controllers CB127, CB144 (MKIV-8) • Synchronizer EC102 • Roll-around stand ZA52L • Rack mount kit (for upright models) RK2B

MX5050BIII Mfg. List \$3,295.00
MX5050BQIII Mfg. List \$5,160.00
MX5050MKIV-2 Mfg. List \$4,295.00
MX5050MKIV-4 Mfg. List \$5,995.00
MX5050MKIV-8 Mfg. List \$6,295.00

Call For BSW Prices

PO100 Table Top Console

An attractive, rugged, economical table top console to accommodate your MX5050BII/III. Replaces the two side panels of your Otari. Installation is a breeze using existing screws.

BSW Price \$79.95



TOLL FREE 800-426-8434

OTARI



MX55 2-Channel Recorder

Loaded with features, the MX55 was designed for fast paced production and mastering applications. Features: DC-servo capstan motor allows +20% vari-speed • Inputs and outputs are transformerless active balanced • LED tape timer with accurate return-to-zero and 3 cue memory points • Concealed front panel audio adjustments • Built-in cue speaker and headphone amplifier • Extra 1/4 track reproduce head

MX55N Mfg. List \$4,295.00

MX55NM (Same as above with meterbridge console) Mfg. List \$5,495.00

Call For BSW Price



MX50 2-Channel Recorder

The Otari 2-track for facilities on a limited budget. Durable transport features DC-servo capstan motor with vari-speed of +7%. Five digit tape timer has return-to-zero and search-to-cue for quick location of desired cue point. Speeds are selectable in pairs of 15/7.5 or 7.5/3.75 ips. Inputs and outputs are transformerless active balanced and have XLR connectors.

Mfg. List \$2,495.00

Call For BSW Price



ARS1000DC 2-Channel Reproducer

1/4" 2-channel, half-track reproducer with 25 Hz tone sensor, end-of-message and cue tone relays with adjustable delay (100 ms to 15s), 7.5/3.75 ips speeds, 19" rack mount. Designed for automated broadcast systems and other high-reliability reproduce only applications. 15/7.5 ips available on special order.

Mfg. List \$2,250.00

Call For BSW Price

REVOX



C270



C274

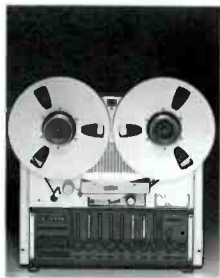

C278

C270 SERIES

2, 4, & 8 Channel Recorders

The C270 series, for the professional user who requires superior audio quality combined with overall value, and the features and capabilities that professionals need.

The 2, 4, and 8-channel machines all have 3 tape speeds 3 3/4, 7 1/2, and 15 ips—any pair of which can be selected and quickly changed in the field. The 4- and 8-channel recorders also come in low speed versions, especially suited for logging applications, with speeds of 15/32, 15/16 and 1 7/8 ips. Constant tape tension on both spooling motors, one-hand servo controlled cueing, built-in varispeed (33% to +50%), an integral scrape-flutter filter in the head assembly and a true autolocator with zero, address and search locate functions allowing for precise search-to-cue are just a few of the features standard in the C270 series.

Professional Audio Electronics

Dolby HX Pro® Headroom Extension and proprietary phase compensated audio electronics, seamless and gapless punch-in and punch-out, plug-in EQ cards for easy service and speed conversion, plus superior audio performance are standard features on every machine.

Rugged Quality, Easy To Maintain

The C270 has full modular audio electronics—all front accessible, even in rack-mount configuration—and a rugged die-cast deckplate, head assembly and chassis. In addition to the features and capabilities standard on every recorder in the C270 series, the 4 and 8-channel machines have these special capabilities: Internal logging time and date code generator and reader capable of searching and locating to any time directly • LED bar graph meters that read both peak and VU program levels simultaneously • Auto reverse playback mode allowing continuous playback in both directions of pre-recorded 1/4-track stereo tapes (on C274 4-channel machine only)

• SMPTE time code capability

C270 (1/4" - Two Channel) Mfg. List \$4,695.00

C274 (1/4" - Four Channel) Mfg. List \$6,395.00

C278 (1/2" - Eight Channel) Mfg. List \$7,795.00

Call For BSW Prices

TASCAM



BR20

2 Channel Recorder

Designed with professional use in mind, the BR20 packs outstanding performance and features into a compact, exceptionally easy-to-use recorder. Standard features include: Balanced +4 dBm inputs and outputs • Front panel audio calibration controls • Precision tension servo controlled transport for exceptionally smooth operation • Switchable 15/7.5 ips tape speed (optional 7.5/3.75 speed available) • Accurate real-time tape counter with 3 presettable locate points and zero locate • Dump edit, manual edit, stop edit, and quick cue modes • Independent L/R reel size selectors • Built in rack mounting • Center track time code and gapless, seamless punch-in/out (on BR20T) • Much more!

BR20 Mfg. List \$2,299.00

BR29T Mfg. List \$2,999.00

Call For BSW Price

Call For BSW Price



32

2-Channel Recorder

The cost effective model 32 offers independent left-right recording, pitch control, dump edit, NAB equalization, and 10 1/2" reel capacity. Sync mode allows over-dub recording with full frequency response. Rack mount is available as an option.

Mfg. List \$1,749.00

Call For BSW Price

REVOX



PR99MKIII

2-Channel Recorder

True to the Studer Revox tradition, the PR99 has always offered the best combination of features, price and long term service. It is one of the best small professional tape recorders available on the market. The sturdy die cast deck plate offers durability while autolocating functions make production or on-air work a breeze. The front panel is less cluttered with easy to find controls and switches to make overall operation easier. (Unit has rack mounting flanges standard. Shown above with optional wood side panels.)

Mfg. List \$3,495.00

Call For BSW Price

TASCAM



34B 4 Channel Recorder

The model 34 provides cost effective 4-track production with all the features of the model 32 plus two extra tracks! Full sync and modular adjustable electronics. (Options: rack kit RM300, remote transport controller RC71F)

Mfg. List \$2,199.00

Call For BSW Price



TSR8 8-Channel Recorder

This compact 8-track recorder offers highest sound quality on a 1/2" tape format. Features include external sync capability, built-in Dbx type-1 noise reduction, automatic, gapless punch-in/out with rehearsal, real-time tape counter and 3-point auto locator, dump edit, manual edit, spot erase and much more. (Options: remote control RC408, rack kit RM408)

Mfg. List \$3,499.00

Call For BSW Price



MSR16 16-Channel Recorder

This 16-track recorder incorporates the most advanced Tascam technology and a wide range of versatile control features. Dbx type-1 noise reduction is built in, providing quiet performance. Auto punch-in/out makes recording smoother and easier than ever, while specially designed circuitry offers gapless and noiseless punch-in/out. The transport offers switchable tape speeds (15/7.5 IPS), and can be externally controlled. (Optional remote control RC416)

Mfg. List \$7,499.00

Call For BSW Price

TASCAM



22-2 2-Channel Recorder

The Tascam 22-2 is a great reel to reel recorder for use where large reels are not needed. Quality electronics and great tape handling. Features: 1/2 track record/playback • 7 inch reel capacity • 7 1/2" - 15 ips • Remote pause function • NAB equalization • Rack mount available (RM22)

Mfg. List \$1,099.00

Call For BSW Price



X300 2-Channel Recorder

1/4 track record/playback, 3 motor transport, 3 head reproduction system. Light touch locking transport controls. Mic/line mixing. Record mute function. Independent left and right output, and line and mic input level controls. Tape/source monitor selector. Frequency response: 30 Hz - 34 kHz (@ 7 1/2 IPS). Signal/noise: 65 dB (3% THD). Wow & flutter: 0.04% (7 1/2 IPS WRMS) Tape speeds: 3 1/4 - 7 1/2 IPS

Mfg. List \$1,099.00

Call For BSW Price



R8 8-Channel Recorder

Although this machine is small (12 1/2" W x 13 1/16" H x 6 5/6" D) it lacks nothing in terms of features and performance. The R8 uses 1/4", 1 mil tape on 7" reels and has a frequency response of 40 to 18,000 Hz ± 3 dB referenced to 1% T.H.D. at 1kHz, 0dB. Features: Full automation features with SMPTE and MIDI control possible • Detachable control panel with optional extension cable includes all control and metering functions • Dolby noise reduction • Pitch control (±10%)

Mfg. List \$2,800.00

Call For BSW Price

Reel Tape / Accessories

AMPEX



456 Audio Mastering Tape

When you demand high output, minimal distortion, and consistent audio quality choose 456 Grand Master from Ampex. 456 is tested and inspected over 150 times during the manufacturing process.

Model	Description	Price Ea.	Price Ea.
45617611T 1/4" x 2500'	10 1/2" pancake	(1-9) \$14.50	(10+) \$12.60
456151111 1/4" x 1200'	7" plastic reel	(1-39) \$10.00	(40+) \$8.70
45617311J 1/4" x 2500'	10 1/2" metal reel	(1-9) \$26.50	(10+) \$23.00

406/407 Audio Mastering Tape

High performance is essential for mastering. The oxides for 406, 407 are specially selected to provide high signal-to-noise ratio, high head room and low distortion.

Model	Description	Price Ea.	Price Ea.
40617613T 1/4" x 2500'	10 1/2" pancake	(1-9) \$11.70	(10+) \$10.10
406151131 1/4" x 1200'	7" plastic reel	(1-39) \$8.40	(40+) \$7.30
40617313J 1/4" x 2500'	10 1/2" metal reel	(1-9) \$21.50	(10+) \$18.80
40717613T 1/4" x 3600'	10 1/2" pancake	(1-9) \$18.50	(10+) \$16.20
407151131 1/4" x 1800'	7" plastic reel	(1-39) \$11.00	(40+) \$9.60
40717613T 1/4" x 3600'	10 1/2" metal reel	(1-9) \$18.50	(10+) \$16.20

632/642 Audio Mastering Tape

The extra low noise/high output formulation of Ampex 632/642 tapes provides enhanced performance capabilities over that obtainable from standard output tapes. A better signal-to-noise ratio provides quieter tape background levels, as well as a higher output level.

Model	Description	Price Ea.	Price Ea.
632131111 1/4" x 600'	5" plastic reel	(1-39) \$3.90	(40+) \$3.40
632151111 1/4" x 1200'	7" plastic reel	(1-39) \$5.90	(40+) \$5.15
632173111 1/4" x 2500'	10 1/2" metal reel	(1-9) \$19.50	(10+) \$17.00
642131111 1/4" x 900'	5" plastic reel	(1-39) \$4.90	(40+) \$4.25
642151111 1/4" x 1800'	7" plastic reel	(1-39) \$8.00	(40+) \$7.05
642173111 1/4" x 3600'	10 1/2" metal reel	(1-9) \$23.90	(10+) \$20.50

Empty Reels And Boxes Plastic Reels

	BSW Prices
5464 5" with NAB Center	65¢
5196 5" with EIE Center	50¢
5231 7" with EIE Center	90¢
6284 10 1/2" with NAB Center	\$3.50
5908 10 1/2" with EIE Center	\$5.45

	BSW Price
6393/600 10 1/2" with NAB Center (includes Box)	\$10.95

	BSW Prices
605 5" Empty Box	45¢
607 7" Empty Box	45¢
630 10 1/2" Empty Box	\$1.10



3M



996 Audio Mastering Tape

996 out performs any other mastering tape on the market with 3 dB greater output level and 3 dB less print through and noise when biased properly. Capable of recording at +9 dB, suggested operating level is +6 dB. Comes in new TapeCare™ Library Box for maximum tape protection.

Model	Description	Price Ea.	Price Ea.
9961425HPB 1/4" x 2500'	10 1/2" pancake	(1-11) \$15.50	(12+) \$12.50
9961412PR7 1/4" x 1200'	7" plastic reel	(1-19) \$10.75	(20+) \$8.75
9961425RD 1/4" x 2500'	10 1/2" metal reel	(1-11) \$28.50	(12+) \$23.00

250 Audio Mastering Tape

3M 250 offers wide dynamic range and great overall signal-to-noise ratio. 1.5 mil. thickness.

Model	Description	Price Ea.	Price Ea.
2501425HPB 1/4" x 2500'	10 1/2" pancake	(1-11) \$14.20	(12+) \$11.50
2501412PR7 1/4" x 1200'	7" plastic reel	(1-19) \$9.80	(20+) \$7.95
2501425RD 1/4" x 2500'	10 1/2" metal reel	(1-11) \$25.95	(12+) \$21.10

226 Audio Mastering Tape

226 Audio Mastering Tape provides versatility for outstanding all around performance. Its unique oxide dispersion significantly reduces print-through without any sacrifice in signal-to-noise. 227 Mastering tape is a one mil. version for remote and extended recording applications

Model	Description	Price Ea.	Price Ea.
2261425HPB 1/4" x 2500'	10 1/2" pancake	(1-11) \$13.25	(12+) \$10.85
2261412PR7 1/4" x 1200'	7" plastic reel	(1-19) \$9.40	(20+) \$7.60
2261425RN 1/4" x 2500'	10 1/2" metal reel	(1-11) \$24.45	(12+) \$19.90
2271436HPB 1/4" x 3600'	10 1/2" pancake	(1-11) \$25.20	(12+) \$20.45
2271418PR7 1/4" x 1800'	7" plastic reel	(1-19) \$14.60	(20+) \$11.90
2271436RN 1/4" x 3600'	10 1/2" metal reel	(1-11) \$40.70	(12+) \$33.00

806 Audio Mastering Tape

Specially formulated to meet the high output low print requirements. 807 is a one mil. thickness for extended recording requirements.

Model	Description	Price Ea.	Price Ea.
8061425HPB 1/4" x 2500'	10 1/2" pancake	(1-11) \$11.30	(12+) \$9.20
8061412PR7 1/4" x 1200'	7" plastic reel	(1-19) \$8.25	(20+) \$6.70
8061425RN 1/4" x 2500'	10 1/2" metal reel	(1-11) \$20.70	(12+) \$16.80
8071436HPB 1/4" x 3600'	10 1/2" pancake	(1-11) \$18.25	(12+) \$14.90
8071417PR7 1/4" x 1700'	7" plastic reel	(1-19) \$11.00	(20+) \$9.00
8071436RN 1/4" x 3600'	10 1/2" metal reel	(1-11) \$29.05	(12+) \$23.60

Recording Accessories

Splicing Tape	BSW Price
67732100 100' Spool	\$5.70

Leader Tape	
61W1415 White Polyester 1500' Reel	\$17.90
61Y1415 Yellow Polyester 1500' Reel	\$17.90

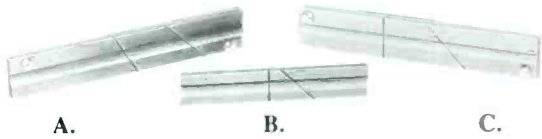

SPLICING BLOCKS

- A. NORTRONICS PF-311 BSW Price \$30.70
- B. EDITALL S3 BSW Price \$39.20
- C. FOSTEX 9930 BSW Price \$18.00

BSW

**164T
Editing Pencils**



White china markers don't require sharpening

Box Of 12 BSW Price \$16.95

GEM

**GEM
Editing Blades**



The popular choice for splicing and editing

Box Of 100 BSW Price \$8.75

3M

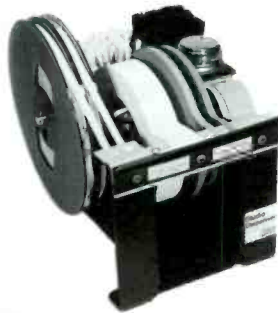

**RSD1
Studio Dispenser**

Everything you need at your fingertips for professional editing and splicing. Includes splicing tape, two leader tapes, hold down tape, cotton swabs. Container for head cleaner and storage for razor blades.

Mfg. List \$217.43

Call For BSW Price

STL/MRL



TEST TAPES

Complete selection of test tapes for every application

Call With Your Requirements

TOLL FREE 800-426-8434

GENEVA



**PF116/PF132/QM108
Head Cleaning Fluids**

Non-flammable, non-toxic, and completely safe on plastics, rubber, metals, painted surfaces, epoxies and elastomer parts.

- PF116 (16 oz. Spray) BSW Price \$11.60
- PF132 (32 oz. Liquid) BSW Price \$22.70
- QM108 (8 oz. Liquid) BSW Price \$5.80

CAIG



**CL27
Head Cleaner**

Caion™ removes oil, grease, and dirt without harming metal, plastic or elastomeric parts.

- CL27S (16 oz. Spray) BSW Price \$9.94
- CL274 (4 oz. Liquid) BSW Price \$5.15

BSW



COTTON SWABS

For cleaning tape heads. Extra long for hard to reach areas.

- BCS 100 (100 Quantity) \$3.50
- BCS 500 (500 Quantity) \$14.50
- BCS 1000 (1000 Quantity) \$29.00

NORTRONICS / VIKRON



TAPE HEADS

BSW handles the complete line of tape heads from Nortronics and Vikron. Chances are we can provide any replacement head you need.

Call Us With Your Requirements

BURK TECHNOLOGY



ARC16 Remote Control

Now, you have a choice: full-time studio control, dial-up telephone control—or both. And because of modular design, the ARC16 offers features never before available in a 16-channel remote control system.

With the studio controller you have a constant link to your transmitter, for instant response to any problem. The 32 character LCD display shows out-of-tolerance conditions at a glance, and it's simple to make adjustments, with clear-text prompting to guide you. Call the ARC-16 from any tone phone: the Digital Speech Unit (DSU) lets you take control using your telephone keypad. It can be used as the only control or in addition to the studio controller and can be installed in the transmitter or the studio unit.

Features:

- Full-time studio control, dial-up control, or both
- Studio controller displays clear text prompts for non-technical operators
- Dial-up speech unit features digitally-recorded human voice
- Built-in subcarrier generators at no extra charge
- Built-in alarms
- Optional computer interface
- Control multiple sites with a single unit

Price Based On Configuration



TC8 Remote Control

The TC8 is a full featured remote control system that requires only 1 3/4" of rack space and provides 8 analog metering channels, 8 status inputs and 16 control outputs (8 raise, 8 lower). Studio and transmitter

units communicate via telco loops or STL/SCA subcarriers. Specify which you prefer at time of ordering. Status inputs accept 5 to 28 V signals and metering channel accept inputs of either polarity from 0.25 to 4 V, ensuring easy interface with all broadcast equipment. Status LED's and a large dot matrix metering display can be read from across the room. CRT display, logging and fully automatic operation is possible using the optional RS-232 interface.

Mfg. List \$2,495.00

Call For BSW Price

GENTNER



VRC2000 Remote Control

This system provides a total solution for controlling your broadcast transmitter where a telephone line, radio link, data link, or bi-directional audio link is available. The VRC-2000 Remote Control System will watch your transmitter for you. It's like having a person on duty at the transmitter continually. The VRC2000 will notify you when something goes out of

tolerance, when security is breached, or if it had to turn on the stand-by because the main failed. It features 16 single-ended analog metering channels, 16 TTL compatible status channels, and 32 "open collector" transistor command outputs. The 32 outputs are configured as 16 separate "Command Channels" with 2 outputs per channel. The unit can be used to automatically monitor conditions at a remote site, automatically log regular reports to a printer, take corrective action based on monitored conditions, and notify a human operator via telephone or radio links should an undesired condition occur. The VRC-2000 has an outstanding list of options and accessories that make installation and operation easy and efficient.

Basic VRC2000 Mfg. List \$2,995.00

BSW System Prices Based on Configuration

MOSELEY



MRC2 Remote Control System

More and more, broadcasters are issuing executive commands through their MRC-2 microprocessor remote control.

Multi-site, Multi-function, the MRC-2 controls and monitors as many as 99 remote sites, with multiple control terminal capability to let you delegate control from master to master as needed. Up to 255 status, 255 telemetry and 255 command channels supervise your sites. Dual tolerance limits can be set to prevent a telemetry parameter from reaching critical levels. Choose from 6 modes in which to calibrate telemetry inputs, and set status inputs to initiate alarms or events on rising or falling waveforms, or both. Command, status, and telemetry set-up is straightforward on the MRC-2 System. Using the remote terminal keyboard and 48 character alpha-numeric LED display, the system provides plain English prompting and "menu" pages for set-up selection. Similar procedures are used at the control terminal to set up and verify telemetry limits, assign data links, and to set up controlled access for restricted functions.

Control Options

Optional automatic loggers provide a printed record of system operation and CRT terminals display your data in plain language. An optional ACU1 automatic control unit automates your operation by issuing programmable time and feedback-actuated sequences of commands without operator assistance. Add multiple direct command and multiple status display options for streamlined operator interface.

Prices Based On Configuration

MOSELEY

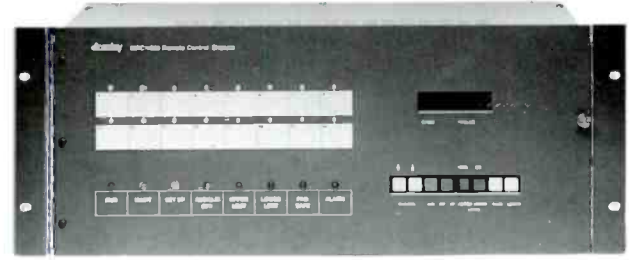

MRC1620 Remote Control System

The MRC1620 system consists of a remote terminal that allows an optional control terminal or IBM PC with TaskMaster20 software to monitor and control a remote facility from both dedicated and/or dial-up control points. The MRC 1620 remote terminal comes equipped with 32 relay isolated command outputs (16 raise/ 16 lower), 16 TTL status inputs and 16 analog metering inputs with the required terminal connectors. The MRC 1620 remote and control terminals are simple to operate and easy to understand. All status channels are simultaneously displayed on a set of 16 LEDs. The front panel displays read-outs of selected channel number and telemetry data. LEDs indicate operation mode, alarms and other system parameters. Telemetry limit checking and status alarm capability ensure that an unmanned facility operates at peak efficiency. During alarm conditions, intelligent automatic corrective action can be taken by the remote terminal under the direction of the TaskMaster20. The remote terminal comes equipped with a built-in internal 1200 baud modem to communicate over dedicated circuits (STL/ TSL/ FMSCA or 2/4 wired leased lines). An external 1200/2400 baud auto-answer modem for dial-up access over the public switched telephone network is also included with the remote terminal. Features: Dial or direct connect to an MRC 1620 remote or control terminal • Display current analog and status values • Display and acknowledge alarms • Manually control an MRC 1620 remote terminal (RT) • Automatically control (via analog limits and status conditions) an RT • Display, edit, and store PC screen labels • Download and store the set-up parameters from the MRC 1620 • Recall and upload the set-up parameters to the MRC 1620 • Maintain and generate log file(s) from up to 16 RT sites at user specified intervals during the day • Generate a printed log

MRC1620 (Remote Terminal) Mfg. List \$2,995.00

MRC1620 (Control Terminal) Mfg. List \$1,495.00

TASKMASTER20 Software Mfg. List \$595.00

Call For BSW Prices



GE CAPITAL

Present
FlexLease

*The fast and easy way to get the equipment you need,
while taking advantage of all the financial benefits
leasing has to offer. Ask your BSW
Sales Rep for all the details.*

Leasing?

*Leasing equipment saves working capital. Talk to your
BSW Sales Representative on the advantages of leasing
your next equipment purchase from BSW.*

MARTI



RPT30



CR10

**RPT30/CR10
Remote Pickup System**

Remotes are a breeze with a Marti Remote Pickup System. Start with an RPT30 transmitter that offers four balanced microphone inputs, one is selectable to line level, and a built-in FM compressor/limiter. Flashing LEDs indicate antenna VSWR problems and over-temperature conditions and a built-in subaudible encoder can activate repeaters or other equipment with the flip of a switch. Single or dual frequency models are available.

The companion CR10 is a rack mounted VHF or UHF base station receiver dual frequency capability built in. It features a built-in test meter, squelch relay, optional DC operation, built-in sub-audible tone decoder with relay, special noise reduction circuit, 90 dB spurious rejection and a front panel monitor speaker.

RPT30 Mfg. List \$1,695.00

RPT30-2 Dual Frequency Mfg. List \$1,725.00

CR10 Mfg. List \$1,195.00

CR10-2 Dual Frequency Mfg. List \$1,225.00

Call For BSW Prices

MOSELEY

4010



4020



**RPL4000
Remote Pickup System**

The RPL 4000 offers the features and specifications you expect from Moseley at a modest cost. The portable RPL4010 transmitter is fully synthesized, light weight and can be used as a complete stand alone unit with three balanced, adjustable inputs, or in conjunction with existing repeaters or portable audio mixers. Features include selectable audio bandwidths from 5-15kHz and noise reduction companding. The 4020 receiver has excellent adjacent channel rejection and selectivity, which is absolutely essential in crowded UHF bands. An industry standard connector is provided for audio control interface with existing equipment.

RPL4010/4020 Mfg. List \$4,250.00

Call For BSW Price

TFT



**8888
Remote Pickup System**

The TFT Model 8888 RPU Transmitter and 8889 RPU Receiver offer outstanding flexibility, versatility and reliability. The transmitter and receiver are frequency synthesized N1, N2 and S bands. Two operating frequencies are programmed by internal DIP switches and are front panel selectable. In addition, frequency deviation and receiver bandwidth are selectable. DTMF control is provided for receiver activation, bandwidth and deviation selection. The 8888 enables you to adjust the RF power output to suit your needs with a maximum RF output power of 25 watts.

8888/8889 Mfg. List \$4,610.00

Call For BSW Price

ICOM



Portable Transceivers

BSW carries a full line of quality ICOM handheld and mobile transceivers to help provide broadcasters with a vital link between station and field. Several models of VHF and UHF radios are available.

Call Toll Free With Your Requirements

FLEX LEASE

Innovative lease programs made available by BSW and GE Capital may be just the right answer for your equipment financing dilemma. Whether you're interested in low monthly payments, 100% financing without the wait, conserving your working capital, or taking advantage of tax incentives there's a Flex Lease program just for you. Call A BSW representative today for more information.

LARSEN

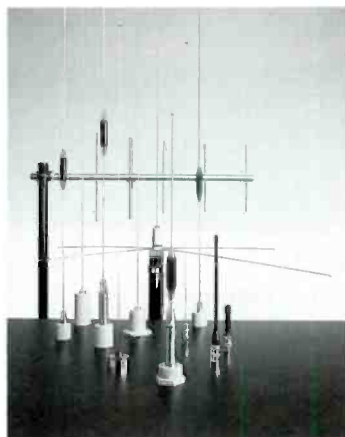

Antennas

Larsen has a large selection of antennas available for both mobile and fixed applications.

Call Us With Your Specific Requirements

SCALA

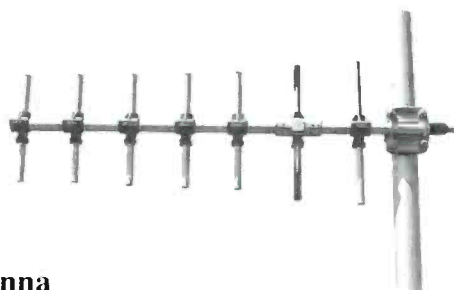

**CA7460
Yagi Antenna**

The CA7460 is a seven-element yagi designed for high performance and long-term reliability even under severe environmental conditions. Its broadband design makes it particularly suitable for systems requiring frequency agility within a specified band. Two standard models cover the 406-420 MHz and 450-470 MHz bands. Custom models are available for other portions of the 200-500 MHz spectrum. Impedance is 50 ohms, gain is 10 dB (over dipole), and input power rating is 100 watts.

Mfg. List \$190.00

Call For BSW Price

MARTI

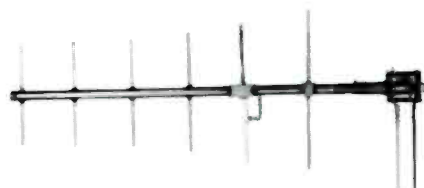

**YC SERIES
Yagi Antennas**

These yagis are available in fixed frequencies ranging from 152.08 to 455.99 to cover any RPU application. The antennas have 5 or 6 elements depending on the frequency, and have a gain of 9 dB.

YC SERIES (All Models) Mfg. List \$135.00

Call For BSW Price

TOLL FREE 800-426-8434

WILL-BURT



Pneumatic Telescoping Masts

TMD masts are used in remote locations to support antennas transmitting broadcast signals back to the studio. Mounted on remote broadcast vehicles, TMD standard duty masts support antenna weights of up to 40 lbs. to heights of 34 ft. allowing the remote to shoot over most local obstructions.

The TMD pneumatic telescoping mast is a series of graduated extruded aluminum tubes that are assembled to nest one inside another. Each tube has a seal at the bottom to contain air pressure and a collar at the top to limit extension of the tube inside it. The masts are extended from their compact nested height by pneumatic pressure supplied by air compressors, hand pumps or compressed air bottles. They can be mounted to extend through the roof of a remote vehicle, or on the vehicles rear bumper.

Call BSW For Pricing And Detailed Specifications

TMD



**HURRY-UP
Telescoping Mast**

Here's a simple, inexpensive, and effective portable antenna mast for your remotes. The TMD Hurry-Up mast is designed for fast and easy deployment of light weight antennas. It consists of 6 graduated aluminum tubes which nest one inside another. The mast is extended by pushing up the sections and fixing them into position using quick lock/release collars. It can be fully extended to 25' in one minute or less. Hurry-Up is free standing in its universal vehicle mounting stand so you can take it on remotes using whatever vehicle is available. Weight is only 20 lbs. with a nested height of 6'-0"

Mfg. List \$1,000.00

Call For BSW Price

MARTI



**STL10
STL System**

The Marti studio transmitter link is a line-of-sight FM communication system providing a high quality broadcast audio channel with two optional sub-channels. A dual link for stereo provides two identical broadcast quality channels with better than 60 dB stereo crosstalk and four optional sub-channels. A dual Marti system offers greater rejection of interference, superior noise performance, lower channel crosstalk and greater redundancy than most composite systems.

Features: Excellent square wave response • User selectable audio processing provides 0, 25, 50 or 75 microsecond de-emphasis options • Low pass filters designed to eliminate overshoot on complex audio waveforms • Helical resonator pre-selector and double balanced mixer • Two IF bandwidths available to meet domestic and international requirements • Computer designed bandpass filters for high selectivity with optimum phase and group delay • Test meter on front panel indicates signal level, main channel audio level, sub-carrier level, supply voltage, L.O. level and mixer level. Additional test points inside receiver • Sensitivity switch on front panel provides optional 10 dB RF attenuation for interference rejection • Built-in automatic switching capability

STL10 Transmitter Mfg. List \$1,625.00

R10 Receiver Mfg. List \$1,625.00

Call For BSW Prices

MOSELEY



**CL100
Communications Link**

The CL100 system gives the broadcaster an alternative to subcarriers and telephone lines for conveying control and telemetry data between the studio and transmitter locations and frees the STL or program subcarrier channels for other uses. CL100 system, available in data and voice versions, provides extremely reliable transmissions, even over a path length of 50 miles (line of sight). The data version has increased audio bandwidth and controlled group delay characteristics to allow 9600 baud data rates. In highly congested RF environments, the improved selectivity of the voice version can be used, providing data rates up to 1200 baud. One or ten watt models are available for AC or DC operation.

CL100-10W (10 watt) Mfg. List \$4,980.00

CL100-1W (1 watt) Mfg. List \$3,980.00

Call For BSW Prices

MOSELEY



**PCL6000 SERIES
Composite STL Systems**

The PCL6010 transmitter and PCL6020 and 6030 receivers employ a synthesized reference oscillator to eliminate fixed frequency crystals. Monaural or composite operation is available from a single system. By selecting appropriate jumpers, you can enable wideband composite stereo or 15 kHz monaural basebands. Two PCL6000 systems can be used in a dual discrete configuration to transmit right and left stereo programs with no measurable crosstalk. Receiver IF bandwidth can be factory or field set for channel spacing of 100 kHz to 500 kHz.

Which system is right for you? If you have no adjacent channel interference, the PCL 6020 will offer superior performance. The PCL 6030 is designed for hostile RF environments where maximum selectivity and adjacent channel rejection are required.

PCL6020 System Mfg. List \$7,800.00

PCL6030 System Mfg. List \$8,800.00

Call For BSW Price

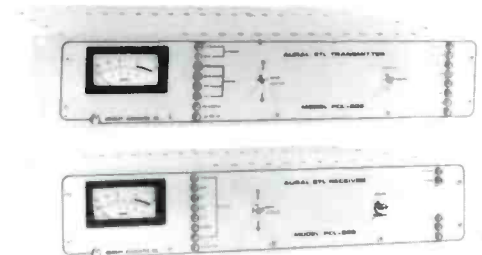

**PCL606/C
Composite STL System**

You're scrupulous about quality. You're running compact discs mastered on digital equipment. You've bought the best console you can afford. Your processing plant is as clean as a whistle. Don't compromise now! Deliver your signal with the only STL that's totally transparent. The composite stereo PCL606/C or the mono PCL606. Find out why Moseley STL'S outsell all others.

Frequency response:

Composite: 30 Hz to 53 kHz (± 0.1 dB or better)

53 kHz to 73 kHz (± 0.3 dB or better)

THD & IMD Distortion

Narrow IF Filter: $\leq 0.3\%$ at 30 Hz to 53 kHz typically $\leq 0.1\%$ at 1kHz

Wide IF Filter: $\leq 0.2\%$ at 30 Hz to 53 kHz typically $\leq 0.7\%$ at 1 kHz

Stereo Separation: ≥ 48 dB, 50 Hz to 15 kHz (typically ≥ 50 dB)

Nonlinear Crosstalk: (Subchannel to Mainchannel, Mainchannel to Subchannel)

Narrow IF Filter ≥ 50 dB, Wide IF Filter ≥ 54 dB

Signal-to-Noise Ratio: ≥ 72 dB (typically 75 dB) below 100% modulation, demodulated, de-emphasized left or right

PCL606/C System Mfg. List \$10,700.00 Call For BSW Price

TFT
8300
Composite STL System

The 8300 is specifically designed for crowded RF signal environments where numerous signals present in the 940-960 MHz band make it difficult to operate composite STL'S without interference problems. Features like S.A.W. filters, selectable RF front end gain, variable bandwidth IF amplifiers and cast aluminum RF shielded housings for critical circuits contribute to the cleanest possible signal with this system. A wide array of options and accessories such as IF repeater, stereo decoder, and 92 kHz SCA capability make the 8300 System perfect for your operation.

8300 Transmitter Mfg. List \$5,065.00 Call For BSW Price
 8301B Receiver Mfg. List \$4,925.00 Call For BSW Price

7700B SERIES
Composite STL System

This high quality STL from TFT provides excellent audio quality and reliability. IF modulation improves S/N ratio and stereo performance. RF output is adjustable from 3 watts to a maximum of 12 watts to generate sufficient signal for long or difficult transmission paths. Both transmitter and receiver provide full status and monitoring capabilities for setup, operation and troubleshooting ease. A full line of accessories and options allow for a fully redundant "Hot Standby" system.

7700B Transmitter Mfg. List \$4,175.00 Call For BSW Price
 7707 Receiver Mfg. List \$3,415.00 Call For BSW Price

8700/8701
TRL Link

The 8700 Transmitter/8701 Receiver System is specifically designed to convey one way data or voice in a 3 kHz band audio link and is ideally suited for remote control and telemetry. Data transmission via external modems, eliminates the need for a telephone line or SCA channel at FM stations. For AM station applications, it provides a data link many times faster than a sub-audio data channel. The TFT 8700 series TSL audio bandwidth of 300 Hz to 3 kHz allows you to convey data transmission from a modem for either one way control or telemetry functions. Provisions are made on the rear panel for connection of a microphone (transmitter) and monitor amplifier (receiver) for voice applications.

8700 or 8701 Mfg. List \$1,520.00 ea. Call For BSW Price

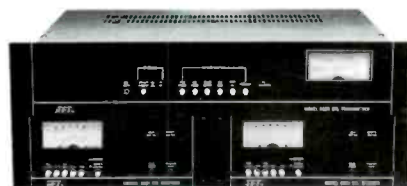
TFT
8600A
Mono STL System

The Model 8600A/8601A is an economical, high quality studio-to-transmitter (STL) system which is specifically designed for either single channel or dual monaural channel radio broadcast applications. FCC rulings permit 100 kHz "drop-ins" in the 950 MHz STL band. The 8600A system meets the FCC criteria which permits broadcasters to use a monaural link between two composite links. It is an ideal narrowband system which is optimized for operation in congested STL environments. The system is designed to deliver superlative audio quality without signal degradation or adjacent channel interference. Based upon TFT's experience with STL designs, the 8600A system incorporates the latest microwave components and LSI devices. System shown above shows dual-link, redundant receivers.

8600A Transmitter Mfg. List \$1,600.00
 8601A Receiver Mfg. List \$1,440.00
 Call For BSW Price

BSW
 BROADCAST SUPPLY WEST

Presents

Flex Lease**Creative Solutions to Equipment Financing**

Equipment leasing programs are available from many companies. But quality leasing programs like quality broadcast equipment come from specialists.

Broadcast Supply West, one of the nation's leading broadcast equipment suppliers has joined forces with one of the most respected names in equipment financing, GE Capital. Together we offer outstanding equipment selection and the best financial services available.

For information on creative solutions to your equipment financing, contact a BSW sales representative today.

MARK

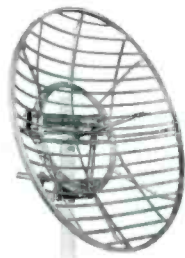

Grid Antennas

Mark grid antennas are very lightweight and durable made of HeliArk welded aluminum for superior strength and rigidity. These grid antennas have virtually the same electrical characteristics of comparable size parabolic reflectors but only about 25-30% of the wind load factor. When ordering specify size, frequency, pressurized or non-pressurized, heated or non-heated.

Price Based On Size And Configuration



SSH9A72GN

Super Short Haul Antenna

When you need to install or replace a short haul STL antenna in a hurry, BSW and Mark antennas can help. The SSH9A72GN is a point-to-point grid antenna designed to work in any frequency between 940-960 MHz. The antenna has a mid band gain of 20 dBi and half power beamwidth of 19° (horizontal) and 10° (vertical). It weighs only 30 lbs. (including feed and mount), and utilizes universal clamps for quick and easy installation on pipe diameters from 1.9" to 3.5" O.D. Best of all these antennas are UPS shippable so they can be shipped quickly and inexpensively.

Mfg. List \$790.00

Call For BSW Price

MARTI

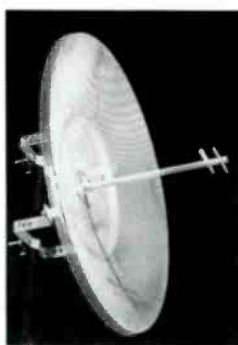

PA48

Parabolic Antenna

This low cost, 4' antenna is broadband for the 940 to 960 MHz aural STL band and is category B rated in vertical and horizontal planes.

Mfg. List \$600.00

Call For BSW Price

Extra Discount Available When Purchased With A Marti STL Package.

SCALA

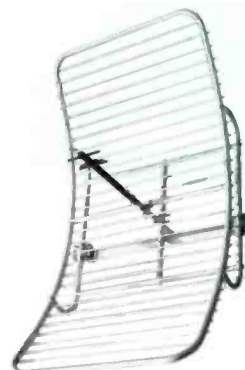

PR450U

Paraflector Antenna

Widely used for point-to-point STL links, telemetry, and UHF-TV, the PR450U Paraflector™ offers rugged construction for reliable long-term service, even in severe environmental conditions. Universal mounting bracket allows for easy horizontal or vertical mounting.

Mfg. List \$580.00

Call For BSW Price



MF960

Miniflector Antenna

For short hops where a full-sized grid or parabolic is not necessary the Mark Miniflector is a rugged, economical way to fulfill your antenna needs.

- Aural broadcast STL
- Telemetry
- Point-to-point communications
- Vertical polarization for STL

Mfg. List \$320.00

Call For BSW Price



8000/450

STL Preamp

Scala offers the 8000/450 STL low-noise preamplifier for use in broadcast STL, TSL and ICR systems. This professional quality preamp is specifically designed to be used by broadcasters where the excellent noise-figure and high gain can provide improved system noise performance, allow the use of smaller receive antennas and coax transmission line than might otherwise be necessary, and help overcome path fades on marginal systems. Gain is 20 dB minimum.

Mfg. List \$400.00

Call For BSW Price

QEI

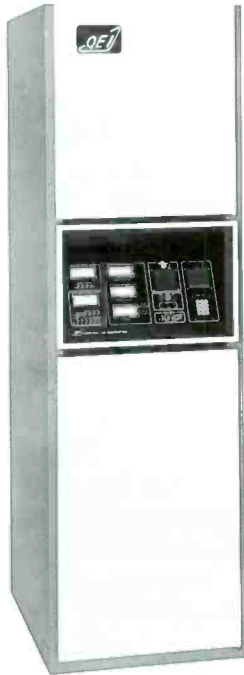

FMQ SERIES FM Transmitters

The FMQ series design blends microprocessor technology with QEI's expertise in solid-state transmitters, control systems, and FM modulation monitors. Features here-to-fore not available in FM transmitters are built into the FMQ series. Alarm points on important parameters will warn you before a catastrophic failure occurs. Automatic Power and Modulation control are available at the flick of a switch; ideal for stations with satellite feed or those that are heavily automated. Auto logging standard, optional dial-up password protected remote control available. All solid-state at 1 kW and grounded grid final amplifiers at high power levels.

Call For Pricing And Configuration

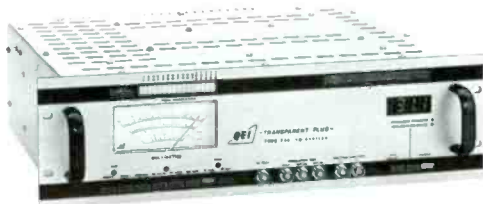

695 FM Exciter

With considerable design effort, QEI has achieved the optimum linearity for an FM exciter. While specifying a distortion level of .025%, a typical 695 will be on the order of .010% or better. Shielding and acoustical insulation of this unique circuitry allow the 695 to maintain a high performance standard while installed in a heat-generating transmitter with a high-vibration blower and a multitude of stray electromagnetic fields.

Features: Super low distortion (typically less than .025%)

- Convection cooled - no fans
- AUTOMOD automatic modulation control
- Displays modulation peaks over 100% built-in modulation monitor and peak control
- Synthesized phase locked loop

Mfg. List \$5,295.00

Call For BSW Price

Broadcast Supply West And GE Capital

Working Together For Your Benefit

Never before has an audio equipment supplier and a financial institution developed a series of leasing programs that make it so easy and fast to acquire the equipment you desperately need. With *Flex Lease* you are able to choose from a variety of programs that are tailored to your individual needs.

BSW's exclusive relationship with GE Capital is based on our high volume of business. This means you get the best possible lease rates, together with the highest level of service available.

For information on creative solutions to your equipment financing, contact a BSW sales representative today.

BSW[®]

BROADCAST SUPPLY WEST

America's Full-Time Broadcast Supplier

ORDERS • INFORMATION • SPECIFICATIONS

7012 27th Street West Tacoma, WA 98466

BROADCAST ELECTRONICS



FX50 FM Exciter

After investing in digital recorders and processing it's only logical to do all you can to ensure the high quality audio is actually reaching your customers. Your exciter, for instance, should be able to pass as clean and transparent a sound as possible so the audiences you are targeting can reap the full benefit of digital sound.

The FX50 is just that sort of exciter - powerful, and very clean. Performance specifications feature a dynamic range that rivals CD players with harmonic and intermodulation distortion values so low that they are virtually unmeasurable. It can bring existing FM transmitters up to CD quality standards and is the ideal retrofit for exciters now in use. Features: THD and IMD less than 0.003% typical for true CD sound • Unmatched 93 dB S/N typical for widest dynamic range • 50 watt MOSFET output power to drive the largest transmitter or act as a stand-alone 50 watt FM transmitter • Advanced linear modulated oscillator for unparalleled performance • Computer optimized phase locked loop greatly improves low frequency response • Completely broadband for transparent performance • Functional front panel controls with LCD displays

Mfg. List \$6,295.00

Call For BSW Price



AX10 AM Stereo Exciter

This second generation C-QUAM® exciter incorporates the most advanced AM stereo technology available providing superior stereo performance using an advanced IF modulation scheme employing independent, non-interfacing left and right channel digital modulators. The result is exceptional AM stereo with full mono receiver compatibility. Features: Synthesized operation (1 kHz increments) • Interfaces with virtually any existing AM transmitter • Built-in LED peak reading modulation display • Compact size (only 3.5 inches of vert. rack space) • Independent equalization for two-transmitter or dual antenna pattern operation • Full remote control capability

Available individually or as complete system featuring AS10 stereo modulation monitor.

AX10 Mfg. List \$5,700.00

AX10P System (includes AX10, AS10, and installation) Mfg. List \$12,500.00

Call For BSW Price

DELTA ELECTRONICS



ASE1 AM Stereo Exciter

The ASE1 produces a low distortion AM stereo quadrature modulated amplitude signal (C-QUAM®) having superior separation throughout the audio spectrum. It's circuitry includes all required processing such as limiters to prevent excessive positive and negative modulation, and a blend processor, which makes high single channel modulation possible by blending a little of each channel with the other. Pre-emphasis is not required.

Large lighted meters and easily accessible controls simplify operation. The meters display either L/R audio levels or L+R and L-R audio levels in dB and percentage of modulation. Stereo or mono operation is selectable as is the 25 Hz pilot tone. A day/night switch selects one of two audio equalization circuits, adjusted to match separate, alternate transmitters. The EQ circuits can be remotely selected.

The ASE1 is available separately or in a complete system with the ASM1 modulation monitor. Installation and proof are available.

ASE1 Mfg. List \$5,550.00

Call For BSW Price

ASE1/ASM1 Mfg. List \$11,850.00

Call For BSW Price

CATEL



FMX2100S FM Modulator

The FMX2100S is a modulator package frequency modulation cable transmitter designed specifically for CATV and CCTV applications. When used with the SM220 Stereo Generator, it makes possible the origination of stereo programming. With direct audio sources such as AM/FM tuner tape decks, microphone preamplifiers and short wave receivers, it can add varied FM signals to the cable system. In addition to re-transmission of audio signals, the wide band (plus or minus 75 kHz) deviation makes the unit ideal for multiplexed voice or data transmission. Specify operating frequency.

Mfg. List \$1,170.00

Call For BSW Price

MARTI
SCG10/SCD10
FM Subcarrier Generator/Demodulator

The SCG10 is designed to operate with an FM transmitter or with the SCD10 demodulator to form an STL subcarrier link. Both the SCG10 and the SCD10 have several options available including: selectable pre-emphasis of zero, 75, 150, or 225 microseconds, low pass audio filters of 3 kHz, 5 kHz, or 7.5 kHz, and separate compander encode and decode boards to help reduce noise and mask certain types of main to sub channel crosstalk.

SCG10 Mfg. List \$695.00

Call For BSW Price

SCD10 Mfg. List \$695.00

Call For BSW Price

MODULATION SCIENCES
SCA186
SCA Generator

Sidekick combines the four elements needed for successful SCA operation into the one package: subcarrier generator, modulation monitor, audio processor and transmitter tuning aid. Engineered to work together, these components form an integrated system which provides a level of performance previously unattainable. Crosstalk is dramatically reduced, signal quality is significantly improved and operation is greatly simplified.

Mfg. List \$3,835.00

Call For BSW Price

MOSELEY
SCG8/SCD8
FM Subcarrier Generator/Demodulator

SCG8 Subcarrier Generator, with automatic muting and front panel peak deviation meter, includes self contained power supply. SCD8 subcarrier demodulator, developed as a companion to the SCG8 generator, features front panel peak deviation, automatic muting, self contained power supply, meter, all electronic squelch and audio low-pass filter. Units available for operation at any standard frequency in the 26 kHz to 185 kHz spectrum. Specify operating frequency when ordering.

SCG8 Mfg. List \$1,490.00

Call For BSW Price

SCD8 Mfg. List \$1,490.00

Call For BSW Price

TOLL FREE 800-426-8434

Broadcast Supply West,



East, North & South

As a company that serves the nation's broadcasters, we have often considered opening regional offices to improve our service or expand our sales. In the final analysis, we determined that regional offices would only serve to retard service and drive our overhead sky high. So here we are in the west, maintaining the most efficient and economical distribution system in the broadcast industry. Regardless of your location, you benefit by saving money, enjoying quick delivery, and receiving exceptional service. We are open 12 hours daily, 9a.m. to 9p.m. east, 6a.m. to 6p.m. west, so you can call us at your convenience for all your audio equipment needs. From any point on the compass, BSW is as close as your telephone.

BSW

BROADCAST SUPPLY WEST

America's Full-Time Broadcast Supplier

ORDERS • INFORMATION • SPECIFICATIONS
7012 27th Street West Tacoma, WA 98466

DIELECTRIC



RF Products

Dielectric manufactures a number of high quality RF related products including dehydrators, switches, loads, isocouplers, antennas and more.

Call us for more information

ELECTRO IMPULSE



RF Coaxial Loads

Electro Impulse is a leading supplier of specialized equipment for the communications and broadcast industries. Innovations such as dry, forced air cooled loads for FM broadcasters, termination type power meters, attenuators, high accuracy calorimeters that measure RF power, and other loads up to 1.5 million watts average power, are all representative of products which have emerged from their years of experience in this field. While many requirements can be met from either stock or custom design units. In either case, all products are backed by a 12 month warranty.

Prices Based On Configuration

TOLL FREE 800-426-8434

KINTRONIC LABORATORIES

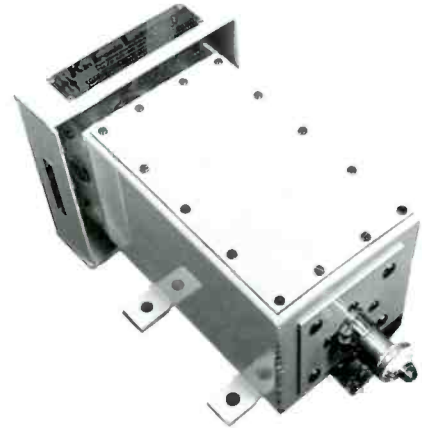

Isocouplers

Kintronic Laboratories Isocouplers provide versatility to existing AM radiating elements by allowing for installation of transmit/receive/FM/TV antennas operating in the frequency range of 30-1000 MHz without disrupting AM antenna characteristics.

**Call BSW Toll Free For Pricing Based
On Your Specifications**

ALTRONIC RESEARCH INC.

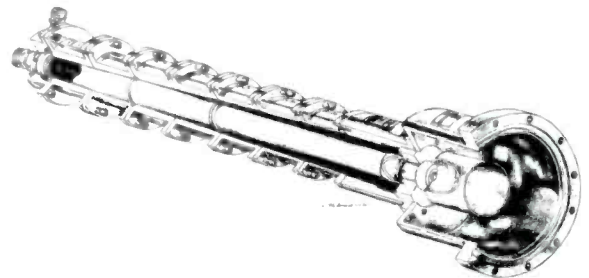

RF Coaxial Load Resistors

Altronic Research, Inc. manufactures the Omegaline RF coaxial load resistors (dummy loads). These are economical, lightweight, portable dummy loads for terminating coaxial transmission lines and are available in air or water cooled models. Users of transmitters, microwave components, and power tubes can be assured of ideal dummy load conditions during testing, adjusting and aligning.

Prices Based On Configuration

*Need prices on a major project? Save yourself
time and FAX us your equipment list. We'll have
a complete price quote back
to you in no time.*

CABLEWAVE



FM Antennas

Cablewave Systems offers a comprehensive line of omnidirectional antenna systems and accessories for the FM broadcast industry. Three basic antenna types are available in either circular or horizontal polarization. CFMLP/HP circularly polarized antennas and HFM LP/HP horizontally polarized antennas are designed for high power commercial broadcast applications and have a power handling capability of 5 to 40 kilowatts depending on the specific antenna configuration.

CP1000 circularly polarized antennas and HP1000 horizontally polarized antennas provide a low power alternative to the CFM and HFM antennas for applications up to 4 kilowatts where high power handling is not required.

ECFM and EHFM antennas are designed primarily for the lower power educational market where power handling requirements do not exceed 500 watts.

Call BSW For Prices And Specifications

DIELECTRIC



DCR-C SERIES

FM Antenna

The DCR-C is Dielectric's most popular FM antenna. It is circularly polarized with a power rating of 10 kW per bay and is available in stacked arrays of up to 16 bays with an input rating to 40 kilowatts. Directional arrays can be custom built to fit any given directivity situation, and options such as raydomes and de-icing equipment are available.

Call BSW For Prices And Specifications

JAMPRO

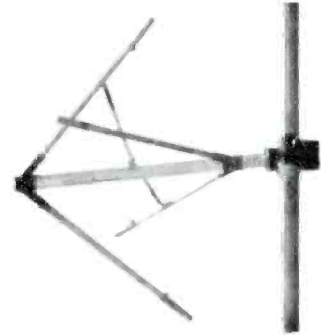

The JHCP antenna is a circularly polarized FM antenna for the broadcaster who wants extremely high-input power capability, coupled with the patented design that has become an industry standard. This design is sophisticated in concept yet simple in execution. Each bay consists of a radiating element with its associated 6 1/8" (15.56 cm) interbay feed line. The element and line are supported by a heavy brass casting which is attached to the support structure by its mounting bracket.

The JHCP antenna is conservatively rated at 30 kW per bay, with a maximum system rating of 80 kW for three bays and above. These ratings are reduced well below both the average and peak power ratings for the power distribution system, with corona and high voltage arcing problems eliminated by the use of very low Q radiating elements.

Call BSW For Pricing And Specifications

SHIVELY

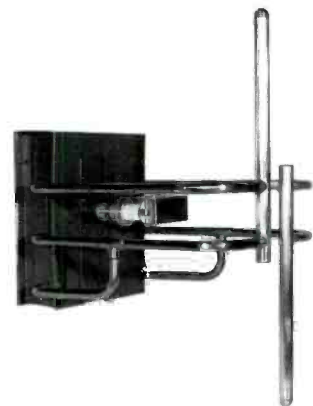

FM Antennas

A good antenna is crucial to quality broadcasting. An antenna that is merely adequate will compromise the performance of even the best studio equipment and transmitter.

Shively regularly includes standard features that other companies either provide only as options or simply do not offer.

- Pressure relief valves which allow purging of the entire system at any time, without climbing the tower.

- Custom designed, solid steel mounting brackets for each installation, instead of chains, as are commonly used.

- Individually grounded bays which give maximum protection to transmission lines from lightning damage without the need to purchase shorting stubs.

Shively engineering expertise and quality components further enhance performance.

Call BSW For Prices And Specifications

ANDREW



The Andrew Corporation, a world leader in the design and manufacture of communications equipment and systems, is well known in the radio broadcast community for supplying high quality transmission cable and related accessories. BSW is proud to represent a complete line of products for all your transmission cabling requirements.

Call BSW Toll Free With Your Requirements

CABLEWAVE

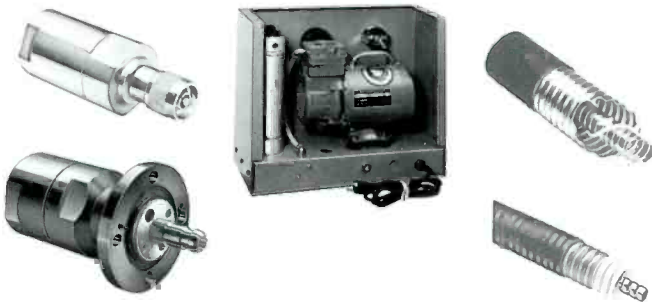

Cablewave Systems is dedicated to the design and manufacture of RF related products including: aluminum and fiberglass parabolic microwave antennas, Flexwell and Cellflex low loss coaxial cables, rigid coaxial lines, Flexwell elliptical waveguides, connectors, pressurization equipment, and RF associated accessories. BSW carries the complete line of Cablewave products and can supply the proper products for any situation.

Call BSW With Your Requirements

DIELECTRIC



Dielectric is the worlds largest manufacturer of rigid coaxial transmission line. They have been supplying transmission line to communications professionals since the early 1940s. Many of Dielectric's early systems are still in operation after years of use and exposure to the elements.

Call BSW For Information And Specifications

RF INDUSTRIES



RFA4024 Unidapt Universal Adaptor Kit

Mix and match any male or female adapter section with any other SMA, N, UHF, BNC, TNC, or mini UHF section. Make any custom adapter you can dream up.

Each Unidapt filter has a common connector end, and a universal adapter end. You simply choose the two common connector ends you need, and screw them together with the universal adapter. It's so easy—that's why technicians love it!

BSW Price \$124.95



RFA4059A Coaxial Signal Sampler

Now you can test for RF power failure or inject signal for noise measurements in transmitter output circuits without dismantling the line. This N male to N female thru-line coax section is inductively coupled to an adjustable BNC female port. This BNC fitting will supply between 20-80 dB of attenuated signal (depending on frequency). Ideal for signal generators, tap offs, modulation meters, or RF millivoltmeters. Male - female connectors can be disconnected—use up to 6 different connectors.

BSW Price \$45.00

MPM INDUSTRIES



JC3 Jumper Cable

3 foot RG8U jumper cable. N male to N male connectors. Custom lengths available.

BSW Price \$13.95

BIRD



**THRULINE® SERIES
Watt Meters**

Each Bird THRULINE® RF directional wattmeter is comprised of a line section and a direct reading 3 scale meter housed in a convenient carrying case. Measuring elements are ordered separately. A precise 50 ohm 1 5/8", 3 1/8", 4 1/16", or 6 1/8" coaxial air line is designed for insertion into your transmission line between transmitter and antenna or load. Each line section is equipped with one or two sockets into which plug-in elements with the desired power and frequency range inserted. Double-socket line sections are for simultaneous measurement of forward and reflected power.

Call BSW For Configurations And Pricing

MODULATION SCIENCES

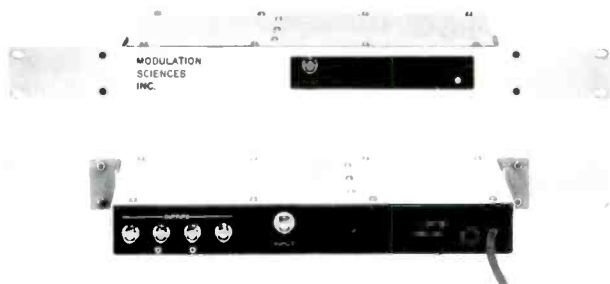

**CLD2504
Composite Distribution Amplifier**

Modulation Sciences' CLD2504 Composite DA is a problem solver. Its one-in four-out, unity gain configuration makes distribution of the composite baseband signal as easy as distributing audio. The high impedance input avoids circuit loading and the four low impedance outputs drive a wide range of equipment with greater than 50 dB of isolation between outputs. All connectors are BNC. The Composite DA lets you continuously and simultaneously drive dual main transmitters, main/aux/back-up transmitters, alternate stereo generators and processor setups, etc. No cable switching, no changeover relays, no level changes and no hassles!

Mfg. List \$950.00

Call For BSW Price

ROHN

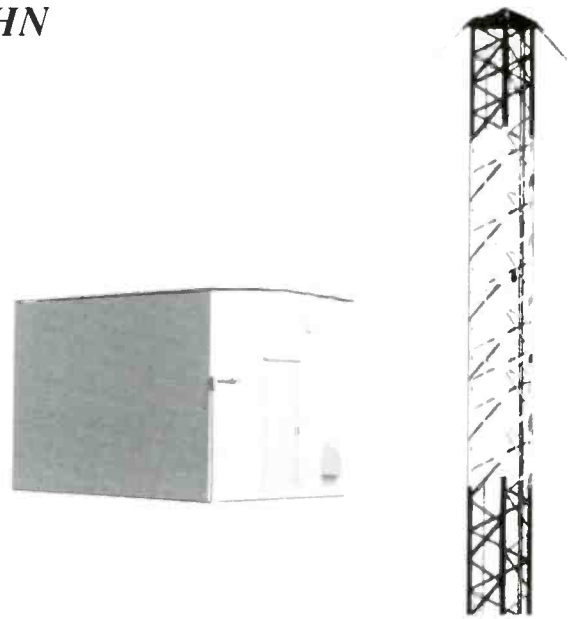

Towers/Shelters

Allow BSW and Rohn the opportunity to give you a quote on your tower and shelter requirements.

Rohn Towers are constructed with the finest materials. All tower sections are completely hot-dip galvanized after fabrication to protect all points of welding and construction against corrosion.

Rohn Shelters are available with a complete environmental control system and optional reinforced insulated aluminum doors with three-point locking systems.

Prices Based On Applications

TWR



Lighting Equipment

BSW sells a variety of tower lighting products including light fixtures, controllers, flashers and replacement bulbs.

Shown above is the OLI signal obstruction light with the following features: FAA approved, non-ventilated construction insures clean interior, copper-free aluminum castings, and neoprene and teflon gaskets.

OLI Mfg. List \$68.00

Call For BSW Pricing And Other Lighting Configurations

COMSTREAM



Satellite Systems

Yesterday it would have been unheard of for a radio station to have their own satellite uplink. The sheer cost of attempting such a feat would be unapproachable. Well, that was yesterday...

Today, having your own satellite uplink is probably one of the more cost effective investments your station can make. Imagine doing a remote broadcast from anywhere in the country with travel time being the only hindrance. Also, imagine your broadcasts being transmitted in full bandwidth digital, rivaling the audio quality of any equipment you own. Or consider your group of stations having its own network, sharing audio feeds and data.

If you want to transform your imagination into reality, read on. BSW is proud to represent ComStream Satellite Equipment. ComStream's innovative technology takes satellite transmission to a new level of performance for a fraction of the cost of existing technology.

ComStream offers several earth station configurations for full duplex operation. Multirate modems allow you to configure for mono or stereo at the bandwidth to match your application with a maximum frequency range of 20 Hz to 15 kHz, ± 0.05 dB at 256 Kbps, less than 0.05% distortion @ 1 kHz, and greater than 90 dB of dynamic range. This is all possible because of ComStream's new digital audio compression techniques that take up less satellite bandwidth and allow these KU-band systems to pass CD quality audio. Several antenna options are available for fixed or portable applications.

From cross country remotes, to creating your own network, the possibilities are limitless with ComStream satellite systems.

Call BSW Toll Free For More Information

TOLL FREE 800-426-8434

In Broadcasting, Time Can Be Your Toughest Competitor



Put Time On Your Side With BSW

Deadlines are a given in broadcasting. When the pressure's on, you need a company you can depend on. Look to BSW. We understand that people who are accustomed to measuring time in seconds, can't wait weeks and months for equipment to arrive from their supplier. That's why we work overtime, everyday, to deliver equipment from our million dollar inventory with unmatched speed and accuracy. Should items ship directly from the factory, our sterling reputation with over 200 manufacturers insures prompt attention to your order. No company is better qualified to put time on your side than BSW, America's Full-Time Broadcast Supplier.

BSW[®]

BROADCAST SUPPLY WEST

America's Full-Time Broadcast Supplier

ORDERS • INFORMATION • SPECIFICATIONS
7012 27th Street West Tacoma, WA 98466

ALC



Dramatic response in a small convenient size. Ideal for broadcast control rooms, studios, remote recording and quality control areas.

10302

Monitor Cube Speaker

- Compact 7 7/8" cube
- Full range
- Snap-away grill
- 60 Hz to 15 kHz

BSW Price \$98.00/pair

20306

Monitor Speaker

- Flat response
- 50 Hz to 20 kHz
- 8" woofer
- Walnut grain vinyl
- Two-way system with phenolic tweeter
- Compact 19 1/2" x 11" x 7 1/4"

BSW Price \$200.00/pair

ELECTRO-VOICE



SENTRY 100A Monitor Speaker

Just because your monitor space is limited, you don't have to compromise on sonic accuracy. The Sentry 100A is a compact, no frills speaker system. It's the oldest member of the Sentry family and has become the industry standard of reliability. The Sentry 100A delivers a flat 45 to 18,000 Hz frequency response with a wide 120° dispersion at 5,000 Hz. The Super Dome™ tweeter handles a remarkable 25 watts of input power and is matched with an 8" direct radiator woofer in an optimally vented enclosure.

SENTRY 100EL

The Sentry 100EL combines the reproduction components of the Sentry 100A with an integral high performance 50 watt power amplifier that's perfectly matched to the requirements of the speaker system.

SENTRY 100A Mfg. List \$317.00 ea.

SENTRY 100EL Mfg. List \$659.00 ea.

Call For BSW Price

JBL



4406

4408

4406 Studio Monitor

The 2-way Model 4406 monitor is ideal for console or close-in listening. The low distortion 6" woofer is composed of a filled polypropylene material which provides both high internal damping and excellent structural integrity.

Mfg. List \$250.00

Call For BSW Price

4408 Studio Monitor

JBL's 2-way 8 inch Model 4408 is an ideal choice for broadcast and general monitoring applications. The low distortion 8" composite woofer gives maximum stiffness, mass and internal damping for superior reproduction of both speech and music.

Mfg. List \$325.00

Call For BSW Price



4410

4412

4410 Studio Monitor

The powerful 3-way 10 inch Model 4410 features a vertical line array that gives maximum spatial detail at greater listening distances. The special laminated high polymer composite 10" woofer has outstanding power handling capabilities, delivering extraordinary punch and fidelity.

Mfg. List \$445.00

Call For BSW Price

4412 Studio Monitor

The 3-way Model 4412 is highlighted by an ultra-large, ultra-precise 12" laminate composite woofer. Its tight cluster arrangement and superior power efficiency make it the ultimate monitor for close-in listening. The mid-range element and larger woofer allow for greater power handling, increased sensitivity and extended bandwidth.

Mfg. List \$750.00

Call For BSW Price

JBL



CONTROL 1

CONTROL 1 PLUS

CONTROL 5

CONTROL SERIES Compact Monitor Speakers

Smooth, powerful, wide range response within a compact enclosure sums up the Control series monitors from JBL. These speakers not only sound great, they combine rugged construction with a wide variety of mounting options for maximum flexibility. The Control 1 is a two way system with a 5 1/4" low frequency speaker and a poly carbonate dome tweeter. Its frequency response is 70 Hz - 20 kHz. The Control 1 plus uses the same enclosure as the control 1, but uses a more powerful woofer and pure titanium diaphragm tweeter for even greater frequency range. The Control 5 monitor features a 6 1/2" woofer and larger cabonate for extended bass response.

CONTROL 1 Mfg. List \$250.00/pair

CONTROL 1 PLUS Mfg. List \$295.00/pair

CONTROL 5 Mfg. List \$395.00/pair

Call For BSW Prices

YAMAHA



NS10MS Studio Monitor

The Yamaha NS-10MS Studio speaker system has been created specifically for close-field monitoring in professional sound studios. Optimum woofer/tweeter matching and careful crossover design ensure smooth, natural transition between frequency ranges with minimum phase variation. Frequency response is remarkably flat from 60 Hz right up to 20 kHz, and superior transient response delivers crisp, transparent sound.

Mfg. List \$475.00/pair

Call For BSW Price

Customer Service

BSW's "after the sale" support is second to no one. Your complete satisfaction is our only goal and we pay for the call.

TOLL FREE 800-426-8434

AURATONE

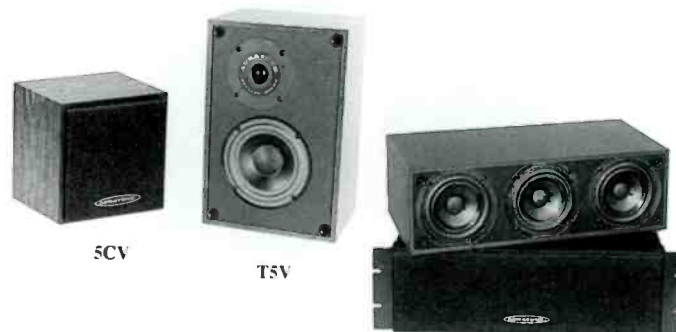

5CV

T5V

5MCV

5CV/5MCV/T5V Compact Monitor Speakers

Auratone speakers have gained a world-wide reputation as reference monitors that reflect realistic sound without excess coloration. The prime example is their compact monitor known as "the Cube". The current "Cube" is the model 5CV Super Cube with shielded magnet.

Model T5V takes the Cube a step further in a compact, shielded magnet, 2-way system that handles 50 watts of program power with an audible response of 40 Hz to 20 kHz.

The 5MCV is actually 3 shielded monitors contained in a three channel, three compartment ultra compact enclosure. It can be rack mounted and provides an excellent way of A/B testing of mono and stereo program sources.

5CV Mfg. List \$119.95/pair

T5V Mfg. List \$229.95/pair

5MCV Mfg. List \$172.50 ea

RM525 (Rack Mount Kit For 5MCV) Mfg. List \$9.95

Call For BSW Prices

RAMSA



WSA10 Compact Loudspeaker/Monitor

This compact loudspeaker system delivers performance impossible to obtain from larger units. The single 4 3/4" vented driver takes advantage of uniform and mid-angle coverage inherent in a simple source of small diameter. Careful attention to engineering details and exacting manufacturing tolerances result in smooth, extended amplitude response, excellent sensitivity, and high power capacity.

Advanced features include magnetic shielding to prevent interference with other equipment and a built-in thermal protection circuit to guard against damage from accidental input overload.

Optional mounting brackets enable the safe and attractive mounting for virtually any application. Available in black or white enclosures to blend with any decor.

Mfg. List \$120.00 ea.

Call For BSW Price

JBL



CONTROL10 Monitor Speaker

This three way speaker can handle 300 watts of power. It utilizes a 1" dome tweeter providing clean, high frequency response at high SPL, a 5" midrange device and a 12" woofer for solid, accurate bass. The Control 10 offers usable frequency response from 40 Hz to beyond 20 kHz. Can be used as a portable monitor or with optional mounting adapters for a number of field applications.

Mfg. List \$575.00

Call For BSW Price



6210/6211 Energizer Amplifiers

The 6210/6211 Energizers are designed to convert the Control 10 or any other 8 ohm speaker into a self-contained powered loudspeaker system. These amps are small enough to fit on the back of most monitor speakers and provide 40 watts into an 8 ohm load. The 6211 differs from the 6210 in that it has a built-in mic preamp with a mic / line selector switch and a low-cut filter switch.

6210 Mfg. List \$325.00

Call For BSW Price

6211 Mfg. List \$365.00

Call For BSW Price



G733 Loudspeaker

The perfect speaker for your road show, the G733 is a three way system utilizing 8" and 10" low frequency drivers in the same chamber for superb low frequency performance, power handling and efficiency. Handles 400 watts continuous program. Perfect for tripod mounting.

Mfg. List \$625.00

Call For BSW Price

TOLL FREE 800-426-8434

RAMSA



WSA200 Loudspeaker

Featuring a 12 inch low frequency transducer in a ported enclosure, a high-quality compression driver mounted to a constant directivity twin bessel horn and a phase compensated two-section frequency dividing network with built-in driver protection, the WSA200 delivers outstanding performance from 70 Hz to beyond the audible frequency range. Rugged resin enclosure with recessed handles and interlocking stacking ribs make it fully portable.

Mfg. List \$590.00

Call For BSW Price

NUMARK



PM330C Self-Powered Loudspeaker

Tired of hauling stacks of amplifiers to clubs or remote set-ups. You don't have to with these self-powered speakers. The internal amplifier only weighs three pounds, but delivers an incredible 225 watts of continuous power to this three way system featuring a 15" woofer, midrange horn, and ring radial tweeter.

Mfg. List \$1,100.00

Call For BSW Price

YAMAHA



CLUB SERIES II Loudspeakers

Here is a great sounding line of portable loudspeakers at very economical prices. They feature rugged construction with scratch resistant coverings, locking corner caps and sockets for stacking and stand mounting, protective metal mesh grill and molded recessed hand grips. High quality Yamaha components make them a great value for the dollar.

Call For Pricing And Specifications

Speakers

ACOUSTECH



MTR4.5
Test Monitor Speaker

Compact 2-way speaker system with built-in power amplifier. Same dimensions as most scopes. Perfect addition to your test bench. 2 balanced inputs and outputs. Front panel volume control Shielded case.

Mfg. List \$549.00

Call For BSW Price

FOSTEX



6301B
Amplified Speaker

The 6301B is completely self contained. The sound is delivered from a full-range speaker that's surprisingly flat and accurate. You get a frequency response of 80 Hz to 13 kHz. which makes the 6301B an ideal reference monitor when you're producing music, radio spots or audiovisual sound tracks. The built-in 10 watt (RMS, into 8 ohms) amplifier will handle anything you feed it. The 6301B's input has been designed to accept any line or instrument-level input, even from an amplifier. There's no confusion. Just one 1/4" phone jack to deal with.

Mfg. List \$350.00/pair

Call For BSW Price

KOSS



SA30
Powered Speaker

These little powered speakers use 4 "C" size batteries (2 per speaker) and plug into the/headphone circuit of any piece of equipment via 1/8 " mini plug (can be modified to 1/4" for standard headphone jacks). Includes bass boost, treble boost, power indicator LED, and separate volume controls per speaker.

Mfg. List \$34.99

Call For BSW Price

OMNIMOUNT



Speaker Mounting Brackets

Installing speakers is no easy task unless you use Omnimount speaker brackets. Only Omnimount offers models that allow you to mount speakers from assorted angles and locations. Weight and handling ranges from 1 pound to 255 pounds. Call BSW with your requirements and we will suggest the proper Omnimounts for you.

Prices Based On Configuration

PIVOTELLI



Speaker Mounting Brackets

Pivotelli supports are made from the finest solid premium grade steel which is contoured at all edges and joints and coated with durable nylon finish for maximum protection. Tightly clamping grips mean you never have to drill holes in speakers or other equipment. Pivotelli supports come in a wide range of styles from simple single pivot to complex multiple pivot systems. They can accommodate cabinet sizes from 7 1/2" to 47" and weights up to 176 lbs. safely and securely.

Call BSW With Your Requirements

EMERSON

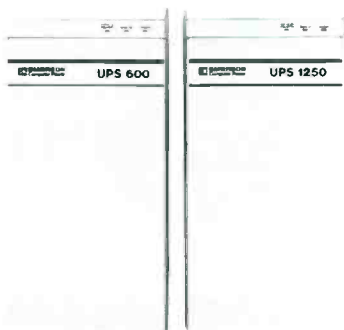

Uninterruptible Power Systems

As microcomputers and microprocessor based equipment grow in memory capacity and speed, the amount of data they hold and their importance in the operation of your business increases dramatically. However, all of this data can be erased and the computer system brought to a halt by a single disturbance on the power line. The lost time and productivity while files are reconstructed can be catastrophic. The Emerson Computer Power Uninterruptible Power System is specifically designed to provide the clean, filtered power required to keep microcomputer systems running smoothly. In addition, if a total outage occurs, self-contained batteries continue to supply power to the computer allowing data to be saved and the application software to be exited before any information is lost. If the computer is unattended the Status Connector on the Emerson UPS can warn the system when utility power is initially lost and again when the UPS batteries are low. The computer system can then automatically initiate a software routine to close all files and prepare for shutdown. Features: Full time power line noise and transient suppression to protect sensitive hardware and software. • Status Connector allows automatic soft ware shutdown for unattended systems. • Self-contained, maintenance-free batteries provide long service • Compact styling and quiet operation permit under-desk placement. • Audible and visual alarms indicate abnormal conditions. • Removable battery tray for easy battery replacement. • U.L. listed

Call For Pricing And Specifications

SCI



6T Surge/Transient Suppressor

Don't let lightning destroy your equipment. Protect it with a 6T surge/transient suppressor from Sine Control. These suppressors will protect your equipment from lightning damage, while filtering out lower voltage spikes that reduce the effective life of your equipment. Handles 60,000 surge AMPS min.

1240VF2-6T (120/240 single phase) Mfg. List \$1,350.00

Call For BSW Price

INNOVATIVE TECHNOLOGIES



PROTECTOR SERIES Surge/Transient Suppressors

Your stations equipment may be insured against theft and fire, but have you considered insurance against overvoltage damage? Surges from lightning or electrical utility problems can wipe out equipment worth thousands of dollars in milliseconds. With the PROTECTOR surge suppressor from Innovative Technologies you can rest assured that you are protected against overvoltage damage. The Protector is a passive unit utilizing the most up-to-date electrochemical technology to protect AC service panels up to 2000 amps. This space saving device is easy to install and mounts directly to the service panel. PROTECTOR not only saves your equipment from serious transients like lightning strikes, it also protects against smaller surges that happen more frequently and break down the effective life of your equipment.

Call us today for a quote on a protector meeting your specifications.



EQ2 EQUALIZER Surge, Spike, And Noise Suppressor

The Equalizer uses a 2-stage solid state suppression network which is electronically bridged to an active chemical compound with energy dissipation capabilities. This chemical link technology allows the Equalizer to internally dissipate large spikes and surges that would destroy other surge suppressors. The Equalizer also has complete EMI/RFI noise filtering.

EQ2 BSW Price \$59.00

(2 outlet unit with EMI/RFI)

EQ2RJ11 BSW Price \$89.00

(2 outlet unit with EMI/RFI and RJ11 jacks for fax line, telephone line or modem protection)

Studio Furnishings

EXPRESS GROUP

Express Group systems represent the highest quality modular furniture in the world, bar none. Since inception, the Express Group's dedication to quality has set a standard of excellence by which all other manufacturer's products are judged. All Express Group Studio Furniture Systems feature the same high-quality materials and craftsmanship throughout.

The following features are common in all six series:

- Void-free birch plywood construction
- Poplar hardwood as internal support pieces for added strength
- Non-splitting, non-marring, high-impact corner guards on all outside corners for protection
- Unique edging system around lower section of all modules to prevent chipping
- Numerous and generous access panels including both front and inside areas
- Quick, quarter-turn fasteners on all removeable access panels
- Factory installed rack rails
- Custom cut-outs for control consoles and turntables are included
- Large built-in wire passes
- High-impact laminates of dove gray and black. Custom colors available
- Easily adjustable



- leveling feet on all floor cabinets
- Built-in passive ventilation
- Open Module bottoms for cable pass from computer floors
- No use of particle board anywhere except for turntable base supports, to eliminate acoustic resonance
- Shipped as fully assembled modular pieces for quick and easy installation
- Delivery of some standard units in as little as two weeks
- Stand-up models available for all series
- Exotic hardwoods available
- Specialize in custom configurations. More than 70% of all Express Group designs and fabrications are custom, one-of-a-kind products.

Call BSW For Complete Details And Pricing

MURPHY FURNITURE

Standard features on all Murphy Furniture include oak trim on all exposed edges, a bumper base covered with a non-chip material, plexiglass panels over racks near operators feet and sloped faces on all returns. Wire management and passive ventilation systems have also been incorporated into the designs.

The Elite Series offers a curved bumper base, single level construction and total modularity.

The Premier Series has a flat bumper base, bi-level construction and offers flexibility of layout

The Dub/Edit Station is a durable desk system with a wire management area.

The Classic Series is an economy line of furniture featuring a wire management area formed by modesty panels around the outside perimeter and aprons around the inside perimeter, 1" thick oak trimmed legs and 1 1/2" x 3/4" oak trim around the counter level. There is a square rack component that sits on the countertop. This line has no undercounter rack space.

Murphy's concept is modular construction with custom fit. The

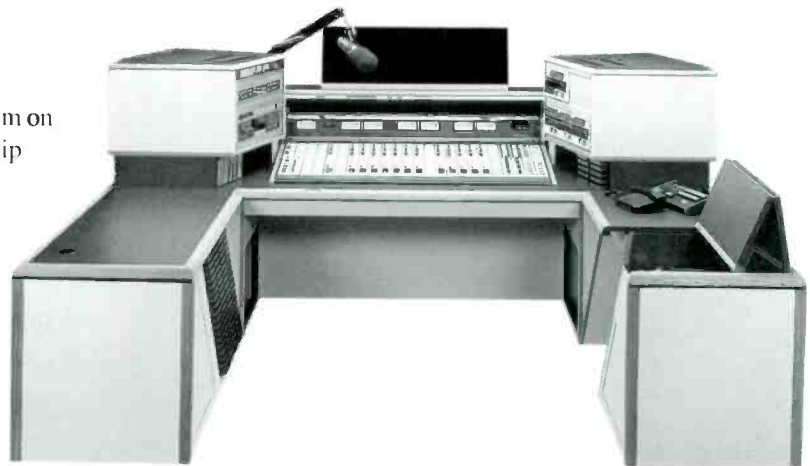

flexibility of these furniture systems will address all your needs. Delivery is 2-8 weeks depending on customization required. This furniture will be shipped "RTA" (Ready To Assemble) via van line carriers. Customization of any system component is available.

Call BSW For Pricing And Configuration

ABCO



280



560

Wire Cart/CD Racks

Models	Mfg. List
300 (Holds 300 carts)	\$391.40
500 (Holds 500 carts)	\$597.00
280 (Holds 280 CDs)	\$351.75
560 (Holds 560 CDs)	\$625.00

Call For BSW Price

FIDELIPAC

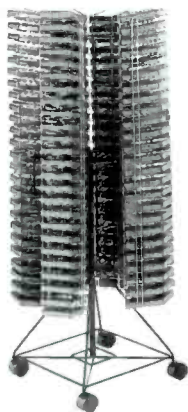

MR200

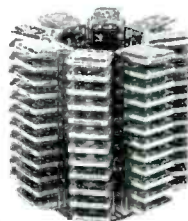

TR96



TR48

Cartridge Racks

- MR200
Lazy Susan (Holds 200 carts) Mfg. List \$371.00
- TR48
Lazy Susan (Holds 48 carts for countertop installation) Mfg. List \$104.00
- TR96
Lazy Susan (Holds 96 carts for countertop installation) Mfg. List \$185.00

Call For BSW Prices

**INFORMATION
DESIGN**

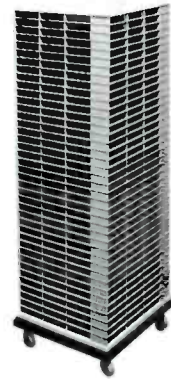

Cart Rack Systems

Features: Desk top or floor use • Modular construction for add-on expansion • High-impact polystyrene

Models	BSW Price
60 Carts	\$109.00
120 Carts	\$160.00
240 Carts	\$261.00
360 Carts	\$358.00
600 Carts With Flat Base And Castors	\$599.00
Flat Base With Castors	\$62.00
Metal Storage Base With Castors	\$161.00

BSW



726EK

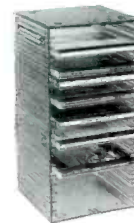

724US



AW20



AW40

**726EK/724US
CD Racks**

Here's our "best value" CD storage units. The 726EK is an 80-space carousel and the 724US is a 20-space single unit that can be wall mounted or ganged in various configurations.

726EK BSW Price \$60.00

724US Mfg. List \$10.00

Call For BSW Price

**AW20
Cart Rack**

Holds 20 carts, Made of high impact polystyrene. Great for wall mounting. Includes mounting screws

BSW Price \$14.25 ea. Quantity Discounts Available

**AW40
CD Rack**

Holds 40 CDs, High impact polystyrene, Wall mounting with mounting screws

BSW Price \$24.95

Studio Furnishings

PRORAX Storage Racks

Hundreds of stations have specified ProRax for their cartridge, cassette and compact disc storage needs. ProRax racks are constructed of the highest quality oak or mahogany hard woods. No particle board or laminates are used. ProRax carousel models have storage on two sides instead of four, allowing for easier indexing and location. The turning radius is smaller so less countertop or floor space is required. With over 27 models to choose from, we are sure to have the ProRax just right for your operation. Most models are in stock for immediate delivery.

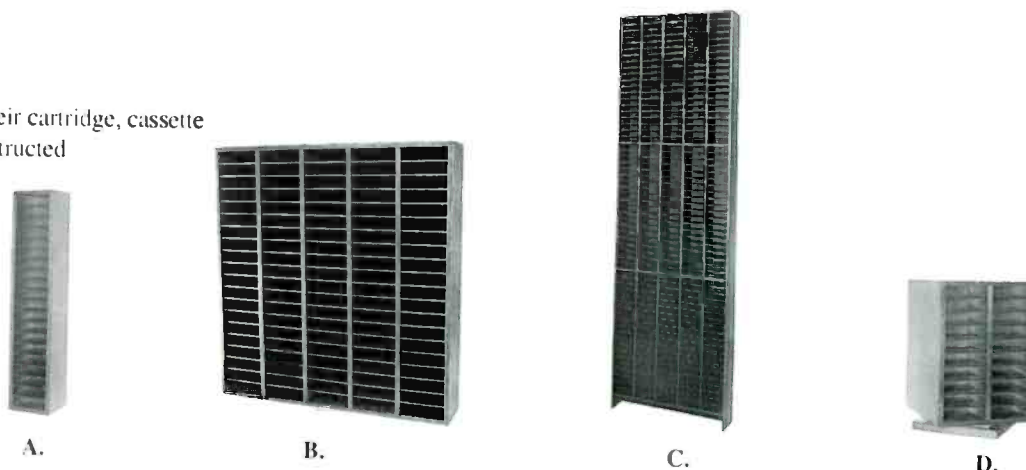

MODEL	DESCRIPTION	WALNUT	OAK
A. W20	Cartridge / Wall Mount - 20 space - 5 1/4"W x 24 1/2"H x 4 3/4"D	\$45.00	Call
B. W100	Cartridge / Wall Mount - 100 space - 23 1/2"W x 24 1/2"H x 4 3/4"D	\$99.95	\$112.00
C. W300	Cartridge / Wall Mount - 300 space - 23 1/2"W x 75 3/4"H x 4 3/4"D	\$347.00	\$429.00
D. C40	Cartridge / Carousel - 40 space - 13 3/4"H - Turning Radius 13 3/8"	\$79.00	\$79.95



MODEL	DESCRIPTION	WALNUT	OAK
E. C80	Cartridge / Carousel - 80 space - 25 1/2"H - Turning Radius 13 1/2"	\$117.00	\$124.00
F. C120	Cartridge / Carousel - 120 space - 25 1/2"H - Turning Radius 17"	\$176.00	\$187.00
G. C160	Cartridge / Carousel - 160 space - 25 1/2"H - Turning Radius 21"	\$239.00	Call
H. C200	Cartridge / Carousel - 200 space - 25 1/2"H - Turning Radius 25"	\$294.00	Call
I. CD20W	CD / Wall Mount - 20 space - 6 1/4"W x 16 1/2"H x 4 3/4"D	\$39.00	\$52.00

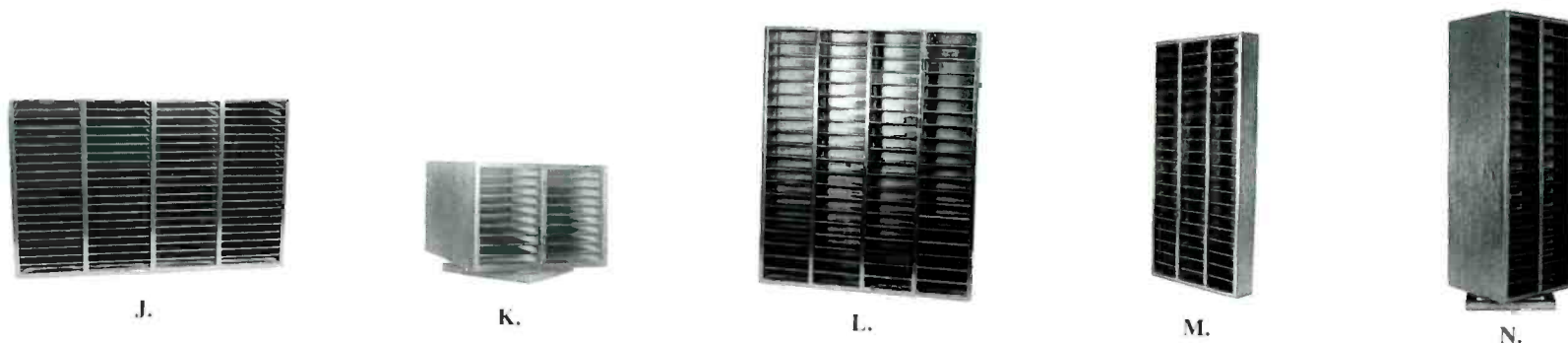

MODEL	DESCRIPTION	WALNUT	OAK
J. CD80W	CD / Wall Mount - 80 space - 23 1/4"W x 15 1/8"H x 4 5/8"D	\$101.00	\$104.00
K. CD40LS	CD / Carousel - 40 space - 9 1/4"H - Turning Radius 11 3/8"	\$78.00	Call
L. CS80W	Cassette / Wall Mount - 80 space - 20 3/16"W x 24 1/2"H x 3"D	\$79.00	Call
M. DRW60	DAT / Wall Mount - 60 space - 23 1/2"H x 12 3/8"W x 2 1/2"D	\$59.00	Call
N. DR80LS	DAT / Carousel - 80 space - 25 1/2" - Turning Radius 11 3/4"	\$99.00	Call

SOUNDOLIER

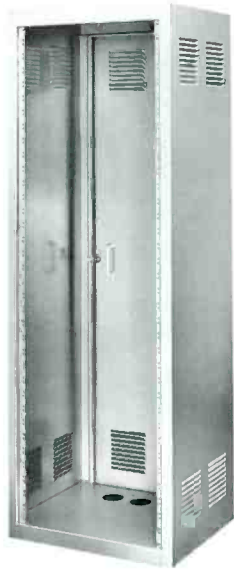

**100 SERIES
Equipment Racks**

100 series rack cabinets from Soundolier are cost effective and come in pre-welded and knocked down versions in a number of sizes and colors. Units come with standard rack rails tapped 10-32, louvered side panels, and louvered, locking rear door.

Pricing Based On Configuration

MIDDLE ATLANTIC



**RX SERIES
Equipment Racks**

High quality, inexpensive equipment racks. Ideal for many applications from displays to installations. Ships flat for easy storage. Assembles quickly with included allen key. Decorative screw caps snap on. Constructed of 5/8" thick, high density particle board, covered with gray or black laminate. Rack rails are 1/8" thick black baked enamel steel, tapped full hole spacing to fit all equipment Rear rack rail option available. 15 7/8" Deep.

- RK8 14"** (8 space) Mfg. List \$108.89
- RK12 21"** (12 space) Mfg. List \$117.78
- RK16 28"** (16 space) Mfg. List \$124.44
- RK20 35"** (20 space) Mfg. List \$137.78

Call For BSW Prices

MIDDLE ATLANTIC



Custom Rack Shelves

A unique method of rackmounting that lets you put anything into a rack, without modifying the unit. This custom rackmount brings your equipment up to the next even rackspace, eliminating unsightly gaps. Each cutout is different depending on unit. A BSW representative can tell you if your particular piece of equipment already has it's dimensions file

Prices Based On Configurations



Rack Storage

This family of storage drawers provide easy storing of many items inside a rack. The fully enclosed top insures that no contents spill out, or debris in. Front panel has an attractive flush spring loaded handle that latches upon closing to keep the drawer closed. Full extension ball bearing slides smoothly extend the drawer 14" out for easy access.

- D2 3 1/2"** (2-space) Mfg. List \$144.44
- D3 5 1/4"** (3-space) Mfg. List \$162.22
- D4 7"** (4-space) Mfg. List \$173.34

Call For BSW Prices



A handy way to store your CDs, cassettes, DATs and LPs right in your equipment rack. These black brushed aluminum holders fit all standard 19" racks and vary in height from 4 to 8 spaces depending on format.

Call For Special Pricing And Configuration.

Middle Atlantic has a wide variety of rack accessories to accommodate just about anything you could store in a equipment rack. Choose from a number of standard or custom shelves, drawers, panels, covers, even rack rails and screws.

Call BSW For Complete Details

EFXX

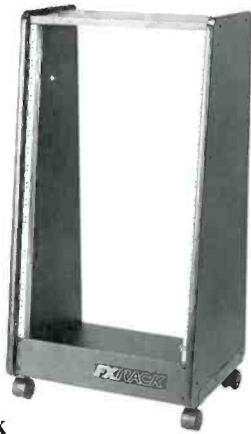

FX RACK Equipment Rack

FX Rack fills the need for an economical 19" equipment rack that can be used for "outboard" signal processors, patchbays, tape decks, power amps etc. The key to FX Rack's exceptional good looks and low cost is its unique design and the use of special wood/laminate materials. FX Rack is shipped flat and requires only a screwdriver for easy assembly. 40"H x 21"W x 16"D (unlimited rack depth). 33 lbs. net weight.

Mfg. List \$129.95

Call For BSW Price

SAUSALITO CRAFTWORKS

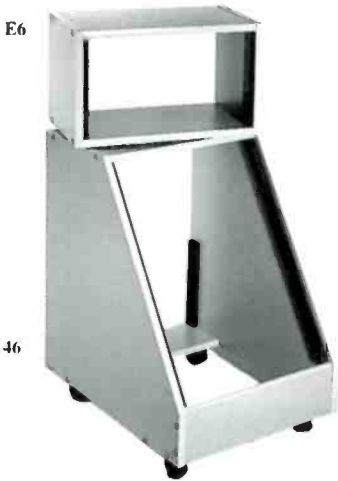

OMNIRAX Equipment Racks

Omnirax from Sausalito Craftworks are a new series of beautiful, yet inexpensive equipment racks. Three series are available: the "O" series in Oak, "E"-series in Grey melmine, or the "B"-series in black medite. Configurations include several models of desk-top and roll-around style racks. Shown above is the O20, 20 space oak rack featuring castors and maple rack rails that hold screws tightly while helping to eliminate grounding problems associated with metal racks. Also shown is the E146 with 14 rack spaces available on it's slanted front face and 6 more spaces available in the back. Sitting on the E146 is the E6, 6-space rack.

Prices Based On Configuration And Style

TASCAM



CS607B Roll Around Equipment Rack

Rack-n-roll your equipment with the Tascam CS607B portable rack. Ideal for engineers and audio professionals on the move. The CS607B is perfect for mounting reel-to-reel machines. Two large knobs and backing pins allow the rack frame to tilt from vertical to horizontal, so equipment can be placed in the most convenient position for your working environment.

BSW Price \$450.00

JUICE GOOSE



TWELVE PAQ Multi-Voltage Power Supply

Here's the ultimate low voltage power supply. This innovative unit provides six separate low voltage outputs, each providing 9 VAC, 18 VAC, 9 VDC, and 12 VDC. So now you can power your interface boxes, effects units, or any items requiring lower voltages from a neat, rack mounted, outlet saving unit. In addition to the six low voltage outs, Twelve Paq includes 6-120 volt outlets, so virtually everything in the rack can be powered from this single rack space device. Since Juice Goose is a leader in power conditioning technology, they've also included excellent noise filtration and spike protection in both the low and high voltage outlets. Custom cables are available to match the Twelve Paq's low voltage outs to the particular inputs of your equipment.

Twelve Paq Mfg. List \$249.00

Call For BSW Price

PROFOAM



PROFOAM Acoustical Foam

Profoam has become very popular in broadcast and recording environments. Large sheets make installation quick and easy. Sheet size is 4 1/2' x 6' (27 square feet). Available in 2" or 3" thicknesses. Color is charcoal grey and blends with most studio surroundings. Profoam is UPS shippable so you'll save on shipping costs and time. 2 sheets per package.

2" BSW Price \$49.95 per sheet

3" BSW Price \$56.95 per sheet

(Adhesives available in spray can or in 1 and 5 gallon containers)

SONEX

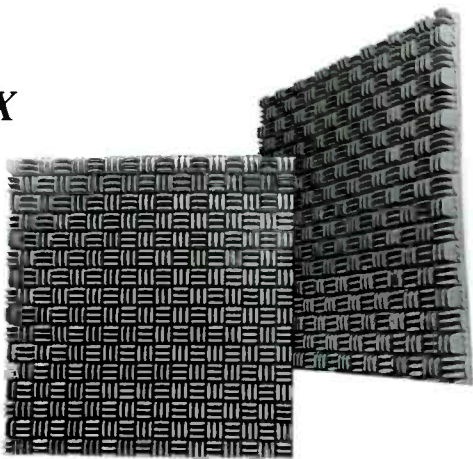

SONEX Acoustical Foam

Sonex gives you the greatest choice of colors, thicknesses and sizes of acoustical treatment. Choose from 2' or 4' squares in 2", 3" or 4" thickness. Colors are charcoal, blue, brown, and beige. Sonex 1 is available for facilities such as schools, churches, offices, anywhere where Class 1 building codes apply.

Call For Pricing And Technical Specifications

About Acoustical Foam

Before you install any acoustical foam, it is best to check with your local fire department for regulations in your area. Building codes differ state-to-state. BSW will not be responsible for removal and return of acoustical equipment after installation. We are happy to provide samples and specifications for the asking.

TOLL FREE 800-426-8434

SOUNDFORMS

Sound Control Panels

Whether you are responsible for music, dialogue or sound effects, it is important to isolate and control the ambience of your recording and sampling environment. Soundforms are lightweight portable and modular sound control panels that enable you to effectively control sound in a recording environment. They can be used free-standing, hung on a wall, or snapped together to form sound booths, sound rooms or sound walls.

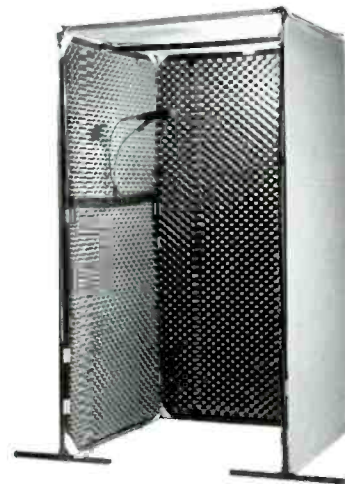

Sound Booth

This package includes: three S-22 panels, one S-15 panel, one pair of T-legs, twelve double-clips, and one cross bar. This system (measures 3.5' x 3.5' x 6.5') and can be used as a sound recording booth inside a studio or in the field.

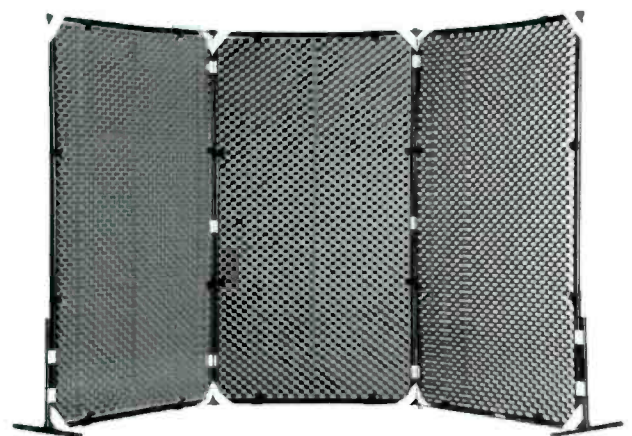

Sound Wall

The Soundforms sound wall includes: three S-22 panels, one pair of T-legs, and six double-clips. This system is used as a baffle wall. The three panels consist of approximately 66 square feet of acoustic foam, weight only 16 lbs., and are collapsible for storage or travel.

Prices Vary with Application. Call BSW
Toll-Free For More Information

FIDELIPAC



340 SERIES

Warning Lights

The standard warning light used nationwide. Back-lit red letters on black background. Available in several languages. Dimensions: 5"H x 10"L x 2 1/2"D. 120 volt

65340 (ON AIR) BSW Price \$65.35

340REC (RECORDING) BSW Price 65.35

PROLITE



Warning Lights

Designed to fit a variety of interior specifications, the Prolite Architectural Series lights are attractive as well as functional to warn that a microphone is on. Housing and canopy are triple ground, cast aluminum with a baked, matte black enamel finish. Dimensions are 7 1/2" square. Two 20W, 6 1/2" long life lamps are supplied. 120 volts is required to operate. Choose from 3 configurations and either on air or recording symbols.

33W6142R (Flat wall, single lens) BSW Price \$87.90

33C6242R (Extended wall, double lens) BSW Price \$113.25

33E6242R (Extended ceiling, double lens) BSW Price \$113.25

33P6242R (Pendent ceiling, double lens) BSW Price \$147.75

Extra blank lens BSW Price \$11.25



L101

On Air Light

The Prolite L101 is a great on air light when space is the most important consideration. The L101 fits in a standard single duplex electrical box. It operates on 12 volt DC (power supply not included). Plastic lens is available in white or red color (specify).

BSW Price \$22.95

TITUS TECHNICAL LABS



OAL SERIES

Warning Lights

Provides the broadcaster and recording studio with a beautiful but practical means of indicating that a studio is in use. These lights feature a smoked glass window mounted in either a gold or silver frame which is attached to a solid wood mounting base. Oak is the standard wood used but custom woods are available. The warning "ON AIR" or "RECORDING" only appears when illuminated and is blacked out when not in use. Orientation is either vertical or horizontal and wiring is class-2 type low voltage.

BSW Price \$122.50

WHEELLOCK

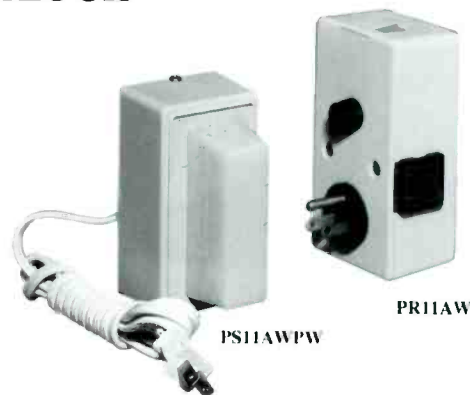

PS11AWPW

Telephone Signal Strobe

Compact telestroke signals emit high intensity flashing light when the telephone rings. Ideal for broadcast studios.

Mfg. List \$78.75

Call For BSW Price

PR11AW

Telephone Relay

Wheelock offers a wide variety of relays for most common telephone ringing applications. Designed for insertion in standard AC receptacles, it can actuate any 115 VAC device up to five amps rated current during on-time of telephone ring cycle.

Mfg. List \$81.70

Call For BSW Price

PROLAMP



LED Replacement Lamps

Our flange based multi LED miniature lamps are exact replacements for T 1 3/4 and T 1 1/4 incandescent miniature lamps. Shock and vibration proof, they keep your lighted panel and switches going "on" for 100,000 hours. Specify lamp you are replacing, color desired (red, green, or yellow), and center-tip polarity of socket.

Price Based On Configuration

LITTLELITE



**L3/12
High Intensity Light**

Here's a gooseneck mounted high intensity light that features a quartz halogen bulb, a dimmer control with off position, a wall plug-in transformer with 6' cord, and permanent mounting hardware included. Perfect for illuminating turntables consoles, or equipment racks.

BSW Price \$45.95

PERFECT DATA



**16007/16008
Copy Holders**

These functional, stylish holders are designed for letter, legal, and A4 size documents. A spring-loaded line guide can be mounted on either the left or right side and a spring loaded holder clip keeps copy in place. Model 16007 features a lightweight arm for normal copy, the 16008 has a heavy-duty arm for books or stacks of copy. Both holders come with a table clamp mount. Model 16055 is an extension piece that allows the holders to accommodate wider copy.

16007 BSW Price \$49.95

16008 BSW Price \$59.95

16055 BSW Price \$19.95

SETH THOMAS



**710
Wall Clock**

Here's our most popular clock that is perfect for all studios. Quartz control assures accurate time. Battery powered by one "C" cell that will last over a year. Brown case, 14" diameter, red sweep hand.

BSW Price \$29.95



**709
Wall Clock**

Electric powered, the model 709 is easy to read from a distance. Diameter is 14". Brown molded case.

BSW Price \$22.95



**2636
Wall Clock**

Quartz accuracy and extra bold dial graphics. Popular 14" case size is light beige in color. Shatter resistant, crystal. Red sweep second hand. Uses one AA battery.

BSW Price \$27.95

**With BSW You never Pay
Extra for outstanding service.**
Place your order by Noon....We'll ship stock items by 5

ESE



ES172
12 Hour Clock

Six digits, Compact enclosure, bright, easy to read 0.4" red LEDs. Three setting controls - Fast Advance, Slow Advance, and Hold. Four line multiplexed BCD is present on the rear connector. Available options are C,D,J,M, and V. Dimensions: 2.10"H x 4.5"W x 4.13"D. Case is high impact black plastic.

Mfg. List \$192.00

Call For BSW Price



ES520
60 Minute Timer

The ES520 is a four digit, sixty minute timer with start, and reset controls. Runs continuously unless stopped or reset. If stopped, display will hold time reading and when restarted will continue from last displayed figure. Reset returns display to zeros. If reset while running, timer will continue to run. Displays are .56" bright orange LED. Also features serial time code output to drive slaves, 4 open collector inputs to trigger reset, and remote capability.

Mfg. List \$169.00

Call For BSW Price

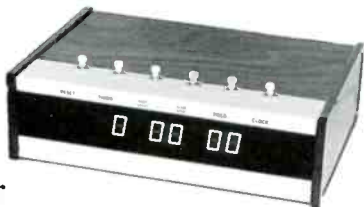

ES562E
Studio Timer

The ES562E is a time of day clock and a count up timer. Display is in hours, minutes, and seconds. Memory allows timer to be used while keeping correct time of day.

Mfg. List \$380.00

Call For BSW Price

RADIX



ST500
Studio Timer

Compact studio timer with many applications in the control room, production or news room. Time events to 9 hour 59 minutes 59 seconds. Large—Highly visible red display digits 1/2" high. Rear terminal strip interface allows remote start, stop and reset. Powerful microprocessor allows preset times from memory to count up or down. Outstanding value.

Mfg. List \$225.00

Call For BSW Price

CALCULATED INDUSTRIES



3032 TIME MASTER
Time Calculator

Get fast accurate answers to your time calculations in the time format of your choice with the Time Master calculator from Calculated Industries. The Time Master is a professional calculator that adds, subtracts, multiplies, and divides in mixed or like time formats. You can easily add amounts of time to points in time, convert time formats, find elapsed times, round time values, multiply by an hourly rate and much more. This useful tool is backed by a 1 year warranty.

Mfg List \$59.95

Call For BSW Price

America's Full-Time Broadcast Supplier

When BSW was founded in 1973, our goal was to establish a single source supply house to serve the needs of America's broadcast professionals. Regional offices solved the problem of time zone but only served to delay delivery of equipment critical to a station's operation.

So we decided to work overtime every day of the week. 12 hours a day, there is a qualified sales engineer on duty who knows your business and your needs. And there's only one number you need to know—toll free across America. 1-800-426-8434 BSW's commitment to service is why we're America's full-time broadcast supplier.

RAINWISE

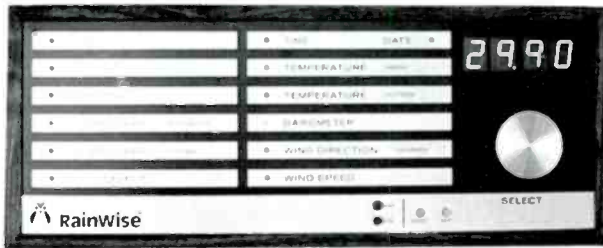

**WS1000
Digital Weather Station**

Engineered for precision and trouble-free operation, the WS1000 monitors nine different weather phenomena. The station provides digital readout for time, indoor and outdoor temperature, barometric pressure, wind direction, wind speed, wind chill, rainfall and accumulates, degree/day heating, and degree/day cooling throughout the year. Maximums and minimums are provided for any desired period to the nearest hour, day, and month. The unit is easy to read and operate. A red light indicates the function chosen by the selector knob, and the value is displayed in bright, .8" LED numerals. An auto select position displays each function in sequence for four second intervals. The unit measures 7" high, 17 1/2" long, 1 1/2" deep, and may be mounted without cutting a hole in the wall. The attractive black and brushed aluminum faceplate is complimented by the genuine walnut frame. The unit operates on safe low voltage from a power supply that plugs into a standard AC receptacle. An optional battery pack prevents loss of memory data in the event of a power failure.

Mfg. List \$1,068.00 Call For BSW Price
Computer Compatible Models Available

ENBERG

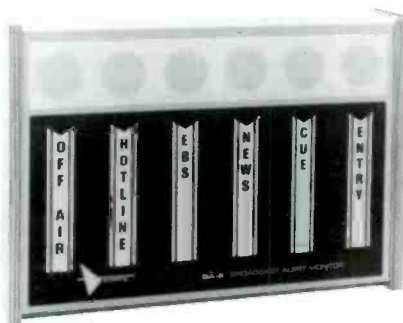

**BA6
Alert Monitor**

Off the Air... EBS warning... Telephone hotline ringing? Find out in an instant visually with the BA6 from Enberg Electronics. This practical device is attractive as well as functional and interfaces with a variety of equipment to inform you of status immediately. Features 3 modes of operation, flashing 4000 hour indicators, opto-isolated inputs and solid state relays. Stick-on labels allow you to customize for your particular requirements.

BA6 BSW Price \$342.00
BA12 (12-Channel) BSW Price \$685.00
6- & 12-Channel Remote Models Available

RODCO



**COMPUTEMP 5
Time & Temperature Monitor**

This unit accurately monitors outdoor and indoor temperatures and time of day. Features: Temperature alarm alerts to any predetermined setting • 24-hour memory of daily high and low temperatures and the exact time of the occurrence • Continually alternating LED display • Battery back-up system to retain memory • Removable temperature sensors • Optional rotary switch for monitoring up to nine locations • 30 feet outdoor cable standard (additional lengths available)

BSW Price \$89.95

TELTEK



**INFORMER II
Digital Temperature Gauge**

For accurate temperature reporting, we recommend the Informer II. LCD display operates on I-AA battery (replace yearly). Records high and low temperatures in memory. Very accurate and works in high RF fields. Includes 50 feet of cable for outside probe (additional lengths available).

BSW Price \$59.00

HALONCO



**HALONCO
Halon Fire Extinguisher**

One of the best investments you can make for your transmitter site and studios... Halon Fire Extinguishers from Halonco™. BSW can supply portable hand-helds or automatic systems that you can install and maintain yourself. All Halonco extinguishers use a formulated blend of Halon that is expelled as a pure vapor. Safe for use on all classes of fire and will not cause costly damage to sensitive electronic components. The fire kill is 3 times more effective than CO2. Each Halonco extinguisher is warranted for 5 years against leakage.

Prices Based On Size And Configuration

CELLABS



LINEJACK II Cellular Interface

Now just about any cellular phone can double as a studio audio link for your remote broadcasts with the Linejack II from Cellabs. Linejack II connects your audio equipment directly to your cellular phone via balanced XLR in/out circuits. Input is mic/line switchable with a separate input (mini jack) for a tuner that is routed to the right side of the headphone output. The 600 ohm output has a separate level control (as does the input). Linejack II operates from the power supplied by the cellular phone.

Mfg. List \$245.00

Interface Cable From \$50.00 Depending On Model Of Cellular.

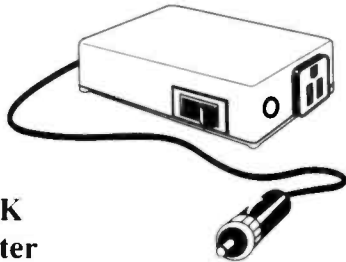

POWERJACK DC/AC Inverter

Cellabs offers an easy way to get AC power in the field. Powerjack provides 115VAC, 60Hz power to equipment drawing up to 100 watts (continuous). Simply plug the Powerjack into the cigarette lighter jack and you're on-line with continuous power.

BSW Price \$195.00

COMREX



PLXMICRO Remote Frequency Extender

Combine a Comrex PLXmicro Frequency Extender with your cellular telephone and create a portable, easy to use, great sounding remote broadcast system. Comrex and cellular are natural partners for remote broadcasts. PLXmicro Portable One Line Encoder is a battery operated duplex one line extender that packs twice the features of older frequency extenders into half the size. The PLXmicro has a built in coupler for direct connection to either standard dial lines or cellular telephones. Monitor decoder, hybrid circuitry and headphone output are included for hands-free, two-way operation. There are both microphone and tape inputs along with AGC and optional external AC power supply.

Mfg. List \$1,450.00

Cellular Interface Mfg. List \$125.00

Call For BSW Price

COMREX



3XP/3XR Multiline Frequency Extender

This is an encode/decode system that provides a frequency response of 50 Hz to 10 kHz on three dial telephone lines. Comrex's proven multiband noise reduction system is incorporated in a seven band configuration to handle the high noise environment of long haul telephone circuits. The Model 3XP Encoder is built in a rugged, portable case and features "one-button" automatic dialing and setup. The 3XP also allows visual and audio communications from the receive site. The 3XR Decoder is housed in a 31J 19" rack with modular Eurocard board construction. It contains all the circuitry necessary to automatically answer and match the gains of incoming telephone lines and to equalize each line across the full telephone band. Real time audio processing is used to allow for simultaneous program backfeed. Optional automatic satellite delay for international feeds handle up to one second of time difference among lines.

3XP Encoder Mfg. List \$6,000.00 Call For BSW Price

3XR Decoder Mfg. List \$6,500.00 Call For BSW Price



2XP/2XR Two Line Frequency Extender

Comrex two line systems give you a full 50 Hz to 5 kHz of program audio using two standard telephone lines. On one line, input audio is shifted upward by 250 Hz, so program audio as low as 50 Hz can pass through the 300 Hz telephone cutoff. On the second line, program is shifted down by 2,000 Hz to pass frequencies as high as 5,000 Hz. Since line noises can also detract from program quality, Comrex two line systems incorporate sophisticated multiband noise suppression that can handle even the high noise environment found on many long haul international circuits.

2XP Encoder Mfg. List \$3,500.00 Call For BSW Price

2XR Encoder Mfg. List \$3,000.00 Call For BSW Price



THX One Line Extender/Hybrid

The Comrex Model THX is a complete telephone line management system and contains all the circuitry needed to interface a telephone line with your broadcast audio facilities. Features: One line extender (encoder and decoder) • Built-in hybrid set-up system • Declicking • Automatic caller leveling • Wide band hybrid • Auto or manual answer • Variable ring count • Connection to any PABX • All functions remotable

Mfg. List \$2,750.00

Call For BSW Price

COMREX



LXT/LXR Single Line Frequency Extender

Here is the most cost effective Comrex extender system you can buy. This basic system restores the low end on telephone transmissions, offering a substantial improvement for telephone remotes. Easy to set up and operate, the basic system works off a single dial-up line. Input is line level via barrier strip. We suggest the use of an outboard mixer.

LXT Mfg. List \$685.00
LXR Mfg. List \$685.00

Call For BSW Price
Call For BSW Price



TCB2A Auto Answer Coupler

It's easy to put your audio on the phone with the TCB2A auto-answer coupler from Comrex. Built specifically for broadcast use, the TCB2A is perfect for listen line applications. Just plug in the standard connectors, attach the power supply and you're ready to go. Coupler answers on the first ring and disconnects when calling party hangs up.

Mfg. List \$275.00

Call For BSW Price



TCB1A Telephone Coupler

TCB1A broadcast coupler sends and receives program material via the switched telephone network. This unit requires no external power and connections are standard modular plugs. The TCB1A contains an FCC registered coupler which provides isolation from hazardous voltages and currents and includes an active circuit to hold the telephone line. 1/4 inch jack provides line level input.

Mfg. List \$135.00

Call For BSW Price

GENTNER



PEOPLELINK Broadcast Telephone System

Broadcasters experience continual frustration when standard business telephone systems fail to meet their specific needs. Gentner answers these frustrations with a new telephone system called PeopleLink. PeopleLink is a highly specialized system designed to meet the requirements of broadcasters. Its unique design and modular format permit you to configure and adapt the system to your specific requirements. PeopleLink can handle up to 40 lines and allows even non-technical people to confidently control multiple line conferences and talk shows. Digital signal processing technology is used to give maximum clarity on all lines and eliminate problems associated with analog systems. Special features include: Poll computer, automated call answering and recording, ability to conference all types of incoming lines (frequency extended or nonextended), multiple points for independent and simultaneous use, and much more. PeopleLink works with almost any standard business telephone system, or can operate as a complete stand-alone system.

Pricing Based On Configuration



TELESWITCH Telephone Call Director

Finally...A simple telephone call director at an affordable price. Gentner's TeleSwitch is the logical solution to your basic telephone line selection needs. No longer do you have to 'hot wire' a multi-line telephone set to access multiple lines. With TeleSwitch, up to five lines can be directly connected, placed on hold, and routed to a hybrid or telephone set. TeleSwitch will work with most business phone systems. Operation and installation are as simple as using a multi-line telephone. Because the unit uses standard RJ11C telephone connectors, it can be installed by virtually anyone. Line status is easily monitored from the TeleSwitch control panel. Control panel lights indicate whether the line is ringing, in use, on hold, or available. You can put calls on hold, conference callers, and even record callers by simply pressing a button.

Mfg. List \$995.00

Call For BSW Price

GENTNER



SPH3A Telephone Interface

The SPH3A telephone system provides an easy, inexpensive method of interfacing your equipment with a telephone system. The SPH3A permits simultaneous send and receive audio (full duplex operation); in addition, a built-in monitor amplifier eliminates the need for guests or talent to wear headsets. The SPH3A is simple to install and is fully remotable.

Mfg. List \$599.00

Call For BSW Price



SPH5 Telephone Hybrid

Designed after the Digital HybridIII, the SPH5 incorporates advanced features not found in most analog hybrids. For instance, with a single push of a button you can automatically start your tape recorder to record both on and off-air calls. The cue function will route audio to the caller via the announcer mic or the mix-minus output of your console, manually or automatically, so you can talk to callers before they go on the air. Low distortion, low noise and maximum telephone frequency response ensures the best possible caller audio quality. The SPH5 represents the ultimate in analog hybrids.

SPH5 Mfg. List \$899.00

Call For BSW Price

SPH5E Mfg. List \$1,329.00

Call For BSW Price

(Includes Built-In Single Line Frequency Extension)



DHII Digital Telephone Hybrid

Now you can take advantage of digital signal processing technology to enhance your telephone audio with the Digital HybridII from Gentner. The DHII delivers the best possible hybrid null so telephone audio is crisp, clear and understandable without annoying feedback or hollowness. In addition to the great sounding audio, the DHII provides two new features that add convenience and ease of use. The one button record feature makes recording calls a snap. Just push the record button and DHII will automatically start your tape machine and stop it at the end of the call. The cue feature allows your talent to use the DHII off the air much like a speakerphone. There's a remote cue input that allows you to use this function automatically via the cue position on your console.

Mfg. List \$1,795.00

Call For BSW Price

GENTNER



EFT3000 3 Line Frequency Extender

A revolutionary advance in technology now allows you to get 7.5 kHz on three standard dial-up telephone lines. Now you can do the whole show, even the music, from the remote. Gentner's exclusive design uses digital signal processing to give you the frequency response you want from your remotes. Set-up is quick and painless because it's automatic. Because you get automatic answer, equalization, phase correction, and group delay realignment, one person can set the remote. The remote location even hears cues from the station. The EFT3000 is the answer for simple high quality audio remotes over standard dial-up telephone lines.

Mfg. List \$9,995.00

Call For BSW Price



EFT1000A Frequency Extender

Have you ever wished you could send one person out to do a remote and not have to worry if all the right "switches" were in the right position at the studio? Now you can trust EFT1000A to get the job done for you. Because the EFT1000A has an automatic answer and automatic encode-decode, just go to the remote, phone the station, and you're ready to go. The EFT1000A is capable of using two different telephone lines. You can transmit on one line and use the other for continuous cues from the station. Two units needed for complete system.

Mfg. List \$1,295.00 ea.

Call For BSW Price



EFT900A Remote Extender System

There's no simpler way to get great audio from your remote over a dial-up telephone line than using the EFT900A. Its digital circuitry ensures improved audio response. In fact, all you need for the remote site is an EFT900A. The telephone coupler, microphone or line level input, and headset amplifier are all built right in. No more hassles doing a remote when you rely on the EFT900A.

Mfg. List \$879.00

Call For BSW Price

GENTNER



EFT100 Frequency Extender

Here is your answer for low cost, good quality remotes. The new Gentner EFT100, for use with your existing hybrid, is a two-way frequency extender. This means you get the benefit of hearing the cues back from the station with just one telephone line. If you already have a hybrid, all you need is the EFT100.

Mfg. List \$495.00

Call For BSW Price



AUTO COUPLER Automatic Phone Coupler

If you're looking for an automatic answering and disconnect hybrid coupler, the Auto Coupler is just what you need. It gives you both "Send" and "Caller" capabilities. Use this with the EFT100 or any time you need an automatic answer and disconnect to a telephone line.

Mfg. List \$299.00

Call For BSW Price



HYBRID COUPLER Phone Coupler

Here's a low cost telephone coupler that provides both "Send" and "Caller" capabilities. This unit turns the two wire telephone circuit into a four wire system. It's a perfect match for the EFT100 or any time you need a connection to a telephone line.

Mfg. List \$129.00

Call For BSW Price



Microtel Telephone Interface

Gentner Engineering's Microtel is a portable, battery operated telephone interface used in a variety of applications. Typically, Microtel replaces the hand-set of the telephone to permit high quality audio feeding down the phone line while simultaneously monitoring the return audio. Microtel is powered by a single 9V battery. Applications: Portable mixing, Studio talkback, In the field news mixing/telephone feeding, Sports console/back-up sports console, Mic to line driver for equalized program loops.

Mfg. List \$219.00

Call For BSW Price

GENTNER



TC100 Automatic Telephone Interface

The most versatile telephone coupler you'll find. The design not only gives you auto-answer, auto-disconnect, and latching or momentary tape starts; it allows you to use the unit as a hybrid for on-air calls, as a remote controller, as a private party line telephone intercom, and more. The TC100 is easy to install and operate, and is fully remotable. Table, undertable, wall and rack mount configurations available. Additional features:

- Direct connection to the phone line (uses USOC RJ11C)
- A-lead control for 1A2 and digital phone systems
- Send and receive level controls are front panel adjustable
- Bi-color LED flashes red on rings and glows green on answer
- Optional Touch-Tone™ decoder board with dial tone detector and call progress decoder
- Manual or automatic operation • Momentary or latching tape starts

Mfg. List \$429.00

Call For BSW Price

RADIX



TLM500 Telephone Line Mixer

This highly portable, battery powered miniconsole can turn any modular telephone into a remote broadcast studio link or telephone interview control center. To use with a telephone, simply plug the telephone handset cord into the TLM (telephone line mixer) along with a studio quality microphone and headphones. The telephone is dialed normally and incoming calls can be answered, the difference is the convenience of the microphone/headphones for broadcast operations and the quality of and control over the audio signals. Features include:

- Mic and line inputs • Low battery indicator • Peak reading LED
- AC adapter available • Headphone amplifier

Mfg. List \$229.00

BSW Price \$198.00

BSW's West Coast Location Allows Late In The Day Shipments. If You Need Equipment Fast, BSW Is Your Supplier.

We Offer Special Discount Rates On Federal Express.

SYMETRIX



111 Adaptive Hybrid

The Symetrix 111 is an automatic digital telephone interface intended for use in situations where audio quality simply cannot be compromised. With its exclusive adaptive hybrid operating system running in a high speed digital signal processing environment, the 111 consistently delivers the best possible trans-hybrid loss with any phone line. By continually analyzing the signals it receives, the Model 111 has the ability to achieve and maintain the optimum null, even as conferenced lines are added and removed. Because it adapts to the changing line conditions in real time, the 111 delivers superb results automatically. Unlike analog hybrids the 111 is able to operate on telephone lines exhibiting a broad range of impedances. By utilizing a multitap adaptive filter, the 111's AutoNull program allows it to work with virtually any two wire phone line or loop. Trans-Hybrid loss is typically 46 dB.

Mfg. List \$1,695.00

Call For BSW Price



TI101 Telephone Interface

The Symetrix TI101 is the most practical, yet economical device on the market today designed specifically for the connection of professional audio equipment to telephone lines in broadcast and production operations. The TI101 employs a carefully engineered electronic hybrid circuit which creates a maximum trans-hybrid loss, yielding effective isolation between your studio's send to the telephone line, and your caller return signal. Your net result is clear, intelligible telephone audio.

Mfg. List \$549.00

Call For BSW Price



SX203 Telephone Interface

The Model SX203 telephone interface is a single line, half-duplex coupling device that provides high quality audio transfer between telephone lines and professional audio equipment. Very fast hook up and ease of operation make the SX203 ideal for radio and television talk shows and news gathering, recording studios, teleconferencing, and rental systems. Only 1/2 rack space.

Mfg. List \$389.00

Call For BSW Price

SYMETRIX



104A Telephone System

If telephone talk is part of your format, then the Symetrix 104A system should be a part of your station. It's a complete stand alone electronic telephone system that provides complete line handling and routing facilities thereby eliminating the need for an additional key switch. The system is simple enough to be controlled by the on-air personality from one console. Control functions for each incoming line include: seize, release, transfer to hold, transfer to cue, and transfer to air. The 104A is a 4 line system and four lines can be put on the air simultaneously. Contains two full duplex electronic hybrids (half duplex available). Allow us to send you a detailed brochure outlining all the technical specifics on this system.

Mfg. List \$2,395.00

Call For BSW Price

MIWLTRONICS



API Auto Answer Interface

Extremely versatile and inexpensive, the Miwltronic API connects your audio source to the phone line. It will auto answer, disconnect and allow multi-lines to get the start of message at the same time. We simply can't list all the features, so call us toll free for more details.

API Mfg. List \$265.00

API/C (With Call Counter) Mfg. List \$315.00

Call For BSW Price

Don't Panic... We're Still Open

BSW's extended hours and West Coast location are great for those times when you just have to have that piece of important equipment. We're open 6 a.m. to 6 p.m. Pacific time, 9 a.m. to 9 p.m. Eastern.

HENRY ENGINEERING



MIXMINUS PLUS
Differential Summing Amplifier

MixMinus Plus is a differential summing amplifier designed to add a "Mix-Minus" output to a broadcast audio console. This output is typically used to feed the send input of a telephone hybrid device. MixMinus Plus has two inputs and one output. One input is fed with the program output of the console. The second input is fed with the hybrid receive audio, tapped just after the phone channel fader on the console. MixMinus Plus subtracts the hybrid receive signal from the program output, creating a program mix minus the receive audio. The null adjustment will provide 40dB rejection of the receive audio signal (30 Hz - 3 kHz). MixMinus Plus is easily connected to most consoles and needs no adjustment once installed.

Mfg. List \$195.00

Call For BSW Price

TELECART II
Auto Answer Interface

An automatic answering unit that permits a standard NAB type cartridge machine to answer a telephone line and play a recorded message to the caller. Features: Digital call counter (records 999 calls) • Failsafe - permits unattended automatic operation • Built-in power supply • Works with virtually any cart machine • Cart cues for all incoming calls

Mfg. List \$225.00

Call For BSW Price

INTERALIA

V SERIES
Digital Announcer



This unit is a solid state digital announcer for stations providing concert information, ski reports, and weather information service to their listeners over the telephone. Your voice or program material is recorded digitally, so the quality does not deteriorate over time. Installation and operation are simple and easy, and the V units will interface with all major telephone systems. Recording time up to 8 minutes is available for one or two phone lines. You could have the same announcement on both, or different messages on each line. The caller always hears the message from the beginning and the line clears immediately after the caller hangs up. Options include remote record, call count, dry contacts, and low impedance.

V22 (one line, two message, 32 sec. storage) Mfg. List \$790.00

Call For BSW Price

V23-V28 (two line, two message, 64 sec. to 8 min. storage)

Price Based On Configuration

SOUND AMERICA



RSVP
Record/Send Phone

Here is the perfect, easy solution for sending or recording audio from the telephone. The RSVP from Sound America is a standard telephone that contains a built-in audio coupler. Cassett recorders will interface directly for recording or sending program material. In addition, the RSVP has an amplified electret condenser microphone for superior voice quality and a mute switch to cut out background noise while recording. Backed by a two year warranty, the RSVP is a perfect product for news and production.

RSVP BSW Price \$127.50

SVP (without record feature) BSW Price \$109.50



VOICEACT
Telephone Coupler

Designed to replace the mic element in older Western Electric or GTE telephones, this versatile phone coupler from Sound America makes it easy to transmit audio through the telephone. Installs in seconds and uses no batteries. Built-in mic element allows for simultaneous voice and tape feed. 1/8" tape input jack. Carrying case included.

VOICEACT WE (for Western Electric) BSW Price \$84.90

VOICEACT GTE (for GTE) BSW Price \$90.90

SHURE



50AC
Telephone Acoustic Coupler

Ideal for voice transmission from remote locations where "hard wiring" to telephone lines is impractical or impossible. Offers convenient hands-free operation with most cassette tape recorders. Ruggedly constructed of rubber and high-impact plastic.

BSW Price \$45.50

AMBER

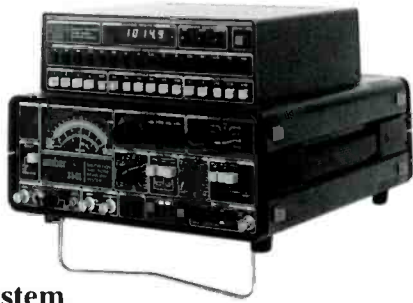

3501B Audio Test System

Conveniently portable and easy to use, this system comes with a balanced input and output, THD+N, IMD, Weighted and Unweighted noise measurement capability. The built-in audio generator covers a 10 Hz to 100 kHz frequency range and can deliver up to +30 dBm to test headroom of pro gear. The system can measure THD+N to below 0.0008% and noise to below -120 dBm. It measures SMPTE IMD to the standard (7 kHz to 60 Hz) but also varies the HF over a 2 kHz to 100 kHz range to let you qualify transient and slew induced distortion at high frequencies. The 3501 has a unique Narrow Band measurement capability that lets you use it as a spectrum analyzer, find crosstalk below the noise, verify tape erasure or look for hum and noise components. The highly sensitive noise meter measures wide band noise (to over 300 kHz), narrow band noise and A-Weighted noise below 1V (-120 dBm). The model 3501 is equipped with a special stereo broadcast switch matrix. Feed left only, right only, L+R and L-R and measure from up to 5 sources. A calibrated modulation percentage switch simplifies transmitter measurements. A preset frequency switch lets you have fast single button access to the popular FCC and test tape frequencies or the smooth 6 to 1 vernier for any frequency from 10 Hz to 100 kHz. An auto-ranging, fast update frequency readout reads either the generator or the external signal to 0.1 Hz resolution. Weighing in at less than 15 pounds and two thirds of a cubic foot, this instrument gives you lab quality performance in a compact, portable and easy to use format.

BSW Price \$4,950.00

DELTA



SNG1 Stereo Noise Generator

The Delta SNG1 offers a number of "laboratory" type features and noise weightings in a very affordable and compact package. Features:

- True balanced front and rear panel outputs
- Selectable white, pink, and USAS1 noise spectra
- Generates true stereo noise (uncorrelated)
- Low DC offset
- Close channel tracking (>0.5 dB)
- External input offers unlimited noise envelopes
- Outs drive either 600 or 50 ohms
- Meets FCC/NRSC and Canadian D.O.C. requirements

Mfg. List \$550.00

Call For BSW Price

TOLL FREE 800-426-8434

POTOMAC



AT51 Audio Test System

An innovative audio test system which facilitates the measurement of critical parameters in monophonic and stereophonic audio equipment. Designed primarily for commercial broadcast proof-of-performance measurements and equipment maintenance, the AT51 handles laboratory type measurements by design engineers, quality control facilities and professional high fidelity service centers. The AG51 Audio Generator and AA51 Audio Analyzer are packaged separately for remote measurements requiring physical separation of signal source and signal analyzer. Both units are RFI shielded to enable accurate measurements in high level radio frequency environments typical to broadcast transmitter facilities. Signal input and output connectors are also RFI shielded.

Mfg. List \$4,310.00

Call For BSW Price

DORROUGH



1200 Audio Test Set

With the 1200 you can take stereo measurements of level, balance, crosstalk, and signal-to-noise over the entire dynamic range of your audio system from noise floor to clipping. The set includes a pair of input amplifiers, a 30 dB step precision attenuator, two "B" scale VU meters (measured in 1 dB increments over a 40 dB range), and two buffered monitor outputs. Servo amplifier inputs guarantee a constant gain over all input configurations and a monitor jack provides an output for oscilloscope, headphones, or monitor amplifier.

Mfg. List \$1,650.00

Call For BSW Price

LOFTECH



TS1 Audio Test Set

The Loftech TS1 provides a combination of three precision test instruments and is capable of making audio frequency tests and measurements with a high degree of accuracy and in less time than conventional test instruments. The TS1 combines a low distortion oscillator, a frequency counter, and a dB meter in a compact unit complete with AC power supply. Features limited two-year warranty.

Mfg. List \$299.95

Call For BSW Price

GOLDLINE



**ASA10B
Audio Spectrum Analyzer**

An affordable, professional quality, 10-octave analyzer covering a wide frequency range, and featuring a built-in mic. Features: IEC A or C weighting • Freeze display function • Battery or external powering • Detector decay function

ASA10B Mfg. List \$339.95

PN2 Pink Noise Generator Mfg. List \$89.95

Call For BSW Price

FOSTEX



**TT15
Test Tone Oscillator**

Battery operated, low distortion sine wave oscillator with five selectable frequencies (40 Hz, 400 Hz, 1 kHz, 10 kHz, and 15 kHz) and three selectable output levels (-30 dB, -10 dB and 0 dB). RCA output jack. Useful for spot checking frequency response, calibrating mixers with tape recorders and other level matching jobs. Output is constant and not affected by battery voltage or frequency. Fits in your tool box.

Mfg. List \$48.00

Call For BSW Price

WHIRLWIND



Cable Tester

Check for shorts and bad connections easily with the Whirlwind Cable Tester. Accommodates XLR, 1/4" and phono plugs. 9 volt battery required. Fits in your tool box.

BSW Price \$49.30

TOLL FREE 800-426-8434

BIRD



Test Equipment

Now in its fifth decade of serving the broadcast industry, Bird Electronic Corporation has been the pioneer in developing products for measurement, filtering and termination of RF power. The Company's products, originally developed in response to specific design requirements of broadcast equipment manufacturers, have since become standards of the industry. Recognizing that broadcast test equipment must be even more reliable than the transmitter, constantly on-call and totally trustworthy, Bird has achieved an enviable record of reliability.

Call BSW With Your Bird Requirements

DELTA



**TCA JR.
RF Ammeter**

The TCA-Jr. series of RF ammeters from Delta Electronics provide broadcasters a reliable means of measuring low power common point and antenna base currents. To reduce susceptibility to lightning, the meter is designed for temporary installation. When the engineer needs to verify operating power or adjust power levels, the meter is simply inserted into a standard J-Plug or Delta's MJ50 meter jack. Since the meter is removable it can be used in multiple tower arrays or by a consultant or contract engineer servicing several stations.

TCA Jr. Mfg. List \$240.00

Call For BSW Price

B&K

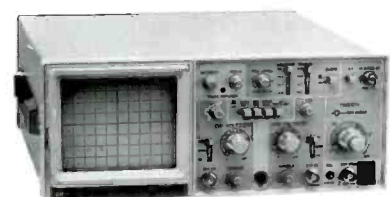

Oscilloscopes

B&K offers one of the industry's broadest lines of oscilloscopes with models ranging from a 15 MHz analog dual-trace unit to a versatile digital storage oscilloscope. No matter what your application B&K has an oscilloscope to meet your requirements.

FLUKE



Test Meters

75

- Analog bar graph • 3200 count display • 0.5% basic accuracy • Auto-ranging with range hold • 10 amp & auto-ranged mA ranges
- Continuity and diode test beeper • Three year warranty

BSW Price \$117.00

73

- Analog bar graph • 3200 count display • 0.7% basic accuracy • Auto-ranging only • Three year warranty

BSW Price \$78.00

77

- Analog bar graph • 3200 count display • 0.3% basic accuracy • Auto-ranging with range hold • 10 amp & auto-ranged mA ranges
- Continuity and diode test beeper • Touch hold • Three year warranty

BSW Price \$157.00

BECKMAN



DM78

Digital Multimeter

Ideal for carrying in your shirt pocket, the pocket-sized DM78 is the smallest digital multimeter on the market yet it has an easy-to-read 3/8" high LCD readout. The autorange feature automatically sets the optimum measuring range to simplify operation and to avoid overloads. Its five functions check up to 450 volts, AC or DC in four ranges, up to 2000 K ohms in four ranges, plus diodes and circuit continuity with a beeper. Includes carrying case.

BSW Price \$29.95



AM10

Analog Multitester

This pocket sized meter is built to perform the most frequent quick circuit checks with jewelled analog meter movement provides an accuracy of 4% of full scale. The unit has 16 measuring ranges in four functions plus decibels on the AC volt scale with 2000 ohms/volt sensitivity, two times scale overload protection, and zero adjust for ohms and meter movement.

BSW Price \$12.95

XCELITE



TC150/ST

Tool Kit

A carefully selected assortment of Xcelite hand tools including interchangeable drivers, blades and handles, soldering iron, and measuring tape. Removable pallets in lid and base have tool pockets.

Mfg. List \$528.00

Call For BSW Price

CAIG



Caig Laboratories, Inc., established in 1956, supplies high quality chemicals and soldering accessories for use in industrial electronic /electrical applications. Many nationally known companies rely on the performance of these quality products. Included in the product line are: • Cramolin® sparys, fluids, and pastes that dissolve resistive oxides from metal surfaces and provide a long-lasting protective molecular layer to prevent oxidation and maintain maximum electrical conductivity • Caeon® cleaner removes oil, grease and dirt without harming metal, plastic or elastomeric parts. Ideal for head and transport cleaning. • Quality instrument oils • Complete line of soldering supplies

Frequently asked for items:

R56

CRAMOLIN® Red 6 oz. spray (cleans, lubricates, preserves)

BSW Price \$8.25

R100L2

CRAMOLIN® Red 2 oz. liquid (cleans, lubricates, preserves)

BSW Price \$13.00

B56

Cramolin® Blue 6 oz. spray (lubricates, preserves)

BSW Price \$8.50

CL27S / CAEON27™ 16 oz. spray **BSW Price \$9.95**

CL274 / CAEON27™ 4 oz. liquid **BSW Price \$5.15**

Call For BSW Prices And Additional Information

BROADCAST ELECTRONICS



**12C
3 Speed Turntable**

Features:

- Instant start, full speed in less than 1/16 revolution
- Rugged construction, only 3 moving parts
- Stereo rumble less than 48 dB (exceeds NAB standards)

12C Mfg. List \$450.00

S320 Tonearm (Shown on turntable) Mfg. List \$200.00

Drilling Fee (Specify tonearm) \$15.00

Call For BSW Price

TECHNICS



**SL1200MKII
2-Speed Turntable**

The industry's most popular turntable is, without a doubt, the SL1200MKII. Two-speed, quartz accurate with fast start-up time, it's the perfect addition to your control room. For production, the pitch change adjustment of $\pm 8\%$ comes in handy. The SL1200MKII includes base, dust cover, and tonearm.

Mfg. List \$479.95

Call For BSW Price

RUSSCO



**STUDIOPRO B
2 Speed Turntable**

Features:

- Precision engineered for quiet, dependable operation
- Solid cast aluminum chassis and turntable
- Illuminated speed indicators
- Rim drive offers fast start-up
- Detachable tonearm mounting plate

Mfg. List \$509.00

Call For BSW Price

RUSSCO



**MARK V
2-Speed Turntable**

MarkV delivers heavy-duty quality at a reasonable price. This precision turntable gives you extremely quick starts: only 2 inches of back-cue at 33RPM, and its deluxe isolated belt rim drive makes it quiet. Speeds are variable by 10% and a bright LED readout shows the actual platter speed. Features: Extra heavy cast aluminum platter with built-in 45 adapter, low profile design, detachable tone arm plate, remote stop/start.

Mfg. List \$749.00

Call For BSW Price

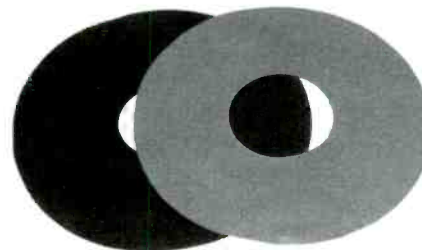

Turntable Felts

Replacements for use with Russco or other brand turntables requiring felt platter pads. Available in the following colors: blue, red, green, yellow, orange, brown, black, and burgundy. Requires adhesive - We recommend standard contact cement or spray adhesive.

BSW Price \$3.00 ea.



Why wait around for your equipment---for just a few dollars more we can Federal Express your order. Tell your BSW Sales Rep to "Fed X" it.

Turntables / Accessories

PROTEC



SA270 Professional Tonearm

Features removable headshell, adjustable tracking weight, and anti-skate adjustment. Tracking weight is 0-3 grams.

Mfg. List \$139.95

BSW Price \$99.00

PROBASE



PROBASEII/PROBASEIII Turntable Bases

Here is a cost effective way to house Technics SP-25 or SP-15 turntables. Probase is 1 1/2" sound absorbing particle board with durable black formica overlay. Heavy duty isolation feet stop feedback and countertop vibration from being transmitted through turntable. ProbaseIII is harmonically balanced for turntable and tonearm to virtually eliminate all transient vibrations going through the system, achieving outstanding sonic quality from your turntable. Nothing on the market is finer, regardless of price. For an extra charge, your Probase can be custom drilled for the tonearm of your choice.

PROBASEII BSW Price \$135.00

PROBASEIII BSW Price \$210.00

ATI

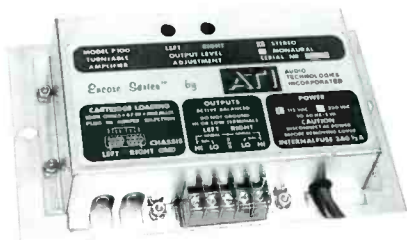

P100S Turntable Preamp

This preamp offers state-of-the-art specs in a cost effective enclosure. Quality components allow the P100S to achieve a 90 dB signal to noise ratio, channel separation of 60 dB minimum distortion 0.1% maximum 20 Hz -20 kHz.

Mfg. List \$279.00

Call For BSW Price

RADIX



TP500 Turntable Preamp

Superb specifications make this Radix model ideal for stereo, or two channel monaural use. And yet, the cost remains competitive with other quality brands. Specifications: Distortion: less than .01% at full output • Noise: better than 76 dB unweighted • Channel separation: 90 dB • Output: +20 dBm single ended 600 ohms +25 dBm balanced 600 ohms • Compact enclosure - easy to install • Outstanding RF immunity

Mfg. List \$289.95

Call For BSW Price

SHURE



M64A Stereo Preamplifier

The M64A is a compact, professional stereo preamplifier which solves a variety of preamplification and equalization problems. A three-position slide switch selects different equalization depending on the desired application.

In the phono position, the M64A provides standard RIAA equalization. In the tape position, playback heads on tape recorders are provided with NAB equalization.

In the flat position, the M64A can be used as a microphone preamplifier or a low-gain buffer amplifier where long cable lengths are necessary.

Mfg. List \$125.00

Call For BSW Price

STANTON



310B Stereo Phono Preamp

The 310B is designed to correctly interface all Stanton and selected magnetic phonograph cartridges for optimum playback of disk records and calibration of audio systems. The 310B features universal mounting by special brackets, instant selection of flat or NAB postemphasis curves, switchable, effective rumble filter, individual adjustments of gains and high frequency responses, trimming of the capacitive cartridge loading at the input, provision for setting the power transformer for either 117 or 230V operation at 50 or 60 Hz and immunity to external magnetic AC fields. The 310B can be used in balanced as well as unbalanced modes and in-phase and out of phase mix of L and R channels for monophonic reproduction of older records.

Mfg. List \$280.00

Call For BSW Price

STANTON



Cartridge

Model	BSW Price
500AMKII	\$15.00
500AL	\$16.50
500EMKII	\$18.00
500EEMKII	\$21.50
681A	\$52.00
681SE	\$58.00
681EEMKIIIS	\$69.00
881SMKIIIS	\$105.00
680AL	\$49.00
680EL	\$54.00

Replacement Styli

Model	BSW Price
D50A MKII	\$7.20
D5107AL	\$7.00
D50EMKII	\$10.50
D50EEMKII	\$14.00
D6807A	\$19.00
D6800SE	\$22.55
D6800EEEIIS	\$26.00
D8111S	\$44.00
D6800AL	\$14.75
D6800EE	\$22.55

SHURE



Cartridge

Model	BSW Price
M44-7	\$29.00
M44-C	\$29.00
M44-E	\$32.50
SC35C	\$46.00
SC39B	\$65.00
SC39EJ	\$73.00

Replacement Styli

Model	BSW Price
N44-7	\$16.30
N44-C	\$16.30
N44-E	\$19.60
SS35C	\$17.50
SS39B	\$26.00
5539EJ	\$33.00

AUDIO-TECHNICA

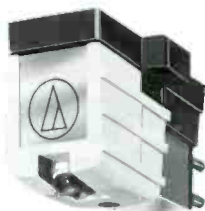

Cartridge

Model	BSW Price
ATP 1	\$31.95
ATP 2	\$42.30
ATP 3	\$56.70

Replacement Styli

Model	BSW Price
ATPN 1	\$18.45
ATPN 2	\$26.90
ATPN 3	\$35.90

BSW

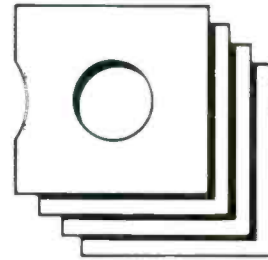

45 RPM Record Jackets

A simple effective way to protect and categorize your 45s. Available in Blue, Red, Green, and Gold. Mix and match for quantity price.

Quantity	1-99	200-499	500-999	1000+
BSW Price	18¢ ea.	16¢ ea.	14¢ ea.	12¢ ea.

DISCWASHER



D4SYSTEM Record Cleaner

Cleans without reduction in record dynamics and fidelity. D4 fluid lifts & suspends contaminants in solution from record surface. D4 pad fibers are directional, lifting dust rather than lining it up.

D4SYSTEM BSW Price	\$15.15
D46OZ (6 Oz.) Refill Bottle BSW Price	\$8.45
D416OZ (16 Oz.) Refill BSW Price	\$13.75

CBS



CTC300 SERIES Test Records

These records are precision signal sources designed to assist both the audio engineer and audiophile in evaluation of audio components, studio equipment and reproduction systems. Your BSW representative will be glad to assist you in finding the correct volume for your equipment.

BSW Price \$30.00 ea.

CONSOLIDATED WIRE



For over 70 years, Consolidated has been dedicated to providing the highest quality wire and cable products to industry. All Consolidated products are designed and fabricated to the exacting physical and electrical standards.

WEST PENN WIRE



291 All Purpose Wire

Twisted pair, 22 AWG, stranded tinned copper, aluminum foil shield with 24 AWG tinned copper. Drain wire. 1000' reels. Your choice of colors: red, blue and grey. Other multi-pair wire available from BSW. Call us for your wiring solution.

BSW Price \$83.50

PANDUIT



E2X2LG6/C2LG6 Wiring Duct

Width: 2 inches, Height: 2 inches, Length: 6 feet.

BSW Price \$22.95

WHIRLWIND



Multi-pair Audio Cable

Whirlwind cable is available from BSW in custom or spooled lengths in sizes from 4- to 52-pairs. Available in standard and super-high quality grades.

Call BSW With Your Requirements

TOLL FREE 800-426-8434

YOU CAN'T ORDER...

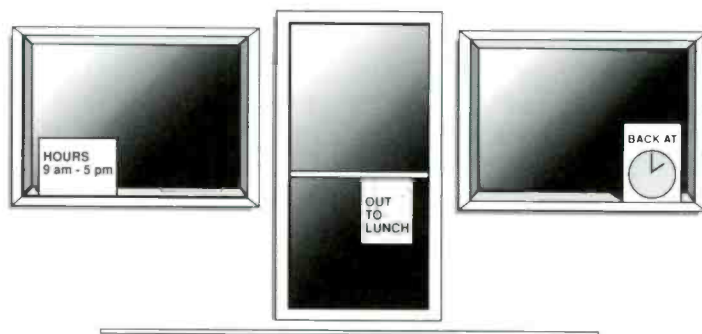

...From A Company You Can't Reach

Accessibility may be the most important quality of a good equipment supplier. A company can offer you a long list of reasons why you should do business with them. Yet, none of these reasons mean a thing if you can't reach them when you need to place an order. At BSW, we work overtime to ensure you immediate access to our qualified sales staff. We're open 12 hours a day (6 a.m. to 6 p.m. Pacific and 9 a.m. to 9 p.m. Eastern) so you can call us when it's convenient for you, morning or evening. With over one million dollars of inventory on hand, chances are we have what you need in stock and can have it in your hands the next day. So the next time you need to reach a supplier, call BSW, America's Full-time Broadcast Supplier.

BSW[®]

BROADCAST SUPPLY WEST

America's Full-Time Broadcast Supplier

ORDERS • INFORMATION • SPECIFICATIONS
7012 27th Street West Tacoma, WA 98466

CRL



**MBL100
News/Talk/Sports Processor**

The MBL100 is designed to increase loudness and coverage area of AM monaural news/talk/sports formats. By combining powerful audio processing topology, and 7.5 kHz audio low-pass filtering, this multi-band limiter provides very high levels of average modulation density. Features: Input band-pass filtering • NRSC compatible filtering • Remote control operation • Dual band AGC/compressor

Mfg. List \$3,495.00 Call For BSW Price

TASCAM



**M2516/M2524
Audio Consoles**

If you need an affordable, compact, yet fully functional multi-track recording console you'll want the M2500 Series console from Tascam.

The M2516 features 16 full-function inputs, 16 tape returns, 8 sub-groups, and L/R outputs. The M2524 has 24 full-function inputs, 24 tape returns, 8 sub-groups, and L/R output.

Both models feature eight buss recording, automated muting via MIDI, in-line stereo monitoring, four aux. sends, three-band EQ, pre-fade listen, 4 effect returns (2 stereo, 2 mono), talkback with built-in mic, and balanced left/right outputs.

M2516 Mfg. List \$2,999.00 Call For BSW Price
M2524 Mfg. List \$3,999.00 Call For BSW Price

ATLAS/SOUNDOLIER



**W150T
Indoor/Outdoor Speakers**

Use these surface-mount speakers anywhere high fidelity sound, compact size and weather-resistance are desired. They're cost effective and come complete with a built-in, screwdriver adjustable 70.7 volt transformer and 8 ohm selector switch for distributive or individual use. Power handling is 50 watts into 8 ohms. Dimensions are 9"H x 6 5/16"W x 6 9/16"D. Unit includes removable U-shaped mounting bracket.

Mfg. List \$267.00 Call For BSW Price

ORBAN



**764A
Programmable Parametric Equalizer**

The 764A combines the experience and audio excellence of several generations of Orban industry standard parametric EQs and the flexibility of total digital recall and programmability. The 764A is available with either one or two equalizer boards installed. Additional channels of EQ (up to 99 channels) are available by adding the 764A/SL slave unit with two EQ boards. Each EQ board includes four bands of true constant "Q", minimum-phase fully parametric equalization, plus separately adjustable high and low-pass filters and an independent digitally controlled input attenuator. Unit includes advanced programming features like EQ grouping, easy channel renaming, instant A/B comparisons, and instant access to parameter status of all EQs. Available with MIDI, RS232, or RS422 interfaces.

764A1 Single Channel Mfg. List \$1,995.00
764A2 Two Channel Mfg. List \$2,495.00
764ASL2 Two Channel Slave Mfg. List \$1,895.00
Call For BSW Price

NUMARK



**CD6020
Dual Transport CD System**

The simple, rugged CD6020 has been developed to meet the needs of broadcasters and the working DJ. The system is divided into two rack mountable pieces (the dual transport unit and the remote control panel) for maximum flexibility and ease of control. It uses 18-bit DACs and 8-times oversampling for the highest quality sound. Special control features include separate speed control sliders ($\pm 8\%$), extra large start/stop controls, simultaneous play of two CDs, Bright LED display of each transport. Beat Sync and Integrate functions allow fades and segues to be handled automatically.

Mfg. List \$1,995.00 Call For BSW Price

HAFLER



**PRO 1200
Power Amplifier**

The most advanced MOSFET technology gives the Pro 1200 unsurpassed efficiency and reliability. 60 watts into 8 ohms (170 watts - mono bridged), balanced 1/4" and XLR inputs.

Mfg. List \$500.00 Call For BSW Price

STUDER DYAXIS

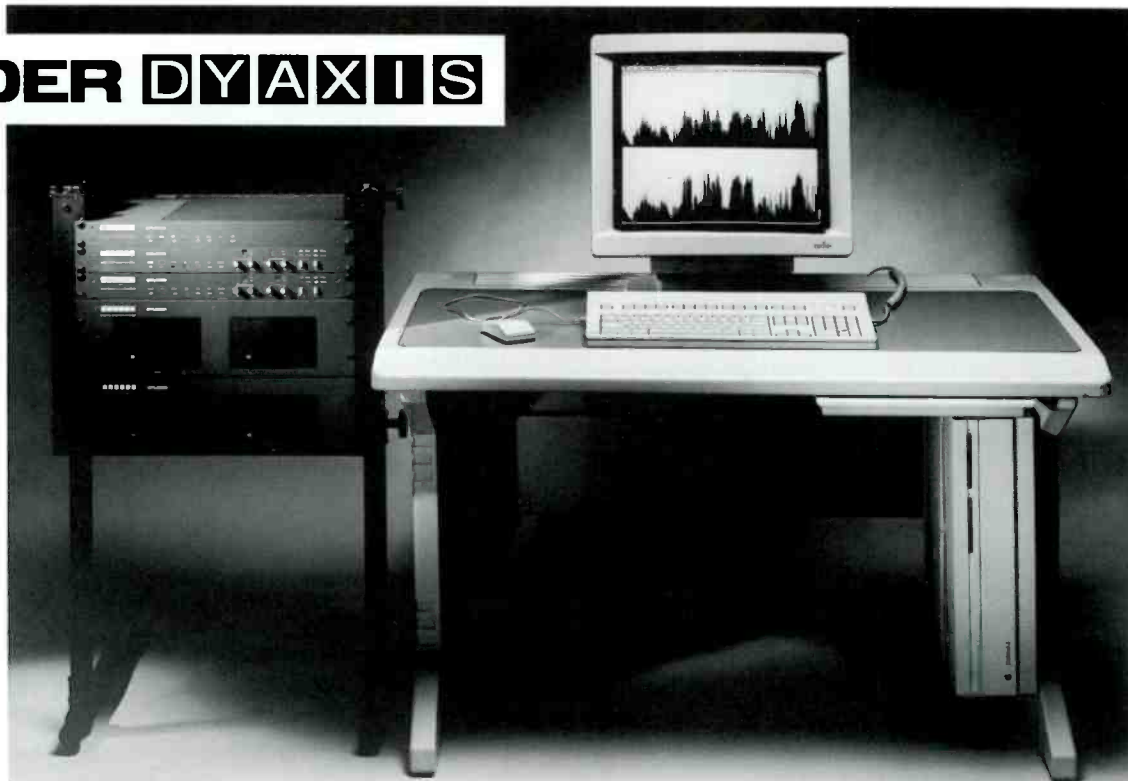

Digital Production

It's no secret that future radio production techniques will largely be based on digital technology. BSW understands that leaders in this industry will master this technology to stay in the lead. As a leading supplier, BSW is committed to supplying this new technology to you from manufacturers you can trust. We are proud to represent Studer Dyaxis Digital Audio Production Systems.

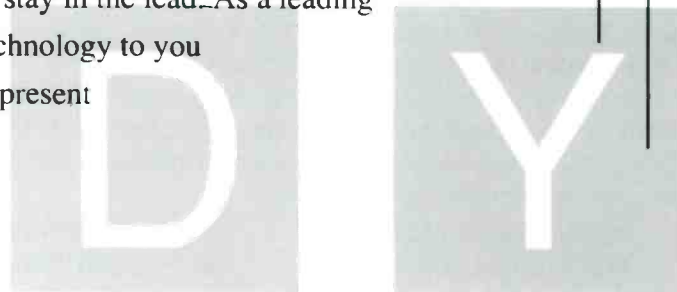

STUDER

Dyaxis Digital Audio Production System

The Studer Dyaxis System gives you everything you need in a digital audio hard-disk system: simple operation, total creative control, and high-power recording and editing capabilities - all at an affordable price. With hundreds of systems installed worldwide, Dyaxis represents years of development, refinement, and advancement in the art of random access digital audio technology.

Dyaxis Systems are designed to work with Apple Macintosh™ computers. They are fully modular, comprised of the Digital Audio Processor, Mass Storage System, your choice of Time Code Interface, and MacMix software. The Macintosh™ is supplied by the user.

Available in 2 or 4 track formats, it can record and play back up to six hours of stereo digital audio with 16-bit resolution in 32, 44.056, 44.1, and 48 kHz sampling rates.

Audio is stored in sound files that can be edited, combined,

cut and pasted to any desired location. On line digital signal processing including level control, equalization, pan, and two types of time scaling, allow you to manipulate audio to your hearts content, all in real time. Editing is non-destructive. Edit changes are stored in separate files so you can always return to the original soundfiles if you change your mind.

Whether you're working on a 30-second radio spot or a full-length feature film, the mixing power of Dyaxis provides you with unlimited freedom of expression because you're not limited to a fixed number of tracks for your mix. The two channel system allows you to combine an unlimited number of high-quality digital tracks into remixed soundfiles and pan them to the right and left outputs. The 4-channel system provides two channels of simultaneous hard-disc recording with up to four channels of simultaneous playback and/or overdubbing. Independent track assignment for each of the 4 channels is available.

STUDER

Digital Audio Processor

The Dyaxis Multi-Format Digital Audio Processor allows you to choose the proper sampling frequency and also choose from a number of I/O formats including: AES/EBU (video D1 and D2)

- ProDigi • Sony 601 PCM processors • SDIF-2 • S/PDIF
- Yamaha Stereo Digital Cascade • Next Computer.

Mass Storage

Dyaxis is available with disk drives each 150, 320, or 640 megabytes of data. Up to six drives can be used in one system. This means at a sample frequency of 44.1 kHz, the Dyaxis system can provide 30 minutes of mono sound for each 150MB drive, 62 minutes (mono) for each 320MB drive, and 128 minutes (mono) for each 640MB drive...on up to six hours of 16-bit digital stereo, or 12 hours of digital mono sound. Any single-drive system can be easily upgraded for multiple drive operation.

Synchronization

Two different modules are available for time code-based interfacing and synchronization to film, video, or automation equipment.

There's the Time Code Interface for low-cost frame-accurate synchronization with a SMPTE/EBU-to-MIDI, MIDI-to-SMPTE/EBU triggering.

The powerful Dyaxis System Synchronizer provides comprehensive SMPTE/EBU or VITC, video, and tach time code synchronizing of the Dyaxis system for sample-accurate, time code-base applications.

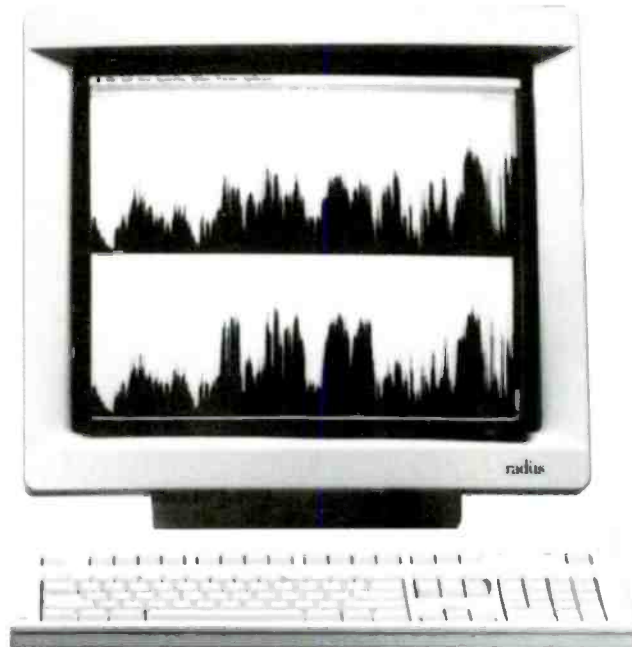

MacMix Software

One of the most important elements of any audio production is its user interface. Dyaxis is delivered with MacMix, the industry's most mature recording, wave form editing, mixing, crossfade, and signal processing package. Used with the Macintosh controller, MacMix places every function on-screen in front of you. It is intuitive, powerful, user-friendly, and easy to learn. Anyone can be up and running with MacMix in just a few hours. If you can use a word processor, you can use MacMix to edit first-generation audio and prepare stunningly complex audio productions. MacMix lets you record, edit, process, and mix multiple mono or stereo files for 2- or 4-channel playback. The user can view the resultant soundfiles on the Mac screen and edit them using familiar point-and-click techniques.

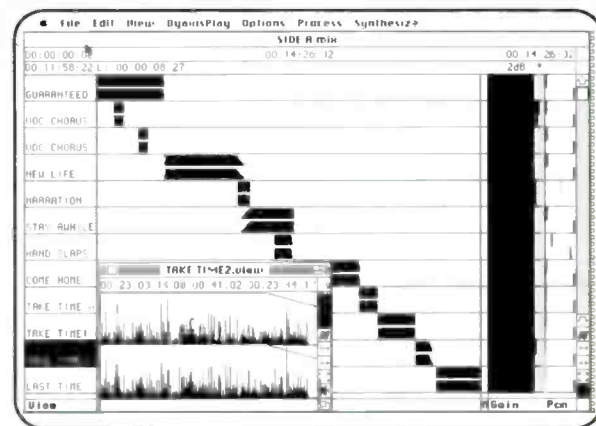

Now is the time to begin your transition into the digital production era. Let BSW show you how a Studer Dyaxis system could revolutionize your productions. Its modular construction means you can start simple, then upgrade to whatever level of sophistication you like. Basic systems start at under \$7,000.00 (less computer)

Call BSW Today For More Information

CARVER



PM120 Power Amplifier

When you need extra power from a single rack-space amplifier you need the PM120. It delivers 40 watts into 8 ohms stereo or can generate 120 watts in mono bridged mode into 8 ohms. THD is 0.1%, output noise is -95dB with reference to 17.8 Vrms output. Additional features: Front panel headphone jack, clipping eliminator circuitry with back panel switch, heavy duty 5-way speaker binding post, XLR, TRS and barrier strip inputs, Switchable XLR pin configuration, Thermal - Short circuit - Ultrasonic protection, passive cooling system, and 70-volt transformer option.

Mfg. List \$560.00

Call For BSW Price

HENRY ENGINEERING



TWINMATCH Interface Amplifier

Twinmatch is a four channel level and impedance interface for matching -10dbv unbalanced equipment to +4 dbm professional gear. It's like the popular Matchbox, but it's "one-way", ideal for CD players. Since Twinmatch has four channels, one unit will work with a pair of stereo CD players, or with a four-channel tape deck. All DC-coupled active circuitry offers great specs like a frequency response from DC to 30 kHz, -85 dB signal to noise, and .008% distortion. Outputs will drive a 600 ohm load to +25 dBm.

Mfg. List \$195.00

Call For BSW Price



MICROMIXER Utility Mixer

This four-input, two-out stereo utility mixer is essentially a "micro-console-in-a-box". Each of the four line level inputs is balanced and bridging, and will accept an input level from -10 to +8. There's a gain control for each input which has a range from "off" to +10 dB gain. Micro-assign switches permit the inputs to be assigned to the Left, Right, or Both outputs in any combination. Use MicroMixer to combine two stereo sources, four mono sources, add mono to stereo, combine stereo to mono...hundreds of uses! The stereo outputs will drive a 600 ohm load to +25 dBm. DC-coupled circuitry for great specs: DC to 30 kHz frequency response, -80 dB noise, and .008% distortion. Same size as the popular Matchbox.

Mfg. List \$195.00

Call For BSW Price

RUSSCO



CIA1 Speech Skimmer

The Commercial Interrogation Assistant (CIA1) records only the speech portion of any radio programming and blocks out the music with approximately 96-98% efficiency. Just connect it to a radio and a cassette recorder and it filters out any radio station's music broadcasting so you can monitor the competition's commercials and promos or keep tabs on your own air talent. One side of a 90 minute cassette could hold approximately 4 to 5 hours of programming (8 to 9 hours on an auto reverse deck). Put this inexpensive little spy to work right away.

Mfg. List \$299.00

Call For BSW Price

In Broadcasting, Time Can Be Your Toughest Competitor

Put Time On Your Side With BSW

Deadlines are a given in broadcasting. When the pressure's on, you need a company you can depend on. Look to BSW. We understand that people who are accustomed to measuring time in seconds, can't wait weeks and months for equipment to arrive from their supplier. That's why we work overtime, everyday, to deliver equipment from our million dollar inventory with unmatched speed and accuracy. Should items ship directly from the factory, our sterling reputation with over 200 manufacturers insures prompt attention to your order. No company is better qualified to put time on your side than BSW, America's Full-Time Broadcast Supplier.

Credit / Lease Application



BROADCAST SUPPLY WEST

America's Full-Time Broadcast Supplier

7012 27th Street West
Tacoma, Washington 98466

*** Items For Lease Application Only**

Applicant/Lessee (Important to list name of legal entity)			
Legal Name and Trade Name			Date
Street Address		City, County, State	Zip Code
Billing Address		City, County, State	Zip Code
Contact Person	Title	Telephone # ()	
Nature of Business	# of Years In Business	Type of Business (Circle One) Proprietorship Partnership Corporation Government	

*** Where is the equipment to be located if not at above address? (Shipping Address)**

Address	City, County, State	Zip Code
---------	---------------------	----------

Parent Company

Name	Contact Person	Telephone # ()
Address	City, State	Zip Code

Bank References

Name of Bank/Branch	How Long?	Checking Acct. #	Telephone # ()	Account Manager
		Loan Acct. #		
Name of Bank/Branch	How Long?	Checking Acct. #	Telephone # ()	Account Manager
		Loan Acct. #		

Trade References

Company Name	City, State	Telephone # ()	Contact Person
Company Name	City, State	Telephone # ()	Contact Person
Company Name	City, State	Telephone # ()	Contact Person

*** Personal Information on Owners, Officers, Partners, or Guarantors**

Last Name	First	Middle	Title	Social Security #
Home Address		City	State	Zip Code
				Home Phone #
Last Name	First	Middle	Title	Social Security #
Home Address		City	State	Zip Code
				Home Phone #

*** Vendor Information**

Transaction Summary

Broadcast Supply West	Vendor # 123450	Lease Plan	Term
7012 27th St. West	Tacoma, WA 98466	Number of Advance Payments	Rate Factor
Contact Person	(206) 565-2301	Total Transaction (equipment cost, shipping, sales/use tax, installation)	

*** (Lease Application Only)**

Lease Applicant & Guarantor(s) authorize General Electric Capital Corporation or BSW and its affiliates to investigate their financial responsibility and creditworthiness, and Credit Applicant & Guarantor(s) agree to provide financial statements, tax returns, or other credit-related information as necessary. Financial statements required on all transactions of \$25,000 and over. Personal guarantees on all transactions for business less than two years old.

Index Of Products By Manufacturer

ABCO	101	EFXX	69,104	PROLITE	106,107
ACOUSTECH	98	ELECTRO IMPULSE	90	PRORAX	102
ADC	60	ELECTRO-VOICE	46,63,95	PROTEC	120
AIWA	29	EMERSON	99	QEI	72,87
AKG	52,62,70	ENBERG	109	QSC	2
ALC	95	ESE	108	RADIO DESIGN LABS	3,8,11,57,68,73
ALTRONIC RESEARCH INC.	90	EVENTIDE	8,15	RADIX	3,55,108,113,120
AMBER	116	EXPRESS GROUP	100	RAINWISE	109
AMPEX	78	FIDELIPAC	20,22,26,27,101,106	RAMSA	2,41,44,49,51,96,97
ANDREW	92	FLUKE	118	RANE	11,13,14,44,45,55
APHEX	3,10,17,56	FOSTEX	53,77,79,98,117	RD SYSTEMS	65
ARRAKIS	35,36,58	GARNER	20	REVOX	76
ART	10,14,15	GEFEN SYSTEMS	19	RF INDUSTRIES	92
ATI	3,9,40,56,68,74,120	GENEVA	20,79	RODCO	109
ATLAS	70,123	GENTNER	3,5,6,46,55,59,61,80,111,112,113	ROHN	93
ATUS	45	GOLDLINE	117	RSC	78
AUDI-CORD	24	GORMAN-REDLICH	71	RUSSCO	40,46,56,119,126
AUDIOARTS	38	HAFLER	123	SAMSON	66
AUDIO DIGITAL	8	HALONCO	109	SAUSALITO CRAFTWORKS	104
AUDIOLAB	20	HENRY ENGINEERING	3,56,115,126	SCALA	83,86
AUDIOPAK	26	ICOM	82	SCI	99
AUDIOSOURCE	34	IGM	18	SCOTCH/3M	78,79
AUDIO-TECHNICA	62,66,121	INFORMATION DESIGN	101	SENNHEISER	52,54,65
AUDIO VISUAL RESOURCES	69	INNOVATIVE TECHNOLOGY	99	SENTRY SYSTEMS	19,73
AUDITRONICS	38	INOVONICS	6,8	SETH THOMAS	107
AURATONE	96	INTERALIA	115	SHIVELY LABS	91
AUTOGRAM	37	ITC	23,26,27	SHURE	3,47,54,55,64,66,68,69,115,120,121
AVSC	20	JAMPRO	91	SIMS	34
BECKMAN	118	JBL	12,14,95,96,97	SONAR	20
BELAR	72	JUICE GOOSE	57,104	SONEX	105
BENCHMARK	55,56	KINTRONIC LABS	90	SONY	29,50,51,53,62
BEYER	52,54,62,66	KOSS	53,98	SOUND AMERICA	115
BIAMP	41,44,45	LARSEN	83	SOUNDCRAFT	41
BIRD	93,117	LEXICON	16	SOUNDCRAFTSMEN	74
B&K	117	LITTLELITE	107	SOUNDFORMS	105
BROADCAST AUTOMATION INC.	19	LOFTECH	116	SOUNDOLIER	103
BROADCAST DEVICES	25	LPB	40	STANTON	120,121
BROADCAST ELECTRONICS	21,39,73	LUXO	70	STEWART	2,68
	88,119	MARANTZ	28	STL	25,79
BROADCAST TOOLS	57,59	MARK ANTENNA	86	STUDER	32,124,125
BSW	19,25,30,34,69,70,79,101,121	MARTI	82-84,86,89	SYMETRIX	2,9,11,12,14,17,55,68,74,114
BURK TECHNOLOGY	80	MIDDLE ATLANTIC	103	TAPECASTER	24,25
CABLEWAVE	91,92	MIWLTRONICS	114	TASCAM	28,29,32,43,50,56,76,77,104,123
CAIG	79,118	MODULATION SCIENCES	6,7,73,89,93	TECHNICS	29,31,50,119
CALCULATED INDUSTRIES	108	MOGAMI	61	TELEX	54,67
CARVER	74,126	MOSELEY	81,82,84,89	TELFAX	48
CATEL	88	MPM	92	TELTEK	109
CBS	121	MRL	79	TFT	71,72,82,85
CELLABS	110	MTS	71	360 SYSTEMS	49,58
COMREX	46,110,111	MURPHY	100	TITUS TECH LABS	58,106
COMSTREAM	94	NEUMANN	65,70	TMD	83
CONEX	18,58	NEUTRIK	69	TRACKMATE	33
CRL	4,9,17,123	NORTRONICS	26,79	TWR	93
CONSOLIDATED	122	NOTEWORTHY	121	UREI	12,14
CROWN	2,65	NUMARK	45,97,123	VALENTINO	34
CUTTING EDGE TECHNOLOGIES	4,5	OMNIMOUNT	98	VALLEY INTERNATIONAL	9,12
DAX	13	ORBAN	7,9,11,13,16,17,123	VEGA	67
DBX	10,13,17	OTARI	24,75	VIKRON	26,79
DELTA	6,73,88,116,117	PANASONIC	29	WEST PENN	122
DENON	31,33	PANDUIT	122	WHELOCK	106
DIC DIGITAL	51	PERFECT DATA	107	WHIRLWIND	68,69,117,122
DIELECTRIC	90,91,92	PIVOTELLI	98	WILL-BURT	83
DIGITECH	13,15	POTOMAC	116	XCELITE	118
DISCWASHER	30,33,121	PROBASE	120	XEDIT	79
DORROUGH	74,116	PROCABLE	70	YAMAHA	2,16,28,29,42,96,97
EDCOR	55	PROFOAM	105	ZERCOM	48



BSW

BROADCAST SUPPLY WEST

America's Full-Time Broadcast Supplier



BSW 7012 27th ST. WEST
TACOMA, WASHINGTON 98466

BULK RATE
U.S. POSTAGE
PAID
TACOMA, WA
PERMIT #275

TIME VALUE

ROUTE TO:
GENERAL MANAGER
PROGRAM DIRECTOR
NEWS DIRECTOR

*****3-DIGIT 571
17261 24 9328 1172
SORENSEN BROADCASTING
604 NO. KIWANIS PLAZA
SIOUX FALLS SD 57104