

Catalog

1 9 9 0

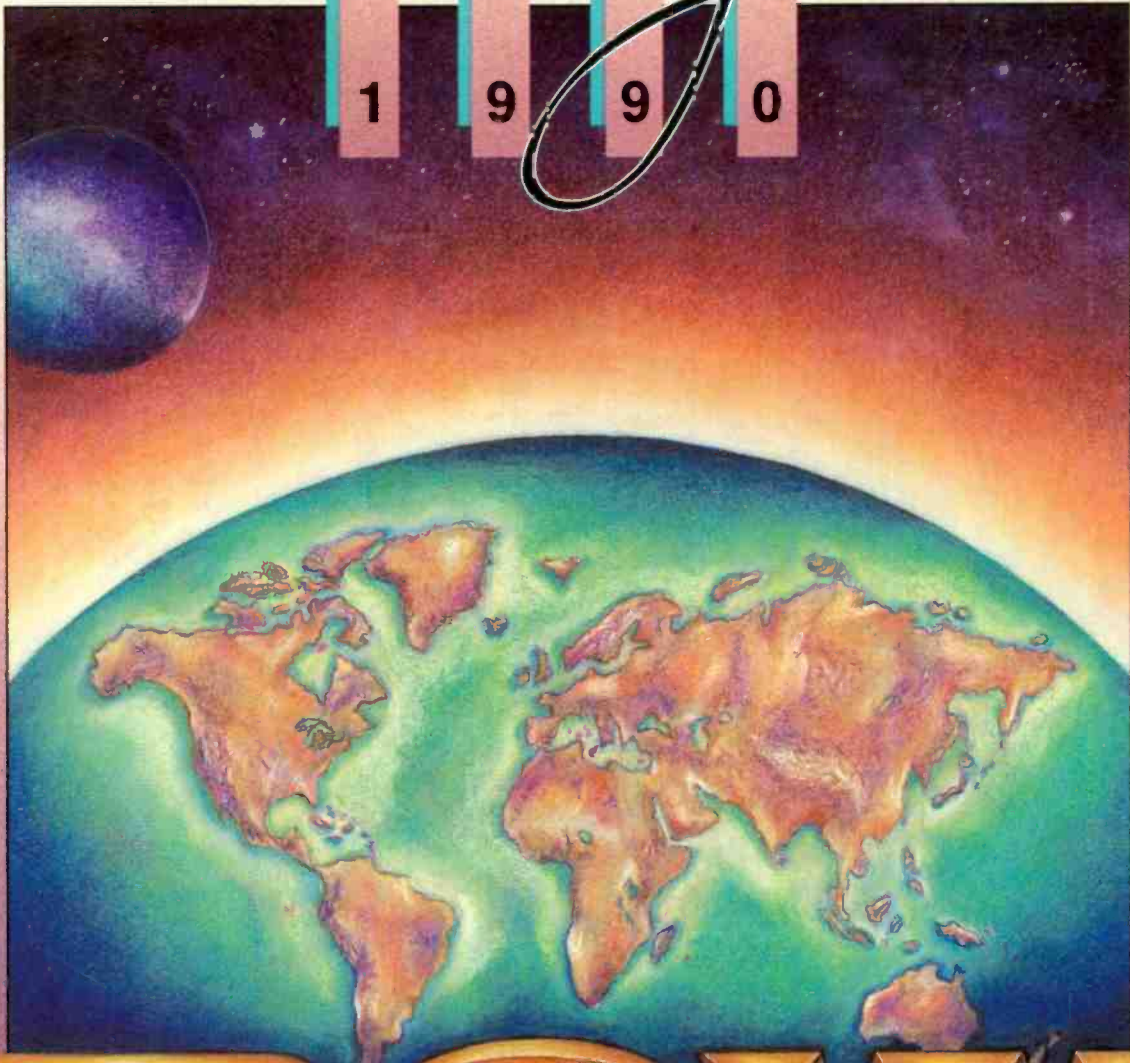

BSW

B R O A D C A S T S U P P L Y W E S T

DENISE KNUDSON

AMERICA'S FULL-TIME BROADCAST SUPPLIER

3 Ways To Measure An Equipment Supplier



Integrity . . .

A company with integrity exhibits honesty and fairness at all times. Repeat customers are a good indication of a company's level of integrity. For 17 years, BSW has been providing audio equipment to broadcasters and other audio professionals worldwide. Thousands of repeat customers continue to put their trust in us daily for all their audio equipment requirements.



Accessibility . . .

When you need equipment or information critical to your operation, time is of the essence. Your equipment supplier must be accessible to respond to you immediately. No company is better qualified than BSW. We maximize accessibility by staying open 12 hours daily, having professional sales assistance constantly available and our toll-free number means you never pay for the call.



Dependability . . .

Deadlines are a given in broadcasting. When the pressure's on, you need a company you can depend on. Put your trust and confidence in BSW. We are continuously expanding our order entry, warehousing, and shipping departments to offer unmatched speed and accuracy. The bottom line is we won't promise if we can't deliver.

Call us for your next equipment purchase and see how well BSW measures up.

OPEN 12 HOURS DAILY
MONDAY THRU FRIDAY
1-800-426-8434

PACIFIC
6:00 - 6:00

MOUNTAIN
7:00 - 7:00

CENTRAL
8:00 - 8:00

EASTERN
9:00 - 9:00

Nationwide and Canada
Local and International
Fax 206-565-8114

800-426-8434
206-565-2301
Telex 910-441-2617

NO MINIMUM ORDER

FOB: Point of Origin

Actual shipping charges with minimal handling fee will apply to each order.

Prices and specifications shown in catalog are subject to change without notice and should be verified prior to ordering. BSW actual selling prices are routinely discounted below manufacturer suggested list prices. Additional discounts may apply depending on size of order or payment terms.

TERMS: NET 30 DAYS ON APPROVED CREDIT

Personal checks up to \$1,000.00 accepted with Telecheck approval.
LEASING AVAILABLE



BSW

BROADCAST SUPPLY WEST

America's Full-Time Broadcast Supplier

7012 27th STREET WEST
TACOMA, WA 98466



Sustaining Member

Copyright© 1990 Broadcast Supply West, Inc.

Index Products By Type

TYPE	PAGE	TYPE	PAGE	TYPE	PAGE
AM/FM RECEIVERS	122	EBS MONITORS		RECORD CLEANERS	85
AMPLIFIERS	2-8, 69, 70, 74	ENCODER/DECODER	78	RECORD JACKETS	85
DISTRIBUTION	4-6, 69, 74	EDITING BLADES	72	RECORDING TAPE &	
HEADPHONE	2, 3, 5, 57	EDITING PENCILS	72	ACCESSORIES	72, 91
INTERFACE	3, 4	EQUALIZERS	14, 16, 17, 21, 23	REEL TO REEL MACHINES	93-97
LINE	2	ERASERS	30, 33, 34, 55	REEL TO REEL ACCESSORIES ..	27, 72
MICROPHONE	2, 4, 5, 69	FIRE EXTINGUISHERS	71	REELS & BOXES (EMPTY)	91
MONITOR/POWER	2, 5, 7, 70	FM EXCITERS	120, 121	REMOTE CONSOLES	49, 50, 52-54
PREAMPS/PHONO	8	FREQUENCY EXTENDERS	109, 110, 112	REMOTE CONTROL SYSTEMS ..	104, 107
ANTENNAS & ACCESSORIES	9-11	FURNITURE, STUDIO	90	REMOTE PICK-UP SYSTEMS ..	102, 105
AUDIO PROCESSING	12-25	HARMONIZERS	12	REVERB UNITS	14, 16, 17, 19, 20
COMPOSITE CLIPPER	19	HEADPHONES/HEADSETS	56-58	ROUTING SWITCHERS,	
COMPRESSORS/LIMITERS		AMPLIFIERS	2-8, 57, 69	AUDIO	8, 70, 84
.....	12-15, 18, 20-25	SPLITTERS	57	SCA GENERATOR/	
DELAY UNITS	12, 18	HEADS, RECORDING	72	RECEIVERS	75, 120
EQUALIZERS	14, 16, 17, 19, 21, 23	CLEANERS	27	SOUND EFFECTS CD & RECORD ..	71
HARMONIZERS	12, 16	INTERCOM	75	SOUNDPROOFING	98
MIC PROCESSORS	14, 16, 18, 23, 24	ISOCOUPERS	76	SPEAKERS	99-100
NOISE GATES	20, 22	JACKS/PANELS	83	MOUNTING BRACKETS	101
NOISE REDUCTION	17, 20, 22, 23	LIGHT BULBS	73	POWERED	99
NRSC FILTER	15	LIGHTS	70, 73, 81, 119	SPLICE FINDERS	30, 33, 34
REVERBS	14, 17	LIVE ASSIST CONTROLLERS	26	SPLICING BLOCKS	27
SPATIAL ENHANCERS	13, 19	MARKING PENCILS	72	SPLICING/LEADER/TAPE	72
SPECIAL EFFECTS	12, 16, 17, 19, 20	METERS	74	STEREO GENERATORS	13, 15
STEREO GENERATORS	13, 15	MICROPHONES	61-67	STEREO SYNTHESIZERS	14
STEREO SYNTHESIZERS	14	ACCESSORIES	59, 60	STUDIO TRANSMITTER LINK	
AUTOMATION	26	AMPLIFIERS	2, 4, 5	EQUIPMENT	102-107
BULK ERASERS	30, 33, 34, 55	BOOMS	68	ANTENNA	9-11
CABLE	128	CABLE ASSEMBLIES	59, 60	REMOTE CONTROL	104, 107
CABLE MODULATORS	77	MIXERS	52-54	REMOTE PICK-UP	102, 105
CARTRIDGES, PHONO	85	PARABOLIC	64	TRL LINKS	105
CARTRIDGES, TAPE	28, 29	PREAMPS	2, 4, 5, 70	STYLI, PHONO	85
CARTRIDGE ACCESSORIES	27	PROCESSOR	14, 16, 18, 23, 24	SUBCARRIER/GENERATOR/	
ALIGNMENT AIDS	27	SHOCK MOUNTS	60	DEMODULATOR	103
DEGAUSSERS, ERASERS ..	30, 33, 34, 55	STAND CLAMPS	60	SURGE PROTECTOR	77
LABELS	27	STANDS	68	SWITCHERS, AUDIO	8, 70, 84
RACKS	86, 87	WINDSCREENS	59, 60	SWITCHERS, RF	128
REBUILDS	29	WIRELESS	66, 67	TELEPHONE EQUIPMENT ..	71, 108-114
SPLICE FINDERS	30, 33, 34	MOBILE DJ SYSTEM	49	COUPLERS	110, 112, 114
TAPE	91	MONITORS	74, 75, 78-80	TEMPERATURE GAUGES	126
WINDERS	35	AUDIO SIGNAL	75	TEST EQUIPMENT	117-119
CARTRIDGE MACHINES	26, 30-35	MODULATION	79, 80	TEST RECORDS	72
CLEANING AIDS	27	EBS WEATHER	78	TEST TAPES	72
TIMERS	35	MULTIMETERS	119	TIMERS, CLOCKS	115, 116
CASSETTES	36	NOISE REDUCTION		TONEARMS	123
CASSETTE DECKS	36-39	SYSTEM	17, 20, 22, 23	TONE SENSORS/GENERATORS ..	75
CLEANERS, HEAD/SWABS	27	ON-AIR LIGHTS	81	TOOLS	117
CLOCKS & TIMERS	115, 116	PATCHBAYS	82	TOWERS/LIGHTS	11, 119
COMPACT DISC PLAYERS	40, 41	PATCHCORDS/JACK PANELS	83	TRANSLATORS	121
COMPACT DISC ACCESSORIES ..	41, 73	PHASE CORRECTORS	76	TRANSMITTERS	120, 121
COMPACT DISC RACKS	88	PHONO CARTRIDGES, STYLI	85	FM EXCITERS	120, 121
COMPRESSOR/		PREAMPLIFIERS, TURNTABLE	8	TUNERS	122
LIMITERS	12-15, 18, 20-25	R-DAT	92	TURNTABLES	124, 125
CONTACT CLEANER	73	RACKS & FURNITURE	86-90	ACCESSORIES	124, 125
CONSOLES	42-54	CARTRIDGE	86, 87	BASES	124
COPY HOLDERS	73	CASSETTE	88	CONTROLLERS	125
DAT DIGITAL AUDIO TAPE	91	COMPACT DISC	88	UTILITY LIGHTS	81
DEHYDRATORS	128	EQUIPMENT	89	VOICE PROCESSOR ..	14, 16, 18, 23, 24
DELAY LINES	12	FURNITURE	90	WEATHER INSTRUMENTS	126
DIGITAL RECORDERS	69	REEL-REEL	89	WIRE & ACCESSORIES	127, 128
DUMMY LOADS	76	RAIN GAUGE	126	WIRING DUCT	127



SHURE®



MODEL FP-12 PORTABLE HEADPHONE AMPLIFIER

The FP-12 is a 1-input, 2 output headphone bridging amplifier designed to provide headphone feeds from any type of audio input. The FP-12 can be used for a wide variety of applications such as multiple headphone feeds, audio line troubleshooting, extra power for existing headphone circuits. The FP-12 features two XLR in/out connectors and two 1/4" in/out jacks. Other features include a Mic/Line input switch, Hi Z/Lo Z headphones switch, headphone level control, and removable belt clip. The FP-12 is powered by one standard 9V battery.

MFG. LIST \$245.00 CALL FOR BSW PRICE

RANE

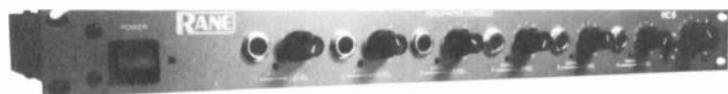

MODEL HC 6 6-CHANNEL HEADPHONE AMPLIFIER

Features:

- Six stereo headphone amplifiers in a single rack chassis
- Main stereo inputs drive all six amps through individual volume controls
- Each headphone amp also has its own separate input which independently by-passes the main stereo input

MFG. LIST \$399.00 CALL FOR BSW PRICE

EDCOR



MODEL HA-400C 4-CHANNEL HEADPHONE AMPLIFIER

Four independent stereo amplifiers, each with its own volume control. Provides high fidelity reproduction, far surpassing all but the most expensive systems.

MFG. LIST \$231.00 CALL FOR BSW PRICE

TASCAM

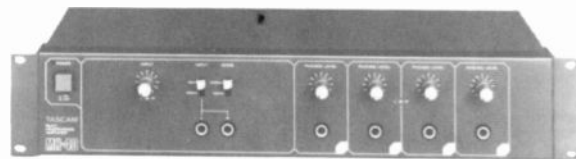

MODEL MH-40B 4-CHANNEL HEADPHONE AMPLIFIER

The MH-40B accepts low or high line level mono or stereo input, which feed in to four independently adjustable headphone outputs. The MH-40B provides increased monitoring capacity - with practically unlimited freedom of expansion and figure configuration.

MFG. LIST \$350.00 CALL FOR BSW PRICE

Symetrix



MODEL A-220 STEREO AMPLIFIER

High performance, low power stereo amplifier. The A-220 will develop better than 20 watts per channel into 8 ohms with full power distortion of less than .02% @ 1 kHz. Typical application includes the powering of headphone distribution boxes and small monitor speakers.

MFG. LIST \$329.00 CALL FOR BSW PRICE

SHURE®



MODEL FP-11 PORTABLE MIC-TO-LINE AMPLIFIER

The FP-11 is a portable, 1-input, 1-output microphone-to-line level amplifier designed for field production. It is ideal for use where long lines must be driven at higher than microphone or auxiliary levels. It can also be used to interface between equipment requiring different signal levels.

The balanced, locking XLR input and output provide for excellent rejection of hum and RF interference. A switchable peak limiter prevents output overload distortion. Additional features include a peak/limiter LED indicator, aux level mini-phone jack input, balanced line-level binding post output, and a removable belt clip. The FP-11 is powered by one standard 9V battery.

MFG. LIST \$260.00 CALL FOR BSW PRICE



GENTNER



**MODEL 6X
HEADSET/SPEAKER AMPLIFIER**

The 6X Headset/ Speaker Amplifier is a six output stereo amplifier capable of delivering up to 2 watts per channel. The flexible input configuration of the 6X makes set-up and operation fast, simple, and adaptable to each and every application.

The 6X has a master stereo input and individual direct inputs for each of six channels. The direct inputs are designed for your flexible applications, providing either mono or stereo input.

MFG. LIST \$595.00 CALL FOR BSW PRICE

Henry Engineering



**MODEL MATCHBOX
INTERFACE AMPLIFIER**

The Matchbox is the ideal, inexpensive way to correctly interconnect "H1 F1" or semi-pro equipment with professional studio gear. The Matchbox is a bidirectional unit with four independent amplifiers providing full stereo input and output interface. Features adjustable output levels.

MFG. LIST \$195.00 CALL FOR BSW PRICE

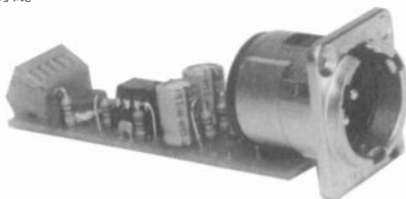

**MODEL DOA-1/DOA-2
INTERFACE AMPLIFIERS**

Interfacing a compact disk player, FM tuner, audio or video cassette machine to the pro audio environment can be a challenge.

The DOAs-1 & 2 provide a professional interface at a very low price. The DOAs have variable gain from off to +26 dB, mount inside equipment where cabling, space, mounting and AC power problems are eliminated. The DOA-1 uses bipolar power from ±6V to ±22V. The DOA-2 uses single + power from +12V to +44V D.C. Power supplies are user provided.

MODEL DOA-1 BSW PRICE \$55.00

MODEL DOA-2 BSW PRICE \$55.00

**APHEX
SYSTEMS**

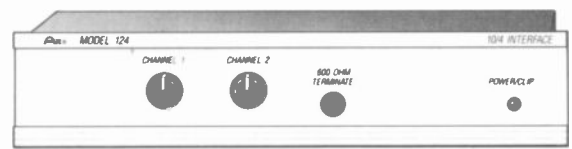

**MODEL 124
INTERFACE AMPLIFIER**

The Model 124 from Aphex will easily interface consumer audio equipment with professional studio and broadcast facilities. Active, servo-balanced circuitry converts +4 dBm (or +8 dBm) line levels to -10 dBm (hi-fi) levels, and back again. XLR and RCA-type connectors enable quick hook-up.

Frequency response: 5 Hz to 50 kHz +0, -0.4 dB ... THD: 0.005 @ 1 kHz ... Crosstalk: -95 dB @ 1 kHz, -78 dB @ 20 kHz ... Noise: -95 dBm, 20 Hz to 20 kHz.

MFG. LIST \$219.00 CALL FOR BSW PRICE

RUSSCO

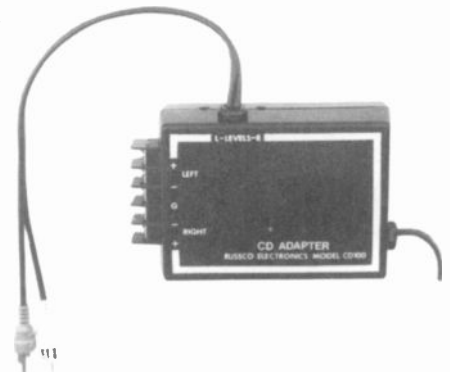

**MODEL CD100
INTERFACE AMPLIFIER**

Don't be fooled by the size or price of this little gem. Despite its small size and inexpensive price tag, the CD100 is an impedance matching amplifier forged from the anvil of craftsmanship.

The CD100 can be used to interface any high impedance output device to a 600 ohm line; balanced or unbalanced. Frequency response: 15 Hz to 30 kHz ... H. distortion -.1% ... Noise: -75 dB

MFG. LIST \$69.95 CALL FOR BSW PRICE

TASCAM



**MODEL LA-40
INTERFACE AMPLIFIER**

The Tascam LA-40 is the perfect one rack space solution to the problem of mismatched line levels or impedances. The LA-40 is a compact 4-channel unit that establishes instant compatibility between Tascam or similar -10 dbv unbalanced inputs and outputs and almost all other equipment. Compatible levels, compatible impedances and balanced/unbalanced operation.

MFG. LIST \$450.00 CALL FOR BSW PRICE



MODEL DA208, DA416 DISTRIBUTION AMPLIFIERS

Two or four inputs, each driving four individually adjustable, active balanced outputs gives you twice the channels for the price — twice the performance in most applications. Need more outputs? Just parallel inputs for up to 1 X 16 operation. Drive everything from balanced 600 ohm lines to Hi-Z IHF phono jack inputs without matching pads or noise compromises. Transparent performance, RF protected.

MODEL DA208 (Dual 1 x 4)
MFG. LIST \$329.00 CALL FOR BSW PRICE

MODEL DA416 (Quad 1 x 4)
MFG. LIST \$469.00 CALL FOR BSW PRICE



MODEL DA1008-1/DA2016-1 DISTRIBUTION AMPLIFIERS

Easily match differing line level requirements with these high output DAs with 8 or 16 individually adjustable outputs. Active and transformer balanced outputs at +22 or +30 dBm. A LED meter with three selectable OVU settings allow you to set nominal line levels and monitor peak headroom. Includes input clipping LEDs and a boosted headphone output.

MODEL DA1008-1 (1 in, 8 out)
MFG. LIST \$850.00 CALL FOR BSW PRICE

MODEL DA2016-1 (Dual 2 in, 8/16 out)
MFG. LIST \$1,195.00 CALL FOR BSW PRICE

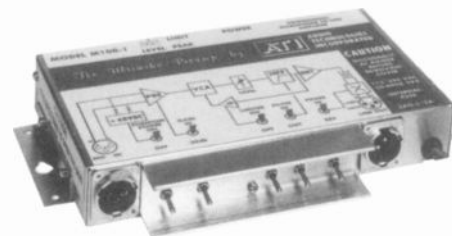

MODEL ULTIMIKE™ M100 MICROPHONE AMPLIFIER

Eliminate dimmer noise, RF pickup and hum loops by mounting this small, rugged, full featured preamp right near the audio source. The unusually quiet, direct balanced, instrumentation amplifier input has impressive hum and RF rejection and accepts +20 dBm maximum input. Features switchable and adjustable gain, limiter, lo-cut filter, 48 volt phantom power and a phase reversing switch. A unique output driver provides the many advantages of the true transformer isolation with no performance compromises. XLR in and out, dual rack mountable.

MFG. LIST \$299.00 CALL FOR BSW PRICE



MODEL DP-100 DiscPatcher™ BALANCING AMPLIFIER

A uni-directional stereo interface for playback only applications. It is designed specifically to convert the unbalanced IHF outputs of digital compact disc players to transformer balanced and isolated 600 ohm line levels with no compromise or degradation of the superb performance available from the digital audio source. The DiscPatcher™ is equally at home on a newsroom desk to interconnect field ENG cassette recorders into broadcast systems for dubbing.

MFG. LIST \$209.00 CALL FOR BSW PRICE



MODEL MAA SERIES DISTRIBUTION AMPLIFIERS

ATI's Multiple Amplifier Arrays are great problem solvers for audio distribution. Choose mic or line level units with either 4 or 8 channels. Use as a distribution amplifier, mono summing networks, combine high and low level inputs for a single balanced output, the list is limited only by your imagination. Audio specifications are outstanding.

CALL FOR PRICING INFORMATION

BSW handles the entire ATI line. Many items are in stock for immediate delivery.

Toll Free 1-800-426-8434



RAMSA



**MODEL WP 9055
POWER AMPLIFIER**

Truly great amplifiers are measured by two standards. Sonic quality and reliability. The Ramsa 9055 power amplifier achieves excellence on both counts.

50 watts per channel, UL listed and an outstanding 5 year warranty. Balanced and unbalanced inputs.

MFG. LIST \$590.00 CALL FOR BSW PRICE

RADIX

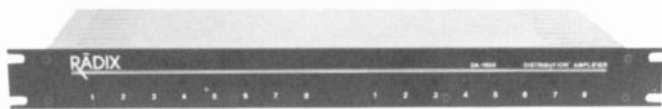

**MODEL DA 1600
DISTRIBUTION AMPLIFIER**

Sure the specs on the Radix DA-1600 are great, but one of the best things about this DA is on the back . . . removable, plug-in connectors. Wiring changes can be made quickly and effortlessly with the DA still in the rack. Connectors require no soldering and are better than barrier strip.



DA 1600 (REAR)

Features and Specifications:

- 8 stereo or 16 mono outputs. Each output has front panel level control
- Exceptionally low noise circuitry
- Selectable pads to accommodate a wide range of input levels
- THD: .01% max @ +20 dBm out
- Noise: 90 dB with respect to 0 dBm out
- Output separation: 90 dB
- Compact design for easy installation

MFG. LIST \$435.00 CALL FOR BSW PRICE

SHURE



**MODEL FP-16
PORTABLE DISTRIBUTION AMPLIFIER**

Shure Model FP-16 is a 1-input, 6-output distribution amplifier specially designed for field production use and offers features and performance rarely found in other distribution amplifiers. Phantom power is available at the input for use with condenser microphones; and all 6 outputs, as well as the input, are individually switchable to mic-or-line level. In addition, the FP-16 features link input and output jacks for interconnecting several FP-16's or adding external signal processing equipment such as equalizers, compressors or limiters. Other features include: ruggedness and reliable operation over wide temperature and humidity extremes; light weight and compactness for portable/location use or rack-mountable (with accessory rack mount kit) for studio installations; powered by AC or built-in battery pack; recessed, screwdriver-adjustable gain controls; and power, normal, and overload LED indicators.

MFG. LIST \$570.00 CALL FOR BSW PRICE

Symetrix

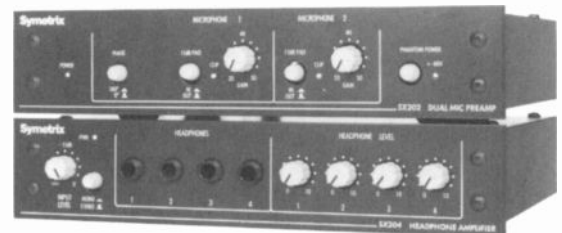

All SX200 Series products from Symetrix have high headroom balanced inputs, very low noise, wide dynamic range, low distortion studio quality circuitry, and low impedance high current balanced and unbalanced output line drivers. The small physical size of the SX200 Series allows them to be used in stand alone table-top operation, or mounted side by side using the optional rack mounting kit.

**MODEL SX202
DUAL MIC PREAMP**

The SX202 Dual Microphone Preamplifier features two ultra clean microphone preamplifiers with variable gain, 15 dB pad, +48 volt phantom powering, left, right, and left + right outputs.

MFG. LIST \$249.00 CALL FOR BSW PRICE

**MODEL SX204
HEADPHONE AMP**

The SX204 Headphone Amplifier, 1-in 4-out amplifier utilizing proprietary high voltage converter technology to drive high impedance headphones like a big power amp, while providing more than ample power for low impedance phones.

MFG. LIST \$269.00 CALL FOR BSW PRICE



APHEX SYSTEMS



MODEL 120 DISTRIBUTION AMPLIFIER

The Model 120 is a high performance audio distribution amplifier with a single high impedance input and four low impedance outputs, all electronically servo-balanced. The 120's transformerless circuits are designed for wide, flat frequency response free from ringing or overshoot, making it ideal for distribution of SMPTE time code as well as audio. Each output has its own amplifier and level control for maximum versatility and isolation. The sturdy steel chassis may be used stand-alone or rack mounted, singly or in pairs. THD is .002% @ +4 dBm, hum and noise better than -90 dB. MFG. LIST \$279.00 CALL FOR BSW PRICE

Henry Engineering

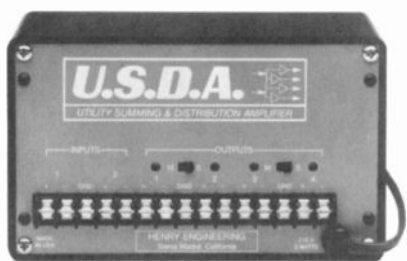

MODEL USDA DISTRIBUTION AMPLIFIER

U.S.D.A. stands for "Utility Summing and Distribution Amplifier". It's a mini-DA that has the unique ability to combine as well as split audio signals for distribution. USDA has two inputs (one stereo pair) and four outputs (two stereo pairs). USDA can be used as a conventional 1x4 or 2x4 distribution amplifier. USDA can also be used to combine a stereo input to a mono output. Each stereo output pair has a STEREO—MONO mode switch to select either mode for that output pair without affecting the other pair. MFG. LIST \$195.00 CALL FOR BSW PRICE

Need prices on a major project? Save yourself time and FAX us your equipment list. We'll have a complete price quote back to you in no time.

BSW FAX # 206-565-8114

GENTNER

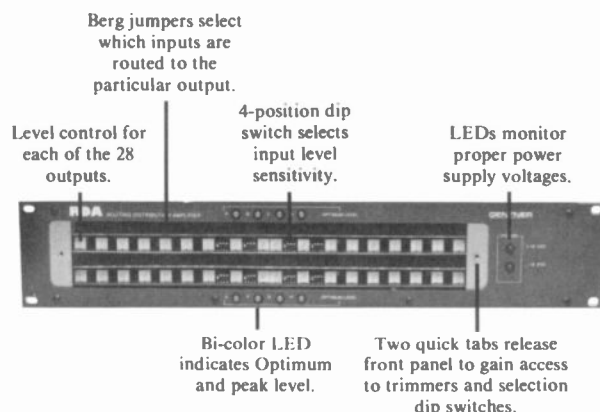

MODEL RDA ROUTING DISTRIBUTION AMPLIFIER

If you're looking for an audio distribution amplifier that can meet your changing needs, the Routing Distribution Amplifier (RDA) is the answer. RDA's unique eight input design gives you uncompromised versatility and flexibility in your installation. Instead of a limited number of inputs (usually one or two) and a fixed number of outputs (usually eight per input), the RDA has eight inputs and 28 outputs. Any input and any combination of inputs can be routed to any output. And, because it can be changed easily and quickly, it continues to provide versatility long after installation.

When it comes to aural performance, the RDA doesn't compromise either. With 98 dB of dynamic range and a computer routed PC board that virtually eliminates cross-talk and ground loops, the RDA delivers your signals with outstanding aural specifications.

The RDA's specially designed Optimum Level input stage ensures the best compromise between sufficient headroom and signal-to-noise ratio. This is done by coarse matching of the input level and then fine tuning it with a trimmer adjustment. This adjustment is made with the aid of an Optimum Level bi-color LED that indicates when you are operating within optimum input level range. After set-up, the Optimum Level LED indicators will continue to give you visual feedback as to the level status of all eight inputs. All adjustments are made from the front panel.

Selection of sources to each of the 28 outputs is also done from the front panel. Berg jumpers are used to select which combination of inputs is routed to each output. Level controls for each output are located adjacent to the selection dip switch.

MFG. LIST \$1,195.00 CALL FOR BSW PRICE



MODEL 1100
STEREO AMPLIFIER

Boasting 50 watts per channel in 8 ohms, the 1100 provides the added power that is needed for today's reference monitors. The 1100 features two headphone jacks on the front panel with separate volume controls. The back panel, like all of our Series One amplifiers, has XLR, 1/4", and barrier strip inputs to make interface simple.

MFG. LIST \$568.00 CALL FOR BSW PRICE

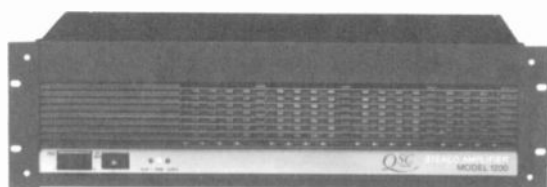

MODEL 1200
STEREO AMPLIFIER

The Model 1200 from QSC is a medium-power amplifier that offers high-performance and reliability. Total output power at 8 ohms is 100 watts per channel. Premium components are used throughout and a wide array of input connections make the Model 1200 an ideal addition to your studio.

MFG. LIST \$598.00 CALL FOR BSW PRICE



MODEL 85
STEREO AMPLIFIER

Features:

- Front panel mounted magnetic circuit breaker
- Power output 35 watts per channel or 90 watts mono (80 ohms)
- Toroidal mains transformer
- Front panel headphone jacks
- Rear panel stereo/mono switch

MFG. LIST \$529.00 CALL FOR BSW PRICE

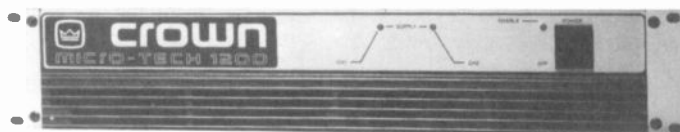

MODEL MT 1200
STEREO AMPLIFIER

Micro-Tech™ series amplifiers from Crown are packed with Crown Quality and plenty of power. Model 600 delivers 200 watts per channel into 8 ohms and Model 1200 delivers 350 watts per channel into 8 ohms. 3 year warranty.

MODEL 600
MFG. LIST \$995.00 CALL FOR BSW PRICE

MODEL 1200
MFG. LIST \$1,295.00 CALL FOR BSW PRICE



MODEL D150A2
STEREO AMPLIFIER

Broadcasters, recording studios, churches and sports arenas all over the world have recognized Crown's D150A as a standard of audio excellence. 80 watts per channel RMS into 8 ohms.

MFG. LIST \$795.00 CALL FOR BSW PRICE



MODEL D75
STEREO AMPLIFIER

Broadcasting's most popular amplifier. 35 watts per channel RMS with harmonic distortion only .05%. The D75 features active balanced inputs and XLR connectors. 3 year warranty.

MFG. LIST \$524.00 CALL FOR BSW PRICE



CONEX

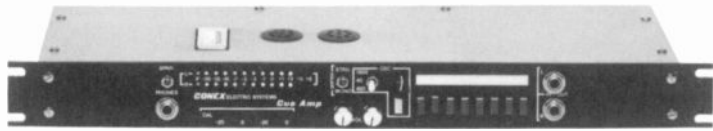

MODEL UM33 CUE & MONITOR AMPLIFIER/SWITCHER

The CONEX UM33 is a stereo, eight channel in, one channel out, general purpose cue, monitor and line amplifier.

The UM33 provides the easiest, least expensive, and most compact way of handling a variety of common monitoring, cueing, amplifying, and switching situations in any audio installation.

Typical UM33 applications include:

- Network or remote line monitor and buffer amplifier
- Transmitter input selector and monitor
- Automation cue amplifier
- Tape recorder input selector
- Telephone line source selector
- Headphone amplifier
- Intercom, communication system, or multi-media testing
- Console input expander

The UM33 has potential use in every studio in a radio station — newsroom, production room, transmitter, master control, and control room.

MFG. LIST \$495.00 CALL FOR BSW PRICE

RADIX

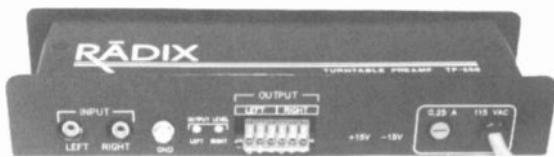

MODEL TP-500 TURNTABLE PREAMP

RADIX is everything you would expect from a high-performance turntable preamp. Superb specifications make Radix ideal for stereo, or dual preamp for two channel monaural use. And yet, the cost remains competitive with other quality brands.

Specifications:

- Distortion: less than .01% at full output
- Noise: better than 76 dB S/N unweighted
- Channel separation: 90 dB
- Output: +20 dBm single ended .600 ohms
+25 dBm balanced .600 ohms
- Compact enclosure - easy to install
- Outstanding RF immunity

MFG. LIST \$289.95 CALL FOR BSW PRICE

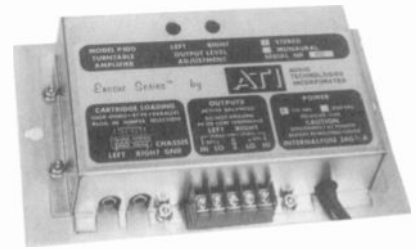

MODEL P-100S PRECISION PHONO PREAMP

When you're on a limited budget (and aren't we all?), you want the very best audio quality without the expensive frills. The P-100S stereo phono preamp from ATI offers state-of-the-art specs in a cost effective enclosure. Quality components allow the P-100S to achieve a 90 dB signal to noise ratio, channel separation of 60 dB minimum distortion .1% maximum 20-20 kHz.

MFG. LIST \$269.00 CALL FOR BSW PRICE

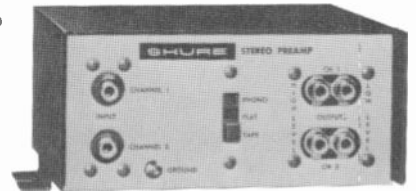

MODEL M64A STEREO PREAMPLIFIER

The M64A is a compact, professional stereo preamplifier which solves a variety of preamplification and equalization problems. A three-position slide switch selects different equalization depending on the desired application.

In the phono position, the M64A provides standard RIAA equalization. In the tape position, playback heads on tape recorders are provided with NAB equalization.

In the flat position, the M64A can be used as a microphone preamplifier or a low-gain buffer amplifier where long cable lengths are necessary.

MFG. LIST \$125.00 CALL FOR BSW PRICE



MODEL 310B PROFESSIONAL PHONO PREAMPLIFIER

The Model 310B Stereo Phono Preamplifier is designed to correctly interface all Stanton and selected magnetic phonograph cartridges for optimum playback of disk records and calibration of audio systems. The 310B preamp features universal mounting by special brackets, instant selection of flat or NAB postemphasis curves, switchable, effective rumble filter, individual adjustments of gains and high frequency responses, trimming of the capacitive cartridge loading at the input, provision for setting the power transformer for either 117 or 230V operation at 50 or 60 Hz and immunity to external magnetic AC fields. The 310B can be used in balanced as well as in unbalanced modes as well as in-phase and out of phase mix of L and R channels for monophonic reproduction of older records.

MFG. LIST \$280.00 CALL FOR BSW PRICE



MARK ANTENNA



SUPER SHORT HAUL ANTENNA

Radiation Systems, Inc., Mark Antenna Division is proud to offer the new Super Short Haul Antenna. It is a welded aluminum grid parabolic section antenna for point-to-point communication in the 940-960 MHz frequency range. The new Super Short Haul provides an increased gain of 1.5 dBi over the standard Short Haul Antenna. The new significant improvements made are in the narrowing of the main beam, side-lobe performance and front-to-back. This is with no increase in size and windloading.

The unique grid construction is patterned after the patented grid construction used on all Mark Antenna Division's full-size parabolic grids.

Feed components are constructed of solid brass and the active element of the radiator is protected by a durable Teflon feed housing to assure long life with trouble-free, pressurized and non-pressurized operations.

The standard termination is a type "N" Female (UG-58) coaxial connector and is non-pressurized. The Antenna meets Category A in the vertically polarized plane.

Simplified mounting utilizes universal clamps for quick and easy installation on pipe diameters from 1.9 to 3.5" O.D. The new Super Short Haul Antenna is UPS shippable.

MFG. LIST \$790.00 CALL FOR BSW PRICE

BSW is a full line Mark Antenna Dealer. Call us with your requirements.

TOLL FREE 1-800-426-8434

or

FAX 206-565-8114

SCALA

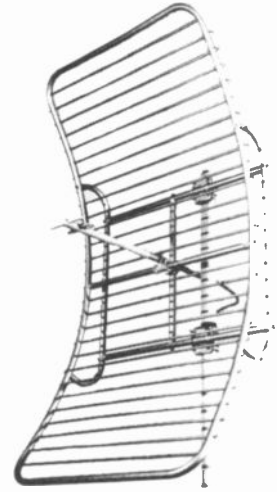

MODEL PR-450U ANTENNA

- Features:
- UHF-TV reception
 - UHF-TV translators
 - Telemetry
 - CATV systems
 - Point-to-point communications
 - Aural broadcast STL systems

MFG. LIST \$580.00 CALL FOR BSW PRICE

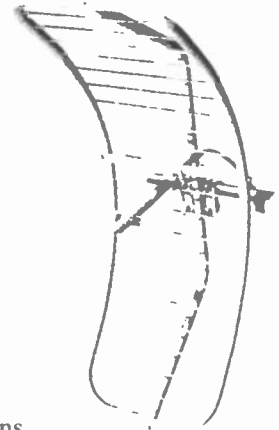

MODEL MF-960 MINIFLECTOR ANTENNA

- Features:
- Aural broadcast STL
 - Telemetry
 - Point-to-point communications
 - Vertical polarization for STL

MFG. LIST \$320.00 CALL FOR BSW PRICE



HDCA-5

MODEL HDCA-5 SERIES RUGGEDIZED YAGIS

Five and ten element single-channel yagis for VHF-TV and FM channels. Anodized aluminum castings and seamless pipe and tubing, plus stainless steel fastenings and hardware for long life in severe environmental conditions. Heavy brass balun structure for improved performance and reliability. Precision coax stacking harness available for two-bay and four-bay arrays.

PRICES BASED ON CONFIGURATION

CALL BSW 1-800-426-8434



Shively Labs

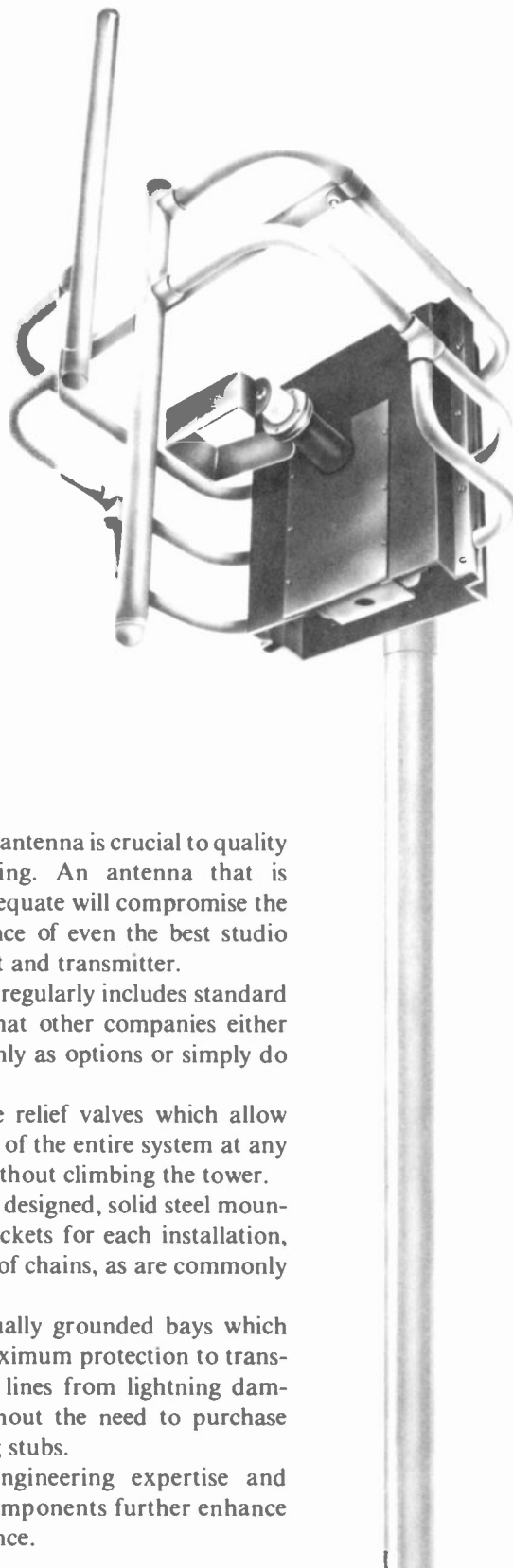

A good antenna is crucial to quality broadcasting. An antenna that is merely adequate will compromise the performance of even the best studio equipment and transmitter.

Shively regularly includes standard features that other companies either provide only as options or simply do not offer.

- Pressure relief valves which allow purging of the entire system at any time, without climbing the tower.
- Custom designed, solid steel mounting brackets for each installation, instead of chains, as are commonly used.
- Individually grounded bays which give maximum protection to transmission lines from lightning damage without the need to purchase shorting stubs.

Shively engineering expertise and quality components further enhance performance.

CALL YOUR BSW REPRESENTATIVE FOR DETAILED INFORMATION, SPECIFICATIONS AND PRICING. 1-800-426-8434

Larsen

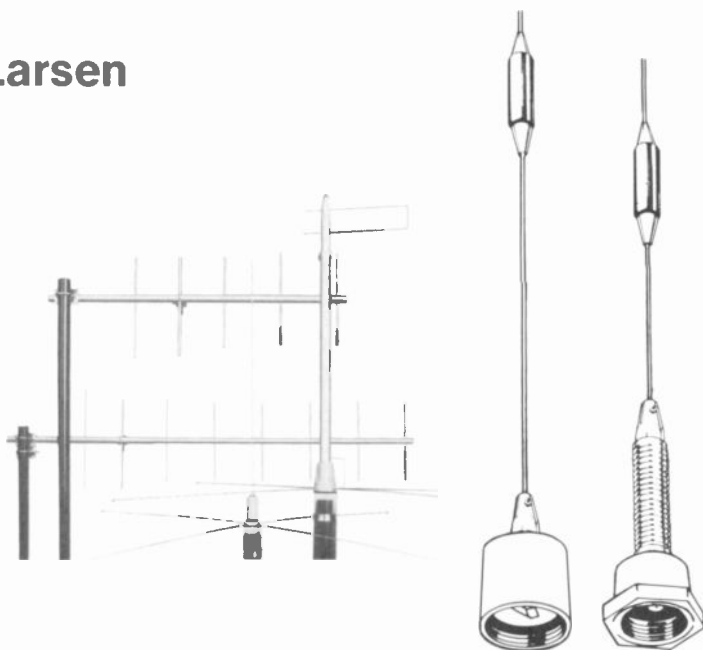

Wide range of base station and mobile antennas. Your BSW representative will assist you with the correct system for your requirements.

CALL FOR BSW PRICES

SCALA



NOW, IMPROVED PERFORMANCE FROM YOUR 950 MHZ RADIO LINK, AT A VERY MODEST COST

MODEL 8000 STL PREAMP

Scala offers the 8000/STL low-noise preamplifier for use in broadcast STL, TSL and ICR systems. This professional quality preamp is specifically designed to be used by broadcasters where the excellent noise-figure and high gain can provide improved system noise performance, allow the use of smaller receive antennas and coax transmission line than might otherwise be necessary, and help overcome path fades on marginal systems. Gain is 20 dB minimum. MFG. LIST \$400.00 CALL FOR BSW PRICE

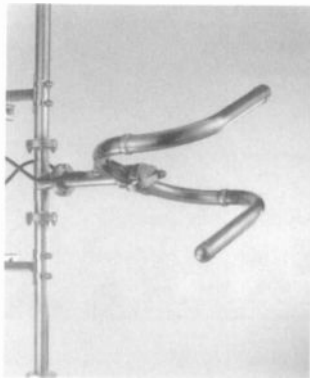
Cablewave Systems

Cablewave Systems offers a comprehensive line of omnidirectional antenna systems and accessories for the FM broadcast industry. Three basic antenna types are available in either circular or horizontal polarization.

CFM LP/HP circularly polarized antennas and HFM LP/HP horizontally polarized antennas are designed for high power commercial broadcast applications and have a power handling capability of 5 to 40 kilowatts depending on the specific antenna configuration.

CP-1000 circularly polarized antennas and HP-1000 horizontally polarized antennas provide a low power alternative to the CFM and HFM antennas for applications up to 4 kilowatts where high power handling is not required.

ECFM and EHFM antennas are designed primarily for the lower power educational market where power handling requirements do not exceed 500 watts.

CALL BSW FOR PRICES AND SPECIFICATIONS

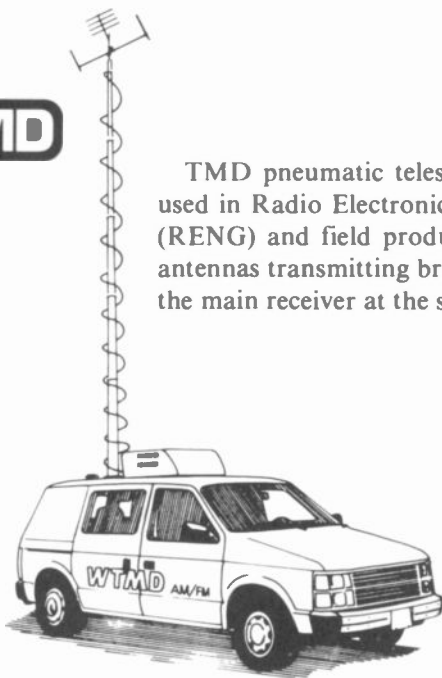
TMD

TMD pneumatic telescoping masts are used in Radio Electronic News Gathering (RENG) and field production to support antennas transmitting broadcast signals to the main receiver at the studio.

Mounted on remote broadcast vehicles, TMD standard duty masts support antenna weights of up to 40 lbs. to heights of 34 ft. allowing the remote to shoot over most local obstructions. In most terrains, these antenna heights allow a greater range on remote broadcasts.

The TMD pneumatic telescoping mast is a series of graduated extruded aluminum tubes that are assembled to nest one inside another. Each tube has a seal at the bottom to contain air pressure and a collar at the top to limit extension of the tube inside it. The masts are extended from their compact nested height by pneumatic pressure supplied by air compressors, hand pumps or compressed air bottles.

CALL BSW FOR PRICING AND DETAILED SPECIFICATIONS
1-800-426-8434

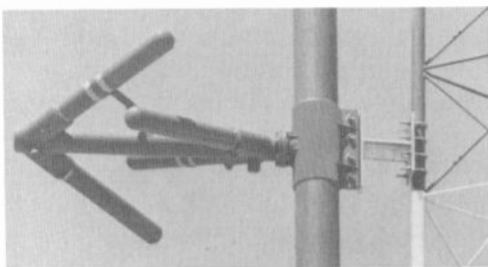

The JHCP antenna is a circularly polarized FM antenna for the broadcaster who wants extremely high-input power capability, coupled with the patented design that has become an industry standard. This design is sophisticated in concept yet simple in execution.

Each bay consists of a radiating element with its associated 6 $\frac{1}{8}$ " (15.56 cm) interbay feed line. The element and line are supported by a heavy brass casting which is attached to the support structure by its mounting bracket.

The JHCP antenna is conservatively rated at 30 KW per bay, with a maximum system rating of 80 KW for three bays and above. These ratings are reduced well below both the average and peak power ratings for the power distribution system, with corona and high voltage arcing problems eliminated by the use of very low Q radiating elements.

CALL BSW FOR PRICES SPECIFICATIONS



orban



MODEL 9100B AM AUDIO PROCESSOR

AM broadcasting technology is being improved. New pulse-width-modulation and digital transmitters offer greatly improved dynamic performance. Standards committees in the United States and other countries have developed (or are developing) pre-emphasis and filtering (bandwidth) standards that will allow receiver manufacturers to increase the high-frequency response of radios without fear of degraded reception due to interference from adjacent-channel stations. And broadcasters are looking to new audio processing not only to increase loudness and coverage but also to noticeably improve AM audio quality. With OPTIMOD-AM, announcers' voices will have presence and impact while still sounding very clean. Music will have real bass, with punch and warmth, not boom. The highs will seem to open up. And loudness and tonal balance will be consistent from source to source... certainly on the new wide-band receivers, but also on the millions of narrow-band receivers that will be in use for years to come.

- MODEL 9100B1 MONO**
MFG. LIST \$4,395.00 CALL FOR BSW PRICE
- MODEL 9100B2 STEREO (For C-QUAM)**
MFG. LIST \$5,995.00 CALL FOR BSW PRICE

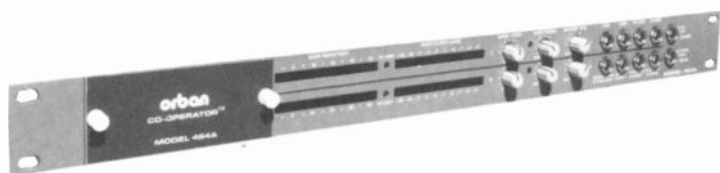

MODEL 464A COMPRESSOR/LIMITER

The Orban 464A is a friendly, automatic "assistant operator" that smoothly and unobtrusively rides gain and limits peaks.

The Orban 464A provides an unprecedented combination of versatility, audio quality and ease of use.

- Features:
- Transparent gain riding — without overshoots
 - Release time and release shape are adjustable to optimize processing for music or voice
 - A defeatable "silence gate" prevents noise rush-up
 - Two channels in a space saving, rugged, all metal 1 3/4" package
- MFG. LIST \$1,195.00 CALL FOR BSW PRICE

Eventide

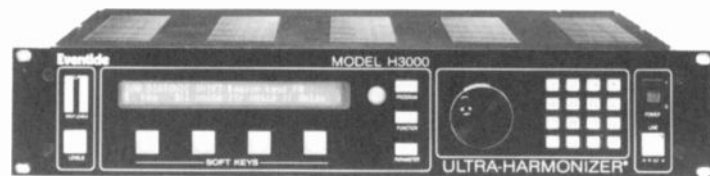

MODEL H3000B SPECIAL EFFECTS GENERATOR

The H3000B is a stereo, special audio effects unit. It allows broadcasters the ability to create special effects and character voices quickly.

Air personalities suddenly have all sorts of unusual voices at the push of a button. When they speak through the H3000B, characters that sound like Max Headroom, Cuzzin It, or a variety of others, mysteriously appear. Thundering helicopters, blasting cannons, and tremendous storm-like effects capture the attention of your listeners and are easy to use.

Now look what the H3000B will do for your production department. This unit features built-in stereo audio time compression and expansion, and it's completely automatic. Changing the running time of recorded reel-to-reel and cart tapes has never been this easy. Just use the numeric keypad to input current running time of the program material and then tell the H3000B how long you want it to be! You get the capabilities of standalone time compression system which costs five times the price of the H3000B!

- MFG. LIST \$2,995.00 CALL FOR BSW PRICE



MODEL BD941/942 AUDIO DELAY UNITS

Now reliable, efficient obscenity protection is so cost-effective, even radio stations that only program occasional live talk shows can afford it. The mono BD941 is available in 6, 12 and 24 second versions — the stereo BD942 offers 3, 6 or 12 seconds of delay. All versions feature full bandwidth and inaudible distortion.

The Eventide BD941 and BD942 provide a simple and practical "one-button" method for eliminating the risk of on-air obscenities. When a "no-no" is uttered, the engineer simply hits the delete button on the front panel, or a remote closure. This control simultaneously bypasses the delay line and closes a relay contact. The relay contact can be used to start a cart jingle or other filler message. At the end of the message, the BD941/2 automatically goes back on line with full delay protection.

- MODEL BD941 MONO (12 second delay)**
MFG. LIST \$2,195.00 CALL FOR BSW PRICE
- MODEL BD942 STEREO (12 second delay)**
MFG. LIST \$2,395.00 CALL FOR BSW PRICE



orban



**MODEL 424A
COMPRESSOR/LIMITER**

Here is one of the most complete, multi-function, audio processors available for the studio. The dual channel 424A features a compressor, limiter, and de-esser all in one package. Professional studios worldwide depend on the 424A for all their dynamic range control requirements.

Features:

- Defeatable gate with adjustable threshold
- Compressor has adjustable attack and release time
- Extensive use of VCA's for low distortion
- Better than 25 dB de-ess gain reduction

MFG. LIST \$1,095.00 CALL FOR BSW PRICE

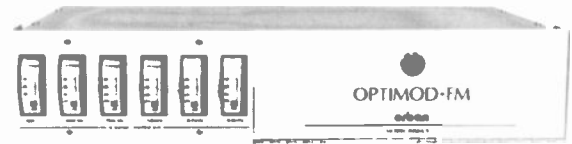

**MODEL 8100A/XT2
SIX-BAND LIMITER ACCESSORY CHASSIS**

The 8100A/XT2 works with any 8100A OPTIMOD™-FM and features two high frequency equalizer controls: Presence and Brilliance.

The XT2 also excels in the most difficult of processing tradeoffs — delivering loudness on music while keeping speech free from clipping distortion. Credit this uniquely capable performance to Orban's patented multiband distortion cancelled clipping system.

The XT2 lets you have it all: natural sound, source consistency, loudness, clean voice and adjustability that lets you tailor bass and treble to your taste and format requirements. And thanks to its efficient single chassis construction and its use of the main 8100A power supply, it lets you have the next step in OPTIMOD™ processing at an exceptionally reasonable price.

MFG. LIST \$2,075.00 CALL FOR BSW PRICE

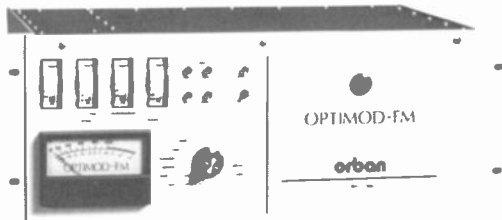

**MODEL 8100A/1 OPTIMOD™
FM AUDIO PROCESSOR/STEREO GENERATOR**

The standard in FM audio processing.

Performance Highlights/Features:

- Multiband compressor/limiter/stereo generator
- Multiband or wideband operation plus versatile setup controls permit precise "tuning" for different formats
- Freedom from processing artifacts and distortion
- Optimum voice/music balances
- Excellent high frequency power handling for brightest sound
- State-of-the-art stereo generator
- Overshoot compensator permits full modulation at all frequencies, yet doesn't increase low frequency IM distortion

Plus

- Dual chassis (studio/transmitter) option
- Plug-in card construction for easy maintenance
- Built-in crosstalk test generator
- Rigorous RFI shielding
- True VCA gain control
- True peak reading gain reduction meter
- Low stereo generator output impedance permits longer base-band cable runs

MFG. LIST \$4,995.00 CALL FOR BSW PRICE



**MODEL 222A
STEREO SPATIAL ENHANCER**

The Orban 222A stereo spatial enhancer can augment your station's spatial image the way your audio processor maximizes loudness and brightness. Your stereo image will become magnified and intensified; your listeners will also hear more loudness, brightness, dynamics and depth.

Highlights:

- Proprietary, patent pending technique detects and enhances psychoacoustic directional cues which are present in all stereo program material.
- Front panel enhancement and width limit controls allow tailoring of processing to user requirements.
- No increase in FM multipath distortion, no unnatural exaggeration of reverberation, and no increase in sensitivity to vertical tracing distortion in disc playback.
- Full mono compatibility.

MFG. LIST \$995.00 CALL FOR BSW PRICE

BSW is a full line Orban dealer and we offer a terrific "try before you buy" program.



MODEL 412A COMPRESSOR/LIMITER

The Orban 412A is a basic, cost effective compressor/limiter with remarkably natural sound and extraordinary ease of use.

A streamlined, straight forward front panel offers the most demanded user controls, including attack time, release time, ratio and threshold. This is a no frills unit with all the essentials at a very attractive price.

MODEL 412A (1 channel)
MFG. LIST \$459.00 CALL FOR BSW PRICE

MODEL 414A (2 channel)
MFG. LIST \$849.00 CALL FOR BSW PRICE



MODEL 245F STEREO SYNTHESIZER

The Orban 245F stereo synthesizer has been designed to take any mono signal and create life like pseudostereo. Unlike many other techniques, the patented Orban stereo synthesis technique causes no change in spectral balance, does not blur the transient definition and adds not the slightest audible noise or distortion to the mono original. The stereo output sums back to the original mono for total mono/stereo compatibility. And the simple controls adjust in seconds to create an optimum stereo effect from any mono original.

MFG. LIST \$459.00 CALL FOR BSW PRICE



MODEL 787A PROGRAMMABLE MIC PROCESSOR

Nearly any voice can be made more appealing by the judicious use of mic processing. Each voice at your station or studio can be assigned a permanent setup for each mic/studio combination for instant recall just before the voice airs. The programmable mic processor gives you an important competitive edge by enabling you to get the sound you want quickly and consistently.

The 787A features three band parametric equalizer, compressor, de-esser, noise gate, compressor gate and optional ducker integrated in a compact, powerful system. Stores up to 32 different control setups in memory for instant recall. Designed for DJ mic processing and voice recording, but versatile enough for many other production uses.

MFG. LIST \$1,995.00 CALL FOR BSW PRICE



MODEL 672A EQUALIZER

A cost effective professional quasi-parametric equalizer with the convenience of graphic type EQ controls. Features very low noise and distortion, high slew rate for minimum TIM (SID), front panel gain control with 12 dB gain available, "peak stretching" overload lamp to warn of clipping, active balanced inputs and unbalanced outputs.

MFG. LIST \$689.00 CALL FOR BSW PRICE



MODEL 642B PARAMETRIC EQUALIZER

Features:

- 4 band, dual channel parametric equalizer. Each section offers overlapping tuning with a 25:1 frequency range + 16 dB boost/ -40 dB cut in each band.
- Bandwidth variable from about 5 to 1/4 octaves ("Q": 0.29 to 5.0).
- "Constant-Q" design enables use of equalizer as a true infinite depth notch filter; vernier frequency control on each band facilitates precise tuning of notches.
- Tunable 18 dB/octave high pass filter and 12 dB/octave "Automatic Sliding Besselworth™" low pass filter provide maximum flexibility while preserving musicality.
- Front panel cascade switch permits use as either a two channel 4 band, or one channel 8 band equalizer.
- Noise and distortion specs significantly better than 16 bit digital.
- Active balanced inputs and outputs with optional output transformer.

MFG. LIST \$995.00 CALL FOR BSW PRICE



MODEL 111-B/1 DUAL REVERB

The 111-B/1 offers two channels of reverb in a single package that combines both electronics and spring delay lines. It is a reverb that combines full Orban quality and reliability with significant advances in cost effectiveness. It's the only choice for anyone needing two channels of fully professional reverb in an economical package.

MFG. LIST \$959.00 CALL FOR BSW PRICE



FM AUDIO PROCESSING SYSTEMS

CRL FM processing systems are modular and are comprised of either two, three or four of the following basic signal processing concepts:

- Input audio gain control
- Optional multiband compression
- Final peak modulation limiting
- Digital stereo generation

When used together, these units provide complete program audio control to maximize stereophonic modulation while maintaining tonal clarity and integrity of original program sources.

Summary of components:

- SGC-800 stereo gain controller. High quality multiband AGC and is designed for use as the first unit in a CRL system. Exclusive to the unit is Dynafex™ noise reduction.
- SEC-800 spectral energy compressor. Allows four channel EQ. Programmable attack/release times. Switch selectable wideband or multiband limit or compress modes.
- SMP-850 stereo modulation processor. Final peak limiter offering maximum performance and fidelity. Unique stereophonic enhancement system can be used to create dramatic stereo sound fields.
- SGA-800A stereo generator. Digitally synthesized providing the ultimate in stereophonic baseband generation.

CRL FM processing can be purchased either as a system or as separate components.

PRICES BASED ON CONFIGURATION



MODEL SPF300 AM NRSC FILTER

The CRL Standard Pre-Emphasis/Filter contains all the functions necessary to convert virtually any monaural audio processing chain to meet the NRSC (National Radio Systems Committee) Voluntary National Standard of January 10, 1987.

This transmission standard defines specific pre-emphasis and filtering requirements which are intended to help solve many of the technical concerns in AM broadcasting. The pre-emphasis curve was developed to allow receiver manufacturers to employ a complementary de-emphasis characteristic in wideband radios while improving the frequency response of narrower and medium bandwidth radios. The filter specification, which limits transmitted audio bandwidth to 10 kHz, is intended to greatly reduce much of the interference between stations by reducing the conditions that cause "splatter" effects.

MFG. LIST \$795.00 CALL FOR BSW PRICE



AM AUDIO PROCESSING SYSTEMS

The CRL AM processing systems are modular and are comprised of either two or three of the following basic signal processing concepts:

- Input audio gain control
- Optional multiband compression
- Final peak modulation limiting

When used together, these units provide complete program audio control to maximize modulation while maintaining tonal clarity and integrity of the original source material.

Summary of components:

- AGC-400 mono SGC-800 stereo gain controller. Designed to be used as the input unit. Offers wideband or multiband processing configuration. In addition, this AGC unit incorporates Dynafex™ noise reduction.
- SEC-400 mono SEC-800 stereo spectral energy compressor. Programmable four channel multiband compressor allows you to tweak your sound. Switchable AGC gating threshold.
- PMC-450A mono SMP-950A stereo peak modulation controller. Incorporates selectable NRSC preemphasis and bandwidth filtering standards. Also standard is adjustable, low frequency phase ("tilt") correction and high frequency overshoot correction.

Purchase as a system or separate components.

PRICES BASED ON CONFIGURATION



YAMAHA



MODEL SPX1000 AUDIO EFFECTS UNIT

The SPX1000 is a highly sophisticated digital reverberation and effects system which offers 40 preset effect programs. These include accurate simulations of natural reverberation and early-reflections, delay and echo effects, gated effects, modulation effects, a versatile compressor, a low-level expander, a harmonic exciter, freeze (sampling) programs and others. The SPX1000 also provides simultaneous processing — up to 5 effects at one time. Both “series” and “parallel” combinations are provided. With a sampling frequency of 44.1 kHz, it delivers full, flat frequency response from 20 Hz to 20 kHz. MFG. LIST \$1,795.00 CALL FOR BSW PRICE



MODEL SPX900 AUDIO EFFECTS UNIT

The SPX900 is a highly sophisticated digital reverberation and effects system offering 50 preset effect programs. These include stunning simulations of natural reverberation and early-reflections, delay and echo effects, gated effects, modulation effects, a versatile compressor, a harmonic enhancer, a freeze (sampling) program and more. The SPX900 also provides simultaneous processing — up to 5 effects at one time! Full-function wired remote control is available to emulate all front panel controls from a distance. MFG. LIST \$995.00 CALL FOR BSW PRICE



MODEL DEQ7 PROGRAMMABLE EQUALIZER

In one compact rack-mount unit the DEQ7 offers every useful graphic equalizer configuration, versatile tone-control type equalization, precision parametric EQ configurations, extremely flexible bandpass and band rejection filters, unique “dynamic” filters and more. All the basic EQ configurations are stored in 30 preset memory locations, and 60 RAM memory locations are provided. All internal signal processing in the DEQ7 is in the digital domain. The DEQ7 delivers high quality sound plus the absolute equalization precision and stability that only digital processing can achieve. MFG. LIST \$1,395.00 CALL FOR BSW PRICE

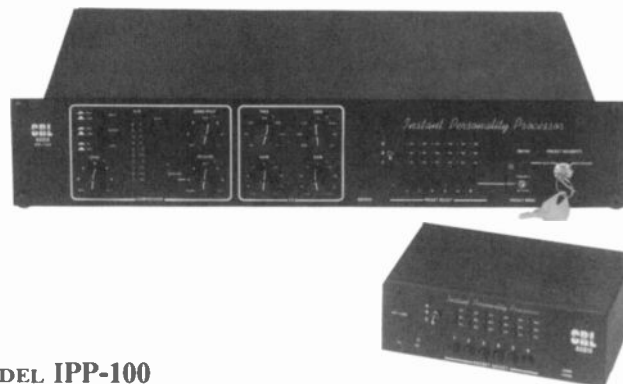

MODEL IPP-100 MICROPHONE PROCESSOR

The IPP-100 incorporates features that are specifically designed to address the problems of voice processing in the broadcast environment. Powerful equalization and compression circuitry are combined with an advanced microcontroller to give a wide range of programmable preset characteristics.

An important goal in the design process has been to achieve a front panel layout that is both easy and quick to use. Anyone who has operated a standard equalizer or compressor before will find the advanced control and programming power found in the IPP-100 very easy to manage. 18 memory “pre-sets” can be loaded into the memory so each individual announcer may have their own customized setting. Lock and key prevents changing of parameters by unauthorized personnel.

Features:

- Selectable microphone or line level inputs
- Two band parametric equalizer, constant Q
- Two band compressor with gain reduction gating
- 18 memories for all user adjustable controls
- Easy to use “analog” controls
- Quick acquisition of preset information
- Security lock prevents alteration of presets
- Fast switching from one preset to another
- Remote jack for switching of presets

MODEL IPP-100
MFG. LIST \$1,495.00 CALL FOR BSW PRICE

MODEL IPP-100R REMOTE PANEL
MFG. LIST \$395.00 CALL FOR BSW PRICE

Don't Panic... We're Still Open

BSW's extended hours and West coast location are great for those times when you just have to have that piece of important equipment. We're open 6 a.m. to 6 p.m. Pacific time, 9 a.m. to 9 p.m. Eastern.

1-800-426-8434

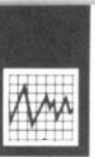

Symetrix



MODEL 511A NOISE REDUCTION UNIT

The Model 511A is a two channel, single-ended noise reduction system configured for use in professional and commercial audio systems. With its dynamic high frequency filter and downward expander, up to 30 dB overall reduction of both high frequency and broadband noise is attainable. The dynamic filter reduces high frequency sounds like hiss, RF artifacts and dimmer noise, while broadband and low frequency phenomena like hum, turntable rumble and air conditioning noise are reduced by the expander. A high performance 18 dB/octave rumble filter is included for optimal treatment of low frequencies.

Because it's a one way system, the 511A works on any signal without pre-processing. No encoding is required, so the unit can be placed anywhere in the signal chain. Using the 511A noise reduction, existing analog gear can be made quiet enough to work right alongside the latest digital products.

Independent two channel or true stereo operation is front panel selectable. In stereo, the left and right control circuits are tied together, assuring a stable stereo image. In mono, the channels operate independently, so each may be used with a separate source.
MFG. LIST \$629.00 CALL FOR BSW PRICE



MODEL SX201 PARAMETRIC EQUALIZER

The Model SX201 Parametric Equalizer is a high performance studio quality parametric equalizer/notch filter designed to handle both low level and line level inputs. Three fully parametric bands of equalization are provided, with +15 dB boost and -30 dB cut capability, allowing the SX201 to be used for both created and corrective equalization. Overlapping frequency controls cover the entire audio range, from 16 Hz to 20 kHz. Bandwidth is continuously variable from .05 octave (for deep notch filtering), to 3.3 octaves (for smooth tone shaping). Distinguished by its superb sonic integrity, extremely low noise and low distortion performance, the SX201 delivers uncompromising quality in a remarkably compact package. Requires only 1/2 rack space.

MFG. LIST \$239.00 CALL FOR BSW PRICE

Lexicon



MODEL LXP-5 AUDIO EFFECTS UNIT

The LXP-5 enhances your arsenal of sounds with an exciting panorama of digital effects, including pitch shift over three octaves. Dramatic delay sweeps. Flanging. Thickening. 64 preset effects in all, from subtle enhancements to wild, space-age sounds. As many as five effects can be used simultaneously. Its 128 user memories allow you to change or expand its sound bank with user customized sounds. And of course, each effect has the clean, quiet performance and rich, musical quality that could only come from Lexicon.

MFG. LIST \$549.00 CALL FOR BSW PRICE



MODEL LXP-1 AUDIO EFFECTS UNIT

A powerhouse of highly advanced reverb and delay programs, the LXP-1 provides a wide range of time-based effects with fast, intuitive control. This versatile processing module gives you all the important features you need in a professional quality digital reverb unit, starting with a tremendous variety of state-of-the-art reverberation programs, including concert halls, rooms, plates, even inverse and gated reverb. Delay and chorus programs complete the picture, and it's all harnessed in a compact, half-rack size package.

MFG. LIST \$549.00 CALL FOR BSW PRICE

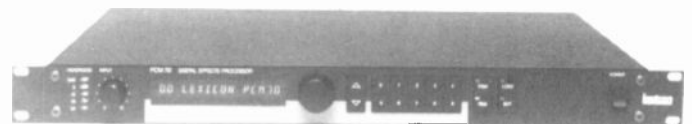

MODEL PCM 70 AUDIO EFFECTS UNIT

The Lexicon PCM 70 lets you choose from more than 40 imaginative factory programs. Versatile effects programs cover chorus and echo, multiband delays and resonant chords each with six voices. In addition, the PCM 70 offers you Lexicon reverb programs like concert hall, rich chamber and rich plate.

Using these factory programs as a basis, you can create 50 of your own individualized programs and store them in separate registers. That gives you instant access to a total of more than 90 available programs.

MFG. LIST \$2,295.00 CALL FOR BSW PRICE



Symetrix

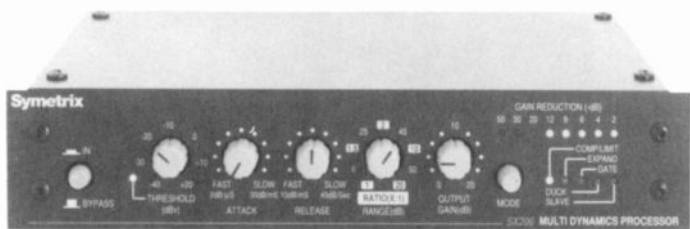

MODEL SX206 MULTI DYNAMICS PROCESSOR

The SX206 Multi Dynamics Processor is a single channel device that may be used as a compressor/limiter, gate, downward expander, ducker, or slave (for stereo operation). A full complement of controls is provided for each operating mode.

This inventive blend of control techniques, implemented with a precision low-noise VCA, soft-knee transition, ultra stable feed-forward control, and +24 balanced output capability, give the SX206 its outstanding sonic integrity.

MEG. LIST \$279.00 CALL FOR BSW PRICE



MODEL 528 VOICE PROCESSOR

The 528 is a complete, self contained voice processor that performs five separate functions: mic preamp, de-esser, compressor/limiter, downward expander and parametric equalizer/notch filter. High density packaging allows all five signal processors to fit comfortably in a single rack space.

But, nothing is left out. Each function is served by a full complement of controls, in an easy-to-use layout. As a dedicated single channel voice processor, the 528 delivers the same processing power found in a sophisticated recording studio signal chain. With the 528 Voice Processor you get all the control you need, without the cost or complications of separate units.

MEG. LIST \$649.00 CALL FOR BSW PRICE

Why wait around for your equipment...for just a few dollars more we can Federal Express your order. Ask your BSW Sales Rep for details.

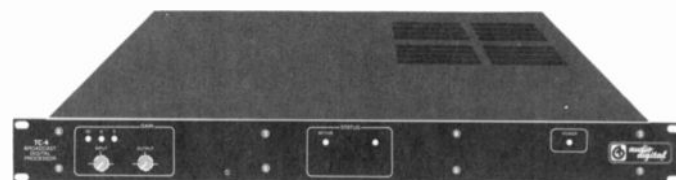

MODEL TC-4 BROADCAST DIGITAL DELAY

A state-of-the-art advancement in broadcast profanity delay. 6.8 seconds delay time, 15 kHz bandwidth, and 85 dB dynamic range. Optional card allows memory dump as well as catchup feature.

MEG. LIST \$1,521.00 CALL FOR BSW PRICE

Symetrix



MODEL 501 COMPRESSOR/LIMITER

Two processor device with variable ratio compressor and an infinity-to-1 peak limiter for the ultimate in compression limiting. Selectable automatic mode significantly reduces overshoot and distortion. Balanced and unbalanced inputs and outputs. Used in broadcasting, music recording, sound reinforcement and tape duplication.

MEG. LIST \$279.00 CALL FOR BSW PRICE



MODEL 525 DUAL CHANNEL COMPRESSOR/LIMITER

Features:

- A multi-function dynamic range controller designed for exceptional performance and ease of operation
- Two independent channels which may be ganged for stereo operation
- Simultaneous compress/limit and expand/gate action
- Separate compress/limit and expand/gate side-chains each of which respond in a program dependent fashion to make set-up quick and simple
- Balanced inputs and outputs

MEG. LIST \$495.00 CALL FOR BSW PRICE

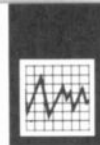

modulation sciences, inc.

**STEREOMAXX™ ADDS EXCITEMENT
TO EVERY MUSIC FORMAT**

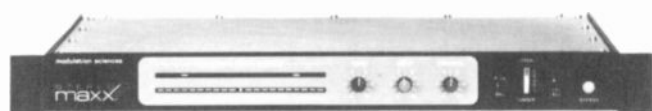

**MODEL STEREO MAXX
SPATIAL IMAGE ENHANCER**

StereoMaxx™ makes your station sound bigger, not just louder. Almost all air chain processors work to increase loudness. But the StereoMaxx is different. It enhances and enlarges your station's stereo image. The stereo image becomes wider and deeper — actually extending beyond the speakers. The effect impacts on all kinds of stereo radios — from expensive hi-fi systems to portable boom boxes and headphone radios. And in the car — wow! No matter what kind of radio your listeners tune, once your station adds the energy and excitement of StereoMaxx, other stations sound rather tired and dull by comparison. Works with all on-air audio processing units.

MFG. LIST \$2,889.00 CALL FOR BSW PRICE



**MODEL CP803RM
FM COMPOSITE PROCESSOR**

Sharpen your competitive edge by adding the CP803RM to your compressor/limiter/stereo generator to enhance the stereo composite signal. Increase your signal by 6 dB with greater dynamic range without the breathing, pumping or swishing associated with conventional processing.

MFG. LIST \$1,245.00 CALL FOR BSW PRICE

DigitTech

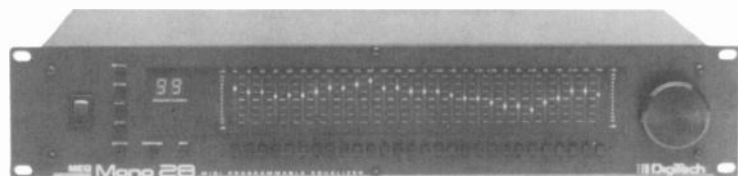

**MODEL MEQ 28
PROGRAMMABLE EQUALIZER**

The new DigiTech MEQ 28 is a professional 28-band programmable graphic equalizer with unparalleled features and performance. Features 99 memory locations, EQ comparison function, security lock-out system.

MFG. LIST \$499.95 CALL FOR BSW PRICE

DigitTech



**MODEL DSP-128 PLUS
STEREO DIGITAL EFFECTS PROCESSOR**

The DSP-128 is a multi-effect digital signal processor with 128 presets. The digital effects signal processor offers reverberation effects, chorusing, flanging, delays and can do more than one effect at the same time. An LED display on the front panel shows the program number in operation, or displays the operating parameters when programming the effects. A matrix field of 12-LED's on the front panel show which effect or effects are being used making it easy to see what the DSP-128 is doing. 12-bit A-D-A conversion with a 16-bit DSP engine and noise gating give the digital processor wide dynamic range and computing power for smooth sounding effects.

MFG. LIST \$459.95 CALL FOR BSW PRICE



**MODEL DSP-256™
MULTI-EFFECT DIGITAL SIGNAL PROCESSOR**

The new DSP-256 adds to the impressive legacy of the DSP-128. This new machine expands the capabilities of digital multi-effects processing to a new level of performance. The DSP-256 has a full 20 Hz to 20 kHz bandwidth with 16-bit resolution, making it an indispensable tool for stage or studio.

Features:

- 4 effects simultaneously
- 24 different effect combinations
- Independent full operation of all effects
- 256 program locations
- Program tilting
- Programmable level controls
- Comprehensive MIDI implementation
- MIDI continuous control of all parameters

MFG. LIST \$529.00 CALL FOR BSW PRICE

BSW Delivers

BSW's extensive inventory assures you outstanding delivery. Our special discount rate on Federal Express saves you dollars and time.



MODEL PROVERB 200 AUDIO EFFECTS PROCESSOR

200 new software developments. A wide bandwidth and host of new sounds! ART delivers the ultimate creative tool at a price hundreds less than comparable units, packaged in a sleek, rugged steel case.

ART has restructured the best digital algorithms and developed one of the most natural sounding multiple effects processors ever. The Proverb 200 delivers a full range of studio effects without the brittleness or harshness of competitive units and incorporated the finest sounding studio effects combinations and made them available at the touch of a button! Unit is a single space rack mountable. Stereo inputs and outputs.

MEG. LIST \$399.00 CALL FOR BSW PRICE

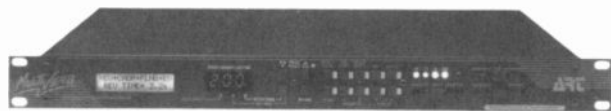

MODEL MULTIVERB II AUDIO EFFECTS PROCESSOR

The power of four. ART rockets digital processing into the 21st century with the best sounding effects processor ever! The Multiverb's new ultra high resolution circuitry yields superior audio performance and unequaled sonic clarity.

The heart of the Multiverb is a new fully optimized 20 Bit digital engine which is surrounded by some of the most sophisticated engineering to date. The result is a processor with incredible capabilities.

Features:

- Up to 4 effects at the same time
- Pitch transposing
- 20 Bit digital processing
- Fully utilized 16 Bit A-D-A conversion
- 32 character liquid crystal display
- Fully programmable
- 100 studio-crafted presets
- Ultra-wide bandwidth
- Full parameter variability
- Rugged internal power supply

MEG. LIST \$599.00 CALL FOR BSW PRICE

BSW's West Coast Location Allows Late In The Day Shipments. If You Need Equipment Fast, BSW Is Your Supplier.

We Offer Special Discount Rates On Federal Express.



UREI ELECTRONIC PRODUCTS

The JBL/UREI 7110 Limiter/Compressor is built in the tradition that has made UREI limiter/compressors the audio professional's choice world-wide. Incorporating both peak and average gain reduction detectors in a single rack space size, the Model 7110 is equally at home in the small recording studio, the sound contractor's rack, portable sound systems, broadcasting studios or anywhere audio levels need to be automatically controlled.

MEG. LIST \$495.00 CALL FOR BSW PRICE



COMPRESSOR

To afford complete control of dynamic range, with an automatic downward expander to remove undesirable noise level recovery.



DE-ESSER

To remove excessive "ess" sounds commonly called sibilance.



NOISE REDUCTION

One-way noise reduction unit to eliminate unwanted noise from audio signals, while improving signal-to-noise ratios.

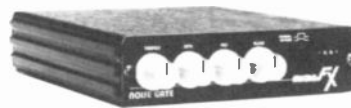

NOISE GATE

To eliminate unwanted noise in musical program, instrument amplifier hum and buzz.

MODEL MICRO FX SERIES AUDIO PROCESSORS

Inexpensive signal processors are not new. But, inexpensive processors capable of delivering truly professional sound quality were practically nonexistent prior to the introduction to Micro FX. Each Micro FX product is designed and manufactured to the same exacting standards which have made Valley International and industry leader in the field of analog signal processing. The time-proven proprietary processing circuit found in our more expensive processing products is also designed into every Micro FX unit.

You will find the same high quality components in each Micro FX unit that you find in the rest of the Valley line, so you can be assured of years of trouble-free operation. And, all of the Micro FX products are made in the USA.

The optional FX rack adaptor allows from 1 to 3 units to be mounted in a 1.75" high rack space.

MEG. LIST \$165.00 EA. CALL FOR BSW PRICE

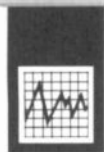

ART

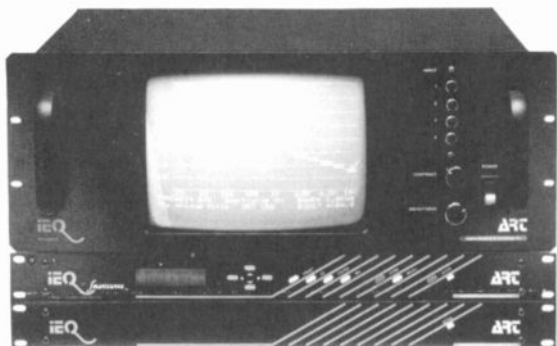

**MODEL 270
PROGRAMMABLE EQUALIZER**

ART offers the IEQ with Smartcurve™. The IEQ family is the next generation in graphic equalizers. They go beyond the latest "constant Q" designs and offer EQs that compensate for the interaction between bands, provide over 128 presets, complete MIDI

interface, and a video output that shows you the actual frequency response.

The IEQ Controller EQ is a professional, programmable, mono 2/3 octave graphic equalizer. The addition of Smartcurve™ makes this one of the most advanced equalizers available. All of the presets and operating parameters are battery backed and can be dumped to a computer using MIDI interface. The alphanumeric LCD display prompts the user making this an easy to use yet powerful equalization tool. A composite video output allows you to see the actual frequency response, "slider" positions, and all of the system and MIDI parameter settings.

The Satellite EQ is an IEQ without the video output and front panel controls. It is about 2/3 the cost of the Controller EQ. Up to 15 Satellite EQs can be controlled by an IEQ Controller EQ. The unit is inherently "tamper proof" since it has no front panel controls.

- MODEL 270 IEQ 2/3 OCTAVE CONTROLLER . . . MFG. LIST \$629.00
 - MODEL 280 IEQ 2/3 OCTAVE SATELLITE MFG. LIST \$429.00
 - MODEL 290 IEQ VIDEO MONITOR MFG. LIST \$495.00
- CALL FOR BSW PRICES**

GENTNER

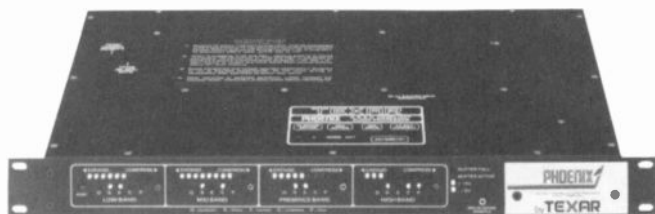

**MODEL PHOENIX™
AM AUDIO PROCESSOR**

The PHOENIX is a complete, monaural, AM processing system. The heart of the PHOENIX is the famous Audio Prism™ multi-band processor used by many FM stations. Digital control insures a clean, bright sound that is sure to please your listeners.

New Life For Old Transmitters

It goes without saying that the better the transmitter, the better the on-air audio. But sometimes a new transmitter just isn't a possibility. In that case, the PHOENIX can do a lot to pump new performance into an old transmitter. Many AM transmitters, particularly those employing plate-modulation, exhibit low-frequency tilt. Tilt can rob you of up to 20% of the modulation you're entitled to. The PHOENIX includes a very effective, low-frequency, tilt corrector that "tunes out" this transmitter weakness.

- Features include:
- Full NRSC compliance
 - All-in-one construction
 - Advanced digital control produces a clean, powerful signal
 - Reduces relected power from narrowband antenna systems
 - Operates in the highest RF environments
 - Internal Phase-rotator
 - Internal low-frequency tilt corrector with 80 Hz square-wave generator
- MFG. LIST \$2,745.00 CALL FOR BSW PRICE

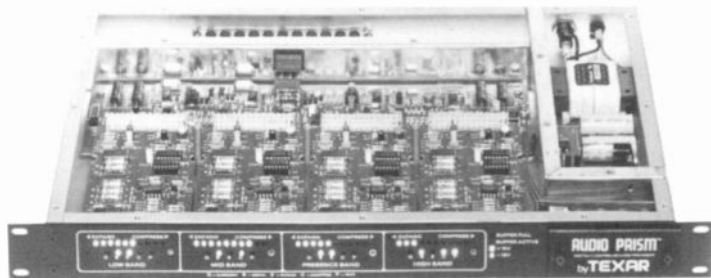

**MODEL AUDIO PRISM™
AUDIO PROCESSOR**

The TEXAR Audio Prism delivers world class modulation punch without the grunge factors that can drive listeners away. The secret is digital control. Digital controls allow you to have the best of both worlds: power and clarity.

In addition, the Audio Prism can deliver full modulation power without the fatigue factors that appear so often when audio processors are set to maximize modulation.

The Audio Prism uses a four-band parallel layout with opto-attenuators assuring predictable and smooth gain change. Should you experience unusually high input levels, you'll stay in normal operating range because the Audio Prism incorporates a broad-band safety buffer. Each band is individually gated. A single density control simultaneously allows for attack and release times to be adjusted.

Set up is quick and painless. A pink noise generator and front panel test points are standard. The Audio Prism is designed to go before a final peak limiter and stereo generator. Two units are needed for stereo.

MFG. LIST \$1,995.00 CALL FOR BSW PRICE

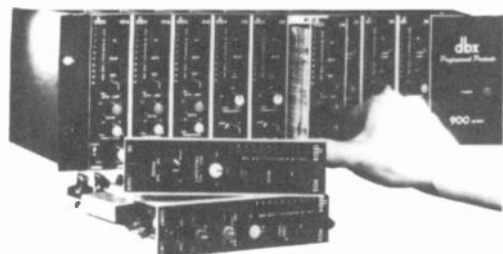

MODEL 900 SERIES SIGNAL PROCESSING SYSTEM

The 900 series modular signal processing system from dbx packs up to 9 processing modules in a single 3 space rack. Fill it up with your choice of noise reduction, de-essers, compressor/limiters, noise gates, and parametric equalizers. Get all the details from your BSW sales representative.

PRICES BASED ON CONFIGURATIONS



MODEL 166 DUAL-CHANNEL GATED COMPRESSOR/LIMITER

Features:

- Noise gating with switchable release rate
- Variable over-easy compression
- Peak stop, for good sounding clipping
- Sidechain monitoring
- Rack mountable; low profile
- Hardwire bypass
- Stereo or dual-mono operation

MFG. LIST \$599.00 CALL FOR BSW PRICE



MODEL 140A BROADCAST NOISE REDUCTION SYSTEM

The dbx Model 140 simultaneous encode/decode broadcast noise reduction system is a two channel compressor/expander providing a minimum of 30 dB broadband audio noise reduction with a 10 dB increase in system headroom. Two channels feature independent encode and decode circuitry.

In the record mode, the system compresses the input signal by a 2:1 ratio, linear in decibels over a 100 decibel range. Upon playback, the circuitry produces an exact mirror image 1:2 expansion of the encoded signal.

The dbx system eliminates tape hiss in recording, and prevents the noise build-up normally encountered in transferring information from one recorded medium to another; it does not remove noise present in the original signal.

MFG. LIST \$569.00 CALL FOR BSW PRICE



MODEL 160X MONO COMPRESSOR/LIMITER

In the world of compressor/limiters, the 160X is known as the standard — and with good reason. It delivers outstanding performance and easy to use operational flexibility in a slimline rack mount package. Its metering system provides an instantaneous picture of the gain reduction of the compressed signal compared with either the input or the output level. The 160X is a textbook lesson in compression.

The 160X has all the features a studio operator, broadcast or sound reinforcement engineer, or professional musician would want, as well as outstanding reliability for difficult road and performance conditions. It is the only compressor/limiter that gives you the choice of over-easy or hard-knee operation, irrespective of compression ratio. The unique infinity + compression offers unusual sonic effects, and access to the rms-defector input offers both frequency and time dependent compression.

MFG. LIST \$429.00 CALL FOR BSW PRICE



MODEL 163X COMPRESSOR/LIMITER PREAMP

The 163X provides traditional dbx sonic quality and performance in a rugged, easy to use package at a very untraditional price. It's designed for the working musician, sound contractor, small studio operator, disco DJ — anyone who needs a low cost, friendly compressor/limiter/preamp.

The 163X was designed for simplicity of use at no sacrifice in sonic quality. A single fader, along with the level-set control, provides the flexible combination of compression and gain at a consistent output level. Rear and front panel inputs allow quick and complete system hookup and operation that can be switched over to instrument or microphone just by "plugging in" to the front panel.

MFG. LIST \$149.00 CALL FOR BSW PRICE

BSW's experienced sales staff is dedicated to meeting the needs of today's broadcasters.

**Call toll free 1-800-426-8434
or Fax 206-565-8114**

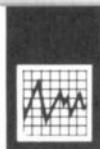

**MODEL DX2
NOISE REDUCTION SYSTEM**

The Dynafex™ model DX-2 incorporates patent pending noise reduction circuitry that provides up to 30 dB of noise reduction without the encode/decode process.

The Dynafex™ system has gained wide popularity in the professional audio market because of its ability to remove noise from virtually any audio source. Companding type noise reduction systems cannot remove noise from original source material; they only prevent further noise build-up during the recording and playback processes. Being a single-ended system, the Dynafex™ is useful in recording studios, on-line in broadcasting, mixdown recording, video and film production, disc mastering, live sound reinforcement, tape duplication, satellite communications, plus many other applications.

MFG. LIST \$820.00 CALL FOR BSW PRICE



**MODEL EM1000-1
MICROPHONE PROCESSOR**

The Emph'a Sizer is a complete processing system for studio microphones. The EM1000-1 is a powerful tool for broadcast applications.

Unit Features:

- Noise gate
- 4 band parametric equalizer with 4 selectable presets
- Compressor/limiter
- Quality mic preamp

MFG. LIST \$1,395.00 CALL FOR BSW PRICE

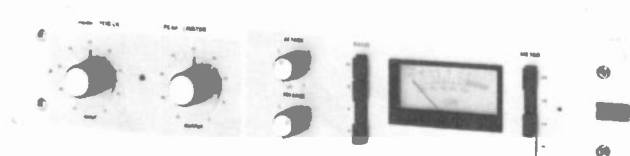

**MODEL 1176LN
PEAK LIMITER**

Features:

- True peak limiter
- Excellent noise specs
- Ultra-fast attack time
- Extremely stable

MODEL 1176LN

MFG. LIST \$730.00 CALL FOR BSW PRICE

MODEL 1178 DUAL PEAK LIMITER

MFG. LIST \$1,150.00 CALL FOR BSW PRICE



**MODEL 535
DUAL GRAPHIC EQUALIZER**

Features:

- Two channels in one complete package
- Ten adjustable equalizers on each channel
- Low distortion, low noise
- Balanced inputs and outputs

MFG. LIST \$690.00 CALL FOR BSW PRICE

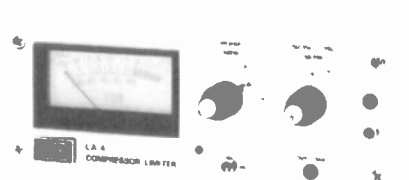

**MODEL LA-4
COMPRESSOR/LIMITER**

Long established in the industry, the Urei LA-4 compressor/limiter gives you smooth, natural sounding compression with selectable compression ratio.

Features include:

- Long life LED attenuator
- Smooth, natural sounding RMS action
- Input overload indicator
- Simple stereo coupling
- Space saving 8½" wide
- Two units needed for stereo

MFG. LIST \$620.00 CALL FOR BSW PRICE

Need prices on a major project? Save yourself time and FAX us your equipment list. We'll have a complete price quote back to you in no time.

BSW FAX # 206-565-8114

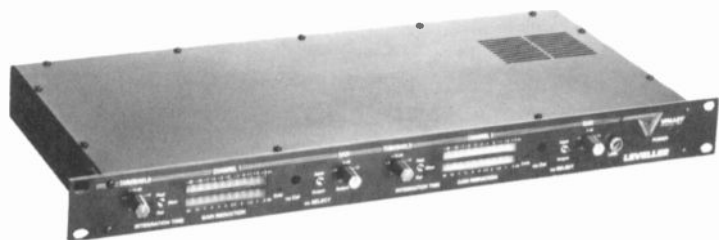

THE LEVELLER AUTOMATIC GAIN CONTROLLER

The Leveller from Valley International is a great device for general purpose levelling applications. While the Leveller uses the latest in state-of-the-art electronic components and complex proprietary circuitry to yield unprecedented level control over your audio signals, you'll find that the sound derived is very warm and natural. In fact, the processed signal is reminiscent of the "tube" sound popular many years ago and recently experiencing revived interest. A suggested application would be for overall level control for your on-air console output.

MFG. LIST \$599.00 CALL FOR BSW PRICE



MODEL 440 COMPRESSOR/LIMITER

Every now and then a truly unique audio signal processor is introduced which evokes the response, "That's just what I've been looking for." The Model 440 limiter/compressor/dynamic sibilance processor is a revolutionary device, sure to put smiles on the faces of broadcasters, recording engineers and sound reinforcement professionals.

The Model 440 limiter/compressor/dynamic sibilance processor offers the convenience of a peak limiter, a high quality compressor/expander package, and a dynamic sibilance processor section, each controlling a common VCA (voltage controlled amplifier). Sophisticated intercoupling of the control circuitry used for each function allows the device to simultaneously limit, compress, expand and eliminate undesirable high frequency components in sibilance.

MFG. LIST \$940.00 CALL FOR BSW PRICE



MODEL 400 MICROPHONE PROCESSOR

How do you emphasize your on-air personalities' impact? Give them a Model 400 mic processor from Valley International! To begin with, the Model 400 contains a high quality mic preamp, so you can go line level into your console.

Other features include:

- 3 band EQ section
- Compressor/expander
- Noise gate
- De-esser

The Model 400 from Valley International offers the ultimate vocal mic control and dynamics processing capability.

MFG. LIST \$649.00 CALL FOR BSW PRICE



MODEL 610 COMPRESSOR/LIMITER

The Model 610 dual compressor/expander offers the convenience of two high quality compressors with the flexibility of multi-function dynamics processing in an attractive, rugged 3 1/2" x 9" rack package. Each of the two channels consists of a compressor section and an expander section both controlling a common channel VCA. A special release coupling circuit provides symmetrical release characteristics for both the compressor and expander making interactive processing possible, thus eliminating the problems associated with using separate dedicated function units.

Applications:

- Compressing mixed program material for increased loudness
- Processing noisy cartridge recordings for increased presence and reduced noise
- Pre-emphasis compensated limiting or compression for stereo STL or program feeds
- AGC and limiting AM stereo

MFG. LIST \$1,250.00 CALL FOR BSW PRICE

Leasing?

Leasing equipment saves working capital. Talk to your BSW Sales Representative on the advantages of leasing your next equipment purchase from BSW.

1-800-426-8434

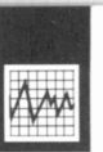

APHEX
SYSTEMS

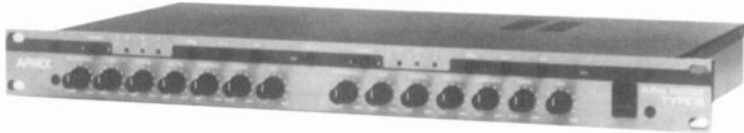

MODEL 250
AURAL EXCITER™ TYPE III

The Aphex Aural Exciter Type III utilizes a patented audio process that will recreate and restore missing harmonics. These harmonics are musically and dynamically related to the original sound. When added, they restore natural brightness, clarity and presence, and can actually extend audio bandwidth.

The Type III is the latest generation, fully professional Aural Exciter loaded with powerful new processing features and improved circuitry. The dual channel Type III adds thrilling new dimensions to Aural Excitement. Noise and distortion are virtually eliminated in the Type III circuitry, while the new special features now make enhancement possible while actually erasing noise from noisy sources.

Use in your on-air processing chain for outstanding audio enhancement, without an increase in modulation.

MFG. LIST \$995.00 CALL FOR BSW PRICE

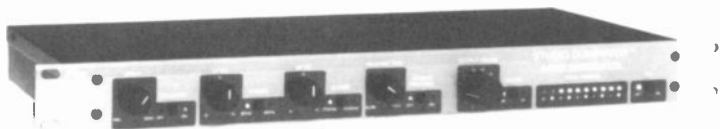

THE DOMINATOR™
STEREO TRI-BAND PEAK PROCESSOR/LIMITER

The Dominator from Aphex is a stereo multiband peak limiter designed to fit a wide range of audio applications. Through the use of multiband techniques along with new proprietary circuits, the audibility of limiting action has been greatly reduced, especially when compared to conventional limiters. This means that greater limiting depth is possible, resulting in higher loudness with maintained audio quality. At virtually any limiting depth, the Dominator is free of "hole punching," "dullness," and most other sound deterioration normally associated with limiters. As a peak overshoot protection limiter, the Dominator is undetectable in line while it absolutely prevents peak levels from exceeding a user settable output level. In addition, the desired limiting effects of greater audio density, increased "punch," etc., are readily available with the Dominator.

Several options make it the ideal final processor for FM, AM, TV or production.

MFG. LIST \$1,195.00 CALL FOR BSW PRICE



MODEL COMPELLOR
COMPRESSOR/AGC

The Compellor is a revolutionary audio processor. It delivers invisible compression, leveling and peak limiting simultaneously! The Compellor control circuits are actually analog computers that constantly monitor the input, adapt and control a single VCA per channel for minimal signal path. Operating controls are kept to a minimum, for the Compellor intelligently varies all the parameters for you. All you need do is set input level to control the amount of processing, adjust output level, and set the balance between compression and leveling. That's it. The Compellor will then provide complete dynamic control — smooth, inaudible gain riding for consistent increased loudness — all automatically. Its unique circuitry actually enhances transient qualities, making even heavy processing undetectable.

This smart, versatile, cost-effective processor is equally at home in broadcast pre-processing microphone control, audio production, tape duplicating, live sound and film dubbing; producing the "consistent sound" audio engineers have always sought, but seldom found.

MONO
MFG. LIST \$795.00 CALL FOR BSW PRICE

STEREO
MFG. LIST \$1,195.00 CALL FOR BSW PRICE

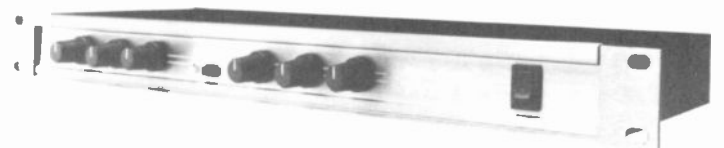

AFFORDABLE PROCESSING FOR PRODUCTION

MODEL TYPE C
AURAL EXCITER™

Aphex Aural Exciters are known for their ability to restore natural brightness, clarity and presence to any audio. They use a patented process involving harmonic restoration rather than some form of equalizer filtering or phase scrambling.

The Type C is the perfect solution to spice up a dull production room. You simply must hear it to believe it. Output noise is a quiet -100 dBm.

MFG. LIST \$299.95 CALL FOR BSW PRICE



SENTRY SYSTEMS



MODEL FS12C AUTOMATION CONTROLLER

Remember the days when the price of an automation system was out of sight? Well, Sentry Systems is changing all that. The FS12C Format Sentry starts at less than \$5,000.00. It is the heart of the automation system and will interface with almost any type of audio gear. When you purchase the FS12C you get the controller and software. All you add are the audio sources and a personal computer. Your station can be operated fully automated, Satellite, or live assist. The memory is large enough to offer 50,000 events. 12 sources standard, expandable to 24. The software allows traffic integration and operates with a real time clock. Complete logging is incorporated so record keeping is all automatic. BSW and Sentry Systems are ready to talk about your next automation system. 1-800-426-8434.

MFG. LIST \$4,900.00 CALL FOR BSW PRICE

M.W. PERSONS



MODEL PROGRAMMER 3A LIVE ASSIST CONTROLLER

Features:

- Use reel to reel tapes in live radio format
- Full logic control including next play memory and auto segue
- Full mono and stereo audio control including cue
- Liquid crystal digital minutes and seconds timer
- Connects directly to up to four channel Otari ARS-1000DC or Revox PR99 reproduce only decks
- Interface with any other reel to reel machine using 25 Hz Tone Processors

MFG. LIST \$990.00 CALL FOR BSW PRICE

IGM

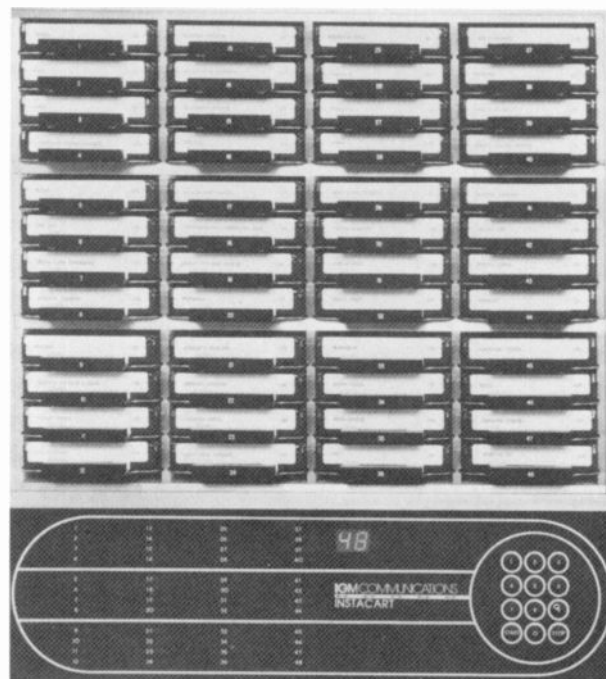

MODEL INSTACART MULTI-CART PLAYBACK SYSTEM

IGM Instacarts are the industry standard cartridge playback units used in automation systems worldwide. Modular construction allows capacity to be available in 4 different configurations. Choose from 12, 24, 36 or 48 cartridge capacity, mono or stereo.

Full manual control of each tray is available should the operator have to bypass the automation system. The tape drive system consists of high quality, high torque motors designed for continuous duty operation. For all the technical details and pricing information on IGM Instacarts call BSW toll free 1-800-426-8434.



MODEL EC AUTOMATION CONTROLLER

The leader in automation systems has developed an inexpensive controller/system. The EC System fits in a 5 1/4" rack space and operates under the control of the Host PC (user provided). Microprocessor control and command features are coupled with switching to provide trouble-free operation. Allows the use of 12 audio sources and 2500 event capacity. Special files for music rotation and random select programming. Floppy disk memory backup during operation.

Call your BSW Sales Rep for information on all IGM Automation equipment.

MFG. LIST \$4,975.00 CALL FOR BSW PRICE



NORTRONICS



MODEL PF-116/PF-132

Non-flammable, non-toxic, and completely safe on plastics, rubber, metals, painted surfaces, epoxies and elastomer parts.

PF-116 HEAD CLEANING SPRAY (16 oz.) \$8.60

PF-132 HEAD CLEANING LIQUID (32 oz.) \$14.80

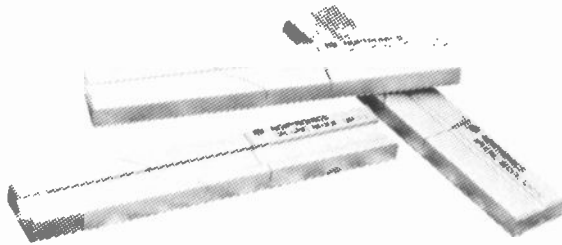

SPLICING BLOCKS

NORTRONICS PF-311

BSW PRICE \$30.70

EDITALL S3

BSW PRICE \$39.20

FOSTEX 9930

BSW PRICE \$18.00



MODEL PF 710

ZENITH HEIGHT GAUGE

Features:

- Two measuring devices in one
- Easy to use

BSW PRICE \$54.70

COTTON SWABS

By BSW



FOR CLEANING TAPE HEADS

Extra long for hard to reach areas.

BCS 100 (100 Quantity) \$3.50

BCS 500 (500 Quantity) \$14.50

BCS 1000 (1000 Quantity) \$29.00

CARTRIDGE LABELS

By BSW



Six colors to choose from (black, red, orange, green, blue, yellow).

ROLLS (1,000 Labels) \$19.95 per roll

SHEET (10 Labels) 1-50 sheets 26¢ per sheet

SHEET 51+ sheets 25¢ per sheet

FIDELIPAC



328

326

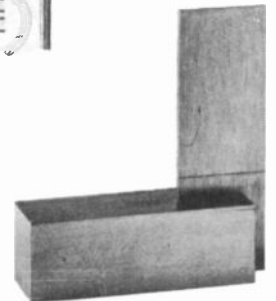

387

MODEL 328

HEAD INSERTION GAUGE

BSW PRICE \$7.90

MODEL 326

HEIGHT GAUGE

BSW PRICE \$28.70

MODEL 387

RIGHT ANGLE ZENITH

BSW PRICE \$34.15

If it has to do with carts, BSW is the supplier for you. We stock the largest supply of cartridges, machines, and maintenance supplies in the industry. When you can't afford to wait, call BSW. 12 hours daily 1-800-426-8434.



3M

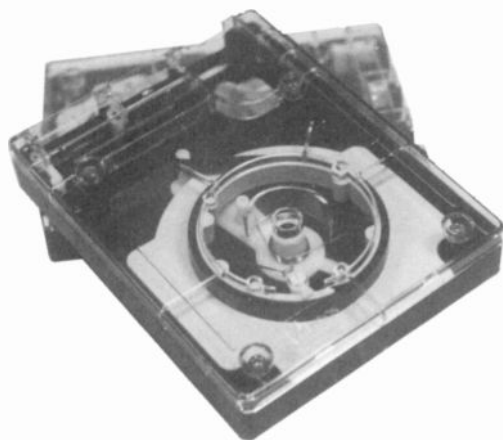

SCOTHCART STEREO CARTRIDGE

Impressive. That's what the Scotchcart broadcast cartridge is. The sales growth and acceptance of this cartridge has been phenomenal to say the least.

Together, the innovative design of this cart and the superior mastering tape formulation offer you performance capabilities far beyond what you have come to expect from broadcast cartridges.

Not only will you hear unbelievable reel-to-reel sound quality, but Scotch has used the most advanced technologies to eliminate many of the most unwanted cart problems.

FOR BEST PRICES AND DELIVERY
CALL BSW TOLL FREE 1-800-426-8434

AUDIOPAK

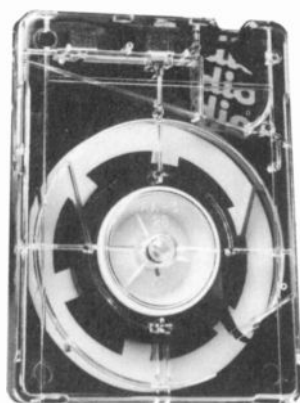

AUDIOPAK AA-3 STEREO CARTRIDGE

Precision molding provides highly accurate tape guiding inside the cartridge for excellent stereo phase stability. Tough, reinforced plastics resist warping and damage due to even severe mishandling, thus assuring the phase will not change under any use conditions for the life of the cartridge.

CALL FOR BSW PRICES

AUDIOPAK

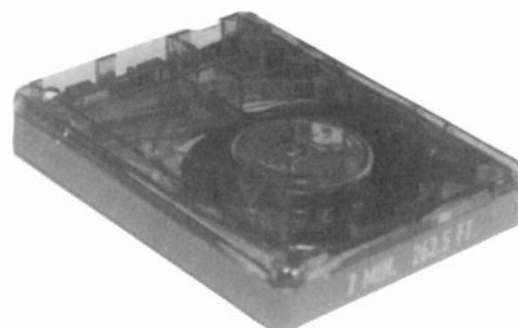

AUDIOPAK AA-4 STEREO CARTRIDGE

The key feature of the AA-4 is the SGS-4 broadcast mastering tape. When recorded on a high quality cartridge recorder, the SGS-4 tape can produce virtually identical copies of the best analog or digital master tapes. The SGS-4 tape, available exclusively in AA-4 cartridges offers nearly 5 dB higher saturation headroom at 16 kHz (7½ ips) compared to the HOLN Tape in AA-3 cartridges. No bias adjustment is usually necessary when recording on machines optimized for HOLN or other "hot" tapes.

CALL FOR BSW PRICES

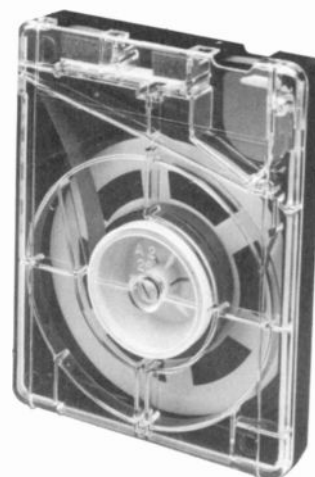

AUDIOPAK AA-2 MONO CARTRIDGE

The most popular cartridge on the market for monaural broadcasting.

CALL FOR BSW PRICES

Customer Service

BSW's "after the sale" support is second to none. Your complete satisfaction is our only goal and we pay for the call.

**Toll Free
1-800-426-8434**



FIDELIPAC®



DYNAMAX STEREO CARTRIDGE

This Dynamax cobalt cartridge is rapidly gaining recognition as something special. A new generation cartridge loaded with broadcasting's first cobalt tape.

The Dynamax shell is constructed of high grade engineering plastic for more strength, greater heat stability and dimensional accuracy.

The new cobalt tape provides extra headroom necessary when carting CD's.

CALL FOR BSW PRICES



FIDELIPAC 300 MONO CARTRIDGE

The widely used grey cart at competitive prices.



MASTERCART AA

The AA cartridge with standard tape for mono or stereo broadcasting.

CALL FOR BSW OUTSTANDING PRICES
AND OUTSTANDING DELIVERY

CARTRIDGE REBUILDING SERVICE By BSW

CARTRIDGE REBUILDING...THE PRACTICAL, AFFORDABLE WAY TO LOWER YOUR CARTRIDGE BUDGET

Your cartridge investment is a substantial one. It's a shame to treat carts like a disposable product when they really aren't. Before you toss them out, send them to BSW.

For over 15 years, BSW has been bringing dead, useless cartridges back to life. Over 200,000 carts have gone through our rebuilding process providing them with many more hours of dependable, quality air time. The end result is new cart performance at 1/3 to 1/2 the price.

What happens when you send your carts to BSW? First they are inspected for any plastic flaws and parts wear. All carts are disassembled and tape removed.

Your carts are now chemically cleaned in a special solution that removes the labels, graphite, wax, dirt, and other debris.

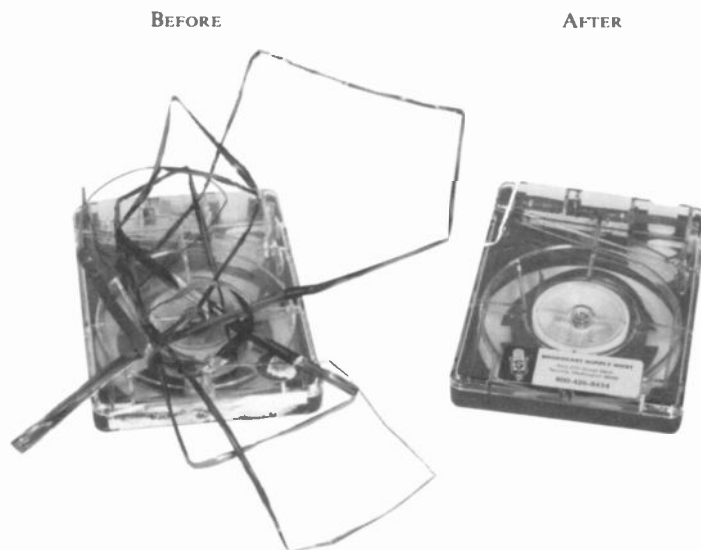

BSW loads the carts in lengths specified by you. Tape is of the finest quality and it's your choice. (There is an additional charge for hot tape.) Upon loading with the new tape, all your carts are tested for technical accuracy.

Several stations accumulate failed and worn-out carts and send monthly or quarterly shipments to BSW. You can too.

Simply box them up, specify the lengths of tape desired and send to BSW, 7012 27th Street West, Tacoma, WA 98466. Within ten working days after receipt of your shipment, your revitalized cartridges will be on their way back to you. BSW rebuild service. Smart cents for your cartridge investment . . .

*BSW is open 12 hours daily from 6:00 a.m. to
6:00 p.m. Pacific Time.*



MODEL DURA TRAK 90 SERIES CARTRIDGE MACHINES

What are the most important criteria in selecting a broadcast cartridge machine? Ask an air personality or programmer and the answer will be "audio quality" or "ease of use". Ask an engineer and you'll surely hear "durability and easy maintenance". And the front office is naturally concerned with the bottom line.

Broadcast Electronics — with thirty years of experience in broadcast cartridge machine design and production — is proud to present the cartridge machines that satisfy all these requirements: the Dura Trak 90.

Available in record/play and playback configurations, Dura Trak 90 cart machines offer sparkling audio performance to meet the demands of today's higher-quality audio sources, and today's more demanding listener expectations.

Dura Trak 90 gives you all the features broadcasters need most, at a most affordable price. And perhaps most important in the non-stop world of radio and television, Dura Trak 90 is built to deliver long term durability.

Features:

- Rugged direct drive motor
- Machined 1/2" thick aluminum deck plate
- Rugged glass epoxy PC board construction
- Low voltage, current regulated solenoid
- Fast forward standard
- Three cue tone sensing standard
- Cart-previously-played lockout
- Toroidal power transformer
- Instrumentation-quality balanced inputs
- Fully floating active balanced outputs
- Front panel 1 kHz record defeat
- Pressure roller cleaning mode

MONO AND STEREO MODELS AVAILABLE
CALL FOR PRICES AND SPECIFICATIONS



MODEL SPLICE TRAK 90 SPLICE FINDER/ERASER

For optimum performance in any system, every cart needs to be prepared before recording: The cart should be deep-erased and the tape splice located and positioned *before* the start of audio. For fast, reliable erasure and splice detection, you can't beat the ST-90 Splice Trak. Running at 27.5 ips (23 ips at 50 Hz), it zips through your carts. Yet it provides a minimum of 85 dB of audio erasure with any NAB standard cart. The splice detector is virtually 100% accurate because it actually senses the thickness of the splice itself rather than using the less-reliable photocell method used by other devices.

MFG. LIST \$1,050.00 CALL FOR BSW PRICE

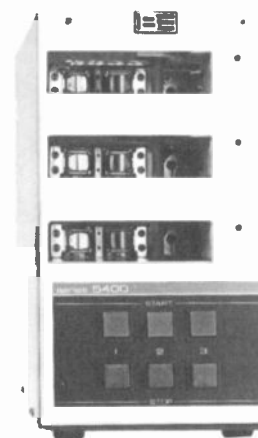

MODEL 5400 SERIES MULTI-DECK CARTRIDGE MACHINE

Clean sound reproduction and smooth, consistent performance are just two of the reasons why the Broadcast Electronics 5400C is one of the most trusted cart machines in the industry today. The 5400C is designed for the user who requires the utmost in long term reliability and ease of operation. As a three deck cart machine, the 5400C will fit perfectly in any production or on-air studio environment.

The 5400C is fully equipped with plug-in decks for quick, easy servicing. The optional recording amplifier (mono model 5409C or stereo model 5410C) is available for recording on deck three independent of the other remaining decks. This allows the 5400C to be utilized as a three deck playback only machine, or as a two deck playback with record/play capability on deck three.

CALL FOR PRICES AND SPECIFICATIONS

All Telephones Lead To BSW

Toll Free from all 50 states including Puerto Rico,
US Virgin Islands and Canada. 1-800-426-8434

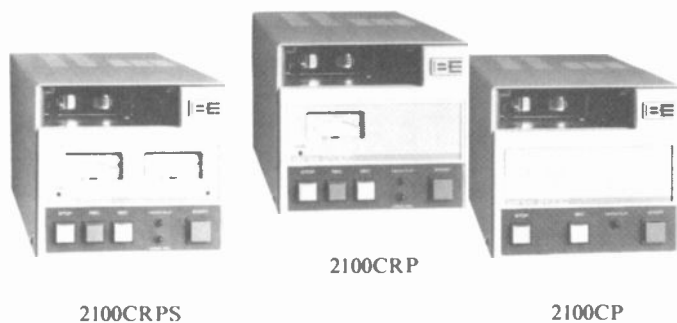

**SERIES 2100C
CARTRIDGE MACHINES**

The Series 2100C's are the most effective professional tape cartridge machines in the industry today. No other cart machine combines the value and economy of the 2100C's. For example, the Series 2100C's include two cue tones (1 kHz and 150 Hz) as standard features. The construction is modular for easy maintenance. Flat response, long life heads offer superb performance and the direct drive transport ensures maximum reliability.

The record circuitry features differently balanced inputs followed by high performance operational amplifiers. This input design permits an extremely wide dynamic operating range.

The stereo 2100C's can be used to record carts that will be compatible with mono machines. A front panel LED indicates when the machine is in the mono recording mode. In the mono mode, the left and right channels are summed together and recorded on the left channel. In addition, the mono encode tone (150 Hz and 1 kHz) is recorded on the cue track.

VU meters are automatically switched between playback and record modes.

Features:

- Two cue tones standard (1 kHz and 150 Hz)
- Exclusive mono/stereo switching
- New precision adjust Phase Lok V head block
- New flat response, long life heads
- Precision machined deck with improved cartridge guidance system
- Direct drive transport
- Modular construction
- Low-voltage air damped solenoid
- Advanced electronics

- MODEL 2100CP** (Mono playback) MFG. LIST \$1,525.00
- MODEL 2100CRP** (Mono record/playback) MFG. LIST \$2,195.00
- MODEL 2100CPS** (Stereo playback) MFG. LIST \$1,625.00
- MODEL 2100CRPS** (Stereo record/playback) MFG. LIST \$2,495.00

CALL FOR BSW PRICES

**SERIES 3000A
CARTRIDGE MACHINES**

The Series 3000A retains the features that made its predecessor famous and adds new improvements and extra features that all users are sure to appreciate. These new improvements include the addition of the Phase Lok V head block, and innovative cartridge guidance system, a powerful air damped solenoid, and flat response long life heads. In addition, automatic/manual fast forward and three cue tones are now standard in the series 3000A. The styling has changed also to include a new front panel layout.

Features:

- New Phase Lok V head block
- Improved cartridge guidance system
- More powerful, air damped solenoid
- Direct drive hysteresis synchronous motor
- Gold to gold contacts
- New flat response long life heads
- Automatic//manual fast forward - standard
- Three cue tones - standard

**MODEL 3100A
SLIM LINE**

For use with NAB A and AA cartridges. Available in mono and stereo playback models. Three units can mount side-by-side in a 19 inch rack shelf.

**MODEL 3200A
COMPACT**

For use with NAB A, AA and B cartridges. Available in mono and stereo record/playback and playback only models. Two 3200A units can mount side-by-side in a 19 inch rack shelf.

- MODEL 3100AP** (Mono playback) MFG. LIST \$1,900.00
- MODEL 3100APS** (Stereo playback) MFG. LIST \$2,050.00
- MODEL 3200ARP** (Mono record/playback) MFG. LIST \$2,925.00
- MODEL 3200ARPS** (Stereo record/playback) MFG. LIST \$3,275.00

CALL FOR BSW PRICES



MODEL PT90PS/PT90RPS CARTRIDGE MACHINES

The Phase Trak 90™ is a completely integrated electronic package specifically designed to meet the changing needs of today's broadcast professional.

Automatic Non-encoding Phase Correction

The phase correction circuit of the Phase Trak 90 continually monitors and corrects the phase relationship between the playback audio of the right and left channels. The output of any cartridge will undergo automatic phase correction when it is played through the Phase Trak 90 - regardless of what machine was used to produce the cartridge originally.

The phase correction capability of the Phase Trak 90 is essentially invisible to the operator, requiring no user adjustments. (A front panel LED bar-graph indicator is provided to show the amount of relative phase correction taking place during the play cycle.)

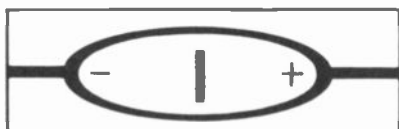

Automatic Tape Analysis

Introducing a new brand of tape is easy with the Phase Trak 90 Record/Play. Through its microprocessor-assisted automatic tape analysis system, the Phase Trak 90 will completely evaluate a new tape and "learn" all of the bias, level and EQ settings necessary to obtain optimum performance. These settings are then stored in memory, ready for selection.

Excellent Audio Performance

The Phase Trak 90 boasts a signal to noise ratio of better than 80 dB (with Dynafex® noise reduction operational). At ±2 dB, 40 Hz to 16 kHz, the excellent frequency response of the Phase Trak 90 delivers "audiophile" quality in any application. Wow and flutter specifications are also outstanding at less than .12%.

Modular Construction

The Phase Trak 90 is completely modular for the ultimate in servicing convenience. All modules are easily removed from the back of the cabinet. Test points and adjustments are reached by removing the top cover.

MODEL PT90RPS (Record/Play Stereo)
MFG. LIST \$4,295.00

MODEL PT90PS (Play Only Stereo)
MFG. LIST \$2,650.00

CALL FOR BSW PRICES



MODEL CTM-10 SERIES CARTRIDGE MACHINES

The CTM-10 series NAB cartridge machines and recorders are designed for broadcast and audio post-production professionals. The microprocessor-controlled CTM-10 cartridge players offer the high performance, outstanding features, and "workhorse" reliability for which Otari productions are known.

The series consists of three models: the CTM-10SR stereo record/play deck; the CTM-10MR mono record/play deck; and the CTM-10 combination mono/stereo playback deck, to which recording capability is a simple conversion. Three CTM-10 series decks may be rack mounted side-by-side in only 5 1/4" of 19" rack space. The record electronics unit, housed in a separate chassis, is the same size as the playback unit.

The tape speed of CTM-10 transports may be user-converted to 15, 7.5 or 3.5 ips by means of internal jumpers.

The CTM-10 record electronics unit uses Dolby HX-Pro™ bias optimization circuitry. HX-Pro increases the CTM-10's high frequency dynamic headroom, to yield high frequency performance at 3.75 ips which is equivalent to non-HX performance at 7.5 ips; and likewise 7.5 ips is equivalent to non-HX performance at 15 ips.

HX-Pro is not noise reduction so it needs no decoding; thus the benefits of HX-Pro recording will be evident in playback on all cart machines.

The CTM series are one of the most feature laden cartridge machines available. Let us tell you more about it. Call us toll free for all the details.

MODEL CTM-10 (Mono/Stereo Play)
MFG. LIST \$2,195.00

MODEL CTM-10M (Mono/Record Play)
MFG. LIST \$2,445.00

MODEL CTM-10S (Stereo/Record Play)
MFG. LIST \$2,695.00

MODEL CTM-10R (Record Electronics)
MFG. LIST \$1,350.00

REQUIRES CTM-10R FOR RECORD FUNCTION

CALL FOR BSW PRICES



ITC

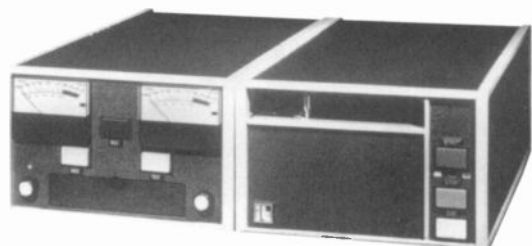

**MODEL 99B SERIES
CARTRIDGE MACHINES**

Loaded with features, the 99B series delights the most discriminating user and listener. Central to the 99B series is the patented ELSA feature found in the recorder. The ELSA cartridge preparation feature automatically erases the cartridge, locates the splice and azimuth aligns the record head for maximum phase response performance. The 99B series standard features include: Microprocessor controlled logic, high speed cueing, and three cue tones. Crystal referenced phase lock loop DC brushless servo motor offers precise speed control and low wow and flutter. Plug-in P.C. boards have socketed I.C.s with gold edge connectors and microprocessor design virtually eliminates all troublesome relays.

More than just a cartridge machine, the 99 Series from ITC is a complete system for recording and playback.

MODEL 99B (Stereo Record/Play)

MFG. LIST \$6,595.00 CALL FOR BSW PRICE



**MODEL OMEGA SERIES
CARTRIDGE MACHINES**

Available in mono record and mono or stereo play versions, the Omega has all the ITC quality you demand, in an affordable package.

High-speed cueing and two cue tones are standard. All logic is microprocessor controlled and the motor is DC servo. Cartridge played indicator and cart replay lock-out reduce possible operator errors.

MODEL 15146 (Mono Record/Play) MFG. LIST \$2,415.00

MODEL 11574 (Mono Play) MFG. LIST \$1,605.00

MODEL 12473 (Stereo Play) MFG. LIST \$1,830.00

CALL FOR BSW PRICE

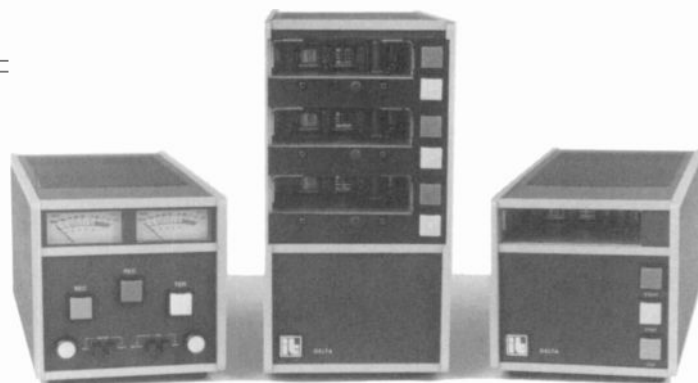

**MODEL DELTA SERIES
CARTRIDGE MACHINES**

The DELTA series consistently meets the tough requirements of professionals who demand outstanding audio performance in a reliable, mid-priced mono or stereo cartridge machine.

Standard features:

- DELTA I single deck or space saving DELTA III triple deck reproducers
- 3 cue tones
- High-speed cue on DELTA I reproducer
- Microprocessor controlled logic
- Crystal referenced phase lock loop DC brushless servo motor
- DELTA IV recording amplifier converts a DELTA I reproducer or the bottom deck of a DELTA III reproducer into a recorder

CALL FOR PRICES AND CONFIGURATIONS TOLL FREE 1-800-426-8434



**MODEL ESL V
ERASER/SPLICE LOCATOR**

The ESL V eraser/splice locator combines erasing and splice locating into one easy, automatic step ensuring consistent high quality audio reproduction from cartridge to cartridge. This eliminates the tedious task and inconsistency of manually bulk erasing cartridges and visually locating splices.

Microprocessor control assures a clean, deep erasure every time, eliminating unwanted program material and noise. High-speed splice locate (30 IPS) frees the operator from visually locating the tape splice. The operator can then perform other tasks, such as cueing tapes, pre-reading copy, locating sound effects or music while the ESL V eraser/splice locator properly prepares the cartridge for recording.

MFG. LIST \$1,200.00 CALL FOR BSW PRICE

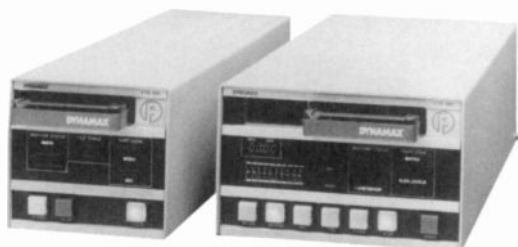

MODEL CTR 100 SERIES CARTRIDGE MACHINES

Here is the top of the line from Dynamax. The CTR 100 Series embodies unique features not available in any other machine in today's market. Central to the CTR 100 Series is CARTSCAN™. Now it is possible for you to intermix mono and stereo carts, elevated and standard levels, plus matrix record and playback, using the same machine. Simply attach a CARTSCAN label to your carts and the CTR 100 automatically changes the characteristics of the machine electronically.

Features:

- Bar graph LED level indicators
- Improved heads for flat low frequency response
- Secondary and tertiary cue tones
- Low voltage constant current solenoid
- Two speed *played* flashing indicator
- Crystal controlled reference for all internal functions
- Front panel 1 kHz add and defeat
- Audio transformerless circuitry
- Audio switcher and mixer
- On-board test oscillator
- Front panel diagnostics
- DC servo drive motor
- Fast forward
- Splice finder
- Played restart disable
- Status display

MODEL CTR112 (Stereo Play)

MFG. LIST \$2,620.00 CALL FOR BSW PRICE

MODEL CTR124 (Stereo Record/Play)

MFG. LIST \$4,390.00 CALL FOR BSW PRICE

CARTSCAN™ LABELS AVAILABLE OPTIONALLY

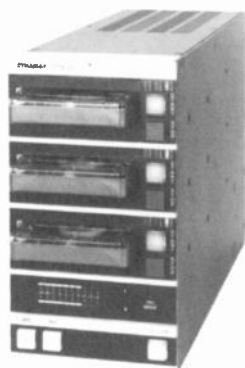

MODEL CTR 30 SERIES CARTRIDGE MACHINES

If space is at a premium, then the CTR 30 Triple Stack from Fidelipac is a must consideration. Three decks with the recorder built-in as standard. The bottom deck records as well as plays. All plug in boards are interchangeable with those used in CTR 10 series machines. All decks are removable for service without disabling the machine. Audio switcher and mixer are included to permit connection to single console input.

Flashing stop lamps warn operators of played cartridges.

MODEL CTR33 MONO

MFG. LIST \$4,800.00 CALL FOR BSW PRICE

MODEL CTR34 STEREO

MFG. LIST \$5,250.00 CALL FOR BSW PRICE

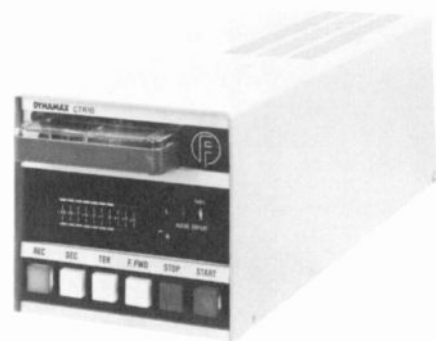

MODEL CTR 10 SERIES CARTRIDGE MACHINES

The Dynamax CTR 10 series of cartridge machines provide unsurpassed audio performance and today's most desired operational features. Compact design allows up to 3 recorders, and/or players to be placed side by side in the available rack mount.

Features:

- Fast forward
- All three cue tones standard
- High speed cueing
- Secondary tone allows control of both fast forward and audio muting
- Selectable front panel metering for audio, phase and cue tones on recorders
- Geometrically correct azimuth adjustment, independent of height and zenith
- On board audio switcher and mixer
- Transformerless audio circuitry
- Played indicator with selectable restart disable
- Industry proven AC synchronous motor for reliable operation and ease of maintenance

MODEL CTR11 (A Size Mono Play) MFG. LIST \$1,730.00

MODEL CTR12 (A Size Stereo Play) MFG. LIST \$1,875.00

MODEL CTR13 (A Size Mono Rec/Play) MFG. LIST \$2,595.00

MODEL CTR14 (A Size Stereo Rec/Play) MFG. LIST \$2,845.00

CALL FOR BSW PRICE

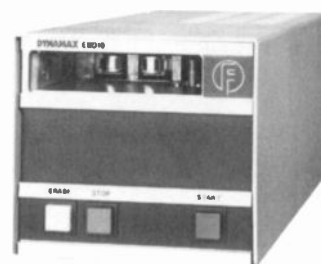

MODEL ESD10 SPlice FINDER/ERASER

Erasing and splice locating cartridges are fast and easy with the Dynamax ESD10.

Dual, full track erase heads are incorporated instead of a coil located below the deck plate. The result is an erase depth of 85dB or more and better signal-to-noise ratio when you record your carts.

Splice detection is extremely reliable and accurate with no adjustments necessary. The ESD10's powerful motor moves tape at 27.5 IPS so you're on your way recording in no time.

MFG. LIST \$1,150.00 CALL FOR BSW PRICE



Tapecaster



MODEL X-701 SERIES CARTRIDGE MACHINES

Look no further for the best value in cart machines... you have found them. Tapecaster has long been established for great performance at a pleasing price.

Features:

- Precision adjustable head bracket
- Super-torque hysteresis synchronous motor
- Heavy duty air-damped solenoid

	MFG. LIST
MODEL X-701P (Playback, Mono)	\$765.00
MODEL X-701PS (Stereo)	\$945.00
MODEL X-701RP (Record/Play Mono)	\$1,050.00
MODEL X-701RPS (Stereo)	\$1,345.00
MODEL X-701RPD (Mono Delay)	\$1,195.00

CALL FOR BSW PRICE



MODEL X-100 AUTOMATIC CARTRIDGE LOADER

The X-100 Automatic Cartridge Loader from Tapecaster provides for the accurate measurement of tape length through precision calibrated minute and second face mounted controls. Ease of operation is provided by one lever which activates the reset, start, and run functions of the X-100. Save money by winding your own carts.

MFG. LIST \$550.00 CALL FOR BSW PRICE

BSW Delivers

BSW's extensive inventory assures you outstanding delivery. Our special discount rate on Federal Express saves you dollars and time.

AUDI-CORD

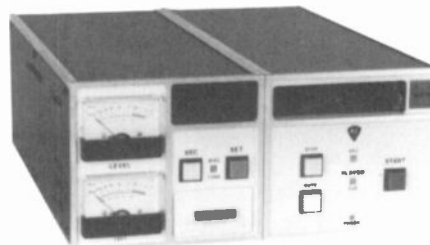

MODEL DL-RS
RECORD/PLAY STEREO



MODEL DL-PS
PLAYBACK STEREO

MODEL DL SERIES CARTRIDGE MACHINES

Here is durability at the lowest cost. The Audicord DL Series stand up to the daily grind of broadcasting and offer features that make the operator's job easier. Features include:

(Playbacks)

- Replay lock-out and reminder to prevent accidental replay errors.
- Manual or automatic muting of output audio (from SEC cue operation).
- Status indicator lamps show at a glance cue tones presence, both SEC and primary.
- Latched lamps verify that both have been sensed.
- Mute lamp to indicate audio on or off status.
- Automatic motor turn-off if selected conserves power and heat.

(Record-Plays)

- Full view meters for accurate level monitoring.
- Bias and tone presence indicators.
- Automatic meter switching from record to replay.
- Recording shutoff with the end of SEC tone option is provided.
- Full +8dBm output ability with 12db of headroom.
- Cart holding system (over top for stereo) for positive location of the cartridge.
- Slide back cover design allows for quick and easy access for cleaning.
- Complete remote control connections. Plugs are furnished.

	MFG. LIST
MODEL DL-PM (Playback, Mono)	\$920.00
MODEL DL-PS (Playback, Stereo)	\$1,000.00
MODEL DL-RM (Record-Play, Mono)	\$1,290.00
MODEL DL-RS (Record-Play, Stereo)	\$1,480.00
MODEL DL-DM (Dual Transport Record-Play, Mono)	\$2,270.00
MODEL DL-DS (Dual Transport Record-Play, Stereo)	\$2,630.00

CALL FOR BSW PRICE

BG ENGINEERING

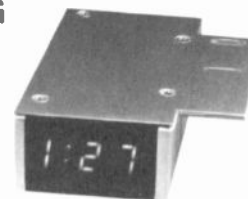

MODEL BGE T1 CART MACHINE TIMER

Should your cartridge machine lack a timer, here is the perfect add on product. The BGE T1 is a 9-minute, 59-second count-up timer that works with most cartridge machines. Fits into spare slot on B size machines and will mount outside smaller sizes.

BSW PRICE \$153.00



CASSETTES By BSW

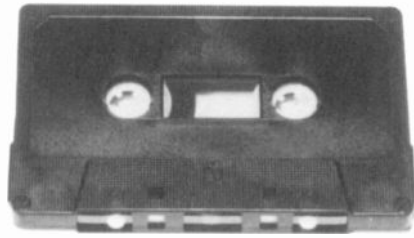

BSW cassettes are custom loaded at our facility. You're assured of the finest quality you demand, without having to pay for middle man mark up and fancy packaging. BSW stocks a complete line of cassette accessories. Call us for more details 1-800-426-8434. Prices shown below are per each. Custom lengths available for the asking.

STANDARD VOICE QUALITY HIGH OUTPUT/LOW NOISE

QUANTITY	25-99	100-499	500-999	1000+
MODEL				
C-5S	.47	.42	.35	.31
C-10S	.49	.43	.37	.33
C-20S	.52	.48	.40	.35
C-30S	.55	.51	.45	.40
C-45S	.59	.55	.52	.46
C-60S	.64	.60	.57	.51
C-90S	.75	.65	.60	.55

DELUXE MUSIC QUALITY SUPER HIGH OUTPUT/LOW NOISE

QUANTITY	25-99	100-499	500-999	1000+
MODEL				
C-5D	.62	.45	.40	.35
C-10D	.64	.46	.42	.38
C-20D	.67	.48	.44	.40
C-30D	.70	.50	.46	.42
C-45D	.74	.55	.51	.47
C-60D	.79	.59	.55	.51
C-90D	.89	.72	.68	.64

PRIME QUALITY HIGH BIAS CHROME

QUANTITY	25-99	100-499	500-999	1000+
MODEL				
C-5P	.78	.60	.55	.50
C-10P	.80	.61	.56	.51
C-20P	.82	.66	.61	.56
C-30P	.84	.67	.62	.57
C-45P	.94	.74	.69	.64
C-60P	1.00	.79	.75	.70
C-90P	1.17	.98	.93	.89

EMPTY CASSETTE BOXES

MODEL	DESCRIPTION	BSW PRICE
CMBOX	Clear Hard Plastic	.28 ea.
POLYBOX	White Soft Plastic	.22 ea.

QUANTITY DISCOUNTS AVAILABLE

TASCAM

PROFESSIONAL CASSETTE DECKS



MODEL 122 MKII STEREO CASSETTE DECK

The 122 MKII is the leader in TASCAM's line-up of professional 2-channel stereo cassette machines. To qualify for "professional" status it offers extended durability and reliability so that it can keep up with the tough, relentless pace of professional operation. At the same time, it features an extremely high standard of audio reproduction quality with a full 3-head system featuring top performance CA (Cobalt Amorphous) record and playback heads, uncompromised electronics, a precision FG-servo direct-drive capstan motor, and balanced XLR type inputs and outputs (+4 dBm), as well as -10 dBV RCA pin connectors. Accurate cue and review function.

MEG. LIST \$1,099.00 CALL FOR BSW PRICE



MODEL 112 STEREO CASSETTE DECK

The 112 is a basic 2-head machine that fully maintains the professional quality performance, stability and reliability of the top-line 122 MKII. Special care has been taken in the 112 transport system to ensure unflinching reliability and stability even under hard non-stop working conditions. The 112 electronics are just as stable and reliable as the rest of the system, while delivering the finest electronic performance possible. The entire electronic system is powered by a precision-regulated bipolar power supply so circuit operation is exceptionally stable, distortion is low and a wide dynamic range is available. Dolby HX Pro is included for significantly increased high frequency MOL, while Dolby B and C type noise reduction aid in making clean, noise free recordings. Balanced inputs and outputs.

MEG. LIST \$679.00 CALL FOR BSW PRICE



TASCAM



MODEL PORTA 05 4 TRACK PRODUCTION SYSTEM

The TASCAM PORTA 05 has been designed specifically to make multitrack recording as easy and as affordable as possible without compromising on performance or features. It's the most compact and lightweight model of its type, and unquestionably the finest in its class. The mixer section is a 4-channel design that offers plenty of versatility for both recording and playback. All four channels accept line-level input from electronic instruments, while channels 1 and 2 also have trim controls and accept microphones or direct input from electric instruments such as guitars. A 2-channel 2-band equalizer is provided on the stereo buss for tonal adjustment during both recording and mixdown.

Since external signal processing is an important adjunct to creative recording, the PORTA 05 lets you hook up virtually any type of external effect device to its effect send/receive loop — it's the only model in this class that offers this capability.

MFG. LIST \$499.00 CALL FOR BSW PRICE



MODEL 133B STEREO PLUS CUE CASSETTE RECORDER

The TASCAM Plus Stereo Cue Cassette Recorder/Reproducer with extensive auto present features.

- Two position cue select for compatibility with all analog or digital programming units
- +4 dBm balanced/-10 dBv unbalanced inputs and outputs
- 2-motor, soft-touch logic control transport
- 2 speeds; 1 7/8 and 3 3/4 ips
- Switchable mic/line inputs
- Dolby noise reduction system
- Input and output level controls for each channel
- "Simul-Sync" recording for multitrack recording auto present features
- Cue pulse/generates a 25 Hz tone on the cue channel, does not affect projector operations, but triggers auto present
- Automatic shutoff or rewind at cue tone

MFG. LIST \$1,349.00 CALL FOR BSW PRICE

marantz.



MODEL PMD430 STEREO PORTABLE CASSETTE

The PMD430 provides professional-caliber location recording in stereo. The PMD430 features 3 heads, for true off-the-tape monitoring during the record process. Noise reduction dbx allows the PMD430 to achieve a totally inaudible signal-to-noise ratio of 75 dB, for clear reproduction of low-level speech and music. Dolby B noise reduction has been included for compatibility with other decks. Other features include:

- Illuminated VU meters
- Built-in speaker
- Bias fine adjustment
- 4-Way power supply
- 3-Position mic attenuators (0-5-30db) limiter
- 3-Position tape selector (metal, CrO₂, normal)
- 3-Digit tape counter
- Memory rewind
- Auto shutoff
- Pitch control
- Auto replay

MFG. LIST \$599.00 CALL FOR BSW PRICE



MODELS PMD221/PMD201 PORTABLE CASSETTE RECORDERS

These are, without a doubt, the most popular portable, mono, cassette recorders used in broadcast. The PMD221 and PMD201 are loaded with features that make life on the road a whole lot easier. 3 "D" size batteries provide 7 1/2 hours of continuous recording and an AC power supply is provided for longer time requirements. Optional Nicad rechargeable battery pack yields 5 1/2 hours of use.

A modular telephone jack is provided for direct telephone recording and playback. The PMD221 is a 3-head design allowing tape monitoring during the recording process. Other features common to both include:

- Switchable limiter
- Built-in monitor speaker
- 3-Digit tape counter
- Cue and review
- 3-Position mic attenuation
- 3-Position tape selector (normal, CrO₂, metal)
- Automatic or manual record level
- Built-in electret condenser microphone
- 3-Position automatic noise cancel switch
- Anti-roll transport
- Vari-speed
- External speaker jack
- Volume and tone control
- Line input and output jacks

MODEL PMD221

MFG. LIST \$369.00 CALL FOR BSW PRICE

MODEL PMD201

MFG. LIST \$299.00 CALL FOR BSW PRICE

Accessories - Carry case option available - Rechargeable battery pack available.



AIWA®



**MODEL AD-S37
STEREO CASSETTE DECK**

If you thought you couldn't find Dolby HX Professional in an affordable best-quality stereo cassette deck, you're about to make a pleasant discovery. The AD-S37 uses this remarkable Dolby achievement to actually improve the dynamic range of any tape on which you record.

The AD-S37 incorporates feather-touch IC logic control, as well as other outstanding features which further serve to maximize the quality potential of all your recordings: Dolby B & C noise reduction, bias fine adjustor, cue and review for automatic cueing. MFG. LIST \$180.00 CALL FOR BSW PRICE



**MODEL AD-S27
STEREO CASSETTE DECK**

If you require a good quality, basic studio cassette recorder, the AIWA AD-S27 is the deck to consider. Operation is simple and straight-forward. Quiet tapes are assured with Dolby B and C noise reduction. Handles all tape formulations.

MFG. LIST \$120.00 CALL FOR BSW PRICE



**MODEL AD-WX777
STEREO DUBBING DECK**

New from AIWA, the AD-WX777 incorporates auto reverse recording and high-speed dubbing. In addition, 24-hour continuous playback is possible. Dolby B and C noise reduction assures quality recording.

MFG. LIST \$330.00 CALL FOR BSW PRICE

SONY.



**MODEL TC-D5 PROII
PORTABLE STEREO CASSETTE DECK**

The TC-D5 PROII is ideally suited to a wide range of professional audio applications. With twin VU meters and LED peak level indicator, you're assured of accurate sound recording. Built-in monitor speaker and headphone jack let you check your recording results simultaneously.

Peak limiter and mic attenuator eliminate clipping and suppress excess signal levels by 20 dB to prevent distortion. Inputs are mic level XLR connectors. Outputs are unbalanced RCA connectors. Powered by 2 "D" size batteries, the TC-D5 PROII allows 4.5 hours of recording time. AC power supply available optionally.

MFG. LIST \$870.00 CALL FOR BSW PRICE

Panasonic



**MODEL RQ 320
MINI MONAURAL CASSETTE RECORDER**

- AC/Battery operation with included AC adaptor
- Sound level equalizer (SLE)
- Auto-stop
- LED indicator (record/battery)
- One touch recording
- Cue and review
- Edit function
- Includes carry strap
- Jacks: DC-in, mic, monitor
- 2 "AA" batteries (not included)
- Silver
- One-year limited warranty

MFG. LIST \$45.95 BSW PRICE \$37.95



TEAC



**MODEL V-285CHX
STEREO CASSETTE DECK**

When price is the issue, the Teac V-285CHX can't be beat.

Features:

- Dolby B and C noise reduction systems
- Dolby HX Pro Headroom Extension
- Bias fine tuning control
- Direct function mechanism
- Full automatic stop mechanism
- Metal tape compatibility
- 3-position tape selector (normal, CrO₂, metal)
- Two-color LED peak program level meter
- One-touch recording
- 3-digit mechanical tape counter

MFG. LIST \$149.95 CALL FOR BSW PRICE

Technics



**MODEL RS-TR355
STEREO CASSETTE DUBBING DECK**

For outstanding quality cassette dubs, look no further than the Technics RS-TR355. Two-speed DC servo motors and full microprocessor logic assures you durability in busy broadcast environments. In addition to Dolby B and C noise reduction, Technics has added Dolby HX Pro Headroom Extension for outstanding noise reduction quality. 24-hour series playback with two 90-minute tapes is possible allowing uninterrupted playback.

MFG. LIST \$299.95 CALL FOR BSW PRICE

America's Full-Time Broadcast Supplier



6:00-6:00
Pacific



7:00-7:00
Mountain



8:00-8:00
Central



9:00-9:00
Eastern

When BSW was founded in 1973, our goal was to establish a single source supply house to serve the needs of America's broadcast professionals. Regional offices solved the problem of time zone but only served to delay delivery of equipment critical to a station's operation.

So we decided to work overtime every day of the week, 12 hours a day, there is a qualified sales engineer on duty who knows your business and your needs. And there's only one number you need to know — toll free across America. BSW's commitment to service is why we're America's full-time broadcast supplier.

BSW®

BROADCAST SUPPLY WEST

America's Full-Time Broadcast Supplier

1-800-426-8434

ORDERS • INFORMATION • SPECIFICATIONS

BSW • 7012 27th Street W • Tacoma, WA 98466 • FAX 206-565-8114

BSW's West Coast Location Allows Late In The Day Shipments. If You Need Equipment Fast, BSW Is Your Supplier.

We Offer Special Discount Rates On Federal Express.



TASCAM



MODEL CD-401 COMPACT DISC PLAYER

The Tascam CD-401 is one CD player that will adapt easily to a wide range of professional applications. To begin with, the CD-401 is rack mount ready, and has XLR balanced inputs. It also allows fader-start operation, and has a remote control unit that can be used in either the wired or wireless mode.

Tascam has spared no effort in giving the CD-401 the finest reproduction quality possible. It has a precision 3-beam pickup controlled by a special track and focus system, 18-bit 4-times oversampling, and dual D/A converters.

MFG. LIST \$799.00 CALL FOR BSW PRICE

Panasonic

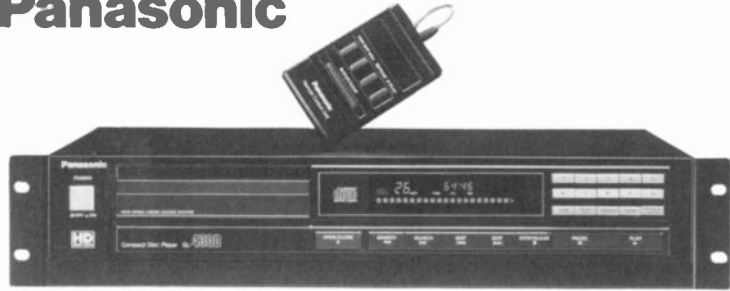

MODEL SL 4300 COMPACT DISC PLAYER

The Panasonic SL 4300 was designed for professional applications where quality audio, hard wired remote control, and rack ability are the requirements. High speed transport goes from one cut to the next so quickly, you can almost segue between two cuts using one machine. The low price of the SL 4300 won't break your bank account either.

MFG. LIST \$300.00 CALL FOR BSW PRICE

TASCAM



MODEL CD-501 COMPACT DISC PLAYER

The Tascam CD-501 compact disc player offers superior CD reproduction performance in a model that has been specifically designed for professional applications. The key words here are durability and compatibility. The CD-501 is built to rugged standards that guarantee consistent, reliable performance even through demanding non-stop use. It also features electronically balanced XLR type line inputs for direct plug-in compatibility with professional equipment.

Each CD-501 includes a full function, hard wired remote control that will operate two players. A rack mount kit is supplied. Audio quality is outstanding thanks to Tascam ZD circuitry which effectively eliminates the "harsh edge" created by D/A conversion.

MFG. LIST \$1,249.00 CALL FOR BSW PRICE

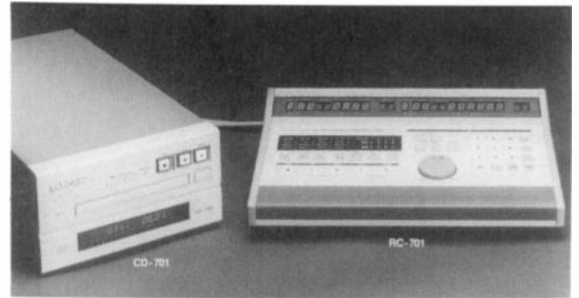

MODEL CD-701/RC-701 COMPACT DISC PLAYER/REMOTE CONTROL

The CD-701 Player Unit and RC-701 Control Unit form the nucleus of a powerful professional CD reproduction system aimed at broadcast and audio production applications. The CD-701 has been created with no compromises in mechanical or electronic design and construction, delivering the most precise, natural CD sound available. It features a full-size turntable and unique disc clamping system that virtually eliminate tracking errors, and the TEAC/TASCAM's superlative "ZD Circuit" for impeccable CD sound with an absolute minimum of digital noise. Up to four CD-701 units can be controlled by the sophisticated RC-701 Control Unit. The RC-701 offers a variety of programming and control functions, including dial-controlled search with frame accuracy, an Auto Cue function which automatically locates the start point, event play, link play $\pm 6\%$ pitch control, and others. Should you only need simple transport functions, the RC-701 allows you to program the CD player for a constant pitch change and auto-cue to music, then the remote control can be removed. You then can have basic transport functions controlled by your console or from the player's front panel.

MODEL CD-701
MFG. LIST \$1,999.99 CALL FOR BSW PRICE

MODEL RC-701
MFG. LIST \$1,249.00 CALL FOR BSW PRICE

Need prices on a major project? Save yourself time and FAX us your equipment list. We'll have a complete price quote back to you in no time.

BSW FAX # 206-565-8114



Technics



MODEL SL-P101
COMPACT DISC PLAYER

The SL-P101 is an outstanding value to the broadcaster who doesn't need frills, just good quality sound reproduction. Quadruple oversampling lets the 101 achieve a signal-to-noise ratio of 96dB and dynamic range of 94dB. High speed linear transport moves from track to track extremely fast. Plus the SL-P101 has the cue-to-music features found in the more expensive Technics players.
MFG. LIST \$199.95 CALL FOR BSW PRICE



MODEL SL-P999
COMPACT DISC PLAYER

The SL-P999 is one of the finest Compact Disc Players available in its price range. Superior electronics like 20-bit signal processing and 8-times oversampling offer outstanding low-level signal reproduction accuracy. Specially selected components such as new non-ferric carbon film resistors help minimize distortion and provide lucid, musical sonic characteristics. S/N ratio is 113dB and dynamic range is 100dB.

The SL-P999 will cue to music if desired and front panel cue wheel allows you to manually cue to any point within the cut. Fast, audible search for cueing up to 76 times normal speed is also accomplished from cue wheel.

MFG. LIST \$549.95 CALL FOR BSW PRICE



MODEL SL-P555
COMPACT DISC PLAYER

Here is the little brother of the SL-P999 shown above. The SL-P555 features 18-Bit signal processing and quadruple oversampling. Signal-to-noise ratio is 100dB and dynamic range is 98dB. Cue-to-music feature is employed and so is the cue wheel which allows turntable-like cueing. Front panel headphone jack with volume control is provided.

MFG. LIST \$379.95 CALL FOR BSW PRICE



MODEL SL-P1300
COMPACT DISC PLAYER

Technics developed the SL-P1300 to serve as a reference CD player for broadcast and other situations where the highest possible sound quality is demanded. No other player has all these features unless it's twice the price. Look at the advantages of the 1300 ... 8 times oversampling, 4 digital-to-analog converters, XLR connectors with +8dBm output, vari speed, digital output, cue wheel for precise cueing with audio. In addition, the SL-P1300 cues to music automatically.

Features:

- High resolution digital filter
- Double isolated anti resonant cabinets
- Search dial cueing - precision pitch control

MFG. LIST \$1,699.95 CALL FOR BSW PRICE

Model SL-P1200 Similar to SL-P1300 but has unbalanced outputs. (not shown)

MFG. LIST \$1,399.95 CALL FOR BSW PRICE

COMPACT DISC TEST DISC



MODEL CD TEST

Turn your compact disc player into a powerful test signal generator. This outstanding CD Test Disc from Denon includes 99 audio tests that include frequency sweeps, tone bursts, pink noise, IM distortion, square waves, and more.

BSW PRICE \$32.00



MODEL 10,000 SERIES AUDIO CONSOLES

The 10,000 series console is a uniquely qualified world class console. Its combination of DC controlled electronics and premium grade components make it ideal for the rigorous professional broadcast environment.

Timeless grace, classic engineering, and the unfailing commitment of Arrakis Systems to excellence makes the 10,000 series broadcast console the new standard of comparison.

Features:

- "On-Air", 4-track and 8-track production are all supported in one mainframe by ten main audio busses, two stereo auxiliary busses, stereo cue buss and stereo solo buss
- Mainframe hinges open on hydraulic lifters for "front of the console" access to all bussing connectors.
- External regulated and protected power supply features independent supplies for audio, logic, monitor and phantom power
- Two stereo auxiliary busses for effects/foldback
- Stereo cue system with autocue switching of earphones
- Stereo solo in place monitoring
- Monitor system provides feeds for console, host, co-host and guest headphones
- Separate control room and studio monitor systems for multiple studios
- Multistation talkback or intercom systems for multiple studios
- Multifrequency test oscillator
- Independent telephone mix-minus module
- Comprehensive remote control logic for each input

PRICES BASED ON CONFIGURATION



MODEL 12,000 SERIES AUDIO CONSOLE

The most advanced technology has been incorporated into the new Arrakis 12,000 Series. Four different input modules are available, each with 2 inputs and 3 stereo outputs. Choose from three mainframe sizes to accommodate up to 28 input modules. Extensive metering and timer are standard. Quality components including Penny and Giles faders, ITT Schadow switches, gold board connectors and solid oak trim are used.

Features:

- Easy connectorized installation
- Stereo cue system
- VCA controlled faders
- Three stereo output busses
- Universal mainframe buss design - any module can be placed anywhere
- Comprehensive logic system
 - Start and stop sources by isolated internal reed relays standard
 - Remote channel On and Off control with Tally lamps for turrets
 - Flashing OFF switches for cart machine status
 - Three muting busses for control room and two studios
 - Timer reset selectable on each module
 - Monitor DIM function during cue and talkback
- Total turret support
- Talkback to two studios
- External regulated and protected power supply
- Mic modules available with panning feature
- Line modules available with mode select feature
- Monitor system for control room and two studios
- Two user-transparent telephone mix-minus busses

PRICES BASED ON CONFIGURATION



MODEL SERIES 5000 AUDIO CONSOLE

The Arrakis 5000 Series Console is a full featured, modular console. The mainframe accommodates 16 channels plus a channel for accessory modules and a standard control room monitor module. The meter bridge boasts meters for both program and audition stereo outputs, and clock and timer. The power supply is external, regulated and protected. The entire modular front panel hinges up and back to expose the input/output terminal strip connectors. All wiring is performed from the front of the console. The compact 30" wide by 17" deep mainframe is ideal for efficient studio design.

The standard console preamp module features two balanced stereo inputs, program and audition output assignment switches, stereo cue accessed by detent on the Penny and Giles slide fader and momentary lighted module on and off switches. Remote start/stop, prefader patch points and remote module controls are standard in the 5000.

PRICES BASED ON CONFIGURATION



2000SC12S



2100SC12S



150SC6S

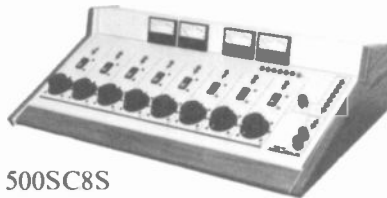

500SC8S



1500SC8S

NUMBER ONE IN CONSOLES

All Arrakis products are engineered to be reliable first. No expense is spared in the use of quality components. Their use of Penny and Giles slide faders and ITT Schadow switches are examples of this. Any product that they build must do more for the price than any competitive product. Arrakis standard features such as mono mixdowns, remote starting, 4 external monitor inputs, etc. provide features in their consoles that aren't available often at twice the price. Arrakis consoles are exceptionally cost effective while not compromising reliability or product features.

Features:

- VCA level controls
- DC controlled - no audio pots or switches
- 10 watt per channel monitor amp
- Solid oak end panels and armrest
- NE5532 integrated circuits
- Modular regulated power supply
- Mono mixdown standard
- Telephone mix-minus standard
- Remote start standard (except 150SC)

MODELS AND PRICES

150SC6S SIX CHANNELS	MFG. LIST \$1,995.00
18 inputs to 6 channels / program output	
1500SC8S EIGHT CHANNELS	MFG. LIST \$3,999.00
28 inputs to 8 channels / program and audition outputs	
500SC8S EIGHT CHANNELS	MFG. LIST \$2,999.00
25 inputs to 8 channels / program and audition outputs	
2000SC12S TWELVE CHANNELS	MFG. LIST \$4,695.00
24 inputs to 12 channels / program and audition outputs	
2100SC12S TWELVE CHANNELS	MFG. LIST \$5,695.00
34 inputs to 12 channels / program and audition outputs	

CALL FOR BSW PRICE

BACKED BY A 2-YEAR WARRANTY

SPECIFICATIONS FOR ALL CONSOLES

CHANNELS: Five through twelve

INPUTS: 1 or 2 per channel

Remote select switches - 7 inputs each

LO LEVEL - 1000 ohms, -50 dBm typical input level

Trim pot adjustable level from -60 to -30 dBm

HIGH LEVEL - 100,000, 0 dBm typical input level 30 dB

trim adjustable A & B inputs

PROGRAM/AUDITION OUTPUTS: Identical 600 ohms balanced, +27 dBm maximum output. Mono mix and mix-minus busses are the same.

MONITOR AMP: Selectable between Program (Audition) and external inputs. 10 watts at 8 ohms per channel. Line out for external amps.

CUE AMP: Selected by detent on the individual volume pot 2 watts RMS at 8 ohms per channel.

EARPHONE AMP: Selectable between Program (Audition), Cue and External, 2 watts RMS at 8 ohms per channel.

REMOTE START: Each of the channels has a ground closure for start. Jumpers determine momentary or sustained action. A & B start individually on 2 input per channel models. The 150SC has no start.

DIMENSIONS: 30"W x 17"D x 7"H.

ELECTRICAL: One channel on a fader at -15 dB.

FREQUENCY RESPONSE: ±5 dB 20 Hz to 20 kHz.

HUM AND NOISE:

MIC CHANNEL: -70 dB below +8 dBm, -50 dBm input, 20 kHz.

LINE CHANNEL: -100 dB below +18 dBm, +18 dBm input, 20 kHz.

TOTAL HARMONIC DISTORTION: .02% typical at +8 dBm.



AUTOGRAM

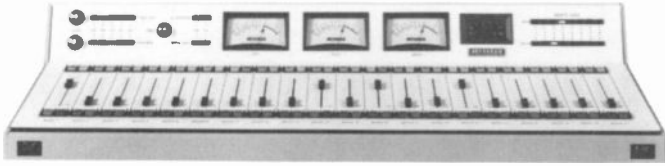

MODEL R/TV 20 AUDIO CONSOLE

When you need mixing flexibility look no further than the R/TV 20 from Autogram. 18 slide faders have a single input to avoid confusion and fader congestion. Faders have 8 inputs each to allow multiple auxiliary sources. Total of 34 stereo inputs on 20 channels.

Features:

- Optional interface card for logging to printer plus interfacing to Live Assist or Computer
- Each channel remote controllable
- Penny and Giles linear conductive plastic pots
- VCA level control
- Electronic switching
- Up to eight patchable microphone preamplifiers
- No audio transformers
- Shadow selector switches

MFG. LIST \$12,995.00 CALL FOR BSW PRICE

MODEL R/TV 12 (not shown)

MFG. LIST \$10,775.00 CALL FOR BSW PRICE

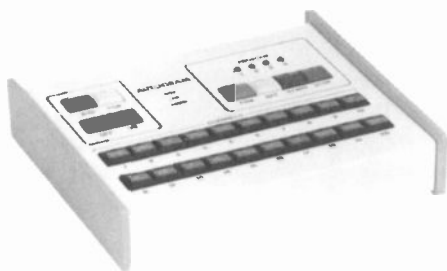

R/TV LIVE ASSIST PACKAGE

The Live Assist Panel plugs into the R/TV Series Console and offers full remote control plus four live assist programs. Each program contains up to 32 steps.

Features: With live assist, the operator can:

- Start, stop and select audio buss for each console channel via remote control
- Observe live assist status at all times
- Monitor sources to transfer on EOM or silence sense
- Use multiple live assist panels for tandem remote control
- Override live assist at any time
- Obtain limited real-time updates for program format control
- Repeat or chain live assist programs for longer walk-away time

MFG. LIST \$1,395.00 CALL FOR BSW PRICE

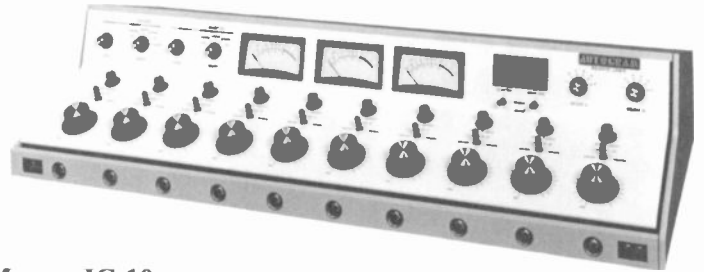

MODEL IC-10 AUDIO CONSOLE

Known the world over for their bullet-proof durability, the Autogram tradition continues. The proven technology of the IC-10 features high quality step attenuators, 2 inputs per channel with 2 six position remote select switches. Remote start switches, headphone monitor and cue amplifiers standard. 2 stereo outputs with mono mixdown are standard as well.

Outputs (Depends on modules used)

- 1 stereo program
- 1 Monophonic program
- 2 Headphone amplifiers
- 2 stereo audition
- 2 Monitor amplifiers
- 1 Cue amplifier

MODEL IC-10A (10 Channel Stereo 28 Inputs)

MFG. LIST \$8,986.00 CALL FOR BSW PRICE

MODEL AC-8A (8 Channel Stereo 26 Inputs)

MFG. LIST \$6,830.00 CALL FOR BSW PRICE

MODEL AC-6A (6 Channel Stereo 23 Inputs)

MFG. LIST \$5,495.00 CALL FOR BSW PRICE

TRANSFORMER VERSIONS AVAILABLE

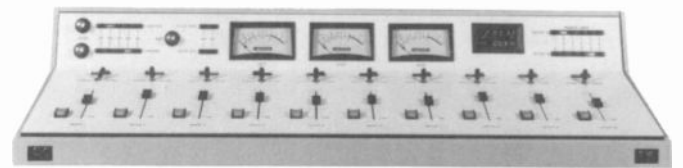

MODEL LC-10A AUDIO CONSOLE

The LC-10A, a complete new look ten-pot audio console. Linear (slide) pots, push button select switches, and the traditional Autogram engraved front panel incorporate to provide a clean and spacious layout.

Using only the highest quality parts, Autogram has selected ITT Shadow switches for monitor and phone select, mono mix, VU meter select, remote select and A/B channel select. Each channel has a remote start switch which is routed through the A/B channel select switch and is placed on the front panel near the linear attenuator. Input and output configurations similar to model IC-10 shown above.

MFG. LIST \$9,404.00 CALL FOR BSW PRICE



**VANGUARD SERIES
AUDIO CONSOLES**

The end result of a rigorous re-evaluation of traditional on-air console design, Vanguard Series Consoles offer superior performance and long term reliability with low initial cost and minimum maintenance.

A lighted, quiet, snap-action panel switch array, sealed from all contaminants, digitally selects all mixer inputs, outputs and monitoring functions.

DC operated VCAs used on all level controls totally eliminate fader noise and tracking errors and reduce the need for costly premium audio faders.

Effective RF protection, punchblock type connections and jumper plug gain matching of input and output levels make for quick, easy and foolproof installation. Modular, plug-in circuit cards allow fast board substitution troubleshooting by non-technical personnel.

Features:

- Headphone amplifier
- Cue amplifier and speaker
- Balanced, bridging inputs
- Modular, plug-in boards
- Compact - 24" or 32" Wide
- Muted monitor drivers
- Two microphone preamps
- Active balanced outputs
- External power module
- Effective RF Protection

- MODEL BC8DSL**
(8 Linear Faders, 12 Stereo Inputs) MFG. LIST \$3,395.00
- MODEL BC8DSR**
(8 Rotary Faders, 12 Stereo Inputs) MFG. LIST \$3,395.00
- MODEL BC12DSL**
(12 Linear Faders, 24 Stereo Inputs) MFG. LIST \$4,995.00

CALL FOR BSW PRICE

AUTOCGRAM



PACEMAKER 648

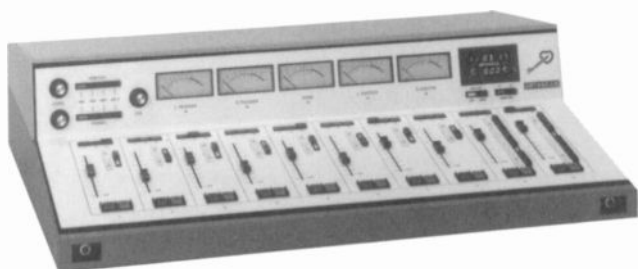

PACEMAKER 1032

**PACEMAKER SERIES
AUDIO CONSOLES**

Autogram enters the 90's with a new series of audio consoles that offers an incredible amount of flexibility without the enormous price tag.

For newsroom operations, check out the Pacemaker 648. This 6-channel console features 8 inputs per channel (48 inputs total). Machine logic controls are standard on each input. Eight patchable microphone preamps are provided.

For control room requirements, the Pacemaker 8-channel 828 or 10-channel 1032 (pictured) offer additional mixing flexibility. The 828 has 28 stereo inputs, the 1032, 32 stereo inputs. Each console has 2 inputs per channel and 2 banks of remote selectors.

Features:

- VCA level controls
- Optional Autolock or Autocount
- No audio transformers
- Electronic switching
- Penny and Giles
- Pluggable miniature terminal strips
- Shadow selector switches
- Engraved front panel

Outputs:

- | | | | |
|-------------------|-------------|----------------|-------|
| 1 Stereo Program | 1 Mix-Minus | 2 Line Monitor | |
| 1 Stereo Audition | 1 Mono | 2 Headphones | 1 Cue |
- MODEL 648** MFG. LIST \$6,495.00
- MODEL 828** MFG. LIST \$5,795.00
- MODEL 1032** MFG. LIST \$7,200.00

CALL FOR BSW PRICE



auditronics, inc.



MODEL 310 SERIES AUDIO CONSOLE

The 310 Series affords the value conscious broadcaster a user defined selection of functional features and a dynamic array of the most important options necessary for uncompromising performance.

Specific attention has been given to not only the audio quality, but to logically located and labeled controls. A comprehensive, built-in, user-programmable logic system simplifies the operation of many internal and external functions. External control ports have been included to provide the possibility of interface to any of several types of external equipment, such as video switchers, editors, etc.

Designed as a modular system, the 310 Series is easily expandable in capabilities, with no sacrifice in performance specifications. All input modules include multiple source selections, and each input has dedicated active balanced input circuitry for optimization of level, noise, common mode rejection, and crosstalk. All output bussing assignments are made via CMOS "Load-Lift" switching, thereby ensuring optimum noise specifications throughout the system at all times.

Standard Features:

- 4 or 8 outputs, plus discrete stereo and mono mix
- Output submastering, with mix-minus capability
- Mono and/or stereo inputs, with or without equalization
- Hi cut and lo cut filters on each input
- VCA level control on all inputs and stereo mix outputs
- VCA control of submaster and mono outputs, with external level and mute control capability
- VCA input grouping
- 4 auxiliary sends
- Auxiliary returns
- Built-in monitor mixer
- Control room monitoring

PRICES BASED ON CONFIGURATION.

CALL BSW TOLL FREE FOR COMPLETE SPECIFICATIONS.

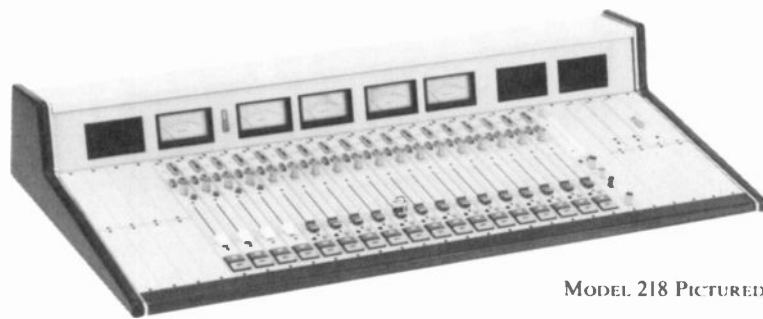

MODEL 218 PICTURED

MODEL 200 SERIES AUDIO CONSOLE

The 200 Series offers a high degree of reliability together with simplicity of use in a compact, operator oriented package. It satisfies the requirements of both engineering and on-air personnel, while offering the station owner a very cost effective investment.

Consoles are available in four mainframe sizes to cover a range of applications from newsrooms to the largest multi-studio installations. The totally modular construction allows initial purchase of only the functions and accessories needed at the time, while allowing for simple future expansion.

Each console includes all mating connectors, installation tools, basic spare parts kit, and service manual at no extra charge.

Available in both mono and stereo outputs, and a wide choice of functions and accessories, the 200 Series is the logical choice for those progressive facilities needing to install equipment with provisions for future adaptability and growth.

Standard Features:

- VCA controlling faders, eliminating noise due to contamination or wear
- Noiseless Hall-effect controlled by CMOS muting
- Comprehensive user-oriented logic system
- On-board power regulation on each module
- +30 dBm output capability
- Control room monitor with 8 input selections
- Headphone amplifier with local EQ
- One year warranty

PRICES BASED ON CONFIGURATION.

All Telephones Lead To BSW

Toll Free from all 50 states including Puerto Rico,
US Virgin Islands and Canada. 1-800-426-8434



UREI



**MODELS 1650, 1680, AND 1690
AUDIO CONSOLES**

The UREI Broadcast Consoles are a fresh answer to the operational requirements of the broadcaster — a top quality, reliable, flexible and affordable line of on-the-air boards which will provide outstanding service for many years.

Excellent specifications and extensive RF shielding make UREI a natural choice in all broadcasting applications. Installation is quick and easy, thanks to barrier strips with clear, easy to read designations. No special tools required.

Features:

- Nine models to choose from (12 channel not pictured)
- Choice of 5, 8 or 12 channels
- Choice of Penny & Giles, Shallco or conductive plastic attenuators
- ± 24 dBm output into 600 ohm load
- Better than 90 dB signal to noise
- Built-in monitor, headphone and cue amplifier
- Built-in cueing loudspeaker

PRICES BASED ON CONFIGURATION.

LPB



**MODEL CITATION II SERIES
AUDIO CONSOLE**

Start with one of the longest running success stories in the radio console business: the LPB Citation I. Then add the combined wisdom of ten years of user feedback and make that "wish list" of features standard. Now you've got the idea behind LPB's new low profile Citation II console.

For durability, Citation II's low profile front panel is protected by a tough Lexan® overlay. And the entire console is built for long life and easy maintenance, in the LPB tradition as well.

For flexibility, the ten-mixer Citation II features three inputs per mixer with lock-out switching, two stereo output busses, mix-minus capability, mono mixdown with independent VU, two user configurable four position auxiliary selectors and programmable monitor and cue muting for the first five mixers.

MFG. LIST \$12,995.00 CALL FOR BSW PRICE

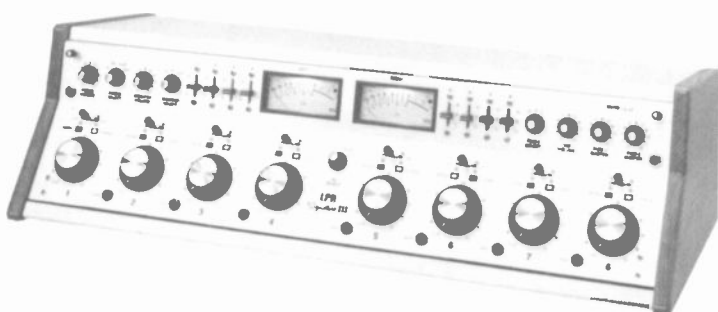

**MODEL SIGNATURE III SERIES
AUDIO CONSOLE**

Signature III consoles offer 3 inputs per mixer, rotary Shallco step or optional P&G stepless faders, plug-in modules, LED peak indicators, switchable mic gain, all transformer inputs and outputs and demonstrated RFI immunity. Mixers 1 through 4 accept either microphone or high level plug-ins (option available for more), others are fixed high level. Monitor speaker muting and tally relays are provided for mixers 1 through 3. Every fader has a cue position, and the consoles include an internal cue amplifier and 5" cue speaker as well as 12/watt channel monitor amplifiers.

MODEL S10 (6 Mixer Dual Stereo) MFG. LIST \$4,195.00

MODEL S13 (8 Mixer Dual Stereo) MFG. LIST \$4,995.00

MODEL S20 (10 Mixer Dual Stereo) MFG. LIST \$5,895.00

MODEL S24 (12 Mixer Dual Stereo) MFG. LIST \$6,895.00

CALL FOR BSW PRICES



SERIES 250A AUDIO CONSOLES

MODEL 10S250A

With their two-tone technical white and gray finish and solid oak end bells, the 250A Series consoles are sure to accent any studio. But don't let their stylish exteriors fool you. These consoles are tough performers! Broadcast Electronics has specifically designed the 250A Series for rugged, reliable service in any demanding on-air or production application.

The quality features of the 250A Series consoles include ladder-type step attenuators (with cue detent) for long life and easy maintenance, roller-cam key switches to designate individual channel assignments.

Each mixer preamplifier offers the flexibility of selecting either a microphone or high level input for each channel. Every 250A Series console also features separate monitor, headphone and cue channels. (Mono/stereo mode switching is optional on all stereo consoles.) All front panel graphics are protected by a laminated polycarbonate overlay.

MODEL 5S250A (5 Mixer Stereo) MFG. LIST \$3,895.00

MODEL 8S250A (8 Mixer Stereo) MFG. LIST \$4,995.00

MODEL 10S250A (10 Mixer Stereo) MFG. LIST \$6,095.00

CALL FOR BSW PRICES

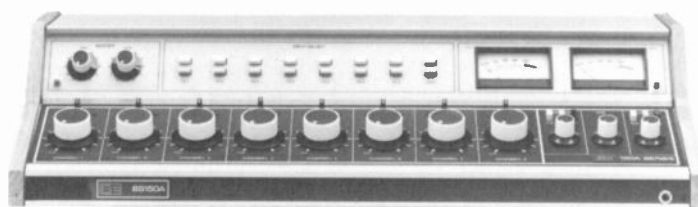

SERIES 150A AUDIO CONSOLES

MODEL 8S150A

The 150A Series consoles offer full featured versatility without straining your budget. Each console features the elegant technical white and gray finish with solid oak end bells. Durable, sealed potentiometers are used in each mixing control with detent cue buss.

Each mixing channel accommodates two pushbutton selectable inputs and may be preset for either microphone or high level service.

Monitor, headphone and cue amplifiers give you full monitoring capability.

MODEL 5S150A (5 Mixer Stereo) MFG. LIST \$3,095.00

MODEL 8S150A (8 Mixer Stereo) MFG. LIST \$3,795.00

MODEL 10S150A (10 Mixer Stereo) MFG. LIST \$5,395.00

CALL FOR BSW PRICES

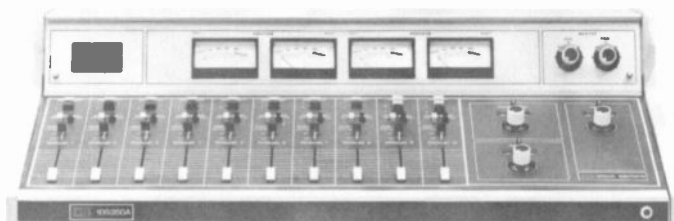

MODEL 10S350A AUDIO CONSOLE

The 350A Series consoles offer the smooth reliability of Penny & Giles precision faders. Each Penny & Giles fader features convenient dual cue switching through the use of a detent "drop cue" or Cue/Program Audition/Off switch. The 350A's also offer separate audition and program metering. This allows simultaneous monitoring of Audition and Program channel levels. The stereo 10S350A console provides four meters (audition right and left plus program right and left). It is attired in a two-tone technical white and gray finish with a laminated polycarbonate overlay.

MFG. LIST \$6,295.00 CALL FOR BSW PRICE

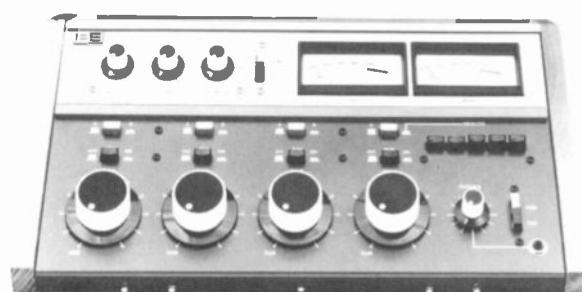

MODEL 4S50A AUDIO CONSOLE

The 4S50A sets the standard for compact stereo consoles. Featuring excellent stereo performance, the 4S50A lends itself well to either production or on-air use. Each of the first three channels accept two high or low level stereo inputs. Channel four can be pre-selected for a single high or low level stereo input, or for one of five high level remote/utility stereo inputs. Each channel mixer control incorporates sealed dual-potentiometers fitted with detent cue switches.

MFG. LIST \$2,195.00 CALL FOR BSW PRICE

Leasing equipment saves working capital. Talk to your BSW Sales Representative on the advantages of leasing your next equipment purchase from BSW.

1-800-426-8434



RUSSCO

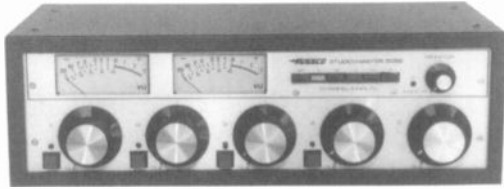

**MODEL 505S
AUDIO CONSOLE**

Five stereo mixing channels; four channels with plug-in stereo preamps which can be quickly modified to accept hi-level line, microphone or phono signals. The 5th channel accepts 5 stereo, hi-level, balanced input lines selected by a push-button switch to give you a total of 9 stereo channels. Cue on any channel can be deactivated by removing a jumper on the P.C. board. Channels 1 thru 4 feature push-button on-air switches with LED indicator lights and monitor muting with an FET switch that can be deactivated. A built-in headphone amplifier with stereo headphone jack allows the use of a monitor headset of high or low impedance. A cue amplifier drives a built-in cue speaker.

MFG. LIST \$2,128.00 CALL FOR BSW PRICE

NUMARK



MOBILE DJ SYSTEM

Here it is . . . the most complete mobile DJ system . . . Numark includes everything you need . . . Turntables, amplifier, equalizer, console, microphone, speakers, all housed in road proof cases . . . Several options and systems available . . . with prices starting as low as \$4,769.00 for the system. Call BSW toll-free 1-800-426-8434 for more information.

YAMAHA

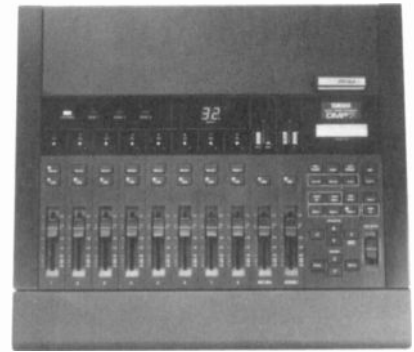

DMP7

**MODEL DMP7/MLA7
DIGITAL MIXING CONSOLE**

Here is a revolutionary digital mixing console and processor from Yamaha. Features:

- 8 inputs - 2 outputs.
- Complete digital signal processing from input to output with 16-bit resolution 44.1-kHz sampling frequency for a full 20 Hz to 20 kHz frequency response.
- Reliable multi-function motorized faders, with adjustment fade time, that serve as channel level controls and effects send level controls.
- Versatile 3-band equalizer for fine control of any portion of the sound spectrum.
- 3 effect loops, each with a high-performance internal digital multi-effect processor. Access to external effects is provided via the effect send and return jacks on the rear panel.
- Memory storage of 30 scenes, which allow instant recall of all console parameters.
- Internal digital stereo compressor.

MFG. LIST \$3,650.00 CALL FOR BSW PRICE

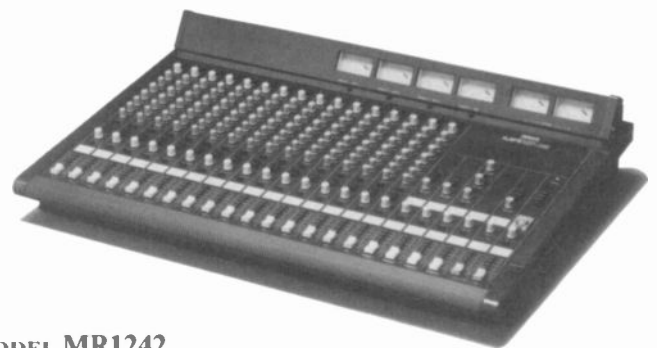

**MODEL MR1242
AUDIO CONSOLE**

This high quality, feature laden console has 12 input channels and 4 outputs. Features:

- 4 group mixing busses and a stereo master buss.
- Mic/line or tape input selection on input channels.
- Peak LED's on each input channel light whenever post-EQ signal comes within 3 dBu of clipping.
- 3-band equalizer on each channel with shelving low and high bands, and a sweepable peaking mid frequency band for extra fine tonal control.
- Monitor assign switches and talkback facilities for maximum flexibility.

MFG. LIST \$1,695.00 CALL FOR BSW PRICE



MODEL WR-8616 PRODUCTION CONSOLE

The WR-8616, a mixer specifically designed for recording and broadcast applications, employs a versatile mainframe that can accommodate a variety of modules to meet the user's specific need. Such a design approach facilitates interfacing with a variety of equipment, such as tape cartridge machines, 2 to 16 track tape machines, turntables, or up to 16 microphones.

The WR-8616 offers a choice of two input modules, a mono mic/line module (WU-8101) and a stereo line module (WU-8106). Depending upon which modules are used, the WR-8616 can accommodate up to 16 mic in signals or 32 line in signals, or a combination thereof. For example, 12 mono modules and 4 stereo modules would have the capability of 12 mic in signals and 20 line signals.

Available with remote start switches and equalization, the WR-8616 is one of the most versatile consoles available in its price range. Call us for detailed pricing and specifications toll free, 1-800-426-8434.

PRICE BASED ON CONFIGURATION

CALL FOR BSW PRICE



MODEL WR-8210A RECORDING CONSOLE

The Ramsa WR-8210A is a compact, versatile 10x4 mixing console designed for multi-track recording. Although it is designed for compactness, it meets requirements of a wide variety of recording applications.

The WR-8210A is a human-engineered product, incorporating the latest circuit technology. This concept includes access jacks on all inputs and group outputs, a modular approach to internal circuit boards, a built-in sub in tape monitor section, and low-noise, electronically balanced mic inputs.

The WR-8210A provides a level of performance and flexibility usually found only in more expensive mixers. In large studio consoles, one of the most important considerations is to minimize repatching. This same design philosophy is evident in the WR-8210A. It offers direct outs and access points on each input, as well as dual outputs on Groups 1 and 2, for connection of a multi-channel tape deck and a mix down recorder.

MFG. LIST \$2,550.00 CALL FOR BSW PRICE

MODEL WR-500 PORTABLE CONSOLE

The WR-500 is a compact, portable console in an integral road case that features 8 electronically balanced inputs and 2 transformer balanced outputs. Each input channel features equalization, pan pot, trim and level selectors, peak reading LEDs, monitor and effects send. The WR-500 is powered by 120 Volt AC or optional 12 Volt DC battery pack.

MFG. LIST \$1,640.00 CALL FOR BSW PRICE



MODEL WR-M10A MULTIPLE SOURCE STEREO CONSOLE

22 input connections, 11 output connections, built-in compression, auto-muting and sub-grouping are among the features that make this a most flexible, compact mixer. Rack mountable and remote start standard.

MFG. LIST \$900.00 CALL FOR BSW PRICE

Don't Panic... We're Still Open

BSW's extended hours and West coast location are great for those times when you just have to have that piece of important equipment. We're open 6 a.m. to 6 p.m. Pacific time, 9 a.m. to 9 p.m. Eastern.

1-800-426-8434



MODEL M-06ST AUDIO CONSOLE

The M-06ST features 6 stereo input channels feeding stereo outputs. For commercial sound installations or other applications which require mixing and processing of a number of stereo sources — including instruments with stereo outputs, the M-06ST can make the job smooth and simple.

Features:

- 6 stereo input channels (channels 1 and 2 have stereo phono inputs for direct connection of turntables while channels 3-6 have stereo line inputs)
- Mic inputs on each channel accept a wide range of signals from microphones, musical instruments and audio equipment
- Stereo AUX inputs with level control provide an extra stereo input
- Insert patch points on channels 5 and 6
- Cue send level controls on each channel

MFG. LIST \$499.00 CALL FOR BSW PRICE



MODEL M-208 AUDIO CONSOLE

The TASCAM M-208 Mixing Console has been designed to handle a wide range of applications with maximum convenience, quality, and dependability. Absolutely no compromises were made in design or construction. Each channel, for example, is built on its own circuit card for maximum isolation and signal quality. The entire system is mounted on a steel chassis for optimum strength and road-worthiness. And, since you need maximum versatility, the M-208 is built to accept inputs from any source.

Features:

- 3-band EQ on each channel combines shelving and sweep-type EQ
- 2 auxiliary mix systems with 2 effect returns
- 4 program groups, each with a master fader and pan control, and a choice of XLR and RCA output connectors
- 8 tape return jacks • LED overload indicators on each channel
- Trim and pad controls on each input provide broad level matching from -70 to +4 dB
- Switchable VU meters with peak-reading LEDs
- 1.5 watt-per-channel stereo headphone amplifier
- Optional RM-208 Rack Mount Kit

MFG. LIST \$1,199.00 CALL FOR BSW PRICE

TASCAM

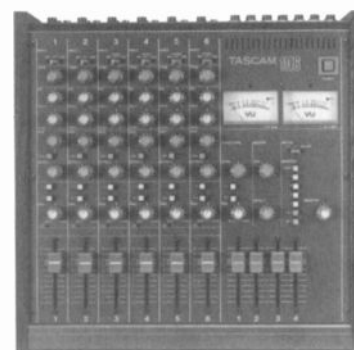

MODEL M-106 AUDIO CONSOLE

In spite of its compact exterior, the M-106 is a remarkably flexible mixing system. In fact, it functions like five mixers in one with its main mix, monitor mix, auxiliary mix, effects mix and return mix.

It offers comprehensive input and output facilities — including direct phono inputs, a convenient practical layout, and solid construction that means stubborn reliability even under demanding on-the-road conditions. Whether it's used for music recording, video post production, audio sweetening, sound reinforcement or DJ mixing, the M-106 will provide all the options you need.

Features:

- All 6 input channels feature microphone and line input connectors
- 4 phono inputs for use in A/V production or club applications
- Trim and pad controls on each input provide broad level matching from -70 to +4 dB
- 2-band shelving EQ on each channel allow up to 15 dB boost or cue at 10 kHz and 100 Hz
- 19-hardrack mountable using the optional RM-106 rack mount kit

MFG. LIST \$699.00 CALL FOR BSW PRICE



MODEL M-312B AUDIO CONSOLE

For sophisticated studio recording, live mixing or production applications, the 300B Series Mixing Consoles offer all the features, signal routing flexibility and audio quality you need. Even complex foldback, effects mixing, subgrouping and monitoring requirements are handled with ease. The 300B Series consoles also deliver clean, dynamic sound thanks to TASCAM's transformerless balanced differential input design, with superior bandwidth and transient response even in the face of signal level or source impedance variations.

Features:

- 48V phantom power supply • Complete talkback system
- Defeatable 3-band EQ on each channel: LOW and MID are sweep types, HIGH is shelving
- 4 program groups, stereo master buss provided w/ balanced outputs
- 3 auxiliary mix systems with 2 effect returns
- Sophisticated solo system with PFL and AFL capability
- Insertion points on each input channel, PGM buss, stereo buss and mono buss
- Transformerless balanced input design
- 8 monitor return channels also function as effect or tape returns

MFG. LIST \$3,399.00 CALL FOR BSW PRICE



TELEFAX



**MODEL TEN 32
REMOTE CONSOLE**

The TEN 32 allows you to mix and send audio, plus communicate with your studio over standard dial telephone lines. The TEN 32 features four low noise Mic inputs, and two tape inputs, line and auxiliary outputs; A headphone amplifier with four jacks, and radio monitor input. Rechargeable Ni-Cads are standard. Other features include: Output level switch, accessory jack and switch for interfacing external audio processors. Optional carrying cases are available.

MFG. LIST \$900.00 CALL FOR BSW PRICE



**MODEL TEN 44
REMOTE CONSOLE**

The TEN 44 has the 32 features shown above, plus:

- Electronically controlled nicad battery
- Digital up/down timer w/alarm and large LCD display
- 1/4" isolated mono phone jacks
- 4 active balanced mic preamps
- 1 kHz test tone oscillator
- Fused power input
- New mini toggle switches for radio monitor switching in headphones
- Noise cancelling on/off master audio "kill" switch and spotter channel

MFG. LIST \$1,050.00 CALL FOR BSW PRICE



**MODEL X-30
REMOTE CONSOLE**

The X-30 utilizes the latest audio circuitry to make it the lightest (2.75 lbs.) and most compact device of its kind on the market today. It's only 1.5" thick, so you can pack it in a briefcase and have lots of room left over. The X-30 features 3 Mic inputs, one Tape Input, a Tape Output, and three headphone jacks. The built-in rechargeable Ni-Cad battery pack can be recharged in just 3 hours.

MFG. LIST \$795.00 CALL FOR BSW PRICE

Zercom



**MODEL MAX-Z
REMOTE CONSOLE**

MAX-Z is a remote broadcast console that provides maximum flexibility, utility, and above all, audio quality.

When it comes to convenience features that help make a remote broadcast run smoothly and sound professional, the MAX-Z has no equal.

A short list of features includes ... carrying case, built-in rechargeable batteries and charger, clock, stopwatch/timer, V.U. meter, wide range and audio inputs (will match almost anything), cue channel, phone line alarms, memory dialing (tone or pulse), etc.

MFG. LIST \$1,095.00 CALL FOR BSW PRICE



**MODEL MAX-Z II
REMOTE CONSOLE**

The MAX-Z II is an abbreviated version of the MAX-Z. High quality audio handling is maintained in the two channels of audio input. AC/DC powered, two headphone outputs, cue channel.

MFG. LIST \$600.00 CALL FOR BSW PRICE

Ev Electro-Voice



**MODEL ELX-1R
REMOTE CONSOLE**

The Electro-Voice ELX-1R is a compact, high-performance audio mixer designed for professional applications where clean audio and reliable operation are important.

The ELX-1R features four balanced inputs, selectable mic or line level. Switchable output limiter prevents clipping, and low cut filters reduce low frequency background noise. Headphone output has a separate power amp and level control will drive any type of headphones or small speaker. Level setting is made easier with the built-in tone oscillator.

MFG. LIST \$540.00 CALL FOR BSW PRICE



RUSSCO



**MODEL T321
REMOTE MIXER**

Russco's Telemote 321 gives you two low impedance microphone inputs and one medium impedance tape recorder input in a handy-dandy 3 pound package. What makes this mixer so unique is that it requires no batteries or any other external power source except your phone line. That's Right! The 321 works right off your dial or touch-tone phone line feed.

While you're broadcasting that important event, you can supply audio up to 3 headsets at once and control their level by a front panel pot. The audio level feeding the telephone line is controlled by a built-in limiter with the limiting action displayed by a LED bar-graph meter. It also incorporates a signal bell that allows calls originating at your station to be received at your remote location.

The Russco Telemote 321, 3 channel mixer makes life easy for you. No batteries or AC plugs to worry about. Just hook up to your phone line and you're on the air!

MFG. LIST \$599.00 CALL FOR BSW PRICE

GENTNER



**MODEL CRM
REMOTE MIXER**

Have you ever had an application where you wished the mic mixer and headset amplifier were all in one box? Gentner's new Combination Remote Mixer just may be your answer. It's the perfect one box solution for easy, quick remotes or similar applications. Four mic inputs, plus four individual headset amps are all built into one convenient package. Each headset output can have its own input and/or input from the "master" audio channel. This means your talent can listen to program audio and independently receive cues.

MFG. LIST \$1,195.00 CALL FOR BSW PRICE

COMREX



SLX SPORTS CONSOLE



STLX SPORTS CONSOLE

THE ULTIMATE IN REMOTE CONSOLES

Ideal for sports or news, the STLX and SLX consoles are completely self-contained remote broadcast packages. The STLX incorporates a two line Frequency Extender encoder with noise suppression. The SLX has a built-in basic single line Frequency Extender encoder.

Features:

- Four mixing channels (2 mic/line)
- Built-in telephone interface
- Custom monitor mix with station talkback available on each headphone
(4 headphones/STLX)
(3 headphones/SLX)
- AGC
- AUX IN and OUT for external PA feeds, monitors, etc.
- Feeds dial or dedicated circuits
- Requires Comrex dual or single line decoder for frequency extension. Call BSW for the complete line of Comrex equipment.

MODEL SLX

MFG. LIST \$3,750.00 CALL FOR BSW PRICE

MODEL STLX

MFG. LIST \$7,750.00 CALL FOR BSW PRICE



SHURE



MODEL FP51
MICROPHONE MIXER

Broadcast and field production professionals will find the Shure FP51 an invaluable time, labor, and space-saving component. By combining a high quality gated-memory compressor with a four-input, one-output professional mixer, the FP51 gives users a lightweight, compact production unit with remarkable versatility and "hands-free" operation. It rides gain automatically, saves on rack space, and eliminates many adjustment problems. It's an ideal component for ENG trucks, remote broadcasts, on-location productions, and sound reinforcement applications. And, like other products in Shure's "FP" Series, the FP51 packs a multitude of useful professional features into an exceptionally space-efficient package.

MFG. LIST \$940.00 CALL FOR BSW PRICE



MODEL FP32
STEREO MICROPHONE MIXER

Professional users asked for it, and Shure delivered! Shure's FP32 Stereo Mixer definitely answers the demand for a reliable, rugged compact stereo audio mixer. Electronic news gatherers and field production specialists agree: the FP32 handles their stringent demands with the utmost aplomb.

MFG. LIST \$1,350.00 CALL FOR BSW PRICE



MODEL FP42
STEREO MICROPHONE MIXER

Field production technicians suffering from audio headaches can rejoice. Shure has a cure in the FP42 - an extraordinarily reliable, compact, feature-packed stereo audio mixer. The FP42 follows in the illustrious footsteps of Shure's classic, industry standard M267, combining Shure ruggedness with all the convenient features that make the M267 so popular - plus full stereo capability!

MFG. LIST \$990.00 CALL FOR BSW PRICE

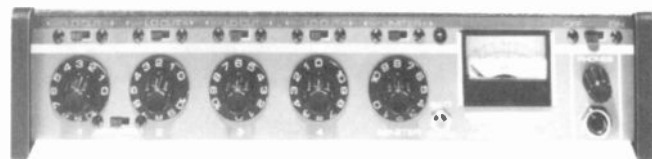

MODEL M267
MICROPHONE MIXER

The Shure M267 offers performance and capabilities never before available in a modestly priced mixer. It has all the features that made the Shure M67 the industry standard mixer, plus additional features and performance improvements that promise to make it the industry standard. These features include... peak limiter, phantom power, built-in battery pack, LED peak indicator, headphone level control. The M267 has four mic or line switchable inputs. It also includes transformer balanced inputs and outputs, mix buss, VU meter, low RFI and line noise susceptibility.

MFG. LIST \$520.00 CALL FOR BSW PRICE



MODEL FP31
MICROPHONE MIXER

A compact, portable microphone mixer specially designed for electronic news gathering (ENG) and electronic field production (EFP) use. Measuring just 6⁵/₁₆" x 5⁵/₁₆" x 1⁷/₈", the FP31 incorporates the features most requested by audio engineers, electronic news professionals, sportscasters, and film and video sound engineers. Three XLR connector inputs and two outputs are provided, each switchable for either microphone or line-level operation. Incorporated in the FP31 is a built-in slate microphone for voice announcements and emergency field use.

MFG. LIST \$990.00 CALL FOR BSW PRICE



MODEL M268
MICROPHONE MIXER

The M268 is a compact, lightweight, five-channel microphone mixer that offers significant improvements in design, performance and versatility over other value-priced mixers including the Shure M68. It is ideal for public address and paging in hotels, schools, community centers, and hospitals, as well as an excellent add-on mixer for expanding current equipment. It is also an excellent mixer for use by the serious tape recording enthusiast.

MFG. LIST \$300.00 CALL FOR BSW PRICE



FIDELIPAC®



From the company that invented the cartridge, comes two erasers that are broadcast tough. Choose from the durable hand held "blank-it" eraser or the desk top model 400. Expect years of trouble free service and quality.

- MODEL 395**
MFG. LIST \$70.00
- MODEL 400**
MFG. LIST \$125.00

CALL FOR BSW PRICES

Taber/AVSC

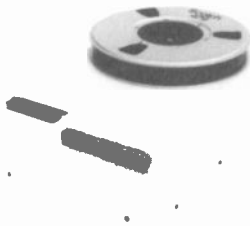

THOROUGHLY ERASES ALL TAPE FORMATS

MODEL 409
Completely erases all audio, video, instrumentation tapes and magnetic films. Audio and video cartridges as well as tapes on reels or in boxes, can be efficiently degaussed. Reel sizes up to 16 inches can be accommodated.
MFG. LIST \$1,295.00 CALL FOR BSW PRICE

AUDIOLAB

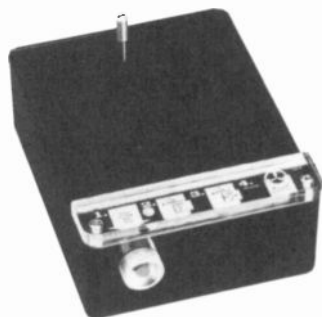

MODEL TD-1B
TABLE TOP ERASER
Erases cartridges and up to 10½" reels. Complete line of audiolab erasers available from BSW.
MFG. LIST \$128.00 CALL FOR BSW PRICE

garner industries



**FOUR MODELS TO CHOOSE FROM
STARTING AT \$990.00**

It takes just 4 seconds to erase all sizes and types of audio tape with Garner Degaussers. Just hit the power button and drop any reel or cartridge on the endless belt. You now have a clean, "no whump" erasure.

CALL FOR BSW PRICES

SONAR



For audio tape degaussing, the Mark I from Sonar offers outstanding value. For all formats from cassettes to carts, Mark I is a wise choice. For video applications, the VP2001 is extremely powerful and will effectively erase up to 1" video tape.

- MODEL VP2001**
MFG. LIST \$179.00
- MODEL MARK I**
MFG. LIST \$69.00

CALL FOR BSW PRICES

NORTRONICS



MODEL PF-211
HAND-HELD ERASER
MFG. LIST \$69.95 CALL FOR BSW PRICE



SENNHEISER



MODEL HD 450

Successor to the HD 414 series, the single best-selling headphone in the world. Open-Aire design, HD 450 provides higher output and improved accuracy using neodymium-iron magnets. Supplied with 10-ft. stranded-steel cable.

Features:

- Frequency response 20-20,000 Hz
- Impedance 70 ohms

MFG. LIST \$79.00 CALL FOR BSW PRICE



MODEL HD 250

The quality of Sennheiser in a closed ear format. Minimize sound leakage. Frequency response 10-25,000 Hz. 600 ohm impedance.

MFG. LIST \$199.00 CALL FOR BSW PRICE



MODEL HD 25

Sennheiser's continued commitment in the application of acoustic technology to headphone design has produced the HD 25 studio monitoring headphone. Utilizing dynamic drivers in a closed supraural design, the HD 25 offers a lightweight and comfortable alternative to professionals who spend a great deal of time wearing headphones. An adjustable split headband insures optimum fit for each user's taste, and a single side audio cable allows for a largely uninhibited degree of freedom when wearing the HD 25. Furthermore, as many professionals wish to cue with single muff monitoring, the HD 25 allows one driver to rotate off the ear and onto the user's temple. Frequency response 30-16,000 Hz. 70 ohm impedance.

MFG. LIST \$199.00 CALL FOR BSW PRICE

We stock replacement parts for all Sennheiser headphones.

KOSS®



MODEL PRO/4AA

Brought back by popular demand, the PRO/4AA has been preferred by professionals for years. Using an oversized diaphragm and 1" voice coil, the PRO/4AA delivers an extended range with outstanding sensitivity for precision monitoring. The foam-filled Pneumalite earcushions provide a comfortable and complete seal that eliminates distracting outside noise and feedback. Frequency response 10-22,000 Hz. Impedance 230 ohm @ 1kHz.

MFG. LIST \$99.95 CALL FOR BSW PRICE



MODEL K/6X PLUS

This lightweight, stereophone delivers the sound of Koss at a popular price. Frequency response 10 to 20,000 Hz. 100 ohms.

MFG. LIST \$31.95 CALL FOR BSW PRICE



MODEL PRO/4AAA PLUS

Feedback on the air a problem??? Koss PRO/4AAA is a great solution... Sealed ear cup provides comfort and durability. Frequency response 10-20,000 Hz. 100 ohms.

MFG. LIST \$70.00 CALL FOR BSW PRICE

Fostex



MODEL T20

Designed for exclusive professional use, the Fostex T20 headphones are, in a word, "outstanding". The ear pad design is somewhere between open and closed so they are very comfortable. Should it ever be necessary, the cable is removable for easy repair. Frequency response 50Hz to 30,000Hz.

MFG. LIST \$89.00 CALL FOR BSW PRICE



MODEL K-240M

The K-240M offers accurate stereo imagery, outstanding fidelity of reproduction at all listening levels, and extreme comfort with virtually no fatigue under prolonged use. Frequency response 15 Hz to 20,000 Hz. 4-600 ohm impedance. MFG. LIST \$120.00 CALL FOR BSW PRICE



MODEL K-141M

A lightweight, semi-open headphone featuring the resonance-free characteristics of "open air" designs. Frequency response 20 Hz to 20,000 Hz. 4-600 ohm impedance. MFG. LIST \$100.00 CALL FOR BSW PRICE



MODEL DT220

Unusually lightweight, closed headphones. Excellent fidelity, sparkling response, and clarity that satisfies even the most discriminating ear. Frequency response 20 Hz to 20,000 Hz. 600 ohm impedance. MFG. LIST \$129.00 CALL FOR BSW PRICE



MODEL DT 990

The DT 990s represent the ultimate expression of sonic realism and listening comfort. With an extended frequency response of 5 Hz to 35,000 Hz, the DT 990s are equalized to the diffuse field to achieve a remarkably flat, natural sonic image across the entire listening spectrum. Impedance 600 ohm. MFG. LIST \$199.00 CALL FOR BSW PRICE



PLUG IN UP TO 6 HEADPHONES

**MODEL HS 160
HEADPHONE SPLITTER**

Headphone signal distribution has never been as easy or inexpensive. Introducing the Radix 1 x 6 headphone splitter. Simply provide amplified headphone signal and plug in up to six headphones. The Radix 160 features isolation resistors to keep signal constant regardless of how many headphones are plugged in. Heavy duty chassis, excellent for field use. Locking 1/4" jacks prevent accidental unplugging.

BSW PRICE \$65.00

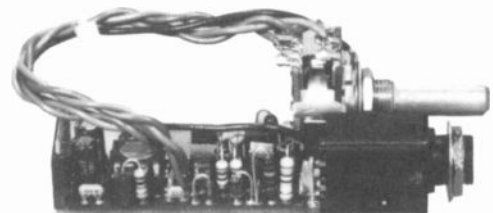

**MODEL HPA-1
STEREO HEADPHONE AMPLIFIER**

The Benchmark jack mounted amplifier series has been called brilliant. We call them practical. The HPA-1 can be used anywhere. Use them in consoles, at the patch bay, in television talkshow roundtables and in test sets, wherever you need individual level control. Use them in studio monitor boxes, with belt-pack mic preamps, and as unbalanced line drivers. You can even use them to drive speakers to moderate levels.

The HPA-1 features a current boosted NE5532 with 60 kHz bandwidth at full gain, a gain range of Off to +18 dB and a noise floor of -90 dBu, again at full gain. The HPA-1 is ideal for the "Studio Series" headphones in the 200 to 600 ohm range but will work with 8 ohm devices as well.

BSW PRICE 60.00

CALL FOR BSW QUANTITY DISCOUNTS



TELEX



**MODEL PH-24
HEADSET**

Television and radio announcers and sportscasters have never before experienced such comfort in a professional headset.

The PH-24 miniature noise cancelling electret microphone provides an extremely flat frequency response of user's voice with significantly attenuated background noises. Headphone response, 50 Hz to 15,000 Hz; microphone, 20 Hz to 20,000 Hz.

MFG. LIST \$220.00 CALL FOR BSW PRICE



**MODEL PH-91
HEADSET**

The Telex PH-91 has long been a favorite of professional announcers. Ideal for studio or on-location sports broadcast from the press box or even from the high noise environment of the playing field. Both earphone and microphone elements are field replaceable. Headphone response, 50 Hz to 15,000 Hz; microphone, 50 Hz to 15,000 Hz.

MFG. LIST \$195.00 CALL FOR BSW PRICE

SENNHEISER



**MODEL HMD224X
HEADSET**

Here is one of broadcasting's most popular headsets from Sennheiser. The HMD224X incorporates a dynamic cardioid microphone that is specially angled on the boom for optimum speech reception. The headphones are very comfortable and enclose the ears guarding against unwanted crowd noise. Headphone frequency response, 16 Hz to 20,000 Hz; microphone, 50 Hz to 12,000 Hz.

MFG. LIST \$275.00 CALL FOR BSW PRICE

beyerdynamic)))



**MODEL DT109K
HEADSET**

A headphone microphone combination for heavy duty use. All parts easily interchangeable. Comfortable to wear over long periods of time. Hyper-cardioid microphone has excellent noise cancelling qualities. Headphone frequency response, 40 Hz to 12,000 Hz; microphone, 30 Hz to 20,000 Hz. MFG. LIST \$214.00 CALL FOR BSW PRICE

SHURE®

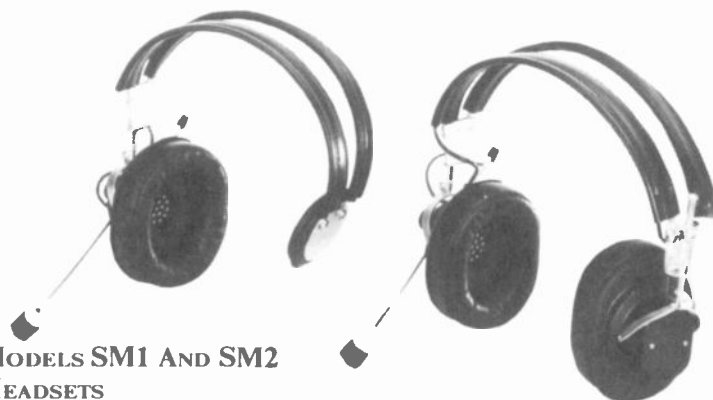

**MODELS SM1 AND SM2
HEADSETS**

Shure Models SM1 and SM2 are professional quality headsets that provide maximum comfort, durability and sound reproduction — designed for broadcasting applications. The SM1 (one ear cue) and SM2 (two ear cue) are loaded with deluxe features that make them an ideal choice for professional TV and radio broadcasters, film and video production crews and other A/V professionals.

Headset features include: a patent boom mount for total flexibility in microphone positioning — the boom adjusts for left or right side use; an all metal boom that is less subject to damage; a rugged, double-braced all metal headband with leather-like covering; and large "pillow-soft" ear pads for maximum comfort as well as superior external noise isolation. Detachable cables for added convenience. Headphone frequency response, 100 Hz to 8,000 Hz; microphone, 50 Hz to 15,000 Hz.

MODEL SM1

MFG. LIST \$182.00 CALL FOR BSW PRICE

MODEL SM2

MFG. LIST \$210.00 CALL FOR BSW PRICE

BSW Delivers

BSW's extensive inventory assures you outstanding delivery. Our special discount rate on Federal Express saves you dollars and time.



SHURE



**LOW-IMPEDANCE TO MEDIUM-IMPEDANCE
LINE MATCHING TRANSFORMERS**

High-quality transformers designed to properly match low-impedance (150 ohm to 600 ohm) microphone outputs to medium-impedance (1 kilohm to 10 kilohm) inputs, such as those frequently used in cassette recorders. Mating connectors for both sides are supplied with the transformer

MODEL A97A

Low-impedance connector . . . three pin professional audio connector. Medium-impedance connector . . . Amphenol MC1M type connector. With mating standard 1/4" phone jack and phone plug.
BSW PRICE \$31.00

MODEL A97F

Low-impedance connector . . . three socket professional audio connector. Medium-impedance connector . . . Amphenol MC1M type connector with mating short cable, terminated by a 3.5mm (9/64 inch) diameter miniature phone plug.
BSW PRICE \$34.70

NEUTRIK®

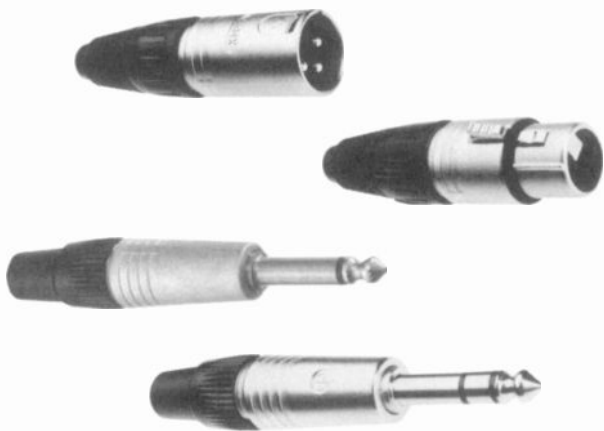

When it comes to quality connectors, choose Neutrik. More than 15 million of these tried and trusted connectors have been made over the last 10 years. Easy to disassemble and reassemble. Built-in strain relief system that insures your connection will remain solid under adverse conditions.

- MODEL NC3MC (XLR Male) BSW PRICE \$2.75
- MODEL NC3FC (XLR Female) BSW PRICE \$3.25
- MODEL NP2C (1/4" - 2 Conductor Male) BSW PRICE \$2.45
- MODEL NP3C (1/4" - 3 Conductor Male) BSW PRICE \$3.60

UNIVERSAL MULTI-COLOR WINDSCREEN SETS

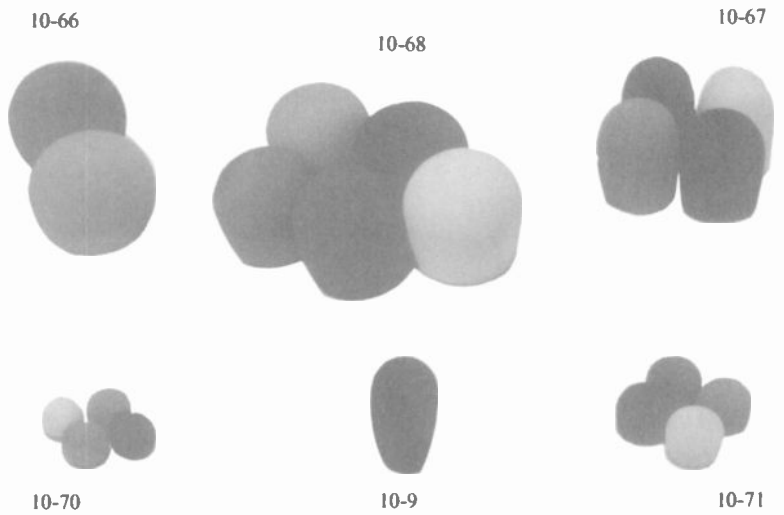

Blocks out unwanted pop, wind, noise and close talking hiss. Made from special soft cut foam, decorative in design. Three multi-color screens add beauty to your microphones. Also identifies each so no mix up will occur when more than one microphone is used.

MODEL 10-9

(2 3/4" high screen universal type . . . Fits slim models from 3/4" to 1 1/8"), color black.
BSW PRICE \$2.00

MODEL 10-66

Contains two 2 3/8" high screens to fit 1 3/4" to 2" diameter microphones, 1-red, 1-blue.
BSW PRICE \$7.25

MODEL 10-67

Contains four 2 3/4" high screens to fit 1 3/8" to 1 3/4" diameter microphones, 1 each red, blue, yellow, black.
BSW PRICE \$8.15

MODEL 10-68

Contains five screens for spherical head microphone 2 3/8" High to fit over 1 3/4" to 2" microphones. 1 each red, blue, yellow, green, black.
BSW PRICE \$19.85

MODEL 10-69

Contains four 7/8" high screens to fit 1/4" to 1/2" microphone. Designed to fit lavalier type microphones. 1 each red, black, yellow, green.
BSW PRICE \$4.20

MODEL 10-70

Contains four 1 1/8" high screens to fit 3/4" to 1" microphones. 1 each red, black, yellow, green.
BSW PRICE \$4.65

MODEL 10-71

Contains four 1 1/2" high screens to fit 7/8" to 1 1/8" ball head microphones. 1 each red, black, yellow, green.
BSW PRICE \$4.65



ProCable



SERIES IIB

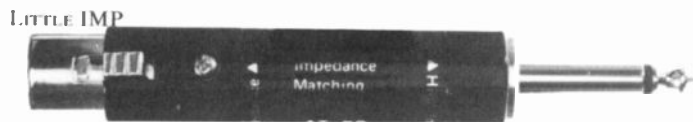

LITTLE IMP

MODEL SERIES IIB MIC CABLE

Outstanding value. 25 ft. XLR connectors.

BSW PRICE \$19.50 EA.
4 OR MORE \$16.25 EA.

MODEL LITTLE IMP MIC TRANSFORMER

Impedance matching transformer XLR type low in to 1/4" high.

BSW PRICE \$10.95

SENNHEISER



MZA 421

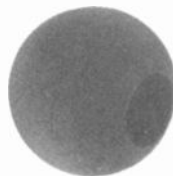

MZW 421

MZA 421 STAND CLAMP (For MD 421U)

BSW PRICE \$35.00

MZW 421 WINDSCREEN

BSW PRICE \$25.00

HZL26-3 MIC CABLE (XLR to Open End)

BSW PRICE \$19.00

audio-technica.



MODEL AT8410A

Universal shock mount with clothespin clamp. For most sizes and shapes of microphones.

BSW PRICE \$38.50

MODEL AT8407

Universal clothespin clamp holds virtually all tubular and tapered body microphones. (Not shown)

BSW PRICE \$15.75

SHURE



A2WSA



A55M

WINDSCREENS

A2WSA FOR SM57 \$10.85
A58WS FOR SM58, 78 \$5.00
90A2089 FOR SM7 \$15.47

STAND CLAMPS

A25B FOR SM57, 58 \$4.00
A57D FOR SM59, 60, 61 \$12.20
A55M ISOLATION MOUNT \$35.55

EV Electro-Voice



314-E



314



309



311

WINDSCREENS

314E FOR 635A

Can be used for pop protection only on front of RE10 and RE15.

BSW PRICE \$9.90

314 FOR RE10 & RE15 Mics

Zippered for easy installation. Rear portion can be used on RE11 and RE16 for wind protection.

BSW PRICE \$20.75

309 SHOCK MOUNT

Use for RE20 microphones. Provides excellent isolation.

BSW PRICE \$84.75

311 STAND CLAMP

Use for 3/4" microphones. Allows slip-out use. Black.

BSW PRICE \$9.90

Need prices on a major project. Save yourself time and FAX us your equipment list. We'll have a complete price quote back to you in no time.

BSW FAX # 206-565-8114



CROWN



**MODEL SASS-P
STEREO MICROPHONE**

The Crown SASS™-P or Stereo Ambient Sampling System™ is a patented, stereo condenser microphone using PZM technology. The SASS uses two premium-quality Pressure Zone Microphones mounted on boundaries (with a foam barrier between them) to make each microphone directional. It is a mono-compatible, near-coincident array designed for professional applications including:

- Classical-music recording (acoustic ensembles)
- Stereo electronic news gathering (E.N.G.)
- Sports ambience and crowd reaction
- Televised theatre and dance • Film ambience

MFG. LIST \$849.00 CALL FOR BSW PRICE



**MODEL SOUNDGRABBER
PZM MICROPHONE**

Crown PZM microphone technology in an inexpensive package. One Soundgrabber in the middle of the table can replace eight conventional microphones for recording purposes. You can understand every word with amazing definition and detail. Comes with mini and 1/4" plug for direct recorder connection. Perfect for news departments.

MFG. LIST \$69.95 CALL FOR BSW PRICE

SONY

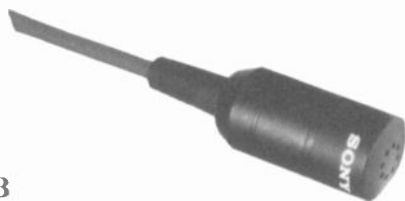

**MODEL ECM-55B
OMNI-DIRECTIONAL LAVALIER**

One of the most popular lavalier microphones we sell. The EMC-55 from Sony has an omni-directional pick-up pattern. It can be powered by AA batteries or external power supply. Comes with mesh windscreen and holder clips.

MFG. LIST \$306.00 CALL FOR BSW PRICE

SENNHEISER



**MODEL MD421-U
CARDIOID**

One of the most versatile and popular of Sennheiser's dynamic microphones. For on-air or production use, the MD421-U from Sennheiser is the natural choice for many stations. Renown for its sonic quality, ability to handle high sound pressure levels and durability. Cardioid pattern. Frequency response 30 to 17,000 Hz.

MFG. LIST \$399.00 CALL FOR BSW PRICE

MODEL TM3

SHOCK MOUNT (Mic stand clamp not included) BSW PRICE \$16.95



**MODEL MKE-4032 P3
SUPERCARDIOID CONDENSER**

In the studio or on the road, this outstanding microphone from Sennheiser has the sound and styling for the nineties. Frequency response is 70-20,000 Hz. Powered by either phantom power (12-48 volt) or by one AA battery.

MFG. LIST \$595.00 CALL FOR BSW PRICE



**MODEL ME80
SHORT SHOTGUN**

Combination of supercardioid at low frequencies, and shotgun above 2,000 Hz. Excellent on-camera mike or hand-held interview mike for ENG/EFP. Increased gain before feedback by using as a podium mike in sound reinforcement. Use with K3U power module. Frequency range 50-15,000 Hz.

MFG. LIST \$239.00 CALL FOR BSW PRICE

MODEL K3U (Power Supply Module)

MFG. LIST \$210.00 CALL FOR BSW PRICE



SHURE®



MODEL SM82LC CARDIOID CONDENSER

An outstanding choice for on-the-spot broadcasting, sound reinforcement and recording applications where a line level microphone with a built-in limiter is needed. It is also ideal for applications involving long cable runs (up to one mile without equalization) such as sporting events, parades, political rallies and other live remotes. Frequency response 40 Hz to 15,000 Hz.

MFG. LIST\$410.00
CALL FOR BSW PRICE



MODEL SM90/SM91 SURFACE MOUNT CONDENSER

Professional, studio-quality, "boundary effect," surface microphones. Ideal for TV settings, news conferences, dramatic productions, choirs or wherever inconspicuous microphone placement is desired. The SM91 is unidirectional and the SM90 is omnidirectional.

MFG. LIST\$310.00
CALL FOR BSW PRICE



MODEL SM83CN CONDENSER/OMNIDIRECTIONAL

The SM83 lavalier was designed to provide superior quality sound reproduction in professional broadcasting. It features a wide range frequency response, specially tailored to provide natural sound. Mic is detachable from the high performance, lightweight pre-amp. Frequency response 80 Hz to 20,000 Hz.

MFG. LIST\$223.50
CALL FOR BSW PRICE



MODEL SM58LC DYNAMIC CARDIOID

The world standard professional stage microphone, with the distinctive Shure upper mid-range presence peak for an intelligible, lively sound. A tough, handsome microphone that weighs less than 11 oz.... the SM58 is often imitated in appearance but never duplicated in performance, ruggedness or reliability. Frequency response 50 Hz to 15,000 Hz. Output, -56 dB.

MFG. LIST\$176.00
CALL FOR BSW PRICE



MODEL SM99 SUPER CARDIOID CONDENSER

Shure has combined outstanding acoustical, electrical, and aesthetic design features to produce the most versatile miniature gooseneck condenser microphone available. Its uniform supercardioid polar pattern and extended frequency response deliver exceptional gain-before-feedback and source isolation, making the SM99 the ideal unit for multi-mic sound reinforcement installations.

MFG. LIST\$240.00
CALL FOR BSW PRICE



MODEL SM7 DYNAMIC CARDIOID

The SM7 is among the finest studio professional dynamic microphones in use today. Its "smooth and silky" sound has made it extremely popular for radio and television work. It features a wide-range, very smooth frequency response with graphic response-tailoring switches to permit the choice of four different microphone response curves. Frequency response 40 Hz to 16,000 Hz. Output, -57 dB.

MFG. LIST\$550.00
CALL FOR BSW PRICE



MODEL SM89 SHOTGUN CONDENSER

The SM89's highly directional polar pattern and fine-tuned frequency response will discriminate at a distance in favor of desired dialogue or effects and against ambient noise, and will accurately pick up sound without excessive on-or-off axis coloration. Frequency response 60 Hz to 20,000 Hz. Output, -52 dB. (Windscreen, carrying case and shock mount optional.)

MFG. LIST\$900.00
CALL FOR BSW PRICE



MODEL SM63LLC OMNIDIRECTIONAL DYNAMIC

The SM63 is an elegant, rugged microphone with very high output... up to 6 dB higher than comparable omnidirectional microphones. Frequency response 50 Hz to 20,000 Hz. Output, -56 dB.

MFG. LIST\$145.00
CALL FOR BSW PRICE



MODEL SM57LC DYNAMIC CARDIOID

The SM57 is a slender dynamic microphone built to provide wide range reproduction of music and voice. Ideal for both studio and remote use in broadcasting, recording, motion picture and critical sound reinforcement applications. It is especially suitable for interview type use where "hand-a-bility" of the microphones is important. Frequency response 40 Hz to 15,000 Hz.

MFG. LIST\$137.00
CALL FOR BSW PRICE



EV Electro-Voice



MODEL RE-11
SUPER CARDIOID

Features:
 • Frequency response 90 Hz to 13,000 Hz
 • Output, -56 dB
 • Built-in blast filter
 MFG. LIST \$235.00
CALL FOR BSW PRICE



MODEL DS35
CARDIOID

Features:
 • Frequency response 60 Hz to 17,000 Hz
 • Output, -60 dB
 • Built-in blast filter
 • Two stage shock mount results in low handling noise
 MFG. LIST \$205.00
CALL FOR BSW PRICE



MODEL CO90
OMNIDIRECTIONAL LAVALIER

Broadcasters' favorite lavalier microphone is the E.V. CO90. Battery power provides 1,000 hours of use. Comes with tie clasp bar, windscreen, zippered pouch, and battery housing with belt clip. Frequency response 40 Hz to 15,000 Hz. Output, -57 dB.
 MFG. LIST \$185.00
CALL FOR BSW PRICE



MODEL RE-20
CARDIOID

One of the most popular microphones used in broadcast environments. The RE-20 has a warm sound which will please the most discriminating announcers. Frequency response 45 Hz to 18,000 Hz. Output, -57 dB.
 MFG. LIST \$555.95
CALL FOR BSW PRICE



MODEL 635A
OMNIDIRECTIONAL

The 635A is our largest seller and for good reasons. Extreme durability and low cost. Frequency response 80 Hz to 13,000 Hz. Output, -55 dB.
 MFG. LIST \$130.00
CALL FOR BSW PRICE



MODEL RE-50
OMNIDIRECTIONAL

Features:
 • Frequency response 80 Hz to 13,000 Hz
 • Output, -55 dB
 • Internal shock and built-in windscreen
 MFG. LIST \$195.00
CALL FOR BSW PRICE



MODEL DO56
SHOCK-MOUNTED
OMNIDIRECTIONAL

Virtually impervious to mechanical noise. Isolated capsule design makes it the ideal microphone whenever there is lots of action. Built-in blast filter reduces "P-popping" to keep your audio clean. Frequency response 80 Hz to 18,000 Hz. Output, -61 dB.
 MFG. LIST \$165.00
MODEL 5056L (Same as above, but has extended handle.)
 MFG. LIST \$180.00
CALL FOR BSW PRICE



MODEL RE45N/D
SHOTGUN CARDIOID

Specifically designed for hand-held use, the Model RE45N/D is a new design concept in shotgun microphones. The exclusive N/DYM™ dynamic element has the output level of a condenser microphone without need for battery or phantom power. The RE45N/D is ideal for field interviews. Frequency response 50 Hz to 15,000 Hz (close). 150 Hz to 15,000 Hz (far). Output, -50 dB.
 MFG. LIST \$386.25
CALL FOR BSW PRICE



MODEL RE-15
SUPER CARDIOID

The RE-15 features wide, flat response for broadcast applications. With its uniform super-cardioid pattern you can extend working distances compared with other cardioid mics. Frequency response 80 Hz to 15,000 Hz. Output, -57 dB
 MFG. LIST \$330.00
MODEL RE-16 (Same as the RE-15 except includes blast filter to reduce "P" pops.)
 MFG. LIST \$345.00
CALL FOR BSW PRICE



audio-technica.



**MODEL AT857QM
CARDIOID MICROPHONE**

The AT857QM Unipoint™ is self-contained, with the power module for phantom powering built into the base. Two gooseneck sections offer flexibility of positioning, while the low weight of just 4¼ ounces eliminates the tendency to sag common to heavier cardioid microphones. An AT8102 two-stage windscreen is included to minimize pops and wind noise.

MFG. LIST \$249.00

CALL FOR BSW PRICE



**MODEL AT815A
"SHOTGUN" MICROPHONE**

With the acceptance angle of approximately 40° at high frequencies, the AT815A provides a useful tool to overcome problems of noise or distance for radio or TV broadcasting special stage applications and motion picture dialogue recording. Its flat response and high output insures well balanced, natural sounding pickup.

MFG. LIST \$285.00

CALL FOR BSW PRICE

RD SYSTEMS



**MODEL P650 EPM
PARABOLIC MICROPHONE**

The EPM Parabolic Microphones are high performance unidirectional microphones perfectly suited to the requirements of the Motion Picture and Broadcast Industries, tape recording, monitoring and other professional or semi-professional applications. The EPM is one of the most directional microphones ever produced; making it possible to record voices, sounds, practically anything — to professional standards without having the microphone anywhere near the subject being recorded.

MFG. LIST \$575.00

CALL FOR BSW PRICE



**MODEL U 89 i
CONDENSER MICROPHONE**

The U 89 i microphone is a studio microphone with switchable directional patterns. Its grille houses a newly developed dual-membrane capsule with a particularly linear frequency response for all polar patterns. A rotary switch beneath the grille permits selection of one of 5 directional patterns: besides the three usual ones — omni, cardioid, figure-8 — the intermediate positions "wide-angle cardioid" and "hypercardioid" are also available.

MFG. LIST \$1,700.00

CALL FOR BSW PRICE



**MODEL RSM 190 i
STEREO MICROPHONE SYSTEM**

The RSM 190 MS-stereo microphone is the heart of a stereo shotgun system with variable directional characteristics, combined with high directional efficiency. Two completely separate capsule assemblies — a short shotgun and a system, with its axis at a right angle and operating in a figure-8 characteristic — provide the middle and the side information.

MFG. LIST \$2,445.00

CALL FOR BSW PRICE



**MODEL TLM 170 i
CONDENSER MICROPHONE**

The TLM 170 i is able to handle sound pressure levels up to 140 dB with minimal distortion. This represents a dynamic range of 126 dB. Five directional characteristics may be selected: omni, wide cardioid, cardioid, hypercardioid and figure-8. The TLM 170 i is equipped with a tiltable, elastically suspended mounting bracket, which isolates the microphone effectively against mechanical noise interference.

MFG. LIST \$1,750.00

CALL FOR BSW PRICE



beyerdynamic))))



**MODEL M500
CARDIOID MICROPHONE**

High quality ribbon microphone has a rising frequency response curve for optimum voice reproduction and vocal presence. Hyper cardioid pickup pattern offers extremely low feedback in sound reinforcement applications. Built-in pop screen eliminates the need for windscreen when using indoors. Frequency response 40 Hz to 18,000 Hz.

MFG. LIST\$300.00
CALL FOR BSW PRICE



**MODEL MC 740 N (C)
CONDENSER MICROPHONE**

Studio quality condenser microphone with frequency-independent, switch-selectable directional pattern: omnidirectional, wide cardioid, cardioid, hypercardioid, bidirectional. Uniform frequency response independent of polar pattern. For 48 V phantom powering. Switch-controlled preattenuation of 10 dB for high sound pressure levels. Available not only in the standard version with 3-pin XLR connector, but also in the special version 5-pin XLR connector for remote control of the directional pattern from the power pack MSG 740. Frequency response 40 Hz to 20,000 Hz.

MFG. LIST\$1,325.00
CALL FOR BSW PRICE



**MODEL M 58
OMNIDIRECTIONAL MICROPHONE**

The M 58 omnidirectional moving coil microphone has been specifically designed to satisfy the demands of electric news gathering (ENG) and electronic field production (EFP) applications in broadcast industry. Its sophisticated internal shockmount dramatically reduces undesirable handling noise. The frequency response has been fine tuned to provide broadcasters with accurate reproduction of voice information with a very high degree of intelligibility. Frequency response 40 Hz to 20,000 Hz.

MFG. LIST\$199.00
CALL FOR BSW PRICE



**MODEL C414B/ULS
CONDENSER MICROPHONE**

AKG staff and engineers have concentrated their efforts and know-how to produce a microphone of transmission qualities matching digital technology. The low inherent self-noise and high overload point guarantee a dynamic range in order of 126 dB. Four different polar patterns selectable on mic. All metal housing in black chrome finish.

MFG. LIST\$1,045.00
CALL FOR BSW PRICE



**MODEL D-1200E
CARDIOID MICROPHONE**

The D-1200E is an extraordinarily versatile microphone. The key to the D-1200E's versatility is an integral B-M-S switch, an AKG exclusive, which permits the user to create an almost endless variety of tone control possibilities. Transducer type: Dynamic. Frequency range: 40 Hz to 17,000 Hz.

MFG. LIST\$250.00
CALL FOR BSW PRICE



**MODEL C 522
STEREO MICROPHONE**

Features:

- Two cardioid condenser capsules with 90° opening angle for XY-stereo recording technique
- Simple to use one-hand operation for quick action often required from reporters on the scene
- Suitable for vocal, speech and music recordings
- Integrated LED for checking battery condition

MFG. LIST\$995.00
CALL FOR BSW PRICE



III Vega



RANGER SERIES

Ranger wireless microphone systems are Vega's answer to competitively priced wireless systems without compromising audio performance. They offer a higher signal-to-noise ratio and wider dynamic range by virtue of their exclusive CVX™ audio processing. You receive smooth, clear, virtually noise-free audio performance.

Ranger is available in both true-diversity and non-diversity configurations, and delivers exceptional RF performance through the transmitter's high radiated power and its sensitive, highly selective receiver.

Ranger offers a wide variety of lavalier microphones and hand-held microphone elements, operates on crystal-controlled frequencies in the 169-216 MHz range, and comes with a three-year warranty.

SYSTEM PRICES START AT ONLY \$1,260.00 FOR NON-DIVERSITY. CALL FOR COMPLETE PRICING AND DETAILED SPECIFICATIONS.



PRO SERIES

For years, Vega wireless microphones have been the yardstick by which the rest of the wireless industry is measured. Their outstanding reliability and superior performance have made them the systems of choice for broadcast and entertainment professionals the world over.

Choose from diversity or non-diversity receivers. Both feature Dynex II audio processing for exceptional audio performance. Separate 10 segment LED displays for audio and RF signal strength.

The belt pack transmitter features an audio overload indicator, allowing easy maximization of usable dynamic range, while silent on/off mute switch permits you to turn off the mic without affecting the RF. Of course hand-held transmitters are available with a wide variety of mic capsules from which to choose.

NON-DIVERSITY SYSTEMS START AT ONLY \$689.00 MFG. LIST. CALL FOR COMPLETE PRICING AND SYSTEM CONFIGURATIONS.

SAMSON®



BROADCAST STD SERIES

The ultimate expression of Samson Wireless Technology, the Broadcast STD (Synthesized True Diversity) Wireless System features 10 selectable digitally-synthesized channels on both transmitter and receiver, to insure complete RF interference-free performance in any application. By visually scanning all 10 channels on the Broadcast STD, BR-3 receiver, you can select the best channel for operation in your area.

For the first time, you have a visual "window", through the use of the BR-3 level LED ladder, to look at the RF level in any given location. After selecting the best or clearest frequency on the BR-3, you simply dial-up the same frequency on your transmitter to correspond to that of the BR-3.

The Broadcast STD Series also provides improved state-of-the-art RF circuitry and utilizes dbx noise reduction to provide expanded dynamic range and the highest level of audio quality.

PRICES BASED ON SYSTEM CONFIGURATIONS



STAGE 2 SERIES

Here is our most popular seller in budget priced wireless systems. The Samson Stage 2 Series offers superior VHF non-diversity wireless performance. Dbx noise reduction assures high signal-to-noise ratio and quiet reception. This system will operate under adverse RF environments and is stable at distances up to 250 feet. Choose from systems that feature different mic capsules in either hand-held or body pack transmitters.

PRICES DIFFER WITH EACH SYSTEM BUT START AT ONLY \$289.00 MFG. LIST. CALL FOR EXACT PRICING AND CONFIGURATION. TOLL FREE 1-800-426-8434



SHURE®



**MODEL L SERIES
WIRELESS SYSTEM**

If you've had doubts about affordable VHF wireless microphones before, try a Shure L Series system. You're in for two pleasant surprises. The performance. And the price.

Each L Series component provides a host of professional performance features found only in far more expensive wireless systems. And the L Series gives you a degree of reliability that's unsurpassed in its price range. L Series systems are available in diversity and non-diversity versions.

SYSTEM PRICES START AT A LOW \$360.00 FOR NON-DIVERSITY. CALL FOR COMPLETE SPECIFICATIONS AND PRICES... TOLL FREE 1-800-426-8434

audio-technica.



**PROFESSIONAL VHF
WIRELESS SYSTEM**

This new diversity system from Audio-Technica offers outstanding features and quality for a very low price.

At the heart of A-T wireless systems is a sophisticated automatic diversity receiver. Two antennas, two complete, independent RF inputs, and a very sophisticated switching system eliminate the multi-path distortion and dropouts that plague some wireless systems.

The receiver has LED signal-strength indicators for each RF input, as well as an audio modulation indicator. Two isolated audio outputs permit simultaneous feeds to both unbalanced and balanced inputs. Choose from either a hand-held microphone or a body pack/lavalier transmitter. Several types of microphones are available. Transmitters may be operated up to 200 feet from receiver even in congested RF fields.

SYSTEM PRICES START AT ONLY \$650.00 MFG. LIST. CALL FOR COMPLETE SPECIFICATIONS.

TELEX



**MODEL FMR-50
WIRELESS SYSTEM**

The FMR-50 uses the latest in CMOS electronics with powerful rejection of RF. Selectivity is further enhanced by the exclusive use of a computer designed system of low distortion, linear phase IF filters. This narrow selectivity permits the operation of up to seven systems in a single location, simultaneously, without interference.

Features:

- Peak reading volume indicator
- Carrier indicator
- Adjustable output control

SYSTEM WITH LAPEL MICROPHONE

MFG. LIST \$999.00 CALL FOR BSW PRICE

SYSTEM WITH HAND-HELD MICROPHONE

MFG. LIST \$929.00 CALL FOR BSW PRICE



**MODEL FMR-25
WIRELESS SYSTEM**

Here is the most economical Telex wireless system. The FMR-25 has less distortion and flatter frequency response than other systems in the same price range. Exclusive compander circuitry improves dynamic range. Line of site working distance is up to 500 feet between transmitter and receiver. Hand-held microphone or lapel/belt pack transmitters are available.

FMR-25 LAPEL SYSTEM

MFG. LIST \$500.00

FMR-25 HAND-HELD SYSTEM

MFG. LIST \$600.00

FMR-25 SYSTEMS ARE AVAILABLE IN DIVERSITY. CALL FOR PRICING.

CALL FOR BSW PRICE



ProBoom



A



B



C



D



E

MOUNTING BRACKETS FOR BOOMS

A. CLAMP MOUNT

B. WALL MOUNT

C. DESK MOUNT

A-C YOUR CHOICE ... \$9.50 ea.

D. PRO-BRACKET 12" PEDESTAL

Rugged all aluminum. Colors: grey, oyster, black and silver.

BSW PRICE \$24.95

E. MODEL LM1-3 41" REACH

Heavy duty model for up to 3 lb. microphones. Oyster or black color.

BSW PRICE \$59.95

BSW PRICE (with 12" pedestal Pro-Bracket) \$72.95

MODEL LM-1 41" REACH

For 1 lb. microphone. Oyster or black color.

BSW PRICE \$59.95

BSW PRICE (with 12" pedestal Pro-Bracket) \$72.95

MODEL LM-2 26" REACH

For 1 lb. microphone. Grey color.

BSW PRICE \$59.95

BSW PRICE (with 12" pedestal Pro-Bracket) \$72.95

ATLAS / SOUNDOLIER



F



G



H



I



J



K



L



M

F. MODEL DS-4
LIGHTWEIGHT STAND

Non-adjustable 4" high chrome tube. 5" diameter phenolic beige base.

BSW PRICE \$7.80

G. MODEL DS-5
GENERAL PURPOSE STAND

Non-adjustable 4" high chrome tube. 6" diameter cast iron charcoal base.

BSW PRICE \$11.50

H. MODEL MS-12c
GENERAL PURPOSE STAND

Grip-action clutch. Low-profile charcoal base with added weight for extra stability. Our best seller. Black or silver.

BSW PRICE \$31.00

I. MODEL DS-2
VIBRATION-ISOLATING STAND

Non-adjustable 3" high chrome tube. Non-reflective 4" x 6" charcoal base.

BSW PRICE \$22.30

J. MODEL DS-7
ADJUSTABLE DESK STAND

Chrome tube assembly, adjustable height 8" to 13". Grip-action clutch. 6" diameter charcoal base. Black or silver.

BSW PRICE \$16.60

K. MODEL DS-14
CONTEMPORARY STAND

For professional styled microphones. Non-adjustable 3" high chrome tube. Charcoal base.

BSW PRICE \$15.30

L. MODEL SB-36w
MOBILE BOOM STAND

Grip-action clutch with integral air suspension to counterbalance boom weight. 3/8"-27 thread at microphone end. Boom length 62". Adjustable vertical height from 48" to 72". Rubber casters for mobility.

BSW PRICE \$261.10

M. MODEL PB-10x
MICROPHONE BOOM

Standard termination for microphone holder. Die-cast swivel, tapered counterweight, coordinated hardware. Attaches to any microphone stand terminating in 3/8" diameter tubing or adapter grip-action clutch. Expandable from 31" to 50".

BSW PRICE \$36.70



Henry Engineering



MODEL SUPERELAY CONTROL INTERFACE

Superelay is a multi-purpose control interface. It is ideal for controlling the various equipment functions that need to be switched when, for example, a control room mic is turned on, e.g. EBS receiver mute, intercom speaker defeat, telephone bell disconnect, skimmer recorder start, warning lights, etc. Superelay can be controlled by virtually any console's muting output, or by any external switch, either momentary or maintained. It provides two types of outputs: relay and switched AC. Six relays can be used for low-voltage and audio switching; a switched AC output will directly power up to 300 watts of "warning lights" and make them flash. Superelay can also be connected to any dial-up telephone line for control of equipment when the line rings.

MFG. LIST \$225.00 CALL FOR BSW PRICE



MODEL LOGI CONVERTER CONTROL INTERFACE

LogiConverter is an interface unit that facilitates remote control of broadcast studio equipment. It eliminates the incompatibility often encountered when a broadcast console is used to provide remote start/stop control of peripheral equipment, e.g., cart machines, CD players, tape recorders, etc. LogiConverter converts TTL/CMOS or 'open collector' console outputs to relay closures for remote interface that is compatible, reliable, and isolated. The unit can be user programmed via internal 'dip switches' to generate either momentary or maintained outputs from various inputs, with 24 input/output combinations possible. LogiConverter will control up to 4 circuits, and can provide start-only or start-stop outputs from a single input signal.

MFG. LIST \$195.00 CALL FOR BSW PRICE

You Supply The Nuts,

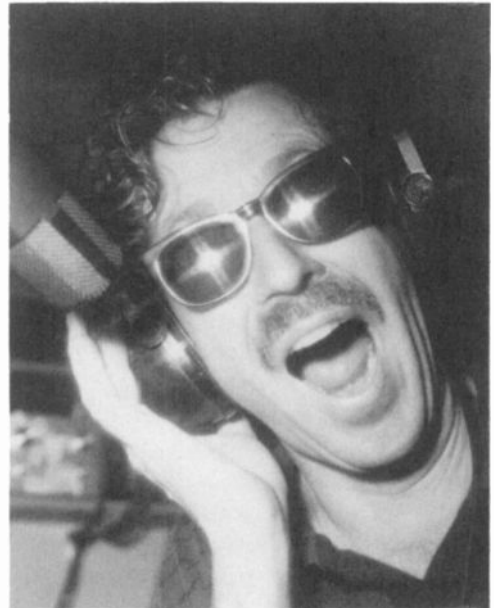

We'll Supply The Bolts

Creative talent requires the best possible tools to make advertising copy come to life. That's where BSW comes in. For over 16 years we have been supplying audio equipment to stations, studios, and agencies all over America. Everything from microphones, consoles, multi-track recorders, to sophisticated audio effect devices. BSW sells the equipment that will bring out the best in your talent. Call for our free catalog.

BSW

BROADCAST SUPPLY WEST

America's Full-Time Broadcast Supplier

1-800-426-8434

ORDERS • INFORMATION • SPECIFICATIONS

BSW • 7012 27th Street W • Tacoma, WA 98466 • FAX 206-565-8114

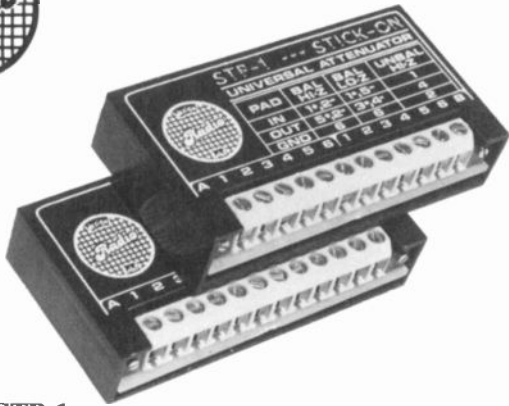

MODEL STP-1
STICK-ON SERIES

The Stick-On Series from Radio Design Labs represents a complete array of products that fill a variety of needs. Each Stick-On measures only 3" x 1.5" and is housed in durable plastic. Stick-On's are so small they can be directly and discretely mounted on equipment or underneath countertops.

The small size of Stick-On's does not affect the quality and workmanship found in each one. Careful attention to audio specifications and durability that professional audio users require are found in every Stick-On. Choose from the wide variety of products available below and get sticking.

ACTIVE "STICK-ONS"

MODEL	DESCRIPTION	BSW PRICE
STA-1	Electronic Transformer, dual channel w/supply	\$109.95
ST-DA3	Distribution Amplifier, mono w/supply	\$99.95
ST-DA3D	Distribution Amplifier, stereo w/supply	\$149.95
STM-1	Microphone Preamp, fixed gain w/supply	\$79.95
STM-2	Microphone Preamp, variable gain w/supply	\$109.95
STA-3	Audio Power Amp, 3 watts RMS w/supply	\$79.95
STA-6	Audio Power Amp, 6 watts RMS w/supply	\$99.95

"STICK-ONS"

MODEL	DESCRIPTION	BSW PRICE
STD-1	Divider/Combiner Network, four channel (On STD Specify 150 or 600 Ohm)	\$32.95
STP-1	Variable Attenuator, two channel	\$32.95
STF-5	Fixed Speaker Pad, 5 steps	\$32.95

RACKING SYSTEM "STICK-ONS"

MODEL	DESCRIPTION	BSW PRICE
STR-19	19" Rack Kit, holds 12 Stick-On's, snaps included	\$159.00
STR-12	Rack Kit Snaps, (additional 12 pack)	\$25.00

All units shown above with power supplies can be ordered without at a substantial discount. Call for details.

PRICES SHOWN ABOVE ARE SUGGESTED LIST. CALL FOR BSW DISCOUNTED PRICES.

Leasing?

Leasing equipment saves working capital. Talk to your BSW Sales Representative on the advantages of leasing your next equipment purchase from BSW.

1-800-426-8434



MODEL MLW-1
AUTOMATIC AUDIO ROUTER

For years broadcasters and production facilities have had the problem of what to do if a stereo channel or the program audio is lost from a broadcast, satellite feed, or stereo production mistake or the problem of matching and switching sources of two different levels. To correct these problems automatically as well as provide valuable ON LINE audio correction and monitoring requires an "intelligent" and sophisticated audio routing device. Such a device is the Titus Technological Laboratories' MLW-1.

The MLW-1 not only detects and corrects problems, its microprocessor based controls make decisions instantly before inaudibly "cross fading" the appropriate MLW-1 functions in or out of the audio chain.

Features:

- Automatic change to alternate channel on loss of channel
- Automatic change to alternate source on loss of channel or loss of signal
- Three balanced, bridging inputs
- Three modes of operation: Automatic, Manual, Forced

MFG. LIST \$1,800.00 CALL FOR BSW PRICE



MODEL L3/12
HIGH INTENSITY LIGHT

Dimmer with off position, 6' cord, wall plug-in transformer, gooseneck, high intensity hood and quartz halogen bulb. Permanent mounting material included. Perfect for illuminating turntables.

BSW PRICE\$39.95



WHEELLOCK



PS11 AWPW

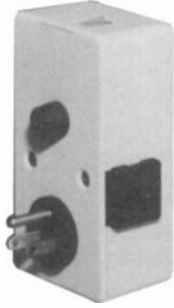

PR-11A-W

**MODEL PS11 AWPW
TELEPHONE STROBE SIGNAL**

Compact telestrobe signals emit high intensity flashing light when the telephone rings. Ideal for broadcast studios.

MFG. LIST \$78.75 CALL FOR BSW PRICE

**MODEL PR-11A-W
TELEPHONE RELAYS**

Wheelock offers a wide variety of relays for most common telephone ringing applications. Designed for insertion in standard AC receptacles, it can actuate any 115 VAC device up to five amps rated current during on-time of telephone ring cycle.

MFG. LIST \$81.70 CALL FOR BSW PRICE

HALONCO™



HALON FIRE EXTINGUISHERS

Here is the best investment you can make for your transmitter site and studios... Halon Fire Extinguishers from Halonco™. BSW can supply portable hand-helds or automatic systems that you can install and maintain yourself. All Halonco extinguishers use a formulated blend of Halon that is expelled as a pure vapor. Safe for use on all classes of fire and will not cause costly damage to sensitive electronic components. The fire kill is 3 times more effective than CO². Each Halonco extinguisher is warranted for 5 years against leakage.

CALL BSW TOLL FREE 1-800-426-8434 FOR PRICES. HAND-HELDS START AT ONLY \$23.95 AND AUTOMATIC SYSTEMS ONLY \$89.95

Valentino, inc

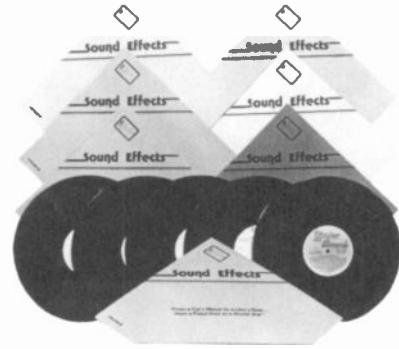

RECORD OR COMPACT DISC

Here is what every production studio should have... a quality sound effects library. This professional library has been specially recorded for broadcasters. Cues up quickly.

MODEL SFXSET (Record set contains over 1,000 effects on 30 lps.)
BSW PRICE \$399.00

MODEL SFXCD (Compact disc set includes 10 CD's and has 650 effects.)
BSW PRICE \$499.00

StarMate

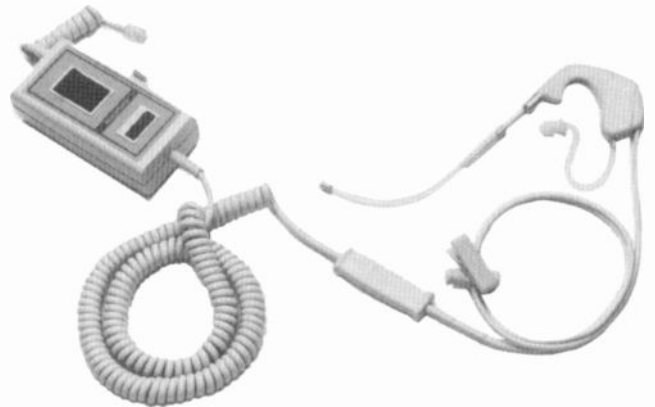

THE FINEST QUALITY TELEPHONE HEADSET

Modular connection attaches in seconds to most telephones with modular connection handsets. Lightweight fit and freedom of head movement lessens "phone fatigue" and increases productivity. Leaves both hands free to take care of other work while talking.

Great for the engineering department or receptionist. Specify telephone model for the exact StarMate set that's right for you. Prices vary with model.

Features:

- Quick-disconnect for user mobility
- Modular connector
- Three position volume control
- Adjustable voice tube
- Adjustable clothing clip
- SoundGuard® system for safe and clear listening levels.

CALL BSW TOLL FREE 1-800-426-8434 FOR MORE INFORMATION.



Scotch

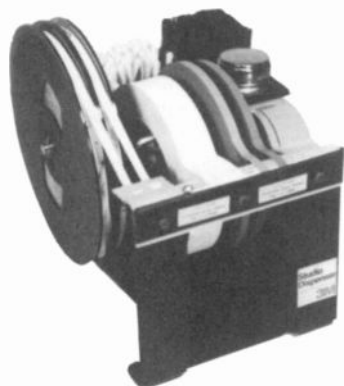

**MODEL RSD1
STUDIO DISPENSER**

Everything you need at your fingertips for professional editing and splicing. Includes splicing tape, two leader tapes, hold down tape, cotton swabs. Container for head cleaner and storage for razor blades.

MFG. LIST \$217.43 CALL FOR BSW PRICE

NORTRONICS



TAPE HEADS

If your equipment has a tape head, Nortronics more than likely makes a replacement head.

CALL US WITH YOUR REQUIREMENTS. 1-800-426-8434

STL AND MRL



TEST TAPES

Alignment tapes, cartridge test tapes, complete selection. CALL 1-800-426-8434 FOR ALL YOUR TEST TAPE NEEDS.

CBS TEST RECORDS



**MODEL CTC 300
TEST RECORD**

The industry's standard test record. Includes complete battery of test tones to check your turntable and preamp system.

BSW PRICE \$30.00

GEO-DISC



GEO-DISC™

For tonearm and phono cartridge alignment, we suggest the GeoDisc™. The GeoDisc looks like a 12" LP record, but is actually a measuring device that enables you to achieve critical alignment to within .003 of an inch. The GeoDisc allows proper phono cartridge off set tracking angle and overhang. A must if you're mounting new tonearms and/or phono cartridges.

BSW PRICE \$24.99

EDITING PENCILS

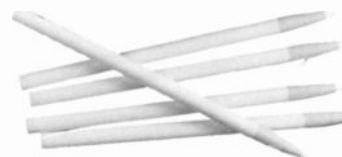

PACKAGE OF 12 \$16.95

GEM BLADES



FOR SPLICING AND EDITING

BOX OF 100 \$8.50

VIKRON



TAPE HEADS

There's a Vikron tape head to match your digital or audio application. Our sales engineers will guide you in selecting a "standard" that meets your specifications, an economical modification, or a custom designed head. The result is a head engineered to "fit your mounting holes".

Performance Engineered

Critical parameters like crosstalk rejection, wear life and low core losses at high frequency make Vikron heads perform better and more reliably. Ultimate quality is assured by the unique hyperbolic face, laminated poles, precision finish and deposited gaps.

Vikron is an approved source for all broadcast cart machines including ITC, Fidelipac, Audicord, SMC, IGM, and BE.

PRICES VARY UPON APPLICATION. CALL BSW FOR DETAILS. 1-800-426-8434



ProLite

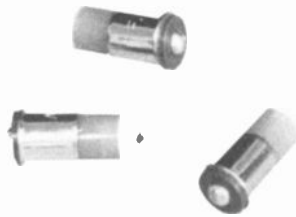

END LAMP REPLACEMENT FOREVER

Relamp your incandescent sockets. Our based multi LED miniature lamps are exact replacements for T 1/4 and T 1/4 incandescent miniature lamps. Shock and vibration proof, they keep your lighted panel and switches going "on" for 100,000 hours.

PRICES BASED ON MODEL NUMBER

REPLACEMENT CD JEWEL CASES

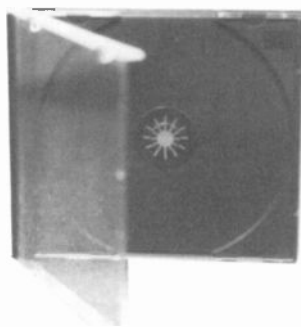

MODEL CD Box

Replace those broken CD cases with our quality CD box. Buy quantity and save.

QUANTITY	BSW PRICE
1-25	79¢ ea.
26-75	74¢ ea.
76-100	69¢ ea.
100 +	59¢ ea.
500 +	50¢ ea.

AudioSource®

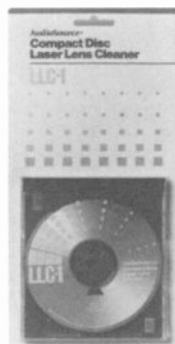

MODEL LLC-1
LASER LENS CLEANER

If your CD player is experiencing false starts, skipping, or distortion, the problem could be a dirty laser lens. The LLC-1 is a digitally encoded compact disc that has a brush to clean the lens automatically. Simple to use with superior results.

BSW PRICE \$29.95

COPY HOLDERS



Features:

- For announcers, newspersons, programmers, secretaries
- Holds any reading material wherever you need it

MODEL 16008 (4 lb.)

BSW PRICE \$59.95

MODEL 16007 (1 lb.)

BSW PRICE \$49.95

CRAMOLIN®



Cramolin cleans, preserves, and lubricates all metal contacts, switches, and connectors. Improves conductivity and reduces wear. Easy to apply with spray or liquid. This non-flammable cleaner is long lasting and economical.

MODEL R5-6 (6 oz. spray)

BSW PRICE \$7.95

MODEL R100L2 (2 oz. liquid)

BSW PRICE \$12.50

ACCESSORIES

MODEL AB-12 (Pkg. of 12 Audio Brushes)

BSW PRICE \$3.50

MODEL LFCC50 (50 Lint Free Cotton Cloths)

BSW PRICE \$4.50

MODEL SWP12 (Pkg. of 12 Foam Swabs)

BSW PRICE \$4.50



modulation sciences, inc.

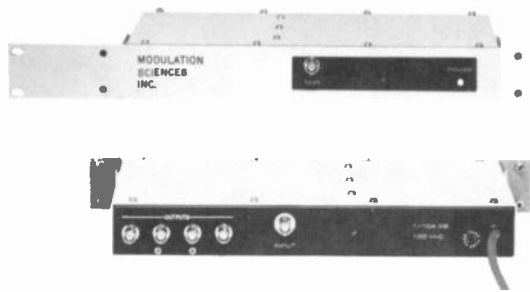

DRIVE MULTIPLE TRANSMITTERS WITHOUT INTERACTION

MODEL CLD-2504 COMPOSITE DISTRIBUTION AMPLIFIER

Modulation Sciences' CLD-2504 Composite DA is a problem solver. Its one-in four-out, unity gain configuration makes distribution of the composite baseband signal as easy as distributing audio. The high impedance input avoids circuit loading; the four low impedance outputs drive a wide range of equipment. All connectors are BNC's. The Composite DA provides greater than 50 dB of isolation between outputs.

The four isolated outputs of the Composite DA let you continuously and simultaneously drive dual main transmitters, main/aux/back-up transmitters, alternate stereo generators and processor setups, etc. No cable switching, no changeover relays, no level changes and no hassles!

MFG. LIST \$950.00 CALL FOR BSW PRICE

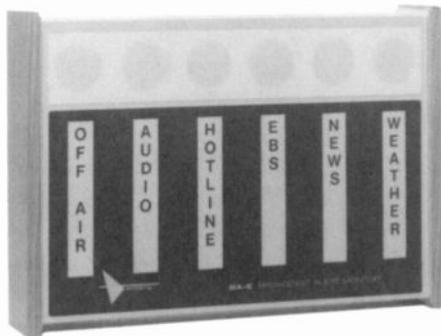

MODEL BA6

Off the Air... EBS warning... Telephone hotline ringing? Find out in an instant visually with the BA6 from Enberg Electronics. This practical device is attractive as well as functional. Interfaces with a variety of equipment to inform you of status immediately. Stick on letters allow you to customize for your particular requirements.

MODEL BA6 BSW PRICE \$342.00

MODEL BA12 12-CHANNEL BSW PRICE \$685.00

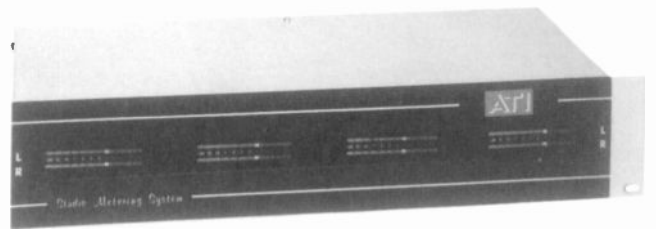

MODEL VU800 VU METERING SYSTEM

Give yourself that warm, secure feeling by economically displaying all your important lines simultaneously. Know at a glance where your signals are (or are not). Expandable ATI MicroMeters display one, two, three or four stereo lines (eight channels) on bright, two-color vacuum fluorescent bar-graph indicators. Balanced, bridging inputs are switchable for 0 VU at -10, +4, and +8 dBm line levels. Displays -20 to +8 VU with peaks stored for several seconds. Backlit, compact 3 1/2" rack mount.

MFG. LIST \$1,249.00 CALL FOR BSW PRICE SMALLER VERSIONS AVAILABLE



MODEL ACM-1 AMPLITUDE COMPONENT MONITOR

What is an amplitude component monitor? The ACM-1 is a precise AM noise meter which connects to the RF sample on an FM transmitter. A digital string display with 20 dB of range displays AM noise for precise transmitter tuning. It interfaces with any remote control to sample and then read back a stable indication of AM noise. An adjustable alarm threshold can signal the station operator when AM noise has increased beyond a level you determine will cause reception problems. The nature of AM noise measured can be examined by the engineer with the oscilloscope output. Audio and data outputs are provided.

MFG. LIST \$1,595.00 CALL FOR BSW PRICE

Customer Service

BSW's "after the sale" support is second to none. Your complete satisfaction is our only goal and we pay for the call.

Toll Free 1-800-426-8434



CONEX

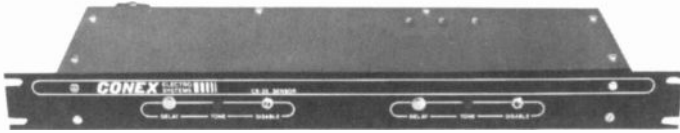

**MODEL CS-25B
25 HZ TONE SENSOR**

The Conex Electro-Systems CS-25B is a compact and reliable bridging-type 25 Hz tone sensor for use in broadcast automation and tape control systems. The unit features two independent sensors, allowing very economical expansion of existing systems.
 MFG. LIST \$389.00 CALL FOR BSW PRICE
 (With Stereo High Pass Filter)
 MFG. LIST \$466.00 CALL FOR BSW PRICE



**MODEL CG-25
25 HZ TONE GENERATOR**

The CG-25 allows you to put 25 Hz tones on your own tapes. Use with automation systems or live assist operations. Timing intervals, tone levels adjustable.
 MFG. LIST \$375.00 CALL FOR BSW PRICE
 (Rack Mount Version)
 MFG. LIST \$375.00 CALL FOR BSW PRICE

BTC



**MODEL 1000
SCA GENERATOR**

The Model 1000 SCA Generator from Broadcast Technology of Colorado, sounds almost too good to be true. You get a dual channel SCA generator for only \$485.00. 19" rack mount. 67 kHz and 92 kHz simultaneous carrier frequencies. Distortion 0.1% or less. Crosstalk -65 dB below program.
 MFG. LIST \$895.00 CALL FOR BSW PRICE

SENTRY SYSTEMS



**MODEL AIR SENTRY II
AUDIO SIGNAL MONITOR**

The Air Sentry is designed to constantly monitor the presence of an audio signal to energize a relay when the audio is absent. Activation of the relay is front panel adjustable from 4 to 20 seconds. The relay may in turn be used to activate an external audible or visible alarm to notify station personnel of the absence of broadcast signal. Air Sentry may be used to monitor any stereo or mono audio source such as audio from AM/FM tuner, TV receiver, or modulation monitor. Air Sentry is built to broadcast standards of reliability and is extremely cost-effective.
 MFG. LIST \$295.00 CALL FOR BSW PRICE

BROADCAST TOOLS

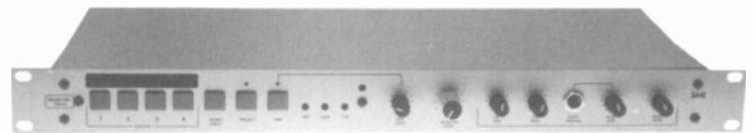

**MODEL SMI
STUDIO MONITOR INTERCOM**

Most broadcast consoles... even very high end consoles... don't have adequate talkback/intercom or monitor capabilities. The Broadcast Tools SMI (Studio Monitor Intercom) provides an efficient, affordable solution.

We all know that communication between studios is vital. The SMI allows you to talk to up to four other studios. Simply buy as many SMI's as you need. Talk with one studio at a time or on an "all call" basis. Each unit has host and guest headphone jacks with bass and treble eq. The SMI automatically dims studio monitors during talkback. In addition, host headphones split for talkback in the right ear and air signal or program in left ear (defeatable while on air). Other features include:

- Fully remote controllable with tally
- Interconnection via convenient 50 pin telco-type connectors, transformer isolated
- Mono/phase check button
- Front panel talkback mic with adjustable AGC
- Aux input for talkback with level control (for remote feeds, etc.).

MOST IMPORTANTLY, THE SMI FROM BROADCAST TOOLS IS AFFORDABLE. ONLY \$625.00 PER STATION CALL BSW TOLL FREE AT 1-800-426-8434 FOR DETAILED SPECIFICATIONS



KINTRONIC LABORATORIES, INC.

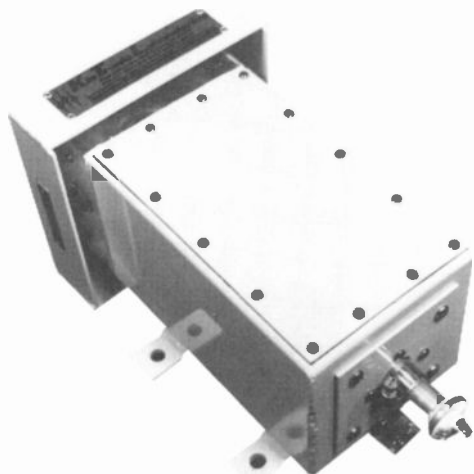

Kintronic Laboratories' Isocouplers provide versatility to existing AM radiating elements by allowing for installation of transmit-receive/FM/TV antennas operating in the frequency range of 30-1000 MHz without disrupting AM antenna characteristics.

CALL BSW TOLL FREE 1-800-426-8434 FOR PRICES AND SPECIFICATIONS

ELECTRO Impulse, Inc.



Electro Impulse is a leading supplier of specialized equipment for the communications and broadcast industries. Innovations such as dry, forced air cooled loads for FM broadcasters, termination type power meters, attenuators, high accuracy calorimeters that measure RF power, and other loads up to 1.5 million watts average power, are all representative of products which have emerged from their years of experience in this field.

While many requirements can be met from our standard and/or stock selection, special needs can be filled through either modified stock or custom design units. In either case, all products are backed by a 12 month warranty.

PRICES BASED ON APPLICATION

bdi

Broadcast Devices, Inc.



MODEL APC-200 PHASE CORRECTOR

It's a fact that stereo phase error drastically affects your mono sound. The smallest phase error can degrade high frequency performance. Larger phase errors are audible in stereo and can affect your stereo image as well. With Broadcast Devices' Rightrack, you no longer have to settle for "dull and muddy" when you can be consistently bright and crisp at an affordable price.

The Rightrack gives you a quick and easy method of making sure that your existing tape equipment consistently provides superior sound — in mono as well as stereo. Both visual and aural indications of phase performance allow you to provide precise phase correction.

The Rightrack is not an encode-decode system. It is designed to work with and improve your existing tape equipment. There is nothing else to add, no special alignment or modifications to perform. With a built-in reference oscillator, the Rightrack doubles as a piece of studio test equipment. Quick and easy alignment and verification of tape head azimuth and frequency response makes the Rightrack even more valuable in any production studio.

MFG. LIST \$995.00 CALL FOR BSW PRICE

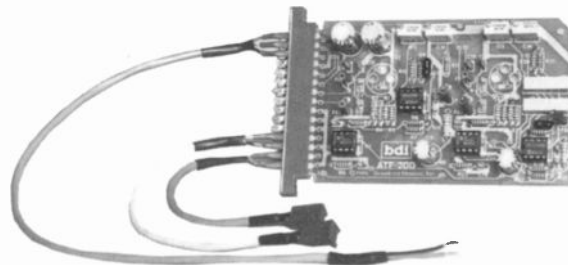

MODEL AFT-200

Replace the input transformers on your ITC Series 99* recorder and improve its performance. Broadcast Devices' AFT-200 Active Transformer Card offers improved headroom, transient response and frequency response over the original transformer balanced inputs.

With an FET differential input, the AFT-200 is a stereo balanced circuit that mounts on the rear of your existing input connectors. It's simple and quick to install — we supply you with all the parts needed, including a step-by-step manual improving your 99's performance. There are no expensive motherboards to replace, or complicated modifications to perform.

The AFT-200 runs off existing power supply and can be either AC or DC coupled to the audio input. Multiturn controls are provided for gain, offset drift and common mode rejection. These are factory preset and/or field adjustable.

*Series 99 is a product of International Tapetronics Corporation/3M BSW PRICE (with edge connector) \$150.00 BSW PRICE (without edge connector) \$129.00

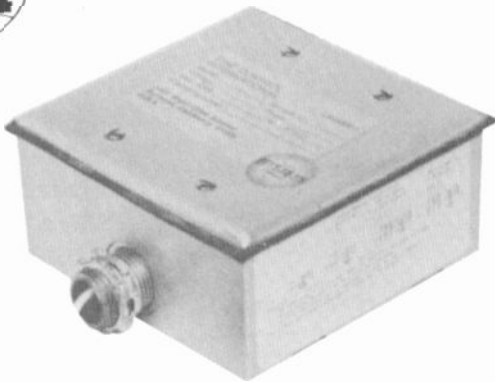

SURGE AND TRANSIENT PROTECTOR

The positive method of choice for the demanding professional in the elimination of transients, harmonic ringing, surges and white noise from the electrical power supply lines.

Sine control suppression devices are voltage dependent (activated) only, precluding the necessity, and expense, of matching amperage ratings of the suppressor with amperage ratings of the equipment it is designed to protect.

Features:

- Stop circuit and power supply damage
- Diminish motor and transformer overheating
- End computer/microprocessor memory loss
- Stop data transmission loss
- Extend equipment life expectancy

PRICES BASED ON APPLICATION. CALL BSW FOR MORE INFORMATION

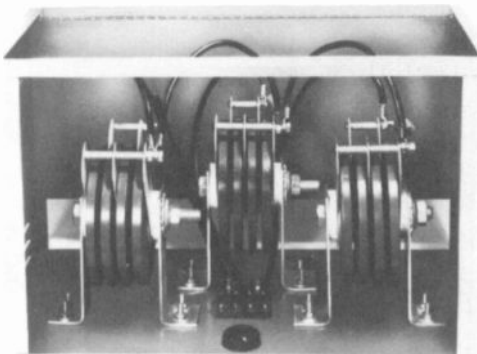

**MODEL S1A
LINE SURGE PROTECTOR**

The Wilkinson Electronics Line Surge Protector is far superior to standard lighting arresters, surge reactors or other AC line protection devices.

AC line voltage surges, caused by lightning, transformer arcing and induced transients are everyday occurrences that cause heavy damage to equipment incorporating silicon rectifiers, mercury vapor tubes, or other semi-conductor devices. The Wilkinson Electronics Model S1A protects valuable equipment from surges that often exceed many times the normal line voltage.

SINGLE PHASE OR THREE PHASE

CALL FOR BSW PRICE

CATEL



**MODEL FMX-2100S
FM MODULATOR**

The FMX-2100S FM Modulator is a modulator packaged frequency modulation cable transmitter designed specifically for CATV and CCTV applications. When used with the SM-2200 Stereo Generator, it makes possible the origination of stereo programming. With direct audio sources such as AM/FM tuners, tape decks, microphone preamplifiers and short wave receivers, it can add varied FM signals to the cable system. In addition to the re-transmission of audio signals, the wide band (plus or minus 75 kHz) deviation makes the unit ideal for multiplexed voice or data transmission. Specify operating frequency.

MFG. LIST \$1,035.00 CALL FOR BSW PRICE



**MODEL EQ-2 EQUALIZER
SURGE, SPIKE AND NOISE SUPPRESSOR**

The Equalizer uses a 2-stage solid state suppression network which is electronically bridged to an active chemical compound with energy dissipation capabilities. This chemical link technology allows the Equalizer to internally dissipate large spikes and surges that would destroy other surge suppressors. The Equalizer also has complete EMI/RFI noise filtering.

MODEL EQ-2 - (2 outlet unit with EMI/RFI)

MODEL EQ-6 - (6 outlet unit with EMI/RFI)

MODEL EQ-2-RJII - (2 outlet unit with EMI/RFI and R-11 jacks for fax line, telephone line or modem protection.)

CALL FOR BSW PRICES

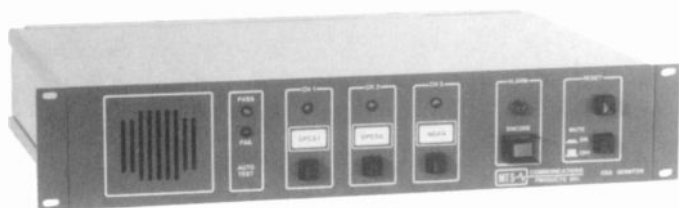

MODEL 3000 EBS/WEATHER MONITOR

Meet System 3000, the ultimate EBS monitor. System 3000 incorporates three monitor receivers, the EBS encoder and decoder into one unit. All in one desk top or rack mountable package three and a half inches high. Most options are already built in. Just a very few options for the fully automatic configuration are not in the standard product.

A single System 3000 can monitor your areas CPCS1, CPCS2, and the local NOAA weather service. Or it can monitor your CPCS1, CPCS2, and an adjacent area CPCS1! Or with 2 or more systems you can monitor EBS and NOAA services over a large area thereby offering your community the best information and protection available.

Additional features include:

- Three channel scan • Continuous automatic self test
- Manual or automatic operation • Program audio loop through
- NOAA weather service receiver • NOAA priority alert decoder
- Left and right channel outputs • Remote operation
- Built-in monitor speaker

MFG. LIST \$1,900.00 CALL FOR BSW PRICE



MODEL 886/887 EBS MONITOR

The Models 886 and 887 Emergency Broadcast System (EBS) receivers are designed for broadcasters to meet Parts 73.940, 73.941 and 73.942 of the FCC Rules and Regulations. The AM receiver, Model 886, is tunable across the AM broadcast band, the FM receiver, Model 887, is a high performance, tunable receiver, using a 4-digit front-panel pushbutton. Both receivers have built-in two tone decoders for the 853 Hz and 960 Hz EBS signaling tones.

Two 2-digit LED displays on the front panels of the receivers show the number of days, up to twelve, since EBS test transmissions were last received and/or sent. This assists in avoiding FCC citations for incorrect use or non-use of the EBS system.

MODEL 886

MFG. LIST\$1,920.00

MODEL 887

MFG. LIST\$1,920.00

CALL FOR BSW PRICES

Gorman-Redlich



MODEL CEB EBS MONITOR

Features:

- Encoder FCC type accepted. Decoder FCC certified. Meets all legal requirements.
- Low cost with uncompromising quality and performance
- Exceeds FCC specifications for EBS requirements
- Provision for remote operation. Programming loop through standard in encoder. Decoder demutes monitor receiver/and or actuates auxiliary alarm.
- Decoder can be self-tested
- Requires outboard tuner

MFG. LIST \$540.00 CALL FOR BSW PRICE

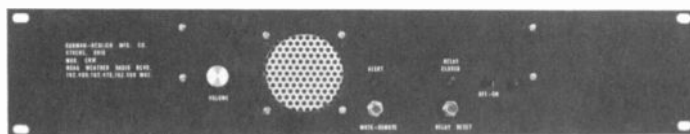

MODEL CRW WEATHER ALERT MONITOR

Receive accurate local weather, plus emergency alert messages, weather radar data or marine information. Automatic warning, severe weather or civil defense emergency.

MFG. LIST \$540.00 CALL FOR BSW PRICE

Don't Panic... We're Still Open

BSW's extended hours and West coast location are great for those times when you just have to have that piece of important equipment. We're open 6 a.m. to 6 p.m. Pacific time, 9 a.m. to 9 p.m. Eastern.

1-800-426-8434

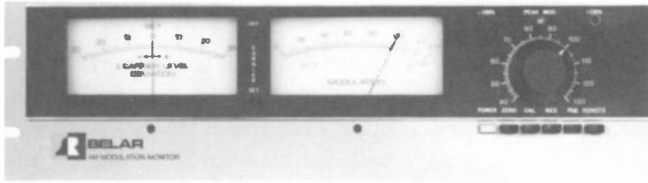

**MODEL AMM-2B
AM MODULATION MONITOR**

- Features:
- Separate 100% negative peak modulation indicator lamp, independent of carrier level
 - Separate 125% positive peak modulation indicator lamp, independent of carrier level
 - Adjustable peak modulation indicator, 40 to 130% in less than 1% increments, independent of carrier level
 - True peak-reading modulation meter responds accurately to the shortest duration program peaks
 - Built-in carrier-off alarm
 - Built-in modulation calibrator

MFG. LIST \$1,195.00 CALL FOR BSW PRICE

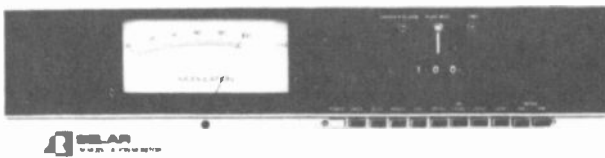

**MODEL FMM-2
FM MODULATION MONITOR**

The FMM-2 sets new standards in accurate FM monitoring — the first to incorporate a sample hold peak modulation meter circuit independent of modulation polarity to allow the meter to respond to program peaks of the shortest duration. The heart of the FMM-2 is an ultra-linear digital discriminator which provides a distortionless baseband signal for accurate monitoring as well as a precise stereophonic, and SCA decoding. FMM-2 required with FMS-2 or SCM-1

MODEL FMM-2 MONO MODULATION MONITOR
MFG. LIST \$1,450.00 CALL FOR BSW PRICE

MODEL FMS-2 STEREO MODULATION MONITOR
MFG. LIST \$1,650.00 CALL FOR BSW PRICE

MODEL SCM-1 SUBCARRIER MODULATION MONITOR
MFG. LIST \$1,695.00 CALL FOR BSW PRICE

BSW Delivers

BSW's extensive inventory assures you outstanding delivery. Our special discount rate on Federal Express saves you dollars and time.

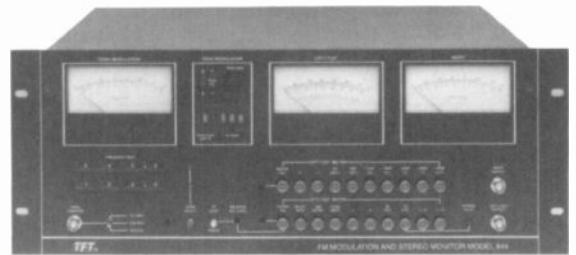

**MODEL 844
FM/STEREO MODULATION MONITOR**

Based on TFT's years of engineering experience — with over 5,000 modulation monitors operating worldwide — these third generation instruments bring you innovations that solve today's advanced technology. You get everything you need for complete proof-of-performance measurements (for distortion, an external analyzer is needed) right on the front panels, plus accuracy, versatility and convenience no other monitors can match.

The Model 844 FM Monitor combines a tunable RF preselector, a baseband monitor and a stereo monitor in one compact instrument. State-of-the-art design, for optimum monitor performance, includes the use of linear phase filters, large scale integrated circuits (LSI) and toroidal power transformers to reduce hum and power line noise. Modular PC cards make service and routine calibrations easy, and high quality, industrial grade electronic components and parts are used throughout.

MFG. LIST \$4,550.00 CALL FOR BSW PRICE

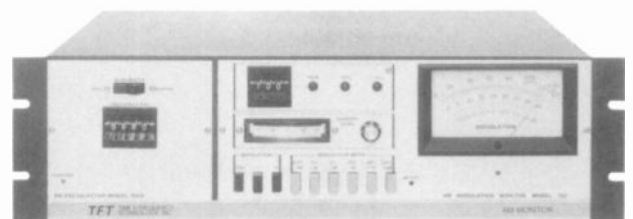

**MODEL 753
AM MODULATION MONITOR**

In today's competitive AM markets, you need to deliver a strong signal to the widest possible area. But, transmitter power alone isn't enough. You also need all the modulation you can legally achieve. That's the basic purpose behind the TFT Model 753 AM Modulation Monitor. Not only does it make extremely accurate proof-of-performance measurements, but more importantly, it allows you to monitor your transmitter so precisely that you can modulate it to the maximum legal limits in absolute confidence.

MFG. LIST \$1,600.00 CALL FOR BSW PRICE



MODEL 691/01
FM MODULATION MONITOR

The 691 FM Monitor/Test Set is a high technology, precision instrument employing a combination of new techniques in a single, highly versatile, but very compact package. It was designed to be a complete FM test package with facilities for all proof-of-performance measurements and a wide range of trouble-shooting tests. Operator convenience and simplicity of use were primary considerations in the design of the 691. Measures FM and SCA modulation. 18 tests can be performed when used with an oscilloscope. MFG. LIST \$6,675.00 CALL FOR BSW PRICE

modulation sciences, inc.



MODEL MODMINDER
FM MODULATION MONITOR ENHANCER

ModMinder™ is an advanced and highly accurate digital device for measuring and displaying peak FM deviation. Using ModMinder's new measuring and reporting technique, most FM stations can increase modulation, reduce processing, or do some of both. ModMinder does not replace your existing modulation monitor — it is designed to supplement conventional monitors. ModMinder processes modulation information digitally using an 80C88 microprocessor.

How does it work?

Conventional modulation monitors respond to peaks of less than 100 microseconds. But ModMinder waits almost 1000 microseconds (1 millisecond) before registering a peak.

This delayed response means the ModMinder ignores brief overshoots that contain very little power. The more rapid response of ordinary monitors means these brief excursions are counted as modulation-robbing peaks. Because ModMinder ignores them, either the average modulation may be raised or the amount of processing greatly reduced. Often, doing some of each is most desirable. Typical improvements in modulation will range from 1 to 4 dB, depending on the amount and type of processing employed?

What does it do?

ModMinder provides a comprehensive front panel display of modulation information, as well as extensive remote control capability. Interface to a conventional broadcast remote is provided by relay contacts.

How well does it work?

ModMinder is highly accurate. Typical monitors have an accuracy of ±5.0%. Their resolution is no better than an operator's ability to read a moving pointer meter. Compare ModMinder, which delivers ±1.0% accuracy and 0.5% digital resolution.

MFG. LIST \$2,395.00 CALL FOR BSW PRICE

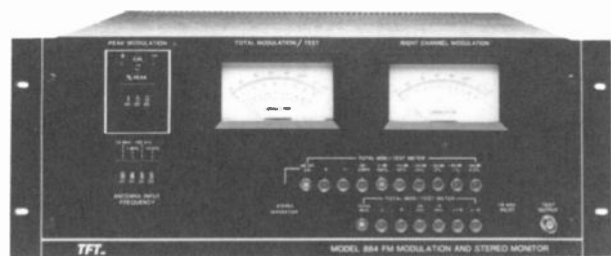

MODEL 884
STEREO MODULATION MONITOR

The TFT Model 884 FM Stereo Modulation Monitor is a cost-effective alternative to TFT's popular Model 844. The 884 allows you to maximize modulation levels while maintaining the highest signal quality.

The 884 can be used for transmitter *Proof-Of-Performance measurements, or at the studio for off-air monitoring. The frequency-synthesized pre-selector can be used to select your own station's signal or the signal of another station for easy and convenient comparison.

*With a 40 dB attenuator inserted before the antenna input.

MFG. LIST \$3,320.00 CALL FOR BSW PRICE

Prolite

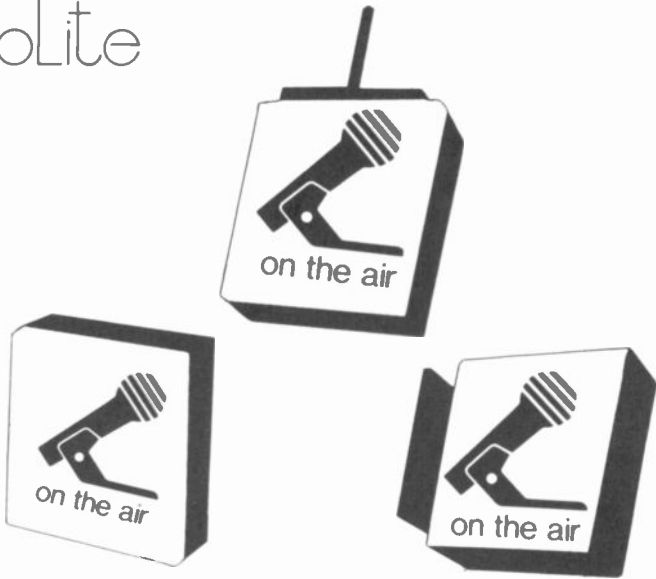

ARCHITECTURAL SERIES
ON AIR/RECORDING LIGHTS

Designed to fit a variety of interior specifications, the Prolite Architectural Series lights are attractive as well as functional to warn that a microphone is on. Housing and canopy are triple ground, cast aluminum with a baked, matte black enamel finish. Dimensions are 7½" square. Two 20W T-6 ½" long life lamps are supplied. 120 volts is required to operate. Choose from 3 configurations and either on air or recording symbols.

MODEL	DESCRIPTION	PRICE
33W6142R	Flat wall, single lens	\$87.90
33C6242R	Extended wall, double lens	\$113.25
33E6242R	Extended ceiling, double lens	\$113.25
33P6242R	Pendent ceiling, double lens	\$147.75
	Extra blank lens	\$11.25

FIDELIPAC®



DIMENSIONS: 5"H x 10"L x 2½"D. 120 volt

MODEL 65340 ON AIR	
BSW PRICE	\$65.35
MODEL 340REC RECORDING	
BSW PRICE	\$65.35



OAL-VS



OAL-HG

MODEL OAL-VS/OAL-HG
ON AIR/RECORDING LIGHTS

Titus Technological Laboratories on air light provides the broadcaster and recording studio with a beautiful but practical means of indicating that a studio is in use. The TTL on air light features a smoked glass window mounted in either a gold or silver frame which is attached to an oak mounting base. The warning "on air" or "recording" only appears when illuminated and is blacked out when not in use.

Features:

- Handsome appearance • Oak base
- Silver or gold frame • Easily serviced
- Horizontal or vertical mounting
- "On air" or "recording" (specify)
- "Blackout" face when not in use
- Low voltage wiring (class 2)

BSW SPECIAL PRICE \$122.50

Prolite



MODEL L101
ON AIR LIGHT

The Prolite L101 is a great on air light when space is the most important consideration. The L101 fits in a standard single duplex electrical box. It operates on 12 volt dc (power supply not included). Plastic lens is available in white or red color (specify).
BSW PRICE \$19.95

Need prices on a major project? Save yourself time and FAX us your equipment list. We'll have a complete price quote back to you in no time.

BSW FAX # 206-565-8114

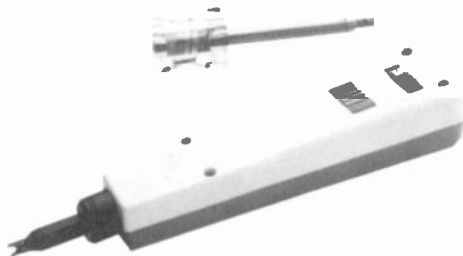
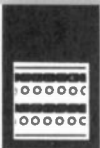

WIRE INSERTION TOOLS FOR ADC PUNCH BLOCK

The insertion tools are used for insertion of wire into the QCP split cylinder modules. The impact tool applies the correct force to the wire by a spring loaded mechanism within the tool. Either of 2 impact forces can be applied, as selected by the LO-HI thumbwheel on the side of the tool. The LO position installs 24 or 26 AWG wire, the HI position installs 22 AWG wire. The impact tool includes 1 removable tip which comes stored in the tool's handle.

The manual tool performs identical functions as the impact tool without the aid of a spring loaded tip.

MODEL Q114 MANUAL TOOL

BSW PRICE \$19.80

MODEL QB1 IMPACT TOOL WITH TIP

BSW PRICE \$68.60

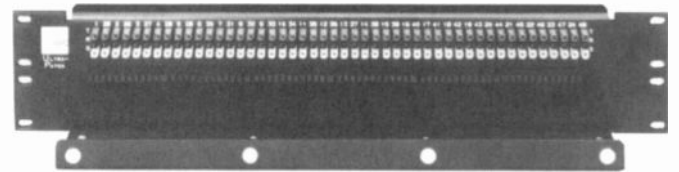

MODEL ULTRA PATCH PUNCH DOWN SYSTEM

Features:

- Utilizes QCP technology - detailed above
- On ultra patch panels with normals, contacts are arrayed to facilitate full and half normalling
- Four design configurations to interface with 24 circuit (48 jack) and 48 circuit (96 jack) patchbays, with provisions for normals if necessary
- Cable support system insures that your cabling will dress neatly and stay that way, without stressing your connections

CALL BSW FOR PRICE AND CONFIGURATION

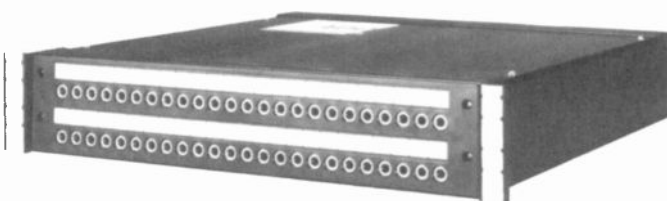

MODEL PRO PATCH MARK II PATCH PANELS

ADC has enhanced the design of Pro Patch front and back to deliver more time and work savings. In front, circuit designations are neat and convenient; and in back, the terminal layout affords faster installation and more flexibility of configuration.

The fully enclosed Pro Patch chassis protects all the internal patchbay wiring as well as eliminating the need for routing and dressing conventional patchbay harnessing.

Front panel and rear panels remove easily for service without removing the unit from the rack — saving downtime.

QCP is featured on Pro Patch. This proven method of cable termination provides numerous benefits.

QCP provides a "gas tight" connection. This means your cable connections are impervious to harmful environments, thereby giving you a connection that will not deteriorate over time.

CALL BSW FOR PRICE AND CONFIGURATION

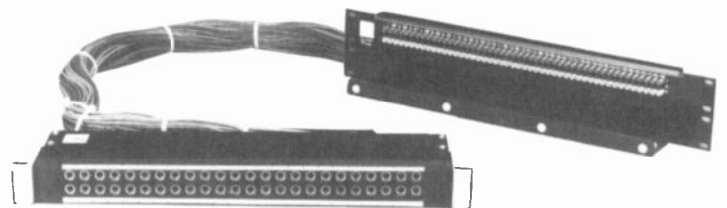

MODEL BJF MKII PREWIRED PATCH PANELS

The standard BJF MKII patch panels include:

- Ultra Patch termination (see below)
 - A four foot cable harness
- BJF MKII patchbays are available in numerous harness length and termination configurations on a special order basis.

CALL BSW FOR PRICE AND CONFIGURATION

BSW's West Coast Location Allows Late In The Day Shipments. If You Need Equipment Fast, BSW Is Your Supplier.

We Offer Special Discount Rates On Federal Express.

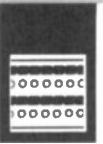

GENTNER

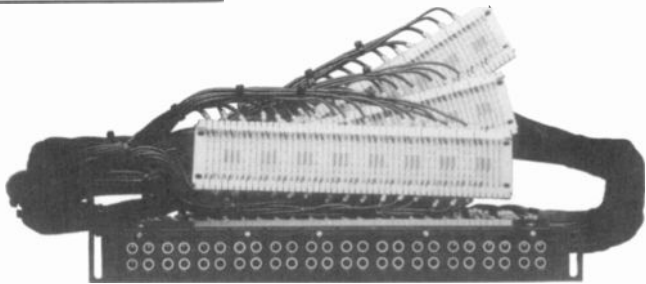

**PRE-WIRED AUDIO
PATCH PANELS**

Hand-wired to your specifications, using the highest quality components. A large variety of bay fronts and terminations are in stock to ensure good delivery time for almost any configuration. CALL FOR PRICES AND CONFIGURATIONS



**MODEL FLEXIBLOCK
TERMINATION PANEL**

A "punch block" for stranded wire. Provides simple, gas-tight connection without cutting strands. Mounting bracket provides easy cable management. 100 terminals configured with 2 rows of 50 terminals; each slot accepts 2 wires. (Split Flexiblock also available; provides 2x50 terminals with 2 wire connections per terminal.)

MFG. LIST \$29.00 CALL FOR BSW PRICE

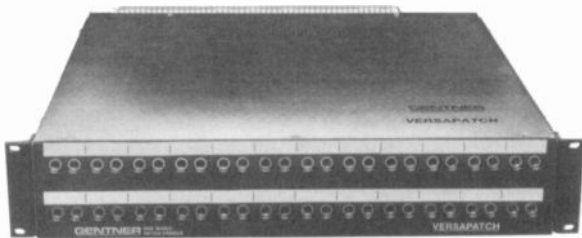

**MODEL VERSAPATCH
PATCH PANEL**

A chassis-enclosed audio patch panel with the termination mounted on the rear panel. Eliminates guesswork on bundle length provides protection against RFI and dust. Offset jack spacing for stereo patching.

CALL FOR PRICES AND CONFIGURATIONS

ADC Telecommunications

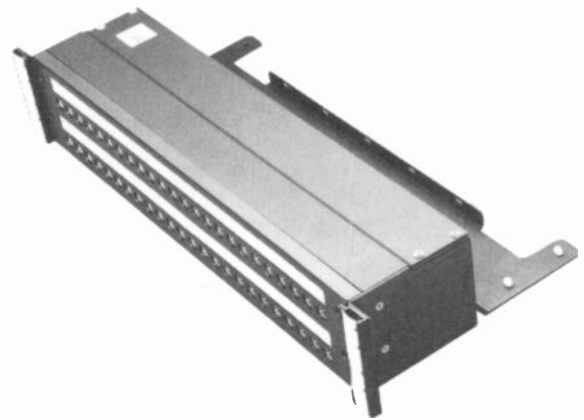

**HERE'S A GREAT WAY TO SAVE MONEY...
PATCH KIT FROM ADC**

Patch Kit has many of the features of the pre-assembled patch-bays, but in a package designed specifically for the do-it-yourselfer. Simply add your own cable and termination panel and you'll have it made, and you'll have made it yourself.

MODEL	DESCRIPTION	MFG. LIST
P-KIT-1	1.75" panels with 2x24 array of long frame (1/4") jacks	\$180.00
P-KIT-3	3.5" panels with 2x24 array of long frame (1/4") jacks	\$180.00
P-KIT-B	1.75" panels with 2x48 array of Bantam jacks	\$240.00

CALL FOR BSW PRICE



BANTAM



LONG FRAME 1/4"

LONG FRAME PATCH CORDS

MODEL	LENGTH	BSW PRICE
PJ-81	1 Foot	\$13.60
PJ-82	2 Foot	\$14.35
PJ-83	3 Foot	\$14.85

BANTAM PATCH CORDS

MODEL	LENGTH	BSW PRICE
PJ-712	1 Foot	\$9.40
PJ-714	2 Foot	\$9.75
PJ-716	3 Foot	\$10.05

OTHER ADC PATCH CORDS IN STOCK...CALL FOR DETAILS

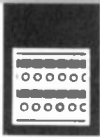

360 Systems



**MODEL AM-16/B
AUDIO ROUTING SWITCHER**

360 Systems has designed an outstanding reliable switcher providing excellent flexibility at a very low price.

The basic switcher is a 16x16 matrix, but may also be configured as an 8x8 stereo unit. For more basic applications, it can easily be programmed to operate as a 16x1 mono or 8x1 stereo selector.

All inputs and outputs are electronically balanced. Several slave units may operate in parallel to provide more than sixteen simultaneous inputs for 16x16 stereo or multi-channel operation.

All active power supply elements are fully redundant, so an AM-16/B can keep working even if all regulated supplies experience a failure. And when power is applied, the AM-16/B restores itself completely to the last configuration. 100 memory presets are standard.

MFG. LIST \$1,195.00 CALL FOR BSW PRICE

GENTNER

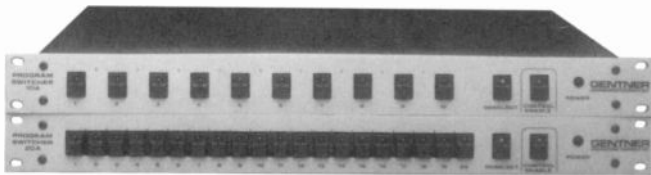

**MODEL SWITCHER 10/SWITCHER 20
AUDIO ROUTING SWITCHERS**

Gentner switchers are insensitive to voltage fluctuations. Even if the units lose power, the proper source remains selected.

Switchers 10 and 20 use highly dependable magnetically latching relays to route audio, data or control signals through your facility. Because the switching process is passive, with no loads or amplifiers of any kind, it's transparent to your signal.

The Signal Switcher 10 selects ten stereo channels to a stereo channel output; the Signal Switcher 20 selects 20 mono channel signals to a mono channel output.

MODEL SWITCHER 10

MFG. LIST \$995.00 CALL FOR BSW PRICE

MODEL SWITCHER 20

MFG. LIST \$995.00 CALL FOR BSW PRICE

CONEX

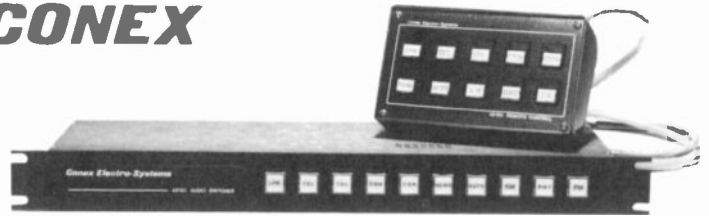

**MODEL AS-101
AUDIO ROUTING SWITCHER**

The Conex AS-101 Audio Routing Switcher allows any one of 10 stereo sources to be switched to the stereo output channel. Switching is accomplished by pressing one of the illuminated buttons on the front panel, or remotely, via the remote control connector on the rear panel. Several remote control devices may be connected in parallel, and all will indicate the selected channel.

MODEL AS-101

MFG. LIST \$895.00 CALL FOR BSW PRICE

MODEL AS-401 REMOTE CONTROL

MFG. LIST \$150.00 CALL FOR BSW PRICE

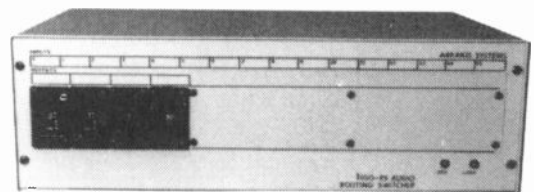

**MODEL 1100ARSS
AUDIO ROUTING SWITCHER**

The RS Audio Routing Switcher is the professional alternative to patch panels, mechanical switches and distribution amps. Ultra-reliable, the power supply is regulated, protected, has a 10 year meantime before failure. LSI integrated circuits reduce parts count to a minimum. All IC's are socketed for ease of placement. The thumbwheel control switches are 1,000,000 operation. Due to the ultra-reliable design, redundant power supplies are unnecessary. These switchers may be used in most critical sections of the audio chain with total confidence.

Features:

- Control by four 16 position binary thumbwheels. One per output
- Remote control - 4 bit binary plus enable
- Size - 5 1/4" x 19" rack mount
- 16 in by 4 outputs stereo
- Expandable

MFG. LIST \$1,195.00 CALL FOR BSW PRICE



**CARTRIDGE MODEL
INCLUDES STYLI**

MODEL	BSW PRICE
500A MKII	\$15.00
500AL	\$16.50
500E MKII	\$18.00
500EE MKII	\$21.50
681A	\$52.00
681SE	\$58.00
681EEE MKIIS	\$69.00
881S MKIIS	\$105.00
680AL	\$49.00
680EL	\$54.00

REPLACEMENT STYLI

MODEL	BSW PRICE
D50A MKII	\$7.20
D5107AL	\$7.00
D50E MKII	\$10.50
D50EE MKII	\$14.00
D6807A	\$19.00
D6800SE	\$22.55
D6800EEEIIS	\$26.00
D81IIS	\$44.00
D6800AL	\$14.75
D6800EE	\$22.55

QUANTITY DISCOUNTS AVAILABLE



**CARTRIDGE MODEL
INCLUDES STYLI**

MODEL	BSW PRICE
M44-7	\$29.00
M44-C	\$29.00
M44-E	\$32.50
SC35C	\$46.00
SC39B	\$65.00
SC39EJ	\$73.00

REPLACEMENT STYLI

MODEL	BSW PRICE
N44-7	\$16.30
N44-C	\$16.30
N44-E	\$19.60
SS35C	\$17.50
SS39B	\$26.00
SS39EJ	\$33.00

QUANTITY DISCOUNTS AVAILABLE

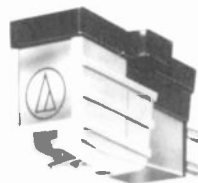

**CARTRIDGE MODEL
INCLUDES STYLI**

MODEL	BSW PRICE
ATP 1	\$31.95
ATP 2	\$42.30
ATP 3	\$56.70

REPLACEMENT STYLI

MODEL	BSW PRICE
ATPN 1	\$18.45
ATPN 2	\$26.90
ATPN 3	\$35.90

QUANTITY DISCOUNTS AVAILABLE

RECORD JACKETS

By BSW



MIX'EM FOR MAXIMUM DISCOUNT

45 RPM RECORD JACKETS

Colors: green, blue, red and gold

QUANTITY	UNIT PRICE
1-199	16c
200-299	14c
300-499	13c
500-999	12c
1,000 +	10c

discwasher® D4



RECORD CARE SYSTEM

Features:

- Cleans without reduction in record dynamics and fidelity
- D4 fluid lifts & suspends contaminants in solution on record surface
- D4 pad mick-fibers are directional, lifting dust rather than lining it up

BSW PRICE\$15.15

REFILLS

6 Oz. BOTTLES \$8.45
16 Oz. BOTTLES\$13.75



FIDELIPAC®

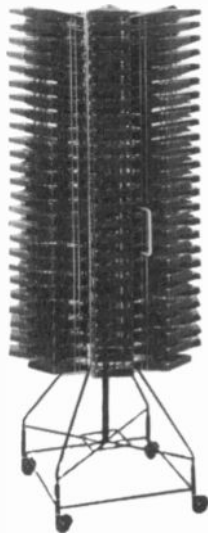

MR-200

MODEL MR-200
LAZY SUSAN (Holds 200 carts)
 BSW PRICE \$346.50

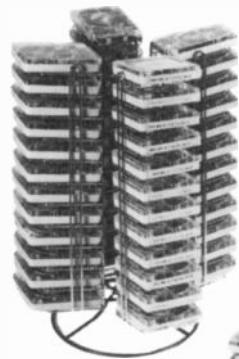

TR-48

MODEL TR-48
LAZY SUSAN (Holds 48 carts, for countertop installation)
 BSW PRICE \$97.00

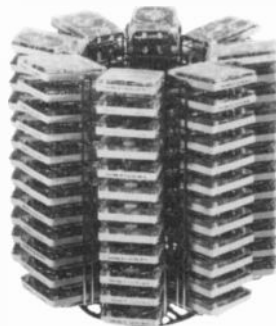

TR-96

MODEL TR-96
LAZY SUSAN (Holds 96 carts, for countertop installation)
 BSW PRICE \$173.25

ARISTOCART.

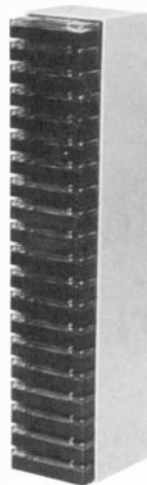

MODEL AW-20
Features:

- Holds 20 carts
- High impact polystyrene
- Great for wall mounting
- Includes mounting screws

BSW PRICE \$12.50 ea.
10 OR MORE \$11.00 ea.
20 OR MORE \$10.50 ea.

CAROUSEL FILE

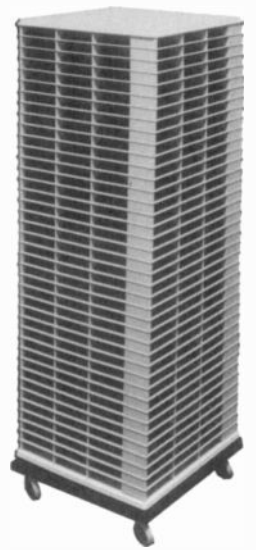

QUALITY HIGH IMPACT POLYSTYRENE LASTS A LIFETIME

- Features:**
- Desk top or floor
 - Modular construction for add-on expansion
 - High-impact polystyrene

DESCRIPTION	BSW PRICE
60 CARTS	\$109.00
120 CARTS	\$160.00
240 CARTS	\$261.00
360 CARTS	\$358.00
600 CARTS WITH FLAT BASE AND CASTORS	\$599.00
FLAT BASE WITH CASTORS	\$62.00
METAL STORAGE BASE WITH CASTORS	\$161.00

ABCO

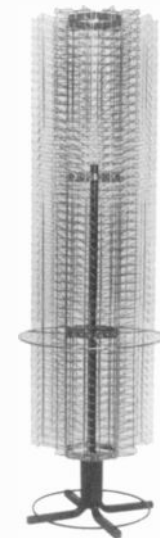

300

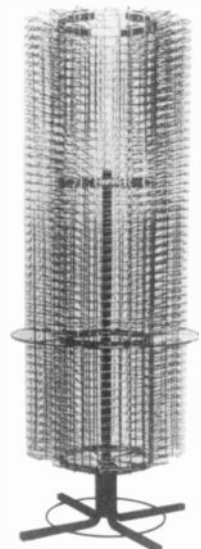

500

WIRE CART RACKS/WIRE CD RACKS

MODEL 300 (Holds 300 carts) BSW PRICE	\$372.75
MODEL 500 (Holds 500 carts) BSW PRICE	\$568.65
MODEL 280 (Holds 280 CD's) BSW PRICE	\$335.00
MODEL 560 (Holds 560 CD's) BSW PRICE	\$600.00

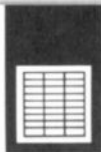

ProRax

CARTRIDGE RACKS AVAILABLE IN OAK OR WALNUT FINISH

OUTSTANDING QUALITY AND FINISH

Hundreds of stations have specified ProRax for their cartridge, cassette and compact disc storage needs. ProRax racks are constructed of the highest quality oak or mahogany hard woods. No particle board or laminates are used.

ProRax carousel models have storage on two sides instead of four, allowing for easier indexing and location. The turning radius is smaller so less counter-top or floor space is required.

With over 27 models to choose from, we are sure to have the ProRax just right for your operation. Most models are in stock for immediate delivery.

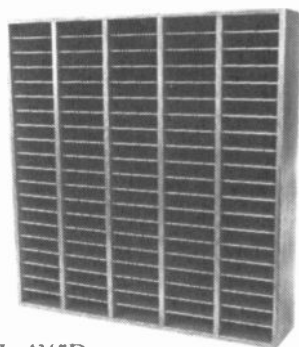

PRORAX 100
WALL OR DESK
Capacity 100
Dimensions
23½" W x 24½" H x 4¼" D



W-20 WALL
Capacity 20
Dimensions
5¼" W x 24½" H x 4¼" D

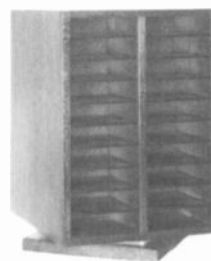

C-40 CAROUSEL
Capacity 40
Dimensions
9⅞" W x 13¾" H x 9½" D
Turning Radius 13⅜"

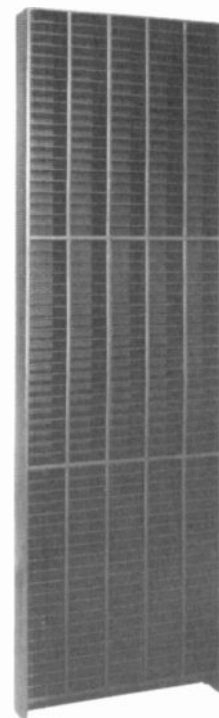

W-300 WALL
Capacity 300
Dimensions
23½" W x 75¾" H x 4¼" D

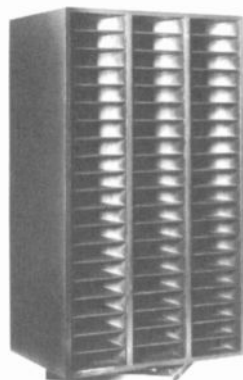

C-120 CAROUSEL
Capacity 120
Dimensions
14" W x 25½" H x 9½" D
Turning Radius 17"

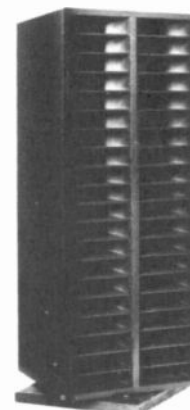

C-80 CAROUSEL
Capacity 80
Dimensions
9⅞" W x 25½" H x 9½" D
Turning Radius 13½"

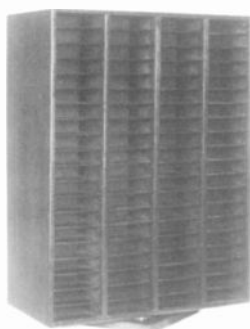

C-160 CAROUSEL
Capacity 160
Dimensions
19" W x 25½" H x 9⅞" D
Turning Radius 21"

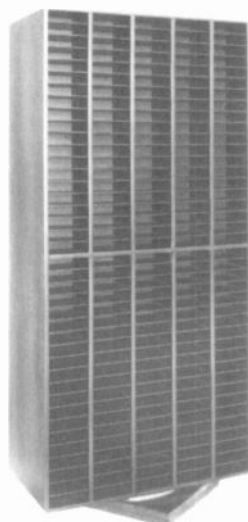

C-400 CAROUSEL
Capacity 400
Dimensions
23½" W x 50¾" H x 12⅜" D
Turning Radius 26⅜"

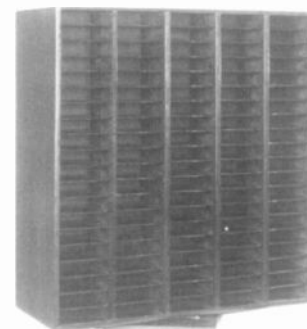

C-200 CAROUSEL
Capacity 200
Dimensions
23½" W x 25½" H x 9⅞" D
Turning Radius 25"



ProRax

COMPACT DISC RACKS

**AW-40 HIGH IMPACT PLASTIC
COMPACT DISC RACK**
Capacity 40 CD's
Dimensions
5¼" W x 21¼" H x 4¾" D

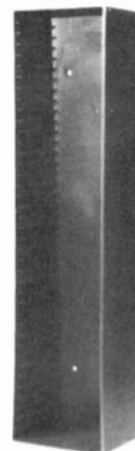

CD-40LS CAROUSEL
Capacity 40 CD's
Dimensions
11½" W x 9¼" H x 11⅜" D
Turning Radius 16"

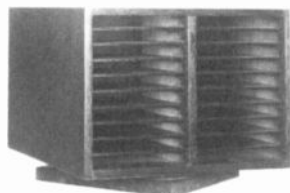

CD-80W
WALL OR DESK
Capacity 80 CD's
Dimensions
23¼" W x 15⅞" H x 4⅞" D

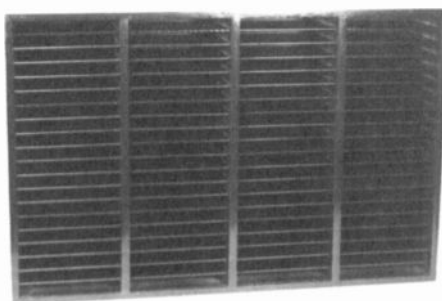

CD-20W
WALL OR DESK
Capacity 20 CD's
Dimensions
6¼" W x 16½" H x 4¾" D

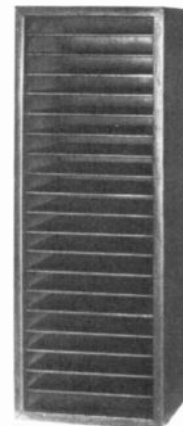

CASSETTE RACKS

CS-160LS CAROUSEL
Capacity 160
Dimensions
19" W x 25½" H x 9⅜" D
Turning Radius 21"

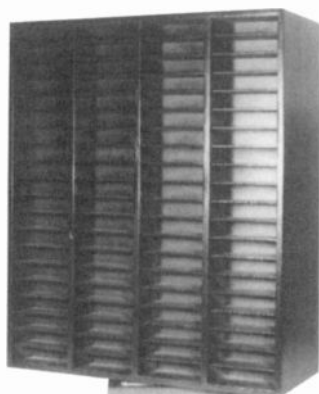

CS-80W WALL
Capacity 80
Dimensions
20⅜" W x 24½" H x 3" D

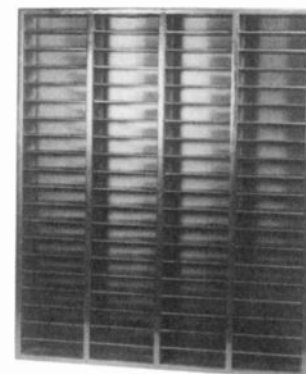

PRORAX PRICE LIST

MODEL	DESCRIPTION	WALNUT	OAK
W-20	WALL CARTRIDGE	\$ 42.95	\$ 49.95
W-100	WALL CARTRIDGE	\$ 89.95	\$103.00
W-300	WALL CARTRIDGE	\$339.00	\$475.00
C-40	CAROUSEL CARTRIDGE	\$ 74.95	\$ 68.95
C-80	CAROUSEL CARTRIDGE	\$107.95	\$115.00
C-120	CAROUSEL CARTRIDGE	\$152.95	\$165.00
C-160	CAROUSEL CARTRIDGE	\$218.95	\$226.95
C-200	CAROUSEL CARTRIDGE	\$269.95	\$279.95
C-400	CAROUSEL CARTRIDGE	\$498.00	\$575.00
CD-20W	WALL COMPACT DISC	\$ 37.95	\$ 49.95
AW-40	WALL PLASTIC COMPACT DISC	\$ 24.95	N/A
CD-40LS	CAROUSEL COMPACT DISC	\$ 74.95	\$ 89.95
CD-80W	WALL COMPACT DISC	\$ 89.95	\$ 93.95
CS-80W	WALL CASSETTE	\$ 76.95	N/A
CS-160LS	CAROUSEL CASSETTE	\$249.95	N/A

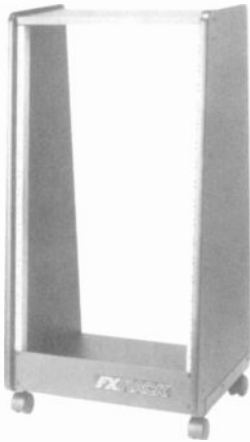
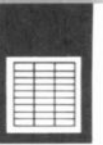

(SHOWN WITH OPTIONAL WHEELS)

**MODEL FX RACK
EQUIPMENT RACK**

FX Rack fills the need for an economical 19" equipment rack that can be used for "outboard" signal processors, patchbays, tape decks, power amps etc. The key to FX Rack's exceptional good looks and low cost is its unique design and the use of special wood/laminate materials. FX Rack is shipped flat and requires only a screwdriver for easy assembly. 40"H x 21"W x 16"D (unlimited rack depth). 33 lbs. net weight.

MFG. LIST \$129.95 CALL FOR BSW PRICE

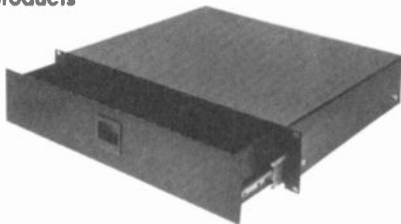

**MODEL D2
RACK DRAWER**

Occupies only 2 spaces (3½") with a depth of 14½". A fully enclosed top insures that no dust goes in, no contents go out. Front panel has a flush spring loaded handle that latches upon closing so the drawer stays closed. Full extension ball bearing slides. Top is 16 gauge steel. Black baked enamel.

MFG. LIST \$144.44 CALL FOR BSW PRICE



**MODEL PO 100
TABLE TOP CONSOLE**

At last, an attractive, rugged and economical table top console to accommodate your Otari 5050 B11 tape transport. Simply remove 8 screws holding the 2 side panels of your 5050 B and attach the two ProRax side panels with the same 8 screws. "Voila," an attractive, versatile table top console at an attractive price.

BSW PRICE \$79.95

soundolier

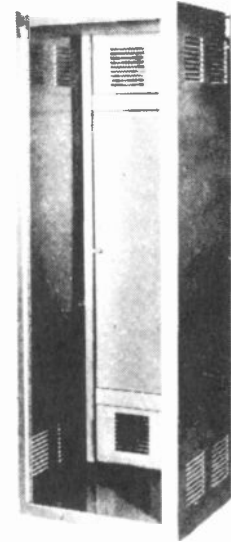

We know . . . you've seen one rack, you've seen 'em all. Not true with Soundolier. They make racks which have bright colors, specialized dimensions, and quality features that will bring out the best in your studio and equipment. Call us for your specialized rack needs.

Oh yea, we do sell the basic racks because we know you need them too. They are priced below and shipped to you welded and completely assembled. Specify color.

SERIES 100	BSW PRICE
WA 100-36"	\$312.00
WA 100-42"	\$325.95
WA 100-61"	\$373.20
WA 100-70"	\$416.00
WA 100-77"	\$415.25

TASCAM



**MODEL CS-607B
ROLL AROUND EQUIPMENT RACK**

Rack-n-roll your equipment with the Tascam CS-607B portable rack. Ideal for engineers and audio professionals on the move. The CS-607B is perfect for mounting reel-to-reel machines. Two large knobs and backing pins allow the rack frame to tilt from vertical to horizontal, so equipment can be placed in the most convenient position for your working environment.

BSW PRICE \$450.00



The Graphic Express Corporation

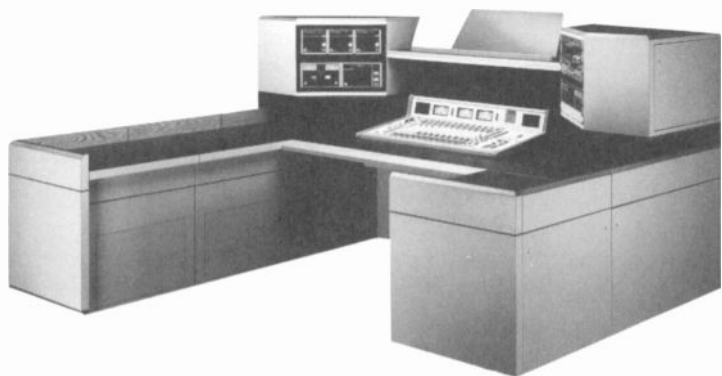

In addition to the stylish combination of solid color high-pressure plastic and solid oak trim, the Series 4000 incorporates all the benefits inherent in the Series 3000, including console cutouts. Popular hardwood structural members, and open cabinet bottoms for sub-floor cable ducting.



The Series 1000 features a solid oak bolster providing a comfortable and elegant touch to the most economic system. This series incorporates the high quality materials and craftsmanship found throughout the entire line, including Birch plywood construction and quarter turn fasteners on all access panels.



Image-enhancing design and quality craftsmanship have made the Series 5000 the hallmark of broadcast furniture. The hand-rubbed solid hardwood trim, sleek styling and contemporary colors will compliment any studio facility while providing a showcase environment.

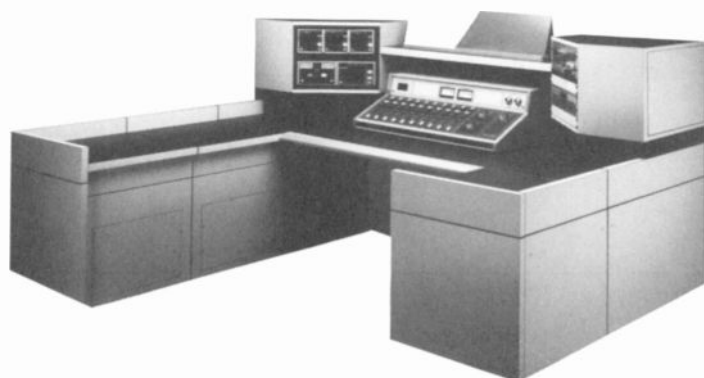

The Series 3000 provides enhanced versatility featuring an Interview Table Module and a Turntable Module with dustcover. Like all the cabinets, the Series 3000 includes leveling feet, factory installed rack rails, and a built-in wire pass.

YOUR BSW REPRESENTATIVE WILL HELP YOU WITH THE SYSTEM THAT WILL BEST SUIT YOUR REQUIREMENTS 1-800-426-8434



AMPEX



When you demand high output, minimal distortion, and consistent audio quality choose 456 Grand Master from Ampex. 456 is tested and inspected over 150 times during the manufacturing process.

MODEL	DESCRIPTION	PRICE EA.	PRICE EA.
456-17611T	1/4x2500PH 10 1/2" pancake	(1-9) \$14.50	(10+) \$12.60
456-151111	1/4x1200 7" plastic reel	(1-39) \$10.00	(40+) \$8.70
456-17311J	1/4x2500NAB 10 1/2" metal reel	(1-9) \$26.50	(10+) \$23.00

High performance is essential for mastering. The oxides for 406, 407 are specially selected to provide high signal-to-noise ratio, high head room and low distortion.

MODEL	DESCRIPTION	PRICE EA.	PRICE EA.
406-17613T	1/4x2500PH 10 1/2" pancake	(1-9) \$11.70	(10+) \$10.10
406-151131	1/4x1200 7" plastic reel	(1-39) \$8.40	(40+) \$7.30
406-17313J	1/4x2500NAB 10 1/2" metal reel	(1-9) \$21.50	(10+) \$18.80
407-17613T	1/4x3600PH 10 1/2" pancake	(1-9) \$18.50	(10+) \$16.20
407-151131	1/4x1800 7" plastic reel	(1-39) \$11.00	(40+) \$9.60
407-17613T	1/4x3600NAB 10 1/2" metal reel	(1-9) \$18.50	(10+) \$16.20

The extra low noise/high output formulation of Ampex 632/642 tapes provides enhanced performance capabilities over that obtainable from standard output tapes. A better signal-to-noise ratio provides quieter tape background levels, as well as a higher output level.

MODEL	DESCRIPTION	PRICE EA.	PRICE EA.
632-131111	1/4x600 5" plastic reel	(1-39) \$3.90	(40+) \$3.40
632-151111	1/4x1200 7" plastic reel	(1-39) \$5.90	(40+) \$5.15
632-173111	1/4x2500 10 1/2" metal reel	(1-9) \$19.50	(10+) \$17.00
642-131111	1/4x900 5" plastic reel	(1-39) \$4.90	(40+) \$4.25
642-151111	1/4x1800 7" plastic reel	(1-39) \$8.00	(40+) \$7.05
642-173111	1/4x3600 10 1/2" metal reel	(1-9) \$23.90	(10+) \$20.50

RECORDING ACCESSORIES

3M SPLICING TAPE
67-7/32100 100' Spool \$5.70

3M LEADER TAPE
61-W1/4-1500 White Polyester 1500' Reel \$17.90
61-Y1/4-1500 Yellow Polyester 1500' Reel \$17.90

LUBRICATED TAPE FOR CARTS

AUDIOPAK FORMULA 17 STANDARD OUTPUT
17-918-100 1800' Reel \$13.30
17-942-605 4200' Hub \$16.25
17-984-605 8400' Hub \$20.00

AUDIOPAK Q17 HIGH OUTPUT/LOW NOISE
17-618-613 1800' Reel \$15.80

SCOTCHCART TAPE HIGH OUTPUT/LOW NOISE
219-1/4-2500HPB 2500' Hub \$18.23

EMPTY REELS AND BOXES

PLASTIC REELS
5464 5" with NAB Center 65¢
5196 5" with EIE Center 50¢
5231 7" with EIE Center 90¢
6284 10 1/2" with NAB Center \$3.50
5908 10 1/2" with EIE Center \$5.45

METAL REELS
6393/600 10 1/2" with NAB Center (includes Box) \$10.95

EMPTY BOX
605 5" Empty Box 45¢
607 7" Empty Box 45¢
630 10 1/2" Empty Box \$1.10

3M

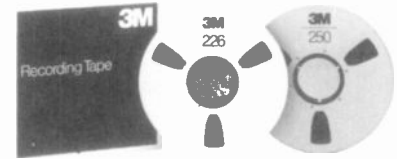

3M 250 AUDIO MASTERING TAPE

3M 250 Audio Mastering Tape is the music mastering tape that outperforms all others. It offers the industry's widest dynamic range and best overall signal-to-noise ratio. 1.5 mil. thickness.

MODEL	DESCRIPTION	PRICE EA.	PRICE EA.
250 1/4x2500HPB	10 1/2" pancake	(1-11) \$14.20	(12+) \$11.50
250 1/4x1200PR7	7" plastic reel	(1-19) \$9.80	(20+) \$7.95
250 1/4x2500RD	10 1/2" metal reel	(1-11) \$25.95	(12+) \$21.10

3M 226 AUDIO MASTERING TAPE

3M 226 Audio Mastering Tape provides versatility for outstanding all-around performance. Its unique oxide dispersion significantly reduces print-through without any sacrifice in signal-to-noise. 3M 227 Mastering tape is a one mil. version for remote and extended recording applications.

MODEL	DESCRIPTION	PRICE EA.	PRICE EA.
226 1/4x2500HPB	10 1/2" pancake	(1-11) \$13.25	(12+) \$10.85
226 1/4x1200PR7	7" plastic reel	(1-19) \$9.35	(20+) \$7.65
226 1/4x2500RN	10 1/2" metal reel	(1-11) \$24.00	(12+) \$19.85
227 1/4x3600HPB	10 1/2" pancake	(1-11) \$25.00	(12+) \$20.45
227 1/4x1800PR7	7" plastic reel	(1-19) \$14.50	(20+) \$11.85
227 1/4x3600RN	10 1/2" metal reel	(1-11) \$40.00	(12+) \$33.00

3M 806 AUDIO MASTERING TAPE

3M 806 Audio Mastering Tape is specially formulated to meet the high output/low print requirements. 807 is a one mil. thickness for extended recording requirements.

MODEL	DESCRIPTION	PRICE EA.	PRICE EA.
806 1/4x2500HPB	10 1/2" pancake	(1-11) \$11.30	(12+) \$9.20
806 1/4x1200PR7	7" plastic reel	(1-19) \$8.25	(20+) \$6.70
806 1/4x2500RN	10 1/2" metal reel	(1-11) \$20.70	(12+) \$16.80
807 1/4x3600HPB	10 1/2" pancake	(1-11) \$18.25	(12+) \$14.90
807 1/4x1700PR7	7" plastic reel	(1-19) \$11.00	(20+) \$9.00
807 1/4x3600RN	10 1/2" metal reel	(1-11) \$29.05	(12+) \$23.60



SONY



ORDER NUMBER	RECORD TIME	PRICE EA.	PRICE EA.
DT 60R	60 min.	(1-9) \$10.50	(10+) \$9.50
DT 90R	90 min.	(1-9) \$12.50	(10+) \$11.50
DT 120R	120 min.	(1-9) \$14.50	(10+) \$13.50



ORDER NUMBER	RECORD TIME	PRICE EA.	PRICE EA.
DIC-30XR	30 min.	(1-9) \$7.50	(10+) \$7.20
DIC-60XR	60 min.	(1-9) \$8.50	(10+) \$8.10
DIC-90XR	90 min.	(1-9) \$11.05	(10+) \$9.65
DIC-120XR	120 min.	(1-9) \$11.50	(10+) \$11.05



SONY



MODEL PCM2500
DIGITAL AUDIO RECORDER

The Sony PCM2500 is the top-of-the-line professional DAT recorder. Wide array of analog or digital input and outputs make the PCM2500 ideal for any professional application. Two remote controls are provided allowing wired or infrared control of the transport and programming functions.

Front panel keypad allows for quick track location. Instant cueing with standby for instant start up. Each cut recorded can be assigned a track index number automatically or manually by operator. Start codes can be manually edited in .03 second increments for very tight cueing requirements. The audio quality of the PCM2500 is outstanding. What else would you expect from Sony?
MFG. LIST \$3,550.00 CALL FOR BSW PRICE

Panasonic



MODEL SV-255
PORTABLE DIGITAL AUDIO RECORDER

Introducing the SV-255 Portable Digital Audio Tape Recorder from Panasonic. Ideal for high quality professional or on-the-job recording applications indoors or out, the ultra-compact SV-255 is just 9" wide, 1 1/4" high, and 5 3/8" front to back. And, it weighs only 3.2 lbs.

The rechargeable battery delivers 2.2 hours of continuous recording or playback. Other valuable features:

- XLR type MIC/LINE input
- 32-step random access programming
- 2-way power supply accepts AC and rechargeable battery
- High speed search that is 60 times faster than standard record/playback rate
- Wide range level meters with peak hold
- LCD display shows: track number in play, next track number, tape counter/program step, inter-track detection level, battery indication
- Digital output terminal • Direct access and skip search

MFG. LIST \$2,700.00 CALL FOR BSW PRICE

Panasonic



MODEL SV-3500
DIGITAL AUDIO RECORDER

Introducing Panasonic's version of a professional R-DAT recorder... the SV-3500. This tough, rack mounted unit has excellent audio characteristics. By employing two A/D converters with 18 bit resolution, distortion is less than .05% and S/N ratio more than 93 dB.

Other valuable features:

- Multiple sampling frequencies: 48 kHz/32 kHz recording and playback, 44.1 kHz playback
- Balanced XLR type analog in/out and coaxial digital in/out terminals
- Wired remote control unit (supplied) enables stop, play, record, pause, fast forward, rewind, forward skip, reverse skip
- Input terminal for serial remote control signal

MFG. LIST \$2,500.00 CALL FOR BSW PRICE

CASIO



MODEL DA-2
DIGITAL AUDIO RECORDER

Leave it to CASIO to come up with cost effective digital recording. The model DA-2 is perfect for field recording. Lightweight, the DA-2 weighs only 3 lbs. with rechargeable battery pack.

Microphone connections are 1/4" jacks. Line inputs and outputs are standard RCA jacks. Headphone amplifier with volume control is provided on the front panel.

Audio specifications are outstanding. 90 dB dynamic range on playback, signal-to-noise ratio 85 dB, and frequency response 10 Hz to 20 kHz (± 1 dB). Up to 2 hours recording and playback is possible on fully charged battery pack. AC adapter is also provided.

MFG. LIST \$1,495.00 CALL FOR BSW PRICE



OTARI

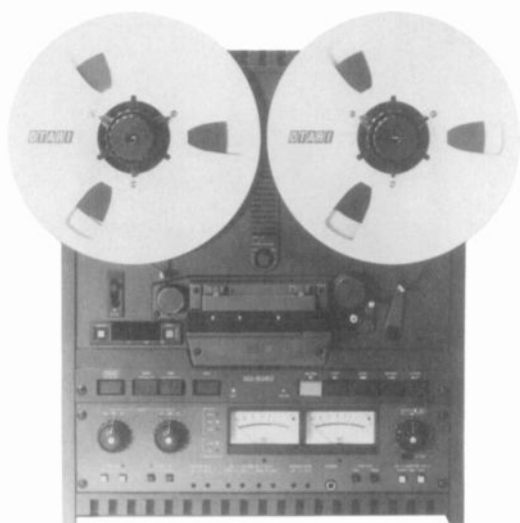

**MODEL MX5050BII
2-CHANNEL RECORDER**

The one integral component found in most radio stations and audio facilities is, of course, the MX5050BII from Otari. For over a decade this machine and its earlier versions have performed day in and day out without a complaint. From the smallest market areas to the largest cities, the 5050BII is, without a doubt, the most sought after tape machine in the industry.

Clean design, with features broadcasters demand, it offers easy editing, vari speed, real time counter, selectable 1/4 track or 1/2 track playback heads.

MFG. LIST \$2,995.00 CALL FOR BSW PRICE



**MODEL MX50
2-CHANNEL RECORDER**

The MX50 is the new generation Otari 2-track for facilities on a limited budget. Durable transport features DC-servo capstan motor with vari-speed of $\pm 7\%$. Five digit tape timer has return-to-zero and search-to-cue for quick location of desired cue point. Speeds are selectable in pairs of 15/7.5 or 7.5/3.75 ips. Inputs and outputs are transformerless active balanced and have XLR connectors.

MFG. LIST \$2,495.00 CALL FOR BSW PRICE

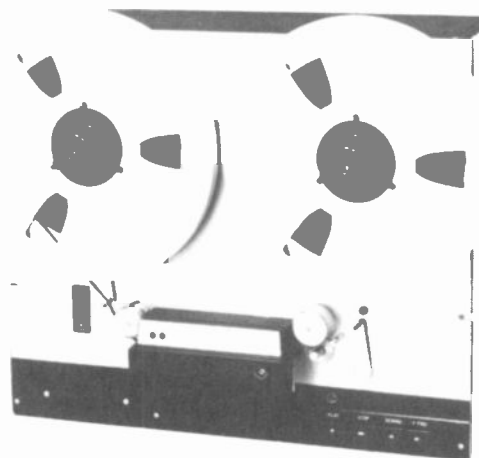

**MODEL ARS 1000DC
2-CHANNEL REPRODUCER**

1/4" 2-channel, half-track reproducer with 25 Hz tone sensor, end-of-message and cuetone relays with adjustable delay (100 ms to 15s), 7.5/3.75 ips speeds, 19" rack mount. Designed for automated broadcast systems and other high-reliability reproduce only applications. 15/7.5 ips available on special order.

MFG. LIST \$2,115.00 CALL FOR BSW PRICE



**MODEL MX55
2-CHANNEL RECORDER**

The MX55 is Otari's top-of-the-line half-track in the MX Series. Loaded with features, the MX55 was designed for fast paced production and mastering applications.

DC-servo capstan motor allows $\pm 20\%$ vari-speed. Inputs and outputs are transformerless active balanced. LED tape timer featuring a return-to-zero and 3 cue memory mini-locator that is extremely accurate. Audio adjustments are all located under-cover on the front panel. Built-in cue speaker and headphone amplifier allow the MX55 to stand alone. Extra 1/4 track head is provided for playback of tapes recorded on other machines.

MODEL MX55
MFG. LIST \$3,895.00 CALL FOR BSW PRICE

MODEL MX55-NM (Same as above with meterbridge console)
MFG. LIST \$4,995.00 CALL FOR BSW PRICE



TEAC

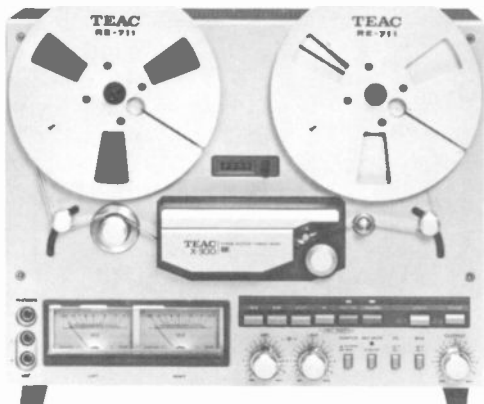

MODEL X-300
2-CHANNEL RECORDER

3 motor transport. 3 head reproduction system. Light touch locking transport controls. Mic/line mixing. Record mute function. Independent left and right output, and line and mic input level controls. Tape/source monitor selector. Front panel mic and headphone jacks. 1/4 track record/playback.

Frequency response: 30 kHz - 34 kHz (@ 7 1/2 IPS)

Signal/noise: 65 dB (3% THD)

Wow & flutter: 0.04% (7 1/2 IPS WRMS)

Tape speeds: 3 3/4 - 7 1/2 IPS

MFG. LIST \$1,145.00 CALL FOR BSW PRICE

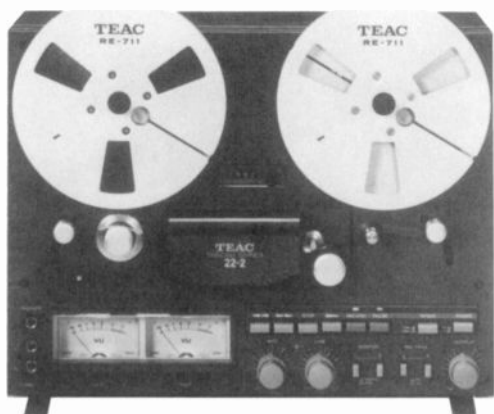

MODEL 22-2
2-CHANNEL RECORDER

The Tascam 22-2 is a great reel to reel recorder for use where large reels are not needed. Quality electronics and great tape handling.

Features:

- 1/2 track record/playback
- 7 inch reel capacity
- 7 1/2" - 15 IPS
- Remote pause function
- NAB equalization
- Rack mount available

MFG. LIST \$1,099.00 CALL FOR BSW PRICE

OTARI



OTARI'S MARK III SERIES. A COMPLETE LINE OF PROFESSIONAL AUDIO TAPE RECORDER/REPRODUCERS FOR BROADCAST PRODUCTION, AUDIO POST-PRODUCTION AND RECORDING STUDIO APPLICATIONS.

MODEL MARK III/2, 4, 8
RECORDERS

Otari's Mark III/2, 4 & 8 recorders, offer the professional a complete range of innovative features and accessories to make any audio recording task easier and more cost effective.

The Mark III/2 1/4" two-channel machine is ideal for recording studio mixdown, as well as for broadcast editing applications. In audio for video or film sound production, Otari's optional speed resolver (the EC-401) makes the Mark III/2 the right choice for daily transfer applications using pilot-tone synchronization.

The Mark III/4 provides you with the 1/2" four-channel format which has been the world standard for both audio post-production mixdown and broadcast production — at a great price.

The Mark III/8 1/2" eight-channel machine offers the recording studio many of the features of Otari's legendary MTR-90, plus performance that rivals 1" eight-channel machines.

MODEL MARK III/2
MFG. LIST \$3,925.00 CALL FOR BSW PRICE

MODEL MARK III/4
MFG. LIST \$5,935.00 CALL FOR BSW PRICE

MODEL MARK III/8
MFG. LIST \$5,495.00 CALL FOR BSW PRICE



TASCAM



**MODEL 42B
2-CHANNEL RECORDER**

The 42B is an exceptionally versatile, high performance, 2-track, 2-channel recorder/reproducer designed especially for demanding production applications. Extra heavy chassis ensures stable tape motion and alignment for long hours of high speed start/stop shuttling.

MFG. LIST \$3,249.00 CALL FOR BSW PRICE



**MODEL 32
2-CHANNEL RECORDER**

Cost effective takes on a new meaning with the Model 32 from Tascam. You won't suffer from lack of features either. The 32 offers independent left-right recording, pitch control, dump edit, NAB equalization, and 10½" reel capacity. Sync mode allows over-dub recording with full frequency response. Rack mount is available as an option.

MFG. LIST \$1,749.00 CALL FOR BSW PRICE

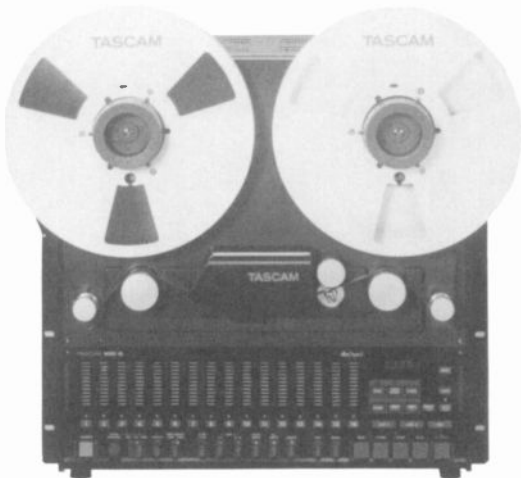

**MODEL MSR-16
16-CHANNEL RECORDER**

The MSR-16 is a ½" 16-track recorder which incorporates the most advanced Tascam technology and a wide range of versatile control features. Dbx type-I noise reduction is built in, providing fully professional performance. Auto punch-in/out makes recording smoother and easier than ever, while specially designed circuitry offers gapless and noiseless punch-in/out performance. The transport offers switchable tape speeds, and is externally controlled.

MFG. LIST \$7,499.00 CALL FOR BSW PRICE



**MODEL 34B
4-CHANNEL RECORDER**

Now there's cost effective 4-track production. The model 34 has all the features of the model 32 plus two extra tracks! Full sync and modular adjustable electronics.

MODEL 34B
MFG. LIST \$2,199.00 CALL FOR BSW PRICE

MODEL 38 8-TRACK
MFG. LIST \$2,999.00 CALL FOR BSW PRICE



Broadcast Supply West,

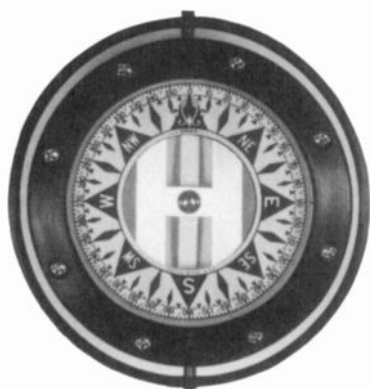

East, North & South

As a company that serves the nation's broadcasters, we have often considered opening regional offices to improve our service or expand our sales. In the final analysis, we determined that regional offices would only serve to retard service and drive our overhead sky high. So here we are in the west, maintaining the most efficient and economical distribution system in the broadcast industry. Regardless of your location, you benefit by saving money, enjoying quick delivery, and receiving exceptional service. We are open 12 hours daily, 9 a.m. to 9 p.m. east, 6 a.m. to 6 p.m. west, so you can call us at your convenience for all your audio equipment needs.

From any point on the compass, BSW is as close as your telephone.

BSW[®]

BROADCAST SUPPLY WEST

America's Full-Time Broadcast Supplier

1-800-426-8434

ORDERS • INFORMATION • SPECIFICATIONS

BSW • 7012 27th Street W • Tacoma, WA 98466 • FAX 206-565-8114

TASCAM



**MODEL 3030
2-CHANNEL RECORDER**

The Tascam 3030 represents a cost effective approach to broadcast two-track audio production. The 3030 has a 4 head system — 2-track, 2-channel erase, record, reproduce and 4-track 2-channel reproduce. The 3030 has both +4 dBm balanced and -10 dBV unbalanced input/output for easy interface to any existing system.

The cobalt amorphous record and reproduce heads, coupled with dbx type-I professional noise reduction, guarantee outstanding audio performance. A number of features make the 3030 a production center. Real-time tape counter will allow you to know the length of the spot in minutes/seconds and the Auto Cue Mark and Dupli-Sync (second deck control) that allows the user to mark a spot, quickly find that spot with search to cue, hit play and this will automatically put the dubbing deck into record.

MFG. LIST \$2,299.00 CALL FOR BSW PRICE

REVOX



**MODEL PR99MKIII
2-CHANNEL RECORDER**

True to the Studer Revox tradition, the PR99 has always offered the best combination of features, price and long term service. In other words overall value.

The new PR99MKIII is one of the best small professional tape recorders available on the market. The sturdy die cast deck plate offers durability while features such as an autolocator make production or on-air work a breeze. The front panel is less cluttered to make overall operation easier. Controls and switches are easy to find making the PR99MKIII a natural performer for your operation. Reserve yours today. (Shown with optional wood side panels. Unit is rack mounted standard.)

MFG. LIST \$2,495.00 CALL FOR BSW PRICE



STUDER REVOX

PRO

For the professional user who requires superior audio quality combined with overall value, the C270 series presents Studer Revox design and engineering integrity in a variety of recording formats.

The C270 1/4" 2-channel recorder, the C274 1/4" 4-channel recorder, the C278 1/2" 8-channel recorder. Every machine in the C270 line comes with all the features and capabilities that professionals need.

Comprehensive Professional Transport Features:

The 2-channel, 4-channel and 8-channel machines all have 3 tape speeds — 3 3/4, 7 1/2, and 15 ips — any pair of which can be selected and quickly changed in the field. The 4- and 8-channel recorders also come in low speed versions, especially suited for logging applications, with speeds of 15/32, 15/16 and 1 7/8 ips. Constant tape tension on both spooling motors, one-hand servo controlled cueing, built-in varispeed (-33% to +50%), an integral scrape-flutter filter in the head assembly and a true autolocator with zero, address and search locate functions allowing for precise search-to-cue — these are just a few of the features standard in the C270 series.

Professional Audio Electronics

Dolby HX Pro® Headroom Extension and proprietary phase compensated audio electronics, seamless and gapless punch-in and punch-out, plug-in EQ cards for easy service and speed conversion, plus superior audio performance are part of the C270 concept of a pro performer, and standard features on every machine.

Rugged Quality, Easy To Maintain

The C270 is built with characteristic Studer Revox attention to service and maintenance throughout a long working life.

Full modular audio electronics — all front accessible, even in rack-mount configuration — and a rugged die-cast deckplate, head assembly and chassis tell you that this sophisticated series of pro performers shares the same construction values that define all Studer Revox tape recorders.

In addition to the features and capabilities standard on every recorder in the C270 series, the 4- and 8-channel machines have these special capabilities:

- Internal logging time and date code generator and reader capable of searching and locating to any time directly
- LED bar graph meters that read both peak and VU program levels simultaneously
- Auto reverse playback mode allowing continuous playback in both directions of pre-recorded 1/4-track stereo tapes (on C274 4-channel machine only)
- SMPTE time code applications

MODEL C270 (1/4" - Two Channel)
MFG. LIST \$3,495.00

MODEL C274 (1/4" - Four Channel)
MFG. LIST \$5,995.00

MODEL C278 (1/2" - Eight Channel)
MFG. LIST \$7,995.00



C270

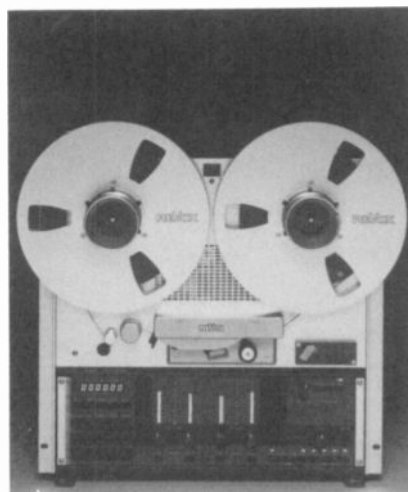

C274

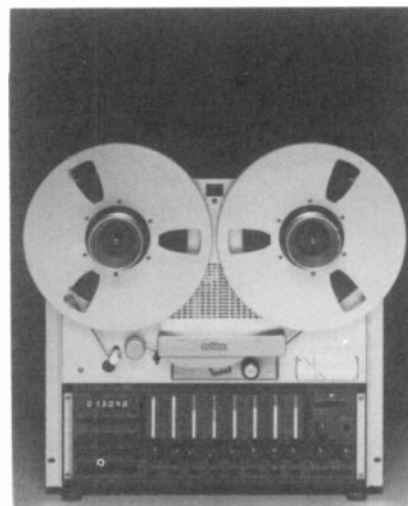

C278

CALL YOUR BSW PROFESSIONAL FOR DETAILED SPECIFICATIONS AND BSW SPECIAL PRICE 1-800-426-8434.



Profoam



PROFOAM ACOUSTICAL FOAM

Profoam has become very popular in broadcast and recording environments. Large sheets make installation quick and easy. Sheet size is 4½'x6' (27 square feet). Available in 2" or 3" thicknesses. Color is charcoal grey and blends with all studio surroundings.

Profoam is UPS shippable so you'll save money and time as well. 2 sheets per package.

2" BSW PRICE 49.95 per sheet

3" BSW PRICE 56.95 per sheet

(Adhesives available in spray can or in 1 and 5 gallon containers)

SONEX

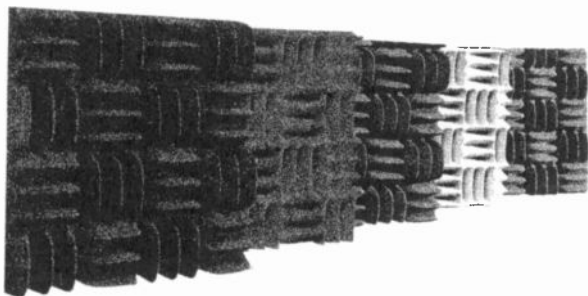

SONEX ACOUSTICAL FOAM

Sonex gives you the greatest choice of colors, thicknesses and sizes of acoustical treatment. Choose from 2' or 4' squares in 2", 3", or 4" thickness. Colors are charcoal, blue, brown, and beige.

Sonex I is available for facilities such as schools, churches, offices, anywhere where Class I building codes apply.

CALL BSW TOLL FREE 1-800-426-8434 FOR PRICING AND TECHNICAL SPECIFICATIONS ABOUT SONEX TODAY.

SOUNDFORMS

Whether you are responsible for music, dialogue or sound effects, it has become extremely important to isolate and control the ambience of your recording and sampling environments. Soundforms are lightweight, portable and modular sound control panels that enable you to effectively control sound in any recording environment. They can be used free-standing, hanging on any wall, or snapped together to form sound booths, sound rooms or sound walls.

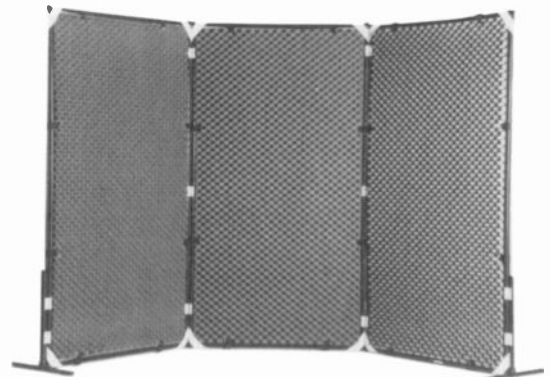
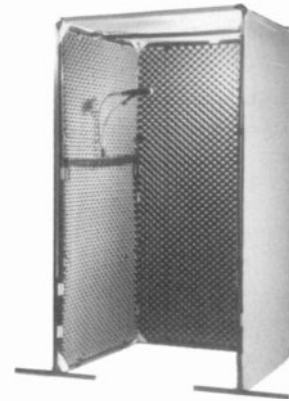

Sound Booth

This package includes; three S-22 panels, one S-15 panel, one pair of T-legs, twelve double-clips, and one cross bar. This system (measures 3.5'x3.5'x6.5') is used as a sound recording booth inside a studio.

Sound Wall

The Soundforms sound wall includes; three S-22 panels, one pair of T-legs, and six double-clips. This system is used as a baffle wall. The three panels consist of approximately 66 square feet of acoustic foam, weight only 16 lbs., and can be easily collapsed for storage or travel in minutes.

About Acoustical Foam

Before you install any acoustical foam, it is best to check with your local fire department for regulations in your area. Building codes differ state-to-state. BSW will not be responsible for removal and return of acoustical equipment after installation. We are happy to provide samples and specifications for the asking. PRICES VARY ON APPLICATION. CALL BSW TOLL FREE 1-800-426-8434 FOR PRICE AND DETAILED SPECIFICATIONS.



Fostex



**MODEL 6301B
AMPLIFIED SPEAKER**

The 6301B is completely self contained. The sound is delivered from a full-range speaker that's surprisingly flat and accurate.

You get a frequency response of 80 Hz to 13 Hz, which makes the 6301B an ideal reference when you're producing music, radio spots or audiovisual sound tracks.

The built-in 10 watt (RMS, into 8 ohms) amplifier will handle anything you feed it. The 6301B's input has been designed to accept any line or instrument-level input, even from an amplifier. There's no confusion. Just one 1/4" phone jack to deal with.

MFG. LIST \$350.00 pr CALL FOR BSW PRICE

EV Electro-Voice



**MODEL SENTRY 100A
MONITOR SPEAKER**

Just because your monitor space is limited, you don't have to compromise on sonic accuracy. The Sentry 100A is a compact, no frills speaker system. It's the oldest member of the Sentry family and has become the industry standard of reliability.

The Sentry 100A delivers a flat 45 to 18,000 Hz frequency response with a wide 120° dispersion at 5,000 Hz. The Super Dome™ tweeter handles a remarkable 25 watts of input power and is matched with an 8" direct radiator woofer in an optimally vented enclosure.

**MODEL SENTRY 100EL
WITH AN INTEGRAL POWER AMPLIFIER**

The Sentry 100EL combines the reproduction components of the Sentry 100A with an integral high performance 50 watt power amplifier that's perfectly matched to the requirements of the speaker system.

MODEL SENTRY 100A
MFG. LIST \$300.00 ea. CALL FOR BSW PRICE

MODEL SENTRY 100EL
MFG. LIST \$625.00 ea. CALL FOR BSW PRICE

JBL

**JBL'S NEW GENERATION OF
STUDIO MONITORS**



4410



4412

**MODEL 4410
STUDIO MONITOR**

The powerful 3-way 10 inch Model 4410 features a vertical line array that gives maximum spatial detail at greater listening distances. The special laminated high polymer composite 10" woofer has outstanding power handling capabilities, delivering extraordinary punch and fidelity.

MFG. LIST \$425.00 CALL FOR BSW PRICE

**MODEL 4412
STUDIO MONITOR**

The 3-way 12 inch Model 4412 is highlighted by an ultra-large, ultra-precise 12" laminate composite woofer. Its tight cluster arrangement and superior power efficiency make it the ultimate monitor for close-in listening. The mid-range element and larger woofer allow for greater power handling, increased sensitivity and extended bandwidth.

MFG. LIST \$675.00 CALL FOR BSW PRICE



4406



4408

**MODEL 4406
STUDIO MONITOR**

The 2-way 6 inch Model 4406 monitor is ideal for console or close-in listening. The low distortion 6" woofer is composed of a filled polypropylene material which provides both high internal damping and excellent structural integrity.

MFG. LIST \$235.00 CALL FOR BSW PRICE

**MODEL 4408
STUDIO MONITOR**

JBL's 2-way 8 inch Model 4408 is an ideal choice for broadcast and general monitoring applications. The low distortion 8" composite woofer gives maximum stiffness, mass and internal damping for superior reproduction of both speech and music.

MFG. LIST \$285.00 CALL FOR BSW PRICE



YAMAHA

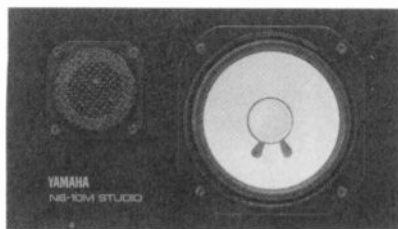

MODEL NS10MS STUDIO MONITOR

The Yamaha NS-10M Studio speaker system has been created specifically for close-field monitoring in professional sound studios.

Optimum woofer/tweeter matching and careful crossover design ensure smooth, natural transition between frequency ranges with minimum phase variation. Frequency response is remarkably flat from 60 Hz right up to 20 kHz, and superior transient response delivers crisp, transparent sound.

MFG. LIST \$475.00 pr. CALL FOR BSW PRICE

RAMSA



MODEL WS-A70 COMPACT MONITOR

The WS-A70's easy listening tonal qualities are complemented by high fidelity sound reproduction of professional studio standard over a wide frequency range. High frequency driver frequency range is 1,250 Hz to 18,000 Hz, while the low frequency driver ranges from 50 Hz to 4,000 Hz. Good frequency separation is achieved by using an 18 dB/oct curve in the crossover network at the 2,000 Hz crossover points. This delivers clear and vivid sound, suppressing irritating peaks in the middle and low frequency ranges.

Recessed ceiling mounting is available, and optional mounting brackets provide a variety of mounting possibilities, such as suspension from the ceiling or walls.

MFG. LIST \$240.00 ea. CALL FOR BSW PRICE

ALC

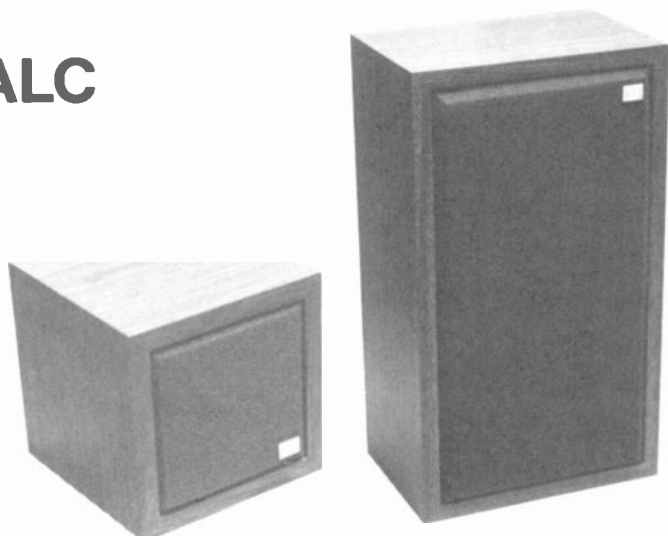

10302

20306

Dramatic response in a small convenient size. Ideal for broadcast control rooms, studios, remote recording and quality control areas.

MODEL 10302 MONITOR CUBE SPEAKER

Features:

- Full range
- Compact 7 $\frac{7}{8}$ " cube
- Snap-away grill
- 60 Hz to 15 kHz

BSW PRICE\$98.00 pr.

MODEL 20306 MONITOR SPEAKER

Features:

- Flat response
- 50 Hz to 20 kHz
- 8" woofer
- Walnut grain vinyl
- Phenolic tweeter
- 19 $\frac{1}{2}$ " x 11" x 7 $\frac{1}{4}$ "
- Two-way speaker

BSW PRICE\$200.00 pr.

AURATONE



MODEL 5MCV THREE-CHANNEL BROADCAST MONITOR

Mixdown monitors contained in three compartment ultra compact enclosure.

MFG. LIST \$169.50 ea. CALL FOR BSW PRICE

RM525 (Rack Mount Kit) BSW PRICE \$9.90



MODEL 5CV MONITOR SPEAKER

Super Sound Cube, known the world over for its outstanding reproductive qualities.

MFG. LIST \$107.30 pr. CALL FOR BSW PRICE



Piv·telli

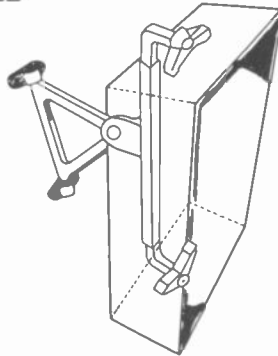

SPEAKER MOUNTING BRACKETS

Here is an easy answer to installing speakers without having to drill into the speaker cabinet.

The Limpet Universal Baseplate can be mounted horizontally or vertically, and grips the cabinet from above, below or behind, with rubber covered clamps. Both clamps swivel, so that even equipment with rounded or tapering sides can be securely held.

This bracket is fixed to the wall with four screws, and nylon wall plugs (included). Construction is high grade solid aluminum, holds up to 88 lbs.

- MODEL S-S** (4" to 10" deep)
BSW PRICE\$69.95 pr.
- MODEL PULM** (11" to 17 1/4")
BSW PRICE\$99.95 pr.

Omnimount™
SYSTEMS



SPEAKER MOUNTING BRACKETS

Installing speakers is no easy task unless you use Omnimount speaker brackets. Only Omnimount offers models that allow you to mount speakers from assorted angles and locations. Weight and handling ranges from 1 pound to 255 pounds. Call BSW with your requirements and we will suggest the proper Omnimounts for you.

- MODEL 100WA** (Holds up to 75 lbs.)
BSW PRICE\$68.95 ea.
- MODEL 75WABC** (Holds up to 40 lbs.)
BSW PRICE\$59.95 ea.

Don't Panic!!!



We're Still Open

Accessibility may be the most important quality of a good equipment supplier. After all, you can't order from a company you can't reach. At BSW we work overtime to ensure you total access to our qualified sales staff. We're open 12 hours a day (6 a.m. to 6 p.m. Pacific and 9 a.m. to 9 p.m. Eastern) so you can call us when it's most convenient for you, morning or evening. With over one million dollars of inventory on hand, chances are we have what you need in stock and can have it in your hands the next day.

So the next time you need to reach a supplier who's still open, call BSW, America's Full-Time Broadcast Supplier.

BSW®

BROADCAST SUPPLY WEST

America's Full-Time Broadcast Supplier

1-800-426-8434

ORDERS • INFORMATION • SPECIFICATIONS
BSW • 7012 27th Street W • Tacoma, WA 98466 • FAX 206-565-8114



MARTI

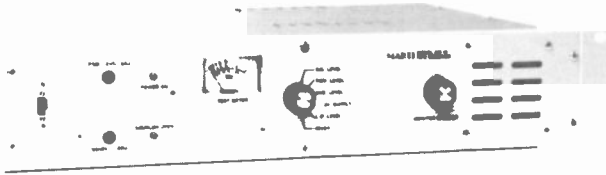

MODEL CR-10 BASE STATION RECEIVER

Model CR-10 is a rack mounted VHF or UHF base station receiver designed for broadcast remote pickup service. This receiver has dual frequency capability built in. Marti technology has provided the highest frequency response with the lowest noise and distortion possible for the assigned channel bandwidth. Special attention has been given to solving today's high interference problems. The CR-10 features a built-in test meter, squelch relay, optional DC operation, built-in sub-audible tone decoder, special noise reduction circuit, 90 dB spurious rejection. Includes front panel monitor speaker.

MODEL CR-10 SINGLE FREQUENCY

MFG. LIST \$1,195.00

MODEL CR-10 DUAL FREQUENCY

MFG. LIST \$1,225.00

CALL FOR BSW PRICES

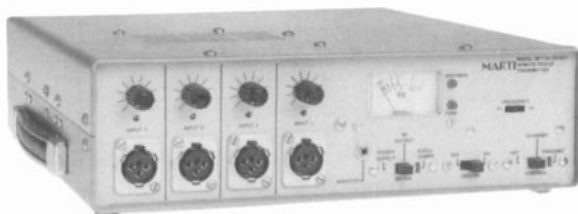

MODEL RPT-30 RPU TRANSMITTER

The Model RPT-30 is a light, compact, but powerful transmitter designed for remote pickup broadcast service. It will operate in continuous duty while providing broadcast quality audio when used with the Marti CR-10 or AR-10 receivers. Operating from internal regulated power supply or external 11 to 13.5 V. DC (negative) ground power, the RPT-30 delivers high performance in mobile, portable or fixed station applications. The RPT-30 is designed to operate with other Marti equipment to function in mobile repeaters, fixed automatic repeaters, base stations and transmitter to studio links (TSL). Four balanced inputs with mixing are provided. Input number four may be switched to balanced line level if desired. Other advanced features include a high performance FM compressor/limiter, sub-audible encoder, dual frequency operation, illuminated meter, warning lights for antenna VSWR and temperature.

MODEL RPT-30 SINGLE FREQUENCY

MFG. LIST \$1,695.00

MODEL RPT-30 DUAL FREQUENCY

MFG. LIST \$1,725.00

CALL FOR BSW PRICES



STL-10 TRANSMITTER

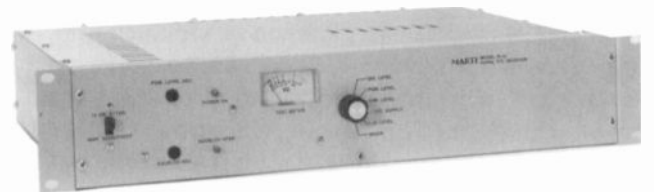

R-10 RECEIVER

MODEL STL-10 TRANSMITTER-RECEIVER

The Marti studio transmitter link is a line-of-sight FM communication system providing a high quality broadcast audio channel with two optional sub-channels. A dual link for stereo provides two identical broadcast quality channels with better than 60 dB stereo crosstalk and four optional sub-channels. This system offers greater rejection of interference, superior noise performance, lower channel crosstalk and greater redundancy.

Features:

- Excellent square wave response
- User selectable audio processing provides 0, 25, 50 or 75 microsecond de-emphasis options
- Low pass filters designed to eliminate overshoot on complex audio waveforms
- Helical resonator pre-selector and double balanced mixer
- Two IF bandwidths available to meet domestic and international requirements
- Computer designed bandpass filters for high selectivity with optimum phase and group delay
- Test meter on front panel indicates signal level, main channel audio level, sub-carrier level, supply voltage, L.O. level and mixer level. Additional test points inside receiver
- Sensitivity switch on front panel provides optional 10 dB RF attenuation for interference rejection
- Built-in automatic switching capability

MODEL STL-10

MFG. LIST \$1,625.00

MODEL R-10

MFG. LIST \$1,625.00

CALL FOR BSW PRICES



Moseley



**MODEL PCL 6000 SERIES
COMPOSITE STL SYSTEM**

As leaders in STL technology for the past 25 years, Moseley has always provided the highest quality program conveyance. Not wanting to design just another STL, Moseley engineered the PCL Series to offer unique and innovative features.

Both the PCL 6010 transmitter and PCL 6020 and 6030 receivers employ a synthesized reference oscillator to eliminate fixed-frequency crystals.

Now, monaural or composite operation is available from a single system. By selecting appropriate jumpers, you can enable wideband composite stereo or 15 kHz monaural basebands. Two PCL 6000 systems can be used in a dual discrete configuration to transmit right and left stereo programs with no measurable crosstalk.

Receiver IF bandwidth can be factory or field set for channel spacing of 100 kHz to 500 kHz. Which system is right for you? If you have no adjacent channel interference, the PCL 6020 will offer superior performance. The PCL 6030 is designed for hostile RF environments.

PCL 6020 SYSTEM
MFG. LIST \$7,800.00

PCL 6030 SYSTEM
MFG. LIST \$8,800.00

CALL FOR BSW PRICE



**MODEL SCG-8
MULTIPLEX FM SUBCARRIER GENERATOR**

SCG-8 Subcarrier Generator, with automatic muting and front panel peak deviation meter, including self contained power supply. Available for operation at any standard frequency in the 26 kHz to 185 kHz spectrum. Specify operating frequency when ordering.

MFG. LIST \$1,490.00 CALL FOR BSW PRICE

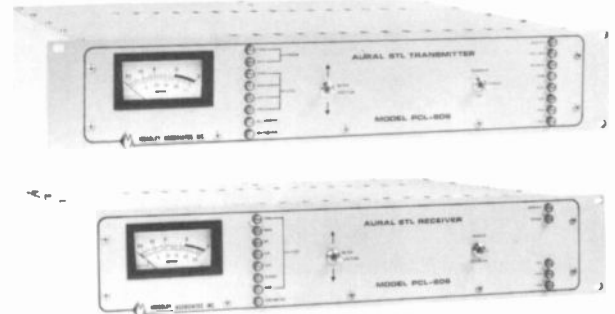

**MODEL PCL-606/C
COMPOSITE STL SYSTEM**

You're scrupulous about quality. You're running compact discs mastered on digital equipment. You've bought the best console you can afford. Your processing plant is as clean as a whistle. Don't compromise now! Deliver your signal with the only STL that's totally transparent. The composite stereo PCL-606/C or the mono PCL-606. Find out why Moseley STL's outsell all others.

Frequency response: Composite: ± 0.1 dB or better 30 Hz to 53 kHz, ± 0.3 dB or better 53 kHz to 73 kHz

THD & IMD 0.3% (0.2%) or less 30 Hz to 53 kHz, typically better than 0.1% (0.7%) at 1 kHz

Stereo Separation 48 dB or better, 50 Hz to 15 kHz (typically 50 dB or better)

Nonlinear Crosstalk: 50 dB (54 dB) or better
Subchannel to Mainchannel
Mainchannel to Subchannel:
Narrow (Wide) to I.F. Filter

Signal-to-Noise Ratio 72 dB or better (typically 75 dB) below 100% modulation, demodulated, de-emphasized left or right

MODEL PCL-606/C TRANSMITTER AND RECEIVER
MFG. LIST \$10,700.00 CALL FOR BSW PRICE



**MODEL SCD-8
MULTIPLEX FM SUBCARRIER DEMODULATOR**

Model SCD-8 Multiplex FM Subcarrier Demodulator was developed as a companion to the SCG-8 generator. Front panel peak deviation, automatic muting, self contained power supply, meter, all electronic squelch and audio low-pass filter are standard equipment. Operating frequency easily changed with plug-in filters from 26 kHz to 185 kHz spectrum.

MFG. LIST \$1,490.00 CALL FOR BSW PRICE



Moseley

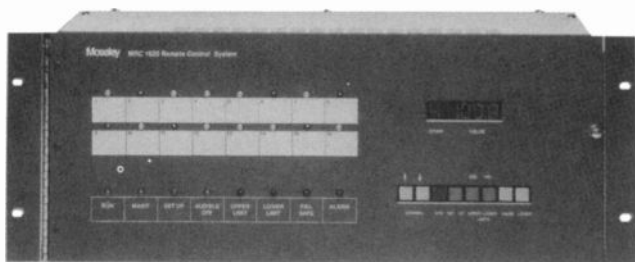

MODEL MRC 1620 REMOTE CONTROL SYSTEM

The MRC 1620 system consists of a remote terminal that allows an optional control terminal or IBM PC with TaskMaster20 software to monitor and control a remote facility from both dedicated and/or dial-up control points. The MRC 1620 remote terminal comes equipped with 32 relay isolated command outputs (16 raise/16 lower), 16 TTL status inputs and 16 analog metering inputs with the required terminal connectors.

The MRC 1620 remote and control terminals are simple to operate and easy to understand. All status channels are simultaneously displayed on a set of 16 LEDs. The front panel displays read-outs of selected channel number and telemetry data. LEDs indicate operation mode, alarms and other system parameters.

Telemetry limit checking and status alarm capability ensure that an unmanned facility operates at peak efficiency. During alarm conditions, intelligent automatic corrective action can be taken by the remote terminal under the direction of the TaskMaster20.

The remote terminal comes equipped with a built-in internal 1200 baud modem to communicate over dedicated circuits (STL/TSL/FMSCA or 2/4 wired leased lines). An external 1200/2400 baud auto-answer modem for dial-up access over the public switched telephone network is also included with the remote terminal.

Features:

- Dial or direct connect to an MRC 1620 remote or control terminal
- Display current analog and status values
- Display and acknowledge alarms
- Manually control an MRC 1620 remote terminal (RT)
- Automatically control (via analog limits and status conditions) an RT
- Display, edit, and store PC screen labels
- Download and store the set-up parameters from the MRC 1620
- Recall and upload the set-up parameters to the MRC 1620
- Maintain and generate log file(s) from up to 16 RT sites at user-specified intervals during the day
- Generate a printed log

MODEL MRC 1620 (Remote Terminal)

MFG. LIST\$2,995.00

MODEL MRC 1620 (Control Terminal)

MFG. LIST\$1,495.00

TASKMASTER20 SOFTWARE

MFG. LIST\$595.00

CALL FOR BSW PRICES

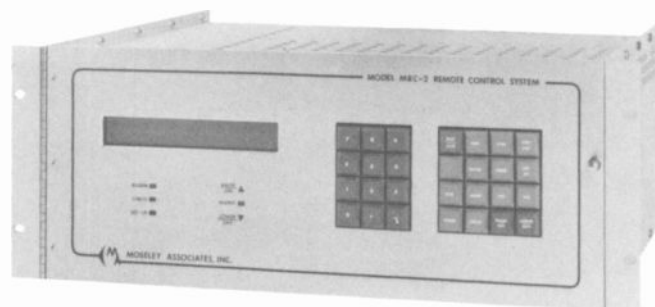

MODEL MRC-2 REMOTE CONTROL SYSTEM

More and more, broadcasters are issuing executive commands through their MRC-2 microprocessor remote control.

Multi-site, Multi-function

The MRC-2 controls and monitors as many as 99 remote sites, with multiple control terminal capability to let you delegate control from master to master as needed. Up to 255 status, 255 telemetry and 255 command channels supervise your sites. Dual tolerance limits can be set to prevent a telemetry parameter from reaching critical levels. Choose from 6 modes in which to calibrate telemetry inputs, and set status inputs to initiate alarms or events on rising or falling waveforms, or both.

Command, status, and telemetry set-up is straightforward on the MRC-2 System. Using the remote terminal keyboard and 48-character alpha-numeric LED display, the system provides plain-English prompting and "menu" pages for set-up selection. Similar procedures are used at the control terminal to set up and verify telemetry limits, assign data links, and to set up controlled access for restricted functions.

Control Options

Optional automatic loggers provide a printed record of system operation and CRT terminals display your data in plain language. An optional ACU-1 automatic control unit automates your operation by issuing programmable time and feedback-actuated sequences of commands without operator assistance. Add multiple direct command and multiple status display options for streamlined operator interface.

PRICES BASED ON CONFIGURATION

All Telephones Lead To BSW

Toll Free from all 50 states including Puerto Rico,
US Virgin Islands and Canada. 1-800-426-8434



Moseley



**MODEL CL-100
COMMUNICATIONS LINK**

The CL-100 system gives the broadcaster an alternative to subcarriers and telephone lines for conveying control and telemetry data between the studio and transmitter locations. CL-100 systems provide the broadcaster with independent control and telemetry circuits, while freeing the STL or program subcarrier channels for other uses. CL-100 system data transmission is extremely reliable, even over a path length of 50 miles (line of sight).

The CL-100 comes in Data and Voice versions. The Data version has increased audio bandwidth and controlled group delay characteristics to allow 9600 baud data rates. In highly congested RF environments, the improved selectivity of the Voice version can be used, providing data rates up to 1200 baud.

- Features:
- Telemetry or voice transmission
 - Superior adjacent channel rejection
 - AC/DC operation
 - 1 to 10 watt options
 - Data and voice versions

MODEL CL-100-10W (10 watt)
MFG. LIST \$4,980.00 CALL FOR BSW PRICE

MODEL CL-100-1W (1 watt)
MFG. LIST \$3,980.00 CALL FOR BSW PRICE

TFT
INC



**MODEL 8888
REMOTE PICKUP SYSTEM**

The TFT Model 8888 RPU Transmitter and 8889 RPU Receiver bring new levels of performance and convenience to Remote Pickup equipment for remote broadcast. Frequency agility, selectable deviation, selectable receiver bandwidth and DTMF control are among the advances that TFT has brought to RPU's for high quality audio performance and convenience.

- Features:
- Frequency Agile Transmitter and Receiver
 - Selectable Transmitter Deviation
 - Selectable Receiver Bandwidth
 - 25 watts RF Power; Switchable to 12 and 6 watts
 - DTMF Signaling for System Security and Cueing
 - Front Panel Diagnostics Metering
 - Transmitter Portable or Rack Mount

MODEL 8888 TRANSMITTER
MFG. LIST \$2,260.00 CALL FOR BSW PRICE

MODEL 8889 RECEIVER (not shown)
MFG. LIST \$1,710.00 CALL FOR BSW PRICE

Moseley



**MODEL RPL 4000
REMOTE PICKUP SYSTEM**

Moseley Associates has designed the most advanced Remote Programming Link available today. The RPL 4000 offers the features and specifications you expect from Moseley at a modest cost.

The versatile RPL 4000 handles every remote programming situation with ease.

A portable 4010 Transmitter is designed to meet stringent demands of quality, ruggedness and flexibility. Fully synthesized and lightweight (weighing less than 8 lbs.), the RPL 4010 is ready to use in conjunction with your existing repeater and portable audio mixers. Extensive front panel metering lets you operate with confidence.

The RPL 4020 Receiver (not shown) has excellent channel rejection characteristics, which are absolutely essential in crowded UHF bands. An industry-standard connector is provided for audio control interface with existing equipment.

RPL 4000 System includes transmitter and receiver.
RPL 4000 System Features:

- Broadcast quality performance
- Audio bandwidths from 5-15 kHz
- 25, 50, and 100 kHz channels
- Encoding and decoding for repeaters
- Noise-reduction companding

MFG. LIST \$3,500.00 CALL FOR BSW PRICE

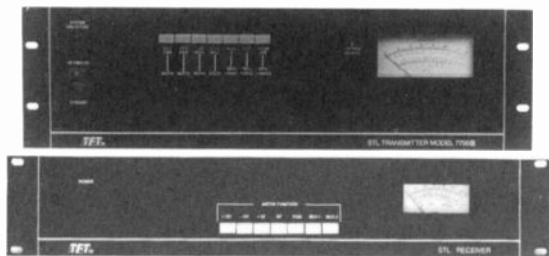

MODEL 7700B SERIES COMPOSITE SYSTEM

This high quality STL from TFT provides excellent audio quality and reliability. IF modulation improves S/N ratio and stereo performance. RF output is adjustable from 3 watts to a maximum of 12 watts to generate sufficient signal for long or difficult transmission paths. Both transmitter and receiver provide full status and monitoring capabilities for setup, operation and troubleshooting ease.

A full line of accessories and options allow for a fully redundant "Hot Standby" system.

MODEL 7700B TRANSMITTER

MFG. LIST \$3,975.00 CALL FOR BSW PRICE

MODEL 7707 RECEIVER

MFG. LIST \$3,250.00 CALL FOR BSW PRICE

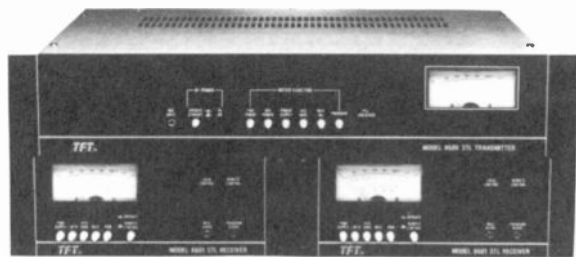

MODEL 8600 MONO STL SYSTEM (950 MHz)

The Model 8600/8601 is an economical, high quality studio-to-transmitter (STL) system which is specifically designed for either single channel or dual monaural channel radio broadcast applications.

FCC rulings permit 100 kHz "drop-ins" in the 950 MHz STL band. The 8600 system meets the FCC criteria which permits broadcasters to use a monaural link between two composite links. It is an ideal narrowband system which is optimized for operation in congested STL environments. The system is designed to deliver superlative audio quality without signal degradation or adjacent channel interference.

Based upon TFT's experience with STL designs, the 8600 system incorporates the latest microwave components and LSI devices.

System shown above shows dual-link, redundant receivers.

MODEL 8600 TRANSMITTER

MFG. LIST \$1,725.00 CALL FOR BSW PRICE

MODEL 8601 RECEIVER

MFG. LIST \$1,700.00 CALL FOR BSW PRICE

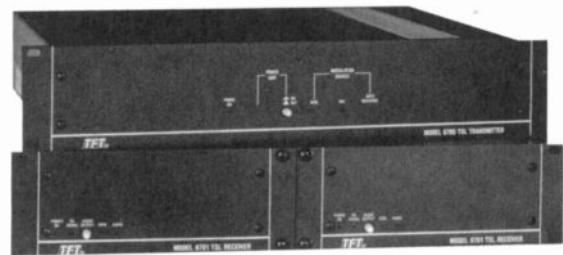

MODEL 8700 TRL LINK

The TFT Model 8700 MHz Transmitter and Model 8701 Receiver System is specifically designed to convey one way data or voice in a 3kHz band audio link. Ideally suited for remote control and telemetry. Data transmission via external modems, eliminates the need of using a telephone line or SCA channel at FM stations.

For AM station applications, it provides a data link many times faster than a sub-audio data channel.

The TFT 8700 series TSL audio bandwidth of 300 Hz to 3 kHz allows you to convey data transmission from a modem for either one way control or telemetry functions. Provisions are made on the rear panel for connection of a microphone (transmitter) and monitor amplifier (receiver) for voice applications.

MODEL 8700 or 8701

MFG. LIST \$1,375.00 CALL FOR BSW PRICE

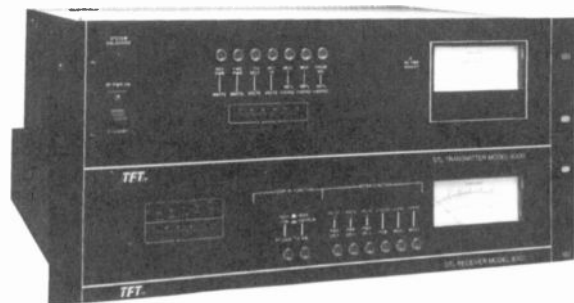

WIDE-BAND COMPOSITE STUDIO TRANSMITTER LINK FOR MAJOR MARKET'S RF SIGNAL ENVIRONMENT

MODEL 8300 COMPOSITE SYSTEM

The 8300 is specifically designed for the major market's RF signal environment where it becomes increasingly difficult to operate composite STL's with the large number of signals present in the 940-960 MHz band. By using the latest technology and components, such as S.A.W. filters, selectable RF front end gain, variable bandwidth IF amplifiers and cast aluminum RF shielded housings for critical circuits; TFT engineers were able to design one of the best STL systems available to the broadcast industry for aural program transmission.

A wide array of options and accessories such as IF Repeater, Stereo Decoder, and 92 kHz SCA capability make the 8300 System perfect for your operation.

MODEL 8300 TRANSMITTER

MFG. LIST \$4,820.00 CALL FOR BSW PRICE

MODEL 8301B RECEIVER

MFG. LIST \$4,690.00 CALL FOR BSW PRICE



GENTNER



THE TOTAL REMOTE CONTROL SYSTEM

**MODEL VRC-2000
REMOTE CONTROL SYSTEM**

The VRC-2000 Remote Control System provides a total solution for controlling your broadcast transmitter from anywhere a telephone line, radio link, data link, or bi-directional audio link is available.

This unit provides several ways to gain access to your transmitter. For instance, you may access your transmitter from any Touch Tone® telephone to communicate with the VRC-2000's synthesized voice. The VRC-2000 will provide full-time data and automatic logging capabilities on a terminal or an IBM® or compatible personal computer. If there are no telephone lines to your transmitter, you can use a radio link, or any bi-directional audio link.

The VRC-2000 Remote Control System will watch your transmitter for you. It's like having a person on duty at the transmitter continually. The VRC-2000 will notify you when something goes out of tolerance, when security is breached, or if it had to turn on the stand-by because the main failed.

The VRC-2000 Remote Control Unit features 16 single-ended analog input channels for use in metering, 16 TTL compatible input channels for use as status monitors, and 32 "open collector" transistor outputs for use as remote "switches" to generate control commands. The 32 outputs are configured as 16 separate "Command Channels" with 2 outputs per channel.

The unit can be used to automatically monitor conditions at a remote site, automatically log regular reports to a printer, take corrective action based on monitored conditions, and notify a human operator via telephone or radio links should an undesired condition occur.

The VRC-2000 has an outstanding list of options and accessories that make installation and operation easy and efficient.

MFG. LIST \$3,195.00 CALL FOR BSW PRICE

**BURK
TECHNOLOGY**



**MODEL TC-8
REMOTE CONTROL**

The TC-8 is a full featured remote control system from Advanced Micro Dynamics.

The TC-8 requires only 1 1/4" of rack space and provides 8 metering channels, 8 status inputs and 8 pair of control outputs. Studio and transmitter units communicate via telco loops or STL/SCA subcarriers. Specify which you prefer at time of ordering.

Status inputs accept 5 to 28 V signals and metering channels accept inputs of either polarity from 0.25 to 4 V, ensuring easy interface with all broadcast equipment. Status LED's and the large dot matrix metering display can be read from across the room.

CRT display, logging and fully automatic operation is possible using the optional RS-232 interface.

MFG. LIST \$2,495.00 CALL FOR BSW PRICE



**MODEL ARC-16
16-CHANNEL REMOTE CONTROL**

Now, you have a choice: full-time studio control, dial-up telephone control — or both. And because of modular design, the ARC-16 offer features never before available in a 16-channel remote control system.

With the studio controller you have a constant link to your transmitter, for instant response to any problem. The 32-character LCD display shows out-of-tolerance conditions at a glance, and it's simple to make adjustments, with clear-text prompting to guide you.

Call the ARC-16 from any tone phone: the Digital Speech Unit (DSU) lets you take control using your telephone keypad. It can be used as the only control — or in addition to the studio controller — and can be installed in the transmitter or the studio unit.

Features:

- Full-time studio control, dial-up control, or both
- Studio controller displays clear text prompts for non-technical operators
- Dial-up speech unit features digitally-recorded human voice
- Built-in subcarrier generators at no extra charge
- Built-in alarms
- Optional computer interface
- Control multiple sites with a single unit

PRICES BASED ON CONFIGURATION

Leasing?

Leasing equipment saves working capital. Talk to your BSW Sales Representative on the advantages of leasing your next equipment purchase from BSW.

1-800-426-8434



Symetrix



MODEL TI-101 TELEPHONE INTERFACE

The Symetrix TI-101 telephone interface is the most practical, yet economical device on the market today designed specifically for the connection of professional audio equipment to telephone lines in broadcast and production operations. The TI-101 employs a carefully engineered electronic hybrid circuit which creates a maximum trans-hybrid loss, yielding effective isolation between your studio's send to the telephone line, and your caller return signal. Your net result is clear, intelligible telephone audio.

MFG. LIST \$549.00 CALL FOR BSW PRICE

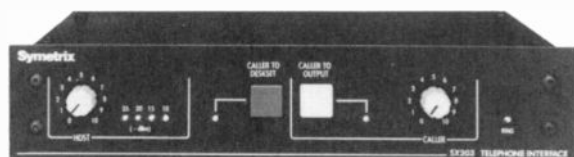

MODEL SX203 TELEPHONE INTERFACE

The Model SX203 telephone interface is a single line coupling device that provides high quality audio transfer between telephone lines and professional audio equipment. Very fast hook up and ease of operation make the SX203 ideal for radio and television talk shows and news gathering, recording studios, teleconferencing, and rental systems. Only 1/2 rack space.

MFG. LIST \$389.00 CALL FOR BSW PRICE

Don't Panic... We're Still Open

BSW's extended hours and West coast location are great for those times when you just have to have that piece of important equipment. We're open 6 a.m. to 6 p.m. Pacific time, 9 a.m. to 9 p.m. Eastern.

1-800-426-8434

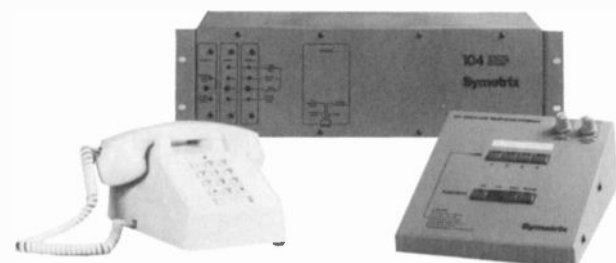

COMPLETE BROADCAST TELEPHONE SYSTEM

MODEL 104A TELEPHONE SYSTEM

If telephone talk is part of your format, then the Symetrix 104A system should be a part of your station. Pictured at right, the 104A is a complete stand alone electronic telephone system that provides complete line handling and routing facilities thereby eliminating the need for an additional key switch. The system is simple enough to be controlled by the on-air personality from one console. Control functions for each incoming line include: seize, release, transfer to hold, transfer to cue, and transfer to air.

The 104A is a 4 line system and four lines can be put on the air simultaneously. Contains two full duplex electronic hybrids (half duplex available). Allow us to send you a detailed brochure outlining all the technical specifics on the Symetrix telephone systems.

MFG. LIST \$2,395.00 CALL FOR BSW PRICE



MODEL 111 ADAPTIVE HYBRID

The new Symetrix Model 111 Adaptive Hybrid is an automatic digital telephone interface intended for use in situations where audio quality simply cannot be compromised. With its exclusive adaptive hybrid operating system running in a high speed digital signal processing environment, the 111 consistently delivers the best possible trans-hybrid loss with any phone line.

By continually analyzing the signals it receives, the Model 111 has the ability to achieve and maintain the optimum null, even as conferenced lines are added and removed. Because it adapts to the changing line conditions in real time, the 111 delivers superb results automatically, call after call.

Unlike analog hybrids the 111 is able to operate on telephone lines exhibiting a broad range of impedances. By utilizing a multi-tap adaptive filter, the 111's AutoNull program allows it to work with virtually any two wire phone line or loop. Trans-Hybrid loss is typically 46dB.

MFG. LIST \$1,695.00 CALL FOR BSW PRICE



COMREX[®]

FREQUENCY EXTENDER SYSTEMS

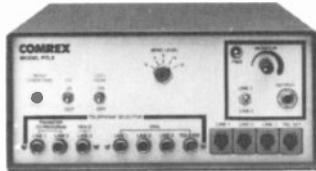

MODEL PTLX

MODEL RTLX

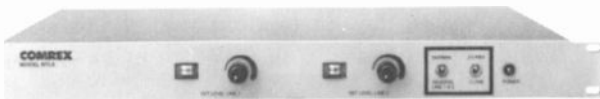

MODEL RTLX/PTLX TWO LINE EXTENDER

Comrex two line systems give you a full 50 to 5 kHz of program audio using two standard telephone lines. On one line, input audio is shifted upward by 250 Hz, so program audio as low as 50 Hz can pass through the 300 Hz telephone cutoff. On the second line, program is shifted down by 2,000 Hz to pass frequencies as high as 5,000 Hz. Since line noises can also detract from program quality, Comrex two line systems incorporate sophisticated multiband noise suppression that can handle even the high noise environment found on many long haul international circuits.

System consists of an encode unit Model PTLX and decode unit Model RTLX.

MFG. LIST \$6,500.00 CALL FOR BSW PRICE



MODEL LXR



MODEL LXT

MODEL LXT/LXR SYSTEM SINGLE LINE EXTENDER

Here is the most cost effective Comrex Extender System you can buy. This basic system restores the low end on telephone transmissions, offering a substantial improvement for telephone remotes. Easy to set up and operate, the Basic System works off a single dial-up line. Input is line level via barrier strip. We suggest the use of an outboard mixer.

MODEL LXT/LXR SYSTEM

MFG. LIST \$1,300.00 CALL FOR BSW PRICE



MODEL 3XP MULTILINE FREQUENCY EXTENDER

The technique of frequency extension was introduced by Comrex in 1976. The original One Line System restores the lower 2½ octaves of program material sent on dial lines. The Two Line System was developed in 1983 and affords the advantage of 50 Hz to 5 kHz program with an effective multiband noise suppression system. There are several thousand Comrex One and Two Line Systems in use around the world today.

Comrex's Multiline System provides even greater frequency response (50 Hz to 10 kHz) and the same excellent noise reduction. The completely automatic setup system allows it to be used easily by non-technical personnel.

Frequency Extenders give you in house control over remote broadcasts. Good program quality along with reliability and ease of use are reasons why more and more people are using Comrex Extenders for instantaneous links to any part of the world.

The Comrex Multiline Frequency Extender is an encode/decode system that provides a frequency response of 50 Hz to 10 kHz on three dial telephone lines. Comrex's proven multiband noise reduction system is incorporated in a seven band configuration to handle the high noise environment of long haul telephone circuits. The Model 3XP Encoder is built in a rugged, portable case and features "one-button" automatic dialing and setup. The 3XP also allows visual and audio communications from the receive site.

The 3XR Decoder is housed in a 3U 19" rack with modular Eurocard board construction. It contains all the circuitry necessary to automatically answer and match the gains of incoming telephone lines and to equalize each line across the full telephone band. Real time audio processing is used to allow for simultaneous program backfeed. Optional automatic satellite delay for international feeds will handle up to one second of time difference among lines.

Features:

- 10 kHz 3 Dial Lines
- "One Button" Auto Dial & Setup
- Comrex Multiband Companding
- Real-Time Audio Processing
- Automatic EQ & Line Leveling
- Built-in Hybrid for Cue Back

MODEL 3XP ENCODER

MFG. LIST \$6,000.00 CALL FOR BSW PRICE

MODEL 3XR DECODER

MFG. LIST \$6,500.00 CALL FOR BSW PRICE



COMREX[®]



(Cellular telephone pictured not included.)

TURN YOUR CELLPHONE INTO A REMOTE BROADCAST SYSTEM

MODEL PLXMICRO REMOTE BROADCAST SYSTEM

Combine a Comrex PLXmicro Frequency Extender with your cellular telephone and create a portable, easy to use, great sounding remote broadcast system. Comrex and cellular are natural partners for remote broadcasts.

PLXmicro Portable One Line Encoder is a battery operated duplex one line extender that packs twice the features of older frequency extenders into half the size. The PLXmicro has a built in coupler for direct connection to either standard dial lines or cellular telephones. Monitor decoder, hybrid circuitry and headphone output are included for hands-free, two-way operation. There are both microphone and tape inputs along with AGC and optional external AC power supply.

MFG. LIST \$1,450.00 CALL FOR BSW PRICE

CELLULAR INTERFACE

MFG. LIST \$125.00 CALL FOR BSW PRICE

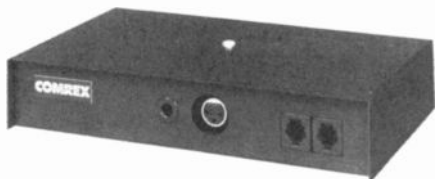

MODEL TCB-2A AUTO ANSWER COUPLER FOR TELEPHONES

It's easy to put your audio on the phone with the new TCB-2A auto-answer coupler from Comrex. Built specifically for broadcast use, the TCB-2A is perfect for listen line applications. Just plug in the standard connectors, attach the power supply and you're ready to go. Coupler answers on the first ring and disconnects when calling party hangs up.

MFG. LIST \$275.00 CALL FOR BSW PRICE



MODEL TH-X ONE LINE EXTENDER/HYBRID

The Comrex Model TH-X is a complete telephone line management system. It contains all of the circuitry that you need to interface a telephone line with your broadcast audio facilities.

The TH-X has all the outstanding quality and workmanship that Comrex is famous for. Call BSW for more technical information and specifications.

Features:

- One Line Extender Encoder and Decoder
- Built-in Hybrid Set-up System
- Automatic Caller Leveling
- Auto or Manual Answer
- Connection to any PABX
- De-clicking
- Wide Band Hybrid
- Variable Ring Count
- All Functions Remotable

MFG. LIST \$3,500.00 CALL FOR BSW PRICE



MODEL TCB-1A BROADCAST TELEPHONE COUPLER

The Comrex Model TCB-1A broadcast coupler sends and receives program material via the switched telephone network. The unit is connected with modular plugs and requires no external power. The TCB-1A contains an FCC registered coupler which provides isolation from hazardous voltages and currents and includes an active circuit to hold the telephone line. 1/4 inch jack provides line level input.

Most Comrex equipment is available for a "no obligation demonstration". Call BSW toll free 1-800-426-8434 to arrange yours. MFG. LIST \$135.00 CALL FOR BSW PRICE

Customer Service

BSW's "after the sale" support is second to none. Your complete satisfaction is our only goal and we pay for the call.

Toll Free 1-800-426-8434



GENTNER



**MODEL SPH-3A
TELEPHONE INTERFACE**

The SPH-3A telephone system provides an easy, inexpensive method of interfacing your equipment with a telephone system. The SPH-3A permits simultaneous send and receive audio (full duplex operation); in addition, a built-in monitor amplifier eliminates the need for guests or talent to wear headsets. The SPH-3A is simple to install and is fully remotable.

MFG. LIST \$599.00 CALL FOR BSW PRICE



**MODEL SPH-4
TELEPHONE INTERFACE**

The Gentner SPH-4 telephone system incorporates a variety of features to give you clean, clear telephone audio for a variety of uses. This unique "caller control" reduces the caller's level when talent is speaking (continuously adjustable); switching transients are suppressed on connection to provide a clean on-air sound. Computer designed equalization assures best hybrid performance.

MFG. LIST \$799.00 CALL FOR BSW PRICE

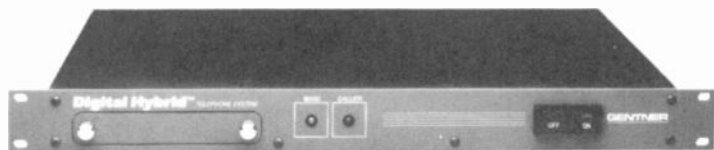

DIGITAL HYBRID

Gentner's Digital Hybrid™ is a digitally processed telephone hybrid that provides a direct interface between a single telephone line and your equipment. It provides the best possible audio quality from the telephone line. The Digital Hybrid™ can be used for all types of telephone interfacing including broadcast talk shows, on-air interviews, teleconferencing, etc. Multiple units may be stacked to provide a teleconference bridge.

- Features:
- Superior hybrid performance
 - Automatic nulling
 - Totally remotable
 - Send and receive audio processing
 - Telephone system compatibility

MFG. LIST \$2,395.00 CALL FOR BSW PRICE

SOUND AMERICA CORPORATION



**MODEL RSVP
RECORD/SEND TELEPHONE**

Here is the perfect, easy solution for sending or recording audio from the telephone. The RSVP from Sound America is a standard telephone that contains a built-in audio coupler. Cassette recorders will interface directly for recording or sending program material. In addition, the RSVP has an amplified electret condenser microphone for superior voice quality and a mute switch to cut out background noise while recording. Backed by a two year warranty, the RSVP is a perfect product for news and production.

MODEL RSVP
BSW PRICE \$127.50

MODEL SVP (without record feature)
BSW PRICE \$109.50



TELEPHONE COUPLER

Designed to replace the mic element in older Western Electric or GTE telephones, this versatile phone coupler from Sound America makes it easy to transmit audio through the telephone. Installs in seconds and uses no batteries. Built-in mic element allows for simultaneous voice and tape feed. 1/8" tape input jack.

MODEL VOICE ACT WE (for Western Electric)
BSW PRICE (case included) \$84.90

MODEL VOICE ACT GTE (for GTE)
BSW PRICE (case included) \$90.90

SHURE



**MODEL 50AC
TELEPHONE ACOUSTIC COUPLER**

- Ideal for voice transmission from remote locations where "hard wiring" to telephone lines is impractical or impossible
 - Convenient hands-free operation with most cassette tape recorders
 - Ruggedly constructed of rubber and high-impact plastic
- BSW PRICE \$45.50



GENTNER



MODEL EFT-1000A
FREQUENCY EXTENDER

Have you ever wished you could send one person out to do a remote and not have to worry if all the right "switches" were in the right position at the studio? Now you can trust EFT-1000A to get the job done for you. Because the EFT-1000A has an automatic answer and automatic encode-decode, just go to the remote, phone the station, and you're ready to go. The EFT-1000A is capable of using two different telephone lines. You can transmit on one line and use the other for continuous cues from the station. Two needed for complete system.

MFG. LIST \$1,295.00 CALL FOR BSW PRICE



MODEL EFT-100
FREQUENCY EXTENDER

Here is your answer for low cost, good quality remotes. The new Gentner EFT-100, for use with your existing hybrid, is a two-frequency extender. This means you get the benefit of hearing the cues back from the station with just one telephone line. If you already have a hybrid, all you need is the EFT-100.

MFG. LIST \$495.00 CALL FOR BSW PRICE



MODEL EFT-900A
FREQUENCY EXTENDER

There's no simpler way to get great audio from your remote over a dial-up telephone line than using the EFT-900A. Its digital circuitry ensures improved audio response. In fact, all you need for the remote site is an EFT-900A. The telephone coupler, microphone or line level input, and headset amplifier are all built right in. No more hassles doing a remote when you rely on our EFT-900A.

MFG. LIST \$795.00 CALL FOR BSW PRICE



MODEL EFT-3000
3 LINE FREQUENCY EXTENDER

A revolutionary advance in technology now allows you to get 7.5 kHz on three standard dial-up telephone lines. Now you can do the whole show, even the music, from the remote. Gentner's exclusive design uses digital signal processing to give you the frequency response you want from your remotes. Set-up is quick and painless because it's automatic. Because you get automatic answer, equalization, phase correction, and group delay realignment, one person can set the remote. The remote location even hears cues from the station. The EFT-3000 is the answer for simple high quality audio remotes over standard dial-up telephone lines.

MFG. LIST \$9,995.00 CALL FOR BSW PRICE



AUTO COUPLER

If you're looking for an automatic answering and disconnect hybrid coupler, the Auto Coupler is just what you need. It gives you both "Send" and "Caller" capabilities. Use this with the EFT-100 or any time you need an automatic answer and disconnect to a telephone line.

MFG. LIST \$299.00 CALL FOR BSW PRICE



HYBRID COUPLER

The Hybrid Coupler is a low cost telephone coupler that provides both "Send" and "Caller" capabilities. This unit turns the two wire telephone circuit into a four wire system. It's a perfect match for the EFT-100 or any time you need a connection to a telephone line.

MFG. LIST \$129.00 CALL FOR BSW PRICE



GENTNER

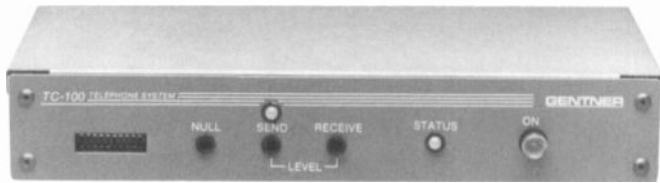

**MODEL TC-100
AUTOMATIC TELEPHONE INTERFACE**

The TC-100 is the most versatile telephone coupler you'll find. The design not only gives you auto-answer/auto-disconnect and latching or momentary tape starts; it allows you to use the unit as a hybrid for on-air calls... as a remote controller (with the Touch-Tone® board option)... as a private party line telephone intercom and more. The TC-100 is easy to install and operate, and is fully remotable.

- Table, undertable, wall and rack mount configurations
- Direct connection to the phone line (uses USOC RJ11C)
- A-lead control for 1A2 and digital phone systems
- Send and receive level controls are front panel adjustable
- Bi-color LED flashes red on rings and glows green on answer
- Optional Touch-Tone® decoder board with dial tone detector and call progress decoder
- Manual or automatic operation
- Momentary or latching tape starts

MFG. LIST \$429.00 CALL FOR BSW PRICE



**MICROTEL-1
PHONE LINE MIXER**

Gentner Engineering's Microtel is a portable, battery operated telephone interface that may be used for a wide variety of applications. In its typical application, Microtel replaces the hand-set of the telephone to permit high quality audio feeding down the phone line while simultaneously monitoring the return audio. Microtel is powered by a single 9V battery.

- Portable mixing
- Studio talkback
- In the field news mixing/telephone feeding
- Sports console/back-up sports console
- Mic to line driver for equalized program loops

MFG. LIST \$219.00 CALL FOR BSW PRICE

RADIX

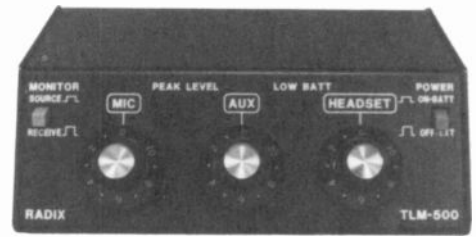

**TLM-500
PHONE LINE MIXER**

The TLM-500 is a highly portable, battery powered mini-console that can turn any modular telephone into a remote broadcast studio link or telephone interview control center.

To use with a telephone, simply plug the telephone handset cord into the TLM (telephone line mixer) along with a studio quality microphone and headphones. The telephone is dialed normally and incoming calls can be answered, the difference is the convenience of the microphone/headphones for broadcast operations and the quality of and control over the audio signals. Features include:

- Mic and line inputs
- Low battery indicator
- Headphone amplifier
- Peak reading LED
- AC adapter available

MFG. LIST \$229.00 BSW PRICE \$198.00

GENTNER

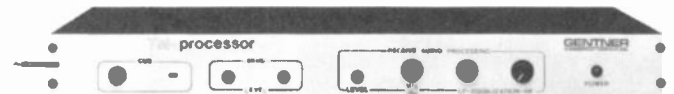

**TELEPROCESSOR
TELEPHONE AUDIO PROCESSOR**

Gentner's teleprocessor improves the sound of any telephone system. Use in conjunction with telephone hybrids, frequency extenders or other interface equipment to enhance your telephone audio.

- Compliments any telephone system. Use with existing hybrid equipment or add to new equipment to further improve phone audio.
- Use with frequency extenders to achieve best possible phone line audio.
- Maintains average send level to caller. This allows you to reduce the send level of your hybrid equipment, thus improving the hybrid null.
- Low and high band EQ adjustments. Maximize sound of each phone line; reduce line hiss and hum.
- Aphex® processing re-creates higher frequencies, giving you improved high-end sound.

Aphex® is a registered trademark of Aphex Systems, Ltd.
MFG. LIST \$499.00 CALL FOR BSW PRICE



Henry Engineering

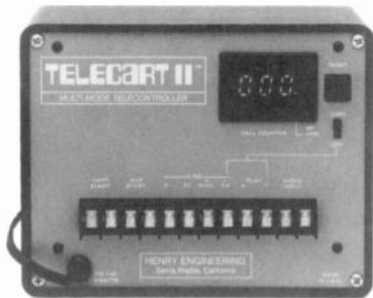

TELECART II AUTO ANSWER INTERFACE

An automatic answering unit that permits a standard NAB type-cartridge machine to answer a telephone line and play a recorded message to the caller.

- Digital call counter (records 999 calls)
- Failsafe - permits unattended automatic operation
- Built-in power supply
- Works with virtually any cart machine
- Cart cues for all incoming calls

MFG. LIST \$225.00 CALL FOR BSW PRICE



MixMINUS PLUS DIFFERENTIAL SUMMING AMPLIFIER

MixMinus Plus is a differential summing amplifier designed to add a "Mix-Minus" output to a broadcast audio console. This output is typically used to feed the send input of a telephone hybrid device. MixMinus Plus has two inputs and one output. One input is fed with the program output of the console. The second input is fed with the hybrid receive audio, tapped just after the phone channel fader on the console. MixMinus Plus subtracts the hybrid receive signal from the program output, thus creating a program mix minus the receive audio. The null adjustment will provide 40 dB rejection of the receive audio signal (30 Hz - 3 kHz). MixMinus Plus is easily connected to most consoles and needs no adjustment once installed.

MFG. LIST \$195.00 CALL FOR BSW PRICE

Miwltronics, Inc.



MODEL API/C AUTO ANSWER INTERFACE

Extremely versatile and inexpensive, the Miwltronics Model API telephone interface does everything but the dishes. In a nutshell, it interfaces your cart machine to the telephone. It will: auto answer, disconnect and allow multi-lines to get the start of message at the same time. We simply do not have the room to tell you all the features, so call us toll free for more details . . . 1-800-426-8434.

MODEL API

MFG. LIST \$265.00 CALL FOR BSW PRICE

MODEL API/C (with call counter)

MFG. LIST \$315.00 CALL FOR BSW PRICE

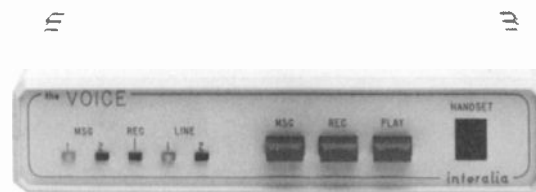

MODEL V23 DIGITAL ANNOUNCER

Concert information, ski reports, weather information . . . If you are currently providing this service to your listeners over the telephone, check out the VOICE V23 from Interalia. This unit is a solid state digital announcer that, unlike cart machines, was designed to interface directly with telephone lines. Your voice or program material is recorded digitally, so the quality does not deteriorate over time. Gone are the days of broken belts, tapes, and motors.

Installation and operation are simple and easy, and the V23 will interface with all major telephone systems. Recording time up to 3 minutes is available and the V23 will handle two phone lines. You could have the same announcement on both or different messages on each line. The caller always hears the message from the beginning and the V23 clears the line immediately after the caller hangs up. In addition, the unit keeps track of how many callers you've had, great for sponsor information.

MFG. LIST \$1,200.00 CALL FOR BSW PRICE



**MODEL ES510ER
60 MINUTE TIMER**

ES510ER is a four digit, sixty minute timer (59:59) with Start, Stop and Reset controls. Runs continuously unless stopped or reset. If stopped, display will hold time reading and when restarted will continue with next count from last displayed figure. Reset returns display to all zeros. If reset while running, timer will continue to run. Displays are .55" bright orange gas discharge. Remote capable.

MFG. LIST \$193.00 CALL FOR BSW PRICE

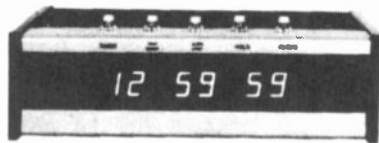

**MODEL ES562E STUDIO TIMER
SIX DIGIT CLOCK/TIMER WITH MEMORY**

The ES562E is a time of day clock and a count up timer. Display is in hours, minutes, and seconds. Memory allows timer to be used while keeping correct time of day.

MFG. LIST \$362.00 CALL FOR BSW PRICE

AUDIOLAB



**MODEL AT1200
STUDIO TIMER**

Event timer provides automatic 3-way operation. Timing starts and stops from any audio source, panel pushbuttons, remote contacts or pulse.

- Interface with any audio source
- Automatic switching from auto to manual operation
- Interface one or more sources for start-stop reset operation
- Minutes/seconds mode displays up to 10 minutes
- Hours/minutes shows elapsed time to 24 hours

- Dimensions 4 1/8" x 3" x 2"
- Rackmountable (4 timers)

MFG. LIST \$228.00 CALL FOR BSW PRICE

GENTNER

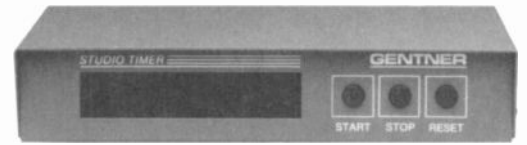

STUDIO TIMER

Accurate studio timing from Gentner times events to 9:59:59. Easy to read LED display in a compact durable housing. All front panel functions can be remote controlled.

MFG. LIST \$189.00 CALL FOR BSW PRICE



COUNTS UP AND DOWN

**MODEL ST-500
STUDIO TIMER**

Compact studio timer with many applications in the control room, production or news room. Time events to 9 hour 59 minutes 59 seconds. Large — Highly visible red display digits 1/2" high. Rear terminal strip interface allows remote start, stop and reset. Powerful microprocessor allows preset times from memory to count up or down. Outstanding value.

MFG. LIST \$225.00 BSW PRICE \$198.00

SEIKO



**PERFECT FOR PRODUCTION
AND NEWSROOM USE**

**SOUND PRODUCER
4 SEPARATE FUNCTIONS**

1. Time Calculator: Allows you to add and subtract time segments in hours, minutes, seconds, without conversion.
2. Timer: Counts down from any pre-set time.
3. Stop Watch: Counts lapped time.
4. Time: Keep regular time of day.

BSW PRICE \$63.00



Seth Thomas

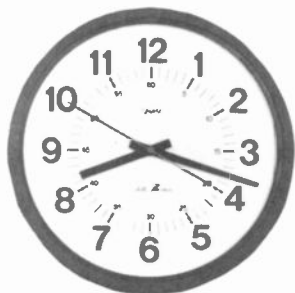

MODEL 710

Here's our most popular clock that is perfect for all studios. Quartz control assures accurate time. Battery powered by one "C" cell that will last over a year. Brown case, 14" diameter, red sweep hand.

BSW PRICE \$29.95



MODEL 709

Electric powered, the model 709 is easy to read from a distance. Diameter is 14". Brown molded case.

BSW PRICE \$22.95



MODEL 2636

Quartz accuracy and extra bold dial graphics. Popular 14" case size. Light beige case. Shatter resistant crystal. Red sweep second hand. Uses one AA battery.

BSW PRICE \$27.95

America's Full-Time Broadcast Supplier



6:00-6:00
Pacific



7:00-7:00
Mountain



8:00-8:00
Central



9:00-9:00
Eastern

When BSW was founded in 1973, our goal was to establish a single source supply house to serve the needs of America's broadcast professionals. Regional offices solved the problem of time zone but only served to delay delivery of equipment critical to a station's operation.

So we decided to work overtime every day of the week. 12 hours a day, there is a qualified sales engineer on duty who knows your business and your needs. And there's only one number you need to know — toll free across America. BSW's commitment to service is why we're America's full-time broadcast supplier.

BSW®

BROADCAST SUPPLY WEST

America's Full-Time Broadcast Supplier

1-800-426-8434

ORDERS • INFORMATION • SPECIFICATIONS
BSW • 7012 27th Street W • Tacoma, WA 98466 • FAX 206-565-8114

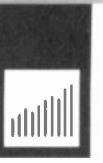

amber

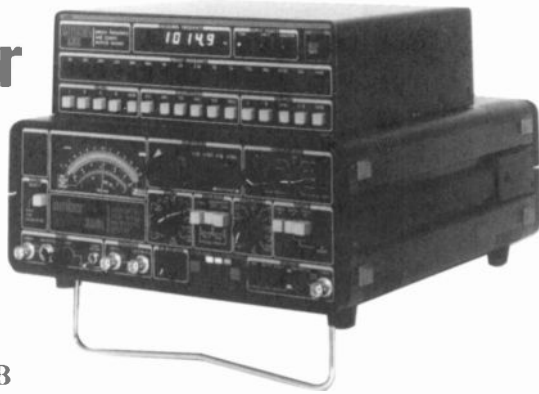

**MODEL 3501B
AUDIO TEST SYSTEM**

We have contracted with Amber to build a special configuration that specifically addresses the needs of the broadcaster. Conveniently portable and easy to use, this system comes with a balanced input and output, THD+N, IMD, Weighted and Unweighted noise measurement capability.

The built-in audio generator covers a 10 Hz to 100 kHz frequency range and can deliver up to +30 dBm to test headroom of pro gear. The system can measure THD+N to below 0.0008% and noise to below -120 dBm. It measures SMPTE IMD to the standard (7 kHz to 60 Hz) but also varies the HF over a 2 kHz to 100 kHz range to let you qualify transient and slew induced distortion at high frequencies.

The 3501 has a unique Narrow Band measurement capability that lets you use it as a spectrum analyzer, find crosstalk below the noise, verify tape erasure or look for hum and noise components.

The highly sensitive noise meter measures wide band noise (to over 300 kHz), narrow band noise and A-Weighted noise below 1 V (-120 dBm).

We have equipped the model 3501 with a special stereo broadcast switch matrix. Feed left only, right only, L+R and L-R and measure from up to 5 sources. A calibrated modulation percentage switch simplifies transmitter measurements. A preset frequency switch lets you have fast single button access to the popular FCC and test tape frequencies or the smooth 6 to 1 vernier for any frequency from 10 Hz to 100 kHz. An auto-ranging, fast update frequency readout reads either the generator or the external signal to 0.1 Hz resolution.

Weighing in at less than 15 pounds and two thirds of a cubic foot, this instrument gives you lab quality performance in a compact, portable and easy to use format.

BSW PRICE \$4,950.00

WHIRLWIND

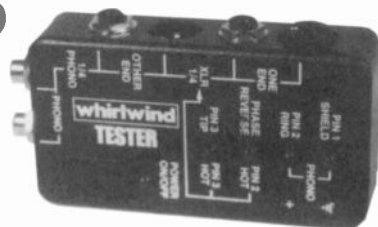

CABLE TESTER

Check for shorts and bad connections easily with the Whirlwind Cable Tester. Accommodates XLR, 1/4" and phono plugs. 9 volt battery required. Fits in your tool box.

BSW PRICE \$49.30

**Potomac
Instruments**



**MODEL AT-51
AUDIO TEST SYSTEM**

The AT-51 is an innovative audio test system which facilitates the measurement of critical parameters in monophonic and stereophonic audio equipment. Designed primarily for commercial broadcast proof-of-performance measurements and equipment maintenance, the AT-51 exhibits features which are unique and well suited to laboratory type measurements by design engineers, quality control facilities and professional high fidelity service centers. The AG-51 Audio Generator and AA-51 Audio Analyzer are packaged separately for remote measurements requiring physical separation of signal source and signal analyzer. Both units are RFI shielded to enable accurate measurements in high level radio frequency environments typical to broadcast transmitter facilities. Signal input and output connectors are also RFI shielded.

MFG. LIST \$4,310.00 CALL FOR BSW PRICE

XCELITE



MODEL TC-150/ST

A carefully selected assortment of Xcelite hand tools; interchangeable drivers, blades and handles; soldering iron and 1 measuring tape. Removable pallets in lid and base have tool-pockets.

MFG. LIST \$499.00 CALL FOR BSW PRICE

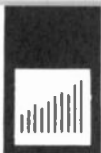

Symetrix



MODEL SX205 AUDIO METER

The SX205 is a two-channel level display that indicates both voltage and power. A 1 kHz sine wave oscillator is included for calibration and alignment.

Unlike old style electro-mechanical meters, the SX205's micro-processor controlled display driver delivers outstanding accuracy. Each channel's integration time can be set to correspond to VU meter ballistic, or PPM (peak program meter).

Hold function allows peak levels to be displayed for any length of time (infinity = manual reset). Bargraph or dot format may be selected for each channel.

MFG. LIST \$279.00 CALL FOR BSW PRICE

GOLD LINE



MODEL ASA-10B AUDIO SPECTRUM ANALYZER

An affordable, professional quality, 10-octave analyzer covering the full range that allows you to balance your audio system; EQ and check out your phono amplifier, tape deck and loud speakers and make sure that your system delivers its optimum performance.

MODEL ASA-10B

MFG. LIST \$339.95 CALL FOR BSW PRICE

MODEL PN2

PINK NOISE GENERATOR

MFG. LIST \$89.95 CALL FOR BSW PRICE

MODEL LL-10

AUDIO SPECTRUM ANALYZER

The Model LL-10 is a 10-band line level Audio Spectrum Analyzer designed to save time for the audio service technician. A 23 dB LED display allows line level readings from tape machines or turntables to be simultaneously displayed over the entire audio range. By making use of pink noise cassette, or the built-in noise generator, it is easy to record and see immediately the performance of the heads or if either bias or dolby noise tracking calibration is required.

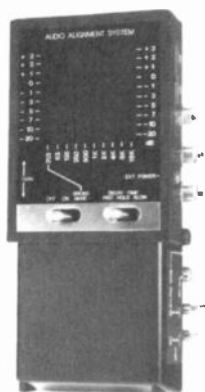

MFG. LIST \$339.95 CALL FOR BSW PRICE

LOFTECH



MODEL TS-1 AUDIO TEST SET

The Loftech TS-1 provides a combination of three precision test instruments that is capable of making audio frequency tests and measurements with a high degree of certainty, accuracy, efficiency, and in less time than conventional test instruments. The TS-1 is a:

- Low distortion oscillator
- dB meter
- Frequency counter

MFG. LIST \$299.95 CALL FOR BSW PRICE



Fostex

MODEL TT-15 TEST TONE OSCILLATOR

Battery operated, low distortion sine wave oscillator with five selectable frequencies (40 Hz, 400 Hz, 1 kHz, 10 kHz, and 15 kHz) and three selectable output levels (-30 dB, -10 dB and 0 dB). RCA output jack. Useful for spot checking frequency response, calibrating mixers with tape recorders and other level matching jobs. Output is constant and not affected by battery voltage or frequency. Fits in your tool box.

MFG. LIST \$48.00 CALL FOR BSW PRICE

BIRD



Now in its fifth decade of serving the broadcast industry, Bird Electronic Corporation has been the pioneer in developing products for measurement, filtering and termination of RF power. The Company's products originally developed in response to specific design requirements of broadcast equipment manufacturers, have since become standards of the industry.

Recognizing that broadcast test equipment must be even more reliable than the transmitter, must be constantly on-call and totally trustworthy, Bird has achieved an enviable record of reliability. CALL TODAY FOR YOUR BIRD EQUIPMENT NEEDS. 1-800-426-8434 TOLL FREE.

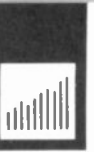

ROHN

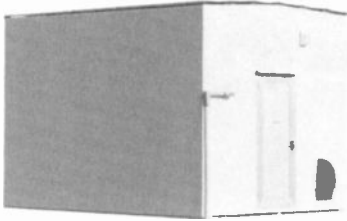

TOWERS AND SHELTERS

Allow BSW and Rohn the opportunity to give you a quote on your tower and shelter requirements.

Rohn Towers are constructed with the finest materials. All tower sections are completely hot-dip galvanized after fabrication to protect all points of welding and construction against corrosion.

Rohn Shelters are available with a complete environmental control system and optional reinforced insulated aluminum doors with three-point locking systems.

Prices are based on applications.

CALL BSW TOLL FREE WITH YOUR REQUIREMENTS

TWR

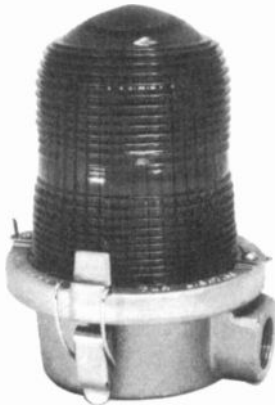

LIGHTING EQUIPMENT

BSW sells a variety of tower lighting products including controllers, flashers and replacement bulbs.

- FAA approved
- Red lens (no color screen required)
- Non-ventilated construction insures clean interior
- Copper - free aluminum castings
- Neoprene and teflon gaskets
- Single piece lens increase light output 10%

CALL US FOR SPECIFICATIONS AND PRICES

Beckman Industrial™



HANDY LOW COST MULTITESTER

MODEL AM10 ANALOG MULTITESTER

The pocket-sized AM10 is built to perform the most frequent quick circuit checks or to be kept in the tool kit as a spare. The jewelled analog meter movement provides an accuracy of 4% of full scale and the unit has 16 measuring ranges in four functions plus decibels on the AC volt scale. With 2000 ohms/volt sensitivity, two times scale overload protection and zero adjust for ohms and meter movement. Buy an extra for your glove compartment.

BSW PRICE ONLY \$12.95

MODEL DM78 MULTIMETER POCKET SIZE W/CARRYING CASE

Ideal for carrying in your shirt pocket, the pocket-sized DM78 is the smallest digital multimeter on the market yet it has an easy-to-read 3/8" high LCD readout. The autorange feature automatically sets the optimum measuring range to simplify operation and to avoid overloads. Its five functions check up to 450 volts, AC or DC in four ranges, up to 2000 K ohms in four ranges, plus diodes and circuit continuity with a beeper. Best value around.

BSW PRICE ONLY \$29.95

FLUKE



THE WORLD'S FINEST DIGITAL MULTIMETER

FLUKE 75

- Analog bar graph • 3200 count display • 0.5% basic accuracy
- Auto-ranging with range hold • 10 amp & auto-ranged mA ranges
- Continuity and diode test beeper • Three year warranty

BSW PRICE \$117.00

FLUKE 73

- Analog bar graph • 3200 count display • 0.7% basic accuracy
- Auto-ranging only • Three year warranty

BSW PRICE \$78.00

FLUKE 77

- Analog bar graph • 3200 count display • 0.3% basic accuracy
- Auto-ranging with range hold • 10 amp & auto-ranged mA ranges
- Continuity and diode test beeper • Touch hold
- Three year warranty

BSW PRICE \$157.00

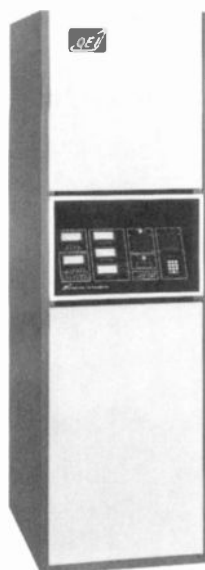

MODEL FMQ5000 (shown)

FM BROADCAST TRANSMITTERS 10 WATTS TO 55,000 WATTS

FMQ SERIES TRANSMITTERS

The FMQ series advanced-technology transmitter offers a myriad of features made possible only by introducing recent technological advances to FM transmitter design. The FMQ series design blends microprocessor technology with QEI's expertise in solid-state transmitters, control systems, and FM modulation monitors. Features here-to-fore not available in FM transmitters are built into the FMQ series. Alarm points on important parameters will warn you before a catastrophic failure occurs. Automatic Power and Modulation control are available at the flick of a switch; ideal for stations with satellite feed or those that are heavily automated. Auto logging standard, optional dial-up password protected remote control available. All solid-state at 1 kW and grounded grid final amplifiers at high power levels.

CALL FOR PRICES AND CONFIGURATIONS

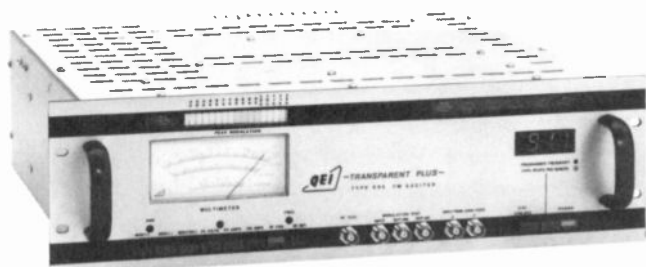

MODEL 695 FM EXCITER

- Super low distortion (typically less than .025%)
- Convection cooled - no fans
- AUTOMOD automatic modulation control
- Displays modulation peaks over 100% built-in modulation monitor and peak control
- Synthesized phase locked loop

MFG. LIST \$5,295.00 CALL FOR BSW PRICE

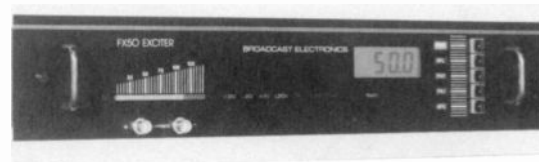

MODEL FX-50 FM EXCITER

The new FX-50 FM Exciter provides performance that is an order of magnitude superior to its predecessor, the industry-standard FX-30. On air and in continuous use since the summer of 1988, you're assured of reaping the benefits of the new technology without taking chances on performance or reliability. Performance specifications feature a dynamic range that rivals CD players with harmonic and intermodulation distortion values so low that they are virtually unmeasurable.

The new FX-50 Exciter can bring existing FM transmitters up to CD quality standards and is the ideal retrofit for exciters now in use.

Features:

- THD and IMD less than 0.003% typical for true CD sound
- Unmatched 93 dB S/N typical for widest dynamic range
- 50 watt MOSFET output power to drive the largest transmitter
- Stand-alone 50 watt FM transmitter
- Advanced linear modulated oscillator for unparalleled performance
- Computer-optimized phase locked loop greatly improves low frequency response
- Completely broadband for transparent performance
- Functional front panel controls with LCD displays

MFG. LIST \$6,100.00 CALL FOR BSW PRICE

modulation sciences, inc.

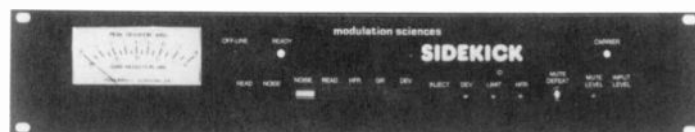

MODEL SCA 186 SCA GENERATOR

Sidekick combines the four elements needed for successful SCA operation into the one package: subcarrier generator, modulation monitor, audio processor and transmitter tuning aid. Engineered to work together, these components form an integrated system which provides a level of performance previously unattainable. Crosstalk is dramatically reduced, signal quality is significantly improved and operation is greatly simplified.

MFG. LIST \$3,195.00 CALL FOR BSW PRICE

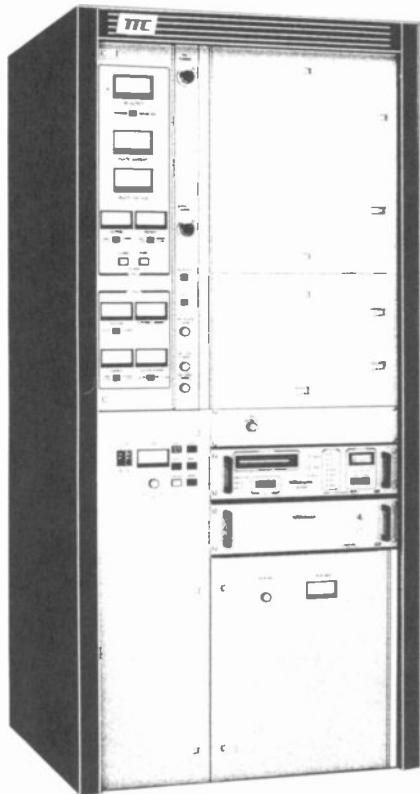

When you buy a new TTC/Wilkinson transmitter, not only do you get a great product, you also get a factory engineer to provide training and turn-on service at your facility and at no extra charge.

AM Transmitters

MODELS 250 WATTS TO 50,000 WATTS

- Features:
- Variable vacuum capacitor tuning eliminates sliding contacts
 - Motorized variable capacitor loading for ease and precision of adjustment
 - Solid state time delay and recycling increases reliability
 - Solid state control circuitry conserves space and reduces complexity
 - Complete metering

FM Transmitters

MODELS 30 WATTS TO 50,000 WATTS

- Features:
- Input and output reflectometers
 - Self-testing Wilkinson silicon rectifiers provide more than 300% voltage and current protection
 - Printed circuit control ladder conserves space, reduces complexity
 - Solid state time delay and recycling increases reliability
 - Conservatively rated, double duty plate transformer and filter reactor
 - VSWR overload protection standard

CALL FOR BSW PRICING AND APPLICATION



MODEL FM TRANSLATORS

- Features:
- 1 and 10 watt models • Very conservatively rated
 - Stable output under any load condition
 - Withstands extreme input overload
 - Choice of selectivity • Stereo monitor
 - Optional local origination
 - Superlative performance • Competitively priced
- CALL FOR BSW PRICING AND APPLICATION

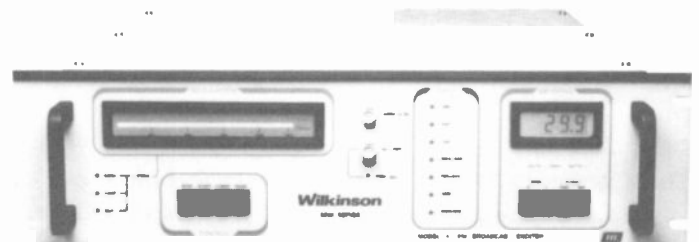

**MODEL X
FM BROADCAST EXCITER**

- Features:
- 5 subcarrier inputs standard
 - Completely broadband - no tuning adjustments
 - Frequency synthesized in 2.5 kHz steps from 76-108 kHz
 - Ultra high performance
 - 28 volt DC power
 - Typical THD and IMD less than .005%
 - Typical FM signal to noise ratio better than -95dB
 - Typical frequency response within .025 dB, 20 Hz to 100 kHz
- MFG. LIST \$5,395.00 CALL FOR BSW PRICE

BSW's West Coast Location Allows Late In The Day Shipments. If You Need Equipment Fast, BSW Is Your Supplier.

We Offer Special Discount Rates On Federal Express.

Soundcraftsmen



**MODEL PRO TUNER FOUR
AM/FM STEREO DIGITAL TUNER**

Soundcraftsmen's advanced technology incorporates sophisticated frequency synthesized tuning with a highly stable quartz crystal oscillator that locks into the broadcast signal and makes station selections precise and drift-free. A 16-station microcomputer memory system, coupled with two-way automatic scanning, provides incredibly simple programming station selection. Rack mountable.
MFG. LIST \$379.00 CALL FOR BSW PRICE

CARVER



**MODEL TX11-B
STEREO AM/FM TUNER**

The Carver TX11-B is one of the finest tuners available anywhere, at any price. For broadcasters, it offers accurate reproduction of your signal, (including your competition) so you can make better judgement calls on your audio processing. The TX11-B has 13 station presets and does not require you to select AM or FM on the preset.

The TX11-B receives AM stereo stations broadcasting C-Quam. Extended bandwidth circuitry makes AM sound as good as FM.
Specifications:

AM Section

DISTORTION (5mV/M)	0.9%
SELECTIVITY	42 dB
IMAGE REJECTION	45 dB
IF REJECTION	34 dB
AGC FIGURE OF MERIT	90 dB
AM STEREO SEPARATION (1 kHz)	40 dB
FREQUENCY RESPONSE	20 Hz to 15 kHz ±1.0 dB
SIGNAL-TO-NOISE RATIO	75 dB

FM Section

FREQUENCY RESPONSE	20 Hz to 15 kHz ±1 dB
SELECTIVITY (at 400 Hz) ...	90 dB (narrow), 35 dB (wide)
CAPTURE RATIO	1.0 dB
AM SUPPRESSION RATIO	50 dB, 65 dB with CCD
IMAGE RESPONSE RATIO	110 dB

MFG. LIST \$749.95 CALL FOR BSW PRICE

CARVER



**MODEL TX10
AM/FM TUNER**

When you need an accurate tuner and don't need the frills found in more expensive ones, take a look at the Carver TX10.

Features:

- 20 AM/FM presets
- Auto/manual tuning
- LED signal strength meter

MFG. LIST \$299.95 CALL FOR BSW PRICE



**MODEL TX12
AM/FM TUNER**

This mid-priced tuner provides accurate reproduction of your station's signal.

Features:

- Advanced, logic-controlled asymmetrical charge-coupled FM detection circuit for dramatically reduced multipath and noise
- 20 FM/AM presets
- Preset/scan
- Auto/manual tuning
- Stereo/mono switch
- Analog signal strength meter
- Dual antennal inputs
- Multi-function remote control

MFG. LIST \$399.95 CALL FOR BSW PRICE

***Don't Panic... We're
Still Open***

BSW's extended hours and West coast location are great for those times when you just have to have that piece of important equipment. We're open 6 a.m. to 6 p.m. Pacific time, 9 a.m. to 9 p.m. Eastern.

1-800-426-8434



Protec



MODEL SA270

New for 1990, we introduce the Protec SA270 professional tonearm. Features removable headshell, adjustable tracking weight, and anti-skate adjustment. Tracking weight is 0-3 grams.

MFG. LIST \$139.95 BSW PRICE \$119.95

 **audio-technica.**



MODEL ATP12T

A demand tonearm in many engineering and programming circles. Fully adjustable tracking weight.

MFG. LIST \$275.00 CALL FOR BSW PRICE

 **MICRO-TRAK**

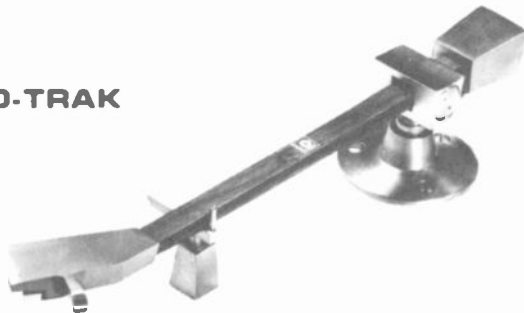

MODEL 303A

Long established reputation of quality. Laminated mahogany shaft for low resonance and small tracking error.

MFG. LIST \$160.00 BSW PRICE \$142.00

 **RUSSCO**



MODEL RTA-12

The RTA-12 is comprised of aluminum and chromed brass which floats on ball bearing races and jeweled pivots.

Stylus pressure is easily adjusted with calibrated weights. Designed for heavy use, it includes a wide tonearm rest, plug-in cable and permanently mounted headshell.

MFG. LIST \$235.00 CALL FOR BSW PRICE

Broadcast Supply West,

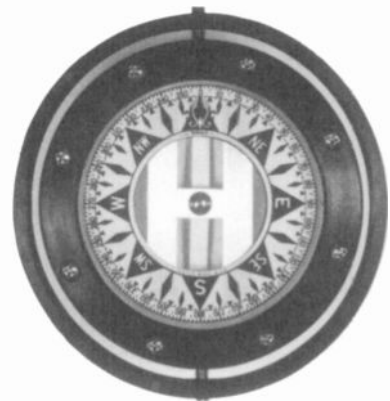

East, North & South

As a company that serves the nation's broadcasters, we have often considered opening regional offices to improve our service or expand our sales. In the final analysis, we determined that regional offices would only serve to retard service and drive our overhead sky high. So here we are in the west, maintaining the most efficient and economical distribution system in the broadcast industry. Regardless of your location, you benefit by saving money, enjoying quick delivery, and receiving exceptional service. We are open 12 hours daily, 9 a.m. to 9 p.m. east, 6 a.m. to 6 p.m. west, so you can call us at your convenience for all your audio equipment needs.

From any point on the compass, BSW is as close as your telephone.

BSW[®]

BROADCAST SUPPLY WEST

America's Full-Time Broadcast Supplier

1-800-426-8434

ORDERS • INFORMATION • SPECIFICATIONS

BSW • 7012 27th Street W • Tacoma, WA 98466 • FAX 206-565-8114



Technics

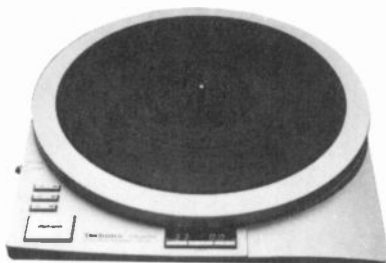

MODEL SP-15
3-SPEED TURNTABLE

This direct drive turntable has digital readout for accurate speed information. Wide range pitch change adjustment allows +9%. Start-up time is .04 seconds at 33¹/₃ RPM for tight cueing. Optional base and tonearm are required for operation.

MFG. LIST \$899.95 CALL FOR BSW PRICE

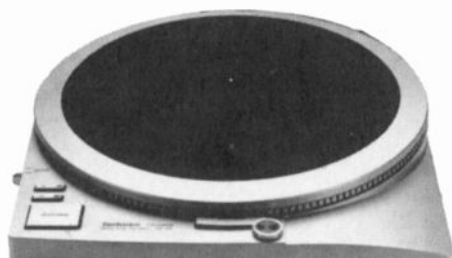

MODEL SP-25
2-SPEED TURNTABLE

The SP-25 is perfect for broadcast environments that do not require three speeds or extremely fast start-up time. Pitch change of +6% is possible and side mounted strobe verifies speed accuracy. Optional base and tonearm required for operation.

MFG. LIST \$569.95 CALL FOR BSW PRICE



MODEL SL-1200 MKII
2-SPEED TURNTABLE

The industry's most popular turntable is, without a doubt, the SL-1200 MKII. Two-speed, quartz accurate with fast start-up time, the SL-1200 MKII is the perfect addition to your control room. For production, the pitch change adjustment of +8% comes in real handy. The SL-1200 MKII includes base, dust cover, and tonearm.

MFG. LIST \$479.95 CALL FOR BSW PRICE

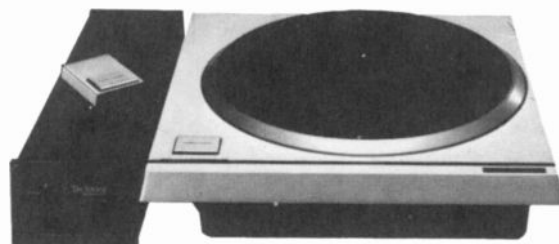

MODEL SP10 MKIIA
3-SPEED TURNTABLE

For professionals who demand the finest, may we recommend the rock-solid SP10 MKIIA? Amazingly fast start-up time... 0.25 seconds for 33¹/₃. Very little wow, flutter, and rumble are exhibited. Separate power supply keeps hum and other interference out of other turntable circuitry. Optional base and tonearm required for operation.

MFG. LIST \$1,399.95 CALL FOR BSW PRICE



MODEL PROBASEII/PROBASEIII
TURNTABLE BASES

Here is a cost effective way to house Technics' SP-25, SP-15, or SP10 turntables. Probases are 1 1/2" sound absorbing particle board with durable black formica overlay. Heavy duty isolation feet have been custom designed for Probases to stop feedback and countertop vibration from being transmitted through turntable. Probases are harmonically balanced for turntable and tonearm to virtually eliminate all transient vibrations going through the system, achieving outstanding sonic quality from your turntable. Nothing on the market is finer, regardless of price.

For an extra charge, your Probases can be custom drilled for the tonearm of your choice. To save even more, BSW can package the tonearm, base, and turntable at a special price. Call us for details.

PROBASEII	BSW PRICE \$129.95
PROBASEIII	BSW PRICE \$199.00
TONEARM DRILLING FEE	\$6.00

In a hurry? Why not have your shipment Federal Expressed. BSW offers low rates on rush shipments.



Henry Engineering



MODEL UTC TURNTABLE CONTROLLER

The Universal Turntable Controller is a control interface device that allows full remote control of popular direct-drive turntables. The "UTC" easily connects to the turntable with just three wires, and provides CMOS/contact closure compatible outputs for separate start and stop switches, plus run and stop tally lamps. The turntable's own start/stop switch can still be used for cueing records, and the UTC always stays in sync with the turntable. One UTC will control two turntables.

MFG. LIST \$195.00 CALL FOR BSW PRICE



MODEL SYNCHROSTART TURNTABLE SYNCHRONIZER

Synchrostart is a unique audio production device that offers two timesaving refinements to the quality conscious broadcast facility. Synchrostart is a turntable-recorder synchronizer with automatic turntable start-muting. It has two primary functions when used with a turntable and cartridge recorder: (A) It eliminates "cue burn", record surface noise, and accidental turntable "wow-in" and (B) takes the guesswork out of dubbing records to tape cartridge. Synchrostart mutes turntable audio during disc start-up, so that all noise preceding the start of audio is squelched. The audio is "ramped-up" smoothly; a disc may be cued within audio permitting efficient "real time editing" of musical content. Synchrostart also provides a synchronized output to start a cartridge recorder at the exact moment the beginning of disc audio is beneath the playback stylus. Carts are consistently "tight" with one-button ease. The unit is fully automatic needing no user adjustment once installed.

MFG. LIST \$395.00 CALL FOR BSW PRICE

RUSSCO



MODEL MARK V 2-SPEED TURNTABLE

Mark V delivers heavy-duty quality at a reasonable price. This precision turntable gives you extremely quick starts: only 2 inches of back-cue at 33RPM, and its deluxe isolated belt rim drive makes it quiet. Speeds are variable by 10% and a bright LED readout show the actual platter speed. Look at these unique features and great specs: Extra heavy cast aluminum platter with built-in 45 adapter; low profile design; detachable tone arm plate; remote stop/start.

MFG. LIST \$720.00 CALL FOR BSW PRICE

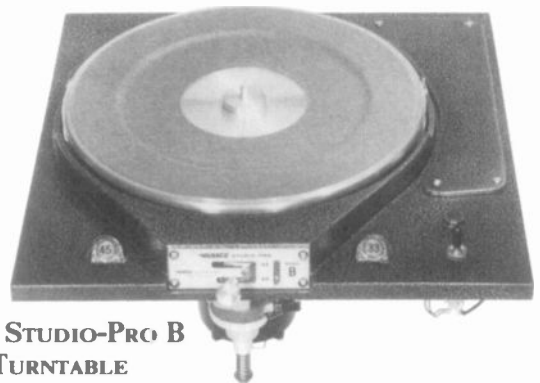

MODEL STUDIO-PRO B SPEED TURNTABLE

Features:

- Precision engineered for quiet, dependable operation
- Solid cast aluminum chassis and turntable
- Illuminated speed indicators
- Rim drive offers fast start-up
- Detachable tonearm mounting plate

MFG. LIST \$499.00 CALL FOR BSW PRICE

BE



MODEL QRK-12C 3-SPEED TURNTABLE

Features:

- Instant start, full speed in less than 1/16 revolution
- Rugged construction, only 3 moving parts
- Stereo rumble less than 48 dB (exceeds NAB standards)

MFG. LIST \$415.00 CALL FOR BSW PRICE
DRILLING FEE (Specify tonearm) \$15.00

SHOWN WITH OPTIONAL
TONEARM



RainWise

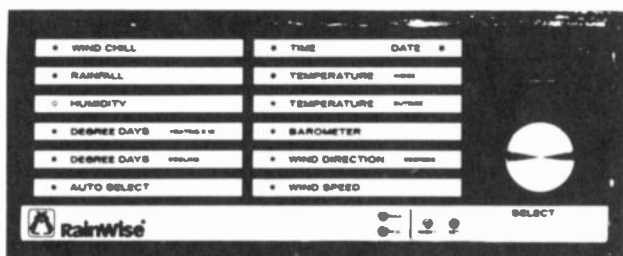

	Windchill Choice of readout in F° or C°		Time 12 hour format Date Month and Day (24 hour format for max min)
	Rainfall Measures in 01 of an inch Provides a cumulative recall		Inside Temperature Choice of readout in F° or C°
	Relative Humidity Shown in percent		Outside Temperature Max min for selected period of time Choice of readout in F° or C°
	Degree Days Heating, X10		Barometric Pressure In inches of mercury Flashing indicates falling Has max min recall *
	Degree Days Cooling		Wind Direction Display in 10° increments of 360° compass rose
	Auto Select Provides 4 second readout of each function in sequence		Windspeed With maximum gust Choice of scales MPH KPH Knots

Outside Temperature is shown *Readout in Millibars available by special order

THE DIGITAL WEATHERSTATION™ ...THE ULTIMATE IN WEATHER INFORMATION

MODEL WS1000 DIGITAL WEATHERSTATION™

Engineered for precision and trouble-free operation, this computer age WeatherStation™ monitors nine different weather phenomena. The station provides digital readout for time, indoor and outdoor temperature, barometric pressure, wind direction, wind speed, wind chill, rainfall and accumulates degree day heating and degree day cooling throughout the year. Maximums and minimums are provided for any desired period to the nearest hour, day, and month. The unit is easy to read and operate. A red light indicates the function chosen by the selector knob, and the value is displayed in bright .8" LED numerals. An auto select position displays each function in sequence for four second intervals.

The unit measures 7" high, 17½" long, 1½" deep, and may be mounted without cutting a hole in the wall. The attractive black and brushed aluminum faceplate is complimented by the genuine walnut frame. The unit operates on safe low voltage from a power supply that plugs into a standard AC receptacle. An optional battery pack prevents loss of memory data in the event of a power failure.

MFG. LIST \$1,068.00 CALL FOR BSW PRICE
COMPUTER COMPATIBLE MODELS AVAILABLE

COMPUTEMP 5



MODEL COMPUTEMP 5 TIME & TEMPERATURE MONITOR

Features:

- Accurately monitors outdoor and indoor temperatures and time of day
- Temperature alarm alerts to any predetermined setting
- 24-hour memory of daily high and low temperatures and the exact time of the occurrence
- Continually alternating LED display
- Battery back-up system, to retain memory
- Removable temperature sensors
- Optional rotary switch for monitoring up to nine locations
- 30 feet outdoor cable standard (additional lengths available)

BSW PRICE \$89.95

TELTEK

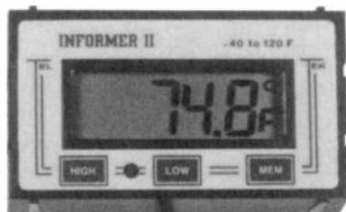

MODEL INFORMER II

For accurate temperature reporting, we recommend the Informer II. LCD display operates on 1-AA battery (replace yearly). Records high and low temp in memory. Very accurate and works in high RF fields. Includes 50 feet of cable for outside probe (additional lengths available).

BSW PRICE \$59.00



PANDUIT

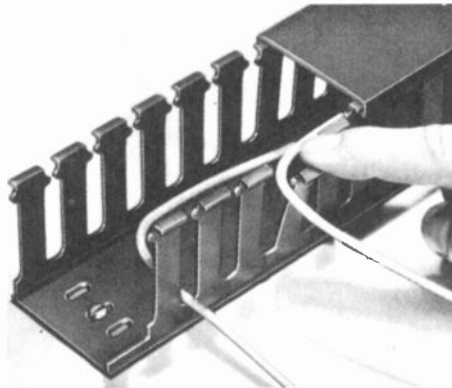

MODEL E2X2LG6/C2LG6
TYPE "E" WIRING DUCT WITH COVER
 Width: 2 inches, Height: 2 inches, Length: 6 feet.
 BSW PRICE\$22.95



MODEL 291
ALL PURPOSE WIRE
 Twisted pair - 22 AWG - stranded tinned copper - aluminum foil shield with 24 AWG tinned copper. Drain wire. 1000' reels. Your choice of colors: red, blue and grey. Other multi-pair wire available from BSW. Call us for your wiring solution.
 BSW PRICE\$82.20

Customer Service

BSW's "after the sale" support is second to no one. Your complete satisfaction is our only goal and we pay for the call.

Toll Free
1-800-426-8434



OUR MOST POPULAR KIT!

MODEL RFA-4024 (30 PCS)
UNIDAPT® UNIVERSAL ADAPTER KIT
 Mix and match any male or female adapter section with any other SMA, N, UHF, BNC, TNC, or mini UHF section. Make any custom adapter you can dream up.
The Universal Adapter Is The Key
 Each Unidapt filter has a common connector end, and a universal adapter end. You simply choose the two common connector ends you need, and screw them together with the universal adapter. It's so easy — that's why technicians love it!
 BSW PRICE\$124.95



MODEL RFA-4059A
COAXIAL SIGNAL SAMPLER
 Now you can test for RF power failure or inject signal for noise measurements in transmitter output circuits without dismantling the line! This N male to N female thru-line coax section is inductively coupled to an adjustable BNC female port. This BNC fitting will supply between 20-80 dB of attenuated signal (depending on frequency). Ideal for signal generators, tap offs, modulation meters, or RF millivoltmeters. Male - female connectors can be disconnected — use up to 6 different connectors.
 BSW PRICE\$45.00



DIELECTRIC

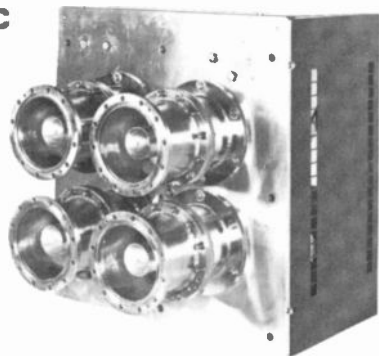

**80 SERIES HIGH POWERED
MOTORIZED SWITCHES**

**MODEL 80 SERIES
HIGH POWER MOTORIZED SWITCHES**

The 80 series of motorized 4 port* cold break coaxial switches is a U-link type (with silver plated contacts) capable of high isolation and high power handling. Your choice of 4¹/₁₆" , 6¹/₈" , and 8³/₁₆" .

Switch position is indicated with a rotating arrow and with auxiliary switches. The auxiliary switches are for readout and interlocking circuits. In the closing mode, the interlock switches do not activate and are ready to accept full power. In the opening mode, the interlock switches open prior to the RF contacts to prevent the breaking of the RF contacts while under power.

Manual operation is provided for through the use of a hand lever. Terminations are EIA fixed flanges with non-removable inner conductors.

**For SPDT applications, one port is not used.*

BSW OFFERS THE COMPLETE DIELECTRIC LINE. CALL YOUR BSW REPRESENTATIVE FOR DETAILS. 1-800-426-8434

Cablewave Systems

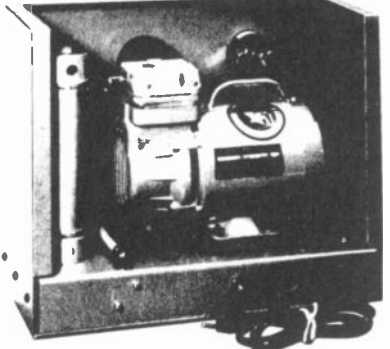

**MODEL APD-20
AUTOMATIC PRESSURIZATION DEHYDRATOR**

The APD-20 Automatic Pressurization Dehydrator is designed for reliable pressurization of elliptical waveguide, coaxial cable, waveguide, and rigid line systems. The dehydrator utilizes the pressure swing absorption drying system with completely automatic operation eliminating the need for replacement or manual reactivation of the desiccant.

MFG. LIST \$1,470.00 CALL FOR BSW PRICE
BSW HANDLES THE COMPLETE CABLEWAVE LINE. CALL US TOLL FREE FOR ALL YOUR CABLEWAVE REQUIREMENTS. 1-800-426-8434

**MPM
INDUSTRIES**



**MODEL JC3
JUMPER CABLE**

3 foot RG8U jumper cable. N male to N male connectors. Custom lengths available.

BSW PRICE\$12.17

ANDREW



LDF4-50A

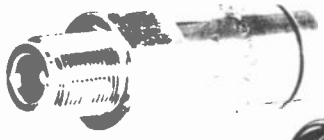

L44N

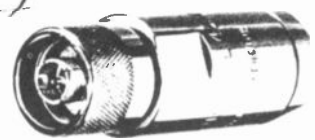

L44W

**MODEL LDF4-50A
HELIAX® COAXIAL CABLE**

These low loss Heliax foam-dielectric cables provide a combination of strength and efficiency not available in other cables. Applications include STL's, RPU and lower power transmitter. 1⁵/₈" , 7⁸/₈" , and 1²/₂" Foam Dielectric. Prices upon application.

MODEL LDF4-50A MFG. LIST \$2.15 per ft.

MODEL L44N (female connector) MFG. LIST \$28.80

MODEL L44W (male connector) MFG. LIST \$28.80

BSW IS A FULL LINE DISTRIBUTOR FOR ANDREW AND CABLEWAVE PRODUCTS. CALL US TOLL FREE FOR YOUR REQUIREMENTS.

*BSW's experienced sales staff is dedicated to meeting the needs of today's broadcasters.
Call toll free 1-800-426-8434
or Fax 206-565-8114*

Index Products By Brand

BRAND	PAGE	BRAND	PAGE	BRAND	PAGE
ABCO	86	GARNER	55	RD SYSTEMS	64
ADC	82, 83	GENTNER	115	REBUILDS	29
AIWA	38	3, 6, 21, 53, 83, 84, 107, 111-113,	115	REVOX	96, 97
AKG	57, 65	GEODISC	72	RF INDUSTRIES	127
ALC	100	GOLDLINE	118	RODCO	126
AMBER	117	GORMAN REDLICH	78	ROHN	119
AMPEX	91	GRAPHIC EXPRESS	90	RSC	91
ANDREW	128	HALONCO	71	RUSSCO	3, 49, 53, 123, 125
APIEX	3, 6, 25	HENRY ENGINEERING	125	SAMSON	66
ARISTOCART	86	3, 6, 69, 114,	125	SCALA	9, 10
ARRAKIS	42, 43, 84	IGM	26	SCI	77
ART	20, 21	INFORMATION DESIGN	86	SCOTCH	28, 72, 91
ATI	4, 8, 23, 45, 74	INNOVATIVE TECHNOLOGY	77	SEIKO	115
ATLAS	35	INTERALIA	114	SENNHEISER	56, 58, 60, 61
AUDI-CORD	35	ITC	33	SENTRY SYSTEMS	26, 75
AUDIODIGITAL	18	JAMPRO	11	SETH THOMAS	116
AUDIOLAB	55, 115	JBL	20, 99	SHIVELY LABS	10
AUDIOPAK	28, 91	KINTRONIC LABS	76	SHURE	2, 5, 8, 54, 58-60, 62, 67, 85, 111
AUDIOSOURCE	73	KOSS	56	SONAR	55
AUDIOTECHNICA	60, 64, 67, 85, 123	LARSEN	10	SONEX	98
AUDITRONICS	46	LEXICON	17	SONY	38, 61, 91, 92
AURATONE	100	LITTLITE	70	SOUND AMERICA	111
AUTOGRAM	44, 45	LOFTECH	118	SOUNDCRAFTSMEN	122
BECKMAN	119	LPB	47	SOUNDFORMS	98
BELAR	79	LUXO	68, 73	SOUNDOLIER	89
BENCHMARK	3, 57	MARANTZ	37	STANTON	8, 85
BEYER	57, 58, 65	MARK ANTENNA	9	STARMATE	71
BG ENGINEERING	35	MARTI	102	STL	72
BGW	7	MICROTRAK	123	STUDER REVOX	97
BIRD	118	MIDDLE ATLANTIC	89	SYMETRIX	2, 5, 17, 18, 108, 118
BROADCAST DEVICES	76	MIWLTRONICS	114	TABER/AVSC	55
BROADCAST ELECTRONICS	30-32, 48, 69, 120, 125	MODULATION SCIENCES	19, 74, 80, 120	TAPECASTER	35
BROADCAST TOOLS	75	MOSELEY	103-105	TASCAM	2, 3, 36, 37, 40, 51, 89, 94-96
BSW	27, 36, 59	MPM	128	TEAC	39, 94
BTC	75	MRL	12, 72	TECHNICS	39, 41, 124
BURK TECHNOLOGY	107	MTS	78	TELEVISION TECHNOLOGY	77, 121
CABLEWAVE	11, 128	MW PERSONS	26	TELEX	58, 67
CAIG	73	NEUMANN	64	TELFAX	52
CARVER	122	NEUTRIK	59	TELTEK	126
CASIO	92	NORTRONICS	27, 55, 72	TFT	78-80, 105, 106
CATEL	77	NOTEWORTHY	85	360 SYSTEMS	84
CBS	72	NUMARK	49	TITUS TECH LABS	70, 81
COMREX	53, 109, 110	OMNIMOUNT	101	TMD	11
CONEX	8, 75, 84	ORBAN	12-14	TWR	119
CRL	15, 16, 23	OTARI	32, 93, 94	UREI	20, 23, 47
CROWN	7, 61	PANASONIC	38, 40, 92	VALENTINO	71
DBX	22	PANDUIT	127	VALLEY INTERNATIONAL	20, 24
DENON	41	PIVOTELLI	101	VEGA	66
DIC DIGITAL	91	POTOMAC	117	VIKRON	72
DIELECTRIC	128	PROBASE	124	WEST PENN	127
DIGITECH	19	PROBOOM	68	WHEELOCK	71
DISCWASHER	85	PROCABLE	60	WHIRLWIND	117
DYNAMAX	34	PROFOAM	98	XCELITE	117
EDCOR	2	PROLITE	73, 81	XEDIT	27
ELECTRO IMPULSE	76	PRORAX	87-89	YAMAHA	16, 49, 100
ELECTRO VOICE	52, 60, 63, 99	PROTEC	123	ZERCOM	52
ENBERG	74	QEI	80, 120		
ESE	115	QSC	7		
EVENTIDE	12	RADIO DESIGN LABS	70, 74		
FIDELIPAC	27, 29, 34, 55, 81, 86	RADIX	5, 8, 57, 113, 115		
FLUKE	119	RAINWISE	126		
FOSTEX	27, 52, 56, 99, 118	RAMSA	5, 40, 50, 92, 100		
FOUR DESIGN	89	RANE	2		

Credits to:

Denise Knudson
Illustrator/Graphic Designer

Kathryn C. Whitacre
Calligrapher

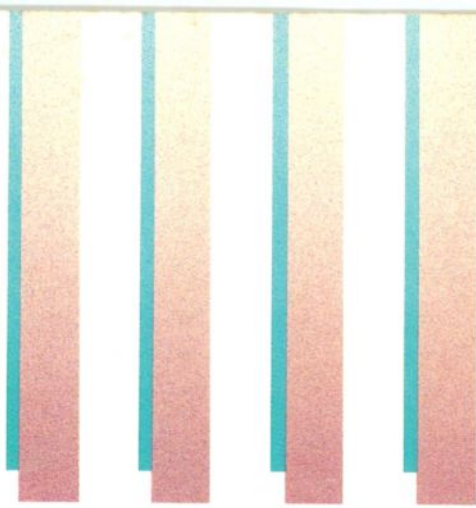

BSW[®]

BROADCAST SUPPLY WEST

America's Full-Time Broadcast Supplier

BSW • 7012 27th ST. WEST
TACOMA, WASHINGTON 98466

BULK RATE
US. POSTAGE
PAID
TACOMA, WA
PERMIT #275

TIME VALUE

ROUTE TO:
GENERAL MANAGER
PROGRAM DIRECTOR
NEWS DIRECTOR