

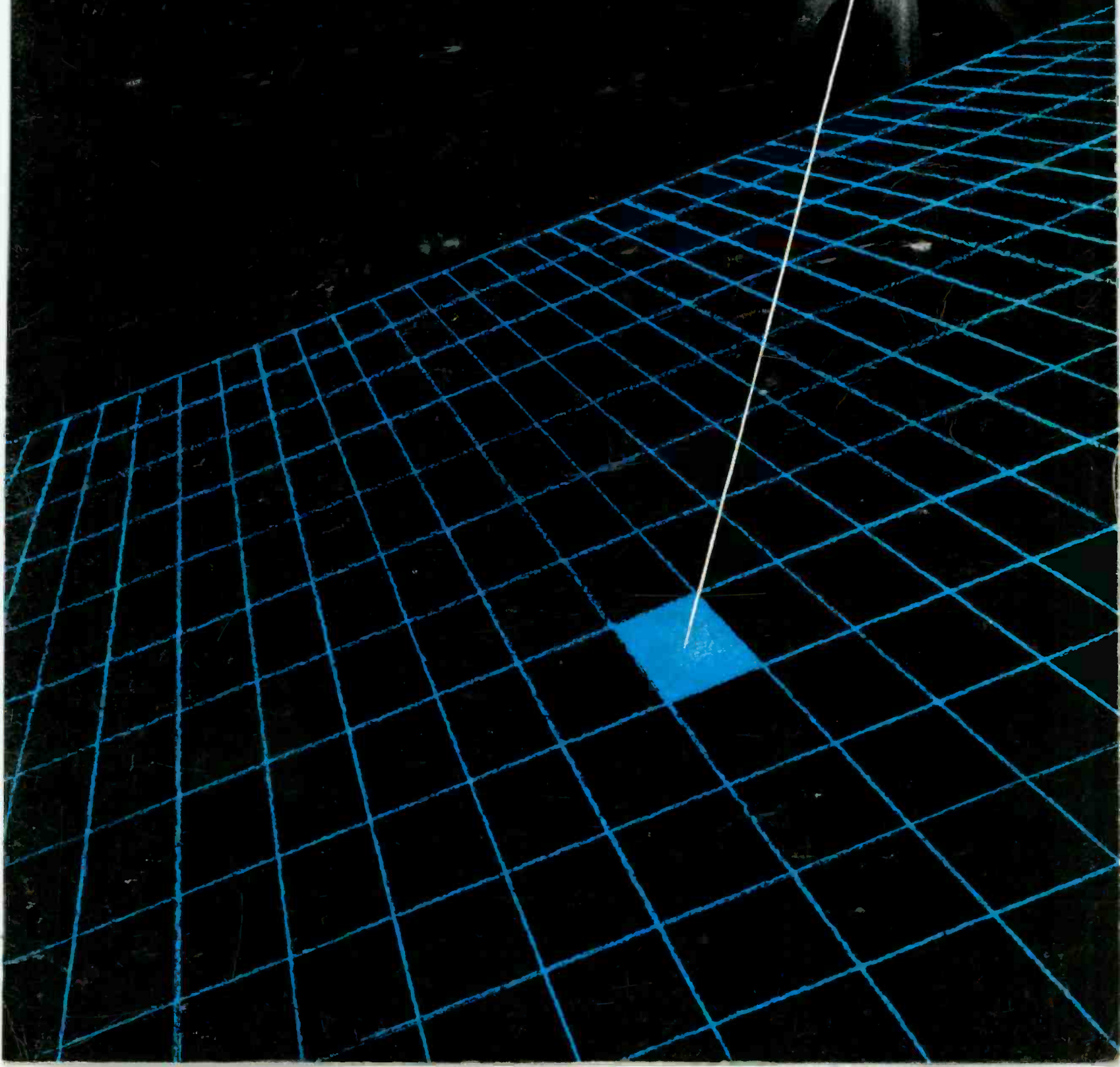

**Broadcast Supply West**

**86**



# **TACOMA - TEHACHAPI - TALLAHASSEE**

## **And All Points Between**

**Broadcast Supply West** is wherever you are - We're as close as your telephone - As a matter of fact, the service from our million dollar inventory is so spontaneous many broadcasters say, "The service is so good we think you're right next door."

**Broadcast Supply West** maintains the most efficient and economical distribution system in the broadcast industry - **all under one roof** - for economy - and computerized order entry and inventory control - for efficiency - Low overhead and efficiency mean **lower operating costs** - and these savings are passed along to you in the form of **lower prices**.

**Broadcast Supply West** is an early pioneer in telemarketing. As a result we have one of the most sophisticated telephone systems in the industry. Regardless of where you are in the United States including Alaska and Hawaii along with Puerto Rico, the Virgin Islands and Canada you only need to know one toll free telephone number to reach **BSW**. For product or ordering information call: **1-800-426-8434**.

**Broadcast Supply West** is your kind of company. We're right next door or as close as your telephone, and rest assured that all twenty five **BSW** employees are anxious to provide the service we know you deserve.

Respectfully,

The Management and Employees of  
**Broadcast Supply West**



- **Now Open Saturday**
- **Open 12 Hours Daily In All Time Zones**
- **Package Deals And Leasing**
- **10 Watts Lines To Serve You And Only One Number To Remember**

**1-800-426-8434**



Terms: 2% - 20 Days Net 30 On Approved Credit  
FOB: Point of Origin



VISA & MASTERCARD ACCEPTED



ITEM	PAGE
AM FM RECEIVERS.....	100
AMPLIFIERS.....	2 - 8
DISTRIBUTION.....	6 - 8
HEADPHONE.....	2
LINE.....	2, 3
MICROPHONE.....	2, 3
MONITOR/POWER.....	4 - 6
PREAMPS-PHONO.....	8, 9
ANTENNAS & ACCESSORIES.....	10, 11
AUDIO PROCESSING.....	12 - 23
COMPRESSOR/LIMITERS.....	13, 15, 17, 18, 20, 22, 23
DELAY UNITS.....	16, 19
EQUALIZERS.....	13, 15, 16, 17, 22
HARMONIZERS.....	19
NOISE GATES.....	15, 18, 22
NOISE REDUCTION.....	18, 21, 22
REVERBS.....	13, 15, 16, 18, 19, 21
STEREO GENERATORS.....	12 - 14
STEREO SYNTHESIZERS.....	13, 21
AUDIO SIGNAL MONITORS.....	65
BULK ERASERS.....	24, 33
CABLE.....	52, 53
CARTRIDGES, TAPE.....	26 - 28
CARTRIDGE ACCESSORIES.....	24 - 26, 28
ALIGNMENT AIDS.....	25, 26
DEGAUSSERS/ERASERS.....	24, 33
LABELS.....	25
RACKS.....	68 - 70
REBUILDS.....	28
RELOAD KITS.....	28
SPLICE FINDERS.....	33
TAPE.....	73
WINDERS.....	25
CARTRIDGE MACHINES.....	28 - 34
CLEANING AIDS.....	25
TIMERS.....	34
CASES.....	60
CASSETTE DECKS.....	34 - 37
CASSETTE TAPES.....	27
CLEANERS HEAD/SWABS.....	25
CLOCKS & TIMERS.....	34, 91, 104
COMPACT DISC PLAYER & ACCESSORIES.....	37
RACKS.....	69
COMPRESSOR/LIMITERS.....	13, 15, 17, 18, 20, 22, 23
CONSOLES.....	38 - 48
LABELS.....	38
REMOTE.....	44, 46 - 48
COPY HOLDERS.....	64
DELAY LINES.....	16, 19
EBS MONITORS ENCODER/DECODER.....	66
EQUALIZERS.....	13, 15 - 17, 22
ERASERS.....	24, 33
EXCITERS.....	23, 101, 103
FURNITURE, STUDIO.....	71, 72
GENERATORS, POWER.....	61
GENERATORS, TONE.....	66, 92, 93
HARMONIZERS.....	19
HEADPHONES/HEADSETS.....	50, 51
AMPLIFIERS.....	2
HEADS/RECORDING.....	26
CLEANERS.....	25
LAPPING.....	25
JACKS/PANELS.....	80, 81
LIGHT BULBS.....	60
LIGHTS.....	64, 65
MARKING PENCILS.....	25
MICROPHONES.....	53 - 58
ACCESSORIES.....	52, 53, 59
AMPLIFIERS.....	3
BOOMS.....	59
CABLE ASSEMBLIES.....	52, 53
MIXERS.....	49
SHOCK MOUNTS.....	52, 56
STAND CLAMPS.....	52, 56
STANDS.....	59
WINDSCREENS.....	52, 53
WIRELESS.....	58
MISCELLANEOUS.....	60 - 66

ITEM	PAGE
COPY HOLDERS.....	64
EBS ENCODER, DECODER.....	66
ICE KRACKER.....	10
LIVE ASSIST CONTROLLER.....	62
ON AIR LIGHTS.....	64
SOUND EFFECTS, RECORDS.....	62
TONE SENSORS, GENERATORS.....	66
TOOL KITS.....	62
UTILITY LIGHTS.....	64, 65
VU METER.....	61
WEATHER, MONITOR.....	66, 104
WIRE.....	66
MONITORS, MODULATION.....	67
NOISE REDUCTION SYSTEMS.....	18, 21, 22, 65
ON AIR LIGHTS.....	64
PATCH BAYS.....	80, 81
PATCHCORDS/JACK PANELS.....	80, 81
PHONO CARTRIDGES & STYLI.....	99
PREAMPLIFIERS, TURNTABLE.....	8, 9
RACKS & FURNITURE.....	68 - 70
CARTRIDGE.....	68 - 70
COMPACT DISC.....	69
EQUIPMENT.....	68, 71
FURNITURE.....	71, 72
RAIN GAUGE.....	104
RECORD CLEANERS.....	99
RECORD JACKETS.....	99
RECORDING TAPE & ACCESSORIES.....	73
REEL TO REEL MACHINES.....	75 - 79
ACCESSORIES.....	65
REELS & BOXES (EMPTY).....	73
REMOTE CONSOLES.....	44, 46 - 48
REMOTE CONTROL SYSTEM.....	84 - 86
REMOTE PICK-UP SYSTEM.....	84, 86, 87
REVERB UNITS.....	13, 15, 16, 18, 19, 21
ROUTING SWITCHERS.....	80
SCA GENERATOR.....	20, 85, 101
SENSOR, TONE.....	66
SOUND EFFECTS, RECORDS.....	62
SOUND PROOFING.....	68
SPEAKERS.....	82, 83
MOUNTING BRACKETS.....	83
POWERED.....	83
SPLICE FINDERS.....	33
SPLICING BLOCKS.....	25
SPLICING/LEADER/TAPE.....	73
STEREO GENERATORS.....	12, 14
STEREO SYNTHESIZERS.....	13, 21
STUDIO TRANSMITTER LINK EQ.....	84 - 86
ANTENNA.....	10, 11
REMOTE CONTROL.....	84 - 86
REMOTE PICK-UP.....	84, 86, 87
STYLI, PHONO.....	99
SUBCARRIER/GENERATOR/MODULATOR.....	85, 101
SURGE PROTECTOR.....	63
TELEPHONE EQUIPMENT.....	88 - 90
TEST EQUIPMENT.....	92, 93
TEST RECORDS.....	26
TIMERS, CLOCKS.....	34, 91, 104
TONE ARMS.....	94
TONE SENSORS, GENERATORS.....	66
TOOLS.....	62
TRANSFORMERS.....	52
TRANSLATORS.....	101
TRANSMITTERS.....	85, 86, 100 - 103
EXCITERS.....	101, 103
TUNERS.....	100
TURNTABLES.....	95 - 97
ACCESSORIES.....	94 - 98
BASES.....	96 - 98
TURNTABLE CARTRIDGES & PHONO STYLI.....	99
ACCESSORIES.....	97, 99
TWO-WAY RADIO.....	81
ANTENNAS.....	10
UTILITY LIGHTS.....	64, 65
WEATHER INSTRUMENTS.....	66, 104
WIRE.....	66
WIRING DUCT.....	62



# Amplifiers: Headphone - Line



## HC 6 Six Channel Headphone Amplifier

- Six stereo headphone amplifiers in a single rack chassis
- Main stereo inputs drive all six amps through individual volume controls
- Each headphone amp also has its own separate input which independently by-passes the main stereo input

Mfg. list \$349.00.....CALL FOR BSW PRICE



FOR PROFESSIONAL USE ONLY

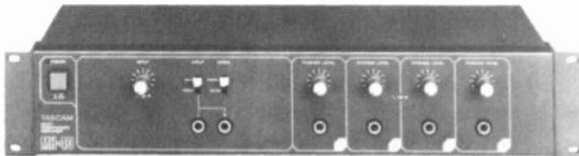

## Model MH-40 4 Channel Headphone Amplifier

The MR-40 accepts low or high line level mono or stereo input, which feed it to four independently adjustable headphone outputs. The MR-40 provides increased monitoring capacity - with practically unlimited freedom of expansion and figure configuration.

Mfg. list \$275.00.....CALL FOR BSW PRICE



## Model HA-400 4 Channel Headphone Amplifier

Four independent stereo amplifiers, each with its own volume control. Provides high fidelity reproduction, far surpassing all but the most expensive systems.

Mfg. list \$247.00.....CALL FOR BSW PRICE

## Portable Mic To Line Amplifier



### FP-11

The FP-11 is a portable, 1-input, 1-output microphone-to-line level amplifier designed for field production. It is ideal for use where long lines must be driven at higher than microphone or auxiliary levels. It can also be used to interface between equipment requiring different signal levels.

The balanced, locking XLR input and output provide for excellent rejection of hum and RF interference. A switchable peak limiter prevents output overload distortion. Additional features include a peak/limiter LED indicator, aux level mini-phone jack input, balanced line-level binding post output, and a removable belt clip. The FP-11 is powered by one standard 9V battery.

Mfg. list \$175.00.....CALL FOR BSW PRICE



## Headphone Bridging Amplifier

### Model FP-12

The FP-12 is a 1-input, 2-output headphone bridging amplifier designed to provide headphone feeds from any type of audio input. The FP-12 can be used for a wide variety of applications such as multiple headphone feeds, audio line troubleshooting, extra power for existing headphone circuits. The FP-12 features two XLR in/out connectors and two 1/4 inch in/out jacks. Other features include a Mic/Line input switch, Hi Z/Lo Z headphones switch, headphone level control, and removable belt clip. The FP-12 is powered by one standard 9V battery.

Mfg. list 160.00.....CALL FOR BSW PRICE

# Amplifiers: - Line & Microphone



## MATCHBOX

By Henry Engineering



The Matchbox is the ideal, inexpensive way to correctly interconnect "HI FI" or semi-pro (IHF Standard equipment with professional studio gear). The Matchbox is a bidirectional unit with four independent amplifiers providing full stereo input and output interface.

Mfg. list \$195.00 . . . . . **CALL FOR BSW PRICE**

## ATI

*Disc-Patcher*

**Model DP-100-1**  
PRO ↔ IHF



**The Disc-Patcher™ DP100**

A uni-directional stereo interface for Playback Only applications. It is designed specifically to convert the unbalanced IHF outputs of Digital Compact Disc Players to transformer balanced and isolated 600 ohm line levels with no compromise or degradation of the superb performance available from the digital audio source. The Disc-Patcher™ is equally at home on a newsroom desk to interconnect field ENG cassette recorders into broadcast systems for dubbing.

Mfg. list \$189.00 . . . . . **CALL FOR BSW PRICE**  
Rack Mt. Panel . . . . . **BSW PRICE \$22.00**

## RUSSCO

**Model MLD-22**  
**Mic-Line Amplifier**  
**Multi Purpose Preamp**

- Mono/stereo preamp
- Line to line booster amplifier
- Reel to reel to telephone line
- Unattended remote equipment
- Combine mic or line into single line out

Mfg. list \$225.00 . . . . . **CALL FOR BSW PRICE**



## ATI



**Model L-1000**  
**Precision Dual Line Amplifier**

- High input overload capability: ± 24dBm bridging
- Low noise: - 107dBm equivalent input noise (20kHz bandwidth)
- Low distortion  
.2% maximum (transformer output), .05% maximum (direct outputs)

L-1000-1 Dual, Transformer Outputs . . . . . Mfg. list \$315.00

L-1000-2 Dual, Balanced Differential Outputs . . Mfg. list \$315.00

L-1000-3 Dual, Single Ended (Unbal.) Outputs . . Mfg. list \$295.00

**CALL FOR BSW PRICE**

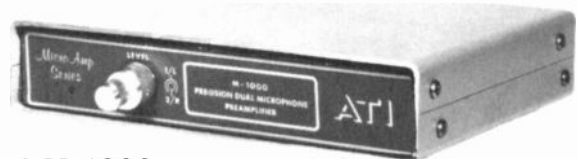

**Model M-1000**  
**Precision Dual Microphone Amplifier**

- Transformer coupled inputs incorporate full electrostatic and magnetic shielding
- XLR type input connectors
- Low noise: - 124dBm equivalent input noise (20kHz bandwidth)
- Flat response: ± 25dB, 50 to 20,000Hz

M-1000-1 Dual, Transformer Outputs . . . . . Mfg. list \$345.00

M-1000-2 Dual, Balanced Differential Outputs . . Mfg. list \$345.00

M-1000-3 Dual, Single Ended (Unbal.) Outputs . . Mfg. list \$325.00

**CALL FOR BSW PRICE**

## TASCAM

**FOR PROFESSIONAL USE ONLY**



**LA-40**  
**Line Amplifier/Impedance Converter**

The Tascam LA-40 is the perfect one rack space solution to the problem of mismatched line levels or impedences. The LA-40 is a compact 4 channel unit that establishes instant compatibility between Tascam or similar - 10 dbv unbalanced inputs and outputs and almost all other equipment. Compatible levels, compatible impedences and balanced/unbalanced operation.

Mfg. list \$360.00 . . . . . **CALL FOR BSW PRICE**



# Amplifiers - Power



### Model D75 Stereo Amplifier

Broadcasting's most popular amplifier. 35 watts per channel RMS with harmonic distortion only .05%. The D75 features active balanced inputs and XLR connectors. 3 Year warranty.

Mfg. list \$524.00 . . . . . **CALL FOR BSW PRICE**



### Model D150A2 Stereo Amplifier

Broadcasters, recording studio, churches and sports arenas all over the world have recognized Crown's D150A as a standard of audio excellence. 80 watts per channel RMS into 8.

Mfg. list \$729.00 . . . . . **CALL FOR BSW PRICE**



### Micro-Tech 1000 Stereo Amplifier 280 Watts Per Channel Power Output

The Micro-Tech™ 1000 - the most advanced amplifier design of the decade. Never before has a single package offered the power and flexibility of the newly developed Micro-Tech.

**Call Your BSW REP. For Complete Details**

Mfg. list \$995.00 . . . . . **CALL FOR BSW PRICE**

## BGW NEW 85 SERIES



### Model 85 Stereo Amplifier

- Front panel mounted magnetic circuit breaker
- Power output 35 watts per channel or 90 watts mono (8 ohms)
- Toroidal mains transformer
- Front panel headphone jacks
- Rear panel stereo/mono switch

Mfg. list \$449.00 . . . . . **CALL FOR BSW PRICE**



### Model 150 Stereo Amplifier

- 50 watts per channel
- .05% THD 8 ohms
- XLR and 1/4 inch input connectors

Mfg. list \$699.00 . . . . . **CALL FOR BSW PRICE**

## EDCOR



### Model GLA-10 Mono Amplifier

The perfect utility amplifier! Single channel with 25V and 70V transformer output. 10 watts of power and 2 inputs for mic or line.

Mfg. list \$180.00 . . . . . **CALL FOR BSW PRICE**



## Symetrix

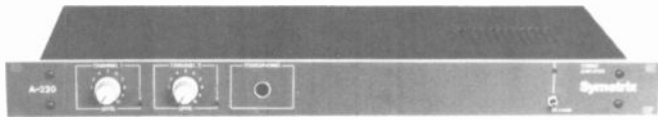

### 20 Watts Per Channel

#### Model A-220 Stereo Amplifier

High performance, low power stereo amplifier. The A-220 will develop better than 20 watts per channel into 8 ohms with full power distortion of less than .02% @ 1kHz. Typical application includes the powering of headphone distribution boxes and small monitor speakers.

Mfg. list \$289.00 . . . . . BSW PRICE \$225.95



### PRICED FOR ACTION

ALL PURPOSE AUDIO AMPLIFIERS  
RUSSCO-RUGGED CONSTRUCTION

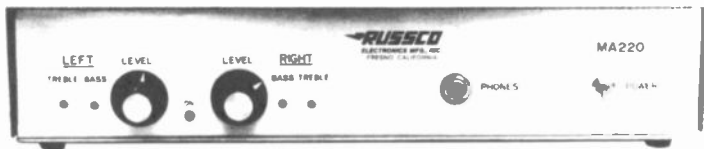

#### Model MA220

#### 20 Watt Stereo Monitor Amplifier

Now Russco brings you the MA220 Stereo Monitor Amplifier with special features that highlight broadcaster convenience and versatility in a trim package that's moderate in price and maximum quality. The MA220 gives you separate level and tone controls for each channel. This little 20 watt dandy works great as a high-powered head-set amp or as a moderate power speaker amplifier.

Mfg. list \$367.00 . . . . . BSW PRICE \$359.65

- Dual Channel 25 Watts RMS Each
- Excellent Channel Separation
- All Solid State
- Low Distortion
- Excellent Frequency Response

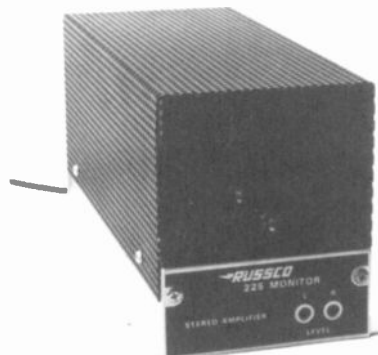

Mfg. list \$279.00 . . . . . BSW PRICE \$273.40

## ATI



#### Model MA-1000-1

#### Precision Stereo Amplifier

- Ideal headphone or small loudspeaker driver for low output consoles, newsroom cart machines, etc.
- 25W Switchable Mono bridged operation
- Complete electronic output protection, impervious to shorts and overloads

Mfg. list \$365.00 . . . . . BSW PRICE \$357.70



## MICRO-TRAK



#### Model 10-P 10 Watt Amplifier

- Fits anywhere
- General purpose amplifier
- Low distortion
- 10 watts per channel.

Mfg. list \$199.50 . . . . . BSW PRICE \$189.50

Rack Mt. Kit . . . . . \$29.95

## TIRED OF BACK ORDERS

## TRY BSW



### Million Dollar In-House Inventory



# Amplifiers: Power - Distribution



## SERIES ONE 100W PER CHANNEL AT 8 OHMS

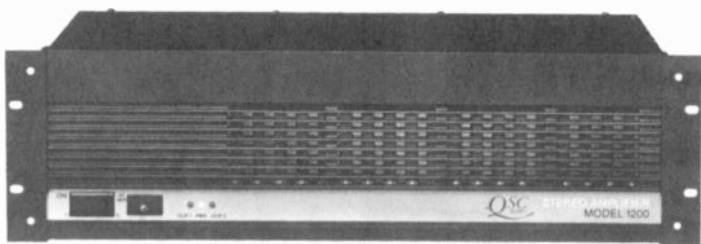

### Model 1200 Stereo Amplifier

- Independent DC and Sub-Audio speaker protection on each channel
- Dual power supplies
- Calibrated gain controls
- Active balanced inputs
- Gold plated octal-socket program switches
- Mono bridging switch
- 1/4" RTS, XLR and barrier input connectors
- 2 year warranty

Mfg. list \$548.00..... **CALL FOR BSW PRICE**



### Model 1080 Stereo Amplifier

The Model 1080 is a moderate power, single rack space amplifier designed for professional and commercial audio applications requiring both high performance and high reliability. The 1080 is loaded with useful features and benefits.

**35 watts per channel at 8 ohms**

Mfg. list \$488.00..... **CALL FOR BSW PRICE**

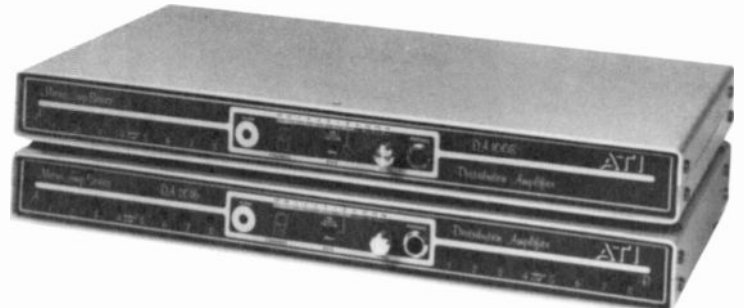

### Model DA1008-1 (1 in, 8 out) Distribution Amplifier

Individual level adjustment for each output - hot molded audio taper controls.

- SCAN monitor system readout shows selected channel for monitoring
- Headphone output with front panel level control
- Rack mount brackets supplied

Mfg. list \$795.00..... **BSW PRICE \$779.00**

### Model DA2016-1 (Dual-2 in, 16 out)

Mfg. list \$1,095.00..... **BSW PRICE \$1,072.95**



## MICRO-TRAK



### Distribution Amplifiers

High performance, balanced, transformer-isolated units with nominal output level of +8dBm and adjustable level controls in a compact, good-looking case.

### Model 7213

A stereo unit with 2-in 3-out design.

Mfg. list \$279.50..... **BSW PRICE \$265.50**

### Model 7116

A 1-in 6-out unit for monaural applications.

Mfg. list \$249.50..... **BSW PRICE \$237.00**



### Model 7216

A 2-in 6-out stereo unit convertible to 1-in 12-out or two 1-in 6-out configurations.

Mfg. list \$459.50..... **BSW PRICE \$436.50**



# Distribution Amplifiers



## RADIO SYSTEMS



**FUNCTIONAL  
SIMPLICITY**

### RSDA-16/RSDA-8 Distribution Amplifier

The RSDA-16 provides 8 stereo or 16 mono, independent audio outputs from one input. The RSDA-8 provides 8 mono outputs. Each output is completely isolated and has an individual level control. A single feed can be routed to multiple locations of varying level requirements and impedance, protecting the integrity of the signal quality through every output.

**RSDA-8**  
Mfg. list \$329.00 . . . . . **BSW PRICE \$295.00**

**RSDA-16**  
Mfg. list \$409.00 . . . . . **BSW PRICE \$365.00**

## ATI



Protect against dangerous paralleled feeds, noisy unbalanced loops, poorly isolated splitters and inaccurate attenuators.

### DISTRIBUTION AMPLIFIERS

Isolate, balance and set levels precisely

- 8 or 16 Balanced +18dBm outputs
- Individual smooth log taper controls
- LED output overdrive indicators
- Parallel inputs for 1x8, 2x8, or 1x16 use
- Short proof outputs
- Triple RFI protection

**DA208 Dual 1x4**  
Mfg. list \$319.00 . . . . . **BSW PRICE \$312.60**

**DA416 Quad 1x4**  
Mfg. list \$469.00 . . . . . **BSW PRICE \$459.60**

## RUSSCO



### DA-2816 Audio Distribution Amplifier

Now you can make your audio system more professionally functional and flexible. The STELLAR DA-2816 gives you simplified routing of multiple audio signals throughout your studio **INEXPENSIVELY**. This dandy distribution amp gives you a total of 16 outputs fed by two balanced line inputs that can be fed by a single audio source or separated and fed by two audio sources. It features two sections of 8 outputs each.

Mfg. list \$440.00 . . . . . **BSW PRICE \$431.20**

## PRIMUS

By Ramko

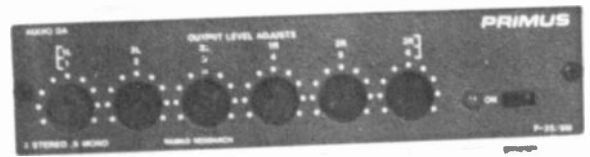

### Model P-3S/6M Audio Distribution Amplifier 1x3 Stereo • 1x6 Mono • Dual 1x3 Mono

- Response through 100kHz
- Practically unmeasurable distortion
- Table top/bracket: Single or dual rack mounting
- Input gain select
- XLR type input and quick disconnect output connectors
- Individual recessed front panel level control
- 3 year warranty

Mfg. list \$254.00 . . . . . **BSW PRICE \$241.30**

Rack Mount Option - \$15.00 Pot & Knob - \$87.00



(Shown with Rack Mount Pot & Knob, V.U. Option)

### Model P-8S/16M Audio Distribution Amplifier 1x8 Stereo • Dual 1x8 Mono • 1x6 Mono

- 17" w x 2" h table top/bracket or 19" w x 1 3/4" h rack mount
- Independent, dual regulated power supplies
- Meter selectable for VU or peak ballistics
- Response flat to 100kHz
- 3 year warranty

Mfg. list \$549.00 . . . . . **BSW PRICE \$521.55**

(OPTIONS NOT INCLUDED)

Rack Mount Option - \$15.00 Pot & Knob Option - \$174.00  
VU Meter Option - \$246.00



# Amplifiers: Distribution - Phono

## SHURE



### Model FP-16 Portable Distribution Amplifier

Shure Model FP-16 is a 1-input, 6-output, distribution amplifier specially designed for field production use and offers features and performance rarely found in other distribution amplifiers. Phantom power is available at the input for use with condenser microphones; and all 6 outputs, as well as the input, are individually switchable to mic-or-line level. In addition, the FP-16 features link input and output jacks for interconnecting several FP-16's or adding external signal processing equipment such as equalizers, compressors or limiters.

Other features include: ruggedness and reliable operation over wide temperature and humidity extremes; light weight and compactness for portable/location use or rack-mountable (with accessory rack mount kit) for studio installations; powered by AC or Built-in battery pack; recessed, screwdriver-adjustable gain controls; and power, normal, and overload LED indicators.

Mfg. list \$350.00.....BSW PRICE \$299.00

## SHURE



### M64 Series Stereo Preamp

The M64 is a compact, professional stereo preamplifier which solves a variety of preamplification and equalization problems. A three-position slide switch selects different equalization depending on the desired application.

In the Phono position, the M64 provides standard RIAA equalization. Using the M64 in this mode, magnetic phono cartridges can operate into auxiliary level inputs, inputs without RIAA equalization or ceramic phono cartridge inputs.

In the Tape position, playback heads on tape recorders are provided with NAB equalization.

In the Flat position, the M64 can be used as a microphone preamplifier or a low-gain buffer amplifier where long cable lengths are necessary.

Mfg. list \$99.00.....BSW PRICE \$84.95

## PRIMUS

By Ramko

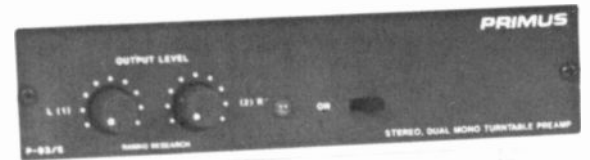

### Model P-93S Phono Preamp

- Lowest noise in the industry
- Dual ground plane, RF beads and extensive bypass caps for complete RF protection
- 300 MV input overhead
- Fast slew-rate I.C.'s for practically unmeasurable TIM & THD
- Ruler flat response
- Balanced 600 ohm outputs
- 3 year warranty

Mfg. list \$277.00.....BSW PRICE \$263.15

## ATI

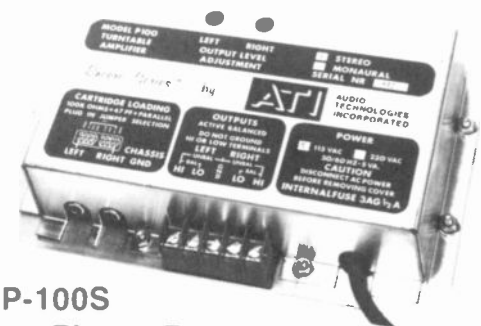

### Model P-100S Precision Phono Preamp

- No compromise audio quality
- Cost effective
- State-of-the-art

BSW PRICE.....\$214.65

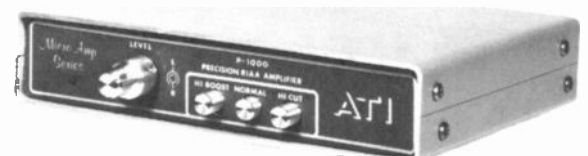

### Model P-1000S Phono Preamp MicroAmp Series

Microamps are available in 3 models: Transformer outputs for high RF environments, balanced differential outputs for maximum output with lowest distortion and widest response. Single ended outputs for lowest cost.

P-1000-1 Transformer.....\$338.00

P-1000-2 Balanced.....\$338.00

P-1000-3 Unbalanced.....\$318.50

# Amplifiers - Phono



## RADIO SYSTEMS



### Model RSPA-1 Phono Preamp *The Preamp That Set The Standards*

Today, with over 2,000 in use, broadcasters have made the PA-1 the sensible choice.

**Real RFI Immunity:**

Time and time again, the PA-1 performs flawlessly in intense RF environments where no other phono pre-amplifier will work.

**Quiet Performance:**

Crosstalk between channels is also so low that the PA-1 makes the perfect dual pre-amp for two channel, mono use.

**Responsive Design:**

Uniformly high-speed circuitry, with response up to the MHz range, insures the unit's capability to reproduce even the fastest music peaks.

Mfg. list \$275.00 . . . . . **BSW PRICE \$247.00**



### Fidelity Pro Phono Preamp

Jammed with value-packed features, these attractive pre-amps include integrated circuits, self-contained power supplies, industrial rated components and a custom-made "Easy-access" enclosure. Mono or Stereo versions are available with balanced or unbalanced output. The FIDELITY-MASTER series offers straight RIAA equalization. The FIDELITY-PRO units feature switchable high and low frequency filters. The balanced output models include highest quality transformers for true line isolation! You'll find the right one for your requirements with Eight Different models in all!

#### **FIDELITY-MASTER                      FIDELITY-PRO**

Unbalanced

**Mono FMMU \$148.60      Mono FPMU \$165.95**  
**Stereo FMSU \$229.65    Stereo FPSU \$247.75**

Balanced

**Mono FMMB \$177.50      Mono FPMB \$197.85**  
**Stereo FMSB \$284.65    Stereo FPSB \$298.00**

## ProAmp



### Model PP220 Stereo Phono Preamp

Engineered for performance and dependability with solid-state plug-in intergrated circuitry. Low noise and inaudible distortion.

**BSW PRICE . . . . . \$169.95**

## Urei



### Model 1122 Phono Preamp

- Precise RIAA/NAB equalization
- Individual high and low frequency
- Equalization trimmers on each channel
- High impedance inputs match almost all magnetic disc reproducers

Mfg. list \$366.00 . . . . . **BSW PRICE \$329.40**

## MICRO-TRAK

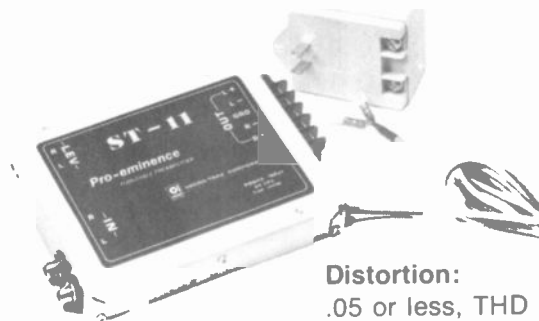

**Distortion:**  
.05 or less, THD and IM.  
**Noise:**  
- 72 db or better, - 122 dB EIN

The Micro-Trak ST-11 PHONO PREAMP is a super high performance unit without frills offering quality at a price thats affordable to every station.

**Model ST11 Stereo . . . . . \$169.50**  
**Model 6410 Mono . . . . . \$170.55**  
**Model 6411 Stereo . . . . . \$218.00**



# Antennas

**SCALA** ELECTRONIC CORPORATION

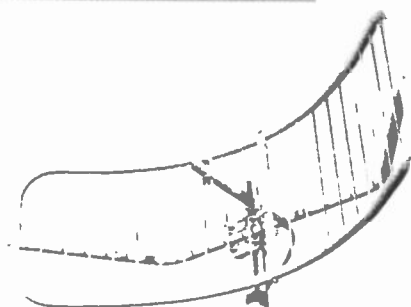

### Model MF-960 Miniflector Antenna

- Aural Broadcast STL
- Telemetry
- Point to point communications
- Vertical polarization for STL

Mfg. list \$300.00.....CALL FOR BSW PRICE

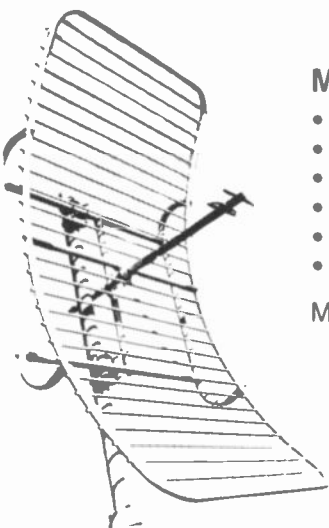

### Model PR-450U Antenna

- UHF-TV reception
- UHF-TV translators
- Telemetry
- CATV systems
- Point to point communications
- Aural broadcast STL systems

Mfg. list.....\$500.00  
CALL FOR BSW PRICE



Full line of

- Micro-wave
- Point to point
- Cellular
- Grid high performance
- Earth station
- Two way

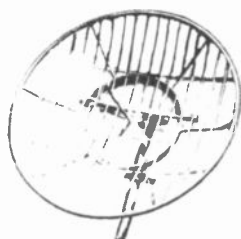

### Grid Parabolic Ringback Antenna

Call for BSW Price

## LARSEN CALL FOR BSW PRICES

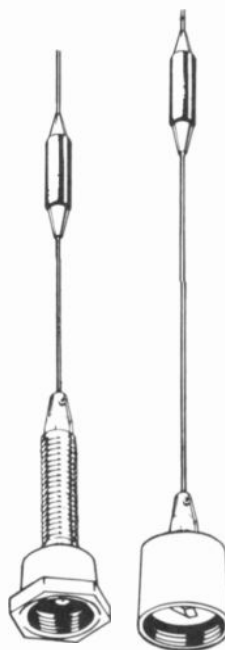

Two Way

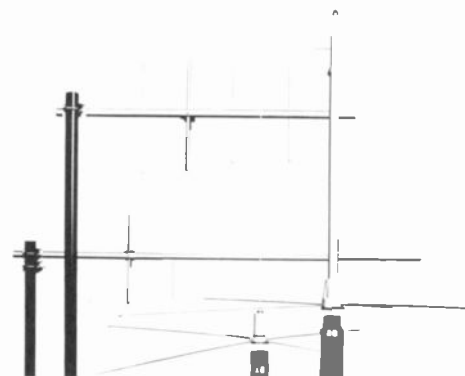

### Base Station

Wide range of Base Station and Two Way antennas. Your BSW representative will assist you with the correct system for your requirements.

# ICE KRACKER

## PROTECT YOUR TOWER

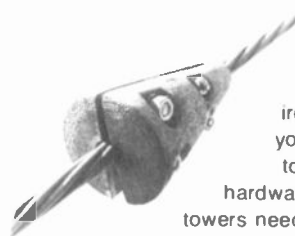

The ICE KRACKER is a substantial and inexpensive, galvanized iron casting in the shape of a cone, which you can bolt onto your guy lines about two to three feet above the guy line anchoring hardware. The following scenario describes why towers need guy line ice protection. **Ice conditions:** During icing conditions, the formation of a cylinder of ice of substantial diameter can occur on the guy lines. As the temperature increases, these cylinders of ice will lose their grip on the wire and can slide down toward the anchors. The speed and weight of the ice running down the line has sufficient force on impact to strip off the hardware and/or unravel the wire grips. When this occurs, the guy tension may be loosened or become detached from the anchor.

5 Models From \$19.95 to \$34.95  
CALL BSW FOR PARTICULARS



## CELWAVE

FM Broadcast Antennas  
Circularly Polarized

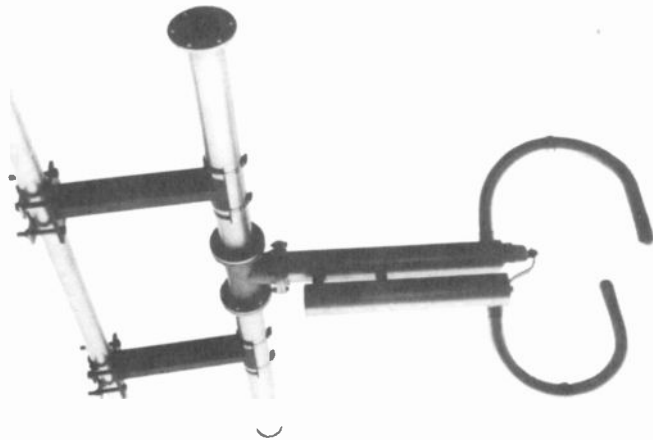

FM Broadcast Antennas  
Circularly Or Horizontally Polarized  
FM Educational Antennas  
Radomes  
Directional Couplers  
Low Pass Filters  
Base Station Antennas  
Cavity Resonators  
Duplexers

Here is a series of circularly polarized and horizontally polarized commercial and educational antennas for the FM broadcast industry. These antennas are less susceptible to corona. The unique circularly polarized antenna assures phase coincidence of the vertical and horizontal components.

Circularly and horizontally polarized antennas are available with any combination of null fill and beam tilt. The High Power and Low Power antennas utilize identical radiating elements. The Low Power series employs 1 5/8 inch feedline. The High Power units use 3 1/8 inch feedline. Both series of antennas are available in systems which incorporate 1 to 16 elements. Normally, systems with 8 or less elements are fed at the bottom; above 8, the system is fed from the center.

For Details  
Call Toll Free  
1-800-426-8434

## CETEC ANTENNAS

FM BROADCAST ANTENNA  
TRUE CIRCULAR POLARIZATION

FM BROADCAST ANTENNA  
EDUCATIONAL & LOW BUDGET

FM BROADCAST ANTENNA  
LOW POWER BROADCAST

FM BROADCAST ANTENNA  
MEDIUM POWER

FM BROADCAST ANTENNA  
HIGH POWER - HEAVY DUTY

FM BROADCAST ANTENNA  
EXTREMELY HIGH POWER  
HEAVY DUTY

RADOMES

ELECTRONIC & AUTOMATIC  
DEICER CONTROLS &  
DEICER HEATING EQUIPMENT

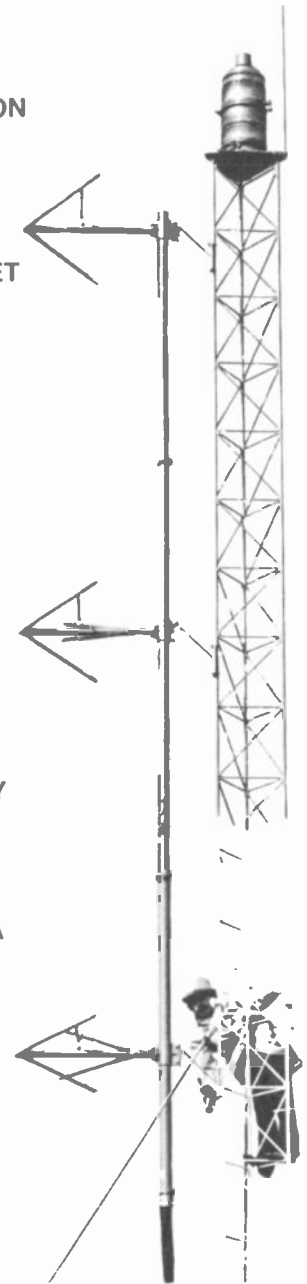

JSCP Series B  
Broadcast Antenna

CETEC Antenna's (Formerly JAMPRO) manufactures a complete line of high quality antenna's & components and deicer equipment for all broadcast applications.

Call BSW Toll Free  
For Configuration & Pricing  
1-800-426-8434



# Audio Processing

## ORBAN

### THE INCOMPARABLE OPTIMOD

**OPTIMOD FM THE PROVEN PERFORMER**



**Model 8100A  
FM Audio Processor/Stereo Generator**

The FM standard in audio processing. The 8100A features multiband compressor/limiter/stereo generator in one unit. The optimod gives you freedom from processing artifacts, distortion, and listener fatigue.

Mfg. list \$4,995.00 . . . . . **CALL FOR BSW PRICE**

**Model 8100AXT**

**6 Band Limiter Accessory For 8100A**

Mfg. list \$1,995.00 . . . . . **CALL FOR BSW PRICE**



**Model 9100A AM Audio Processor**

The OPTIMOD AM is an integrated audio processing system for AM radio, including compression, program equalizer, Multiband limiter, clipper, and transmitter equalizer. It supplies very high average modulation, exceptional fidelity, and freedom from processing artifacts to yield FM like sound from typical radios.

**Model 9100A/1 Mono**

Mfg. list \$3,995.00 . . . . . **CALL FOR BSW PRICE**

**Model 9100A2 Stereo**

Mfg. list \$5,395.00 . . . . . **CALL FOR BSW PRICE**

### TV STEREO



**Model 8182A  
Television Audio Processor**

Orban Audio Processor for T.V. An integrated approach to: Ride gain, performing desired compression, controlling excessive loudness, and controlling peaks by high frequency limiting. Includes CBS loudness circuit.

Mfg. list \$4,995.00 . . . . . **CALL FOR BSW PRICE**



Mfg. list \$4,995.00 . . . . . **CALL FOR BSW PRICE**

**Model 8182A/SG  
Television Stereo Generator**

Orban T.V. Stereo Generator Works in conjunction with the 8182A processor only.

In the ten years since the introduction of Orban's original OPTIMOD-FM Model 8000A, FM stereo has grown up and they've grown with it. There are more Orban FM stereo audio processors and stereo generators in service than all other makes combined.

Now Orban brings this experience to the design of a BTSC-standard television stereo system. It starts with the refined, field-proven OPTIMOD-TV Model 8182A stereo audio processor, with patented CBS Loudness Controller and the exclusive Hilbert-Transform Clipper peak limiter. To this they add a BTSC stereo generator chassis precisely harmonized to the 8182A. Some of its special features include:

- Left and right computer-optimized filters which not only notch out the 15734Hz horizontal line frequency, but also equalize the 8182A to make it even flatter than it would be without the filters!
- A genuine dbx encoder card to assure tightest conformance with dbx standards.
- A high-precision realization of the required (and infamous) sum-and-difference 11-pole 15kHz low-pass filters which draws upon every bit of Orban's computer aided filter design experience to assure highest standards of accuracy and stability over time and temperature.
- A stereo baseband generator based on the servo stabilized matrix design used in the OPTIMOD-FM Model 8100A, literally thousands of which are in service.
- Auxiliary input for separate SAP generator.
- Prewired card positions for optional Professional Channel Generator

**THE BEST PART IS THE LOW  
SYSTEM'S PRICE**

Mfg. list \$9,990.00

**CALL BSW FOR YOUR  
SPECIAL LOW PRICE**



## ORBAN



### Model 622B Parametric Equalizer

The ideal combination of quality, reliability and cost-effectiveness. Features include active, balanced inputs, built-in power supply, master in/out switch and in/out switch for each equalization section, 20-20,000 Hz tuning range, "peak-stretching" overload to warn of clipping, front panel gain control with +20 dBm output capability and an active RC design.

#### Model 622A (1 channel)

Mfg. list \$569.00 . . . . . **CALL FOR BSW PRICE**

#### Model 622B (2 channel)

Mfg. list \$879.00 . . . . . **CALL FOR BSW PRICE**



### Model 245F Stereo Synthesizer

The Orban 245F Stereo Synthesizer has been designed to take any mono signal and create life-like pseudostereo. Unlike many other techniques, the patented Orban stereo synthesis technique causes no change in spectral balance, does not blur the transient definition, and adds not the slightest audible noise or distortion to the mono original. The stereo output sums back to the original mono for total mono/stereo compatibility. And the simple controls adjust in seconds to create an optimum stereo effect from any mono original.

Mfg. list \$399.00 . . . . . **CALL FOR BSW PRICE**



### Model 412A Compressor/Limiter

The 412A Compressor/Limiter is Orban's entry into the general-purpose level control sweepstakes - it's designed to make you, the audio professional, the winner! Available in mono (412A) and stereo (414A) versions, it's loaded with features that most other low-cost units don't offer - but the real proof is in the listening. We invite you to compare its natural, transparent sound to any other compressor/limiter you might know or use. After you do, we feel confident you'll make it your essential AGC.

#### Model 412A

Mfg. list \$425.00 . . . . . **CALL FOR BSW PRICE**

#### Model 414A

Mfg. list \$799.00 . . . . . **CALL FOR BSW PRICE**



### Model 672A Equalizer

A cost-effective professional quasi-parametric equalizer with the convenience of graphic-type EQ controls. Features very low noise and distortion, high slew rate for minimum TIM (SID), front panel gain control with 12 dB gain available, "peak-stretching" overload lamp to warn of clipping, active balanced inputs and unbalanced outputs.

Mfg. list \$689.00 . . . . . **CALL FOR BSW PRICE**

## STUDIO OPTIMOD



### Model 424A Processing For Your Production

The 424A can be applied anywhere that current compressors, limiters, and/or de-essers are used, since its versatility does not limit it to a single sound, but instead lets it operate as a smooth, gentle compressor, a peak limiter, a de-esser or any combination.

Mfg. list \$989.00 . . . . . **CALL FOR BSW PRICE**



### Model 111-B/1 Dual Reverb

The 111-B/1 offers two channels of reverb in a single package that combines both electronics and spring delay lines. It is a reverb that combines full Orban quality and reliability with significant advances in cost-effectiveness. It's the only choice for anyone needing two channels of fully professional reverb in an economical package.

Mfg. list \$899.00 . . . . . **CALL FOR BSW PRICE**



# Audio Processing



## THE AM-4 AUDIO PROCESSING SYSTEM



### Model AM-4 Mono System

The AM-4 Processing System is the result of years of research and development by engineers who have grown up in the broadcast industry.

#### Features:

- Four channel multiband control
- User controlled loudness
- Dynamic equalization
- Selectable AGC gating

AM-4 Mono.....Mfg. list \$3,450.00  
 AM-4 Stereo.....Mfg. list \$5,950.00

**CALL FOR BSW PRICE**

## THE FM-4 STEREO PROCESSING SYSTEM

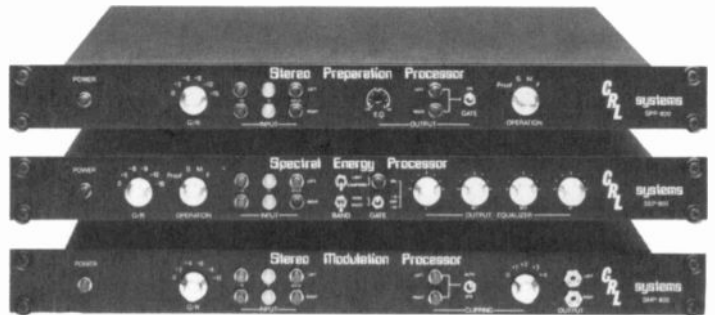

The FM-4 System is a careful blend of superb sounding stereo multiband AGC's, low distortion pre-emphasis limiters, and overshootless low pass clipping filters which make outstanding quality and loudness improvements easy to obtain.

#### Includes:

- SPP Stereo Preparation Processor
- SEP 800 Stereo Spectral Energy Processor
- SMP 800 Stereo Modulation Processor

Mfg. list \$6,750.00.....**CALL FOR BSW PRICE**

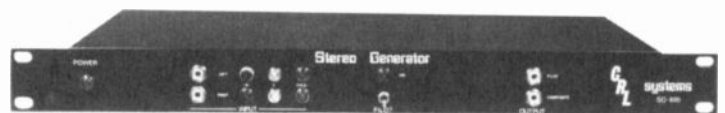

### Model SG800 FM Stereo Generator

The SG800 from CRL is the first stereo generator designed to handle highly processed audio.

The SG800 has outstanding specs. One of the reasons is CRL's exclusive Balanced Modular design. This allows ultralinear modulation of the 38kHz subcarrier, while maintaining a precision digital phase lock with the pilot to prevent any frequency drift.

Audio Frequency Response: 10Hz to 15kHz, plus or minus 0.2 db.

THD Distortion: (10 to 15kHz) less than .03%

IM Distortion: less than .03% (60Hz/7kHz at 4:1)

S + N/N: 80db or greater, referenced to calibrate level Pilot

Frequency Stability: Less than 1Hz from -10°C to +40°C.

Crosstalk: Left/Right and Right/Left, 60db or greater

Crosstalk: Main to Sub and Sub to Main, 60db or greater

Mfg. list \$1,450.00.....**CALL FOR BSW PRICE**

**BSW IS OPEN  
12 HOURS DAILY  
IN  
YOUR  
TIME ZONE**



**Check Daily  
Schedule On Back  
Cover**





## DORROUGH

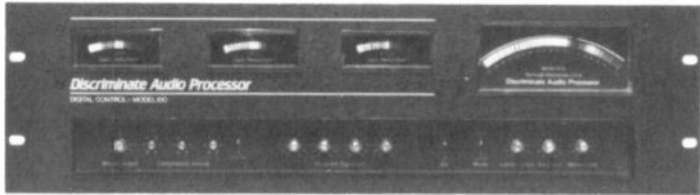

### Model 610 Discriminate Audio Processor

The Discriminate Audio Processor Model 610 is a digital controlled tri-band audio processor. A maximum of three channels has proved to be the most colorless and least modifying of program material. The use of gain reduction independently in the three channels eliminates the typical restrictions heard on single channel devices. It is the intention of this device by virtue of the three bands not to doctor or modify the average or peak of the program content in any way that would be offensive to the ear.

The Discriminate Audio Processor Model 610 operates in the following sequence:

- Splitter,
- Three Channels,
- Program Equalizer,
- Peak Limiter,
- For AM/FM/TV.

Mfg. list \$3,900.00 . . . . . CALL FOR BSW PRICE

## Fostex

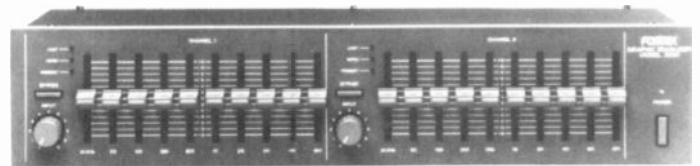

### Model 3030 Graphic Equalizer

**Compact - Flexible - Affordable**

Gives you important extra control over your music! Plus it's easy to set up and very easy to use.

Mfg. list \$250.00 . . . . . CALL FOR BSW PRICE



### Model 3070

#### 2 Channel Gated Compressor/Limiter

The Fostex 3070 is an excellent example of compressor/limiter technology as applied for today's producer/engineer.

Mfg. list \$400.00 . . . . . CALL FOR BSW PRICE

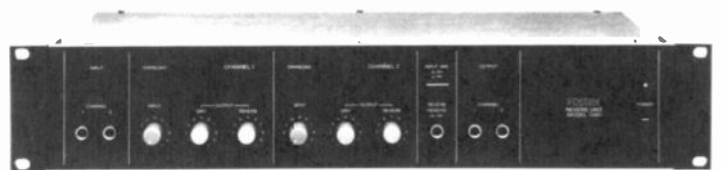

### Model 3180

#### 2 Channel Reverb Unit

The Fostex 3180 is a shining example of how modern technology has achieved a remarkable natural reverb sound at a remarkable reasonable price.

Mfg. list \$400.00 . . . . . CALL FOR BSW PRICE

**Low Overhead  
From One Location  
Means**

**LOWER PRICES**

**TRY US**

**We're As Close As  
Your Telephone**

**TOLL FREE**

**1-800-426-8434**



**BSW IS OPEN  
SATURDAY**



# Audio Processing



# TEAC

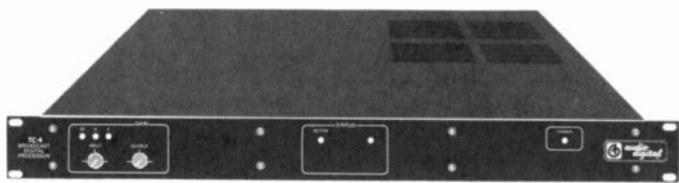

### Model TC-4 Broadcast Digital Delay

A state-of-the-art advancement in broadcast profanity delay. 6.8 seconds delay time, 15kHz band width, and 85dB dynamic range. Optional card allows memory dump as well as a catch-up feature.

Mfg. list \$1,395.00 . . . . . **CALL FOR BSW PRICE**

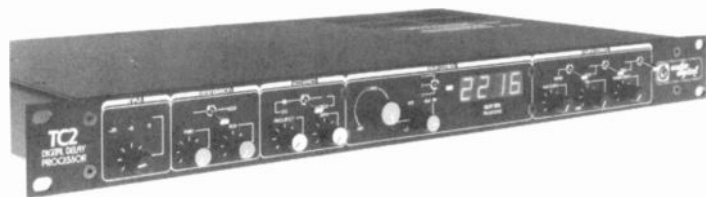

### Model TC-2 Digital Delay Processor

#### Studio Quality Effects

The TC-2 Digital Delay System includes all the features you need in one package.

- Positive and negative flanging
- Chorusing
- 1 second delay adjustable echo

Mfg. list \$1,095.00 . . . . . **CALL FOR BSW PRICE**

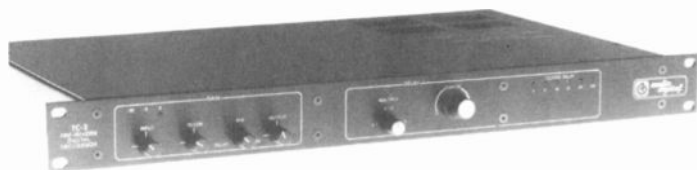

### Model TC-3 Pre-Reverb Digital Processor

The Audio Digital Pre-Reverb Digital Processor is useful in studio applications requiring enhancement of a mechanical reverb system. Because of its flexibility it will also perform as a stand-alone studio quality Digital-Delay. Delay time is selectable in one millisecond increments up to 260 milliseconds, with a 20kHz bandwidth, and 90db dynamic range. Built-in mixing and regeneration controls enhance the TC-3 as a stand-alone processor in live as well as studio applications.

Mfg. list \$599.00 . . . . . **CALL FOR BSW PRICE**



### Model EQA-10B MKII Stereo 10-Band Graphic Equalizer

- Ten-band audio frequency spectrum analyzer
- Source and tape input
- Equalizer In/Out switch
- Pre/Post equalizer switch
- Equalizer boost/cut controls

Mfg. list \$199.00 . . . . . **BSW PRICE \$149.00**

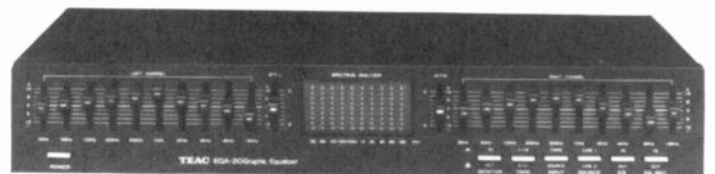

### Model EQA-20 Graphic Equalizer

Same as EQA-10B (shown above) plus

- LED Light On Slide Knobs
- Left & Right Attenuators
- Tape Monitor Capability During Recording
- Recording Two Decks Simultaneously

Mfg. list \$249.00 . . . . . **BSW PRICE \$172.95**

**BSW IS OPEN  
12 HOURS DAILY  
IN YOUR  
TIME ZONE**



**Check daily  
schedule on back  
cover.**

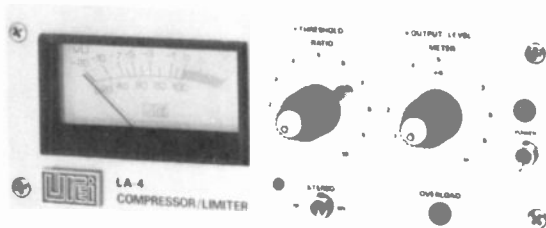

### Model LA-4 Compressor/Limiter

- Long-life LED attenuator
- Smooth, natural-sounding RMS action
- Selectable compression ratio
- Input overload indicator
- Simple stereo coupling
- Space-saving 8½ inches wide
- Two units needed for stereo

Mfg. list \$496.00..... **BSW PRICE \$446.40**



### Model 1176LN Peak Limiter

- True peak limiter
- All transistor circuitry
- Excellent noise specs
- Ultra-fast attack time
- Extremely stable

Mfg. list \$596.00..... **BSW PRICE \$536.40**

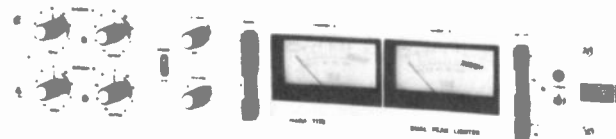

### Model 1178 Dual Peak Limiter

A two channel version of the 1176 LN with two independent Peak Limiters. Excellent for stereo limiting. Features perfect tracking and very fast action.

Mfg. list \$896.00..... **BSW PRICE \$806.40**



### Model 535 Dual Graphic Equalizer

- Two channels in one complete package
- Ten adjustable equalizers on each channel
- Low distortion, low noise
- Standard rack mounting

Mfg. list \$496.00..... **BSW PRICE \$446.40**

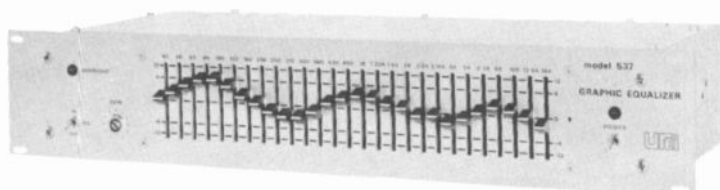

### Model 537 1/3 Octave Graphic Equalizer

- 27 adjustable equalizers
- Stepless, noiseless controls

Mfg. list \$896.00..... **BSW PRICE \$806.40**

## ONE CALL DOES IT ALL

1-800-426-8434

TWX 910-441-2617  
Tacoma 206-565-2301

BSW HOURS

<p><b>EASTERN TIME</b> 9:00AM TO 9:00PM</p> <p><b>CENTRAL TIME</b> 8:00AM TO 8:00PM</p>	<p><b>MOUNTAIN TIME</b> 7:00AM TO 7:00PM</p> <p><b>PACIFIC TIME</b> 6:00AM TO 6:00PM</p>
---	--



# Audio Processing

# dbx



## Model 140 Broadcast Noise Reduction System

The dbx Model 140 simultaneous encode/decode broadcast noise reduction system is a two-channel compressor/expander providing a minimum of 30 dB broadband audio noise reduction with a 10 dB increase in system headroom. The two channels feature independent encode and decode circuitry.

In the record mode, the system compresses the input signal by a 2:1 ratio, linear in decibels over a 100 decibel range. Upon playback, the circuitry produces an exact mirror image 1:2 expansion of the encoded signal.

The dbx system eliminates tape hiss in recording, and prevents the noise build-up normally encountered in transferring information from one recorded medium to another; it does not remove noise present in the original signal.

Mfg. list \$589.00 . . . . . **CALL FOR BSW PRICE**



## Model 166 Dual-Channel Dynamics Processor

### Features:

- Noise gating with switchable release rate
- Variable OverEasy compression with infinity: 1 effects
- PeakStop, for good-sounding clipping
- Sidechain monitoring
- Rack-mountable; low-profile
- Hardwire bypass
- Stereo or dual-mono operation

Mfg. list \$549.00 . . . . . **CALL FOR BSW PRICE**

**FOR THE COMPLETE  
dbx LINE-UP  
CALL BSW TOLL FREE  
1-800-426-8434**

# TASCAM

FOR PROFESSIONAL USE ONLY

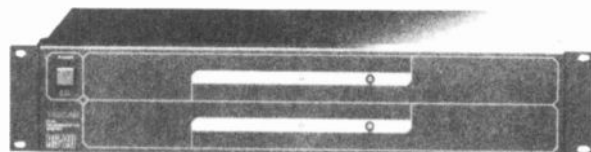

## Model RS-20B Stereo Reverberation System

The RS-20 is straight forward, easy to connect and operate. There are a pair of unbalanced input jacks with foldback jacks for "chaining" the signal to another signal processor, and a pair of unbalanced output jacks. The only operating controls are the power switch and a level switch to select between input/output of -10 dbv or +4 dbv. A bi-color LED on each channel usually show when signal is present, and changes color when the minimal load is exceeded.

Mfg. list \$400.00 . . . . . **CALL FOR BSW PRICE**

# URSA MAJOR



## Model SST-282 Effects Unit

An innovative new digital reverb system that adds warmth and body to a speaker's voice, and enhances both live and recorded music and generates special effects that range from the subtle to the exotic. With the Space Station's propriety Multi-Tap Digital Delay algorithm, you can simulate an almost endless variety of reverberant spaces, from tiny rooms to parking garages and concert halls. The Space Station is one of the most complete effects units we sell.

Mfg. list \$2,195.00 . . . . . **CALL FOR BSW PRICE**

  
**TIRED OF BACK  
ORDERS?  
ORDER FROM  
BSW  
MILLION DOLLAR  
IN-HOUSE INVENTORY**



## Eventide



### Model H949 Harmonizer

A combination digital delay line, pitch changer and all-around special effects unit. Features pitch change of one octave up, two down; two delay outputs of up to 400 milliseconds each; frequency response of 15kHz; dynamic range of 96dB and micro-pitch change for extremely precise, stable settings. Time reversal, repeat, randomized delay and flanging controls are also provided.

Mfg. list \$3,500.00 . . . . . **CALL FOR BSW PRICE**

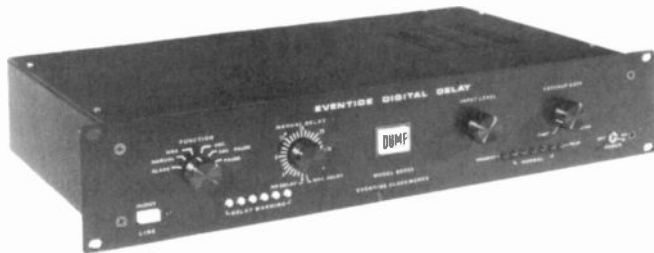

### Model BD955 Broadcast Audio Delay Line

Designed for policing of live talk shows. RAM based digital delay line available in two frequency ranges—7.5kHz for telephone audio and 15kHz for quality reproduction of the full audio spectrum. Two maximum delay times available—3.2 or 6.4 seconds. Unique catch-up feature enables unit to regain delay safety margin automatically.

15 KHZ UNITS: 3.2 seconds . . . . . Mfg. list \$3,350.00  
 6.4 seconds . . . . . Mfg. list \$4,300.00  
 7.5 KHZ UNITS: 6.4 seconds . . . . . Mfg. list \$3,350.00

**CALL FOR BSW PRICE**



### Model BD931 Delay Line

- 16kHz frequency response
- Greater than 90dB dynamic range
- Mono or stereo available

	BD 931 Mono Mfg. list	BD 932 Stereo Mfg. list
3.2 Second Delay	\$1,795.00	\$2,595.00
6.4 Second Delay	\$2,295.00	\$4,495.00

**CALL FOR BSW PRICE**

## THE NEXT STEP



### Model H969 ProPitch Harmonizer

#### New Features Of The H969

Eventide Harmonizers® have always set the world standard in pitch change technology. The new H969 ProPitch™ Harmonizer maintains Eventide's leadership with the cleanest, highest quality pitch change ever, for the most demanding applications. New effects and convenience features have also been included in the H969. This new top-of-the-line Eventide Harmonizer is ready for you to audition now.

- ProPitch for unprecedented pitch change quality
- Twelve instant pitch presets at precise musical intervals
- Wide delay range and added delay feature
- Extended reverse and repeat modes
- New doppler effect and extended flanging

Mfg. list \$4,500.00 . . . . . **CALL FOR BSW PRICE**



### SP2016 Generation II Effects Processor/Reverb

The SP2016 has been designed as an extremely versatile and capable general purpose audio signal processor. The hardware designs required for a no-compromise, natural sounding digital reverberator meeting Eventide performance standards are also capable of a wide variety of other audio effects and functions.

Mfg. list price now only \$6,895.00

**CALL FOR BSW PRICE**



# Audio Processing

## MODULATION SCIENCES



### Model CP803 FM Composite Processor

Sharpen your competitive edge by adding the CP803 to your compressor/limiter/stereo generator to enhance the stereo composite signal. Increase your signal by 6dB with greater dynamic range without the breathing, pumping or swishing associated with conventional processing.

Mfg. list \$889.00 . . . . . **CALL FOR BSW PRICE**

## SIDEKICK

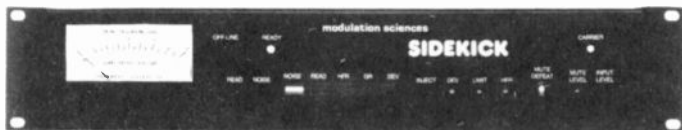

### Model SCA 186 SCA Generator

Sidekick combines the four elements needed for successful SCA operation into the one package: subcarrier generator, modulation monitor, audio processor and transmitter tuning aid. Engineered to work together, these components form an integrated system which provides a level of performance previously unattainable. Crosstalk is dramatically reduced, signal quality is significantly improved and operation is greatly simplified.

Mfg. list \$2,450.00 . . . . . **CALL FOR BSW PRICE**



**WE ARE READY FOR BUSINESS  
WHEN YOU ARE . . . . .  
12 HOURS DAILY  
IN YOUR TIME ZONE**

## VALLEY PEOPLE

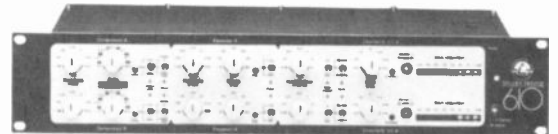

### Model 610

The Model 610 Dual Compressor/Expander offers the convenience of two high quality compressors with the flexibility of multi-function dynamics processing in an attractive, rugged 3½" x 19" rack package. Each of the two channels consists of a compressor section and an expander section both controlling a common channel VCA. A special release coupling circuit provides symmetrical release characteristics for both the compressor and expander making interactive processing possible, thus eliminating the problems associated with using separate dedicated-function units.

Mfg. list \$995.00 . . . . . **CALL FOR BSW PRICE**



### 430 Series

Design criteria dictated that the "400" series do all things exceedingly well to outperform the very best "dedicated-purpose equipment." Proprietary circuitry evolved through exhaustive studies of the physics and psycho-acoustics of dynamic manipulation is employed in the "400" series to increase dynamic integrity or "listenability." Yet, the "400" series remains the most versatile and cost-efficient approach to multifunction signal processing on the market today!

**The Dyna-Mite (430)**, available in mono or stereo, performs several variations of 18 specific operating modes, including: limiting; expanding; noise gating; keying; FM limiting; de-essing; and "voice-over".

**The Dyna-Mic/Mite (431)** combination adds transformerless brilliance to a variety of input impedances and optimizes them for routing through the 3-band EQ section and/or the Dyna-Mite. The signal then appears at the output enhanced by processing which only a device of this caliber can deliver.

**The Dyna-Mic (432)**, available in mono or stereo, offers 2 independent, transformerless preamps, with on-board 3-band tone control. Each of the 2 inputs on a Dyna-Mic card may be optimized for microphone, line or musical instrument impedances and levels. The single output of each card is switchable to +4 dBm, -10 dBv or -20 dBv nominal line levels.

**Model 430** Mfg. list \$560.00 . . . . . **CALL FOR BSW PRICE**

**Model 431** Mfg. list \$560.00 . . . . . **CALL FOR BSW PRICE**

**Model 432** Mfg. list \$560.00 . . . . . **CALL FOR BSW PRICE**

# Audio Processing



## MASTER ROOM BY CRL

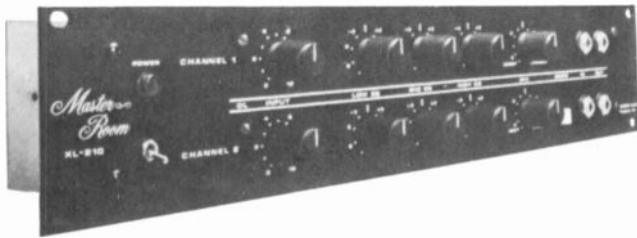

### Model XL-210 Reverberation System

Provides smooth, natural reverberation without internal limiting or other signal processing to compensate for chamber deficiencies. The XL-210 is a self-contained 3½" rack-mount unit featuring two independent channels for true stereo operation and EQ controls for each channel. High quality reverberation at an affordable price.

CALL FOR BSW PRICE



## Dynafex™ BY CRL

### Model D-2B Noise Reduction System

The Dynafex™, Model D-2B is a non-encode/decode noise reduction system designed to be used on virtually any audio signal. This device incorporates proprietary circuit design to achieve up to 30dB of noise reduction without unwanted side-effects.

The Dynafex is a two-channel device that will operate as a stereo unit with the channels tracking together, or it may be used on two totally independent monaural sources.

CALL FOR BSW PRICE

## STUDIO TECHNOLOGIES INC



### Model AN-2 Stereo Simulator

Unlike most outboard devices such as time delays, harmonizers and equalizers, the Studio Technologies Stereo Simulator is fully mono compatible. This means recordings produced with the Stereo Simulator suffer no balance distortion when heard on AM radio. The Stereo Simulator is also a valuable resource for television broadcasters that offer stereo transmission since much of the material they must broadcast is, in fact, monaural. And, it's ideal for converting mono film tracks to a fuller, more contemporary "stereo sound for either broadcast or theater use. As a very affordable method for creating stereo sound from mono materials, the Stereo Simulator is without equal.

Mfg. list \$650.00 . . . . . CALL FOR BSW PRICE



### Model RCU-1 Recognition Control Unit

- Recognizes stereo or monaural input signals. circuitry compensates for phase and level difference errors.
- Automatically switches stereo simulator in-circuit on detection of mono. Compatible with Studio Technologies AN-2 Stereo Simulator, shown above, or other manufacturers' products.
- Manual override functions using front panel controls or +5V logic signals.
- Auxiliary relay contacts provide contact closure on recognition of mono and simulator in-circuit conditions.

Mfg. list \$1,200.00 . . . . . CALL FOR BSW PRICE

**NOW OPEN SATURDAY**



**And  
We Are As  
Close  
As Your Telephone  
TOLL FREE  
1-800-426-8434**



**Million Dollar  
In House  
Inventory  
For  
Immediate  
Delivery**



# Audio Processing

## Symetrix



### Model 501 Peak-RMS Compressor/Limiter

The Symetrix 501 combines more usable features into one compressor limiter than any other on the market.

Mfg. list \$425.00 . . . . . **BSW PRICE \$282.50**



### Model 511 Noise Reduction System

The Symetrix Model 511 Noise Reduction System is a professional signal processing device which removes unwanted noise from audio signals. By inserting the 511 in the signal path following a reel to reel tape recorder, cart machine, VTR, or cassette recorder, the user can obtain improvements in signal to noise ratios of up to 30dB from previously recorded tapes which have been found to be objectionably noisy. No previous encoding of the recorded signal is necessary.

Mfg. list \$575.00 . . . . . **BSW PRICE \$413.50**

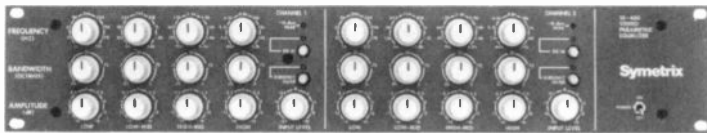

### Model SE-400 Stereo Parametric Equalizer

The Symetrix SE-400 Stereo Parametric Equalizer is a professional signal processing tool which offers the user state-of-the-art sonic performance from a device that has been painstakingly designed and constructed with the professional in mind. The same attention to quality, uncompromising performance and workingman's economy which typifies the entire line of Symetrix signal processing devices has been built into the SE-400.

Mfg. list \$550.00 . . . . . **BSW PRICE \$366.95**



### Model CL-150 Fast RMS Compressor/Limiter

The Symetrix CL-150 Compressor/Limiter offers the audio professional a compressor/limiter with truly superior performance characteristics at a very economical price. Continuing in the tradition of previous Symetrix compressor/limiter designs the CL-150 processes audio signals without the addition of objectionable side effects like distortion, noise, or "pumping" which are so often associated with compressor/limiters.

Mfg. list \$335.00 . . . . . **BSW PRICE \$222.50**



### Model 522 Expander Gate Ducker Compressor/Limiter

The Symetrix Model 522 is a multi-function dynamic range control device. The 522 incorporates two channels which may be used independently or in a stereo interconnect mode. Each channel of the 522 may be set to perform one of the following functions: (1) compression/limiting, (2) downward expansion, (3) noise gating, (4) ducking. In addition the user has the option of patching the two channels in series to combine functions. For example, with channel one in the compressor mode and channel two in the gate mode the 522 functions as a monaural "gate compressor/limiter." This of course is only one of many possible combinations. Each channel is essentially a "four-in-one" dynamic range processor.

Mfg. list \$595.00 . . . . . **BSW PRICE \$428.00**



### Model 525 Dual Gated Compressor/ Limiter

The Model 525 Dual Gated Compressor/Limiter is the latest addition to the Symetrix family of dynamic range controllers.

#### Features:

- A multi-function dynamic range controller designed for exceptional performance and ease of operation.
- Two independent channels which may be ganged for stereo operation.
- Simultaneous compress/limit and expand/gate action.
- Separate compress/limit and expand/gate side-chains each of which respond in a program dependent fashion to make set-up quick and simple.
- Balanced inputs and outputs.

Mfg. list \$495.00 . . . . . **BSW PRICE \$356.00**





Picture not available.

## Aphex II Broadcast Aural Exciter

The Aphex Aural Exciter has become a standard in the music industry and has been used for years on thousands of albums, movies, broadcast productions, commercials and concerts. The Aural Exciter is now accepted as a unique method to achieve clarity, definition and dimensionality in reproduction of sound. The program material literally "opens up" possessing more detail and intelligibility, as well as greater apparent frequency and dynamic range.

- Improved intelligibility and clarity
- No listener fatigue
- Enhance stereo imaging
- Complete mono capability
- Easily interfaced with any system
- Restored natural quality to processed signals

Mfg. list \$2,495.00 . . . . . **CALL FOR BSW PRICE**



## Compellor

Introducing The Compellor™, the most revolutionary audio processor in the world. It thinks, adapts and delivers three separate functions—simultaneously.  Its control circuits are actually an analog computer which has a single VCA for minimal signal path to give you simultaneous compression, leveling and peak limiting.  You just set The Compellor™ once and its three separate functions work together harmoniously to deliver a loud and clean sound. The kind that audio engineers have always wanted but which wasn't available before.  The Compellor™ provides complete dynamics control, smooth inaudible compression, increased loudness, freedom from constant gain riding and the desired density—all automatically.  This smart, versatile audio processor is extremely cost effective and thoroughly functional for broadcast pre-processing, microphone control, audio production and tape duplication.

## Stereo

Mfg. list \$1,195.00 . . . . . **CALL FOR BSW PRICE**

## Aural Exciter™ Type C Affordable Processing For Production

- Newest version of the Aural Exciter™ from Aphex—the **originators** of psychoacoustic enhancement.
- Uses the same principles as the more expensive Aural Exciters™ used on thousands of hit albums, concerts and movies, and on the air on hundreds of radio stations worldwide.
- Restores **natural** brightness and presence; makes your sound **real** again.
- Improves intelligibility; makes individual sounds distinct from one another.
- Increases perceived loudness without changing actual gain or EQ.

Mfg. list \$299.95 . . . . . **CALL FOR BSW PRICE**

## Million Dollar In-House Inventory



**For  
Immediate  
Delivery**

**CALL BSW TODAY  
1-800-426-8434**



# Cartridge Accessories

## TAPE DEGAUSSERS For Audio, Video, Computer And Cartridge Tape ERASING MADE EASY

### AUDIOLAB

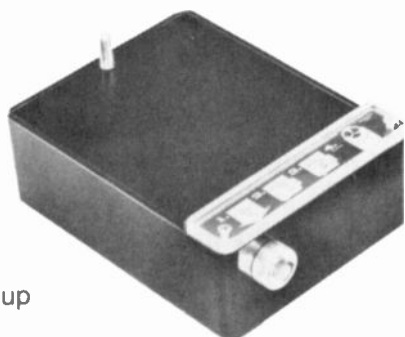

#### Model TD-1B Table Top Eraser

Erases cartridges and up to 10½" reels.

Mfg. list \$115.00..... BSW PRICE \$106.50

### SONAR MARK I



#### Heavy-Duty Hand-Held Eraser

Mfg. list \$52.00

**ONLY ..... \$39.95**

### FIDELIPAC



#### Model 395 Magnetic Tape Eraser

Greater magnetic field strength and longer on-duty cycle than any other hand-held eraser on the market.

- Burn-out proof
- Almost indestructible
- Easy to operate

Mfg. list \$64.75..... BSW PRICE \$49.95

### SONAR VIDEO

#### PULSATING VIDEO ERASER by SONAR



#### Model VP-2001

The VP-2001 is specifically designed to fully erase all grades of up to 1" video tape, ¾" u-matic and even the time codes. One year warranty.

Mfg. list \$165.00

**ONLY ..... \$149.95**



#### Model 400 Magnetic Tape Eraser

Erases cartridges and up to 10½" reels.

Mfg. list \$99.50..... BSW PRICE \$85.00

 NORTRONICS



#### Model PF-211 Hand-Held Professional Bulk Eraser

Mfg. list \$54.95..... BSW PRICE \$35.95

# Cartridge Accessories



**NORTRONICS**  
**PF-116 Head Cleaning Spray**.....\$7.65  
**PF-132 Head Cleaning Liquid**.....\$14.00

Non-flammable, non-toxic trichlorotrifluoroethane is completely safe on plastics, rubber, metals, painted surfaces, epoxies and elastomer parts.

## EDITING PENCILS

White China Markers  
Package of 12

**\$9.45**



**SPLICING BLOCKS**  
 Nortronics PF-311.....\$27.75  
 Editall S3.....\$33.95  
**SPLICING TABS**  
 PF-524 50 Metal Sensing....\$6.50  
 PF-526 200 Reel Tabs.....\$14.00



**NORTRONICS**  
**PF 707 Lapping Kit**.....\$135.00  
 Includes magnifying lens, support angle and head holder, and three grades of high quality lapping film to obtain optimum finish.

## COTTON SWABS

For Cleaning Heads

BCS 100...	2.95
BCS 500...	9.95
BCS 1000...	17.95



Used By Professional Winders

**Tapecaster X-100**  
**Automatic Cartridge Loader**

Full Timing Capability  
 10 1/2" Tape Capacity

**BSW PRICE**.....\$495.00

**NORTRONICS**  
**Model PF-710**  
**Zenith Height Gauge**  
 • Two Measuring Devices In One  
 • Easy To Use Package  
**BSW PRICE**.....\$51.85

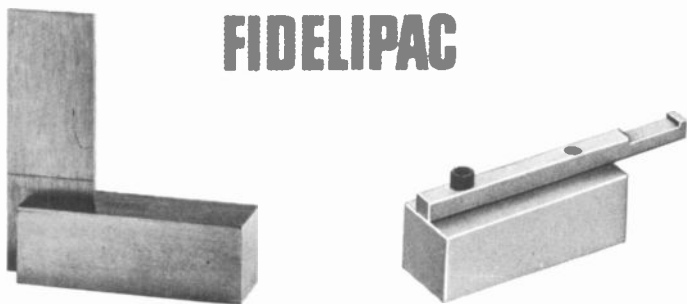

**387 Right Angle Zenith**  
**BSW PRICE**..\$32.95

**326 Height Gauge**  
**BSW PRICE**..\$27.95

**BROADCAST SUPPLY WEST**  
**CARTRIDGE LABELS**

**BROADCAST SUPPLY WEST**

Six Assorted Colors  
 Rolls (1000 Labels).....\$17.95 per roll  
 Sheet (10 Labels) 1-50 sheets .26 per sheet  
 51 + sheets .25 per sheet



**Fidelipac**  
**328 Head**  
**Insertion Gauge**  
**BSW PRICE**..\$6.95



# Cartridges & Accessories

## NORTRONICS HEADS

LARGE SELECTION  
IN INVENTORY  
FOR IMMEDIATE DELIVERY  
ALL PRICES DRAMATICALLY  
REDUCED - CHECK OUR  
EVERYDAY LOW PRICES

## NORTRONICS

THE INDUSTRIES'  
QUALITY HEAD

STL & MRL  
ALIGNMENT TAPES  
CARTRIDGE TEST TAPES  
COMPLETE SELECTION  
FOR  
IMMEDIATE DELIVERY

CALL TOLL FREE FOR  
CONFIGURATION & PRICES  
1-800-426-8434

## CBS TEST RECORD

MODEL STR 151

MONOPHONIC

STEREOPHONIC

SIDE 1

SIDE 2

Low Level Check

Phase & Balance

Wow & Flutter

Spot Frequency Test

Frequency Response

Level Check

Rumble Reference

Level

BSW PRICE.....\$15.00

## FIDELIPAC



FIDELPAC  
#300

MASTERCART  
AA

MASTERCART  
II

THE ORIGINAL ENDLESS LOOP CARTRIDGES

FIDELPAC Model 300

For Monaural Broadcasting

MASTERCART AA

The AA Cartridge With Standard or Hot Tape  
For Stereo Broadcasting

MASTERCART II

The AA Cartridge With High Output  
Low Noise Tape For Mono  
Or Stereo Broadcasting

### LOW PRICE VOLUME DISCOUNTS

## ScotchCart

THE CART THAT DARES  
TO BE DIFFERENT

Manufactured By 3M  
Recommended By ITC  
AA standard and wound with  
3M high performance tape



### LOW PRICES VOLUME DISCOUNTS

## GEM BLADES

FOR SPLICING AND EDITING

BOX 100  
\$7.95

CARTON 1000  
\$49.50



**SUPERIOR BY DESIGN  
AND THEY COST LESS  
MUCH LESS**

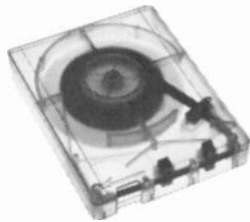

**Model AA Standard  
For Monaural Broadcast**

**Model AA II For Stereo**      **LOW PRICES**  
**And Or FM Broadcast**      **VOLUME DISCOUNTS**

**Dramatically Exceeds NAB AA Standards**



**ARISTOCART**

**LOW PRICES  
VOLUME DISCOUNTS**

**A Or AA Configuration**

Aristocart guarantees a sound equivalent to or better than the finest open reel on properly adjusted machines.

Aristocart's 2006 TAPE guarantees lower distortion and faster response, with greater life expectancy than any other Holn tape.

## AUDIOPAK Broadcasters Favorite Cartridge



**AUDIOPAK A-2**  
**Your Choice**  
**BSW Or Factory Wound**

**THE MOST POPULAR CARTRIDGE  
FOR MONAURAL BROADCASTING**

**AUDIOPAK AA-3**  
**Big Seller For**  
**AM/FM Stereo**



**AUDIOPAK AA-4**  
**For All You Want A**  
**Cart To Do**  
**This Cart's For You!**

**LOW PRICES  
VOLUME DISCOUNTS**

# BUY 'EM BY THE DOZEN AND SAVE

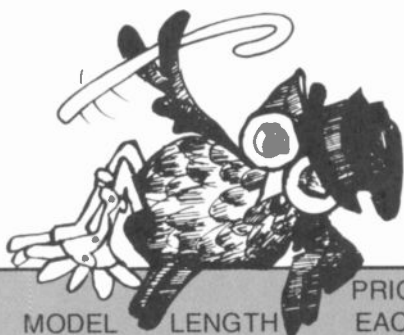

MODEL	LENGTH	PRICE EACH	12 EA. PRICE
CM05	5 min.	.73	.63
C10	10 min.	.75	.65
C20	20 min.	.80	.70
C30	30 min.	.85	.75
C45	45 min.	.90	.80
C60	60 min.	.95	.85
C90	90 min.	1.25	1.15
CM120	120 min.	1.85	1.75
Hard Phillips Box		.20	.17

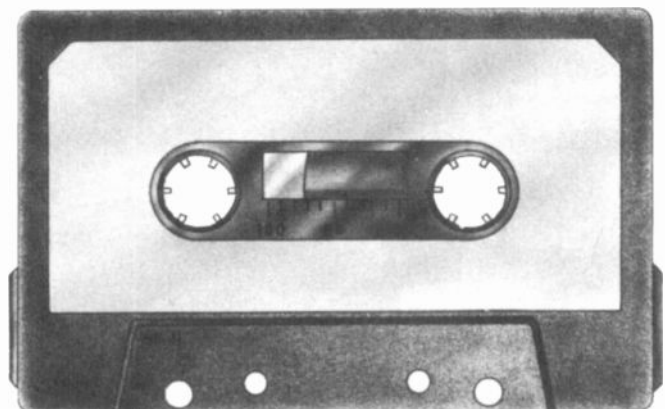



# Cartridge Machines & Accessories

## NEW RELOAD KIT FROM FIDELIPAC



Dynamax Reload Kits are available in all standard cart times, from 20 seconds to 10.5 minutes at 7.5 i.p.s. Kits come in three tape formulas: Standard HOLN and—the never-before-available HOLN-DX (High Output Low Noise-High Overload) tape.

**CALL BSW FOR DETAILS AND PRICE**

**CARTRIDGE REBUILDING  
THE PROFESSIONAL WAY**

# 5

## DAY SERVICE

5 Working Days

### BSW Rebuilds

Hand & chemical cleaning procedures to remove all old labels, dirt & grime and restore your rebuilt cartridge to like-new condition.

Replacement of all necessary parts to assure proper performance, then professionally wound by caring operators using the finest custom built winding machines and materials.

The end result is more mileage from your cartridge investment at a lower than replacement cost.

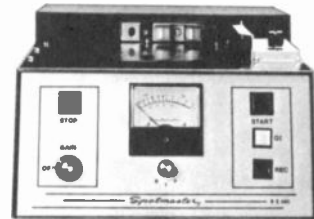

### Model 500D/DL Record/Play/Delay Cartridge Machine

Records, stores and plays back any program material for pre-determined length on standard cartridges. Also normal record/playback functions.

Mfg. list \$1,450.00 . . . . . **CALL FOR BSW PRICE**



### Model 2100RPS Stereo Record/Playback Cartridge Machine

The 2100 line of direct-drive cartridge machines at an affordable price. Series 2100 handles A, B, and C size carts, includes two cue tones (1 kHz and 150 Hz) as standard and provides unique switching for monaural/stereo compatibility. Modular construction, 1/2-inch aluminum transport, low-voltage air-damped solenoid and much more mean that the 2100 gives you more for your money than any cart machine on the market.

#### Record/Play

#### 2100RP Mono

Mfg. list \$1,725.00 . . . . . **CALL FOR BSW PRICE**

#### 2100RPS Stereo

Mfg. list \$2,025.00 . . . . . **CALL FOR BSW PRICE**

#### Play Only

#### 2100P Mono

Mfg. list \$1,150.00 . . . . . **CALL FOR BSW PRICE**

#### 2100PS Stereo

Mfg. list \$1,250.00 . . . . . **CALL FOR BSW PRICE**

# Cartridge Machines



**3 DECK  
FOR  
AA SIZE  
CARTRIDGES**



## Model 5400

Clean sound can come only from fine equipment like Broadcast Electronics Model 5400. The superb electronics is designed for the purist. The clean sound is because of the low wow and flutter from the direct drive synchronous motor, the 52 dB stereo S/N, the Phase Lok IV head bracket for optimum stereo phasing and the solid 1/2 inch aluminum precision machined deck for stable cartridge positioning. The new Model 5400 Three-deck machine is a meld of ruggedness, reliability and outstanding performance. Inside this new three deck, construction follows the rugged mechanical design acclaimed by thousands of users of the field proven model 5300B. Access to electronics and mechanical assemblies is superb. Plug-in decks and PC cards make maintenance and servicing a snap. Clean and practical design attention has produced the coolest running, best sounding, multideck cart tape equipment you can buy today. And, the trim line design permits three machines to be rack mounted side by side.

**5401 Mono**  
Mfg. list \$3,100.00 . . . . . **CALL FOR BSW PRICE**

**5403 Stereo**  
Mfg. list \$3,700.00 . . . . . **CALL FOR BSW PRICE**

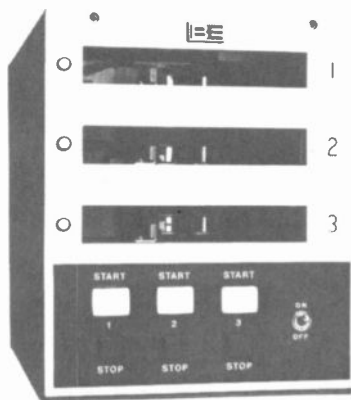

**PLUG-IN  
REMOVABLE DECKS  
AND SUPERB  
ELECTRONICS**

## Model 5300B

**3 DECK  
FOR A&B  
SIZE CARTS**

**5301-B Mono**  
Mfg. list \$2,950.00

**5303-B Stereo**  
Mfg. list \$3,450.00

**Call for BSW Price**



## Model 5310

**COMPANION RECORD  
UNIT FOR 5300B**

**Call for BSW Price**

5310 Stereo Mfg. list \$1,325.00  
5309 Mono Mfg. list \$1,075.00

**CALL FOR THE  
BSW "EVERYDAY"  
LOW PRICE**



## Model 3200 Compact

BE's top of the line record/play cartridge machine. The 3200 series features air damped solenoid direct drive motor, Nor- tonics Duracore Heads, and outstanding performance. Fast forward and additional cue tone available as options.

**Record/Play**  
**3200RP Mono**  
Mfg. list \$2,175.00 . . . . . **CALL FOR BSW PRICE**

**3200RPS Stereo**  
Mfg. list \$2,525.00 . . . . . **CALL FOR BSW PRICE**

**Play Only**  
**3200P Mono**  
Mfg. list \$1,275.00 . . . . . **CALL FOR BSW PRICE**

**3200PS Stereo**  
Mfg. list \$1,425.00 . . . . . **CALL FOR BSW PRICE**



## Model 3100 Slim Line

A compact and reliable playback cart machine. Includes Nor- tonics Duracore heads. Fast forward and additional cue tones are available as options.

**3100P Mono Play Only**  
Mfg. list \$1,250.00 . . . . . **CALL FOR BSW PRICE**

**3100PS Stereo Play Only**  
Mfg. list \$1,400.00 . . . . . **CALL FOR BSW PRICE**



## EVERYONE KNOWS ABOUT

- **BSW - Great Service**
- **BSW - Low Prices**
- **BSW - Million Dollar Inventory**
- **BSW - Toll Free Telephone Service**

PUYALLUP

PEORIA

**All Under One Roof  
For More Efficient And  
Economical Operation  
And The Savings  
Are Passed On To You**



**STUDIO  
PACKAGE DEALS**

**LEASING**

**All You Have To Do Is DIAL  
1-800-426-8434**

PAWTUCKET





## AUDI-CORD

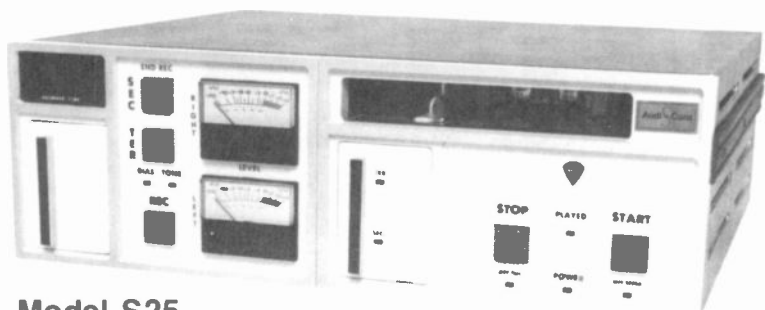

### Model S25 S Series Record/Play

- Plug-in companion to any similar playback. Easily field exchanged to distribute transport wear if desired.
- All front access operator controls in pull-out drawer.
- Multi-function meter system with automatic switching from record to replay.
- Dual recorder equalization—HI and LO.
- Internal 3 tone response check facility.
- Bias and tone recording indicators.
- Compatible with all known automation encoders.

- Mono S21**  
Mfg. list \$1,799.00 . . . . . CALL FOR BSW PRICE
- Stereo S26**  
Mfg. list \$1,989.00 . . . . . CALL FOR BSW PRICE
- Mono S11 Play Only**  
Mfg. list \$1,029.00 . . . . . CALL FOR BSW PRICE
- Stereo S16 Play Only**  
Mfg. list \$1,119.00 . . . . . CALL FOR BSW PRICE

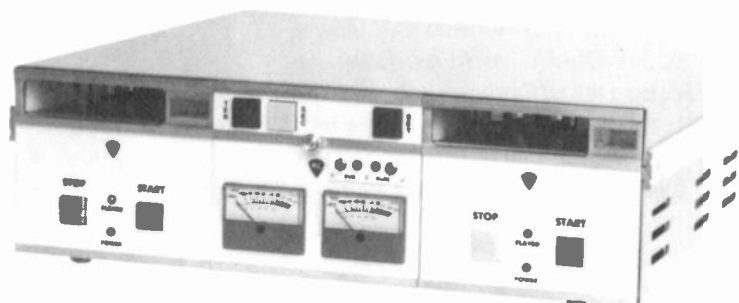

### Model E50 Twin Transport Record-Play

A brand new concept in record-play design. Most useful studio production machine ever produced.

- Regular Single Deck Recordings
- Dual Recordings
- Sound Over Sound
- Composites
- Copies (Dubs)

- E50 Mono**  
Mfg. list \$2,219.00 . . . . . CALL FOR BSW PRICE
- E55 Stereo**  
Mfg. list \$2,539.00 . . . . . CALL FOR BSW PRICE

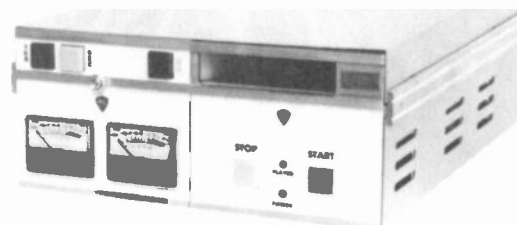

### Model E25 E Series Record/Play

- High quality, modest price
- Audio switching meters
- Unique slide-out panel for control access
- Secondary, tertiary tones available

- E20 Mono**  
Mfg. list \$1,379.00 . . . . . CALL FOR BSW PRICE
- E25 Stereo**  
Mfg. list \$1,619.00 . . . . . CALL FOR BSW PRICE
- E10 Mono Play Only**  
Mfg. list \$819.00 . . . . . CALL FOR BSW PRICE
- E15 Stereo**  
Mfg. list \$889.00 . . . . . CALL FOR BSW PRICE



### Model TD51 S Series Play Only Twin Deck

- Extensively modular design with plug-in circuit cards thru-out.
- SEC, TER and PLAYED signal lights for each deck.
- Replay reminder system with full selectable use options.
- Selectable 600 or 150 ohm balanced transformer audio outputs.
- Full +20dBm clipping point audio amplifier system.
- Complete remote control facilities.
- Automatic motor shut down when both carts have played

- TDS1 Mono**  
Mfg. list \$1,499.00 . . . . . CALL FOR BSW PRICE
- TDS6 Stereo**  
Mfg. list \$1,679.00 . . . . . CALL FOR BSW PRICE



# Cartridge Machines

## Dynamax™ By Fidelipac

### NEW and EXCITING

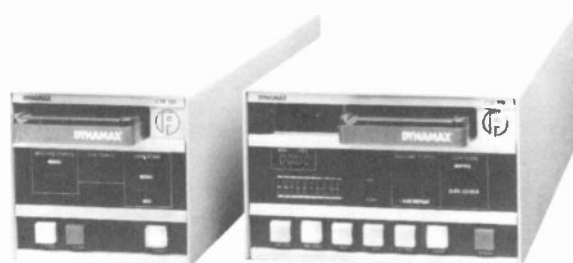

## REVOLUTIONARY CARTRIDGE MACHINES

### CTR 10 Series

The Dynamax CTR 10 series of cartridge machines provide unsurpassed audio performance and today's most desired operational features. Compact design allows up to 3 recorders and/or players to be placed side by side in the available rack mount.

- Standard fast forward feature
- All three cue tones standard
- High speed cueing
- Secondary tone allows control of both fast forward & audio muting
- Selectable front panel metering for audio, phase and cue tones on recorders
- Geometrically correct azimuth adjustment, independent of height and zenith
- On board audio switcher & mixer
- Transformerless audio circuitry
- Played indicator with selectable restart disable
- Industry proven AC synchronous motor for reliable operation & ease of maintenance

Model	Description	Mfg. list
CTR11	A Size Mono Play	\$1,150.00
CTR12	A Size Stereo Play	\$1,290.00
CTR13	A Size Mono Rec/Play	\$1,890.00
CTR14	A Size Stereo Rec/Play	\$2,350.00

**CALL FOR BSW PRICE**

### CTR 100 Series

The industry's most prominent name in tape cartridges now manufactures the cart machine that could become the standard of the broadcast industry. It is a revolutionary machine, designed by a team of respected engineers.

The CTR 100 Series embodies unique features not available in any other machine on today's market.

- Front Panel Diagnostics
- DC Servo Drive Motor
- Fast Forward
- Secondary and Tertiary Cue tones
- Low Voltage Constant Current Solenoid
- Audio Switcher and Mixer
- Status Display
- Audio Transformerless Circuitry
- 150 Hz Control of Audio Gate
- Group Delay Compensation
- Crystal Controlled Reference for All internal Functions
- Front Panel 1 kHz Add and Defeat
- Fully-switchable Metering with Automatic Changeover Function
- Two Speed *Played* Flashing Indicator
- Played Restart Disable
- Active Bias and Signal Mixing
- Constant Current Recording
- Bar Graph LED Level Indicators
- Improved Heads for Flat Low Frequency Response
- On-board Test Oscillator
- Splice Finder

Model	Description	Mfg. list
CTR111	A Size Mono Play	\$1,900.00
CTR112	A Size Stereo Play	\$2,060.00
CTR123	B Size Mono R/P	\$3,135.00
CTR124	B Size Stereo R/P	\$3,465.00

**CALL FOR BSW PRICE**

# Cartridge Machines



## ITC/3M

### INTERNATIONAL TAPETRONICS CORPORATION

**CALL FOR THE  
BSW "EVERYDAY"  
LOW PRICE**



**Delta I Reproducer:** High speed recue and triple cue tones standard. Accepts "AA" cartridges. NAB 1975 equalization or CCIR. 110-240V; 50/60 Hz. 5 5/8"W x 12"D x 5 1/4"H.

Mono . . . . . Mfg. list \$1,995.00  
Stereo . . . . . Mfg. list \$2,155.00  
**CALL FOR BSW PRICE**



**Delta IV Recording Amplifier:** Works with Delta I, Delta II, or Delta III to provide recording and reproducing capability. 5 5/8"W x 12"D x 5 1/4"H.

Mono Mfg. list \$1,225.00  
Stereo Mfg. list \$1,325.00  
**CALL FOR BSW PRICE**

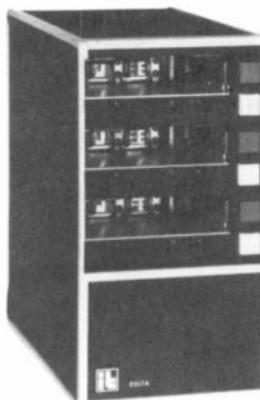

**Delta III Reproducer:** All three decks are removable independently for servicing. Triple cue tones Standard. Accepts "AA" sized cartridges. NAB 1975 equalization or CCIR. 110-240V; 50/60 Hz. 5 5/8"W x 12"D x 10 1/2"H.

Mono . . . . . Mfg. list \$4,345.00  
Stereo . . . . . Mfg. list \$4,695.00  
**CALL FOR BSW PRICE**

**ESL V Eraser/Splice Locator:** Improved design capable of erasing new technology cartridges. Accepts NAB "A" & "AA" size cartridges. Combines cartridge erasing & splice locating in a single, automatic high speed operation! Call BSW for more information.

5 3/4"H x 5 3/4"W x 12"L.

Mfg. list . . . . . \$995.00  
**CALL FOR BSW PRICE**

## ERASER SPLICE LOCATOR

## OMEGA Series

Affordable Performance You Can Trust

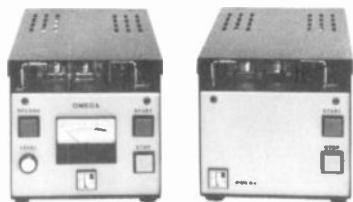

**CALL FOR  
THE  
BSW PRICE**

**OMEGA Mono Reproducer**  
Mfg. list \$1,050.00 . . . . . **CALL FOR BSW PRICE**  
**OMEGA Stereo Reproducer**  
Mfg. list \$1,195.00 . . . . . **CALL FOR BSW PRICE**  
**OMEGA Mono Recorder/Reproducer**  
Mfg. list \$1,575.00 . . . . . **CALL FOR BSW PRICE**

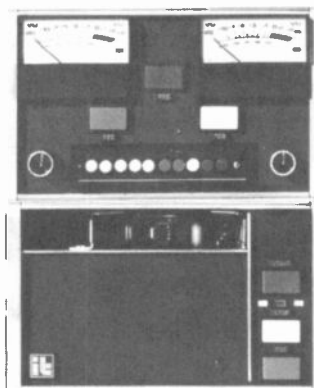

**Series 99B Recorder/Reproducer:** A new generation of cartridge machines. Accepts NAB "AA" and "BB" size cartridges. Includes high-speed cue tones. NAB (1975) equalization. ELSA function (Erase, Locate, Splice, Azimuth) optional. Table top mounting. 8 1/2"W x 15 1/2"D x 5 1/4"H.

**RPM-Mono**  
Mfg. list \$4,425.00 . . . . . **CALL FOR BSW PRICE**  
**RPS-Stereo**  
Mfg. list \$5,025.00 . . . . . **CALL FOR BSW PRICE**  
**RPME-Mono**  
ELSA Mfg. list \$5,550.00 . . . . . **CALL FOR BSW PRICE**  
**RPSE-Stereo**  
ELSA Mfg. list \$5,995.00 . . . . . **CALL FOR BSW PRICE**  
**Series 99B Reproducer Only:** Playback version of above.  
**PM-Mono**  
Mfg. list \$2,580.00 . . . . . **CALL FOR BSW PRICE**  
**PS-Stereo**  
Mfg. list \$2,795.00 . . . . . **CALL FOR BSW PRICE**



# Cartridge Machines & Cassette Decks

## Tapecaster



### Model X-700RP

- Precision adjustable head bracket
- Super-torque hysteresis synchronous motor
- Heavy duty air-damped solenoid

#### SPECIFICATIONS

Equalization: NAB Standard

Frequency Response:  $\pm 2\text{db}$  50-12,000Hz @ 7.5 IPS.  
 $\pm 3\text{db}$  40-15,000Hz @ 7.5 IPS.

Distortion: 2% or less.

Signal to Noise Ratio: 55db or better.

Wow and Flutter: 0.2% or less @ 7.5 IPS.

Tape Speed: 7.5 IPS.

Input (Line): 0.1 Volt (Bridging)

Input (Microphone, 150 ohms): .5 mv.

Output: 0 dbm @ 600 ohms.

Cue-Tones: Primary—1,000Hz (stop)  
Secondary—150Hz (optional)

Cueing Accuracy: 0.1 second.

Starting Time: 0.05 second.

#### PLAYBACK

##### X-700P Mono

Mfg. list \$695.00 . . . . . **CALL FOR BSW PRICE**

##### X-700PS Stereo

Mfg. list \$895.00 . . . . . **CALL FOR BSW PRICE**

#### RECORD/PLAY

##### X-700RP Mono

Mfg. list \$995.00 . . . . . **CALL FOR BSW PRICE**

##### X-700RPS Stereo

Mfg. list \$1,295.00 . . . . . **CALL FOR BSW PRICE**

##### X-700RPD Mono Delay

Mfg. list \$1,150.00 . . . . . **CALL FOR BSW PRICE**

### Model X700P Play Only

## TASCAM

FOR PROFESSIONAL USE ONLY



### 122-B

#### Studio Cassette Recorder/Reproducer

- 3 heads: erase-record-play
- 2 speed 1 7/8 - 1 3/4 ips.
- Front panel line inputs (unbalanced)
- Dolby HX-Headroom extension circuits and Dolby B
- +4 dbm balanced/ -10 dbv unbalanced inputs and outputs
- Optional dbx II interface
- Memory rewind and replay
- Adjustable bias and EQ select

Mfg. list \$825.00 . . . . . **BSW PRICE \$726.00**



### Model 133B

#### Stereo Plus Cue Cassette Recorder/Reproducer

The TASCAM Plus Stereo Cue Cassette Recorder/Reproducer with extensive auto present features.

- Two position cue select for compatibility with all analog or digital programming units
- +4 dBm Balanced/ -10 dBv Unbalanced Inputs and Outputs
- 2-Motor, Soft-Touch Logic Control Transport
- 2-Speeds: 1 7/8 and 3 3/4 ips
- Switchable Mic/Line Inputs
- Dolby Noise Reduction System
- Input and Output Level Controls for each Channel
- "Simul-Sync" Recording for Multitrack Recording Auto Present Features
- Cue Pulse/generates a 25 Hz tone on the cue channel, does not affect projector operations, but triggers the auto present
- Automatic shutoff or rewind at cue tone

Mfg. list \$1,300.00 . . . . . **BSW PRICE \$1,144.00**

## Fostex MULTI-TRACKER 4 CHANNEL CASSETTE RECORDER

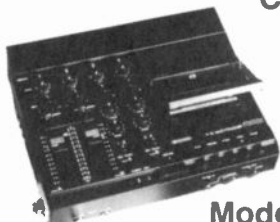

A mini-recording studio with maxi capabilities. A four track cassette recorder with built-in mixer.

### Model X15

Truly portable, works on batteries; its own or your car's as well as AC.

The Most Capability  
The Most Affordable

Call for BSW Price  
Mfg. list \$495.00

## BG ENGINEERING CARTRIDGE TIMING DEVICE

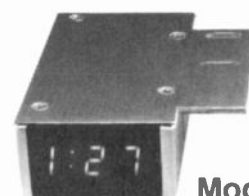

### Model BGE T1

FITS MOST  
CARTRIDGE MACHINES

BSW PRICE . . . . . **139.99**



## Technics



**Model RS-B100**  
**Replaces Model RS-M85 MKII**  
**dbx, Direct Drive 3 Head**  
**Stereo Cassette Deck**

Insist on the highest fidelity from all your listening sources. Reward yourself with the RS-B100 from Technics. The RS-B100 employs a closed-loop double capstan system which completely isolates the tape from adverse influence. It also features quartz lock and direct-drive. The recording and playback head gaps are separated. Optimized, amorphous-alloy, laminated construction offers excellent frequency response and distortion characteristics. A direct-coupled recording and playback amp circuit system is enhanced with phase compensation and linear feedback—real waveform fidelity. It's the Technics' flagship. The RS-B100 employs three noise reduction systems—dbx & Dolby B-C NR. The result—an uncompromising deck.

Mfg. list \$800.00 . . . . . **BSW PRICE \$645.00**

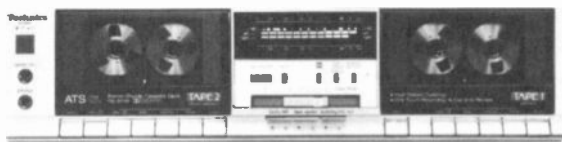

**Model RS-B11W**  
**High Speed Dubbing Stereo Cassette Deck**  
**More Than Two Decks in One**

The RS-B11W is easier to use than two separate decks. And so much more. With this high speed dubbing stereo cassette deck you can copy and at about twice the normal speed. Performance is outstanding, thanks to the metal compatible MX head, FL meters, and soft-touch controls.

**High Speed Dubbing**

Copy one tape in half the time. Copy two tapes as fast as you could make one copy on ordinary decks. No extra connections. Just put your master cassette in one side of the RS-B11W and put a blank cassette in the other side. A valuable convenience when you need tape copies for production or sales.

Mfg. list \$210.00 . . . . . **BSW PRICE \$198.00**

**NOBODY**  
**Offers Better**  
**Service Or Prices**

**NOBODY**



**And**  
**We're As Close**  
**As Your Telephone**

**TOLL FREE**  
**1-800-426-8434**

## Technics

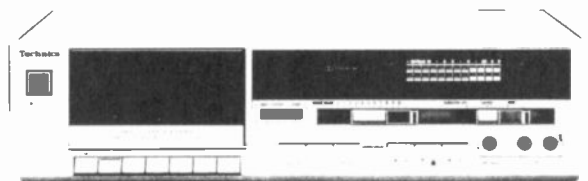

**Model RS-B18**  
**dbx/Dolby B-C NR Cassette Deck**

Since it expands dynamic range to 110dB, dbx permits successful recording of all sources. Dolby B and C NR are included for compatibility. Soft-touch control provides convenient and flexible operation including cue and review and one-touch recording. Mechanical logic control allows direct mode switching from ff (or rew) to play. FL meters for accurate signal referencing. Slider-type input level and balance controls. MX head optimizes sound quality and reliability. Unattended recording and automatic playback are possible with connection of an optional timer unit. Wow & flutter: 0.07% WRMS. Frequency response: 20—17,000Hz (Metal). S/N ratio: 92dB (dbx in, CrO<sub>2</sub>).

Mfg. list \$180.00 . . . . . **BSW PRICE \$165.95**



# Cassette Decks

## Panasonic

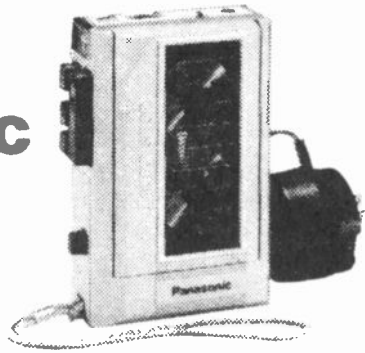

### Model RQ-350

• Mini Monaural Cassette Recorder • AC/Battery Operation with Included AC Adaptor • Digital Tape Counter • Full Auto Stop • One Touch Recording • High/Low Mic Sensitivity • Lockable Pause • Cue and Review • Edit Function • LED Indicator • Easy-Matic Recording • Built-In Condenser Mic • Carry Strap Included • DC-In, Mic, Remote, Monitor Jacks.

**BSW PRICE.....\$37.95**

## Scribe Recorders, Inc.

### The Scribe Recorder

The first portable cassette recorder specifically designed for broadcast news departments. Features include:

- Rugged all metal construction
- Reliable cassette mechanism
- XLR mic input
- Balanced output - line level
- Talk over for field mixing
- Made in the USA!



Call For More Specifics

**BSW PRICE.....\$350.00**

- One Location
- One Telephone Number
- One Million Dollar Inventory

**MEANS  
LOW PRICES  
GOOD SERVICE**

**TOLL FREE 1-800-426-8434**



## marantz



### PMD-430 Stereo Portable Cassette

- Dolby B noise reduction
- dbx noise reduction
- 3 Heads
- Pitch control
- Bias fine adjustment
- Auto shutoff
- Memory rewind
- Auto replay
- 3 Position mic attenuators (0-5-30db) limiter
- 3 Position tape selector (metal, CrO<sub>2</sub>, normal)
- Illuminated VU meters
- 3 Digit tape counter
- 4 Way power supply
- Built-in speaker
- Headphones
- Output jack

Mfg. list \$449.95..... **BSW PRICE \$399.95**



### PMD 221 Mono Portable Cassette Recorder

Deluxe Portable Three-Head Two-Speed Cassette Recorder

- 3-Head Design
- Two-Speed 1 7/8 and 15/16 IPS
- Full Auto Shutoff
- 3-Way Power with Low Battery Indication
- Vu Level Indication
- Switchable Limiter
- 3 Position Mic Attenuation (0, 10, 20, dB)
- Built-in Monitor Speaker
- 3-Digit Tape Counter
- Direct Telephone Connective Jack
- Telephone Pickup Jack Modular
- Line Input and Output Jacks
- External Speaker Jack
- Anti-Roll Transport
- Vari-Speed
- 3-Position Tape Selector (Normal, CrO<sub>2</sub>, Metal)
- Automatic or Manual Record Level
- Built-In Electret Condenser Microphone
- Cue and Review
- Volume and Tone Control
- 3-Position Automatic Noise Cancel Switch
- External Mic Jack
- Headphone Jack
- Memory Rewind and Replay

**PMD 221**  
Mfg. list \$279.95..... **BSW PRICE \$235.00**

**PMD 201 (Same As Above Except 2 Head Design)**  
Mfg. list \$219.95..... **BSW PRICE \$185.00**

### Accessories

Carry Case..... **BSW PRICE \$25.00**  
Rechargeable Battery Pack... **BSW PRICE \$35.00**

# Cassette Decks and Compact Disc Players



## TANDBERG



### Professional Cassette Deck

#### Model TCD910 Master Cassette Recorder

The most sophisticated cassette deck available to the broadcast industry.

**Microprocessor control:** This "computer in a tape deck" controls such functions as:

- Transport safety; auto end stop, damaged or defective tape, tape improperly inserted.
- Tape tension including wind, rewind, cue, play and record modes.
- Auto slack take-up prior to all function responses.
- Up to 10 cue points in real time can be retained in a volatile memory.
- Auto search by cut gaps, by program cut number.

#### Tape transport and head system

Reliability of the tape drive system is paramount in any professional application. The TCD 900 transport has been designed from the start with all this in mind. This drive system features:

- Four servo control motors — one each iron coreless spooling, one dc. servo frequency generator capstan drive and one dc. servo pinch roller/head bridge actuation.
- Constant wind three speeds — standard wind is: one second wind equals one minute play/record. Slow wind and search cut speed is 1/2 that of standard speed. Cueing speed is further reduced to 1/4 for easy locating.

Mfg. list \$1,995.00 . . . . . **BSW PRICE \$1,855.95**



#### Model TCD 911 Playback Cassette Deck

All The Same Features Of The TCD 910 Except In A Playback Only Format.

Mfg. list \$1,795.00 . . . . . **BSW PRICE \$1,669.95**

## REVOX

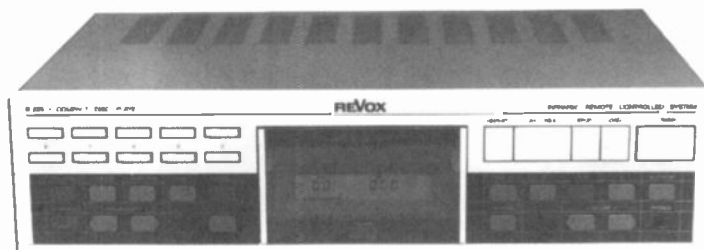

### PROFESSIONAL COMPACT DISC PLAYER

#### Model B-225

Advanced micro computer controlled electronics fulfills the functions expected in a complete system with

### ALL THE BELLS & WHISTLES

#### A FULL RANGE OF FEATURES.

Almost every conceivable feature has been realised by REVOX: professional programming capacity with 19 program steps, extremely short cueing times, calibration tone for adjustment of system levels, adjustable headphones output and two audio outputs. The "oversampling" technique developed in Europe, eliminates distortion of frequencies above half of the sampling rate without affecting phase relationship and guaranteeing highest sound resolution.

Mfg. list \$1,150.00 . . . . . **BSW PRICE \$898.00**

### *discwasher*

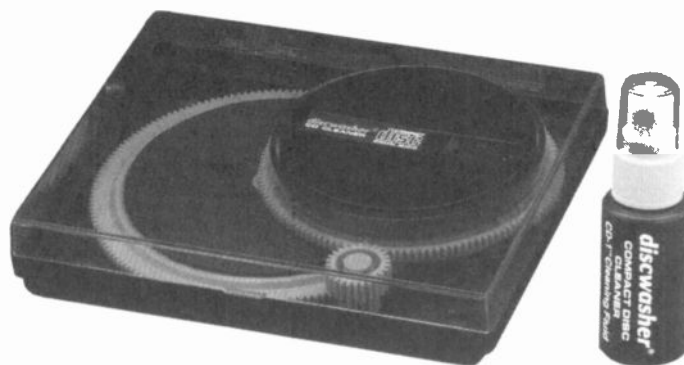

### Compact Disc Cleaner

The new compact disc's need to be cleaned for better quality response and sound. Discwasher has developed the best C.D. cleaner on the market.

**BSW PRICE . . . . . \$15.50**



# Consoles

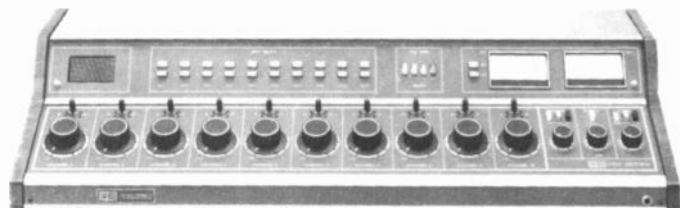

### Model 10S250

The Model 10S250 Stereo Console accommodates 20 inputs into 10 mixing channels. It features ladder-step attenuators, modular plug-in electronics, contact-free bus selection, telephone-type channel key switches, four line-level outputs and talkback capacity. Mono mix-down option available as a plug in module. Durable front panel graphics are designed for years of service.

### Model 10S250 Stereo

Mfg. list \$5,795.00 . . . . . **CALL FOR BSW PRICE**

### Model 10M250 Mono

Mfg. list \$4,650.00 . . . . . **CALL FOR BSW PRICE**

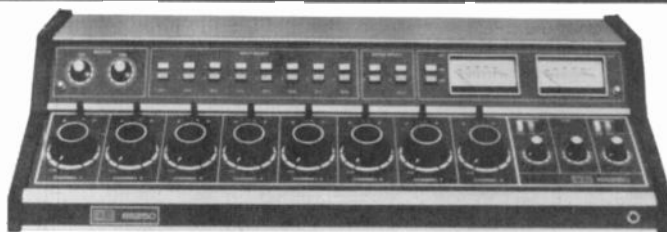

### Deluxe 250 Series Rotary Mixer Consoles

Featuring ladder-type maintainable step attenuators with cue bus switching, telephone-type channel keys and contact-free FET bus selection. Separate monitor, headphone and cue channels. Field proven modular plug-in electronics. Two pushbutton preselection and microphone/high level capability for each mixing channel. Stereo models include mono/stereo mode switching. Front panel graphics are under a laminated polycarbonate overlay for maximum durability.

**Model 5M250 Deluxe 5-Mixer Dual Channel Mono**  
Mfg. list \$2,695.00 . . . . . **CALL FOR BSW PRICE**

**Model 5S250 Deluxe 5-Mixer Stereo**  
Mfg. list \$3,550.00 . . . . . **CALL FOR BSW PRICE**

**Model 8M250 Deluxe 8-Mixer Dual Channel Mono**  
Mfg. list \$3,595.00 . . . . . **CALL FOR BSW PRICE**

**Model 8S250 Deluxe 8-Mixer Stereo**  
Mfg. list \$4,650.00 . . . . . **CALL FOR BSW PRICE**



### Model 4S50 4 Mixer Stereo

Features high/low input sensitivity selection, cue switches on all faders and individual monitor, cue and headphone amplifiers. Allows preselection of eight input sources with intermix and level control of four of these simultaneously. Ideal for stereo production or on-air use.

### Model 4S50

Mfg. list \$1,995.00 . . . . . **CALL FOR BSW PRICE**

### Model 4M50 4 Mixer Mono

Mfg. list \$1,050.00 . . . . . **CALL FOR BSW PRICE**



### 150 Series

Mixing controls are of sealed potentiometer, high reliability, long-life design, each equipped with cue bus switches. The 150 Series features contact-free FET bus selection and plug-in modular electronics. Each mixing channel accommodates two pushbutton-selected inputs, and may be preset for either microphone or high level service. Stereo models include mono/stereo mode switching. Headphone and cue amplifiers insure full-monitoring capability. Front panel graphics are under a laminated polycarbonate overlay for maximum durability.

**Model 5M150 5-Mixer Dual Channel Mono**  
Mfg. list \$2,295.00 . . . . . **CALL FOR BSW PRICE**

**Model 5S150 5-Mixer Stereo**  
Mfg. list \$2,850.00 . . . . . **CALL FOR BSW PRICE**

**Model 8M150 8-Mixer Dual Channel Mono**  
Mfg. list \$2,795.00 . . . . . **CALL FOR BSW PRICE**

**Model 8S150 8-Mixer Stereo**  
Mfg. list \$3,550.00 . . . . . **CALL FOR BSW PRICE**

**Model 10M150 10-Mixer Dual Channel Mono**  
Mfg. list \$4,195.00 . . . . . **CALL FOR BSW PRICE**

**Model 10S150 10-Mixer Stereo**  
Mfg. list \$5,150.00 . . . . . **CALL FOR BSW PRICE**

LOOK PROFESSIONAL

CONSOLE LABELS

296 LABELS PER SHEET

15.95

LOOK SHARP!





## LPB

### CITATION SERIES

LPB's TOP OF THE LINE CONSOLE

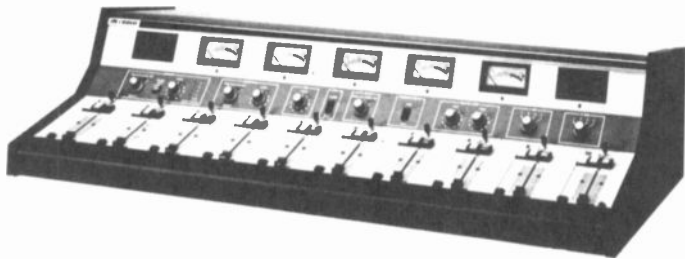

**Model C-10S 10 Channel Dual Stereo Console  
Shown with Optional VU Meters**

**Features**

- Pre-fader cue
- 3 inputs per mixer
- Illuminated on/off switches
- Remote start on each channel
- Attractive, elegant styling

**What can you say about LPB engineering and dependability. They simply always work and they work very well.**

**Model C-10S 30 Inputs**

Mfg. list \$7,995.00.....CALL FOR BSW PRICE

**Model C-8S 8 Channel 24 Inputs**

Mfg. list \$6,995.00.....CALL FOR BSW PRICE

## LPB

### SIGNATURE SERIES

THE WORKHORSE

LONG TIME FAVORITE

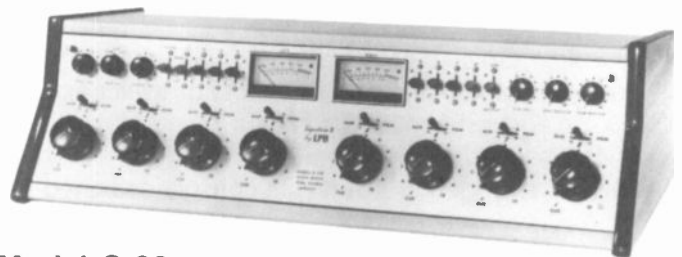

**Model S-20**

**10 Channel Dual Stereo**

- 30 inputs
- Step attenuators
- LED peak indicators
- Pre-wired for simulcast option

**The dependable console. Takes abuse and keeps on playing along. The versatility and dependability that keeps cost down.**

**Model S20**

Mfg. list \$5,395.00.....CALL FOR BSW PRICE

**Model S-12 5 Mixer Stereo**

Mfg. list \$3,395.00.....CALL FOR BSW PRICE

**Model S-13-C 8 Mixer Stereo/Mono**

Mfg. list \$4,495.00.....CALL FOR BSW PRICE

**BSW IS OPEN  
SATURDAY  
FOR YOUR  
CONVENIENCE**



**Check Saturday  
Hours On Back  
Cover**



# ATI

**Model BC8DS**

**Dual Stereo Console**

- 2 Stereo program outputs
- 12 Balanced inputs with 2 assignable mic preamps
- 8 Mixer rotary or linear faders DBX VCA's

**ALL THIS AND MORE — ONLY**

Mfg. list \$2,995.00.....CALL FOR BSW PRICE



# Consoles



## Model 500SC

- 8 channels
- 25 balanced inputs total
- Balanced program and audition outputs with mono mix down
- VCA level controls - stereo tracking to within 1dB
- DC controlled audio - no audio on pots or switches
- NE5532 integrated circuits
- External regulated power supply

The 500SC is a rugged and versatile console designed for 'ON THE AIR', production, or portable broadcast applications. Plug in construction enables the engineer to replace defective PC boards quickly and easily. DC control means there is no audio on any of the pots or switches. This dramatically improves pot and switch life. All switching functions are silent and extremely reliable.

## Model 500SC8S Stereo

Mfg. list \$2,999.00 . . . . . **CALL FOR BSW PRICE**



## Model 2000SC

### Features

- 12 channels
- 24 balanced inputs total
- Penny and giles slide faders
- VCA level controls - stereo tracking within 1dB
- DC controlled audio - no audio on pots or switches
- Remote start standard
- Telephone mix minus buss standard

The 2000SC is designed for easy of operation, uncompromising performance, and maximum durability. Each of the 12 channels features a single input per channel. Two remote select switches bring in an additional 14 inputs. Cue is accomplished by a detent on the slide fader while lighted momentary switches actuate the Program and Audition busses. VU meters monitor both the Program and Audition busses simultaneously. What console can be simpler to operate. Remote start is actuated by the Program and Audition switches.

## Model 2000SC12S Stereo

Mfg. list \$4,695.00 . . . . . **CALL FOR BSW PRICE**

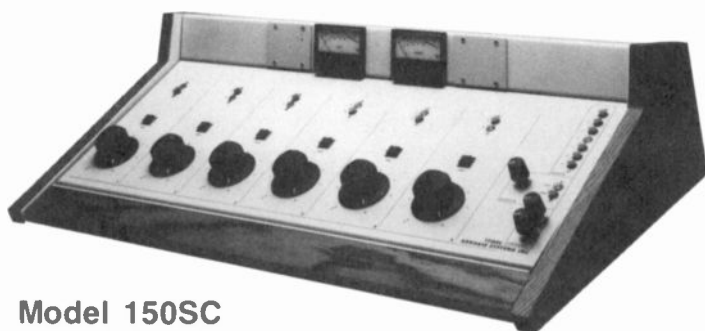

## Model 150SC

The 150SC is specifically engineered to provide levels of durability, features, and performance previously unavailable in consoles in this price range. The 150SC is ideally suited for small ON AIR, production or newsroom studios.

The 150SC has 6 channels which each have 2 inputs. The A input can be either mic or line level. A 7 input remote select switch completes the total inputs. A lighted latching switch above the rotary fader is the channel ON/OFF switch. A two position interlocked switch above the ON/OFF switch performs the input selection. Monitor, earphone and cue controls are on the right side of the console. The monitor amp is 10 watts per channel and is selectable between an external input and Program. The earphone amp is 2 watts and automatically selects between the monitor switch and cue. The cue amp is 2 watts and selected by a detent on the individual rotary fader. All three amps have individual level controls on the front panel. A built in muting relay (3PDT) is provided for on air lights, telephone, muting, and logging recorders. The 150SC is logically laid out for fast and efficient operation.

## Model 150SC6S Stereo

Mfg. list \$1,995.00 . . . . . **CALL FOR BSW PRICE**



## Model 2100SC

Has all the features of the 2000SC shown above: but gives you 34 balanced inputs.

## Model 2100SC12S

Mfg. list \$5,695.00 . . . . . **CALL FOR BSW PRICE**



## RAMKO

TOUGH SOPHISTICATION  
IN A BROADCAST CONSOLE

14 MODELS TO  
CHOOSE FROM

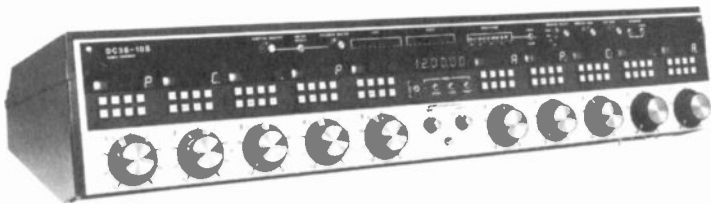

### Model DC 38-10S Console

#### Features

- Dual channel
- 5, 8, & 10 mixer versions
- 4 inputs per mixer
- Plug in electronics
- Differential balanced inputs and outputs
- DC control—no audio on front panel
- Zero tracking error on stereo consoles
- 3 power supplies w/AC line filtering
- High Z bridging inputs
- Switch selectable cue and mute on all inputs
- Back-lit status displays
- Built-in talk back
- Solid state led VU meters
- Mono/phase meter on stereo consoles
- Optional digital clock and production timer
- Optional remote equipment start/stop

## FOUR YEAR WARRANTY

No console is easier to service. If something should go wrong, you simply push two buttons and the front panel hinges down for complete accessibility to all components. All modules (including the supply), IC's and other crucial components are plug-in. Lighted LED's tell the status of the supply voltages at a glance.

Mfg. list \$8,325.00 . . . . . CALL FOR BSW PRICE

## RADIO SYSTEMS

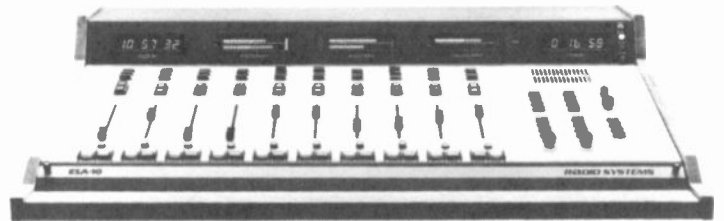

### Model ESA-10 Stereo Console

The ESA-10 continues Radio Systems tradition of superb audio performance. Transformerless design, careful component selection and state-of-the-art engineering yield incredibly low distortion at full band width and remarkably low noise levels.

#### Standard Features

- 30 inputs into 10 linear faders
- 2 stereo outputs, each with mono mixdown
- 3 stereo LED meters with peak hold
- 2, 4 position auxiliary switchers
- 5 internal mic pre-amps (5 additional-optional)
- 10 remote start circuits
- 3 muting circuits
- Time of day clock
- 5 segment up-counter
- Hydraulically assisted front panel lift
- Input and output barrier strip connectors
- Internal cue speaker and amp.
- Internal test oscillator
- Internal set-up meter

Mfg. list \$9,950.00 . . . . . CALL FOR BSW PRICE

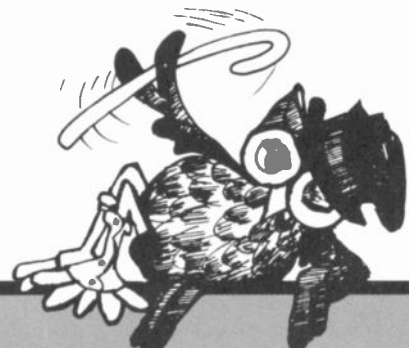

**WE ARE READY FOR BUSINESS  
WHEN YOU ARE . . . . .  
12 HOURS DAILY**



## Consoles

---

### The UREI 1650, 1680 and 1690 Broadcast Consoles

- Nine models on-air boards
- Choice of 5-mixer, 8-mixer or 12-mixer units.
- Choice of Penny & Giles, Shallco or conductive plastic attenuators
- +24 dBm output into 600-ohm load
- Better than 90 dB signal to noise ratio
- Built-in monitor, headphone and cue amplifiers
- Built-in cueing loudspeaker
- Competitively priced

The UREI 1650, 1680 and 1690 series Broadcast Consoles are a complete line of nine on-the-air boards with the features most requested by engineers and consultants and with full UREI quality, yet priced within the budget of the small-market station.

These consoles offer a choice of five, eight, or twelve mixers and a choice of attenuator types as well. There is ample provision for customization to fit individual station requirements, but no accessories are required to put them on the air—each board is ready to operate as supplied from the factory.

# UREI BROADCAST CONSOLES

## NINE MODELS Rotary Or Slide Faders

### FAMOUS UREI QUALITY

FACTORY PRICED FROM \$2700.00 - \$7000.00

## CALL FOR BSW PRICE

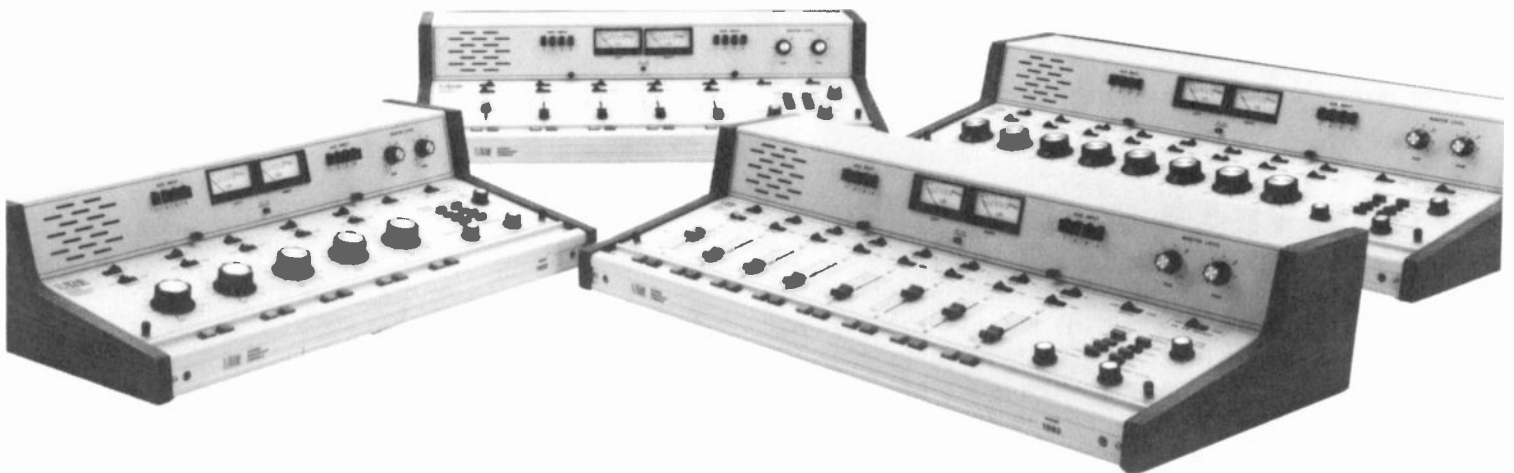



## AUTOGRAM

### BUILT LIKE A BRICK AND LASTS FOREVER

Autogram consoles feature modular construction, remote control on all channels, a high-level cassette input and, of course, famous Autogram engineering.

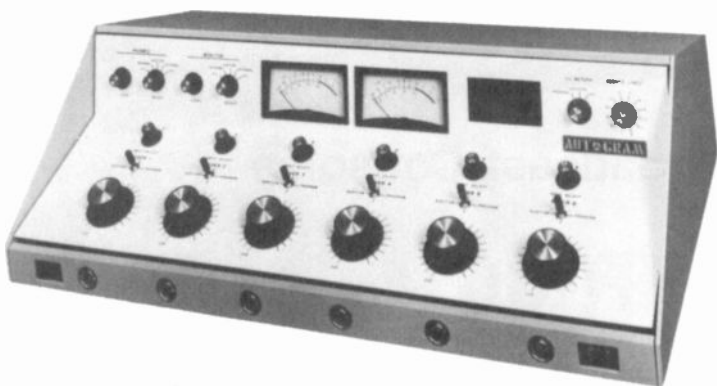

**Model AC-6**  
Mono/Stereo Console  
6 Channels 23 Inputs

**AC-6 Mono**

Mfg. list \$4,485.00 . . . . . CALL FOR BSW PRICE

**AC-6 Stereo**

Mfg. list \$5,114.00 . . . . . CALL FOR BSW PRICE

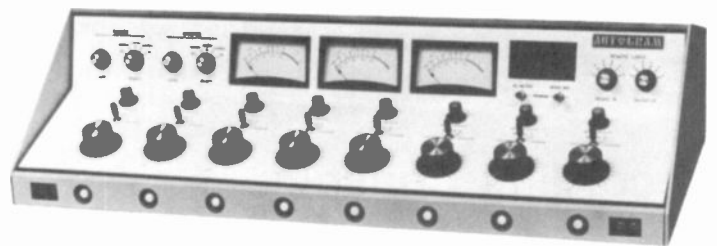

**Model AC-8**  
Mono/Stereo Console  
8 Channels 26 Inputs

**AC-8 Mono**

Mfg. list \$5,676.00 . . . . . CALL FOR BSW PRICE

**AC-8 Stereo**

Mfg. list \$6,405.00 . . . . . CALL FOR BSW PRICE

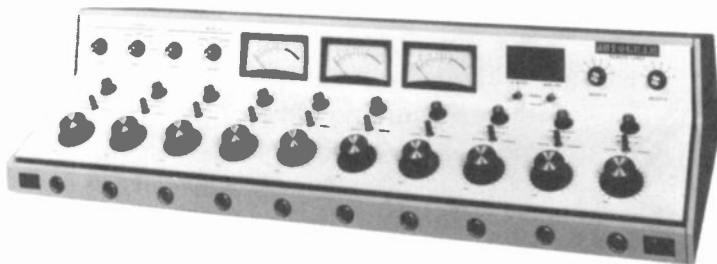

**Model IC-10**  
Mono/Stereo Console

10 channels - 28 inputs

#### THE HARD WORKING IC-10

This is the unit that developed Autogram into a long term respected console manufacturer.

**IC-10 Mono**

Mfg. list \$7,803.00 . . . . . CALL FOR BSW PRICE

**IC-10 Stereo**

Mfg. list \$8,614.00 . . . . . CALL FOR BSW PRICE

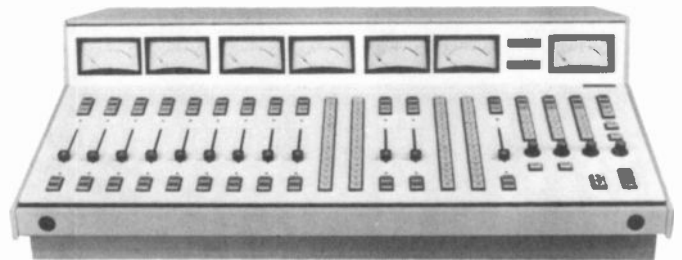

#### Autogram's Advanced Microgram® Audio Console

**FLEXIBLE, SINGLE POINT CONTROL FOR ALL ON-AIR OPERATIONS**

Autogram's Microgram microprocessor controlled audio console is a powerful addition for any broadcast control room. It's built to handle board functions with ease while signaling and mixing numerous prescheduled events simultaneously. The Microgram console can handle three stereo audio busses simultaneously; or run two completely separated automation systems on AM and FM, and still leave a bus open for production; or allow one bus to call another bus for simulcasting and other special situations. In fact, the Microgram console can perform just about any control room function you want it to: from handling your daily schedules; to joining and leaving local or network programming; to turning on or off a coffee pot and station lights.

**CALL FOR PRICE & CONFIGURATION**



# Consoles

## RAMSA



### Recording Console

## WR8210A

#### Compact-Size Versatile Performance

The Ramsa WR-8210A is a compact versatile 10 x 4 mixing console designed for multi-track recording. Although it is designed for compactness, it meets the requirements of a wide variety of recording applications.

Mfg. list \$1,995.00 . . . . . **CALL FOR BSW PRICE**



### Broadcast Consoles

## WR-8616

#### On Air or Production Console

- Expandable to 16 balanced inputs.
- Stereo line inputs available.
- Left and right stereo outputs, XFMR balanced.
- Extremely cost effective.
- Meets broadcast configuration standards.
- Remote Start-Stop control for cart machines, turntables, etc.
- Extensive metering facilities.

**CALL BSW FOR PRICES AND CONFIGURATIONS**



## WR-500

#### Remote/Recording Mixer

- Portable mixer, ideal for remote recording applications or sound reinforcement.
- Inputs 1 through 8, with peak level indicators, are the XLR-type, and comprise a balanced input system through high quality operational amplifier circuitry.
- Echo input and output contains high and low equalizers for adjustment of sound balance ( $\pm 12\text{dB}$  at 100Hz and 10kHz).
- Each balanced and unbalanced outputs are provided.
- Can be connected to CUE or echo effect unit through PRIMIX outputs and can be connected to echo effect unit through FROM ECHO to ECHO.
- Two VU meters.
- Three way power capability, Battery 10V DC, and AC Line.
- Built in rugged flight case.
- Rack mount option.

Mfg. list \$1,195.00 . . . . . **CALL FOR BSW PRICE**



## Howe Audio Consoles

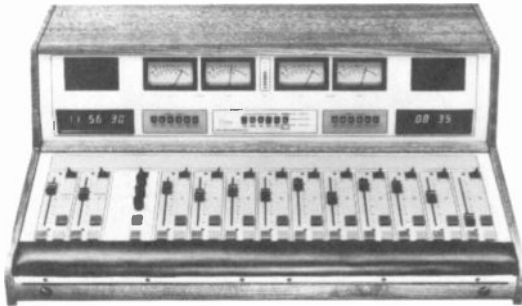

### Series 7500 Model 7512A

12 Faders, 22 Inputs

HOWE AUDIO 7512A CONSOLES are unrivaled in quality and cost efficiency. Their sleek styling and professional design assure years of dependable operation. All Howe Audio consoles come complete with a three year warranty backed by 24-hour-a-day, 7-day-a-week service. Equip your facility with the best...the HOWE AUDIO SOUND SOLUTION!

Mfg. list \$10,500.00 . . . . . **CALL FOR BSW PRICE**

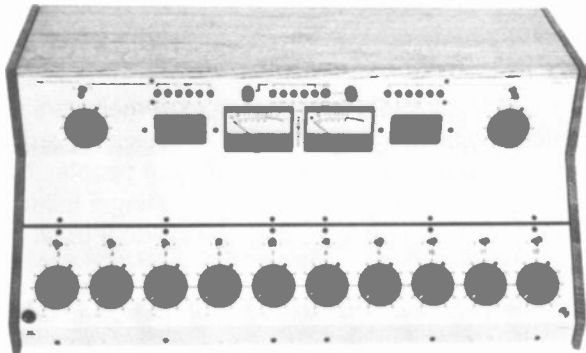

### Series 7000 Model 7012

The Howe Audio 7012 is a twelve-fader, twenty-two input console with stereo program, audition, and mono program outputs. Careful attention to operator efficiency has been given to the design of the 7012. The control panel is sloped for comfortable operation from a standing or sitting position. Each program-audition switch contains extra contacts for convenience of the user.

A peak-reading, ten-position LED meter is located in the middle of the upper panel. The meter is connected to the "air" position of the monitor to give the operator convenient visual indication of the modulation levels.

The 7012 is more than a console. It is an eye-catching piece of studio furniture. Its hardwood cabinet blends with any decor. The subtle earth-tone control panels will add just the right touch to your control room.

Mfg. list \$6,900.00 . . . . . **CALL FOR BSW PRICE**

## SERIES 9000—THE ONLY MODULAR AUDIO CONSOLE WITHOUT A MAIN FRAME



### Series 9000

**Howe 9000 Series.** . . a new concept in consoles. The only modular consoles that do not require the broadcaster to purchase an expensive main frame. This means a substantial savings to you, yet still affords you the ability to add on channels and features at a later time.

The Series 9000 consoles are available in sizes from 8 to 22 channels. Check these features and compare them with the other modular consoles.

- 3 inputs per channel
- 3 outputs per channel, including mix-minus
- Each channel can be either mic or line level
- TTL Digital Logic for machine controls, assignable to each of your input selections
- Membrane switches for spill and dust proof service
- Linear faders designed to resist spillage
- VCA level control for the cleanest audio possible
- LED Status indicators for each channel function
- Standard analog V.U. meters
- Optional Vacuum Fluorescent meters
- Built-in Cue Speaker
- Built-in Headphone Amp
- Your choice of a clock or timer standard in smaller units
- Both clock and timer standard in larger units

. . . All this and much more, making the **Series 9000** consoles from Howe Audio clearly the best value for broadcasters now and in the coming years.

Mfg. list \$8,995.00 — 21,825.00 . . . **CALL FOR BSW PRICE**

**Call for the BSW Everyday Low Price**

**3 Year Warranty  
Price Based on Configuration**



# Consoles

## TASCAM FOR PROFESSIONAL USE ONLY

### Model 106

- 6 input channels with selectable inputs, provide:
- 6 MIC IN
- 6 LINE IN
- 4 RIAA PHONO IN
- 4 PGM busses
- AUX buss with master level control
- EFFECT buss with master level control
- Rack Mount Kit Available



Mfg. list \$595.00 . . . . . CALL FOR BSW PRICE



**Model 208**  
**8 Input**  
**4 Buss**  
**2 Aux**  
**Stereo Buss**

- ★ All Channels Selectable Mic/Line or Tape Input
- ★ All Channels Balanced Mic Inputs
- ★ 2 Program Outputs For Buss

Mfg. list \$995.00 . . . . . CALL FOR BSW PRICE

## TASCAM'S New 500 Series



### Model 512

Tascam has introduced the new Series 500 consoles designed for production professionals. Built to accommodate either +4 dBm or -dBV nominal levels in and out.

The M-512 has 12 input channels, 8 track monitor section and power supply built into the mainframe. The M-520 (not shown) has 20 inputs, 16 monitor section and outboard power supply.

With features galore, the 500 Series consoles lend themselves to radio and television production recording studios and editing rooms.

Mfg. list \$3,995.00 . . . . . CALL FOR BSW PRICE

# STUDIO 8

**COMPLETE STUDIO  
 THE WORKS  
 ONE NEAT LITTLE PACKAGE**



### Studio 8

The TASCAM 388 "STUDIO 8" is an extremely versatile tool for creative people in a variety of fields; musicians, arrangers, composers and film/video post production people. The 388 is a complete recording system incorporating a full-function 8-in/8-buss mixer and a full servo controlled 8-track reel-to-reel recorder.

The mixer section includes 8 input channels, 8 PGM output busses, L/R stereo busses, Aux buss, Effect buss, 2 Effect return systems and Monitor section. Each input channel offers; wide range XLR balanced input, 1/4" line input, Access send/receive, 3-band parametric EQs, etc.

The recorder section was adopted compact 1/4" tape, 7" reel, 8-track format. We designed the new 3-motor full servo-controlled mechanism for the "STUDIO 8". Features include; Real time counter, SMPTE compatibility, Locator functions, built-in dbx with on/off (1-4 & 5-8) and ch. 8 defeat switches, and TAPE LOAD mode. The servo system and rec/play amps can be aligned and adjusted easily from the top.

Mfg. list \$3,495.00

**CALL FOR BSW  
 SPECIAL PRICE**





**MICRO-TRAK**



### Studiomaster 505

- Built-in phono preamp
- 25 watt monitor amp (mono only)
- Cues on all channels
- Headphone amp and jack
- 5 Channels, 9 inputs
- Large VU meter

### Mono 505

Mfg. list \$1,469.00..... **CALL FOR BSW PRICE**

### Stereo 505S

Mfg. list \$2,150.00..... **CALL FOR BSW PRICE**

**Rack Mount Version Available**



### Model 6510 DBS

#### Dual Buss Broadcast Consoles

- 10 channels
- 14 inputs
- Low cost-high performance
- Proven VCA technology
- Rotary faders-ruggedized
- Plug-in parts
- Easy maintenance

### Stereo 6510 DBS

Mfg. list \$3,495.00..... **CALL FOR BSW PRICE**

### Mono 6510 DBM

Mfg. list \$3,150.00..... **CALL FOR BSW PRICE**

## 5 MIXER SINGLE BUSS

### Stereo 6509 RS

Mfg. list \$1,995.00..... **CALL FOR BSW PRICE**

### Mono 6509 RM

Mfg. list \$1,795.00..... **CALL FOR BSW PRICE**



Headphones  
not included

### Model SLX Portable Console

The SLX is a complete, self contained remote broadcast package with a built in frequency extender encoder. The SLX provides facilities for 4 microphones, 3 headphones, 2 tape inputs. It is capable of feeding up to two program loops (telco or RF) and two dial telephone lines, simultaneously. A third dial telephone interface is provided for communications. A comprehensive headphone matrix permits custom monitor mixing, plus talk back to the studio. Complete telephone dial interface is included.

Mfg. list \$3,495.00 w/case. **CALL FOR BSW PRICE**

## THE DITTY DESK



**EASILY FITS  
IN YOUR  
STATION WAGON**

- Low cost remote broadcasting package
- 5 channel console
- Tonearms
- XLR termination panels
- Formica covered
- Chrome legs
- Technics SP25 turntables

### Mono 6509 RM Ditty

Mfg. list \$1,795.00..... **CALL FOR BSW PRICE**

### Stereo 6509 RS Ditty

Mfg. list \$3,795.00..... **CALL FOR BSW PRICE**



# Consoles-Remote

## MAXI-TEL

### For The Best Remote Broadcast

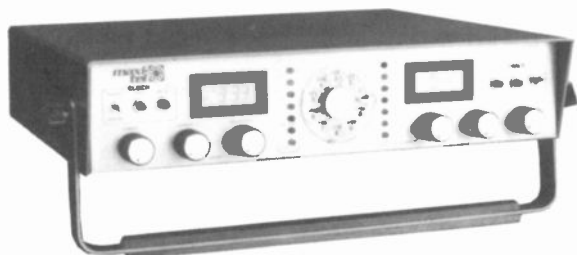

#### Maxi-tel Remote Console

Human Engineering Designed System, the only controls you need while broadcasting are in front of you-no more cluttered control console. 4 mic line channels. Spotter channel, 4 headphone jacks and much more.

Mfg. list \$825.00.....CALL FOR BSW PRICE



#### The Sport III Remote Console

A professional-quality self-contained portable sports console featuring three headphone outputs for announcer and spotter, auxiliary input for commercials, talk-back capability for set-up and a telephone dial option. AC and battery power supplies are built-in, with automatic switchover in case of power loss. Attractively packaged in self-contained carrying case.

#### Sport III with 2 mic Inputs

Mfg. list \$699.50.....CALL FOR BSW PRICE

#### Sport IV with 4 mic Inputs

Mfg. list \$849.50.....CALL FOR BSW PRICE

**NEW**  
From **RUSSCO**



**NO  
EXTERNAL  
POWER  
NEEDED**

#### Telemote T-321 Remote Console

Here's the Remote Mixer you've been waiting for! The STELLAR SERIES TELEMOTE 321 gives you two low impedance microphone inputs and one medium impedance tape recorder input in a handy-dandy 3 pound package. What makes this tiny dynamo so unique is that it requires no batteries or any other external power source except your phone line. That's Right! The 321 works right off your dial or touchtone phone line feed!

Mfg. list \$550.00.....CALL FOR BSW PRICE

## TOLPOX

#### Model TFX-131A Remote Console

- Push button dialing with memory redial
- LCD clock stopwatch/timer
- 4 mic inputs-2 aux. inputs
- Tone oscillators
- Closed circuit spotter channel
- Built-in carrying handle
- Superior audio quality



Mfg. list \$795.00.....CALL FOR BSW PRICE

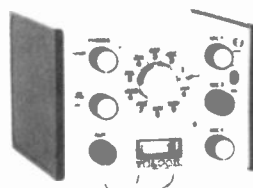

#### Model TFX-31C Telephone Remote Console

A "feature-packed" miniature self-contained telephone remote unit with everything needed for sports and news broadcasts.

- Built-in telephone dial, line amplifier, buzzer and light for incoming calls. No phone company equipment needed.
- Three microphone inputs, plus an auxiliary input for a cassette recorder. Each input has its own pot. An auxiliary output jack is also provided for feeding a recorder or PA system.
- Built-in headphone amplifier with two output jacks for headphones. Monitors phone line at all times.

Mfg. list \$595.00.....CALL FOR BSW PRICE



## SHURE

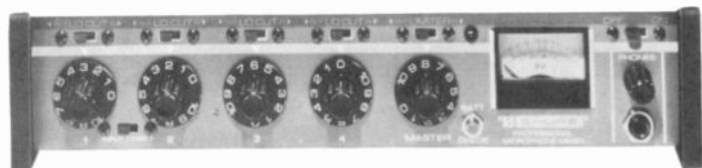

### Model M267 Professional Microphone mixer

The Shure M267 offers performance and capabilities never before available in a modestly priced mixer. It has all the features that made the Shure M67 the industry standard mixer, plus additional features and performance improvements that promise to make it the new industry standard. New features include... PEAK LIMITER, PHANTOM POWER, BUILT IN BATTERY PACK, LED PEAK INDICATOR, HEADPHONE LEVEL CONTROL. The M267 has four mic or line switchable inputs. It also includes transformer balanced inputs and outputs, mix bus, VU meter, low RFI and line noise susceptibility.

Mfg. list \$440.00.....**CALL FOR BSW PRICE**



### M268 Professional Microphone Mixer

The M268 is a compact, lightweight, five-channel microphone mixer that offers significant improvements in design, performance and versatility over other value-priced mixers including the Shure M68. It is ideal for public address and paging in hotels, schools, community centers, and hospitals, as well as an excellent add-on mixer for expanding current equipment. It is also an excellent mixer for use by the serious tape recording enthusiast.

Mfg. list \$257.00.....**CALL FOR BSW PRICE**

### Model FP31 Compact Portable Mixer

A compact, portable microphone mixer specially designed for electronic news gathering (ENG) and electronic field production (EFP) use. Measuring just 6 5/16" x 5 5/16" x 1 7/8", the FP31 incorporates the features most requested by audio engineers, electronic news professionals, sportscasters, and film and video sound engineers. Three XLR connector inputs and two outputs are provided, each switchable for either microphone or line-level operation. Incorporated in the FP31 is a built-in slate microphone for voice announcements and emergency field use.

Mfg. list \$830.00.....**CALL FOR BSW PRICE**



## EV Electro-Voice



### Model ELX-1 Portable Microphone Mixer

Versatility and uncompromising audio performance. The ELX1 mixer packs the features you've asked for. In the studio or in the field, the ELX1 delivers the same exceptional performance that has made EV equipment the standard of the broadcast industry.

#### Features

- 4 mic or line inputs
- Phantom power
- Peak Limiter
- AC/DC power
- Headphone amplifier
- 1 khz tone oscillator
- balanced inputs/outputs

The ELX-1 meets the challenge of news gathering, sports coverage, or studio production.

Mfg. list \$532.00.....**CALL FOR BSW PRICE**

## PRIMUS

By Ramko



### Model PM42 Portable Mixer With Built-In Intercom

The ideal, ultra compact, audio mixer for ENG, remote broadcasts or any other application where high performance and reliability are required in a battery operated package. Includes slate and level set tones, built in intercom system, and phantom power capability.

- 4 balanced inputs. All adjustable mic thru high level
- Cueing on all inputs
- Switch selectable compression. +7dBm and +14dBm.

Mfg. list \$398.00.....**CALL FOR BSW PRICE**



# Headphones

**AKG**  
ACOUSTICS



### Model K-240M

The K-240M is the first totally sound-and comfort-engineered headphone incorporating all the features necessary for complete listening enjoyment accurate stereo imagery, outstanding fidelity of reproduction at all listening levels, extreme comfort with virtually no fatigue under prolonged use.

Mfg. list \$99.00..... **BSW PRICE \$82.75**

 **SENNHEISER**



### HD 414 SL

Introducing the worthy successor to the famous HD 414—the largest selling headphone in history. The HD 414 SL features improved transient response and wider dynamic range. Like all Sennheiser headphones, the new HD 414 SL is perfect for digital sound.

Sennheiser's Open-Aire technique, plus new contoured cushions, adjustable headband and advanced structural design, make owning the HD 414 SL a most pleasurable experience.

Mfg. list \$84.00..... **BSW PRICE \$74.95**

**Model HD410SL**  
**Open Air and**  
**Cost Effective at \$43.95**  
Mfg. list..... \$49.00

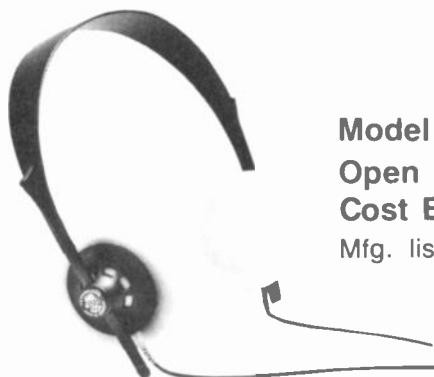

**Fostex**



### Model T 20 Studio Headphone

Patented RP (Regular Phase) System combines the accuracy and smoothness of an electrostatic with the simplicity and durability of a dynamic. For comfort, performance, and broadcast durability.

Mfg. list \$79.00..... **CALL FOR BSW PRICE**

**KOSS**

Model K/20  
**TWICE THE SOUND**  
**AT HALF THE PRICE**

**ONLY**  
**\$19.95**

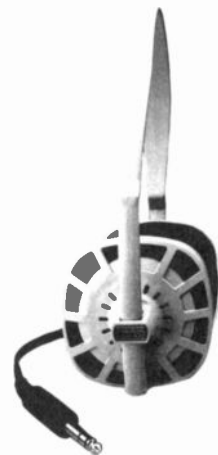

### Model K6X

- Low angle dynamic drivers deliver wide frequency response
- Extra-wide headband construction provides maximum comfort
- Stainless steel yokes and slide bars

**BSW PRICE.....\$29.95**



### Model K6XLC

- Low angle, minimum-distortion drivers offer breathtaking clarity and fidelity
- Slide bar controls on each ear cup adjust volume and balance
- Extra-wide adjustable headband for maximum comfort
- Unique ear cushion design creates acoustical seal for superior bass

**BSW PRICE.....\$39.95**



# Headsets



## SENNHEISER



### Model HMD224 Remote Headset

- Sealed ear cushions guard against ambient noise
- 16-20,000Hz frequency range headphone
- 50-12,000Hz frequency range microphone
- Soon to be the new industry standard

Mfg. list \$220.00 . . . . . **BSW PRICE \$195.00**

## TELEX



### Model PH92 Sportcaster Headset

- Push-to-cough switch
- Omni-dynamic microphone

Mfg. list \$225.00 . . . . . **BSW PRICE \$169.95**

## Astrolite

**MADE FAMOUS  
BY  
ALL THE MAJOR  
NETWORKS**



8650 Omni Microphone Electret . . . . . **BSW PRICE \$259.00**  
8649 Cardioid Microphone Electret . . . . . **BSW PRICE \$259.00**  
436B Omni Microphone Dynamic . . . . . **BSW PRICE \$208.00**

## BEYER

### Model DT109K Headsets

A headphone/microphone combination for heavy duty use. All parts easily interchangeable. Comfortable to wear over long periods of time. Hypercardioid microphone has excellent noise-cancelling qualities.



Mfg. list \$153.00 . . . . . **BSW PRICE \$139.95**

## SHURE

### SM1 and SM2 Headsets

Shure Models SM1 and SM2 are professional quality headsets that provide maximum comfort, durability and sound reproduction—designed for broadcasting applications. The SM1 (one ear cue) and SM2 (two ear cue) are loaded with deluxe features that make them an ideal choice for professional TV and Radio broadcasters, film and video production crews and other A/V professionals.

Headset features include: a patent boom mount for total flexibility in microphone positioning—the boom adjusts for left or right side use; an all metal boom that is less subject to damage; a rugged, double-braced all metal headband with leather-like covering; and large “pillow-soft” ear pads for maximum comfort as well as superior external noise isolation.

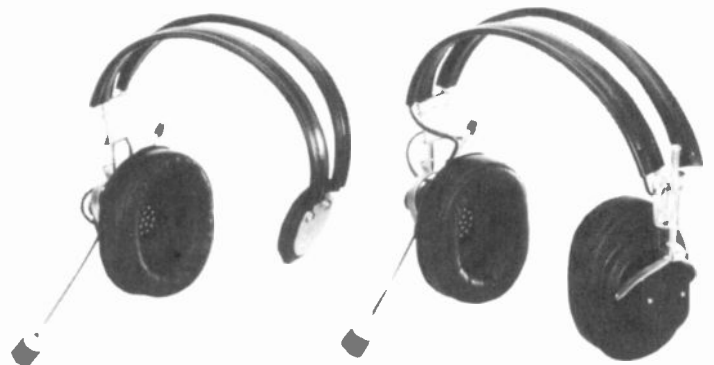

### Model SM-1

Mfg. list \$175.00  
**BSW PRICE \$149.95**

### Model SM-2

Mfg. list \$200.00  
**BSW PRICE \$169.95**

**CARDIOID POLAR  
PATTERN**



# Microphone Accessories

**BSW Stocks a variety of microphone accessories  
Call 1-800-426-8434 for the accessories you need**

## ProCable



**Model Series IIB  
25 Ft. XLR to XLR Mic Cable**  
Excellent quality, outstanding value

**BSW PRICE. \$15.95 ea. 4 or More . . . \$12.50 ea.**



**Audix Transformers  
AT-52**

Impedance matching transformer XLR type low in to 1/4" high.

**BSW PRICE . . . . . \$21.45**



**AT8410A**

Universal shock mount with clothespin clamp. Fits most sizes and shapes of microphones.

**BSW PRICE . . . . . \$27.50**

**AT8407**

Universal clothespin clamp holds virtually all tubular and tapered body microphones.

**BSW PRICE . . . . . \$8.65**



## ACCESSORIES FOR SENNHEISER MICROPHONES

**MZW 421 Windscreen . \$23.35  
MZW 40 Windscreen . . \$27.55**

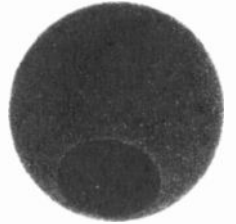

**HZL26-3 Mic Cable  
XLR to Open End . . . \$16.30**

**MZA 421 Stand Clamp  
For MD421U . . . . . \$25.50**

**MZA 441 Stand Clamp  
For MD 441U . . . . . \$35.60**

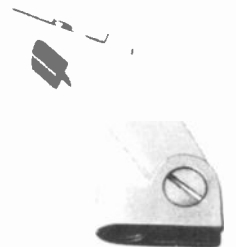

## Windscreens

**A2WSA for SM57 . . . . \$10.85  
A61WS for SM58, 78 . . . \$4.70  
90A2089 for SM7 . . . . \$7.40**



## Stand Clamps

**A25B for SM57,58 . . . . \$3.75  
A57D for SM59, 60, 61 . \$12.20  
A55M Isolation Mount . . 35.55**



## Stand Clamps



301: Stand clamp for 1" to 1 1/8" diameter microphones. Allows snap-out use. Black or gray  
**BSW PRICE . . . . . \$8.50**



310: Stand clamp for 3/4" microphones. Allows slip-out use. Black or gray  
**BSW PRICE . . . . . \$8.50**



312: Stand clamp for 3/4" microphones. Allows snap-out use. Black or gray  
**BSW PRICE . . . . . \$8.50**



## Electrical Accessories

AC24: Phantom power supply. AC24M provides remote power for two microphones from standard 117 VAC power. Expandable in multiples of four to accept up to 10 microphones by using AC24S Expander Modules.

**AC24S BSW PRICE . . \$121.00  
AC24M BSW PRICE . . \$143.00**

## Windscreens

314: For RE10 and RE15 mikes. Zippered for easy installation. Rear portion can be used on RE11 and RE16 for wind protection.  
**BSW PRICE . . . . . \$18.00**



314E: For 631B and 635A. Can be used for pop protection only on front of 660, 661, RE10 and RE15.  
**BSW PRICE . . . . . \$8.50**



355A: For D054, RE55, 654A, 655C mics  
**BSW PRICE . . . . . \$8.50**



# Microphones & Accessories



## Multi-Color Windscreens Sets

Used by many entertainers and recording engineers. Blocks out unwanted pop, wind, noise and close talking hiss. Made from special soft cut foam, decorative in design. These multi-color screens add beauty to your microphones. Also identifies each so no mixup will occur when more than one microphone is used.

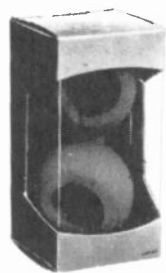

10-66



10-9

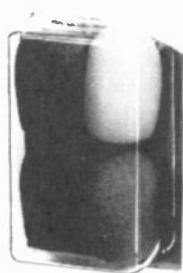

10-67



10-69

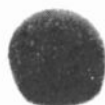

10-71



10-68



10-70

**10-9** (2 3/4" High Screen Universal Type—Fits slim models from 3/4" to 1 1/8") Color Black. **BSW PRICE \$1.35**

**10-66** Contains two 2 3/8" High screens to fit 1 3/4" to 2" dia. microphones, 1-Red, 1-Blue. **BSW PRICE \$4.60**

**10-67** Contains four 2 3/4" High screens to fit 1 3/8" to 1 3/4" dia. microphones, 1 each Red, Blue, Yellow, Black. **BSW PRICE \$5.00**

**10-68** Contains five screens for spherical head microphone 2 3/8" High to fit over 1 3/4" to 2" microphones. 1 each Red, Blue, Yellow, Green, Black. **BSW PRICE \$11.15**

**10-69** Contains four 7/8" High screens fit to 1/4" to 1/2" microphone. Designed to fit lavalier type microphones. 1 each Red, Black, Yellow, Green. **BSW PRICE \$2.90**

**10-70** Contains four 1 1/8" High screens to fit 3/4" to 1" microphones. 1 each Red, Black, Yellow, Green. **BSW PRICE \$5.00**

**10-71** Contains four 1 1/2" High screen to fit 7/8" to 1 1/8" ball head microphones. 1 each Red, Black, Yellow, Green. **BSW PRICE \$5.00**

## EV Electro-Voice



### Model RE 34 Cardioid Mic/Line Level Microphone

In the race for the ratings, when getting set up first means everything, the RE34 mic/line level condenser microphone saves valuable time. Specifically designed for ENG/EFP use, the RE34 combines mic and preamp in a single unit for convenient and reliable transmission. You'll have no more problems with "down-the-line" preamps getting stepped on, driven over or even dropped in puddles.

Nor will you go on location and find the mic you need is back at the studio. The RE34 is the only microphone available with switchable mic/line levels for compatibility with virtually any audio input.

And no other mic will make your story sound better. A cardioid microphone with an excellent front-to-back ratio and unusually consistent polar patterns, the RE34 has a field-proven tailored response that's ideal for hand-held interview and stand-up applications in news and sports reporting.

Mfg. list \$413.00

**BSW PRICE \$330.40**

## EV Electro-Voice

**NEW**



### RE98 Lavalier

The model RE98 is a miniature, omnidirectional, electret lavalier microphone designed specifically for the broadcast industry and sound reinforcement. The frequency response of the microphone is tailored to provide a full-range, well-balanced sound character with ultralow distortion for clean and accurate sound reproduction. The RE98 is designed to be attached to the performer's clothing using the supplied tie clasp or the optional 390 dual tie clasp with the electronics module clipped to the users belt.

**CALL FOR BSW PRICE**



CANARE MIC CABLE



TYPICAL 2 CONDUCTOR MIC CABLE

Canare professional microphone cable is a unique shielded 4-conductor microphone cable that blocks induced electromagnetic and electrostatic noise from the most problematic sources such as SCR dimmers and fluorescent lights.

**25 ft. XLR to XLR. . . . BSW PRICE \$18.95 ea.**  
**Model ECO25FA. . . . . 2 or more \$15.95 ea.**

**TIRED OF BACK ORDERS?  
TRY BSW**

**MILLION  
DOLLAR  
IN-HOUSE  
INVENTORY**





# Microphones



# Electro-Voice

## FOR BROADCASTING PROFESSIONALS



### Model RE-16 Super Cardioid

Dynamic element. 56 dB output.  
Built-in blast filter.

Mfg. list \$289.00

**BSW PRICE . . . . \$215.95**



### Model 635A Omnidirectional

Dynamic element, 55dB output.  
Very popular.

Mfg. list \$106.00

**BSW PRICE . . . . \$74.95**



### Model RE-15 Super Cardioid

Frequency response 80-15,000Hz

Mfg. list \$276.00

**BSW PRICE . . . . \$206.95**



### Model RE-20 Dynamic Cardioid

Dynamic element, 57 dB output.  
Integral blast and wind filter

Mfg. list \$532.00

**BSW PRICE . . . . \$398.95**

### Other Electro-Voice Microphones

Model 649B	Lavalier . . . . .	127.20
Model DO54	Omnidirectional . . .	128.00
Model DS35	Single D Cardioid . .	137.60
Model RE-10	Super Cardioid . . . .	147.20
Model RE-50	Omnidirectional . . .	128.80
Model RE-55	Omnidirectional . . .	213.60
Model RE-30	Omnidirectional . . .	330.40
Model RE-85	Noiseless Lavalier .	129.60



### Model RE-11 Dynamic Super Cardioid

Built-in blast filter

Mfg. list \$196.00

**BSW PRICE . . . . \$146.95**



### Model CO90 Omnidirectional Lavalier Mic

- Tie clasp lavalier, battery powered
- Includes tie clasp, belt clip, storage pouch

Mfg. list \$155.00 . . . **BSW PRICE \$124.00**



### Model RE-18 Shock-Mounted Super Cardioid

Combines the best performance features of the famous RE 15 and RE16 with superb mechanical noise insulation. Uniform frequency response at all angles for colored pickup on and off axis. Consistent sound quality at any working distance. Refined, low-profile blast filter.

Mfg. list \$300.00 . . . . . **BSW PRICE \$240.00**



### Model DO56 Shock-Mounted Dynamic Omnidirectional

Virtually impervious to mechanical noise. Isolated capsule design makes it the ideal microphone whenever there is lots of action. Built-in blast filter reduces "P-popping" to keep your audio clean.

Mfg. list \$134.00 . . . . . **BSW PRICE \$107.20**



# Microphones



## SHURE



**Model SM5B**  
**Unidirectional Dynamic**  
**Cardioid**  
 Boom microphone FR 50 to 15,000 Hz  
 Mfg. list \$551.75  
**BSW PRICE.....\$413.95**



**Model SM58LC (less cable)**  
**Self-Windscreened**  
**Unidirectional Dynamic**  
**Cardioid**  
 Mfg. list \$164.75  
**BSW PRICE.....\$131.80**



**Model SM7**  
**Unidirectional Dynamic**  
**Cardioid**  
 Output: 57 dB FR 40-16,000 Hz  
 Mfg. list \$510.00  
**BSW PRICE.....\$382.50**



**Model SM57LC (Less Cable)**  
**Unidirectional Dynamic**  
**Cardioid-Real Popular**  
 Mfg. list \$127.75  
**BSW PRICE.....\$102.20**  
**A2WSA Windscreen..\$10.85**



**Model SM63LC (Less Cable)**  
**Omnidirectional Dynamic**  
**Lightweight, Includes Cable**  
 Mfg. list \$110.00  
**BSW PRICE.....\$88.00**



**Model SM82LC**  
**Hand-Held Line Level**  
**Condenser Unidirectional**  
 Mfg. list \$365.00  
**BSW PRICE.....\$292.00**

## AKG



**D130E**  
**Dynamic**  
**Omnidirectional**  
 50-13,000 Hz  
**BSW PRICE \$87.75**  
 Mfg. list \$105.00



**D-330BT**  
**Dynamic**  
**Hypercardioid**  
 50-20,000 Hz  
**BSW PRICE \$175.45**  
 Mfg. list \$210.00



**D-12E**  
**Dynamic**  
**Cardioid**  
 30-15,000 Hz  
**BSW PRICE \$246.50**  
 Mfg. list \$295.00



**C-414EB/P48**  
**Dynamic**  
**Hypercardioid**  
 50-20,000 Hz  
**BSW PRICE \$697.50**  
 Mfg. list \$795.00



**D-190E**  
**Dynamic**  
**Cardioid**  
 30-15,000 Hz  
**BSW PRICE \$96.10**  
 Mfg. list \$115.00



**C-568EB**  
**Condenser**  
**Shotgun**  
 20-20,000 Hz  
**BSW PRICE \$246.50**  
 Mfg. list \$295.00



# Microphones



## SOUND GRABBER PZM TECHNOLOGY

The hottest new microphone concept for conferencing, news gatherings and meetings. Fantastic pick up qualities from all corners of the room. Pressure-zone-microphone technology.

Mfg. list \$99.00.....BSW PRICE \$69.95

# SONY



## Professional Omnidirectional Electret Condenser Microphone With Miniature Design

### Model ECM55S/B

The new Sony ECM55 series Lavalier microphones have been improved over Sony's ECM50 series. Some new benefits include:

- Output transformers have better tonal quality.
- Power supply has been redesigned for easy serviceability.
- 6000 hour battery life. Available in Silver or Black. Omnidirectional pick up pattern

Mfg. list \$235.00.....BSW PRICE \$199.75



## NO OVERLOAD NO MATTER WHERE YOU USE IT



### Model MD421-U In Studio or On Location

From a whisper to the roar of a full blown rock concert, nothing can overload the MD421—NOTHING.

Mfg. list \$332.00.....BSW PRICE \$199.00

### Model MZS-1 Shock MT (Mic stand clamp not included)

BSW PRICE.....\$15.95

### Model MD441-U Unidirectional Dynamic Studio Microphone

Sennheiser's top-of-the-line dynamic microphone. Designed for professional applications in broadcast, TV and film studios, but also perfect for first-class PA installations.

- Frequency range from 30-20,000 Hz
- Super-cardioid pattern
- Shock-mounted capsule to prevent handling noise.
- Highest SPL without distortion
- Ten different switchable response curves
- Built-in pop filter

Mfg. list \$469.00.....BSW PRICE \$415.85



# Microphones



Countryman Associates Inc.

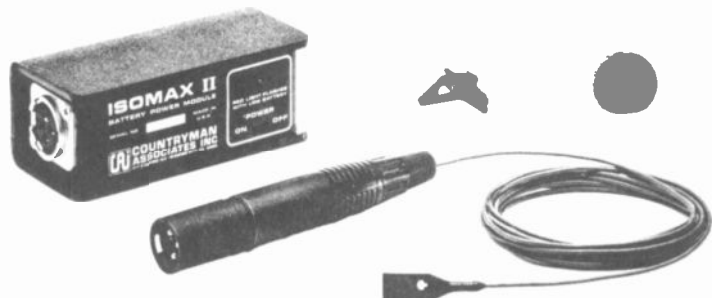

ISOMAX II H with wind screen, clip and optional battery power module.

## COUNTRYMAN ISOMAX II Series Precision Microphone

These microphones are precision electret condenser devices for professional recording and sound reinforcement. They feature:

- Excellent Frequency Response
- Wide Dynamic Range
- Very Low Noise
- Miniature Size
- Phantom or Battery Power

The ISOMAX II is a new family of microphones engineered to expand the highly successful ISOMAX PRO Series. Never before has such precise control of directional characteristics been available from such miniature microphones. Four different pick-up patterns are available: (1) Cardioid, (2) Hypercardioid, (3) Bidirectional and (4) Omnidirectional. The COUNTRYMAN ISOMAX II Series may be used in a wide variety of both general and exotic applications. Theatre, broadcast, film, musical instrument, sound reinforcement and certain acoustical measurements.

CALL FOR BSW PRICING AND CONFIGURATION

## RD SYSTEMS



## Model P650 EPM Parabolic Microphone

The EPM Parabolic Microphones are high performance unidirectional microphones perfectly suited to the requirements of the Motion Picture and Broadcast Industries, tape recording, monitoring and other professional or semi-professional applications.

The EPM is one of the most directional microphones ever produced; making it possible to record voices, sounds, practically anything - to professional standards without having the microphone anywhere near the subject being recorded.

## EXCELLENT SENSITIVITY

The EPM is capable of picking up and magnifying signals up to 75 times that of a normal omni-directional microphone while remaining virtually impervious to overload.

**BSW PRICE . . . . . \$399.00**  
**ASK ABOUT QUANTITY DISCOUNTS**



### AT802 Omni-Dynamic

Whether for broadcast, sound reinforcement, or recording, the AT802 is an essential part of any complete microphone collection. Often designated a "workhorse" microphone, its rugged dependability, simplicity, and freedom from handling noise makes it a favorite of news broadcasters for interviews and for TV news teams.

Mfg. list \$165.00  
**BSW PRICE . . . . . \$88.00**



### AT815A "Shotgun"

With the acceptance angle of approximately 40° at high frequencies, the AT815A provides a useful tool to overcome problems of noise or distance for radio or TV broadcasting, special stage applications, and motion picture dialogue recording. Its flat response and high output insures well-balanced, natural-sounding pickup.

Mfg. list \$385.00  
**BSW PRICE . . . . . \$189.95**



### AT812 Cardioid-Dynamic

For reliable, high quality sound reinforcement of musical instruments and general remote and studio broadcasting, the Model AT812 is the clearly logical choice. Housed in a sturdy, compact body, the rugged dynamic cardioid element has been tailored in response to solve the practical problems of professional sound engineers.

Mfg. list \$200.00  
**BSW PRICE . . . . . \$106.65**



# Microphones-Wireless

## PACKAGE DEALS AND LEASING



Ask Your BSW Representative for Details  
1-800-426-8434

# TELEX



**Model FME-2**  
**FM Wireless Mic Receiver**  
**Model WT-100**  
**Belt-Pack Transmitter**

The Telex wireless microphone system adds significant innovations to the state of the art. Innovations which not only make Telex an outstanding value among wireless systems, but provide performance capability that equals or exceeds that of wired microphone systems for professional applications. Applicable equipment is FCC type accepted.

Mfg. list \$890.00 . . . . . **CALL FOR BSW PRICE**

## Vega



**Econo-Mic ECS-2 Wireless Mic**

An economical professional quality system designed and priced for school, church, business and broadcasting.

Mfg. list \$653.00 . . . . . **CALL FOR BSW PRICE**



**Model 77/D11 Wireless Mic Transmitter**

Compact pocket transmitter equipped with Dynex II® Dynamic Expansion, offering lower noise and wider dynamic range. (Microphone not included)

Mfg. list \$983.00 . . . . . **CALL FOR BSW PRICE**



**Model R41 Wireless Mic Receiver**

Cetec Vega's PRO-PLUS wireless microphone receivers offer a new standard of performance with Dynex II®. Sensitivity, selectivity, and stability are exceptional.

Mfg. list \$1,763.00 . . . . . **CALL FOR BSW PRICE**

# Microphone Stands



## ProBoom

### Standard Brackets



A  
6.75



B  
6.75



C  
6.75



- LM1 41" Reach  
For 1 lb. Microphones  
LM2 26" Reach  
For 1 lb. Microphones  
LM1-3 41" Reach  
For 3 lb. Microphones

BSW Price  
Includes  
Standard  
Bracket

34.95  
34.95  
34.95

BSW Price  
Includes  
12" Pedestal  
Pro-Bracket

49.95  
49.95  
49.95

Pro-Bracket  
12" Pedestal  
Rugged All  
Aluminum

Colors  
Grey  
Oyster  
Natural

BSW PRICE  
17.95



Model  
51900

The Heavy Duty  
Mic Boom With  
12" Pedestal  
For Behind  
Equipment Placement

BSW PRICE . . 69.95

### AUDIOTEC Mic Stand

#### Our Best Seller

Boomstand with hinged feet. Maximum height: 62" without boom. Boom length 36".

Model S-99  
BSW Price 29.95

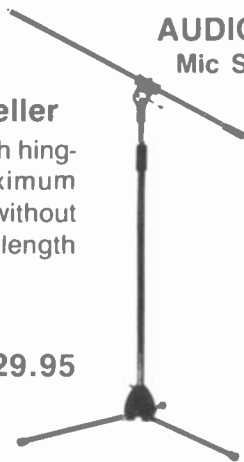

#### SB-36w Mobile Boom Stand

Grip-action clutch with integral air suspension to counterbalance boom weight. 5/8"-27 thread at microphone end. Boom length 62". Adjustable vertical height from 48" to 72". Rubber casters for mobility.

197.50

#### b. PB-1x Microphone Boom

Standard termination for microphone holder. Die-cast swivel, tapered counterweight, coordinated hardware. Attaches to any microphone stand terminating in 5/8" dia. tubing or adapter Grip-action clutch. Expandable from 31" to 50". (Blk. or Silv.)

27.95

#### c. DS-5 General Purpose Stand

Non-adjustable 4" high chrome tube. 6" dia. cast iron charcoal base.

8.85

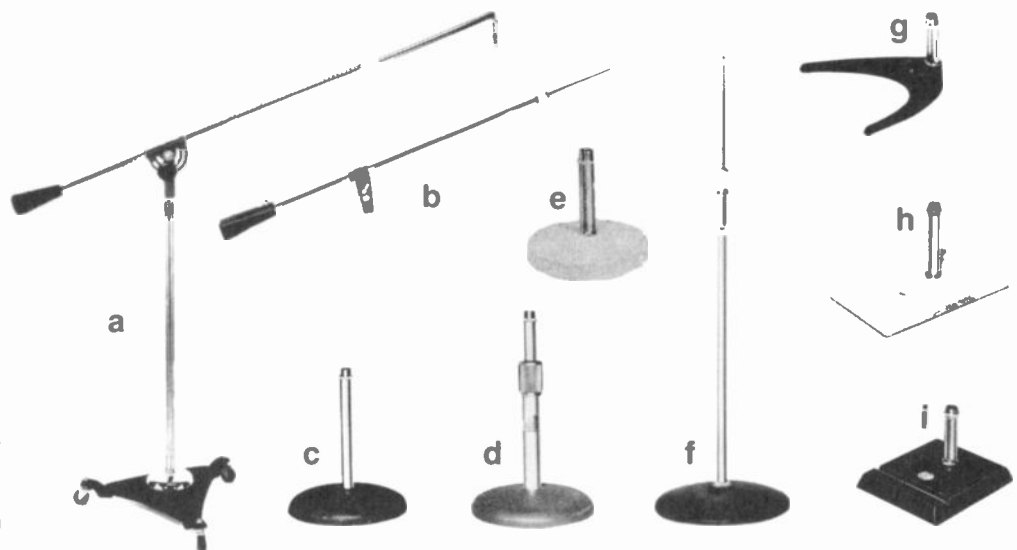

#### d. DS-7 Adjustable Desk Stand

Chrome tube assembly, adjustable height 8" to 13". Grip-action clutch. 6" dia. charcoal base. (Blk. or Silv.)

12.85

#### e. DS-4 Lightweight Stand

Non-adjustable 4" high chrome tube. 5" dia. phenolic beige base.

5.95

#### f. MS-12c General Purpose Stand

Grip-action clutch. Low-profile charcoal base with added weight for extra stability. (Blk. or Silv.)

23.90

#### g. DS-14 Contemporary Stand

For professional styled microphones. Non-adjustable 3" high chrome tube. Charcoal base.

11.60

#### h. DS-1 Executive Stand

Non-adjustable 3" high chrome tube. Luxurious 5" x 7" polished white carerra marble base.

21.80

#### i. DS-2 Vibration-isolating Stand

Non-adjustable 3" high chrome tube. Non-reflective 4" x 6" charcoal base.

16.98

## ATLAS MICROPHONE STANDS THE WORLD'S STANDARD



# Miscellaneous

## ProLite

### END LAMP REPLACEMENT FOREVER

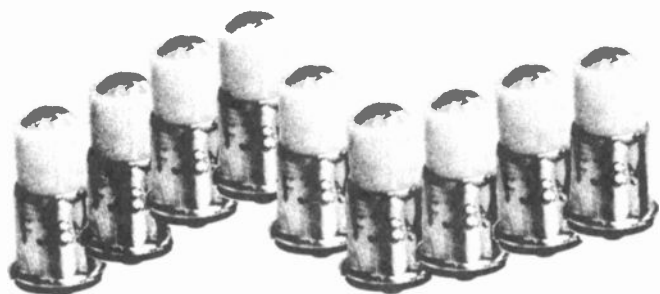

Relamp your incandescent sockets. Our based multi LED miniature lamps are exact replacements for T 1¼ and T 1¼ incandescent miniature lamps. Shock and vibration proof, they keep your lighted panel and switches going "on" for 100,000 hours.

#### COLORS

Red Yellow Green

- LOW POWER AND LOW HEAT CONSUMPTION
- SHOCK AND VIBRATION PROOF
- PERFECT REPLACEMENT BULBS FOR CART MACHINES!

### SAVE TIME SAVE MONEY

### RELAMP WITH PROLITE

### CALL BSW FOR PRICING & CONFIGURATIONS

## PHASE CHASER

By Howe Audio



#### Model 2100

The Phase Chaser is an electronically controlled precision time-delay network which corrects for the relative phase-errors between the left and right channels of a stereo audio signal.

This provides for optimum combining of left-plus-right signals for monaural compatibility. No other audio parameter is affected.

Mfg. list \$1,200.00 . . . . . **BSW PRICE \$1,097.50**

## ANVIL CASES

### FOR EVERY PURPOSE

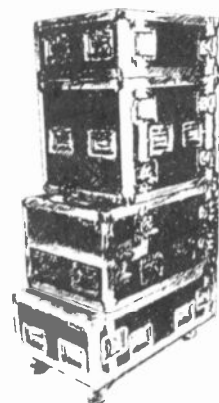

### COMPLETE SELECTION OF ELECTRONIC AUDIO AND/OR VIDEO SHIPPING & STORAGE CASES

Otari MX5050BII case

Mfg. list \$254.00 . . . . . **BSW PRICE \$227.95**



## DORROUGH LOUDNESS MONITOR

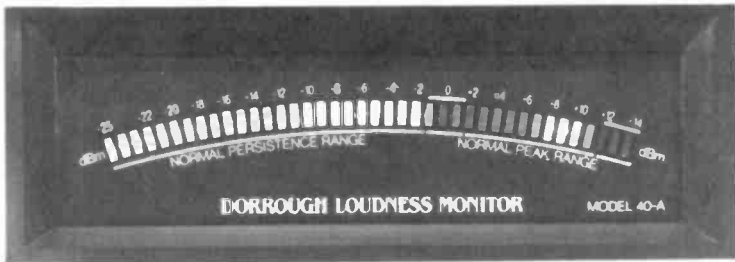

### Model 40-A

The Dorrough Loudness Monitor is an indicating device which displays the composition of the average acoustically related program material in visual form, as well as peak amplitude of the audio signal.

**BSW PRICE.....\$475.00**

## *RADIO SYSTEMS*



### LED METERING

#### For High Accuracy AND Visibility

Famous Radio Systems stereo LED meters, previously only available on their console line, are now packaged for stand-alone use.

These beautiful, high definition meters are tri-colored and switchable for peak level or VU indication. One double sized segment lights and holds to display audio peaks. Internal, independent level sets are provided for left, right and peak-hold channels.

The meters are available in a counter top box, or rack mounted in groups of 1, 2, 3, or 5 meters. The meter can also be purchased with a bracket and bezel for custom mounting. Every meter is provided with a companion power supply/amplifier board that provides all operating voltages and balanced audio inputs.

**CALL BSW FOR  
CONFIGURATION-PRICE-SPECIFICATIONS**

## ONAN PORTABLE POWER GENERATORS



### Model K450

No matter what the application, ONAN'S new tag along generators are there to get the job done. Portable power when you need it, where you need it. Two models, 450 and 1000 watts.

**K450 BSW PRICE.....\$329.95**

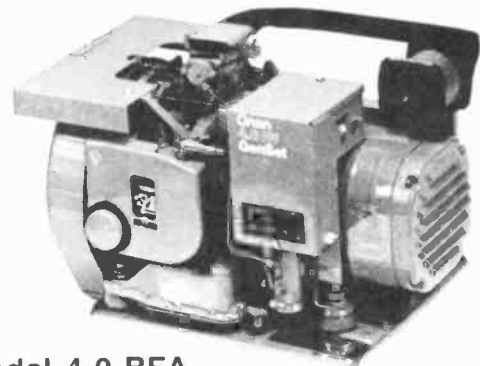

### Model 4.0 BFA For Mobile Vans

Quality performance and dependability for the broadcaster on the move. From 3000 to 6500 watts.

**4.0 BFA BSW PRICE.....\$1,922.75**

**IT'S THE EVERYDAY  
LOW PRICE THAT COUNTS**



**Million Dollar  
In House  
Inventory  
For  
Immediate  
Delivery**



# Miscellaneous

## M.W. Persons



### Programmer 3A Live Assist Controller

- Use reel to reel tapes in live radio format
- Full logic control including next play memory and auto segue
- Full mono and stereo audio control including cue
- Liquid crystal digital minutes and seconds timer
- Connects directly to up to four channel Otari ARS-1000DC or Revox PR99 reproduce only decks
- Interface with any other reel to reel machine using one 25Hz Tone Processors for each machine

**BSW PRICE.....\$980.00**

## SOUND EFFECTS RECORDS

**From A Cat's Meow  
To A Lion's Roar  
From A Pistol Shot  
To A World War**

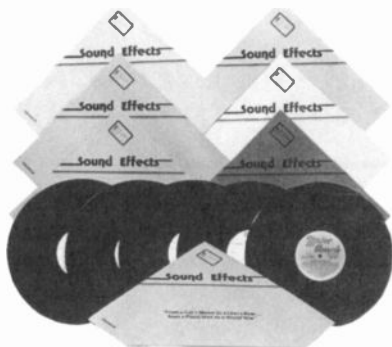

- Ideal for television, radio and film
- Quick cued for easy use
- The professional broadcasters' library
- Recorded the way your ears hear it
- Over 1000 different effects

**Complete Set Of 30 LPs. . . . BSW PRICE \$395.00**

## COMPLETE TOOL KIT



### Xcelite Model TC-150/ST

A carefully selected assortment of Xcelite hand tools; interchangeable drivers, blades and handles; soldering iron and 1 measuring tape. Removable pallets in lid and base have tool pockets.

#### Contents:

- Regular and tee driver handles
- Driver extension
- .050," 1/16" to 3/16" Allen hex-socket type blades (9)
- 3/16" to 3/8" hex nutdriver blades (7)
- 3/16" and 1/4" slotted screwdriver blades
- Reamer
- 4 round-blade slotted screwdrivers
- 2 square-blade slotted screwdrivers
- Phillips screwdriver
- 7/16" and 1/2" hollow-shaft nutdrivers
- 1/4" and 5/16" magnetic nutdrivers
- Seizer
- Rosin-core solder
- Midget slip-joint plier
- 7" utility plier
- Long-nose plier
- 4" diagonal plier
- 5" diagonal plier
- 5 1/2" needle-nose plier
- 8" Chain-noise plier
- Electronic snips
- Wire stripper
- Knife
- Weller WP25 soldering iron
- 10' tape
- Adjustable wrench

**BSW PRICE.....\$328.98**

## PANDUIT

Wiring Duct

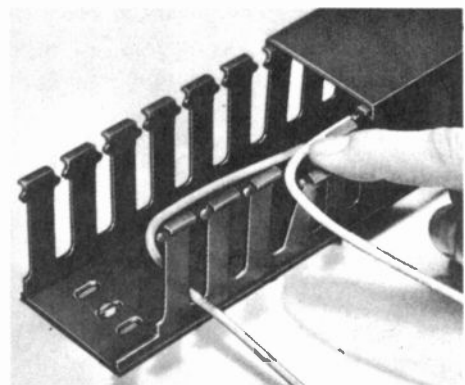

### TYPE "E" - PRICE INCLUDES COVER

- Width: 2 inches
- Height: 2 inches
- Length: 6 feet

**BSW PRICE Each Unit.....\$23.50**





## WILKINSON By TELEVISION TECHNOLOGY

### AC LINE SURGE PROTECTOR

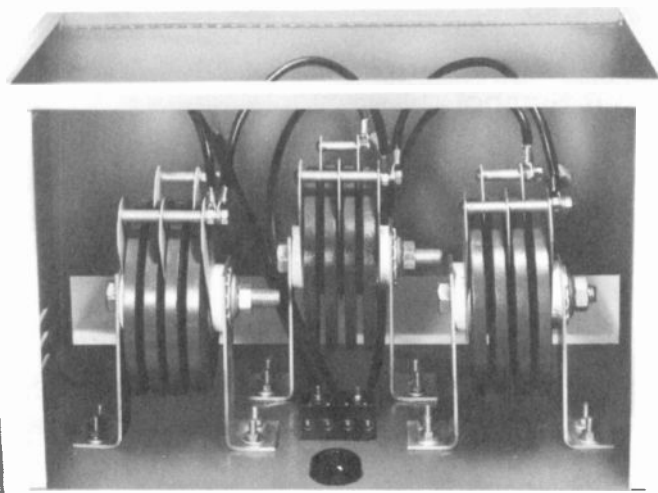

#### Model S1A Designed for Broadcasters

The Wilkinson Electronics Line Surge Protector is far superior to standard lightning arresters, surge reactors or other AC line protection devices.

AC line voltage surges, caused by lightning, transformer arcing and induced transients are everyday occurrences that cause heavy damage to equipment incorporating silicon rectifiers, mercury vapor tubes, or other semi-conductor devices. The Wilkinson Electronics Model S1A protects valuable equipment against surges that often exceed many times the normal line voltage.

The Wilkinson AC line surge protector will pay for itself over and over again by saving your expensive equipment from damage or total destruction.

Model	BSW Price
S1A-1 110V Single Phase.....	\$686.00
S1A-2 220V Single Phase.....	\$882.00
S1A-3 220V Three Phase.....	\$1,372.00
S1A-4 480V Three Phase.....	\$1,470.00

### DALE SERIES SPA Secondary Power Arresters



#### Description

Dale SPA secondary power arresters, when connected across an AC power line, limit surge voltages caused by lightning and other transients. They provide excellent protection for wiring, appliances, electrical and electronic equipment of all kinds. These arresters use the Dale rotating arc spark gap which has the capability to withstand multiple lightning strokes. In addition, SPA arresters provide protection from extreme surge amplitudes. Power-follow current is limited and extinguished within one-half cycle. Pre-ionizing of the spark gap yields protection during the fast-rising wavefront of the transient. The arresters are hermetically sealed in a strong steel case and completely contain the surge discharge. High reliability and long life make these arresters especially suitable for isolated or remote installations.

#### Features:

- Three basic models provide optimum protection for most secondary power installations:  
SPA-100 for 120 volt AC circuits, SPA-200 for 208-277 volt AC circuits, SPA-400 for 480 volt AC circuits.
- Consumer protection—SPA-100 is UL listed. Control No. 509H.
- Automatically resets—has multi-stroke protection capability.
- Weatherproof housing for indoor or outdoor use.
- Easy installation.
- Maintenance free.
- No power consumption.

Model	BSW Price
SPA-100 110/120 Volt.....	\$79.95
SPA-200 220/277 Volt.....	\$79.95
SPA-400 480 Volt.....	\$118.95

CALL FOR QUANTITY DISCOUNTS



# Miscellaneous

## Prolite

### ADJUSTABLE

Handles Any Standard Bulb to 100W

Put the Light  
Where the Need is  
A Real Little  
Beauty  
And Only  
\$15.95

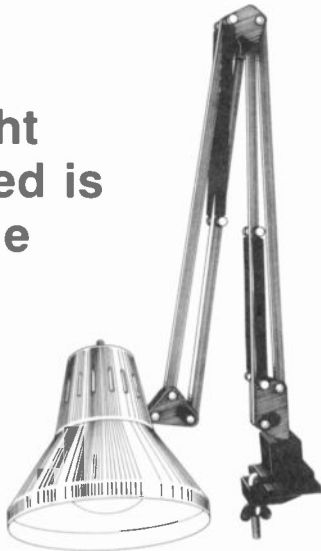

2 For.....\$27.00  
6 For.....\$72.90

## LUXO OR LITE-HEART COPY HOLDERS



### Copy Holders

- For announcers, newsmen, programmers, secretaries
- Holds any reading material wherever you need it

Model 16008 4lb.....BSW PRICE \$57.50  
 Model 16007 1lb.....BSW PRICE \$39.95  
 Model LH801 1lb.....BSW PRICE \$26.95

## Prolite

### ARCHITECTURAL SYSTEMS

33W6142R  
Flatwall  
On Air Lens  
\$72.95  
  
Blank Lens  
Without Symbol  
\$8.95



33C6242R  
Extended Ceiling  
Double Face  
\$89.95

or  
33E6242R  
Wall On Air Lens  
Double Face  
\$95.00

Blank Lens  
Without Symbol  
\$8.95

33P6242R  
Pendent  
On Air Lens  
Double Face  
\$129.95  
  
Blank Lens  
Without Symbol  
\$8.95



Dimensions: 7½" square and includes two 20 watt lamps.

## Fidelipac



340 On Air Light

BSW PRICE.....\$47.50



VIF

NAB HUB ADAPTER

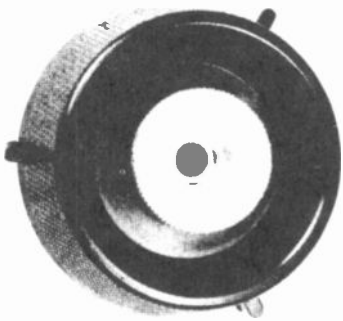

Fits Most Professional Reel To Reel Machines

BSW PRICE.....\$16.95 ea.

Littlite



Model L-3/12 High Intensity Light

Dimmer with off position, 6' cord, wall plug-in transformer, gooseneck, high intensity hood and quartz halogen bulb. Permanent mounting material included.

BSW PRICE.....\$39.95

SAE



Model 5000A Noise Reduction System For Phonograph Records

Impulse noise is generated by static discharge, record blemishes or accumulation of dirt, and is often referred to as "clicks" and "pops". Now, with the 5000, most of these problems can be overcome. Many virtually lost recordings can be played again and again with their fidelity unmarred by impulse noise.

Mfg. list \$199.00.....BSW PRICE \$189.95

D.E. WINGET

AIR SENTRY Audio Signal Monitor

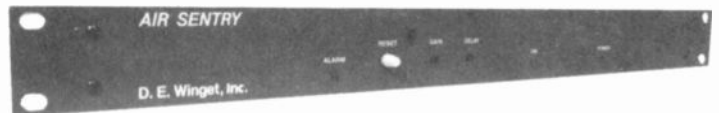

The AIR SENTRY is designed to constantly monitor the presence of an audio signal and to energize a relay when the audio is absent. Activation of the relay is front panel adjustable from 4 to 20 seconds. The relay may in turn be used to activate an external audible or visible alarm to notify station personnel of the absence of broadcast signal. AIR SENTRY may be used to monitor any stereo or mono audio source such as audio from an AM/FM tuner, TV receiver, or modulation monitor. AIR SENTRY is built to broadcast standards of reliability and is extremely cost-effective.

BSW PRICE.....\$295.00

TAPE SENTRY Sensing Device

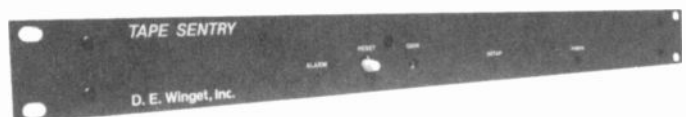

TAPE SENTRY from D.E. Winget, Inc. is a sensing device intended for use in broadcast automation systems to alert station personnel that the end of an audio tape has been reached.

TAPE SENTRY simultaneously monitors up to six tape machines and at the end of any tape provides a relay contact closure which may be used to trigger external audible and/or visible alarms.

TAPE SENTRY detector circuitry is triggered by sub-audible 25Hz tones of six second (or greater) duration. This makes TAPE SENTRY compatible with most leading music programming formats.

TAPE SENTRY compatible with most leading music programming formats.

BSW PRICE.....\$295.00



# Miscellaneous

## CONEX

### SENSORS & GENERATORS

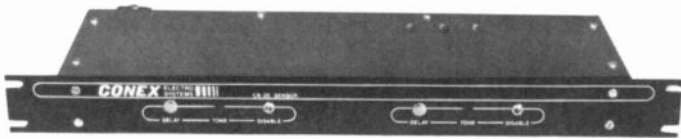

#### Model CS-25A 25 Hz Tone Sensor

- Plug-in circuitry
- All IC's in sockets
- Tone indicator lights
- Front panel adjustable
- Jones connectors standard
- 10K Ohm unbalanced
- Rack mount standard

#### Dual Sensor

Mfg. list \$395.00 . . . . . **CALL FOR BSW PRICE**

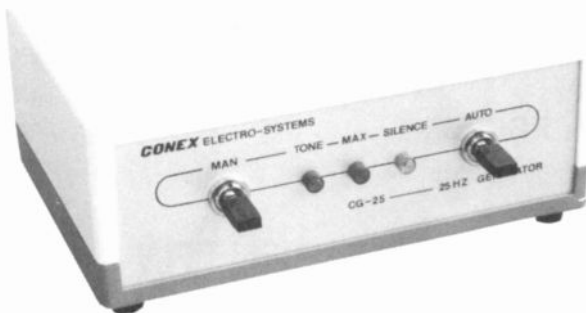

#### Model CG-25 25 Hz Tone Generator

- All functions adjustable
- Jones connectors standard
- Selectable channel switch
- Balanced bridging inputs
- Balanced 600 Ohm outputs

#### Mono/Stereo

Mfg. list \$350.00 . . . . . **CALL FOR BSW PRICE**

## WEST PENN WIRE

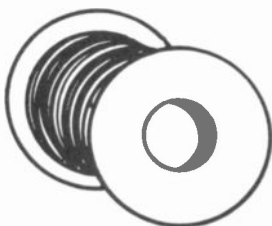

MODEL NUMBER

# 291

SHIELDED PAIR

# \$64.95

REEL 1000 FT.

SIMILAR TO BELDEN 8761

## Gorman-Redlich EBS MONITORS

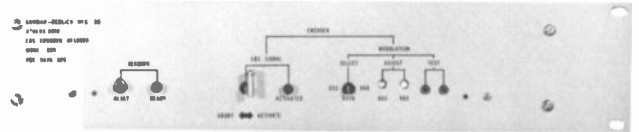

#### Model CEB Encoder/Decoder EBS Monitor

- Encoder FCC type accepted. Decoder FCC certified. Meets all legal requirements
- Low cost with uncompromising quality and performance
- Exceeds FCC specifications for EBS requirements
- Provision for remote operation. Programming loopthrough standard in encoder. Decoder demutes monitor receiver and/or actuates auxiliary alarm
- Decoder can be self-tested

**BSW  
PRICE**

Encode Only(CE) . . . . . **\$330.00**

Decode Only (CD) . . . . . **\$280.00**

Encoder-Decoder (CEB) . . . . . **\$475.00**

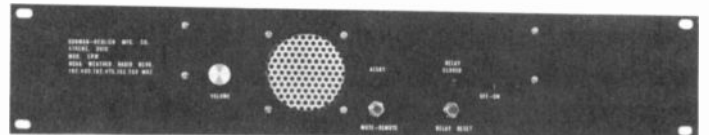

#### Model CRW

#### Weather, Emergency Alert Monitor

Receive accurate local weather, plus emergency alert messages, weather radar data or marine information. Automatic warning, severe weather or civil defense emergency.

**BSW PRICE . . . . . \$475.00**

## EXTENDED BSW HOURS



**EASTERN TIME**

9:00AM TO 9:00PM

**CENTRAL TIME**

8:00AM TO 8:00PM

**MOUNTAIN TIME**

7:00AM TO 7:00PM

**PACIFIC TIME**

6:00AM TO 6:00PM

# Monitors - Modulation



**BELAR  
ELECTRONICS**

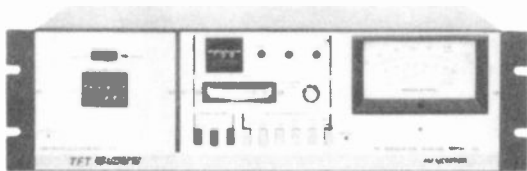

## Model 753 AM Modulation Monitor

In today's competitive AM markets, you need to deliver a strong signal to the widest possible area. But, transmitter power alone isn't enough. You also need all the modulation you can legally achieve. That's the basic purpose behind the TFT Model 753 AM Modulation Monitor. Not only does it make extremely accurate proof-of-performance measurements, but more importantly, it allows you to monitor your transmitter so precisely that you can modulate it to the maximum legal limits in absolute confidence.

Mfg. list \$1,425.00 . . . . . **CALL FOR BSW PRICE**

## Model AMM-2B AM Modulation Monitor

- Separate 100% negative peak modulation indicator lamp, independent of carrier level
- Separate 125% positive peak modulation indicator lamp, independent of carrier level
- Adjustable peak modulation indicator, 40 to 130% in less than 1% increments, independent of carrier level
- True peak-reading modulation meter responds accurately to the shortest duration program peaks
- Built-in carrier-off alarm
- Built-in modulation calibrator

Mfg. list \$1,095.00 . . . . . **CALL FOR BSW PRICE**



## Model 844 FM/Stereo Modulation Monitor

Based on TFT's 14 years of engineering experience - with over 5,000 modulation monitors operating world wide - these third generation instruments bring you innovations that solve today's modulation problems, using today's advanced technology. You get everything you need for complete proof-of-performance measurements (for distortion, an external analyzer is needed) right on the front panels, plus accuracy, versatility and convenience no other monitors can match.

The Model 844 FM Monitor combines a tuneable RF preselector, a baseband monitor and a stereo monitor in one compact instrument. State-of-the-art design, for optimum monitor performance, includes the use of linear phase filters, large scale integrated circuits (LSI) and toroidal power transformers to reduce hum and power line noise. Modular PC cards make service and routine calibrations easy, and high quality, industrial grade electronic components and parts are used throughout.

Mfg. list \$3,995.00 . . . . . **CALL FOR BSW PRICE**

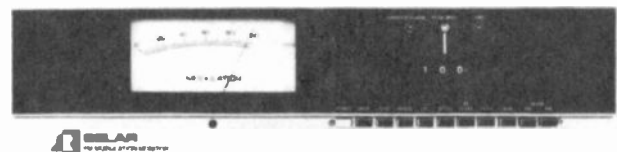

## Model FMM-2 FM Modulation Monitor

The FMM-2 sets new standards in accurate FM monitoring - the first to incorporate a sample hold peak modulation meter circuit independent of modulation polarity to allow the meter to respond to program peaks of the shortest duration. The heart of the FMM-2 is an ultra-linear digital discriminator which provides a distortionless baseband signal for accurate monitoring as well as precise stereophonic, and SCA decoding.

- FMM-2**  
Mfg. list \$1,350.00 . . . . . **CALL FOR BSW PRICE**
- FMS-2 Stereo Modulation Monitor**  
Mfg. list \$1,550.00 . . . . . **CALL FOR BSW PRICE**
- SCM-1 Subcarrier Modulation Monitor**  
Mfg. list \$1,650.00 . . . . . **CALL FOR BSW PRICE**



# Racks, Cartridge

## Carousel File Cartridge Racks

Quality High Impact  
Polystyrene  
Lasts a Lifetime

- Desk top or floor
- Modular construction for add-on expansion
- High-Impact Polystyrene

	BSW PRICE
60 Carts.....	\$105.00
120 Carts.....	\$154.00
240 Carts.....	\$252.00
360 Carts.....	\$346.00
60EX Cart expansion..	\$49.50
Flat base with castors..	\$49.00
Metal storage base with castors.....	\$124.00
600 Carts with flat base and castors.....	\$564.00

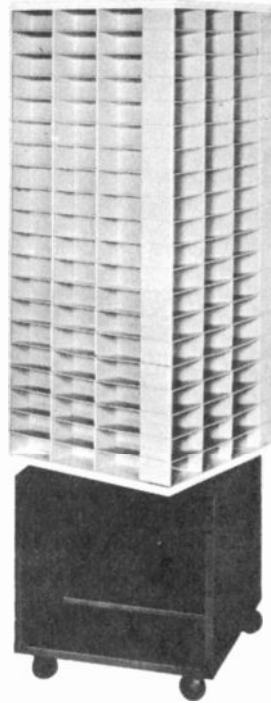

## soundolier Equipment Racks

Welded &  
Completely  
Assembled

	BSW PRICE
Series 100	
WA 100-36..	\$224.72
WA 100-42..	\$234.30
WA 100-61..	\$268.29
WA 100-70..	\$299.04
WA 100-77..	\$313.44

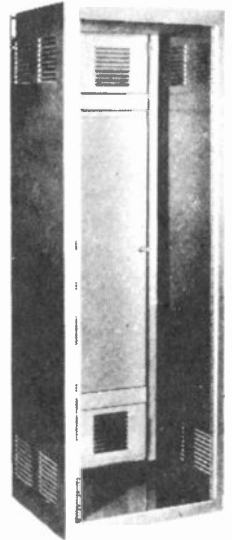

## ABCO

### Wire Cart Racks

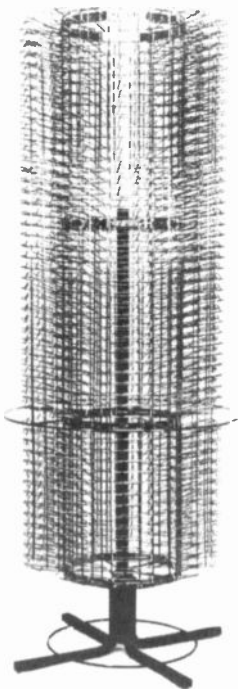

500

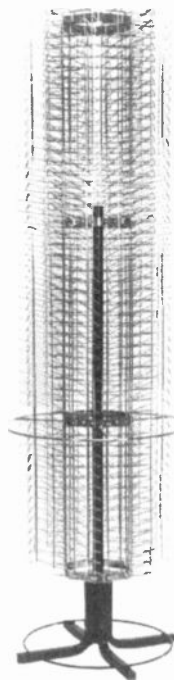

300

Model 300 (Holds 300 Carts)	
BSW PRICE.....	\$327.00
Model 500 (Holds 500 Carts)	
BSW PRICE.....	\$498.00

## SONEX FOR CLEAN SOUND

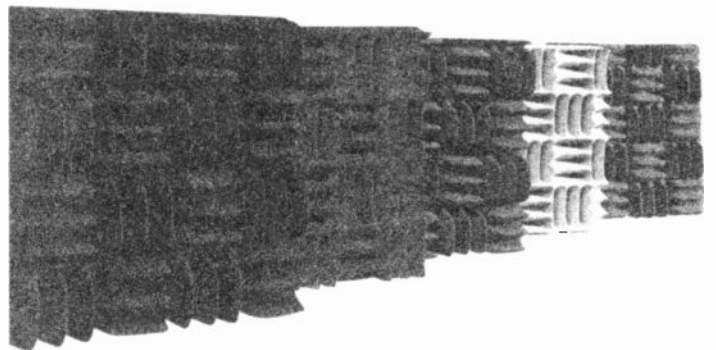

SONEX kills all the stray reflections, so the mike processes a clean signal of the announcer's voice. The announcer hears himself in a warm environment, and there's less clutter to waste watts. The result is a noiseless, clear signal and greater market penetration.

Get the facts today. SONEX is available in five colors, in three thicknesses, and in standard four-ft. square panels. Use it in broadcasting, recording, videotaping or performing areas for really pure clean sound.

**CALL BSW ORDER DESK FOR  
CONFIGURATIONS & PRICING**

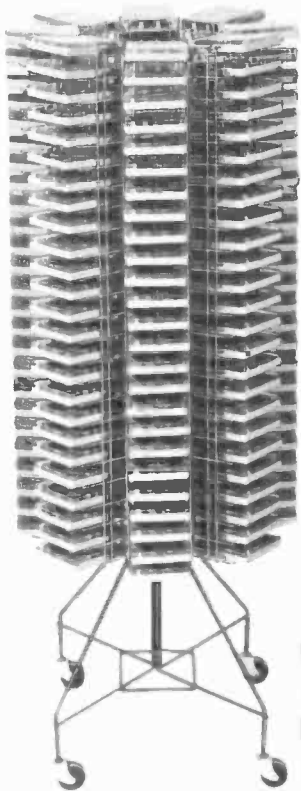

BSW PRICE  
\$289.95

MR-200  
Lazy Susan  
Holds 200  
Carts

## FIDELIPAC

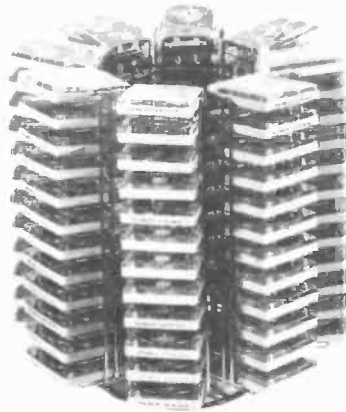

TR-96 Lazy Susan BSW PRICE  
Holds 96 carts \$145.95

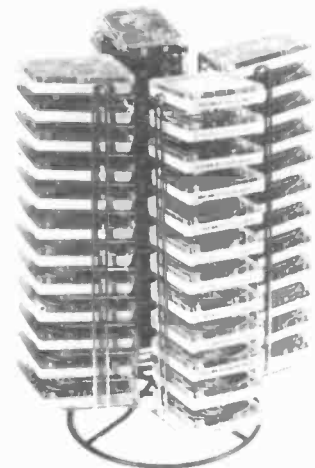

TR-48 Lazy Susan BSW PRICE  
Holds 48 Carts \$82.95

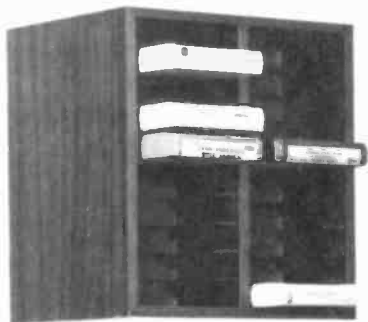

K-670 Lazy Susan BSW PRICE  
\$29.95

- Walnut finish
- Swivel base
- Holds 40 carts or cassettes
- Low per-tray cost

ProRax

### COMPACT DISC RACKS



**CD-40LS Carousel**  
Capacity 40  
Dimensions  
11 1/2''W x 9 1/4''H x 11 3/8''D  
Turning Radius 16''  
BSW PRICE  
**\$69.95**



**CD-20W Wall or Desk**  
Capacity 20  
Dimensions  
6 1/4''W x 16 1/2''H x 4 3/4''D  
BSW PRICE  
**\$39.95**



K-675 BSW PRICE  
\$19.95

- Walnut Finish
- Console or wall mount
- Holds 20 carts or cassettes
- Mass wall mounting

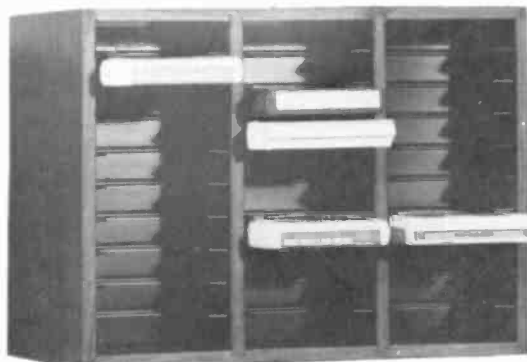

K-671 Lazy Susan BSW PRICE  
\$39.95

- Walnut finish
- Swivel base
- Low per-tray cost
- Holds 60 carts or cassettes

### Aristocart AW-20

- Holds 20 carts
  - High impact polystyrene
  - Will not break, rust or mildew
  - Lowest per-tray cost
  - Great for console or mass wall mounting
  - Includes mounting screws
- \$10.95 ea.**

**10 or more \$9.75 ea.**  
**20 or more \$8.95 ea.**





# Racks, Cartridge

## ProRax

### WALL, DESK, & FLOOR CAROUSELS

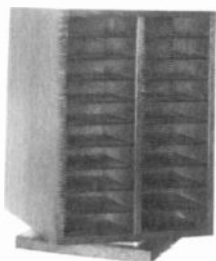

**C-40 Carousel**    **BSW PRICE**  
Capacity 40        **\$67.95**  
Dimensions  
9 5/8"W x 13 3/4"H x 9 1/2"D  
Turning Radius 13 3/8"

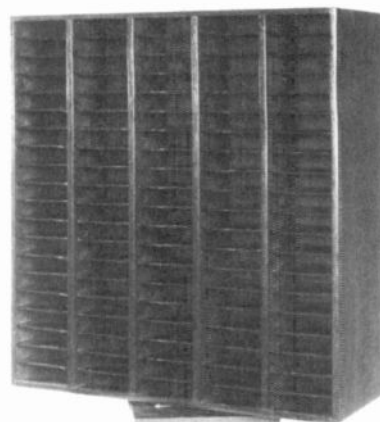

**C-200 Carousel**    **BSW PRICE**  
Capacity 200        **\$244.95**  
Dimensions  
23 1/2"W x 25 1/2"H x 9 3/8"D  
Turning Radius 25"

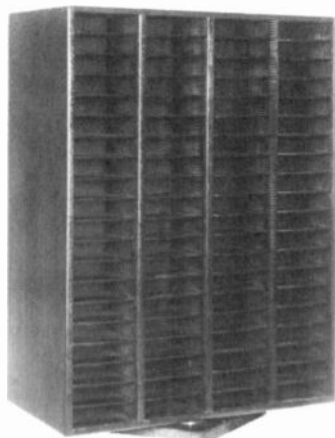

**C-160 Carousel**    **BSW PRICE**  
Capacity 160        **\$198.95**  
Dimensions  
19"W x 25 1/2"H x 9 3/8"D  
Turning Radius 21"

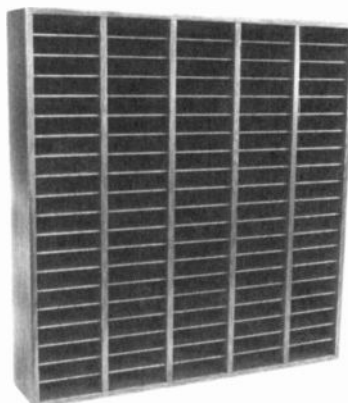

**100 Wall or Desk**    **BSW PRICE**  
Capacity 100        **\$79.95**  
Dimensions  
23 1/2"W x 24 1/2"H x 4 3/4"D  
4 or more \$74.95

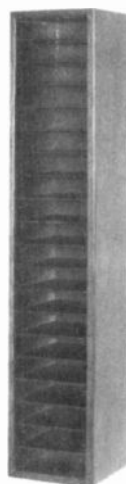

**W-20 Wall**        **BSW PRICE**  
Capacity 20        **\$39.95**  
Dimensions  
5 1/4"W x 24 1/2"H x 4 3/4"D

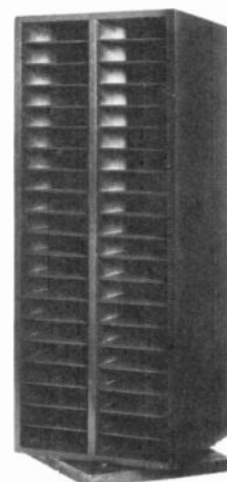

**C-80 Carousel**    **BSW PRICE**  
Capacity 80        **\$98.00**  
Dimensions  
9 5/8"W x 25 1/2"H x 9 1/2"D  
Turning Radius 13 1/2"

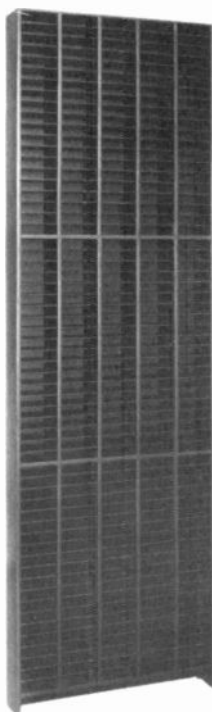

**W-300 Wall**        **BSW PRICE**  
Capacity 300        **\$295.00**  
Dimensions  
23 1/2"W x 75 3/4"H x 4 3/4"D

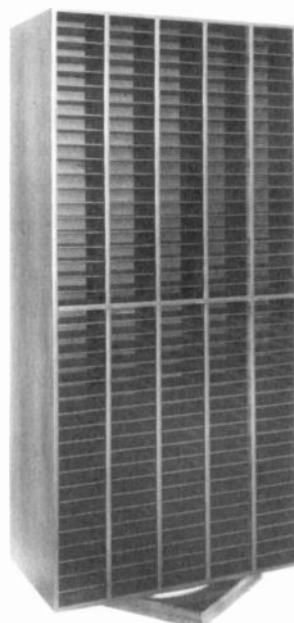

**C-400 Carousel**    **BSW PRICE**  
Capacity 400        **\$489.95**  
Dimensions  
23 1/2"W x 50 3/4"H x 12 3/8"D  
Turning Radius 26 3/8"

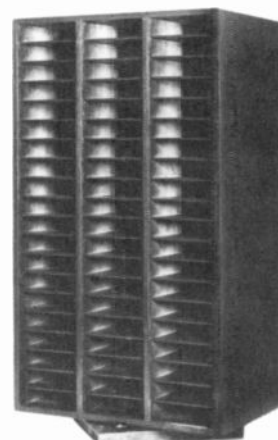

**C-120 Carousel**    **BSW PRICE**  
Capacity 120        **\$138.95**  
Dimensions  
14"W x 25 1/2"H x 9 1/2"D  
Turning Radius 17"





## TASCAM FOR PROFESSIONAL USE ONLY



### STUDIO FURNITURE

## Roll Around Equipment Rack

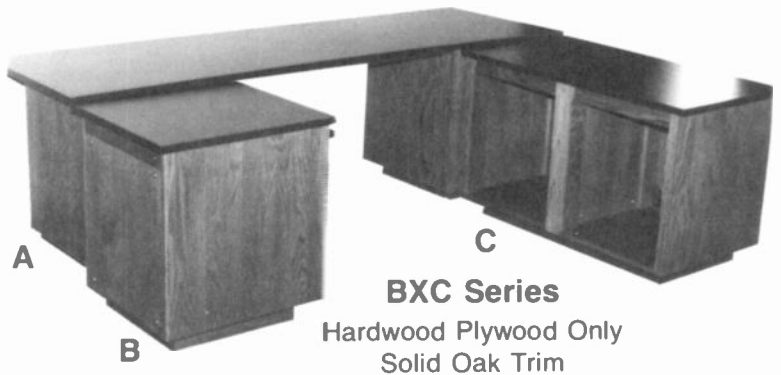
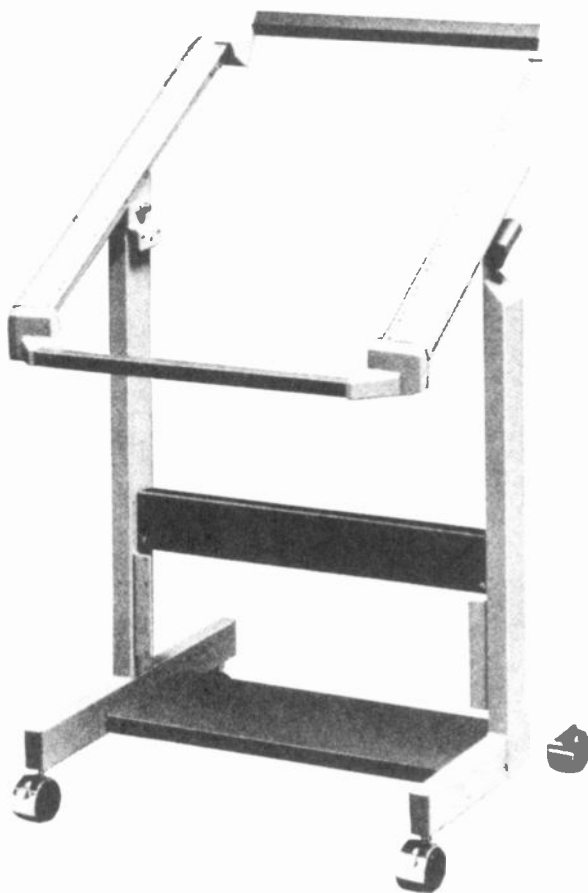

**BXC Series**  
Hardwood Plywood Only  
Solid Oak Trim

THE HIGH QUALITY  
STUDIO FURNITURE  
AT ATTRACTIVE  
COMPETITIVE PRICES

**A LRP Console Table**

96"W x 30"D Includes Left & Right Pedestals

Mfg. list \$867.00 . . . . . **BSW PRICE \$822.95**

**B SP Single Pedestal Cabinet**

24"W x 26"D Includes Front Removable Panel

Mfg. list \$389.00 . . . . . **BSW PRICE \$369.95**

**C DP Double Pedestal Cabinet**

48"W x 26"D Includes Front Removable Panels

Mfg. list \$643.00 . . . . . **BSW PRICE \$609.95**

**CS-607  
Roll Around Equipment Rack**

The CS-607 is an ideal home on wheels for the Tascam rack mount series or for any standard rack mount equipment. Its top section has a standard 19" wide, pre-drilled EIA rack that measures 21" high (12 standard 1 3/4" spaces). Two large knobs and backing pins allow the rack frame to tilt from vertical to horizontal, so equipment can be placed in the most convenient position for your working environment.

Mfg. list \$310.00 . . . . . **BSW PRICE \$244.95**

**NOW OPEN SATURDAY**



*And  
We Are As  
Close  
As Your Telephone*  
**TOLL FREE  
1-800-426-8434**



# Racks & Furniture



## MICRO-TRAK

The Graphic Express Corporation

THE WORLD'S FINEST AUDIO CABINETRY

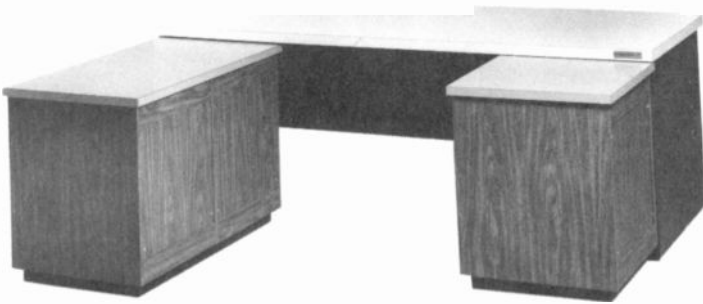

### L SERIES FURNITURE BEAUTIFUL AND COST EFFECTIVE

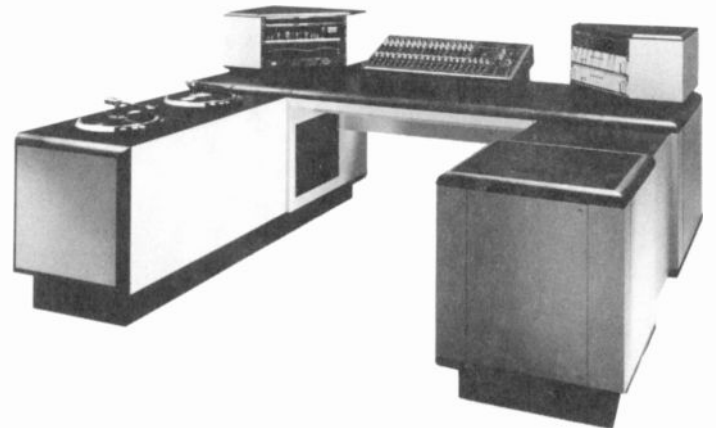

**Finish:** Cortena pecan wood grain formica on vertical surfaces. Cortena applejack gold on cabinet tops.

**Construction:** Panels fabricated from high density particle board 3/4" thick (front and rear closure panels 5/8" thick) with formica uniformly bonded.

**Panel Space:** 17 1/2" high openings front and rear to accommodate 19" E.I.A. style equipment panels on steel mounting rails.

	MFG. LIST	BSW PRICE
Single Bay Cabinet	289.00	274.55
Double Bay Cabinet	360.00	342.00
Console Table	386.00	365.95

**IN STOCK  
IMMEDIATE DELIVERY**

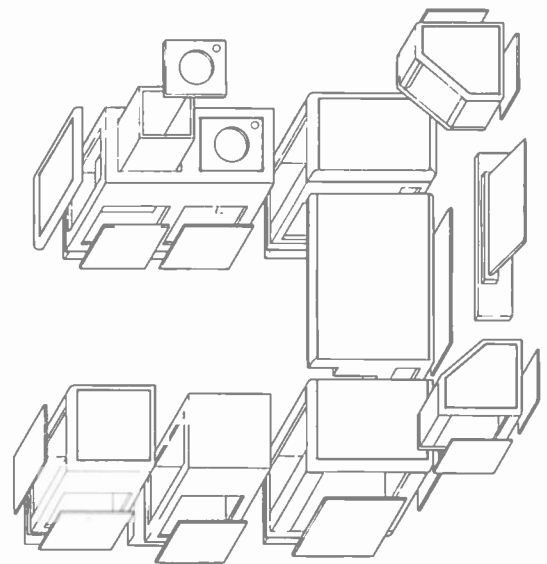

Developed through years of experience, Graphic Express offers extreme flexibility thru modular construction.

The ability to choose precisely the modular components needed, simplifies studio layout and gives you exactly the system desired. You can expand or modify later as your requirements change.

Premium quality materials are used throughout. Hardwood plywood, formica laminate, sabil walnut edges, hand rubbed watco oil finish and Rydex plastic bases.

The large numbers of access panels, held in place with turn fasteners, allow easy cable handling and quick access to cable runs. All units provide access through cabinet bottoms for sub flow cable ducting. Custom studio design available — talk to your BSW representative.

**Call for BSW Price**

**TIRED OF BACK ORDERS?  
TRY BSW**

**Million  
Dollar  
In House  
Inventory**



# Recording Tape & Accessories



CATALOG NUMBER	REEL MIL SIZE	PACK	UNITS PER CASE	PRICE PER REEL			CATALOG NUMBER	REEL SIZE	PACK	PRICE EACH
				SINGLE REEL	10 PACK	40 + PACK				

## Ampex Audio Tape

### STANDARD OUTPUT

631-17611T	¼ x 2500PH	1.5	HUB BULK	10	-	5.98	5.30
631-151111	¼ x 1200	1.5	7" BOX	40	6.00	4.45	3.95
631-173111	¼ x 2500NAB	1.5	10½" BOX	10	-	14.90	13.15

### LOW NOISE/HIGH OUTPUT

632-131111	¼ x 600	1.5	5" BOX	40	4.40	3.25	2.85
632-17611T	¼ x 2500PH	1.5	HUB BULK	10	-	6.30	5.60
632-151111	¼ x 1200	1.5	7" BOX	40	6.70	4.90	4.35
632-173111	¼ x 2500NAB	1.5	10½" BOX	10	-	16.20	14.30
642-17611T	¼ x 3600PH	1.0	HUB BULK	10	11.25	8.25	7.30

### STUDIO MASTERING - LOW NOISE/HIGH OUTPUT

406-17613T	¼ x 2500PH	1.5	HUB BULK	10	13.15	9.65	8.50
406-151131	¼ x 1200	1.5	7" BOX	40	9.50	6.95	6.15
406-17313J	¼ x 2500NAB	1.5	10½" BOX	10	24.35	17.85	15.75
407-17613T	¼ x 3600PH	1.0	HUB BULK	10	20.95	15.40	13.60
407-151131	¼ x 1800	1.0	7" BOX	40	-	9.15	8.05

### GRAND MASTER

456-17611T	¼ x 2500PH	1.5	HUB BULK	10	16.30	12.00	10.60
456-151111	¼ x 1200	1.5	7" BOX	40	11.25	8.25	7.30

CATALOG NUMBER	REEL MIL SIZE	PACK	UNITS PER CASE	PRICE PER REEL		
				SINGLE REEL	12 SING. PK	48 + PK

## 3M Scotch Audio Tape

### LOW NOISE

176	¼ x 2500HPB	1.5	HUB BULK	12	-	6.10	5.35
176	¼ x 1200	1.5	7" BOX	12	7.50	5.50	4.85

### LOW NOISE/HIGH OUTPUT

206	¼ x 2500HPB	1.5	HUB BULK	12	12.75	9.35	8.25
206	¼ x 1200	1.5	7" BOX	12	9.75	7.15	6.30
206	¼ x 2500RN	1.5	10½" BOX	12	24.20	17.75	15.65

### STUDIO MASTERING - LOW NOISE/HIGH OUTPUT

250	¼ x 2500HPB	1.5	HUB BULK	12	-	11.50	10.15
250	¼ x 1200	1.5	7" BOX	12	-	8.05	7.15
250	¼ x 2500RN	1.5	10½" BOX	12	-	21.00	18.50

## Scotch Splicing Tape

41-7/3266		BOX	1.98
-----------	--	-----	------

## Scotch Leader Tape

20-¼-1000		BOX	3.85
61-W¼-1500		BOX	12.45
61-Y¼-1500		BOX	12.45

## Lubricated Tape

### Capital Formula 17

17-918-100	1800'	BOX	6.90
17-984-605	8400'	HUB	14.00

### Scotchcart Tape

219-¼-2500HPB	2500'	HUB	17.35
---------------	-------	-----	-------

### Capital Q 17 Holn

17-618-613	1800'	BOX	9.60
------------	-------	-----	------

## RSC Empty Reels and Boxes

### PLASTIC REELS

5464	5" NAB	BULK	.50
5196	5"	BULK	.40
5231	7"	BULK	.65
6284	10½" NAB	BULK	3.05
5908	10½" EIE	BULK	3.75

### METAL REELS

6393/600	10½" NAB	BOX	9.95
----------	----------	-----	------

### EMPTY BOXES

605	5"	BULK	.35
607	7"	BULK	.35
630	10½"	BULK	.85

# EXTENDED BSW HOURS



**EASTERN TIME**  
9:00AM TO 9:00PM

**CENTRAL TIME**  
8:00AM TO 8:00PM

**MOUNTAIN TIME**  
7:00AM TO 7:00PM

**PACIFIC TIME**  
6:00AM TO 6:00PM



**It Makes No Difference  
Where You Are**

**SPRINGFIELD**

**We Are As Close  
As Your Telephone**

**1-800- 426-8434**

**SEATTLE**

***OUR SERVICE IS SO GOOD YOU'LL THINK  
WE'RE RIGHT NEXT DOOR***

**SAVANNA**

- **All Under One Roof For Economy & Efficiency**
- **Million Dollar In-House Inventory For Fast Delivery**
- **Toll Free Telephone Service**
- **Open 12 Hours Daily (Your Time Zone)**
- **Now Open Saturday**





## REVOX

### PR-99

WITH FEATURES  
NORMALLY FOUND IN MACHINES  
SELLING FOR 5 TO 10K



IF YOU CAN FIND A  
BETTER MACHINE  
UNDER \$3,000.00 BUY IT!

#### Model PR-99 Record/Reproduce

Revox has greatly enhanced the production capabilities of the PR-99 professional open reel recorder by adding several important features. The updated model, the PR-MKII, incorporates an LED real time tape counter and built-in vari-speed control, along with zero locate, address locate, and auto repeat functions.

Other features of the PR-99 MKII include expanded facilities for repro treble adjustment, a serial remote connector for accessing the microprocessor controlled functions (tape counter, address locate, zero locate), and automatic braking adjustment for large or small tape reels.

Mfg. list \$2,250.00 . . . . . **CALL FOR BSW PRICE**

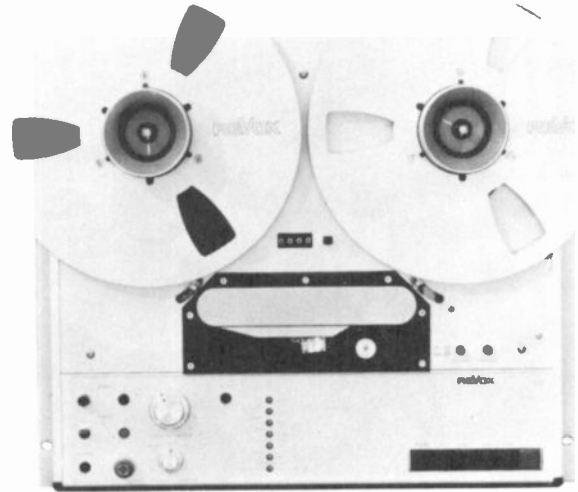

#### Model PR-99 Reproduce Only

- Ideal for broadcast automation
- 25Hz sensor, filter switchable in or out of circuit
- LED indicates presence of 25Hz tone
- Front access to controls for HF equalization (separate for high and low speeds), repro level, and EOM stop delay time.
- Audio output through XLR or multi-pin connectors
- Status and remote signals available through multi-pin connector.

Mfg. list 1,449.00 . . . . . **CALL FOR BSW PRICE**



#### Model B-77

The features you'd expect to find in a high-quality stereo tape recorder.

- Integrated drive logic
- Computer push-point keys
- Easy, precise editing
- Abundant headroom
- Built-in tape cutter

Mfg. list \$1,799.00 . . . . . **CALL FOR BSW PRICE**



# Reel To Reel

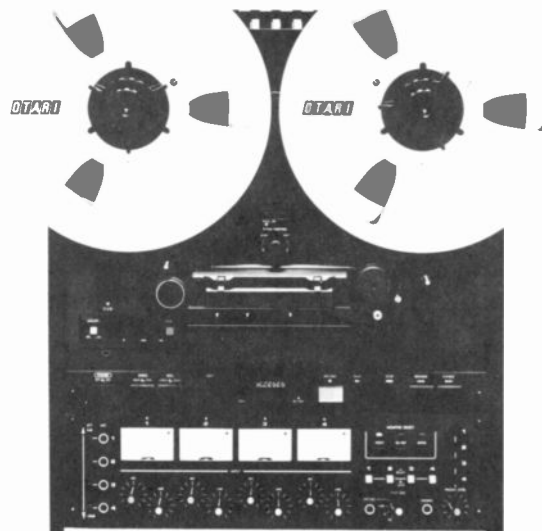
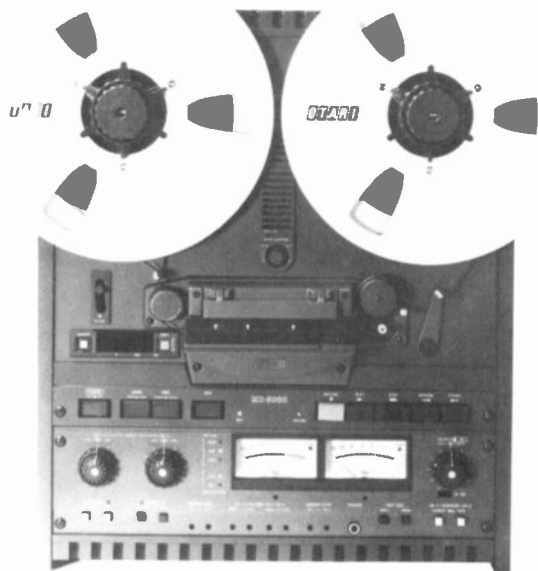

## Model 5050B-II 1/4" Two Channel Recorder

Each 5050B-II Incorporates these standard features:

- Plug-in four head design with hinged head cover for easy access.
- Fourth head for 1/4 track stereo playback.
- Reel size capability: 10 1/2"
- Integral tape splicing block.
- Microprocessor-controlled real-time counter with Memory Rewind and L.E.D. display.
- Dump edit control.
- Front panel cue control (tape lifter defeat).
- Built-in test oscillator (1kHz & 10 kHz) and external oscillator input.
- Active, balanced microphone inputs with switchable 20dB pad.
- Active, balanced line inputs and outputs.
- Switchable +4 or -10dBm input and output reference level.
- XLR type input/output and microphone connectors.
- Variable low frequency Reproduce equalization (switch defeatable).
- Switchable NAB/IEC Equalization (rear panel switch) with front panel L.E.D. indicators.

Mfg. list \$2,295.00 . . . . . CALL FOR BSW PRICE

## Model MX5050 BQII 1/4" Four Channel Recorder

- Designed for recording Studios, Radio-TV Production, Video and A/V facilities.
- Microprocessors provide real time counting with LED display
- Dynamic braking and transport logic

Mfg. list \$2,995.00 . . . . . CALL FOR BSW PRICE

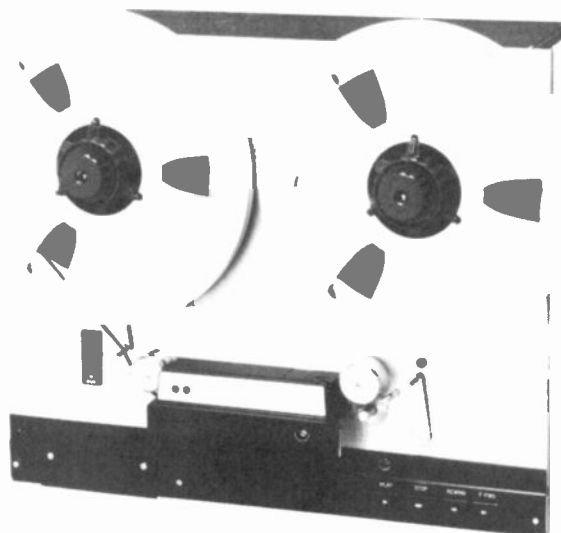

## AUTOMATED RADIO STATION REPRODUCER

### Model ARS-1000DC

- Ruggedly engineered
- Two channel stereo
- 7 1/2 & 3 3/4 IPS
- Excellent performance
- With or without 25Hz sensor

Mfg. list \$1,595.00 . . . . . CALL FOR BSW PRICE

**Call BSW**  
**1-800-426-8434**  
**It's the Everyday Low Price**  
**That Counts**



## TASCAM FOR PROFESSIONAL USE ONLY



### Model 42NB 2 Channel Recorder/Reproducer

Everything you've considered a must is there, and a whole lot more. Balanced and unbalanced, with individual connector to interface with broadcast automation equipment and SMPTE control, the 42 fits in anywhere.

To more precisely control tape tension, and yours, the rugged transport is built with a full computer control on all three motors. The autocolor function with Return-to-zero and Search-to-cue doesn't just start putting on the brakes when it hits the mark, it stops on the dime.

You also get a positive/negative real time counter and a precision splicing block mounted just below the plug-in fixed mount assembly, where it belongs. That translates to faster, more accurate editing, and the peace of mind that comes with it.

Mfg. list \$2,295.00 . . . . . CALL FOR BSW PRICE

**THE MOST  
COST EFFECTIVE  
2 TRACK  
TAPE MACHINE  
ON THE MARKET**

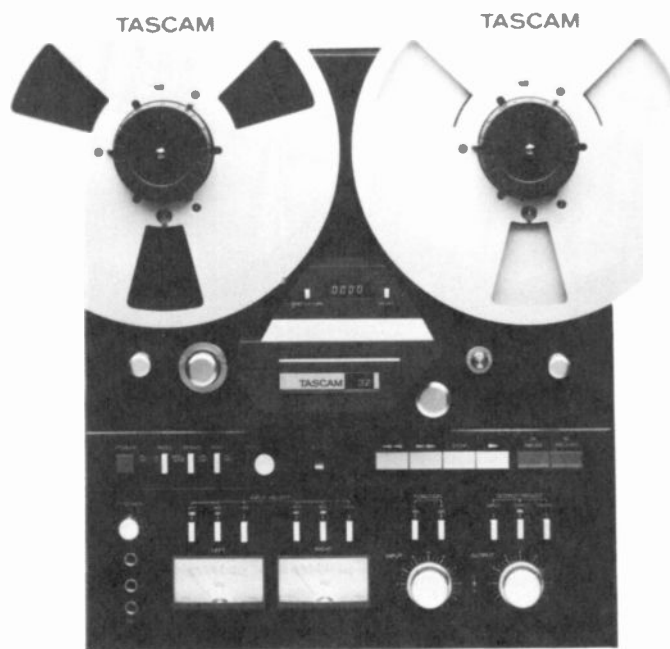

### Model 32 Recorder/Reproducer

- 2 track record/playback
- 10½" reel capacity
- 7½ - 15 IPS
- Dump edit
- N.A.B. E.Q.
- Pitch control

Mfg. list \$1,300.00 . . . . . CALL FOR BSW PRICE

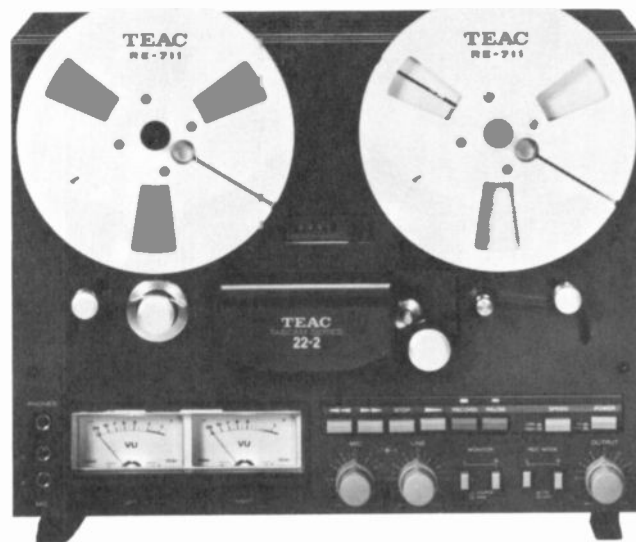

### Tascam Model 22-2 Recorder/Reproducer

- 2 track record/playback
- 7 inch reel capacity
- 7½ - 15 IPS

Mfg. list \$775.00 . . . . . CALL FOR BSW PRICE



# Reel To Reel

## TASCAM

FOR PROFESSIONAL USE ONLY

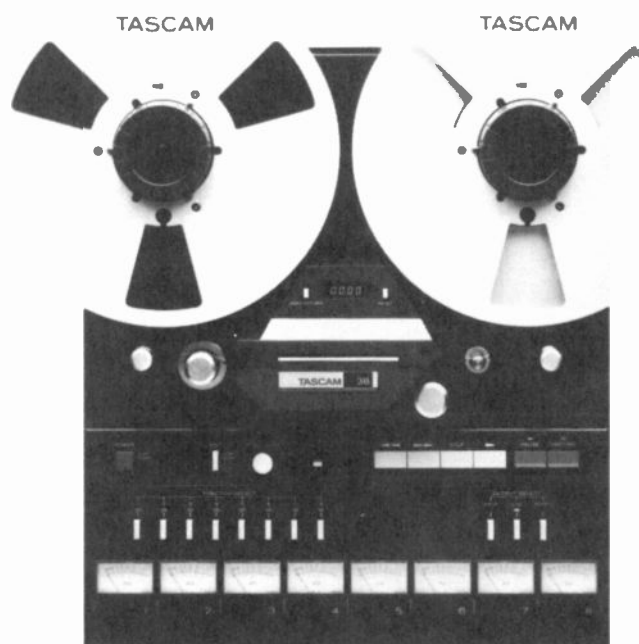

### Model 38

The lowest cost "half inch" 8 track recorder Teac has ever built. Features include:

- Pitch control
- Dump edit
- Motion sensing logic

Mfg. list \$2,790.00 . . . . . **CALL FOR BSW PRICE**

## Technics



### Model RS-1500US

#### 2 Channel Recorder/Reproducer

Open-reel tape deck with single-capstan "Isolated Loop" and 3-motor direct drive. Phase locked loop quartz crystal control. Wow/flutter 0.018% WRMS at 15 IPS. "Isolated Loop" maintains low tape tension for radically reduced modulation noise. Electronic tape tension for precise stacking in fast-forward and rewind. 3 tape speeds - 15, 7½, and 3¾ IPS. 4-head configuration with 4-track playback. Super-large capstan (3.4 cm diameter). Variable pitch control. Stroboscope for monitoring tape travel speed. Real time tape counter. Separate, 3-position bias and equalization switches.

Mfg. list \$1,600.00 . . . . . **CALL FOR BSW PRICE**

## TEAC

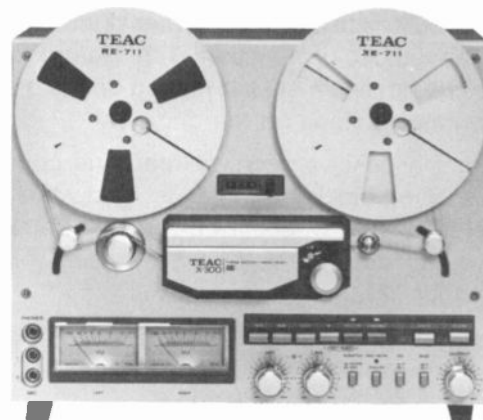

### Model X-300 2 Channel Recorder/Reproducer

3-motor transport. "EE" tape. 3 head reproduction system. Light-touch locking transport controls. Mic/line mixing. Record mute function. Independent left and right output, and line and mic input level controls. Tape/source monitor selector. Front-panel mic and headphone jacks. ¼ track record/playback.

Frequency response: 30-34 kHz (@ 7-½ IPS)

Signal/noise: 65 dB (3% THD)

Wow & flutter: 0.04% (7-½ IPS WRMS)

Mfg. list \$620.00 . . . . . **BSW PRICE \$435.00**

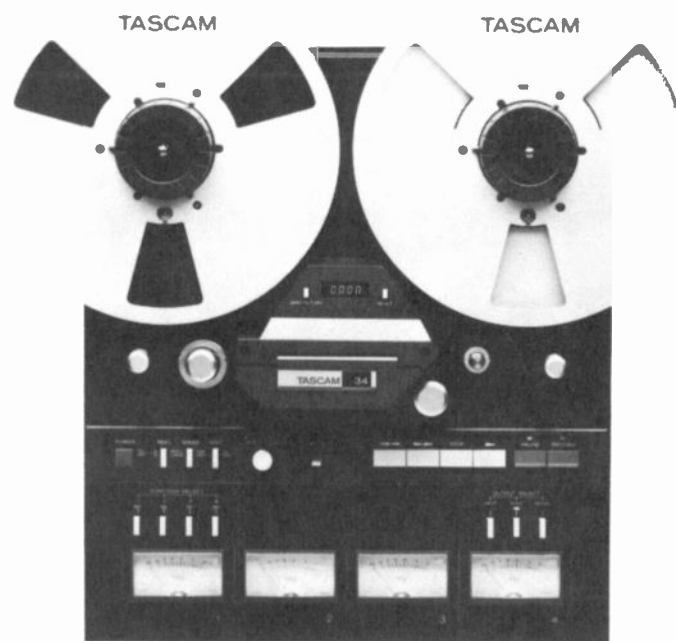

### Model 34B

Now there's cost effective 4 track production. The model 34 has all the features of the model 32 plus two extra tracks!! Full sync. and modular adjustable electronics.

Mfg. list \$1,700.00 . . . . . **CALL FOR BSW PRICE**





**TASCAM**  
FOR PROFESSIONAL USE ONLY



### Model 48L 8 Channel Logger

- Tape speed 15/32 IPS
- Over 24 hours continuous recording

The TASCAM 48L is slow speed, logger version of the 48 multi-channel recorder/reproducer. It is designed for long term, multi-channel recording in an industrial, broadcast, or governmental setting. The 48L may be externally controlled for continuous operation by means of a computer, or intermittent operation by means of a voice actuated circuit (VOX) or computer control. Connections for computer or VOX are made at the rear panel 38 pin Accessory Connector.

Mfg. list \$4,995.00 . . . . . **CALL FOR BSW PRICE**

Low Overhead  
From One Location  
Means

**LOWER PRICES**

**TRY US**

We're As Close As  
Your Telephone

**TOLL FREE**

**1-800-426-8434**

**TANDBERG**



### Model TD20A-L Logging Recorder

- Up to 25 hours continuous recording on 10½" reel
- Tape speed 15/32 IPS
- Outstanding reproduction at low speed

Mfg. list \$1,995.00 . . . . . **CALL FOR BSW PRICE**



# Routing Switchers & Patch Panels



## Routing Switchers

The RS Audio Routing Switcher is the professional alternative to patch panels, mechanical switches, and distribution amps. Ultra-reliable the power supply is regulated, protected, and has a 10 year meantime before failure. LSI integrated circuits reduce parts count to a minimum. All IC's are socketed for ease of replacement. The thumbwheel control switches are 1,000,000 operation. Due to the ultra-reliable design redundant power supplies are unnecessary. These switchers may be used in most critical sections of the audio chain with total confidence.

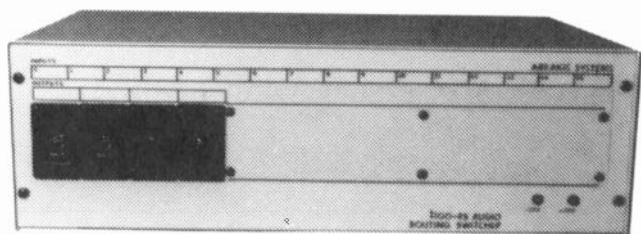

### Model 1100ARSS Routing Switcher

- Control-by four 16 position binary thumbwheels. One per output
- Remote control - 4 bit binary plus enable
- Size - 5 1/4" x 19" rack mount
- 16 in by 4 outputs stereo
- Expandable - yes, in and out

**BSW PRICE**.....\$975.00

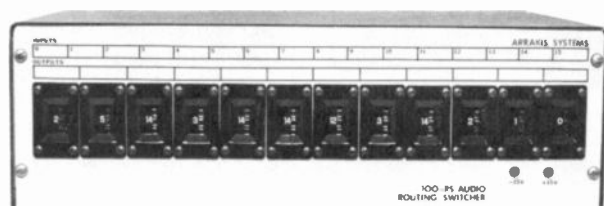

### Model 100RSM Routing Switcher

- Expandable - more outputs only, no additional inputs
- Control-by twelve 16 position thumbwheels. One per output
- Size - 5 1/4" x 19" rack mount
- 16 in by 12 outputs mono
- Remote control - 4 bit binary

**BSW PRICE**.....\$1,470.00

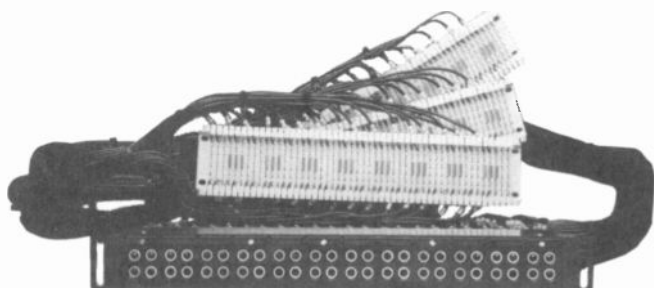

## Pre-Wired Patch Bays

Gentner patch panels are available in virtually any desired configuration. Each patch panel is handwired to customer specifications; terminations include punch block, Gentner Flexiblock, X-Mas Tree, barrier blocks or customer-supplied termination. Delivery is quick and prices are reasonable.

**Call For BSW Price On Configuration**

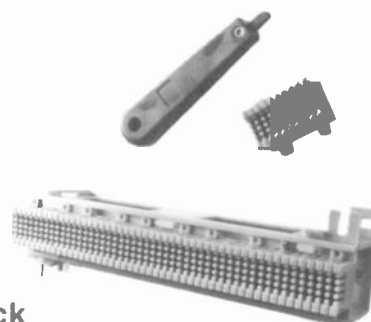

## Flexiblock

Gentner Flexiblock offers fast, easy and reliable punch-down connections, using stranded or solid wire. High number of connections in a small amount of space. Revolutionary termination and connections are virtually short circuit proof.

**Call For BSW Price On Configuration**

## Ramko



### Model RS-1616 Routing, Amplifying Distribution System

- Easy to operate and install
- Wide band width to 100 KHz
- Mono or stereo operation
- Front panel control and displays
- Levels remain constant as outputs are switched
- 3 year warranty

**Call For BSW Price On Configuration**

# Jack Panels & Patch Cords



## COMPLETE LINE OF PATCH CORDS & ACCESSORIES

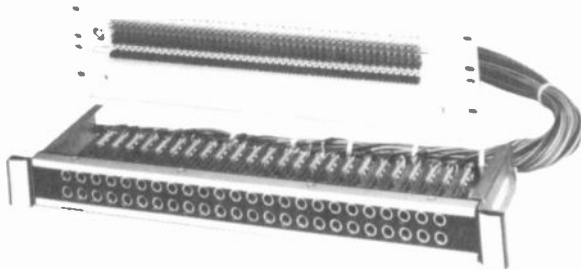

### Pre-Wired Audio Jackfields

ADC's standard line of audio jackfields features an extensive selection. Choice of jacks, panel size, normalling options, cable length and a variety of terminations combine to give you more than 280 possible configurations. Save time, labor and money. Call BSW for your next customized Patch Bay.

**Call For BSW Everyday Low Price**

## PATCH CORDS

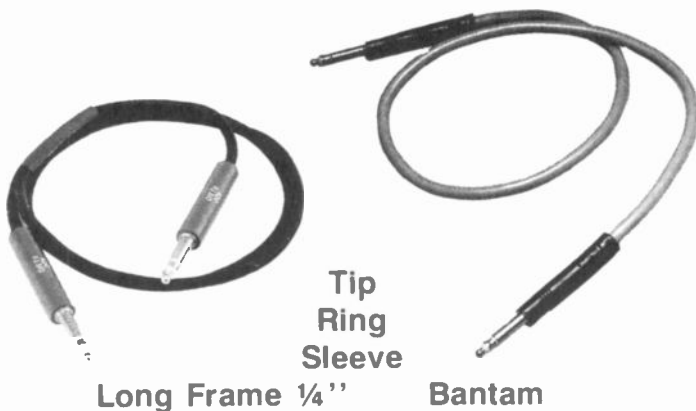

Tip  
Ring  
Sleeve

Long Frame 1/4"

Bantam

### LONG FRAME

ADC NO	Length	Price
PJ-81	1 Foot	\$11.75
PJ-82	2 Foot	\$12.35
PJ-83	3 Foot	\$12.90

### BANTAM

PJ-712	12 Inch	\$7.40
PJ-714	24 Inch	\$7.75
PJ-716	36 Inch	\$8.00

## PRO-PATCH & ULTRA-PATCH NEW CONCEPTS IN AUDIO PATCHING

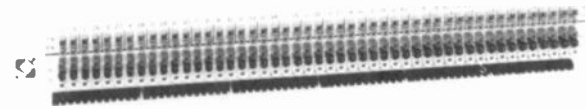

Ultra-Patch

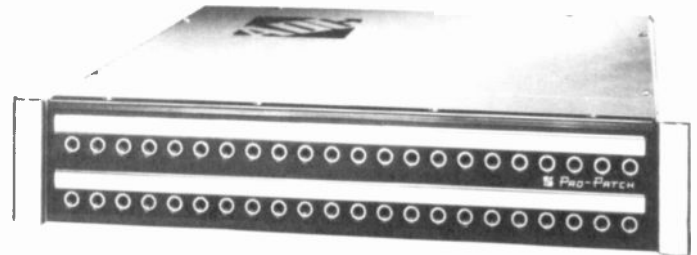

Pro-Patch

Pro-Patch™ jackfields and Ultra-Patch™ interconnect panels use ADC's new split cylinder contact which provides a highly reliable, "punchdown" (insulation displacement) method of terminating audio circuits. Pro-Patch jackfields and Ultra-Patch panels completely eliminate wire stripping and allow connections to be established with one swift insertion of a wire termination tool. The color-coded field enables quick, accurate identification of termination points.

**Call For BSW Everyday Low Price**

## STANDARD JACK PANELS

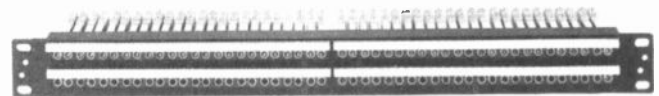

### PJ-390

Includes 52 PJ339 1/4" jacks and reinforcing strips.

**BSW PRICE.....\$96.40**



### PJ-739

Includes 96 PJ839 Bantam jacks. Designation cards and windows included.

**BSW PRICE.....\$153.40**



# Speakers

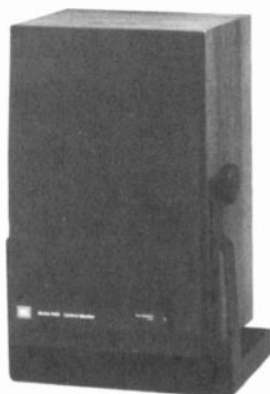
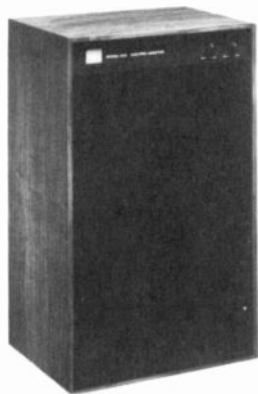

### Model 4312 LR

- Wide response in a compact enclosure
- Mirror imaged for better stereo
- 90° dispersion allows vertical or horizontal placement

Mfg. list \$432.00

**CALL FOR BSW PRICE**

### Model 4401

The most compact of the JBL 2-way studio monitors, the 4401 is ideal for use as a monitor in applications where space is at a premium.

Mfg. list \$189.00

**CALL FOR BSW PRICE**

### Model 4301 BWX

- Accurate reproduction
- 45-15,000Hz ± 3dB
- 8 inch low frequency driver
- 1.4 in high frequency direct radiator

Mfg. list \$243.00

**CALL FOR BSW PRICE**

## AURATONE

Recording Monitors For The Real World



### Model 5C

Super Sound Cube Known The World Over For It's Outstanding Reproductive Qualities.

Mfg. list \$99.00 Pr. . . . . **CALL FOR BSW PRICE**



### Sentry 100A Rackmountable Broadcast Studio Monitor

Designed with the broadcaster in mind. The tweeter will handle 25 watts. (Most tweeters operate at 5 watts). No more will your speakers go up in smoke when someone rewinds a tape - at full volume.

Mfg. list \$255.00 . . . . . **CALL FOR BSW PRICE**  
**SRB-7 RACK/WALL MOUNT . . . . . \$25.00**

### AURATONE RACK MOUNTABLE

# NEW



### Model 5MC Three Channel Broadcast Monitor

Mix down monitors contained in three compartments ultra compact enclosure.

Mfg. list \$159.00 . . . . . **CALL FOR BSW PRICE**  
**Rack Mount Kit RM525 . . BSW PRICE \$10.00**

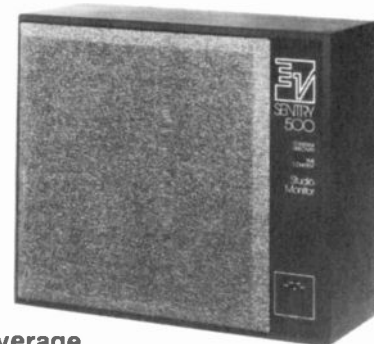

### Sentry 500 Studio Monitor Sentry 500 for wider coverage

The Sentry 500 provides virtually uniform coverage over a 100° angle from 250 Hz on up to 10,000 Hz. Even out to 18,000 Hz, the dispersion is still a wide 60°. This Constant Directivity feature of the Sentry 500 eliminates "hot spots" or "dead zones" at particular frequencies and allows several sets of ears to check out the identical sound.

Mfg. list \$499.00 . . . . . **CALL FOR BSW PRICE**

# Speakers & Brackets



## SPEAKER MOUNTING BRACKETS

Holds up to 70 lbs.

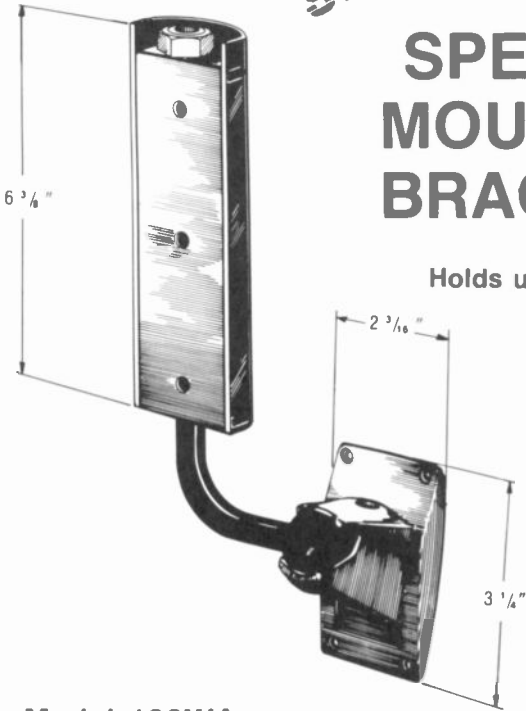

**Model 100WA**  
Mfg. list \$69.95 ea. . . . . **BSW PRICE \$63.95 ea.**

**NOBODY**  
Offers Better  
Service Or Prices

**NOBODY**

And  
We're As Close  
As Your Telephone

**TOLL FREE**  
**1-800-426-8434**



## POWERED MONITOR SPEAKER

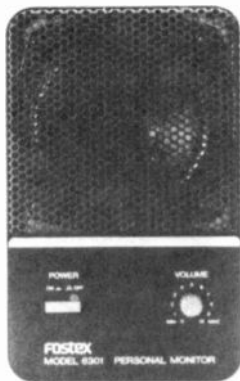

**Model 6301**  
The 6301 is completely self-contained. The sound is delivered from a full-range speaker that's surprisingly flat and accurate.

You get a frequency response of 80Hz-13KHz. which makes the 6301 an ideal reference when you're producing music, radio spots or audio-visual sound tracks.

The built-in 10 watt (RMS, into 8 ohms) amplifier will handle anything you feed it. The 6301's input has been designed to accept any line or instrument-level input, even from an amplifier. There's no confusion. Just one 1/4" phone jack to deal with.

Mfg. list \$298.00 Pr. . . . . **CALL FOR BSW PRICE**



U \* S \* A

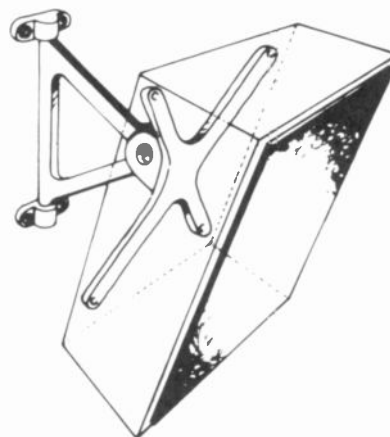

**STRONG ELEGANT SPACE SAVER**

Holds up to 110 lbs.

**Model PU Speaker Mounting Brackets**  
**Construction:** High grade sobel aluminum  
**Finish:** Durable nylon in matte black  
**Mounting screws included**

**BSW PRICE . . . . . \$69.50 Pr.**



# Studio Transmitter Link



## REMOTE PICKUP SYSTEMS

### Model RPL-3A

Moseley Remote Pickup Links provide unsurpassed audio performance for remote broadcasts. Two full-time microphone and high level line audio inputs are standard. Transmitters are only 4" high and weigh a mere 16 pounds, complete with audio mixing and AC/DC power supplies. The companion receiver occupies on 1 3/4 inches of standard 19-inch rack space. Transmitter operates from 120/240 VAC, 50-60Hz source or + 13.5 VDC battery.

Mfg. list

- RPL-3A 148-174 MHZ \$5,995.00 . . . CALL FOR BSW PRICE
- RPL-4A 450-470 MHZ \$6,995.00 . . . CALL FOR BSW PRICE
- RPL-4B 450-470 MHZ \$6,995.00 . . . CALL FOR BSW PRICE

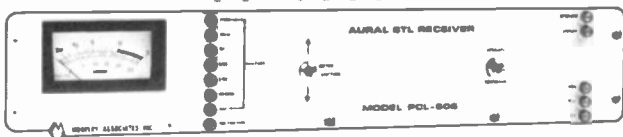

### Models PCL-606 and 606/C STL System

The Models PCL-606 and PCL-606/C Studio-Transmitter Links provide broadcasters and industrial users alike with the highest quality program interconnect currently available in equipment of this type. By the use of the latest technology available in today's market, significantly improved specifications and performance are achieved, even in overly congested areas or high density RF environments. Designed for monaural audio service, the PCL-606 can be used in a dual configuration for stereo service. The PCL-606/C, composite stereo version, conveys composite stereo waveform with virtually no degradation.

### Model PCL-606/606C

Mfg. list \$9,795.00 . . . . . CALL FOR BSW PRICE

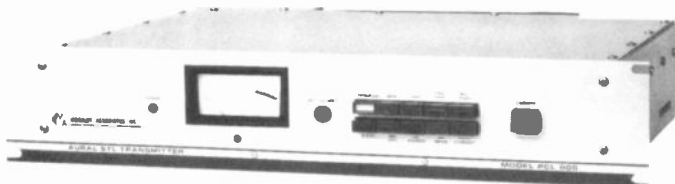

### Model PCL-505/C Aural STL Transmitter/Receiver

The Model PCL-505/C utilizes state-of-the-art stripline techniques and direct FM for completely dependable performance. Solid-state integrated circuitry and continuous-duty design provide ease of operation and maintenance. The PCL-505/C carries composite stereo on a single RF carrier with an automatic transfer panel for standby stereo.

Mfg. list \$7,195.00 . . . . . CALL FOR BSW PRICE



### Model MRC-2 Remote Control 16 Channel

The MRC-2 Microprocessor Remote Control System brings a new level of sophistication to remote control, telemetry and status acquisition. Not only have system size and operational capabilities been greatly expanded over previous remote control systems, but the use of the CRT Option allows plain-English displays and optional logging of command, status and telemetry functions. In addition, the Automatic Control Option allows even greater capabilities by adding time-oriented and feedback-oriented command capabilities to the system.

Mfg. list \$12,095.00 . . . . . CALL FOR BSW PRICE

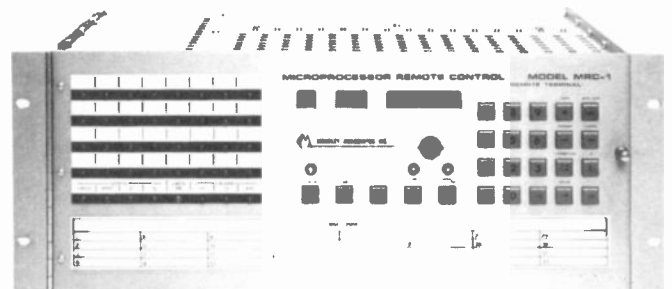

### Model MRC-1 Remote Control System

In step with technology, the MRC-1 provides features previously available only in elaborate, computer-assisted systems. Provides up to 32 channels of status and telemetry, 64 command lines and 9 separate remote sites.

Mfg. list 7,995.00 . . . . . CALL FOR BSW PRICE

## PACKAGE DEALS AND LEASING



Ask Your BSW Representative For Details

1-800-426-8434

# Studio Transmitter Link



## Model PCL-101 Transmitter

Designed for continuous service, the PCL-101 provides high quality audio performance. The PCL-101 STL is ideally suitable for AM and shortwave broadcasters. Two Model PCL-101 systems operated in the "split channel" method is ideally suitable for AM stereo service.

- 148-174 MHZ & 215-240 MHZ . . . . . Mfg. list \$5,195.00
- 300-330 MHZ & 450-470 MHZ . . . . . Mfg. list \$5,695.00
- 890-960 MHZ . . . . . Mfg. list \$5,995.00

**CALL FOR BSW PRICE**

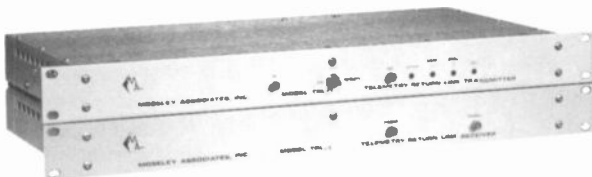

## Model TRL-1 Telemetry Return Link

The Model TRL-1 Telemetry Return Link allows you to transmit telemetry or control data to or from your control point on the 450MHz band. The TRL-1 receiver and transmitter characteristics have been optimally selected for continuous duty and unattended service. An optional MCW identifier and battery pack as well as a separate MIC input for voice communication are also provided.

Mfg. list \$3,495.00 . . . . . **CALL FOR BSW PRICE**

### MCW IDENTIFIER MODULE

Mfg. list \$275.00 . . . . . **CALL FOR BSW PRICE**



## Model SCG-8

### Multiplex FM Subcarrier Generator

Model SCG-8 Multiplex FM Subcarrier Generator offers extreme stability, excellent sound quality, and simplicity of operation. A peak-reading audio meter and all electronic muting are included.

Mfg. list \$1,495.00 . . . . . **CALL FOR BSW PRICE**



## Model SCD-8

### Multiplex FM Subcarrier Demodulator

Model SCD-8 Multiplex FM Subcarrier Demodulator was developed as a companion to the SCG-8 Generator. Front-panel metering, all electronic squelch, and audio low-pass filter are standard equipment. Operating frequency easily changed with plug-in filters.

Mfg. list \$1,295.00 . . . . . **CALL FOR BSW PRICE**

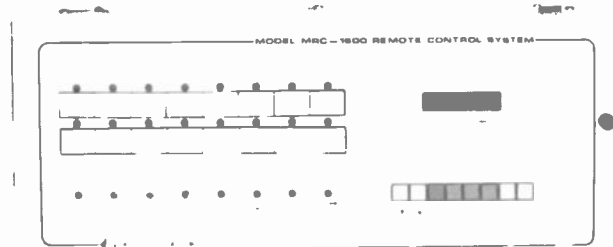

## Model MRC-1600 Remote Control

The MRC-1600 Microprocessor Remote Control offers microprocessor flexibility and sophistication in an economical and dependable package for general AM-FM remote control applications. It comes equipped with 16 status inputs, 16 telemetry inputs, 16 raise command outputs and 16 lower command outputs. Each command output is relay-isolated. Adapting the MRC-1600 to current system interconnections is easy. Plug-in modules can be ordered to accommodate almost any interconnection system, from standard 2-wire or 4-wire telephone lines to FM subcarriers, subaudible telemetry, or a custom combination of any of these.

Mfg. list \$4,395.00 . . . . . **CALL FOR BSW PRICE**



### MRC-1600 CRT

- Installs at MRC-1600 control terminal
- Full keyboard and 12 inch CRT
- 15 foot cable and software
- 1200 baud (120 characters/second)

Mfg. list \$1,175.00

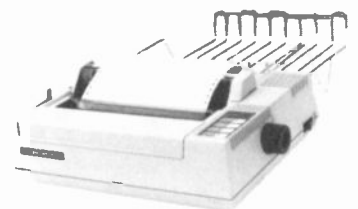

### MRC-1600 Logger

- Texas Instrument Model 850 printer
- Use programmable channel list header text, and log intervals
- 15 foot cable, attaches to auxiliary port on CRT terminal
- 1200 baud

Mfg. list \$895.00

**CALL FOR BSW PRICE**

**RETROFIT KIT AVAILABLE  
FOR YOUR EXISTING MRC-1600**



# Studio Transmitter Link

# MARTI

## Aural Broadcast Studio - Transmitter Links Intercity Relay

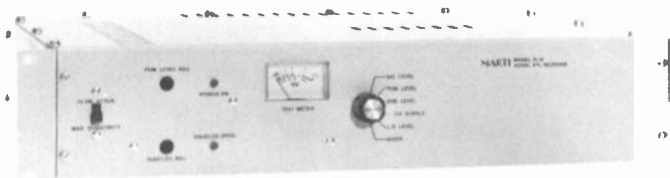

### Model STL-10 Transmitter/Receiver

Marti beats the high-priced competition. Compare the Marti STL-10 system with others—Distortion less than 0.25%, Response  $\pm 0.25$  db, Noise—75 db, Crosstalk—72 db, 60 db signal to noise ratio with only 14uV signal, dual channel reliability and simplicity. Compare Performance, Price and Reliability. Save hundreds - even thousands of dollars with a Marti STL-10 System.

**Call For BSW Price  
Prices Based Upon Configuration**

### Remote Pick-up Systems

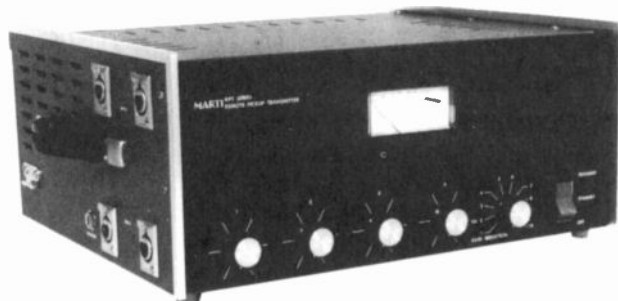

### Model RPT-25

Models RPT-25 and RPT-40 RPU Transmitters provide uncompromised performance in portable and mobile remote broadcast service.

#### Features:

- RPT-25 Type accepted for all UHF RPU channels (25 Watts continuous output.)
- RPT-40 Type accepted for all VHF RPU channels (40 watts continuous output.)
- Four audio inputs with mixing type controls
- Built-in FM Compressor-Limiter
- Built-in AC supply or external DC
- Optional encoder and dual frequency
- Built-in metering

	Mfg. list Single Freq.	Mfg. list Dual Freq.
RPT-25	\$1,745.00	\$1,895.00
RPT-40	\$1,495.00	\$1,645.00

**CALL FOR BSW PRICE**

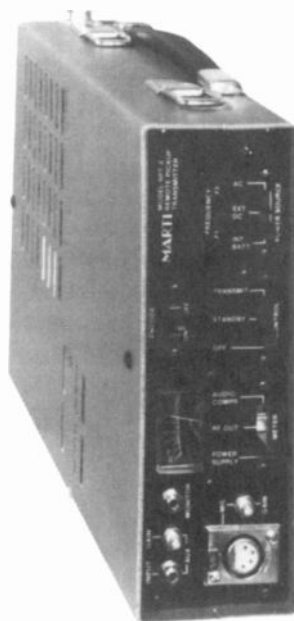

### Model RPT-2 Series

**HAND-CARRIED PORTABLE  
Model RPT-2 Transmitter  
2.5 watts continuous output  
BROADCAST QUALITY**

#### The RPT-2 has these features:

- 3-way power option
- Internal ni-cad battery
- Internal charger and AC supply
- Type accepted on all VHF-UHF RPU channels
- Dual frequency provision
- Sub-audible encoder
- Built-in metering
- FM Compressor-Limiter
- Mixing mic and line inputs

**CALL FOR BSW PRICE  
PRICE BASED ON CONFIGURATION**

# Symetrix

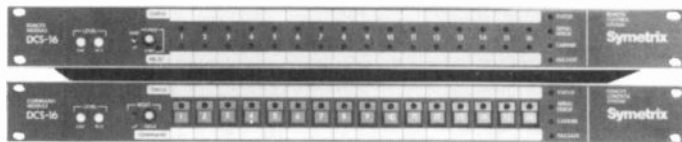

### Model DCS-16 Remote Control System

The DCS-16 incorporates features presently available only in very expensive remote control systems, yet the DCS-16 system is compact, extremely reliable and low cost. Many of the advanced performance features of the DCS-16 are made possible through the use of microprocessors as the main control and logic elements of both the Remote and Command Modules.

Some but certainly not all of the applications of the DCS-16 include: ENG microwave antenna switching, remote VCR/VTR/ATR control and tally, STL/TSL switching and status monitoring, AM/FM/TV/LPTV transmitter control and status indication with failsafe, and remote audio or video router control and status. You can also use the DCS-16 to update your existing control system with additional command and status lines and failsafe capabilities.

Mfg. list \$1,750.00 . . . . . **BSW PRICE \$1,330.00**



# Two-Way Radio



## YAESU

### VHF/UHF/FM REPEATERS

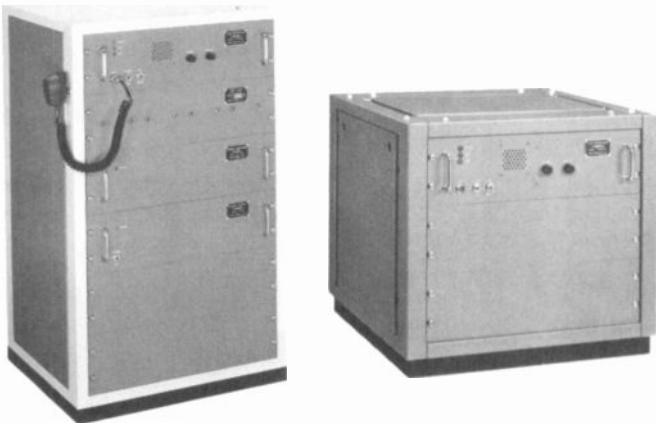

**FTR-710 A**  
**FTR-2410 A**  
**FTR-5410**

**68-88 MHz**  
**134-174 MHz**  
**400-512 MHz**

- 10 Watt FM Repeaters
- AC Line Or 12V DC Source
- Automatic AC To DC Switching And/Or DC To AC
- AC Provides Constant Trickle Charge To Batteries

**CALL FOR CONFIGURATION & PRICE**

**CALL YOUR BSW REPRESENTATIVE FOR DETAILS & PRICE**



**Model FTC 2640**  
**VHF - FM Mobile Transceiver**

**Compact, High Power, Extremely Simple and Built to Last. A Real Workhorse.**

The days of ordering and waiting for crystals are gone! Yaesu brings you an eight-channel synthesized transceiver with 8000 frequencies that can be programmed in seconds. Without any tuning, 2000 synthesized channels are programmable in 5 kHz steps. The Utopia-II Series also allows simplex or split operation.

Mfg. list \$698.00.....**CALL FOR BSW PRICE**



**SYNTHESIZED VHF/UHF HAND HELD TRANSCEIVER EASY TO PROGRAM**

**Model FTC-1123**

The FTC-1123 is a lightweight hand-held transceiver that provides 5 watts (or 0.5 watts, selectable) RF output on any 10 preprogrammed channels in a 10 MHz range between 140 and 174 MHz. The newest automated design and production techniques have now been applied to business communications, resulting in the lightest and most convenient hand portable transceiver ever. Not one, but two internal microprocessors make the FTC-1123 the ultimate in simplicity of operation - with channel selection or scanning at just the touch of a button. But that's not all; press a few more buttons and the scanner will skip over the very busy or unused channels, so you need only monitor those you choose.

**FTC 1123 VHF**

Mfg. list \$499.00.....**CALL FOR BSW PRICE**

**FTC 1143 UHF**

Mfg. list \$550.00.....**CALL FOR BSW PRICE**



**VHF/UHF COMMUNICATION RECEIVER**

**FRG-9600**

**60-905 MHz All Mode VHF/UHF 100 Keypad Programmable Memory Channels**

The FRG-9600 is an all mode scanning receiver that provides features never offered before, covering 60 through 905 MHz continuously, with 100 keypad-programmable memory channels.

In addition to FM wide (for FM and TV broadcasts), FM narrow (for two-way police, military, business and amateur communications), and AM wide and narrow (for aeronautical and amateur communications), the FRG-9600 also provides SSB (single sideband) reception up to 460MHz, allowing monitoring of amateur and military CW and SSB, and the new ACSB mode now used by the military and experimentally as the mode of the future for VHF.

Mfg. list \$649.00.....**CALL FOR BSW PRICE**



# Telephone Equipment

## COMREX<sup>H</sup>

### ASK ABOUT FREE 10 DAY TRIAL

#### Frequency Extenders

The Comrex Frequency Extender is an encode/decode system which restores the low frequency response of dial telephone, microwave, satellite and cable circuits. In addition, the extender provides a remarkable reduction in the low frequency noises often found on common carrier circuits.

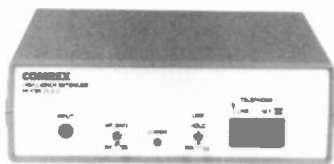

#### PLX-II Encoder

The PLX-II is designed to operate from the output of a Shure M67 or similar remote mixer where program levels will be controlled at the mixer. Modular jacks are provided on the PLX-II for connection to the telephone line and a telephone set. Telephone line interface circuitry is built into the PLX-II for holding the line.

#### PLX-II

Mfg. list \$995.00 . . . . . **CALL FOR BSW PRICE**

#### RLX-II

Mfg. list \$1,400.00 . . . . . **CALL FOR BSW PRICE**

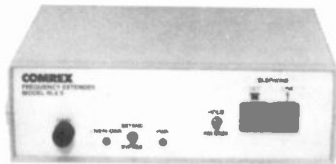

#### RLX-II Decoder

The RLX-II is a desk top decoder with a built-in telephone coupler. It is compatible with all models of Comrex Frequency Extender single line encoders. The EXTEND/BYPASS switch allows the RLX-II to be used as a general purpose telephone coupler for incoming telephone feeds.



#### Model TCB-1A Broadcast Telephone Coupler

The Comrex Model TCB-1A Broadcast Coupler is designed for use by radio and television broadcasters as a means of sending and receiving program material via the switched telephone network. The unit is connected with modular plugs and requires no external power. The TCB-1A contains an FCC registered protective voice coupler which provides longitudinal impedance balance, isolation from hazardous voltages and currents, and includes an active circuit to hold the telephone line. 1/4 inch jack provides line level input.

**BSW PRICE . . . . . \$99.00**

## COMREX<sup>R</sup>

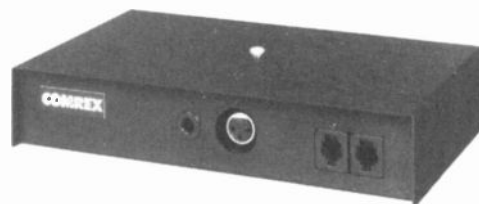

#### Model TCB-2A

#### Auto Answer Coupler For Telephones

It's easy to put your audio on the phone with the new TCB-2A Auto-answer coupler from Comrex. Built specifically for broadcast use, the TCB-2A is perfect for Listen Line applications. Just plug in the standard connectors, attach the power supply and you're ready to go. Coupler answers on the first ring and disconnects when calling party hangs up.

**BSW PRICE . . . . . \$195.00**

#### Model PS14203 Power Supply

**BSW PRICE . . . . . \$12.95**

# NEW

## FROM

# GENTNER

## ENGINEERING COMPANY, INC.



#### Model EFT 1000

#### Extended Frequency Transceiver

Gentner Engineering's EFT-1000 is a telephone line frequency extender that improves the sound of remote broadcasts by shifting, or encoding, audio frequencies before transmission on the phone line and then decoding on the receiving end. The EFT-1000 is unique in many respects: it is a transceiver, capable of both sending and receiving encoded audio; full duplex operation on one phone line is possible, thereby eliminating a costly long distance line for return cues; fully automatic features ensure correct encoding status. The EFT-1000 has internal telephone couplers, headset amplifier, and will accept mic or line input. This product may also be used in nonencoding applications.

Mfg. list \$1,899.00 . . . . . **CALL FOR BSW PRICE**



## Symetrix

BROADCAST TELEPHONE SYSTEM

**NEW**



DESIGNED SPECIFICALLY  
FOR BROADCAST

FAR OUT PERFORMS  
ANYTHING ON THE  
MARKET TODAY

**8 Lines Under \$2,000.00**

**4 Lines Under \$1,000.00**

If listener involvement is a part of your format you need a multi-line telephone interface specifically designed for broadcast. The Symetrix Model 104 Four-line Interface and Model 108 Eight-line Interface (108 remote console shown here) connect your on-air or production consoles directly to incoming phone lines. Sophisticated 104/108 firmware makes system operation simple and fool-proof. Consider these important advantages: **FCC certified** for direct connection to incoming phone lines via standard RJ-11 (modular) connectors. **Loop current detectors** assure no dial-tone on air; if a caller abandons he is automatically released. **Stand alone operation** - the 104 and 108 are complete electronic phone systems and require no additional telco equipment to operate. **Caller conferencing** - up to six callers on air at once with the 108, four callers with the 104. **Call director option** - the 108 system supports the addition of a second remote console specifically programmed for off-air call handling. **Plus**, additional system features too numerous to list. Please call or write for the complete 104/108 system brochure.

**CALL FOR BSW PRICE  
THERE'S NOTHING  
LIKE IT**

## WHEELLOCK

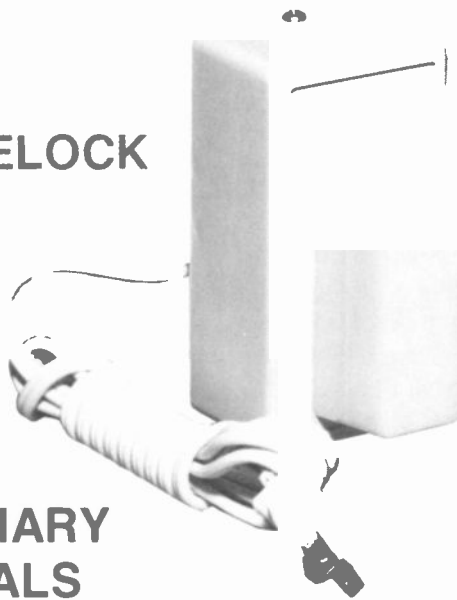

## AUXILIARY SIGNALS FOR TELEPHONE SYSTEMS

**Model PS11 AWPW  
Telephone Strobe Signal**

Compact Telstrobe signals emit high intensity flashing light when the telephone rings. Ideal for broadcast studios.

Mfg. list \$58.00..... **BSW PRICE \$54.95**

**Model PR-11A-W  
Telephone Relays**

Wheellock offers a wide variety of relays for most common telephone ringing applications. Designed for insertion in standard AC receptacles, it can actuate any 115 VAC device up to five amps rated current during on-time of the telephone ring cycle.

Mfg. list.....\$63.00  
**BSW PRICE.....\$59.95**

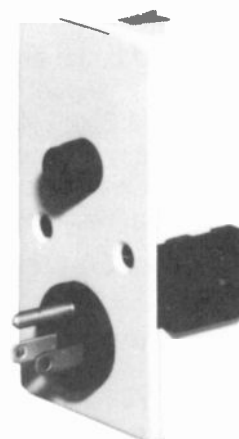

## EXTENDED BSW HOURS



**EASTERN TIME  
9:00AM TO 9:00PM  
CENTRAL TIME  
8:00AM TO 8:00PM  
MOUNTAIN TIME  
7:00AM TO 7:00PM  
PACIFIC TIME  
6:00AM TO 6:00PM**



# Telephone Equipment

**GENTNER**  
ENGINEERING COMPANY, INC.



## SPH-3A Telephone Interface

The SPH-3A telephone system provides an easy, inexpensive method of interfacing your equipment with a telephone system. The SPH-3A permits simultaneous send and receive audio (full duplex operation); in addition, a built-in monitor amplifier eliminates the need for guests or talent to wear headsets. The SPH-3A is simple to install and is fully removable.

Mfg. list \$499.00..... **CALL FOR BSW PRICE**



## SPH-4 Telephone Interface

The Gentner SPH-4 telephone system incorporates a variety of features to give you clean, clear telephone audio for a variety of uses. The unique "caller control" reduces the caller's level when talent is speaking (continuously adjustable); switching transients are suppressed on connection to provide a clean on-air sound. Computer-designed equalization assures best hybrid performance.

Mfg. list \$699.00..... **CALL FOR BSW PRICE**

# VOICE-ACT III

from **SOUND AMERICA** CORPORATION

### Better Faster Telephone Communications

- For field or studio phone
- Transmit any electronic source over phone
- Uses no batteries
- Installs in seconds
- Select MIC or EXTERNAL or mix both
- Frequency compensated amplifier gives wider response
- May be left permanently on phone
- Maintain instantaneous 2-way contact while feeding



**Western Electric..... BSW PRICE \$82.95**

**GTE..... BSW PRICE \$88.95**

**Price includes case.**

**GENTNER**  
ENGINEERING COMPANY, INC.

## Microtel-1

- Portable Mixing
- Studio Talkback
- In the field News Mixing/telephone feeding
- Sports Console/Back-up Sports Console
- Mic to Line Driver for equalized program loops



Gentner Engineering's Microtel is a portable, battery operated telephone interface that may be used for a wide variety of applications. In its typical application, Microtel replaces the handset of the telephone to permit high-quality audio feeding down the phone line while simultaneously monitoring the return audio. Microtel is powered by a single 9V battery.

Mfg. list \$199.00..... **BSW PRICE \$159.95**

# Symetrix



## Model TI-101 Telephone Interface

The Symetrix TI-101 Telephone Interface is the most practical, yet economical device on the market today designed specifically for the connection of professional audio equipment to telephone lines in broadcast and production operations. The TI-101 employs a carefully engineered electronic hybrid circuit which creates a maximum trans-hybrid loss, yielding effective isolation between your studio's send to the telephone line, and your caller return signal. Your net result is clear, intelligible telephone audio which helps you keep pace with today's rapid improvements in AM, FM, and TV audio.

Mfg. list \$495.00..... **BSW PRICE \$369.60**

# FONE-BOX

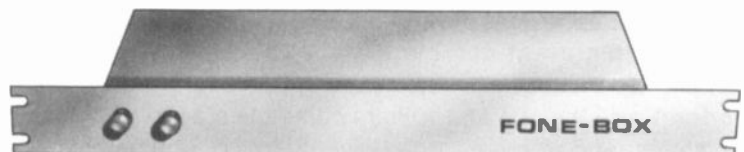

## Fone Box Telephone Interface

The Fone Box provides an inexpensive and effective method of interconnecting standard telephone lines with broadcast facilities for direct airing or recording of telephone material.

And there is nothing complicated about its installation. No special circuits are required. Simple installation instructions are included.

So you get it all: performance, ease of installation and, best of all, low cost.

Mfg. list \$744.00..... **BSW PRICE \$695.00**

# Timers & Clocks



## RADIO SYSTEMS



### Model RSTM-1 Studio Timer

- Times events to 9:59:59
- Interfaces with tape machines, turntables, automation
- Easy to read 1/2" digital readout
- Barrier strip connections

Mfg. list \$155.00.....BSW PRICE \$139.00



### Model ES510ER 60 Minute Timer

- Start/stop reset
- Four digits
- Remote capable

BSW PRICE.....\$189.95



### Model ES562E Studio Timer Six Digit Clock/Timer with Memory

BSW PRICE.....\$341.55

*Seth Thomas*

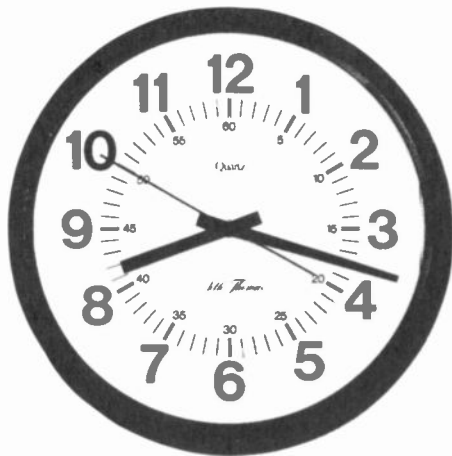

### Model 710

- Brown molded case textured finish
- Red sweep seconds hand (full length)
- QUARTZ (one "C" battery)
- Glass lens
- Diameter 14", D. 2 3/4"
- Large easy-to-read dial graphics

Mfg. list \$34.00.....BSW PRICE \$26.95

### Model 709

- Brown molded case
- White dial
- Arabic numerals
- Sparkling glass lens
- Electric
- Diameter 13 3/8", D. 2 3/4"  
(Not Shown)

Mfg. list \$24.00.....BSW PRICE \$18.95

## AUDIOLAB



### Model AT1200 Studio Timer

ACTUAL SIZE

Event timer provides automatic 3-way operation. Timing starts & stops from any audio source-panel pushbuttons-remote contacts or pulse.

- Interface with any audio source
- Automatic switching from auto to manual operation
- Interface one or more sources for start-stop reset operation
- Minutes/seconds mode displays up to 10 minutes. Hours/minutes shows elapsed time to 24 hours.
- Dimensions 4 1/8" x 3" x 2"
- Rackmountable (4 timers)

BSW PRICE.....\$152.90



## Test Equipment

# Potomac Instruments

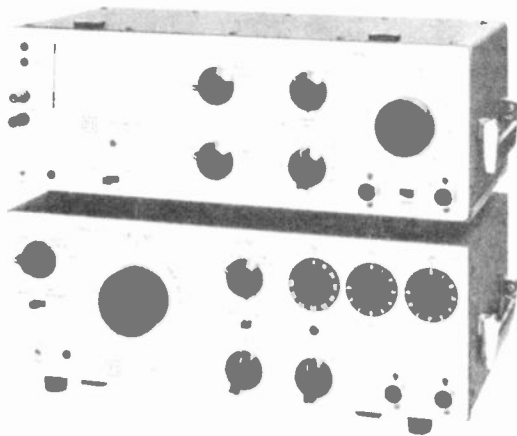

### Model AT-51 Audio Test System Measures

Harmonic Distortion, Intermodulation Distortion, Volts, dB, Signal + Noise/Noise Ratio, Wow and Flutter, Stereo Phasing, Differential Gain in Stereo Channels.

### Features

Separate Generator and Analyzer — Transformerless Stereo Outputs (Balanced or Unbalanced; switch selectable) — Source Resistance 150 ohms or 600 ohms (switch selectable) — Automatic Signal Leveling — Precision 10 dB, 1.0 dB and 0.1 dB Step Attenuators — RFI Shielding — Automatic "Set Level" and "Balance" Circuits — Scope Display of distortion products — Output Level Monitor.

The AT-51 is an innovative audio test system which facilitates the measurement of critical parameters in monophonic and stereophonic audio equipment. Designed primarily for commercial broadcast proof-of-performance measurements and equipment maintenance, the AT-51 exhibits features which are unique and well suited to laboratory type measurements by design engineers, quality control facilities and professional high fidelity service centers. The AG-51 Audio Generator and AA-51 Audio Analyzer are packaged separately for remote measurements requiring physical separation of signal source and signal analyzer. Both units are RFI shielded to enable accurate measurements in high level radio frequency environments typical to broadcast transmitter facilities. Signal input and output connectors are also RFI shielded.

Mfg. list \$3,575.00 . . . . . **CALL FOR BSW PRICE**

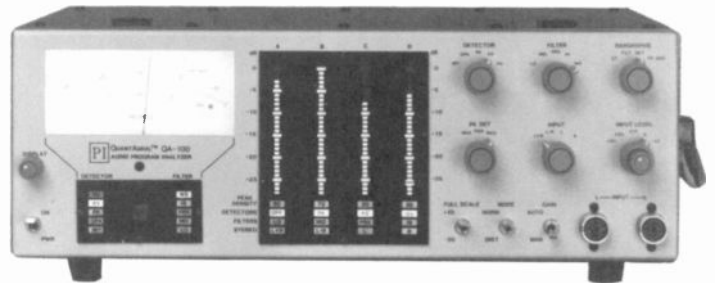

### New Audio Program Analyzer Qualifies Sound For Best Competitive Broadcast Advantage

### Model QA-100

Potomac Instruments has introduced the new Quantaural QA-100 Audio Program Analyzer designed to provide a quantitative analysis of the entire broadcast audio signal. Using the QA-100, a program director may now accurately measure all of the components in a station's "sound". With these measurements, adjustments may then be made in the studio equipment and audio processor to achieve the desired sound for maximum audience response.

The QA-100 effectively operates in a manner similar to the human perception of sound. The audio input signal may be monaural or stereo; from a receiver, tape recorder, modulation monitor, production studio output, or audio processing equipment. The measurements, displayed on a meter and 4 multi-function LED bargraphs, include the maximum peak level, overall audio processing effectiveness (average level), tightness of sound and processing control (peak density), tonal balance and consistency, stereo image width (L-R to L + R ratio), preemphasis, and the "punch" (special "aural intensity" measurement).

Mfg. list \$3,500.00 . . . . . **CALL FOR BSW PRICE**

**BSW HANDLES THE  
COMPLETE LINE OF  
POTOMAC INSTRUMENTS**

**BSW IS THE  
PLACE TO BUY!**

# Test Equipment



## AUTOCGRAM

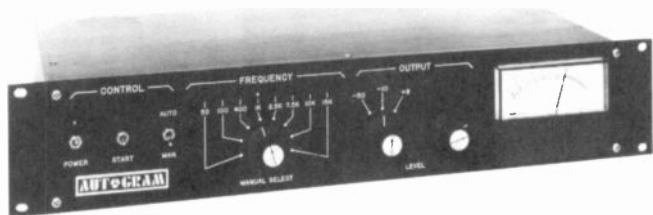

### Model T-8 Frequency Response Test Set

Response test of complete radio station audio system in just 16 seconds. 8 audio frequencies transmitted are: 50-100-400-1K-2.5K-7.5K-10K-15Khz.

Mfg. list \$498.00.....CALL FOR BSW PRICE

## Fostex



### Model TT-15 Test Tone Oscillator

Battery operated, low distortion sine wave oscillator with five selectable frequencies (40Hz, 400Hz, 1kHz, 10kHz and 15kHz) and three selectable output levels (-30dB, -10dB and 0dB). RCA output jack. Useful for spot checking frequency response, calibrating mixers with tape recorders and other level matching jobs. Output is constant and not affected by battery voltage or frequency.

BSW PRICE.....\$39.95

## GOLD LINE

### LL-10 Audio Spectrum Analyzer

The Model LL-10 is a 10-band line level Audio Spectrum Analyzer designed to save time for the audio service technician. A 23dB LED display allows line level readings from tape machines or turntables to be simultaneously displayed over the entire audio range. By making use of a pink noise cassette, or the built-in noise generator, it is easy to record and see immediately the performance of the heads or if either bias or dolby noise tracking calibration is required.

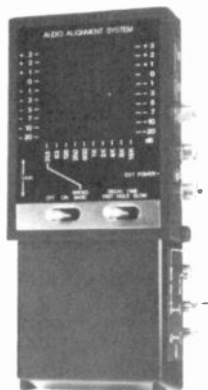

Mfg. list \$339.95.....CALL FOR BSW PRICE

### ASA-10B

Audio Spectrum Analyzer. An affordable, professional-quality, 10-octave analyzer covering the full audio range that allows you to balance your audio system; EQ and check out your phono-amplifier, tape deck, and loud speakers and make sure that your system delivers its optimum performance.

### ASA-10B

Mfg. list \$339.95.....CALL FOR BSW PRICE

### PN2 Pink Noise Generator

Mfg. list \$79.95.....BSW PRICE \$71.95



## Urei

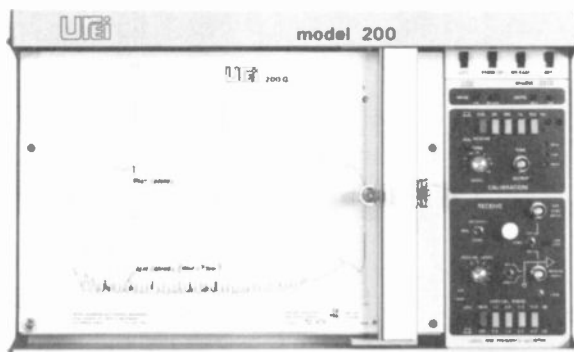

### Model 200 Plotter

Hard copy plots on paper has an auxiliary port for an oscilloscope. Available with different modules to measure frequency response, level and frequency detection.

Call for Prices

## XEDIT METERS

### XEDIT Model 20-P Drift and Flutter Meter



- Flutter measurements: subjective PEAK value meets DIN and IEEE standards. RMS value conforms to JIS. Ranges: .05% - .1% - .5%F.S. Accuracy: within  $\pm 3\%$  of F.S. reading
- Drift measurement: percentage of speed deviation in relation to stable reference oscillator. Range:  $\pm 5\% \pm 3\%$  accuracy

BSW PRICE.....\$550.00



# Tonearms

## ProTec



**Model S220**  
**The Rugged Professional**

- 12" tone arm
- Rugged, all metal construction

**BSW PRICE.....\$89.95**

 **audio-technica**  
• INNOVATION □ PRECISION □ INTEGRITY



**Model ATP-12T**

Mfg. list \$175.00..... **BSW PRICE \$149.95**

## RUSSCO



**Model RTA-12**  
**Russco Usual Quality**

- Designed for broadcast
- Aluminum brass construction
- Precision ball and jewelled bearings

Mfg. list \$199.00..... **BSW PRICE \$189.95**

 **MICRO-TRAK**



**Broadcastings Most Popular Tonearm**

- Laminated mahogany shaft
- Small tracking error
- Low resonance

**Model 303 12"**

Mfg. list \$129.50..... **BSW PRICE \$123.00**

**Model 306 16"**

Mfg. list \$169.50..... **BSW PRICE \$161.00**

# SME

**PRECISION PICKUP ARMS**  
**"The World's Finest"**



**Model III SB**

**BSW PRICE.....\$207.50**



**Model 3009R**

- New Balance system
- Low mass head shell with double draw-in pins
- Mounts on all standard turntables

**BSW PRICE.....\$319.00**



# Turntables



Shown With  
Optional Tonearm

## Model QRK-12C 3 Speed Turntable

- Instant start, full speed in less than 1/16 revolution
- Rugged construction, only 3 moving parts
- Stereo rumble less than 48 db (exceeds NAB Standards)

**BSW PRICE (Undrilled).....\$343.00**  
**Drilling Fee.....\$15.00**

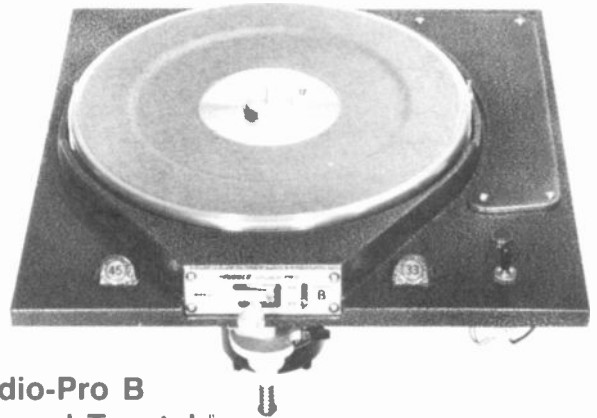

## Studio-Pro B 2 Speed Turntable

- Precision engineered for quiet, dependable operation
- Solid cast aluminum chassis and turntable
- Illuminated speed indicators
- Tightest cue potential in the industry
- Detachable tone arm mounting plate
- Rim drive

Mfg. list \$479.00.....**CALL FOR BSW PRICE**



## Model RT700 Extensive Research And Years Of Experience Means RT700

- Direct drive
- Phase locked servo
- Rumble - 50dB
- Quartz controlled
- Wow & flutter .025%
- Enormous starting torque

Mfg. list \$850.00.....**CALL FOR BSW PRICE**

## Henry Engineering



## TURNTABLE REMOTE CONTROL FOR DIRECT DRIVE TURNTABLES

**DESCRIPTION:** The UNIVERSAL TURNTABLE CONTROLLER is a control interface device that allows full remote control of popular direct-drive turntables such as Technics SP10s, SP15s, and the new Russco RT-700. The "UTC" easily connects to the turntable with just three wires, and provides CMOS/contact closure compatible outputs for separate START and STOP switches, plus RUN and STOP tally lamps. The turntable's own start/stop switch can still be used for cueing records, and the UTC always stays IN SYNC with the turntable. One UTC will control TWO turntables.

Mfg. list \$180.00.....**BSW PRICE \$169.95**



## Cue Master 3 Speed Turntable

- No-slip starting rim drive
- Bronze platter shaft bearing
- Motor on/off switch light
- Simple capstan-to-idle drive
- Rugged construction - only 3 moving parts

Mfg. list \$425.00.....**CALL FOR BSW PRICE**



# Turntables

## Technics

### QUARTZ CONTROLLED DIRECT DRIVE

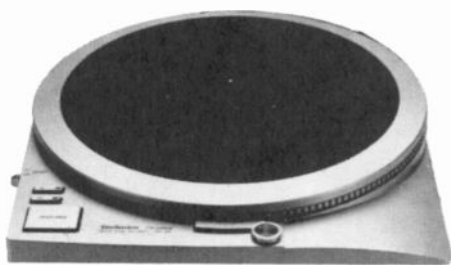

**Model SP-25**  
**Quartz-Synthesizer-Controlled**  
**Direct-Drive Turntable**

Quartz-controlled. Pitch control of  $\pm 6\%$  of standard speeds. High torque. Electronic brakes.

Mfg. list \$400.00 . . . . . **BSW PRICE \$298.00**

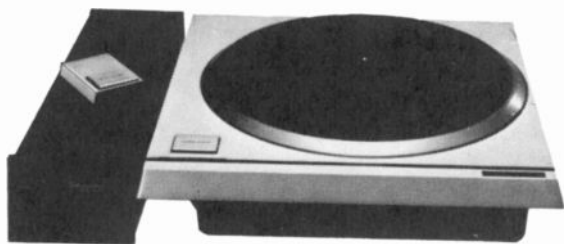

**Model SP-10MKIIA**  
**Broadcast Turntable with Quartz Phase-**  
**Locked Direct-Drive Motor**

Quartz control for virtually perfect speed accuracy (max.  $\pm 0.002\%$  deviation). Direct drive for virtually no rumble, wow or flutter. Electronic brakes. Enormous torque.

Mfg. list \$1,100.00 . . . . . **BSW PRICE \$798.00**

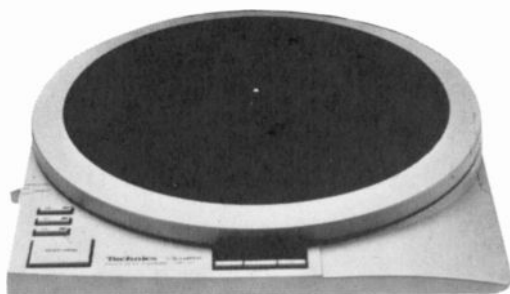

**Model SP-15**  
**Quartz-Synthesizer-Controlled**  
**Direct-Drive Turntable**

Quartz synthesizer permits up to  $\pm 9.9\%$  deviation with digital readout. Enormous torque. Electronic brakes.

Mfg. list \$700.00 . . . . . **BSW PRICE \$518.00**

**BSW IS OPEN**  
**SATURDAY**  
**FOR YOUR**  
**CONVENIENCE**



Check Saturday  
Hours On Back  
Cover



**Model SL-1200 MKII**  
**Quartz-Controlled Direct-Drive Turntable**

Mfg. list \$400.00 . . . . . **BSW PRICE \$325.00**

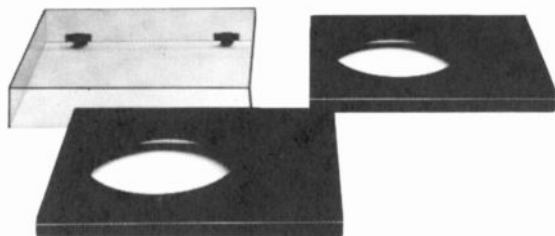

**Models SH-15B3/10B3**  
**Bases for Models SP-15/SP-25/SP-10MK II**

Specially designed for outstanding vibration insulation. Finished in black.

**SH-15B3 FOR SP-15/SP-25**  
Mfg. list \$280.00 . . . . . **BSW PRICE \$239.95**

**SH-10B3 FOR SP-10MKIIA**  
Mfg. list \$520.00 . . . . . **BSW PRICE \$439.95**



# Technics

## TECHNICS & PROBASE PACKAGE DEAL

## ProBase for Technics



(SP-25 Pictured)

SP-15	\$518.00	SP-25	\$298.00
ProBase	\$95.00	ProBase	\$95.00
Protec		Protec	
Tone Arm	\$89.95	Tone Arm	\$89.95
<b>Total</b>	<b>\$702.95</b>	<b>Total</b>	<b>\$482.95</b>

**BSW  
PACKAGE PRICE  
\$599.95**

**BSW  
PACKAGE PRICE  
\$399.95**

- Beautiful designed turntable base
- Black overlay on 1½" sound absorbing particle board
- Free floating, low resonance
- Heavy duty audio insulator, adjustable base legs with wide rubber non-slip pads for isolation & stability

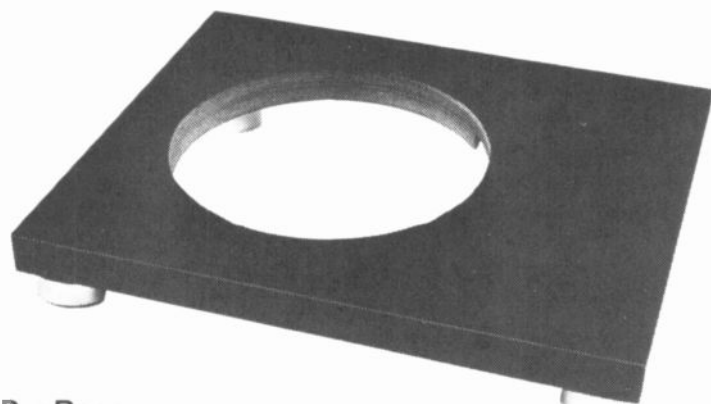

**ProBase  
For SP-15 & SP-25  
BSW PRICE.....\$95.00**

SPIOMKIIA	\$798.00
ProBase	\$95.00
Protec Tone Arm	\$89.95
<b>Total</b>	<b>\$982.95</b>
<b>BSW PACKAGE PRICE.....</b>	<b>\$898.00</b>

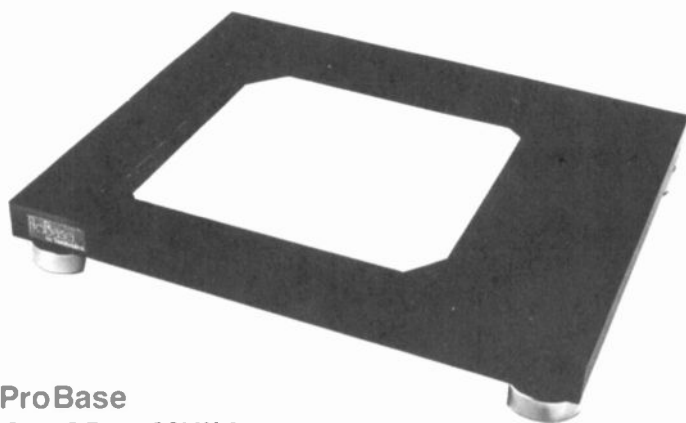

**ProBase  
For SP-10MKIIA  
BSW PRICE.....\$95.00**

- One Location
- One Telephone Number
- One Million Dollar Inventory



**MEANS  
LOW PRICES  
GREAT SERVICE**

**TOLL FREE 1-800-426-8434**

## Geo-Disc™

For tone arm and Phono Cartridge alignment we suggest the Geo-Disc™. The Geo-Disc looks like a 12" LP record but is actually a measuring device that enables you to achieve critical alignment to within .003 of an inch. The Geo-Disc allows proper phono cartridge off set tracking angle and overhang. A must if you're mounting new tone arms and/or phono cartridges.

**BSW PRICE.....\$24.99**



# Turntable Suspension System

## SIMS

### VIBRATION DYNAMICS

# STOPS RUMBLE DEAD IN ITS TRACKS

- BLOWER AND AIR CONDITIONERS
- HOLD A DANCE IN CONTROL ROOM

## ALL VIBRATION ELIMINATED

### NO RUMBLE



(Turntable not included)

**Model GSP 1000**  
**Turntable Base For**  
**Technics SL-1200 MK II**

The art of sound reproduction has been plagued with vibration problems since its inception. An effective vibration isolation system for separate component turntables has long been awaited. Never before has there been a turntable audio isolation system as effective in providing complete vibration isolation in a professional application as the new GSP-1000.

**BSW PRICE.....\$198.00**

**Model GSP 1000E**  
**Turntable Base For Technics**  
**Models SP10 - SP15 - SP25**

The GSP-1000E Electric Audio Isolator eliminates feedback over the entire audio spectrum, from 20 - 20,000 Hz at any volume level and reduces transit vibration over 100% at audio frequency levels above 50 db. Airborn echo and low bass rumble are virtually eliminated. It is designed to function when subjected to variable disturbing forces such as blowers and air conditioners and is not just limited to narrow bands of isolation, but throughout the entire audible frequency range.

**BSW PRICE.....\$498.00**

# Turntable Cartridges & Phono Styli



## Stanton Cartridges

Model	1-3	4-11	25% 12 PLUS
500A MKII	13.15	11.85	10.55
500AL	15.65	14.10	12.50
500E MKII	13.50	12.15	10.80
500EE MKII	17.50	15.75	14.00
600A	22.00	19.80	17.60
600E	25.50	22.95	20.40
600EE	27.50	24.75	22.00
681A	55.00	49.50	44.00
681SE	60.00	54.00	48.00
681EEE MKIIS	70.85	63.75	56.65
881S	96.65	86.95	77.35



## Stanton Replacement Styli

Model	1-3	4-11	12 PLUS
D50A	7.20	6.75	6.50
D5107AL	7.20	6.75	6.50
D5105AA	10.00	9.00	8.00
D50E	10.00	9.00	8.00
D50EE	12.90	11.60	10.35
D6071A	12.15	11.55	10.95
D6004E	15.00	14.50	14.00
D6003EE	16.50	16.00	15.50
D6807A	19.40	18.90	18.40
D6800SE	23.40	22.25	21.10
D6800EEE	27.00	26.50	26.00
D6800EEIIS	27.00	26.50	26.00
D81S	45.00	44.50	44.00
D5107A	7.20	6.75	6.50

## Shure Phono Cartridges

M44-7	23.85	19.05	16.70
M44-C	23.85	19.05	16.70
SC35C	40.50	32.40	28.35
SC39B	56.25	45.00	39.40
SC39EJ	63.00	50.40	44.10



## Shure Replacement Styli

N44-7	13.50	10.80	9.45
N44-C	13.50	10.80	9.45
SS35C	15.30	12.25	10.70
SS78E	19.35	15.50	13.55
SS39B	22.95	18.35	16.05
SS39EJ	28.80	23.05	20.15
SS39ED	36.00	28.80	25.20

## Audio Technica Cartridges

ATP 1	28.70	22.95	20.10
ATP 2	37.80	30.25	26.45
ATP 3	51.30	41.05	35.90

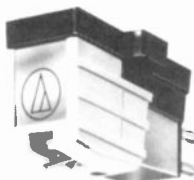

## Audio Technica Replacement Styli

ATPN 1	15.10	12.10	10.55
ATPN 2	22.50	18.00	15.75
ATPN 3	30.15	24.10	21.10

discwasher®

**D4™**

Record  
Care  
System



**BSW PRICE.....\$15.00**

- Cleans without reduction in record dynamics & fidelity
- D4 fluid lifts & suspends contaminants in solution on record surface.
- D4 pad mick-fibers are directional, lifting dust rather than lining it up.

### Refills

6oz. bottles.....\$8.35  
16oz. bottles.....\$13.60

**45 RPM  
Record  
Jackets**

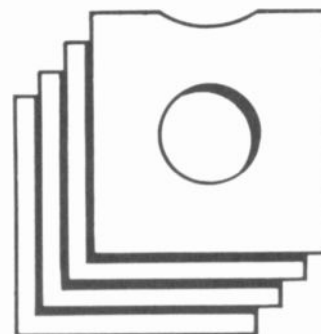

Mix 'em for  
maximum discount

Green  
Blue  
Red  
Gold

QUANTITY	1-199	200	300	500	1000
UNIT PRICE	.12	.10	.09	.08	.06



# Tuners & Transmitters

## Soundcraftsmen



### Model T6200 AM-FM Stereo Tuner

Soundcraftsmen's advanced technology incorporates sophisticated Frequency Synthesized Tuning with a highly stable Quartz Crystal Oscillator that locks onto the broadcast signal and makes station selections precise and drift-free. A 14-station Microcomputer Memory System, coupled with two-way Automatic Scanning, provides incredibly simple pre-programming and station selection.

#### Rack Mountable

Mfg. list \$299.00 . . . . . **CALL FOR BSW PRICE**

## Technics



Model ST-G6T



Model ST-G3

### ST-G6T Quartz Digital AM/FM Stereo Tuner

- All DC circuitry and twin quartz control for wide frequency response of 4Hz - 18kHz (+0.2dB, -0.5dB) and 106dB dynamic range.
- Low distortion DC linear switching MPX circuit.
- Computer controlled automatic IF bandwidth selection.
- AM/FM 16-station random access preset memory.
- Built-in programmable timer
- Automatic preset memory and auto-scan tuning.
- Variable auto-scan stop level (off/30dB/40dB/50dB).
- 19kHz pilot signal automatic canceler.

Mfg. list . . . . . \$270.00  
**BSW PRICE . \$238.50**

### ST-G3 Quartz Digital AM/FM Stereo Tuner

- Twin quartz DC digital tuning system for accurate tuning and wide stereo separation.
- Low distortion DC linear switching MPX circuit.
- AM/FM 16-station random access preset memory.
- Automatic preset memory and auto-scan tuning.
- Variable auto-scan stop level (30dB/40dB/50dB).
- 19kHz pilot signal cancel circuit for extended high range frequency response (4Hz-18kHz, +0.5dB, -1.5dB).
- Multi-function low-noise LCD display.

Mfg. list . . . . . \$185.00  
**BSW PRICE . \$164.25**

## LPB

### Low Power Transmitters For AM Broadcast

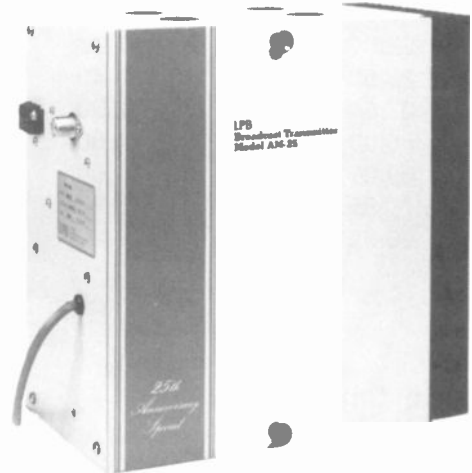

### Model AM-25P 25 Watt AM Broadcast Transmitter

The AM-25 Transmitter has been designed to be universal in its application. With its 50 ohm unbalanced RF output, it can readily interface with direct radiating systems employing impedance matched radiators. The companion TCU-30 Transmitter Coupling Unit is used with the AM-25 for carrier current installations and other applications utilizing non-standard radiating elements.

The AM-25 Transmitter is completely solid-state, using a balanced emitter output transistor pair which will withstand output mismatch or short circuit condition. A high-stability crystal oscillator operates at six times the carrier frequency and utilizes digital countdown circuitry. A computer designed elliptic function output filter provides a high degree of RF harmonic suppression.

4 Other Models To Choose From 30-50-100-150 Watt

**CALL BSW FOR PRICING**

# ANDREW CABLE WAVE Transmission Cable

## Call BSW for Pricing and Configuration

### 1-800-426-8434

# Transmitters

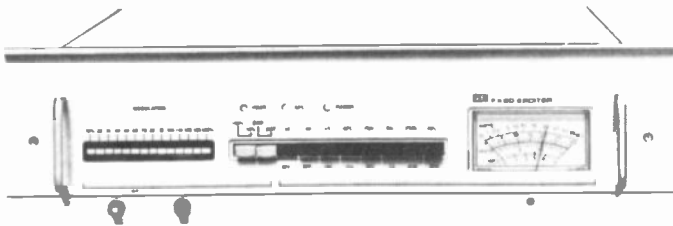

## Model FX-30 FM Broadcast Exciter

- Superior performance rivals the best Hi-Fidelity Tuners
- Ultra-linear modulated oscillator for unexcelled stereo and SCA performance
- Composite inputs compatible with all stereo and SCA generators
- Extremely low distortion - THD and IMD less than 0.08%
- First exciter to specify transient intermodulation distortion (TIM) at less than 0.1%
- Advanced dual-speed phase locked loop greatly improves low frequency response
- Quiet operation - typical S/N ratio of 78dB
- Completely broadband - requires no tuning

**BSW PRICE . . . . . \$5,595.00**



## Model FC30 FM Subcarrier Generator

- Very low FM noise, highly-stable, ultra-linear 67 kHz modulated oscillator ensures minimum distortion
- Memory logic retains mode of operation during power interruption up to one hour, with automatic restart
- Advanced dual-mode, controlled-decay subcarrier attenuator ensures noise-free receiver muting
- Unique, optically-isolated remote control operation
- Front panel LED peak modulation indicators and control adjustment access

**BSW PRICE . . . . . \$1,495.00**

## THE ALL NEW WILKINSON BY TELEVISION TECHNOLOGY



## 8090 Series Model X FM Broadcast Exciter

- 5 subcarrier inputs standard
- Completely broadband - no tuning adjustments
- Frequency synthesized in 2.5 KHz steps from 76-108 KHz
- Ultra high performance
- 28 volt DC power

Typical THD and IMD less than .005%  
 Typical FM signal to noise ratio better than - 95 dB  
 Typical frequency response within .025 dB,  
 20 Hz to 100KHz

Proving daily that this new WILKINSON EXCITER now manufactured by Television Technology is superior in every way. Your test equipment will prove it. More importantly your ears will actually notice the difference.

Mfg. list \$5,850.00 . . . . . **BSW PRICE \$5,735.00**

## TELEVISION TECHNOLOGY FM TRANSLATORS



### XLFM Series

- 1 and 10 watt models
- Very conservatively rated
- Stable output under any load condition
- Withstands extreme input overload
- Choice of selectivity
- Stereo monitor
- Optional local origination
- Superlative performance
- Competitively priced

**Call BSW for  
Pricing and Configuration**

**NOW OPEN SATURDAY**



**And  
We Are As  
Close  
As Your Telephone  
TOLL FREE  
1-800-426-8434**



# Transmitters

## CSI

**CSI TRANSMITTER  
MATERIAL  
DID NOT ARRIVE  
BY PRESS TIME**

**HOWEVER  
BSW  
HANDLES  
THE  
ENTIRE CSI  
TRANSMITTER  
LINE**

**CALL FOR  
APPLICATION  
&  
PRICING**

## WILKINSON

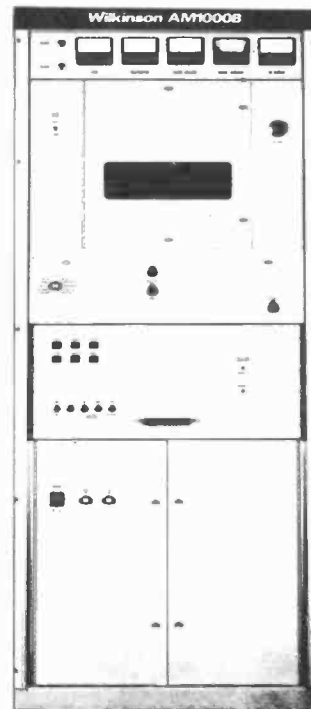

AM-Transmitter

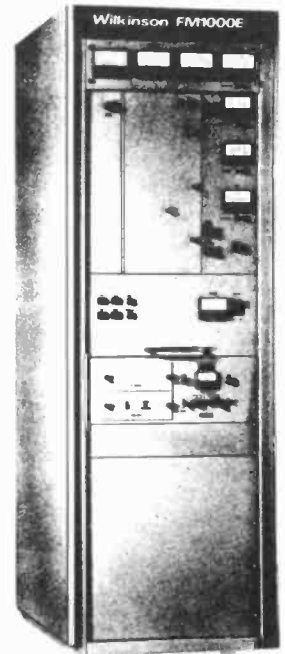

FM-Transmitter

### AM TRANSMITTERS

**6 Models - 250 Watt To 25000 Watt**

- Variable vacuum capacitor tuning eliminates sliding contacts.
- Motorized variable capacitor loading for ease and precision of adjustment.
- Solid state time delay and recycling increases reliability
- Solid state control circuitry conserves space and reduces complexity.
- Complete metering.

**CALL FOR BSW PRICING & APPLICATION**

### FM TRANSMITTERS

**12 Models - 100 Watts To 30,000 Watts**

- Input and output reflectometers
- Self-testing Wilkinson silicon rectifiers provide more than 300% voltage and current protection.
- Printed circuit control ladder conserves space, reduces complexity.
- Solid state time delay and recycling increases reliability
- Conservatively rated, double duty plate transformer and filter reactor
- VSWR overload protection standard

**CALL FOR BSW PRICING & APPLICATION**





# ELCOM BAUER

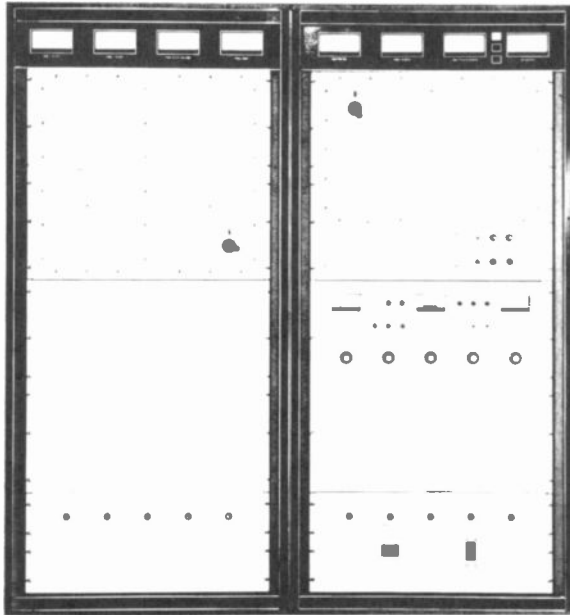

## CALL FOR APPLICATION & PRICING

### AM Transmitter

Available 250 Watts - 50,000 Watts

#### Operational Benefits

- 125% positive peak capability.
- Stable high level plate modulation.
- Three (3) tubes.
- Plug-in solid state low level audio and RF driver stages.
- Adaptable for AM stereo.
- Oil-filled modulation transformer.
- Two (2) ovenless crystals switchable.
- Unexcelled accessibility.
- Remote ready — wire or STL.
- Interface for standard telemeter control equipment.
- Step start.
- Three (3) step overload.
- FCC primary circuits metered and continuously monitored.
- Secondary operating parameters with multimeter readout.
- Front panel circuit breakers.
- Fuses with fault indicators.
- Tally light fault indicator with memory system.
- Remote resettable fault indicator.

### FM Transmitters

Available 250 Watts to 55,000 Watts

Elcom Bauer single tube FM transmitter designs are aimed at absolute reliability achieved through state-of-the-art solid state technology coupled with classical vacuum tube design. The basic requirement is simplicity - with resultant dependability - and uncluttered, easy-maintenance interiors.

#### FEATURES:

- Minimal Floor Space
- Low Operation Cost
- Ease of Maintenance
- One Tube
- Automatic Power Control
- VSWR Protection
- Automatic Recycling
- Remote Control Interface
- Varian EIMAC Designed Power Amplifier Assembly
- High Performance Exciter
- Field Proven Control Circuitry
- Soft Start Protection

## CALL FOR BSW PRICE

### FM Exciter

The all new 690PLL Exciter from Elcom • Bauer combines all of the high-performance, high-reliability features most wanted by FM broadcasters.

Frequency stability is excellent:  $\pm 300$  Hz, with  $\pm 100$  Hz typical. Noise and distortion levels are very low. 690PLL accepts signals from monaural programming, composite signal sources, and SCA generators. It is compatible with, and will enhance, any audio processing system.

Frequency modulation is direct, and incorporates phase-locked loop technology. Power supplies are controlled by integrated circuit voltage regulators for stability and reliability.

### FM EXCITER

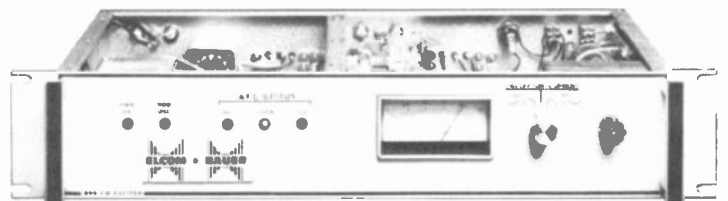

#### Model 690

Output frequency range is 88 MHz to 108 MHz, programmable in 100 KHz steps. RF power output is 1 to 15 watts, continuously variable.

Mfg. list \$2,850.00 . . . . . CALL FOR BSW PRICE



# Weather Instruments

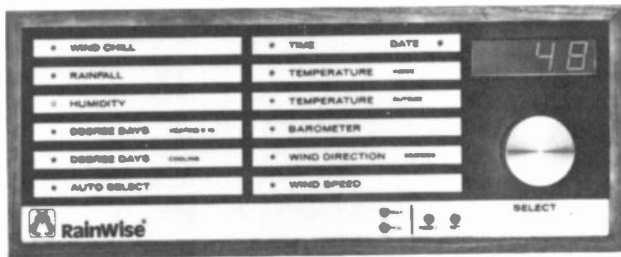

	Windchill Choice of readout in F° or C°		Time 12 hour format Date Month and Day (24 hour format for max min)
	Rainfall Measures in 01 of an inch Provides a cumulative recall		Inside Temperature Choice of readout in F° or C°
	Relative Humidity Shown in percent		Outside Temperature Max min for selected period of time Choice of readout in F° or C°
	Degree Days Heating, X10		Barometric Pressure In inches of mercury Flashing indicates falling Has max min recall *
	Degree Days Cooling		Wind Direction Display in 10° increments of 360° compass rose
	Auto Select Provides 4 second readout of each function in sequence <small>Outside Temperature is shown</small>		Windspeed With maximum gust Choice of scales MPH KPH knots <small>*Readout in Millibars available by special order</small>

## RainWise Does It All

### Model WS1000 The Digital WeatherStation™ ...the Ultimate In Weather Watching

Engineered for precision and trouble-free operation, this computer-age WeatherStation™ monitors nine different weather phenomena. The station provides digital readout for Time, indoor and outdoor Temperature, Barometric Pressure, Wind Direction, Wind Speed, Wind Chill, Rainfall, and accumulates Degree Day Heating and Degree Day Cooling throughout the year. Maximums and minimums are provided for any desired period to the nearest hour, day, and month. The unit is easy to read and operate. A red light indicates the function chosen by the selector knob, and the value is displayed in bright .8" LED numerals. An Auto Select position displays each function in sequence for four second intervals.

The unit measures 7" high, 17½" long, 1½" deep, and may be mounted without cutting a hole in the wall. The attractive black and brushed aluminum faceplate is complimented by the genuine walnut frame. The unit operates on safe low voltage from a power supply that plugs into a standard AC receptacle. An optional battery pack prevents loss of memory data in the event of a power failure.

Mfg. list \$990.00..... **BSW PRICE \$695.00**

## COMPUTEMP

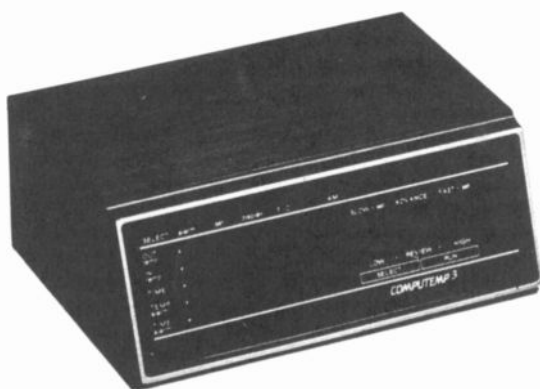

### Computemp 3 The Fascinating Approach To Time & Temperature

- Accurately monitors outdoor and indoor temperatures and time of day.
- Temperature alarm alerts to any predetermined setting
- 24-hour memory of daily high and low temperatures, and the exact time of the occurrence
- Continually alternating LED display
- Battery back-up system, to retain memory
- Removable temperature sensors

Mfg. list \$72.95..... **BSW PRICE \$59.95**

## RainWise

### The Raingauge You Never Have to Empty



#### Model 100

- Rain gauge indicator
- Re-set button
- Battery powered (batteries not included)
- Wire
- Collector
- Electronic Measuring

**BSW PRICE.....\$69.95**

ITEM	PAGE
ABCO	68
ADC	81
AKG	50, 55
AMPEX	73
ANDREW	100
ANIXTER MARK	10
ANVIL	60
APHEX	23
ARISTOCART	27, 69, 90
ARRAKIS	40, 71, 80
ATI	3, 5 - 8, 39
ATLAS	59
AUDI-CORD	31
AUDIO-DIGITAL	16
AUDIOLAB	24, 91
AUDIOTEC	59
AUDIO TECHNICA	52, 57, 94, 99
AUDIX	52
AURATONE	82
AUTOGRAM	43, 93
BELAR	67
BEYER	51
BG ENGINEERING	34
BGW	4
BROADCAST ELECTRONICS	28, 29, 38, 95, 101
BSW	25
CABLEWAVE	100
CANARE	53
CAPITOL	27, 73
CBS	26
CELWAVE	11
CETEC	11
CETEC VEGA	58
COMPUTEMP	104
COMREX	47, 88
CONEX	66
COOPER GROUP	62
COUNTRYMAN ASSOC.	57
CRL	14, 21
CROWN	4, 56
CSI	102
DALE	63
DBX	18
D.E. WINGET	65
DISCWASHER	37, 99
DORROUGH	15, 61
EDCOR	2, 4
EDITALL	25
ELCOM BAUER	103
ELECTRO-VOICE	49, 52 - 54, 82
ESE	91
EVENTIDE	19
FIDELIPAC	24 - 26, 28, 32, 64, 69
FOSTEX	15, 34, 50, 83, 93
GEM	26
GENTNER	38, 80, 88, 90
GEO-DISC	97
GOLDLINE	93
GORMAN REDLICH	66
GRAPHIC EXPRESS	72
HENRY ENGINEERING	3, 95
HOWE AUDIO	45, 60
ICE KRACKER	10
ITC	33
JBL	82
KOSS	50
LARSEN	10
LITTLITE	65
LPB	39, 100
LUXO	59, 64
MARANTZ	36
MARTI	86
MICROTRAK	5, 6, 9, 47, 48, 72, 94
MODULATION SCIENCES	20

ITEM	PAGE
MOSELEY	84, 85
MRL	26
MW PERSONS	62
NORTRONICS	24 - 26
NOTEWORTHY	99
OMNIMOJUNT	83
ONAN	61
ORBAN	12, 13
OTARI	76
PANASONIC	36
PANDUIT	62
PIVOTELLI	83
POTOMAC	92
PROAMP	9
PROBASE	97
PROBOCM	59
PROCABLE	52
PROCART	27
PROLITE	60, 64
PRORAX	69, 70
PROTEC	94
QSC	6
RADIO SYSTEMS	7, 9, 41, 61, 91
RAINWISE	104
RAMKO	7, 8, 41, 49, 80
RAMSA	44
RANE	2
RD SYSTEMS	57
REVOX	37, 75
RSC	73
RUSSCO	3, 5, 7, 8, 9, 47, 48, 94, 95
SAE	65
SCALA	10
SCOTCH	26, 73
SCRIBE	36
SENNHEISER	50 - 52, 56
SETH THOMAS	91
SHURE	2, 8, 49, 51, 52, 55, 99
SIMS	98
SME	94
SONAR	24
SONEX	68
SONY	56
SOUND AMERICA	90
SOUNDCRAFTSMEN	100
SOUNDOLIER	68
STANTON	99
STL	26
STUDIO TECHNOLOGIES	21
SYMETRIX	5, 22, 86, 89, 90
TANDBERG	37, 79
TAPECASTER	25, 34
TASCAM	2, 3, 18, 34, 46, 71, 77 - 79
TEAC	2, 3, 16, 18, 34, 46, 71, 77 - 79
TECHNICS	35, 78, 96, 97, 100
TELEVISION EQUIPMENT	51
TELEVISION TECHNOLOGY	101
TELEX	51, 58
TELFAX	48
TFT	67
UREI	9, 17, 42, 93
URSA MAJOR	18
VALENTINO	62
VALLEY PEOPLE	20
VEGA	58
VIF	65
WEST PENN.	66
WHEELOCK	89
WILKINSON	63, 101, 102
XCELITE	62
XEDIT	93
YAESU	87
ZERCOM	48

# One Call Does It All

## BSW 800 Number Includes

Washington • Alaska • Hawaii • Puerto Rico • Virgin Islands • and Canada

## Six Lines To Serve You

12 Hours Daily



## We Are Ready For Business When You Are

### WEEKDAY SCHEDULE

**Pacific Time**  
6:00 AM to 6:00 PM

**Mountain Time**  
7:00 AM to 7:00 PM

**Central Time**  
8:00 AM to 8:00 PM

**Eastern Time**  
9:00 AM to 9:00 PM

### SATURDAY SCHEDULE

6:00 AM to 2:00 PM

7:00 AM to 3:00 PM

8:00 AM to 4:00 PM

9:00 AM to 5:00 PM



**Broadcast Supply West**  
7012 27th Street West  
Tacoma, WA 98466

BULK RATE  
U.S. POSTAGE  
PAID  
TACOMA, WA.  
PERMIT NO. 275

Time Value

Route To . . .  
General Manager  
News Director  
Program Director  
Prices Subject To Change