

# ALLIED

Broadcast Equipment

1983 CATALOG

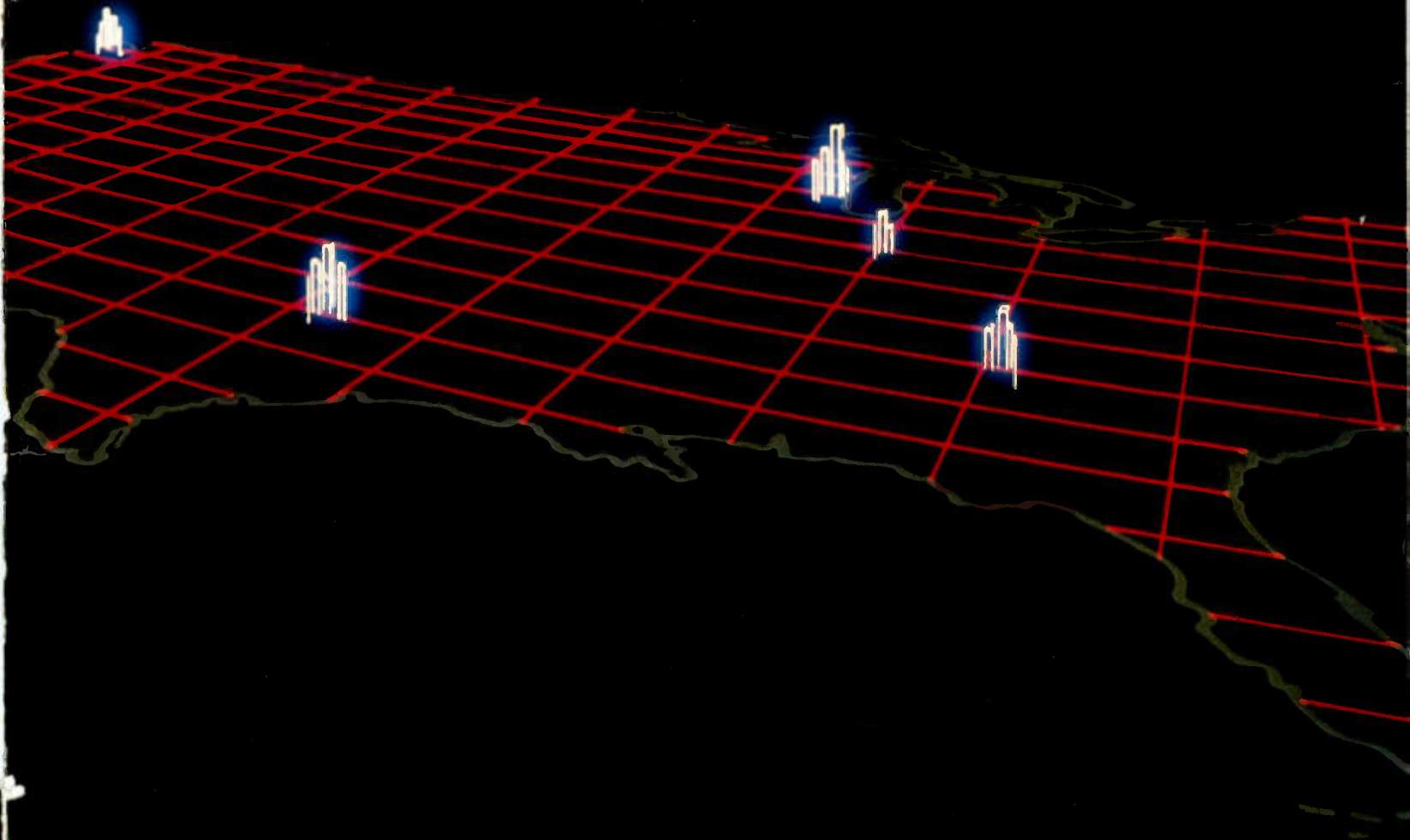



## ...about Allied Broadcast Equipment

Dear friend and customer:

Allied's 1983 catalog brings you the largest and most complete selection of radio broadcast equipment in the industry.

Our position of leadership in the industry is not without justification. Allied's philosophy is simple . . . specialization. Our personnel, our facilities and our marketing are broadcast orientated. Our company is staffed with an abundance of trained and experienced personnel in all departments. We have the desire and make it a practice to stay in tune with our industry. The steady growth in regional sales offices, new product lines, additional personnel and customer services have created a confidence unexcelled in our industry. We are very much aware of our obligation to deliver on time the latest and best of products and services. In fact, it's the only way we know how to do business.

The radio broadcast industry is very fortunate. Unlike some of the other media today, our future is secure and positive. We're not without problems but as long as we stay current with new technological advances, new program formats and innovation, we'll continue to be the envy of many.

Roy M. Ridge  
President



CORPORATE OFFICE: 635 South E Street • P. O. Box 1487 • Richmond, IN 47374

**CROWN D75 AMPLIFIER**

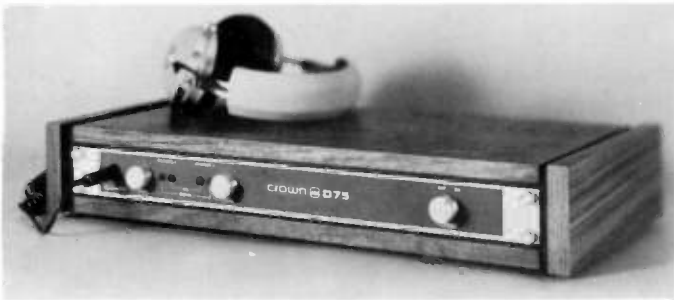

The CROWN D75 offers significant benefits to the professional user that were not previously available.

Standard features include:

- IOC-Input/Output Comparator that reports all forms of signal overload.
- Lockable level control shafts.
- Active, balanced XLR connectors as well as unbalanced 1/4 inch phone plugs.
- Signal presence indicators that notify the user whenever the D75's output signal is greater than 1/8 watt into 8 ohms.

D75 ..... \$499.00

Case, Headphones Optional

**CROWN D-150A SERIES II AMPLIFIER**



Retaining the D-150A's tradition for sonic accuracy and reliability, the restyled Crown D-150A Series II is rated at 125 watts per channel into 4 ohms (250 watts into 8 ohms mono).

FREQUENCY RESPONSE:  $\pm 0.1$ dB DC-20kHz at 1 watt into 8 ohms;  $\pm 1$ dB DC-100kHz.

HARMONIC DISTORTION: Less than 0.001%.

I.M. DISTORTION: Less than 0.01%.

SLEWING RATE: 6 volts per microsecond.

D-150A Series II ..... \$729.00

**CROWN DC-300A SERIES II AMPLIFIER**



(cont.)

Since its introduction in 1967, the DC-300 and its modifications have been a standard of sonic accuracy, power and reliability. It is FTC rated at 250 watts per channel into 4 ohms; 500 watts into 8 ohms mono.

So Crown decided to keep it available, in this improved version.

The DC-300A Series II looks different from the front, with a scratch-resistant, baked enamel front panel, a new power switch, and relocated level controls.

It is still the DC-300A; the choice of traveling sound companies, top recording studios, and sound system installers all over the world.

It is generally regarded as the most reliable amplifier ever built.

Crown DC-300A Series II ..... \$1149.00

**CROWN PS-400 AMPLIFIER**



The Crown PS-400 power amp is designed exclusively for, built exclusively for, and available exclusively for professional sound systems. Into four ohms, it will provide 260 watts per channel; 520 watts into 8 ohms mono. It is tough, tested, and totally new.

It is, in every sense, a Crown amplifier: powerful, out-of-the box reliable; immune to damage from mismatches, shorted outputs, low impedance, or physical abuse. It is professional in every sense of the word.

Check the all-pro features: Terminal strips and phono jacks. Ground separation strip. Stackable. Mono-stereo switch, with binding posts conveniently positioned for quick conversion. Detented controls. Four-second turn-on delay. IOC distortion and signal-presence indicators.

Crown PS-400 ..... \$1179.00

**CROWN PS-200 AMPLIFIER**



The Crown PS-200 power amp is designed as a lower power companion for the PS-400. Like the 400, the 200 is designed, built and available only for professional sound systems.

(cont.)



# AMPLIFIERS & AUDIO PROCESSING

It delivers 135 watts per channel into 4 ohms, 270 watts into 8 ohms mono.

It is another powerful, all-day reliable Crown amplifier. It is unaffected by mismatches, shorted outputs, low impedance or physical abuse. It is totally professional.

**Crown PS-200** ..... \$769.00

## CROWN M600 AMPLIFIER



**M-600** ..... \$2695.00

## CROWN STRAIGHT LINE TWO



- Preamplifier for total control of audio system 19" x 1 3/4" panel
- Automatic muting eliminates thumps and pops
- Five switched, one unswitched 115VAC outlets

### INPUTS

- Tuner, Phono, Aux 1 & 2, Tape 1 & 2, Processor

### OUTPUTS

- Main 1 & 2, Tape 1 & 2, Processor, Front-panel

### CONTROLS

- Detented level controls for resettability
- Loudness control for accurate bass, balanced at low levels
- Detented bass boost/cut ( $\pm 10$ dB)
- Detented treble boost/cut ( $\pm 10$ dB)

**Straight Line Two** ..... \$549.00

**Case Optional**

## CROWN POWER LINE TWO

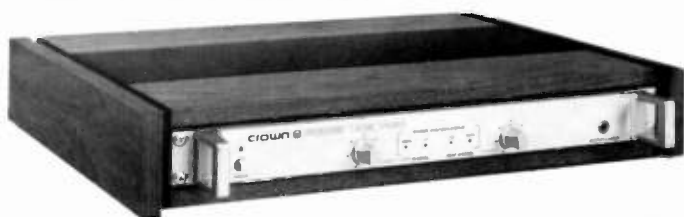

- FTC rated at 50 watts/19" x 1 3/4" front-panel
- Detented level controls — precision selection of level
- Dynamic Analyzing Display includes IOC distortion indicator

**Power Line Two** ..... \$579.00

**Case Optional**

## CROWN POWER LINE THREE



- FTC rated at 90 watts/channel into 8 ohms
- T.H.D. less than .05%
- I.M.D. less than .05%
- Slew Rate: 12 volts/u sec

### FREQUENCY ANALYZING DISPLAY:

A Crown music analysis instrument:

- Monitors peak levels in each of three frequency bands;
- Provides information on spectral balance to check system, music, amp, speakers or room.
- EIA 19" rack mount with die cast handles, 5 1/4" front panel

**Power Line Three** ..... \$949.00

**Case Optional**

## CROWN POWER LINE FOUR



- Stereo power amplifier
- FTC rated at 165 watts/channel
- Frequency Analyzing Display
- IOC distortion indicator
- EIA 19" rack mount with die cast handles, 7" front panel

**Power Line Four** ..... \$1349.00

**Case Optional**

**ALLIED HANDLES OVER  
160 PRODUCT LINES - SEE INSIDE BACK COVER  
FOR COMPLETE LISTING**

(cont.)

## UREI MODEL 6150 POWER AMPLIFIER



UREI amplifiers offer the knowledgeable professional the reliability he demands *and* the sound quality he deserves. Exceptionally large power supplies and exceedingly high speed, high current circuitry combine to produce low-end punch and high-end sparkle which is unexcelled in professional power amps. Moderate use of negative feedback results in fast recovery from transient overloads and avoids excessive high order harmonic distortion when the amplifier is driven into clipping. 80 watts per channel.

Model 6150 ..... \$646.00

## UREI 6500 DUAL POWER AMPLIFIER



As opposed to the "fix-it-up with feedback" approach in common use today, UREI carefully departed from conventional design techniques. Overall negative feedback is used primarily to fix gain and establish the output operating point. Each amplifier stage in the 6500 was engineered for optimum performance with no overall feedback applied.

- Two channels on independent, modular plug-in chassis with front panel access.
- Output Power & Distortion: 275 watts into 8 ohms per channel (20Hz-20kHz, .1% THD)

UREI 6500 ..... \$2196.00

## SYMETRIX A-220 STEREO AMPLIFIER



**POWER OUTPUT:** 20-20kHz stereo mode, both channels driven - 8 ohm load: 20 watts channel. Monobridge mode - 8 ohm load, 40 watts (16 dBW) total. .08% max. distortion.

**INPUT IMPEDANCE:** 20k ohms (electronically balanced)  
30k ohms unbalanced. (cont.)

WE HONOR



**CONNECTORS:** Input - 3 pin "XLR" type for connection to balanced sources. 1/4" phone jack for connection to unbalanced sources. Output - dual banana jack (rear panel) stereo phone jack (front panel)

A-220 ..... \$289.00

## NAD 3020 AMPLIFIER



The NAD 3020 is perhaps the most highly praised integrated amplifier in the world. A 20W state-of-the-art unit, the NAD 3020 offers totally uncompromised performance at a cost that most budget-minded buyers can afford. Among other things, the 3020 contains a unique Soft-Clipping circuit which allows it to play much louder than its rated power suggests.

- Rated power 20 watts/channel
- Less than 0.02% of all types of distortion
- LED peak power indicator

NAD 3020 ..... \$218.00

Rack Mounts for 3020 ..... \$ 20.00

## RTS 410 MONITOR AMPLIFIER

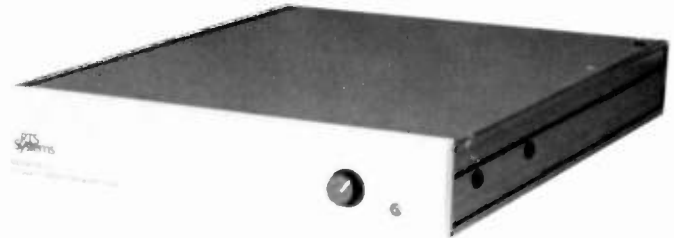

The Model 410 is a self-contained compact 10-watt power amplifier designed to power loudspeakers, headphones or 70-volt loudspeaker distribution systems. Its input is balanced and designed to bridge 600 ohm/ + 4 dBu program lines. The 410 features a front panel volume control and two separate outputs: a direct amplifier output available on push terminals and/or 1/4 inch phone jack, and an optional transformer isolated output, on a barrier strip, for 70-volt distribution. The input connection may be made via a 3 pin XLR type connector and/or 1/4 inch phone jack.

**FREQUENCY RESPONSE:** ± 0.25 dB, 50 Hz to 20 kHz

**SIGNAL/NOISE RATIO:** -95dB

**OUTPUT POWER:** 10 watts

**TOTAL HARMONIC DISTORTION:** 0.05%

RTS 410 ..... \$288.00

Rack Mount & 70V Transformer Available Optionally



# AMPLIFIERS & AUDIO PROCESSING

## BGW 75 PROFESSIONAL POWER AMPLIFIER



- Transient free turn-on and turn-off.
- All new circuitry featuring low noise discrete matched differential amplifier input circuitry.
- 25 watts per channel (8 ohms, 20Hz-20kHz, .05% maximum THD) 50 watts monaural, .08% THD.

**BGW 75** ..... \$399.00

## BGW PROFESSIONAL POWER AMPLIFIER 250D/250E



Identical but for their front-panel power indicators, the Models 250D & E offer these exclusive features:

- Magnetic circuit breaker mains switch.
- Redundant output stage circuitry using six (6) 150-watt complementary transistors per channel.
- High-speed, 15MHz operational amplifier front-end.
- Professional input connectors including XLR-type and 1/4"
- 100 watts minimum sine wave continuous average power output per channel with both channels driving 8 ohm loads over a power band from 20Hz to 20kHz.

**250D** ..... \$819.00

**250E - Front Panel Indicators** ..... \$929.00

## BGW 150 PROFESSIONAL POWER AMPLIFIER



**INTERMODULATION DISTORTION:** Less than 0.02%.  
**FREQUENCY RESPONSE:** +0, -0.25dB, 20Hz to 20kHz.  
**HUM & NOISE LEVEL:** Better than 102dB below 50 watts.  
**LOAD IMPEDANCE:** Designed for any load impedance equal to or greater than 4 ohms.  
**DIMENSIONS:** 1 3/4" by 19" standard rack front panel by 11 1/2" deep.

**BGW 150** ..... \$619.00

## BGW PROFESSIONAL POWER AMPLIFIER 750B/750C



- 225 watts minimum sine wave continuous average power output per channel with both channels driving 8-ohm loads over a power band from 20 Hz to 20 kHz.
- Guaranteed transient intermodulation distortion of less than 0.02%.
- Increased power output: 720 watts total.
- Inclusion of clipping indicators on the Model 750C.
- Addition of LED light ladder V.U. meter display on the Model 750B.
- Dual professional input connectors (both XLR and 1/4" phone jacks provided).
- Plug-in input matching transformer provision.

**750B - Front Panel Indicators** ..... \$1399.00

**750C** ..... \$1299.00

## CALZONE CUSTOM BUILT CASES

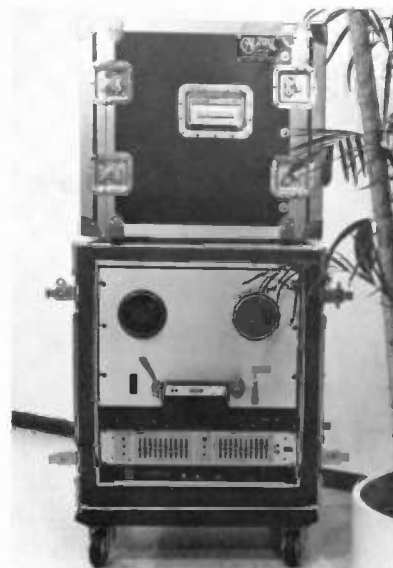

Custom built cases to fit almost any need.

Call an Allied Sales Professional with all your case needs — he'll be glad to quote you a price.



# AMPLIFIERS & AUDIO PROCESSING

## ALLIED'S ARCHITECTURAL SERIES OF ON-AIR LIGHTS

### INCANDESCENT 33 SERIES

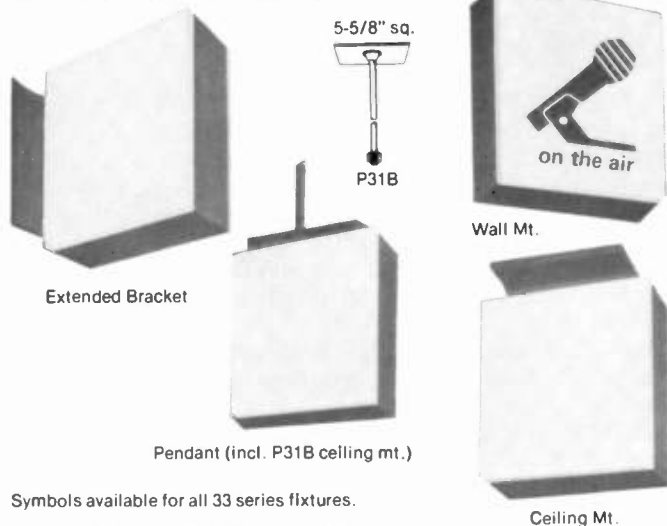

Symbols available for all 33 series fixtures.

WORDS ONLY: "ON AIR" and "LIVE MIC" also available on plain lens.

### TYPICAL SIGN CLUSTERS TYPE 33 FLAT WALL

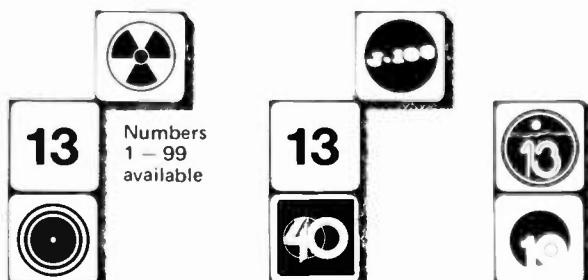

Enhance the environment of any broadcast situation. On-Air/Mic symbol standard. Blank lens available for your custom logo or lettering.

Die cast aluminum housing of matte black finish. 7 1/2" square translucent white acrylic lens. Two 20 watt lamps included.

\*Wall mount (flat wall mount) is single faced only. Extended, Ceiling, Pendant, all double faced.

\*Specify Red or Black.

TYPE	BLANK	WORDS/ SYMBOLS
Flat Wall Mount	\$64.00	\$82.00
Extended Bracket	\$70.00	\$104.00
Ceiling Mount	\$70.00	\$104.00
Pendant	\$102.00	\$137.00

### KOSS PRO4AA HEADPHONES



THE BROADCAST STANDARD

PRO4AA ..... \$35.00

## COMPUTEMP 2 TIME & TEMP



**TEMPERATURE MEMORY:** At your fingertips, Computemp 2 will display the day's extreme temperatures, and you'll know the exact time each took place. The electronic memory records the information automatically.

**TEMPERATURE ALARM:** As the temperature reaches a pre-determined setting, one you choose anywhere within the -40°F to +130°F range, the Computemp 2 alerts you. The many uses for this function are limited only by your imagination. May be switched in or out.

**TIME ALARM:** The unit even has a handy time alarm which will alert you daily as needed. Computemp 2 continuously displays information at a glance with a bright LED readout, easily visible.

Computemp 2 is handsomely designed. The contemporary exterior of attractive rich pecan wood finish with black and brushed aluminum accents gives the unit an elegant appearance. Computemp 2 works well in most RF environments.

Accuracy: ± 2° F

Power: 8 watts

Size: 6 1/2" W x 2 3/4" H x 4 1/2" D

Standard outside probe wire length: 40' (100' extension is available)

Warranty: Limited 1 year

Computemp 2 .....	\$89.95
100' Probe Extension .....	\$ 9.95

### ORBAN 8100A OPTIMOD FM AUDIO PROCESSOR



(cont.)



# AMPLIFIERS & AUDIO PROCESSING

The FM STEREO Processor. Cleaner, Brighter, Louder than the industry-standard 8000A it replaces.

### PERFORMANCE HIGHLIGHTS:

- Wideband or multiband operation
- More versatile setup controls permit precise "tuning" for different formats.
- Improved voice/music balances
- Improved stereo generator with cleaner baseband
- New overshoot compensator permits full modulation at all frequencies, yet doesn't increase low frequency IM distortion.

### PLUS:

- Dual chassis (studio/transmitter) option
- Built-in crosstalk test generator
- Rigorous RFI shielding
- True VCA gain control

8100A Standard Single Unit ..... \$4395.00  
 Dual-chassis, separable model ..... add \$795.00

## ORBAN 9100A/1 & A/2 OPTIMOD AM AUDIO PROCESSOR



The 9100A/1 & A/2 Optimod was designed for the state-of-the-art AM Broadcaster. If your station has:

1. An AM transmitter & audio chain which will come close to passing an FM proof
2. A studio to transmitter link (STL or phone line) good out to 15kHz (or co-located facilities)
3. An antenna system (Phasor, LTU's, etc.) capable of 11kHz min. bandwidth (15kHz is optimum)...

there is not a better AM processor made.

OPTIMOD 9100A/1 Mono ..... \$4395.00  
 OPTIMOD 9100A/2 Stereo ..... \$5295.00

## ORBAN 418A STEREO LIMITER/COMPRESSOR



The 418A is a complete limiting system consisting of a pair of ganged broadband compressor/limiters with exceptionally smooth and subtle characteristics, followed by a high frequency limiter with four different time constants, user selectable by means of a front-panel switch. This variable time constant feature is unique in the industry, and permits the characteristics of the high-frequency limiter to be tailored to the recording medium following the limiter, such as disc, cassette, or 7.5 ips tape.

Not suitable for use by itself as an FM processor.

Orban 418A ..... \$849.00

**ALLIED OFFERS PACKAGE DISCOUNTS**

## ORBAN 422A/424A GATED COMPRESSOR/LIMITER/DE-ESSER



The Model 424A - a Gated Compressor/Limiter/De-Esser with versatile controls, simple set-up, and a natural, transparent sound that must be heard to be appreciated.

- Production AGC device based on Model 8100A FM Broadcast Processor achieves high average loudness without undesirable artifacts.
- Separate Compressor/Limiter and De-Esser control loops, each with optimized, program-controlled parameters.
- Defeatable gate with adjustable threshold freezes gain to prevent noise rush up, pumping or breathing during pauses.
- Adjustable attack time, release time, and compression ratio permit extremely natural processing or special effects.
- Attack and release time controls crosscoupled to simplify set up. Peak output level independent of control parameters, minimizing need to trim output attenuator.
- Independent De-Esser similar to popular Orban 526A De-Esser.
- Intuitive and natural operation—you don't need a chart or an advanced degree to figure out what's happening.
- Low distortion operation combines clean Class-A VCA with distortion cancelling control circuitry.
- 25dB gain reduction available in compressor/limiter
- Better than 25dB de-ess gain reduction **in addition** to 25dB compressor/limiter gain reduction.
- True peak-reading output level meter allows operator to positively prevent VCA clipping (or to permit controlled amounts of clipping for broadcast or disc mastering applications).
- True peak-reading gain reduction meter.
- Selectable linear (general purpose) or exponential (special purpose) release time characteristics.
- Rugged all metal 19" rack-mount package for ruggedness, road-worthiness, RFI shielding. Industrial grade parts and construction.
- Highly cost effective; available in mono or stereo (channels independent or strappable).
- Extensive RFI suppression.
- Balanced inputs and outputs and 115/230V, 50/60Hz power supply standard.

Model 424A Dual Channel ..... \$899.00  
 Model 422A Single Channel ..... \$569.00

## INOVONICS MAP II MULTIBAND AUDIO PROCESSOR

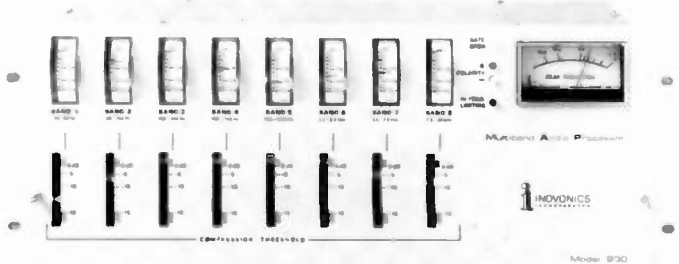

A user-oriented discriminate processor of advanced design to assure optimum modulation, specifically in AM (cont.)



Broadcast applications.

- Selectable High-Pass Filter
- Gated A.G.C.
- Multiband Compressor
- Built-In Pink Noise Source
- Two MAP II's may be interconnected for stereo operation. Not only are the Bandpass Compressors slaved on a band-for-band basis, but one Phase-Follower may be slaved to the other or both may be defeated.

Complete AM Processor per channel ..... \$1775.00  
 Complete FM Processor per channel ..... \$1750.00  
 (2 Needed for Stereo)

## TEXAR AUDIO PRISM



The TEXAR AUDIO PRISM is a very high-performance multi-band audio processor designed for major market broadcast use and other applications where sophisticated program handling is required. It utilizes four intelligent, digitally-controlled processor cards to achieve high apparent loudness while producing few processing artifacts. This absence of undesirable subliminal listener aggravation reduces listener tune-out, producing higher quarter-hour ratings.

For AM broadcast, the AUDIO PRISM is designed to be used with the TEXAR EAGLE AM Modulation Controller. For FM, the AUDIO PRISM is designed to be used in conjunction with a high-quality limiter/stereo generator combination. If transmitter and studio are at separate locations, the preferred placement for the AUDIO PRISM is at the studio. This prevents accidental overdriving of the telephone lines or STL and provides the maximum signal-to-noise ratio over the program circuit.

AM or FM Audio Prism ..... \$1795 per channel  
 AM Eagle Clipper ..... \$ 795 per channel  
 (2 needed for stereo)

## DORROUGH DAP-610 DISCRIMINATE AUDIO PROCESSOR



The Dorrough Discriminate Audio Processor DAP-610 operates on the same discriminate tri-band principle as the classic 310.

The DAP-610 departs from conventional gain reduction techniques which utilize a servo loop to control attenuation of the audio signal. Instead, the DAP-610 utilizes a frequency discriminate digital control signal, operating in real time, to control the action of analog attenuators, which are located within the discriminate path of the input audio signal. This concept eliminates the delay in attenuator action associated with the standard servo approach, and its attendant action on the leading edge of the input waveform. Attack and release time are now a function of

(cont.)

the program in the digital control circuit and are fixed, as are the discriminate frequency bands of this device.

Dorrough DAP-610 Per channel ..... \$3200.00  
 (2 Needed for Stereo)

## WIREWORKS MICROPHONE ACCESSORIES

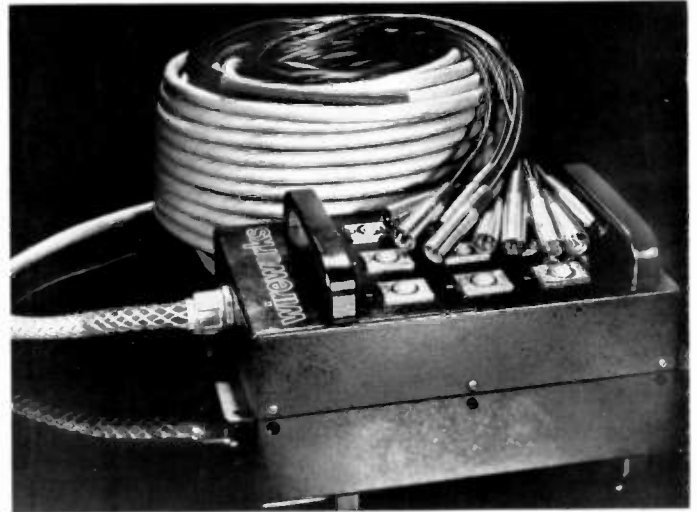

The number one name in microphone "snakes," custom cables and accessories can supply stock to custom orders. Call Allied With Your Specifications.

## UREI LA-4 COMPRESSOR OR LIMITER



The LA-4 Compressor/Limiter is another great performer in the continually expanding product line from UREI — the company which has built and sold more limiters and compressors throughout the world than any other manufacturer. Making use of patented Electro-Optical Attenuator technology owned by UREI, the LA-4 offers smooth, predictable performance coupled with ease of operation.

- Long-life LED Optical Attenuator
- Smooth natural-sounding RMS action
- Selectable compression ratios
- Simple stereo coupling

UREI LA-4 ..... \$446.00

## UREI 1176LN LIMITER



(cont.)

- F. E. T. Gain Reduction ahead of first stage. No tricky balancing required, ever. No distortion adding active element in gain reduction circuit.
- Pushbutton selection of four different compression ratios, to satisfy every program requirement.
- ULTRA FAST attack time... independent of peak duration or frequency. Adjustable from front panel during operation.

UREI 1176LN per channel ..... \$546.00

## UREI 1178 DUAL PEAK LIMITER

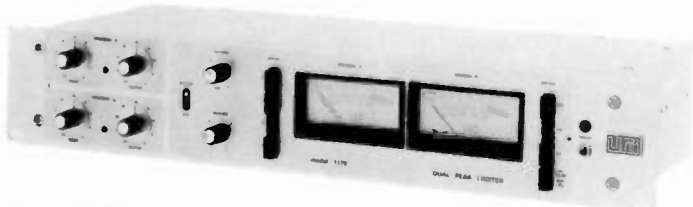

The Model 1178 is a two channel version of the very successful 1176LN Peak Limiter used in many recording studios and broadcast stations. The Dual Peak Limiter was designed for those applications where two channels of program material are processed and the balance of these audio channels must be maintained. The two limiters inside the Model 1178 are perfectly matched to assure the high degree of tracking necessary for critical stereo applications.

The Model 1178 was designed to have performance characteristics similar to the single channel 1176LN. Limiting is accomplished by utilizing FETs as voltage variable resistors.

Model 1178 ..... \$796.00

## ADR TRANSDYNAMIC TRI-BAND PROCESSING SYSTEM

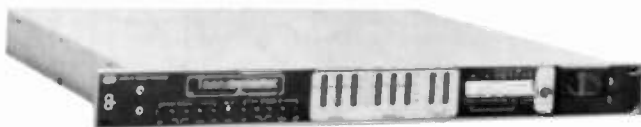

- Must be used with 3 separate bands of outboard compression per channel - 3 compex, 1 1/2 E-Z Rider or 1 1/2 Express or any 3 channels of limiting per channel.
- Two independent program channels, for stereo or dual mono processing.
- Selectable 0, 25, 50 or 75uS Pre-emphasis in the control circuits (not the signal path) of the output limiter.
- Adjustable Peak Modulation asymmetry for AM operations.
- Electronically balanced in & out.

Transdynamic Processing System ..... \$2880.00

## ADR EASY RIDER

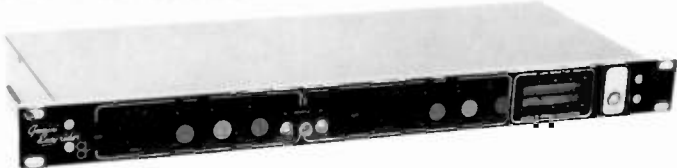

Controlled Signal Processing At Your Fingertips... At home in any production room.

(cont.)

## IN BRIEF

The Gemini Easyrider processes any 'line' level signal (i.e. output of pre-amp). It has two channels, which can be stereo coupled for mastering, each with independent input control, output preset.

The compression ratio (COMP) can be varied from 1:1 to 20:1 (LIM) with semi-automatic attack and release controls. Gain Reduction is indicated in twin, 20 element, calibrated l.e.d. displays. The threshold of compression is automatically varied to average 10dB compression under dynamic conditions, with constant output level at any ratio.

### SPEC. FOR ONE CHANNEL

Input impedance: Greater than 10k at 1kHz unbalanced  
 Output impedance: Less than 1 Ohm at 1kHz unbalanced  
 Thresholds/Ratios: switched 1:1 variable 1.5:1 to 20:1 thresholds automatically adjusted  
 Limit Attack: Fast: 500uS for 10dB over limit threshold  
                   Slow: 5mS for 10dB over limit threshold  
 Release: Fast: 15mS on 10dB over limit threshold  
               Slow: 4 secs on 10dB over limit threshold  
 Auto: 15mS on 5 Secs  
 Power Consumption: 15 watts  
 Size: STD Rack, 1 3/4" x 19" x 7 1/2"  
 Weight: 5.5 lb.

ADR Easy Rider Stereo or Dual Mono Compressor \$750.00

## ADR FM STEREO EX-PRESS LIMITER



- Compressor-Limiter-Expander (AGC)
- Switchable Ultimate Level Clipper (employing Audio & Design's exclusive Clever Clipper Circuit)
- Dynamic Pre-Emphasis (switchable—25, 50, 75 u-sec.)
- Function Switching via Digital Logic
- Stereo—Self Powered—1 3/4" ht. Rack Mounting
- Differential Inputs/Outputs

Express Stereo Limiter ..... \$1450.00

## DBX 160X COMPRESSOR/LIMITER



The Model 160X compressor/limiter provides the studio operator, broadcaster, or sound reinforcement specialist with outstanding performance and operational flexibility in a slim-line rack mount package. The 160X has all the features of the famous Model 160, and more. It is the only compressor/limiter that offers you the choice of Over Easy® or hard-knee operation—regardless of compression ratio selected.

DBX 160X ..... \$420.00

SHIPPING AND HANDLING  
 CHARGES WILL BE ADDED TO ALL ORDERS  
 UNLESS OTHERWISE SPECIFIED



# AMPLIFIERS & AUDIO PROCESSING

## DYNA-MITE



### PRICE — FLEXIBILITY — QUALITY

In one quantum leap, you're into a place somewhat beyond the state of the art.

Name your processing function — limiting, expansion, de-essing, noise gating, Kexping, ducking — Dyna-Mite does it all, and does it best. Even FM processing.

Dyna-Mite includes proprietary techniques such as linear integration detection, anticipatory release computation, log domain processing, the champion EGC series VCA... the works. RF proof, too.

<b>Mono DYNA-MITE 410-1</b> .....	<b>\$320.00</b>
<b>(Convertible to Stereo)</b>	
<b>Stereo DYNA-MITE 410-2</b> .....	<b>\$535.00</b>
<b>Rack Mount Adaptor 400-R</b> .....	<b>\$40.00</b>

## VALLEY PEOPLE'S DYNA-MIC PREAMPLIFIER MODELS 420-A Mono, 420-2 Stereo, 420-C Card only



The Dyna-Mic Preamplifier is a dual preamplifier module designed primarily to allow interfacing microphones and musical instruments with both the Dyna-Mite multi-function dynamic processor, and most popular instrument amplifiers.

The Dyna-Mic, in its basic configuration, is a two-input, single output mixer with a simple tone control equalizer built around musical center frequencies. The unit features high quality, low noise balanced differential input stages which are switchable to provide optimum noise performance at low impedances (Mic), high impedances (Inst.), and line levels (Line).

<b>420-1 Mono</b> .....	<b>\$320.00</b>
<b>420-2 Stereo</b> .....	<b>\$535.00</b>
<b>420-C Card only</b> .....	<b>\$245.00</b>

**ALLIED HAS A LEASE  
PLAN TO SUIT YOUR INDIVIDUAL NEEDS**

## DBX 165A COMPRESSOR/LIMITER



As the saying goes, "the best just keep getting better." In this case, the most versatile compressor/limiter around, the DBX 165, just got better - as the 165A.

The formula DBX used was 165 + PEAKSTOP = 165A. The new PEAKSTOP circuit, which follows the compressor/limiter circuitry, is a specially designed "soft clipper" that rounds the leading and trailing edges of the peak being clipped. By avoiding the normally sharp edges of a clipped peak, far fewer high order harmonics are generated making PEAKSTOP less audible than other types of clippers. In fact, our clipper is less audible than peak limiting since it doesn't adversely affect the program material following the peak.

<b>DBX 165A</b> .....	<b>\$670.00</b>
-----------------------	-----------------

## MEI 100MP BROADCAST PROGRAMMER



An easy-to-use, self-contained automation controller which allows a station to operate manually, live-assist, or fully automatically at the push of a button.

Simply connect any standard tape machines to the 100MP, dial in the sequence of machines you wish it to play, and walk away. The system is fully operational. The entire program is in plain view at all times. Changes can be made immediately and without confusion.

Your announcer can "go live" as often and as long as he wishes with a push of the "hold" button. A built in Lazy-Time Clock always insures that commercial breaks are played at the proper times. Furthermore, the built-in silence sense circuit guards against dead air during unattended operation.

*Consider these features for versatile operation:*

- Completely self-contained. 25 Hz filter, 25 Hz sensor, and silence sense are an integral part of the circuitry. No other equipment to purchase or add on.
- Directly connects to any standard equipment. No interface boards needed.

(cont.)

- No relays. Solid state FET audio switching for reliable and quiet operation.
- Format flexibility. 24 and 48 Event models with 8 sources plus NET input. Infinitely adjustable dead roll, source delay and silence sense. Use any music syndication service and adjust the sound the way you'd like.
- Lazy-Time Clock control. Automatically determines when the programmer should skip unneeded music and advance to a commercial break. Walk away with confidence.
- Remote control console with hold and continue. Maintain control of your station with ease.

Price on Application

## MEI CONTROL-3



Control-3 is the only control unit that can randomly select cartridges from 3 machines, carousels, instacarts, or go-carts. And since it not only selects the proper machine and tray, but also switches audio to a common output, it can be used independently as a programmer to create a cartridge-oriented system.

Control-3 can also be added to your present automation equipment to provide random-select capability and expand available sources.

Over 900 events can be programmed for long walk-away periods, but you may stop and "go live" after any event by simply pushing a "hold" button.

Control-3 offers the ideal, low-cost means of controlling music and commercials on cartridge.

Consider these additional features:

- Microprocessor controlled for versatile, reliable operation.
- Three large LED displays to show "event", machine number, and tray number for both present and upcoming events, plus a separate display to keep track of events programmed. Human engineering at its best.
- Insert and delete programming capability.
- Status lights show current operational mode, plus Start, Hold, and EOM/EOC.
- Battery backup
- Controls 3 machines
- Controls carousels, instacarts and go-carts.
- Switches audio
- Programmable hold and reset codes

Price on Application

## DBX 900 SERIES MODULAR SIGNAL PROCESSING SYSTEM



Today signal processing plays a greater role in sound production than ever before, both in the studio and on the road. As a result, rack space is at a premium. Innovative packaging eliminates redundant power supplies, simplifies interconnects, and saves space. With this in mind, DBX has created the 900 Series Modular Signal Processing System.

The DBX 900 Series features convenience with flexibility. You can fit up to 8 sophisticated signal processing modules into a rackmount unit measuring just 5¼" high. Each 900 Series module represents a step forward in state-of-the-art technology. Installation is quick and easy to accomplish. Standard connectors enable you to wire the rack into your system like any other component. The interchangeable signal processing modules slip in and out in seconds.

The DBX 900 Series is the ultimate in flexibility. These modules place at fingertip control creative tools to express your unique sense of artistry in sound production.

### 902 DE-ESSER

The Model 902 De-esser can be used as a conventional broadband de-esser, or for attenuating only a user-determined portion of the high frequency range of the audio signal. Gain reduction is adjustable from 0 to -20 dB.

### 903 COMPRESSOR

The Model 903 Compressor gives you all the features you'd expect from DBX. And then some. For starters, you have at your command a unique new negative compression feature that actually begins reducing output volume once the threshold is exceeded. Signals are given a new and unusual sense of "punch." And the 903, like our acclaimed 165, is an Over Easy compressor, with a soft knee threshold that increases compression ratio gradually over a range of several dB.

### 904 NOISE GATE

The Model 904 Noise Gate is the ultimate noise gate, with a combination of features not found on any other noise gate, at any price. It features adjustable attack and release rates, threshold adjustment from -30 to +10 dB, attenuation limit adjustment from 0 to 60 dB, with DBX Over Easy downward expansion for a smooth sound.

DBX 902 .....	\$325.00
DBX 903 .....	\$325.00
DBX 904 .....	\$325.00



# AMPLIFIERS & AUDIO PROCESSING

## DBX 941/942 & 906



941/942

- 30 dB broadband audio noise reduction
- 10 dB added system headroom
- True RMS level detection for proper encode/decode tracking
- Linear decibel compression/expansion over 100 dB range does not require pilot tones or level matching
- Electronically balanced input
- + 24 dBm output drive capability
- Two noise reduction channels per module (941-dual encode, 942-dual decode)
- Can be used in dbx 900 Series frame to provide up to 16 channels of noise reduction in 5¼" vertical rack space
- LED function indicators
- Decodes dbx encoded discs (942 only)

Input impedance: Balanced—25 k ohms;  
Unbalanced—18.5 k ohms

Output impedance: 22 ohms, designed to drive 600 ohms or greater, single ended

Maximum input level: + 24 dBm

Maximum output level: + 24 dBm into 600 ohms or greater

The dbx Models 941 and 942 provide broadcasters with dbx Type II Noise Reduction in the convenient 900 series modular format. The Model 941 is a two-channel encode-only Type II noise reduction module. The Model 942 is a two-channel decode-only Type II noise reduction module which features an additional switchable provision for decoding dbx encoded discs. The two modules can be used independently or in conjunction to provide up to 16 channels of dbx Type II noise reduction in a single dbx 900 Series frame occupying only 5¼ vertical inches of rack space.

The Type II Noise Reduction format provides a minimum of 30 dB of broadband noise reduction with a 10 dB increase in system headroom for audio storage and transmission media. In the encode process the system compresses applied audio signal by a 2:1 ratio, linear in decibels over a 100 dB range. In the decode process the circuitry produces an exact mirror image 1:2 expansion of the encoded signal. There are no pilot tones or routine calibrations of the Type II system necessary for accurate decoding of encoded material.

The Model 906 Flanger answers the need for an electronic system that achieves precise, predictable control of the flanging effect while providing the signal quality, 100:1 frequency sweep, and low noise previously obtained in

(cont.)

the studio by using matched tape machines. The 906 is also a high quality doubler. The model 906 Flanger not only offers true "tape flanging" sound with unprecedented control, it provides a vast range of flanging and doubling effects.

DBX 941 .....	\$260.00
DBX 942 .....	\$270.00
906 FLANGER .....	\$720.00
Housing including P.S. ....	\$525.00
Blank Plates (ea.) .....	\$ 17.50

## VALLEY PEOPLE'S KEPEX II

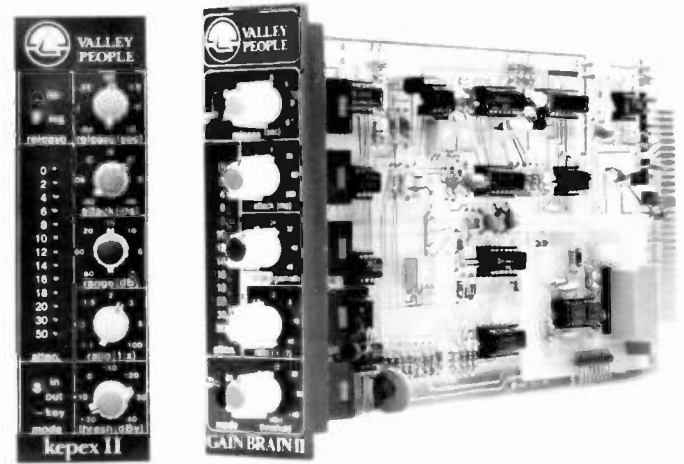

### Keyable Program Expander

### NOISE CONTROL APPLICATIONS

KEPEX II is a multi-use device which tends not to sit idle in the equipment rack. It's the "problem solver" in the broadcast studio. In the area of noise reduction, or noise gating, reduction or elimination of the following undesirable noise sources is possible:

- Multi-track tape noise
- Instrument amplifier hum, buzz, noise, etc.
- Leakage noise from other instruments
- "Room sound" (reverberation, ambience, echo)
- Air conditioner rumble, set noise, street noise, etc.
- Breath noises, lip "smacks," etc.

### EFFECTS APPLICATIONS

KEPEX II is capable of an enormous number of special effects — effects which often make the difference between a dull, unexciting program, and a dramatically "punchy" production. Best of all, most KEPEX effects can be created "in the mix," from already recorded tracks, as can KEPEX noise reduction processing. Some of the many possible effects are:

- Removing excess cymbal ring... accentuating percussive impact
- Bringing "distant sound" up close... increased presence
- Stereo simulation from mono tracks
- Electronic music effects... keying one track from another
- Increasing dynamic range via active expansion
- Requires separate mount housing and/or P.S.

KEPEX II Model 810 .....	\$380.00
--------------------------	----------

## VALLEY PEOPLE'S GAIN BRAIN II

GAIN BRAIN II combines the functions of limiter, compressor and ducker, in a small but powerful package. A

(cont.)



# AMPLIFIERS & AUDIO PROCESSING

most of proprietary circuitry advances are employed, yielding a new level of performance, compared with other devices.

- Widely adjustable *Limiting/Compressor* and *Ducker*, optimized for *production work*.
- "Intelligent" detector increases dynamic integrity via waveform recognition.
- Proprietary Release Strategy discourages pumping, squashing and modulation distortion.
- The "all purpose" device which is optimized for *any purpose*. No compromises.
- Requires separate mount housing and/or P.S.

**GAIN BRAIN II Model 811** ..... \$380.00

## ORBAN 622 PARAMETRIC EQUALIZER



The 622 Parametric Equalizer consists of a balanced input buffer amplifier, an input attenuator, and four peak/dip equalization sections connected in series, assuring no interaction between sections. The final section contains a current booster capable of driving 600 ohm loads. The output of the input buffer and each of the equalization sections is monitored at all times by the overload indicator. The EQ IN/OUT switch bypasses all circuitry but the input buffer and output amplifier; it is arranged so that the gain and signal polarity are maintained constant in the IN and OUT modes.

Equalization is accomplished by adding or subtracting the output of a two-pole bandpass filter to the main signal. This arrangement, which we call "constant Q," results in non-reciprocal curves. However, it permits narrowband notch curves to be created. In addition, the characteristics tend to be more musical than the usual reciprocal characteristics, because large amounts of equalization do not result in increased "Q" with concurrent increases in ringing, resonance, and objectionable coloration. If reciprocal characteristics are desired, they may be generated exactly by simply readjusting the bandwidth control.

**622A Single Channel** ..... \$509.00  
**622B Dual Channel** ..... \$799.00  
**Optional Output Balancing Transformer**  
**RET-5, 1 per channel (ea.)** ..... \$ 16.00

## ORBAN 672A PARAMETRIC EQUALIZER ORBAN 674A PARAMETRIC EQUALIZER

The ORBAN MONO 672A and STEREO 674A are cost-effective, professional, quasi-parametric equalizers with the convenience of graphic-type EQ controls. Wide-range high- and low-pass filters with 12dB/octave Butterworth slopes follow the graphic section for added versatility.

Each feature has been thoughtfully chosen and cleverly implemented to make the equalizer a particularly powerful tool in nearly all areas of audio: sound reinforcement, public address, recording studio, broadcasting, motion picture sound, disco, theater...

### GRAPHIC EQ SECTION

- Eight bands, each with TUNING and BANDWIDTH control
- Each band tunes over 3:1 frequency range

(cont.)

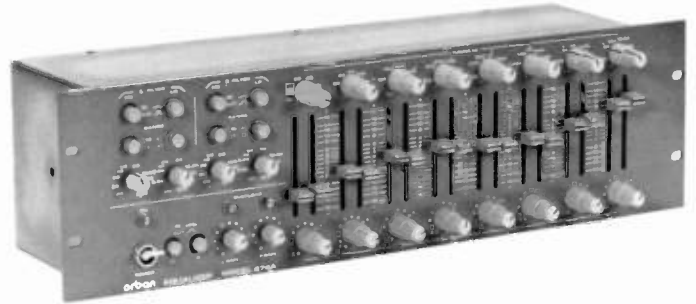
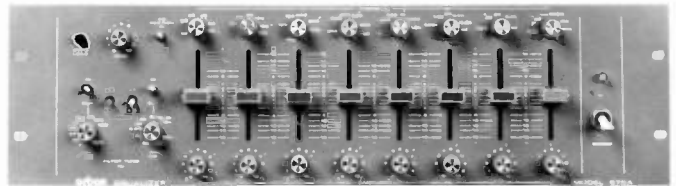

- "Q" typically variable between 0.3 and 20 (center TUNING)
- $\pm 16$ dB equalization range

### HP/LP FILTER SECTIONS

- Each section continuously tunable over 100:1 range in 2 decades
- Each section independently switchable
- 12dB/octave slopes

### GENERAL

- Very low noise and distortion
- High slew rate for minimum TIM (SID)
- Active balanced inputs; unbalanced outputs. Transformer-balanced outputs optional

**672A Mono** ..... \$629.00

**NEW 674A Dual Parametric Equalizer** ..... \$1179.00

**Optional Output Balancing Transformer - RET-6**

**1 per channel (ea.)** ..... \$16.00

## WHITE ACTIVE EQUALIZERS 4000 SERIES



27 One-third octave bands from 40 Hz through 16 kHz. 10 dB control range. 12 dB/octave high-pass filter variable from 20Hz through 160 Hz. Noise better than -90dBm. Accessory socket for optional low-level crossover networks. Barrier strip connectors.

**4001 Transformer isolated input, single-ended outputs** ..... \$950.00  
**4002 Single-ended input and outputs. Wood end blocks. Optional rack mounting. Phono connectors** ..... \$975.00  
**4003 Transformer isolated input and outputs Barrier strip connectors** ..... \$990.00

**ALLIED OFFERS PACKAGE DISCOUNTS**



# AMPLIFIERS & AUDIO PROCESSING

## WHITE TWO CHANNEL, OCTAVE BAND, ACTIVE EQUALIZERS 4100 SERIES



Each channel features 10 octave bands from 31.5 Hz through 16 kHz.  $\pm 10$  dB control range. 12 dB/Octave high-pass filter variable from 20 Hz through 160 Hz. LED overload indicator. In addition an accessory socket provides for the insertion of optional low-level crossover networks. An EQ in/out switch is mounted on the front panel.

4100RM	Rack mounted, Phono Connectors	...	\$890.00
4100RMP	Same as 4100RM. 0.25" phone jack connectors	.....	\$890.00
4103	Rack mount. Transformer isolated inputs. Barrier strip connectors	.....	\$925.00
4104	Rack mount. Transformer isolated inputs and outputs. Barrier strip connectors	.....	\$980.00

## WHITE 151 PINK NOISE GENERATOR



Compact battery powered digitally generated Pink Noise. 268,000,000 bit word length. Flat 20 Hz through 20 kHz. Microphone or line level output. Rugged — inexpensive.

White 151	.....	\$140.00
-----------	-------	----------

## TELEVISION TECHNOLOGY XLFM SERIES FM TRANSLATORS



- Up to two 1 or 10 watt outputs with independent ALC.
- Rugged power amplifier can operate continuously into any load.
- Phase Locked Loop upconverter virtually eliminates off-channel noise and heterodyne spurious signals.
- Phase linear filtering for outstanding selectivity at low distortion.

(cont.)

- High dynamic range front end.
- Low noise figure.
- Optional solar powering available - 1 watt unit.
- Stereo audio monitor.
- Rugged power supply is immune to wide power line variation.
- Local announcements may be activated automatically or by remote tone control.
- No unreliable blowers or fans - convection cooled.
- Optional mono modulator module available.
- Modular construction permits all major subassemblies to be easily removed with a screwdriver.

Model XL1FM	— 1 watt single output	.....	\$2850
Model XL1FM2	— 1 watt dual output	.....	\$3310
Model XL10FM	— 10 watt single output	.....	\$3050
Model XL10FM2	— 10 watt dual output	.....	\$3700

## TAPCO PRV-1 PARAMETRIC EQUALIZER-REVERB



- QUIET—improved low noise circuitry for superbly quiet performance.
- AUTHENTIC REVERBERATION—frequency compensated reverb circuit using the Accutronics Type 9 mechanical delay line for realistic reverberation.
- FULL PARAMETRIC EQUALIZATION—two bands with separate boost/cut, frequency, and bandwidth controls for excellent tonal response control of the reverb signal or the line signal.
- INDEPENDENT LEVEL CONTROLS—permit the levels of reverb and line signals to be set independently.
- LED LADDER DISPLAY—provides an easy to read display of the reverb drive signal. This facilitates optimum level selection.
- BALANCED AND UNBALANCED INPUTS AND OUTPUTS—flexibility for all hookup requirements. **No transformers required.**
- SIGNAL ROUTING SWITCHES—allow independent selection of line and reverb signals to be OFF, ON and FLAT, or ON and EQUALIZED.
- ALL STEEL RACKMOUNT CHASSIS—for increased strength and improved shielding.

PRV-1 per channel	.....	\$499.00
-------------------	-------	----------

## CROWN EQ-2 EQUALIZER



The CROWN EQ-2 is a stereo equalizer designed for the professional user and sophisticated audiophile. Eleven bands per channel provide full equalization from 10Hz to

(cont.)



# AMPLIFIERS & AUDIO PROCESSING

20kHz with each band featuring a  $\pm 15$  dB boost or cut capability. Nineteen-position step switches permit precision control of the individual band levels. The filters are of half octave constant band width design, set nominally on octave centers. Each filter has an associated control allowing  $\pm .5$  octave adjustment of the center frequency. The two channels can be cascaded to produce a full range half-octave equalizer.

The EQ-2 may be rack mounted, or as shown, an optional cabinet is available.

FREQUENCY RESPONSE: 10Hz to 100kHz  $\pm .3$ db  
CLIP LEVEL: 10V RMS before overload  
HUM AND NOISE: 90dB below rated output  
RATED OUTPUT: 2.5V RMS into IHF load  
DISTORTION IM: Less than .01% at rated output  
INPUTS: Balanced (transformerless) and unbalanced inputs  
INPUT IMPEDANCE: 25K unbalanced, 20K balanced (transformerless)  
OUTPUT IMPEDANCE: 300 Ohm, 600 Ohm balanced  
DIMENSIONS: 19 x 7 x 14½ inches  
WEIGHT: 16 lbs.

EQ-2 ..... \$1299.00  
Case Optional

## UREI 535 DUAL GRAPHIC EQUALIZER

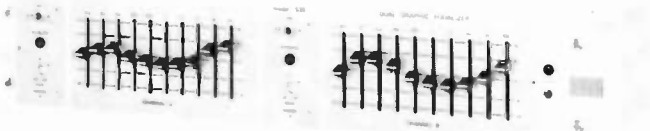

The 535 Dual Graphic Equalizer is a studio quality product which has wide application in recording, sound reinforcement, radio and TV production, and high fidelity music systems. It is a successor to the popular UREI Model 530 offering 10 filter sections per channel with increased control range, and more output capability.

The 535 provides 12 dB of boost or cut at each of its 10 frequencies, which are centered at ISO one-octave increments from 31.5 Hz to 16 kHz.

- Two Channels in one compact package
- 12 dB boost or 12 dB attenuation at each center frequency
- Optional front panel security cover

### ELECTRICAL: (Each Channel)

INPUT: Balanced bridging differential amplifier  
INPUT IMPEDANCE: 40 kohms, used as balanced input  
20 kohms, used as unbalanced (single ended) input  
MAXIMUM INPUT LEVEL: + 20 dB (Ref. 0.775 V rms)  
EQUIVALENT INPUT NOISE: Less than -90 dBm  
GAIN: Variable -10 dB to + 20 dB,  $\pm 1$  dB  
FREQUENCY RESPONSE:  $\pm 1$  dB, 20 Hz - 20 kHz, (with no EQ)

OUTPUT: Floating, transformer isolated  
OUTPUT LOAD: 150 ohms or greater  
DISTORTION: Less than 0.25% THD, 30 Hz - 15 kHz, at maximum rated output.

CENTER FREQUENCIES: Standard ISO, (Hz)  
31.5 63 125 250 500 1k 2k 4k 8k 16k  
DIMENSIONS: 19" x 3½" rack panel, depth behind panel 8", (19" x 3½" x 8")  
WEIGHT: 9.5 pounds

ACCESSORY: Model SC-1 Security Cover; smoke gray transparent plastic; covers all operating controls.

UREI 535 ..... \$496.00

## UREI 537 1/3 OCTAVE EQUALIZER

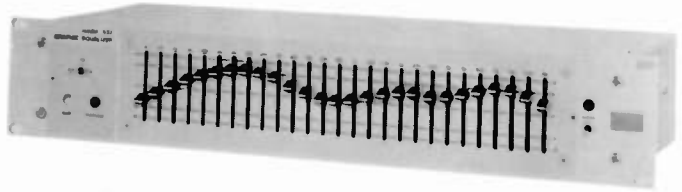

Model 537 is an active filter set for general purpose frequency response adjustment of audio signals. It is a worthy successor to the highly popular UREI Model 527A, offering greatly improved signal-to-noise characteristics and increased control range.

- 27 adjustable equalizers on ISO 1/3-octave center frequencies.
- 12 dB boost or 12 dB attenuation at each center frequency.
- Stepless, noiseless controls, precision calibrated.
- State-of-the-art active L - C filter circuitry.
- Low distortion, lowest noise, minimum phase shift.
- Zero insertion loss, up to 20 dB gain.
- Standard rack mounting, only 3½ inches high.
- Optional front panel security cover.
- Competitively priced.
- UREI quality, of course.

UREI 537 ..... \$846.00

## UREI 539 ACTIVE FILTER ROOM EQUALIZER

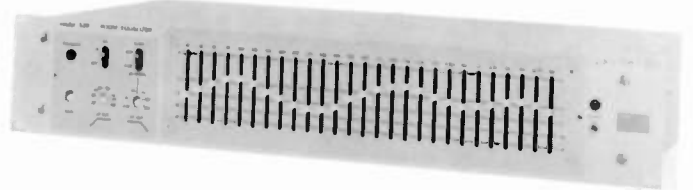

Model 539 is an active filter set specifically designed for room "equalization" or tuning. Successor to the highly popular UREI Model 529, the 539 utilizes advanced circuit technology and latest state-of-the-art components to achieve quantum improvements in performance, and added features at lower cost.

Signal-to-noise ratio is better than 110 dB at maximum output. Filter parameters have been optimized to produce excellent combining and minimum phase shift. Output capability of + 24 dBm combined with this exceptional noise figure provides widest dynamic range. Band-end tunable hi-pass and lo-pass filters are 12 dB/octave, with the lo-pass (H.F. cut) switchable to 6 dB/octave to permit more accurate control of band-end contouring and "house curve" rolloff.

UREI 539 ..... \$996.00

## UREI 567 P.A. PROCESSING SYSTEM



The Model 567 P.A. Processing System has been designed to satisfy the requirements for signal processing in a

(cont.)



# 4

# AMPLIFIERS & AUDIO PROCESSING

majority of public address and sound reinforcement installations. It is particularly cost-effective in church and small auditorium systems where economic restraints preclude full 1/3-octave equalization and/or elaborate tuning. The system is designed to operate at high or low impedances and at any nominal level from -20 dB (Ref. 0.775 V), allowing use with low level mixers, high or low impedance, balanced or single-ended circuits.

- Input preamp allows operation from low level, high or low impedance mixers.
- Built-in pink noise generator for equalization and setup.
- Headroom indicator monitors signal levels and the approach of overload.
- Ten-band octave Graphic Equalizer  $\pm 10$  dB each frequency.
- Four independent, tunable notch filter Feedback Suppressors.
- Built-in peak clipper for Feedback Suppressor Setup.
- 12 dB per octave, tunable Electronic Crossover.
- Patch point allows addition of limiter, compressor, etc.
- Bypass switches for easy setup and A-B comparison.
- Low distortion, low noise, wide dynamic range.
- Optional front panel security cover.
- Self-contained regulated power supply.
- 3½" standard rack mounting.
- UREI quality, of course.

UREI 567 ..... \$846.00

## SHURE M610 FEEDBACK CONTROLLER

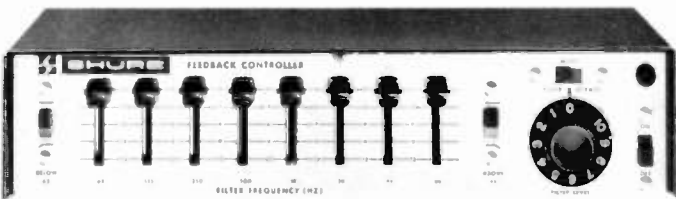

The Shure M610 Feedback Controller marks the beginning of a new era in sound reinforcement. When the M610 is included in the sound system, its special set of filters and roll-off switches are used to smooth out the peaks and valleys in the system's frequency response, so that the system gain may be increased to significantly higher levels before reaching the feedback threshold! The user is able to "tune" the sound system according to the special acoustics of the room to maximize output and minimize feedback.

Rack Mount Available  
M610 ..... \$214.00

## EVENTIDE HARMONIZER H949



Eventide Harmonizers are used by top bands and top recording organizations around the world. They are incredibly versatile units, combining digital delay, pitch

change, and a variety of other features. They can be used for "doubling" vocals, for delay equalization in sound reinforcement, and for many types of reverb/echo. When used with a variable speed tape recorder, a Harmonizer can be used to tailor program material to fit a particular time-slot, while retaining the original pitch.

- PITCH CHANGE: one octave up, two down
- DELAY: two outputs, each 393.75 ms
- FREQUENCY RESPONSE: 15 kHz
- DYNAMIC RANGE: 96 dB. Micro pitch change, for extremely precise, stable settings near unison. Time reversal, repeat, randomized delay, flanging. High and low feedback equalization. Two selectable algorithms, to optimize pitch change performance. Long delay permits simulated reverb.

H949 ..... \$3500.00

## EVENTIDE BROADCAST DIGITAL AUDIO DELAY LINE BD931 - MONO • BD932 - STEREO



Eventide, the world leader in digital broadcast audio delays, presents the "no compromise" economy obscenity delays—the BD931 (MONO) and BD932 (STEREO)—each in 3.2 and 6.4 second configurations. Priced to be cost-effective even for stations that air only limited talk programming.

### Quality without Compromise

Eventide broadcast delays are the clear choice of broadcasters for policing telephone talk shows and other live programming. Digital RAM-based circuitry eliminates all the problems of tape loop delays - the tape loops that snap, the moving parts that break, the dead air that results. The BD931 / BD932 series meets the needs of the station on a budget, with no compromise in audio quality.

### Full 16kHz Bandwidth Performance

Every BD931 / BD932 model features full 16kHz bandwidth and greater than 90dB dynamic range. These specs far exceed the performance of competitive economy delays, which achieve their low prices by sacrificing audio quality. The full bandwidth, wide dynamic range BD931 / BD932 units NEVER degrade your audio, as other economy delays can!

### A Model for Every Application

Choose from mono (BD931) and stereo (BD932) models. Each is available with either 3.2 or 6.4 seconds of fixed delay. The front panel features a clear 10-segment LED bar-graph level display for each channel. All units are a compact 1¾" high rack panel, except BD932/6.4 seconds, which is 3½" high. This model only is configured as two linked mono units, thus the 3½" height (1¾"x2). The two units can also be operated completely independently and physically separated, as two mono 6.4 second delays. This provides additional system redundancy and operating flexibility.

BD931 Mono . . . 3.2 sec. \$1795.00 . . . 6.4 sec. \$2295.00  
BD932 Stereo 3.2 sec. \$2595.00 . . . 6.4 sec. \$4495.00

(cont.)

## EVENTIDE BD955 BROADCAST AUDIO DELAY LINE



The BD955 was designed specifically for the policing of live talk shows. It is a RAM based digital delay line, available in two frequency ranges—7.5 kHz for reproduction of telephone audio, and 15 kHz for quality reproduction of the full audio spectrum. There are three maximum delay times available—1.6, 3.2 or 6.4 seconds.

The unit has a unique 'catch-up' feature, which enables it, after the objectionable material has been dumped, to regain its delay safety margin automatically, without recourse to a taped jingle or announcement. For use as a production tool, the delay line can be set to give delay times ranging from 6.5 milliseconds up to its maximum by adjustment of a front panel control. The protection of tape delay with no moving parts.

15 kHz Units:	3.2 s - \$3350.00	6.4 s - \$4300.00
7.5 kHz Units:	3.2 s - \$2700.00	6.4 s - \$3350.00

Stereo Interconnect - \$150.00, Plus Cost of Two Units

## EVENTIDE DELAY LINE 1745M



The modular construction of this unit makes it exceptionally flexible—up to five outputs, each with a maximum of 320 ms of delay (640 ms in the 'double' mode), selectable in 20 us steps. Optional modules available include a pitch changer, which will change the frequency of the input signal up to an octave above or below the original, and a remote control module which controls the delay line with a microcomputer.

FREQUENCY RESPONSE: 16 kHz (8 kHz in 'double' mode).

DYNAMIC RANGE: 90 dB

1745M	.....	\$4100.00
Balancing Input Transformer (07)	.....	\$ 15.00
Balancing Output Transformer, per output (05)	..	\$ 25.00

## URSA MAJOR SPACE STATION SST-282



(cont.)

The Space Station SST-282 from Ursa Major is a highly sophisticated audio signal processing unit which employs a digital delay line with multiple taps (outputs) to produce a wide variety of reverb, echo and comb filter effects. There are sixteen Audition Delay Programs which provide four basic families of effects: Rooms, Combs, Delay Clusters and Space Repeats. There is also a switch for selecting either reverb or echo mode of operation. The Space Station provides the user with front panel control over a wide variety of operating parameters with the result that many totally unique sound effects can be generated—in addition to the more familiar sounding reverb and echo effects.

Input: active differential, 10kohm high pin, 20kohm low pin; XLR connector

Output: Single-ended, source resistance 47 ohm; left and right on XLRs.

SST-282	.....	\$2195.00
---------	-------	-----------

## ORBAN 245F STEREO SYNTHESIZER



The Organ Model 245F Stereo Synthesizer has been designed to take any mono signal and create lifelike pseudo-stereo. Unlike many other techniques, the patented Orban stereo synthesis technique causes no change in spectral balance, does not blur the transient definition, and adds not the slightest audible noise or distortion to the mono original. The stereo output sums back to the original mono for total mono/stereo compatibility. And the simple controls adjust in seconds to create an optimum stereo effect from any mono original. The major new features added to the 245F are a standard active balanced input and provisions for mounting optional output transformers to provide balanced outputs. Enhanced RFI suppression is provided on both audio and power leads. In addition, front-panel cosmetics have been revised.

245F	.....	\$399.00
------	-------	----------

## ORBAN 516EC DYNAMIC SIBILANCE CONTROLLER



The O/P Model 516EC is the industry's first truly satisfactory de-esser. Unlike older designs, the 516EC has noise and distortion characteristics comparable to state-of-the-art amplifiers. Attack and release times have been optimized to totally eliminate pumping and audio "holes." The 24 dB/octave filter selectivity eliminates possibility of false triggering by low-frequency information. Sibilants are controlled by reducing the gain of the whole channel - not filtering - so sibilants are not colored by the action. There is only one control, which controls the balance between energy in the sibilance range and low-frequency energy. De-essing is constant whether the input is loud or soft. Control action can be switched in or out without

(cont.)

clicks, pops, or gain changes. An LED lights whenever control action occurs. For voice only.

- 516EC 3-Channel Unbalanced ..... \$719.00
- 526A Single Channel Balanced ..... \$469.00

**TAPCO 4400A REVERB**



The 4400 Reverberation System represents the new state-of-the-art in low cost reverb systems. The many design innovations incorporated into the 4400 have given it the kind of flexibility and quality you would expect only in systems costing many times more. Complete compatibility is inherent in the design of the 4400, so it can be used with all common Audio equipment. And like all TAPCO products, the 4400 is built to withstand all the rigors of professional use, day in and day out.

**INPUT/OUTPUT**

- 2 Line level inputs and outputs (phone jacks)
- 2 AutoPad gain controls
- Stereo input level meters (adjustable)
- 2 Channel in/out switches
- 2 Spring delay lines
- 2 Specially designed reverb contouring equalizers each with 4 slide controls giving 15dB of cut or boost.
- 2 reverberation percentage slide controls (9% - 100%)
- 2 Independent slide output gain controls with AutoPad Circuitry - single ended in/out.

TAPCO 4400A ..... \$495.00

**ORBAN 111B/1 2-CHANNEL SPRING REVERB**



The integral "floating threshold limiter," exclusive to Orban/Parasound protects the spring against both overload and "boing" sounds. This circuit serves to eliminate sharp, sudden changes in level regardless of average level. This makes it possible to reverberate such instruments as guitar or drums for the first time with a spring system.

The limiter makes sure that "twangs" are ducked out and masked by the direct sound mixed with the echo return.

ORBAN 111B/1 ..... \$849.00

**DBX 140 TYPE II BROADCAST NOISE REDUCTION SYSTEM**



(cont.)

The dbx Model 140 simultaneous encode/decode broadcast noise reduction system is a two-channel compressor/expander providing a minimum of 30 dB broadband audio noise reduction with a 10 dB increase in system headroom. The two channels feature independent encode and decode circuitry. Not compatible with Type I.

The dbx system eliminates tape hiss in recording, and prevents the noise build-up normally encountered in transferring information from one recorded medium to another; it does not remove noise present in the original signal. The dbx 140 noise reduction system is built to professional standards using the latest advances in circuit design and technology.

Input impedance: 75 kohm balanced, 54 kohm single ended  
Output impedance: Single-ended low, designed to drive 600 ohms or greater

Input level: + 24 dBm maximum

Output level: + 24 dBm maximum into 600 ohms

DBX 140 ..... \$590.00

**ATI L-1000 SERIES PRECISION DUAL LINE AMPLIFIERS**



- L-1000-1 Dual, Transformer Outputs
- L-1000-2 Dual, Balanced Differential Outputs
- L-1000-3 Dual, Single Ended (Unbalanced) Outputs
- Balanced differential inputs: 30,000 ohm bridging, fully transient protected and RF suppressed.
- 80dB common mode hum rejection.
- High input overload capability: + 24dBm bridging.
- Low noise: -107dBm equivalent input noise (20kHz bandwidth).
- Low distortion: .2% maximum (transformer) .05% maximum (direct outputs).
- Flat response: ±.25dB, 50 to 20,000Hz.
- 34dB voltage gain: Front panel adjustable.

**OUTPUT CLIPPING LEVEL:**

- + 22dBm/600 ohms (L-1000-1,3)
- + 26dBm/600 ohms (L-1000-2)

**DISTORTION:**

- + 20dBm output and input levels to + 24dBm
- .2% maximum THD, 30 to 20,000Hz

**FREQUENCY RESPONSE: ±.25dB, 50 to 20,000Hz**

**INPUT OVERLOAD: + 24dBm bridging**

**GAIN: 34dB, front panel adjustable**

**INPUT IMPEDANCE:**

Balanced differential inputs, 30,000 ohm bridging  
SIZE: 8 1/2"W x 1 3/4"H x 7"D, 2 1/2 lbs.

MOUNTING: Suction feet for non slip desk mounting, Rack Mount Kit 20021-501 mounts single MicroAmp-Rack Mount Kit 20024-501 mounts two MicroAmps side by side. Rack Mount kits optional at extra cost.

- L-1000-1 ..... \$315.00
- L-1000-2 ..... \$315.00
- L-1000-3 ..... \$295.00

## VALLEY PEOPLE'S HH 2 x 2 LEVEL MATCHING INTERFACE

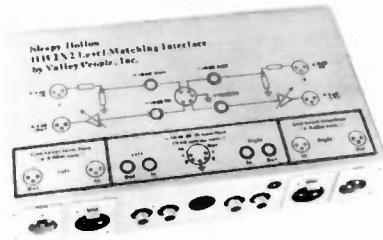

The HH 2 x 2 Level Matching Interface is a line amplifier/attenuator which interfaces +4 or +8 dBm professional recording or broadcasting equipment with -10dBm Hi/Fi and semi-pro equipment. Because the unit is transformerless, it achieves improved transient response.

Each HH 2 x 2 Level Matching Interface is a **complete stereo system**. Indeed, it is a stereo amplifier which boosts -10dBm signals from cassette or quarter-track machines, budget signal processing gear, and certain multi-track machines and consoles to a nominal +4 or +8 line level output.

### APPLICATIONS

- Interfacing cassette and other copy machines into recording and other audio facilities at the proper levels and impedances.
- Permits -10 devices to operate effectively with professional audio consoles and machines. Avoids impedance mismatches and overloading.
- Interfacing with the audio sections of video tape recorders and video disc players.
- Enables Hi/Fi components and signal processing gear to drive your console or other equipment.
- Makes A/B comparisons super easy by returning all machines at the same level.
- Rack mount available.

HH 2 x 2 ..... \$215.00

## RTS 444 BUFFER AMPLIFIER



The Model 444 is a dual, two-channel buffer amplifier designed to interface professional systems with semi-pro and home high-fidelity equipment. Although components designed for home use offer desirable features for studio applications, interconnections between the two kinds of equipment are complicated by differences in levels, impedances and balanced and unbalanced modes of operation. The 444 corrects these problems while maintaining signal integrity.

(cont.)

**ADVANTAGES:** The Model 444 provides a transparent, trouble-free interface between balanced and unbalanced inputs and outputs. It prevents the distortion, hum, instability and inconvenient signal levels that often result from direct connection of home and semi-pro equipment into professional systems. It is a convenient, easy to use device that will find numerous applications in any studio. Complete in/out compatibility between pro & semi-pro stereo equipment. RF Proof.

**FREQUENCY RESPONSE:** ±.25 dB  
**TOTAL HARMONIC DISTORTION:** 0.1%  
**CHANNEL SEPARATION:** 70 dB  
**SIGNAL/NOISE RATIO:** 90 dB

RTS 444 ..... \$342.00

## AUDIO-METRICS MLA-1 MIC/LINE AMPLIFIER



The MLA-1 is a compact and versatile mic/line amplifier. The unit will accept 2 mic or hi level inputs and incorporates up to 60dB of amplification and active balancing circuitry to provide line level, balanced outputs. A switch combines the 2 inputs for mono-mixer applications.

**MIC INPUT:** 400 ohms bal.; Nom. level 2.5mv; Max. input 80mv

**LINE INPUT:** 40K ohms bal.; Nom. level -10dBm; Max. input +20dBm.

**OUTPUT:** 200 ohms active bal.; Nom. level +8dBm; Max. output +25dBm.

**DISTORTION:** T.H.D. & I.M. .03% max.

**NOISE:** Mic -75dB; Line -80dB

**FREQUENCY RESPONSE:** .2dB 20-20kHz

**GAIN:** Mic 60dB max.; Line 20dB max.

- Mic pre-amp (inputs to mic level / mode-stereo)
- Buffer amp (inputs to line level / mode-stereo)
- Line Amp (inputs to line level / mode-stereo balanced or not)
- Mixer / Amp (inputs to mic or line / mode-mono)

MLA-1 Mic/Line Amplifier, Stereo/Mono ..... \$275.00

## ONAN POWER GENERATORS

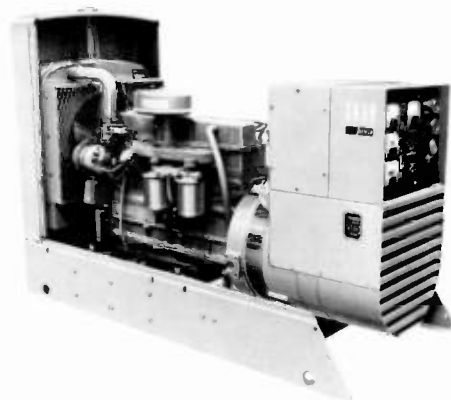

(cont.)

# 4

## AMPLIFIERS & AUDIO PROCESSING

... off the air is more than a panic. In some markets, one point in the book can mean a million dollars in business gained or lost.

From 1.7 to 750KW, there is an Onan Power Plant exactly right for your requirements.

Natural gas, gasoline, LP, or diesel.

Call Allied for a quote on your standby power needs.

### TELEMIX



TELEMIX will be at home in every room at your station. As a talk-show system at the most sophisticated station it will handle up to 7 lines quietly and easily. Lines are normally grouped into "incoming" (5 lines) and "dedicated conference" (2 lines). Since these two groups are switched separately, a telephone guest can be kept on the air on a conference trunk while incoming calls are switched in and out smoothly and quietly. The two-way interaction between host and caller is adjustable... from "full ducking," similar to the speaker-phone sound, to a nicely-balanced mode where caller and host can outshout each other.

Please refer to Page 89 for more information and pricing.

### RTS 1400 MICROPHONE PREAMPLIFIER



The RTS 1400 is more than a microphone preamplifier; it is a unique and versatile tool. Its well-planned features, rugged construction and excellent specifications make it a professional problem solver, an audio "adapter" with countless applications.

The 1400's gain is continuously variable via a front panel control. At lower gain settings (minimum 23dB) the 1400 will boost the level from a low-output microphone to drive low-gain mixers at their specified nominal level. At higher gain settings (56 dB maximum), the 1400 has ample gain to boost a mic output to line level. Because the 1400 has a high quality built-in limiter, it can be used to prevent overdrive of individual mic (or line) inputs while maintaining high average levels. These features make it useful in loca-

(cont.)

tion recording, remote broadcasting, and broadcast production. Powered by 2, 9V batteries not included.

RTS 1400 ..... \$297.00

### RTS 465 MICROPHONE PREAMPLIFIER



The Model 465 is a single channel, wideband microphone preamplifier designed for professional use in areas such as broadcast operations, television production, sound reinforcement, and commercial and industrial applications. It features outstanding electrical specifications along with fully floating transformer balanced input and output circuits, switchable phantom microphone powering, and an integral power supply. The 465 employs a (switchable) limiter to preclude the possibility of pre-amplifier overload from any microphone source. AC only.

FREQUENCY RESPONSE: +0, -1 dB  
 TOTAL HARMONIC DISTORTION: -50 dB/0.03%  
 EQUIVALENT INPUT NOISE: -127 dBm  
 INPUT IMPEDANCE: 1000 ohms  $\pm$  15%  
 MAXIMUM OUTPUT LEVEL: +22 dBm

RTS 465 ..... \$432.00

### ATI M-1000 SERIES PRECISION DUAL MICROPHONE AMPLIFIERS



M-1000-1 Dual, Transformer Outputs  
 M-1000-2 Dual, Balanced Differential Outputs  
 M-1000-3 Dual, Single Ended (Unbalanced) Outputs

- Transformer coupled inputs and outputs incorporate full electrostatic and magnetic shielding.
- XLR type input connectors.
- Low noise: -124dBm equivalent input noise (20kHz bandwidth).
- High input overload: 125mVrms minimum.
- High gain: 72dB, front panel adjustable.
- Low distortion: .2% maximum with input levels up to 100mVrms.
- Flat response:  $\pm$  .25dB, 50 to 20,000Hz.

OUTPUT CLIPPING LEVEL:  
 + 22dBm/600 ohms (M-1000-1, 3)  
 + 26dBm/600 ohms (M-1000-2)

(cont.)



# AMPLIFIERS & AUDIO PROCESSING

DISTORTION: .2% maximum THD 30 to 20,000Hz

INPUT IMPEDANCE:

5000 ohms minimum, transformer coupled

GAIN: 72dB, front panel adjustable

SIZE: 8 1/2"W x 1 3/4"H x 7"D, 2 1/2 lbs.

MOUNTING: Suction feet for non slip desk mounting,  
Rack Mount Kit 20021-501 mounts single MicroAmp,  
Rack Mount Kit 20024-501 mounts two MicroAmps side  
by side. Rack Mount kits optional at extra cost.

M-1000-1	.....	\$345.00
M-1000-2	.....	\$345.00
M-1000-3	.....	\$325.00

## MAP IMPAC SERIES MODULAR PC CARD SYSTEM

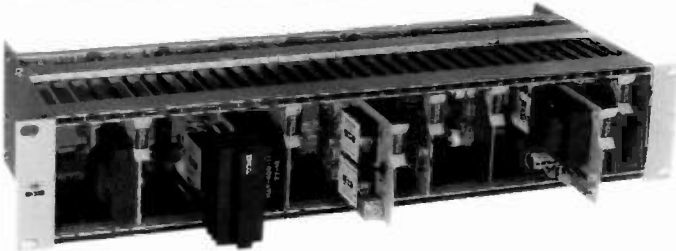

A COMPLETE LINE OF PLUG-IN PC CARD AUDIO  
MODULES AND ACCESSORIES FOR PROFESSIONAL  
APPLICATIONS IN

- AM — FM — TV BROADCASTING
- RECORDING STUDIOS
- ENGINEERED SOUND SYSTEMS

(Current requirements listed in MA or amps)

**Model 4003 (AM—27) Microphone Preamp Card:** Lo-noise mic preamplifier with input and output transformer plus aux unbalanced output. 65MA ..... \$140.00

**Model 4004 (ABL—27) Bridging Line Amplifier Card:** Designed to bridge broadcast impedance med & hi level sources. Input/output transformer plus aux direct output. 65MA ..... \$143.00

**Model 4006 (AL—27A) Line - Booster - Differential or Combining (Summing) Amplifier Card:** Multi-purpose featuring external connections to determine operating characteristics. Output transformer plus direct unbalanced aux output. 65MA ..... \$ 91.00

**Model 4007 (PM—40A) Power Amplifier Card:** 15 watts RMS into 4 ohm load. Active balanced input and direct-coupled output stage. 2 amps..... \$115.00

**Model 4008 (AT—27) Tape Equalized Preamp Card:** Standard NAB tape EQ with HF & LF trim & gain controls. Output transformer plus aux direct output. 65MA ..... \$110.00

**Model 4009 (AP—27) Phono Equalized Preamp Card:** Standard RIAA phono reproduce EQ. HF trim. Input Z51 Kohms. 65MA ..... \$103.50

**Model 4010 (PPI—27) Peak Program Indicator Card:** 4 channels of peak indication on single card. Bridge across almost any audio source. 50MA ..... \$ 80.00

**Model 4011 Solid-State (FET) Audio Switching Card:** 4 independent remote controllable FET audio switches. Channel assignment, routing switcher, etc. 10MA ..... \$ 75.00

**Model 4102 Voltage Controlled Amplifier Card:** Use for remote control, fader grouping, or automated mixing. Differential output. 60MA ..... \$135.00

(cont.)

**Model 4202 Voltage Controlled Amplifier Card:** Similar to model 4102 with output transformer added. Balanced 600 ohm + 27 dBm output plus direct aux output. 65 MA ..... \$153.00

**Model 4820 Audio Distribution Amplifier Card:** 8 active-balanced 600 ohm outputs at + 20 dBm max. Active balanced bridging input with single gain control. 100MA ..... \$140.00

**Model 4012 Oscillator Card:** Versatile oscillator provides for cues, slating, alignment, and testing. Trimmable 40Hz to 20kHz. Output transformer plus aux direct output. 95MA ..... \$100.00

**PC Board Modular Power Supplies (plug directly into 4900)**

**Model 4000 ± 15VDC at 100 MA max 1-1/4" wide** \$100.00

**Model 4005 ± 15VDC at 200MA max. 1-1/2" wide** \$112.50

**Model 4050 ± 15VDC at 500MA max. 2-3/8" wide** \$247.00

**Model 3151 Power Supply:** Not rack mount ±14 to 16 VDC (adjustable) at 1 amp max. PC type pinout with connector supplied ..... \$305.25

**Model 7000 + RP7000 Power Supply:** ± 14 to 16 VDC at 4 amps max. Barrier terminals+RP7000 (Rack mount) \$560.00

**Model 4900 Rack Mounting Frame With Cover:** Holds up to 11 cards placed on a center of 1-1/2" ea. or 16 cards placed on a center of 1" each (card sizes vary) . . . \$125.00

## VOICE-ACT TELEPHONE/VOICE/CASSETTE INTERFACE



Now for the first time. . . A new, proven device for newsmen that brings studio quality to reporting and feeding tape by telephone.

All newsmen know the shortcoming of telephoned reports: typical "phone quality;" the inconvenience of using alligator clips; not being able to talk while clipped on; and disconnects while setting up.

Voice-Act is versatile. Use it whether your spots are live or on tape. It's also great for play-by-play sportscasting, remotes, stocks and weather reports, talk shows—any phone communication that's aired! Simply put Voice-Act onto the telephone and you're all set. It's as simple as that!

**For Western Electric Bell System** ..... \$78.00  
**For Most Other Systems** ..... \$83.00

**Includes Handy Carrying Case**

**SHIPPING AND HANDLING  
CHARGES WILL BE ADDED TO ALL ORDERS  
UNLESS OTHERWISE SPECIFIED**

## MICRO-TRAK SPORT III TELEPHONE REMOTE UNIT



This two channel console incorporates many features found desirable by sports broadcast personnel.

- Talkback for set up
- Built in AC supply
- Low cost batteries
- Telephone dial (Touchtone)
- Three headphone outputs

The SPORT III is attractively packaged in a self-contained carrying case. Open the cover, connect the telephone line, plug in the AC if available, turn to battery operation if not. Plug in a microphone, or sportscaster headset and its play by play time.

### POWER:

Line: 115 VAC 50-60 Hz. Battery supply automatically takes over on power failure.

Battery: Four 9V Alkaline transistor radio cells. Provides 5 approximately five hours operation (battery life will vary with output levels. Batteries not included.)

SIZE: 13.75 x 9.5 x 4.00 inches

WEIGHT: 6.5 lbs. with batteries. 8 lbs. packed.

SPORT III w/Dial option .....	\$649.50
SPORT III w/o Dial option .....	\$549.50

## MICRO-TRACK SPORT IV



All features of the SPORT III with 5 mic inputs, 4 mix to program + spotter to headset only. With or without telephone dial.

SPORT IV w/dial option .....	\$799.50
SPORT IV w/o dial option .....	\$699.50

## TELFAX TFX 131



From Telfax, manufacturers of the most widely used miniature phone remote units in North America, comes a revolutionary new unit for the *professional* broadcaster . . . The TFX-131. More features . . . like pushbutton dialing with memory redial, LCD Clock/stopwatch timer, four microphone inputs, two auxiliary inputs, tone oscillator, closed circuit spotter channel, instant compatibility with Low Frequency Extenders and other external audio processors, custom engraved call letter nameplate, modular phone line connectors, and much more. Even with all these new features The TFX-131 control panel is uncluttered, with seldom used controls hidden behind the easily removed access/nameplate cover. It makes remote broadcasting easier than ever! Superior audio quality, miniature size, and loaded with features.

TFX 131 .....	\$695.00
---------------	----------

## RUSSCO'S T411 TEL-A-MOTE



- Built-in rotary dial
- Three mic channels, number 3 switches to spot operation
- Channels 2 & 3 switch to phono equalization
- Switchable line equalization improves audio response from phone or wires
- Built-in 9 volt battery pack backs up 115 Volt power source (Batteries not included)
- Headset amp drives up to 4 headsets
- Built-in test oscillator
- Carrying handle and feet
- The "lost" led will come on whenever the line fails or is disconnected in many Telco Systems

T411 .....	\$695.00
------------	----------



# AMPLIFIERS & AUDIO PROCESSING

## BONNEVILLE DA-6 AUDIO DISTRIBUTION AMPLIFIER

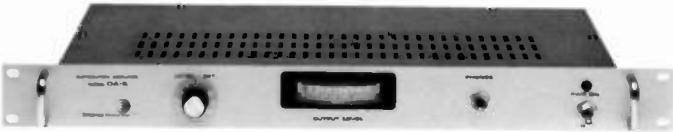

- Transformer In/Transformer Out
- Bridging (20K ohm) Input
- + 24dBm Outputs
- Outputs protected against continuous short-circuits
- 60dB Isolation between Outputs (full bandwidth)
- Gain adjustable to + 30 dB
- Self-contained regulated power supply

The Bonneville model DA-6 is a premium-quality general-purpose audio distribution amplifier for the professional. It is suitable for multiple line-level feeds from a single source.

Heat build up is no problem. 30 are stacked one immediately above the other at KNX for over two years, now.

The DA-6 is supplied with six outputs. Up to ten outputs can be ordered or field-installed in the prepunched chassis. The unit meets design specifications with all ten outputs, as well as six.

<b>DA-6 Audio distribution amplifier (with six outputs)</b> .....	<b>\$545.00</b>
<b>Additional outputs, per output (Ten total outputs maximum)</b> .....	<b>\$12.00</b>
<b>Black anodized panel option</b> .....	<b>\$15.00</b>

## BONNEVILLE A-10 AUDIO ACCESSORY

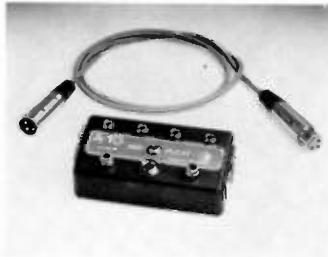

1 x 7 Multiple Output Box

The Bonneville model A-10 audio accessory is a passive interface box designed to provide multiple isolated outputs from a single line-level input. Several cassette tape recorders may be driven from a single distribution amplifier: line-level input.

All output jacks are insulated from the case. A grounding switch is provided to maximize the flexibility of the unit.

<b>A-10 Accessory for DA-108 or PC-1 amplifier</b> .....	<b>\$49.00</b>
--	----------------

## BONNEVILLE DA-108 AUDIO DISTRIBUTION SYSTEM

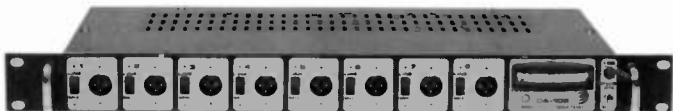

- XLR Connectors—in and out
- Transformer In/Transformer Out
- Bridging (20 K ohm) Input
- Up to + 24 dBm outputs
- Selectable output levels: Line or mic.
- Gain adjustable to + 30 dB
- Self-contained power supply

The DA-108 is particularly suited to provide multiple microphone or line-level outputs to reporters and sound cameramen at press conferences. It is also suited for multiple feeds in portable sound reinforcement systems.

<b>DA-108 Audio distribution system — XLR connectors (with eight mic/line outputs)</b> .....	<b>\$595.00</b>
--	-----------------

## BONNEVILLE PC-2 AUDIO DISTRIBUTION PACKAGE

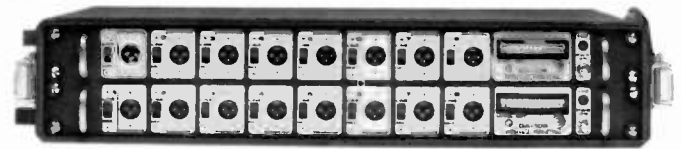

- Mono 1 x 16 or Stereo 2 x 8 configuration
- Mic or Line-level outputs
- + 24 dBm capability offers high headroom
- Transformer inputs and outputs
- Full built-in metering
- Rugged portable carrying case

An active audio distribution system with sixteen XLR mic/line selectable outputs.

The Press Corps-2 audio distribution package combines two of our popular DA-108 distribution amplifiers in a rugged carrying case. The two DA's may be bridged from a single input line using the cable supplied, or may be operated independently as separate 1 x 8 units.

The carrying case has detachable front and back covers to completely protect the distribution system during transport. (CC-1, optional)

Transformer isolation on all inputs and outputs protects against A-C ground-loop currents and RF interference problems.

<b>PC-2 Press Corps Distribution system (with sixteen mic/line outputs)</b> .....	<b>\$1295.00</b>
---	------------------

WE HONOR



**THE MOST CONVENIENT  
WAY TO ORDER FROM ALLIED  
IS BY TELEPHONE — SEE INSIDE BACK COVER  
FOR MORE INFORMATION**

(cont.)





# AUTOMATION

## MAXI-TWO



- 2 mixing channels
- Only 13" x 7" x 3½"
- 6 lbs.
- AC or DC

MAXI-TWO ..... \$425.00

## MAXITEL

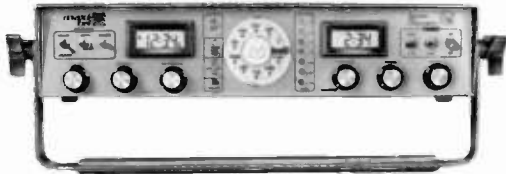

- 4 channels of mixing
- Dial or dedicated
- Battery or AC
- LCD countup and Real time clocks

MAXITEL ..... \$795.00

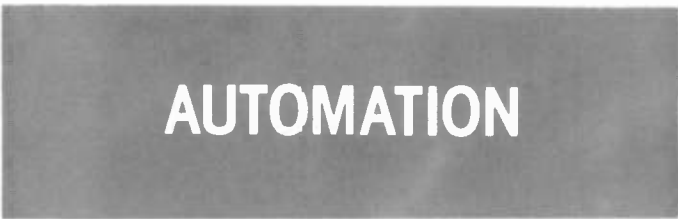

## MEI 100MP BROADCAST PROGRAMMER



An easy-to-use, self-contained automation controller which allows a station to operate manually, live-assist, or fully automatically at the push of a button.

Simply connect any standard tape machines to the 100MP, dial in the sequence of machines you wish it to play, and walk away. The system is fully operational. The entire program is in plain view at all times. Changes can be made immediately and without confusion.

Your announcer can "go live" as often and as long as he wishes with a push of the "hold" button. A built in Lazy-Time Clock always insures that commercial breaks are played at the proper times. Furthermore, the built-in silence sense circuit guards against dead air during unattended operation.

(cont.)

Consider these features for versatile operation:

- Completely self-contained. 25 Hz filter, 25 Hz sensor, and silence sense are an integral part of the circuitry. No other equipment to purchase or add on.
- Directly connects to any standard equipment. No interface boards needed.
- No relays. Solid state FET audio switching for reliable and quiet operation.
- Format flexibility. 24 and 48 Event models with 8 sources plus NET input. Infinitely adjustable dead roll, source delay and silence sense. Use any music syndication service and adjust the sound the way you'd like.
- Lazy-Time Clock control. Automatically determines when the programmer should skip unneeded music and advance to a commercial break. Walk away with confidence.
- Remote control console with hold and continue. Maintain control of your station with ease.

Price on Application

## IGM INSTACART



Since its original introduction in 1969, the IGM instacart has found wide acceptance in both broadcast and industrial fields. This ingenious device has established an impeccable record of reliability and performance in highly demanding, continuous-duty applications.

Instacart opened up new dimensions in programming for all broadcast modes, whether live or fully automated, because the principle of instant access allows you to record fragments of a sentence on several different cartridges and play them back as one continuous sentence. The true significance of this instant-access capability to radio programming is that you are freed completely from concern about the location of a particular "carted" feature, PSA, commercial or music selection. You simply command any cartridge to follow any other cartridge from the same machine.

Models	12 PBM, 12 cartridge playback, mono
	48 PBM, 48 cartridge playback, mono
	24 PBS, 24 cartridge playback, stereo
	24 PBM, 24 cartridge playback, mono
	12 PBS, 12 cartridge playback, stereo
	48 PBS, 48 cartridge playback, stereo

Pricing on Request



# AUTOMATION

## IGM GO CART

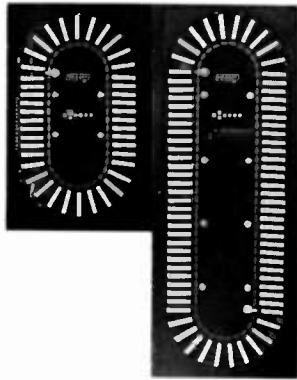

"We want the cart in contact with the playing table."

Time and again we've heard this from broadcasters. With some competitive units, the cartridge sits on a tray. The tray is dragged noisily into the player, shoved into position and the cart is played while in its carrier. The mechanical uncertainty of such units can cause misalignment at the playing head, which in turn causes phasing problems, loss of audio gain, poor frequency response and loss of stereo separation.

Go-Cart's design eliminates virtually all of these problems. A unique mechanism gently slides the cartridge onto a rigid play table of 1/2 inch thick precision-milled aluminum plate. The cartridge is left directly in contact with the rigid platform, free of any artificial guidance system. Upon receiving a "start" command from the controller, the cartridge plays airing a sound that approximates that of the finest reel-to-reel playbacks.

This superb sound of Go-Cart makes the unit ideal for both stereo and mono, music and voice. (Both stereo and mono units are available.)

In the "remote" mode, Go-Cart quietly and efficiently moves a selected cartridge to the play table position, and plays it upon command. In this mode the unit can be operated sequentially: a cartridge plays, ejects to the carrier and rotates to the next cartridge number, placing that new cartridge onto the play table to await the start signal. If any cartridge carriers should be empty, the unit moves on to the next filled position.

IGM Go Cart 24, 42, & 78 tray models . Pricing on request

## CP 201 PROGRAM CONTROL UNIT



Provides 100 event, random selection for carousel type multiple cartridge players.

Easy manual programming by means of front panel keyboard. Keyboard entries are entered into memory by pressing ENTER key. Manual control of EVENT counter is provided by (a) RESET key which resets counter to zero. (b) COUNTER key which advances counter at 6 Hz rate. (c) ADVANCE key advances counter one step.

100% solid state. No relays. Two LED type displays indicate event number and tray selection. Mounts in standard (cont.)

19 inch rack. Requires 3 1/2 inch panel space. Three size AA rechargeable batteries hold memory and event counter during power failure. Battery charge is maintained during normal operation.

CP 201 ..... \$695.00

## CONEX CG-25 25HZ TONE GENERATOR



- Built-in high pass filters for both left and right channels
- Front panel LED's to indicate duration of tone, silence and maximum length of untimed tone.
- All timing intervals, tone levels and audio levels easily adjustable from rear panel.
- Standard six-pin "Jones" type connectors provided for simple connection between console and recorder.
- Switch selectable for recording tones on left and / or right channels.
- All IC's are on sockets for easy maintenance
- Low distortion circuitry . . . Oscillator and audio typically less than .5% THD. Balanced bridging inputs and balanced 600 OHM outputs.
- Compact size . . . Measures only 8"W x 3 1/4"H x 5 1/2"D

CG-25..... \$350.00

## CONEX CS-25A DUAL 25Hz TONE SENSOR



The Conex Electro-Systems CS-25A is a compact and reliable bridging-type 25Hz tone sensor for use in broadcast automation and tape control systems. The unit features two independent sensors, allowing very economical expansion of existing systems.

- DPDT relay contacts actuated for the duration of the 25Hz tone.
- SPDT relay contacts which are actuated for approximately 0.5 seconds at the end of the tone, or at the end of an adjustable "stop delay" at the end of the tone.
- Front panel stop-delay adjustment to accommodate any tape format.
- Indicator lights on the front panel (one for each channel) to show the presence of a tone.
- Front panel disable switches which inhibit the relays (but not the indicators), allowing a tape to be run without stopping at tones or signalling the automation system.
- Separate open-collector logic outputs actuated for the duration of the tone to allow easy interfacing to various types of external circuitry.
- Quick and easy interconnection via standard "Jones Plugs" which are supplied.
- Front panel tone sensitivity adjustments to allow proper operation with a variety of tape decks and operation levels.

CS-25A ..... \$395.00



# CARTRIDGE MACHINES

## CARTRIDGE MACHINES

### AMPRO CARTRIDGE MACHINES



- Solid 1/2 inch precision machined aluminum deck.
- Precision airdamped solenoid.
- SELF-ALIGNING, BALL BEARING PINCH ROLLER.
- Cool running (17w) four inch direct drive capstan motor.
- Timed and shaped F.E.T. audio muting eliminates pops and clicks.
- Wideband, DIGITAL cue detectors, immune to noise.
- DIGITAL cue tone generator guarantees stable cue.
- Remotable by momentary contact closures.
- RELOAD INDICATOR flashes ready light after play.
- DIGITAL MESSAGE TIMER (optional)—5 digit LED display of elapsed playing time.
- ELECTRONIC SPLICE FINDER (option).

#### Optional Features (Notes 1, 2 & 3:

	End Cue	Teip Cue	Fast Fwd.	Monaural			Stereo		
				Model	Price	Code	Model	Price	Code
Series 2500	—	—	—						
Reproducer	X	X	—	CT2505B	\$1200.00	D	CT2515B	\$1360.00	D
NAB Type A Carts	X	X	X	CT2507B	\$1320.00	D	CT2517B	\$1480.00	D
Series 3500	—	—	—						
Reproducer	X	X	—	CT3525B	\$1200.00	D	CT3535B	\$1360.00	D
NAB Type A&B Carts	X	X	X	CT3527B	\$1320.00	D	CT3537B	\$1480.00	D
Series 3500	—	—	—						
Recorder-Reproducer	X	X	—	CT3545B	\$2070.00	D	CT3555B	\$2445.00	D
NAB Type A&B Carts	X	X	X	CT3547B	\$2190.00	D	CT3557B	\$2565.00	D
Series 4500	—	—	—						
Reproducer	X	X	—	CT4565B	\$1230.00	D	CT4574B	\$1425.00	D
NAB Type A, B&C Carts	X	X	X	CT4567B	\$1350.00	D	CT4577B	\$1545.00	D
Series 4500	—	—	—						
Recorder-Reproducer	X	X	—	CT4585B	\$2070.00	D	CT4595B	\$2445.00	D
NAB Type A, B&C Carts	X	X	X	CT4587B	\$2190.00	D	CT4597B	\$2565.00	D

- NOTES: 1. ALL UNITS INCLUDE 1K Hz STOP CUE AND AUDIO SWITCHER AS STANDARD FEATURES.
2. Units are available 50 Hz operation. D \$133.00
3. Mono Recorder-Reproducers are available with erase feature. D \$278.00
4. Electronic Splice Finder (installed) is available on models 3547, 3557, 4587 and 4597. Must be ordered with fast forward option D \$478.00

\*DIGITAL MESSAGE TIMER FOR SINGLE DECK TAPE CARTRIDGE EQUIPMENT .....\$200.00

**SHIPPING AND HANDLING CHARGES WILL BE ADDED TO ALL ORDERS UNLESS OTHERWISE SPECIFIED**

### AUDI-CORD 100 SERIES PLAYBACK

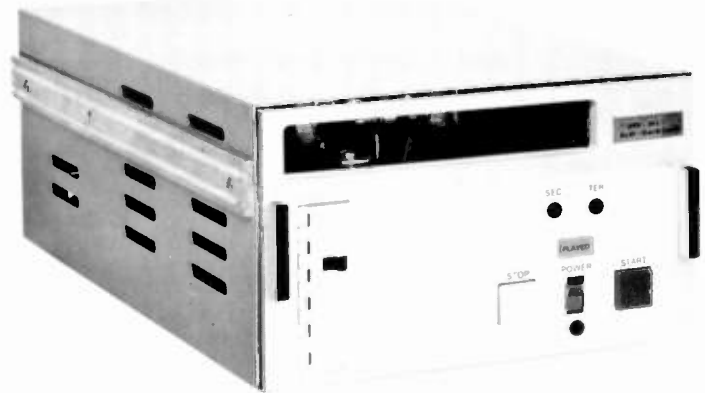

- Very rugged head mountings with top adjustments that stay put.
- Thick aluminum deck is overlaid with stainless steel for a wearing surface.
- Fully solid state and motionless control system includes cartridge sensing, solenoid and motor switching.
- All front accessible controls.
- Dual equalization — HI and LO
- All principal circuits on plug-in boards.
- Extensive use of mother boards.
- Replay/Lock system to prevent accidental replays. Selectable for operation.
- Complete remote facilities include internal strappable options.

#### 100 Series Premium Playbacks

100 Mono, 1 Cue	\$969.00
101 Mono, 3 Tones	\$999.00
105 Stereo, 1 Cue	\$1049.00
106 Stereo, 3 Tones	\$1089.00

### AUDI-CORD 3 TRANSPORT REPRODUCER



- Just 5 1/4" high—perfect for those console built-ins where height is a premium.
- Three independent outputs—three independent control systems.
- Rack or desk mountings.
- Same features of single playbacks.

#### "A" Series 3 Transport

A30 Mono, 1 Tone	\$2300.00
A31 Mono, 3 Tones	\$2375.00
A35 Stereo, 1 Tone	\$2450.00
A36 Stereo, 3 Tones	\$2525.00

**ALLIED HANDLES OVER 160 PRODUCT LINES - SEE INSIDE BACK COVER FOR COMPLETE LISTING**



# CARTRIDGE MACHINES

## AUDI-CORD 100 SERIES RECORD-PLAY

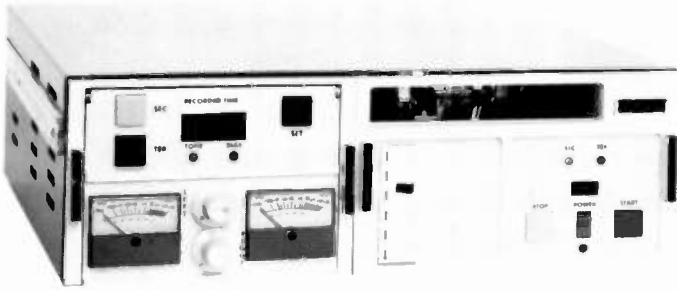

- Front accessible controls. Panel tilts open for principal adjustments.
- Dual record equalization — HI and LO.
- Bias and tone recording indicators.
- 5 K ohm bridging input — balanced transformer.
- Optional precise digital recording timer.

### 100 Series Premium Record-Playbacks

110 Mono, 1 Cue .....	\$1649.00
111 Mono, 3 Tones .....	\$1689.00
115 Stereo, 1 Cue .....	\$1789.00
116 Stereo, 3 Tones .....	\$1829.00
120 Mono, 1 Cue w/Timer .....	\$1719.00
121 Mono, 3 Tones w/Timer .....	\$1759.00
125 Stereo, 1 Cue w/Timer .....	\$1849.00
126 Stereo, 3 Tones w/Timer .....	\$1889.00

## AUDI-CORD "A" SERIES PLAYBACK

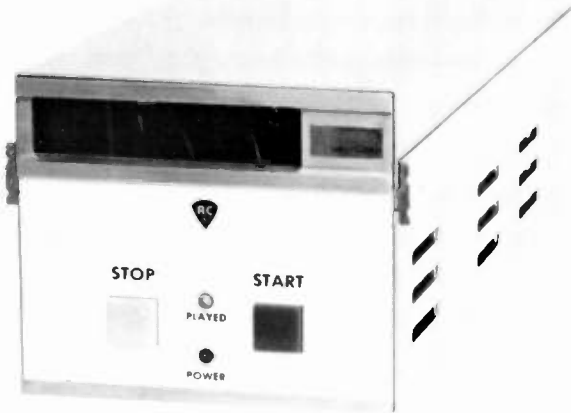

- Interchangeable transports and other assemblies.
- 1 or 3 tone — mono or stereo.
- Replay reminder system.
- Full remote control — automation compatible.

### "A" Series Playbacks

A10 Mono, 1 Tone .....	\$775.00
A11 Mono, 3 Tones .....	\$800.00
A15 Stereo, 1 Tone .....	\$835.00
A16 Stereo, 3 Tones .....	\$860.00

### "A" Series Record-Playbacks

A20 Mono, 1 Tone .....	\$1289.00
A21 Mono, 3 Tones .....	\$1319.00
A25 Stereo, 1 Tone .....	\$1519.00
A26 Stereo, 3 Tones .....	\$1549.00

## AUDI-CORD TWIN TRANSPORT RECORD-PLAY

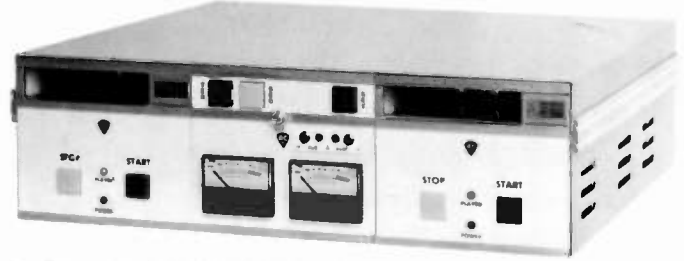

- Each deck records or plays
- Mono or stereo — 1 or 3 tones.
- Slide-out front panel (recorder).
- All the other "A" Series features

### "A" Series Dual Transport R/P

A50 Mono, 1 Tone .....	\$2025.00
A51 Mono, 3 Tones .....	\$2095.00
A55 Stereo, 1 Tone .....	\$2340.00
A56 Stereo, 3 Tones .....	\$2410.00
A51-6 Mono w/L.H. Stereo Deck .....	\$2195.00
A56-1 Stereo, w/L.H. Mono Deck .....	\$2335.00

## BROADCAST ELECTRONICS

### 3000 SERIES TAPE CARTRIDGE MACHINES



(cont.)



# CARTRIDGE MACHINES

The 3000 Series is now in use worldwide, proven and up-dated during continuous production. This family of equipment represents a new standard of excellence.

Long Life Nortronics Duracore Heads Are Now Standard Components In All Spotmaster Series 3000 Tape Cartridge Machines.

Series 3000 machines offer numerous benefits: a wide selection of options and models; an inherently reliable electronic design which makes extensive use of solid-state and integrated circuit technology; the exclusive Phase Lok III head bracket; and a rugged mechanical design which is second to none.

3100P	Mono, P/B Only, A Sz. Carts	\$1125
3100PS	Stereo, P/B Only, A Sz. Carts	\$1275
3200P	Mono, P/B Only, A&B Sz. Carts	\$1150
3200RP	Mono, R/P, A&B Sz. Carts	\$1970
3200PS	Stereo, P/B Only, A&B Sz. Carts	\$1300
3200RPS	Stereo, Rec/Play, A&B Sz. Carts	\$2325
3200RP/DL	Mono, Delay/Prog, A&B Sz. Carts	\$2350
3300P	Mono, P/B Only, A,B&C Sz. Carts	\$1225
3300RP	Mono, Rec/Play, A,B&C Sz. Carts	\$2025
3300PS	Stereo, P/B Only, A,B&C Sz. Carts	\$1400
3300RPS	Stereo, Rec/Play, A,B&C Sz. Carts	\$2375
3300RP/DL	Mono, Delay/Prog, A,B&C Sz. Carts	\$2400
3400P	Mono, P/B Only, Rack Mount	\$1275
3400PS	Stereo, P/B Only, Rack Mount	\$1425
3400RP	Mono, Rec/Play, Rack Mount	\$2025
3400RPS	Stereo, Rec/Play, Rack Mount	\$2375
3400RP/DL	Mono, Delay Programmed, Rk. Mnt.	\$2400

## BROADCAST ELECTRONICS 2100 SERIES TAPE CARTRIDGE MACHINES



Totally new, Broadcast Electronics' 2100 family of tape cartridge machines combine versatile operation, quality components and top specifications, all at an economical price. There's more value in the 2100 series than ever found before in any professional cart machine. The combination of advanced engineering design and Broadcast Electronics' cost saving production methods produces a cart machine with double value for the most quality minded users and for those who can now afford the best.

2100P	Mono, P/B Only 115V, 60Hz	\$1050.00
2100RP	Mono, Rec/Play, 115V, 60Hz	\$1550.00
2100PS	Stereo, P/B Only, 115V, 60Hz	\$1150.00
2100RPS	Stereo, Rec/Play, 115V, 60Hz	\$1850.00

(cont.)

2100PA	Mono, P/B w/Aud/Spkr, 115V, 60Hz	\$1150.00
2100P	Mono, P/B Only, 220V, 50 Hz	\$1150.00
2100RP	Mono, Rec/Play, 220V, 50Hz	\$1650.00
2100PS	Stereo, P/B Only, 220V, 50Hz	\$1250.00
2100RPS	Stereo, Rec/Play, 220V, 50Hz	\$1950.00
2100PA	Mono, P/B w/Aud/Spkr, 220V, 50Hz	\$1250.00
	Rack Mount Shelf for EIA 19" Rack	\$75.00
	Top Cover for 2114 Shelf	\$35.00
	Rack Shelf Filler Panel, 1/3 Rack	\$20.00
	Rack Shelf Filler Panel, 2/3 Rack	\$30.00
	Test Extender PC Board	\$50.00
	Adj. for Equal. to IEC/CCIR Spec	N/C

## BROADCAST ELECTRONICS 5300 SERIES TRI-DECK CARTRIDGE MACHINES



The Model 5300A is the most advanced multi-deck cartridge machine on the market. It is a top-of-the-line professional machine which features: solid-state/integrated circuit design, a direct-drive hysteresis synchronous motor, air damped solenoid, and a one-half inch thick machined aluminum deck.



Record Module

5301B	Mono Playback (A&B Size)	\$2625.00
5302B	Mono P/B, Sz. A&B, w/Cue Tones	\$2825.00
5303B	Stereo Playback (A&B Size)	\$3075.00
5304B	Stereo P/B, Sz. A&B, w/Cue Tones	\$3275.00
SW5E	Audio Switcher for 3 Decker	\$250.00
	Recorder, Mono for 3 Decker, Without Q Trip Option	\$925.00

(cont.)



# CARTRIDGE MACHINES

Recorder, Stereo for 3 Decker, Without Q Trip Option .....	\$1150.00
Secondary (150Hz) & Tertiary (8kHz) Q Trips for Mono Recorder .....	\$ 75.00
Secondary (150Hz) & Tertiary (8kHz) Q Trips for Stereo Recorder .....	\$ 75.00
Rack Mount (1) Unit, 3 Decker .....	\$ 50.00
Rack Mount (2) Units, 3 Decker .....	\$ 30.00
Additional Cost for 220/50Hz	
Power Source, 5300 Series .....	\$ 150.00
Extender PC Board .....	\$ 50.00

## SCULLY SERIES 8300 THREE DECK CARTRIDGE TAPE REPRODUCER

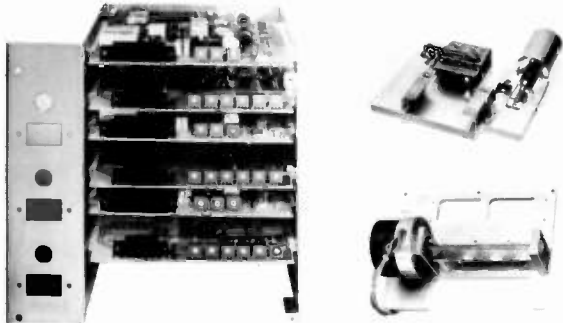
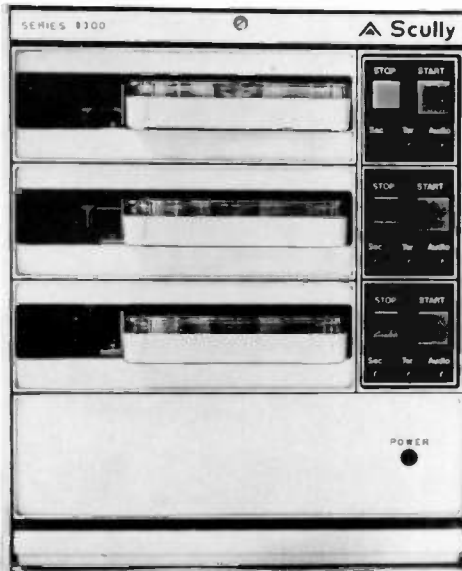

The new Scully Series 8300 three deck tape cartridge reproducer provides a new standard of excellence in a convenient modular configuration. All presently marketed three deck machines were evaluated, which resulted in a new packaging concept with all decks removable, a new servo motor without bearing adjustments, a new head bridge assembly, and graphics that won't wear off.

Standard features include a two bearing crystal-controlled D.C. brushless servo motor, 150 Hz secondary cue tone, audio mixer, audio switcher, and a reload indicator.

**CLOSED LOOP SERVO MOTOR** — The motor used in the Series 8300 is of totally new design and a Scully exclusive. It is a brushless D.C. motor controlled by a crystal referenced phase locked loop. This is the first three deck with a servo motor designed specifically for this application.

(cont.)

**HEAD BRIDGE ASSEMBLY** — A new concept was pioneered for the Series 8300 head bridge assembly. The entire assembly including overbridge, head mounting and guides, mount to the deck with only three screws, allowing a prealigned assembly to be quickly installed.

**MODULAR DESIGN** — The front panel hinges down and all decks are removable (a Scully exclusive) after removing one screw from the bulkhead.

**AUDIO MIXER/SWITCHER** — An Audio Mixer/Switcher is standard. The audio mixer combines (sums) audio from two or more decks. If the switcher control bus is activated, only the most recently started deck will appear at the output.

Mono .....	\$2620.00
Stereo .....	\$2950.00

## CARTRIDGE ACCESSORIES

### ALLIED LAZY SUSAN 500 CART RACK



- Overall height 76"
- Diameter (max.) 28"
- Assembly Required

ALLIED 500 Cap. L.S. Wire Cart Rack .....	\$469.00
ALLIED 50 Cap. Wall Wire Cart Rack .....	\$ 39.95



# CARTRIDGE ACCESSORIES

**ABCO 300 CARTRIDGE RACK**  
300 Cartridge Capacity

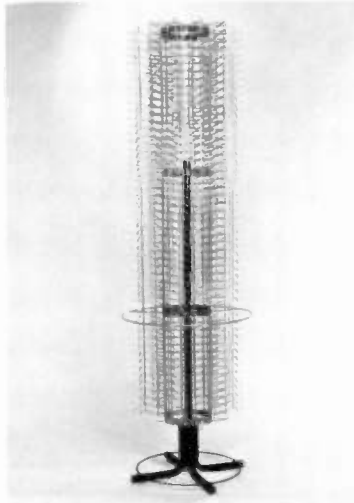

ABCO 300 .....\$309.00

**KUSTOM KRAFT 400LS CART RACK-WALNUT,  
GOLD, PECAN OR BLACK LAMINATE STANDARD**

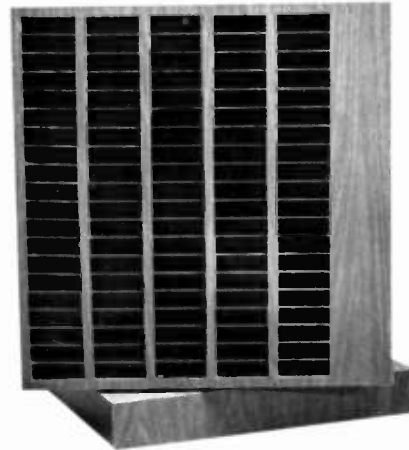

KK400LS  
29-1/8" Sq. x 26-1/8"T, Turn Dia. 42" ..... \$481.00  
KK800LS  
29-1/8" Sq. x 52-1/8"T, Turn Dia. 42" ..... \$811.00

Crating fee included

**KUSTOM KRAFT  
KK240LS LAZY SUSAN CART RACK**



Kustom Kraft Lazy Susans are available to hold from 100 to 1200 cartridges. Kustom Kraft Lazy Susans are available in walnut, pecan, black, or gold laminate.

We will build, at additional charge, any size lazy susan to meet your individual needs. Special laminates in your preferred color or pattern available at additional charge.

**Walnut, Pecan, Black or Gold Laminate Standard**

KK240LS  
19 3/4" Sq. x 25-7/8"T, Turn Dia. 28" ..... \$281.00  
KK100LS  
12-5/8" Sq. x 33-3/8"T, Turn Dia. 18" ..... \$161.00  
KK160LS  
15" Sq. x 25-7/8"T, Turn Dia. 22" ..... \$241.00

Crating fee included

**KUSTOM KRAFT KK1000LS CART RACK-  
WALNUT, PECAN, GOLD OR BLACK LAMINATE  
STANDARD**

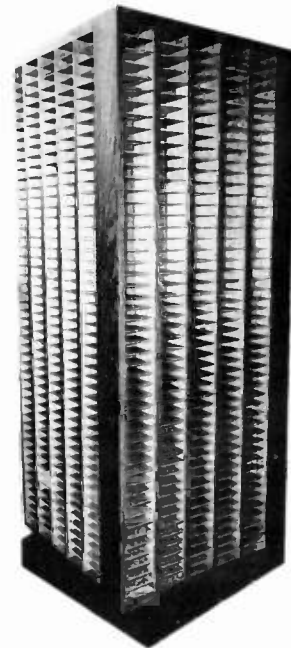

KK1000LS  
29-1/8" Sq. x 63 1/2" T, Turn Dia. 42" ..... \$1264.00  
KK1200LS  
29-1/8" Sq. x 75-5/8"T, Turn Dia. 42" ..... \$1464.00

Crating fee included

**THE MOST CONVENIENT  
WAY TO ORDER FROM ALLIED IS BY  
TELEPHONE — SEE INSIDE BACK COVER FOR  
MORE INFORMATION**



# CARTRIDGE ACCESSORIES

## KUSTOM KRAFT WALL CART RACKS

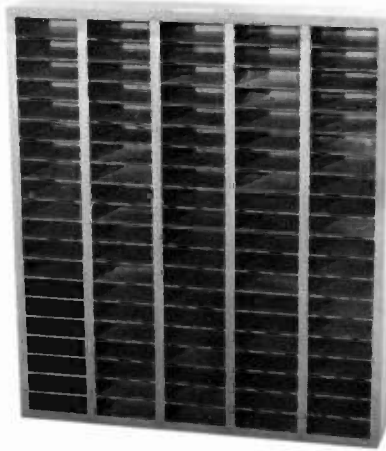

Custom size cart racks to fill your exact needs available. Please call with your measurements. Special laminates in your preferred color or pattern available at additional charge.

Walnut, Pecan, Gold or Black Laminate Standard

### REGULAR SERIES CARTRIDGE RACKS

Crating Fee included

Model	Cap.	Rows W / H	Dimensions Wide / High	Price
KK 20	20	5 x 4	25-1/8"x7-7/16"	\$21.00
KK 40	40	5 x 8	25-1/8"x13-5/8"	\$38.00
KK 50	50	5 x 10	25-1/8"x13-5/8"	\$47.00
KK 60	60	5 x 12	25-1/8"x16-1/8"	\$56.00
KK 100A	100	5 x 20	25-1/8"x25-7/8"	\$81.00
KK 100B	100	10 x 10	50-1/4"x13-5/8"	\$81.00
KK 150	150	10 x 15	50-1/4"x19-3/4"	\$124.00
KK 200	200	10 x 20	50-1/4"x25-7/8"	\$164.00

### N SERIES CARTRIDGE RACKS

Narrow Cartridge Racks in Walnut, Pecan, Gold or Black Laminate

Model	Cap.	Rows W / H	Dimensions Wide / High	Price
KK 100N	100	2 x 50	10-1/2"x67"	\$84.00
KK 150N	150	3 x 50	15-5/8"x67"	\$124.00
KK 200N	200	4 x 50	20-1/4"x67"	\$164.00
KK 250N	250	5 x 50	25-1/8"x67"	\$213.00
KK 300N	300	6 x 50	30" x67"	\$247.00
KK 350N	350	7 x 50	34-1/8"x67"	\$292.00
KK 400N	400	8 x 50	39" x67"	\$326.00
KK 450N	450	9 x 50	43-7/8"x67"	\$371.00
KK 500N	500	10 x 50	50-1/4"x67"	\$416.00
		(2, 250Ns)		
KK 600N	600	(2, 300Ns)	60" x67"	\$471.00
KK 800N	800	(2, 400Ns)	78" x67"	\$623.00
KK1000N	1000	(2, 500Ns)	100 1/2" x67"	\$815.00

**SHIPPING AND HANDLING CHARGES WILL BE ADDED TO ALL ORDERS UNLESS OTHERWISE SPECIFIED**

## TAPECASTER MODEL X-100 CARTRIDGE LOADER



Loading Speed: Approx. 50 IPS

2 direct drive motors

Floating aluminum tape supply-disc holds 7" reel or 10.5" pancake of lube tape.

Solenoid operated brake stops the supply-disc at the end of wind.

Adjustable tension control for the supply-disc brake.

EDITall splice block, designed for the X-100.

Ramp design tape guides.

Heavy steel top plate mounted on Formica trimmed base.

• Automatic Tape timing/Shut-off.

4 gold contact rotary switches programs the wind time at 7.5 IPS.

Wind time is accurately metered by the light chopper, nylon counter wheel.

B & C size cartridges may be loaded by removing splice block.

Adapter to lead the 3M cartridge option extra.

Model X-100.....\$495.00

### ALLIED CARTRIDGE LABELS



1. It sticks when you want.

2. It comes off easily & totally when you want.

Available in Brown, Red, Orange, Yellow, Green, Lt. Green, Blue, Purple, Grey, Gold.

Custom logo imprints available - inquire.

Cart Labels ..... any quantity, 18 cents per sheet of 10

### KUSTOM KRAFT 36 HOLER

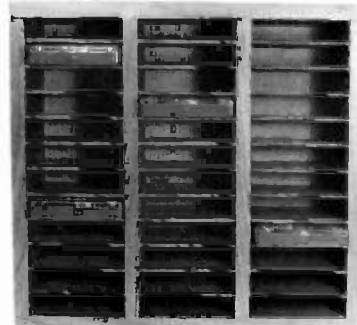

The Allied \$1.00-a-slot rack storage system. 36 capacity, \$36.00.

Kustom Kraft 36 Holer.....\$36.00





# CARTRIDGE ACCESSORIES

## BROADCAST ELECTRONICS WIRE UNIT LS-200 LAZY SUSAN

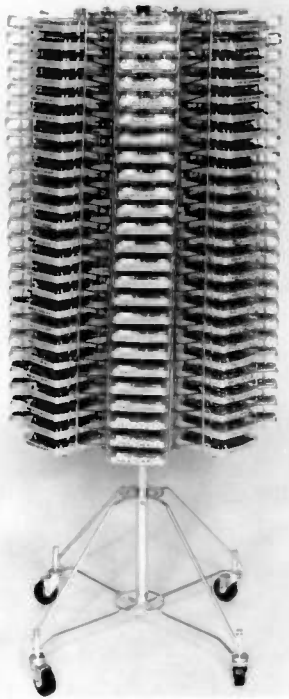

LS-200

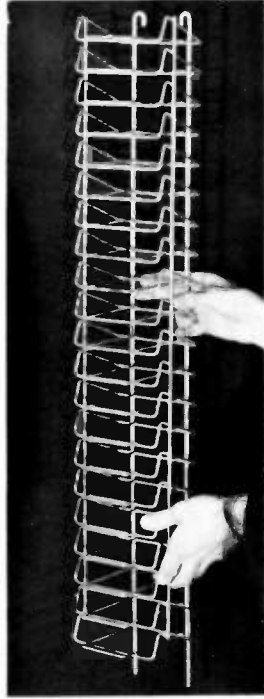

RS-25

Holds 200 cartridges on rotating stand. Ideal for large storage situations requiring mobility. Equipped with 4 heavy-duty casters and constructed of heavy steel rod finished bright zinc. Each individual RS-25 section is removable. 51 1/4" high, 20 1/2" diameter.

LS-200 ..... \$300.00  
RS-25 ..... \$ 30.00

## BROADCAST ELECTRONICS DESK MOUNT MODULES

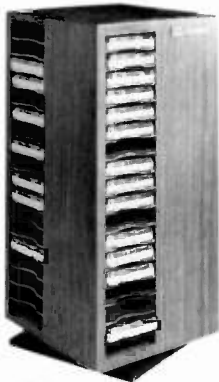

DM-72

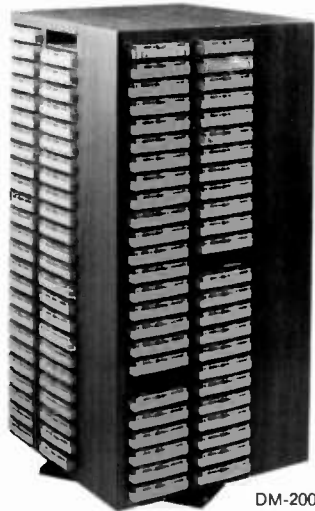

DM-200

Rotating racks present four-sided storage in attractive Walnut Formica. DM-72 holds 72 cartridges, measures only 22"H x 11"W x 11"D. DM-200 provides 200 storage slots. 29 1/2"H x 15 3/4"W x 15 3/4"D.

DM-72 ..... \$135.00  
DM-200 ..... \$200.00

## BROADCAST ELECTRONICS DM-20 WALNUT WOODGRAIN FINISHED CABINET

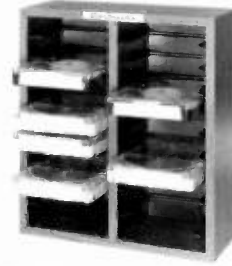

Holds 20 "A" cartridges. Units may be stacked; 9 1/2"W x 4"D x 10-7/8"H. Weight 3 1/4 lbs.

DM-20 ..... \$35.00

## BROADCAST ELECTRONICS DM-40 WALNUT WOODGRAIN FINISHED CABINET



Lazy Susan designed for tabletop operation; holds 40 "A" cartridges. 9 1/2"W x 8"D x 11-7/8"H. Weight 6 1/2 lbs.

DM-40 ..... \$60.00

## BROADCAST ELECTRONICS RM-20 RACK MOUNT CART RACK



Designed for standard 19" rack installation. Put vacant rack space to good use. Holds 20 "A" size cartridges in only 5 1/4" vertical space. Made of aluminum.

RM-20 ..... \$125.00

**THE MOST CONVENIENT  
WAY TO ORDER FROM ALLIED  
IS BY TELEPHONE — SEE INSIDE BACK COVER  
FOR MORE INFORMATION**



# CARTRIDGE ACCESSORIES

## BROADCAST ELECTRONICS RM-100 WALL MOUNT RACK

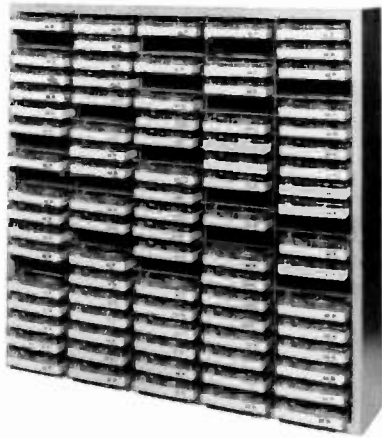

Holds 100 "A" size cartridges in minimum space. Walnut Formica trim. 2'H x 2'W x 4-3/8"D.

RM-100 ..... \$110.00

## ARISTOCART SPACE SAVER UNITS



Low cost slim line Space Saver units hold 20 Broadcast cartridges in slanted slots. Mount them on any convenient wall. Can be stacked in series. Rugged high impact styrene construction. Sky blue or saddle tan finish. Pre-drilled wall mounting screws supplied.

Space Saver, ea. .... \$12.00

## MICRO-TRAK L-72 LAZY SUSAN CARTRIDGE RACK



The Model L-72 Lazy Susan Cartridge Tape Rack shown is Micro-Trak's answer for an attractive and durable tape rack at a reasonable price. Designed to complement the Series L studio furniture line, the L-72 provides a small, but substantial rotary tape rack for use at the console. Only 10½ inches square and 22 inches high, the L-72 packs in 72 of the most used spots for easy access by your DJs. The L-72's clean stylish lines and its low cost make it an attractive addition to any studio. The wood grain formica covering with the contrasting black and white interior will attractively complement any studio decor.

L-72 ..... \$79.50

## MICRO-TRAK L-90 WALL OR CONSOLE RACK



The most useful member of the Series L Cartridge Rack group is the Model L-90. The L-90 can be used as a wall mounted unit, stacked from floor to ceiling, mounted on the inside and outside of a closet door, or as a stand alone unit at the console. Also with addition of simple 2 x 4 supports, the L-90 can be mounted over the top of your turntables. Flexibility, low cost, attractive wood grain Formica brand covering, versatility are all reasons that you should equip your studio with several L-90s. The L-90 rack will attractively complement your present system.

L-90 ..... \$79.50

## CAPITOL AUDIOPAK TAPE CARTRIDGES "The Broadcaster's Choice"



Capitol Audiopak Broadcast Cartridges - for stations who care how they sound.

(cont.)

(cont.)



# CARTRIDGE ACCESSORIES

**A-2**  
Time and  
Length  
(Loaded)  
I. Standard Lengths

Empty		\$2.07
10	Second	\$3.04
20	Second	\$3.04
35	Second	\$3.04
40	Second	\$3.04
65	Second	\$3.04
70	Second	\$3.04
90	Second	\$3.04
100	Second	\$3.04
140	Second	\$3.39
2.5	Minute	\$3.39
3.0	Minute	\$3.39
3.5	Minute	\$3.39
4.0	Minute	\$3.39
4.5	Minute	\$3.39
5.5	Minute	\$3.75
7.5	Minute	\$3.75
8.5	Minute	\$3.75
10.5	Minute	\$3.75

A-2 Reload Lube Tape, 7" Reel-1800'		\$ 6.90
(Formula 17)	4200' Hub	\$ 9.10
AA3 Reload Lube Tape, 7" Reel-1800'		\$ 9.60
(Formula Q17)	3600' Hub	\$16.20
	7200' Hub	\$26.40

Prices Subject To Change Without Notice  
Quantity Discounts Available

**AA-3**  
Time & Length  
(Loaded)  
HOLN Tape  
I. Standard Lengths

10	Second	\$3.86
20	Second	\$3.86
35	Second	\$3.86
40	Second	\$3.86
65	Second	\$3.86
70	Second	\$3.86
90	Second	\$3.86
100	Second	\$3.86
140	Second	\$4.33
2.5	Minute	\$4.33
3.0	Minute	\$4.33
3.5	Minute	\$4.33
4.0	Minute	\$4.33
4.5	Minute	\$4.33
5.5	Minute	\$5.04
7.5	Minute	\$5.04
8.5	Minute	\$5.04
10.5	Minute	\$5.04

2½	Minute	\$4.49
3	Minute	\$4.49
3½	Minute	\$4.49
4	Minute	\$4.49
4½	Minute	\$4.49
5	Minute	\$5.26
5½	Minute	\$5.26
7½	Minute	\$5.26
8	Minute	\$5.26
10	Minute	\$5.26
10½	Minute	\$5.26

For Cartridges Loaded With H.O.T. Tape, Add —H To Part Number And Increase Cost By 15%.

Master Cart II (NAB Type AA) loaded with Fidelipac TAS-500 Series H.O.T. Tape.

Empty		\$3.28
20	Second	\$3.64
40	Second	\$3.70
70	Second	\$3.78
90	Second	\$3.86
100	Second	\$3.94
140	Second	\$4.01
2½	Minute	\$4.09
3	Minute	\$4.18
3½	Minute	\$4.26
4	Minute	\$4.35
4½	Minute	\$4.44
5	Minute	\$4.53
5½	Minute	\$4.61
7½	Minute	\$4.90
8	Minute	\$4.99
10	Minute	\$5.28
10½	Minute	\$5.36

## FIDELIPAC PROFESSIONAL TAPE CARTRIDGES



Master Cart I

Master Cart II

Model 300

All List Prices

Mastercart I — for the stereo broadcaster

Empty		\$3.72
20	Second	\$4.03
40	Second	\$4.03
70	Second	\$4.03
90	Second	\$4.03
100	Second	\$4.03
140	Second	\$4.49

Model 300 — for the mono broadcaster

Empty		\$2.39
20	Second	\$3.16
40	Second	\$3.16
70	Second	\$3.16
90	Second	\$3.16
100	Second	\$3.16
140	Second	\$3.60
2½	Minute	\$3.60
3	Minute	\$3.60
3½	Minute	\$3.60
4	Minute	\$3.60
4½	Minute	\$3.60
5	Minute	\$4.29
5½	Minute	\$4.29
7½	Minute	\$4.29
8	Minute	\$4.29
10	Minute	\$4.29
10½	Minute	\$4.29
16	Minute	\$9.62
Empty 600		\$5.07
32	Minute	\$19.20
Empty 1200		\$7.51

For Cartridges Loaded With H.O.T. Tape, Add —H To Part Number And Increase Cost By 15%.

(cont.)



# CARTRIDGE ACCESSORIES

## 3M SCOTHCART RADIO BROADCAST CARTRIDGE

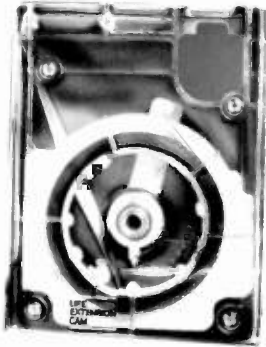

Impressive performance characteristics with the added bonus of extended life. ScotchCart provides constant tension where the tape meets the head. Output characteristics which are every bit as good as 3M's best professional audio tapes. You get quality sound, longer life, a better cartridge.

No minimums. Custom length not available. Discounts!

Empty	.....	\$4.38
20	Second	\$4.45
40	Second	\$4.51
70	Second	\$4.60
100	Second	\$4.72
140	Second	\$4.84
2 1/2	Minute	\$4.88
3	Minute	\$4.96
3 1/2	Minute	\$5.08
4	Minute	\$5.20
4 1/2	Minute	\$5.32
5 1/2	Minute	\$5.57
7 1/2	Minute	\$6.04
9 1/2	Minute	\$6.55

## ARISTOCART TAPE CARTRIDGES - A or AA



Prices  
subject to  
quantity discount

Empty	.....	\$3.56
40	Second	\$4.20
70	Second	\$4.29
90	Second	\$4.38
100	Second	\$4.38
2 1/2	Minute	\$4.61
3 1/2	Minute	\$4.70
4 1/2	Minute	\$4.88
5 1/2	Minute	\$5.02
6	Minute	\$5.43
7	Minute	\$5.52
8	Minute	\$5.70
9	Minute	\$5.91

## FIDELIPAC ACCESSORIES



### WORLD STANDARD STUDIO WARNING LIGHTS

340	On Air	.....	\$46.60
340-S	On Air, in French, German, Greek, Japanese, Polish, Russian, Spanish or Swedish. Specify when ordering	...	\$46.60
340-REC	RECORDING	.....	\$46.60
340-REC-S	GRABANDO (Recording in Spanish)	.....	\$46.60
<b>NEW AND REDESIGNED CARTRIDGE RACKS</b>			
WR-25	Wall Rack—Holds 25	.....	\$25.25
MRB-1	Mobile Rack Base—Holds 8 WR-25 Racks	.....	\$57.25
MR-200	Mobile Cartridge Rack—Holds 200	.....	\$259.25
TR-48	Table Top Cartridge Rack—Holds 48	.....	\$72.50
TR-96	Table Top Cartridge Rack—Holds 96	.....	\$124.40

### CARTRIDGE MACHINE PRECISION ALIGNMENT EQUIPMENT

390	Wow & Flutter Meter	.....	\$430.00
401	Cartridge Equipment Test System—Mono	.....	\$578.00
402	Cartridge Equipment Test System—Stereo	.....	\$578.00
450	Alignment Cartridge—Monophonic	.....	\$52.20
451	Alignment Cartridge—Stereophonic	.....	\$52.20
452	Wow & Flutter Cart—3150 Hz	.....	\$35.60
455	Fast Sweep Cart—Monophonic	.....	\$43.85
456	Fast Sweep Cart—Stereophonic	.....	\$43.85
457	Cue Tone Test Cartridge	.....	\$48.25
326	Height Gage	.....	\$28.00
328	Head Insertion Gage	.....	\$7.60
387	Right Angle Zenith Gage	.....	\$33.25

### CARTRIDGE MAINTENANCE & TAPE ITEMS

395	Blank-It, Bulk Eraser, Hand Held (110 Volt)	.....	\$64.75
406	Professional Splicing Block, for 1/4" Tape	.....	\$25.20
310	Professional Splicing Kit—1/4" Tape	.....	\$30.45

### FIDELIPAC INSPECTED & CERTIFIED LUBRICATED CARTRIDGE TAPE

TAS-434	4200' 10" hub Ampex 675 lubricated tape (bulk packed) each	.....	\$8.35
---------	--	-------	--------

(cont.)



# CLOCKS & TIMERS

- TAS-436 2100' 7" reel Ampex 675 lubricated tape (individually boxed) each ..... \$5.35
- TAS-437 4200' 10" hub Ampex 675 lubricated tape (individually boxed) each ..... \$9.45

## FIDELIPAC HIGH-PERFORMANCE LUBRICATED TAPE—H.O.T. TAPE

- TAS-500 4200' 10" hub (bulk packed) ea. .... \$13.61
- TAS-501 2100' 7" reel (individually boxed) ea. ... \$7.45
- TAS-502 4200' 10" hub (individually boxed) ea. \$14.90

## DELAY CARTRIDGES

- 140-5DL Model 300, 8 sec., Curved Pressure Pads and Special Lube ..... \$8.30
- 140-6DL Model 300, 10 sec., as above ..... \$8.30
- 149-5DL Model 600, 8 sec., Curved Pressure Pads and Special Lube ..... \$10.35
- 149-6DL Model 600, 10 sec., as above ..... \$10.35

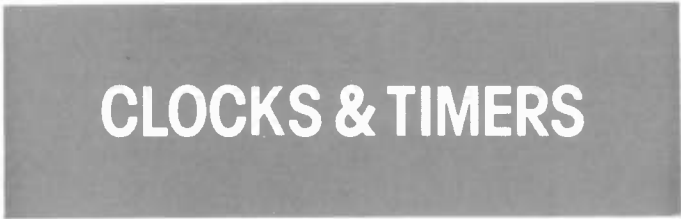

## AUDIO-METRICS STUDIO TIMER



The Audio-Metrics Studio Timer is designed as a versatile, easy to operate broadcast accessory with the capability of timing events out to 9:59:59. The timer will readily and simultaneously interface with all types of tape machines, turntables, and other studio equipment for automatic operation. 1/2" readouts.

### OPERATION AND REMOTE CONNECTIONS

Three front panel pushbuttons control timer functions. "Reset" returns the display to 0:00:00 when in either the run or stop mode. "Start" initiates or continues the count and "Stop" holds the display reading constant.

All three functions can be remotely controlled through rear panel connections. "Start" and "Stop" functions are activated through a return to ground connection.

Multiple machine interface connections are provided for the reset function so that the unit can be made to automatically count and display last-event timing. Start up or pull-to-ground. Barrier strip.

**Studio Timer ..... \$149.00**

## WESTCLOX QUARTZMATIC CLOCK — PRECISION ACCURACY

- 12" Clock ..... \$49.95
- 8" Clock ..... \$45.95

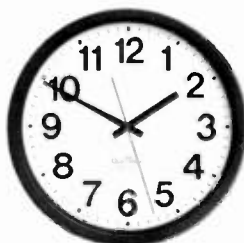

## FAVAG CLOCK



Favag secondary impulse clocks are available in both the second-impulse type and the less expensive minute impulse type where a second hand is not required. The Favag Master clock will produce either second impulses only or a combination of both second and minute impulses depending upon the model and accessories selected.

The QMS series of Master clocks are available in several configurations of plug-in modules which may be added to, allowing for system expansion as requirements increase. With the OS precision oscillator module the system has an accuracy better than one second per year; without the OS module the accuracy is 0.1 second per day. Internal battery power maintained on a constant charge will allow the system to function during power outages. Numerous accessories, such as programmers (timers) and additional driver modules may be added initially or later.

The most reliable of all systems is the 2QMS-2 with separate OS precision oscillator consisting of two separate clocks each with an accuracy of better than 0.1 seconds per year. If one of these clocks should fail, the clock signal is transferred to the remaining good clock and appropriate supervisory alarms are given. If the clocks differ in their timing, the incorrect clock is determined by means of comparing the signals with a hypothetical third clock signal normally derived from the other two, thus any abnormal change in one of the clocks will signal a failure. Oil bath models necessary for in-studio use.

Write or call Allied with your Favag Model # for a quote.

	Surface Mount Type	Flush Mount Type
<b>Second Impulse, Non Oil Bath</b>		
2" Panel Mtg. ....		
3" Panel Mtg. ....	3200.066	
10" Dial ..... 12" Dial .....	3200.041 3200.039	3200.246 3200.047
16" Dial ..... 10" Dial, Extra Flat .....	3200.051 3201.002	3200.065
12" Dial, Extra Flat ..... 16" Dial, Extra Flat .....	3201.003 3201.004	
<b>Second Impulse, Oil Bath (Silent)</b>		
5" Table Top ..... Panel Mtg. Adaptor for above ..	3200.069	
10" Dial ..... 12" Dial .....	3200.044 3200.040	3200.048 3200.049
16" Dial ..... 20" Dial .....	3200.052 3200.074	3200.061
24" Dial ..... 10 1/2" Rk. Mt. Dial, Illuminated .....	3200.075 141-2	
20" Dial, Illuminated ..... 24" Dial, Illuminated .....	3271.011 3271.012	
<b>Minute Impulse, Non Oil Bath</b>		
2" Panel Mtg. .... 3" Panel Mtg. ....		
10" Dial ..... 12" Dial .....	3215.005 3210.002	3211.002
16" Dial ..... 20" Dial .....	3210.003 3210.004	3211.003 3211.004
24" Dial ..... 10" Dial, Extra Flat .....	3210.005 3210.006	
12" Dial, Extra Flat ..... 16" Dial, Extra Flat .....	3216.002 3216.003	
10", 12" & 16" Decorative .....	3216.004	Prices on application



# CLOCKS & TIMERS

## ES 112/124

### DIGITAL CLOCK \$158

ES 112 (12 hr.) and ES 124 (24 hr.) are solid state, six digit clocks. Can drive 80 Series and 90 Series slaves. Displays are incandescent filament, 6" high.  
Dimensions: 2 1/2" High x 8" Wide x 6" Deep.



## ES 142/144

### DIGITAL CLOCK THERMOMETER \$283

ES 142 (12 hr.) and ES 144 (24 hr.) are solid state digital clock/thermometers. Six digits of time (hours, minutes, seconds) and 3 digits of temperature (-50°F to +150°F or -45°C to +66°C) in gas discharge displays. 55" high. Temperature sensor on 25 ft. cable included.  
Dimensions: 2 1/2" High x 10" Wide x 6" Deep.

## ES 240/241

ES 240 DIGITAL THERMOMETER is calibrated for °F and °C. Displays are planar gas discharge, 55" high. \$185  
Dimensions: 2 1/2" High x 8" Wide x 6" Deep.  
ES 241 DIGITAL THERMOMETER is calibrated for °F and °C, alternating between the two every four seconds. Displays are planar gas discharge, 55" high. \$225

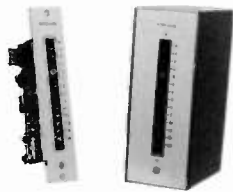

## ES 211/214

### DYNAMIC AUDIO LEVEL INDICATOR

The ES 214 is a highly accurate audio level indicator which is designed to simulate the action of a conventional VU-Meter but with superior dynamic characteristics. The LED meter is five to one hundred times faster in responding to complex waveforms than the mechanical meter without sacrificing the familiar meter "movement". \$130 \$109

#### SPECIFICATIONS

Number of Indicators: 14 LED Lamps in 3 colors.

Scale: +4, +3, +2, +1 dB—Red  
0 dB—Yellow  
-1, -2, -3, -5, -7, -10,  
-15, -20, -25 dB—Green

Input Impedance: 2200 ohms at maximum sensitivity, 6800 ohms at +8dBm "House Level", 10,000 ohms at minimum sensitivity

Input Circuit: Transformer isolated, balanced bridging

Frequency Response: 20-20 KHz ± 1 dB (all modes)

Rise Times: Less than 250 MicroSec (Peak Mode), less than 25 Millisec (Fast Averaging Mode), Approximately 300 Millisec (Optional VU Standard)

Fall Times: (All Modes) About 300 MicroSec from full scale

Modes of Operation: Peak Reading, Fast Averaging (Apparent Loudness), Slow Averaging (USA VU-Standard)



## 70 SERIES

### CONSOLE MOUNT CLOCKS AND TIMERS

ES 172 SIX DIGIT, 12 HOUR CLOCK: Three setting controls—Fast Advance, Slow Advance and Hold. \$152

ES 174 SIX DIGIT, 24 HOUR CLOCK: Otherwise identical to the ES 172. \$152

ES 370 FOUR DIGIT, ONE HUNDRED MINUTE UP/DOWN TIMER: Six controls—Count Up, Count Down, Stop, Minutes Advance, Seconds Advance, Reset. \$194

ES 371 UP/DOWN TIMER: Similar to the ES 370 except with Leverwheel. Preset capability for faster setting of the desired time. \$304

ES 570 FOUR DIGIT, SIXTY OR 100 MINUTE TIMER: Select 60 or 100 minute mode on rear connector. Start, Stop and Reset controls. Runs continuously unless stopped. Reset will return all displays to zero. Unit will run if reset while running or will stay at zero if reset when stopped. \$152

ES 572 SIX DIGIT, 12 HOUR CLOCK OR TIMER: Five controls—Start, Stop, Reset, Fast Advance, Slow Advance. Will run continuously to 12:59:59. Advances to 1:00:00 and continues as clock unless stopped or advanced. \$185

ES 574: A 24 hour version of ES 572. \$185

ES 575: Exactly like ES 570, with the addition of a "freeze" button. When the button is released, the display "catches up" with the correct elapsed time. \$185

Dimensions: 2.16" High x 4.5" Wide x 4.13" Deep.



## 80 SERIES

### JUMBO CLOCKS AND TIMERS

Large, bright 1" gas discharge displays provide effortless long distance viewing from 40 feet.

ES 182 SIX DIGIT, 12 HOUR CLOCK: Three rear-mounted setting controls—Fast Advance, Slow Advance, and Hold. \$262

ES 184 SIX DIGIT, 24 HOUR CLOCK: Otherwise identical to the ES 182. \$262

ES 380 FOUR DIGIT, 100 MINUTE UP/DOWN TIMER: Displays minutes and seconds, with rear-mounted connector to allow remote wiring of six momentary SPST CONTROLS—Count Up, Count Down, Stop, Minutes Advance, Seconds Advance and Reset. Other features similar to ES 301. \$304

ES 381 UP/DOWN TIMER: Similar to ES 380, except that leverwheel preset is used. \$400

ES 580 FOUR DIGIT, 60 MINUTE TIMER: Displays minutes and seconds. Rear connector allows remote wiring of three momentary SPST controls—Start, Stop and Reset. Reset returns all displays to zero, and timer will continue to run from zero if reset while running.

80 Series slaves are also compatible with other ESE clocks and timers: ES 112/124, 301, 302 and 510. \$218

Dimensions: 4.45" High x 10.38" Wide x 6.58" Deep.

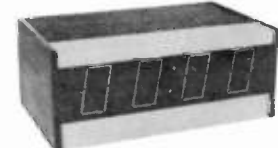

## 90 SERIES

### 2 INCH DISPLAYS—VIEWABLE AT 60 FEET

ES 301—Presettable Up/Down Timer: 100 Minute Range—Displays Minutes and Seconds, uses Leverwheel Preset Controls are Count Up, Count Down, Stop, Reset and Preset. \$468

Dimensions: 4.45" High x 10.38" Wide x 6.58" Deep

ES 590—Sixty Minute Timer: Displays Minutes and Seconds. Rear-mounted connector provides for wiring to user's single pole, momentary, push-button controls: Start, Stop and Reset. Reset returns all displays to zero, and timer will continue to run from zero if reset while counting. \$338

Dimensions: 4.45" High x 10.38" Wide x 6.58" Deep

ES 982/984—6 Digit Clocks: ES 992 (12 Hr) and ES 994 (24 Hr)—Hours and Minutes on Two Inch Gas Discharge Displays. Seconds on One Inch Gas Discharge Displays. Three top-mounted setting controls—Fast Advance, Slow Advance and Hold. \$432

Dimensions: 5" High x 12" Wide x 3 1/2" Deep.

Many Options Available



## ES 562/564

### SIX DIGIT CLOCK/TIMER WITH MEMORY \$301

ES 562/564 is a combination six digit clock and 24 hour timer with memory, allowing the user to set the clock to the correct time of day, switch to timer mode, then switch back to time of day by pushing one button; time of day will be correctly displayed, in hours, minutes and seconds. Five pushbutton controls are mounted on the top of the unit, near the front of the desk-top case. When panel mounting is specified, they will be mounted on the front panel, below the display. The controls may also be remoted, through two rear-mounted five pin connectors (Option R or Option D). These controls are Clock, Fast/Start, Slow/Stop, Timer and Hold.

Display: Six digits of .55" Planar Gas Discharge Display.

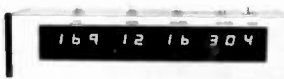

## ES 280

### AUDIO TIME CODE GENERATOR/READER

The ES 280 is a 10 Digit Audio Time Code Generator/Reader, capable of laying down a serial BCD time code on audio tape in the Generator Mode, and recovering and displaying it in Digital form in the Reader Mode. The code has been designed by ESE. It is not a standard code, such as SMPTE or IRIG. The frequencies used to produce the code have been selected to be compatible with cartridge machines as well as other tape recording and playback equipment. Amplitude adjustment assures the right amount of signal for the particular machine being used.



## ES 510LR

### FOUR DIGIT 60 MINUTE TIMER \$155

ES 510 is a four digit, sixty minute timer (59:59) with Start, Stop and Reset controls. If stopped, display will hold time reading and when restarted will continue with next count from last displayed figure. If reset while running, timer will continue to run. ES 510 can drive 80 Series and 90 Series Slaves.

Dimensions: 2 1/2" High x 6" Wide x 6" Deep.



## ES 203/205

ES 203/205 is a 20 Input Timer/Source Interface. It was designed to provide a simple means of connecting a variety of sources such as carts and turntables to the remote input of ESE Timers. The most common application for this product is resetting either an ES 400 or ES 510 Timer each time a source is started.

The 20 inputs are divided into ten DC voltage inputs and ten contact closure inputs. Activation of any one of these inputs will cause an output which will momentarily reset an ESE timer.

Mechanical: Aluminum Case 8" x 6" x 2"



## ES 301/302

### 100 MINUTE UP/DOWN TIMERS \$225 \$280

ES 301 is a four digit, one hundred minute timer (99:59) with six controls: Count Up, Count Down, Stop, Minutes Advance, Seconds Advance, Reset. Counting can be activated up or down or set back to zero. When "Stop" control is pressed, the four digit display is held. Counting direction (up or down) can be changed or time can be reset to zero without stopping the count. The ES 301 can drive 80 Series and 90 Series Slaves. Displays are gas discharge, 55" high.



With the ES 302, the user can preset times much faster than with the ES 301, because lever-wheel type switches are used for the preset feature. The ES 302 can drive 80 Series and 90 Series Slaves.

Dimensions: ES 301: 2 1/2" High x 8" Wide x 6" Deep.  
ES 302: 2 1/2" High x 10" Wide x 6" Deep.



## ES 206

### VIDEO TIME AND DATE GENERATOR \$550

The ES 206 has been designed to allow the addition of Time and Date information to a video signal. Two rear-mounted video jacks permit "looping" the video information through the 206 to add the data.



## ES 270

### IRIG B TIME CODE READER \$350

The ES 270 TIME CODE READER has been designed to be an economical solution to the problem of receiving and displaying IRIG B.

Nine digits (Days, Hrs, Min, Sec) of time are shown on bright red LED's, 3" character height. ES 270 comes in a rack mounting enclosure, 1 1/4" High, 19" Wide and 10" Deep. The power requirement is 117V AC, 50/60 Hz, 230V AC, 50 Hz is available as an option.

QUESTION CONCERNING  
YOUR ORDER? CALL (317) 962-8596 AND ASK FOR  
CUSTOMER SERVICE

## CONSOLES & MIXERS

### BROADCAST ELECTRONICS 4-MIXER, STEREO, MODEL 4S50



**ACCOMMODATES 12 STEREO INPUT SOURCES** — This versatile console allows preselection of eight stereo input sources with intermix and level control of four of these simultaneously.

- High/Low Input Sensitivity Selection
- Cue Switches, All Mixers
- Individual Monitor, Cue, Headphone Amplifiers
- Excellent Performance-Reasonable Cost
- Ideal for Stereo Production, Discotheque or On-Air

4S50 .....	\$1895.00
4S50R Rack Mount Version .....	\$1950.00

### BROADCAST ELECTRONICS 4-MIXER, MONO, MODEL 4M50



**COMPACT, PROFESSIONAL PERFORMANCE** — Incorporating modern solid-state technology, the Broadcast Electronics Model 4M50 4-Mixer Monaural Console affords professional performance at reasonable cost.

- Selectable Hi/Lo Sensivity, All Channels
- Individual Monitor, Headphone and Cue Amplifiers
- Straightforward, Neat Installation
- Excellent for On-Air, Newsroom, Remote and Production Use.

4M50 .....	\$995.00
4M50R Rack Mount Version .....	\$1050.00

### BROADCAST ELECTRONICS 150 SERIES ROTARY MIXER CONSOLES

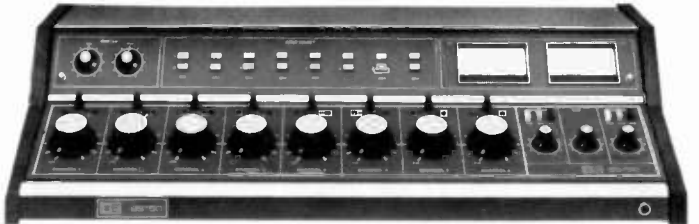

Mixing controls are of sealed potentiometer, high-reliability, long-life design, each equipped with cue bus switches. The 150 series features contact-free FET bus selection and field-proven 3600 series plug-in modular electronics. Each mixing channel accommodates two pushbutton-selected inputs, and may be preset for either microphone or high-level service. Mono/stereo mode switching optional on stereo models. Monitor, headphone and cue amplifiers insure full-monitoring capability. Front panel graphics are under a laminated poly carbonate overlay for maximum durability.

5S150 5 Mix Stereo, Sealed Pots, (Dual Channel and/or Mono Outputs Optional) .....	\$2595.00
8S150 8 Mix Stereo, Sealed Pots, (Dual Channel and/or Mono Outputs Optional) .....	\$3295.00
5M150 5-Mix Mono, Sealed Pots, .....	\$2095.00
8M150 8-Mix Mono, Sealed Pots, .....	\$2595.00

### BROADCAST ELECTRONICS DELUXE 250 SERIES ROTARY-MIXER CONSOLES

Featuring ladder-type maintainable step attenuators with cue bus switching, telephone-type channel keys and contact-free FET bus selection. Separate monitor, headphone and cue channels. Field proven 3600 Series modular plug-in electronics. Two input pushbutton pre-selection and microphone or high level capability for each mixing channel. Mono/stereo mode switching optional on stereo models. Front panel graphics are under a laminated poly carbonate overlay for maximum durability.

5S250 5 Mix Deluxe Stereo, Step Type Atten.,	\$3395.00
8S250 8 Mix Deluxe Stereo, Step Type Atten.,	\$4495.00
5M250 5-Mix Deluxe Mono, Step Type Atten.,	\$2495.00
8M250 8-Mix Deluxe Mono, Step Type Atten.,	\$3395.00

**ALLIED HAS A LEASE  
PLAN TO SUIT YOUR INDIVIDUAL NEEDS**



# CONSOLES & MIXERS

## BROADCAST ELECTRONICS DELUXE 10-MIXER, DUAL CHANNEL STEREO 10S250



**NEW TEN MIXER STEREO CONSOLE** — The Broadcast Electronics 10S250 Stereo Console accommodates twenty inputs into ten mixing channels. The console features identical line-level output stereo program and audition channels, with VU meter switching to either stereo channel pair. Mixing controls are maintainable, step-type dual ladder attenuators. Quiet-operating, telephone-type channel select switches are used.

- Ladder Step Attenuators
- Modular Plug-In Electronics
- Contact-Free Bus Selection
- Telephone-Type Channel Key Switch
- Talk-Back Capability
- Four Line-Level Outputs
- Mono Mix-Down Option Available

10S250 .....\$5695.00

## BROADCAST ELECTRONICS DELUXE 10-MIXER, DUAL CHANNEL, MONO

**NEW TEN MIXER MONO CONSOLE** — The Broadcast Electronics 10M250 Mono Console accommodates twenty inputs into ten mixing channels. The console features identical line-level output mono program and audition channels, with VU meter switching to either mono channel. Mixing controls are maintainable, step-type ladder attenuators. Quiet-operating, telephone-type channel select switches are used.

- Ladder Step Attenuators
- Modular Plug-In Electronics
- Contact-Free Bus Selection
- Telephone-Type Channel Key Switch
- Talk-Back Capability
- Mono styled as above

10M250 .....\$4495.00

## NEOTEK SERIES III RECORDING CONSOLES

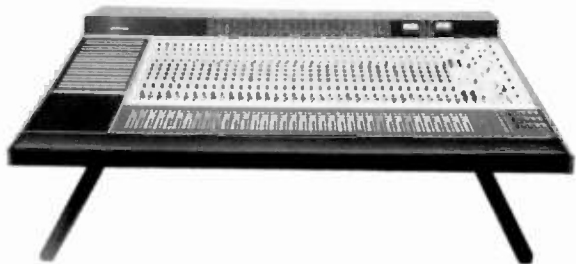

NEOTEK is the established leader in the application of advanced circuit design techniques to professional audio (cont.)

consoles. For over eight years we have exclusively produced consoles that are completely transformerless from inputs to outputs. They feature innovative high-speed circuit topology state-variable equalizers, and logic controlled solid state switching. The insurmountable lead this experience has given us accounts in part for the reputation NEOTEK consoles have earned for clearly superior sonic quality. Although our noise and distortion specifications are by far the best in the industry, it is more significant that in every direct comparison with other consoles without regard to cost, the sound quality of NEOTEK has always been judged superior.

When price is no object and the sound is everything, demanding professionals choose NEOTEK.

NEOTEK Series III ..... Price on Application

## AUDIOMETRICS DISTRIBUTION AMPLIFIER

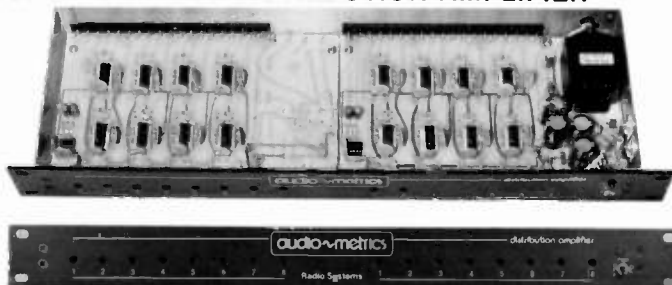

Please refer to Page 50 for complete information and pricing.

## ARRAKIS 150SC CONSOLE



The 150SC is rugged & reliable. If each front panel control is operated in sequence, one per minute, 24 hours per day for 5 years, you wouldn't reach the average life expectancy of a single control. The VCA's dramatically extend pot life. Every active input is protected against 200 VDC & 5000 V transients. Any or all inputs & outputs can optionally receive Jensen transformers for isolation & RF rejection. This console is so reliable that we give it a special 2 year warranty.

No console at any price audibly outperforms the 150SC. The NE5532 IC's and reed relay switches (not F.E.T.'s) assure the cleanest possible audio signal path.

- 5 Channels
- 11 Balanced Inputs
- VCA Level Controls
- Rack or Table Mount
- Expands with 150SC-X to 10 Channels
- Portable—Plug In Connectors
- External Regulated Power Supply

150SC Series Prices start at .....\$1550.00



## ARRAKIS 500SC CONSOLE

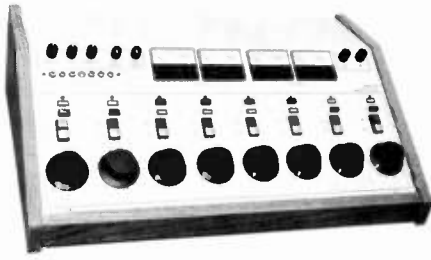

The 500SC is a rugged, versatile console designed for "on the air," production, or portable broadcast applications. Plug-in construction enables the engineer to replace defective PC boards quickly & easily. DC control means there is no audio on any pot or program select switch. Switching is silent & reliable. Solid oak end panels with heavy aluminum panels assure a durable & lasting appearance. The external regulated power supply reduces 60 cycle hum. The console is available with either active balanced electronics or Jensen transformer plug-in-compatible PC boards. Remote start is standard. The 500SC is truly the console of the 80's.

- 8 Channels
- 25 Balanced Inputs
- Dual Program, Audition Outputs
- VCA Level Controls
- Plug-in PC Boards with Motherboard
- External Regulated Power Supply
- Solid Oak End Panels

500SC -8S (Transformers, extra)..... \$3250.00

## ARRAKIS 2000SC CONSOLE

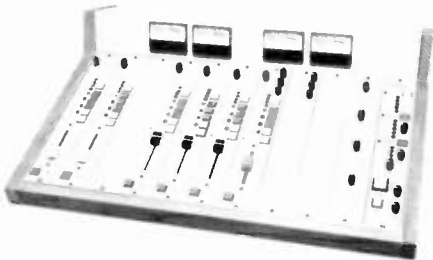

The 2000SC is designed for uncompromising performance & long life. VCA's (Voltage Controlled Amplifiers) mean that there is no audio on the slide fader & assure excellent stereo tracking. The program-audition switches are silent, momentary, & lighted. Remote start is standard. Gold-plated miniature connectors make console wiring a joy. Cue is stereo derived.

The 2000SC will withstand 200 VDC & 5000 V transients on the active inputs. The console is available with any or all channels either active balanced or Jensen transformer balanced. The 2000SC is the ultimate in reliable performance.

- 12 Channels
- 24 Balanced Inputs
- VCA Level Controls
- Reed Relay Switching
- Program, Audition Output
- Active or Transformer Circuitry
- Remote Start Standard
- External Regulated Power Supply

2000SC-S (Transformers Extra) ..... \$5300.00

## ARRAKIS 2000R CONSOLE



The Arrakis 2000 Series Modular Consoles are the ultimate in the state of the art audio technology at an affordable price.

These consoles are available in mainframes of 8 to 16 channels with four basic families of input modules. Modules have up to 4 inputs, 4 outputs, 3 band E.Q., sub-master, panning, and remote start-stop.

An Arrakis Console means quality and reliability. Every function of the console is DC controlled. There is no audio on any pot or switch. Plug-in-compatible PC boards allow the choice of active balanced or Jensen transformer balanced electronics.

The Arrakis 2000 Series Consoles have few peers in professional broadcast communications.

- Modular Construction
- 5 Mainframes
- 4 Families of Modules
- 3 Band E.Q.
- Submaster Send
- Panning
- Fully DC Controlled

2000R (Transformers extra)..... Starts at \$6900.00

## ARRAKIS 100-RS AUDIO ROUTING SWITCHER

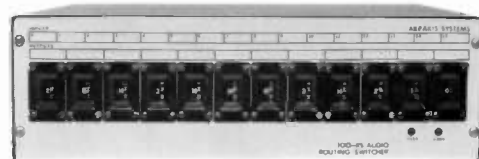

The 100RS represents a major price breakthrough in audio routing switchers. For the first time, electronic switchers are competitive with patch panels and other mechanical switches. Despite this dramatic improvement, the 100RS maintains professional specifications and construction throughout.

Physically, the switcher is exceptionally simple. For each of the 12 outputs there is a single PC board. A mother board busses inputs between output boards and supports the terminal strip inputs and outputs. PC board sockets are of the highest quality and gold plated. PC boards pull from the front while terminal strips are accessed at the back. All IC's are socketed.

Electronically, the switcher is also simple. Every output can access any of the 16 inputs independently or simultaneously. Each input is resistively buffered and will withstand 10,000 V transients without harm. Balanced CMOS transistors perform the switching function. Balanced switching doubles the number of crosspoints and is generally prohibitively expensive. The unique design of

(cont.)

# 4

## CONSOLES & MIXERS

the 100RS however, uses balanced crosspoints to decrease price. Balanced crosspoints decrease distortion, switching noise, and reduce RF interference. Signetics NE5532 IC's perform the buffering, amplification and output drive. Switch selection is accomplished by 4 bit binary coding which makes remote operation easy to accomplish. A regulated power supply reduces hum and noise. Distortion is .1% maximum at +8dBm with crosstalk less than 65dB at 10kHz. S/N is better than 75dB.

The 100RS audio routing switcher obviously has many possible applications in a broadcast or production studio. It replaces unwieldy patch panels, distribution amplifiers, and remote select mechanical switches. It can increase the total number of inputs at the control console and conveniently interconnect studios. It is ideal for switching satellite links to recorders, studios, or on the air. The possibilities are limited only by the imagination.

- 16 in by 12 outputs mono
  - 8 in by 12 outputs stereo
  - Expandable
  - Rack or table mounted
  - Balanced Crosspoints
  - NE5532 Signetics IC's
  - 1,000,000 operation thumbwheel select
  - PC boards front mount
  - Terminal strip outputs & inputs on back
- 100RS ..... \$1250.00

### HOWE AUDIO 7000 SERIES CONSOLES

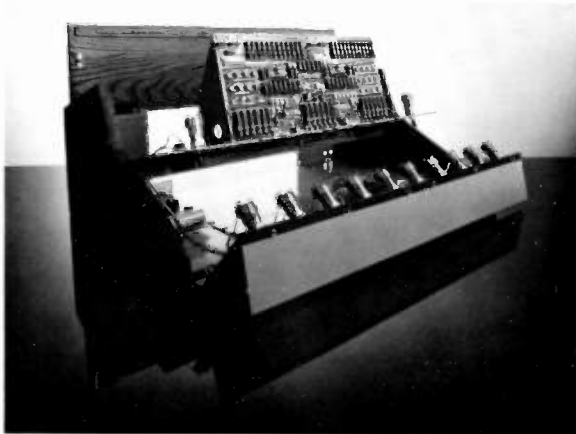

The Audio 7000 series consoles are packed with the most advanced features, yet are designed to be simple to operate and maintain. The interior of the console is readily accessible. There are no catches or latches; it just unfolds.

The VCA (voltage controlled attenuator) is a unique Howe Audio design employing optically-coupled transistors to separate the DC control signal from the audio section. This circuit has been in use by Howe Audio since 1978.

The controller, which fades and routes each channel, contains only DC levels. There is no audio on the pots or switches.

Installing a Howe Audio 7000 is very easy. Molex® quick-connect male pins protrude through the bottom plate of the audio card. A supply of Molex® connectors and a crimping tool come with your Howe Audio console to enable you to set up and get on the air quickly. Once in operation, sources and loads can be rearranged easily and without tools.

### HOWE AUDIO 7012 CONSOLE

### HOWE AUDIO 7012A CONSOLE

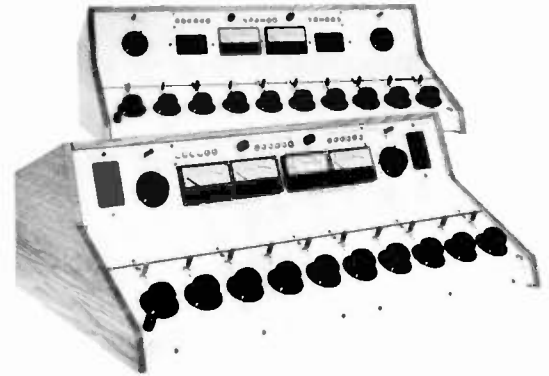

The Howe Audio 7012 is a twelve-fader, twenty-two input console with stereo program, audition, and mono program outputs.

7012 ..... \$5800.00

The Howe Audio 7012A adds the versatility of left and right audition meters. An operator can then insure perfect segues, do off-air production, monitor remote lines, and perform many other tasks. Like the 7012, the 7012A also has ample space for user additions on a fully removable 4"x31" panel above the control knobs.

7012A ..... \$6100.00

### HOWE AUDIO 7500 CONSOLE

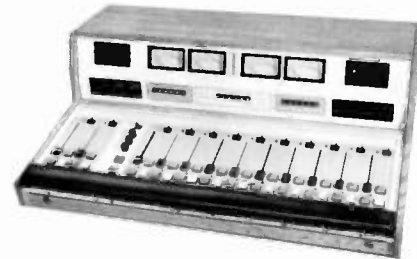

This outstanding console will easily withstand continuous professional use and deliver unparalleled audio performance.

The Howe Audio 7500 has all the features of the popular 7000 series consoles. In addition, the 7500 offers:

- professional-grade linear slide faders
- all pushbutton operation
- full logic control of on-off-cue functions
- LED status lights for each fader
- exceptional ease of operation and installation.

The Howe Audio 7500 is a streamlined package of durable Lexan® over metal with solid hardwood panels and top. A large complement of options and accessories is available.

The 7500 represents yet another achievement of Howe Audio, bringing the most recent technology to the broadcaster at a most affordable price.

FINISH: Earth-tone Lexan® finish. Solid hardwood trim with oil and urethane sealed finish.

SIZE: 33" wide, 23" deep, 10½" high

WEIGHT: 80 lbs.

7500 ..... \$9100.00

## AMPRO AC CONSOLES



**ILLUSTRATED:**

The Ampro AC-12, our ten, eight and six channel consoles are available, also.

Ampro consoles are complete, full-function audio control centers, requiring no options, and built for operational simplicity and ease of maintenance.

Representing the ultimate in electronic and human engineering, Ampro consoles are designed to shut out built-in obsolescence. They feature total flexibility and versatility for virtually any control situation, and offer you years and years of reliable operation.

- Balanced transformers on all mic and high level inputs.
- Stereo preamps for all mic and high level inputs on all stereo, dual stereo and simulcast models.
- Four interlocked pushbutton switches per input channel.
- Step-type rotary faders with silver contacts and detented cue.
- Telephone grade lever switches.
- Fully shielded.
- Muting programmer to control any of the four muted monitor outputs.
- Two-studio intercom
- 20 Watt monitor amplifier.
- Headphone amplifier with 4 selectable inputs
- Plug-in modular electronics.

Plus logical board layout for ease of operation without extensive operator training, wear-proof etched and filled front panel markings and full shielding to virtually eliminate RFI problems.

6 Channel Monaural, 24 inputs	\$3530.00
6 Channel Dual Monaural, 24 inputs	\$3906.00
6 Channel Stereo, 24 inputs	\$5067.00
6 Channel Stereo with Summing Amp	\$5400.00
8 Channel Monaural, 32 inputs	\$4228.00
8 Channel Dual Monaural, 32 inputs	\$4577.00
8 Channel Stereo, 32 inputs	\$5764.00
8 Channel Stereo with Summing Amp	\$6097.00
8 Channel Dual Stereo, 32 inputs	\$6268.00
8 Channel Dual Stereo with Summing Amp	\$6601.00
8 Channel Stereo-Mono, 32 inputs	\$6114.00
10 Channel Monaural, 40 inputs	\$5276.00
10 Channel Dual Monaural, 40 inputs	\$5624.00
10 Channel Stereo, 40 inputs	\$6758.00
10 Channel Stereo with Summing Amp	\$7091.00
10 Channel Dual Stereo, 40 inputs	\$7255.00
10 Channel Dual Stereo with Summing Amp	\$7588.00
10 Channel Stereo-Mono, 48 inputs	\$7106.00
12 Channel Monaural, 48 inputs	\$5919.00
12 Channel Dual Monaural, 48 inputs	\$6268.00
12 Channel Stereo, 48 inputs	\$7610.00
12 Channel Stereo with Summing Amp	\$7943.00
12 Channel Dual Stereo, 48 inputs	\$8100.00
12 Channel Dual Stereo with Summing Amp	\$8433.00
12 Channel Stereo-Mono, 48 inputs	\$7960.00

All consoles listed are rotary step-attenuator types.

## AMPRO MICROTOUCH CONSOLES



The Ampro Microtouch is a complete, full function audio control center built for operational simplicity and long life. Ampro, the leader in broadcast console design, has utilized the latest component and packaging technology to produce a cost-effective console for the station that demands the quality, low maintenance, ease of use and ease of service of a top-of-the-line board. Ideal for small to medium studio use, newsrooms, remote vans and TV audio. MICROTOUCH avoids the component reliability compromises and maintenance headaches inherent in most economy console approaches.

- MICROTOUCH bus switching eliminates lever key switches.
- Balanced transformer input preamps on all mixers eliminate RF pickup and ground loops.
- 2 Inputs per mixer, selectable mic, high level or mixed.
- Programmable muting for every input.
- 5 Input remote line selector assignable to any high level input.
- 3 Input selector to 10-watt monitor amplifier, two muting relays.
- 3 Input selector to 1-watt headphone amplifier.
- Built-in cue amplifier and speaker.
- Dual mono and dual stereo program outputs plus extra output line, front panel switchable to either PROGRAM 1 or PROGRAM 2 outputs.
- All circuits on plug in boards, one preamp and one program amplifier spare the entire console. (Optional)
- Power supply status indicators.
- Tally outputs for on-air light relay control.
- All user connections to screw terminal barrier strips.
- Entire input selector panel is removable with all user connections intact for ease of console service. All plug-in boards accessible through top cover.
- Permanent anodized panel markings.
- Extended life AB pots — 3 times normal life.
- Comfortable, full width armrest.
- Optional script rack.

Available stereo or mono, rotary or slide fader, 5 or 8 mixers.

Dual Monaural, 5 Rotary Mixers	\$2375.00
Dual Monaural, 5 Linear Mixers	\$2575.00
Dual Stereo, 5 Rotary Mixers	\$2875.00
Dual Stereo, 5 Linear Mixers	\$3455.00
Dual Monaural, 8 Rotary Mixers	\$2899.00
Dual Monaural, 8 Linear Mixers	\$3310.00
Dual Stereo, 8 Rotary Mixers	\$3935.00
Dual Stereo, 8 Linear Mixers	\$4645.00
Optional Script Rack	\$91.00
Spare Semiconductor Kit	\$85.00
Spare Preamp board, Monaural	\$97.00

(cont.)



# CONSOLES & MIXERS

Spare Preamp board, Stereo .....	\$121.00
Spare Program Amplifier board, Mono .....	\$97.00
Spare Program Amplifier board Stereo .....	\$121.00

## AUTOGRAM AC-6 MONO/STEREO AUDIO CONSOLE



Autogram consoles are built in only one series. A premium-grade series which features ladder-type attenuators, engraved numbers and letters, 1/4 inch front panel, and fully balanced and floating inputs and outputs. Flexible, Functional and "Bullet-proof."

- 23 Inputs
- 1 High level cassette
- Height: 10 inches
- Depth: 20 inches
- Width 32-3/8 inches

AC-6 Typical Stereo .....	\$4590.00
AC-6 Typical Mono .....	\$4028.00

## AUTOGRAM AC-8 MONO/STEREO AUDIO CONSOLE

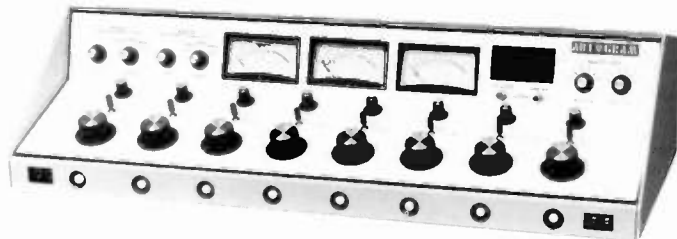

- 26 Inputs — customer's option as to use by plug-in modules
- 1 High level cassette
- Height: 10 inches
- Depth: 20 inches
- Width: 37 1/4 inches

AC-8 Typical Stereo .....	\$5753.00
AC-8 Typical Mono .....	\$5100.00

## AUTOGRAM IC-10 MONO/STEREO AUDIO CONSOLE

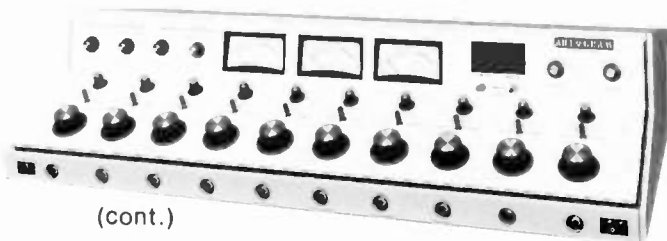

(cont.)

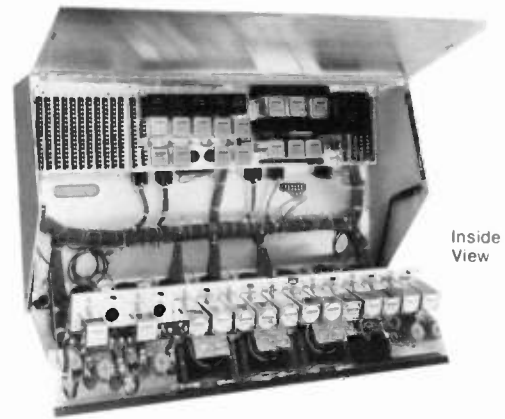

Inside View

- 28 Inputs-customer's option as to use by plug-in modules
- 1 High level cassette
- Height: 10 inches
- Depth: 20 inches
- Width: 44 inches

### INPUT CHARACTERISTICS COMMON TO ALL SERIES:

#### IMPEDANCES:

Microphone, 200 or 50 ohms. High level 10K ohm bridge or 600 ohm terminate. External monitor 10K ohm.

#### LEVELS:

Microphone -65 to -50 dBm. High level -10 dBm to +10 dBm. External monitor -10 dBm to +10 dBm.

#### NOISE:

Program/audition -120 dBm, Monitor -110 dBm. E.I.N.

### OUTPUT CHARACTERISTICS COMMON TO ALL SERIES

#### OUTPUTS (DEPENDS ON MODULES USED)

1 program, 1 audition, 1 or 2 monitor amplifiers, 2 head-phone amplifiers, 1 cue amplifier.

#### IMPEDANCES:

Program/audition 600 ohm balanced or unbalanced — 10K ohm balanced or unbalanced. Monitor 4-16 ohm unbalanced. Cue 4-16 ohm unbalanced.

#### LEVELS:

Program/audition or mono: +8 dBm nominal - +24 dBm maximum. Monitor — 15 watts RMS into 8 ohm load. Cue and headset — 1 watt into 8 ohm load.

#### FREQUENCY RESPONSE:

Program/audition ±1 dB 30 to 15 kHz. Monitor ±1.5 dB 30 to 15 kHz.

#### DISTORTION:

Program/audition less than 0.5% THD. Monitors less than 1.5% THD.

IC-10 Typical Stereo .....	\$7736.00
IC-10 Typical Mono .....	\$7011.00

## AUTOGRAM NEW CONSOLE

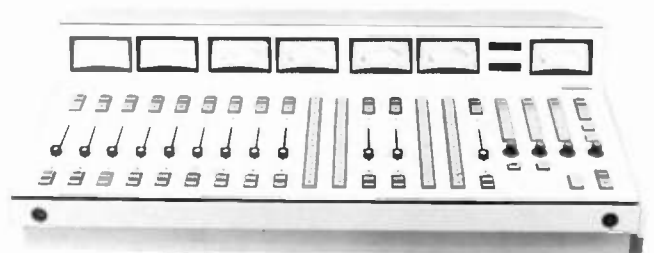

(cont.)



# CONSOLES & MIXERS

The new audio console that fits today's and tomorrow's broadcast needs is announced by Autogram Corporation in Plano, Texas. Three stereo audio output busses, as well as a cue and a mono buss, allow operation of two on-the-air programs as well as a stereo production buss. Thus, one console supplies programming for two separate stations as well as production. The console is micro-processor based allowing an automation computer to directly control audio paths and levels in the console through an RS-422 interface. That is, every operation whether done manually by operator or by external automation computer is accomplished solely by its self-contained microprocessor. The front panel is modular in construction allowing semi-custom configurations. Four of the five modules may be any mixture of two subassemblies. One is a four-stereo channel, single-source module and the other is a sixteen-stereo source by two-channel multi-line module. The fifth module is the monitor panel. AM monaural configurations are also available and upgradable to stereo by plugging subassemblies into existing sockets.

Each buss, as well as the cue and mono buss, is equipped with VU meters. The console is equipped with a 12-hour clock display and stop watch clock display. The latter also can display the temperature on demand with an external temperature probe either in fahrenheit or celsius. The remote machine control interface can be rack-mounted up to 400 feet from the console and provides start control as well as selection of the log data for the automation computer.

The automation computer, if used, can be located up to 400 feet from the console and can simultaneously control two of the three audio busses with individual sequential and timer event programs, and print on separate printers. The logging of programs may be stored on disk and may be modified or reviewed while the programs are running.

This console contains the same Autogram high quality and features recognized in other Autogram consoles, such as engraved front panels, true VU meters, high quality components, excellent workmanship, and attractive appearance.

**Autogram New Console . . . . . On Application**

## **RUSSCO STUDIO/MASTER 505 & 505S AUDIO-MIXERS**



RUSSCO's STUDIO/MASTER 505 packs a Terrific Value into a compact package at an unheard of Bargain price! Designed for broadcast studio use, this terrific 5 channel mixing console is as modern as tomorrow, with sophisticated features and full integrated circuitry for dependability. The STUDIO/MASTER is engineered for easy operation and simple servicing, and it's as good looking as it is good working!

**LOOK AT THE FEATURES!** 5 mixing channels, four channels with built-in preamps. Each preamp can be quickly modified to accept microphone, phono or high  
(cont.)

level signals. The 5th mixer channel accepts 5 balanced, high level input lines, each selected with long-life, push-button switches. The STUDIO/MASTER features push-button on-air switches, with LED indicator lights. It cues on any channel and has a 3½ inch true VU meter. A built-in 25 Watt Monitor Amplifier provides power to your external speaker. A built-in headphone amplifier with stereo headphone jack allows you to use a monitor headset of high or low impedance. The built-in Amplifier features FET muting. A cue amplifier drives a built-in 3 inch cue speaker. Also featured are Allen-Bradley Mod Pots for quiet, trouble-free performance. The STUDIO/MASTER is available as a rack mount model (505R) fitting in a 5¼" x 19" rack space, or an attractive blue-grey, maroon or black table model (505). When can we send you yours?

**505 In-built Monitor Amp . . . . . \$1235.00**  
**505S Stereo—No In-built Monitor Amp . . . . . \$1770.00**

## **MICRO-TRAK MODEL 6618 AUDIO CONSOLE**

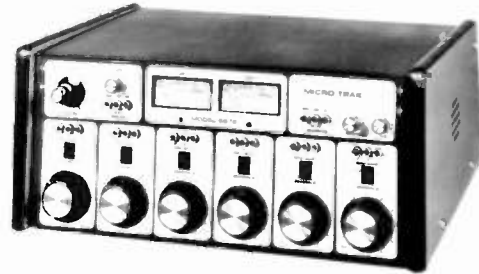

Broadcast, Six Channel, Stereo/Mono

- Six mixing channels
- Eighteen inputs — three per channel
- Stereo and Mono outputs
- Built-in 10 watt monitor amp
- Selectable muting
- Relays for "on-the-air" lights
- Voltage controlled attenuators
- Choice of input preamplifier types
- LED line switch indicators
- Barrier terminal strip input and output terminations
- Extra monitor output at line level
- Conductive plastic main pots

**Microtrak 6618 . . . . . \$2945.00**

## **QUANTUM BROADCAST PRODUCTION ON-AIR CONSOLES**



(cont.)



# CONSOLES & MIXERS

## FEATURES:

- 8, 14, 20, 28 Input Mainframes
- Total Modular Construction—Including Back Panel Access
- All Inputs and Outputs Balanced
- Stereo Outputs
- Program/Audition Masters
- 4 Independent Submaster Trim Controls
- 4 Position Tone Oscillator (30 Hz, 100 Hz, 1K Hz, 10K Hz)
- LED EQ "ON" Indicators
- Peak Overload Indicators
- XLR Talkback Connector (For Extended Talkback)
- Rack Mounted Power Supply
- "On-Air" Light Supply

## INPUT POSITIONS

- Flexible EQ: 3 Section/6 Position with In/Out Switch, 3 Section with In/Out Switch
- Available without EQ for "On-Air" use.
- Echo, Headphone and Que Sends
- Input On and Remote Starts
- 104mm Input Faders
- Stereo-to-Mono Combining Networks
- Input Level Adjusts
- Individual MIC/Line A/B Switching
- Panning and Balance Controls with In/Out Switching
- Phase Switching

## OUTPUT BUSSES

- 2 Stereo Balanced
- Low Noise, Low Distortion
- +4 dB or +8 dB

## MONITORING

- Integral Que and Control Room Headphone Amplifiers
- Echo Return to Individual Busses
- Talkback to: Busses, Phones, Studio

QUANTUM offers the following options for the Production/On-Air Series:

- Mounted Time Control
- Mono Output Meter (Switchable)
- Phantom Power Supply
- Direct Outputs
- Patch Bay

Typical 8-Input .....	\$6900.00
Typical 14-Input .....	\$9950.00
Typical 20-Input .....	\$13,500.00

**SHIPPING AND HANDLING  
CHARGES WILL BE ADDED TO ALL ORDERS  
UNLESS OTHERWISE SPECIFIED**

## AUDITRONICS 110A RECORDING/REMIXING/ PRODUCTION AUDIO CONTROL CONSOLE



The Model 110A is an expandable, completely modular professional recording/remixing audio control console built by professionals experienced in sophisticated console design and manufacture. Designed to accommodate up to 16 track mixing, the free standing unit is expandable to 18 mixing positions—36 inputs—in only 38" width. The system provides complete metering, two echo send/receive channels, talkback communications, programmable control room and studio muting, optional EQ at each input, two foldback mix outputs (one optional), test oscillator, optional stereo inputs, and a full line of matching accessories including a plug-in patch bay. A second generation, full capacity system at a moderate price, the 110A fills the gap between conventional consoles and sophisticated recording consoles. Customization of each console is possible simply by selecting from a wide variety of plug-in modules those that exactly meet your requirements. Call or write for a spec/option brochure.

**110A Systems Start At ..... \$14,910.00**

## AUDITRONICS 200 SERIES ON-AIR CONSOLES



- VCA Input Level Control
- Equalized Headphone Module
- 2-Way Communications from Both Studios to Control Room
- Precision Adjustable Stereo Line Input Padding
- Penny & Giles Plastic Conductive Faders
- +30 dBm Output Capability
- Telephone Mix-Minus Interface Option
- Active Transformerless Stereo Inputs

(cont.)



# CONSOLES & MIXERS

- On-Board Compressor Option
- Personality Equalizer Option

## MAINFRAMES

Model 206-MF	6-Input Position Mainframe . . .	\$4615.00
Model 212-MF	12-Input Position Mainframe . . .	\$5170.00
Model 218-MF	18-Input Position Mainframe . . .	\$6110.00
Model 224-MF	24-Input Position Mainframe . . .	\$6610.00

Note: All Mainframes include the following basic modules: 2 Model 200-SLO, 1 Model 200-MLO, 1 Model 200-CRM, blank panels for all optional accessory positions and power supply.

## MODULES

Model 200-CSM	Communications/Studio Monitor Module . . . . .	\$490.00
Model 200-SLI	Stereo Line Input Module . . . . .	\$640.00
Model 200-MIS	Microphone Input Module . . . . .	\$640.00

## OPTIONAL ACCESSORY MODULES

Model 200-LS8	Stereo Line Selector-8 Station . .	\$ 250.00
Model 200-PEQ	Personality Equalizer . . . . .	\$ 340.00
Model 200-EQP	Plug-In Equalizer Card for 200-PEQ	\$25.00
Model 200-TEL	Telephone Interface Module . . . .	\$500.00
Model 200-DT	Digital Timer (includes Model 200-TC Timer control Module) . .	\$ 450.00
Model 200-DC	Digital Clock . . . . .	\$ 325.00
Model 200-VC	Voice Controller Module . . . . .	\$ 450.00
Model 200-TRC	5-Button Tape Remote Control Module . . . . .	\$ 200.00
Model 200-B7	Blank Panel - 7" . . . . .	\$ 15.00
Model 200-B14	Blank Panel-14" . . . . .	\$ 22.00

Let us put a system together for you at a package price.

## TAPCO SERIES 74 MIXER

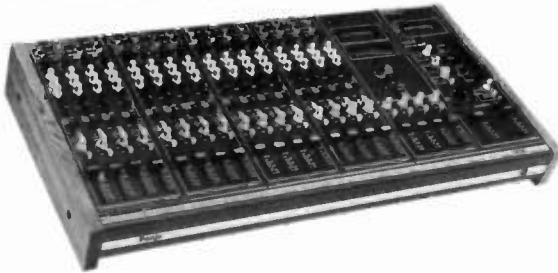

The Series 74 mixing consoles all feature a 4x2x1 output section that consists of 4 subgroups that mix down to Stereo Masters, which in turn sum into a Mono Master. The mechanical design of the console has been optimized to provide a complete list of professional features in an easily portable and cost effective package. Four different models give you a choice of input configurations of 8, 16, 24, or 32 inputs. These mixers may be equipped with TAPCO's new optionally available A.D.R. - Adjustable Decay Reverb system. Outstanding features include 3-band EQ with selectable midrange, Phantom Power, Solo System, 3 bus sends (Aux, Monitor, Effects), mic-line switch, gain trim control, and overload LED. The Series 74 also features selectable fluorescent bargraph indicators instead of conventional VU meters, an Aux Stereo Tape input with level and balance controls, and a versatile talk-back system which allows the operator to talk to either the mains, aux, or monitor busses independently.

Series 74, -8-\$2495. -16-\$3395. -24-\$4995. -32-\$6495.

## TAPCO C-12 MIXER



- 12 x 4 x 2 x 1 in/out format
- Stereo and mono sub groups
- 3 Knob, sweep midrange EQ on every input channel
- Solo on inputs, send masters
- Stereo headphone monitoring with automatic solo switching
- Self contained stereo headphone amp
- Solo switching to main outputs
- + 48 phantom power
- Extensive patching/routing facilities with front panel patchbay
- Transformer coupled balanced inputs
- Overload LEDs, all inputs
- Mic/line switching
- 2 Pannable effects returns
- 3 Sends on each input; pre, post and pre/post
- Switchable metering
- Compatible with +4 and -10dB tape machines

Tapco C-12 . . . . .	\$2850.00
Tapco C8E 8-Channel Expander, Add . . . . .	\$1795.00

## THE UREI 1650/1680 SERIES BROADCAST CONSOLES

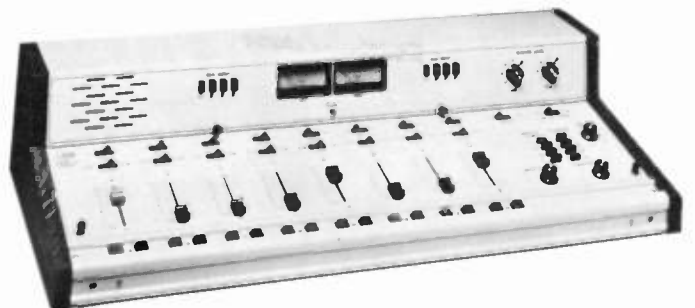

The UREI 1650 and 1680 Series Broadcast Consoles have the features most requested by engineers and consultants, priced within the budget of smallmarket stations...and built with full UREI quality.

The new consoles offer a choice of five (Series 1650) or eight (Series 1680) mixers and a choice of attenuator types...rotary conductive plastic, Shallco precision rotary, or Penny & Giles straight line. Provisions are for customization to fit individual station needs, but no accessories are required to put them on the air as they are shipped.

Prices Start At . . . . . \$2696

**QUESTION CONCERNING  
YOUR ORDER? CALL (317) 962-8596 AND ASK FOR  
CUSTOMER SERVICE**

## UREI MOD-1 MIXING CONSOLE



UREI Models 110 Mono, 210 Stereo

- Up to 10 input modules. Will provide maximum of 30 inputs, high level or microphone monaural or stereo.
- Silent action switches for all on-air functions. Illuminated PGM-OFF-AUDITION lever switches.
- Long life conductive plastic vertical faders, with detented cue position (line & cartridge modules).
- Automatic muting of monitor & cue speakers.
- Monitor Select Switch with aux. & tape inputs.
- VU meter switching.
- Built-in headphone amplifier.
- Highest quality components throughout for troublefree service.
- Easy installation — easily expandable.
- Modern, attractive styling.

UREI 110	5 Mixer Mono	Typical	.....	\$4580.00
UREI 110	8 Mixer Mono	Typical	.....	\$5530.00
UREI 110	10 Mixer Mono	Typical	.....	\$6106.00
UREI 210	5 Mixer Stereo	Typical	.....	\$5105.00
UREI 210	8 Mixer Stereo	Typical	.....	\$6230.00
UREI 210	10 Mixer Stereo	Typical	.....	\$6989.00

## CONEX CUEAMP UM33

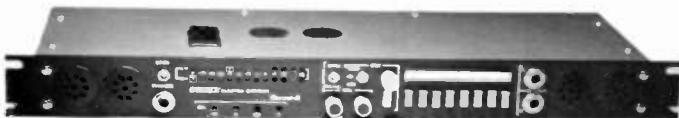

Newsrooms and similar operations seldom require a console since the Conex CueAmp UM33. The CONEX CueAmp is a stereo eight channel in, one channel out general purpose cue and monitor amplifier. The CueAmp provides many essential functions for any radio or television station with multiple sources of audio. The CueAmp provides the easiest, least expensive, and most compact way of handling a variety of monitoring, cueing, and amplifying situations.

A sample of such uses of the CueAmp are:

- Remote/network line monitor and buffer amplifier
- Transmitter input selector and monitor
- Automation cue amplifier

(cont.)

- Tape recorder input selector
- Telephone line source selector
- Earphone amplifier
- Intercom, communication system, or multi-media tester

The CueAmp has potential use in every studio in a radio station—newsroom, production room, transmitter, control room, and so on.

### SPECIAL FEATURES OF THE CUEAMP

- Stereo LED VU meters with front panel calibration (-20 to +8 dBm)
- Capacity to drive external stereo speakers at 2 watts per channel
- Also contains two built in speakers
- Front panel headphone jack and speaker switch
- Built in 3 frequency oscillator (40, 400, 7500 Hz) with level control for checking frequency response of tape decks, phone lines, etc.
- Front panel jacks for easy test equipment connection to switched audio bus
- Stereo or mono capacity
- All contained in a compact 1 3/4" rack mounting package

Cue Amp UM33..... \$495.00

## TEAC/TASCAM MODEL M35 MIXER



One of the hottest selling mixers available today is the Tascam Model M35. An incredible amount of control is packed into this small, sixty-two pound unit, and it has an amazingly low price tag. The basic mixer is modular, and has eight inputs and four outputs; an expander accessory can increase the total number of inputs to twenty.

- Slide fader for volume control with 2-3/8" travel.
- A two section equalizer with: (1) Up to 15 dB low-frequency boost or cut at 75 Hz or 250 Hz. (2) Up to 15 dB high-frequency boost or cut at 3 kHz or 10 kHz.
- Pre-fader cue send "pot."
- Post fader echo send "pot."
- A switch to select line input or microphone.
- A "pot" for varying the input gain (affecting both microphone and line).
- A switchable pad switch with 0 dB, 20 dB or 40 dB of attenuation for microphone inputs.
- Four switches and a pan-pot allow assignment of input signal into combinations of four outputs.
- A solo pushbutton.
- A pushbutton assigning the input signal to a "direct output" jack on mixer's rear panel.

Model M35 Mixer 8-In, 4-Out, 4 Monitor ..... \$2300.00  
Model M35 EX 8-Input Expander ..... \$1650.00



## TEAC/TASCAM M-15B MIXING CONSOLE

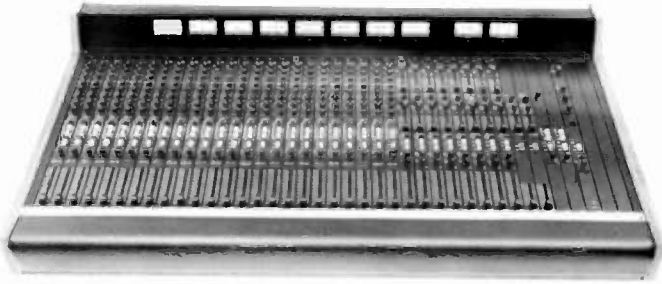

The M-15 mixing console is an incredibly flexible tool, an audio control center whose functions can be changed to suit the specific and changing needs of your multitrack studio. The keys to the M-15's flexibility are visible on its rear panel, where numerous patch points and bridged inputs let you re-route the audio signals in minutes. And you may save literally thousands of dollars on patch cables because the M-15 uses RCA connectors on single ended cables. This system delivers top audio quality and noise specs because we have taken great care in laying out the grounding. We also packaged the power supply for remote mounting, and extensively decoupled the supply, thus keeping heat and hum away from the amplifiers. Audio performance is further improved by the use of discrete FET mic preamps. The preamps are discrete (not chips) for greater consistency of channel-to-channel performance, and for lowest noise and distortion.

### Configurations

When your work begins at 8 and goes to 16, the 15SL is the answer. It's the "short load" version of our M-15.

You get an 8-in/8-out console with a double 8-track monitoring system. It's expandable on a modular basis up to 24 inputs.

16-track monitoring is built-in, and each input module has a direct output. So there are plenty of mixing facilities to meet and solve the audio problem at hand.

- 16 or 24 input positions
- 8 main program mixing busses with submaster faders
- 8 main board outputs
- Solo buss
- 100mm conductive plastic faders for smooth, positive control
- 6-frequency 4-knob equalizers that may be switch bypassed
- Stereo Monitor Mixes for Control Room & Studio
- 2 auxiliary mixing busses
- 16x2 channel or dual 8x2 channel monitor selection

M-15B ..... Prices start at \$5990.00

## SHURE M67 MIXER/REMOTE AMPLIFIER



The M67 is a transistorized microphone mixer/remote amplifier specifically designed for professional applications. The excellent performance and versatility of this

(cont.)

complete, compact console make it an ideal choice for studio, remote, or original sound reinforcement use, and as an "add-on" mixer for expanding existing facilities. It is also ideally suited for use with tape recorders and VTR's to provide multiple microphone inputs.

NOISE: Equivalent input Noise -129 dBV. Equivalent input hum and noise -125 dBV.

DISTORTION: Under 1% THD from 20 to 20,000 Hz.

MINIMUM COMMON MODE REJECTION: 100 dB with microphone input of 10 volts at 100 Hz.

M67 ..... \$365.00

## SHURE M267 MIXER

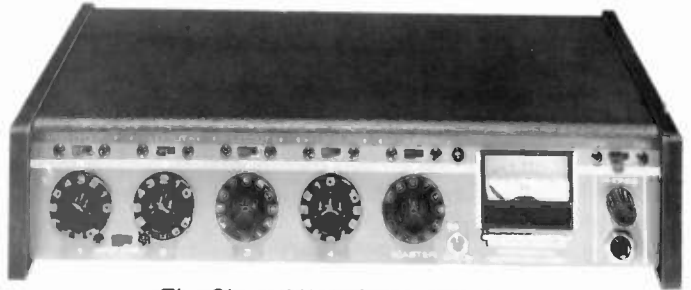

The Shure Mixer for the 80's . . .

For Professional Broadcasting. Both TV and Radio — in the studio and for remote broadcast applications.

For Professional Recording.

For Professional Sound Reinforcement. For more complex public address systems.

With all these new features:

- Switchable, fast-attack limiter
- LED peak indicator
- All inputs switchable for mic or line
- Simplex power
- Greater headphone power
- Built-in battery compartment
- Lower noise
- Reduced distortion

... and all of the famous M67 original features.

M267 ..... \$415.00

## OTARI MTR-10 SERIES PROFESSIONAL TWO & FOUR CHANNEL PRODUCTION/MASTERING RECORDERS

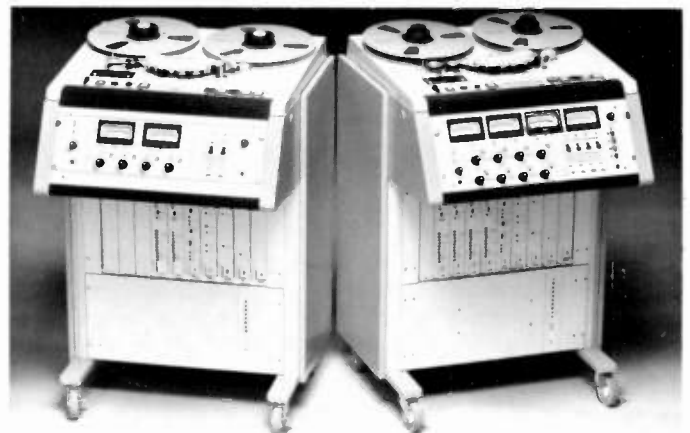

MTR-10-2

MTR-10-4

Please refer to Page 73 for complete details.



# CONSOLES & MIXERS

## RTS HPM-41 MICROPHONE MIXER



The Model HPM-41 microphone mixer is a compact, light-weight unit, designed for professional applications ranging from location film and tape to major recording console input augmentation. A no-compromise design provides high performance electronic circuitry in a functionally efficient, durable package.

### INPUTS

- Four balanced, transformer-isolated input positions with phase reverse switches and high quality Neutrik XLR-type connectors.
- Switchable 12 V A-B and 48 V phantom power for condenser microphones.
- Selectable pre-transformer pads for reduction of input levels.
- Switchable dual-frequency high pass filters to cut rumble, wind noise, and pops.
- Switchable limiter on each input prevents over-drive distortion without affecting other channels.
- Auxiliary unbalanced line level input.

### OUTPUTS

- Balanced (floating) 600-ohm output available on binding posts for TelCo (telephone feeds).
- Balanced (floating) low impedance output on XLR-type connector is switchable between line and microphone level.
- Power headphone amplifier with front panel volume control and output jack.
- Two independent IHF line-level outputs available to feed external equipment such as: video cassettes, audio cassettes, consumer audio gear, etc.

HPM-41 ..... \$1164.00  
Battery pack optional.

## SHURE SE30 GATED COMPRESSOR/MIXER



The SE30 Gated Compressor/Mixer was the first component for professional users that combined a mixer with 600 ohm line output (for remote or studio applications) with a high-quality "hands-free" gain riding compressor in a single, portable unit. Makes output control in remote pickups, talk shows, recording, program line compression and professional sound reinforcement smoother, surer and more trouble-free than it's ever been before.

The SE30 offers maximum compatibility with all types of associated professional equipment, especially field equipment widely used in news, sports and special events remote coverage (such as sound film cameras, and tape and cassette recorders).

Wide range of input and output options (microphone, line and high level auxiliary) equip it for almost any professional application.

SE 30 ..... \$710.00

## LPB CITATION SERIES AUDIO CONSOLES

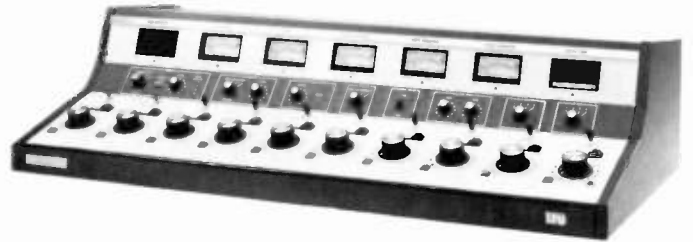

- 2 Models—8 & 10 mixer dual stereo
- Transformer Balanced Inputs and Outputs
- 3 Inputs Per Mixer—internal pads allow mic/line selection on the same mixer
- Two 4-Input Auxiliary Input Selectors—may be assigned to any mixer
- Pre-fader Pushbutton Cue—in addition to normal CCW fader cue position
- Led Status Indicators—color coded to aid in instant identification of function selectors
- Momentary or Continuous Remote Control Contacts—internally selectable, also controls optional digital timer reset/ start
- Full Metering Capability—two meters standard, up to four meters and/or digital clocks and timers optionally available, all meters provided with LED peak indicators
- Gain Selectable Microphone Preamps—provided with center tap access for phantom condenser microphone power, processor input/output port with buffer amplifier for outboard compressors, limiters, etc.
- Programmable Muting Logic—internal pin-programmed matrix allows any selection of monitor and cue muting for the first five mixer positions
- Accessories and Options—mono mixdown, high impedance (cassette) line input plug-ins, reference oscillator/line input plug-in, additional microphone input plug-ins, digital clock, digital timer, linear faders.

C8S ..... \$6995.00  
C10S ..... \$7995.00

## LPB MONOGRAM II SERIES FIVE MIXER CONSOLES



- All Input Circuitry Plug-In
- Visible Indicator Input Selectors
- Torque Controlled Cermet Attenuators Standard
- All Active Components Plug-In
- Barrier Strip Input/Output Connections
- All Outputs Short-Circuit-Proof
- Bi-Polar Regulated Power Supply

Model M-5M, 5 Mixer Mono ..... \$2195.00  
Model M-5S, 5 Mixer Stereo ..... \$2695.00  
Model M-8S, 8 Mixer Stereo ..... \$3295.00  
Model M-8SL, 8 Mix Linear Stereo ..... \$3995.00

## LPB SIGNATURE II AUDIO CONSOLES



Designed and manufactured to a high level of operational capability and electronic/mechanical reliability for the master control requirements of broadcasting and production.

Signature II consoles utilize classic human engineered *control knobs* which readily conform to the grasp. Position markings allow immediate recognition of level settings at a glance from any direction.

All *program buss switches* are rugged telephone-type roller cam design with gold alloy contacts.

A unique feature of the Signature II Stereo Consoles is the *mono/stereo input switch* located behind the front panel, which enables a mono source to be split to the left and right program busses.

The *rotary step attenuators* are 2dB per step, 20 steps, with appropriate tapers at either end of the control range.

Signature II 8 and 10 mixer consoles feature 3 position *input selector switches* giving 24 and 30 input source capability.

All *input-output connections* are made to screw terminal barrier strips clearly identified to aid in wiring without reference to the manual. The console harness cables are also identified and correspond to the internal circuit board wiring point markings and the wiring diagram.

**OUTPUT DIRECTOR SWITCH:** Dual Consoles have a three position output director switch on the audition output line, other consoles have this switch on the program output line.

**INTERNAL CUE SYSTEM:** A 5" speaker and 1 watt power amplifier are located within the console to provide high quality audio performance.

**CHASSIS CONSTRUCTION:** Consoles are constructed completely of aluminum alloy, with wood grain formica and vinyl covered warp free end panels attached to the metal end plates.

**MODULAR ELECTRONICS:** All active signal processing circuitry is "plug-in," and located on 2 "mother board" main frame assemblies.

**DUAL LINE LEVEL OUTPUTS:** All audition (P2) outputs of Signature II Series consoles are balanced line level and metered, identical in performance to the main program (P1) output.

(cont.)

Model S-12, 5 Mixer Stereo .....	\$3195.00
Model S-13C, 8 Mixer Stereo/Mono .....	\$4295.00
Model S-20, 10 Mixer Dual Stereo .....	\$4995.00
Model S-14A, 5 Mixer Mono .....	\$2495.00
Model S-15A, 8 Mixer Dual Mono .....	\$3195.00
Model S-21B, 10 Mixer Dual Mono S21B .....	\$3995.00

## DISTRIBUTION AMPLIFIERS

### MICRO AMP SERIES DA2016/DA1008 DISTRIBUTION AMPLIFIERS

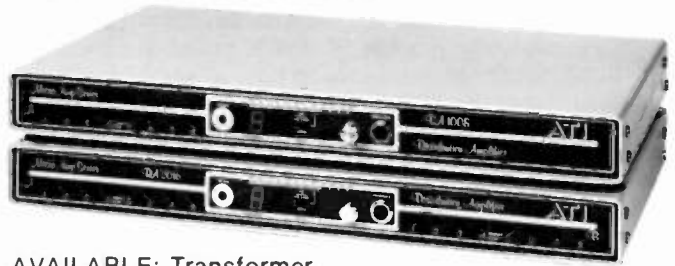

AVAILABLE: Transformer,  
Differential, Single-Ended

#### OUTPUT CLIPPING LEVEL:

All channels simultaneously driven to full output.

DA2016-1,2: + 22dBm, 600/150 ohms

DA1008-1,2: + 22dBm, 600/150 ohms

DA1008-3,4: + 30dBm, 600/150 ohms

**DISTORTION:** .25% maximum THD, 30 to 20,000Hz

Rated output and input levels to + 24dBm bridging

**FREQUENCY RESPONSE:** ± .25dB 30 to 20,000Hz

**OUTPUT NOISE:** -60dBm maximum

20kHz measurement bandwidth, 600 ohm source impedance, full gain

**HUM REJECTION:** 80dB; common mode, 60 to 120Hz

**INPUT OVERLOAD:** + 24dBm bridging, 600 ohms

**INPUT IMPEDANCE:** Balanced differential inputs 30,000 ohm bridging

**GAIN:** 24dB, front panel screwdriver adjustable

**POWER:** 115/230 VAC ± 10%, 47-63Hz

**SIZE:** 17"W, 1 3/4"H, 10 1/2"D, 10 lbs.

**METERING:** Electronic SCAN switching, 12 segments, 3 color, peak reading LED VU indicator, 0 VU selectable to +4, +8, or +18dBm by front panel switch. LED channel indicator.

**HEADPHONE OUTPUT:** 20 volt p-p output to 600 ohm phones, 30mW output to low impedance phones

**MOUNTING:** Suction feet for non-slip desk mounting and brushed aluminum extrusion rack mount brackets supplied.

**INPUT/OUTPUT CONNECTIONS:** High density screw terminal barrier blocks. Fanning strips supplied for easy installation.

DA2016 .....	\$995 to \$1375
DA1008 .....	\$755 to \$1095

ALLIED OFFERS PACKAGE DISCOUNTS



# DISTRIBUTION AMPLIFIERS

## TELLABS MODULAR DISTRIBUTION SYSTEM

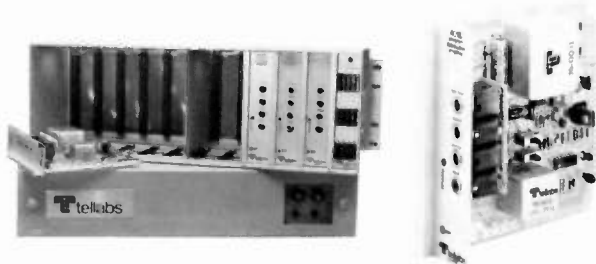

Each Tellabs 4018 module provides a 1 x 8 audio D.A., high-impedance bridging (or 600 ohm) input and 600 ohms-each-port output. The 1012 housing permits mounting of up to 11 — 4018 modules plus a 9021 fuse protection module. Combine this package with a rack-mounted 8013 power supply, and you have up to 11 x 88 distribution amplifier for about \$22.00 per port. A fully-loaded system sells for \$1925.00 including power supply.

Start with one, two, three, or more cards, the 1012 housing, 9021 protection module, and 8003 power supply and add 4018 modules as needed for a total of up to 11 — 4018 modules.

All Tellabs equipment is connected via .075 wirewrap terminals. Cabinets must be wired by user as applicable.

Frequency Response: 50Hz to 15kHz  $\pm$  1 Db  
 Distortion: Less than .24% at +10 dBm, 0.5% at +16 dBm  
 Output: +16 dBm minimum  
 Input: -8 to +8 dBm, switchable 15K bridging or 600 ohms  
 Output Z: 600 ohms each port (balanced)  
 Integrated gating noise threshold circuit (bypassable)

Tellabs 4018 1 x 8 D.A. Module .....	\$133.00
Tellabs 1012 Housing .....	\$122.00
Tellabs 8003 Power Supply .....	\$138.00
Tellabs 9021 Fuse Protection Module .....	\$65.00

## AUDIOMETRICS DISTRIBUTION AMPLIFIER

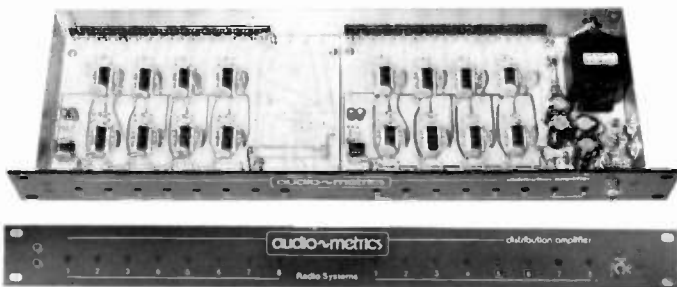

The "Audio-Metrics" distribution amplifier combines solid state electronics and functional flexibility into one small package. A single high quality audio op amp provides balanced output, and individual gain adjustments for each channel are provided.

Excellent isolation is provided between outputs. Each balanced channel, regardless of level set and load, is unaffected by the other channels. Audio sources can be routed to multiple locations with various level requirements and impedances while maintaining the integrity of the signal quality throughout.

The distribution amplifier is available in a single channel, 8 output mono version, or dual channel, 16 output version.

### MOUNTING

The DA-8 and DA-16 occupy only 1 3/4 inches of height in a

(cont.)

19" rack. Since almost no heat is generated, little ventilation is necessary. Allow 2 rack increments between units.

### CONNECTIONS

The units are primarily designed for balanced inputs and outputs. The input ground is connected to the chassis and power supply at a single point.

If unbalanced lines are used, tie the unused input terminal to ground. But, do not tie the unused output terminal to ground. Take the output between one output terminal and the input ground terminal.

Although the outputs are short circuit proof, operating into less than a 600 ohm load is not recommended. The input is bridging (high impedance) and will not load down any source.

### OPERATION

Controls consist simply of a front panel power switch and a recessed gain adjustment for each channel. Normal operating ranges are 0 dBm input and +10 dBm output.

INPUT IMPEDANCE: 40K ohms, balanced bridging

IC's: NE 5533

GAIN: 0 to +20 dB

OUTPUT LEVEL: +26 dBm max. into 600 ohms

OUTPUT IMPEDANCE: 200 ohms, balanced

FREQ. RESPONSE:  $\pm$ .1 dB 20 Hz to 20 kHz

THD at +18 dBm: .01% max. 20 Hz to 20 kHz

SMPT E IM at +18 dBm: .01% max.

MAXIMUM INPUT LEVEL: +20 dBm

COMMON MODE REJECTION: 60 dB at 60 Hz min.

NOISE: min. 90 dB relative 0 dBm input

SLEW RATE: 13V / micro sec.

OUTPUT CHANNEL ISOLATION: infinite

DIMENSIONS: 19" rack mount, 1 3/4" high, 6" deep

DA-8 (1 x 8) .....	\$275.00
DA-16 (2 x 16) .....	\$375.00

## AUDITRONICS 1100 SERIES AUDIO DISTRIBUTION AMPLIFIER

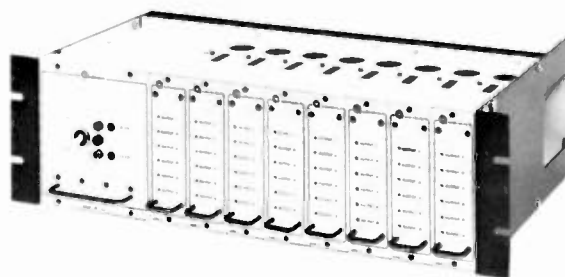

Designed to meet the requirements of the modern broadcast facility, the DA-6 Series Audio Distribution Amplifiers mount in either the 1100-MF or 1100-MFP Audio Accessory System 19 inch rack mount mainframe. Each DA-6 Series card includes 1 input and 6 outputs as well as local on-board voltage regulation to prevent mass failure. Frequency response is wide enough to permit passage of SMPTE or EBU time code.

### DA-6

The DA-6 Audio Distribution Amplifier includes 1 balanced input with internally accessed master gain control and 6 balanced outputs.

INPUT: Active Differential, and balanced

INPUT IMPEDANCE: 60K ohms balanced, 30K ohms unbalanced

COMMON MODE REJECTION RATIO: in excess of 80dB at 1kHz

(cont.)

## DISTRIBUTION AMPLIFIERS

MAXIMUM INPUT LEVEL: +24dBm  
 INPUT GAIN RANGE: 0 to +15dB  
 OUTPUT: Active Balanced  
 OUTPUT IMPEDANCE: 200 ohms balanced, 100 ohms unbalanced  
 MAXIMUM OUTPUT LEVEL: +24dBm  
 OUTPUT ATTENUATION RANGE: (DA-6/LC only) 0 to -12dB  
 FREQUENCY RESPONSE: 10Hz - 80kHz ±1dB  
 DISTORTION: Less than .05% 20Hz - 20kHz at +24dBm  
 NOISE FLOOR: -97dBm unweighted 20Hz - 20kHz  
 POWERING REQUIREMENTS: ±24 VDC at 100 MA

### DA-6/LC

The DA-6/LC Audio Distribution Amplifier includes 1 balanced input with internally accessed master gain control and 6 balanced outputs each with individual front panel accessible attenuation controls.

**1100MFP, Power-supplied 8 capacity mainframe . \$850.00**  
 DA-6 ..... \$180.00  
 DA-6/LC ..... \$200.00

### HEACO 5002A AUDIO DISTRIBUTION AMPLIFIER



The new HEACO 5002A Audio Distribution Amplifier is a technically "ideal" distribution amplifier. The 15K balanced input is a transformed input; thus, the input signal is isolated in all respects from the amplifier ground by many megohms. The frequency response of the amplifier itself is down less than 1/4 db over a frequency range from 20 Hz to 20 kHz. Distortion is less than .25% over the same frequency range. Eighteen 600 ohm balanced outputs are provided that are isolated by greater than 80 db. Thus, an input to the DA is highly isolated, then amplified, and distributed to eighteen individual outputs. The output level, as well as input level, can be monitored by a high quality VU meter allowing the operator to check the operation of the distribution amplifier as well as accurately set the audio level to the output loads. Panel height is small (1 3/4 inches), so that many inputs may be distributed in a small area.

- 1-In, 18-Out
- All-integrated circuitry
- 18 isolated outputs
- "Popless" input to output meter switch

5002A ..... \$369.00

### HEACO 5004A AUDIO DISTRIBUTION AMPLIFIER



The new Dual HEACO 5004A Audio Distribution Amplifier is a technically "State-of-the-Art" amplifier, only 1 3/4 inches high and obsoletes bulky, costly audio distribution systems. The 5004A consists of dual, extremely low distortion amplifiers. Each amplifier has a differential, balanced, bridging input. The frequency response is down less than 1/4 db over a frequency range from 20 Hz to 20 kHz. Distortion is less than .25% over the same frequency range. Eight 600 ohm balanced outputs per amplifier are

(cont.)

provided, that are isolated by greater than 80 db. Thus, input signals are fed into balanced circuitry, amplified, and distributed via rear terminal strips. The output levels, as well as input levels, can be monitored by high quality VU meters, allowing the operator to check the operation of each distribution amplifier as well as accurately set the audio levels to the output loads.

- 1-In, 8-Out x 2 (2 x 16)
- All-integrated circuitry
- 8 Isolated outputs per channel
- "Popless" input to output meter switch

5004A ..... \$565.00

## FURNITURE

### KUSTOM KRAFT FURNITURE

KUSTOM KRAFT specializes in custom and standard design furniture of all types for control, production, and record and tape storage.

If your requirements are special, do not hesitate to talk with one of Allied's sales specialists about them. We have assisted many stations and production facilities in realizing their ideas.

Choose from the standard designs pictured here, or let us know your ideas for the custom facility you desire.

### KUSTOM KRAFT STANDARD BROADCAST DESK MODEL KK230



Here is a heavily-built, "real" piece of control room furniture. Standard in 29" height with a tabletop of 30" x 96", this unit can be varied in size to meet your precise needs.

A pull-out kneewell back affords easy access to hidden wiring compartments. Black, Walnut, Pecan or Gold laminate.

Shipped modular for rapid assembly.

KK230 Without Drawers ..... \$575.00  
 KK2300 With 2 Drawers in Bridge ..... \$625.00

Prices include crating

(Amplifier is extra and shown to illustrate possibilities)

**"STANDARD OR CUSTOM, KUSTOM KRAFT WILL BUILD IT TO YOUR NEEDS"**



# FURNITURE

"CUSTOM CRAFTED BY KUSTOM KRAFT"



## KUSTOM KRAFT SERIES KKR EQUIPMENT RACKS



KUSTOM KRAFT equipment racks offer an attractive method of mounting components in the esthetics-conscious operation. EIA increments of from 7" table top racks to 78¾" floor models are available. Depths of 18" or 24". Walnut, Pecan, Black or Gold Laminate.

Call Allied With Your Needs

SHIPPING AND HANDLING CHARGES WILL BE ADDED TO ALL ORDERS UNLESS OTHERWISE SPECIFIED

## KUSTOM KRAFT RECORD STORAGE CABINETS

Model No.	Record Size	Storage Capacity	Dimensions W x D x H	Suggested Retail Price
KK1000A	7"	1000/45s	24"x 7 ½"x84"	\$215.00
KK1500A	7"	1500/45s	36"x 7 ½"x84"	\$255.00
KK3000A	7"	2000/45s	48"x 7 ½"x84"	\$305.00
KK750B	12"	750/LPs	24"x12¾"x84"	\$220.00
KK1000B	12"	1000/LPs	36"x12¾"x84"	\$256.00
KK1500B	12"	1500/LPs	48"x12¾"x84"	\$314.00

Custom Sizes Available

Prices include crating



KK3000A



KK1500B

## KUSTOM KRAFT TAPE STORAGE CABINETS

Model No.	Tape Size	Storage Capacity	Dimensions W x D x H	Suggested Retail Price
KK500TB	7"	500	40"x 7¾"x84"	\$294.00
KK200TC	10½"	200	28"x11¼"x84"	\$254.00
KK400TC	10½"	400	40"x11¼"x84"	\$304.00

All Kustom Kraft record and tape cabinets come with walnut laminate sides and trim on exposed edges.

Custom Sizes Available

Prices include crating

## KUSTOM KRAFT 201 SERIES TURNTABLE PEDESTALS

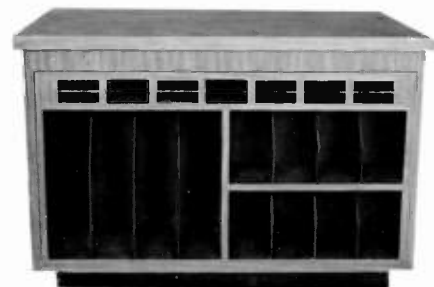

Illustrated Insert Optional

(cont.)

# 4

# FURNITURE

Single, Dual (shown), and triple-bay cabinets of conventional design permit the user to facilitate turntables and tonearms up to a total of 3. Standard pricing includes rack rails in the vertical portion of the cabinet beneath each bay which faces the operator. These spaces have integral cover plates available in the same laminate pattern as the remainder of the cabinet at extra cost.

As shown in the illustration, custom record, tape and storage slots are available at additional charge. These storage compartments can be customized to your needs. The 201 Series perfectly complements the KK230 broadcast desk.

- KK201A Single pedestal TT base 22x24x29" . . . . . \$215.00
- KK201B Dual-bay pedestal TT base 42x24x29" . . . . \$330.00
- KK201C Triple-bay pedestal TT base 62x24x29" . . . \$425.00

Walnut, pecan, black or honey gold laminate standard. Various colors, color combinations, and patterns of laminates available at additional charge. Price includes crating

---

## RUSLANG MODULAR FURNITURE



If you're building or remodeling, you can add the elegant look of expensive furniture for much less than you might expect to pay. Modular control stations, consisting of single and double turntable cabinets and console tables, mix and match to form an efficient unit that will best utilize your available space. Table and cabinet tops come in a variety of colors while bottom sections are walnut wood grained. Customized stations using standard units, such as overhead bridges for additional rack space, are available on request. All our modules are constructed of quality materials, including high pressure laminates, making them sturdy and functional as well as attractive. For further information, contact Allied.

- Console Base Panels (Set of 4) . . . . . \$493.10
- Vanity Shield 12" Wide . . . . . \$12.39
- Single Pedestal T.T. Cabinet . . . . . \$247.73
- Dual Pedestal T.T. Cabinet . . . . . \$408.75
- Blank Panel, (ea.) . . . . . \$28.53
- 32" x 96" Console Table-Top . . . . . \$176.11

ALLIED HAS A LEASE  
PLAN TO SUIT YOUR INDIVIDUAL NEEDS

## RUSLANG FURNITURE RL500



Accepts any 19" x 15 3/4" tape transport, such as Ampex, MCI, Otari, Scully & Tascam. Designated RL500, this console is constructed with the same care as the Scully consoles manufactured for the past 16 years.

- RL500 Typical Size . . . . . \$450.22
- Tilt Feature Included

---

## RUSLANG FURNITURE RL600



Accepts decks which are 19" by up to 21". This console was designed specifically for the newer generation of decks which have their electronics integrated with the transport including 5050B & ATR700. Designated RL600, this console is constructed with the same care as the Scully consoles manufactured for the past 16 years.

- RL600 . . . . . \$383.93
- Tilt Feature Included

---

THE MOST CONVENIENT  
WAY TO ORDER FROM ALLIED IS BY  
TELEPHONE — SEE INSIDE BACK COVER FOR  
MORE INFORMATION



# FURNITURE

## SOUNDOLIER RELAY RACKS

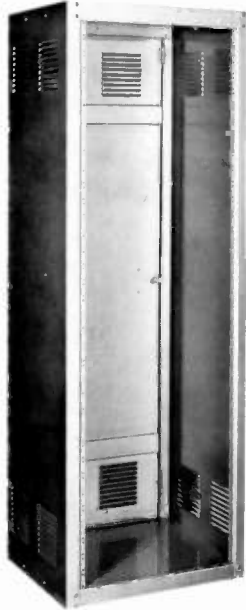

- 16 Gauge CRS throughout
- Standard EIA panel mount spacing
- 5/8" offset for panel mount
- 10-32 tapped mounting rails
- 10-32 x 5/8" pan head screws for assembly of panels
- Slip jointed hinges on rear door
- 3/4"-1" conduit knockouts on top, bottom and rear flanges (exclusive with Soundolier).
- Internal louvers on all sides and rear door (exclusive with Soundolier).
- Engineered scuff resistant packing
- WA Series is welded and assembled. Ready to use.
- Standard 19" mount — 18" equipment depth
- Standard finish grey hammertone on phosphate coating
- Other standard and non-standard colors. Available at slight increase in price.

### List Prices

WA 100-36	Rack Space 36.75"	.....	\$200.00
WA 100-42	Rack Space 42.00"	.....	\$208.53
WA 100-61	Rack Space 61.25"	.....	\$238.79
WA 100-70	Rack Space 70.00"	.....	\$266.15
WA 100-77	Rack Space 77.00"	.....	\$278.96

All prices plus freight

## SERIES 500 MULTI RACKS, ADD-A-RACKS

Soundolier Multi Racks are designed for standard 19" rack panels and for maximum flexibility. Multi Racks can be readily joined together and because of its open side construction, electrical wiring is simple and convenient. Multi Racks are supplied with a rear door, hung on slip-jointed hinges, with a top pin hinge extra long to reduce alignment problems when assembling. A cylinder lock and low profile handle are supplied with each rear door. Panel mounting rails are adjustable, manufactured of 11 gauge C.R.S. and are tapped for 10-32 screws.

### Optional Accessories:

Series 510 Front Door.

(cont.)

**Series 530 Mounting Rails.** While Soundolier 500 Series Multi Racks are supplied with one set of 11 gauge C.R.S. mounting rails, additional sets of rails are available at customer's option.

**Series 540 Side Panels.** One pair of 540 Series Side Panels is required, whether rack is installed singly or in a row. Side panels are simply installed by hooking them over internal side channels in 500 Series Racks. Multi Rack side panels are supplied with Soundolier's exclusive internal louvering for maximum ventilation and clean appearance.



- Slip jointed hinges on rear door and continuous piano hinge on optional front door.
- Optional Front Door can be installed for right or left hand hinging.
- All models shipped welded and assembled.
- Standard Finish is baked grey hammertone over iron phosphate coated metal. Other standard colors available at no extra cost.
- 18" depth.
- Rack space of 61-7/16, 70-3/16, 77-3/16 available.

Call Allied with your requirements and for a price quote.

## ALLIED TURNTABLE ISOLATOR



Intended for use only with direct drive turntables

The AK10 MKII, a sandwich consisting of an upper and a lower plate which reduces physical contact to live rubber only, can be accommodated to all popular turntable/tone arm combinations. Installation is a breeze.

The sandwich's upper plate is composed of high-density particle board with an inlaid lead strip around the entire

(cont.)



# 4

## FURNITURE

perimeter to reduce resonance and vibrations to an even greater degree. Coupling to the bottom plate is achieved through suspension with compounded natural rubber only. The bottom plate is supplied in sufficient size to completely cover any previous turntable hole. This permits easy retrofit with existing turntable pedestals. Problems associated with two turntables having to share the same cabinet will thus be ameliorated.

Tests in a real studio environment with the help of a real-time analyzer and calibrated attenuator reveal the following data:

- The head-room of the speaker-to-tonearm/turntable acoustic coupling (structure-borne and air-borne) was increased 8 dB
- Acoustic coupling (feedback) was not only reduced, but the coupling took place in the spectrum area of 200 Hz instead of 80 Hz, as was the case without the sandwich. 80 Hz would tend to damage speakers more readily than 200 Hz.
- Tapping fingers and tapping pencils, as well as infuriated fists, were all reduced better than 20 dB with the use of the sandwich.
- Thuds, which were identified in the spectrum as peak energy around 100 Hz, were reduced 18 dB.

Different environments, woods, floors, etc., are going to exhibit different figures. However, this method provides solutions simply, easily and economically. This new isolation system, the AK10 MKII is available in any color or combination of laminate. 12" tonearms only.

**Allied Turntable Isolator AK10 MKII . . . . . \$229.00**  
Walnut, Pecan, Black, or Gold laminate finish standard.  
For any Pattern Laminate, Call for quote

### THE ALLIED SHOCK ABSORBER

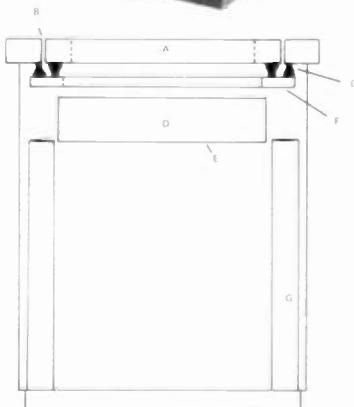

(cont.)

Allied's Shock Absorber solves the many problems associated with protecting otherwise noise-free turntable/arm combinations. 8-10dB feedback headroom improvement and up to 20dB isolation.

Three-fourths of the cabinet is sand loadable creating an acoustic and sympathetic-vibration-free environment for the further isolated top plate, turntable and arm.

- A. Custom cut for your turntable—inlaid lead around entire plate perimeter.
- B. Turntable mount plate isolated from perimeter.
- C. Double suspension compound rubber shock mounts.
- D. Pocket door — access to shelf for electronics — shelf removes so that sand may be poured or bagged into lower chamber. (Before turntable installation.)
- E. Below this line, all joints are sealed for sand loading.
- F. Cutout of lower plate is large enough to accommodate turntable, arm, arm cord and arm rest underhang to insure that there is no physical contact with upper plate.
- G. 2" I.D. plastic ABS pipe—one left rear corner, one right rear corner. AC cords—audio cords.

Attractively finished in black, gold, walnut, or pecan laminate. Other patterns available at extra cost.

For use only with direct drive units.

12" tone arms only.

**Allied Shock Absorber . . . . . \$499.00**

### ALLIED'S STUDIO PACKAGE



Here in one neat compact system is all necessary equipment for production, remote program origination, or disco use, wired and tested, with ample space and input facilities for additional sources such as reel machines, cart decks and others.

The basic system includes the cabinetry, two Russco Cuemaster 3 speed professional 12" turntables, Syntec tone arms, Stanton 500AL cartridges, Shure M-64 pre-amps and a Spotmaster 4M50 mono 4 channel console or Russco mono 5 channel mixer. Microphones and a choice of tone arms and cartridges are available at slight extra cost. This complete system is assembled and tested in our facility, ready for immediate use.

For stereo operation, we offer a choice of the 4 channel Spotmaster 4S50 stereo console or the Russco 5 channel 505S stereo mixer. The Numark DM1800W disco mixer is supplied in the disco package.

- Mono Package (Spotmaster 4M50 mono) . . . \$2815 + frt.**  
(Russco 505 mono) . . . . . \$2830 + frt.
- Stereo Package (Spotmaster 4S50 stereo) . . . \$3844 + frt.**  
(Russco 505S stereo) . . . . . \$3404 + frt.
- Disco Package (Numark DM1800W stereo) . . \$1937 + frt.**

**Packing Charge (Unless picked up at our dock) \$70.00**  
**Cabinetry Alone . . . . . \$260.00**

**HEADSETS**

**AKG K-40 AKG K-141 HEADPHONES**



K-141



K-40

The AKG K-40 is an economical version of the much touted K-140. Designed with supra-aural foam pads, the K-40 allows for an acoustic awareness of the listener's surroundings... contributing to greater listening comfort.

**K-40** ..... \$29.00

**K-141** Deluxe Cardan Stereo Headphone. Quality stereo headphone that is lightweight and comfortable. It is semi-open featuring resonance-free characteristics but with greater freedom from low-frequency side effects. The K-141 provides an extremely broad, flat response almost totally free of coloration — sound which is warm, not boomy; open and present, without harshness. Wt. 9¼ oz.

**K-141** ..... \$75.00

**BEYER DYNAMIC DT302 HEADPHONE  
BEYER DYNAMIC DT440 HEADPHONE**



DT440



DT302

- Weighing only 2.3 ounces, the DT302 is no light-weight on sound reproduction. Full range response (20Hz to 20kHz) ensures accurate translation of any audio program.
- Impedance: 600 ohms per headphone

**DT302** ..... \$35.95

(cont.)

- The alternative to the 'closed ear' headphones. This 'open' headphone weighs less than 9 ounces. Frequency response 20Hz to 20kHz.
- Impedance: 600 ohms per headphone.

**DT440** ..... \$69.95

**KOSS PRO 4AA HEADPHONES**



**PRO 4AA** (While quantities last) ..... \$35.00

**THE MOST CONVENIENT  
WAY TO ORDER FROM ALLIED IS BY  
TELEPHONE — SEE INSIDE BACK COVER FOR  
MORE INFORMATION**

**SENNHEISER HD 414X HEADPHONE  
SENNHEISER HD400 HEADPHONE**



HD 414X



HD 400

**HD 414X**

- Impedance: 2000 ohms
- Frequency Response: 20 to 20,000 Hz
- Open aire dynamic transducers
- Big and soft ear cushions
- Weight: 135 g.
- Reliable cord

**HD 414X** ..... \$79.00

The HD 400 well complements the line of Sennheiser's well-known open stereo headphones. It was designed with the requirements of many who wish to obtain headphones

(cont.)



# HEADSETS

of outstanding quality at a moderate price. The very low weight of only 80 g sets an example for any high-quality stereo headphones and it is mainly this low weight which makes the HD 400 so comfortable. Even after many hours of wearing, the HD 400 will not cause discomfort.

- Impedance: 600 ohms
- Frequency Response: 20 to 18,000 Hz
- Dynamic 600 ohm transducers
- Super light—only 80 g
- Especially rugged connecting cable

HD 400 ..... \$46.00

## SENNHEISER HD 424X HEADPHONE SENNHEISER HD420 HEADPHONE



HD 424X

HD 420

The HD 424X was developed from the HD 414 and features, of course, the acoustically open design with its uninhibited and natural sound impression.

- Impedance: 2000 ohms
- Frequency Response: 16 to 20,000 Hz
- Open aire dynamic transducers
- Large-area ear cushions of soft foam
- Weight: 170 g.
- Durable cable

HD 424X ..... \$115.00

The HD 420 gives you very good comfort, no distortion, excellent sound definition. The dynamic headphones with superior price-quality-ratio.

The outstanding transient response is due to the extremely small mass of the new whirl-shaped surround diaphragm.

- Impedance: 600 ohms
- Frequency Response: 18 to 20,000 Hz
- Open aire dynamic transducers
- Weight: 127 g
- Durable cable

HD 420 ..... \$89.00

## R-COLUMBIA MODEL TR-50 FM WIRELESS INTERCOM HEADPHONES R-COLUMBIA TYPE BQ HEADPHONES R-COLUMBIA TYPE C3 HEADPHONES

A Whisper Transmits Loud and Clear without Wires—Truly a cordless wonder... any number of R-Columbia Model TR-50 wireless intercom headphones can communicate within the range of operation. Within that range (up to 150 yds. depending on terrain) the TR-50 will provide 2-way

(cont.)



TR-50

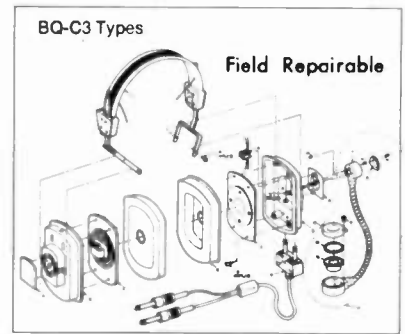

voice communication as clear as any wired system, and superior to many!

FCC certified as a wireless transceiver, the TR-50 can be ordered to operate on any one of 5 channels: Ch A (49.830 MHz), Ch B (49.845 MHz), Ch C (49.860 MHz), Ch D (49.875 MHz), or Ch E (49.890 MHz).

**TR-50 FM Wireless Intercom Headphones —**  
Double ear headphone/microphone with built-in FM transmitter and receiver. Complete wireless intercom headphone with crystals and accessories for single channel operation . . . less batteries, each ..... \$297.00

R-Columbia "Broadcast Quality" headphones provide acoustic performance desirable in broadcasting, recording and industry. The basic headphone main frame is identical to the "time proven" R-Columbia C1C3 Series. Fatigue over long listening periods is greatly reduced.

FREQUENCY RESPONSE: 20Hz to 20 kHz

SENSITIVITY: 100 dB re .0002 micro-bar for 1 mw input at 1 kHz.

HARMONIC DISTORTION: Less than 0.3% at 90 dB SPL

COLOR: Two tone brown

**BQ3 - Monaural headphone - 8 ohm impedance . . . \$59.50**

**Type BQ3H - Same as BQ3, but in Impedances of 150, 600, and 2K ohms (specify) . . . \$65.95**

**Type BQ - Stereo headphone - 8 ohms per channel . \$69.95**

**Type BQH - Same as stereo Type BQ, except in impedances of 150, 600, or 2K ohms per channel (specify) . . . \$78.95**

**Type C3 - Monaural headphone - 8 ohm Impedance . \$36.95**

**Type C3H - Same as C3, but in Impedances of 16, 150, 300, or 600 ohms (specify) . . . \$39.95**

**Type C3H - As above, but in Impedances of 2K, 10K, or 50K ohms (specify 50K ohms to replace crystal types like Clevite) (specify) . . . \$54.50**

**Type C3X - Same as C3, but with built-in volume control . . . \$49.00**

**Type C3HX - Same as C3H, but with volume control (16, 150, 300, or 600 ohms) (specify) . . . \$52.95**

**Type C3HX - As above, but 2K, 10K, or 50K ohms, (specify) . . . \$59.95**

WE HONOR





# HEADSETS

## ASTROLITE 8600 SERIES ELECTRET HEADSETS



The New Astrolite Electret has a noise-cancelling electret mic with performance equalling fine studio microphones. Its noise cancellation properties make it suitable for use in noisy environments. New thicker foam cushions gently envelop—but do not press—on your ears and provide better attenuation to ambient noise.

Two watch batteries located in an earshell will power the electret mic for 1 year or, optionally, the headset can be phantom powered from consoles equipped with this facility.

The improved mic performance, superior to many studio mics now in service, makes it ideal for DJs and talk show hosts as it will eliminate off-mic problems. The independently wired earphones can be wired for program monitor and cueing. Coiled cord.

STYLE: Double Phone/noise cancelling electret mic  
HEADPHONE IMPEDANCE: 200 Ohm; independently wired.

NOISE CANCELLATION: 25dB at 100Hz—reverts to pressure mic at 2.2kHz.

POWER SUPPLY: 3-30 VDC at 0.1 MA

8649 Battery Powered, Coiled Cord ..... \$240.00

8697 Phantom Powered, Coiled Cord ..... \$216.00

## ASTROLITE SPORTCASTER HEADSETS



Sportscasters—Disc Jockeys eliminate off-mic problems—Sportscaster headsets are in daily service by ABC, CBS, NBC and major group and independent radio and TV stations across the country for news, sports commentary and D.J. applications. These specially modified Astrolite headsets are supplied with close-talking dynamic or noise-cancelling dynamic mics which equal the performance of studio mics—even in noisy environments.

Sportscaster headsets are supplied with a coiled split cable for mounting both a mic plug and phone plug.

433B Close-Talking, Coiled Cord ..... \$193.00

436B Noise-Cancelling, Coiled Cord ..... \$270.00

## EDCOR HEADPHONE AMPLIFIER



Small headphone amplifier designed to power four headphones—Individual controls.

AP10 ..... \$202.50

RM100 (Rack mount kit for one AP10) ..... \$ 36.00

Studio Headphone Amplifier designed to power eight headphones—Individual controls. Ready to rack mount. 1.75 x 19 inches.

HA100 ..... \$322.50

## TELEX CS-91 SPORTCASTER HEADSET



Professional, binaural headphone and wide range, omnidirectional, dynamic boom microphone for live, remote broadcasting. Non-metallic headphone and microphone elements resist environmental extremes for precise transmission and reception under all conditions. Supplied with 80 inch un-terminated cord and in-line "push-to-cough" switch. Padded headband and ear cushions. Black with grey trim.

CS-91 ..... \$165.00

## RANE HC 6 HEADPHONE CONSOLE



The HC 6 offers more performance and flexibility than you probably hoped for. We didn't stop at just a straightforward headphone distribution amp. We designed in a separate input for each of the six stages, which individually bypasses the master stereo inputs. This allows the HC 6 to handle up to six totally separate programs, for many additional applications such as custom headphone monitor mixing.

A lot of performance for an innocent-looking single rack-space headphone amplifier.

HC 6 ..... \$349.00

**INTERCOMS**

**RTS TW INTERCOM SYSTEM**



The TW Intercom System is an innovative new intercom system for teleproduction communications in the studio and field. With Super System Phase III, we've incorporated a number of advances which mark a significant increase in product versatility.

Our new design features the portability of 12 volt battery power and convenience of dry-line operation. The system can be arranged with up to 50 various user stations on line, and may be coupled to existing communications lines with one of our active interface devices.

Phase III offers impressive capabilities like powerful headphone amplification, two (or more) channel operation, microphone level limiting, and stable sidetone level. The new units are handsomely packaged and completely field serviceable.

**For Information, Contact Allied Broadcast Equipment.**

Refer to headset section for R-Columbia Model TR-50 FM wireless intercom headphones.

**RANE HC 6 HEADPHONE CONSOLE**



The HC 6 offers more performance and flexibility than you probably hoped for. We didn't stop at just a straight-forward headphone distribution amp. We designed in a separate input for each of the six stages, which individually bypasses the master stereo inputs. This allows the HC 6 to handle up to six totally separate programs, for many additional applications such as custom headphone monitor mixing.

A lot of performance for an innocent-looking single rack-space headphone amplifier.

**HC 6 ..... \$349.00**

**MICROPHONES**

**AKG D1000E MICROPHONES**



The D1000E has been developed to meet the broadcaster's special needs for equalizing tonal color right at the microphone. A unique "B-M-S" switch controls the bass and mid-frequency response of the D1000E.

**D1000E ..... \$135.00**  
**(With MCH-20, 20' Mic Cable & PF-10 Windscreen**  
**Combination) ..... \$157.00**

**Allied Carries the Entire AKG Microphone Line.**

**AKG D80 MICROPHONE**



- Integral "pop" screen
- On-Off switch
- Professional black matte finish
- 15' cable w/ male/female XLR's
- Universal stand adaptor
- Lo-Z broadcast quality

**FREQUENCY RANGE: 60 to 15,000Hz**  
**RATED IMPEDANCE: 210 ohms**  
**MAXIMUM SOUND PRESSURE LEVEL FOR LESS**  
**THAN 1% THD: 128dB SPL**

**CONNECTOR TYPE: 3-pin male, standard XLR-type**  
**HOUSING MATERIAL: Brass w/semi-matte black paint**  
**DIMENSIONS: Length 7-5/16"; head diameter 2-1/8"**  
**INCLUDED ACCESSORIES: 15 ft.**

**shielded cable with female 3-pin standard XLR-type-**  
**connector, quick-disconnect stand adapter**

**D80 ..... \$80.00**

# 4

# MICROPHONES

ELECTRO-VOICE 635A MICROPHONE  
 ELECTRO-VOICE RE20 MICROPHONE  
 ELECTRO-VOICE RE15 MICROPHONE



RE20

RE15

The 635A is quite simply the most rugged, durable microphone Electro-Voice manufactures. The 635A's moderately high output level (-55dB) is appropriate for a broad range of studio and field applications. Omnidirectional.

**EV635A** ..... \$95.50

The RE20 was created especially for critical recording, broadcast, and sound reinforcement applications which require response that extends to the frequency extremes. Its Variable-D design frees it of any bass-boosting proximity effect.

**Model RE20** ..... \$484.50

**Model RE15** ..... \$256.75

ELECTRO-VOICE RE16 MICROPHONE  
 ELECTRO-VOICE RE18 MICROPHONE  
 ELECTRO-VOICE RE10 MICROPHONE



RE18

RE16

**Model RE16** ..... \$269.50

**Model RE18** ..... \$279.25

**Model RE10** ..... \$166.50

ELECTRO-VOICE RE11 MICROPHONE  
 ELECTRO-VOICE DO56 MICROPHONE  
 ELECTRO-VOICE RE50 MICROPHONE

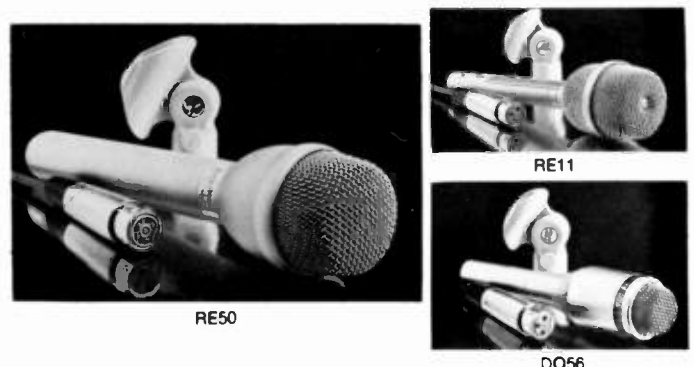

RE50

RE11

DO56

The DO56 is a shock-mounted omnidirectional microphone for hand-held broadcast and sound reinforcement applications. All handling noises and cord vibration are isolated from the microphone element. Shock isolation is enhanced by having the main acoustic cavity and the diaphragm/voice-coil assembly isolated as a unit from the case. Butyl rubber shock rings act as the spring in the isolation system. A capsule/case collision is impossible. The "G-factor" margin makes the DO56 less susceptible to the bell-like clang heard from other shock-mounted microphones when they are accelerated or decelerated rapidly. A slim, attractive silhouette and the silver tone beige finish are ideal for on-camera use.

**Model DO56** ..... \$125.00

The RE50 was designed expressly for hand-held news-gathering work. It has the same tailored frequency response and high output level as the famous 635A. The RE50's rubber shock-mount "mike-within-a-mike" design achieves a degree of shock isolation never before known in the industry.

**Model RE50** ..... \$156.00

**Model RE11** ..... \$179.50

SENNHEISER  
 STUDIO CARDIOID MICROPHONE MD421



The Model MD 421-U-5 comes equipped with XLR connector. This model is also low impedance and balanced. The MD 421-U-5 comes with a black semigloss surface.

**MD 421-U-5** ..... \$327.00

ALLIED HANDLES OVER  
 160 PRODUCT LINES - SEE INSIDE BACK COVER  
 FOR COMPLETE LISTING



# MICROPHONES

## SHURE SM11 MICROPHONE



MODEL SM11: The Shure Model SM11 is a miniature dynamic lavalier microphone designed for use in television broadcasting (on-camera), sound reinforcement, in certain radio and motion picture applications.

SM11-CN ..... \$95.00

## SHURE SM7 MICROPHONE



MODEL SM7. A dynamic microphone with a very smooth, flat, wide-range frequency response; cardioid polar pattern, uniform with frequency and symmetrical about the axis; internal "air suspension" shock isolation.

SM7 ..... \$495.00

## SHURE SM33/SM5B MICROPHONES

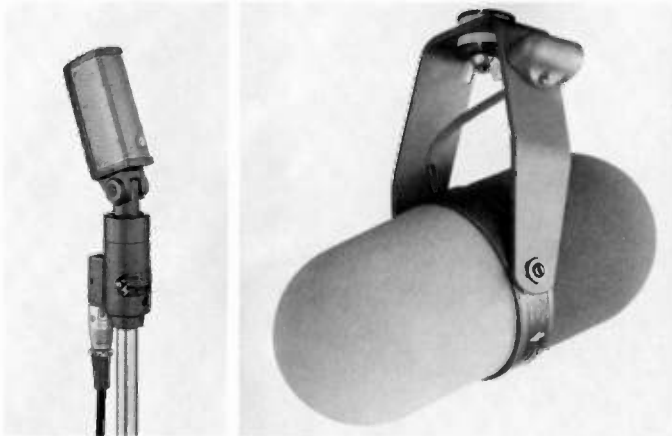

SM33

SM5B

MODEL SM33: A compact and rugged unidirectional ribbon microphone combining wide range response and a super-cardioid directional pattern.

Frequency Response: 40 to 15,000 Hz.

SM33 ..... \$342.00

MODEL SM5B: Specifically designed to minimize boom microphone problems in television and motion-picture sound stage and location recording. Painstakingly developed to provide extremely high reproduction quality and great flexibility of application. Including voice over.

The SM5B features a wide-range, smooth, natural response, especially tailored for dialogue and vocal pickup with excellent presence, yet well-suited to scoring assignments. Its pickup pattern is cardioid. Very mellow.

SM5B ..... \$535.50

## SHURE SM53/SM57 MICROPHONES



SM57



SM53

Model SM53 ..... \$315.00

Model SM57 ..... \$139.00

## SHURE SM58/SM59 MICROPHONES



SM58



SM59

SM58 ..... \$175.00

SM59 -CN ..... \$205.00

**QUESTION CONCERNING  
YOUR ORDER? CALL (317) 962-8596 AND ASK FOR  
CUSTOMER SERVICE**

(cont.)



# MICROPHONES

## SHURE SM81 MICROPHONE



MODEL SM81: A high-quality, unidirectional condenser microphone designed for professional applications in studio recording, broadcasting and sound reinforcement. Especially applicable in situations requiring extremely wide frequency response, low noise and distortion characteristics, very low RF susceptibility, and reliable operation over a wide range of temperature and humidity extremes.

SM81-CN ..... \$348.00

## SHURE SM14/SM18 MICROPHONES

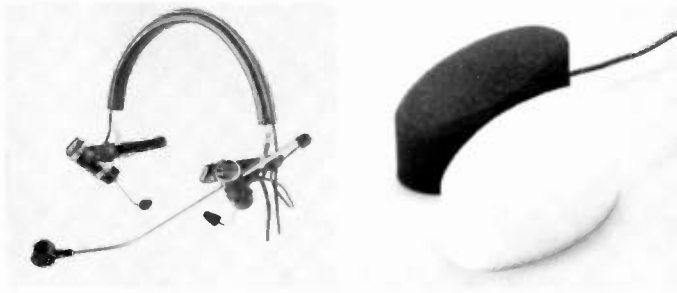

SM14

SM18

MODEL SM14: Professional head-worn microphone with receivers. Low impedance, unidirectional, dynamic microphone with two integral earphone assemblies. Close talking microphone allows use under noisy conditions. Lightweight and reliable.

SM14A-CN ..... \$225.00

MODEL SM18: The Shure SM18 microphone is a high quality, palm-sized microphone available encased in either a white or brown foam "envelope." They are designed to be virtually invisible when placed on altars, lecterns, tables, and in other settings. Great for conference table pick-up.

SM18B-CN Brown or White ..... \$85.00

## SONY CONDENSER ECM-50PS MICROPHONE

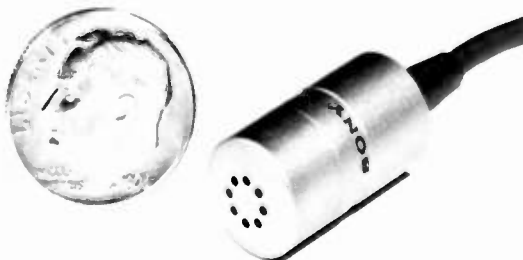

Professional omni-directional electret condenser microphone with miniature design.

- Wide frequency response
- 2-way powering system
- Non-reflective design

ECM-50PS ..... \$225.00

## SONY C-37P MICROPHONE



Professional condenser microphone with selector switch for omnidirectional characteristics.

- Phantom power system . . . 48V
- Windscreen and shock mounting available

C-37P ..... \$495.00

## SONY ECM-56F MICROPHONE



Professional uni-directional back electret condenser microphone with exceptional frequency response.

- Back electret condenser capsule
- External power system
- Battery check lamp
- Adjustable angle

ECM-56F ..... \$265.00

**ALLIED HAS A LEASE  
PLAN TO SUIT YOUR INDIVIDUAL NEEDS**

(cont.)





# MICROPHONES

## FOSTEX FLAT COIL TYPE MICROPHONES



The first family of public radio microphones. Fostex flat coil ribbon series.

Seven models from which to choose including the M22RP, the only M-S Dynamic Stereo microphone available today. Complete descriptive brochures available.

Call or write Allied for complete pricing and delivery info

## CROWN PRESSURE ZONE MICROPHONE

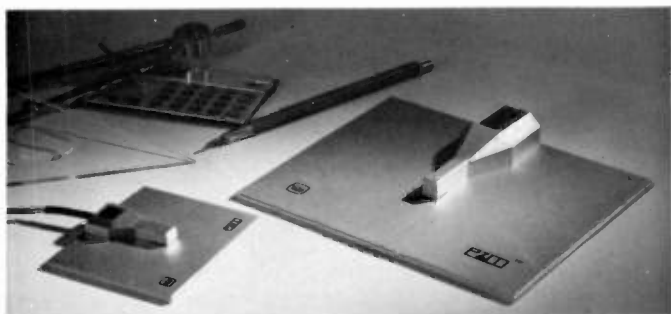

The CROWN PZM is a radical departure from conventional microphone technology. Available in several models including a lavalier, each includes its own power supply in the listed pricing.

<b>5" x 6" General Purpose</b>	
PZM-30GPG (Gold) .....	\$359.00
PZM-30GPB (Black) .....	\$359.00
<b>Low Profile</b>	
PZM-6LPG (Gold) .....	\$359.00
PZM-6LPB (Black) .....	\$359.00
<b>Lavalier</b>	
PZM-3LVC (Champagne) .....	\$269.00
PZM-3LVB (Black) .....	\$269.00

(cont.)

Recess Mount	
PZM-20RMG (Gold) .....	\$299.00

Microphone price includes a power supply.

Please specify one of the units listed below:

PX-18B — Transformer, battery or phantom powered

PA-18B — Active, battery or phantom powered

## VEGA MICROPHONE SYSTEMS



Vega offers a variety of systems that give you a new order of freedom and fosters new confidence in your performance. The sound these systems deliver, especially systems with diversity receivers, is comparable to hardwired microphones.

<b>Professional I</b>	
Model 77 transmitter & Model 58 receiver .....	\$1998.00
<b>Professional II</b>	
Model 77 transmitter & Model 63 receiver .....	\$3096.00
<b>Performer I</b>	
Model 80 transmitter & Model 58 receiver .....	\$2189.00
<b>Performer II</b>	
Model 80 transmitter & Model 63 receiver .....	\$3287.00
<b>Traveler I</b>	
Model 77 transmitter & Model 66 receiver .....	\$1884.00

**Econo-Mic** Transmitter with separate lavalier microphone and stainless steel belt clip.

This version of the Econo-Mic Transmitter is ideal for that application where a small lavalier type microphone is preferred.

The basic operating instructions for the Econo-Mic System are permanently printed on the Model ER-1 Receiver Case. Excellent quality at this price. Used regularly in several broadcast situations.

(cont.)

# 4

## MICROPHONES

### ALADDIN MIC FLAGS



DM1



DM3



SM



RM

Prices listed are for 2-color helvetica or roman alpha- numerics only. For each additional color up to a maximum of 4, add \$25 per color.

Please state Mic make and model, or the diameter of the Mic head and/or barrel for proper mounting.

An additional \$25 one-time charge is applicable to reproduce custom logos, per logo. We must have two copies of the logo in color (or colors specified). To avoid a "Too busy" flag, the Mfgr. suggests you consider call letters on opposite sides with your logo on alternates.

#### STYLE DM1

Single disc ident in three sizes with plastic coated clip.

2" .....\$12.00 • 2½" \$13.00 • 3" \$15.00

#### STYLE DM3

Triple disc ident, each 2" diameter, with plastic coated clip.

2" .....\$20.00

#### STYLE SM

Four sided cube, each side 2" square. Foam filled for securing to mic.

2" .....\$24.00

#### STYLE RM

Rectangular ident, 1½" x 6" with 2 plastic coated clips for attaching to the longer mics.

1½" x 6" .....\$15.00

### LUXO LM-1 MICROPHONE ARM



LM-1

Black or Oyster

EXTENSION: 41 inches

WEIGHT RANGE: 1 ounce to 3 pounds

RECOMMENDED MOUNTS: A, B or C included

LM-1 .....\$40.00

### ALLIED SPRING LOADED MICROPHONE BOOM



Heavy-duty spring-loaded mic boom. 1 ft. pedestal riser permits behind-console or cart machine placement.

Mic Boom .....\$75.00  
w/Extra Heavy Springs .....\$92.00

### POTOMAC INSTRUMENTS FIM-71

#### SOLID STATE VHF FIELD STRENGTH METER

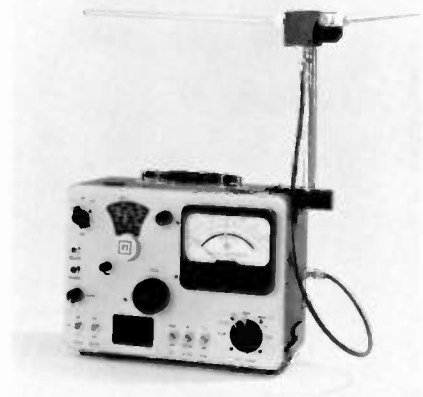

The FIM-71 Field Strength Meter is a truly portable test instrument of laboratory quality which is designed to withstand the rigors of extended field use. Combining a calibrated half-wave dipole antenna and a highly accurate tuned voltmeter with a range of 140 dB, this instrument is suitable for practically all types of RF emission measurements in the 45 mHz to 225 mHz frequency spectrum.

- Accurate—Direct Reading—Volts or dB
- 45 mHz to 225 mHz—Continuous Tuning
- Peak or Averaging Detector (switch selectable)
- Wide or Narrow IF Bandwidth (switch selectable)
- 20 dB or 60 dB Meter Range (switch selectable)
- AM or FM Demodulator (switch selectable)
- Calibrated Dipole Antenna, Mounted on Case for Near-Ground Measurements or Removable for TASO Measurements
- 140 dB Measurement Range (1  $\mu$ V to 10V)
- 4½ Inch, Mirrored Scale, Taut-Band Meter
- Front Panel Speaker
- Recorder Output
- Rugged, Portable Package
- Calibrated Signal Generator, 45 mHz to 225 mHz
- Battery or External Power
- Use as Signal Source/ Selective Voltmeter for Insertion Loss Measurements of Filters, etc.
- Measures FM Harmonics to -80 dB

FIM-71 (Available for rent) .....\$3450.00

ATLAS SOUND STANDS, ADAPTORS, & FITTINGS

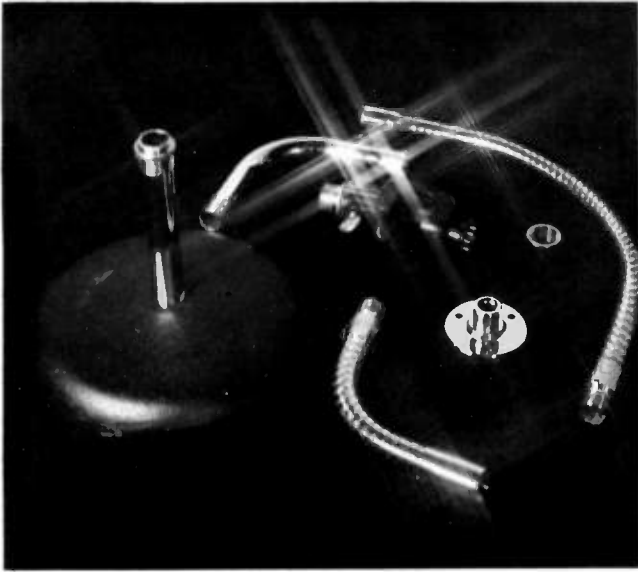

Allied carries the complete Atlas line.

**SHIPPING AND HANDLING  
CHARGES WILL BE ADDED TO ALL ORDERS  
UNLESS OTHERWISE SPECIFIED**

## MONITORS

**QEI MULTIPLEX MONITOR/TEST SET MODEL 691  
FCC APPROVED MODULATION MONITOR**



QEI 691 — Oscilloscope Optional

The QEI 691 FM Multiplex Monitor/Test Set provides the broadcaster or consultant with a reliable, precision instrument capable of monitoring all required functions necessary for stereo/SCA multiplex transmission.

The instrument may be set to any 100kHz increment of the (cont.)

88 to 108mHz FM band by means of a front panel thumb-wheel. An RF amplifier plug-in allows precision monitoring of off-air signals. A built in signal sampler along with an external dummy load allows direct observation of power levels up to 100 watts.

One of the most useful features of the instrument is the capability of producing an 80db log spectrum analyzer display on an external low cost oscilloscope. The sweep width is either  $\pm 100\text{kHz}$  or  $\pm 300\text{kHz}$  and may be centered on any 100kHz increment in the band. This feature allows true Bessel zero calibration, extremely accurate THD & IMD measurements and signal strength measurements.

The total modulation Display section provides a modulation meter with FCC ballistics, a digitally selected Peak Indicator and a 100% Peak per minute readout.

The Test Display section features two independent displays each with an autoranging voltmeter and digitally selected Peak Indicator. These displays allow easy measurement of separation, crosstalk, pilot level & phase, 38kHz suppression, generator phase, left S/N, right S/N, FM S/N, AM S/N, incidental AM and SCA injection, SCA modulation and SCA crosstalk with the optional SCA plug in.

Additional front panel outputs are provided for distortion measurements, scope observation of signal components and frequency (IF, Pilot & SCA).

Rear panel outputs include left & right balanced 600 ohm + 10 dBm audio and remote meter drivers. An external composite input is also provided to allow direct generator measurements.

- Synthesized frequency
- Built in signal sampler
- Built in RF amplifier, plug-in
- Spectrum Analyzer Display output
- 100% Total Peak per Minute Counter
- Three independent digitally set Peak Indicators
- Two Autoranging Voltmeters
- Null type monitor and generator phase calibrators
- Front panel distortion and scope outputs
- Front panel frequency outputs
- Optional SCA plug in: 59 to 75 kHz only
- + 10 dBm balanced audio outputs
- Remote meter drivers

RF Frequency Range: 88.0-107.9 mHz (Thumbwheel select)

RF Input: Sensitivity: .2V to 10V RMS

RF Amplifier option: 30uv for 60db S/N

Spectrum Analyzer Output: 80db;  $\pm 100\text{kHz}$  or  $\pm 300\text{kHz}$

X (horiz.): 4Vpp

Y (vert.): 0.5V/10 dB

Total Modulation Display: Modulation Meter:

Accuracy:  $\pm 2\%$  entire range

Frequency Response: 0.2dB 30Hz - 75kHz

Range: 0-133% (-20dB to +2dB)

Ballistics: per FCC regulations

Peak Indicators:

Range: 0-199% in 1% increments

Accuracy:  $\pm 1\%$

Peak Counter:

Set Point: 100%  $\pm 1\%$

Time: 1 minute  $\pm 1$  sec.

Distortion: 0.05% THD or IMD

S/N: better than 75dB (with 75  $\mu$  sec de-emp)

Test Displays (2):

Meter Accuracy:  $\pm 2\%$  entire range

Peak Indicator Accuracy:  $\pm 1\%$

Meter Range: 133% to -75dB (autoranging)

Pilot & SCA Injection Accuracy:  $\pm 0.5\%$  (6% to 12%)

(cont.)



# MONITORS

### Separation:

L into R or R into L: 55dB

### Crosstalk:

Main into Sub: 70dB

Sub into Main: 70dB

SCA into Sub or Main: 70dB

Pilot into Sub or Main: 70dB

### Monitoring Modes:

- |                    |            |
|--------------------|------------|
| 1) Left            | Right      |
| 2) Main            | Sub        |
| 3) Pilot Level     | Phase Cal. |
| 4) 38kHz           | Gen. phase |
| 5) FM S/N          | AM S/N     |
| 6) SCA Inj. wide   | SCA Mod.   |
| 7) SCA Inj. narrow | Main       |

### Distortion (Left or Right):

THD: 0.05%

IMD: 0.1% (SMPTE)

SCA (4kHz dev.): 1% 50Hz to 5kHz (150us)

### Outputs:

Left: +10 dBm bal. and Hi-z

Right: +10 dBm bal. and Hi-z

Scope: 1V pp

Frequency: X.O, I.F. Pilot, SCA (TTL)

Dimensions: 10 1/2"H x 19"W x 7"D

Weight: 16 lbs.

Maximum Operating Temp.: 122°F (50°C) Ambient

691 FM Stereo Monitor ..... \$4995.00

691/01 Monitor including SCA Monitor ..... \$5995.00

## BELAR FMM-1 FM FREQUENCY & MODULATION MONITOR



The Belar FM monitors were designed as a totally integrated, solid state system to enable the broadcaster to fulfill his monitoring equipment requirements as the need arises. The Belar FMM-1 Frequency and Modulation Monitor is a wideband, all solid state FM monitor designed expressly to fulfill all the new requirements for monaural monitoring as well as to provide a virtually pure, distortionless demodulated signal to drive the companion FMS-1 Stereo Frequency and Modulation Monitor and the SCM-1 SCA Frequency and Modulation Monitor for multiplex monitoring.

FMM-1 ..... \$1650.00

## BELAR FMS-1 FM STEREO FREQUENCY MONITOR



(cont.)

Belar FM monitors were designed as a totally integrated, solid state system to enable the broadcaster to fulfill his monitoring equipment requirements as the need arises. The Belar FMS-1 Stereo Frequency and Modulation Monitor, when added to the FMM-1 FM Frequency and Modulation Monitor, provides complete monitoring and test functions to meet the daily requirements for stereo monitoring and provides additional facilities for making the proper tests for weekly and monthly maintenance checks to insure maximum performance from stereo transmitters.

FMS-1 ..... \$1500.00  
(Requires FMM-1 to operate)

## BELAR FMM-2 FM MODULATION MONITOR



The FMM-2 sets new standards in accurate FM monitoring - the first to incorporate a sample hold peak modulation meter circuit independent of modulation polarity to allow the meter to respond to program peaks of the shortest duration. The heart of the FMM-2 is an ultra-linear digital discriminator which provides a distortionless baseband signal for accurate monitoring as well as precise stereophonic, quadrasonic and SCA decoding. The Belar FM monitors were designed as a totally integrated system to allow the broadcaster to fulfill his monitoring requirements as the need arises.

FMM-2 ..... TBA

## BELAR FMS-2 FM STEREO MODULATION MONITOR



- Two independent peak modulation meters for simultaneous monitoring of left and right channels or L + R and L-R.
- Two independent auto-ranging voltmeters with LED displays for simplified automatic measurement of channel separation, crosstalk, sub-carrier suppression, and noise.
- Pilot alarm with front panel indicator.
- Rear illuminated meters eliminate shadows for easy viewing.
- Balanced audio outputs, +10 dBm.
- Outputs for proof-of-performance measurements.

FMS-2 ..... TBA  
(Requires FMM-2 to operate)

ALLIED OFFERS PACKAGE DISCOUNTS



# MONITORS

## BELAR SCA FREQUENCY & MODULATION MONITOR



The Belar FM monitors were designed as a totally integrated solid state system to enable the broadcaster to fulfill his monitoring equipment requirements as the need arises. The Belar SCM-1 SCA Frequency and Modulation Monitor, when added to the FMM-1 Frequency and Modulation Monitor, provides complete monitoring and test functions for SCA storecasting and remote telemetering applications. Up to four crystal switch positions allow four channels to be operated and tested.

SCM-1 ..... \$1500.00  
(Requires FMM-1 to operate)

## BELAR RFA-1 SOLID STATE FM RF AMPLIFIER



For Off-Air monitoring at remote control location in conjunction with main and sub-channel FM modulation monitoring equipment.

RF INPUT SENSITIVITY: 100uV for full output.  
RF INPUT IMPEDANCE: 50-75 ohms.  
RF FREQUENCY RANGE: 88-108 MHz

RFA-1 ..... \$550.00

## BELAR AMM-2A AM MODULATION MONITOR

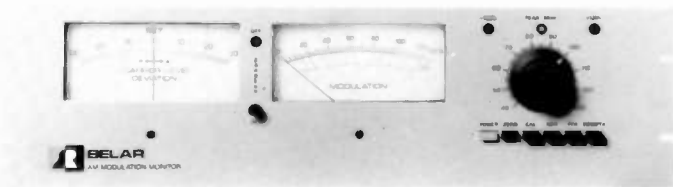

The AMM-2 Modulation Monitor sets new standards in accurate AM monitoring—the first AM monitor to incorporate true ratio-type peak indicators. The AMM-2 contains a unique modulation cancellation scheme to recover unmodulated carrier to reference the modulation peaks. Thus the instantaneous carrier without the need of time-constants, as with AGC devices. True carrier is indicated with asymmetrical modulation encountered in today's high positive peak modulation, and peaks are automatically referenced to this true carrier to give the most accurate indication of program peaks.

FCC Type Approval No. 3-224

AMM-2A ..... \$950.00

## BELAR AMM-3 AM MODULATION MONITOR



The AMM-3 Modulation Monitor sets new standards in accurate AM monitoring—the first AM monitor to incorporate true ratio-type metering circuits. The AMM-3 contains a unique modulation cancellation scheme to recover unmodulated carrier to reference the modulation peaks. Thus the instantaneous program peaks are referenced to the instantaneous carrier without the need of time-constants, as with AGC devices. True carrier is indicated with asymmetrical modulation encountered in today's high positive peak modulation, and peaks are automatically referenced to this true carrier to give the most accurate indication of program peaks.

- Two modulation meters—one for positive and one for negative modulation, independent of carrier level.
- Outputs for listening as well as test functions.

FCC Type Approval No. 3-231

AMM-3 ..... \$1400.00

## BELAR RFA-2 AM RF AMPLIFIER



The state-of-the-art design of the BELAR RFA-2 AM RF Amplifier—a selective, high gain, all silicon solid state unit with automatic gain control (AGC)—companion to the BELAR modulation monitors—now makes it possible to monitor off-the-air AM signals accurately and conveniently without the problems associated with changes in transmitter power level, antenna patterns, and signal fading. The RFA-2, when used with the AMM-1, AMM-2 & AMM-3 allows monitoring of modulation characteristics from a point remote from the transmitter, usually the studio, for AM transmitters in the 530-1610 kHz band.

RF SENSITIVITY: 100 uv across 50 ohms  
ANTENNA REQUIRED: Whip or loop

RFA-2 ..... \$595.00

## BELAR RFA-4 AM RF AMPLIFIER



The Belar tunable RF amplifier allows the broadcaster to monitor any station in the AM band. A front panel three digit thumb-wheel switch assures quick and precise frequency selection from 500 kHz to 1.99 MHz in 10 kHz steps. A frequency synthesized digital front end and a wide range AGC provides a virtually distortionless, spurious-free output for modulation monitoring. A rear panel lock-in switch presets the amplifier to station frequency

(cont.)



# MONITORS

and overrides the thumbwheel switch, thus preventing unauthorized personnel from inadvertently changing frequency. A 12 volt DC output is provided to power antennas with active loads or amplifiers via the center conductor of a coaxial cable. An optional 10 kHz whistle filter and a switchable narrow band IF filter may be added. The RF amplifier may be used with any Belar AM modulation monitor.

- Frequency synthesized digital tuning.
- Quick frequency selection via 3-digit thumbwheel switch.
- Rear illuminated input level meter.
- Front panel attenuator allows operation in the strongest RF fields.
- Extremely wide range AGC assures constant output.
- Front panel LED lock indicator.
- Low profile design.

RFA-4 ..... TBA

## McMARTIN PRECISION TWO-TONE EBS GENERATOR

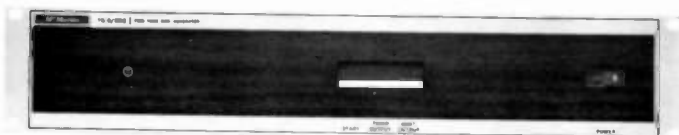

The McMARTIN Model TG-2/EBS Precision Two Tone EBS Generator is FCC Type-Accepted to produce the Two-Tone Attenuation Signal for the Emergency Broadcast System (EBS). Effective for all AM, FM and TV stations.

TG-2/EBS ..... \$375.00

## McMARTIN EBS TWO-TONE MONITOR

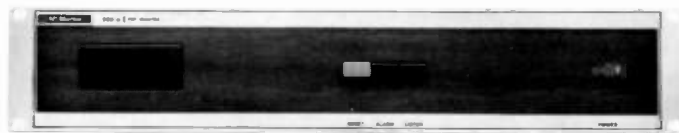

The McMARTIN Model EBS-2, EBS Monitor is FCC certified and satisfies the need for a reliable, trouble-free method of monitoring the two-tone Emergency Broadcast Service (EBS).

EBS-2 ..... \$275.00

## McMARTIN AM/FM FIXED-FREQUENCY TUNERS



The McMARTIN AMR-1 and FMR-D are low cost, high performance, AM or FM broadcast tuners. These professional tuners insure high-reliability, fixed-frequency signal sources for use with sound distribution systems ideally suited for EBS receivers.

AMR-1 (Specify AM frequency) ..... \$210.00  
FMR-1D (Specify FM frequency) ..... \$275.00

## GORMAN REDLICH EBS EQUIPMENT

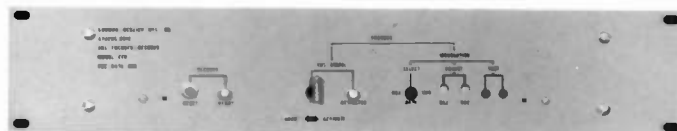

The Model CEB offers, in a single 3½" rack mounting chassis, everything necessary for the two-frequency EBS system required by the FCC except a receiver than can be tuned to the station being monitored. Any stable receiver will do; if you presently have a satisfactory EBS receiver it can be used with the Model CEB. If you are interested in a low cost, tunable AM/FM, EBS monitor receiver, we can supply a receiver for..... \$100.00

- Encoder FCC type accepted. Decoder FCC certified. Meets all legal requirements.
- Exceeds FCC specifications.
- Provision for remote operation. Programming Loop-Through Standard in Encoder. Decoder Demutes Monitor Receiver and/or Actuates Auxiliary Alarm.

CEB Encoder-Decoder ..... \$380.00  
CE Encoder only ..... \$265.00  
CD Decoder only ..... \$205.00

## THE RADIO BY PROTON



Model 300-AM-FM Digital Tuner w/tape input and 25 watt powered 2-way speaker ..... \$280.00

## McKAY DYMEK DA5 ANTENNA

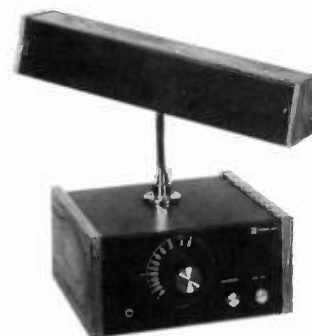

A shielded ferrite rod directional AM antenna with frequency and sensitivity controls—The DA/DL is a shielded ferrite rod directional antenna containing a FET two stage amplifier with frequency and sensitivity controls. The shielded ferrite rod can be rotated and tilted to null out undesirable signals. A frequency control permits precise selection of incoming signals while a sensitivity control provides optimum reception of distant stations.

(cont.)

# 4

## MONITORS

This state-of-the-art antenna is designed to eliminate interference and background noise commonly prevalent in AM reception, plus it will greatly enhance reception in areas where AM signals are marginal. Nighttime off-air monitoring in congested-signal-areas is now a reality.

Mod monitor accuracy is enhanced.

- DA100D Antenna, All Wave, 50kHz-29.7mHz . . \$159.00
- DA9/DL4 AM, 540-1605kHz, Shielded, Directional \$248.00
- DA9/DW1 International, 150-300kHz & 540-1605kHz  
Shielded, Directional . . . . . \$238.00

### POTOMAC INSTRUMENTS — FIELD STRENGTH METERS

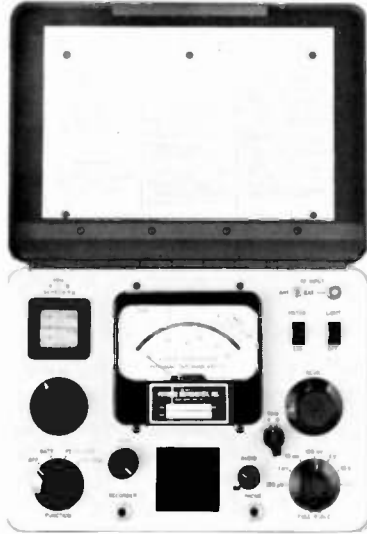

The Models FIM-21, FIM-22, and FIM-41 represent a new generation of precision instruments for direct measurement of electro-magnetic fields in the 100kHz to 5.0 mHz frequency spectrum. These units are intended for portable field use and include a laboratory quality receiver, integral shielded loop antenna, precision attenuator, internal calibration source, and voltage regulated battery power supply. An interlock switch prevents inadvertent battery discharge when the cover is closed. Batteries Not Included.

- FIM-21 535 to 1605kHz . . . . . \$1750.00
- FIM-22 200 to 550kHz . . . . . \$2350.00
- FIM-41 540kHz to 5mHz (rental available) . . . . \$2350.00

### POTOMAC INSTRUMENTS ANTENNA MONITORS



(cont.)

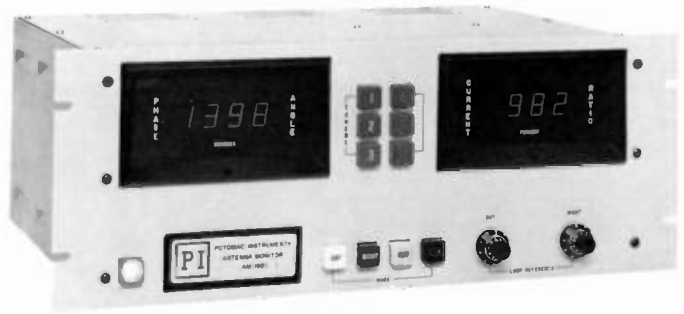

- AM-19 (204) . . . . . 2-tower \$2200.00
- AM-19D (210) . . . . . 2-tower \$2900.00
- PM-19 . . . . . 2-tower \$5700.00

### DELTA DAM-1 DIGITAL ANTENNA MONITOR



This is a true digital antenna monitor that utilizes the latest digital techniques to achieve a truly digital approach toward phase and ratio measurements. FCC type approved, the DAM-1 combines simplified pushbutton operation with the accuracy of a digital display. The DAM-1 phase accuracy is  $\pm 1$  degree, and the typical current ratio accuracy is  $\pm 2\%$ . Increased ratio accuracy can be provided for stations with critical arrays. Output data from the digital circuit appears on the rear connector, as well as on the front panel display, permitting remote reading without any loss of accuracy.

- DAM-1 2 Towers . . . . . \$5030.00
- 3 Towers . . . . . \$5120.00
- 4 Towers . . . . . \$5205.00

### DELTA AAM-1 ANALOG ANTENNA MONITOR

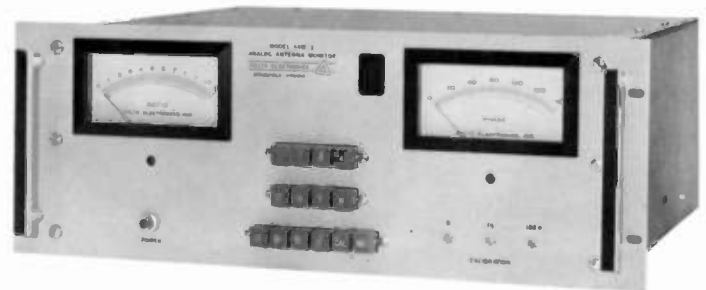

This FCC type approved monitor combines state-of-the-art circuitry with simplified operation. The AAM-1 provides true ratio monitoring, and does not require the operator to recalibrate if reference tower variations occur. The ratio displayed is self-correcting for reference tower amplitude changes. Operation is pushbutton, and all data and operating functions are available through a rear connector for remote control interfacing.

- AAM-1 2 twr . . . . . \$3230.00
- Additional twr inputs (ea.) . . . . . \$130.00



# MONITORS

## DELTA AMC-1 AMPLITUDE MODULATION CONTROLLER



The AMC-1 utilizes a patented closed-loop concept to provide modulation enhancement. The AMC-1 detects and corrects over or under-modulation operation, as well as providing a digital display of the number of over-modulation bursts for the previous and present one-minute period. An optional ATS panel is available to make this product conform with the FCC requirements concerning modulation control in an automatic transmitter atmosphere.

**AMC-1 Amplitude Modulation Controller . . . . \$3495.00**  
**With ATS Option . . . . . \$3870.00**

## DELTA APC-1 AUTOMATIC POWER CONTROLLER



The APC-1 monitors the output power of either AM or FM broadcast stations; and by interconnection to the transmitter's Raise/Lower power controls, it causes the power to remain well within the F.C.C. limits. An optional ATS panel provides a means for incorporating the APC-1 into an ATS system.

**APC-1 Automatic Power Controller . . . . . \$2085.00**  
**With ATS Option . . . . . \$2385.00**

## POTOMAC SMR-11 RECEIVER/ANT-11 ANTENNA

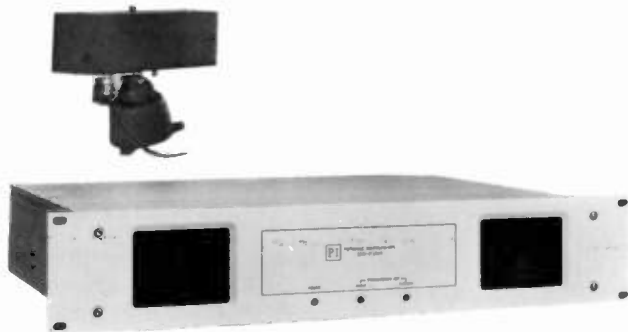

The SMR-11 is an AM broadcast band receiver of superior performance with many capabilities useful to the broadcaster.

Receiver tuning is continuous, 530kHz-1700kHz, and can be locked with crystal accuracy at any desired frequency.

(cont.)

The antenna can be a remotely located tunable ferrite rod unit (ANT-11), a broadband wire, or a whip.

Bandwidth is determined by two switch-selected 455kHz ceramic filters with band-widths of 28kHz and 12kHz.

Other special filters are available, and can be installed.

Distortion is less than 0.2% total harmonic at 99% modulation and remains low for modulation peaks to 150%.

Modulation metering is provided on a front panel meter which accurately indicates peak modulation up to 150%.

Audio outputs for 600 ohms balanced lines are available delivering + 3.5dBm at 95% modulation.

Dimensions and mounting for rack mounting: 19 inches wide, 3½ inches high and 11 inches deep. For office use a wood case is available: 20 inches wide, 4½ inches high, and 12 inches deep overall.

**SMR-11R . . . . . \$1295.00** **SMR-11D . . . . . \$1395.00**  
**ANT-11 . . . . . \$395.00**

## GORMAN REDLICH MODEL CM DIGITAL ANTENNA MONITORS FOR DIRECTIONAL AM ARRAYS

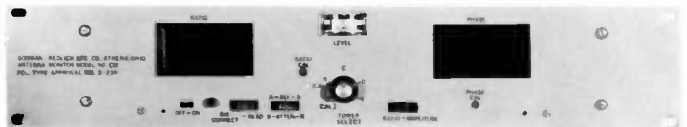

The Model CM is a stable, accurate monitor for DA installations not requiring telemetering of antenna readings.

- True ratio readout. Non-reference and reference amplitudes are separately measured and divided electronically to give a digital readout that will not change with transmitter power and is exceptionally stable under conditions of asymmetric modulation. Stability of readout makes readings easy to take and accurate.
- Stable phase indication with automatic display of phase sign.
- Either True Ratio or Relative amplitude may be selected.
- FCC type approval No. 3-239.

**2 Towers, DA1, with engraved aluminum front panel, brushed or black anodized finish . . . . . \$1440.00**

**2 Towers, DA1, with steel front panel, grey enamel silkscreened finish (illus.) . . . . . \$1390.00**

**DA2 Option . . . . . \$ 25.00**

**Extra Tower Connections, ea. . . . . \$ 35.00**

## GORMAN REDLICH MODEL CMR DIGITAL ANTENNA MONITOR FOR DIRECTIONAL AM ARRAYS

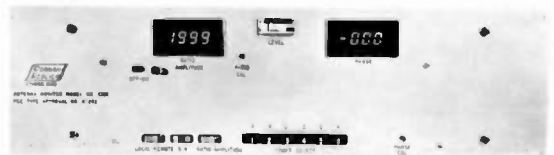

The Model CMR is a state-of-the-art instrument at a price comparable with analog monitors. With typical modulation, the CMR's true ratio readout is a factor of 10 more stable than instruments that measure normalized amplitude, and its phase readout is rock solid. Phase sign is automatic; no extra operation. Practically, these features mean quick, accurate log or remote cal. readings. The CMR is fully remotable via land line or telemetry, using standard remote control equipment. An optional repeater-

(cont.)





# MONITORS RECORDERS

controller is available for hardwire remote control and readout via multiconductor cable at distances up to 1500 feet.

- True Ratio Reading. Non-Reference and Reference amplitudes are separately measured and divided electronically to give an accurate digital reading (and an equally accurate D.C. voltage for remote readings) that will not vary with carrier level, and is exceptionally stable under conditions of deep, assymmetric modulation.
- Up to 6 towers DA-1 or DA-2.
- FCC type approval No. 3-242.

2 Tower, DA-1, Grey silkscreened front panel . . . \$1950.00  
 2 Tower, DA-1, Alum. engraved front panel . . . . \$1990.00  
 CMR-1 Remote controller . . . Grey—\$430. Alum.—\$450.

## GORMAN REDLICH BROADCAST QUALITY WEATHER RECEIVER



Take advantage of the expanding network of National Weather Service VHF weather stations. This sensitive, selective (and reasonably priced) receiver can bring you accurate local weather, national weather, weather radar data, emergency alert messages, plus farming and marine information where applicable. Its capability for unattended recording of emergency alert messages and update forecasts can save time and money. Rebroadcast is FCC authorized.

Receiver is rack mountable, remotable, with an attractive black anodized panel. Demuting and remote alarm are initiated by 1050 Hz "Alert" tone. A relay closure is initiated by either the 1050 Hz tone or a 1650 Hz forecast update signal tone. These are the only tone signals NWS uses. 600 ohm output available.

Crystal and ceramic IF Filters, plus double tuned dual gate MOSFET RF stage, give excellent interference rejection and high sensitivity (.28 microvolts for 12 dB (S + N)/N). Whip antenna, jack and terminals for external antennas. Guaranteed to work where others won't. Even in Chicago.

Weather Receiver . . . . . \$358.00



## OTARI MX5050B II BROADCAST RECORDER

Otari's MX5050B II is used by television and radio broadcasters worldwide. The 5050B II has proven features including front adjustable bias and record EQ, built-in test oscillator, edit and cue, splicing block, motion sensing, selective reproduce, ultra reliable TTL switching, noise free inserts, three speeds in field-selectable pairs of 15/7½ or 7½/3¾ ips, 24 dBm headroom with 28 dBm output into 600 ohms, dc capstan servo and ±7% speed control, peak reading LED plus standard full sized VU meters, and LED function indicators, among others.

(cont.)



Add these features to a 66 dB S/N ratio and a frequency response from 30 to 22,000 Hz ± 2 dB at 15 ips and you have a machine that competes with those costing thousands of dollars more. The world's best seller.

MX5050B II (2 track) 2 Ch. ½ track . . . . . \$2295.00

Now with differential balanced inputs standard.

## OTARI 5050 MARK III/4 ½" FOUR CHANNEL RECORDER



The Otari 5050 MARK III/4 is a compact, tabletop console recorder in the ½" four channel format. Proprietary microprocessors govern tape handling including dynamic braking, motion sensing and transport logic. Additionally, an integral microprocessor controls a real-time electronic counter that features an L.E.D. real-time display and zero-return function.

The capstan is under servo control and speeds are switchable between 15 and 7.5 ips. The true, three head design machine also has a ±7% variable speed control, selective reproduce for overdubbing, a built-in dual frequency test oscillator and easy-access electronics adjustments under the top cover or behind a hinged front panel assembly.

The 5050 MARK III/4 is capable of interfact to tape machine controllers and synchronizers and is compatible with DBX noise reduction products.

A transport remote control (Model CB-102) is available.

- *Tape Width and Channels:* ½" (12.7mm) tape, 4 channels

(cont.)

- *Tape Speeds:* 15 and 7.5 ips
- *Maximum Speed Deviation:*  $\pm 0.2\%$
- *Reel Size:* 1/2" x 10 1/2", NAB
- *Heads (3, in-line):* Erase (ferrite), record/reproduce (hard permalloy)
- *Motors:* D.C. servo-controlled capstan motor, two induction reel motors
- *Rewind Time:* Less than 90 seconds for 2400' reel
- *Pitch Control:* Variable within  $\pm 7\%$
- *Wow and Flutter:* 15 ips, 0.05%;  
(NAB weighted): 7.5 ips, 0.06%

MARK III/4 .....	\$3895.00
MARK III/2 .....	\$2795.00

## OTARI 5050BQ SERIES II PROFESSIONAL 1/4" FOUR CHANNEL RECORDER



The new Otari 5050BQ-Series II is the logical successor to the proven design and performance of the MX5050-QXD. More compact in overall design, the "BQ" 1/4", four channel machine retains features such as: dual speed (15/7 1/2 ips); variable speed D.C. capstan servo; selective reproduce; motion sensing control logic; built-in test and cue oscillator; plug-in heads; and easily accessible electronics adjustments.

An ideal professional machine for small studios, broadcast stations, educational or A/V facilities, and serious home recordists, the "BQ" now delivers additional performance and flexibility with these following new features:

- A proprietary microprocessor to govern transport control
- An electronic real-time counter with LED display
- Automatic monitor switching
- Selectable 20 dB microphone input attenuator on each channel
- Headphone monitoring for each channel (selectable combinations)
- Peak reading indicators on each channel
- Separate mic/line mixing on each channel
- Integral electronics chassis design

Tape Width & Channels: 1/4 inch

Tape Speeds: Switchable Speed Pairs: 3 3/4 / 7 1/2; 7 1/2 / 15 ips

Reel Size: 5, 7, or 10 1/2 inch, EIA or NAB

Heads: Four head stacks: erase (tracks 1 and 3), erase (tracks 2 and 4), record (four track), and reproduce (four track).

Connectors: Line input and line output, standard three-pin XLR. Microphone standard 1/4 inch phone jack.

(cont.)

Weight: 60 lbs.

Mounting: Vinyl covered wood cases (standard). Rack mounting kit and floor console (optional).

Standard Accessories: Vinyl covered wood cases, empty 10 1/2 inch NAB reel, NAB reel precision hold down knob, fuse, NAB reel shims, instruction manual.

Optional Accessories: Balanced 600 ohm line input and output transformers, remote control unit, floor console, rack mounting adaptors, and front and rear snap-on covers.

Height: 20 3/4"

Width: 17 1/4 inches

Depth: 11 1/4 inches

5050BQ-Series II .....	\$2995.00
------------------------	-----------

## OTARI 5050 MARK III/8 PROFESSIONAL 1/2" EIGHT CHANNEL RECORDER



The new Otari 5050 Mark III/8 is the logical successor to the proven design and performance of the MX5050-8D. More compact in overall design, the 1/2" eight channel machine retains features such as dual speed (15 & 7 1/2 ips); variable speed D.C. servo capstan; selective reproduce for overdubbing; motion sensing logic; built-in dual frequency test oscillator; and easily accessible electronics for rapid test and set-up. A true, three head design is used to yield unsurpassed performance in a 1/2" eight track machine.

The 5050 MARK III/8 is designed for recording studios, radio and television production studios, video and A/V facilities and serious musicians/composers who need a professional and compact machine. The MARK III/8 offers these new features for additional performance and flexibility:

- Proprietary microprocessors provide real time counting with L.E.D. display, dynamic braking and transport logic
- Automatic monitor switching
- Headphone monitoring for each channel (selectable combinations)
- Peak reading indicators on each channel

5050 MARK III/8 .....	\$5295.00
-----------------------	-----------

**THE MOST CONVENIENT  
WAY TO ORDER FROM ALLIED IS BY  
TELEPHONE — SEE INSIDE BACK COVER FOR  
MORE INFORMATION**

# 4

# RECORDERS

## OTARI MTR-10 SERIES PROFESSIONAL TWO & FOUR CHANNEL PRODUCTION/MASTERING RECORDERS

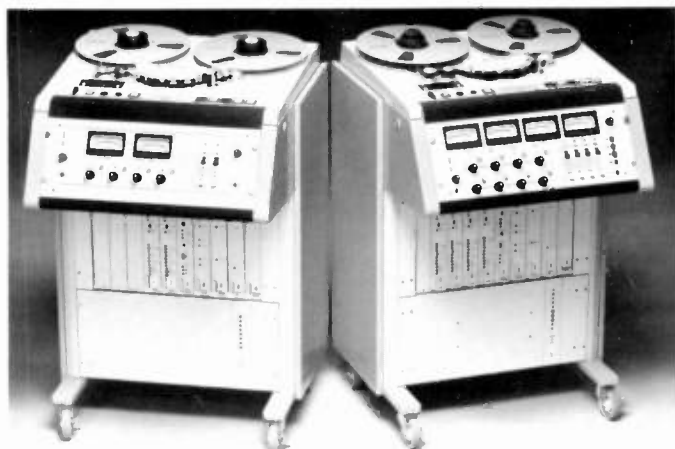

MTR-10-2

MTR-10-4

Offered in two professional formats, 1/4" two-channel and 1/2" four-channel, Otari's MTR-10 Series have been engineered to offer the professional the most advanced features and performance from state-of-the-art electronics and mechanical design. The MTR-10 Series yield a new level of performance for audio and video post-production applications because of the following features:

- Full D.C. PLL servo tape transport operation governed by an on board microprocessor.
- Transport logic and real time counting are controlled by a separate proprietary microprocessor.
- Direct-coupled outputs; active balancing of inputs and outputs. Transformers are optionally available.
- Audio and transport electronics card frame is located conveniently for ease of adjustment and servicing.
- Adjustable phase compensation, bias, record and playback levels which are aided by an internal multi-frequency square/sine wave generator.
- Hinged-top transport deckplate for easy access.
- ± 20% stepless vari-speed, readout can be in ips, percentage of variation or blank.
- Return-to-zero feature is standard
- Optional tape locator with ten position memory and shuttle.
- Rear-panel interface to transport and time-base functions for SMPTE interlock.
- Fast threading, simple tape path.
- Tape splicing block, selectable edit modes, tape shuttle control, NAB adaptors, and desk-height console on casters.

The four channel model, MTR-10-4 is also easily converted to 1/4", two channel with a simple plug-in headblock change. Whether the application is for recording studio, broadcast production, soundtrack or advanced industrial requirements, the MTR-10 Series will deliver exceptional quality master recordings with the highest reliability obtainable in a professional recorder.

Tape Speed (3 speeds, 2 versions): 30/15/7.5 ips or 15/7.5/3.75 ips

Speed Deviation: ± 0.03%

Wow & Flutter: at 30 ips: 0.04% Unweighted. At 15 ips: 0.06% Unweighted

Control: Microprocessor, Full D.C. Servo

I/O: Input: 20K balanced (transformerless), transformer balancing optional.

(cont.)

Output: Transformerless, direct coupled and balanced, transformer balancing optional.

Source Impedance: less than 5 ohms

Load Impedance: 200 ohms or greater

Maximum Level: + 28 dBm

Equalization: Switchable, NAB/IEC/AES

Record Level: Switchable, 320/250/185 nWb/m

Frequency Response: 30 ips: 1/4", 2-Track—40 to 28 kHz ± 2.0 dB. 1/2", 4-Track—60 to 28kHz ± 2.0 dB.

15 ips: 1/4", 2-Track—30 to 20kHz ± 2.0 dB. 1/2", 4-Track—30 to 20kHz ± 2.0 dB

Signal-To-Noise Ratio: (Unweighted): 30Hz-18kHz at 520 nWb/m measured with Scotch 226 tape.

30 ips: AES: 66 dB/2-Track

15 ips: NAB: 65 dB/2-Track & 4-Track

Distortion: 0.3% or less at 1kHz with 250 nWb/m

Erase Effect: Better than 80 dB

External Servo Capability: Yes

Return-To-Zero: Yes (no overshoot)

Standard Reference Level: Input and Output

Test Oscillator: 100, 1K, 10K sine wave, 1K, 10K square wave

MTR-10-2 . . . As shown . . . . . \$6450.00

MTR-10-4 . . . As shown . . . . . \$8450.00

CB-109 (Transport, RTZ, + 10 memory and Vari-Speed remote control) . . . . . \$ 700.00

CB-111 (Transport plus RTZ and Vari-Speed remote control) . . . . . \$ 300.00

CK-42 (4 trk. to 2 trk. conversion kit) . . . . . \$ 835.00

Overbridge version available

## OTARI MX7800 RECORDER



- 1 inch, 8 track
- Full-servo constant-tension tape drive
- Dynamic braking
- 30/15 ips (15/7½ on special order)
- Coarse and fine ± 12% pitch controls
- DC capstan servo with direct drive motor

(cont.)

# 4

## RECORDERS

- Automatic monitor switching
- Built-in 700 and 15,000 Hz test oscillator
- Rapid access to transport and electronics

MX7800 .....	\$10,900.00
CB-105 .....	\$700.00
ZA- 52C Timer .....	\$400.00
IPT Balanced Input Transformers, each .....	\$60.00

### OTARI ARS-1000 AUTOMATED RADIO STATION REPRODUCER



Widely used in leading automation systems. Specifically designed to meet their stringent requirements for highest audio performance, long term reliability and around-the-clock operation. Basically, the ARS-1000 is a work horse two-channel stereo reproducer with two tape speeds (7½ and 3¾ ips) and the following features: heavy duty 19-inch top plate, head mounted preamp to minimize hum and RFI and yield superior S/N. It's easy to maintain with its plug-in PCB's and mother board configuration, easy-access flip-up head cover, and front adjustable output level and head azimuth (to minimize stereo phasing errors). Its operating features include remotable Play and Stop, a ready light to indicate proper tape threading, head lifters for fast modes, a cue control for audible monitoring and optional 25 Hz cue tone sensor. All connectors are brought out to a single 25 pin Cinch connector.

ARS-1000 DC with tone sensors .....	\$1595.00
ARS-1000 DS less tone sensors .....	\$1535.00

### REVOX PR99 REPRODUCE ONLY

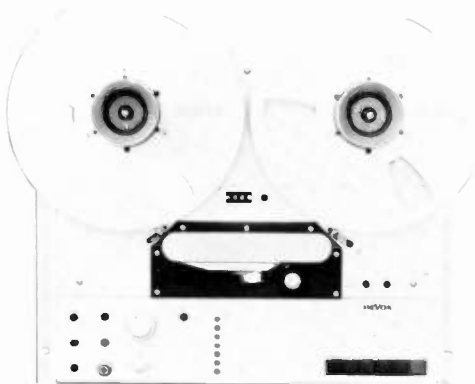

PR99 .....	\$1449.00
------------	-----------

### SCULLY 250 SERIES RECORDER/REPRODUCER



#### Series 250 Recorder/Reproducer

250-FT Full Track, Mono .....	\$2620.00
250-1 Half Track, Mono .....	\$2620.00
250-2 Two Track, Stereo .....	\$2745.00
250-24 Quarter Track, Stereo .....	\$2745.00

Two Speeds—Specify 7.5—15 in/s or 3.75-7.5 in/s When Ordering.

#### Series 255 Reproducer Only

255-FT Full Track, Mono .....	\$1525.00
255-1 Half Track, Mono .....	\$1525.00
255-2 Two Track, Stereo .....	\$1595.00
255-24 Quarter Track, Stereo .....	\$1595.00

Single Speed—7.5 in/s Standard; 3.75 in/s Available on Request.

Mic Preamps, input/output transformer, 25 Hz tone sensor, remote control, extender board, optional at extra cost.

### SCULLY 270 SERIES PROFESSIONAL LONG PLAY RECORDER

The Scully 270 professional long play reproducer has become the standard of excellence in the automated broadcast industry. Designed to run for long periods, reliably and with trouble-free performance, the 270 is an extra-rugged, heavy duty reproducer designed and built with typical Scully craftsmanship.

Last of the 14" playbacks.

HEAD CONFIGURATION: Monophonic half or full-track; stereo 2 or quarter-track.

TAPE SPEED: 3¾—7½ ips; 7½—15 ips.

TAPE WIDTH: ¼"

REEL SIZE: Up to 14".

270-FT mono F.T. ....	\$4325.00
270-1 mono ½ T., bi-directional .....	\$4485.00
270-2 stereo 2 T., 2-channel .....	\$4870.00
270-44 stereo ¼ T., 2-channel, bi-directional .	\$5345.00

**ALLIED HANDLES OVER  
160 PRODUCT LINES - SEE INSIDE BACK COVER  
FOR COMPLETE LISTING**



# RECORDERS

## SCULLY 285B REPRODUCER

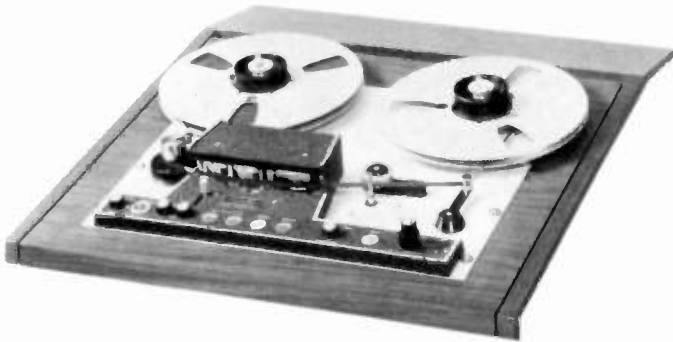

The Scully 285B Reproducer is a professional quality playback or editing system for broadcast or studio applications, as automated tape players, quality control monitors, broadcast control room reproducers, or music library reproducers. The 285B electronics include 600 ohm line output and 8 ohm (3 watt) speaker output for cueing, editing and monitoring. Speaker gain control is on the front panel.

- 1/4" tape, up to 11.5" reels

285B-FT	Mono Full Track	.....	\$3383.00
285B-2	Stereo 2 Track, 2 Channel	.....	\$3505.00
285B-24	Stereo Qtr. Track, 2 Channel	.....	\$3505.00

## SCULLY 280B PRO RECORDING SYSTEM



A Benchmark! Scully's 280B continues to be a leader. Heavy-duty, precision, professional... The phrases have never been better applied.

All the important features you seek in a pro recording system including motion-direction sensing, dynamic braking, and constant tension are incorporated with a machine full of desirables.

Scully offers either AC or servo drive. The servo drive permits vari-pitch control. Two advantages are gained, in addition to servo control: The ability to adjust pitch up or down to a desired level; and the more positive tape drive at all speeds afforded by the large capstan and pinch roller in the servo system.

All this adds up to a standard in broadcast and studio recording where smooth, positive tape handling, low noise electronics, and control convenience provide truly professional results. (cont.)

		A.C.	Servo
280B-FT	1/4" Mono, Full Track	.....	\$3990.00 \$4350.00
280B-1	1/4" Mono, Half Track	.....	\$3990.00 \$4350.00
280B-2	1/4" Ster., 2 Trk, 2 Chan	.....	\$5025.00 \$5385.00
280B-4	1/2" Quad, 4 Trk, 4 Chan	.....	\$7015.00 \$7375.00
Consoles Extra			
280B-24	1/4" Stereo Qtr. Trk., 2 Chan	.....	\$5075.00 \$5440.00
280B-44	1/4" Quad 4-Trk, 4 Chan	.....	\$7134.00 \$7620.00

## SCULLY 284B SERIES RECORDER/REPRODUCER



Scully's Master Recorder/Reproducer is available in an eight channel version using the popular low noise 280B electronics. These 284B-8's use 1" tape for maximum eight-channel separation and quality; up to 14" tape reels to provide a realistic supply of tape for program-length recording and post-production. The 284B-8 has motion-direction sensing, dynamic braking, and automatic start-torque boost for smooth, positive tape shuttling; uses Scully's new constant tension system for added tape handling precision in the Play/Record modes. Scully DC capstan servo drives are standard on all units, as is the variable pitch control. Any two specified adjacent speed-pairs will be present when the machine is ordered. Equalization is automatically switched with speed control. A sturdy console cabinet is included as standard equipment. These features make the Scully 284B-8 the most desirable eight-track system in its price range.

ACCESSORIES: Vari-Sync Accessory, remote transport control.

284B-8	1" 8 Track, 8 Channel (complete w/servo & console)	.....	\$13,915.00
--------	--	-------	-------------

WE HONOR





# RECORDERS

## AMPEX ATR-700 SERIES RECORDER



ATR-700-1	F.T.	1/4"	\$1995.00
ATR-700-2	2 T.	1/4"	\$1995.00

Please specify 3 3/4 / 7 1/2 ips or 7 1/2 / 15 ips

NAB hubs, connectors, rack screws, extender board, etc. included.

## AMPEX ATR-800 AUDIO RECORDER



In a busy broadcast environment, every minute counts. That's why Ampex designed the ATR-800 with saving time in mind. With more standard features than any other recorder in its class, the ATR-800 is the perfect choice for broadcast professionals and recording studio engineers.

The ATR-800 has a built-in cue amplifier to permit monitoring of a single channel or multiple channels during editing, or while the unit is being cued; it has hands-on reel and tape dump modes for manual editing convenience; and is equipped with a variable shuttle control to regulate speed and direction. Standard on the system is the single point search-to-cue, which allows the recorder to return automatically to a designated cue or edit point. An electronic tape timer enhances editing capabilities of the recorder by providing accurate timing of recorded segments at 7 1/2, 15 and 30 ips, in hours, minutes, and seconds.

The ATR-800 has a new quick change head assembly  
(cont.)

which is made of metal laminate construction. The recorder has been designed to accommodate a fourth head for playback of two different tape formats without requiring head change. The variable speed mode on the unit permits recording and playback of up to ±10 percent of nominal speed to correct tape recordings made off speed, or for special effects. The ATR-800 is available in one-, two-, and four-channel configurations. The basic two-channel model is priced at \$5,450 which you can lease for as little as \$154 per month plus taxes.

ATR800-1U	F.T.	\$5195.00
ATR800-2U	2T. Stereo	\$5450.00
ATR800-4U	4 T.	\$7145.00
Console Cabinet	1 or 2 T.	\$495.00
Console Cabinet	4 T.	\$545.00
Rollaround Pedestal		\$395.00

## AMPEX ATR-100 SERIES RECORDER



Four standard record/playback speeds are available on all ATR-100 Series recorders, any two of which can be selected—or changed—by the user. The speeds do not even have to be adjacent. Choose any pair from 3 3/4, 7 1/2, 15 or 30 inches per second. You can order a 7 1/2 / 15 in/s version, for example and later set it up for any other speed pair, even 3 3/4 and 30 in/s if you wish.

ATR-101	F.T.	1/4"	\$6500.00
ATR-102	2 T.	1/4"	\$8100.00
ATR-104	4 T.	1/2"	\$10,850.00

**QUESTION CONCERNING  
YOUR ORDER? CALL (317) 962-8596 AND ASK FOR  
CUSTOMER SERVICE**



# RECORDERS

## REVOX B77 TAPE RECORDER



- Integrated Drive Logic
- Operation by Computer-Type Pushpoint Keys
- Cutter Device to Facilitate Tape Editing

**B77 Standard 2 or 4 Track ..... \$1799.00**

## REVOX PR-99 RECORDER



As a broadcaster you know the value of Studer reliability — and the importance of Revox economy. Now both are built into the Revox PR99. And what's more, it's designed specifically for your needs.

The PR99 offers balanced inputs and outputs; XLR-type connections, with calibrated or uncalibrated levels; and ASA-VU metering with LED peak indicators.

The rugged die-cast chassis is designed for rack or console mounting. Reel capacity is 10.5 inches and tape speeds are selectable at 3.75, 7.5 or 15 ips with a vari-speed remote control option.

Complete editing facilities include dump editing, full head access and 2-way self-sync which help make the PR99 the best machine in its class.

The Studer designed transport and die-cast head assembly block and tension arms provide instant smooth start-up and outstanding tape handling.

Here's traditional Studer quality built into the Revox PR99. Perfect for broadcasters or any professional.

**PR-99 ..... \$2095.00**

## TASCAM SERIES 30 MODEL 32



Half Track Master Recorder/Reproducer 1/4" Tape

- 10 1/2" Reel Capacity
- 15 and 7 1/2 ips
- Independent Record Mode L&R
- Simul-Sync
- Full Frequency Response in Sync Mode
- Zero Return
- Punch In/Out Recording
- Pitch Control ± 12%
- Dump Edit
- Mic Inputs
- Independent Input/Output Level Control
- Headphone Jack & Volume Control
- Cue Control
- Digital Tape Counter

See 34 for nominal specs

**Tascam Series 30 Model 32 ..... \$1300**

## TASCAM MODEL 34 RECORDER/REPRODUCER



TAPE WIDTH: 1/4"  
 REEL SIZE (Max.): 10 1/2"  
 TAPE SPEEDS: 15/7.5 ips  
 WOW & FLUTTER (Weighted): 15 ips 0.06% peak;  
 7 1/2 ips 0.09% peak  
 FAST WIND TIME (2400 ft., 10 1/2" reel): 90 sec.  
 DIMENSIONS: 16"W, 17.5"H, 8.43" D  
 WEIGHT: 44 lbs. Net  
 MOUNTING: Stands vertically or horizontally (on back);  
 can be rack mounted with optional RM-300 kit.  
 LINE: INPUT/OUTPUT: Unbalanced high impedance RCA  
 jacks, nominal level -10dBV (cont.)



# RECORDERS

THD at 1kHz: 0.8% at 0 VU; 3% at +13 VU  
 SIGNAL TO NOISE RATIO (NAB): 15 ips, 68dB A wtd.;  
 7½ ips, 66 dB A wtd.  
 ADJACENT CHANNEL CROSSTALK (overall, at  
 1kHz, 0 VU): Better than 50dB down  
 OVERALL FREQUENCY RESPONSE (Sync & Repro,  
 ±3dB) at 0 VU: 15 ips, 40Hz-22kHz; 7½ ips, 40Hz-16kHz  
 ERASURE DEPTH (at 1kHz, +10 VU reference):  
 less than 65dB  
 HEADROOM ABOVE 0 VU, at 1kHz:  
 Recording Amplifier, less than 25dB  
 Reproduce Amplifier, less than 43dB  
 SEARCH FUNCTION: Search-shuttle to 0000 when zero  
 search feature activated during rewind; not a simple  
 memory rewind.  
 CONNECTORS:  
 Line inputs & outputs: RCA jacks  
 Remote control: multi-pin  
 Punch in/out remote: ¼" phone  
 POWER REQUIREMENT: 73 W

Model 34 ..... \$1700.00

## TEAC TASCAM 22-2 RECORDER/REPRODUCER



Presenting the TASCAM 22-2, to provide the industry with the necessary function at an economical price.

The areas for practical compromise in order to reduce the cost, were the size of the reels, the need for bias and equalization switching and full remote control capability. The result is a 2-speed (15 and 7½ ips) transport with a new light touch locking switch Transport Control System, which is capable of remote pause in both the record and play modes.

This 3-motor, 3-head design is quite simply a classic. Two eddy-current outer rotor reel motors maintain positive torque balances to assure smooth, even tape handling and precise tape-to-head contact.

Our DC servo controlled capstan motor is specifically designed for speed accuracy. Deviations (Wow & Flutter) are kept to the absolute minimum.

All three heads—erase, record and reproduce—are standard half-track format. Fully independent electronics permit source or tape monitoring and record or reproduce mode to be selected independently for either track.

- Compact and lightweight - Ideal for remote recording.
- Independent monitor and record ready controls for each channel.
- Mic/Line Mixing
- Optional RP-22 remote pause control.
- Optional RM-22 rack mount kit (19" EIA)

(cont.)

- Optional TZ-530 dust cover.
- Dimensions: W 16-1/8" x H 12-7/8" x D 9-1/8"
- Weight: 30.8 lbs. net

22-2 ..... \$775.00  
 RP22 Remote Pause Control ..... \$ 35.00  
 RM-22 Rack Mount Kit ..... \$ 40.00

## DIGIMAX MODEL D1200



Please refer to Page 92 for complete information and pricing.

## TASCAM MODEL 38 RECORDER/REPRODUCER



TAPE WIDTH: ½"  
 REEL SIZE:(maximum): 10½"  
 TAPE SPEED: 15 ips  
 WOW & FLUTTER (weighted): 0.06% peak  
 FAST WIND TIME (2400 ft., 10½" reel): 100 sec.  
 DIMENSIONS: 16"W, 17.5"H, 10.75"D  
 WEIGHT: 59.5 lbs. Net  
 MOUNTING: Stands vertically or horizontally (on back);  
 can be rack mounted with optional RM-300 kit.  
 LINE: INPUT/OUTPUT: Unbalanced high impedance RCA  
 jacks, nominal level -10dBV  
 THD at 1kHz: 0.8% at 0 VU; 3% at +13 VU  
 SIGNAL TO NOISE RATIO (NAB): 68dB A wtd.  
 ADJACENT CHANNEL CROSSTALK (overall, at  
 1kHz, 0 VU): Better than 50dB down  
 OVERALL FREQUENCY RESPONSE (Sync & Repro,  
 3dB) at 0 VU: 40Hz-22kHz  
 ERASURE DEPTH (at 1kHz, +10 VU reference):  
 Less than 65dB  
 HEADROOM ABOVE 0 VU, at 1kHz:  
 Recording Amplifier: Less than 25dB  
 Reproduce Amplifier: Less than 43dB

(cont.)



# 4

# RECORDERS

**SEARCH FUNCTION:** Search-shuttle to 0000 when zero feature activated during rewind; not a simple memory rewind.

**CONNECTORS:**

- Line inputs & outputs: RCA jacks
- Remote control: multi-pin
- Punch in/out remote: 1/4" phone

**POWER REQUIREMENT:** 100 W

**Model 38** ..... \$2750.00

## TECHNICS RS-M85MK2 CASSETTE DECK

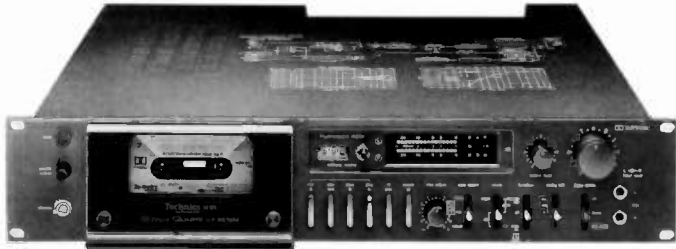

Behind its elegant "Flat-chassis" design, this cassette deck boasts a quartz-locked direct-drive capstan motor for durability and excellent speed control (wow and flutter is just 0.035% WRMS). Metal tape compatibility provides great specs: frequency response is 30-17,000Hz ± 3dB with metal tape, and S/N ratio is 69dB.

**RS-M85MK2** ..... \$750.00

## REVOX B710 MKII CASSETTE DECK

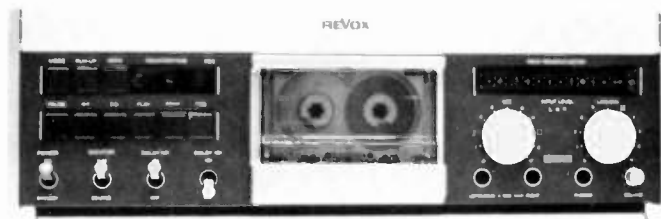

- Highly stable die-cast frame with 4 direct drive motors: two MMD motors under quartz-crystal control; separate precision DC reel motors with tacho generators controlled via microprocessor. Capstans employ wide-spaced dual bearings.
- Full microprocessor control for tape transport, counter, clock, and memory. Start/stop positions (tape counter and clock time) can be set and cancelled electronically. Loop function permits non-stop repetition. Timer function also controls switched AC outlet. 4-digit LED displays; standby function, in which clock remains on; automatic timer function, nonvolatile memory.

**B710** ..... \$1999.00

## TASCAM 122 CASSETTE DECK



**122** ..... \$725.00

## NAD 6150C STEREO CASSETTE DECK WITH DOLBY C NOISE REDUCTION

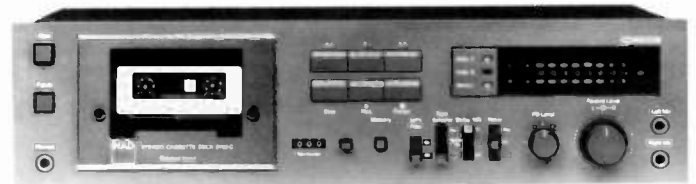

In the early 1970s the cassette recorder was transformed from a toy into a quality high-fidelity recording medium by the introduction of Dolby B noise reduction, high-coercivity tape (chromium dioxide), and reliable low-flutter tape transports. Now, in the early 1980s, cassette recording has again made a quantum leap forward in quality with the introduction of metal-particle tape and Dolby C noise reduction—and NAD leads the way with the debut of the Model 6150C.

**6150C** ..... \$398.00

## MARANTZ PORTABLE CASSETTE SYSTEMS



The Marantz 200 and 220 portable cassette systems are the obvious successors to the broadcast radio ENG format. Sony's TC-110 and TC-142 and Superscope's previous models 204, 205, 206, and 207 have been discontinued.

The new 200 and 220 by Marantz offer more to the Broadcast News Operation than ever before available.

- Outstanding Features Include: 15/16 ips (1/2 speed) or regular 1-7/8 ips
- Vari-speed control which allows correction of tapes which may have been recorded with less-than-full battery power
- DC servo controlled motor for accuracy under all conditions
- Tone Control
- PA/Play mix permits one of the most sought-after abilities: Live intro with optional microphone, actuality on tape, then back to live. (Using the cassette machine as an integral part of a telephone report)

In addition to features listed which are common to both machines, the 220 also has three heads and variable bias for normal, CrO<sub>2</sub>, and /FeCr Tape. FeCr tape permits a frequency response of up to 14 kHz.

**200 2 heads** ..... \$185.00  
**220 3 heads** ..... \$250.00

**Optional Accessories Include:**

**CLC-330 Carrying Case** ..... \$ 25.00  
**RBC-1 Rechargeable Battery Pack** ..... \$ 35.00



# REMOTE CONTROL

## OTARI DP4050-C2 CASSETTE COPYING MACHINE



Otari's new DP4050-C2 is a full professional 8:1 speed In-Cassette Duplicator System scaled down in size but not in performance, features, or reliability. Basically, the DP4050-C2 is a new family member of the world popular Otari DP4050 Series In-Cassette Duplicator.

It consists of one cassette master deck and two slave-recorders in one desk top type cabinet and expandable up to 11 slaves using 3 add-on slave units which contain 3 slaves each. Two C-30 copies may be made in less than two minutes, or two C-60's in less than four minutes. All tracks, four track stereo, are copied simultaneously in one pass so that the cassette doesn't have to be turned over to copy the other side.

**AUTOMATIC REWIND:** Photocell sensing of reflective tape at beginning and end of programme.

**FREQUENCY RESPONSE:** 50 to 10,000 Hz  $\pm$  3 dB. (with Maxell UD cassettes).

**WOW & FLUTTER:** 0.25% WRMS

**S/N RATIO:** Greater than 50 dB

**BIAS FREQUENCY:** 800 kHz

**TOTAL HARMONIC/DISTORTION:** Less than 1.5%

**EXPANDABILITY OF SLAVE UNIT:** Up to 3 (1 unit contains 3 slaves).

**AVERAGE PRODUCTION:** 30 C-60 cassettes per hour

**DP4050-C2 Master w/2 Slaves** ..... \$3295.00

**DP4050-Z3 3-Slave unit add-on** ..... \$3095.00

## OTARI DP4050-OCF PROFESSIONAL 8:1 IN-CASSETTE DUPLICATOR SYSTEM



Both sides of the cassette are recorded in one pass, either four track stereo or two track mono, so that cassettes do not have to be turned over to record the other side.

- Professional quality and reliability
- Two-speed reel-to-reel master (7½ or 3¾ ips) with 6 slaves
- 8:1 speed ratio; both sides duplicated in one pass
- Produces six C-30 copies in less than two minutes
- Handles C-30 through C-90 cassettes
- Duplicates ¼ or ½ track mono or ¼ track stereo
- Easy to operate by non-technical personnel
- Automatic rewind of master tape with easily applied reflective tape and photosense cell

**DP-4050-OCF** ..... \$8995.00



## MOSELEY MICROPROCESSOR REMOTE CONTROL

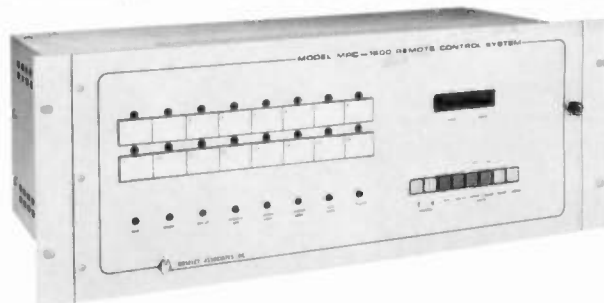

The MRC-1600 Microprocessor Remote Control offers microprocessor flexibility and sophistication in an economical and dependable package for general AM-FM remote control applications. It comes equipped with 16 status inputs, 16 telemetry inputs, 16 raise command outputs and 16 lower command outputs. Each command output is relay-isolated. Adapting the MRC-1600 to current system interconnections is easy. Plug-in modules can be ordered to accommodate almost any interconnection system, from standard 2-wire or 4-wire telephone lines to FM subcarriers, subaudible telemetry, or a custom combination of any of these.

The MRC-1600 front panel is simple to operate and easy to understand. All status channels are displayed simultaneously on a set of 16 LEDs. Alphanumeric LEDs give read-outs of selected channel number and telemetry data while 8 color-keyed LEDs indicate system operation mode, alarms, etc.

**MRC-1600** ..... \$3695

## MOSELEY TCS-2A TELECONTROL SYSTEM



(cont.)

(cont.)



# REMOTE CONTROL

TCS-2A COMMAND TERMINAL—Meets FCC requirements for AM and FM Transmitter Remote Control. Micro-processor based; multi-site capability. One-man calibration.

- 8 Channels Command
- 8 Channels Status
- 8 Channels Telemetry

TCS-2A ..... \$4495.00

**ALLIED HAS A LEASE  
PLAN TO SUIT YOUR INDIVIDUAL NEEDS**

## POWER PAK SMG-40 STEREO GENERATOR

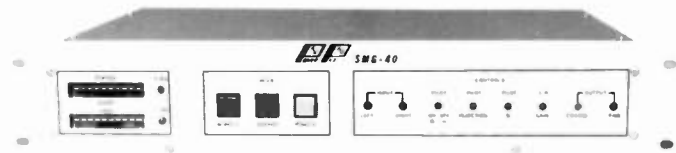

### SPECIFICATIONS

Separation	50 db or better
Distortion	.2% or less
Noise	-72 db or better
Cross talk	-60 db or better
Input	+ 10 dbm at 1 KHz. (Adj.)
Output	3 V. Peak-To-Peak, 600 ohm, (Adj.)

### FEATURES

- Dual LED Bar Graph Modulation Indicator
- Remote Stereo/Mono Control
- 19 KHz. Pilot In/Out - On/Off Provision
- Pre-Emphasis & Low Pass Filter Enable/Disable

SMG-40 ..... \$1895.00

## MOSELEY MODEL MRC-2 MICROPROCESSOR REMOTE CONTROL



The MRC-2 Microprocessor Remote Control System brings a new level of sophistication to remote control, telemetry and status acquisition. Not only have system size and operational capabilities been greatly expanded over previous remote control systems, but the use of the CRT Option allows plain-English displays and optional logging of command, status and telemetry functions. In addition,

(cont.)

the Automatic Control Option allows even greater capabilities by adding time-oriented and feedback-oriented command capabilities to the system.

These features translate into greater transmitter plant control and security at lower operating costs, very important factors in today's complex broadcast operation. The MRC-2 System provides the broadcaster with greater control of the transmitter plant through quick, positive monitoring and control of all desired parameters. Critical parameters, such as transmitter power output, are constantly monitored for compliance with pre-programmed tolerance limits, allowing maximum performance within regulatory and safe operating limits. The use of dual limits allows an operator or the system itself to adjust parameters before a critical limit is reached.

Plant security is improved by the ability of the MRC-2 to continuously monitor the transmitter facility for intrusion, fire, or equipment failure that could endanger the transmitter, its enclosure or peripheral equipment. The system can even employ backup communication links to improve system reliability.

The MRC-2 does not simply move the technical operations from the transmitter site to the studio, it also frees technical personnel from the need to operate the transmitter, reducing or eliminating human intervention for transmitter plant operation.

MRC-2 Systems Start at ..... \$14,995.00

## MOSELEY MRC-1 MICROPROCESSOR REMOTE CONTROL



In step with technology, the MRC-1 provides facilities and features only available before in much more elaborate, computer assisted systems. Up to 32 channels of status and telemetry, 64 command lines and 9 separate remote sites outline the capabilities.

Keyboard telemetry calibration, programmable assignment of control, full telemetry tolerance alarming, momentary/latching control and status, as well as software power to linear conversion, and indirect power calculation are provided. Automatic Logging, CRT, Multiple Direct Command, and Long Term Memory optionally available.

MRC-1 Systems start at ..... \$6995.00

## DELTA ELECTRONICS RCS-1 REMOTE CONTROL ATS SYSTEM

It talks to you! This unit provides a basic simplified approach to today's micro-processor technology. The RCS-1 displays all parameters on a video monitor, simplifying operation for non-technical operators.

The RCS-1 is modular so the engineer need only purchase the number of plug-in metering and control channel boards that are required. Additional boards or options may be added later.

(cont.)



# REMOTE CONTROL



Options include a Modulation Monitor Bargraph (patent pending) complete with peak indicators, an Autolog Printer Option to provide hard-copy logs, and a Telephone Coupler Option that permits the RCS-1 to "talk" via synthesized speech to the engineer. The system is competitively priced with other microprocessor-based remote control systems. An ATS option will soon be available. A detailed data sheet can be obtained by calling Allied Broadcast Equipment.

**RCS-1 Basic systems start at about . . . . . \$13,000.00**

## QEI MODEL 7775 FM AUTOMATIC TRANSMISSION SYSTEM

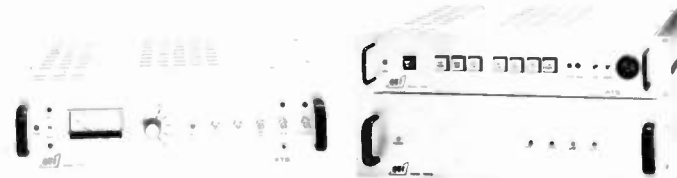

- Fully complies with parts 73.340, 73.342, 73.344, and 73.346 of the FCC rules and regulations for commercial FM Broadcast Stations.
- Failsafe design with internal, once per minute, automatic system verification.
- Compatible with all brands and models of FM transmitters.
- Designed to interface with the stations existing remote control system if desired. No additional equipment is necessary.
- Remote control operation may be accomplished by STL, remote pickup or a single voice grade phone line.
- Self-contained design. No special interfacing equipment is required for existing local or remote controlled stations.
- A high quality, crystal controlled, FM Receiver is included in the studio unit for off-air monitoring.
- All automatic control functions are performed at the transmitter site for maximum reliability and minimum of complexity.
- Control of the station's modulation level is performed on the output of the stereo generator or Composite STL receiver rather than directly on the program lines. In this manner, proper phasing is preserved with no loss in stereo performance.
- A modulation detector is built into the transmitter unit to eliminate the need to interface with the stations existing modulation monitor.
- Power can be controlled by the direct or indirect method
- Individual, engraved, illuminated indicators for displaying the following conditions:

- Over Power
- Over Modulation
- ATS System Failure
- Tower Lights
- Loss of Modulation
- Loss of Transmitter Power Output
- Low Power Output

• **WARRANTY: One year Parts and Labor.**

**Model 7775 . . . . . \$4495.00**

## HALLIKAINEN DIGITAL TELEMETRY TEL 171



The TEL 171 converts your Moseley TRC-15AW or TRC-15AR to digital metering transmission and the TEL 172 does the same for the Moseley PBR30, a method that eliminates the offset and gain drift in the analog metering. A local display in the transmitter control unit duplicates the readings displayed by the studio control unit. This permits one-man weekly meter calibration.

The system consists of printed circuit boards which substitute directly for the audible metering generator, the audible metering demodulator, and the meter. The local display for the transmitter control unit includes a replacement front panel and a liquid crystal display printed circuit board.

Installation is quick and simple since the same PC mounting hardware is used, and the same wiring harness connects to the new boards.

3½ digit (-1999 to +1999) display are used. These easily read displays are updated twice a second. Should the metering carrier be lost, or a framing or parity error occur, the display at the studio will blank and a front panel LED will indicate the problem.

Through the use of digital transmission and display, we eliminate the error inherent in analog transmission, and simplify the task of remote calibration and meter reading.

**TEL 171 For Moseley TRC-15AW or AR . . . . . \$800.00**

**TEL 172 For Moseley PBR-30 . . . . . \$920.00**

## BIRD HARMONIC FILTER-COUPPLERS



Contact Allied for details and pricing.

(cont.)

**REMOTE PICK-UP**

**MARTI REMOTE PICKUP SYSTEM**



Marti is a generic for remote pickup. "Hook up the Marti unit . . . We'll broadcast it on the Marti Unit."  
 Broadcasters all over America are short circuiting their local telephone companies in favor of shooting the game, grand opening, news report, etc. directly back to the station. Marti pricing permits easy justification for the initial expense by paying for itself in a very short time.  
 For maximum coverage and use, remember: Use the largest practical coax at your receiver to overcome the downlead loss (don't lose any of that precious free signal in the downlead that you don't have to); Yagi antennas at the transmitting site will channel all the Marti transmitter's energy in one direction . . . back to your station; and, if the downlead at the receiving end is inordinately long, invest in a Marti preamp.\* Everything you do to insure maximum signal upon installation will permit further remotes and fewer telephone loops. Use no RG8.  
 \* Preamps may not be used on HOT AM towers.

**AMPEX & SCOTCH RECORDING TAPE**



Professional recording tape in all sizes and formulas. Scotch & Ampex.

**MARTI RPT-2/150 & RPT-2/450 PORTABLE BROADCAST REMOTE PICKUP TRANSMITTERS**



- 2.5 Watts
- Portable operation on internal rechargeable nickel-cadmium battery. Total weight only 5¼ lbs.
- All solid-state
- Built-in battery charger
- Dual frequency operation (one crystal included)
- Whip antenna mounted directly on unit
- Broadcast-quality compressor/limiter handles toughest remote pickup conditions
- Two microphone inputs (one push-to-talk) and one Hi-Level input each with individual mixing gain control
- 15 Watt unit now available

**SPEAKERS**

**ALC 10302 SPEAKER**



The ANNOUNCER full range loudspeaker is the ultimate in performance in a compact size. The wood cabinet is covered in walnut grained vinyl and is perfectly square, 7-7/8" cube. As with all ALC loudspeakers, the grill snaps away and the system has a protective fuse.

**ALC 10302 . . . . . \$60.00**



# SPEAKERS

## ALC 20106 SPEAKER

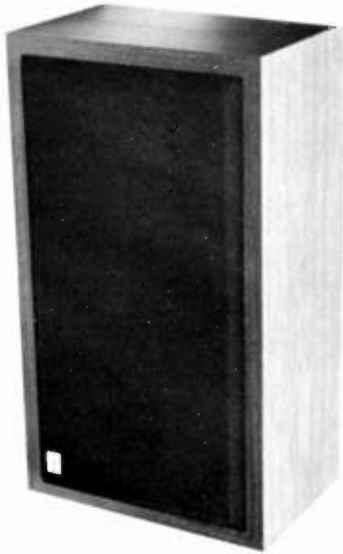

The MONITOR-II full range system incorporated two 4½" transducers each with a 10 oz. magnet, in a ported cabinet. A series L-C network and two L-pads on the front panel allow adjustment of high frequency response and contour between low and midrange.

- Size: 19½" x 11" x 7¼"
- Weight: 20 lbs. Net

ALC 20106 ..... \$113.00

## ALC 20306 SPEAKER



The MONITOR 2-way system incorporates an 8" woofer with a 14 oz. magnet in a ported cabinet; combined with an L-C crossover network at 2800 Hz; L-pad, and a 1¾" phenolic ring tweeter with a 2.4 oz. magnet.

- Size: 19½" x 11" x 7¼"
- Weight: 20.25 lbs. Net

ALC 20306 ..... \$131.00

**ALLIED HANDLES OVER  
160 PRODUCT LINES - SEE INSIDE BACK COVER  
FOR COMPLETE LISTING**

## TOA RS21M SPEAKER

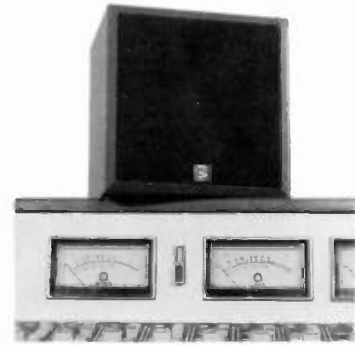

Only 6.7" square by 5.9" deep. Great for "What a spot will sound like at home or in the car."

TOA RS21M ..... \$99.00 pair

## OMNIMOUNT MOUNTING SYSTEM

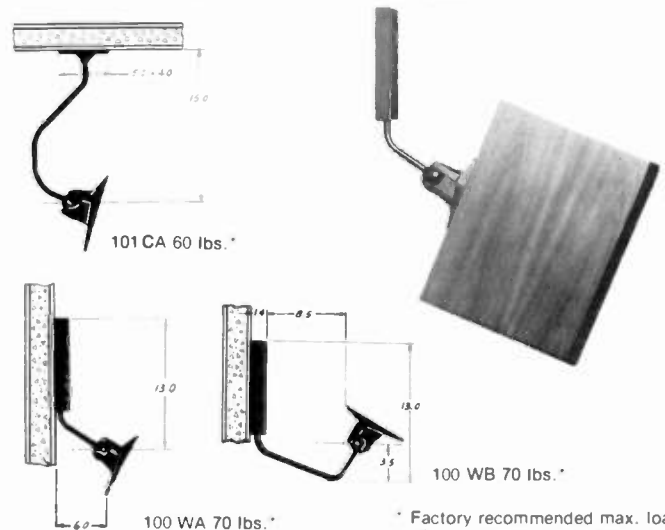

\* Factory recommended max. load when properly installed.

Omnimount is of industrial quality, built to last a long time. A key to its remarkable performance is the ball joint design. The ball is moulded of an ebonite polymer compound, with excellent memory-return; and it is just about indestructible.

The ball is bonded to the thick-walled carbon steel tube in the same way that heavy duty motor mounts are bonded. The clamp/flange is made of 356-T6 aluminum alloy. The ball-and-clamp unit decouples electricity and helps absorb vibration. The Omnimount System ends up so stable, it is even used in moving vehicles.

You can mount Omnimount on the wall or ceiling. It does its job with extraordinary flexibility, not limited to the usual "pan and tilt" functions.

Little things mean a lot, too, with Omnimount. For example, the leads can dress-down right through the tube for a neat and clean installation.

Omnimount is one of a kind. You'll know why when you use it. With Omnimount, you can focus speakers so that a balanced stereo image is directed to any point within a wide listening area. The sound stays where it belongs and goes where it belongs—in splendid acoustic isolation. Omnimount looks great of itself—when you see it. Its job is not really to be seen, but to make whatever you put on it look and work its best, as if magically in mid air.

Omnimount ..... \$59.95



# SPEAKERS

## ELECTRO-VOICE SENTRY 100 RACK-MOUNTABLE BROADCAST/RECORDING STUDIO MONITOR



It's here at last! The compact high-performance monitor speaker system that is specifically human engineered to meet the complex demands of today's broadcast, recording and production studios.

The Sentry 100 is sized for use in those tight quarters where serious monitoring is required but high-quality systems have previously been too large. Cabinet dimensions are only 17.25" high x 12" wide x 11.125" deep. And, it's even rack-mountable!

- Frequency Response: 1 meter on axis, 45 to 18,000 Hz, Sound pressure level at 1 meter, 91 dB/watt.
- Long-Term Average Power-Handling Capacity (above 40 Hz): 30 watts
- Net Weight: 28 lbs.

Sentry 100 ..... \$219.00  
 SRB-7 Accessory Rack Mounts ..... \$ 18.00

## ELECTRO VOICE SENTRY 500 MONITOR SPEAKER



- Constant Directivity Monitor System
- 40 to 18,000Hz
- Efficiency: 1w/m = 96dB spl
- 100 watt average capacity

Sentry 500 ..... \$458.00

## CALZONE CUSTOM BUILT CASES



Custom built cases to fit almost any need.

Call an Allied Sales Professional with all your case needs — he'll be glad to quote you a price.

## JBL MODEL 4401 STUDIO MONITOR



The most compact of the JBL studio monitors, the new 4401 is ideal for use as a main monitor in applications where space is at a premium. Its exceptionally flat direct-field response also makes the 4401 an excellent choice for use as a console-mount secondary monitor.

(cont.)



# SPEAKERS STL

- Smooth, accurate response from 70Hz to 18kHz ( ± 3dB)
- Sensitivity: 88dB SPL, 1W, 1m
- Components: 6½ in. low frequency loud speaker, 1 in. high frequency dome radiator
- Oiled walnut enclosure

OPTIONAL EQUIPMENT: MC4401 Speaker Cradle for free standing use or wall or ceiling mount.

DIMENSIONS: 14¾ in. x 9-3/8 in. x 7-3/16 in. deep  
SHIPPING WEIGHT: 35 lbs.

4401 ..... \$177.00

MC4401 Cradle ..... \$30.00

## JBL 4411 CONTROL MONITOR



As technology improves dramatically, the demands placed on studio monitor loudspeaker systems increase. Digital and advanced analog recording techniques require monitors of high accuracy, high power handling, and exceptionally wide dynamic range. Traditional monitor requirements of high power handling and rugged construction gain additional importance.

The 4411 is a three-way system with the drivers arranged in a close cluster to permit close-in monitoring. Mirror imaging improves the stereo perspective.

FINISH: Oiled walnut

GRILLE COLOR: Dark Blue

DIMENSIONS: 23¼ in. x 14½ in. x 12-7/8 in. deep

NET WEIGHT: 52 lbs.

SHIPPING WEIGHT: 59 lbs.

4411 ..... \$534.00

JBL . . . The most extensively used monitor for broadcast and recording facilities. Available in a wide range of configurations and prices, this is the quality control tool most desired by sound professionals for their finished product.



## MOSELEY AURAL STUDIO-TRANSMITTER LINKS

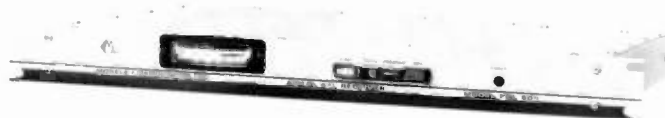

The Model PCL-505 and PCL-505/C composite Aural Studio-Transmitter Links offer superior program handling capabilities. State-of-the-art strip-line techniques and direct FM provide completely dependable performance.

(cont.)

Solid-state integrated circuitry and continuous duty design make for ease of operation and maintenance.

PCL-505 System, Single Channel ..... \$5595.00  
PCL-505C Composite for Stereo System ..... \$5995.00

## MOSELEY PCL 606 STUDIO TRANSMITTER LINK

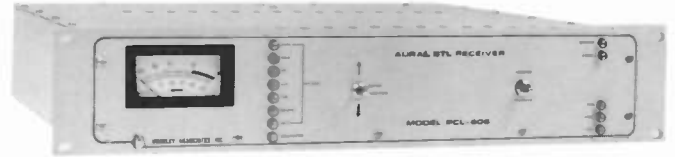

The new 606 and 606C offer, for the first time, a system capable of delivering STL signals worthy of the 1980's new breed of FM exciters and transmitters. Exhibiting noise and distortion specifications which will permit all your links to be strong, the 606 is non-composite and the 606C is composite.

Moseley PCL 606, Single Channel ..... \$7395.00  
Moseley PCL 606C, Composite for Stereo ..... \$7595.00

## MARTI AURAL STUDIO-TRANSMITTER LINK



### STL-8 TRANSMITTER

- All solid state
- Direct FM modulator
- Modular construction
- Test meter built-in
- Proven reliability in hundreds of installations
- Unsurpassed for dual channel stereo STL, Single channel AM STL or inter City Relay.

### Specifications—Stereo

- Stereo Cross Talk . . . -65 dB
- Noise . . . -65 dB or less
- Response . . . ± 0.5 dB 30-15,000 Hz
- Distortion . . . Less than 0.5%

### STL PACKAGES

Package A AM and/or FM Monaural ..... \$2680.00

(1) STL-8 Transmitter, c/w crystal & tuned

(1) R-200/950 Receiver, c/w crystals & tuned

Package B AM and/or FM Monaural w/HOT STANDBY ..... \$5935.00

(2) STL-8 Transmitters, c/w crystals & tuned

(2) R-200/950 Receiver, c/w crystals & tuned

(1) ASO-8A Transmitter switcher

(1) ASO-200A Receiver switcher

Package C FM Stereo ..... \$4965.00

(2) STL-8 Transmitters, c/w crystals & tuned

(cont.)



- (2) R-200/950 Receivers, c/w crystals & tuned
- (1) HRC-8 Transmitter combiner
- (1) MTS-1 Receiver combiner
- Package D FM stereo w/HOT STANDBY . . . . \$10,950.00
- (4) STL-8 Transmitters, c/w crystals & tuned
- (4) R-200/950 Receivers, c/w crystals & tuned
- (2) HRC-8 Transmitter combiners
- (2) MTS-1 Receiver combiners
- (1) ASO-8A Transmitter switcher
- (1) ASO-200A Receiver switcher

**MOSELEY TRL-1 TELEMETRY RETURN LINK**



The TRL-1 Telemetry Return Link allows you to transmit telemetry or control data to or from your control point on the 450 MHz band. The TRL-1 receiver and transmitter characteristics have been optimally selected for continuous duty and unattended service. An optional MCW identifier and battery pack as well as a separate MIC input for voice communication are also provided.

- TRL-1 . . . . . \$2995.00
- MCW Identifier . . . . . \$ 275.00
- Battery Pak is available

**SCALA PR-450U ANTENNA**

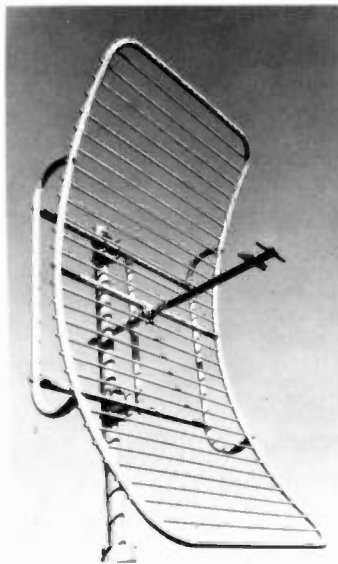

- Aural Broadcast STL
- UHF-TV Reception
- UHF-TV Translators
- Telemetry

- PR-450U . . . . . \$450.00
- Vertical or Horizontal Polarization
- Call Allied for Information on Any Scala Antenna

**ANIXTER-MARK MICROWAVE GRID PARABOLIC ANTENNAS**

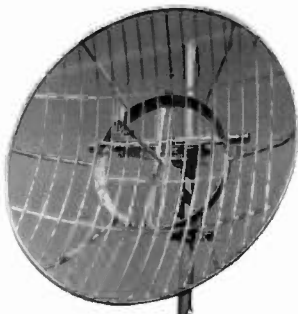

(cont.)

- Aural STL applications meets or exceeds all existing FCC requirements
- Lightweight, yet extremely strong
- Cross polarization discrimination response exceeds solid parabola

Vertical or Horizontal Polarization  
Call Allied for Pricing



**ELGIN EC-30A VOICE COUPLER**



**PURPOSE**—Provide 2-wire connection of customer-provided (CP) voice transmitting and/or receiving equipment to telephone lines. This is the telco accepted method of direct connection to the switched networks. The coupler provides dc isolation and limits excessive signals.

- EC-30A . . . . . \$42.00

**ELGIN ESC20721-1 RDMZR**



The Elgin ESC20721-1, when interfaced between a telephone line and your air sound, will permit any potential time buyer to hear your air sound simply by dialing the appropriate number — anywhere in the world!

Also great for multi-feed remote pick-up. The subscriber simply dials the number assigned, is answered by the pre-arranged program feed via the RDMZR and contact is made without personal intervention at the feed end. The RDMZR must see a battery reversal or momentary open from the locally associated central office or it will not hang up. Check with your local telephone company. \*\*

\*\*New TD-4 Dial tone detector now permits use of 20721 in all telephone systems. See page 110

- ESC20721-1 RDMZR . . . . . \$215.00
- Required 2012B transformer . . . . . \$9.75
- If multi-pin connector is required for connection with your equipment — 42F249 + 45F991 . . . . . \$10.00
- \*\*TD-4 Dial tone detector . . . . . \$54.00

**ALLIED HAS A LEASE  
PLAN TO SUIT YOUR INDIVIDUAL NEEDS**



# TELEPHONE EQUIPMENT

## ELGIN ERC 19645-4 RCZ RECORDER CONNECTOR



The 19645 RCZ recorder connector provides interface between the telephone and/or multi-line key pad and the input to your audio equipment. A defeatable beep occurs every 15 seconds, and AGC keeps both sides of the conversation just about equal in level. Ideal for phone news actualities, talk shows, and remotes. Amplifies both sides of conversations. Not designed for sending audio back down a Telco line.

19645-4 RCZ ..... \$198.00  
Required 2012B transformer ..... \$ 9.75

## ELGIN ERC-19522-21 and ERC-19522-22



Elgin's 19522-21 & 22 are expressly for use with your automatic answering devices in conjunction with concert lines, weather lines, news lines, etc. Useful with answer-only and answer-record message situations. A beep tone is provided to inform the caller when to leave his message on the 2W models.

The 21 model is self-powered.

The 22 model is self-powered and includes a VOX card which automatically disconnects the coupler from the line after 12 seconds of dial tone or no audio. Central office action as described for model 20721 must occur with model 21. If no battery reversal or momentary open is provided by the exchange, model 22 should be ordered. If only an answer function is required, the 21 will be sufficient. The associated customer provided machinery must supply the end signal with the 21 model if no open or reversal is available. All 19522 models provide NC/NO contact functions at beginning and end of desired cycle.

19522-21 RDL ..... \$310.00  
19522-21-2W RDM ..... \$302.00  
19522-22 RDL ..... \$382.00  
19522-22-2W RDM ..... \$374.00  
If multi-pin connector is required for connection  
with your equipment — 43F250 + 29F2663 ..... \$ 10.25

## TELLABS TELEPHONE LINE EQUALIZATION



248C

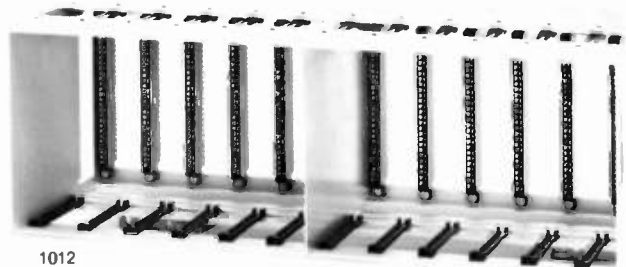

1012

The Tellabs line of equalization equipment was designed expressly for use with telephone circuits. No other form of equalization can offer the flexibility or specs necessary to achieve the quality for AM and/or FM (stereo) feeds via leased telephone circuits.

If the circuit is unloaded and if the length vs. gauge criterion is not exceeded, you can install your own equalization and pay for it in a very short time. The only alternative is to pay the telephone company a monthly fee for this service. If telephone circuit lines are a necessity in your operation, there's no reason for you to also pay for the eq on a monthly basis.

All Tellabs equipment is connected via the wire wrap method and all cabinets must be wired for application by the user. Wrap terminals .075".



4008



4424

4425

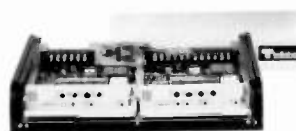

1913

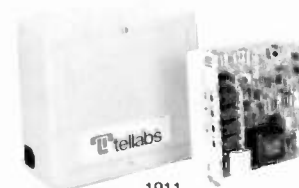

1911

ALLIED OFFERS PACKAGE DISCOUNTS

(cont.)



# TELEPHONE EQUIPMENT

A typical mono application would consist of:

1. 1 ea. 4424 repeat coil card
2. 2 ea. 1911\* housing
3. 1 ea. 4008 equalizer module
4. 1 ea. 1913 list 4 power transformer

A typical stereo application would consist of:

1. 1 ea. 4425 repeat coil card
2. 1 ea. 1911 repeat coil housing
3. 1 ea. 1913\* housing (dual, for 2, stereo, 4008 modules)
4. 2 ea. 4008 equalizer modules
5. 1 ea. 1913 list 4 power transformer

\*RF at receive end may necessitate 248RF cabinet which is designed with suppression and bypassing especially for use in RF-intense applications.

## TELEMIX



- Transformerless inputs and outputs.
- Unique conferencing system which provides maximum power transfer between line groups output.
- Connects to your console just as does any other program source.
- Telemix logic allows it to be slaved to mike circuitry: turning the mike on can automatically switch in the Telemix.
- Internal expansion circuitry acts as a noise-gate to the send audio. Low-level sound such as room noise or paper rustling are kept out of the mix.
- High-fidelity balanced-level mixing system.
- The internal electronic hybrid in Telemix allows you to remove and send audio from the telephone output if you wish.
- Bandpass filtering and send levels comply with FCC rules part 68 for interconnect equipment.
- Input is line-level bridging; the active input can be tailored to accept nearly any input level. The active output is 600 ohms balanced and its level is adjustable.
- Telemix send level and hybrid null are one-time adjustments.
- Telemix incorporates electronic "click-mute" to remove line-switching noises. No transients.
- Telemix features an "electronic hold" which quietly removes calls from the air and puts them on hold.
- To gain maximum use of the full facilities of Telemix, the use of a key service unit (KSU) is necessary, in which case it looks electrically just like any other desk set with push-buttons. Or parallel with existing multi-button phone. Existing phone may be taken in another studio for screening, hold function, etc.
- Use Telemix II directly on incoming lines in lieu of a KSU. However, KSU gives full tallies including hold, flash, off-hook, etc. Cannot be used directly with electronic system (Horizon, etc.). Separate KSU system must be installed before use in station with electronic system.
- The two Telemix modes enable you to answer calls off-air using your mike and headphones. Other logic arrangements are limited only by the imagination.
- Telemix incorporates a stereo headphone amplifier with bridging inputs. Normal stereo program audio is fed through Telemix and when a call is answered headphones can "split" with phone in one ear and program in the other.
- The Telemix "Caller-Override" allows you to vary the amount of caller-ducking from the full even two-way to the "Speakerphone" sound.
- Telemix is furnished with a comprehensive instruction manual which includes information on interconnection to most telephone systems. Further assistance is immediately available.
- Telemix handles seven lines in two groups; five in an "incoming" group, two in the "conference" group. All lines can be switched mutually-exclusively as is done

(cont.)

### TELEPHONE LINE EQUALIZATION

TYPICAL ARRANGEMENT TO UPGRADE ANY LOOP WHICH MEETS INDICATED CRITERIA

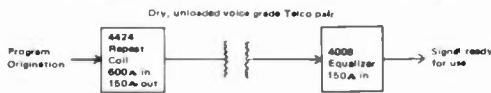

Up to 30dB low differential 50-15kHz  
(22 ga. cable typically 5.9 mi. max @ 15kHz)

UP TO 3 UNITS MAY BE CASCADED AT APPROX. 5 MI. INTERVALS WITH MAINTENANCE OF ACCEPTABLE NOISE & DISTORTION SPECS (RE 22 GA. CABLE)

TYPICAL EQUALIZATION LIMITS - 15 KHZ

CABLE GA.	MAX. LENGTH
19	8.7 mi.
22	5.9 mi.
24	4.2 mi.
26	3.4 mi.

If you wish to equalize a number of circuits, such as church loops, sports loops, etc., you may wish to use the 248C rack mount housing which will accommodate up to eight 4008 modules. (9 with user wiring)

If several repeat coil modules are to be used, the 1012 housing will hold 12 cards.

Repeat coils and 4008 modules may be mixed in the 248C housing when wired accordingly. All terminals are .075" wire wrap and user wired.

<b>4008 Program Amplifier with 8 and 15kHz Equalizers</b> . . . . .	\$202.00
<b>4424 wide band Repeat Coil, single</b> . . . . .	\$51.00
<b>4425 wide band Repeat Coil, dual</b> . . . . .	\$69.00
<b>1913 Dual Card Housing for 4008 and/or 4424/25</b> . . . . .	\$92.00
<b>1911 Single Card Housing</b> . . . . .	\$19.00
<b>1913 List 4 Transformer (will power not more than two 4008's)</b> . . . . .	\$15.00
<b>248RF Program Amplifier Housing (one ea. 4008, 4424/25 may be mounted side by side, or two 4008's)</b> . . . . .	\$306.00
<b>8003A Power Supply for use with 248C Housing to power 3 or more 4008 modules</b> . . . . .	\$138.00
<b>248C Housing for use with up to eight 4008's</b> . . . . .	\$363.00
<b>1012 Housing for use with up to 12 Repeat Coil Cards</b> . . . . .	\$122.00

**THE MOST CONVENIENT WAY TO ORDER FROM ALLIED IS BY TELEPHONE — SEE INSIDE BACK COVER FOR MORE INFORMATION**

# A

# TELEPHONE EQUIPMENT

with the standard desk set, or lines can be conferenced together by pushing two or more buttons at once.

- Accessory front-panel switches can be wired to control "Panic/dump" and "Delay out" switching.

Telemix ..... \$2495

## TELEPHONIC



With the Standard Program the ACT will:

- Automatically answer after the third ring.
- Flash the appropriate lamp at the normal ring-in rate for three minutes.
- When there is a queue the telephone will ring for one half second every four seconds.
- After the first three minutes the appropriate lamp will flash at a special flutter rate for four minutes.
- After a total of seven minutes, the telephone will ring two seconds on and two seconds off.

Optional programs are available.

### BENEFITS:

- Reduces caller frustration during peak load periods.
- No confusion as to which line to answer next
- Visual indication of oldest call as well as how old that call is.
- Indicates oldest call per groups (queue).
- Gives precedence to important lines over other lines. WATS, long distance, etc.
- Data output provides flexibility in staffing.

The common equipment for an ACT 100 will support up to 40 trunks/lines and consists of one ACT 500 microprocessor, one ACT 200 voice announcement unit, four ACT 400 tape cartridges and the necessary ACT 600/601 connecting cables. One 100 or 1000 line card is required for each line. ACT 100 for direct retrofit into an existing KSU which utilizes 400 type cards — ACT 1000 for use in your complete stand-alone system to bypass existing leased telco system or with existing PABX or electronic key system.

### KTS-500 TELEPATCHER:

Complete conference and call forwarding system in a sleek walnut case. Permits conference calls to be set up on as many as five lines — internal or external. Line switches correspond with the phone pushbuttons — they light up and lock when depressed, release when pressed again. An audible and visual signal indicates when conferees flash or hang up.

*Amplified to compensate for bridging loss.* Incoming calls can be redirected to the proper parties. Can be used with all types of key systems, rotary or tone dial. Other calls can be received or initiated while a conference call is in progress.

Ideal in applications where an attendant is setting up conferences for others. Supervisory feature makes it unnecessary to continuously monitor patched calls in order to know when to release the lines. (cont.)



ACT-200 Voice Announcer PN27002



KTS-350



KTS-500



10/20



PN 14054-2



PN 14055-3

### KTS-350 TELEPATCHER:

Five-line conferencing and bridging unit for those who do their own conferencing. Similar to KTS-500 except does not have disconnect supervision or attendant recall features; i.e. does not signal when patched parties flash, hang up, or press "0" Operator button. Unit is amplified. Red indicator light comes on when user's handset is placed on hook reminding user to release all telepatcher line switches upon completion of conference.

To order a KTS-500 Telepatcher, order one P/N 13008.

To order a KTS-350, Telepatcher, order one P/N 12001.

Separate power supply is required for either, order on P/N 13015.

### 10/20 SERIES TELEPATCHER:

All 10/20 Series Telepatchers are all amplified, nine-line units which provide conferencing with disconnect supervision on all types of telephone lines.

The 10/20 models use the same electronics equipment cabinets (5½" x 10" x 2½") which can be mounted under desk or wherever convenient near telephone.

*Amplified to compensate for bridging loss.*

To order a 10/20 Telepatcher for a 10 button telephone, order P/N 14054-1.

To order a 10/20 Telepatcher for a 20 button telephone, order P/N 14054-2.

To order a 10/20 Telepatcher installed in a console, order P/N 14055-x. The x following the P/N 14055 indicates the number of telepatchers to be installed in the console - maximum of three.

Series 10/20 available in black, green, beige, white, light ash, cocoa brown, or ivory.

Prices subject to change without notice.



# TEST EQUIPMENT

## ALLIED FONE-BOX

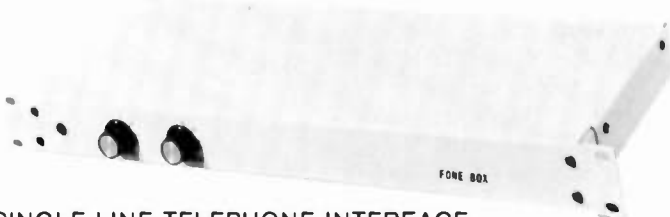

### SINGLE-LINE TELEPHONE INTERFACE

For the first time, here is a device that will adapt easily between telephone circuits and broadcast consoles, allows you to control the levels of both the incoming call and the interviewer's microphone, and permits you to hear the incoming call without fighting feed-back. The use of an integrated band pass filter helps to eliminate hiss, hum and extraneous noises. The Fone-Box gets the best sound possible from available telephone circuits, recorded at a level which doesn't suck you into the speaker, or drive you out the door.

There's nothing complicated about its installation—no special amps or circuits.

So you get it all... isolation, ease of installation, and low cost. (FCC Registered)

**Fone-Box** ..... \$695.00



## DELTA ELECTRONICS CPB-1 COMMON POINT IMPEDANCE BRIDGE



The Common Point Impedance Bridge is an invaluable device for directional array maintenance. The CPB-1 is designed for permanent installation in existing phasing equipment to provide an accurate indication of the common point impedance. The CPB-1 will handle common point powers of up to 5kW with 100% amplitude modulation. The CPB-1A is designed for powers up to 50kW.

**CPB-1 to 5kW** ..... \$1590.00  
**CPB-1A to 50kW** ..... \$1890.00  
**RF Ammeters, If Desired, Are Optional**

## DELTA ELECTRONICS OIB-1/OIB-3 OPERATING IMPEDANCE BRIDGES



The Operating Impedance Bridge is a device that measures the impedance of networks, transmission line sections, radiators, and the like, while they are functioning under normal power. This "operating impedance" cannot be measured by conventional bridges due to the disrupted system characteristics that occur when such a bridge is inserted. The OIB-1 provides the engineer with the capability to directly read up to  $\pm 400$  ohms resistive and  $\pm j 300$  ohms reactive. The OIB-3 offers additional ranges of up to  $\pm 1000$  ohms resistive and  $\pm j 900$  ohms reactive.

**OIB-1** ..... \$1540.00  
**Extended R&X, R to 1000 ohms & X to 900 ohms** .. \$425.00  
**OIB-1 Transport Case** ..... \$245.00  
**D3354 Installation of DC Amp** ..... \$220.00  
**OIB-3 (Available for rent)** ..... \$2100.00

## DELTA ELECTRONICS RG-3 RECEIVER/GENERATOR



The RG-3 is designed to provide interference-free, accurate measuring capability for AM broadcast antenna measurements. The RG-3's many features include a frequency counter, correlation detector for interference elimination, high output power, excellent receiver shielding, and single-knob continuous tuning. Operation from AC line current or rechargeable Nicad batteries. The RG-3 is designed to be used with any conventional impedance bridge.

**RG-3** ..... \$4560.00  
**D51-8-4 Set of 2 Coax Cables** ..... \$55.00  
**D05-72 Set of 10 Rechargeable Nicad Batteries** ... \$205.00

**ALLIED HAS A LEASE  
PLAN TO SUIT YOUR INDIVIDUAL NEEDS**



# TEST EQUIPMENT

## POTOMAC INSTRUMENTS — AT51 TEST SYSTEM



AT51 System available for rent.

Designed primarily for commercial broadcast proof-of-performance measurements and equipment maintenance. The AG51 Audio Generator and AA51 Audio Analyzer are packaged separately for remote measurements requiring physical separation of signal source and signal analyzer. Both units are RFI shielded to enable accurate measurements in high level radio frequency environments typical to broadcast transmitter facilities. Signal input and output connectors are also RFI shielded.

MEASURES: harmonic distortion, intermodulation distortion, volts, dB, signal + noise/noise ratio, wow and flutter, stereo phasing, differential gain in stereo channels.

- Separate generator and analyzer
- Transformerless stereo outputs (balanced or unbalanced; switch selectable)
- Source resistance 150 ohms or 600 ohms (switch selectable)
- Automatic signal leveling
- Precision 10 dB, 1.0 dB and 0.1 dB step attenuators
- RFI shielding
- Automatic "set level" and "balance" circuits
- Scope display of distortion products output
- Output level monitor

AT51 System consisting of AA51 & AG51 . . . .	\$3195.00
AA51 Analyzer Only . . . . .	\$1875.00
AG51 Generator Only . . . . .	\$1490.00
Balancing transformers (ea.) . . . . .	\$ 125.00

## DIGIMAX FREQUENCY COUNTER



FREQUENCY RANGE: 10Hz-1.2GHz  
 ACCURACY OVER TEMP: .1PPM (+ 55° to 85° F) proportional 10mHz oven  
 READ OUTS: 9  
 SENSITIVITY: 50Hz to 25mHz: 5 to 50MV;  
 25mHz-450mHz: 15 to 50MV;

(cont.)

1GHz: 50 to 75MV  
 POWER REQUIRED: AC-12 Req. for 110VAC, 8-15VDC  
 500MA  
 ACCURACY AS STATED EQUALS—  
 ± 0.1Hz at 1mHz  
 ± 1.0Hz at 10mHz  
 ± 100Hz at 1GHz

Order number D1200—AC12—BAC12—T1200

Digimax 10Hz to 1.2GHz 9 digit frequency counter, package includes AC adapter, rechargeable battery pack, and antenna. Meets and exceeds all FCC requirements.

Digimax Package (Available for rent) . . . . . \$352

## CROWN RTA-2 AUDIO SPECTRUM ANALYZER



The Crown RTA-2 is designed for audio-range real-time spectrum analysis in 1/3 and full octave bands. All the sub-systems needed to perform quick, accurate on-site equalization of sound-reinforcement systems are included in the RTA-2.

Pink-noise output is balanced (XLR connector) or unbalanced at either line or MIC levels. The RTA-2 can be used on stage, in the hall, or in control or projection booths.

The Crown RTA-2 has a 16Hz to 20kHz bandwidth. The full audio bandwidth (compatible with full bandwidth equalizers) is displayed for accurate acoustic equalization.

The filtered signal is fed to precision full-wave detectors which are optimized for use in the RTA-2. Full-wave detection (rather than the 1/2-wave common in other units) provides a more accurate display for each frequency band. In addition, the pink-noise generator is pseudorandom which eliminates random drop-outs. The result is a more accurate real-time equalization curve achieved sooner and with less effort.

The Crown RTA-2 weighs only 22 pounds (39 with optional carrying case which qualifies as carry-on luggage for air travel, 50 in optional shipping container which is recommended for air travel as checked baggage).

RTA-2 . . . . . \$2450.00

Cases optional at extra cost.

## CROWN BDP-2 AUDIO MICRO-COMPUTER



(cont.)

## INPUTS

Line: Differential, balanced, active (transformerless). 51K impedance, nominal. Unbalanced sources may be used. 1/4" phone jack on front and rear panels with front normalized to rear. Sensitivity (for 0dB display): 1.0, 3.16, 10.0, 31.6 volts, RMS (10dB steps).

Mic: Differential, balanced, active (transformerless). Designed for 200 ohm or lower source impedance. Balanced phantom powering also allows use of dynamic and self-powered microphones. Standard XLR female connector. Sensitivity (for 0dB display): 3.16, 10.0, 31.6, 100, 316 millivolts RMS (10dB steps).

## OUTPUTS:

DGFS source, 1/4" phone jack, unbalanced on front and rear panels, XLR male connector front only. Video-BNC panel connector, front and rear panel.

## DISPLAY:

5" color, single-gun resolution CRT. Display offers choice of 1, 3, or 6dB/division graticule. One line of the graticule is marked as the 0dB reference, 6dB/division shows a +20 to -60 range, 3dB/division shows +10 to -30, and 1dB/division shows +5 to -15. On the 1dB/division range, levels may be read to within 1/4 dB, and the display may be scrolled upward 10, 20, or 30dB so that the weaker signal components may be read with this resolution.

## CONTROLS

Program controls are keyboard switches with program-defined functions and on-screen labeling.

Power on/off (push/push with orange LED)

"B" Begin - initiates program

"P" Previous - recalls previous screen frame

"G" Graticule - on/off for graticule display

"L" Labels - on/off for on-screen function labels

CRT Tint, CRT Color, CRT Contrast and CRT Brightness are screwdriver adjustments on front panel.

## CONSTRUCTION

The BDP-2, in the best Crown tradition, is ruggedly built for tough, professional service in the shop or on the road. Metal all-around case protects against damage and EMI. The main circuit boards and CRT are shock mounted, while all circuit cards and program modules are plug-in for easy field serviceability.

## GENERAL

19" wide x 5 1/4" high x 20" deep (EIA rack mount). Net weight 31 1/2 lbs. Shipping weight 35 1/2 lbs.

**BDP-2** ..... \$5495.00

## WHITE 151 PINK NOISE GENERATOR



- Compact battery powered digitally generated pink noise
- 268,000,000 bit word length
- Flat 20 Hz through 20 kHz
- Microphone or line level output
- Rugged
- Inexpensive

**White 151** ..... \$140.00

## WHITE 200 SIGNAL ANALYZER



30 Triple-tuned filters on 1/3 octave I.S.O. centers from 25 Hz through 20 kHz. Octave band and 1/6 octave plug-in filters are available. 30 by 15 LED display plus separate dB-SPL, overrange, and 2 seven segment readouts. 8 memories. One, two and three dB scales. Processes peak and average simultaneously. 3 Time constants. All functions are microprocessor controlled. Long list of plug-in options.

**White 200** ..... Starts at \$3600.00

## WHITE 140 SOUND ANALYZER



27 Double-tuned 1/3 octave filters on I.S.O centers from 40 Hz through 16 kHz. 27 by 10 LED display plus separate dB-SPL and overrange readout. One and two dB scales. Display vernier. Built in pink noise generator. Mic and line level inputs. Sync and log amplifier outputs for remote oscilloscope display. Rugged road case. Meets ANSI S1.11-1971 Class II Specifications.

**White 140** ..... \$2800.00

## INOVONICS 500 ACOUSTIC ANALYZER

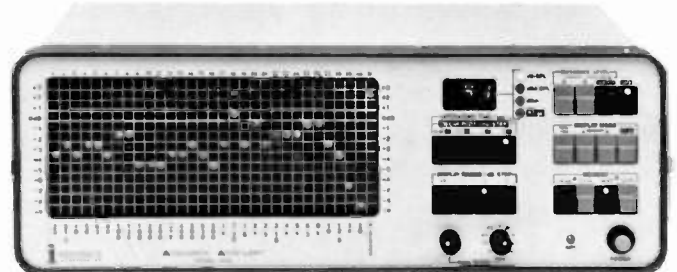

A fully portable unit for real time, one-third octave audio spectrum display and reverberation analysis. Peak and averaged measurements, two memories, RT60 and Decay Plot capabilities, built-in Pink Noise generator. I/O logic interfaces with digital peripherals.

**Inovonics 500** ..... \$2975.00

**SHIPPING AND HANDLING  
CHARGES WILL BE ADDED TO ALL ORDERS  
UNLESS OTHERWISE SPECIFIED**



# TEST EQUIPMENT

## STL PRECISION MAGNETIC TEST TAPES



STL Test Tapes are recorded directly from precision generating equipment to provide the most accurate reference possible. An independent standards laboratory, STL provides a completely objective service, with test tapes available to major manufacturers, governments, and all who need a precision reference tool.

### GENERAL DESCRIPTIONS

- Reproduce Alignment**— Contains Azimuth tone, voice announced frequency run and level set tone. Programs A, B, C and E.\*
- Pink Noise**—20-20,000Hz for phase alignment of multi-track systems, and response check with 1/3 octave filters.†
- Sweep**—Log 100ms, 700-15,000Hz with adequate dead section between sweeps to facilitate scope synchronization.†
- Frequency Check**—Contains 2-second spot check tones. No voice. Program F and G. Repeats.\*
- Azimuth**—Single Tone (see program of equivalent alignment tape for frequency).†
- Level Set**—Single Tone (see program of equivalent alignment for frequency).†
- Flutter & Speed**—A crystal-controlled frequency source recorded at low flutter and accurate speed.†

\*See Test Tape Programs.

†4 minutes on 1/4" reel-to-reel, as marked on other formats.

### TEST TAPE PROGRAMS

A*	B*	C*	E	H	J
15 kHz 30 sec. 0	15 kHz 30 sec. -10	10 kHz 30 sec. -10/20	1 kHz 20 sec. 0	315 Hz 30 sec. 0	1 kHz 15 sec. 0
700 Hz 20 sec. 0	700 Hz 20 sec. -10	400 Hz 20 sec. -10/20	1 kHz 10 sec. -10	6.3 kHz 30 sec. -20	31.5 Hz 15 sec. 0
15 kHz 30 sec. 0	15 kHz 30 sec. -10	15 kHz 30 sec. -10/20	12.5 kHz 30 sec. -10	12.5 kHz 30 sec. -20	50 Hz 15 sec. 0
12 kHz 12 sec. 0	12 kHz 12 sec. -10	12 kHz 12 sec. -10/20	50 Hz 5 sec. -10	315 Hz 10 sec. -20	12.5 kHz 15 sec. 0
10 kHz 12 sec. 0	10 kHz 12 sec. -10	10 kHz 12 sec. -10/20	63 Hz 5 sec. -10	31.5 Hz 10 sec. -20	16 kHz 15 sec. 0
7.5 kHz 12 sec. 0	7.5 kHz 12 sec. -10	7.5 kHz 12 sec. -10/20	125 Hz 5 sec. -10	40 Hz 10 sec. -20	31.5 Hz 5 sec. 0
5 kHz 12 sec. 0	5 kHz 12 sec. -10	5 kHz 12 sec. -10/20	250 Hz 5 sec. -10	63 Hz 10 sec. -20	50 Hz 5 sec. 0
2.5 kHz 12 sec. 0	2.5 kHz 12 sec. -10	2.5 kHz 12 sec. -10/20	500 Hz 5 sec. -10	100 Hz 10 sec. -20	100 Hz 5 sec. 0
1 kHz 12 sec. 0	1 kHz 12 sec. -10	1 kHz 12 sec. -10/20	1 kHz 5 sec. -10	125 Hz 10 sec. -20	250 Hz 5 sec. 0
500 Hz 12 sec. 0	500 Hz 12 sec. -10	500 Hz 12 sec. -10/20	2 kHz 5 sec. -10	250 Hz 10 sec. -20	500 Hz 5 sec. 0
250 Hz 12 sec. 0	250 Hz 12 sec. -10	250 Hz 12 sec. -10/20	4 kHz 5 sec. -10	500 Hz 10 sec. -20	1 kHz 5 sec. 0
100 Hz 12 sec. 0	100 Hz 12 sec. -10	100 Hz 12 sec. -10/20	8 kHz 5 sec. -10	1 kHz 10 sec. -20	2 kHz 5 sec. 0
50 Hz 12 sec. 0	50 Hz 12 sec. -10	50 Hz 12 sec. -10/20	10 kHz 5 sec. -10	2 kHz 10 sec. -20	4 kHz 5 sec. 0
30 Hz 12 sec. 0	700 Hz 20 sec. 0	400 Hz 20 sec. 0	12.5 kHz 5 sec. -10	4 kHz 10 sec. -20	8 kHz 5 sec. 0
			16 kHz 5 sec. -10	6.3 kHz 10 sec. -20	10 kHz 5 sec. 0
			1 kHz 20 sec. 0	8 kHz 10 sec. -20	12.5 kHz 5 sec. 0
				10 kHz 10 sec. -20	16.0 kHz 5 sec. 0
				12.5 kHz 10 sec. -20	1 kHz 15 sec. 0
				14 kHz 10 sec. -20	1 kHz 15 sec. -4
				16 kHz 10 sec. -20	0 dB = 250 nWb/m ANSI
				18 kHz 10 sec. -20	-4 = 160

\*Double-length tones on one- and two-inch tapes.

Repeats—5 min. cassette, 4 min. other.

### EQUALIZATION AND PROGRAM LEVELS

#### REEL TO REEL—U.S. Standards (NAB, AES and ANSI)

Speed ips	Standard	Characteristic (Microseconds)	STL Standard Level nWb/m ANSI	Optional Elevated 3 Level nWb/m ANSI
7 1/2	NAB 1965	3180-50	185	260
15	NAB 1965	3180-50	185	260
30	AES 1971	Inf.-17 1/2	185	260

#### Broadcast Cartridge—U.S. Standards (NAB and ANSI)

Speed ips	Standard	Characteristic (Microseconds)	Standard Level nWb/m ANSI
7 1/2	NAB 1976		160
7 1/2	NAB 1965 Reel Std.	3180-50	185

#### Cassette—International and European Standards (IEC and DIN)

Speed ips	Standard	Characteristic (Microseconds)	STL Standard Level nWb/m ANSI
1-7/8	1976 DIN 45513 Teil 6	3180-120	150

(cont.)





# TEST EQUIPMENT

## RECORDING STUDIO CATEGORY

**Reel to Reel—Full Track Test Tapes**—recorded at standardized flux levels (no fringing compensation)

To order: NAB/AES Tapes referenced to 185 nWb/m level, use listed catalog number.

NAB/AES Tapes referenced to 260 nWb/m level, add -EL3 to catalog number. (available only if indicated by \*)

IEC/CCIR Tapes referenced to 295 nWb/m level, add -IEC to catalog number. (available only if indicated by \*)

Tape System Characteristics		Reproduce Alignment Tapes				Pink Noise Tapes		100MS Sweep Tapes		Freq. Check Program G		Azimuth Tapes		Level Set Tapes	
Width	Speed (ips)	Cat. No.	Program*	Freq. Run Level (dB)	Price (\$)	Cat. No.	Price (\$)	Cat. No.	Price (\$)	Cat. No.	Price (\$)	Cat. No.	Price (\$)	Cat. No.	Price (\$)
1/4"	7 1/2	2*	B	-10	45	P-2	45	F-2	45	—	—	A-2	30	L-2*	25
	7 1/2	22	A	0	45	—	—	—	—	G-22	45	—	—	—	—
	15	3*	A	0	45	P-3	45	F-3	45	G-3	45	A-3	35	L-3*	30
	30	4*	A	0	55	P-4	55	F-4	55	G-4	55	A-4	40	L-4*	35
1/2"	7 1/2	5*	B	-10	95	P-5	95	F-5	95	—	—	—	—	—	—
	15	6*	A	0	95	P-6	95	F-6	95	—	—	—	—	—	—
	30	7*	A	0	110	P-7	110	F-7	110	—	—	—	—	—	—

**Cassette Test Tapes—1-7/8 IPS**—Full track recordings. Tapes are checked for accuracy on the "A" side only—Suitable for use on stereo or mono equipment. In high quality screw type cassettes.

Description	Program	Characteristic (Microseconds)	Op. Level (nWb/m) DIN	Freq. Run Level (dB)	Catalog No.	Price (\$)
Reproduce Alignment	C	3180-120*	160	-10	26	60
Frequency Check	F	3180-120*	160	0	80	60
Frequency Check	G	3180-120*	160	-10	81	60
Pink Noise	5 min.	3180-120*	—	—	P-26	60
Sweep (100ms)	5 min.	3180-120*	160	-10	F-26	60
Azimuth (10kHz)	5 min.	—	—	—	A-26	35
Azimuth (6.3kHz)	5 min.	—	—	—	A-26-6	30
Level Set (400Hz)	1 min.	—	160	—	L-26	25
Level Set (400Hz—Dolby)	1 min.	—	200	—	28	25

\*Correction chart supplied for 3180-70 usec equalization

## BROADCASTING STUDIO CATEGORY

**Reel to Reel—2 Channel 1/2 Track Test Tapes**—.075" tracks. (Azimuth tapes are Full Track)

Tapes listed are NAB or AES referenced to 185 nWb/m level. Catalog numbers marked \* are available at 260 (280) nWb/m 3dB elevated level. Add -EL3 to catalog number.

Tape System Characteristics		Reproduce Alignment Tapes				Pink Noise Tapes		100MS Sweep Tapes		Freq. Check Program G		Azimuth Tapes		Level Set Tapes	
Width	Speed (ips)	Cat. No.	Program*	Freq. Run Level (dB)	Price (\$)	Cat. No.	Price (\$)	Cat. No.	Price (\$)	Cat. No.	Price (\$)	Cat. No.	Price (\$)	Cat. No.	Price (\$)
1/4"	7 1/2	2-2*	B	-10	45	P-2-2	45	F-2-2	45	—	—	A-2	30	L-2-2*	25
	7 1/2	22-2	A	0	45	—	—	—	—	G-22-2	45	—	—	—	—
	15	3-2*	A	0	45	P-3-2	45	F-3-2	45	G-3-2	45	A-3	35	L-3-2*	30
	30	4-2*	A	0	55	P-4-2	55	F-4-2	55	G-4-2	55	A-4	40	L-4-2*	35

**Broadcast Cartridge Test Tapes—7 1/2 IPS speed**—A type cartridge

Specify the cartridge desired by adding the suffix indicated below to the catalog number: —SC (Scotchcart), —AR (Aristocart), —AS (Aristocart AA), —AP (A2 Audiopak), —AA (AA3 Audiopak), —FI (Fidelipac 350), —MA (Mastercart)

For equipment adjusted to current NAB 1976 ∞-50 μsec. equalization

DESCRIPTION	PROGRAM	FREQ. RUN LEVEL (dB.)	REFERENCE nWb/m ANSI	CATALOG NUMBERS			PRICE \$
				STEREO	MONO	COMPATIBLE	
Reproduce Alignment (NAB Program)	E	-10	160	34-2	34-1	34	55
Reproduce Alignment (ITC/3M Program)	J	0	250	39-2	39-1	—	55
Pink Noise	4 min.	—	—	P-34-2	P-34-1	P-34	55
Sweep (100 ms)	4 min.	—	—	—	—	F-34	55
Level Set (1 kHz, 160 nWb/m)	1.5 min.	—	—	L-34-2	L-34-1	L-34	30
Level Set (1 kHz, 250 nWb/m)	1.5 min.	—	—	L-39-2	L-39-1	—	30
Azimuth (12.5 kHz)	1.5 min.	—	—	—	—	A-34	35
Q Track Test Primary, Secondary, & Tertiary Tones—Std. Level—500 ms. bursts—repeats	—	—	—	—	—	Q-95	55

## FLUTTER/SPEED TEST TAPES All Categories

3150 Hz Carrier

**Reel to Reel—Full Track**—Flutter less than .03% RMS Speed better than 0.1% at 74°F and 4 ounces tension.

Speed (IPS)	1/4" Tape		1/2" Tape		1" Tape	
	Cat. No.	Price (\$)	Cat. No.	Price (\$)	Cat. No.	Price (\$)
7 1/2	52-1	45	61-1	55	71-1	100
15	53-1	50	62-1	60	72-1	115
30	54-1	55	63-1	65	73-1	125

(cont.)



# TOWERS

**Broadcast Cartridge**— 7½ IPS—Q track area not recorded—Catalog number 35. Price \$50.

Specify the cartridge desired by adding the suffix indicated below to the catalog number: —AR (Aristocart), —AS (Aristocart AA), —AP (A2 Audiopak), —AA (AA3 Audiopak), —FI (Fidelipac 350), —MA (Mastercart), —SC (Scotchcart)

**Cassette**—1-7/8 IPS—5 minute recording, flutter less than .05% RMS—Speed accuracy 0.15% at 74°F. Catalog number 29. Price \$40.

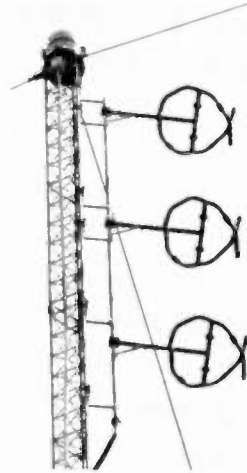
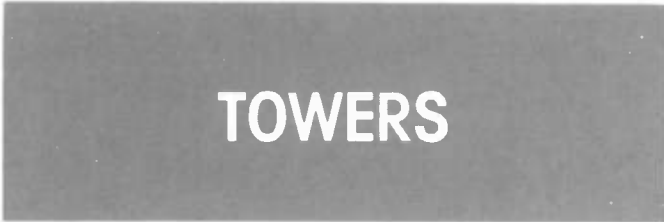

## DURO-TEST CODE BEACON AND OBSTRUCTION BULBS

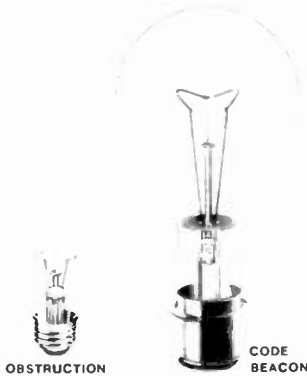

You need rugged, dependable, long-lasting, quick-to-see bulbs where there are tall traffic hazards. The best bulbs that money can buy are built by Duro-Test.

In addition to giving added protection, Duro-Test Code Beacon and Obstruction bulbs are life-rated to reduce changes at precarious heights, cut down on dangerous burn-outs . . . and save money in terms of replacement and maintenance costs.

Heavier, longer filaments withstand severe intermittent operation. Automatically positions filament for maximum visibility.

- Radio Towers
- TV Towers
- Microwave Towers
- Building Towers

**Code Beacon** . . . . . \$26.31

Watts: 620 Bulb: PS-40 Base: Mog. Pref. Description: Clear Voltage: 125-130 Lumens: 10,500 Hours: 4500-5500

**Obstruction** . . . . . \$3.95

Watts: 116 Bulb: A-21 Base: Med. Description: Clear Voltage: 125-130 Lumens: 1260 Hours: 7500-8500 Meets Requirements of F.A.A. Obstruction Marking & Lighting

## PI-ROD TOWERS

- Solid rod, all-welded construction provides greatest strength with minimum surface exposure to wind and icing conditions. Local wind and icing conditions are analyzed for optimum design efficiency. Slim Line

(cont.)

- design offers minimized air resistance.
- A complete line of standard (proven performance) models.
- Computerized analysis of loading factors for structure conformity to meet and exceed customer specifications. Working with these data, licensed professional engineers review your specific requirements and determine the ultimate solution.
- Engineered concepts utilizing minimum space requirements. We design systems to meet critical space limitations, with 50% and smaller guy radii available.
- Minimized interference with reduced face width design improves transmission—another PI-ROD engineering innovation.

Contact Allied for Pricing

## UNION METAL SELF-SUPPORT STEEL ANTENNA POLES



Pole and accessories assembled on ground prior to erection.



Pole in position to be lowered on plumbing nuts.

- No guy wires required
- 25'-300'

(cont.)



# TRANSMISSION LINE

• Also suitable for top-mounting FM antennas on towers

Contact Allied for Pricing

## TRANSMISSION LINE

### CABLEWAVE SYSTEMS

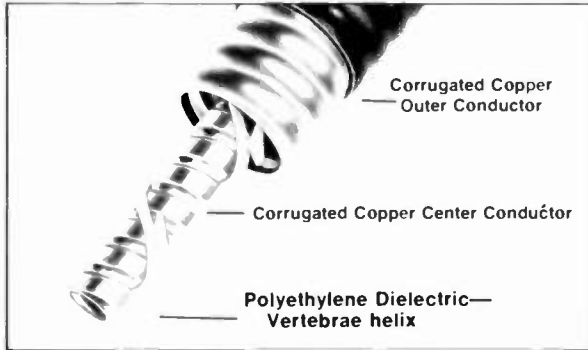

1-5/8" Air Wellflex — Type HCC	
1-5/8" Jacketed HCC158-50J	810903-001 9.40/ft.
1-5/8" EIA (GP)	738314 ... \$151.00
1-5/8" EIA (GB)	738303 ... \$158.00
N Female	738301 ... \$144.00
7/8" EIA (GP/Low VSWR Tunable)	738308 ... \$344.00
7/8" EIA (GB/Low VSWR Tunable)	738310 ... \$358.00
7/8" EIA Reducer (GB)	738304 ... \$178.00
7/8" EIA Reducer (GP)	738311 ... \$174.00
End Terminal	738306 ... \$216.00
Splice	738305 ... \$204.00
LC Female	738302 ... \$204.00
3" Air Wellflex — Type HCC	
3" Jacketed HCC300-50J	810905-001 17.80/ft.
3-1/8" EIA (GP)	738355 ... \$267.00
3-1/8" EIA (GB)	738350 ... \$279.00
Splice	738352 ... \$328.00
3 1/2" Air Wellflex — Type HCC	
3 1/2" Jacketed HCC312-50J	810915-001 19.74/ft.
3-1/8" EIA (GP)	734579 ... \$398.00
3-1/8" EIA (GB)	734578 ... \$410.00
Splice	734574 ... \$398.00

(cont.)

3-1/8" EIA Anchor Inner Connector	622720 ... \$46.00
4-1/8" (4 1/2" O.D.) Flexwell	
4-1/8" (4 1/2" O.D.) Jacketed HF 4-1/8" Cu2Y	28.90/ft.
6-1/8" EIA (GP)	734600 ... \$780.00
6-1/8" (GB)	734602 ... \$830.00
6-1/8" Bullet	920270 ... \$176.00

Call Allied for the Complete Cablewave Line

### ANDREW HELIAX CABLE



1-5/8" Air-Dielectric Heliax Cable	
HJ7-50A 1-5/8", 50 ohm cable	10.30/ft.
87R 1-5/8" EIA flange	\$155.00
87G 1-5/8" flange, gas barrier	\$182.00
87S Reducer to 7/8" EIA	\$182.00
87SG Reducer to 7/8" EIA, gas barrier	\$210.00
87N N Jack	\$162.00
87T End terminal	\$240.00
87L LC jack	\$220.00
1061 90° EIA miter elbow	\$168.00
1261B 1-5/8" EIA gas barrier	\$160.00
2061 1-5/8" EIA end terminal	\$158.00
34660 1-5/8" EIA inner connector	\$23.00
3" Air Dielectric Heliax Cable	
HJ8-50B 3", 50 ohm cable	19.60/ft.
78ARM 3-1/8" EIA flange, male	\$265.00
78AGM 3-1/8" EIA flange, male, gas barrier	\$290.00
78ARF 3-1/8" EIA flange, female	\$260.00
78AGF 3-1/8" EIA flange, female, gas barrier	\$280.00
15093A 3-1/8" EIA inner	\$54.00
78AS Reducer to 1-5/8" EIA	\$325.00
78BZ Splice	\$325.00
1062 90° EIA miter elbow	\$295.00
2062 3-1/8" EIA end terminal	\$295.00
4" Air-Dielectric Heliax Cable	
HJ11-50 4", 50 ohm cable	21.30/ft.
81GF 3-1/8" EIA flange, female, gas barrier	\$440.00
81RF 3-1/8" EIA flange, female	\$420.00
15093A 3-1/8" EIA inner connector	\$54.00
42896 6-1/8" EIA flange, female	\$1000.00
42826 6-1/8" EIA flange, female, gas barrier	\$1080.00
18902 6-1/8" EIA inner connector	\$230.00
1062 90° 3-1/8" EIA miter elbow	\$295.00
2062 3-1/8" end terminal	\$295.00
1861 Reducer, 3-1/8" to 1-5/8" EIA	\$180.00
81Z Splice	\$450.00
5" Air-Dielectric Heliax Cable	
HJ9-50 5", 50 ohm Cable	31.50/ft.
79R 6-1/8" EIA flange, male	\$790.00

(cont.)

# 4

# TRANSMITTERS

79G	6-1/8" EIA flange, male, gas barrier . . . .	\$840.00
1073	90° miter elbow, 6-1/8" EIA . . . . .	\$910.00
1872	Reducer, 6-1/8" to 3-1/8" EIA . . . . .	\$1000.00
79AZ	Splice . . . . .	\$840.00

Call Allied for the Complete Andrew Coax Line

# TRANSMITTERS

## BIRD 8645 25KW MODULAR LOAD RESISTOR



- Power rating 25KW continuous duty up to 900 mHz
- Weight: 155 lbs.
- Distilled water or Ethylene Glycol.
- 10KW and 80KW in this series plus 2½ to 7KW dry loads and Econo wet loads up to 80KW.

Contact Allied for Pricing - We carry the complete Bird line.

## BIRD ELECTRONICS

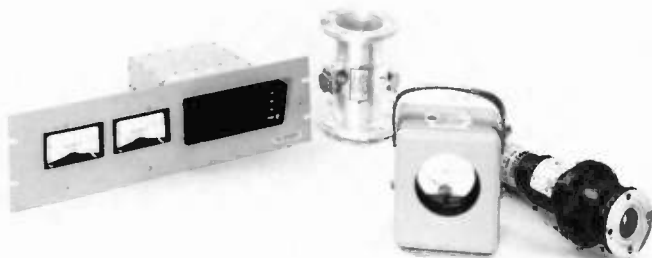

Bird Electronics known for accuracy for more than a quarter of a century, offers thru-line RF directional watt meters, RF load resistors, up to 80KW, and "watcher" protection systems.

Allied carries the entire BIRD professional line.

Call Allied for Complete Information and Pricing.

## TRANSMITTING TUBES

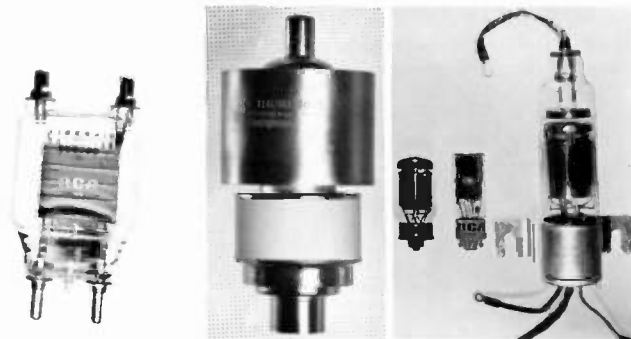

Allied has a broad selection of transmitting tubes to fit your requirements with same-day shipment.

Call Allied for Complete Information and Pricing.

## BROADCAST ELECTRONICS FX-30 EXCITER

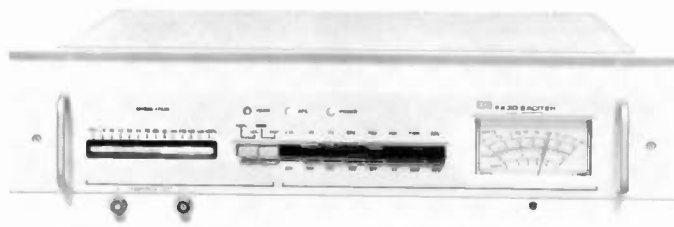

The new Broadcast Electronics FX-30 Exciter offers performance so superior that it rivals the best hi-fidelity tuners available. Distortion in the FX-30 is extremely low, while programming is loud and clear.

Whether it is used in one of the new Broadcast Electronics FM transmitters, or as a replacement for an existing exciter, the FX-30 is the new performance leader in FM broadcasting.

A digitally programmed frequency synthesizer that permits field frequency changes in 10 kHz increments puts more than 2000 channels at your command, without requiring new crystals.

The solid-state FX-30 exciter is completely broadband and requires no tuning adjustments for a conservative 30 watt output. The RF output is continuously adjustable from 3 watts to 30 watts.

A color coded LED display constantly monitors the composite signal applied to the modulated oscillator, and provides a clear indication of short transient peaks exceeding 100% modulation. The ballistics and speed of this built-in modulation monitor make it more accurate and useful than ordinary modulation monitors.

The entire chassis is mounted on slides, so when the unit is pulled out from the rack or transmitter, all sub-assemblies are easily accessible while the unit continues to operate.

Front panel test jacks allow measurements of the composite signal to be made without removing or opening the unit. Other connections are made to the rear panel via a clearly labeled terminal strip and BNC connectors.

MODULATION TYPE: Direct FM at the carrier frequency

MODULATION INDICATION: Peak reading, color coded, LED display with baseband overmodulation indicator.

ASYNCHRONOUS AM S/N RATIO: 70 dB below reference carrier with 100% AM modulation at 400 Hz, 75 micro-second de-emphasis. (no FM modulation present)

(cont.)

# 4

# TRANSMITTERS

SYNCHRONOUS AM S/N RATIO: 50 dB below reference carrier with 100% AM modulation at 400 Hz, 75 microsecond de-emphasis. (Fm modulation  $\pm 75$  kHz at 400 Hz)  
 CABINET SIZE: 17.70"W x 5.25"H x 19.00"D. Standard 19" rack mounting with slide out feature for easy access.  
 COMPOSITE FM S/N RATIO: 72 dB below  $\pm 75$  kHz deviation at 400 Hz (78 dB typical). Measured in a 30 Hz to 1.00 kHz bandwidth with 75 microsecond de-emphasis.  
 COMPOSITE HARMONIC DISTORTION: 0.08% or less (0.04% typical)  
 COMPOSITE INTERMODULATION DISTORTION: 0.08% or less (.04% typical)  
 COMPOSITE TRANSIENT IMD: 0.1% or less (square wave/sine wave)  
 COMPOSITE AMPLITUDE RESPONSE:  $\pm 0.1$  dB 30 Hz to 100 kHz  
 COMPOSITE PHASE RESPONSE:  $\pm 0.5^\circ$  from linear phase 30 Hz to 53 kHz  
 COMPOSITE GROUP DELAY: 390 nanoseconds  $\pm 25$  nanosecond 30 Hz to 53 kHz  
 COMPOSITE SLEW RATE: 12 V/microsecond (symmetrical)  
 SCA INPUTS: 2 Total (1) unbalanced and (1) balanced, BNC connectors  
 MONO AUDIO FREQUENCY RESPONSE:  $\pm 0.5$  dB 30 Hz to 15 kHz, selectable flat, 25, 50 or 75 microsecond pre-emphasis.  
 MONO HARMONIC DISTORTION: 0.08% or less 30 Hz to 15 kHz  
 MONO INTERMODULATION DISTORTION: 0.08% or less, 60 Hz/7 kHz 4:1 ratio  
 MONO TRANSIENT IMD: 0.1% or less (square wave/sine wave)  
 MONO FM S/N RATIO: 72 dB below  $\pm 75$  kHz deviation at 400 Hz (78 dB typical) measured in a 30 Hz to 15 kHz bandwidth with 75 microsecond de-emphasis.

Specifications subject to change without notice.

The FX-30 is included in all Broadcast Electronics transmitters and is available for use with any transmitter.

**FX-30** ..... \$5595.00

## BROADCAST ELECTRONICS FM-30, 30KW, SINGLE TUBE FM TRANSMITTER



FM-30

FM 3.5

(cont.)

Totally new, the 30 kW Model FM-30 is the most advanced transmitter since the advent of FM broadcasting.

The single-tube FM-30 incorporates a unique folded half-wave cavity power amplifier design, digitally programmed FX-30 ultra-linear exciter and, for the first time in a broadcast transmitter, a microprocessor based control system.

Broadcast Electronics' experienced engineering group has created the first truly unique power amplifier design since the beginning of FM broadcasting. The new high power cavity employs a half-wavelength folded tank circuit. This new cavity design eliminates the plate blocking capacitor and all sliding contacts.

The FM-30 uses a single, efficient, high gain Eimac 8990/4CX 20000A tetrode to provide 30 kW power output on any frequency between 87.5 and 108 MHz. The tetrode operates in a high-gain, grid-driven configuration.

Plate efficiency of the final amplifier approaches 80% at 30 kW output, resulting in comparatively low power consumption.

The solid-state IPA assembly in the FM-30 transmitter is composed of 5 identical amplifier modules (one used as a driver for the other four) coupled together by a quadrature hybrid combiner/splitter.

Failure of any of the four output IPA modules will cause only a 15 percent power reduction, and in the event of two modules failing only a 35 percent transmitter power reduction will result.

Since all five modules in the IPA are identical, only one type of spare module is necessary.

The FM-30 transmitter is designed so that all necessary operating functions can be remote controlled. The control logic circuitry used in the transmitter can interface directly with most modern remote control and ATS systems.

- World's most powerful one-tube FM transmitter
- Folded half-wave output cavity — no plate blocking capacitor or sliding contacts
- Microprocessor control provides 127 status indications
- Includes synthesized FX-30 exciter with extremely low distortion
- Conservative 30 kW output
- High efficiency for low operating cost

POWER OUTPUT: (From 15kW to 30kW)

OUTPUT CONNECTOR: 3-1/8" EIA flange

RF HARMONICS: Suppression meets all FCC requirements and CCIR recommendations

POWER SUPPLY RECTIFIERS: Silicon

AC INPUT POWER: 208/240V, 60Hz, three phase (taps for 196 to 252V range) (Available for 50Hz to order) Exciter operates from 87V to 133V, 50/60Hz or 194V to 266V, 50/60Hz.

POWER CONSUMPTION: 50kW

SIZE: Transmitter (excluding HV supply) 56.5"W x 70"H x 31.5"D. HV power supply cabinet - 34.5"W x 70"H x 31.5"D

WEIGHT & CUBAGE: Transmitter (excluding HV supply) 1500 lbs.; packed 1750 lbs.; 72 cu. ft. HV power supply 1200 lbs.; packed 1250 lbs.; 44 cu. ft.

**FM-30** ..... \$55,950.00

**FX-30 Exciter Included** — See details on FX-30 for further specifications. 1.5 & 3.5 kW models available.

**SHIPPING AND HANDLING CHARGES WILL BE ADDED TO ALL ORDERS UNLESS OTHERWISE SPECIFIED**



# TRANSMITTERS

## CSI TRANSMITTERS

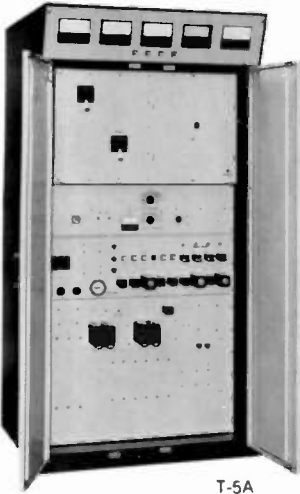

T-5A

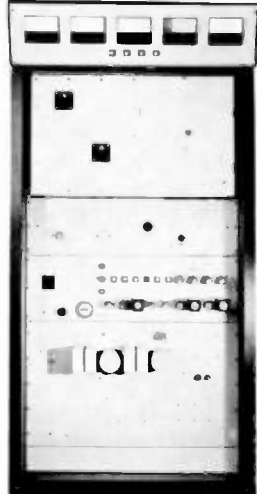

T-1A

CSI AM Transmitters are available in power levels from 250 watts to 10Kw. Modifications include power cutbacks and in many cases, conversion to a higher power.



T-1F



FM 12000E

CSI FM transmitters utilize a grounded grid configuration and proven design for excellent efficiency. Power levels include 1Kw, 3Kw, 5Kw, 12Kw, 20Kw, and 25Kw.

## McMARTIN TRANSMITTERS



BF-3.5M

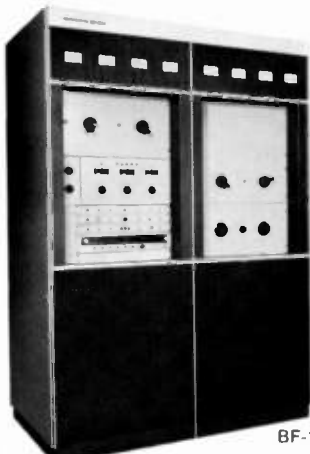

BF-10M

The complete McMARTIN line of AM & FM transmitters is available through Allied.

## POWER PAK SMX-40 EXCITER/ SMG-40 GENERATOR

The SMX-40 is a fully frequency synthesized, FM Exciter with up to 40\* watts of absolute RF drive power and extensive status indication and protection, rivaling *all* competitive exciters presently available at *any* price.

Coupled with the SMG-40 Stereo Generator with switchable (in or out) Preemphasis and Low Pass Filter, faithful audio performance is achieved, assuring transmission quality consistent with present day high fidelity FM Stereo Multiplex receivers. Warranty 2 years.

\*W/Optional Blower

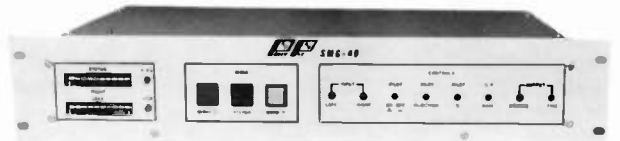

### SMX-40 SPECIFICATIONS:

- Power Output:* 3 - 30 Watt (variable) 40 watts with accessory blower.
- Output Impedance:* 50 ohms. BNC connector. (open & short protected).
- Frequency Range:* 88 - 108 MHz. Digitally programmed in 10 kHz increments.
- Frequency Stability:*  $\pm 300$  Hz, 0° to 50° C
- Modulation Capability & Type:* 200 kHz, Direct FM.
- Harmonic/Spurious Suppression:* -60 dB or better.
- AM Noise:* -60 dB below carrier.
- FM Noise:* -70 dB or better, below 100% modulation at 400 Hz.
- Composite Audio Response:*  $\pm 0.2$  dB, 30 Hz to 100 kHz.
- Composite IMD:* 0.2% or better.
- Composite Slew Rate:* 12 V/usec. (symmetrical)
- Composite Input Impedance:* 10K Ohms, resistive.
- Mono Audio Input Impedance:* 600 Ohms, balanced.(xfmr)
- Frequency Response [mono]:* -1 dB, 30 Hz to 15 kHz, 75 usec pre-emphasis.
- FM Signal-To-Noise Ratio [mono]:* -70 dB below 100% modulation at 400 Hz, 75 dB typical.
- SCA Inputs:* 2, unbalanced. BNC connectors.
- Modulation Indication:* Peak reading LED Bar Graph & average reading analog meter.
- Cabinet Size:* 5 1/4" high x 19" wide x 12 1/4" deep.

**SMX-40 Exciter** ..... \$2995.00

### SMG-40 SPECIFICATIONS:

- Separation:* 50 dB or better across audio passband.
- Distortion:* .2% or less.
- Noise:* -72 dB or better.
- Input:* + 10 dBm at 1 kHz, adjustable.
- Output:* 3V peak-to-peak with 600 ohm load, adjustable.
- Cross talk:* -60 dB or better.
- Remote stereo/mono control.
- Dual LED bar graph modulation indicator.
- Provision for 19 kHz pilot on-and-off/in-or-out.
- Pre-Emphasis & Low Pass Filter "Enable-Disable" Provision.

**SMG-40 Generator** ..... \$1895.00



# TRANSMITTING ANTENNAS

## TRANSMITTING ANTENNAS

### COMARK CIRCULARLY POLARIZED ANTENNAS



The series of FMC Circularly Polarized Antennas utilizes identical radiating elements for both the Lower Power (L) and High Power (H) series. The L series utilizes 1-5/8" feedline while the H series uses 3-1/8" feedline. Both series of antennas are available in systems that incorporate 1 to 14 elements. Normally, systems with 8 or less elements are fed at the bottom while above 8, the system is fed from the center.

Each antenna contains a matching tuner which is approximately 6 ft. long. It is extremely simple to adjust and has a fool-proof method of adjustment without losing pressure. Mounting brackets are supplied with the antenna to assure proper mounting to the supporting structure.

Up to 6-1/8 input & feedline and up to 75 KW pwr input on special order.

- Prices include complete mounting hardware for leg mounting on uniform guyed towers
- Brackets for face mounting or self supporting towers are extra
- Prices upon request
- Antenna input flange on H series is 3-1/8" EIA Female. The L series is 1-5/8" EIA Female
- Windload ratings are 50/33 PSF, 110 miles per hour
- Antenna weights include standard mounting hardware. Add 5 pounds per bay for deicers.
- Deicers require 230 volts, single phase balanced to ground with 400 watts consumption per bay.

FMC Model No.	Power Gain	Max. Input In KW	Net Wt. Pounds	Price
FMLC-1	.44	5	40	\$1395.00
FMHC-1	.47	10	60	\$1805.00
FMLC-2	.97	10	90	\$2125.00
FMHC-2	.99	10	140	\$3255.00
FMLC-3	1.50	10	140	\$3085.00
FMHC-3	1.54	15	220	\$4710.00
FMLC-4	2.04	10	190	\$4020.00
FMHC-4	2.14	20	300	\$6145.00
FMLC-5	2.55	10	240	\$4975.00
FMHC-5	2.70	25	380	\$7590.00
FMLC-6	3.14	10	290	\$5835.00
FMHC-6	3.30	30	460	\$8915.00

(cont.)

FMLC-7	3.65	10	340	\$6770.00
FMHC-7	3.84	35	560	\$10,345.00
FMLC-8	4.18	10	390	\$7710.00
FMHC-8	4.30	40	640	\$11,405.00
FMLC-10	5.20	10	490	\$9585.00
FMHC-10	5.40	40	570	\$14,395.00
FMLC-12	6.25	10	580	\$10,525.00
FMHC-12	6.54	40	730	\$16,925.00
FMLC-14	7.30	10	660	\$13,330.00
FMHC-14	7.70	40	860	\$19,995.00
Deicers/Bay				\$220.00
Deicer Control Box				\$495.00
Replacement Deicer Element (each)				\$19.85
Non Standard MTG Bracket (each)				\$130.00

Educational	Bays	Pwr Gain	Net Wt/Lb	Nom. Pwr In KW	Wind Load/Lb	Price
FMCE-	1	.43	10	.5	20	\$425.00
FMCE-	2	.90	22	.5*	40	\$845.00
FMCE-	3	1.4	35	.5*	65	on Request
FMCE-	4	1.92	47	.5*	88	\$1615.00
FMCE-	5	2.4	59	.5*	112	on Request
FMCE-	6	2.90	68	.5*	135	\$2410.00

\* = 2, 3, 4, 5, & 6 Bay will take .5 KW more per bay (Up to 3KW on 6 bay) with 1-5/8 input available at \$236.00 more per complete antenna.

Normally supplied w/N-fitting which will take Nominal .5KW input.

Interbay Feeds are of Flexible Cable.

FMCE 2 through FMCE 6 are Center Fed.

WHEN ORDERING BE SURE TO SPECIFY: Antenna Type Numbers—Deicers, if any—Frequency (between 88-108 mHz)—Description of Tower—Make and Model.

### JAMPRO JSCP SERIES B FM BROADCAST ANTENNA

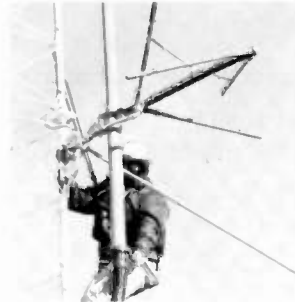

True circular polarization, excellent VSWR bandwidth help make it a standard for the broadcast industry.

The Jampro B Series JSCP antenna is an improved version of a circularly polarized FM broadcast antenna that has become one of the industry standards. Each bay consists of a radiating element with associated 3-1/8 inch flange, and both are supported by a heavy casting bolted to the mounting bracket for that bay. The interbay feed lines are joined by 3-1/8 inch flanges.

Power Rating:

The JSCP is conservatively rated at 10KW per bay up to four bays, with a 40KW maximum rating for five bays and above.

VSWR Rating:

The JSCP antenna has excellent VSWR bandwidth. To assure lowest VSWR, each antenna is completely assembled and tuned at the factory on a structure similar to the end user's.

(cont.)



# TRANSMITTING ANTENNAS

Type No. —Bays	Pwr. Gain Ratio	Gain in dB	Field Gain	FS at 1 mile 1KW, MV/M	Safe Pwr. Rating	Net Weight with Mounting Brackets	Windloads at 50/33PSF (112 mph) w/Mounting Brackets	Price
JSCP-1	0.46	-3.37	0.678	93.2	10KW	25 lbs.	48 lbs.	\$2290
with deicers						34 lbs.	57 lbs.	\$2625
with radomes						55 lbs.	128 lbs.	\$2850
JSCP-2	1.0	0.0	1.0	137.6	20KW	125 lbs.	195 lbs.	\$3650
with deicers						143 lbs.	219 lbs.	\$4320
with radomes						185 lbs.	355 lbs.	\$4760
JSCP-3	1.5	1.76	1.23	168.4	30KW	199 lbs.	320 lbs.	\$5260
with deicers						225 lbs.	368 lbs.	\$6250
with radomes						289 lbs.	560 lbs.	\$6920
JSCP-4	2.1	3.22	1.45	199.2	40KW	274 lbs.	443 lbs.	\$7440
with deicers						308 lbs.	516 lbs.	\$8770
with radomes						394 lbs.	763 lbs.	\$9660
JSCP-5	2.7	4.31	1.64	225.2	40KW	350 lbs.	568 lbs.	\$9390
with deicers						393 lbs.	664 lbs.	\$11,050
with radomes						500 lbs.	968 lbs.	\$12,160
JSCP-6	3.2	5.05	1.79	246.0	40KW	498 lbs.	730 lbs.	\$11,540
with deicers						506 lbs.	851 lbs.	\$13,530
with radomes						678 lbs.	1210 lbs.	\$14,860
JSCP-7	3.8	5.80	1.95	268.0	40KW	532 lbs.	854 lbs.	\$13,380
with deicers						591 lbs.	999 lbs.	\$15,720
with radomes						742 lbs.	1414 lbs.	\$17,270
JSCP-8	4.3	6.34	2.07	285.2	40KW	609 lbs.	979 lbs.	\$15,010
with deicers						677 lbs.	1148 lbs.	\$17,680
with radomes						849 lbs.	1619 lbs.	\$19,450
JSCP-9	4.9	6.90	2.21	303.8	40KW	713 lbs.	1122 lbs.	\$16,730
with deicers						796 lbs.	1316 lbs.	\$19,720
with radomes						1825 lbs.	1842 lbs.	\$21,720
JSCP-10	5.5	7.40	2.35	322.4	40KW	774 lbs.	1265 lbs.	\$18,430
with deicers						859 lbs.	1483 lbs.	\$21,760
with radomes						1074 lbs.	2065 lbs.	\$23,980
JSCP-11	6.0	7.78	2.45	336.8	40KW	868 lbs.	1288 lbs.	\$19,270
with deicers						969 lbs.	1632 lbs.	\$22,930
with radomes						1240 lbs.	2270 lbs.	\$25,370
JSCP-12	6.6	8.20	2.57	353.2	40KW	929 lbs.	1514 lbs.	\$21,550
with deicers						1032 lbs.	1780 lbs.	\$25,550
with radomes						1289 lbs.	2475 lbs.	\$28,210
JSCP-14	7.8	8.92	2.79	383.5	40KW	1051 lbs.	1760 lbs.	\$25,150
with deicers						1158 lbs.	2077 lbs.	\$29,810
with radomes						1473 lbs.	2885 lbs.	\$32,920

## JAMPRO ELLIPTICALLY POLARIZED PERFORMER FM ANTENNAS

Now Class A and educational broadcasting stations can take advantage of superior quality and craftsmanship of Jampro's latest contribution to FM broadcasting.

The JACP series is rated at 3KW per bay up to a max of 10KW and is available in models from 1 to 12 bays. Low VSWR over 200kHz provides excellent conditions for stereo broadcasting service.

These PERFORMER antennas are designed for low VSWR values. Each antenna is complete with a VSWR tuner, which is adjusted for best operation after installation. The

antenna is completely air tight and may be pressurized for long, trouble free service.

Galvanized steel mounting brackets are included with each antenna for leg mounting on uniform cross section towers. Face mounting and tapered tower mounting brackets are priced on request. Other special mounting brackets are available.

The JLCP feed system consists of a vertical 1-5/8" line, across which are shunted the various bays. The input of the antenna is a 1-5/8" EIA flange.

Radomes are available at additional cost.

Type No. and Bays	Pwr. Gain	Gain in dB	Field Gain	FS at 1 mile 1 KW, MV/M	Net Weight	Safe Pwr. Rating	Windload 50/33 PSF	Pricing Standard w/Radomes	
JLCP-1	0.475	-3.23	0.69	94.94	12 lbs.	3KW	15 lbs.	\$1660.00	\$2190.00
JLCP-2	0.955	- .20	0.977	134.44	51 lbs.	5KW	70 lbs.	\$2580.00	\$3420.00
JLCP-3	1.50	1.76	1.22	167.87	71 lbs.	6KW	130 lbs.	\$3640.00	\$4650.00
JLCP-4	2.05	3.12	1.43	196.77	90 lbs.	8KW	183 lbs.	\$4930.00	\$5890.00
JLCP-5	2.60	4.15	1.61	221.54	107 lbs.	10KW	242 lbs.	\$6160.00	\$7140.00
JLCP-6	3.15	4.98	1.77	243.55	132 lbs.	10KW	295 lbs.	\$7280.00	\$8370.00

Prices include complete mounting hardware for leg mounting, guyed towers only. Mounting brackets not included in net weight or windloading. No deicers available, 8, 10 and 12 bay available.





# TRANSMITTING ANTENNAS

## JAMPRO JHCP — FM BROADCAST ANTENNAS

Extremely high-power handling capacity, heavy-duty mechanical construction.

The JHCP antenna is a circularly polarized FM antenna for the broadcaster who wants extremely high-input power capability, coupled with the patented design that has become an industry standard. This design is sophisticated in concept yet simple in execution. Each bay consists of a radiating element with its associated 6-1/8 inch interbay feed line. The element and line are supported by a heavy brass casting which is attached to the support structure by its mounting bracket.

The radiating element consists of four 3-inch diameter quarter wave brass arms attached to a 3 1/4 inch brass support internal feed boom by brass castings. The inter-bay feed lines and boom are pressurized out to the feed point by the transmission line pressurization system.

### POWER RATING:

The JHCP antenna is conservatively rated at 30KW per bay, with a maximum system rating of 80KW for three bays and above.

### RADIATION PATTERN:

The circularity of the JHCP element is  $\pm 1.0\text{dB}$  in free space. The azimuth pattern will tend to be distorted somewhat by the structure on which the antenna is mounted, with circularity of the antenna typically  $\pm 1.2\text{dB}$  mounted on a steel pole and typically  $\pm 3.0\text{dB}$  mounted on a 30 inch face tower. Jampro pattern measurement service is recommended for this and all antennas to insure that there are no azimuth pattern nulls at the broadcaster's

service area.

### ANTENNA MOUNTING:

The JHCP antenna is supplied with standard galvanized brackets for round-leg mounting on uniform face towers. Special galvanized brackets can be supplied at additional cost for mounting the JHCP on tapered towers, on poles, or for towerface mounting. All hardware is included with mounting brackets. Custom antenna support poles can be supplied. Contact Allied for pricing.

### DEICING:

Deicing equipment is recommended for the JHCP in environments where regular icing and sleet conditions prevail in order to preserve the antenna's excellent VSWR specifications.

Radomes are also available for the JHCP antenna where electrical deicers are impractical.

### BEAM TILT AND NULL FILL:

The JHCP antenna is optionally available with custom beam tilt and/or null fill to satisfy the requirements of the customer and consulting engineer, in order to optimize radiation toward the desired service area. Power gain figures at the horizontal plane will be affected by beam tilt or null fill; details supplied upon request.

### DIRECTIONAL ANTENNAS:

Custom Directional antenna patterns are available to meet FCC requirements, or for use in countries where such directional antennas are readily usable. Nulls may be produced depending on protection requirements of azimuth heading and null depth. Full-scale antenna range testing and pattern certification are offered for directional antennas. Specific details for special requirements available upon request.

(cont.)

Type No. and Bays	Pwr. Gain	Gain in dB	Field Gain	FS at 1 mile KW, MV/M	Net Weight	Safe Pwr. Rating	Windload 50/33PSF	Price with Deicers
JHCP-1	.46	-3.37	0.678	83.2	212 lbs.	30KW	269 lbs.	\$4020.00
JHCP-2	1.0	0	1.0	137.6	425 lbs.	60KW	540 lbs.	\$7350.00
JHCP-3	1.6	1.98	1.25	172.0	634 lbs.	60KW	806 lbs.	\$10,940.00
JHCP-4	2.1	3.30	1.46	201.0	1007 lbs.	80KW	1254 lbs.	\$16,200.00
JHCP-5	2.7	4.35	1.65	227.0	1167 lbs.	80KW	1460 lbs.	\$18,350.00
JHCP-6	3.3	5.20	1.82	250.0	1320 lbs.	80KW	1662 lbs.	\$21,810.00
JHCP-7	3.9	5.90	1.97	271.0	1540 lbs.	80KW	1970 lbs.	\$25,410.00
JHCP-8	4.5	6.50	2.11	291.0	1758 lbs.	80KW	2245 lbs.	\$28,240.00
JHCP-10	5.7	7.53	2.38	328.0	2202 lbs.	80KW	2827 lbs.	\$35,300.00
JHCP-12	6.7	8.26	2.59	356.0	2640 lbs.	80KW	3410 lbs.	\$38,470.00

Deicers per bay \$535.00 — Deicer Thermostat \$300.00

## JAMPRO MODEL JBCEP — FM ANTENNA

Up to 1/2" radial ice - no radomes or deicers.

For the broadcaster who wishes to eliminate deicers and radomes in climates otherwise requiring them.

The Jampro model JBCEP antenna, manufactured by Cetec Antennas, is a circularly polarized FM antenna designed for applications requiring relative insensitivity to icing along with high antenna input power. The antenna elements are fabricated of high strength thick wall copper with a 3-1/8 inch outside diameter. The JBCEP antenna will handle up to 40KW per bay and up to 120KW per system, depending upon the number of bays, shunt line size and input connector.

The JBCEP antenna is inherently broadband, using an internal pressurized feed system; it can be used for diplexing applications with a VSWR of 1.20 to one or better over a 4MHz bandwidth, making it suitable for diplexing. On a single frequency, the VSWR is 1.07 to one  $\pm 200\text{kHz}$  of carrier with field tuning; deicers are not

(cont.)

normally required, as the typical VSWR is 1.4 to one or better with up to 1/2 inch of radial ice. The individual radiating elements may be field tuned for best VSWR. The VSWR at the antenna input without field tuning will be 1.5 to one or less when side mounted on a tower.

## JAMPRO PATTERN STUDY AND OPTIMIZATION SERVICE

These measured patterns were taken from actual production files, during antenna pattern correction service. They are typical of what can be expected when FM antennas are arbitrarily mounted on the leg or face of common size towers. The measured patterns resulting from "best guess" types of mounting, without any pattern correction, are shown as a dash line. The shaded areas indicate the minimum field strengths desired by the broadcaster. The solid line shows the measured field strength after the tower mounted antennas was pattern corrected with parasitic elements, mounted around the tower.

(cont.)

# 4

## TRANSMITTING ANTENNAS

Power distortion is caused by the tower legs, horizontal and diagonal bracing, lighting conduits, coax lines, size and shape of the tower section, and other factors. Nulls as deep as 35dB have been measured. (three hundreds of 1% power!) 20dB nulls are quite common (1% power). Only by actual azimuth pattern measurements, on the operating frequency, on the tower, or a replica of it, can the field pattern be determined accurately. Mounting the antenna on the side of the tower or pole nearest the service area does not guarantee best results. Nulls may be inadvertently pointed at the heart of the service area.

Jampro Antennas Pattern Optimization Service is used to improve the circularity of side-mounted Jampro FM antennas while repositioning the azimuth pattern null(s) to a heading that will be least detrimental to potential coverage.

The Jampro all-weather test range, located in the Sacramento Valley, is used for pattern measurement. One or more antenna bays are placed on an exact duplicate of the proposed antenna mounting structure for measurement, and parasitic elements are used to adjust the azimuth pattern in the horizontal polarization. Antenna positioning relative to the mounting structure is used to adjust the vertically polarized azimuth pattern. The parasitic elements are fabricated of steel and then hot dip galvanized for long life. Customized installation drawings are provided for ease of installation in the field. As a large number of variables, including number of antenna bays, mounting structure configuration and size, and orientation of the mounting structure relative to desired radiation directions, pricing for Pattern Optimization is on a custom basis.

Pricing may be obtained through Allied. Jampro stocks a number of standard mounting towers; where necessary, pricing will include any required tower duplication charges for proper testing.

DASH LINE — Original Pattern  
SOLID LINE — After Optimization  
SHADED AREA — Desired Coverage

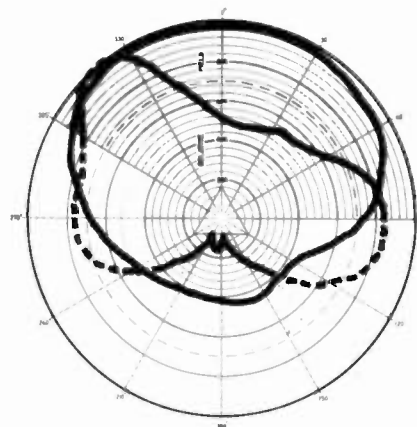

ACTUAL CASE TEST

Frequency = 94.5MHz, Tower = 7 feet triangular,  
Original Circularity =  $\pm 10.48$ dB, Antenna Leg Mounted  
After Adjustment, Circularity =  $\pm 3.75$ dB

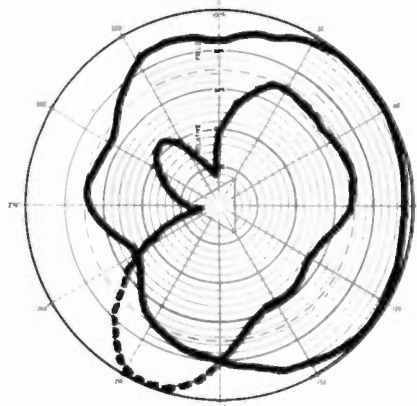

ACTUAL CASE TEST

Frequency = 102.5MHz, Tower = 42 inch triangular  
Original Circularity =  $\pm 10.55$ dB, Antenna Leg Mounted  
After Adjustment, Circularity =  $\pm 3.09$ dB

### PHELPS-DODGE CIRCULARLY POLARIZED FM BROADCAST ANTENNAS

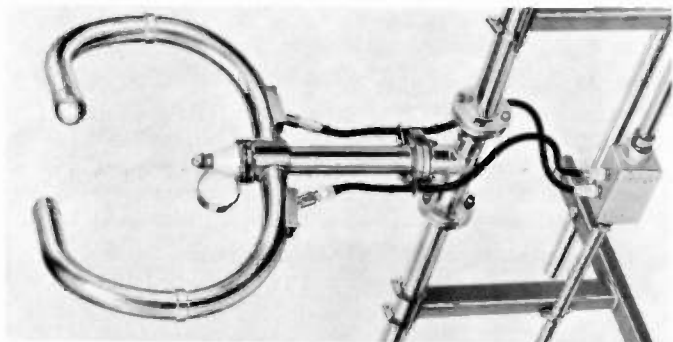

Standard circularly polarized FM antennas are fabricated of 1-5/8" O.D. copper tube formed into a 1 1/2 turn helical radiating element. This element produces a transmitted signal that is circularly polarized in all directions in the azimuth plane.

Antennas are available with all elements fed inphase to produce maximum gain on the horizon with 1 through 8 elements end fed and 10 through 16 elements center fed. If beam tilt and/or null fill is required the multi-element

(cont.)

array needed to produce the required pattern is center fed with appropriate power divider and phaser supplied.

All antennas are supplied complete ready for installation on the tower. Each antenna has an input transformer to correct for any minor variations between the antenna test site and the actual field installation.

If required, stainless steel internal deicer heaters are available.

- Length of antenna in feet is 984 divided by frequency in MHz x (No. of Bays—1) Plus 6 1/2.
- Power gains are for 50/50 horizontally and vertically polarized ratios. Other ratios available.
- Antenna polarization is circular in all directions of azimuth.
- Prices include complete mounting hardware for leg or face mounting on uniform towers 24" face or less. Brackets for other than uniform towers are extra and will be quoted upon request.
- High Power Antennas—input flange is 3-1/8" EIA female  
Low Power Antennas—input flange is 1-5/8" EIA female
- Antenna weights include standard mounting hardware. Add 10 lbs. per bay for deicers. Deicers require 230 volts single phase balanced to ground with 500 watts consumption per bay.

(cont.)



# TRANSMITTING ANTENNAS

Type No. & Bays	Power Gain	Net/Wt. Lbs.	Power Rating KW	Price
CFM LP-1	.45	118	5	\$1603.00
CFM HP-1	.475	178	5	\$2131.00
CFM LP-2	.95	145	10	\$2440.00
CFM HP-2	1.00	223	10	\$3725.00
CFM LP-3	1.5	172	10	\$3460.00
CFM HP-3	1.55	268	15	\$5320.00
CFM LP-4	2.05	198	10	\$4485.00
CFM HP-4	2.15	313	20	\$6920.00
CFM LP-5	2.55	225	10	\$5605.00
CFM HP-5	2.70	358	25	\$8520.00
CFM LP-6	3.15	251	10	\$6505.00
CFM HP-6	3.30	404	30	\$9935.00
CFM LP-7	3.65	278	10	\$7565.00
CFM HP-7	3.85	449	35	\$11,470.00
CFM LP-8	4.2	305	10	\$8585.00
CFM HP-8	4.4	494	40	\$12,690.00
CFM LP-10	5.2	365	10	\$10,580.00
CFM HP-10	5.5	600	40	\$15,990.00
CFM LP-12	6.25	418	10	\$11,600.00
CFM HP-12	6.6	690	40	\$18,775.00

CFM LP = Circularly Polarized Low Power Shunt Fed with 1-5/8" Feed Line complete with 1-5/8" Fine Matcher.

CFM HP = Circularly Polarized High Power Shunt Fed with 3-1/8" Feed Line Complete with 3-1/8" Fine Matcher.

When Ordering—specify: Antenna Type No., Deicers, PD-1201 (\$292.00 ea.), Frequency (88.1 to 107.9 mHz), 1-8 bays end fed, 10-16 bays center fed, Horizontal and Vertical Power Gains, Description of Tower—make and model, Beam tilt and Null Fill, if required (extra), Thermostat and Control Box—PD1202 (\$649.00). No Radomes.

## PHELPS DODGE FM EDUCATIONAL ANTENNAS

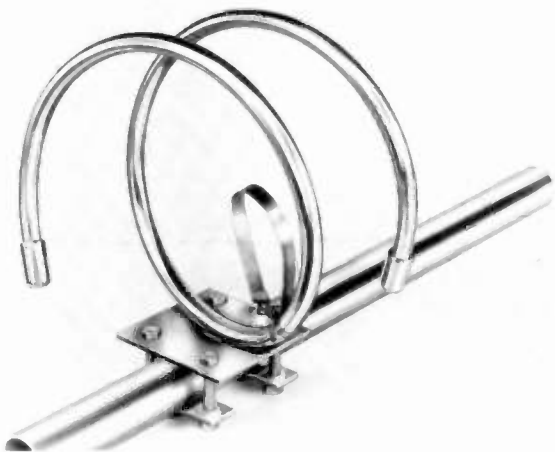

Educational FM antennas using the same general design concepts as the commercial High Power and Low Power antennas are available.

However, these antennas, because of the normally lower power required in the educational service, are fabricated of 7/8" stainless steel tube. The circularly polarized antenna is a 1 1/2 turn helix and the horizontal polarized element has a U configuration. The educational antennas are complete with a matching harness of RG type cables and are designed to mount on tower legs or support pipes 1 1/4" to 2 3/4" diameters. The multi-element arrays have an

(cont.)

element spacing of 10 feet.

- Educational FM Antennas are designed to mount on tower legs or support pipes having diameters up to 2 3/4". The spacing between bays is 10 ft.
- Educational FM Antennas are fed with RG-8 and RG-11 cables and all have a type N Male Input Connector.

Type No. & Bays	Power Gain	Net/Wt. Lbs.	Power Rating KW	Price
ECFM-1	.43	9	.2	\$471.00
ECFM-2	.90	21	.4	\$932.00
ECFM-3	1.42	32	.5	\$1401.00
ECFM-4	1.95	43	.5	\$1859.00
ECFM-6	2.99	65	.5	\$2731.00

When ordering specify Radome PD-1203 at \$413.00/Bay  
Radomes available only for this antenna.

## DECCA AUSTIN INSULATORS

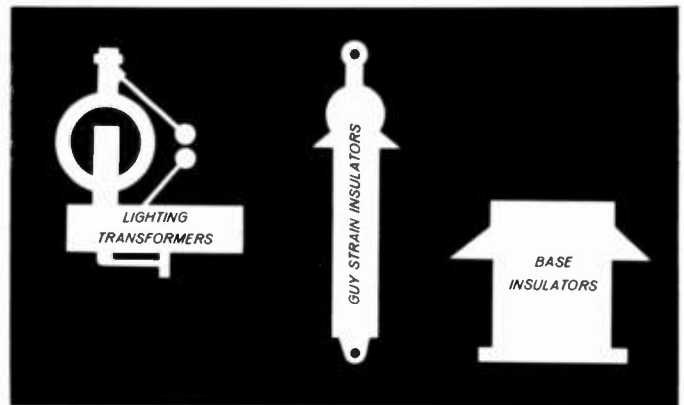

Contact Allied for details and pricing.

# TRANSMITTING RF EQUIPMENT

## COPPER WIRE, STRAP SCREEN



Copper Wire, Strap and Screen at competitive prices.



# TRANSMITTING RF EQUIPMENT

## COMARK 2300 & 2600 SERIES LOW PASS FILTER



The Comark Low Pass Filters are reactive type structures designed to attenuate the second, third and fourth harmonics at the transmitter output to ensure compliance with FCC regulations.

Each filter is manufactured for a single channel with an extremely low VSWR for system compatibility. Standard EIA flanges (one fixed and one swivel) are supplied with an anchor connector for simple installation.

FREQUENCY RANGE: Any single FM channel

CONNECTORS: Up to 6-1/8"

POWER: Up to 60 KW

Model	Connectors	Freq. Band	Power Peak Sync	Price
CI-2310	3-1/8" EIA	UHF	30kW	\$985.00
CI-2311	3-1/8" EIA	VHF	35kW	\$1295.00
CI-2312	3-1/8" EIA	VHF-FM	25kW (avg)	\$985.00
CI-2314	1-5/8" EIA	VHF-FM	3kW (avg)	\$645.00
CI-2610	6-1/8" EIA	UHF	60kW	\$1295.00
CI-2611	6-1/8" EIA	VHF-FM	50kW	\$1995.00

## COMARK MANUAL PATCH PANEL

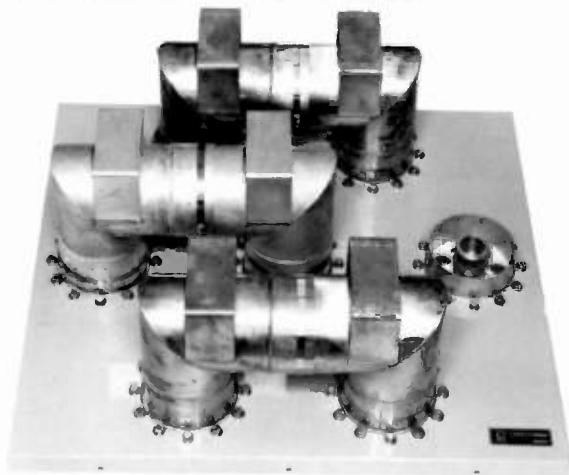

Coaxial Patch Panels are available in all standard transmission line sizes in three, four and seven port standard configurations. The patch link construction allows the patch link to self align with the panel ports for ease of operation.

- Self aligning

(cont.)

- Take apart patch lines
- Handles for ease of patching

Model	Line Size	Poles	Links	Price
CI-7511	1-5/8	3	1	\$635.00
CI-7512	1-5/8	4	2	\$825.00
CI-7513	1-5/8	5	2	\$1035.00
CI-7514	1-5/8	7	3	\$1315.00
CI-7541	3-1/8	3	1	\$795.00
CI-7542	3-1/8	7	3	\$1825.00
CI-7543	6-1/8	3	1	\$2210.00
CI-7544	6-1/8	7	3	\$4365.00
CI-7545	3-1/8	4	2	\$1235.00

## COMARK MOTORIZED COAXIAL TRANSFER SWITCH



The 9301, 9302 & 9303 Coaxial Transfer Switches have been totally designed from the standpoint of the operator.

Features such as watchband spring contacts, visual status of position, and ease of maintenance provide a versatile switch for use in the "real world." Micro switch interlocks supplied are easily interfaced with any transmitter, for protection & control.

Features such as low VSWR and low insertion loss together with maximum isolation make these switches the ideal instrument for routing RF, especially in remote control applications. The positive action switching solenoid may be remotely controlled or manually overridden.

An optional control panel is available for remote RF switching and includes visual RF flow indication. The panel is 5 1/4" high and mounts in a standard 19".

Watchband springs are used for all electrical connections to provide the most reliable contact possible. Three separate watchband springs are used for each inner conductor to further assure troublefree operation.

IMPEDANCE: 50 ohms

FREQUENCY RANGE: dc to 900 mHz

CONNECTORS:

110mHz  
avg. pwr.

CI-9100A	1-5/8" EIA fixed flange	12KW	\$2295.00
CI-9300A	3-1/8" EIA fixed flange	40KW	\$2735.00
CI-9600A	6-1/8" EIA fixed flange	80KW	\$5480.00

## DELTA ELECTRONICS 6700 SERIES 1-5/8 & 3-1/8 INCH COAXIAL TRANSFER SWITCH

The 6700 series of Coaxial Transfer Switches provides the engineer with the capability to switch between transmitters, antennas, or dummy loads with a minimum of off-the-air time. Both models can be operated by remote control or manually. Remote operation can be achieved using either 120V or 220/240V, 50/60 Hz. The transfer switch is

(cont.)

# 4

## TRANSMITTING RF EQUIPMENT

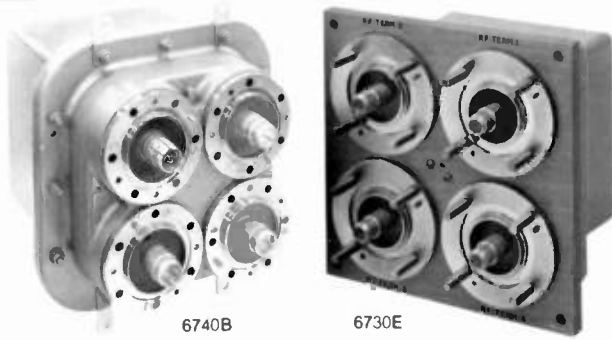

fully interlocked with two isolated interlock circuits that duplicate the RF path exactly. The 6730/6732E is a 1-5/8 inch switch. The 6740B/6742B is a 3-1/8 inch switch and may be pressurized up to 16 lb/sq. in. A gas barrier is built into each terminal, and an air inlet port is also provided in the 6740B/6742B model.

	<b>110MHz avg. pwr.</b>		
6730E	115VAC	12KW	\$1375.00
6732E	230VAC	12KW	\$1485.00
6740B	115VAC	49KW	\$3600.00
6742B	230VAC	49KW	\$3700.00
33630A	Control Panel		\$450.00

### COMARK RIGID TRANSMISSION LINE



Comark's rigid 3-1/8" thru 8-3/16" transmission line is fabricated from high conductivity copper tubing with precision machined teflon insulators. The inner conductors are connected by a 1/2 fixed compression style bullet with dual silver plated watch band springs for the best possible contact. This provides outstanding features such as constant impedance, high power capacity, low insertion loss, and minimum heat build-up. Heliarc Welded Flanges. The bullet is tightly secured to the inner conductor cup by utilization of a piece of hard-drawn copper tube, an expandable stainless steel spring, and a stainless steel hex head bolt and lockwasher.

Comark takes great pride in stating that they have never had an R.F. failure with this highly specialized design. Call or write for complete information and prices.

**ALLIED HAS A LEASE  
PLAN TO SUIT YOUR INDIVIDUAL NEEDS**

### MCI COAXIAL TRANSFER SWITCH



MCI Coaxial Transfer Switches are designed primarily for application in television, FM and AM broadcast transmitter plants, and HF, VHF, and UHF communications systems. As four-port transfer switches they will switch two signal sources between two loads. Since they can also be used as SPDT switches, complex switching matrices can be easily assembled.

MCI can furnish completely integrated switching systems and control/indicator panels to any degree of complexity. Outline your particular requirements for a prompt and comprehensive proposal.

- 6-1/8", 3-1/8" and 1-5/8" EIA
- Very fast switching
- Independent interlock/logic circuits
- Compatible with computer control
- Compact, light weight

	<b>110 mHz avg. pwr.</b>		
61103	1-5/8	6KW	\$2090.00
61104	3-1/8	39KW	\$2500.00
61105	6-1/8	80KW	\$5200.00

High power models available - approximately 20% increased avg. power ea. model

### MICRO COMMUNICATIONS RF COMPONENTS

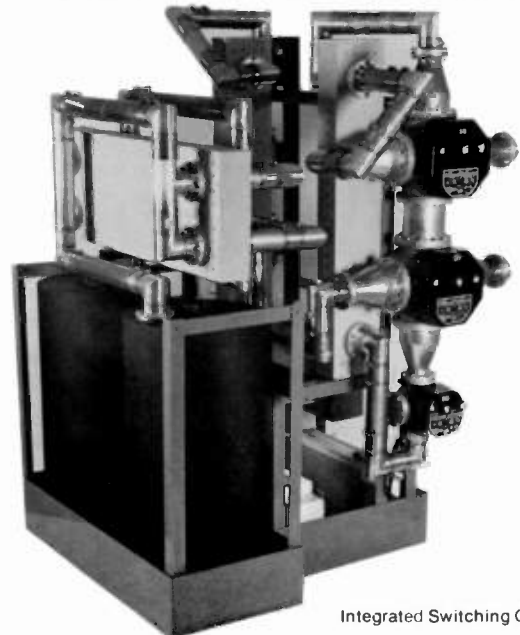

Integrated Switching Combiner

(cont.)



# TRANSMITTING RF EQUIPMENT

Micro Communications, Inc. is a communications system oriented company and a manufacturer of equipment used extensively by the broadcasting industry.

- RF Components of all types and sizes
- VHF and UHF duplexers with capabilities up to 220KW
- VHF, FM and UHF combiners with capabilities up to 220KW
- Filters, directional couplers, loads, hybrids, switching systems, etc.
- Master antennas
- Complete RF systems

Contact Allied for Complete Information and Pricing

## ELECTRONIC RESEARCH ISOLATION TRANSFORMER — TYPE 425



The isolation transformer is designed to couple the FM power across the base insulator of a transmitting tower used jointly as an AM and FM radiator without introducing objectionable mismatch into the FM antenna feed line. An isolation transformer is especially desirable for feeding high impedance AM radiators or AM radiators which are part of an AM directional antenna system which might be adversely affected by a "bazooka" isolation system.

### Mechanical Specifications:

Weight of Transformer & Cradle: 256 lbs.

Flange to Flange Length: 39" ± 1/8"

Max. Diameter of Tank: 28 1/2"

Designed for use in a pressurized system with gas passing through the unit.

### Electrical Specifications:

VSWR: Less than 1.05 to 1 at customer's frequency ± 0.5 mHz when terminated in a matched 50 ohm load.

Bandwidth: Over 2 mHz between 1.1 to 1 VSWR points when terminated in a matched 50 ohm load.

Power Rating into Matched 50 ohm Load: 25 KW

Insertion Loss: Less than 0.1 db.

Input: 3-1/8" EIA 50 ohm male flange with captive bullet ... output same.

AM Shunt Capacity to Ground: 60 to 70 pf.

AM Peak Voltage Rating: 40,000 volts.

Lightning Protection: Heavy duty D.C. shorts between the inner and outer conductors on both the input and output of the transformer.

Isolation Transformer - Type 425 ..... \$5320.00

ALLIED OFFERS PACKAGE DISCOUNTS

## BIRD 8645 25KW MODULOAD LOAD RESISTOR



- Power rating 25KW continuous duty up to 900 mHz
- Weight: 155 lbs.
- Distilled water or Ethylene Glycol.
- 10KW and 80KW in this series plus 2 1/2 to 7KW dry loads and Econo wet loads up to 80KW.

Contact Allied for Pricing

## BIRD ELECTRONICS



Bird Electronics known for accuracy for more than a quarter of a century, offers thru-line RF directional watt meters, RF load resistors, up to 80KW, and "watcher" protection systems.

Allied carries the entire BIRD professional line.

## BIRD HARMONIC FILTER-COUPPLERS



Call Allied for details and pricing.



# TRANSMITTING RF EQUIPMENT TUNERS

## ELECTRO IMPULSE



DPTC 50KFM

DPTC 10KFM

- Selectivity 62 dB
- Dual-gate MOSFET front end, phase-locked loop multiplex decoder

4020A ..... \$218.00  
 Rack Mounts ..... \$ 20.00

## SEQUERRA

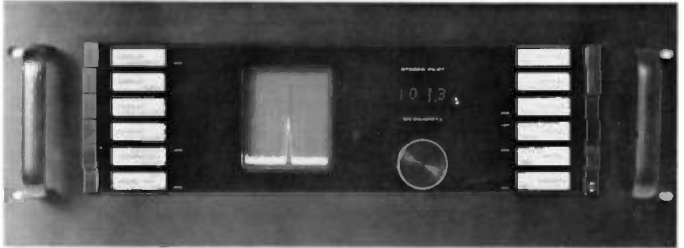

A dozen years ago, the *finest* proved its title to the world. No other similar device has come near.

No stranger to the limits of technology, the Model 1 has enjoyed a place of prominence in many quality conscious FM stations for a decade.

Expensive? Yes! . . . Luxurious? Hardly! Many engineers rely on the Model 1 as a tool of quality control vital to their own success as well as a diagnostic analyzer of their competition.

- How do you measure your station's performance?
- How does your operator ascertain on a continual basis, the quality of the program going out on the air?

A simple analysis will easily demonstrate the *Cost Effectiveness* of installing this monitoring system in your station.

The Model 1-BR is not cheap. But neither is the cost of being number one.

Sequerra ..... \$4500.00

## CROWN FM1 TUNER



Sonically, the FM1 is simply luxurious. Nothing has been spared to make it possible for you to capture FM signals that are as clear, complete, and undistorted as possible.

It is therefore, a very special audio component, suitable for the most demanding listeners.

The FM1 is all-digital and controlled through a combination of touch buttons for tuning, and push buttons for auxiliary functions.

There is no tuning dial, nor a tuning wheel. But tuning is easy, instantaneous, precise and absolutely stable, because the FM1 is a true digitally synthesized tuner.

The FM1 is a professional tuner in that it controls frequency in the same manner that commercial broadcasters do.

"Pre-set" or memory is one reason why Crown chose an all-electric tuning system. The FM1 memory system

(cont.)

RF Coaxial Loads— Air, oil, dry, and water cooled of all sizes from .5 to 80 KW.

Representative models and prices include:

1500 watt oil dielectric cooled and self-contained Model CPTN-1500-Good out to 1 GHz ..... \$630.00  
 10,000 watt dry load, forced air cooled and self contained Model DPTC-10KFM-Good out to 110MHz ..... \$1825.00  
 25,000 watt dry load, forced air cooled and self contained Model DPTC-25KFM-Good out to 110MHz ..... \$3575.00

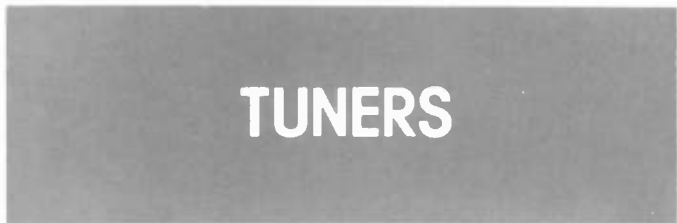

## NAD 4020A TUNER



A sensitive, low-distortion, high-performance AM/FM tuner with a minimum of frills. In real-use conditions the 4020A equals the performance of many tuners costing two or three times more.

- 1.8uV (10.3 dBf) IHF sensitivity
- 50 dB quieting sensitivity: 16 dBf mono, 38.3 dBf stereo
- 70 dB S/N ratio in stereo, 75 dB in mono

(cont.)

# 4

# TUNERS TURNTABLES-ARMS-CARTRIDGES

depends on an electronically alterable ROM integrated circuit. This IC makes it possible to store stations without any risk of memory loss due to power failure. And there are no batteries in the FM1 to worry about.

**SENSITIVITY:** 10.8dBf IHF Usable  
**QUIETING:** .6 microvolt (75 ohm) for 30dB mono quieting. 36dBf for 50dB stereo quieting. 10.8dBf for 50dB mono quieting  
**SIGNAL TO NOISE RATIO:** Mono 70dB below 100% modulation at 65dBf reference level. Stereo 65dB below standard stereo modulation at 65dBf reference level  
**ALTERNATE CHANNEL SELECTIVITY:** 75dB at 25dBf  
**FREQUENCY RESPONSE:** ±.5dB 30 Hz to 15 kHz  
**AM SUPPRESSION RATIO:** Greater than 73dB at 25dBf

**FM1** ..... \$995.00

## CROWN FM TWO



- FM tuner
- Cascoded J-FET Front End eliminates RF intermodulation; aligns automatically; rejects spurious signals; no AGC - equivalent or superior performance with minimum distortion.
- Linear ceramic filters
- Heavily-modulated stations (rock) sound better
- AM suppression — 80 dB
- Pulse-count digital circuit cannot drift
- All touch-button tuning
- Crystal-controlled — phase locked loop
- Station frequency displayed via vacuum fluorescent
- Signal strength indicator
- Six station memory

**FM Two** ..... \$699.00

## ELGIN TD-4 DIALTONE DETECTOR

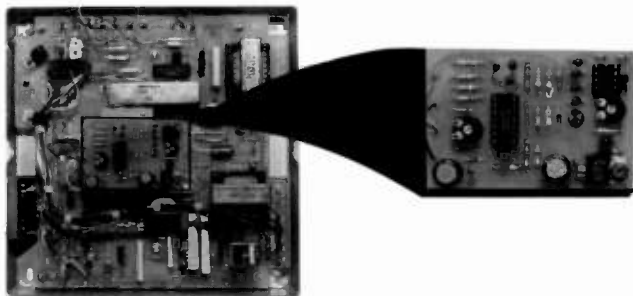

Now, all areas can take advantage of the Elgin 20721 Listen Line. Even if your local telco doesn't supply battery-reversal or momentary-open functions, this will permit use of the 20721.

This direct retrofit module acts as a dial tone detector. Your calling party listens as long as desired, and hangs up. The detector senses the dialtone remaining and releases the line so that the listen line coupler may accept the next call.

The TD-4 dialtone detector takes its power from the host 20721 coupler.

**TD-4 Dialtone Detector** ..... \$54.00

## TURNTABLES-ARMS CARTRIDGES

### TECHNICS SP-15 TURNTABLE



- Setting high standards for professional performance and flexibility.
- Quartz Synthesizer Pitch Control in 0.1% steps up to ± 9.9% at all three standard speeds—with digital display
- Instant starts (0.4 sec.) (About 1/3 revolution).
- Heavy duty construction stands up to long term professional use.
- Three precision speeds, 33-1/3, 45 and 78.26 rpm make this unit perfect for all phono reproduction applications.

**SP-15** ..... \$700.00

### TECHNICS SP-10MKII QUARTZ-CONTROLLED DIRECT-DRIVE TURNTABLE



The first with instant torque and no rumble. The world's best and most desired professional turntable. Used by 80 of the 100 top U.S. Radio Stations.

**SP-10MKII** ..... \$1100.00

### TECHNICS SP-10MKIII DIRECT-DRIVE TURNTABLE



(cont.)



# 4

# TURNTABLES-ARMS-CARTRIDGES

Presenting the SP-10MKIII, the most advanced quartz synthesizer DD turntable from Technics, the acknowledged hi-fi turntable leader. Both specifications and sound quality reveal that the SP-10MKIII extends the frontiers of excellence. For example, starting torque is 16 kg•cm, and only one quarter of a second is required to reach rated speed; moment of inertia is 1.1 ton•cm<sup>2</sup>, wow & flutter is 0.15% WRMS, rumble is -92dB (DIN-B), and quartz locked pitch is adjustable in 0.1% step increments or decrements up to ± 9.9%. For serious professionals, this is the turntable by which all the others must be judged.

A separate control unit houses the power supply and all circuitry except the motor itself, thereby assuring more reliable operation with freedom from noise. On the smoked acrylic front panel are high visibility LED displays (speed and pitch setting) as well as the on/off switch and soft-touch switches for speed selection and pitch control (with tactile switch feel). Start/stop and speed selector switches are provided on the turntable itself as well.

**SP-10MKIII** ..... \$1700.00

## TECHNICS SP-25 TURNTABLE



The new SP-25 offers you a high professional standard of excellence, plus the kind of flexibility and convenience that is important for home use. Features include total quartz-locked pitch control within ±6% range from rated speeds, full cycle detection FG, extremely high torque for fast starts and load stability, large turntable platter with extra-high moment of inertia, electronic braking system, integral rotor/platter motor construction, and highly effective damping.

- 45 and 33 RPM
- About 1/2 revolution to full speed

**SP-25** ..... \$400.00

## THE ALLIED SHOCK ABSORBER MODEL KK8100

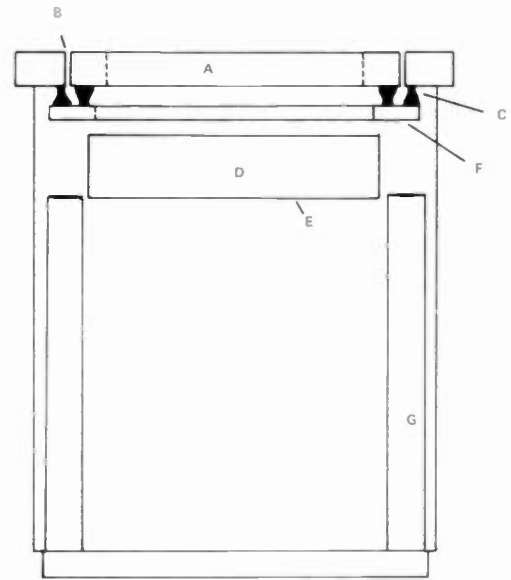

Allied's AK10 MKII turntable isolator has been integrated into a new package known as the "shock absorber." This approach attacks head-on the many problems associated with protecting otherwise noise-free turntable/arm combinations from all types of interference.

Three-fourths of the cabinet is sand loadable creating an acoustically- and sympathetic-vibration-free environment as a foundation for the further isolated top plate, turntable, and arm. For use only with direct-drive turntables.

- A. Custom cut for your turntable—inlaid lead around entire plate perimeter.
- B. Turntable mount plate isolated from perimeter.
- C. Double suspension compound rubber shock mounts.
- D. Pocket door—access to shelf for electronics—shelf removes so that sand may be poured or bagged into entire lower chamber.
- E. Below this line, all joints are sealed for sand loading.
- F. Cutout of lower plate is large enough to accommodate turntable, arm, arm cord, and arm rest underhang to ensure that there is no physical contact with upper plate.
- G. 2" I.D. plastic ABS pipe—one left rear corner, one right rear corner. AC cords—audio cords.

### PROBLEM

1. Airborne Noise
2. Structureborne Noise
3. Acoustical Coupling Feedback
4. Floor Vibrations and Shocks

### SOLUTION

1. The Shock Absorber
2. The Shock Absorber
3. The Shock Absorber
4. The Shock Absorber

**Allied Shock Absorber Model KK8100** ..... \$499.00

## RUSSCO STUDIO-PRO



- Unit is powered by a heavy duty Bodine synchronous motor.
- 2 Speeds — 45 & 33 RPM

**Studio-Pro** ..... \$448.00

(cont.)



# TURNTABLES-ARMS-CARTRIDGES

## RUSSCO CUE-MASTER



- The unit is powered by a heavy duty Bodine synchronous motor.

**Cue-Master** ..... \$398.00  
**Not mechanically compatible with ATP12T Tonearm**

## BROADCAST ELECTRONICS TURNTABLE



Shown with optional S320 tone arm

- Three Standard Speeds: 33 1/3, 45, 78
- Instant Start (Full Speed in Less than 1/8th Revolution)
- Rugged Construction, Only 3 Moving Parts
- Rim Drive Assures Minimum Rumble, Maximum Starting Torque
- 45 RPM Adapter Built Into Precision Platter
- Stereo Rumble Less Than -38 dB (Exceeds NAB Standards)

**B.E. Turntable 12C3/U** ..... \$400.00

## RUSSCO MARK V VARI-SPEED TURNTABLE



Here's the fantastic NEW value packed variable speed turntable from the people who have set the industry standard for performance and reliability! The speeds are now precision variable plus or minus 10% at 33 or 45 RPM. The Mark V is instant starting! . . . Less than one inch back cue required at 45. Here's more good news . . . Remote start & stop & digital speed readout.

This dandy RUSSCO RUGGED low profile turntable also features an attractive antique silver no mar finish that makes the studio deluxe.

**Mark V Broadcast Std.-Fixed readout** ..... \$625.00  
**Mark V Broadcast Deluxe-vari readout** ..... \$720.00  
**Mark V Disco/Prod'n.-vari readout w/knobs** ..... \$720.00

## ALLIED TURNTABLE ISOLATOR



Intended for use only with direct drive turntables

The AK10 MKII, a sandwich consisting of an upper and a lower plate which reduces physical contact to live rubber only, can be accommodated to all popular turntable/ tone arm combinations. Installation is a breeze.

The sandwich's upper plate is composed of high-density particle board with an inlaid lead strip around the entire perimeter to reduce resonance and vibrations to an even greater degree. Coupling to the bottom plate is achieved through suspension with compounded natural rubber only.

The bottom plate is supplied in sufficient size to completely cover any previous turntable hole. This permits easy retrofit with existing turntable pedestals. Problems associated with two turntables having to share the same cabinet will thus be ameliorated.

**Allied Turntable Isolator AK10 MKII** ..... \$229.00  
**Walnut, Pecan, Black, or Gold laminate finish standard.**  
**Add 15% for any Pattern Laminate.**

## BROADCAST ELECTRONICS S-320 TONE ARM

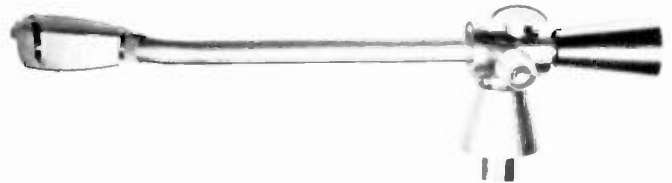

This attractive tone arm is constructed of tubular aluminum with a die-cast cartridge shell, that accepts all standard stereo or mono cartridges. It has a vertical height adjustment and friction-free chrome steel ball vertical movement. It tracks at 1 gram or less and includes a counterweight. Connects with standard plugs.

**S-320** ..... \$130.00

## SYNTEC S-220 PROFESSIONAL STEREO TONE ARM



Removable Cartridge Shell

**MOUNTING:** 7/8" diameter single hole, 1" long threaded shank

**LATERAL BALANCE:** Adjustable to compensate for various cartridges

**TRACKING FORCE ADJUSTABLE:** Adjusts tracking force for any cartridge

**ARM HEIGHT ADJUSTABLE:** Locking screws on shafts of arm and rest adjust height of arm from 1-9/16"-2-3/8"

**S-220** ..... \$99.00

# TURNTABLES-ARMS-CARTRIDGES

## RUSSCO TONE ARM RTA-12

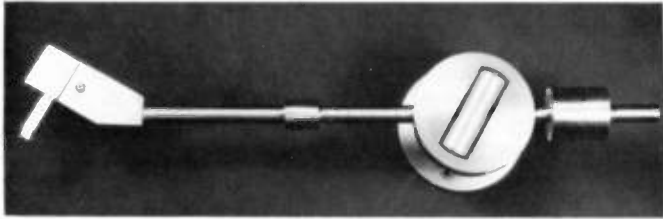

- Rugged Aluminum and Chromed Brass construction
- Length: 13"
- 5 grams maximum tracking force
- 1 gram minimum tracking force
- Less than 2 degrees tracking error
- Range of Height Adjustment is 1.8"
- Mounting flange diameter: 2.75"
- Mounting hole diameter: 7/8"
- Distance from arm pivot point to turntable spindle: 8.31"
- 4" overhang from pivot to rear
- Cable Capacity: 135pF
- Shipping weight: 3 lbs.

RTA-12 ..... \$140.00

## MICRO-TRACK 303 TONE ARM

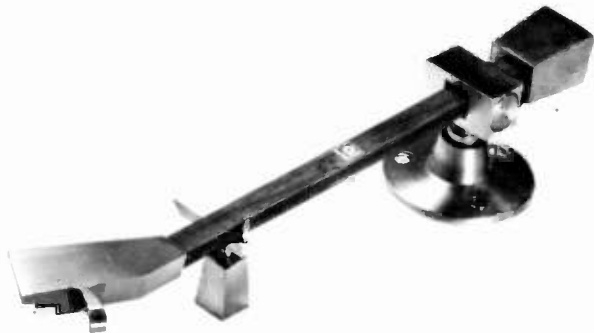

This tone arm features modern styling, plug-in memory balance head, laminated wood and epoxy body makes for rugged, lightweight construction. Stylus force once set is tamper proof, and adjusted by counter-weight. A standard of the industry.

303 (12 inch) ..... \$119.50

## AUDIO-TECHNICA ATP-12T TONE ARM

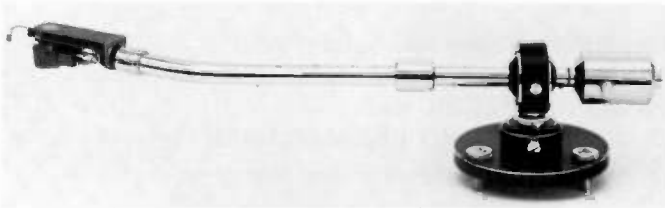

- Fits wide range of turntable heights and base thicknesses.
- Sealed horizontal and vertical ball bearing pivots.
- Accurate, built-in VTF gauge, no accessory gauge needed.
- Low resistance, anti-corrosion, gold-plated connectors throughout.

(cont.)

- Simplified installation... plug-in head shell with color coded wiring, 4 cartridge mounting positions.
- Handy arm lift and tone arm rest provided.
- Pre-wired, color-coded, low capacity cable with ground lug.
- Set screws provided to lock all critical adjustments, if desired.

ATP-12T ..... \$150.00  
(Will not fit Russco or QRK Tables)

## STANTON 500A PHONO CARTRIDGE STANTON 500AL PHONO CARTRIDGE



For Heavy-Duty On-The-Air Use With Excellent Sound Reproduction.

For all around broadcast application, the 500A is widely recognized and applauded. It satisfies the most stringent requirements of the control room, from Bach to rock.

500A ..... \$15.75

For Heavy-Duty On-The-Air Use With Wide Tracking Force Range.

Even under the most adverse handling, 500AL operates trouble-free without sacrificing broadcast quality. Small Wonder, that it has become "the broadcasters' mainstay." And small wonder too, that it is probably the first choice of more broadcasters than any other cartridge.

500AL ..... \$15.75

## STANTON 600A PHONO CARTRIDGE



In all broadcast usages, the 600A is applicable to those situations that demand a spherical stylus tip—and a cartridge that tracks at 2 to 4 grams. It has been successfully employed by many hundreds of radio stations for on-the-air usage.

600A ..... \$24.20

## STANTON 681A PHONO CARTRIDGE



(cont.)

# TURNTABLES-ARMS-CARTRIDGES

This cartridge is indispensable for the recording engineer as a calibration standard for recording system checkout. Features extreme linearity plus widest and flat-test possible response essential for precise alignment of cutting heads.

Its factory calibrated frequency response meets the most rigid tolerances.

681A ..... \$55.00

**SHURE SC35C  
PROFESSIONAL STUDIO PHONO CARTRIDGE  
SHURE SC39 PROFESSIONAL PHONO CARTRIDGE**



The SC35C is designed for use on the heaviest and most rugged tone arms which require a tracking force of 4 to 5 grams. The stylus assembly of the SC35C is rigid enough to withstand the punishment of continuous backcueing, yet compliant enough to offer excellent mid- and high-frequency reproduction.

SC35C ..... \$36.00  
SS35C Spherical Stylus is the replacement stylus . \$16.00

Up to now, it was necessary to compromise true hi-fi performance to get the ruggedness required for professional use. . . . To identify precisely the use and abuse to which professional phono cartridges were subjected in actual work situations, Shure engineers went into the field where they virtually "lived with" the professionals: they sat up with the all-night man in broadcast stations; they worked in recording labs; they shared the booth in discos.

- Built to stand up to professional use
- Designed to stand up to a professional's critical listening

SC39ED 3/4 to 1 1/2 grams, Biradial (Elliptical) stylus ..... \$64.00  
SC39EJ 1 1/2 to 3 grams, Biradial (Elliptical) stylus ..... \$56.00  
SC39B 1 1/2 to 3 grams, Spherical stylus ..... \$50.00

Allied carries the entire Shure line—Many in stock

**AUDIO-METRICS PHONO PREAMPLIFIER PA-1**



**WHAT IT DOES. . .**

**NOISE**—A combination of discrete and integrated circuit components in the input gain stage and low noise resistors, hold noise to near theoretical limits.

**TRANSIENT RESPONSE**—The realization of the import-

(cont.)

ance of dynamic distortion figures is so recent that a rating standard is yet to be agreed upon. Yet, audiophiles attest to the significance of these factors for accurate reproduction. Uniformly high speed circuit design with response up to the MHz range, insures this unit's capability to reproduce even the fastest music peaks. Therefore, slew induced distortion and transient intermodulation are virtually non-existent.

**INPUT OVERLOAD**—With second stage equalization, the first stage gain block effectively buffers the cartridge from loading changes and provides broadband high input overload protection.

**AUDIO TRANSFORMERS**—The challenge was to eliminate the transformers and their inherent audio distortion, and still maintain RF protection and balanced outputs. The technical answer to the problem involves the use of state-of-the-art integrated circuits, ground plane circuit boards and input and output RF suppression. The practical side of the story is simpler and more important. Tests in ultra high RF environments have proven the unit to be RF interference proof.

**WHAT IT DOESN'T DO. . .**

**EQUALIZATION**—The Audio-Metrics preamp rigidly adheres to the RIAA curve. It does not allow for the user adjustment of high and low frequency response. Broadcasters uniformly told us that the preamp was not the place for tone compression.

**SWITCHES AND RELAYS**—No special auxiliary turntable start/stop switching or other accessories are included in the Audio-Metrics preamp. It seems obviously inappropriate to expect every user to pay for special features applicable to only a few special situations.

Tested and proven in the most RF intense environment in the U.S.

Input: 47k ohms parallel 180 pf.  
Maximum Input: 350 mv any frequency.  
Maximum Gain: 5 mv at 1 kHz = + 5 dBm single ended out, = + 10 dBm balanced out.  
Maximum Output: + 22 dBm single ended into 600 ohms, + 27 dBm balanced into 600 ohms.  
Output Impedance: 100 ohms single ended, 200 ohms balanced.  
Frequency Response: ± .25 dB RIAA (using new curve, specifying low end roll off).  
THD: .03% + 18 dBm into 600 ohms.  
IM Distortion: .04% + 18 dBm into 600 ohms SMPTE.  
Signal to Noise: 80 dB relative 5 mv at 1 kHz. Input terminated 620 ohms. Measured: unweighted - broadband. 96 dB relative 12 mv at 1 kHz. Input shorted. Measured: A weighted.  
Channel Separation: 90 dB.  
Connectors: Input - phono jacks. Output - barrier strip.

Audio-Metrics Phono Preamp PA-1 ..... \$275.00

**RTS 405 PROFESSIONAL  
2-CHANNEL PHONO PREAMPLIFIER**



(cont.)



# TURNTABLES-ARMS-CARTRIDGES

The Model 405 is a high-quality two-channel phono pre-amplifier designed for professional applications, including disc mastering rooms, broadcast stations and high quality commercial installations. It features adjustable cartridge termination, switchable rumble filter, two selectable sets of level controls and two output formats.

FREQUENCY RESPONSE: Re RIAA  $\pm 0.5$  dB  
SIGNAL/NOISE RATIO: -72 dB  
TOTAL HARMONIC DISTORTION: -90 dB / .003%  
MAXIMUM OUTPUT LEVEL, BALANCED: +24 dBm

RTS 405 ..... \$378.00

## UREI 1122 STEREO TRANSCRIPTION PREAMPLIFIER



The 1122 is a two-channel, solid-state, equalized pre-amplifier/line amplifier designed to provide the highest quality disc reproduction for broadcast and recording applications. While primarily intended for stereo use, it may be utilized for two separate monophonic channels.

- Precise RIAA/NAB equalization
- Individual high and low frequency equalization trimmers on each channel
- Separate level controls on each channel
- Extremely low noise and rf susceptibility
- Transformer isolated balanced output
- Line level output capability

UREI 1122 ..... \$366.00

## STRAIGHT WIRE AUDIO PH2 PHONO PREAMP

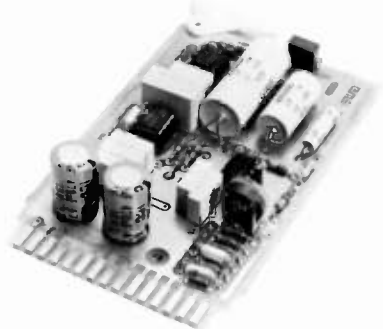

### Public Radio's Favorite

The design of a phono preamp can have an effect on the quality of the turntable's sound and the station's. The difference between the average and the best is not night-and-day, but is quite audible in comparison to some preamps. The difference could be worthwhile to some stations which use records for large blocks of their program day.

The phono preamp we are discussing is the Straight Wire Audio PH2. It was based on papers by Walt Jung and others.

PH2 ..... Price on application

## STANTON 310 PROFESSIONAL PHONO PREAMPLIFIER



Model 310 stereo phono preamplifier, designed to interface correctly all phonograph cartridges for optimum performance, precision playback of disc records and calibration of audio systems. Universal mounting of the unit by means of special brackets supplied with the unit, instant selection of flat or NAB post-emphasis curves, switchable effective rumble filter, individual adjustment of gains and high frequency responses, & trimming of the capacitive cartridge loading at the input.

310 ..... \$190.00

## RUSSCO FIDELITY—PRO & FIDELITY—MASTER PROFESSIONAL PHONO PREAMPLIFIERS



Mono or stereo versions available with balanced or unbalanced output. The FIDELITY-MASTER series offers RIAA equalization. The FIDELITY-PRO units feature switchable high and low frequency filters. The balanced output models include highest quality transformers for true line isolation!

FPMU	Monaural — Unbalanced Output	.....	\$153.70
FPMB	Monaural — Balanced Output	.....	\$183.38
FPSU	Stereo — Unbalanced Output	.....	\$229.00
FPSB	Stereo — Balanced Output	.....	\$275.60

## MICROTRAK 6410/6411 MONO/STEREO PREAMPLIFIER



6410	Mono Preamp	.....	\$169.50
6411	Stereo Preamp	.....	\$199.50



# TURNTABLES-ARMS-CARTRIDGES

## ATI P-1000 SERIES PRECISION STEREO PHONO AMPLIFIERS



- P-1000-1 Dual/Stereo Transformer Outputs
- P-1000-2 Dual/Stereo Balanced Differential Outputs
- P-1000-3 Dual/Stereo Single Ended (Unbalanced) Outputs

### OUTPUT CLIPPING LEVEL:

- + 22dBm/600 ohms (P-1000-1, 3)
- + 26dBm/600 ohms (P-1000-2)

DISTORTION at + 20dBm output: .2%

SIGNAL TO NOISE RATIO Unweighted, ref. 10mVrms

1kHz input: 80dB, 20kHz bandwidth

FREQUENCY RESPONSE: RIAA Curve  $\pm$  .25dB, 30 to 20,000Hz

SIZE: 8 1/2"W x 1 3/4"H x 7"D, 2 1/2 lbs.

MOUNTING: Brackets supplied for internal turntable cabinet or desk top mounting. Single and dual rack mount kits available.

P-1000-1	.....	\$345.00
P-1000-2	.....	\$345.00
P-1000-3	.....	\$325.00

## ATI ENCORE PRE AMP

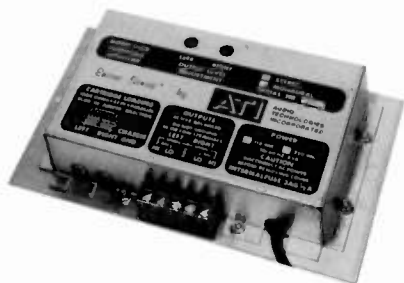

- Input Impedance: programmable, 50K to 100K ohms, 50 to 400 pf in 50 pf steps.
- Input Level: 5 mV nominal for + 4dBm output, 250 mVRMS maximum at 1 KHz.
- Noise: S/N 80db minimum unwtgd, 90db "A" wgt. ref. 10mVrms at 1 KHz, 600 ohm input termination and 20 KHz measurement band.
- Output Level: + 18dBm into 600 ohm balanced or unbalanced loads. 10Vrms into high impedance loads.
- Output Impedance: 400 ohms balanced, 200 ohms single ended, split and RF bypassed.

ATI Encore ..... \$199.00

## RUSSCO PHONO-MATE

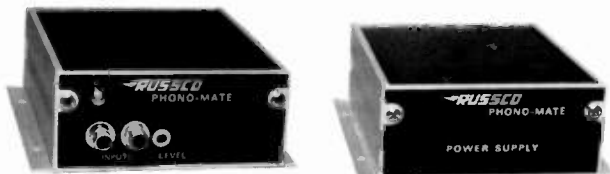

(cont.)

Consider These Value-Packed Features Of The PHONO-MATE Pre-Amps:

- Full solid state circuitry
- Lots of headroom at + 16 dBm
- RIAA equalization
- Mono or stereo versions are available with balanced or unbalanced output
- The balanced output models include highest quality transformers for true line isolation

1U	Mono, Unbalanced	.....	\$96.00
1B	Mono, Balanced	.....	\$108.00
2U	Stereo, Unbalanced	.....	\$148.00
2B	Stereo, Balanced	.....	\$169.00
PS	Power Supply (will power 4 preamps)	.....	\$53.00

## SHURE M64 UNIVERSAL STEREO AMPLIFIER

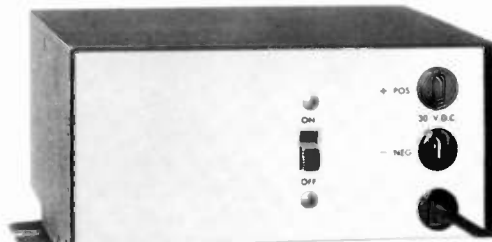

The Model M64 is a low-cost, versatile, compact, low noise and low distortion stereo preamplifier that provides gain, equalization, and choice of impedances and levels to solve an unusually broad variety of preamplification and equalization problems. Silicon transistor circuitry, easy permanent-mount installation. Single ended output.

- For phonographs, tape decks, microphones
- Equalizes and amplifies tape decks

M64 ..... \$99.00

## XEDIT SPLICE BLOCKS



KITS, Audio—

KP-2	.....	\$8.00
KS-1	.....	\$21.00
KS-2	.....	\$18.50
KS-3	.....	\$ 22.00
KS-3.5	.....	\$ 37.00
KS-3.75	.....	\$ 42.00
KS-4	.....	\$ 47.00

BLOCKS ONLY, Audio—

P-2	.....	\$6.00
S-1	.....	\$ 19.00
S-2	.....	\$ 16.50
S-3	.....	\$ 20.00
S-3X	.....	\$ 22.00
S-3.5X	.....	\$ 42.00
S-3.75	.....	\$ 40.00
S-4	.....	\$ 45.00
A-2	.....	\$120.00



# WEATHER EQUIPMENT

## WEATHER EQUIPMENT

### GORMAN REDLICH BROADCAST QUALITY WEATHER RECEIVER



Take advantage of the expanding network of National Weather Service VHF weather stations. This sensitive, selective (and reasonably priced) receiver can bring you accurate local weather, national weather, weather radar data, emergency alert messages, plus farming and marine information where applicable. Its capability for unattended recording of emergency alert messages and update forecasts can save time and money. Rebroadcast is FCC authorized.

Receiver is rack mountable, remotable, with an attractive black anodized panel. Demuting and remote alarm are initiated by 1050 Hz "Alert" tone. A relay closure is initiated by either the 1050 Hz tone or a 1650 Hz forecast update signal tone. These are the only tone signals NWS uses. 600 OHM output available.

Crystal and ceramic IF filters, plus double tuned dual gate MOSFET RF stage, give excellent interference rejection and high sensitivity (.28 microvolts for 12 dB. (S + N)). Whip antenna, jack and terminals for external antennas. Guaranteed to work where others won't. Selective enough to perform in downtown Chicago.

Weather Receiver ..... \$380.00



### TEXAS ELECTRONICS MARK IV-T WEATHERMINDER

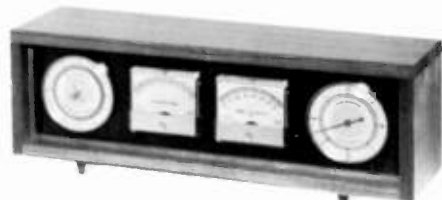

These attractive consoles continuously give a direct indication of wind velocity, wind direction, barometric pressure and outside air temperature.

- Wind velocity
- Wind direction
- Barometric pressure
- Outside temperature

Mark IV-T ..... \$717.00

**SHIPPING AND HANDLING  
CHARGES WILL BE ADDED TO ALL ORDERS  
UNLESS OTHERWISE SPECIFIED**

### TEXAS ELECTRONICS SERIES 800

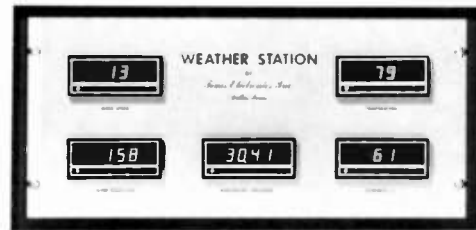

Digital Readout Meteorological Instruments.

Typical Price as Shown ..... \$4500.00  
(Send for Complete Details)

### TEXAS ELECTRONICS DIGITAL REMOTE READING TEMPERATURE SYSTEM



The Model 809 is an all electronic remote reading thermometer which indicates air temperature on a large easily read digital display. Range indications span from -40° to +120°F, and -40° to +50°C. The thermal sensing elements may be located up to 1000 feet or more away from the indicator.

Model 809 ..... \$385.00

## PRODUCTION AIDS

### NORTRONICS PF250 PROFESSIONAL AUDIO/VIDEO BULK TAPE ERASER



The PF250 Professional Audio Video Table Top Bulk Tape Eraser employs a "U" core/coil having 240 turns of 15 awg. wire. The PF250 draws 15 amps of current at 115 VAC 50/60 Hz operation. A thermal protective device is incorporated in the coil of the PF250 which automatically opens the electrical circuit, and actuates the overheat indicator when the internal coil temperature reaches 115°C. The coil will remain off until it has had time to return to its normal operating temperature usually requiring about 30 minutes, at which time the thermal device will reset itself. The safe

(cont.)

# PRODUCTION AIDS

operating duty cycle for the QM250 is 2 minutes "ON" 15 minutes "OFF." From a cold start the QM250 will run continuously for 5 minutes.

PEAK MAGNETIC FIELD STRENGTH: On Surface—3,000 Gauss; at 1/4" Spacing—1,300 Gauss.

REEL SIZES: Up to 10 1/2"

DIMENSION: 10" x 7" x 3 1/4"

WEIGHT: 11 pounds

PF250 ..... \$345.00

## GARNER TAPE ERASERS



Garner tape erasers provide clean erasures in only four seconds—with no noise residue. Tapes are wiped cleaner than new. Our simple, safe, continuous belt operation handles all sizes of reels, cartridges and cassettes. Several models: Up to 16". Also Video Erasers. No "Whump."

Contact Allied for complete details and pricing.

## AUDIOLAB ELECTRONICS TD-1B TAPE DEGAUSSER

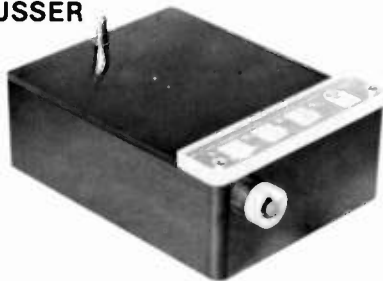

- Erases audio, video, computer, data tape, magnetic films, cartridges and cassettes.
- Accommodates up to 10 1/2 inch NAB reels.
- Provides a wide focused magnetic field to assure complete erasure.
- Radio's most popular bulk eraser.
- Positive results everytime with a simple two pass operation for broadcast NAB audio cartridges.

TD-1B ..... \$99.50

## AUDIOLAB ELECTRONICS TD-2A TAPE DEGAUSSER

Erases Audio, Video, Computer and Cartridge Tape.

- Erases tape reels up to 14 inches in diameter and 2 1/2 inches wide.
- Built in timer has adjustable "ON" cycle and automatic shut-off.
- Efficient "ferro-tune" design assures strongest degaussing field.

(cont.)



- Built in blower makes normal continuous service cool and quiet.
- Standard 5/16 inch center post and 3 inch NAB hub supplied.
- Designed for radio, television, computer and audio-visual tapes.

DUTY CYCLE: 50%, 30 minutes maximum with fan on.

POWER CONSUMPTION: 500 watts nominal.

DIMENSIONS: 13 x 17 x 4 inches.

TD-2A ..... \$690.00

## AUDIOLAB ELECTRONICS TD-3A TAPE DEGAUSSER

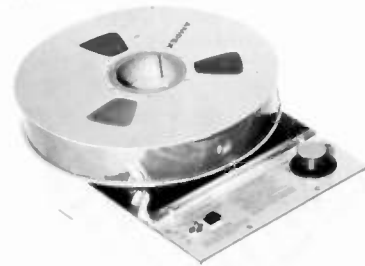

Erases Audio, Video, Computer, and Cartridge Tape.

- Strong degaussing field insures full erasure of new high coercivity tapes.
- Erases tape reels up to 14 inches in diameter and 1 inch wide.
- Tapes may be erased in original carton by sliding along guide rail.
- Timer with adjustable ON cycle and automatic shut-off.
- Built in blower assures cool and quiet operation.
- Standard 5/16 inch center post and NAB hub supplied.

DUTY CYCLE: 50%, 30 minutes maximum with fan on.

POWER CONSUMPTION: 1350 watts nominal.

DIMENSIONS: 10 x 13 x 4 inches.

TD-3A ..... \$520.00

## ALLIED WARNING LIGHT



Horizontal or vertical format ..... \$40.00





# PRODUCTION AIDS

## EVENTIDE H910 HARMONIZER



PITCH CHANGE: one octave up, one down  
 DELAY: output one, 112.5 ms. output two, 82.5 ms.  
 FREQUENCY RESPONSE: 12 kHz  
 DYNAMIC RANGE: 90 dB. Feedback control

H910 ..... \$1500.00  
 Transformer Balancing In/Out ..... \$100.00

## AUDISAR REPEAT COIL

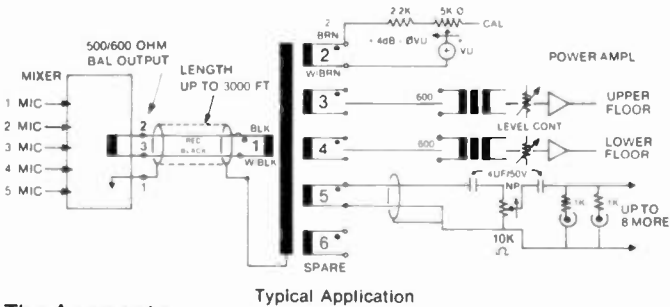
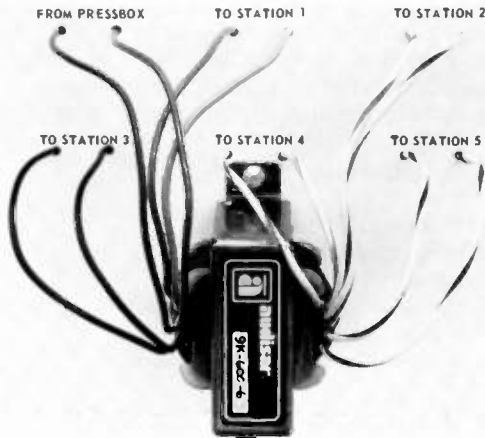

The Answer to:

- Mass Feeds
- Telephone Conferencing
- Distribution

FREQUENCY RESPONSE: 50Hz to 20 kHz  
 INSERTION LOSS: 0.75 dB  
 HEAD ROOM: + 30 dB at 1 kHz  
 WEIGHT: 11.5 oz.  
 IMPEDANCE: 600 ohm x 6 (1 in, 5 out)

Audisar Repeat Coil (ea.) ..... \$75.00  
 Audisar Repeat Coil Orders of two or more (ea.) ... \$70.00

## WEST PENN WIRE 291

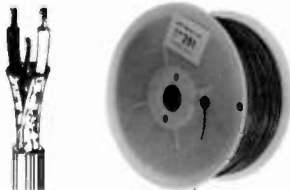

(cont.)

Brown, Red, Orange, Yellow, Green, Blue, Violet, Gray,  
 White or Black.  
 1000' Spools Only.

West Penn Wire 291 ..... \$85.80

## BELDEN'S UNREEL CONTINUOUS CABLE PAYOUT SYSTEM



Belden's Unreel continuous cable payout system means fewer set-ups and reduced processing time.

Some of the most dramatic savings derived from Belden UNREEL cartons are reported by the users of Belden's palletized multi-carton, continuous cable payout system. In this system, cables in individual UNREEL cartons are linked together by a taped splice joining the leading end of one cable to the trailing end of another.

Allied carries the Belden line—Call for complete information and pricing.

## SWITCHCRAFT/ADC PRODUCTS

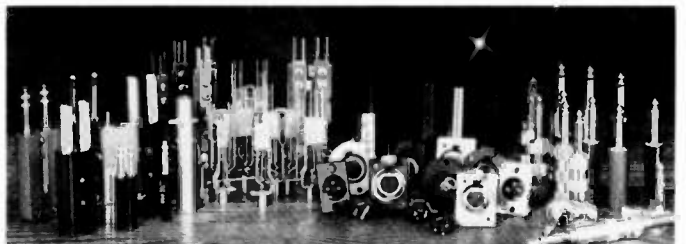

If you're in the business of getting sound from one place to another, ADC and Switchcraft have a growing ensemble of products to help you. Eliminate interconnection problems.

## ALLIED PRE-WIRED PATCH BAYS

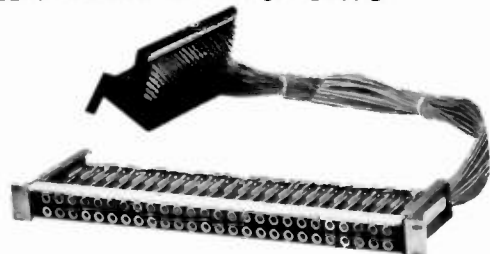

(cont.)



# PRODUCTION AIDS

## JACK FIELD:

Number of Jacks: 24 or 48 standard

Bay Type:

48 jack tip-ring

48 jack tip-ring-slv

Bay Specifications:

Chassis & Brackets: Steel with cadmium plate plus chromate finish.

Jack Mountings: Black termoset plastic.

Electrical: Greater than 110dB isolation at audio frequencies

Insertion Loss: .1 dB maximum

Bundle Length: 5 ft. standard - Feeds left from rear unless ordered otherwise.

## TERMINATION TREES:

Christmas Tree:

Number of Terminals: 6 x 25

Punch Blocks: 66B3-50

Number of Terminals: 2 x 50

Custom Wiring on Request

### LONG FRAME 1/4" JACK BAYS

Jack Type	Termination	*Normals	Jacks	Part Number	Price
Tip-Ring	Xmas Tree	At Panel	48	48DR-TR-AB-XT	\$369.00
Tip-Ring	66 Punch Block	At Panel	48	48DR-TR-AB-PU	\$359.00
Tip-Ring	Xmas Tree	At Tree	48	48DR-TR-BO-XT	\$419.00
Tip-Ring	66 Punch Block	At Block	48	48DR-TR-BO-PU	\$399.00
T-R-Slv	Xmas Tree	At Panel	48	48DR-TRS-AB-XT	\$399.00
T-R-Slv	66 Punch Block	At Panel	48	48DR-TRS-AB-PU	\$389.00
T-R-Slv	Xmas Tree	At Tree	48	48DR-TRS-BO-XT	\$599.00
T-R-Slv	66 Punch Block	At Block	48	48DR-TRS-BO-PU	\$589.00

### BANTAM, TINY-TELEPHONE BAYS

T-R-Slv	Xmas Tree	At Panel	96	96BA-AB-XT	\$699.00
T-R-Slv	66 Punch Block	At Panel	96	96BA-AB-PU	\$689.00

\*All prewires are normal unless otherwise requested. Select normal at panel or brought out to termination block/tree.

Prewired Panels of all types and configurations available to your custom specifications. 24, 48 and 52 jack long frame models; 96 and 144 jack bantams. Special terminations or unterminated Bundles available. Bundles feed left from rear of panel unless ordered otherwise.

## ARRAKIS ROUTING SWITCHER 100RS

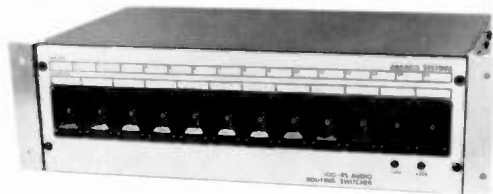

The 100RS represents a major price breakthrough in audio routing switchers. For the first time, electronic switchers are competitive with patch panels and other mechanical switches. Despite this dramatic improvement, the 100RS maintains professional specifications and construction throughout.

Physically, the switcher is exceptionally simple. For each of the 12 outputs there is a single PC board. Another board busses inputs between output boards and supports the terminal strip inputs and outputs. PC board sockets are of the highest quality and gold plated. PC boards pull from the front while terminal strips are accessed at the back. All IC's are socketed.

Electronically, the switcher is also simple. Every output

(cont.)

can access any of the 16 inputs independently or simultaneously. Each input is resistively buffered and will withstand 10,000 V transients without harm. Balanced CMOS transistors perform the switching function. Balanced switching doubles the number of crosspoints and is generally prohibitively expensive. The unique design of the 100RS however, uses balanced crosspoints to decrease distortion, switching noise, and reduce RF interference. Signetics NE5532 IC's perform the buffering, amplification and output drive.

Switch selection is accomplished by 4 bit binary coding which makes remote operation easy to accomplish. A regulated power supply reduces hum and noise. Distortion is .1% maximum at +8dBm with crosstalk less than 65dB at 10kHz. S/N is better than 75dB.

The 100RS audio routing switcher obviously has many possible applications in a broadcast or production studio. It replaces unwieldy patch panels, distribution amplifiers, and remote select mechanical switches. It can increase the total number of inputs at the control console and conveniently interconnect studios. It is ideal for switching satellite links to recorders, studios, or on the air. The possibilities are limited only to the imagination.

- 16 in by 12 outputs mono
- 8 in by 12 outputs stereo
- Expandable
- Rack or table mounted
- Balanced crosspoints
- NE5532 Signetics IC's
- 1,000,00 operation thumbwheel select
- PC boards front mount
- Terminal strip outputs & inputs on back

**100RS ..... \$1250.00**

## OMNIMOUNT MOUNTING SYSTEM

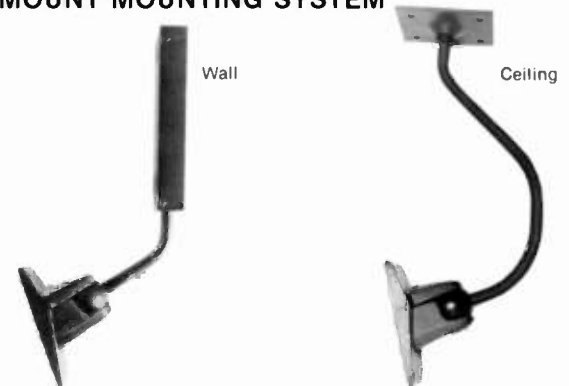

Omnimount is of industrial quality, built to last a long time. A key to its remarkable performance is the ball joint design. The ball is moulded of an ebonite polymer compound, with excellent memory-return; and it is just about indestructible.

The ball is bonded to the thick-walled carbon steel tube in the same way that heavy duty motor mounts are bonded. The clamp/flange is made of 356-T6 aluminum alloy. The ball-and-clamp unit decouples electricity and helps absorb vibration. The Omnimount System ends up so stable, it is even used in moving vehicles.

You can mount Omnimount on the wall or ceiling. It does its job with extraordinary flexibility, not limited to the usual "pan and tilt" functions.

Little things mean a lot, too, with Omnimount. For example, the leads can dress-down right through the tube for a neat and clean installation.

(cont.)



# PRODUCTION AIDS

Omnimount is one of a kind. You'll know why when you use it. With Omnimount, you can focus speakers so that a balanced stereo image is directed to any point within a wide listening area. The sound stays where it belongs and goes where it belongs—in splendid acoustic isolation.

Omnimount ..... From \$68.95

## LITTLITE GOOSENECK LAMPS AND ACCESSORIES

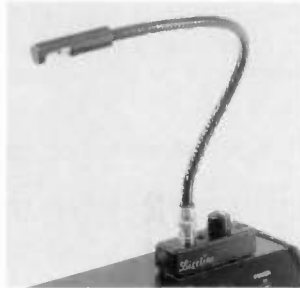

**L-1**  
Detachable 12" lamp, bulb, dual mounting position base with dimmer with off position, wall plug-in power supply, 6' cordset, storage clips and mounting hardware. For applications where equipment is portable and gooseneck needs to be removed for transit or storage. Although the 12" is most popular, the L-1/18" and L-1/6" are available.  
L-1/6", 12", or 18" ..... \$49.95

**Adjustable Mounting Clip (CL)**  
For temporarily clamping an L-1 to a panel or lip, i.e., console sideplates, clipboards, etc. Adjusts to clamp over material from 1/16" to 3/4" thick.  
(CL) ..... \$4.00 ea.

**Weighted Base (WB)**  
Allows free standing operation of L-1 where application requires a movable lamp or user would prefer not to affix lamp assembly to equipment.  
(WB) ..... \$6.00 ea.

**Plastic Snap Mount (SM)**  
Used for attachment of L-1 or L-2 on equipment. Allows fast placement of lamp directly on equipment, and easy removal for storage with minimal effect on the equipment.  
(SM) ..... \$2.00 ea.

## CALZONE CUSTOM CASES

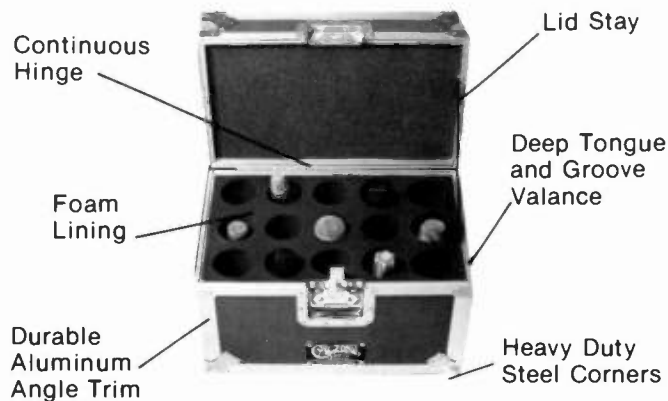

# MISCELLANEOUS

## CBS TECHNICAL SERIES PROFESSIONAL TEST RECORD



**STR 151 Broadcast Test Record**  
The Broadcast Test Record STR 151 was developed especially to meet the needs of broadcast engineers, audio-philosophers, and other professionals seeking a convenient signal source for the testing and adjustment of all audio equipment. As a means for measuring phonograph pickup response this record is an essential tool. In providing complex waveforms for special tests, it is a device which can be used to great advantage by all AM, FM, and TV broadcasters. Includes reverse RIAA curve.  
STR 151 ..... \$25.00

## ONAN STANDBY POWER EQUIPMENT

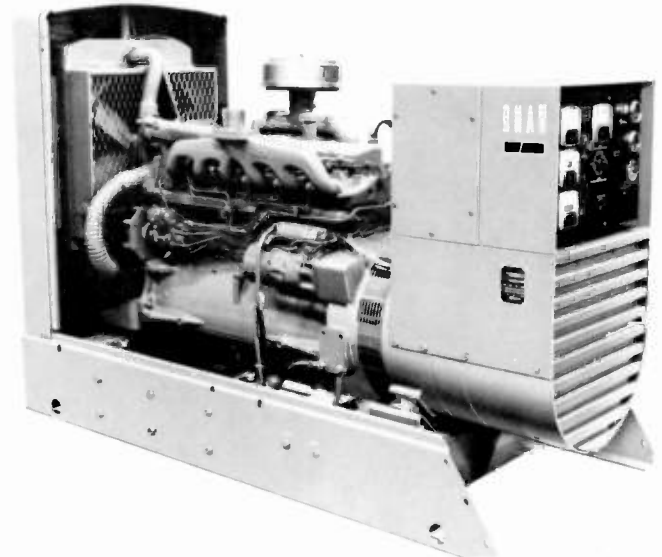

Protect your station against power outages with an Onan Standard Power System—an independent source of electricity right there when you want it during a commercial power outage. Allied can help you pick the size you need—small, medium or large, manual or automatic operation. Onan manufactures a complete line of standby electric generating sets. Choose from more than 45 different sizes, from one to 750 kW, gas/gasoline or diesel-powered, air-cooled or radiator-cooled. Onan makes hundreds of different models, and one of them is built and equipped to fill your exact requirements.

Call Allied for Full Details and Pricing.

# A

## MISCELLANEOUS

### 3M/ SIEMON EQUIPMENT

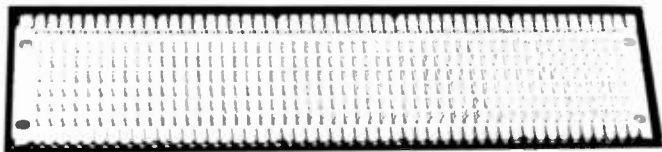

The ST push-on connector in Figure A is a clever little machine which will accept Belden 8450 or 8451, for example, and, without skinning provides a firm anchor whose electrical integrity is excellent. The wire is inserted in one of the two holes provided—the ST is pressed together with an E9E tool (Figure B) or regular pliers. This pressing action closes the ST and simultaneously makes electrical connection. After collapsing with tool, the ST is only 7/32" square x 17/32" overall length.

The third element of this time-saving trio is a telephone-type terminal block shown in Figure C. While the ST was particularly designed for use on Christmas-Tree type blocks, it also perfectly fits the telephone block.

Easy reassignment is accomplished merely by removing and reinstalling the ST's on different pins. A second wire may also be inserted in the ST in the second hole provided for tapping, bridging, etc. Absolute RF integrity.

Figure A (per 100)	.....	\$17.00
Figure B (each)	.....	\$20.00
Figure C (each)	.....	\$14.00

### STUDIO ACCESSORIES



- Modern Design
- Plastic Coated Spring Clips
- Unbreakable
- Bold Roman Style Letters
- Allow 18 Weeks for Delivery.

Contact Allied for complete ordering information.

### VANNER-VERTER DC/AC INVERTER

Presenting the most advanced products for DC to AC current inversion. The patented voltage regulation allows it to operate all types of electrical loads, either resistive or reactive. 12VDC to 120VAC, 60Hz. Remote system, turntables, tape recorders. (cont.)



- Pulse width modified output with less than 14% distortion.
- Frequency controlled to 60Hz ± .1Hz.
- 87% efficient for more usable power.
- High surge capability.
- Light weight
- Compact size
- Lighted remote control on/off switch, cable & plug included.
- Excellent stability for turntables, tape recorders, etc.
- 220VAC available.

Model 20-2000, 200W	.....	\$ 550
Model 20-500, 500W	.....	\$ 850
Model 20-1000, 1000W	.....	\$ 925
Model 20-2200, 2200W	.....	\$1855

### SONEX

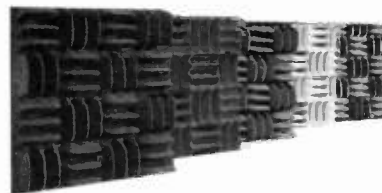

- 4' x 4' Sheets
- 2", 3", 4" thickness
- Available natural charcoal, white, brown, orange, green.
- 15" x 15" Tiles
- 1" thickness
- Available all colors above except natural charcoal
- Reasonably priced sample kits available.
- Call your Allied rep with requirements.

### BEVCO CONTROL ROOM CHAIR



Just as important to your air sound as a turntable—ALLIED HAS IT—The chair built for any environment including black Naugahyde back and seat covers and wheels. (High or low versions for standup or sitdown)

Bevco Chair	.....	\$90.00
-------------	-------	---------

# Conditions of Sale

**BY TELEPHONE:** The most convenient way to order from Allied is by telephone, confirmed with a written purchase order. When placing an order, call the Allied office that serves your area. (See inside back cover.) Allied provides toll free ordering service where possible - collect calls are not acceptable. Office hours are 8:00 AM to 5:00 PM local time. Written purchase orders, sent to confirm a telephone order, must be stamped CONFIRMING. Failure to do so could result in additional charges for freight and handling.

**CREDIT TERMS:** We ship open account to firms rated high by Dun & Bradstreet Inc., otherwise, terms are cash or chargeable to Visa or Master Card with Bank approval. Payment terms are Net/30 days from date of invoice unless otherwise specified. Accounts placed for collection lose all credit privileges. COD orders require a 25% payment in advance unless the customer is established with ABE. Shipping terms are F.O.B. Richmond, Seattle, or point of origin if factory drop shipped.

**PARTIAL BILLING:** Unless previous arrangements are made, partial shipments will be invoiced to open accounts when shipped and the net charges shall become due as the terms dictate on each shipment.

**TRIALS & SALES ON APPROVAL:** Trials and sales on approval require a firm purchase order or payment in advance unless otherwise specified. Approval terms are applicable only if specified in advance on the order and accepted by our Sales and Credit Department. Goods must be returned within the specified time on the invoice or the sale is considered final. Normal trial period is 10 days.

**LEASING:** Allied offers several Leasing Plans from various companies arranged to suit your individual needs, including a Lease Purchase Plan. The customer is responsible for all transportation and insurance charges unless previously arranged in advance with the Leasing Company.

**USED EQUIPMENT:** Used equipment offered and purchased "as-is, no-return," must be paid for in advance or sent C.O.D. Allied will make a fair representation and the customer will buy at his own risk. Allied will authorize returns on repaired used equipment within 10 days of delivery in which the customer will be credited full amount of purchase, less all shipping and packing charges.

**BACK ORDERS:** Items ordered that are temporarily out of stock or have to be drop shipped from the manufacturer, will be placed on back order. If the merchandise cannot be shipped within a reasonable time, you will be advised of the shipping date.

**TAXES:** Sales tax will be added where applicable. Firms operating under tax free condition must state applicable license or contract numbers and be prepared to furnish necessary certificates of proof.

**SHIPMENT:** Your order will be shipped via UPS, if possible. Otherwise, equipment will be shipped via Parcel Post, Truck or Air Freight. If you require a special or particular form of shipment, please specify. Please be aware that there are Insurance limitations on certain forms of shipments and that we may not be able to follow your exact shipping requests due to limitations on services available in various parts of the country and tariff restrictions. Allied will make every effort to ship your merchandise in a fast and inexpensive manner. Merchandise in stock will be shipped within 24 hours of receipt of order. If it is a drop ship-

ment from the manufacturer, a request will be made via telephone to expedite shipment. Pickups are made several times a day from our facility to expedite service. Please allow extra time for truck shipments and parcel post.

**GUARANTEE:** All merchandise is covered by the manufacturer's warranty. Allied backs these warranties with personal interface between the problem and the factory solution. Many parts and replacement units are available from our stock or will be expedited from the manufacturer at Allied's direction as the customer requests. Allied or the manufacturer will, at their option, repair or replace defective parts or merchandise in warranty. The customer will be billed for the replacement or repair and full credit will be issued, less the freight, upon satisfactory return of the defective unit in the time period specified.

**CLAIMS & RETURNS:** Inspect all shipments immediately upon receipt. Missing cartons or obvious damage to cartons, shipped by common carrier, should be noted on the delivery receipt. Concealed damage or loss should be reported at once to the carrier and an inspection requested. Losses or damage to parcel post shipments should be reported to our Customer Service Department. All claims for shortage or damage must be made within two days after receipt of shipment. Claims for lost shipments must be made within 20 days of receipt of invoice or other notification of shipment. Save damaged or pilfered cartons until claim is settled. Do not return any goods to Allied without obtaining prior approval and instructions from our Customer Service Department. Goods returned unauthorized by collect freight may be refused. Goods returned which were ordered by customers in error are subject to a 15% restocking charge. **IMPORTANT** — Under present rules and regulations by most carriers it is the end user's responsibility to inspect and report losses and damage. It is essential you follow correct procedure in applying for claims and most of all, do it promptly.

**REPAIRS & WARRANTY SERVICE:** Contact our Customer Service Department at 317-962-8596 for instructions on repair. Do not return goods without instruction and make sure proper documentation is enclosed stating the problem encountered. If you feel your problem can be solved by conversation with a technician, please ask our Customer Service Department to connect you with the Repair Department.

**PERSONAL SERVICE:** Regardless of quantity, it's our Company policy to treat each order and inquiry as a person-to-person encounter. Your questions, comments and criticisms are welcome. Our staff is made up entirely of professionals willing to give you helpful assistance and work out possible problems to your full satisfaction.

**CORPORATE REFERENCES & POLICIES:** Allied Broadcast Equipment and Allied International are divisions of Allied Advertising Corporation, an Indiana Corporation since 1966. It is our sincere desire to give the broadcast and recording industry the best possible service anywhere. Please direct any comments concerning service and policy to...President, Allied Broadcast Equipment, PO Box 1487, Richmond, Indiana 47374 USA.

**NOTE:** Prices are manufacturer suggested list and are for reference only, discounts are available to qualified clients on many items. Terms are cash, net/30 days on approved credit, Visa or Master Card. Freight will be added to all shipments. Prices subject to change without notice.

# Index

<b>AMPLIFIERS AND AUDIO PROCESSING</b>	1 THRU 22
Power Amplifiers	1,2,3,4
Preamps	2,9
Monitor Amplifiers	3
Custom Built Cases	4
On Air Lights	5
Headphones	5
Processors	5,6,7,8,10,14
Computemp 2	5
Compressors/Limiters	6,7,8,9
Microphone Snakes	7
Broadcast Programmers	9,10
Noise Reduction	11,16,17
Equalizers	12,13,14
Pink Noise Generators	13
FM Translators	13
Feed Back Controllers	15
Delay Lines	15,16
Harmonizers	15
Stereo Synthesizers	16
Reverb	17
Line Amplifier	17
Level Matching Interface	18
Buffer Amplifier	18
Microphone Amplifiers	18,19,20
Power Generators	18
Telephone Interface	20
Remote Broadcast Line Equipment	21,23
Distribution Amplifiers	22,38
<b>AUTOMATION</b>	23 THRU 24
Broadcast Programmers	23
Instacart	23
Go Cart	24
Program Control Units	24
Tone Generators	24
Tone Sensors	24
<b>CARTRIDGE MACHINES</b>	25 THRU 28
Recorders	25,26,27
Reproducers	25,26,27
Multi Deck Machines	27,28
<b>CARTRIDGE ACCESSORIES</b>	28 THRU 34
Cart Racks	28,29,30,31,32
Cart Loaders	30
Cart Labels	30
Audio Carts	32,33,34
Cart Machine Alignment Equipment	34
On Air Lights	34
Cart Maintenance Equipment	34,35
<b>CLOCKS AND TIMERS</b>	35 THRU 36
Studio Timers	35,36
Quartz Clocks	35
Impulse Clocks	35
Digital Clocks	36
<b>CONSOLES AND MIXERS</b>	37 THRU 49
Stereo Mixers	37,43
Mono Mixers	37,43
Rotary Mixer Consoles	37,38,39,47,48,49
Recording Consoles	38,39,43,44
Audio Distribution Amp	38
Audio Switching Router	39
Studio Consoles	40,41,42,44,45
Slider Mixer Consoles	45,46,47
Cue Amps	46
Production/Mastering Recorders	47
Compressor/Mixer	48
<b>DISTRIBUTION AMPLIFIERS</b>	49 THRU 51
<b>FURNITURE</b>	51 THRU 55
Desks	51
Racks	52,54
Storage Cabinets	52
Turntable Pedestals	52
Modular	53
Tape Transports	53
Consoles	53
Turntable Isolator	54
Turntable Shock Absorbers	54
Studio Package	54
<b>HEADSETS</b>	56 THRU 58
Stereo Headsets	5,56,57,58
Mono Headsets	56,57
Wireless Intercom Headsets	57
Sportscaster Headsets	58
Headphone Consoles	58,59
<b>INTERCOMS</b>	59
<b>MICROPHONES</b>	59 THRU 65
Studio Mics	59,60,61,62,63
Lavalier Mics	61
Boom Mics	62
Condenser Mics	62
Pressure Zone Mics	63
Wireless Mic Systems	63
Mic Flags	64

Mic Arms and Booms	64
VHF Field Strength Meters	64
Sound Stands	65
<b>MONITORS</b>	65 THRU 71
Modulation Monitors	65,66,67
Frequency Monitors	66,67
RF Amps	67
EBS Equipment	68
Tuners	68
AM/DF Antenna	68
Field Strength Meters	69
Antenna Monitors	69,70
Modulation Controllers	70
Power Controllers	70
NOAA Monitors	71
<b>RECORDERS</b>	71 THRU 80
Reel to Reel	71,72,73,74,75,76,77,78
Cassette	79,80
<b>REMOTE CONTROL</b>	80 THRU 82
Microprocessor	80,81
Stereo Generator	81
Automatic	82
Telemetry	82
<b>REMOTE PICKUP</b>	83
<b>SPEAKERS</b>	83 THRU 86
Monitor	83,84,85,86
Mounts	84
<b>STL</b>	86 THRU 87
Aural	86
Telemetry Return	87
Antennas	87
<b>TELEPHONE EQUIPMENT</b>	87 THRU 91
Couplers	87
Answer Devices	87,88
Connectors	88
Equalization	88
Interface	89
Controllers	90
Patches	90,91
<b>TEST EQUIPMENT</b>	91 THRU 95
Impedance Bridges	91
Receiver-Signal Generators	91,92
Digital Frequency Counters	92
Spectrum Analyzer	92
Pink Noise Generator	93
Signal Analyzer	93
Sound Analyzer	93
Acoustic Analyzer	93
Magnetic Test Tapes	94,95
<b>TOWERS</b>	96
Beacon Lights	96
<b>TRANSMISSION LINES</b>	97
<b>TRANSMITTERS</b>	98 THRU 100
Load Resistors	98
Exciters	98,100
Tubes	98
<b>TRANSMITTING ANTENNAS</b>	101 THRU 105
<b>TRANSMITTING RF EQUIPMENT</b>	105 THRU 109
Copper Wire/Strapping/Screen	105
Lo Pass Filters	106
Patch Panels	106
Transfer Switches	106,107
Rigid Transmission Line	107
Isolation Transformer	108
Watt Meters	108
Load Resistors	108,109
Filter Couplers	108
<b>TUNERS</b>	109 THRU 110
Dialtone Detector	110
<b>TURNTABLES-ARMS-CARTRIDGES</b>	110 THRU 116
Turntables	110,111,112
Tone Arms	112,113
Cartridges	113,114
Phono Preamps	114,115,116
Splicing Blocks	116
<b>WEATHER EQUIPMENT</b>	117
<b>PRODUCTION AIDS</b>	117 THRU 121
Bulk Erasers	117,118
Harmonizer	119
Repeat Coil	119
Cable	119
Jacks, Plugs, Audio Connectors	119
Pre-wired Patch Bays	119,120
Routing Switchers	120
Speaker Mounts	120
Gooseneck Lights	121
Custom Cases	121
<b>MISCELLANEOUS</b>	121 THRU 122
Power Generators	121
Test Records	121
ST Connectors	122
Telephone Blocks	122
Connector Tool	122
Mic Flags	122
DC-AC Inverters	122
Acoustical Tile	122
Control Room Chairs	122

# To Order

Call the TOLL FREE number listed for your state — Thank You

## **RICHMOND, IN Sales Office**

Colorado  
Connecticut  
Delaware  
Iowa  
Kansas  
Kentucky  
Maine  
Maryland  
Massachusetts  
Missouri  
Nebraska  
New Hampshire  
New Jersey  
New York  
North Dakota  
Ohio  
Pennsylvania  
Rhode Island  
South Dakota  
Vermont  
Virginia  
West Virginia  
Wyoming

635 South E Street, Box 1487  
Richmond, IN 47374

**800-428-6954**

Indiana (within state) 800-382-6907

## **CHICAGO, IL Sales Office**

Illinois  
Michigan  
Minnesota  
Wisconsin

5097 N. Elston Ave., Suite 303  
Chicago, IL 60630

**800-621-3726**

Illinois (within state) 800-572-9138

## **SEATTLE, WA Sales Office**

Arizona  
California  
Idaho  
Montana  
Nevada  
Oregon  
Utah

1112 S. 344th Street, Suite 312  
Federal Way, WA 98003

**800-426-9781**

Washington (within state) 800-562-8178

## **DALLAS, TX Sales Office**

Arkansas  
Louisiana  
New Mexico  
Oklahoma

Suite 309 - Chaddick Center  
1201 E. 15th, Plano, TX 75074

**800-527-4392**

Texas (within state) 800-442-4741

## **ATLANTA, GA Sales Office**

Alabama  
Florida  
Mississippi  
North Carolina  
South Carolina  
Tennessee

Shannon Towers, 4405 Mall Blvd.  
Suite 314, Union City, GA 30291

**800-241-0192**

Georgia (within state) 800-282-0246

## **CUSTOMER SERVICE**

Alaska 206-941-5453  
Hawaii 317-962-8596  
Puerto Rico 800-428-6954  
Telex II 810-345-1394

# Product Line

ADC	LITTLITE
ADR	LPB
AIPHONE	LUXO
AKG	McKAY DYMEK
ALC	McMARTIN
AMPEX	McPHILBEN
AMPRO	MARANTZ
ANDREW	MARTI
ANIXTER-MARK	MAXELL
ARISTOCART	MCI
ARRAKIS	MICROTRAK
ATI	MILAB
ATLAS	MODULATION ASSOC
AUDICORD	MODULATION SCIENCES
AUDIOCOM	MODULAR AUDIO
AUDIOLAB	MOSELEY
AUDIO-METRICS	MUNN ASSOC
AUDIO-TECHNICA	NAD
AUDISAR	NEOTEK
AUDITRONICS	NEUMANN
AUTOGRAM	NORTRONICS
AUTOMATED BROADCAST	NUMARK
BELAR	OMNIMOUNT
BELDEN	ONAN
BEVCO	ORBAN
BEYER	OTARI
BGW	PARALLAX
BIRD	PHELPS-DODGE
BROADCAST ELECTRONICS	PI-ROD
CABLEWAVE	POTOMAC
CAPITOL	PRECISION
CART-A-LIGN	PROTON
CALZONE	QEI
CBS TEST RECORDS	QRK
CLARK	QUANTUM
COMARK	RANE
COMEX	R-COLUMBIA
COMPUTEMP	REVOX
CONEX	RKO
COPPER	RTS
CRL	RUSLANG
CROWN	RUSSCO
CSI	SCALA
CSP	SCOTCH
DBX	SCULLY
DECCA	SENNHEISER
DECIBEL	SEQUERRA
DELTA	SHURE
DICTAPHONE	SIEMON
DIELECTRIC	SONEX
DIGIMAX	SONY
DISCWASHER	SOUNDOLIER
DORROUGH	STANTON
DUROTEST	STEVENSON INTERFACE
EDCOR	STL
EIMAC	STRAIGHT WIRE AUDIO
ELECTRO IMPULSE	SWITCHCRAFT
ELECTRO SOUND	SYNTEC
ELECTRO VOICE	TAPCO
ELECTRONIC RESEARCH	TEAC
ELGIN	TECHNICS
ESE	TELEMIX
EVENTIDE	TELEVISION TECHNOLOGY
FIDELIPAC	TELEX
FOSTEX	TELFAX
FOUR CORNERS	TELLABS
GARNER	TEXAS ELECTRONICS
GENTNER	TFT
GORMAN REDLICH	TOPAZ
GREGG LABS	TRANSTECTOR
HALLIKAINEN	TUBES
HME	UREI
HOWE AUDIO	UNION METALS
IGM	URSA MAJOR
INOVONICS	VALLEY PEOPLE
IRISH	VEGA
IVIE	VERSA COUNT
JAMPRO	VIF
JBL	VOICE ACT
KINTRONICS	WHITE INSTRUMENTS
KOHLER	WILKINSON
KOSS	XEDIT
KUSTOM KRAFT	

**ALLIED**   
Broadcast Equipment

Corporate Office:  
P.O. Box 1487 • 635 South E Street • Richmond, Indiana 47374