

CONTINENTAL ELECTRONICS / BROADCAST TRANSMITTERS

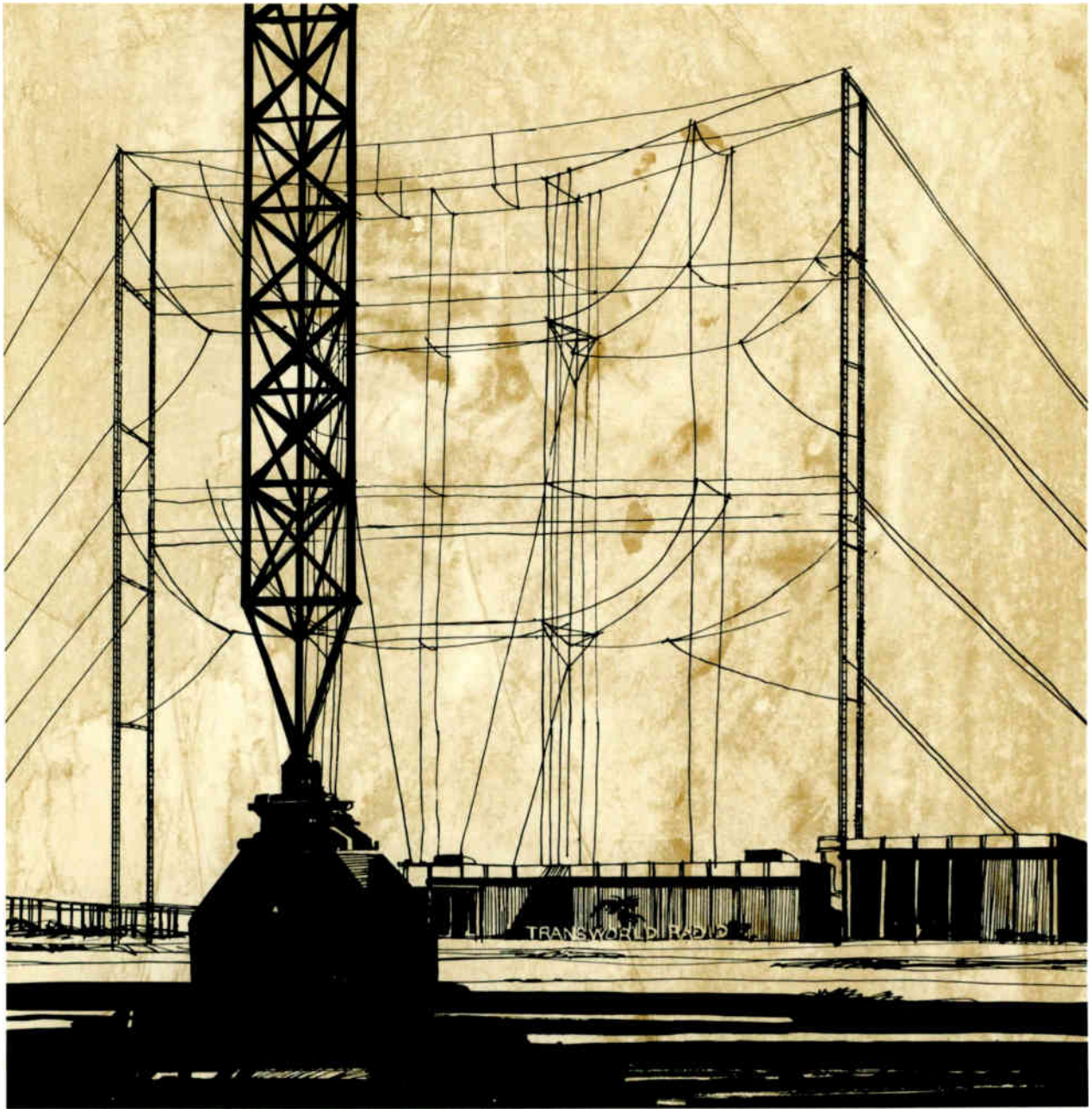

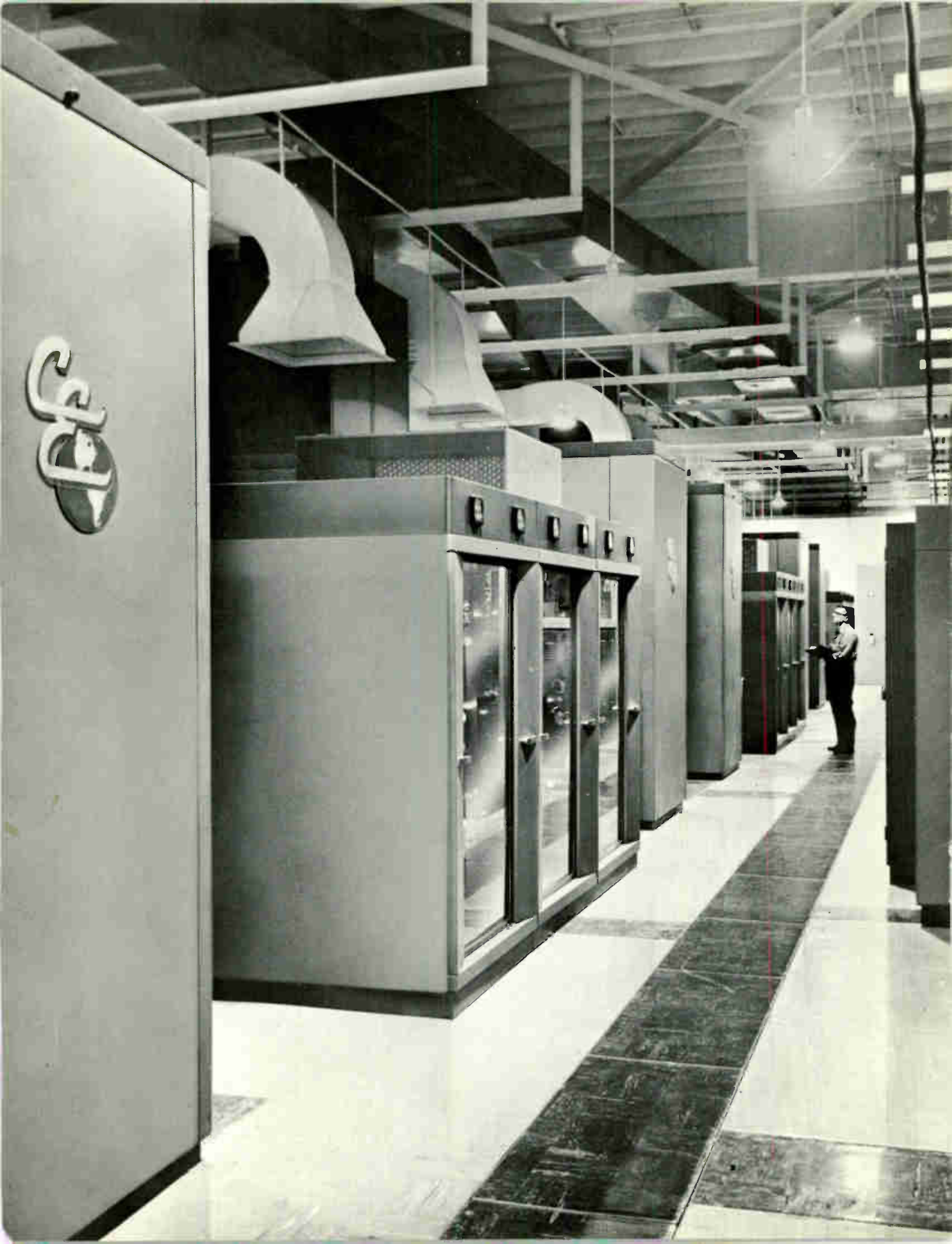

TYPE 310A
40 WATT MF
SOLID STATE BROADCAST TRANSMITTER



MF BROADCAST TRANSMITTER

BULLETIN 310A-1

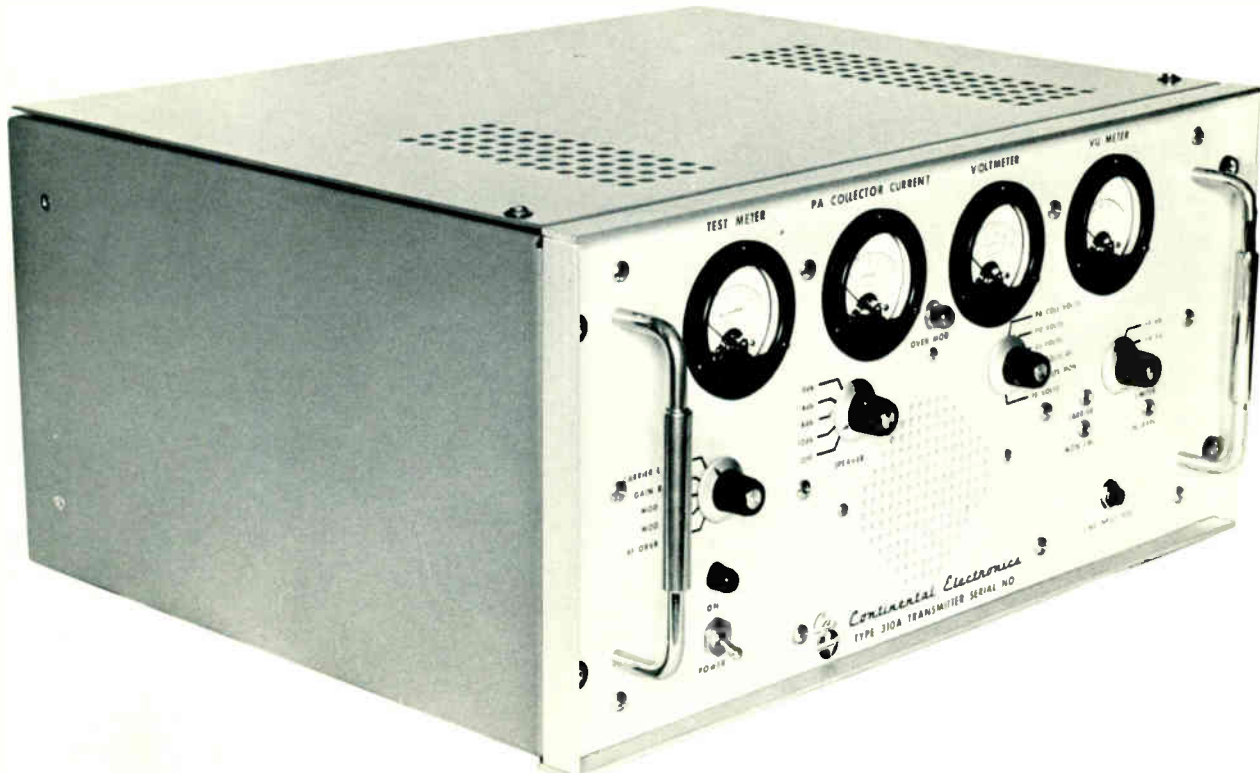

TYPE 310A 40 WATT MF SOLID STATE BROADCAST TRANSMITTER

GENERAL DESCRIPTION. Designed for low power standard broadcast service for local coverage of small isolated communities, public service, and disaster areas. The type 310A 40 watt transmitter is completely solid state for maximum reliability and minimum maintenance, capable of unattended operation for long periods of time with little or no attention.

The Type 310A is completely self-contained and includes built-in fast acting peak limiter that will accommodate input levels up to 20 dB above the level required to modulate 100% without causing overmodulation.

A high quality monitor amplifier with 1 watt output is used to monitor the demodulated RF output signal. A self-contained speaker is provided for local monitoring.

Also built in is a modulation monitor with flasher lamp to indicate negative modulation in excess of 95%. A standard VU meter driven by the monitor amplifier is calibrated in conjunction with the flasher lamp to indicate percentage of modulation. A switch that transfers the input of the monitor amplifier to the program input also switches the VU meter across the line for input level measurement.

A position on the test meter indicates average RF carrier level.

The transmitter is designed to work into a 50 ohm non-inductive load.

EXTERNAL ITEMS REQUIRED

The transmitter is designed to work into a 50 ohm non-reactive load. Since the radiating antenna will have a feed point impedance other than this, a coupler is available to match an unknown antenna impedance to the transmitter. The coupler will transform antenna resistance as low as 10 ohms with capacitive reactance as high as 150 ohms up to the required 50 ohm load.

For tuning, an RF bridge is a self-contained feature of the coupler. A 50 ohm non-inductive resistor (which may also be used as a dummy load), is connected at one corner of the bridge with the unknown antenna impedance at the opposite corner. The coupler is adjusted until a null is obtained on the indicating meter at which point the unknown impedance is equal to the 50 ohm load resistor. A thermocouple RF ammeter is provided as part of the coupler for power measurement into the 50 ohm load.

TYPE 310A
40 WATT MF
SOLID STATE BROADCAST TRANSMITTER

TYPE 310A TRANSMITTER BLOCK DIAGRAM

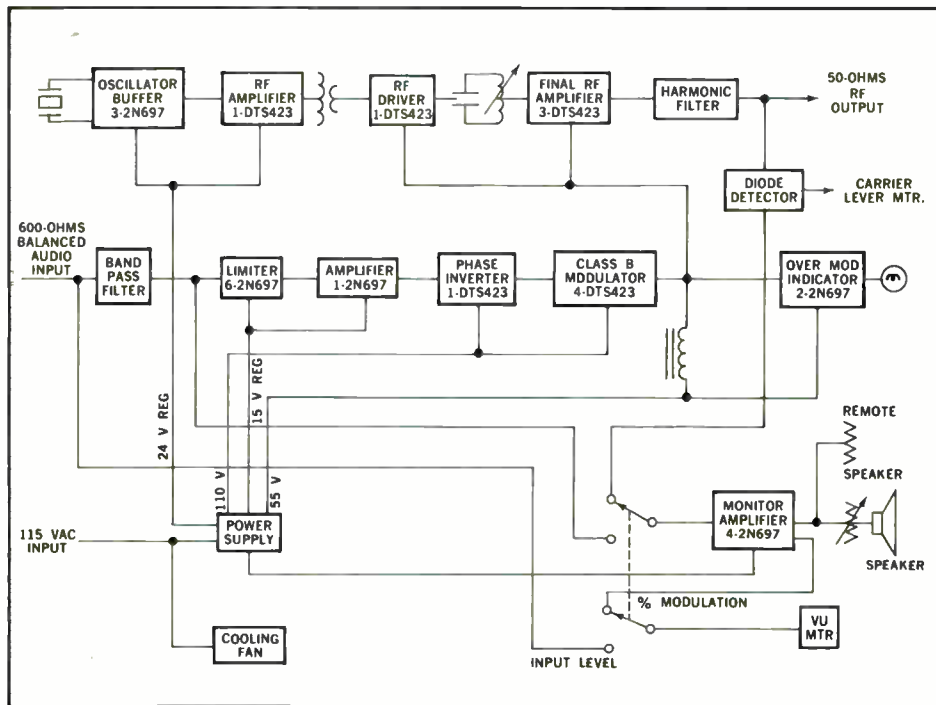

TECHNICAL SPECIFICATIONS

Audio Input Impedance:	600 ohms balanced
Audio Input Level:	0 to +8 dBm, adjustable by input level control
Audio Frequency Response:	±1.0 dB from 120 to 5000 Hz, down 16 dB or more at 40 Hz and 12,000 Hz
Harmonic Distortion:	3% or less, 100-5000 Hz at 95% modulation
Noise Level:	50 dB or more below 100% modulation
Carrier Shift:	Less than 2%
Type of Modulation:	Collector modulation of RF output stage
Frequency Range:	535 — 1620 kHz
Frequency Stability:	±5 Hz
Output Load Impedance:	50 ohms unbalanced
Output Power:	40 watts
Ambient Operating Temperature:	0 — +50° C.
Power Requirements:	115 volts, 50/60 Hz, 200 VA
Overall Dimensions:	Standard 19" rack mounting, 8¾" high, 15¼" deep
Weight:	50 lbs.

Continental Electronics 
MANUFACTURING CO. SUBSIDIARY OF  RESALAB, INC.

MAILING ADDRESS: P.O. BOX 17040 DALLAS, TEXAS 75217

SUPER-POWER BROADCAST TRANSMITTERS

Continental's pre-eminence in the design and development of super-power transmitters is perhaps exemplified by the design and manufacture of five 1,000,000 watt broadcast transmitters for the USIA Voice of America program.

Four of the VOA transmitters were designed for operation in the MF range, and the fifth was a LF broadcast transmitter. Three of these transmitters were installed in Germany, Okinawa and the Philippines in 1953. The fourth was divided into two installations for VOA Project Gamma in Greece. The fifth installation site is near Bangkok, Thailand.

In 1952, Continental began development of a 500,000 watt HF broadcast transmitter. Six of these HF transmitters are in operation at the Voice of America's Greenville, North Carolina facility. These HF transmitters are the world's most powerful and the only 500,000 watt HF broadcast transmitters known to be in operation anywhere in the world.

From the experience gained in the development of super-power transmitters such as these, Continental has manufactured a complete product line of AM broadcast transmitters. Ranging in power from 5,000 to 1,000,000 watts, with potential through combining techniques of substantially higher power levels, these MF and HF transmitters are setting industry standards at installations throughout the United States and abroad.

Opposite page: Partial view of transmitter room in USIA's Greenville, North Carolina broadcast station for the Voice of America, showing two of Continental's six 500,000 watt HF transmitters installed at the station. Below: Continental's new production-rate facility is a radical departure from accustomed model shop methods of manufacturing medium-power and high-power transmitters. Production programs are executed by on-line fabrication, assembly and testing. Unique in design concept and production capacity, Continental's transmitter "production lines" can deliver a variety of transmitter power levels, from 5,000 watts to 250,000 watts, in quantity and to a pre-determined schedule.



**ADVANCES IN TRANSMITTER
TECHNOLOGY**

Continental's patented High Efficiency High Level Screen Modulated RF Power Amplifier is a unique state-of-the-art innovation for high power broadcasting. Combining high over-all efficiency with low power consumption, it is an outgrowth of several Continental developments spanning early super power technologies. Continental's 50,000 watt MF, 100,000 watt MF, 500,000 watt MF, 1,000,000 watt MF and 250,000 watt HF transmitters are using this advanced circuit, making them the most efficient broadcast transmitters at their power levels known to be in operation. Continental's new 10,000 watt and 5,000 watt MF transmitters are the first to have 100% solid-state exciters; use only two tubes and one tube type.

Below: Continental's Type 316F/315F 10,000 watt/5,000 watt MF AM broadcast transmitter. Bottom of page: Continental's Type 317C 50,000 watt MF AM broadcast transmitter.

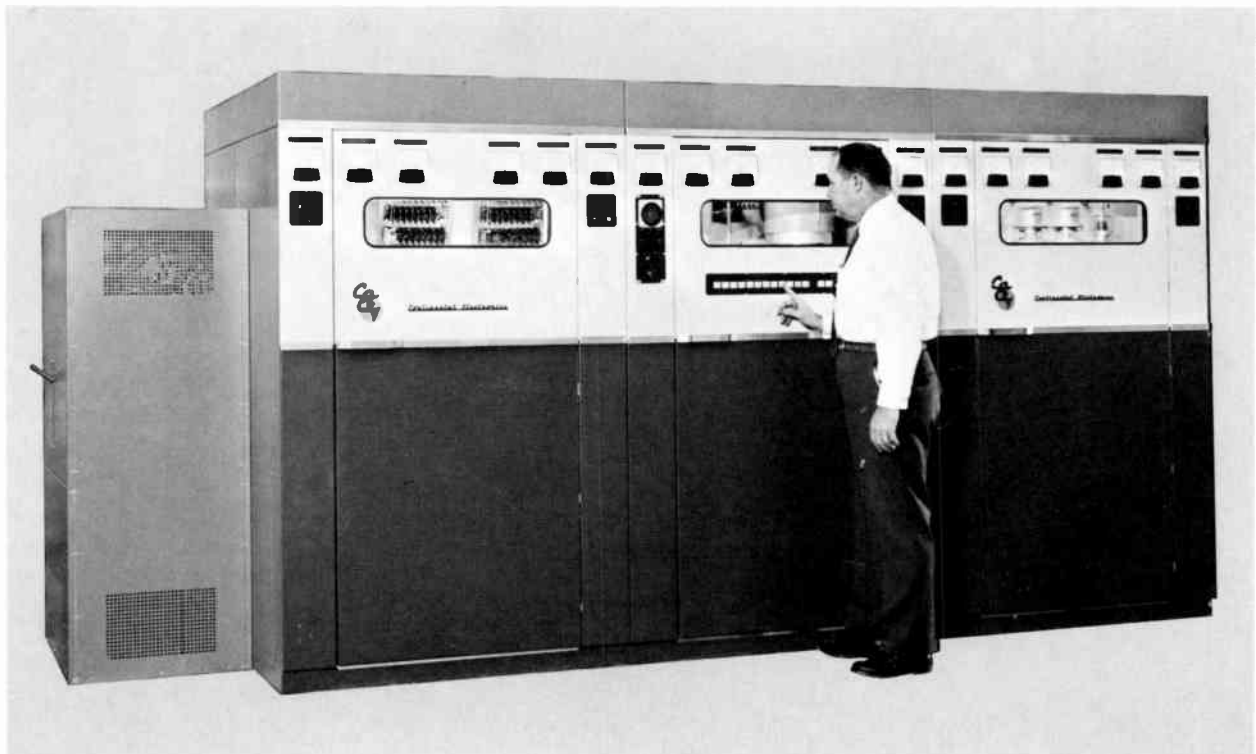
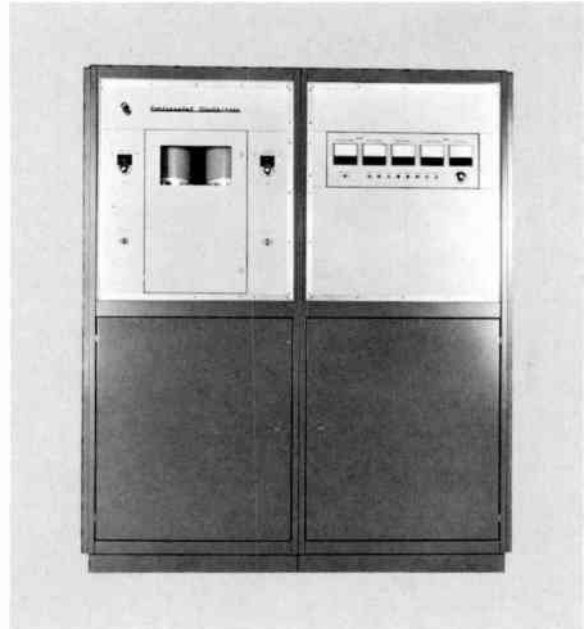

Right: Continental's Type 319A 250,000 watt MF AM broadcast transmitter. Middle left: Continental's Type 318A 100,000 watt MF AM broadcast transmitter. Middle right: power amplifier tubes for the Type 318A. Bottom left: high-voltage silicon power supply for the Type 318A. Continental pioneered the use of solid-state power supplies in high-power transmitters. Bottom right: Continental's Type D319A 500,000 watt MF AM broadcast transmitter combines two 250,000 watt transmitters to achieve 500,000 watts output.

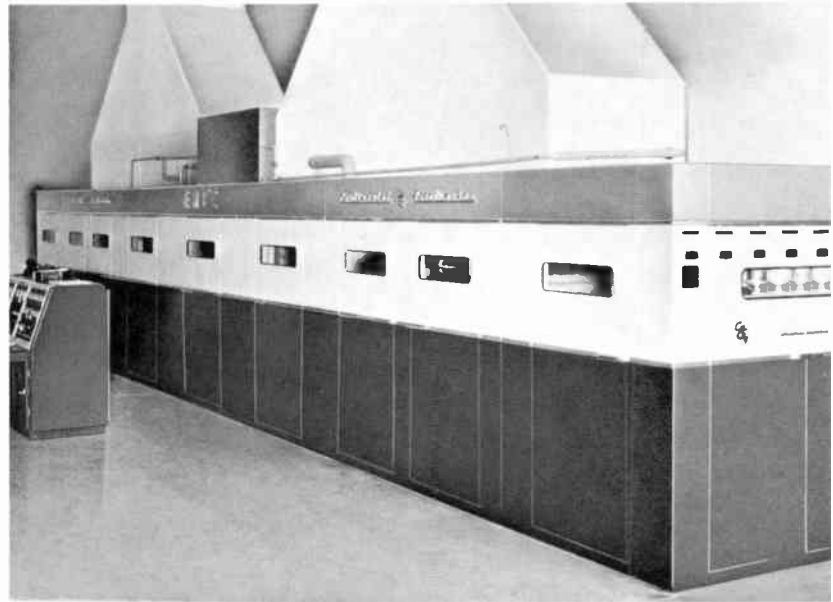
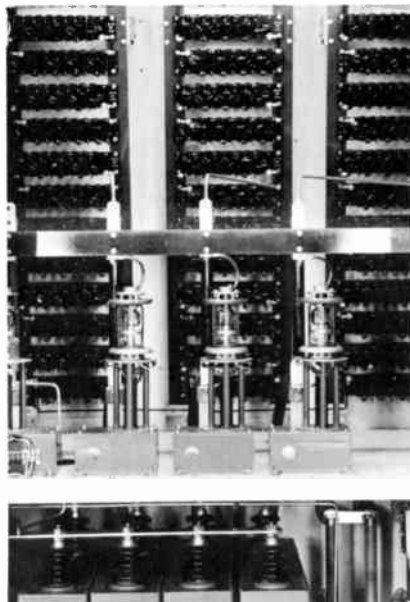
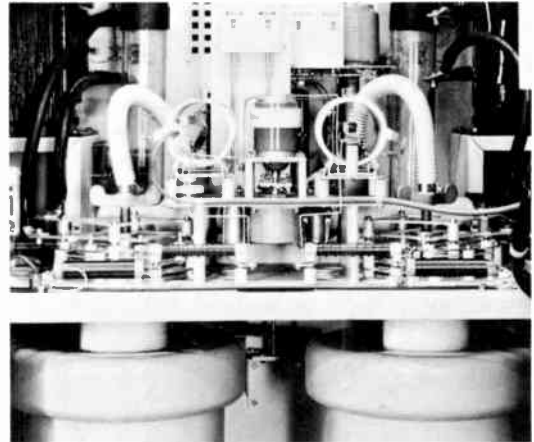
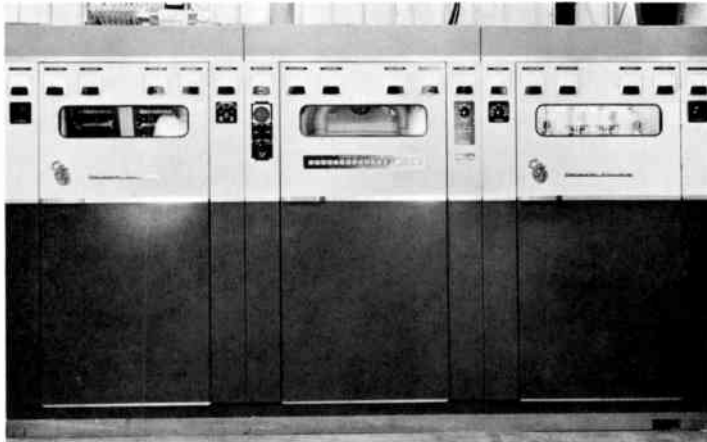
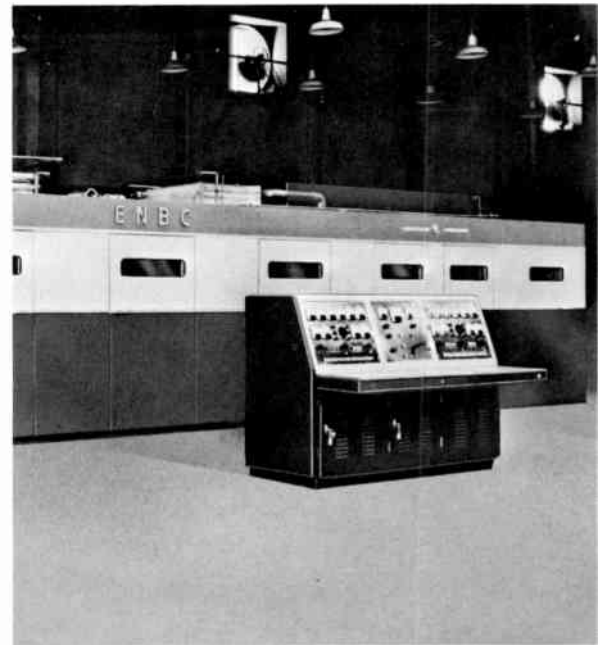



**PIONEER DESIGNER AND
WORLD'S MOST EXPERIENCED
BUILDER OF SUPER-POWER
1,000,000 WATT BROADCAST
TRANSMITTERS**

Continental designed and built the first super-power transmitter for the Voice of America. Delivering 1,000,000 watts of continuous power to the antenna, it was installed at Munich in 1953. Similar Continental 1,000,000 watt broadcast transmitters are installed in Okinawa, the Philippines, Thailand, Central America and Egypt.

Left: Partial view of USIA's Philippine Relay Station showing Continental's 1,000,000 watt MF broadcast transmitter which has been operating since 1953. Below: Continental's newest 1,000,000 watt MF transmitter.

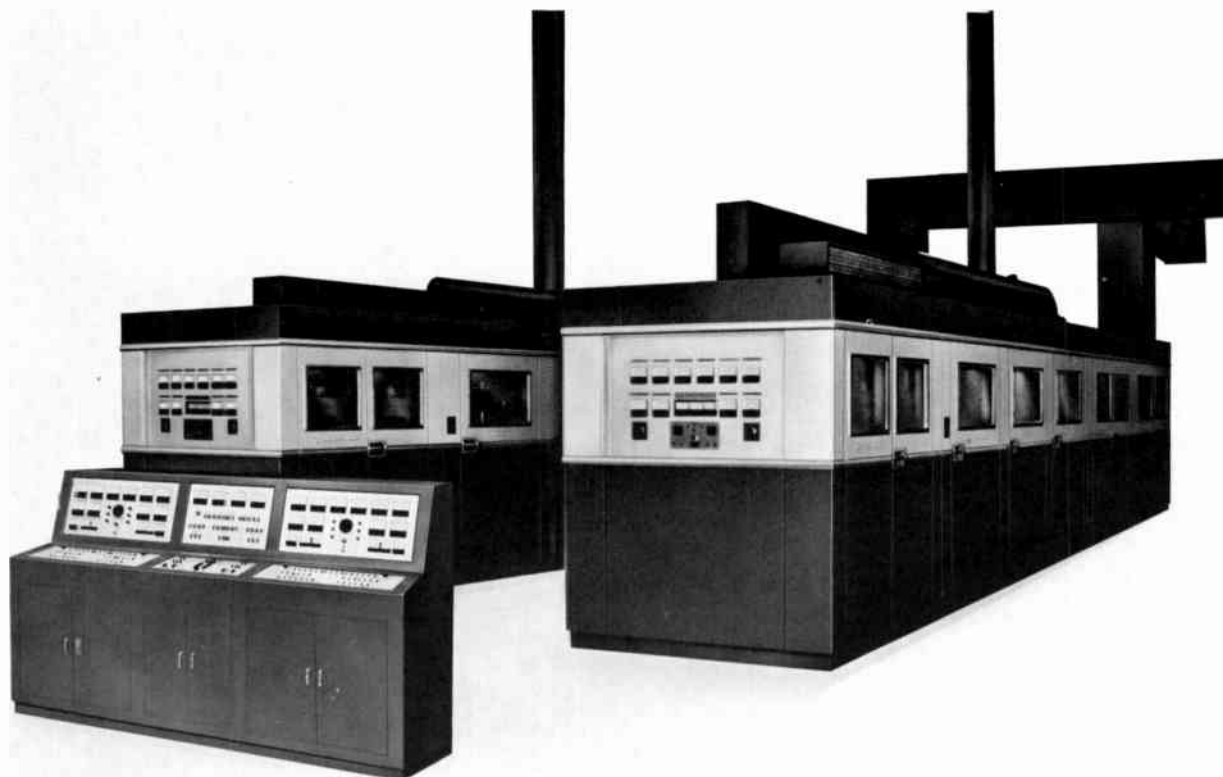

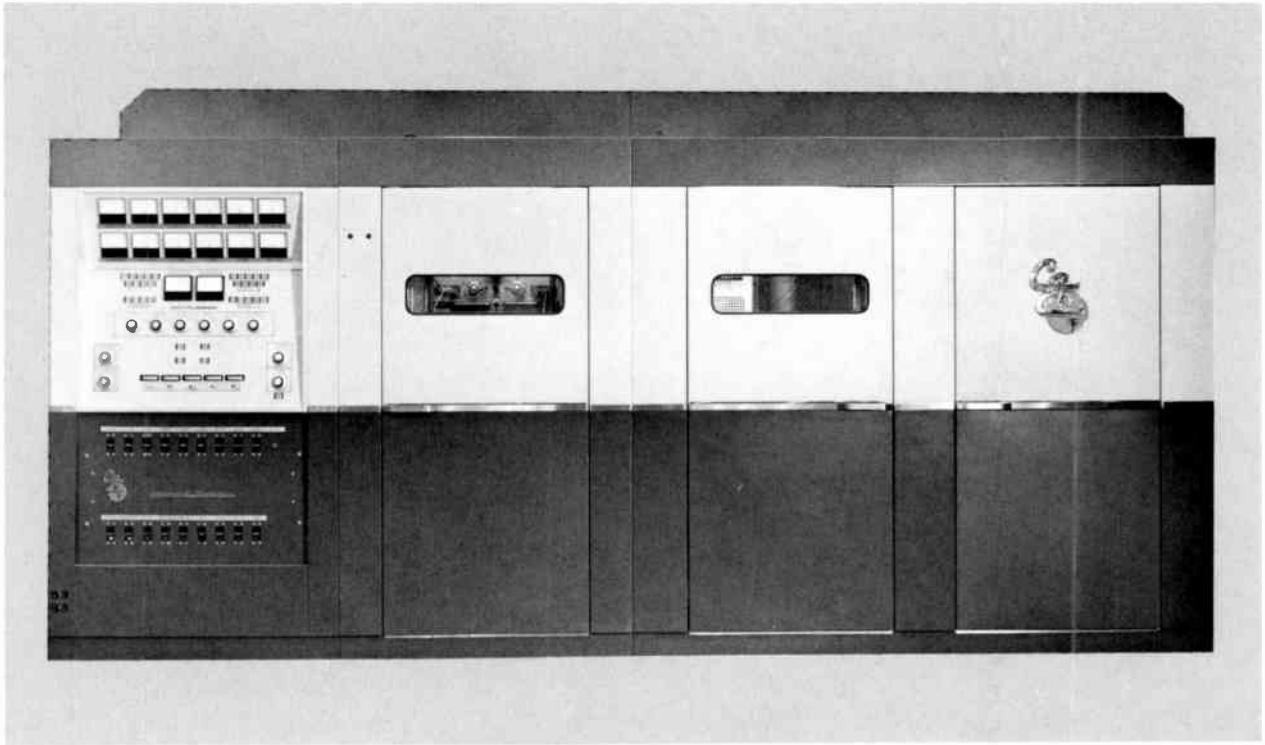

**SHORT WAVE BROADCAST
TRANSMITTERS**

Above: Continental's Type 418D 100,000 watt HF transmitter. Below: Continental's Type 419E 250,000 watt HF transmitter. Continental is building ten of these transmitters for the USIA.

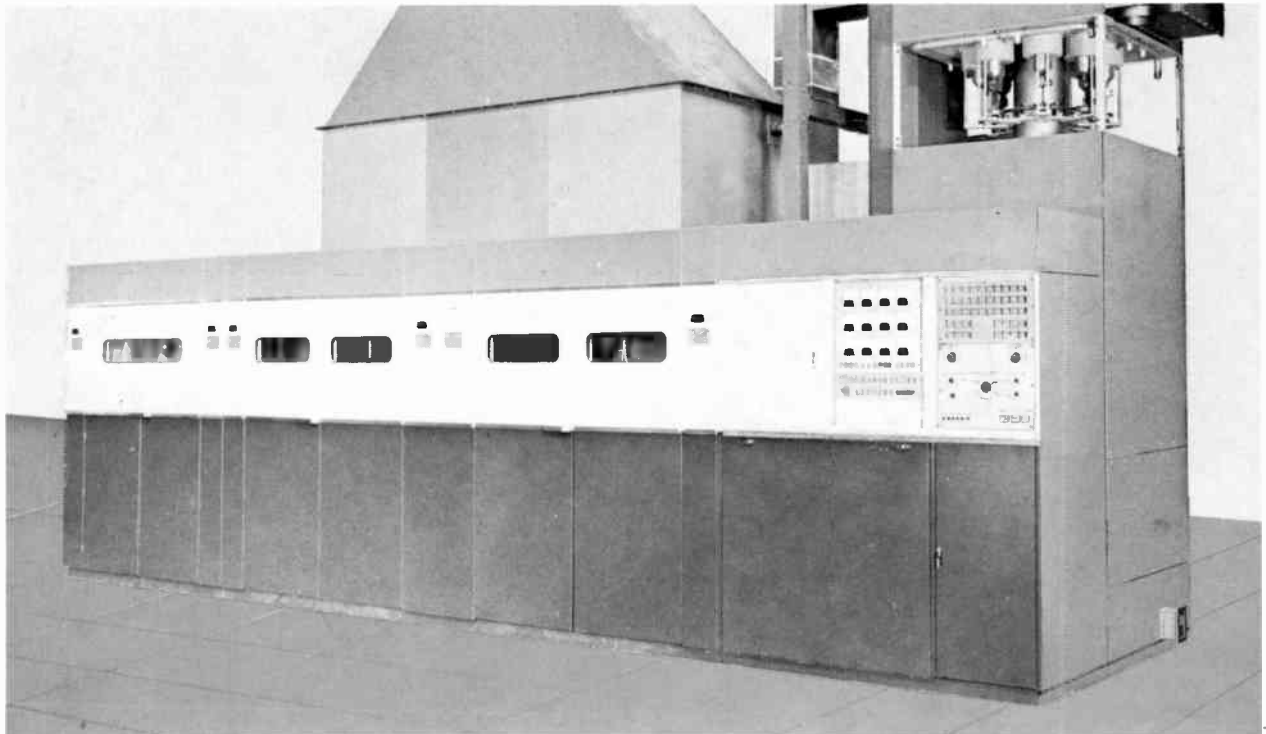

EXTRAORDINARY BROADCAST STATIONS

The USIA Voice of America's consolidated East Coast short wave broadcast facilities consist of two separate transmitter sites and a receiving site covering 6,000 acres of cleared timber land near Greenville, North Carolina. This facility utilizes 400 steel towers and 95 antenna systems to beam the Voice of America programs to South America, Europe, Africa, and the Near East. Each of the two transmitting sites has three Continental super-power 500,000 watt transmitters, plus three 250,000 watt, three 50,000 watt and two 5,000 watt transmitters, for a combined total transmitting power of 4,820,000 watts.

Continental was actively in charge of the management of this entire facility, and directed all electronic aspects of this enormous project.

Several of Continental's international installations are noteworthy because of their high power . . .

The broadcast station for Trans World Radio on the Island of Bonaire, in the Netherlands Antilles of the West Indies, was a complete turnkey project including Continental 500,000 watt MF, 250,000 watt and 50,000 watt HF broadcast transmitters, antennas and ancillaries. Installation also included a short wave receiving facility for rebroadcasting programs from Holland.

Installation and engineering supervision for a Continental 500,000 watt MF broadcast station including a four-element directional antenna system for the Eastern Nigeria Broadcasting Company in Nigeria.

Supervision and installation of Continental's 1,000,000 watt MF transmitter for the UAR located at Alexandria, Egypt.

100,000 watt MF transmitters installed for radio station XEX at Mexico City, and for Broadcasting Corporation of China, Republic of China, at Taipei, Taiwan.

The international short wave broadcasting station of Emissora Nacional de Radiodifusão at Lisbon, Portugal incorporates four of Continental's new Type 418B 100 kw HF transmitters.

Other international installations using Continental transmitters are located in Burma, Vietnam, Italy, South Africa, Pakistan, Canada, Mexico, England, Puerto Rico, Costa Rica, Guatemala, Venezuela, Ecuador, Peru, UAR, Germany, Holland, Iraq.

Below: Progress photo (1963) shows construction detail on antennas for the Greenville VOA station. This facility was dedicated in 1964. Opposite page: (top) Factory test of two Continental 100,000 watt MF broadcast transmitters for the Voice of Freedom, Viet Nam. Transmitters are combined to develop 200,000 watts output. In addition to the transmitters, Continental supplied the dummy loads and complete phasing and coupling equipment on this turn-key installation. (middle left) Partial view of transmitter room of Trans World Radio's broadcast station on the Island of Bonaire, Netherlands Antilles. (middle right) Emissora Nacional de Radiodifusão broadcasting station in Lisbon, Portugal, uses four Continental 100,000 watt HF transmitters. (bottom) Partial view of the Radio Liberty Committee installation near Barcelona, Spain. The station uses four Continental 250,000 watt HF transmitters.

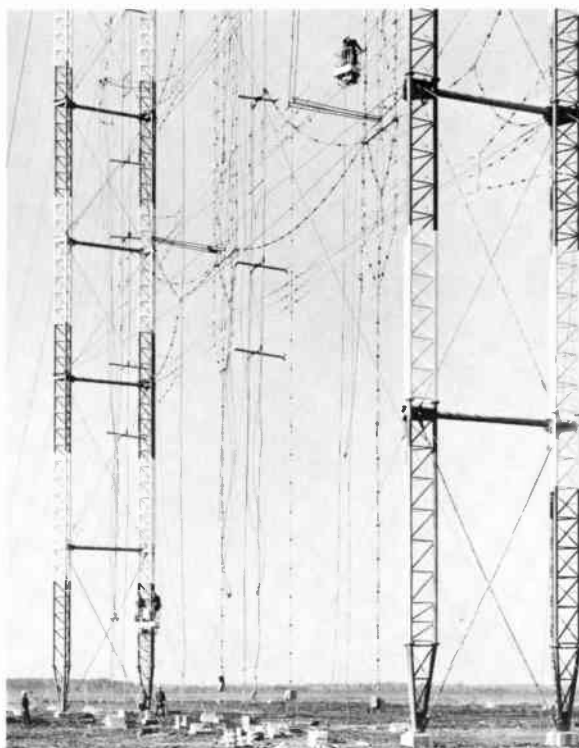

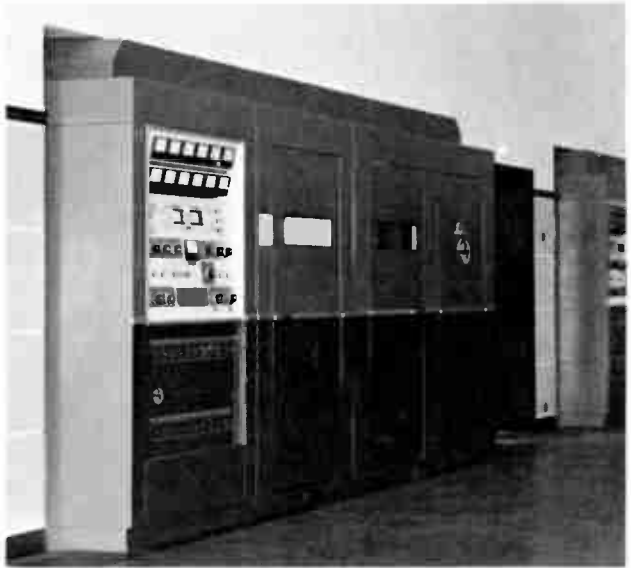
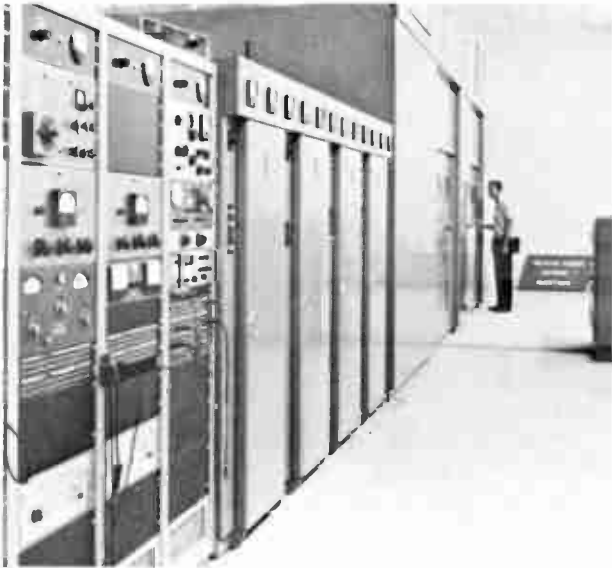
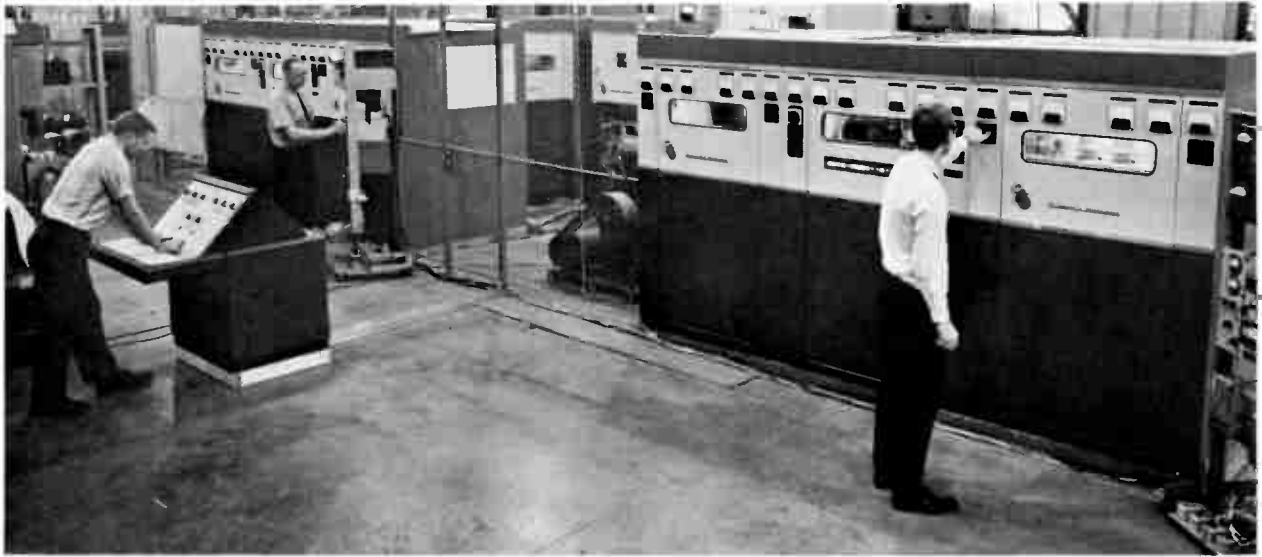

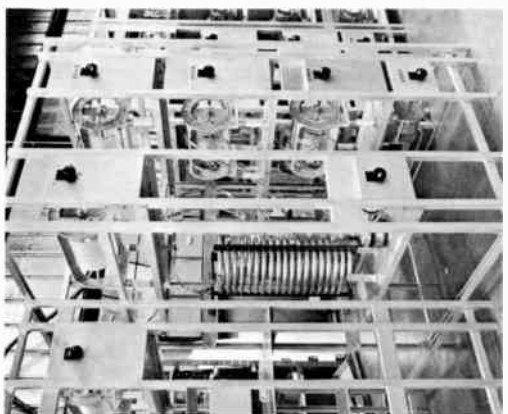
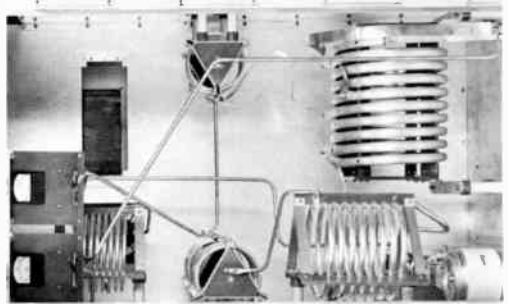
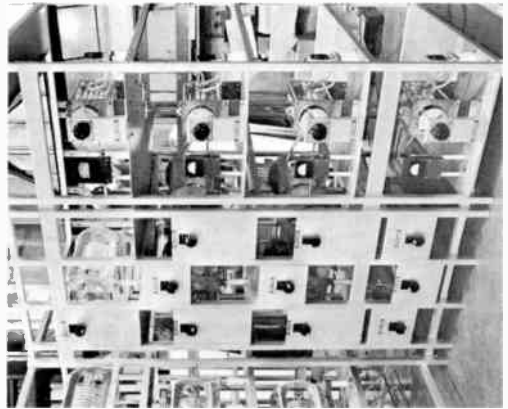
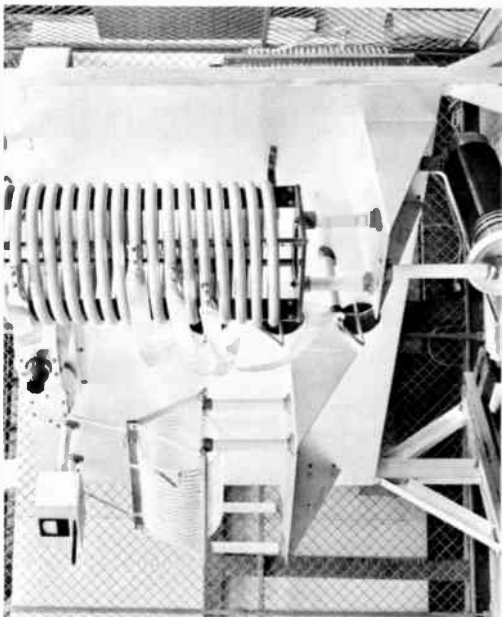
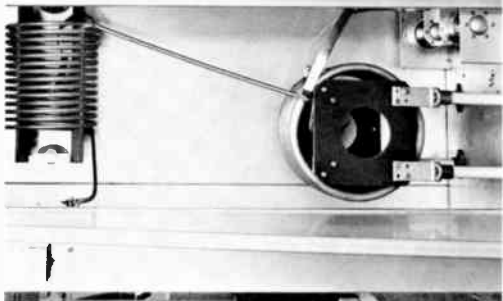
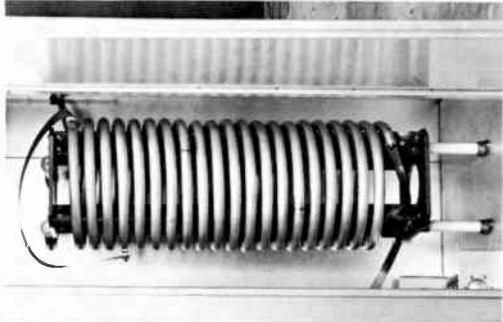
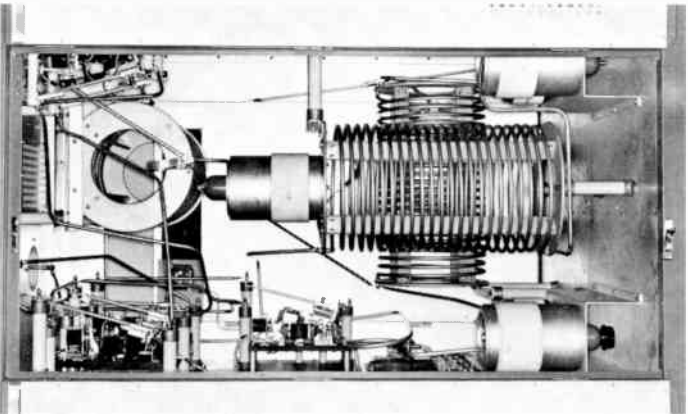
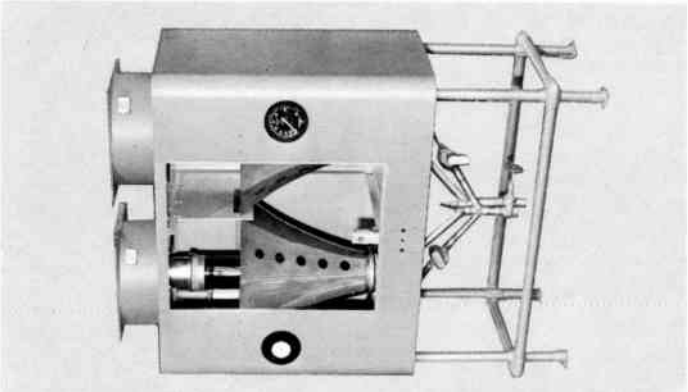
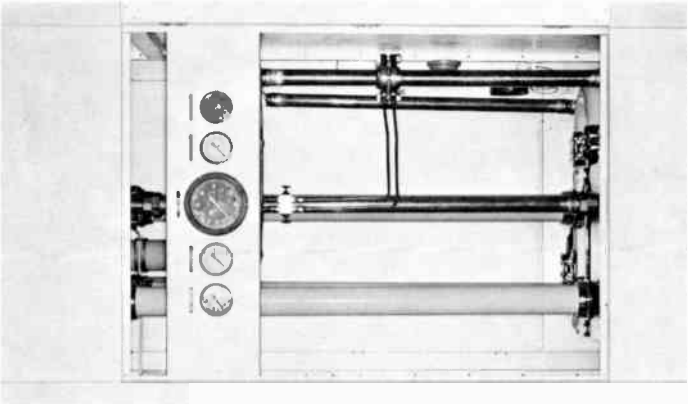

HIGH-POWER BROADCAST SYSTEM COMPONENTS

Continental has gained world-wide experience in the design, engineering, development, construction and installation of specialized broadcast systems and components. This equipment includes: specialized antenna systems, transmitter dummy loads, phasing and coupling equipment and combiners, for a wide range of transmitter power levels.

Right: High frequency curtain-type transmitting antenna developed for 500,000 watt transmission. Bottom right: Portion of rf transmission line switching matrix installed for the USIA at Delano and Dixon, California. System handles 250,000 watts between 4 and 30 mHz, and is capable of automatically switching any one of 10 transmitters into any one of 22 antennas. Bottom: Portable antenna system which has radiation resistance per element equal to tower three times its height; develops high efficiency while using limited ground wire installation. Antenna configuration is a 60-foot cube, tuneable from 530 kHz to 1600 kHz; components can be erected by five men with or without power equipment. Opposite page: (top left) 200,000 watt MF combiner, (top center) 300,000 watt HF dummy load, (top right) 200,000 watt MF dummy load, (middle and bottom) phasing and coupling equipment.

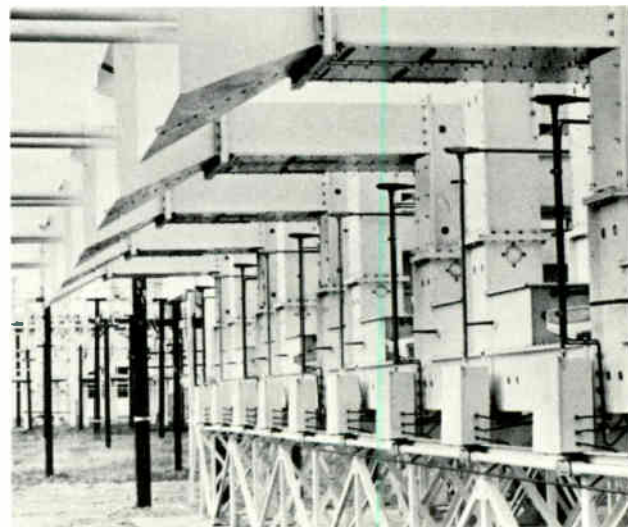
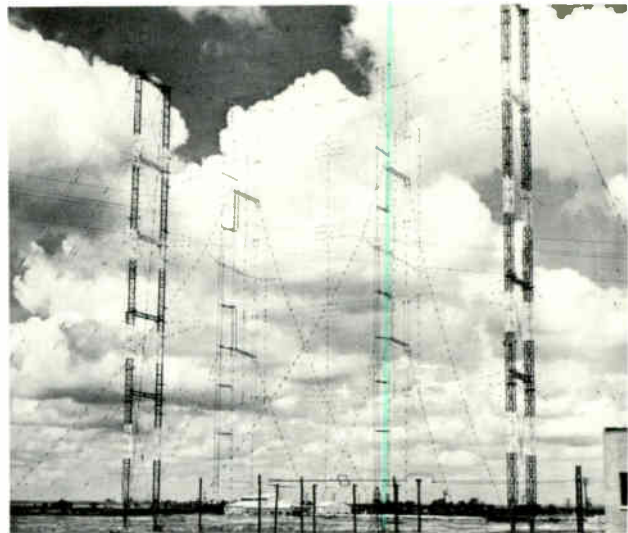

Continental Electronics 
MANUFACTURING CO. SUBSIDIARY OF  RESALAB, INC. 

MAILING ADDRESS: P.O. BOX 17040 DALLAS, TEXAS 75217