



**THE
LEADING-EDGE
OF
RF TECHNOLOGY**



Continental Electronics Corporation





CONTINENTAL ELECTRONICS CORPORATION THE INNOVATION LEADER

When Continental Electronics Corporation (CEC) started back in 1946 they had one goal in mind: To create an extensive and unique capability in RF product design.

◆ Today, CEC — a Tech-Sym Company — has become an innovative leader in RF technology. In fact, our engineering oriented corporation specializes in the design and manufacture of low, medium and high power radio frequency transmitters for radio broadcast, communications, radar and scientific research applications.

◆ From the very beginning, CEC has an unmatched record of advancements in the RF energy field. Therefore, most of our company's innovative engineering designs have been at the forefront of our industry and have helped pave the way for many technological advanced product developments. Also at CEC, our commitment to excellence is reflected in the quality of workmanship in our products and in the operational performance of all our radio/electronic equipment which bridge the spectrum from ELF to UHF, S-Band and beyond.

◆ Over the years, the scientific community has relied on CEC to design high voltage power supplies and accelerator RF systems to meet the most stringent criteria. Our capabilities in this area are evident by the extraordinary relationship that has been established around the world with these laboratories.

◆ CEC is also very committed to commercial and governmental facilities around the world which rely on our transmitters for local, regional and international broadcast and communications purposes. In fact, some of these projects require special teaming or joint ventures with other companies which allows us to meet practically any customer specifications, anywhere in the world today.

◆ With all our experience in high power RF it's easy to see why our expertise has led to many innovative adaptations for specific applications such as particle acceleration, radio astronomy, fusion plasma heating, line-of-sight radar and over-the-horizon radar. So, in the following pages, you'll see why CEC is — and always will be — on the leading-edge of RF technology.



CEC Plant Facility.

THE LEADING-EDGE OF SPECIAL PRODUCTS.

Continental's high power radio frequency energy sources have helped to advance the frontier of science. In fact, CEC modulators, pulsed power supplies and power amplifiers are used in innovative projects and programs that have helped to make many scientific advancements.

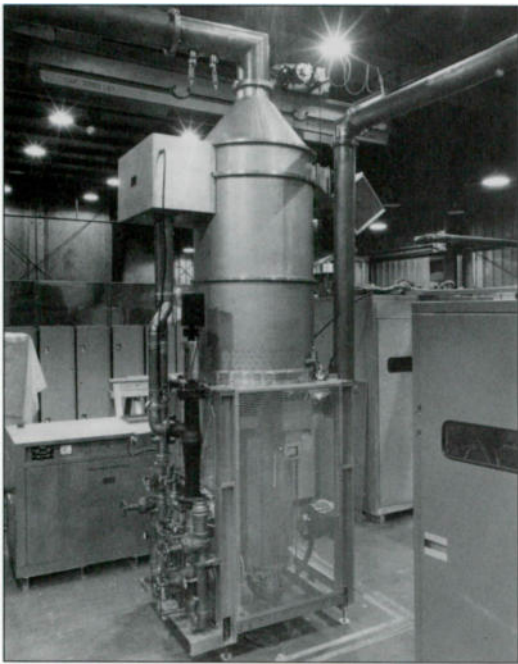

Final amplifier for Oak Ridge National Laboratory produces 1.5 MW over 40 to 80 Mhz frequency range.

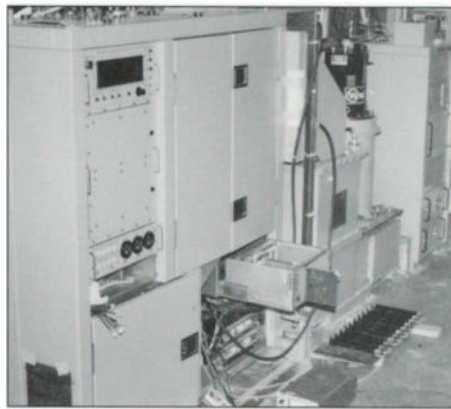

Interior view of transportable high power radar transmitter.

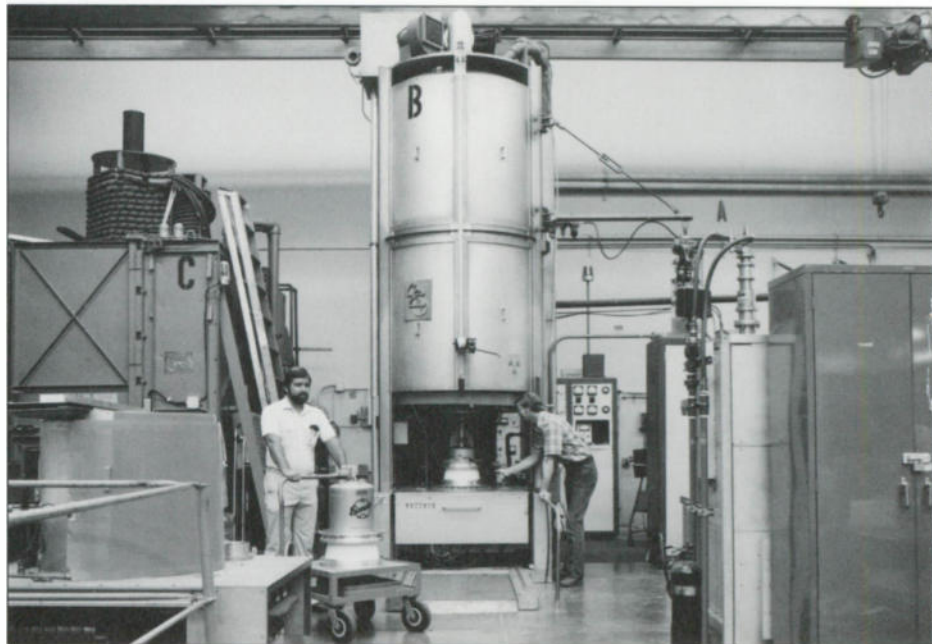

Cavity for testing of Varian one to two megawatt vacuum tubes over 3 - 13 Mhz frequency range.

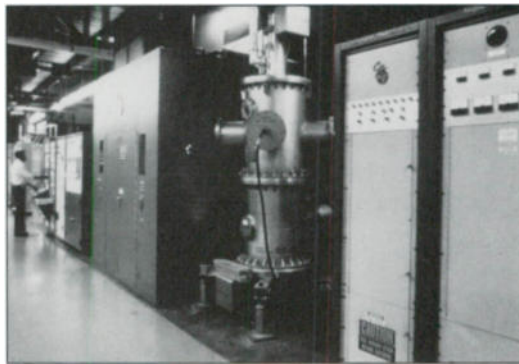
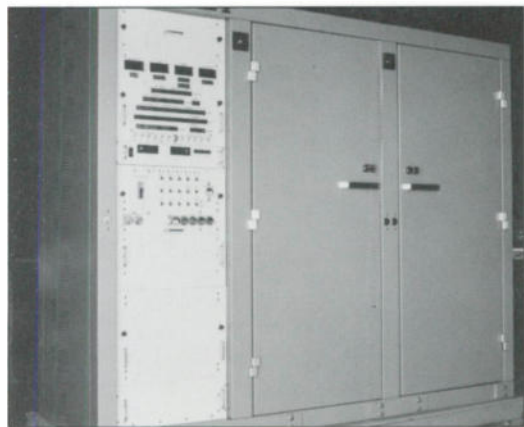

*Far Left: X-Band Klystron RF source
Left: Five megawatt, 201 Mhz, RF
source for Fermilab.*

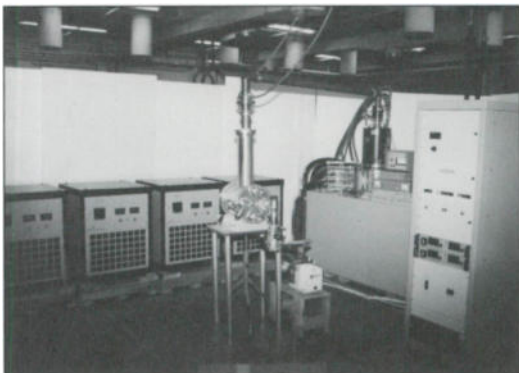

*28 Ghz, 10 kW, Gyrotron CW RF source for industrial
heating applications.*

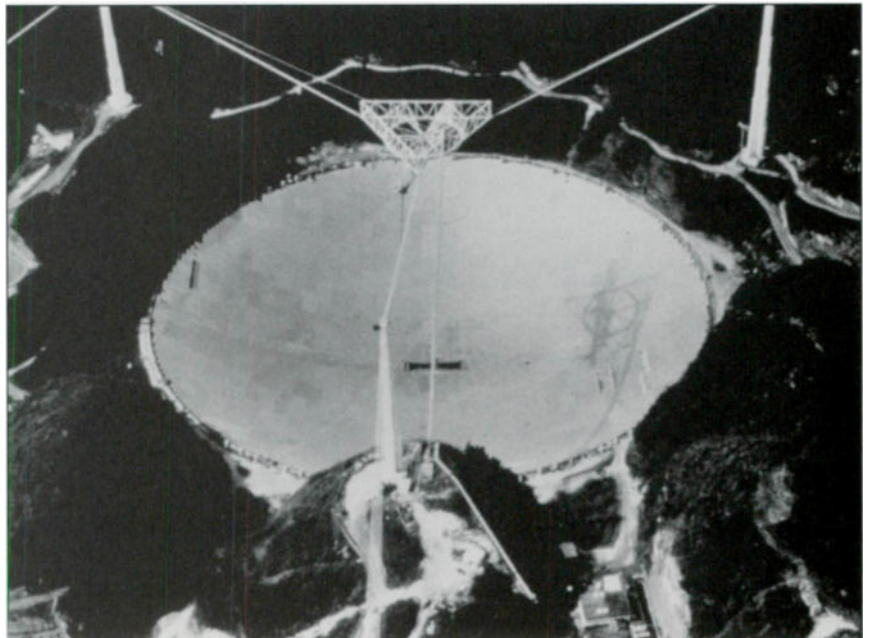

*One megawatt, CW, S-Band
transmitter for Arecibo Interplanetary Radar.*

THE LEADING-EDGE OF SPECIAL PRODUCTS.

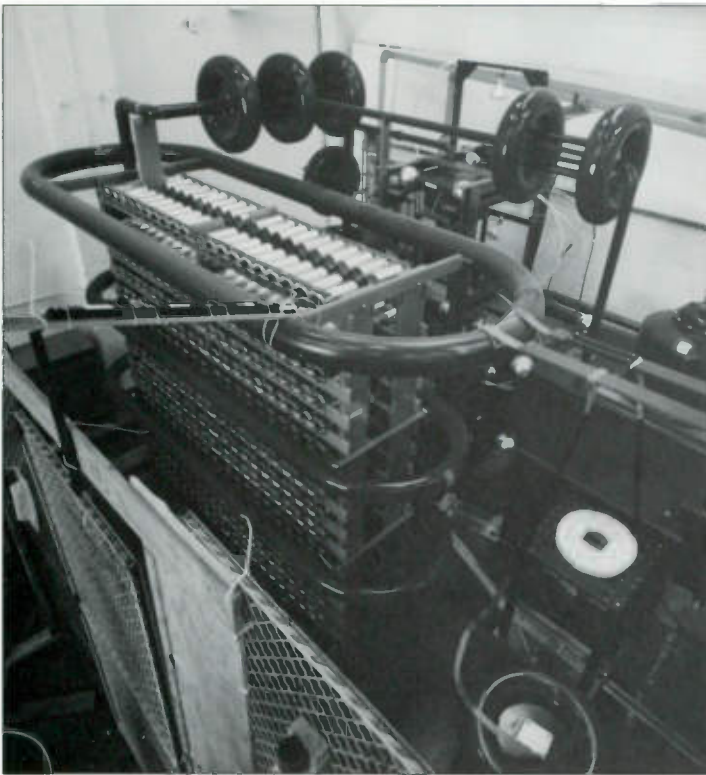

Gyrotron hard-tube series modulator for Princeton Plasma Physics Laboratory's Tokamak Fusion Test Reactor. Capable of switching 80KV to 20 A.

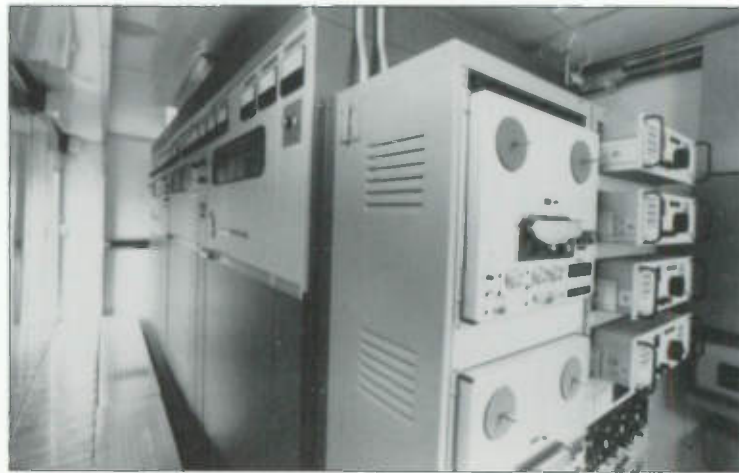

Above and Below: Transportable transmitters for broadcast and communications.



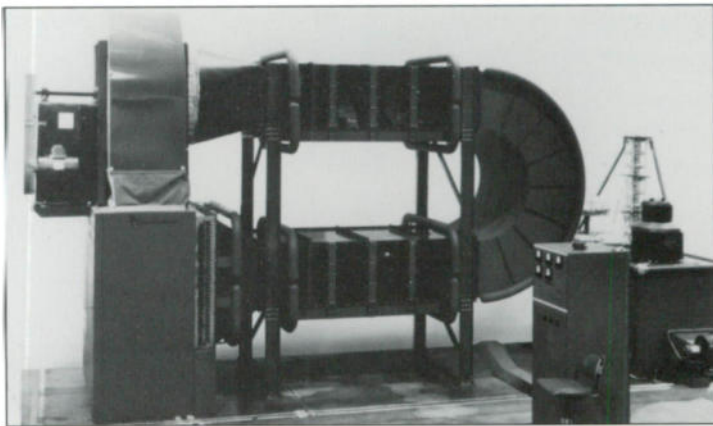
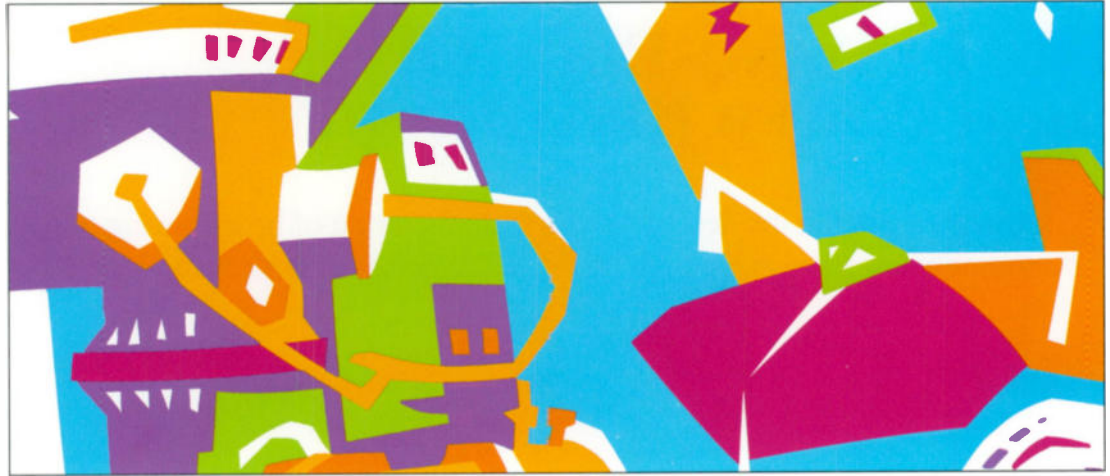

Shunt Regulator, 80KV, 40 A, Voltage regulator for Princeton Plasma Physics Laboratory.

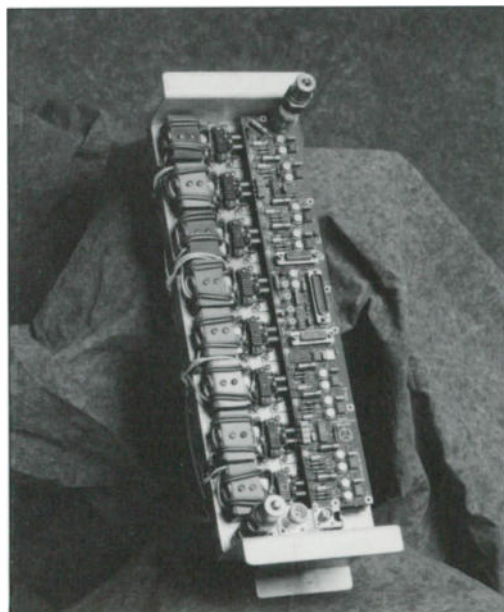

HF 1 kW Solid State Broadband Amplifier.

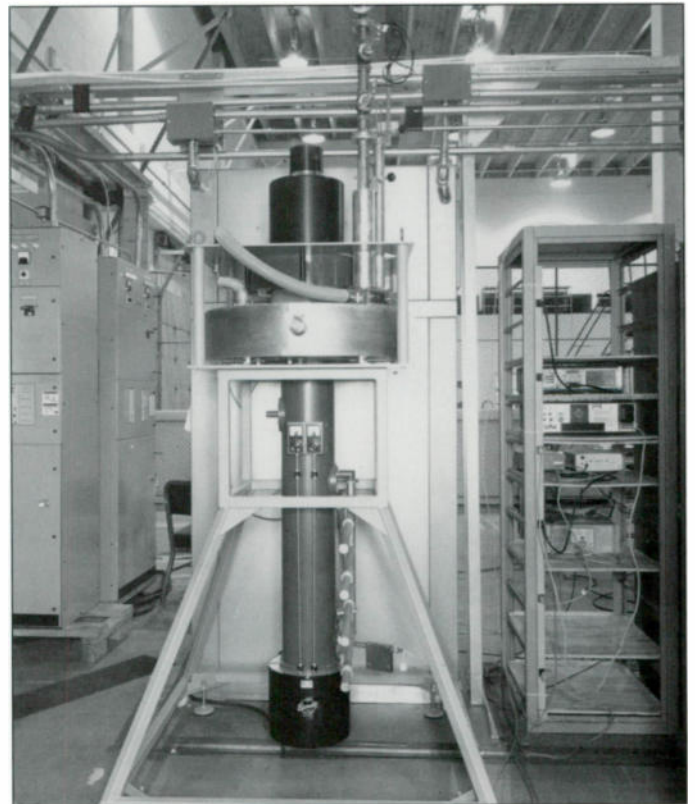

RF amplifier Klystron used on Chalk River Nuclear Facility's proton accelerator.

THE LEADING-EDGE OF HIGH POWER BROADCAST.

As a world leader in the designing and manufacturing of broadcasting transmitters, CEC is committed to specialized high power RF projects for customers around the world.

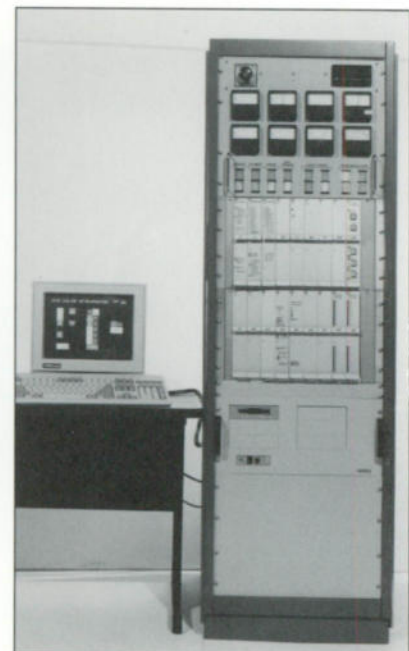
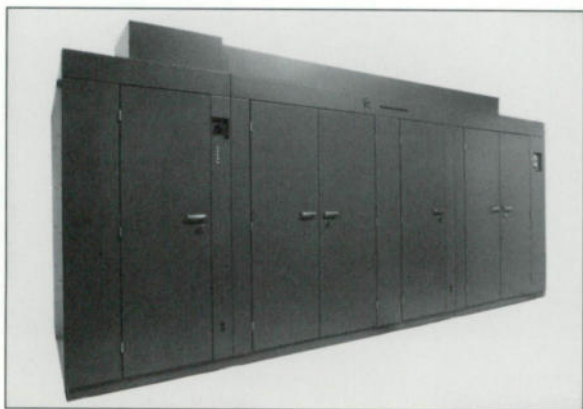
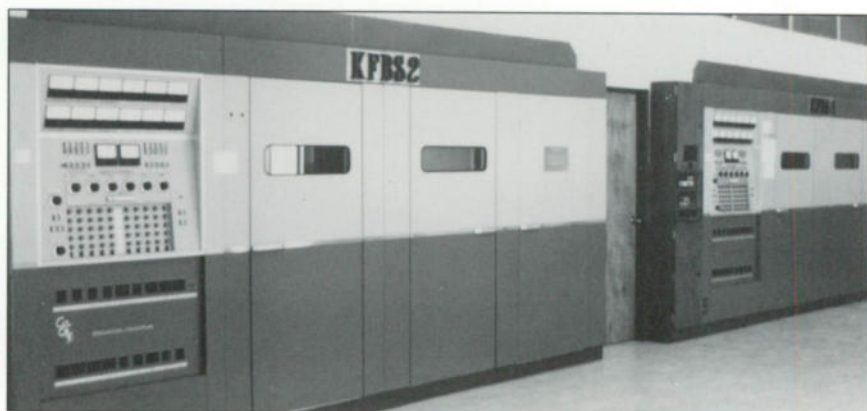

Top: WEWN Birmingham, AL - 4 ea. 500kW SW transmitters.

Bottom: 300/600 kW MW transmitter.

Top: FEBC Saipan 2 ea. 100 kW SW transmitters.

Bottom Left: 1,000 kW MW transmitter during factory testing.

Bottom Right: Control, status and monitoring computer for the 300/600 kW MW transmitter.

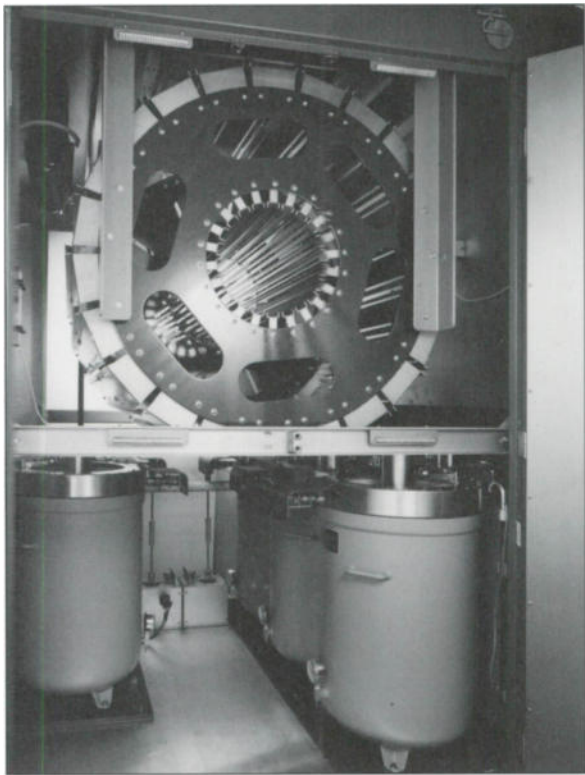

Toroid coil and gas filled capacitors used as part of the output tuning in the 300/600 kW MW transmitter.

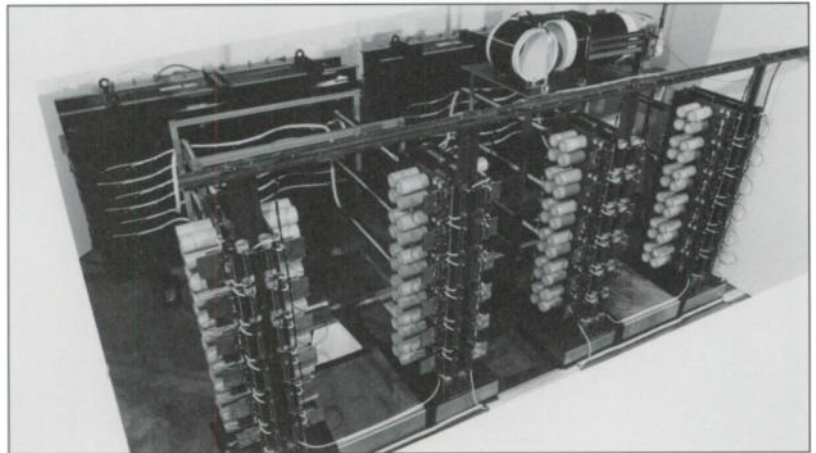

Solid state modulator using insulated gate bipolar transistor technology to achieve power capability from 100 kW to 1,000 kW in the MW and SW frequencies.



High power broadcast facility in Taiwan housing 300 kW MW transmitters and 100 kW SW transmitters.

THE LEADING-EDGE OF VLF/LF.

Today, CEC's high power communications transmitters are used by governments and agencies throughout the world for applications such as VLF military fleet/submarine communications, navigation and time/frequency standards broadcasts, LF shore-to-ship communications, MF short-to medium-range communications and navigation.

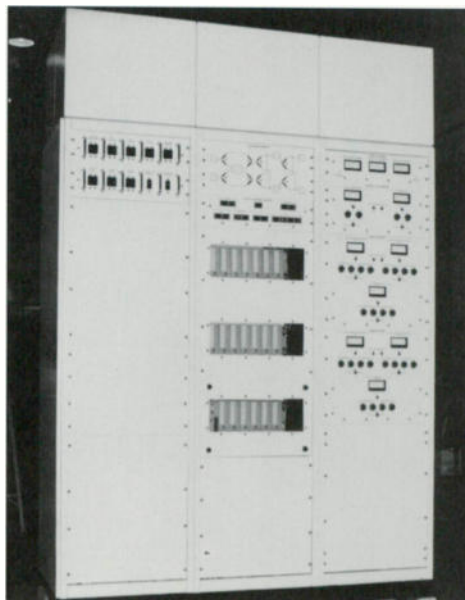

Far Left: VLF/LF transmitter operating from 13 to 160 kHz for communications, time clock and paging. Power output of this transmitter ranges from 15 kW to 56 kW and can be increased by adding additional power modules.

Left: Control and routing cabinet for combining and tuning of VLF/LF antenna system.

Bottom: 2 megawatt VLF installation in Australia. Used for shore to ship communications.



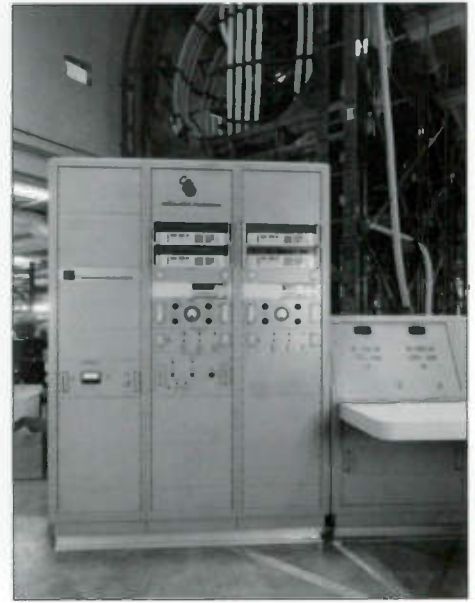
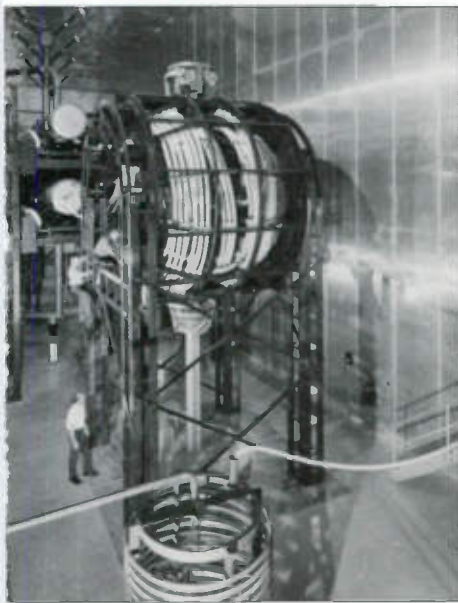

Top Left: Variometer used for tuning of 2 megawatt VLF/LF antenna system.

Top Center: Gas filled capacitors used in phasing and coupling units, high power tuning units and firing of industrial furnaces.

Top Right: Exciter of 1 megawatt VLF transmitter.

Left: 300 kW LF or LW transmitter used for broadcast or communications.

THE LEADING-EDGE OF AM AND FM BROADCAST

Continental transmitters are used around the world by commercial and government radio stations for local, regional and international broadcasting.

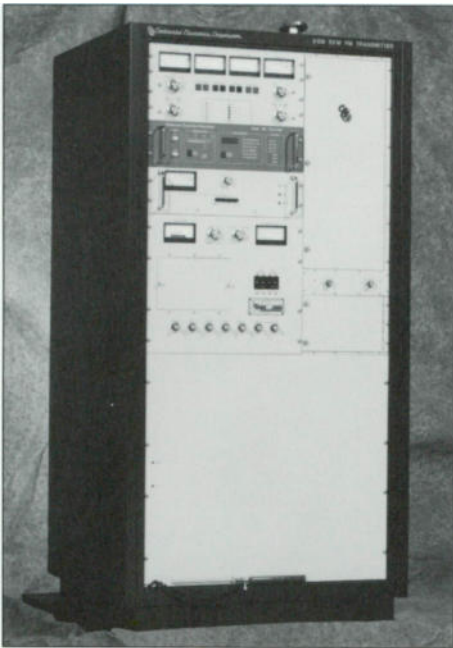

5 kW FM transmitter.

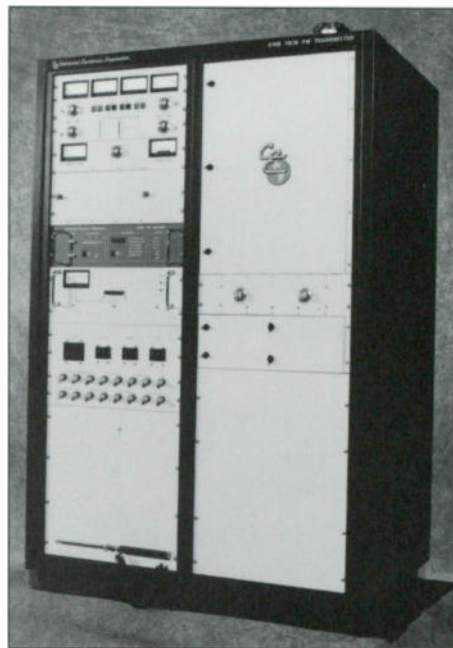

11 kW FM transmitter.



1 kW FM transmitter.

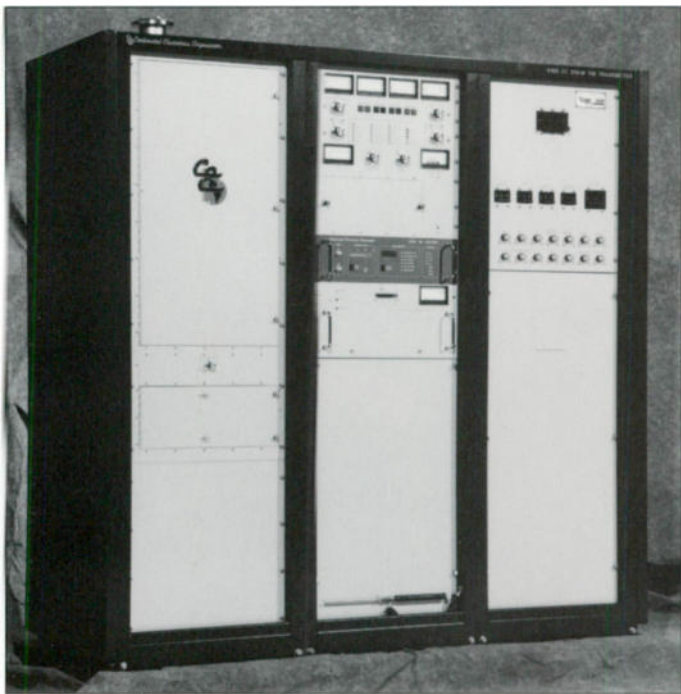

21.5 to 35 kW FM transmitter.



50W FM Exciter.

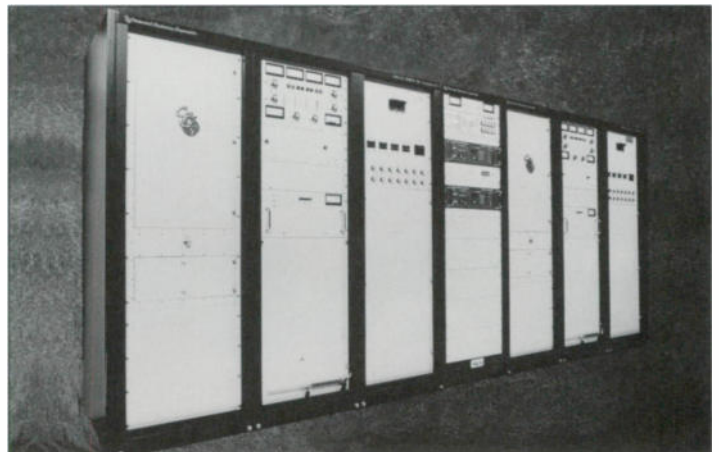

40 to 70 kW FM transmitter.

CONTINENTAL ELECTRONICS CORPORATION
a Tech-Sym Company

4212 S. BUCKNER BLVD.

DALLAS, TEXAS 75227

Mailing Address

P.O. BOX 270879

DALLAS, TEXAS 75227-0879

(214) 381-7161

(214) 381-4949 FAX

TELEX: 73-398

© 1994 Continental Electronics Corporation
2/94 5M



CONTINENTAL TYPE 212P-2 8 CHANNEL STUDIO CONTROL CONSOLE



Continental Mark 8 Type 212P-2 8-channel audio console

The Mark 8 audio console is a sound investment for AM and FM studio and production use. The 8-mixer console, designed for stereo or mono operation, outperforms more expensive models in reliability, operating efficiency, maintenance savings, and quality sound.

- Maximum on-air time.
- Minimum maintenance.
- High performance operation.
- Unsurpassed on-air sound.
- And competitive price.

Flexible operation

- Eight mixing channels with 26-input pair capacity.
- Six mixers with two independent inputs per mixer.
- Two mixers with one direct and 6 indirect inputs per mixer.
- The Mark 8 has balanced, transformer/coupled inputs that may be strapped for either 150 or 600 ohms; the nominal input level is -20 VU/-10 dBm. The six indirect inputs to channels seven and eight may be connected as 10,000-ohm bridging inputs. The lighted meter (VU) display improves monitoring.

- An optional, externally mounted, machine control interface provides single button control of external machines (turntables, cartridge players, and reel-to-reel tape players). This machine control interface has start/stop machine control slaved to the channel on/off push button associated with the specific unit.

Easy Maintenance

- Mark 8 switches, pc boards, attenuators, and amplifiers keep maintenance to a minimum with all plug-in construction.
- The audio console also features solid state, noise-free switching circuitry and long life, step type ladder attenuators. Both features minimize maintenance.
- Console construction permits easy access to all gain adjustments and fast fuse, lamp, and module replacement.
- The silk-screened back panel shows the complete console layout, including location and numbering of all terminal strips.

High performance

- Stereo monitor amplifiers deliver a full 25 watts rms per channel, and each amplifier has three outputs for monitor speakers.

- Two outputs feed individual muting relays for studio speakers, and one direct output provides unmuted speaker use. You may switch the monitor amplifier to monitor the console program output or an external off air monitor.
- The Mark 8 stereo headphone amplifier drives headphones of 4 ohms or greater impedance. The headphone amplifier delivers a minimum of 5 watts into 8 ohms, and is selectable to monitor the console program output, an external air monitor, or the console cue bus.
- The console also features a built-in cue amplifier and speaker. The control room muting relay mutes the built-in cue speaker. Use of an external, high quality speaker gives an added capability in evaluation of program material.
- The Mark 8 reduces AC fields and noise pickup with an externally mounted power supply.
- A monaural program output may be derived from the console for feeding an AM transmitter by connection of a combining network.

Specifications
Mark 8
8 Channel Studio Console

Inputs

Impedance

Microphones:
 Nominal 150 ohms
 Medium Level:
 Nominal 150/600 ohms

Level

Microphones:
 — 50 dBm nominal
 Medium Level:
 — 10 dBm nominal

Number of Inputs:
 26 medium level

Any two inputs may be strapped for microphones

Outputs

Program

Level:
 + 18 dBm nominal,
 + 30 dBm maximum

Impedance:

600 ohms, balanced
 Mono Mix Output:
 — 2 dBm, 600 ohms balanced
 (external network)

Monitor

Level:
 25 watts rms into 8-ohm load

Impedance:

Total load must not be less than 8 ohms

Headphone

Level:
 5 watts rms into 8-ohm load

Impedance:

4 ohms minimum

Noise:

— 125 dBm in 20-kHz bandwidth

Distortion:

Less than 0.5% harmonic
 Less than 0.25% IM
 (60 Hz and 7000 Hz: 4:1)

Frequency Response:

± 1.0 dB 30 Hz to 15 kHz

General

Power Source:

120/240 volts
 50/60 Hz ac

Size Weight:

Console Shell:
 34" (863.6 mm) W
 8.75" (222.2 mm) H
 18.5" (469.9 mm) D
 66 lb. (29.9 kg)

Power Supply:
 4.56" (115.8 mm) W
 10" (254 mm) H
 6.72" (170.7 mm) D
 15 lb. (6.8 kg)

Machine Control:
 8.82" (224 mm) W
 2.81" (71.4 mm) H
 15.65" (397.5 mm) D
 2 lb. (0.91 kg)

Model:

Stereo: 212P-2

Interior Mark 8

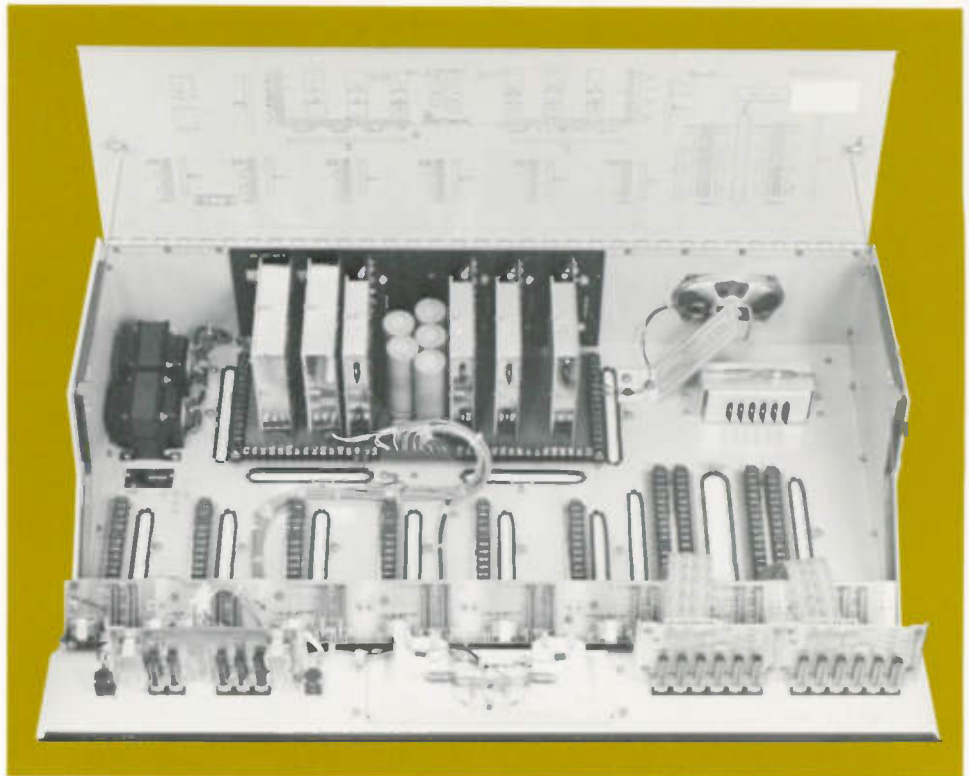

Simplified Schematic

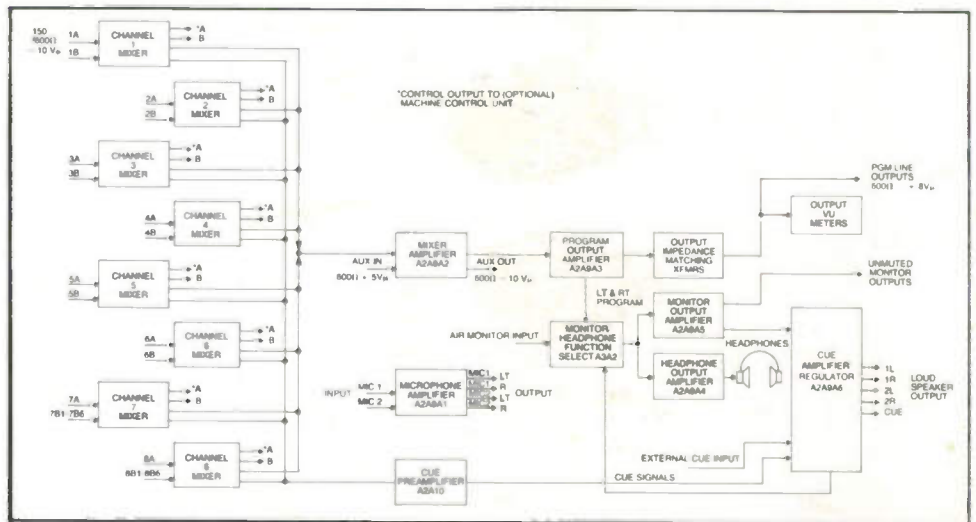

Continental Electronics

Continental Electronics Mfg. Co. Box 270879 Dallas, Texas 75227 (214) 381-7161



Specifications
Rock 10
10 Channel Studio Console

Console Program

Inputs

30 stereo

Mixers

10 stereo

Input

Normal: -10 dBm, 150 600 ohms
balanced
Microphone: -50 dBm,
150 ohm, balanced

Outputs

Normal: +18 dBm, 600 ohms balanced
Maximum: +30 dBm, 600 ohms balanced

Mono Mix Down

Normal: 18 dBm, 600 ohms balanced
Maximum: +30 dBm, 600 ohms
balanced

Response

±0.5 dB 50 -15,000 Hz

Distortion

0.25% THD 50 - 15,000 Hz
0.25% IMD (4:1 SMPTE)

Noise

75 dB below +18 dBm high level
-125 dB Equivalent Input Noise
Microphone

**Headphone and Monitor Amplifiers
(stereo, per channel)**

Power

Monitor 25 watts into 8 ohms
Headphone 5 watt headphone

Response

±1.0 dB 50 - 15,000 Hz

Distortion

0.25% THD
0.25% IMD (SMPTE)

Dimensions

254 mm (10") H
1066.8 mm (46") W
508 mm (20") D

Weight

49.9 kg (110 lbs)
includes power supply

Model:

212R-1

Functional Block Diagram

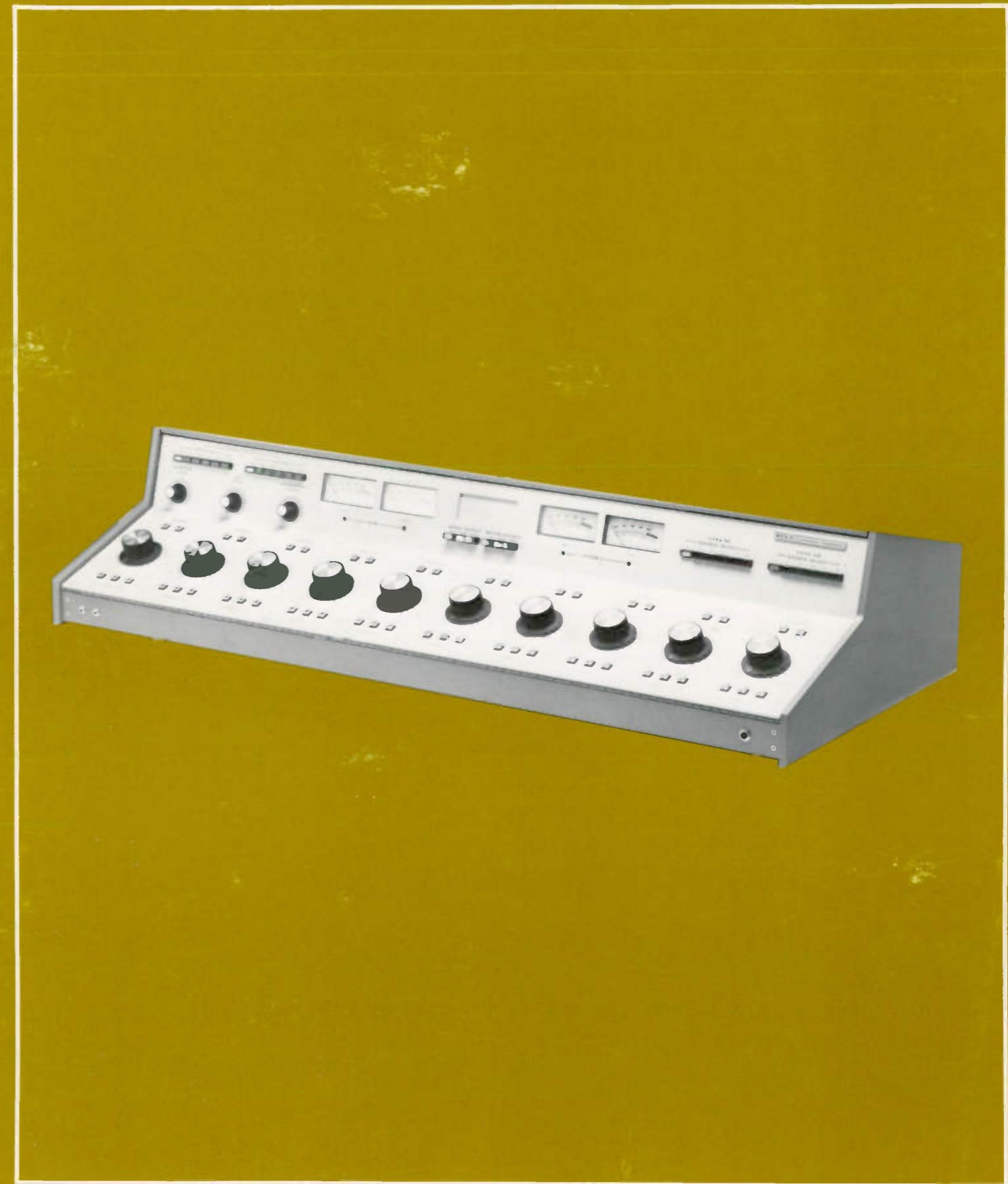
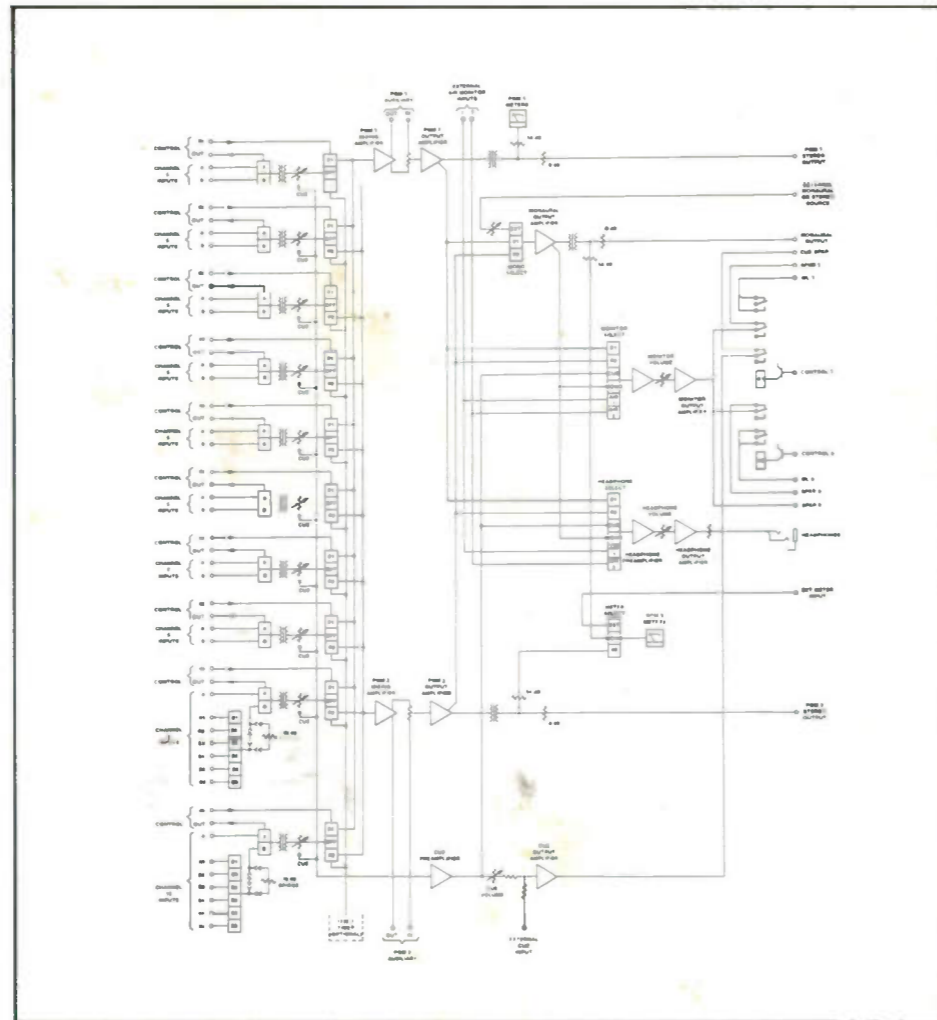

Printed in USA 1181 3M 4679

© 1981 Continental Electronics Mfg. Co.

CONTINENTAL 10 CHANNEL STUDIO CONTROL CONSOLES

Continental Rock 10 Type 212R-1 10-channel audio console

The Rock 10 console meets the needs of both programming and engineering. Modular construction offers flexibility and easy maintenance. Optional machine control interface gives start/stop control of turntables or tape machines; can provide sequencing or "mini-automation" capability. The Rock 10 provides audio brilliance and transparency; with overall performance to meet the most demanding studio requirements.

LED-equipped Program and input Switches. Push-button actuated, solid state audio switching eliminates mechanical and electrical clicks and pops. These durable, momentary push buttons allow rapid switching. Multi-colored LED's are contained within the switches for instant identity. Each LED is covered with a small Fresnel lens to make it more visible. Unlike conventional lever switches, no audio is present on the contact.

The program switches perform three functions with a single action:

- turn individual audio channels on and off
- reset the optional timer
- start and stop other control room equipment using the optional machine control interface.

Rotary Step Attenuators. We continue to use step attenuators (2 dB per step) for their reliability, ruggedness, low noise, and quality. They are accessible for cleaning and lubrication and easily removable without unsoldering.

Metering. Both stereo channels are metered individually. An additional pair of meters can monitor Program 2 stereo, mono mix-down output or an external audio source. Meters are internally lighted and have large numerals. Meter calibration for all five metering functions are located inside the console on the back plane.

Output Amplifiers. The amplifiers for programs, monitors and headphones are individually shielded interchangeable plug-in modules internally strapped for proper gain. 25 watts are available to drive monitor speakers and up to 5 watts for headphones. Amplifiers are separately fused to protect solid state components. Master gain controls are located inside the modules. Contacts are gold-plated.

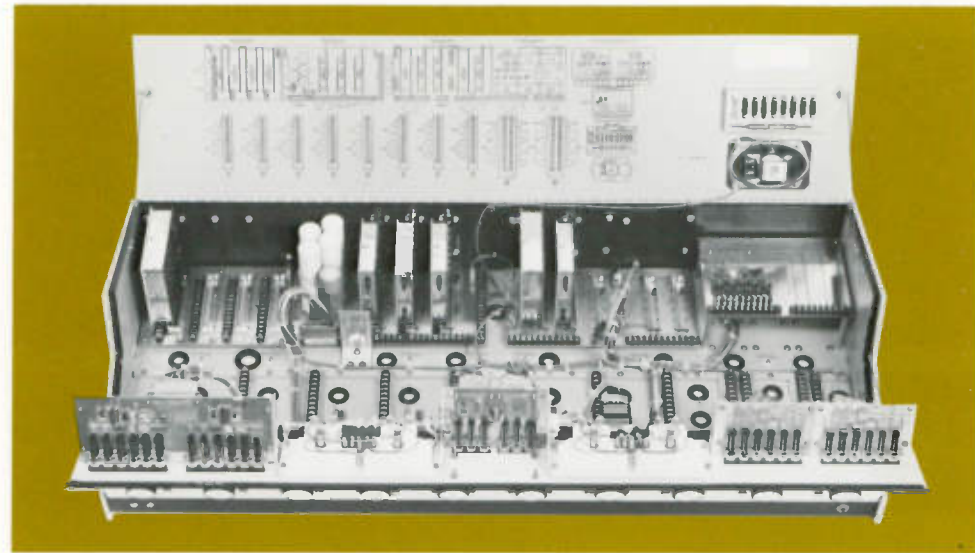

Interior Rock 10

External Power Supply. The separate power supply keeps transformer hum away from the audio circuits. The power supply is on a chassis with provision for easy mounting away from the console. An on-off toggle switch cuts power for maintenance.

All Metal Cabinet. The heavy gage aluminum panels are rigid and distortion free, and provide additional RF shielding. All surfaces are painted, silk-screened and protected with a clear plastic coating. It's designed to last.

Monitoring and Headphone Outputs. Both the monitor speakers and headphones can be selected to monitor. Program 1, Program 2, mono mix-down, cue of either of two external stereo audio sources. Cue inputs to the monitor system can be selected for a quick check of proper stereo phasing and monaural quality. Separate gain controls are on the face of the console for monitor speakers and headphones. Three stereo speaker outputs are available of which two can be muted.

Muting and Warning Light Provisions. Provision for monitor speaker muting is contained within the console for muting in the control room and one other location, such as a newsroom. Normally open dry contacts are available for warning lights for each location. In addition, the cue speaker is muted whenever the control room microphone is live. Muting can be assigned to any of the mixer channels.

OPTIONS

Machine Control Interface. This option gives the Audio Rock 10 the expanded versatility to handle the start/stop operation of equipment such as turntables, cart decks and reel-to-reel machines. The machine control interface can control up to 12 functions. These are internally programmed to provide either momentary (as used in most cart decks) or latching (as used in most turntables) action. Internal plug-in jumpers are arranged for normally-open or normally-closed contact operation. The machine control interface is programmed at installation (by hand-wiring) but can be reprogrammed for future operation changes.

This option is provided by a separate unit mounted away from the congestion in the area of the console.

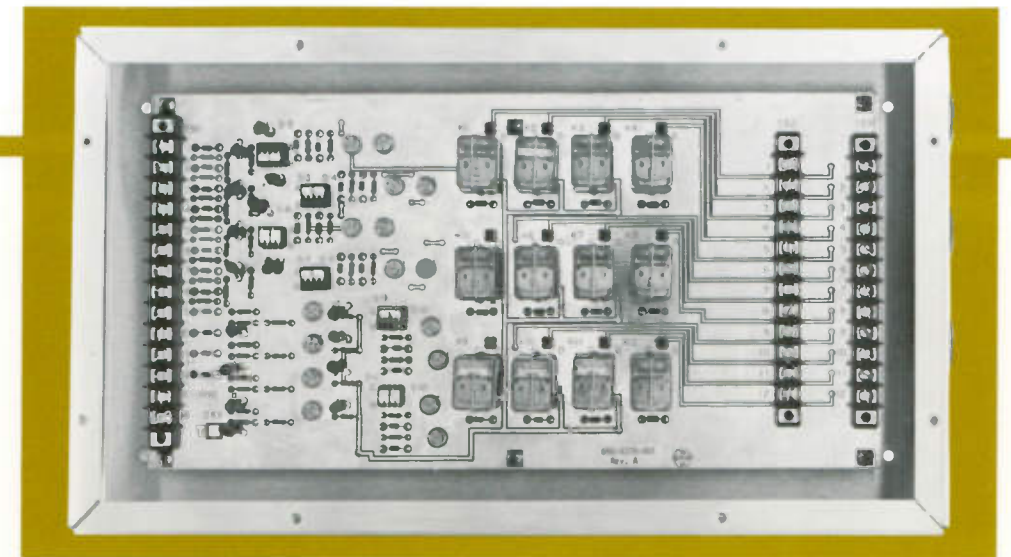

Machine Control Interface

Digital Timer. Located in the center of the console with large legible numbers, the count-up timer can be strapped to automatically reset each time a new channel is selected. In the external mode the timer may be started and stopped by an external machine. It is useful in production work as a cumulative timer for recording multiple cuts on a single tape. The timer has front panel switches for manual resetting and selecting internal and external modes.

Additional Microphone Preamplifiers. If your format requires it, the Audio Rock 10 can accommodate up to eight mono or four stereo microphone inputs (2 mono/1 stereo are standard). They are assignable to any of the mixers on the console.

Program Amplifiers for Program 2 (Audition). These amplifiers are useful if Program 2 is used as a back up program channel; for recording news or network feeds onto tapes or to adjust inputs in advance of putting them on the air.

Mono Mix-Down. With the other features already built in, this option is all that's required to provide an AM signal when simulcasting with FM stereo. The mono mix down is front panel selectable for either Program 1 or Program 2 while still preserving stereo separation. Mono mix-down is also selectable from an external source.

Continental Rock 10



CONTINENTAL TYPE 802A
FM EXCITER

FM

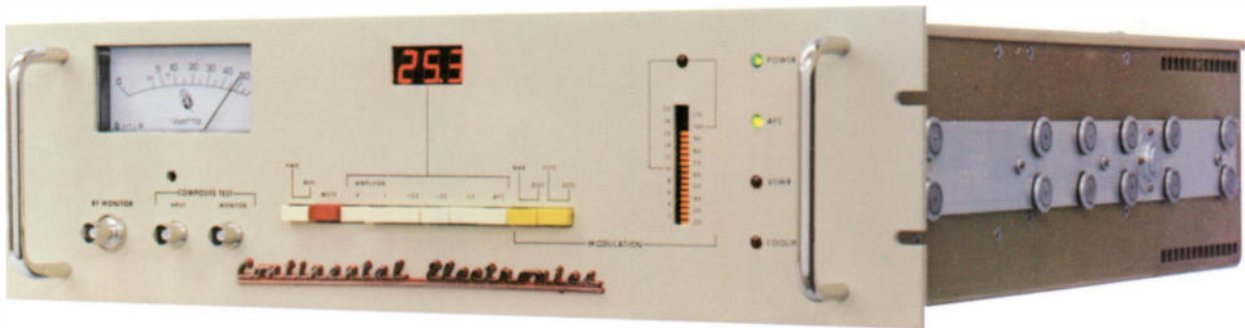

Continental Electronics

Continental Electronics Mfg. Co. Dallas, Texas



Introducing the ultimate FM Exciter

Continental's Type 802A solid-state FM Exciter offers broadcasters outstanding performance, high-quality construction, outstanding reliability.

With its variable output of 5 to 50 watts and self-contained harmonic filter, the 802A can be used as a low power transmitter.

State of the art design

The 802A continues the tradition of excellent and reliable performance set by Continental's Type 510R-1, one of the world's most popular FM exciters.

The 802A is completely solid-state. All subassemblies are modularized and fully accessible from the front. All components of the 802A have been selected with proven reliability as well as electrical suitability as a prerequisite. The 802A FM Exciter is fully equipped to accept the composite baseband signal from any fine quality stereo generator, and STL system, or monaural audio and SCA programming.

Refined Linearity

Modulation linearity of the 802A Exciter is exceptional. Measurements of distortion and noise indicate performance that approaches the measurement capability of some of the most advanced test equipment. Continental's 802A is designed to provide outstanding performance under any condition within its specified operating environment.

Digital Frequency Selection

The 802A FM Exciter generates its operating frequency with a digitally programmed, dual speed, phase-locked frequency synthesis system. Internal programming switches provide instant selection of any one of 2200 channels in increments of 10 kHz: from 87 MHz to 109 MHz. A highly stable, temperature-compensated, crystal master oscillator operating at 10 MHz provides carrier frequency stability and accuracy of ± 250 Hz at all environmental and line voltage conditions. An oscillator giving a carrier frequency stability of 100 Hz is available as an extra cost option for specialized applications.

50 Watts Output Broadband Amplifier

The 802A Exciter is completely solid state and is entirely broadband. It requires no tuning adjustments other than the digital selection of the operating frequency. Power output of the 802A Exciter is conservatively rated at 50 watts into a 50 ohm load at all frequencies in the FM band. With any 2:1 VSWR 50 ohm load, the maximum power output will exceed 40 watts.

Automatic Power Control

Automatic output power level control maintains the output at any pre-set level from 5 watts up to the maximum level. A strip line directional coupler is incorporated into the power amplifier subassembly, and a meter on the front panel shows both forward and reflected power. A special circuit protects the amplifier from any mismatched load, including open or short circuits.

Sophisticated Styling

Front panel readouts present a clear and accurate indication of system performance while preserving an uncluttered and tasteful appearance. A digital LED display indicates the true peak level of the modulating signal in 5% increments, with an accuracy of better than $\pm 2\%$ over the entire modula-

tion bandwidth. An analog meter gives indications of forward and reflected rf power output, and a digital meter with associated push button switches displays accurate and unambiguous measurements of the amplifier current and operating voltages of the exciter. Individual LEDs indicate conditions of VCO lock, over modulation, VSWR, cooling status, and input power. BNC connectors located on the front panel provide a sample of several of the rf and modulating signals at levels suitable for signal analysis.

Modular Construction

Because of its modular design and construction, any subassembly within the exciter can be removed without disturbing other components or assemblies. All exciter subassemblies can be reached and extracted without disconnecting the exciter from the transmitter. The entire exciter is slide-mounted for easy subassembly access, even with the system in full operation. For bench servicing, the exciter can be quickly and easily removed by disconnecting the few electrical connections and uncoupling the slides.

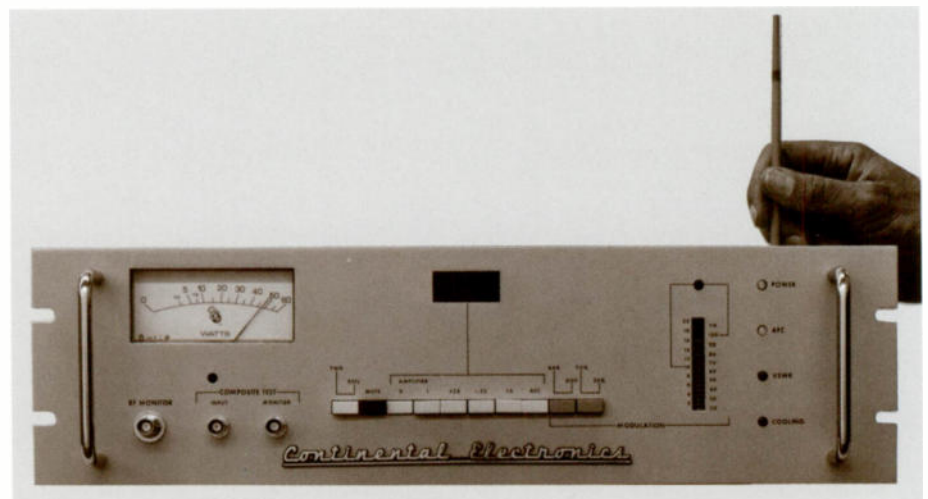

Exciter power output can be adjusted without removing its cover.

Frequency Response and Transient Characteristics

Square wave modulation of the Type 802A Exciter shows its outstanding frequency response and transient characteristics.

A comparison between the modulating square wave and recovered modulation from a Modulation Analyzer shows no significant differences, indicating a virtually transparent exciter.

Upper trace, modulating signal.

Lower trace, recovered modulation.

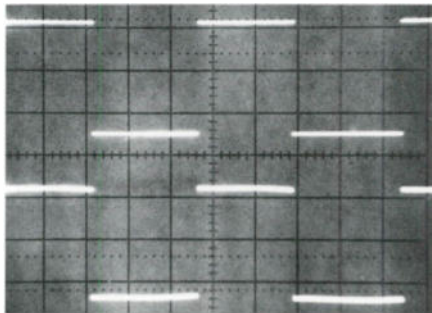

10 Hz

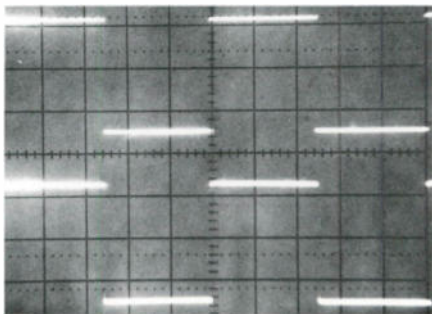

100 Hz

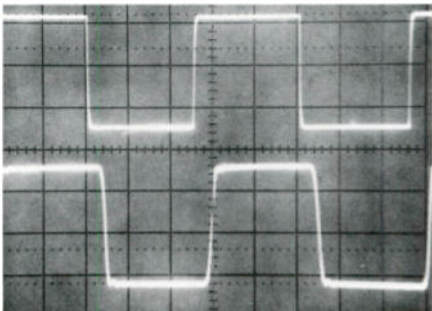

10kHz

Intermodulation Distortion and Crosstalk

Spectrum analyzer displays, with Type 802A Exciter being modulated by Stereo signals, show that Intermodulation Distortion and Cross Talk have been reduced below the level of any practical significance.

Modulation capability of the exciter is beyond the ± 75 kHz to accommodate foreseeable composite signal requirements. Supplemental data are available that describes Monophonic, Stereophonic and Multi-channel SCA performance with several stereo generators and SCA monitors.

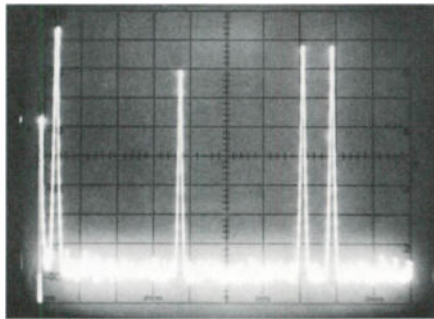

Stereo at 100% modulation: 2.0 kHz in left channel; pilot at 9% of 75 kHz deviation. Full scale equals 75 kHz deviation, 10 dB per division.

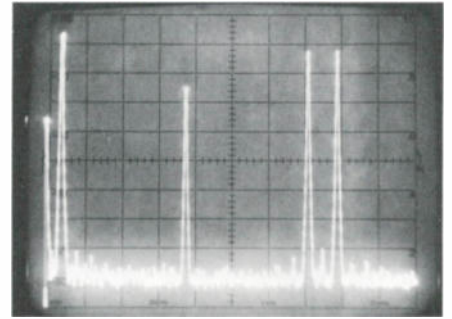

Stereo at 150% modulation: 2.0 kHz in left channel; pilot at 9% of 75 kHz deviation. Full scale equals 112.5 kHz deviation, 10 dB per division.

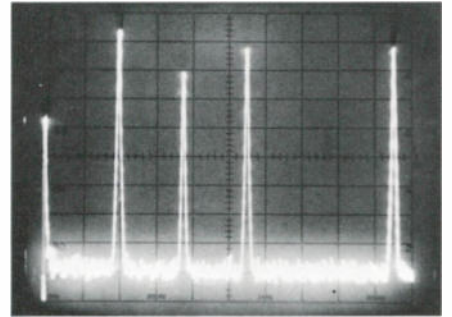

Stereo at 100% modulation: 10 kHz in left channel; pilot at 9% of 75 kHz deviation. Full scale equals 75 kHz deviation, 10 dB per division.

Typical Performance of the Type 802A FM Exciter with Stereophonic and SCA Signals*

*Performance characteristics were recorded using a variety of available, high-quality stereophonic and SCA generators. Please contact Continental Electronics Mfg. Co. if you would like to discuss the performance using specific equipment.

Monaural Operation Performance

Input level:

+ 10 dBm \pm 3 dB for \pm 75 kHz deviation

Input impedance:

600 ohms, balanced with a return loss of 30 dB or better

Frequency response:

\pm 0.5 dB or less deviation from a 75 microsecond pre-emphasis (typical 0.25 dB); 25 and 50 microsecond pre-emphasis available

Total harmonic distortion:

not more than 0.08%, 20 Hz to 15 kHz at 100% modulation (typical: 0.02%)

Intermodulation distortion:

not more than 0.08% for 60 Hz to 17 kHz, 4:1 ratio at 100% modulation (typical: 0.015%)

FM s/n ratio:

78 dB minimum, below \pm 75 kHz deviation; 50 Hz to 15 kHz bandwidth (typical: 82 dB, 50 Hz to 15 kHz bandwidth; 80 dB, 20 Hz to 15 kHz bandwidth)

Wideband Operation Performance

Composite input level:

$1.25 V_{RMS}$ ($3.54 V_{p-p}$) \pm 3 dB for \pm 75 kHz deviation

Composite input impedance:

5000 ohms, balanced or unbalanced (via floating BNC connector)

SCA input level:

$1.25 V_{RMS}$ ($3.54 V_{p-p}$) \pm 3 dB for \pm 7.5 kHz deviation (two inputs)

Frequency response:

\pm 0.1 dB, 20 Hz to 100 kHz (typical: \pm 0.05 dB)

Total harmonic distortion:

not more than 0.08%, 20 Hz to 100 kHz at 100% modulation (typical: 0.02%)

Intermodulation distortion:

not more than 0.08%, 60 Hz to 17 kHz, 4:1 ratio at 100% modulation (typical: .015%, with two tone signals in the frequency range of 60 Hz to 100 kHz; at a 1:1 ratio, IM products are typically not greater than 0.004%)

Transient intermodulation distortion:

not more than 0.1%, as measured with a 3.18 kHz square wave and a 15 kHz sine wave at 100% modulation (typical: 0.02%)

Stereo FM and SCA Performance with External Generators

Stereo channel separation:

at least 48 dB, 50 Hz to 15 kHz (typical: 55 dB or better)

Stereo crosstalk:

at least 55 dB below either single channel level; main-to-subcarrier, subcarrier-to-main (typical: 65 dB)

Stereo frequency response:

\pm 0.25 dB, 20 Hz to 15 kHz (typical: \pm 0.1 dB)

Stereo total harmonic distortion:

not more than 0.08%, 20 Hz to 15 kHz at 100% modulation (typical: 0.02%)

Stereo intermodulation distortion:

not more than 0.08%, 60 Hz to 17 kHz, 4:1 ratio at 100% modulation (typical: 0.015%)

SCA crosstalk into stereo subchannel:

typically not more than 65 dB below 90% modulation of main channel, with 67 kHz SCA at 10% modulation; at 92 kHz, SCA crosstalk typically improves to 75 dB with a 5 kHz tone modulating SCA channel to \pm 4 kHz

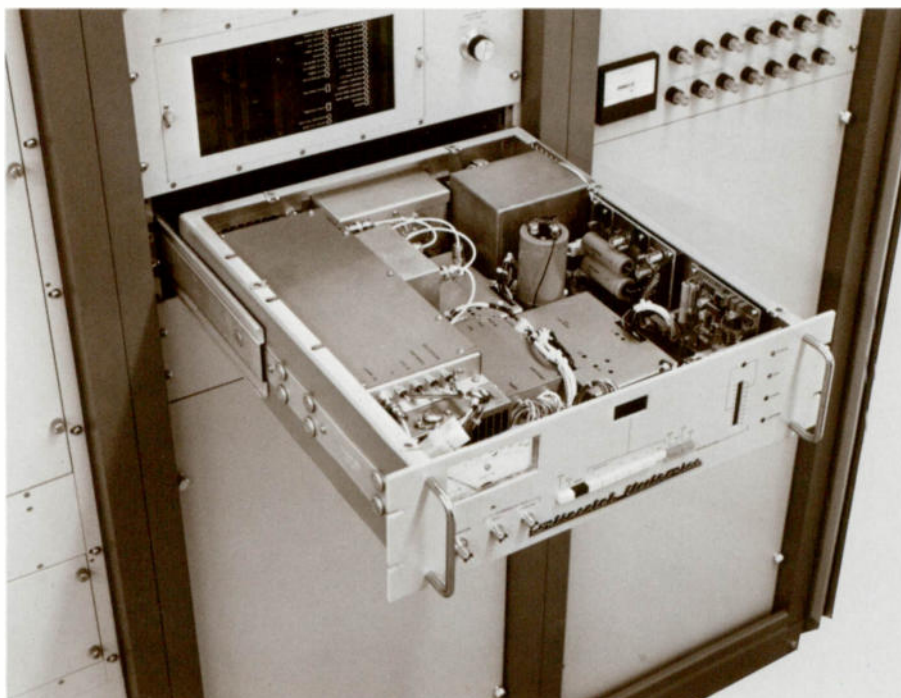

All exciter components are easily reached from the front of the transmitter. Exciter moves on tracks for easy access; shown here with top cover removed.

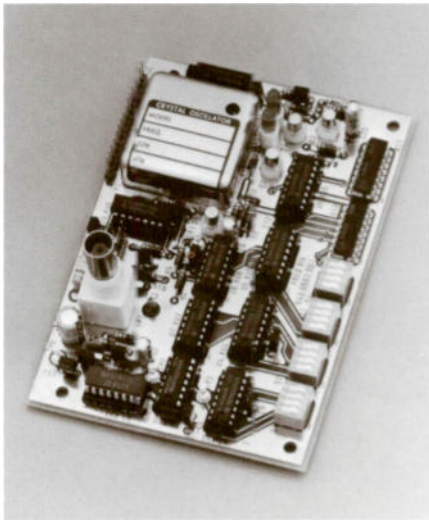

Frequency divider module

This board contains the 10 MHz frequency standard, the various frequency dividers of the frequency synthesizer, and the BCD coded DIP switches for selecting operating frequency. Frequency selection is made by a direct BCD code: no frequency off-sets are involved in the coding. LED indicators on the board show operational status of the frequency standard, and the modulated oscillator.

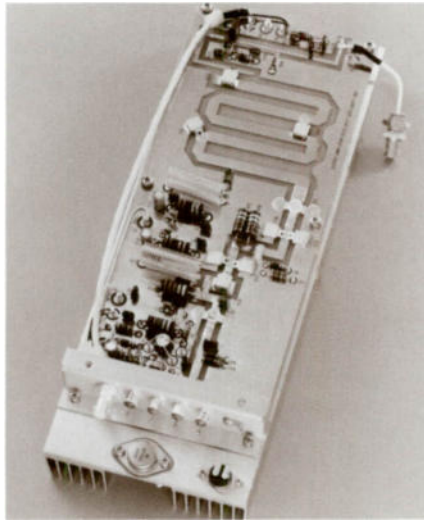

Output amplifier module

The output amplifier is a three stage, strip line, broadband amplifier with 50 watts output power capability. There are no tuning controls. The amplifier is mounted on a large, forced air cooled heat sink to assure maximum reliability. RF power output is regulated by a series pass transistor which is also mounted on the heat sink. Directional couplers are built into the amplifier circuit board to give indications of forward and reflected power; these couplers also provide automatic power level control and protection from high VSWR loads.

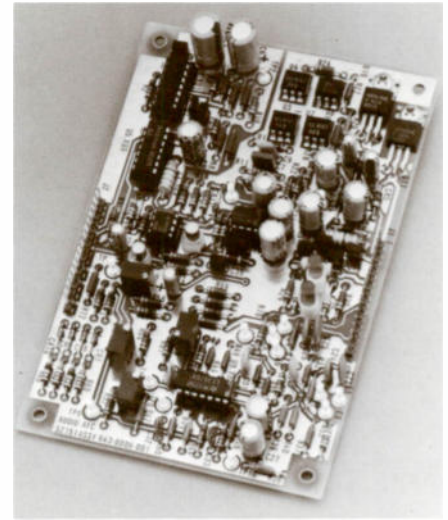

Audio/AFC circuit module

This board contains all of the baseband amplification and signal-shaping circuits: the frequency synthesizer phase comparator, loop filter, phase lock detector, modulated oscillator bias circuits, and the voltage regulators for these circuits. The board has multi-turn potentiometers for adjusting modulation level and for optimizing signal-shaping circuits to help achieve the highest program quality possible.

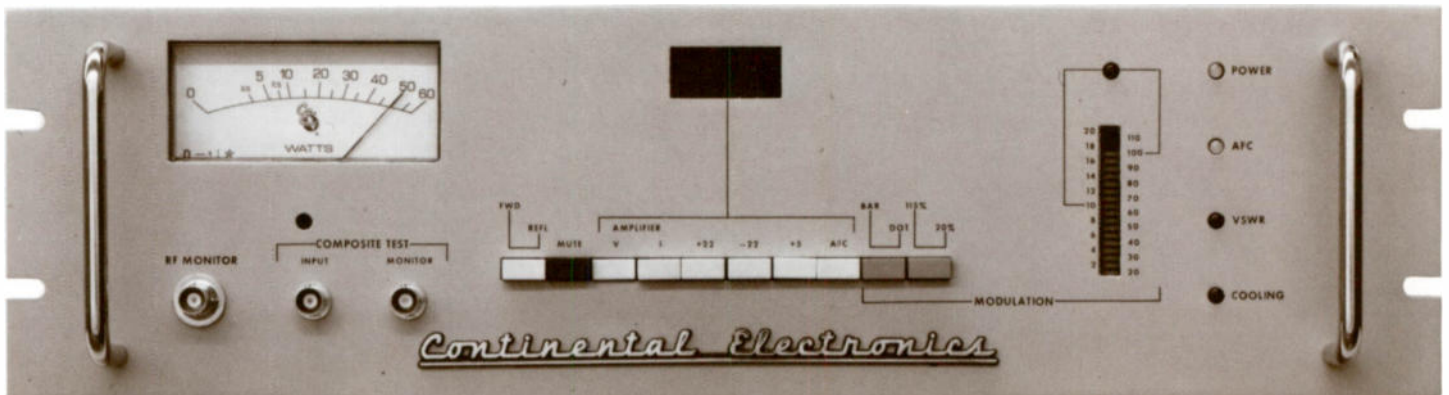

Front view, Type 802A FM Exciter

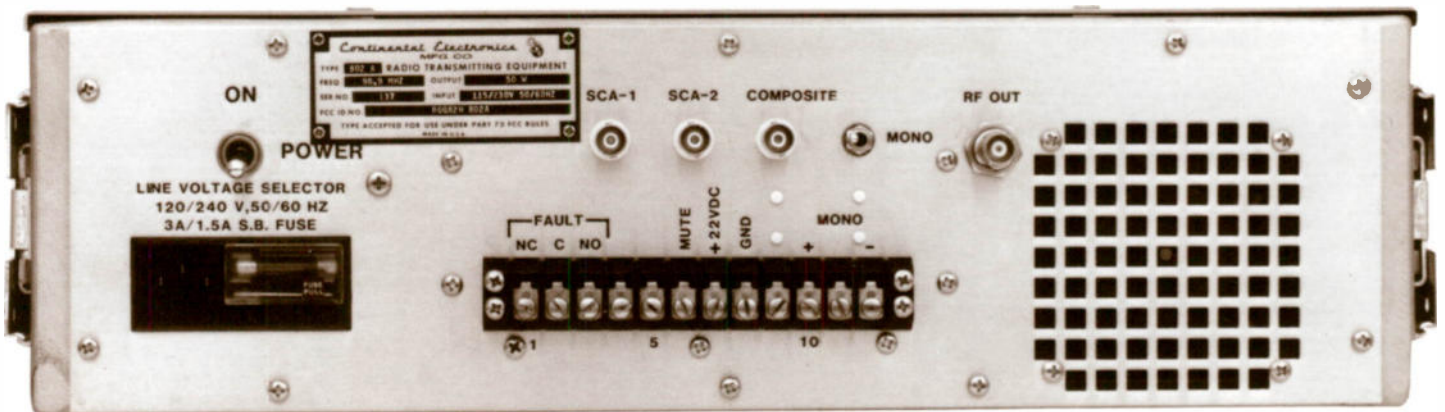

Rear view, Type 802A FM Exciter

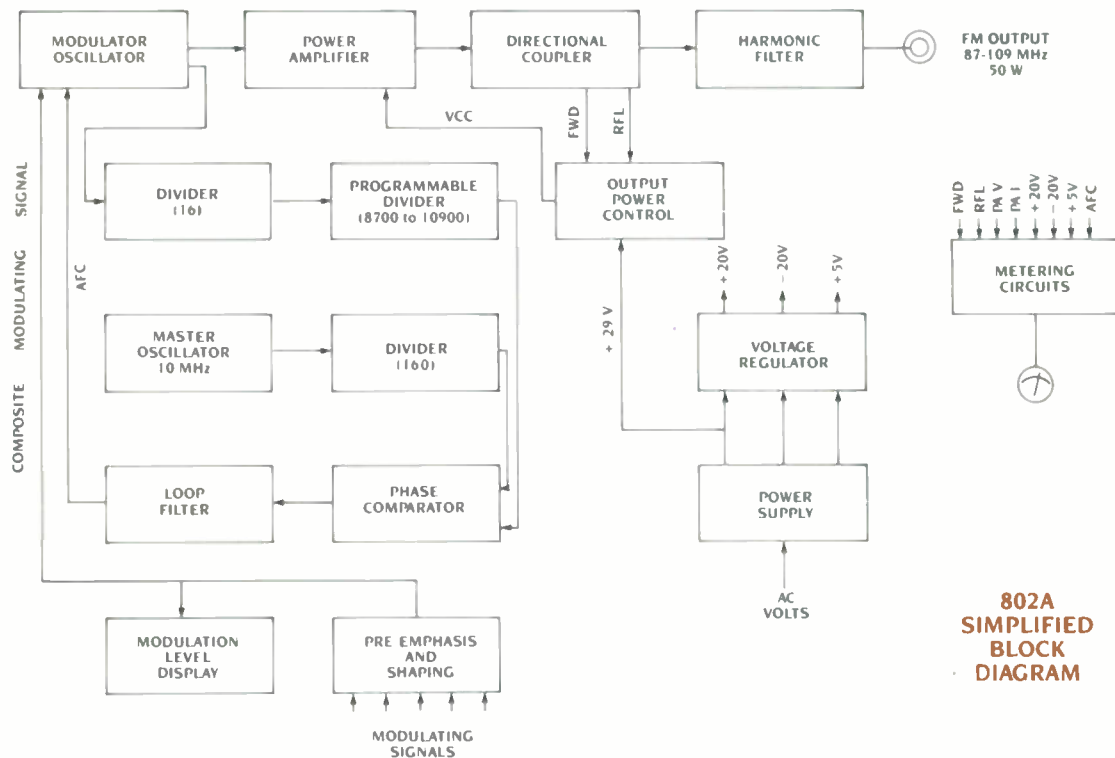

**802A
SIMPLIFIED
BLOCK
DIAGRAM**

**SPECIFICATIONS,
TYPE 802A FM EXCITER
(FCC ID # BQQ-82H802A)**

Size and Weight:

17½ in. wide (444.5 mm), centered in a 19 in. wide (482.6 mm) rack-mounting panel; 5¼ in. high (133.35 mm); 22 in. deep (558.8 mm); approx 31.5 lbs (14.3 kg)

Input power:

115v or 230v ± 10%; 50/60 Hz ± 5%; single phase, 200 w max.

Temperature range:

-20°C to +55°C (-4°F to +131°F)

Altitude range:

0 to 4600 M (0 to 15,100 ft.)

Relative Humidity Range:

0 to 95%

Power Output:

5 to 50 w, continuously adjustable

RF Harmonic and Spurious:

60 dB or more below rated output

Frequency Range:

87 to 109 MHz in 10 kHz steps

Frequency Control:

PLL Frequency Synthesis from high stability master oscillator

Frequency Stability:

±250 Hz, -20°C to +55°C (-4°F to +131°F)

Modulation Type:

Direct carrier frequency modulation

Modulation Indication:

Peak reading LED display with overmodulation indicator

Asynchronous AM S/N:

73 dB minimum, relative to carrier level

Synchronous AM S/N:

65 dB minimum, relative to carrier level

WIDEBAND OPERATION

Composite Inputs:

Balanced, unbalanced and test

Composite Input Impedance:

5 k ohms, nominal

Composite Input Level:

1.25V RMS (3.54 volts peak to peak) for ±75 kHz deviation

Composite Amplitude Response:

±0.1 dB, 20 Hz to 100 kHz

Composite Phase Response:

±0.5°, 20 Hz to 75 kHz

Composite Group Delay:

390 ns ± 25 ns, 20 Hz to 75 kHz

Composite Total Harmonic Distortion:

0.08% maximum;

Composite Intermodulation Distortion:

0.08% maximum; 60 Hz/7 kHz, 4:1 ratio

Composite Transient IMD:

0.1% maximum

Composite FM S/N Ratio:

78 dB minimum below ±75 kHz deviation

SCA Inputs:

Balanced and unbalanced

SCA Input Impedance:

50,000 ohms, nominal

SCA Input Level:

1.25 V RMS for ±7.5 kHz deviation

SCA Amplitude Response

±0.3 dB, 40 kHz to 100 kHz

MONAURAL OPERATION

Audio Input Impedance:

600 ohms, balanced

Audio Input Return Loss:

30 dB or better

Audio Input Level:

±10 dBm (6.93 volts peak to peak @ 600 ohms) for ±75 kHz deviation

Audio Frequency Response:

±0.5 dB; flat, 25, 50 or 75 usec pre-emphasis 20 Hz to 15 kHz

Total Harmonic Distortion:

0.08% maximum; 20 Hz to 15 kHz

Intermodulation Distortion:

0.08% maximum; 60 Hz/7 kHz, 4:1 ratio

Transient IMD:

0.1% maximum

FM S/N Ratio:

78 dB minimum below ±75 kHz deviation

All specifications are subject to change without notice.
© 1984 Continental Electronics Mfg. Co./5465 3M284

Continental Electronics

Continental Electronics Mfg. Co. Box 270879 Dallas, Texas 75227 (214) 381-7161



How's this for a guarantee?

**0.5% IM distortion in stereo
...half that in mono.**



Get it with Collins' Phase 4 Exciter.

Here's the end to ho-hum sound — to humdrum transmitter performance. Collins' new Phase 4 Exciter, heart of the new Generation 4 Transmitter line, improves the performance of any FM transmitter. It produces such a clean sound that Collins guarantees specification on IM distortion of only 0.5% in stereo and half that in mono.

That's why you'll get crisp, sparkling sound for all your programming — sound that stands out in any market place.

For further information about Collins' new line of Generation 4 FM Transmitters featuring the Phase 4 Exciter, see the specifications below or contact D. A. Senter, Marketing Manager, Broadcast Products, Collins Radio Group, Rockwell International, Dallas, Texas 75207. Phone: (214) 690-5574.

IM Distortion: 0.25% max Mono; 0.5% max Stereo
Output Impedance: 50 Ohm, VSWR 2:1 maximum
Frequency Range: 88-108 MHz
Frequency Stability: ± 500 Hz
Modulation Capability: ± 100 kHz
Audio Input Level: 10 dBm ± 2 dB
Audio Frequency Response: ± 1 dB of preemphasis curve
Audio Frequency Distortion: 0.25% max mono; 0.5% max stereo
Stereo Separation: 50 Hz to 15,000 Hz 35 dB minimum reaching 50 dB at mid range
Harmonic Attenuation: Exceeds FCC requirements
FM Noise Level: 65 dB below 100% modulation
AM Noise Level: -55 dB rms
Permissible Line Voltage Variation: $\pm 5\%$



Rockwell International

**COLLINS BROADCAST DIVISION
DOMESTIC SALES OFFICES**

DISTRICT 1

A. A. (Art) Silver

Box 223
Titusville, N.J. 08560
Telephone: 609-737-3691

Connecticut, Maine, Massachusetts,
New Jersey, New Hampshire, New York,
Rhode Island, Vermont

DISTRICT 2

C. M. (Clarence) Beverage

10104-M Woodlake Drive
Cockeysville, Md. 21030
Telephone: 301-666-7059

Delaware, Maryland, Pennsylvania,
Virginia (No. Half), West Virginia,
Ohio (Eastern Half)

DISTRICT 3

R. C. (Ray) Evans

Rt. #2, Box 12, Glenmore Drive
Rockford, Tennessee 37853
Telephone: 615-573-9717

Kentucky, North Carolina, Tennessee,
and Virginia (Southern Half)

DISTRICT 4

R. J. (Jerrell) Henry

14018 W. Parsley Drive
Madeira Beach, Florida 33708
Telephone: 813-391-8065

Florida, Georgia, South Carolina

DISTRICT 5

D. W. (Dave) Hill

38780 Hartwell
Sterling Heights, Mich. 48077
Telephone: 313-979-6320

Illinois, Indiana, Michigan and
Western Ohio

DISTRICT 6

W. J. (Bill) Monroe

8427 Ridgemont Drive
Pineville, Louisiana 71360
Telephone: 318-640-3412

Alabama, Louisiana, Mississippi,
and Arkansas

DISTRICT 7

J. L. (Jim) Littlejohn

200C West Branch Road
Maple Plain, Minnesota 55359
Telephone: 612-479-2633

Iowa, Michigan (North & West of Lake
Michigan), Minnesota, Montana, Nebraska
Wisconsin, North and South Dakota

DISTRICT 8

J. C. (John) Shideler

Route #1, Box 217-B
Oak Grove, Missouri 64075
Telephone: 816-229-1441

Colorado, Kansas, Missouri,
Wyoming and Oklahoma

DISTRICT 9

W. R. (Terry) Sheffield

Collins Radio Group
Rockwell International
1200 No. Alma Rd., Richardson, Tex. 75080
Telephone: 214-690-5424; 214-259-1440

Texas

DISTRICT 10

Morris (Court) Courtright

1450 W. Arroyo Dr., Yuma, Ariz. 85364
Telephone: 602-783-6380

Arizona, Southern California (South of
Fresno), New Mexico and Utah

DISTRICT 11

T. T. (Tom) Cauthers

1122 N.E. 122nd Ave., Rm B-211
Portland, Oregon 97230
Telephone: 503-254-2818

California (North of Fresno), Idaho,
Nevada, Oregon, Washington

DISTRICT 12

R. F. (Ron) Cassidy

P. O. Box 2743
Fairbanks, Alaska 99707

Alaska

CANADA

Toronto

Applied Electronics, Ltd.
299 Evans Ave.
Toronto, Ontario M8Z 1K2
416-252-3761

Montreal

Telvicom Ltee.
822 Halpern Ave.
Dorval, Quebec
514-631-9089

Calgary

Applied Electronics, Ltd.
Bay No. 1, 4519 12th St., N.E.
Calgary, Alberta
403-277-8600



Rockwell International

Type 314DL-1, 1,000 watt Dummy Load
Type 516DL-1, 5,000/10,000 watt Dummy Load
Type 517C-2, 50,000 watt Dummy Load

AM

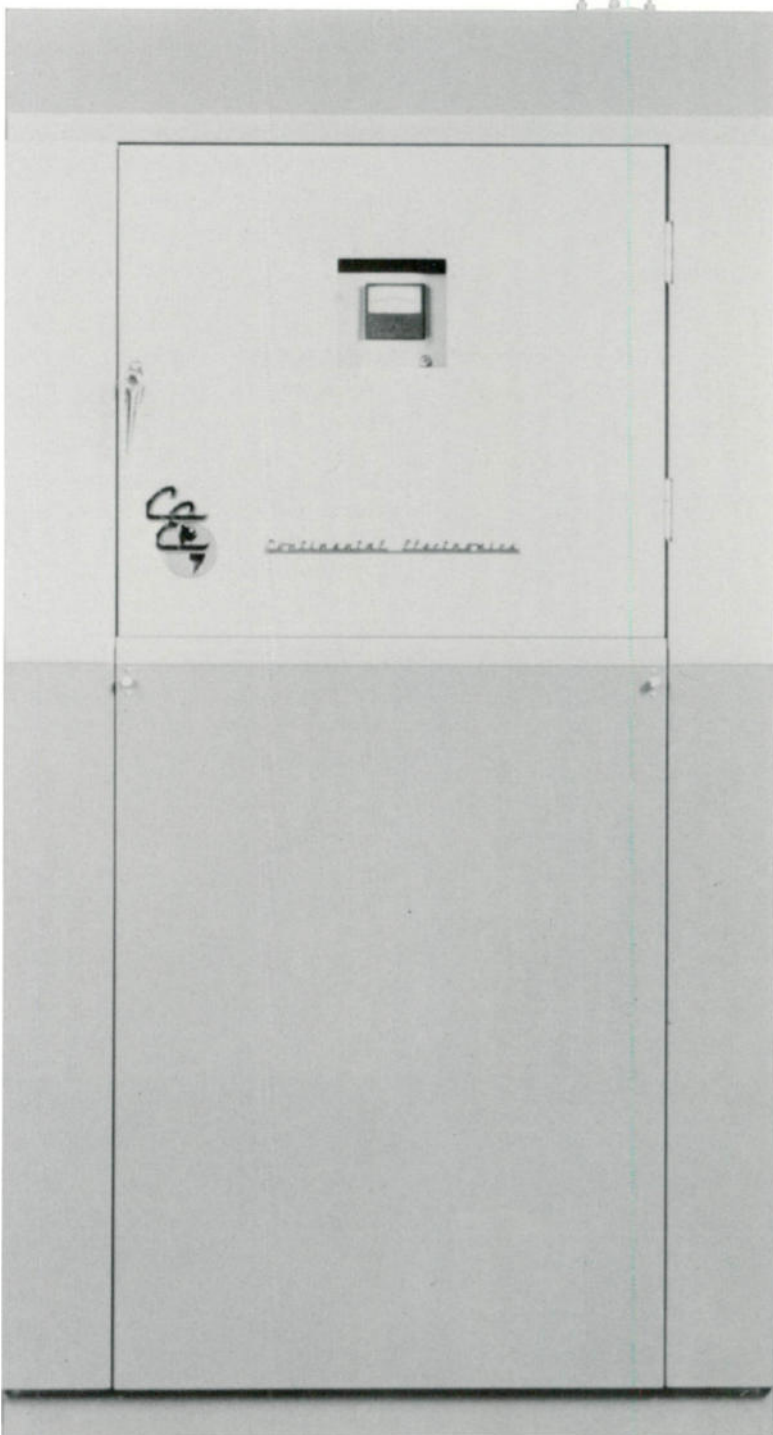

Type 517C-2
50,000 watt Dummy Load

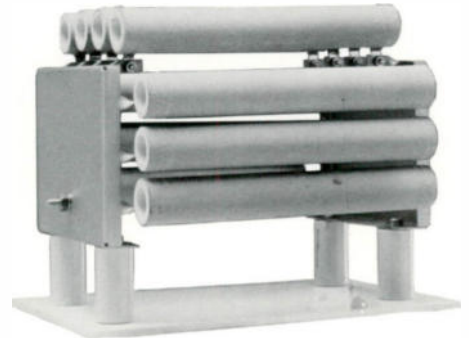

Type 314DL-1
1,000 watt Dummy Load

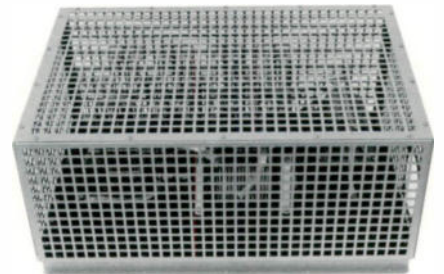

Type 516DL-1
5,000/10,000 watt Dummy Load

**Type 314DL-1,
1,000 watt Dummy Load**

Continental's 314DL-1 is a convection air cooled dummy load that will handle a 1,000 watt transmitter at 125% modulation. It is supplied with 50 ohms resistance and with stud connection.

Size: 10" wide, 12" long, 9" high
Weight: 12 lbs.

**Type 516DL-1,
5,000/10,000 watt Dummy Load**

Continental's 516DL-1 is a convection air cooled dummy load that will handle a 5,000 or 10,000 watt transmitter at 125% modulation. It is supplied as an essentially flat load, including "L" network, on the customer's frequency and impedance in the standard medium wave broadcast band. A Delta TCA ammeter and 1 $\frac{5}{8}$ " EIA termination are optional. Coil and capacitor sizes vary with frequency and impedance.

Size: 40" wide, 12" high, 26" deep
Weight: 60 lbs.

**Type 517C-2,
50,000 watt Dummy Load**

Continental's 517C-2 is an air-cooled rf dummy load designed for continuous and reliable operation over the frequency range of 535 to 1620 kHz. The "L" network is adjusted at the factory.

The load is designed for use with 50,000 watt AM broadcast transmitters, to provide a load for the rf power amplifier for testing purposes, or when it is not desirable to radiate rf output. The load will handle a 50,000 watt AM transmitter at 125% modulation.

The dummy load is housed in a single cabinet having excellent shielding properties while providing easy access.

A Delta TCD ammeter is used to determine power, and it can be viewed thru a glass panel in the front door. An air-flow interlock switch shuts-off transmitter plate voltage if dummy load or transmitter doors are opened, or if there is a loss of air pressure in the dummy load or transmitter cooling systems.

RF connections: A 3 $\frac{1}{8}$ " EIA. termination is furnished.

Size: 42" wide, 78" high, 40" deep.
Weight: 950 lbs.

Printed in USA IM385/5852

P/N 142289 Envelope Demodulator
P/N 142340 Automatic Power Controller
P/N 142288 Battery Power Supply
P/N 142407 Magniphase Totalizer

AM



P/N 142289 Envelope Demodulator

Continental's Envelope Demodulator removes the rf from transmitter sample and provides for an accurate audio signal for measuring distortion and audio. RF input is routed back thru a rear BNC connector. Designed for use with Continental Type 317C 50,000 and 361F 10,000 watt AM transmitters, the unit can be adapted for other transmitters.

Technical Characteristics

Power required: 100-130 vac, 0.25 a,
50/60 Hz RF input level required: 70 v
max, peak-to-peak, unmodulated
Audio monitor output: AC coupled
Distortion measurement: BNC con-
nector, front panel
Size: 19" wide, 2" high, 6" deep,
18 lbs.

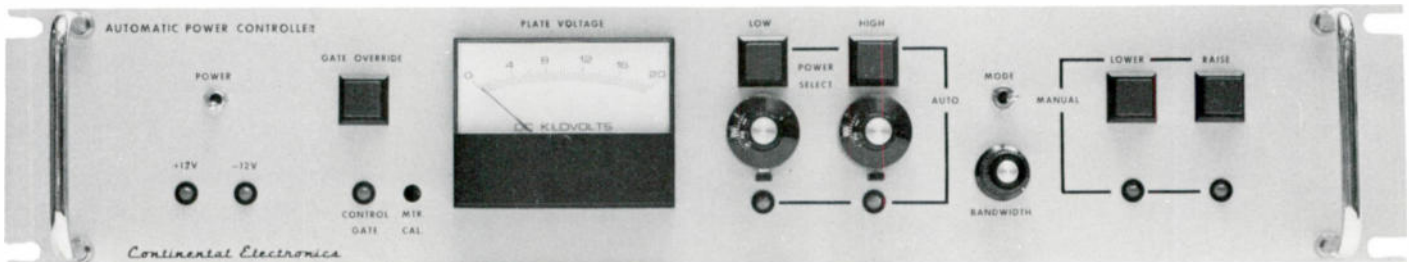

P/N 142340 Automatic Power Controller

Continental's Automatic Power Controller corrects for line voltage changes by automatically raising or lowering power amplifier plate and screen voltage, using variable transformers already in the transmitter. Circuit sensitivity is adjustable so that plate voltage variations due to modulation will not cause a continual "hunting" condition. Designed for use with Continental's 317C 50,000 watt AM transmitters.

Technical characteristics

Power required: 100-130 vac,
50/60 Hz
Size: 19" wide, 3½" high, 8" deep,
16 lbs.



**P/N 142288
Battery Power Supply**

Continental's rechargeable 12-volt Battery Power Supply provides low voltage for controlling relays, interlocks and overload status lights of a broadcast transmitter in the event of a main power loss. It's designed for use with Continental's 317C-2 50,000 watt AM transmitters.

Technical characteristics

Battery: 12 vdc, Ampere/hours 4.5,
Charging rate 0 to 2.0 amperes
Charger: 12 vdc, Fast charges @ 2.0
amperes, Trickle charge @ 0.5 amperes,
Charger power requirements:
100-130 vac, 50/60 Hz
Size: 19" wide, 4" high, 7" deep, Lbs.

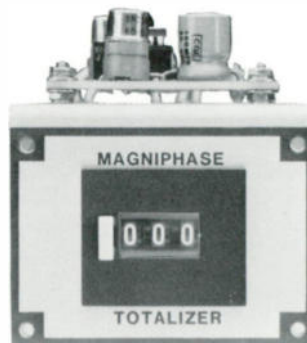

**P/N 142407
Magniphase Totalizer**

Continental's Magniphase Totalizer automatically records Magniphase trips; has resetable counter. Designed for use on Continental Type 317C 50,000 and 316F 10,000 watt AM transmitters, unit mounts on transmitter front; can be adapted to other transmitters using Magniphase.

Technical characteristics

Power required: 100-130 vac,
50/60 Hz
Size: 2 1/4" wide, 2 1/2" high, 3 1/2" deep,
1 lb.

Printed in USA IM385/5851

Continental Electronics

Continental Electronics Mfg Co Box 270879 Dallas, Texas 75227 (214) 381-7161



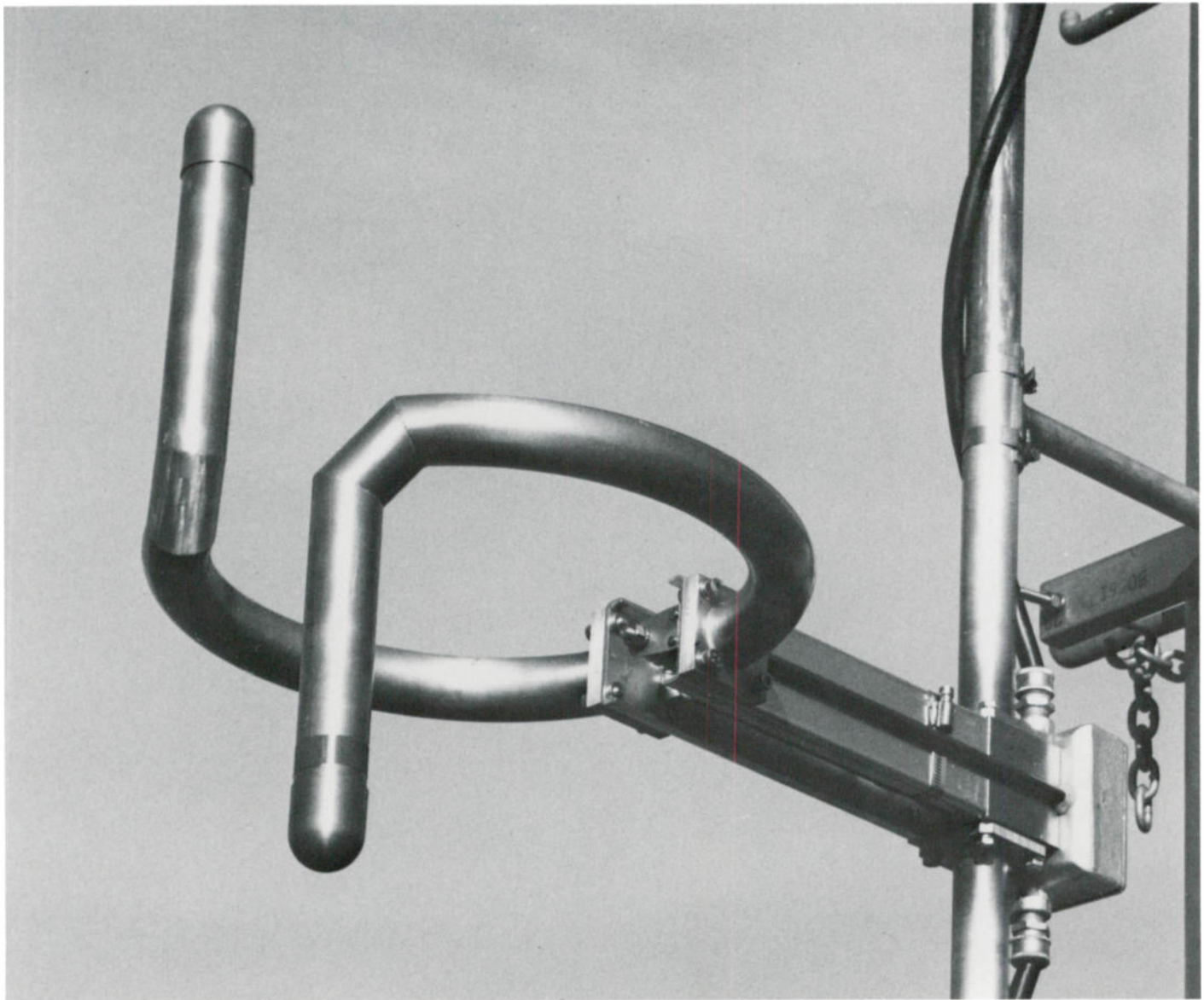

The G4CPL series of circularly polarized FM antennas meets the requirements of virtually all Class "A" licensed stations. This is an end-fed antenna having a maximum input power of 7.5 KW and power gains ranging from 0.46 for one bay up to 4.48 for the 8-bay model. A single bay of G4CPL for one bay does have an input power limitation of 3 KW. Power gains, weights and windloads are shown in the chart on the opposite side of this brochure.

A d.c. short which puts the antenna at ground potential for added protection against lightning damage to the transmitter and transmission

line is an integral part of the G4CPL design. Beam tilt and null fill are not available with the G4CPL series and no power splits other than 50/50 are offered with these antennas.

If the G4CPL is to be used where icing conditions can occur, either factory installed deicers or radomes are recommended.

A 6-foot matching transformer extends below the bottom bay of the antenna and terminates in a 1^{5/8}" EIA input flange.

The use of only brass, copper and stainless steel in the construction of the G4CPL antenna assures long

term service and freedom from the maintenance problems suffered by some antennas as a result of weather conditions.

SPECIFICATIONS

Frequency Range: 88 to 108 MHz.

Polarization: Circular (Clockwise)

Power Gain: See tables

Azimuthal Pattern: ± 2 dB in free space, both horizontal and vertical

Ellipticity: ± 3 dB in free space

WSWR at Input (without field tuning) 1.1:1 top pole mounting; 1.5:1 or better side mounting.

VSWR at input (with field tuning) 1.1:1 or better

Type	Power Gain		dB Gain		Field Gain		Input Power Rating kW	Approx. Length (m) ft	Weight (Including Brackets) (kg) ft	Wind Load Based on 244/161	Weight (With Radomes Incl. Brackets)	Wind Load With Radomes Based on 244/161
	Horiz	Vert	Horiz	Vert	Horiz	Vert				kg/sq.m (50/33 lb/sq ft)	(kg) ft	(kg) ft
G4CPL-1	0.4611	0.4611	-3.3623	-3.3623	0.6790	0.6790	3	—	(16) 36	(34) 74	(24) 54	(73) 161
G4CPL-2	0.9971	0.9971	-0.0128	-0.0128	0.9985	0.9985	6	(3) 10	(35) 77	(47) 104	(52) 115	(153) 338
G4CPL-3	1.5588	1.5588	1.9278	1.9278	1.2485	1.2485	7.5	(6) 20	(54) 118	(115) 254	(78) 172	(234) 515
G4CPL-4	2.1332	2.1332	3.2903	3.2903	1.4605	1.4605	7.5	(10) 30	(72) 159	(156) 344	(105) 231	(314) 693
G4CPL-5	2.7154	2.7154	4.3384	4.3384	1.6478	1.6478	7.5	(12) 40	(91) 200	(197) 434	(132) 290	(385) 870
G4CPL-6	3.3028	3.3028	5.1888	5.1888	1.8174	1.8174	7.5	(15) 50	(109) 241	(238) 524	(158) 349	(475) 1047
G4CPL-7	3.8935	3.8935	5.9034	5.9034	1.9732	1.9732	7.5	(18) 60	(128) 282	(279) 614	(185) 408	(555) 1224
G4CPL-8	4.4872	4.4872	6.5197	6.5197	2.1183	2.1183	7.5	(21) 70	(147) 323	(319) 704	(212) 467	(636) 1402

All antenna brackets are stainless steel. All weights given include brackets, interbay line, and transformer section. Factory-installed deicers are available using either 300 watts or 500 watts per bay. Specify 120 or 230 volts. Heater elements are replaceable in the field. Shielded interbay heater cable and junction boxes are supplied. Heater weight, including junction boxes and interbay cable, is 6 lb (2.7 kg) additional per bay.

1M385/5938

Continental Electronics

Continental Electronics Mfg Co Box 270879 Dallas, Texas 75227 (214) 381-7161



CONTINENTAL'S G-6 SERIES FM ANTENNA

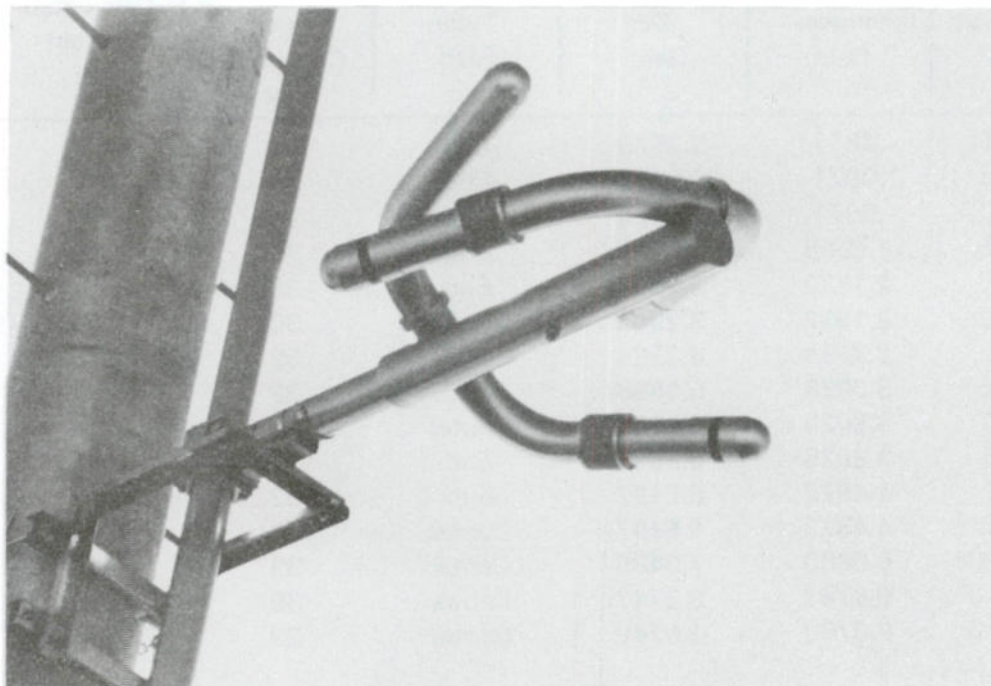

TYPE G-6 FM SIDEMOUNT ANTENNA

- * All stainless steel hardware
- * D.C. grounded input
- * Pressurized internal feed system
- * Heliarc'd rigid brass construction

BANDWIDTH WITH FIELD TUNING:

VSWR 1.07:1 for $f_0 \pm 100$ KHz

VSWR 1.15:1 for $f_0 \pm 200$ KHz

Circularity

Free space horizontal plane patterns in horizontal and vertical polarization are circular to better than + 2 db.

Free space axial ratio better than + 3 db.

Due to the design of the internal feed and the element geometry, the Series 200 ant-

ennas offer exceptional axial ratio and free space pattern circularity. This is especially important when fringe area coverage is important to the broadcaster..

Optional antenna pattern measurement service is available for the G-6 antenna. We offer pattern measurements as well as pattern optimization. Quotations for these services are available upon request.



Continental Electronics

a Division of Varian Associates, Inc.

P.O. BOX 270879 DALLAS, TEXAS 75227 (214) 381-7161
CABLE ADDRESS: CONTRONICS TELEX ADDRESS: 72-398



varian

Z1-20(1)

PRELIMINARY SPECIFICATIONS FOR THE G-6 FM ANTENNA

Antenna Type	Power Gain	DB Gain	Type Feed	Power. Input Capability (kw)	Calculated Weight (lbs)	Calculated Windload* (lbs)
G6-1AE	.4611	-3.3623	End	10	108	176.4
G6-2AE	.9971	-0.0128	End	20	225	382.5
G6-2AC	.9971	-0.0128	Center	20	243	405.7
G6-3AE	1.5588	1.9278	End	20	342	588.6
G6-4AE	2.1332	3.2903	End	30	459	794.7
G6-4AC	2.1332	3.2903	Center	30	477	817.9
G6-5AE	2.7154	4.3384	End	32	576	1000.8
G6-6AE	3.3028	5.1888	End	32	693	1206.9
G6-6AC	3.3028	5.1888	Center	39	711	1230.1
G6-7AE	3.8935	5.9034	End	32	810	1413.0
G6-8AE	4.4872	6.5197	End	32	927	1619.1
G6-8AC	4.4872	6.5197	Center	39	945	1642.3
G6-10AC	5.6800	7.5435	Center	39	1179	2054.5
G6-12AC	6.8781	8.3747	Center	39	1413	2466.7
G6-14AC	8.0798	9.0740	Center	39	1647	2878.9

*Windload calculated based on 50/33 psf, 112 mph actual wind velocity. — No ice.

Power input capability up to 2,000 ft above mean sea level. Derating required above 2,000 ft.

Note: All antenna systems have 50 ohm female inputs.

Weight and windload calculations include brackets.

Radiating element is of brass construction and has a 3-1/8" outside diameter. The feed system is completely internal within a pressurized environment. Each element has an internal D.C. short so a quarterwave stub is not necessary.

Antenna models: Two versions of 200 type antenna system are available. The "E" version which is end fed model and the "C" version which is centerfed. Both versions have 3-1/8 inch 50 ohm, EIA standard female flanged input connections.

Each antenna system is completely assembled, tuned to the customers frequency and pressure tested at the factory to assure proper operation of the system at the time of installation.

Deicers are available as an accessory which must be installed at the factory at an additional cost and must be specified at the time the order is placed.

Anti-rotation brackets are recommended for leg mounted systems on towers with less than 3" o.d. legs.

Specifications subject to change without notice.



The advantages and benefits of a Super Power Antenna in a new Medium-Power size.

The Continental G5CPM Series of Medium Power Circularly Polarized FM Antennas

- A New Standard of Excellence and Reliability
- A New Standard of Performance and Longevity
- Capable of Normal Operation Without Deicers — Even with 12.7 -mm (½-in) Radial Ice
- Wide Bandwidth

Utilizing the proven design and construction techniques employed in the G5 Super Power series of antennas, the G5CPM series extends the advantages and benefits of this superior design to medium power antennas for class A and class B applications. Made with 44.5 -mm (1¾ in.) heavy-duty brass radiating elements and 41.3 -mm (1⅝ in.) interbay line to withstand 125 mph (200 kph) wind velocities and moderate ice loads, the G5CPM antennas feature a completely pressurized internal feed point, with inner conductors constructed to reduce losses and heating. Deicers are not available. Radomes are available. The typical vswr with 12.7 -mm (½-in) radial ice is 1.5:1 or less.

Specifications

No. of Bays	Power Gain ¹	dB Gain ¹	Type Feed ²	Female 50-Ohm Input mm (in.)	Power Input Capability	Calculated Weight kg (lb)	Calculated Windload ³ kg (lb)	Approx. Length m (ft) ⁴
1	0.4611	-3.3623	End	41.3 (1 5 8)	9 kW	23.1 (51)	41.7 (92)	
2	0.9971	-0.0128	End	41.3 (1 5 8)	9 kW	46.3 (102)	87.1 (192)	3 (10)
2	0.9971	-0.0128	Center	79.4 (3 1 8)	12 kW	61.2 (135)	121.6 (268)	3 (10)
3	1.5588	1.9278	End	41.3 (1 5 8)	9 kW	70.3 (155)	133.8 (295)	6.1 (20)
3	1.5588	1.9278	Center	79.4 (3 1 8)	12 kW	85.7 (189)	168.3 (371)	6.1 (20)
4	2.1332	3.2903	End	41.3 (1 5 8)	9 kW	94.8 (209)	180.1 (397)	9.1 (30)
4	2.1332	3.2903	Center	79.4 (3 1 8)	12 kW	109.8 (242)	214.6 (473)	9.1 (30)
5	2.7154	4.3384	End	41.3 (1 5 8)	9 kW	118.8 (262)	226.8 (500)	12.2 (40)
5	2.7154	4.3384	Center	79.4 (3 1 8)	12 kW	134.3 (296)	261.3 (576)	12.2 (40)
6	3.3028	5.1888	End	41.3 (1 5 8)	9 kW	143.3 (316)	273.1 (602)	15.2 (50)
6	3.3028	5.1888	Center	79.4 (3 1 8)	12 kW	158.3 (349)	308.0 (679)	15.2 (50)
7	3.8935	5.9034	Center	79.4 (3 1 8)	12 kW	182.8 (403)	354.3 (781)	18.3 (60)
8	4.4872	6.5197	Center	79.4 (3 1 8)	12 kW	206.8 (456)	401 (884)	21.3 (70)
9	5.0826	7.0608	Center	79.4 (3 1 8)	12 kW	231.3 (510)	447.7 (987)	24.4 (80)
10	5.6800	7.5435	Center	79.4 (3 1 8)	12 kW	255.4 (563)	494 (1089)	27.4 (90)
11	6.2783	7.9785	Center	79.4 (3 1 8)	12 kW	279.9 (617)	540.7 (1192)	30.4 (100)
12	6.8781	8.3747	Center	79.4 (3 1 8)	12 kW	303.9 (670)	587 (1294)	33.5 (110)

¹Power split is 50/50 vertical and horizontal only. Beam tilt and null fill, are available as extra cost options on center fed antennas, but will change the gain figures given above and may reduce the power rating.

²End feeding is done with a 1.83-m (6-ft) matching transformer section. Center feeding of an odd number of bays is done at a point one-half bay below the center of the antenna. A 3-m (10-ft) matching transformer is connected to an elbow at the center feed point and extends downward.

³Windload based on 244.1 161.1 Kgm² (50/33 lb psf). Brackets are included in weight and windload calculations.

⁴End fed antenna lengths do not include transformer.

Continental Electronics

CONTINENTAL ELECTRONICS MFG. CO. BOX 270879 DALLAS, TEXAS 75227 (214) 381-7161



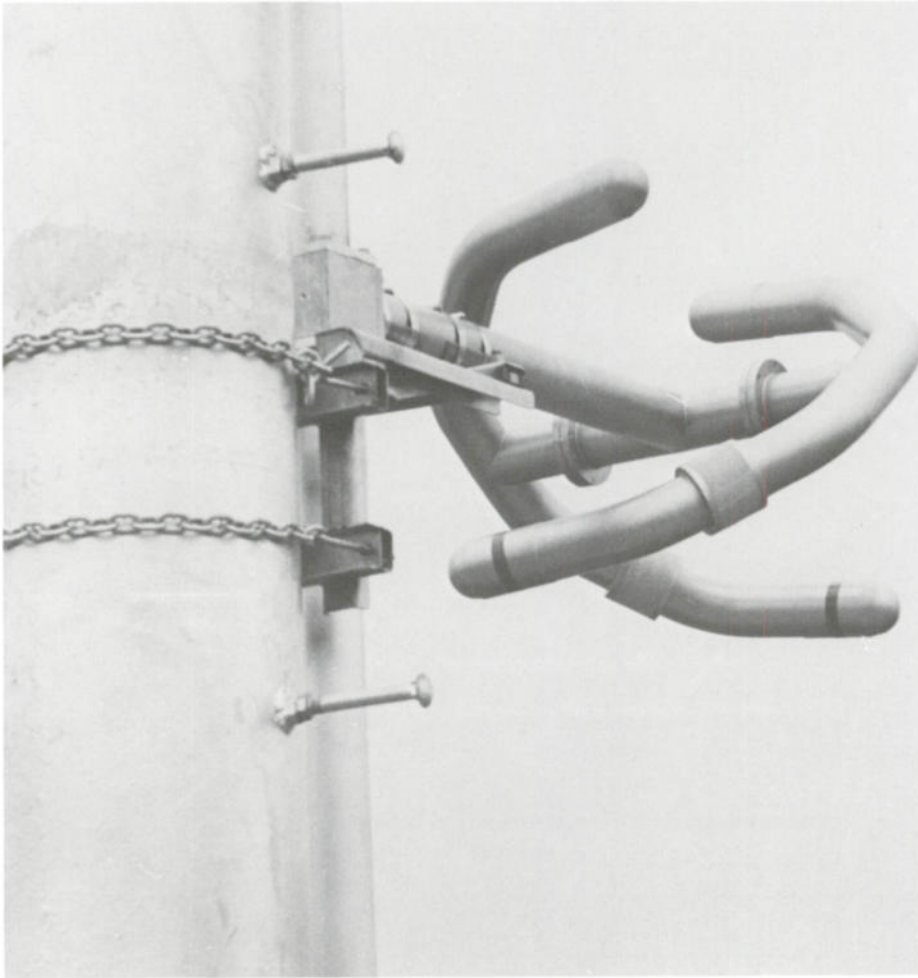

The Continental G5CPS series of super power, circularly polarized antennas was designed for stations needing input powers up to 120KW. In addition to their high power handling capabilities, G5CPS FM antennas offer the broadband characteristics that are important to optimum main and sub-carrier performance, and also give this series its well above average immunity to the detuning caused by icing. Radomes or deicing heater elements are needed only where the most severe icing conditions are likely to occur. Typical VSWR is 1.5:1 or less with $\frac{1}{2}$ " of radial ice.

Long life reliability and freedom from the deteriorating effects of weather, including salt air, are the result of using only brass, copper and stainless steel in the making of the G5CPS series antennas. The brass radiating elements have an outside diameter of $3\frac{1}{8}$ " with a feed point

that is completely internal and pressurized to prevent the accumulation of moisture through condensation.

Power handling capability of the G5CPS series is determined by three main factors: 1. Size of input flange. 2. Size of interbay line. 3. Method of feeding, either end or center. One bay of G5CPS antenna with $3\frac{1}{8}$ " input flange will handle 32 KW of input power, while a 3 bay "C" series antenna with $6\frac{1}{8}$ " interbay line and $4\frac{1}{8}$ " input stem can handle a 120 KW input. A chart on the other side of this sheet gives details of the many combinations available to suit any station's particular requirements.

Since first introduced, a number of improvements have been made in the design and manufacture of the G5CPS series. Where initially the elements were formed through the use of several mitred and welded sections, they are now formed by a ma-

chine specially designed for bending large diameter tubing. This substantially reduces the possibility of air or gas leaks.

The horizontally polarized horizontal-plane radiation pattern of the G5CPS is essentially omni-directional when pole mounted atop a tower. ± 2 dB circularity is typical when mounted on a 14 inch diameter pole. When side mounted on a tower, the antenna pattern will be affected by the tower structure. Antenna pattern studies are available on a quotation basis and are recommended where it is essential to know exactly what the radiation pattern will be on a particular tower. These measurements are made full scale on an exact duplicate of a 20-foot section of the customer's tower, including such things as ladders, other transmission lines, lighting conduits and other antenna elements. Pattern optimization is available for both horizontal and vertical polarizations where optimum circularity is essential.

Bandwidth of the G5CPS series antenna is extremely broad. A low standing wave ratio of 1.07:1 or less can be achieved over a 200 KHZ bandwidth with field trimming. VSWR at antenna input without field trimming is 1.2:1 for pole mounting; 1.5:1 or less when side mounted on a tower.

This broadband characteristic also means that the G5CPS series is suitable for multi-station operation in many instances. Continental Electronics will be pleased to quote the filtering and multiplexing components required for this type of operation.

SPECIFICATIONS

Frequency range: 88 to 108 MHz factory tuned to one frequency.

Polarization: Circular (Clockwise)

Power Gain: See tables, opposite side

Azimuthal pattern: ± 2 dB in free space, both horizontal and vertical

Ellipticity — ± 3 dB in free space

VSWR at input (without field trimming) 1.2:1 pole mounting; 1.5:1 or better side mounting.

VSWR with field tuning: 1.1:1 or better.

Series A 3 1/8" interbay line, 3 1/8" element stem

No. of Bays	Power Gain	DB Gain	Type Feed	Female 50 Ohm Input	Power Input Capability	Lbs. Calculated Weight	Lbs. Calculated Wind Load *	Approx. Length **
1	0.4611	-3.3623	End	3 1/8"	32 KW	114	137	—
2	0.9971	-0.0128	End	3 1/8"	32 KW	225	304	10'
2	0.9971	-0.0128	Center	3 1/8"	39 KW	250	319	10'
2	0.9971	-0.0128	Center	6 1/8"	64 KW	301	421	10'
3	1.5588	1.9278	End	3 1/8"	32 KW	336	470	20'
4	2.1332	3.2903	End	3 1/8"	32 KW	447	637	30'
4	2.1332	3.2903	Center	3 1/8"	39 KW	472	652	30'
4	2.1332	3.2903	Center	6 1/8"	64 KW	523	758	30'
5	2.7154	4.3384	End	3 1/8"	32 KW	558	804	40'
6	3.3028	5.1888	End	3 1/8"	32 KW	669	971	50'
6	3.3028	5.1888	Center	3 1/8"	39 KW	694	986	50'
6	3.3028	5.1888	Center	6 1/8"	64 KW	745	1096	50'
7	3.8935	5.9034	End	3 1/8"	32 KW	780	1138	60'
8	4.4872	6.5197	End	3 1/8"	32 KW	891	1305	70'
8	4.4872	6.5197	Center	3 1/8"	39 KW	916	1320	70'
8	4.4872	6.5197	Center	6 1/8"	64 KW	967	1433	70'
10	5.6800	7.5435	Center	3 1/8"	39 KW	1138	1653	90'
10	5.6800	7.5435	Center	6 1/8"	64 KW	1189	1770	90'
12	6.8781	8.3747	Center	3 1/8"	39 KW	1360	1987	110'
12	6.8781	8.3747	Center	6 1/8"	64 KW	1411	2108	110'

Series B 4 1/8" interbay line, 4 1/8" element stem

1	0.4611	-3.3623	End	6 1/8"	40 KW	159	201	—
2	0.9971	-0.0128	End	6 1/8"	56 KW	297	407	10'
2	0.9971	-0.0128	Center	6 1/8"	80 KW	336	468	10'
3	1.5588	1.9278	End	6 1/8"	56 KW	435	613	20'
4	2.1332	3.2903	End	6 1/8"	56 KW	573	818	30'
4	2.1332	3.2903	Center	6 1/8"	112 KW	612	879	30'
5	2.7154	4.3384	End	6 1/8"	56 KW	711	1024	40'
6	3.3028	5.1888	End	6 1/8"	56 KW	849	1229	50'
6	3.3028	5.1888	Center	6 1/8"	112 KW	888	1290	50'
7	3.8935	5.9034	End	6 1/8"	56 KW	987	1435	60'
8	4.4872	6.5197	End	6 1/8"	56 KW	1125	1641	70'
8	4.4872	6.5197	Center	6 1/8"	112 KW	1164	1702	70'
10	5.6800	7.5435	Center	6 1/8"	112 KW	1440	2113	90'
12	6.8781	8.3747	Center	6 1/8"	112 KW	1716	2524	110'

Series C 6 1/8" interbay line, 4 1/8" element stem

1	0.4611	-3.3623	End	6 1/8"	40 KW	205	260	—
2	0.9971	-0.0128	End	6 1/8"	80 KW	410	520	10'
3	1.5588	1.9278	End	6 1/8"	120 KW	615	780	20'
4	2.1332	3.2903	End	6 1/8"	120 KW	820	1040	30'
5	2.7154	4.3384	End	6 1/8"	120 KW	1025	1300	40'
6	3.3028	5.1888	End	6 1/8"	120 KW	1230	1560	50'

*Wind load based on 50/33 PSF.

**End fed antenna lengths do not include the 6' matching transformer.

Note: Brackets included in weight and wind load calculations.

*Power input capability up to 2000 feet above mean sea level, derating required above 2000 feet.

3M385/5926

Continental Electronics

Continental Electronics Mfg Co Box 270879 Dallas, Texas 75227 (214) 381-7161





The G5CPM series of FM antennas has many of the characteristics of the super power G5CPS series, but is designed for use by low to medium power station. Input powers of up to 9 or 12 KW can be used depending upon the number of bays and whether the antenna is center or end fed.

All G5CPM antennas have radiating elements made of 1 $\frac{3}{4}$ " diameter, heavy duty brass and 1 $\frac{5}{8}$ " interbay line.

Two characteristics which the G5CPM antenna shares with the G5CPS is its broadband response and formed, rather than welded radiating elements. As a result, the G5CPM is capable of normal operation with up to $\frac{1}{8}$ -inch of radial ice. While heaters and radomes are now available for the G5CPM series, they

are recommended only for areas where icing conditions are likely to be severe. Once pressurized, loss of dry air or nitrogen gas is rarely encountered.

As with the G5CPS series, the G5CPM uses a 6-foot transformer section for impedance matching and fine tuning after installation, if the very lowest VSWR is required. VSWR without field tuning is normally 1.1:1 when pole mounted; 1.5:1 when side mounted on a tower.

Freedom from deterioration caused by weather elements is assured through the use of brass, copper and stainless steel throughout the antenna.

The feed point is completely internal and includes a pressurized environment up to the feed point of each bay.

Because of the broadband characteristics achieved by the design of the G5CPM series, these antennas are well suited to optimum performance of both the main and any sub-carrier channels.

Detailed specifications covering one to twelve bays of G5CPM antennas with end or center-fed construction will be found on the other side of this page. Current prices may be obtained by contacting your nearest Continental Electronics sales representative, or calling the Marketing Department of Continental Electronics in Dallas. All prices quoted include custom-made mounting brackets. A quarter-wave grounding stub which places the antenna at ground potential for additional protection against lightning is available as an option at added cost.

No. of Bays	Power Gain ¹	dB Gain ¹	Type Feed ²	Female 50-Ohm Input (mm) In.	Power Input Capability	Calculated Weight lb. (kg)	Calculated Windload ³ lb. (kg)	Approx. Length ft. (m) ⁴
1	0.4611	-3.3623	End	(41.3) 1½	9 kW	57 (25.85)	102 (46.27)	
2	0.9971	-0.0128	End	(41.3) 1½	9 kW	114 (51.71)	212 (96.16)	10 (3.05)
2	0.9971	-0.0128	Center	(79.4) 3½	12 kW	147 (66.68)	289 (131.09)	10 (3.05)
3	1.5588	1.9278	End	(41.3) 1½	9 kW	170 (77.11)	323 (146.51)	20 (6.10)
3	1.5588	1.9278	Center	(79.4) 3½	12 kW	204 (92.53)	399 (180.98)	20 (6.10)
4	2.1332	3.2903	End	(41.3) 1½	9 kW	227 (102.97)	433 (196.41)	30 (9.14)
4	2.1332	3.2903	Center	(79.4) 3½	12 kW	260 (117.93)	509 (230.88)	30 (9.14)
5	2.7154	4.3384	End	(41.3) 1½	9 kW	283 (128.37)	543 (246.30)	40 (12.19)
5	2.7154	4.3384	Center	(79.4) 3½	12 kW	317 (143.79)	620 (281.23)	40 (12.19)
6	3.3028	5.1888	End	(41.3) 1½	9 kW	340 (154.22)	654 (296.65)	50 (15.24)
6	3.3028	5.1888	Center	(79.4) 3½	12 kW	373 (169.19)	730 (331.12)	50 (15.24)
7	3.8935	5.9034	Center	(79.4) 3½	12 kW	430 (195.04)	840 (381.02)	60 (18.29)
8	4.4872	6.5197	Center	(79.4) 3½	12 kW	486 (220.45)	950 (430.91)	70 (21.34)
9	5.0826	7.0608	Center	(79.4) 3½	12 kW	543 (246.30)	1060 (480.81)	80 (24.38)
10	5.6800	7.5435	Center	(79.4) 3½	12 kW	599 (271.70)	1171 (531.16)	90 (27.43)
11	6.2783	7.9785	Center	(79.4) 3½	12 kW	656 (297.56)	1281 (581.05)	100 (30.48)
12	6.8781	8.3747	Center	(79.4) 3½	12 kW	712 (322.96)	1391 (630.95)	110 (33.53)

¹Power split is 50/50 vertical and horizontal only. Beam tilt and null fill, are available as extra cost options on center fed antennas, but will change the gain figures given above and may reduce the power rating.

²End feeding is done with a 6 ft. (1.83m) matching transformer section. Center feeding of an odd number of bays is done at a point one-half bay below the center of the antenna. 6 ft (1.83 m) matching transformer is connected to an elbow at the center feed point and extends downward.

³Windload based on 50/33 psf (244.1/161.1 kgm). Brackets are included in weight and windload calculations.

⁴End fed antenna lengths do not include transformer.

3M385/5927

Continental Electronics

Continental Electronics Mfg Co Box 270879 Dallas, Texas 75227 (214) 381-7161



Antenna
Phasing and Coupling
Equipment

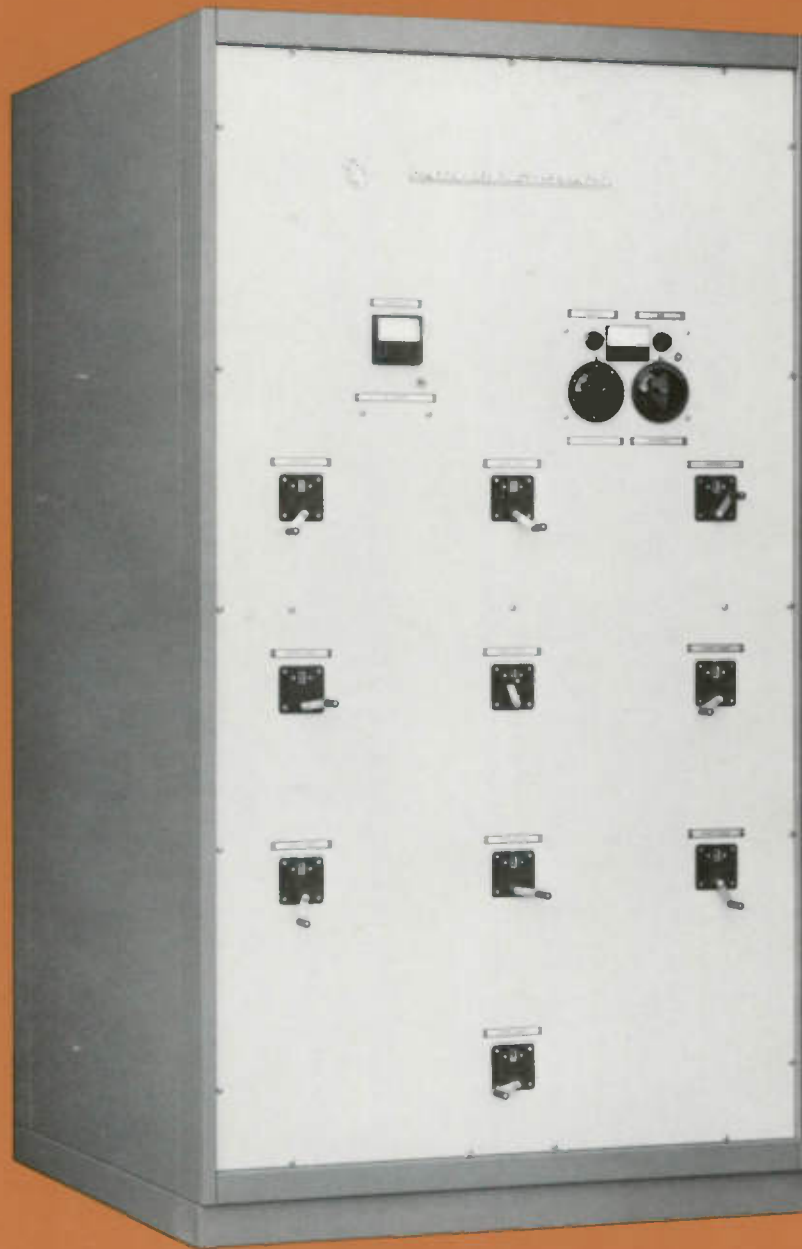



Introduction

Since its founding in 1946, Continental Electronics has designed and manufactured phasing and coupling equipment to meet the needs of broadcasters around the world.

Many of the techniques used today in phaser design were pioneered, developed and refined by Continental engineers. Continental engineering and manufacturing personnel can draw upon a wide and varied experience in preparing your phasing equipment proposal: experience that includes designing, building, installing, testing and operating transmitters and related rf equipment ranging in power from 1,000 to 2,000,000 watts.

Required Design Data

You, or your consultant, must supply certain data before we can prepare your phasing system design. Data typically includes:

- call letters and station location; frequency of operation; operating power (day and night); and mode of operation
- description of towers; tower manufacturer; type number and tower height; self-supported or guyed; and cross-section dimensions
- spacing and orientation of all antennas in the array
- phase relationship and ratios of the radiation fields
- location of phasing unit
- type and length of each transmission line.

For your convenience, a questionnaire form, which can be mailed to us, is included in the back of this brochure. Your Continental Representative has additional questionnaires. These forms provide the data we need in order to construct a computer model of your phasing system.

Typical System

A directional antenna phasing and branching system consists of:

- an impedance matching circuit which matches the power divider input impedance to the common point impedance at which the power input is measured
- a branching circuit in which power is precisely divided into the amounts of power necessary to give the proper ratio of fields from individual antennas
- phase shifting networks in series with each of the transmission lines going to the individual antenna towers
- the transmission lines
- the antenna coupling unit (ACU) for impedance matching between each transmission line and its associated antenna tower.

Continental Phaser Design Practices

Continental phasing systems offer optimal impedance and pattern bandwidths with a wide adjustment range based on highly accurate, computer analysis of antenna tower impedances.

All designs avoid network configurations which directly impair bandwidth, such as those which have excessive individual phase shifts or excess tower base reactance tuning. If special bandwidth compensation networks or rejection filters are used, rf losses, voltage gradient and circulating currents are carefully calculated and their impact is included in the final system design.

All system components are carefully evaluated and selected on a best-performance/best-engineering practice basis. For example: vacuum capacitors and vacuum rf contactors are used when appropriate.

Conservatively-rated components are used throughout the design.

A static drain device is provided in the antenna coupling unit for each tower, unless this function is performed by the ground winding of an existing lighting choke, or other means.

Accuracy of network calculations is enhanced by the use of digital computers. Special system analysis is used to predict or optimize adjustment interaction, sensitivity and bandwidth. Continental's ongoing antenna systems research assures all customers that they will benefit from the most current proven designs.

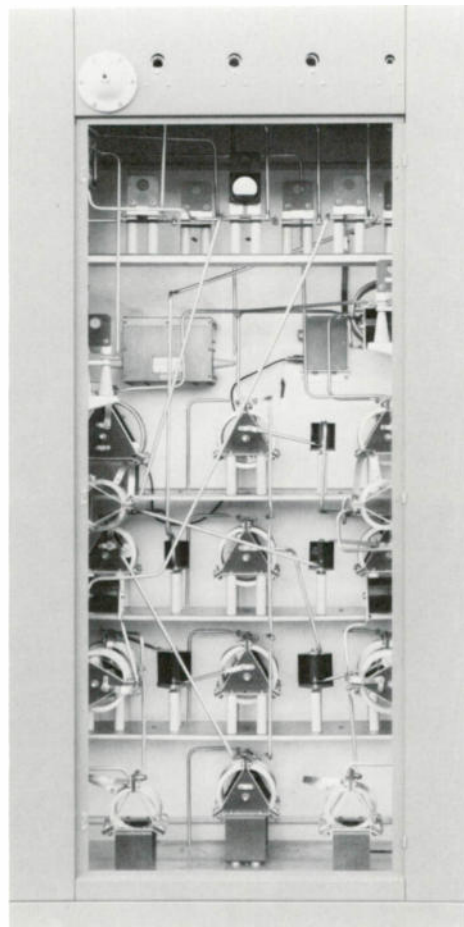

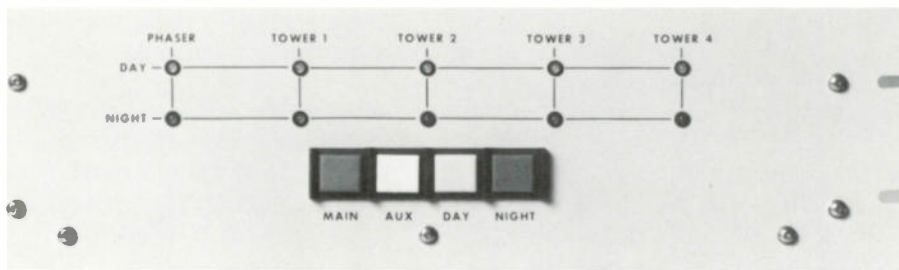

Continental "Wideband" Phaser

Continental engineers have developed a technique that optimizes the impedance and pattern bandwidths of a phased array. Following is an overview of this technology.

After completion of the initial phaser design, the sideband self and mutual impedances are calculated based on electromagnetic propagation less than the speed of light. Because sideband parameters are frequency dependent, different tower electrical heights and spacings exist from those specified for the carrier frequency.

Then, three network models of the towers are calculated: one at carrier, and one at each sideband. The components of each network are placed in the phaser topology, and the whole system is then analyzed by a computer program using admittance matrix algebra. Component reactances and transmission line lengths are automatically adjusted for frequency. The effects of coil Q and transmission line loss are included.

The frequency-sensitive tower impedance model answers two questions which cannot be answered if the tower system's current ratios or operating impedances are assumed to be constant. They are:

- (1) Tower currents at the sidebands.
- (2) Tower currents at the carrier during the adjustment process.

Obtaining the common-point impedance, VSWR and the tower currents, and the effect each

component has on these parameters, enables Continental engineers to prepare an optimum system design. In addition to "widebanding," this technique can be used to study adjustment sensitivity at carrier. It can also be used to give advance indication when a power divider control is more of a phase control and vice-versa. Adjustment interaction can be optimized during the design process.

Typical Network Construction Practice

Interconnecting bus matches associated inductor tubing, or is based on a minimum of $\frac{1}{8}$ -inch of diameter per each 10 RMS amps of current. The smallest diameter tubing used is $\frac{3}{8}$ -inch. Where flexible connections are required, $\frac{1}{2}$ -inch x 20-mil copper strap is used per 10 RMS amps of current.

The bus size will be selected to minimize or optimize voltage gradient when a dielectric-heating or ionization probability exists.

All components are removable from inside the cabinets or from the front surface of wall panels. All mounting screws fit in tapped holes or captive nuts, so separate nuts are not required. All hardware is non-ferrous.

Aluminum and copper parts are Iridited, cadmium or silver plated, or as specified.

A cabinet that is located in a transmitting room has an interlock circuit, if requested.

Epoxy-cast mica capacitors are provided with flanges for additional heat-sinking, and to facilitate connection and mounting.

Front panel controls consist of knobs or handles, counters and insulated, flexible couplings.

Co-ax outer conductor "U" clamps are provided for transmission line termination unless other termination is specified.

Photo-etched nameplates are used on all phaser cabinet front-panel meters and controls.

Phaser cabinets use overhead grills to allow convection cooling.

Panels which act as electrical ground are aluminum, and are bonded to each other with two-inch wide copper straps.

A rolled six foot length of two-inch or four-inch wide copper strap, depending upon power level, is provided with each cabinet for connection to the customer's ground system.

The selection of stand-off insulators and insulation materials is based on strength, low dielectric dissipation factor and low moisture absorption.

Tubing inductor taps are plated, solid brass to provide good electrical connection and heat sinking.

Jacks are always positioned so that a plug-in ammeter will face the operator from a horizontal position.

All co-ax input/output connections are located to customer specifications. If the customer has no preference, input co-ax connections will be located at the top of the phaser cabinet, output coax connections at the bottom. Control connections will usually be located at the bottom of all cabinets or panels. ACU inputs will usually be at the lower left; outputs at the upper right.

Typical Control Circuit Design Practices

Continental's standard 28 vdc control circuit is designed for mounting in a 19-inch rack; either directly in the front panel of the phasor, or externally. Color-coded LEDs give status indications for each tower and phasor cabinet.

The momentary push-button switches must be depressed for a full second before switching will begin. This prevents accidental mode change if an operator accidentally depresses a push-button, and assures that the transmitter has adequate time to remove rf output. If desired, the full-second contact can be performed automatically with the addition of two relays.

Remote control capability is built-in to the standard circuit with a "local only" switch for personnel safety during maintenance. A separate remote control panel is available as an option.

Control lines can be specified as 28 vdc or 220 vac. Line voltage to the control panel can be specified as 120 vac or 240 vac; 50 or 60 Hz.

A "Failsafe" circuit will prevent the transmitter from returning to the air if a mode change is incomplete.

All relays are the same plug-in type. Time delay is accomplished with RC delay networks.

Building the Complete Antenna Array

In addition to designing and providing phasing and coupling equipment, Continental can also supply your complete antenna array: including towers, guying, transmission lines and other related antenna system equipment.

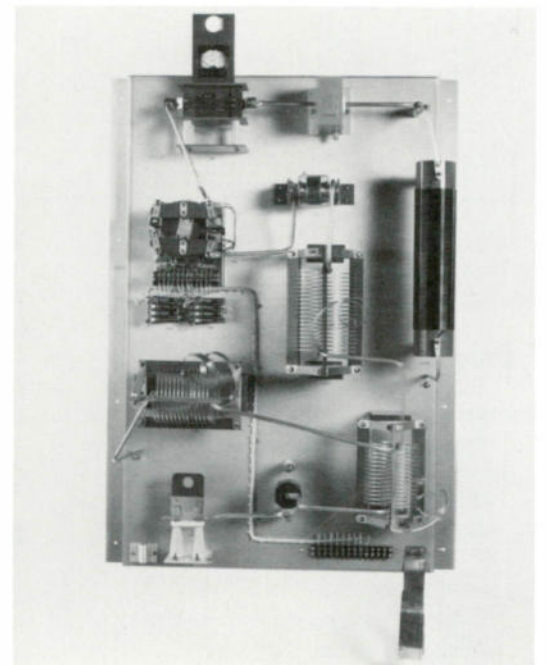
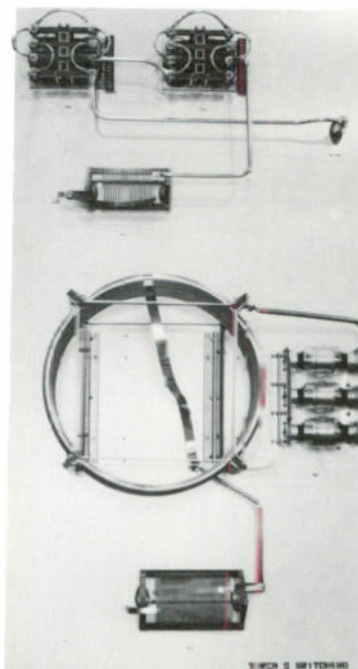
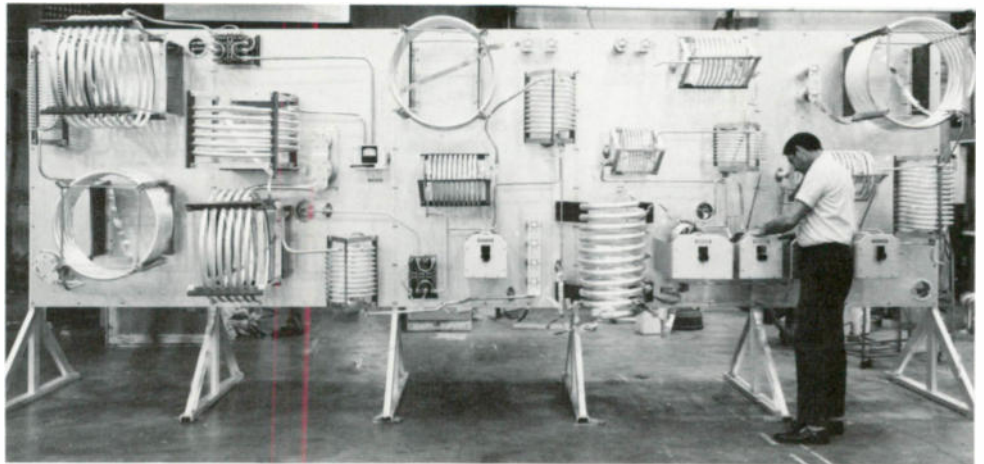
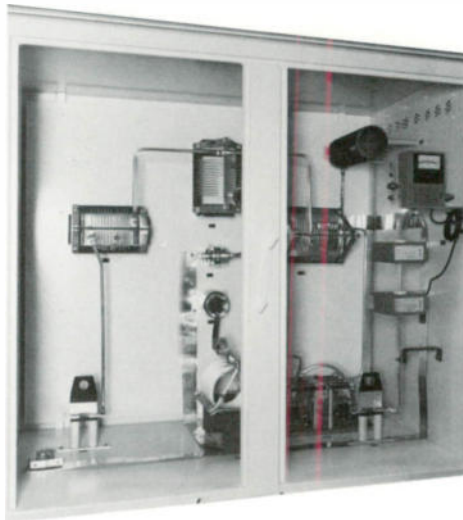

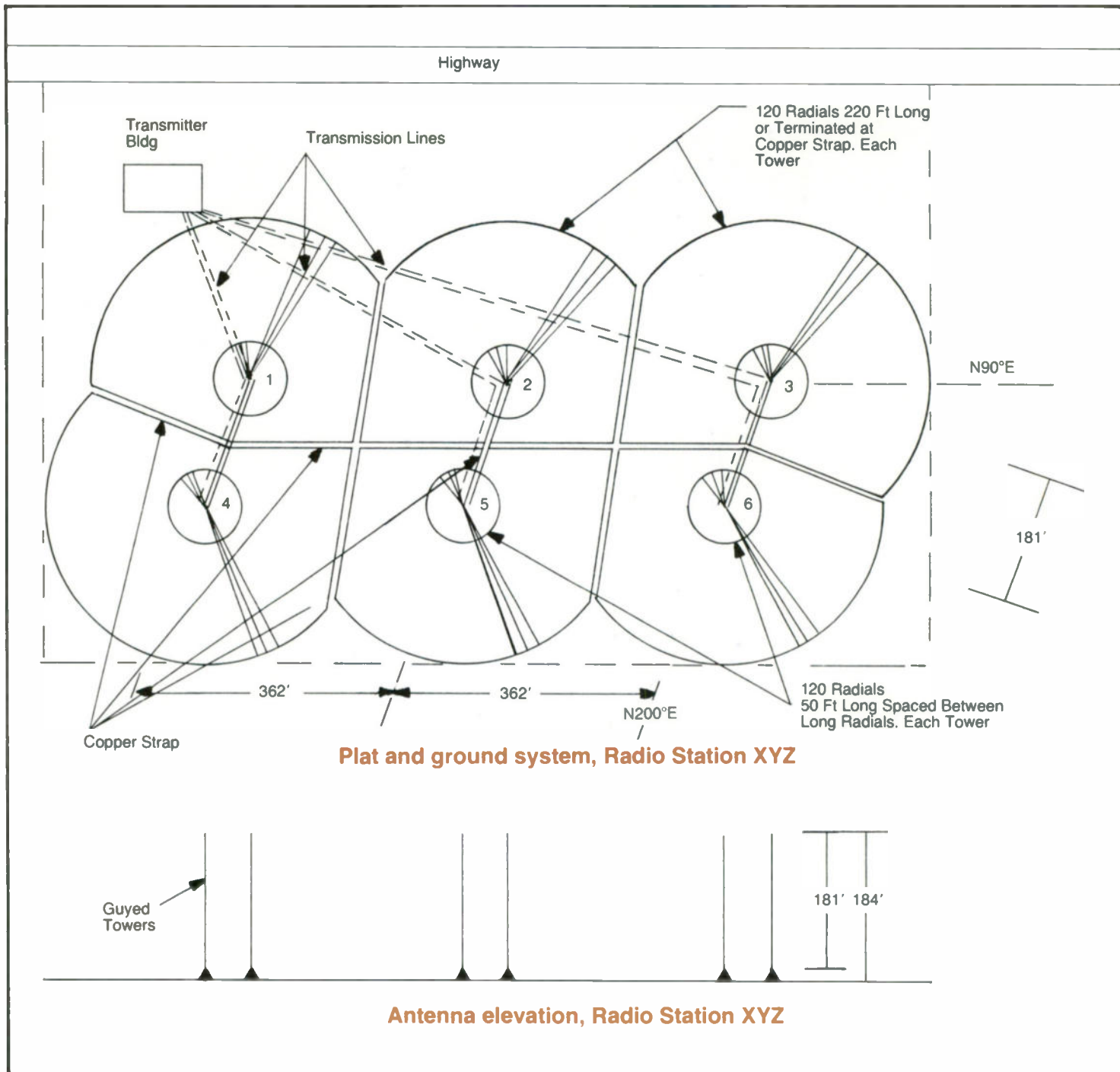

Description of directional antenna system, Radio Station XYZ

Frequency:
1360 Hz

Power:
1,000 watts

Operation:
DA-1

Number of elements:
6

Element type:
uniform cross section, guyed, insulated base

Top loading:
none

Height of each element above insulators:
181 feet (55.21 m)

Over-all height of each element above ground level:
184 feet (56.12 m)

Orientation of array:
see diagram plot, above

Spacing of towers:
see diagram plot, above

Phasing and ratio of fields:

	ratio	phasing
tower 1:	1	0°
tower 2:	2	45°
tower 3:	1	90°
tower 4:	1	180°
tower 5:	2	135°
tower 6:	1	90°

Ground system:

120 radials 220 feet (67.10 m) long, and 120 radials 50 feet (15.25 m) long; all radials equally spaced around each tower except for overlap

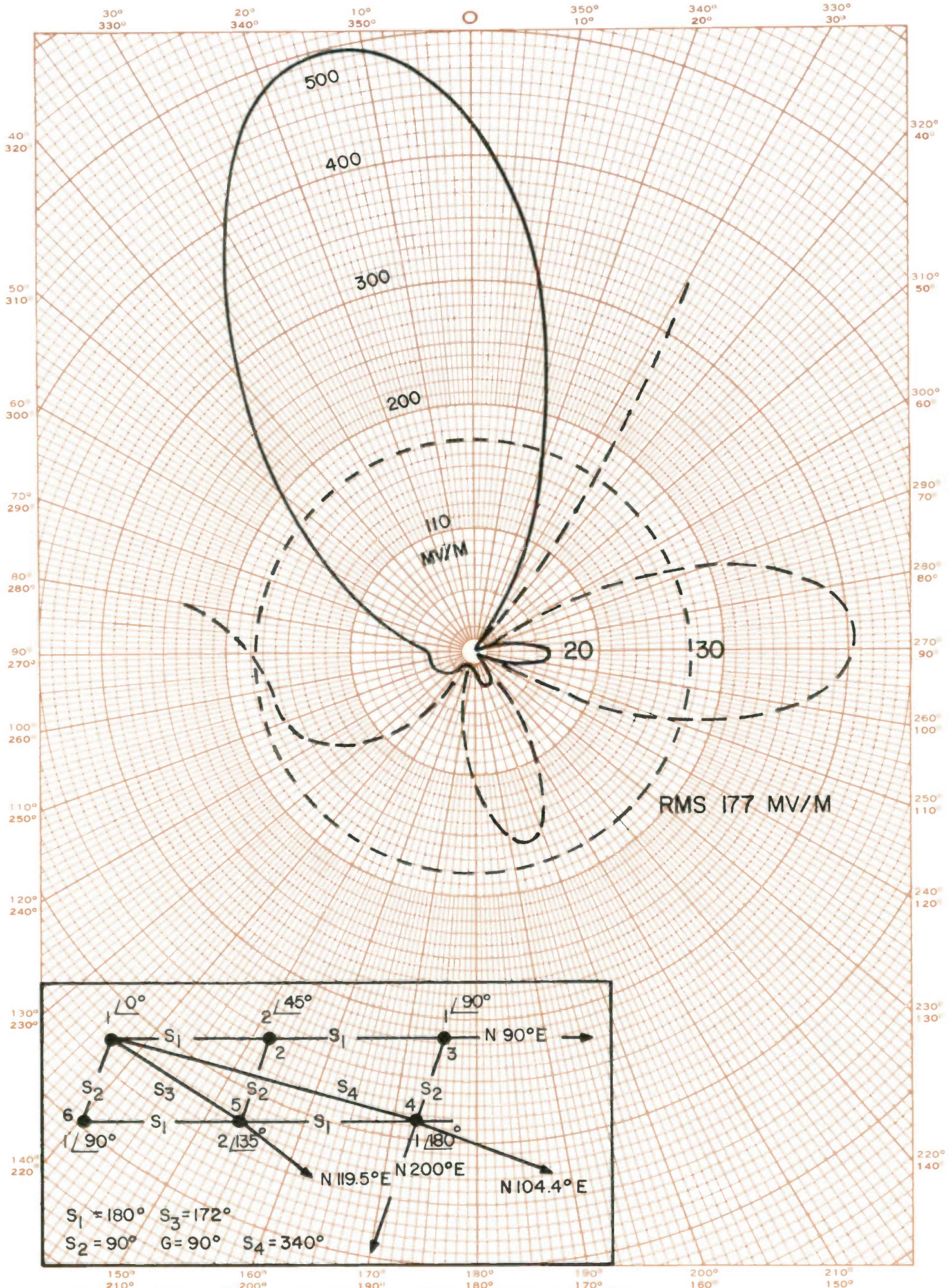

Horizontal Plane Pattern, Radio Station XYZ, 1360 kHz, 1 kW, DA-1

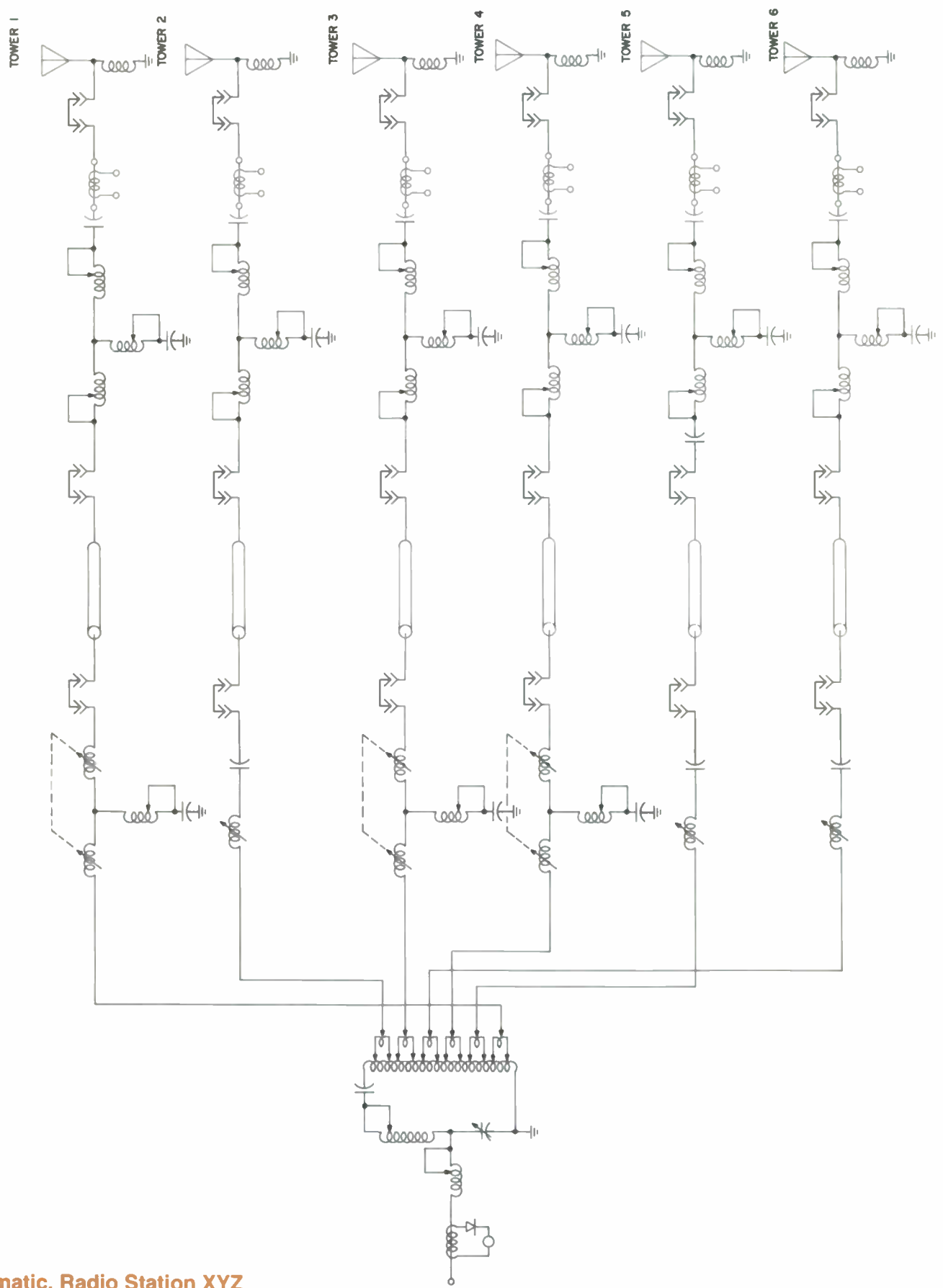

Schematic, Radio Station XYZ

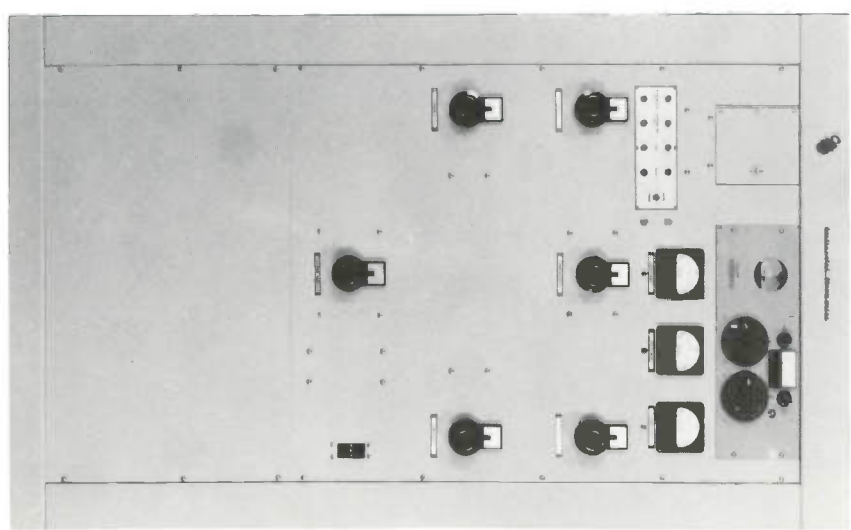
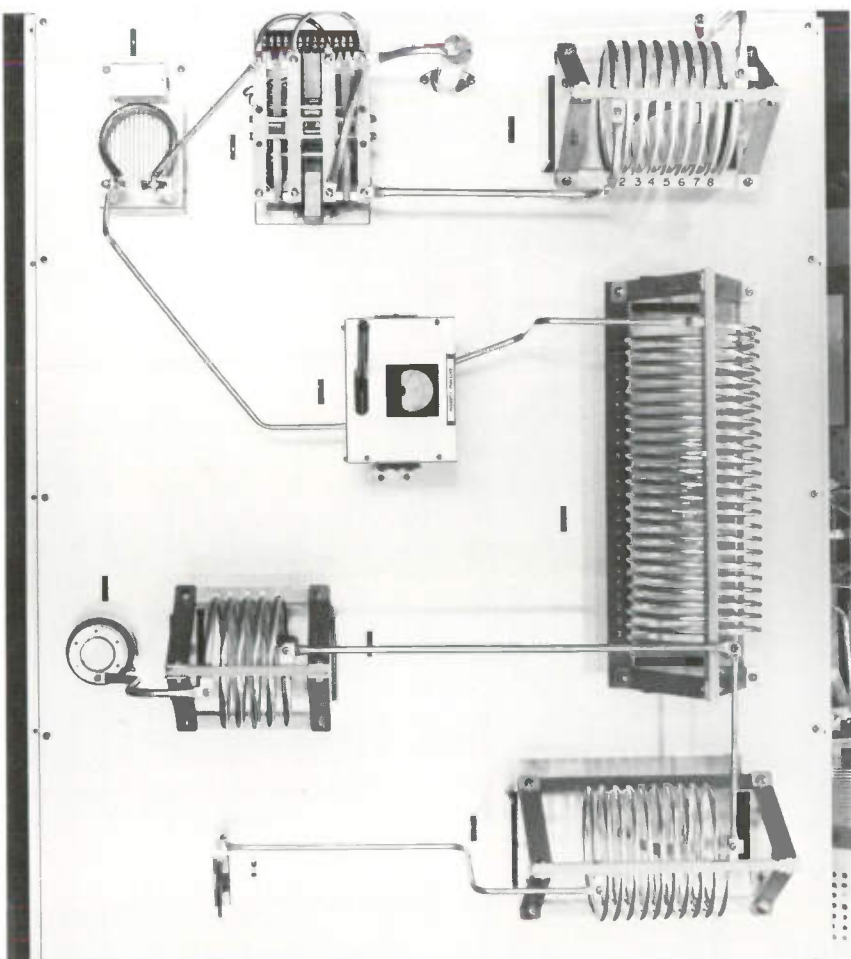
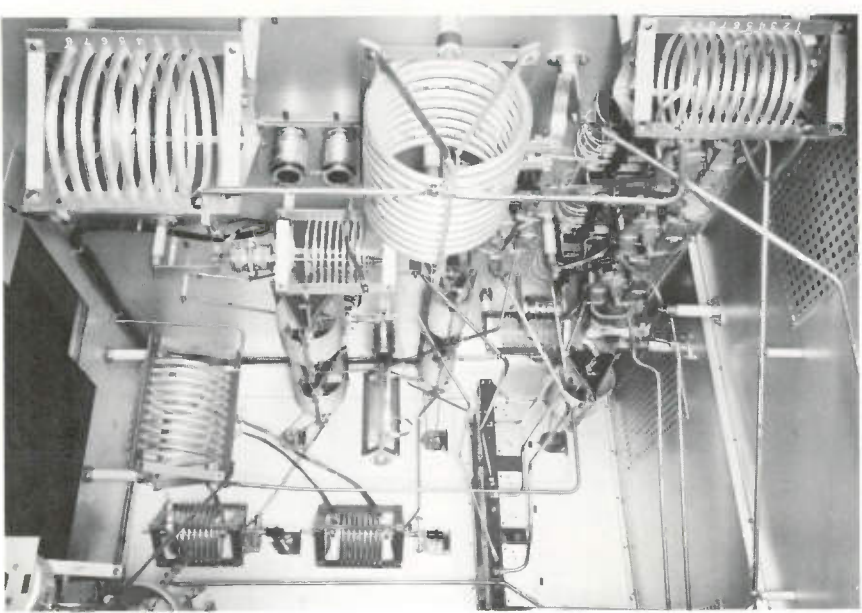
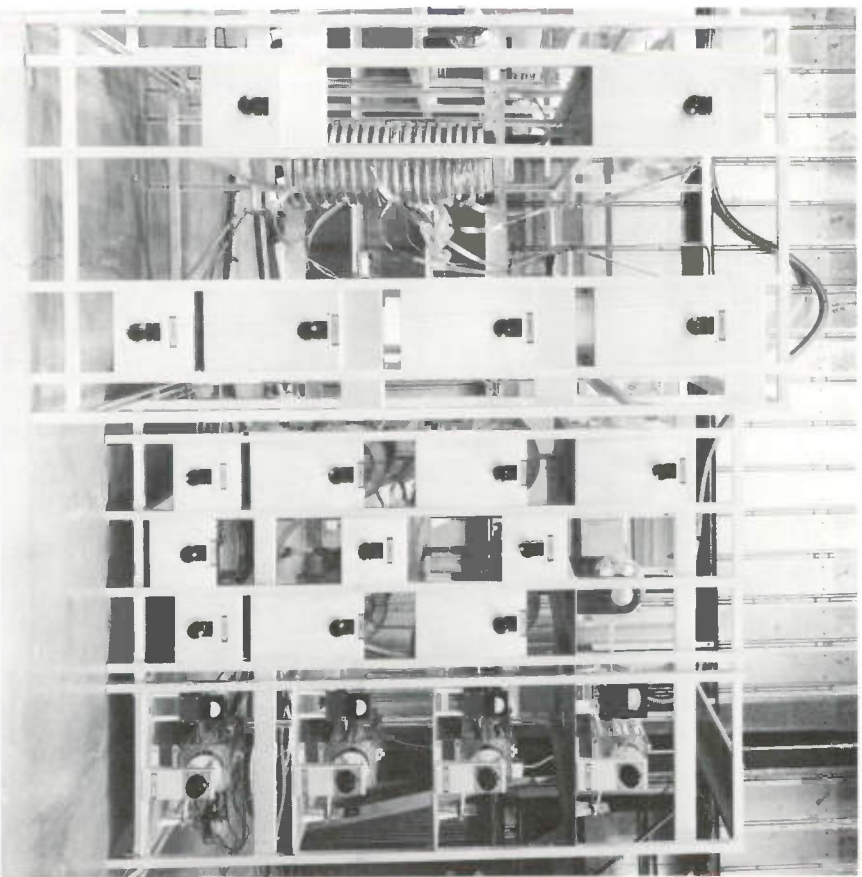

Directional Antenna System Questionnaire

Mail completed questionnaire to: Broadcast Sales Dept.; Continental Electronics Mfg. Co.; PO Box 270879 Dallas, Texas 75227 Phone (214) 381-7161.

I. GENERAL

A. Operating power (watts)

1. Daytime _____
2. Nighttime _____
3. Pre-sunrise _____

B. Antenna will be: (check one)

1. Directional night, non-directional days DA-N _____
2. Directional night and day, same pattern DA-1 _____
3. Directional night and day, different patterns DA-2 _____
4. Directional daytime only DA-D _____

C. Tower no. _____ To be used for non-directional operation

D. Transmission line type: _____

E. Transmission line lengths Tower #1 _____ Tower #2 _____ Tower #3 _____
 Tower #4 _____ Tower #5 _____ Tower #6 _____
 Tower #7 _____ Tower #8 _____ Tower #9 _____

F. Sampling loops: Insulated? Yes _____ No _____ Not required _____

G. Insolation coils tuned? Yes _____ No _____ Not required _____

H. Current transformers? Yes _____ No _____

I. Include a sketch of the arrangement of towers and transmitter building with lengths of all transmission lines indicated. Number each tower and show position of phasing unit if not located in the transmitter building. Show spacing and orientation of towers.

J. Include the following plans and specifications with this completed questionnaire: Horizontal plane pattern, ground plot plan, antenna specifications sheet.

K. Tower data (complete table below)

	Tower #1	Tower#2	Tower#3	Tower#4	Tower#5	Tower#6
Self-impedance (if known)						
Type of radiator (guyed/self-support)						
Manufacturer						
Height						
Field ratio daytime						
Phase angle daytime (degrees)						
Field ratio night						
Phase angle nights (degrees)						

II. PHASING UNIT

- A. Position with respect to transmitter, if not adjacent. Include a sketch with dimensions with this questionnaire.
- B. If adjacent, which side when viewed from front? Right _____ Left _____
- C. Transmitter manufacturer: _____ Transmitter type: _____
- D. Phaser to be mounted: In standard cabinet _____ In matching cabinet _____ On panel _____
- E. Give phaser cabinet/panel size limitations: _____
- F. List special features required on separate sheet and attach to questionnaire.
- G. Type and location of input and output terminals of phasing unit:
 - 1. Input terminal type: EIA _____ Clamp _____ 3. Output terminal type: EIA _____ Clamp _____
 - 2. Input terminal location: Top _____ Bottom _____ 4. Output terminal location: Top _____ Bottom _____
- H. Aux/Main/Test loading switching? Yes _____ No _____
- I. Common-point bridge? Yes _____ No _____
- J. Remote control? Yes _____ No _____
- K. Pattern switching? Two Pattern (DA-N/DA-2) _____ Three Pattern (DA-2 + Non-Dir.) _____ None _____
- L. Transmitter switching? Yes _____ No _____

III. ANTENNA COUPLING UNIT (ACU)

- A. ACU to be mounted: In weatherproof cabinet _____ On panel for customer's building _____
- B. Lighting chokes? Yes _____ No _____ Static drain chokes? Yes _____ No _____
- C. ACU meters: Switched _____ Plug-in _____ None _____

IV. METERS: Thermocouple? Yes _____ No _____ Delta? Yes _____ No _____

V. WHO WILL DO THE TUNE-UP? _____

VI. CUSTOMER INFORMATION:

Company Name: _____

Address: _____

City: _____ State: _____ Zip: _____

Station call letters: _____ Frequency: _____

Chief Engineer: _____ Phone: (_____) _____

Consulting Engineer: _____ Phone: (_____) _____

Questionnaire completed by: _____ Date: _____

Continental Electronics



Continental Electronics Mfg. Co. Box 270879 Dallas, Texas 75227 (214) 381-7161

Type 377C-1A Automatic Exciter Control
 Type 377D-1 Automatic Combiner Control
 Type 377D-2 Automatic Transmitter Control

**AM
FM**

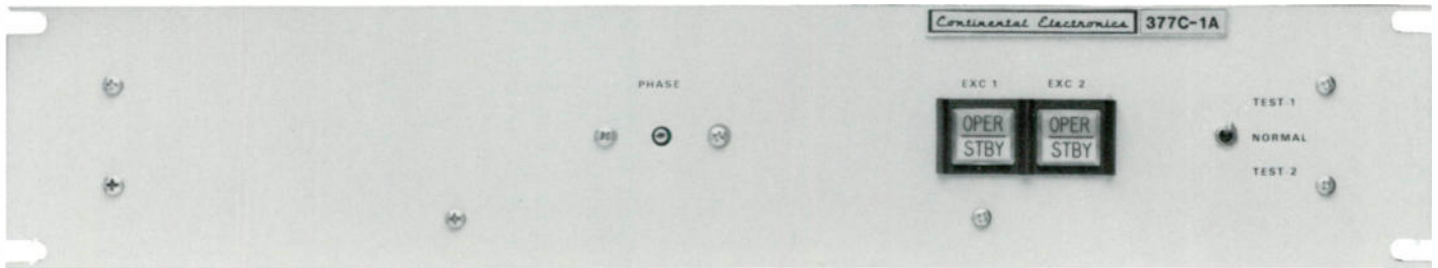

Type 377C-1A

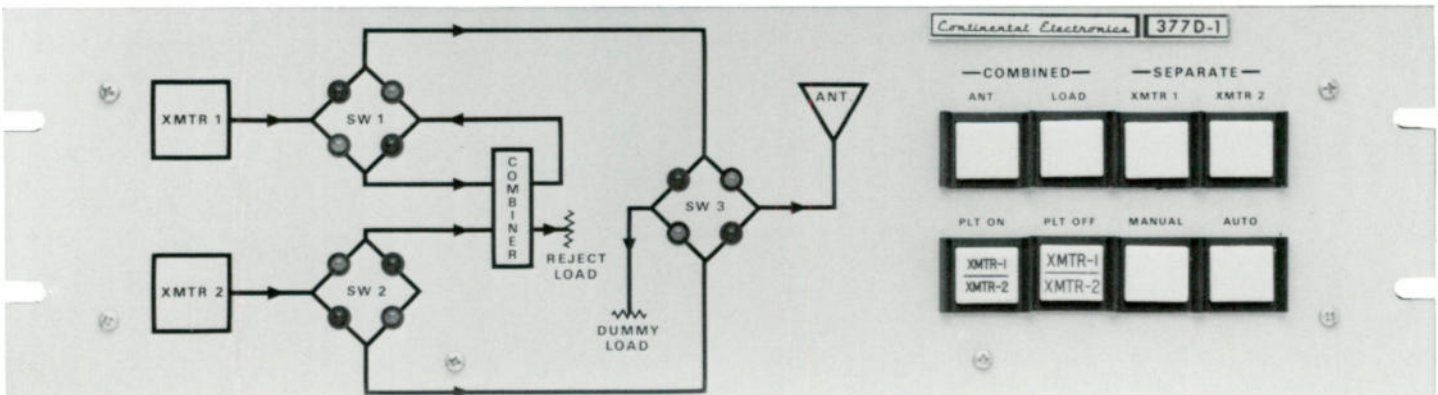

Type 377D-1

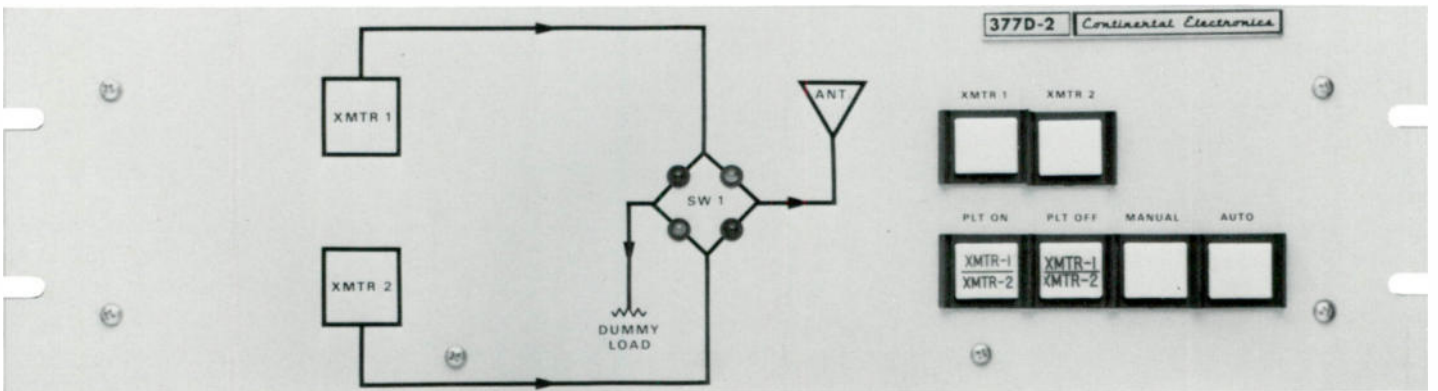

Type 377D-2

Introduction

Continental Electronics Type 377C-1A Exciter Control, 377D-1 Combiner Control, and 377D-2 Transmitter Control units provide both automatic and

manual automatic rf switching for AM or FM transmitter plants. The units can be mounted on a 19" rack, are compatible with most radio

transmitters, and provide an easy uncomplicated way to achieve automatic switching for totally redundant transmitter station operation.

Type 377C-1A Exciter Control

Continental's Automatic Exciter Control monitors the status and controls two exciters.

During typical operation, the Type 377C-1A switches one exciter to the transmitter to be driven. The second exciter is operated into a 100-watt load provided with the unit. If the primary exciter fails, the standby exciter is switched on line in less than 100 milliseconds. If used with Continental Type 802A FM exciters, the standby exciter is held at 5% of normal power by a bias voltage from the Type 377C-1 A until full power is needed.

Front panel controls include Operate/Standby push-buttons for both exciters, and a Normal/Test switch for station monitors.

The Type 377C-1A occupies 3½" of rack space and uses BNC connectors for rf connections, a barrier strip for control connections.

Type 377D-1 Combiner Control

Continental's Automatic Combiner Control provides control commands and monitoring for a pair of parallel transmitters and their associated motor-driven coax switches.

By monitoring predetermined parameters, the Type 377D-1 can switch one transmitter directly into the antenna system and thereby avoid the normal power loss of 6 dB that takes place in a hybrid combiner.

If one PA fails, the down unit is automatically switched to a dummy load for service.

System status is shown by a series of 12 LEDs, and a flow chart gives a quick visual reference from a distance. 8 illuminated push-buttons program the Type 377D-1.

Operating modes include: combined power to load; combined power to antenna; transmitter 1 or 2 to antenna; transmitter 1 or 2 Plate On or Plate Off; and Manual or Automatic operation.

The Type 377D-1 uses IC logic to give status and command functions, and has its own ni-cad power supply across the dc lines to hold memory during a power failure. After a primary power failure, transmitter operation will automatically resume in its last mode.

The Type 377D-1 occupies 5¼" of rack space, has standard BNC connectors on the back for rf connections, and uses barrier strips for control connections.

Type 377D-2 Transmitter Control

Continental's Automatic Transmitter Control is similar in operation to the Type 377D-1 except that it controls two transmitters in an alternate/main or "hot standby" condition.

The Type 377D-2 has a ni-cad power supply across the dc lines to hold memory during a power failure.

Front panel controls include Transmitter 1, Transmitter 2, Plate On, Plate Off, Manual, Automatic. An LED flow chart show rf routing to an antenna system and dummy load.

The type 377D-2 occupies 5¼" of rack space, has standard BNC connectors on the back for rf connections, and uses barrier strips for control connections.

Type 377D-2A Option

Continental's type 377D-2A is the same as the Type 377D-2 except that it has a sensing device to monitor transmitter audio level.

If the audio drops below a preset level, the 377D-2A automatically switches the down unit into a dummy load and puts the alternate/hot standby transmitter on the air.

All specifications are subject to change without notice.
Printed in USA IM385/5831

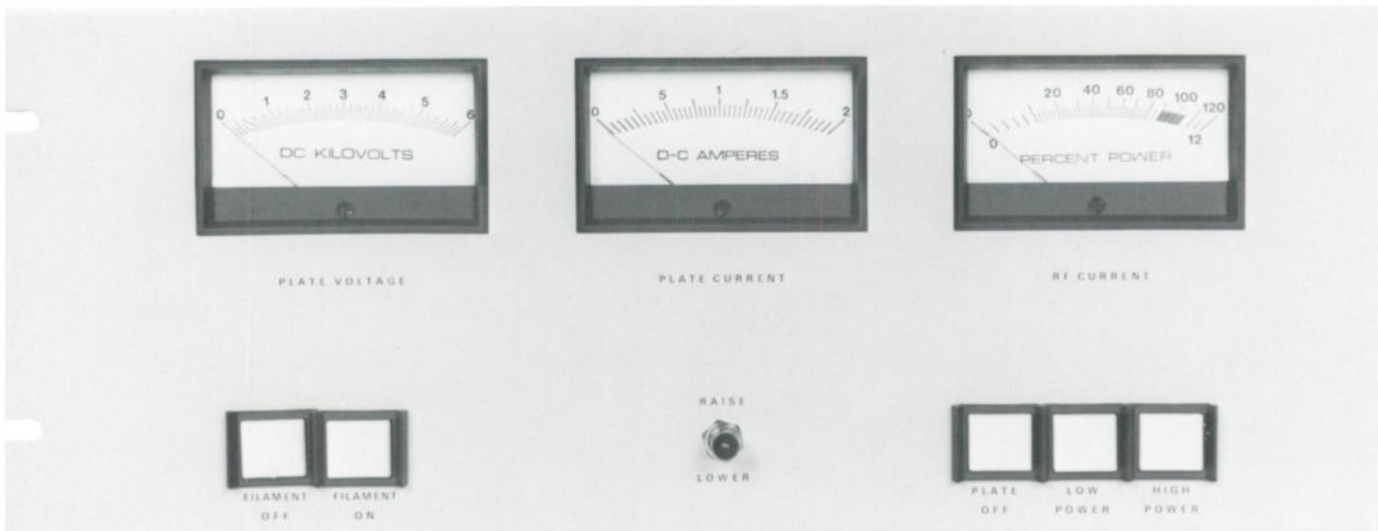

Top: AM extended control and meter panel. Bottom: FM extended control and meter panel.

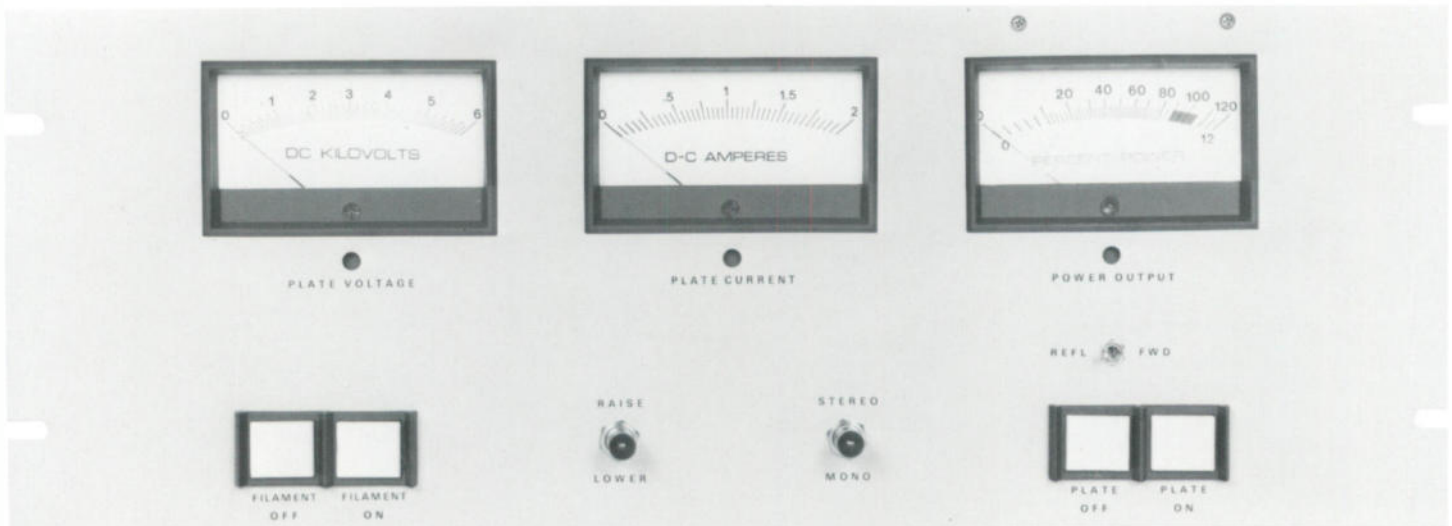

AM and FM extended control and meter panels

AM and FM transmitter extended control and meter panels are used in situations where the operator cannot view the transmitter but must be able to control it and read critical meters.

The AM control panel provides meters for reading plate voltage, plate current and RF line current. Controls are provided for filament on/off, raise/lower, plate off, low power and

high power.

The FM control panel provides meters for reading plate voltage, plate current and power output with provisions for reading reflected power. Controls are provided for filament on/off, raise/lower, stereo-mono mode, plate on and plate off.

These panels meet FCC requirements (73.276) for operation of a transmitter in the same building, on the same floor, or not more than one

story above or below the transmitter, and where operator's ready path to the transmitter is not more than 100 feet (30.5 m).

Size:

19" (48.3 cm) W x 7" (17.78 cm) H x 5-1/2" (13.9 cm) D

Weight:

7 lb (31.7 kg)

All specifications are subject to change without notice.



AM AND FM TRANSMITTER EXTENDED CONTROL AND METER PANELS



Top: AM extended meter panel. Bottom: FM extended meter panel.

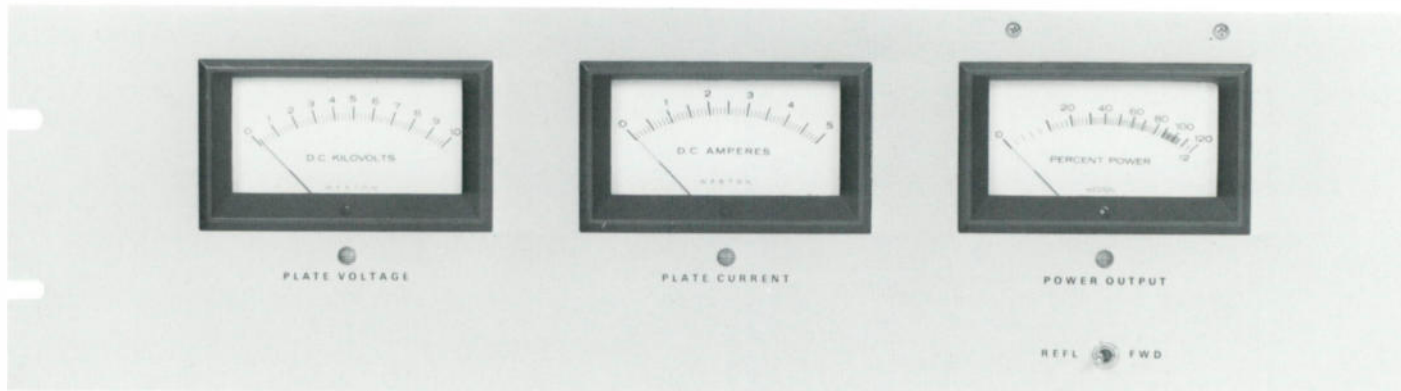

AM and FM extended meter panels

AM and FM transmitter extended meter panels are used in those situations where the operator can view the transmitter but is too far away to be able to read critical meters.

The AM meter panel provides meters for plate voltage, plate current and RF line current.

The FM panel provides meters for plate voltage, plate current and power output with provisions for reading reflected power.

Size:

19" (48.3 cm) W x 5-1/4" (13.3 cm) H
x 5-1/2" (13.9 cm) D

Weight:

5 lb (2.27 kg)

All specifications are subject to change without notice.
© 1987 Continental Electronics / 6373
Printed in USA 1M387



Continental Electronics



® a Division of Varian Associates, Inc. PO Box 270879 Dallas, Texas 75227 Ph: (214) 381-7161 Telex: 73-398 varian