

Olson®

FOR THE ELECTRONICS IN YOUR LIFE

© Olson Electronics 1973

1974 ELECTRONICS
CATALOG NO. 740

FEATURING THE NEWEST AND THE BEST NAME-BRAND PRODUCTS!

• STEREO AND 4-CHANNEL SOUND SYSTEMS • TAPE RECORDERS AND ACCESSORIES • TV • CB AND HAM GEAR • RADIOS • PHONOS • KITS • ANTENNAS • PA SYSTEMS • VHF-UHF MONITORS • SECURITY • TEST EQUIPMENT • CALCULATORS • PARTS • TUBES • BATTERIES • MUCH MORE

Complete IndexPage 151
Satisfaction GuaranteedPages 3, 6, 152
Store LocationsPage 5
Ordering and Charge/Credit InformationPages 3-5, 152
Order FormPage 153

LAWRENCE LAKASHMAN, President

A TELETYPE COMPANY

260 SOUTH
AKRON, OHIO 44301
(216) 535-9191

The electronics field has expanded into a galaxy of products not even dreamed of as little as five years ago--NO industry has moved as fast! Our experts have sorted through these new products and brands in order to bring you the best of these miracles in terms of performance, serviceability and value. We have worked diligently to make our 1974 catalog an essential guide to exciting new electronic products plus parts, accessories and staples that keep existing products in top shape. Our selection is backed by our 40 years of continuous growth...by service facilities at every one of our retail locations...by guaranteed satisfaction for our customers. You can purchase from us with confidence.

Lawrence Lakashman
President, Olson Electronics

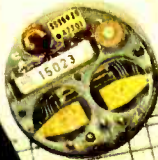

Tone Comp.

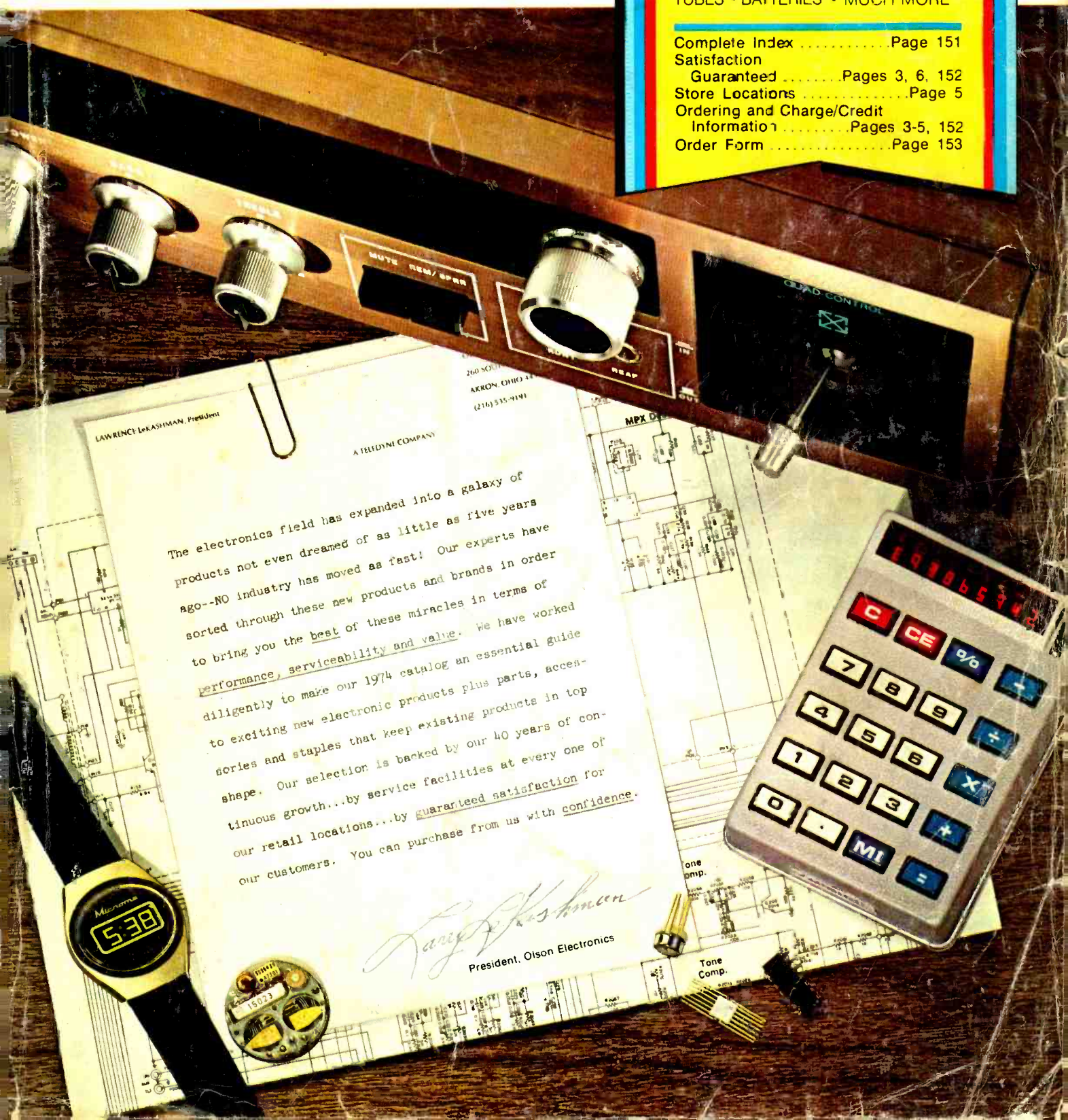



Now There Are TWO "Zero Tracking Error" Turntables



Save ^{up} to **29⁹⁵**

See Cartridge Bonus Below

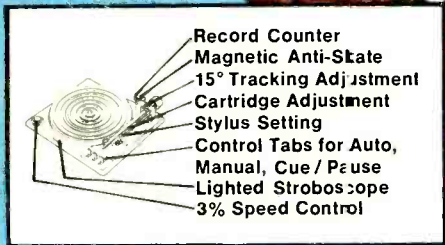

29⁹⁵
base and cartridge extra

The Zero 100C—Garrard's Finest

Has every feature of the famous "Zero 100" plus two dramatic, *new* improvements. First—a built-in counter which records the number of records played—a very important "safety feature" that lets you know exactly when you should replace your cartridge or stylus. Second—two-way damped cueing, provides a smooth lifting action even if the cue control is activated with strong pressure or too suddenly. It's the turntable you **NEED** for truly flawless record reproduction. 33½ and 45-rpm speeds. 15½ x 14½"—requires 4⅝" above, 2½" below mounting board. Base extra (see page 41) and cartridge (below). For 117 VAC.

RP-410J. Shpg. wt. 15 lbs. **209.95**

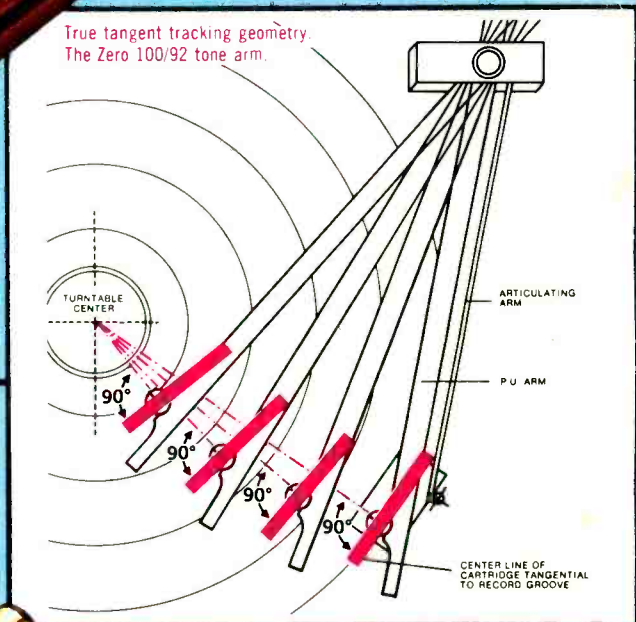

Save ^{up} to **29⁹⁵**

See Cartridge Bonus Below

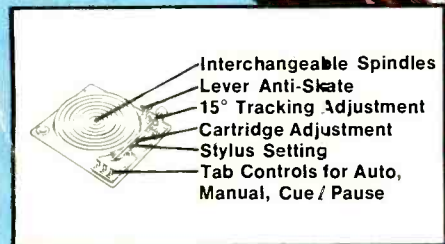

169⁹⁵
base and cartridge extra

The Zero 92—"Mid-Priced" Pro!

Has every feature of the Zero 100C, except for the variable speed, counter, strobe and magnetic anti-skating. The anti-skate control on this model is a lever-type control which provides exceptional precision, second only to the Zero 100C. The cartridge carrier is identical to the Zero 100C, the articulated tone arm is identical in every electrical and functional respect. All in all the differences between this and the Zero 100C above would be significant only to the *most critical and demanding listeners*. Same size as above. Base extra (see page 41) cartridge offers below.

RP-460J. Shpg. wt. 15 lbs. **169.95**

Choice-of-Cartridge Bonus

Reg. \$29.95 Audio-Technica AT-12E. Reg. \$39.95 Audio-Technica AT-13E.
 AS-585J. 1¢ with Zero 100 . . Total 209.96 AS-807J. \$10 with Zero 100 . . Total 219.95
 AS-808J. 1¢ with Zero 92 . . Total 169.96 AS-809J. \$10 with Zero 92 . . Total 179.95

See page 50 for description of cartridges.

from **Olson**®

1 FAMOUS TELEDYNE and OLSON products

exceptional quality that saves you money

2 the best of all the FAMOUS NAME BRANDS

more major lines—more to select in each

3 the famous OLSON Special Buys

bargains you'll find only at Olson

BUY AND SAVE

at your nearest Olson store

Visit any of our stores—see list on page 5 for the store nearest you. Shop in person for the electronics in your life. Enjoy Olson's complete selections and helpful personal service. Pocket BIG SAVINGS on every purchase you make.

SEE COMPLETE STORE LIST ON PAGE 5

Order by mail

Shop the easy way! Make your selections from this complete catalog. To order, use the handy form on page 153—and we'll do the rest. You can count on us to ship exactly what you order in the fastest and best way possible.

Order by phone

Enjoy the extra convenience of shopping by phone. Our Phone Order Desk is at your service 24 hours a day, 7 days a week. Just dial 216-535-1800, and give your C.O.D. or Credit Card order to our personal service shopper.



CHARGE ANY OLSON PURCHASE



USE YOUR MASTER CHARGE OR BANKAMERICARD. Whether you shop in person, by mail, or by phone. You can budget your payments over a period of time, or you can pay your balance in full before your next billing date with NO finance charge. Makes mail order shopping especially easy—all you send is our handy order form with your charge information filled in.

Olson Guarantees Your Satisfaction

If, for any reason, you are not satisfied with your purchase, return it to us within 30 days for exchange or credit (less transportation charges). Page 152.

SEE DETAILED DOUBLE GUARANTEE ON PAGE 152
FOR OUR SPECIAL HI-FI GUARANTEES, SEE PAGE 6.

HANDY INDEX

Alarms 156-162, 166
 Amateur Gear 112-120, 206, 209, 213
ANTENNAS
 Amateur/SWL 114, 115, 117, 209, 213
 CB 204, 208, 213
 Scanner 219
 TV, FM, and Accessories 27, 155, 192-201
 Audio Accessories 49, 70, 71
AUTO
 Radios, Tape Players 136-150, 165
 Speakers 138, 139, 163
 Accessories 87, 89, 94, 137-139, 155, 159, 162-166
 Batteries 102, 103
 Books 109-111, 168, 171, 175
 Calculators 98-101
 Cartridges, Phono 50-52
 CB Equipment 161, 202-214
 Color Lights 228, 229
 Fiber Optics 105, 229
 Four-Channel Hi-Fi 7-12, 15-17, 18-21, 24-35, 45, 46, 240
 Garage Door Opener 136
 Headphones 21, 53-55, 119, 164
HI-FI STEREO
 Amplifiers 18, 28, 29, 33, 46
 Cabinetry & Carts 42-44
 Four-Channel 7-12, 15-17, 18-21, 24-35, 45, 46, 240
 Receivers 7-27, 29-35, 45
 Speakers 26, 56-69, 78
 Tuners 28, 29, 46
 Ignition Systems 162, 166
 Intercoms 72, 73
KITS
 Marine Equipment 120, 122
 Microphones 74-77, 116
 Monitors & Accessories 205, 215-219
 Motors 187
 Parts Values 167-179, 182-191
 Power Supplies 104, 108, 116, 117, 119, 137, 177
 Power Tools 90, 91
PUBLIC ADDRESS 69, 72, 78-81, 230
RADIOS
 Table and Portable, Multi-band, Police, Weather 154, 215-227
 Record Changers,
 Turntables 2, 21, 36-41, 48, 49
 Recording Tape 130-135
 Relays 182, 183
 Security Equip 156-162, 166
 Semiconductors 174, 175, 179
 Soldering Equipment 87, 93, 94, 183
SPEAKERS & SPEAKER SYSTEMS
 26, 56-69, 78, 138, 139, 163, 164
 Switches 116, 176, 206
 Tape Recorders, Decks, Players,
 Cartridge, Cassette, Reel-to-Reel &
 Access 18, 24, 55, 97, 128-135, 142-149, 231-243
 Telephones & Access 125-129
 Test Equipment 82-89, 95
 Tools and Hardware 90-94, 96, 123, 124
 Treasure Finders 122
 Closed Circuit TV 156, 157
 TV Sets 47, 157
 Tubes 189-191
 Walkie-Talkies 161, 203, 207
 Watches preceding page 63, 121, 166
 Wire and Cable 180-181

for **COMPLETE INDEX**
 & INDEX OF MANUFACTURERS
SEE PAGE 151

for the electronics in your life—
shop at your nearest Olson store



you'll like our special services ▼



STEREO HI-FI COMPARISON DEMONSTRATIONS

Custom-select your Stereo System in the Audio Department at any Olson store. Here you can listen to and compare a wide variety of hi-fi component combinations. Make your selection from our own exclusive Teledyne and Olson Stereo components or from our stocks of famous name equipment.



CATALOG ORDER STATION

Now you can order any item in this catalog at any Olson store. Just step up to the Catalog Order Station and our friendly salespeople will help you write your order for catalog items not in stock for over-the-counter delivery. We'll ship your order fast from our main warehouse in Akron. You can specify delivery to your home, or you can ask for will-call store delivery for easy pickup. All orders placed at the Catalog Counter can be charged, of course, to your BankAmericard or Master Charge.

you'll like our people

We try our best to make your shopping experience at any Olson store a pleasant one. And no one tries harder than our carefully trained sales people. We believe you will find them well-informed and interested in helping you. They know how to answer your questions and are qualified to make money-saving product recommendations that fit your needs in the most satisfying way.

you'll like our prices

We save you money in a lot of ways! Our own exclusive Teledyne and Olson products are priced far below competitive equipment of anywhere near comparable quality. Our special value buys—available only from Olson—are unbeatable. You won't want to miss them! Finally, our giant purchasing power enables us to meet any competition—and that means you save when you buy at Olson!

you'll like our in-store electronics repair facilities



at Olson, Service Is Part Of The Sale

Each of our stores services what we sell, whether purchased by mail or in any of our stores. We'll also service products bought elsewhere, since we're fully staffed with qualified technicians expert at all types of electronics repair. We're the only nation-wide network of full-line electronics stores offering such complete service facilities. You can buy with confidence from Olson because you always know "Service is Part of the Sale".

you'll like our trade-ins

We invite your trade-ins on audio components, Ham, CB, PA, & test equipment. Just bring what you want to trade to your Olson store. Regardless of age or condition, we'll make you the fairest offer toward the purchase of any new equipment from us. Save even more with a trade-in deal at Olson!

FREE Tube Testing Available In Every Olson Store

now 80* full-line Olson Stores nationwide

your one-stop source for everything in electronics

*And more opening all the time—everywhere! Watch for Grand Opening ads . . . check your Yellow Pages

CALIFORNIA

- BURBANK** 4115 W. Burbank Blvd. 91503
(213) 842-3494
- EL CAJON** Parkway Plaza
Regional Shopping Center
Opening Sept '73
- INGLEWOOD** 4642 West Century Blvd. 90304
(213) 674-5740
- LONG BEACH** 714 Pine Avenue 90813
(213) 436-3222
- LOS ANGELES** 3620 West Pico Blvd. 90019
(213) 731-2177
- LYNWOOD** 10906 Atlantic Avenue 90262
(213) 639-2372
- PASADENA** 30 North Lake Avenue 91101
(213) 796-3134
- POMONA** 680 West Holt Avenue 91768
(714) 623-0673
- SAN DIEGO** 2519 El Cajon Blvd. 92104
(714) 297-2946
- SAN DIEGO** Kerny Mesa
Convoy and Ranson
Opening Sept '73
- SANTA ANA** 1329 South Main Street 92707
(714) 541-6673
- SANTA CLARA** 2125 El Camino Real 95051
(408) 248-4886
- TORRANCE** 20914 South Hawthorne Blvd. 90503
(213) 542-9282
- WHITTIER** 14301 East Whittier Blvd. 90605
(213) 696-3313

FLORIDA

- CORAL GABLES** 5833 Ponce de Leon Blvd. 33146
(305) 666-3327
- FORT LAUDERDALE** 2808 North Federal Hwy. 33306
(305) 566-7819
- HIALEAH** 40 W. 49th St. 33012
(305) 823-1600
- HOLLYWOOD** 2318 Hollywood Blvd. 33020
(305) 925-7272
- MIAMI** 1644 N.E. Second Ave. 33132
(305) 374-4121
- ST. PETERSBURG** Tyrone Square Shopping Center
6901 22nd Ave. N.
Opening Sept '73
- TAMPA** 1215 Dale Mabry Hwy. 33609
(813) 253-3129

GEORGIA

- ATLANTA** 485 Peachtree St. N.E. 30308
(404) 873-5656
- ATLANTA** Westgate Shopping Center
3131 Campbellton Rd. S.W. 30311
(404) 349-3628
- DECATUR** Suburban Plaza Shopping Center
2571 North Decatur Road 30033
(404) 378-4201
- SANDY SPRINGS** Cromwell Square Shopping Center
6334 Roswell Road 30328
(404) 255-5778

ILLINOIS

- CHICAGO** 4101 North Milwaukee Ave. 60641
(312) 545-7336
- CHICAGO** 123 N. Western Avenue 60612
(312) 421-3533
- CHICAGO** Evergreen Park
2641 W. 95th St. 60642
(312) 425-6192

- OWNER'S GROVE** 1734 Ogden Avenue 60515
(312) 852-9650
- HOFFMAN ESTATES** 721 W. Golf Road 60172
(312) 882-7330
- MELROSE PARK** 1354 Winston Plaza 60160
(312) 344-6200
- MORTON GROVE** 6231 Dempster Street 60053
(312) 966-6700

INDIANA

- BLOOMINGTON** 435 S. Walnut 47401
(812) 339-3981
- CLARKSVILLE** Greentree Mall 47130
(812) 283-4433
- INDIANAPOLIS** 5353 North Keystone 46220
(317) 253-1584
- INDIANAPOLIS** 3400 S. U.S. 31 46227
(317) 783-2926

KENTUCKY

- LEXINGTON** 117 Southland Drive 40503
(606) 278-9413
- LOUISVILLE** 4137 Shelbyville Rd 40307
(502) 893-2562

MICHIGAN

- ALLEN PARK** 15847 Southfield Rd. 48101
(313) 388-9150
- BLOOMFIELD HILLS** 1990 Woodward 48013
(313) 334-4759
- DETROIT** 29097 Dequince Rd.
Madison Hts. Michigan
Opening Oct '73
- DETROIT** 15620 Grand River Ave. 48227
(313) 838-0777
- DETROIT** 14243 Grotiot Ave. 48205
(313) 372-1317
- LIVONIA** 19045 Middlebelt Rd. 48152
(313) 477-0210
- MT. CLEMENS** 37627 Grotiot Ave. 48043
(313) 463-7074
- WESTLAND** 200 North Wayne Rd. 48185
(313) 722-3440

MISSOURI

- FLORISSANT** Florissant Meadows Shopping Center
750 North Hwy. 140 63031
(314) 838-1800
- ST. LOUIS** Central City Shopping Center 63129
4425 LeMay Ferry Rd.
(314) 892-2900
- ST. LOUIS** 1517 Olive St. 63103
(314) 241-2911

NEVADA

- LAS VEGAS** Wonderworld
3651 Mayland Parkway 89109
(702) 732-2755
- LAS VEGAS** Wonderworld
1560 N. 25th St. 89106
(702) 642-6069

NEW YORK

- BUFFALO** 3259 Sheridan Drive 14226
(716) 837-6300
- BUFFALO** 711 Main St. 14203
(716) 856-2504
- BUFFALO** 4401 Transit Rd. 14221
(716) 633-6644

OHIO

- AKRON** Summit Mall
3265 W. Market St. 44313
Opening Aug '73
- AKRON** 69 West State St. 44308
(216) 762-0301
- AKRON** Chapel Hill Shopping Center
1994 Brittain Rd. 44310
(216) 633-4338
- BEAUFORD** 414 Northfield Rd. 44146
(216) 663-5970
- CLEVELAND** 2020 Euclid Ave. 44115
(216) 621-6387
- CLEVELAND** Mayfield Heights
6153 Mayfield Road 44214
(216) 449-2690
- CLEVELAND** River Plaza Shopping Center
21850 Center Ridge Rd. 44116
(216) 331-4600
- CLEVELAND** Southland Shopping Center
6813 Pearl Road 44130
(216) 845-2424
- CINCINNATI** 815 Main St. 45202
(513) 621-9393
- CINCINNATI** Northgate Mall
9719 Colerain Ave. 45239
Opening Oct '73
- COLUMBUS** 3745 East Broad St. 43213
(614) 231-7308
- COLUMBUS** 2280 Morse Rd. 43229
(614) 475-3366
- PARMA** 1193 W. Pleasant Valley Rd. 44134
(216) 888-6366
- WILLOUGHBY** Willo Plaza Shopping Center
36212 Euclid Ave. 44094
(216) 946-5457
- YOUNGSTOWN** Southern Park Mall Shopping Center
7401 Market St. 44512
Opening Sept '73

PENNSYLVANIA

- PITTSBURGH** 5918 Penn Ave. 15206
(412) 362-1333
- PITTSBURGH** 3405 Saw Mill Run Road 15227
(412) 881-0702

TEXAS

- DALLAS** 6215 Hillcrest Ave. 75205
(214) 528-6420
- DALLAS** 420 Northlake Shopping Center 75238
(214) 341-4513
- DALLAS** 105 Preston Valley Shopping Center 75230
(214) 233-8881
- HOUSTON** Windsor Plaza Shopping Center
5154 Richmond Ave. 77027
(713) 622-0011
- HOUSTON** Memorial Square Shopping Center
825 Frostwood Drive 77024
(713) 464-5546
- PASADENA** 2025 S. Richey 77502
(713) 477-6479
- WISCONSIN**
- MILWAUKEE** 423 W. Michigan St. 53203
(414) 271-9920
- MILWAUKEE** 5830 W. Fond du Lac Ave. 53218
(414) 461-0700
- WEST ALLIS** 3125 South 108th St. (Hwy. 100) 53227
(414) 541-1406

For Store Hours, Check the Store in Your Locality

you'll like our unadvertised bargains

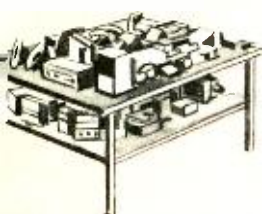

SAVE UP TO 75%! Be sure to look for the special Bargain Display you'll find in every Olson store. Check it for huge savings on trade-ins, demonstrators, special close-outs, overstocks, ones-of-a-kind. All items are sold "as is" but at our price savings of 50% to 75%, you just can't lose! Remember, these are unadvertised bargains, so come in and make your own big money-saving "finds".

you'll like our flexible credit policy

Of course you can use your Master Charge or BankAmericard to charge your purchases at any Olson store. It's the easy way to own "the electronics in your life" right now.

Important: Most Olson stores also have their own Extended Payment Plan offering you special credit advantages. Be sure to check with your local Olson store and use the credit plan which is best for you.





why so many careful buyers
select their stereo hi-fi at **Olson**.

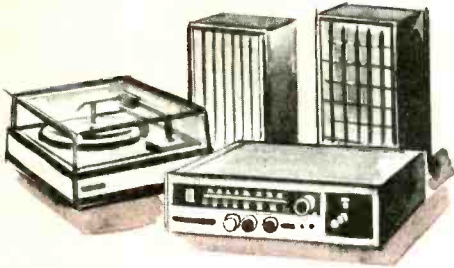
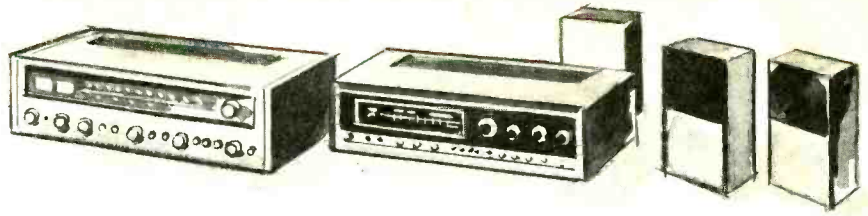

1 you save on TELEDYNE and OLSON products

Our own exclusive TELEDYNE and OLSON high-fidelity components, developed, designed and built to the finest audio standards, offer you an opportunity to own and enjoy the best in Stereo entertainment at very substantial savings.

2 you save on Olson-priced complete systems

Whether you choose an Olson expert-selected system from among the many offered in this catalog, or ask for a quotation on your own system selection—you'll find you get the biggest system savings from Olson.

3 you select from the largest offering of famous brands

Olson offers you the best of the famous hi-fi brands, in a wide selection of components and systems. NOW you can buy these major brands conveniently by mail, as well as at any Olson store.

4 you enjoy these great hi-fi guarantees

When you buy your hi-fi components or system from Olson, you enjoy the protection of the strongest components guarantees ever made. In addition to the standard Manufacturers' guarantees, you get Olson's own **extra** guarantees on specific components as follows:

High-Fidelity Speaker Systems (where indicated) / **5 YEARS**

Hi-Fi Receivers, Tuners, Amplifiers (where indicated) / **2 YEARS**

All other items carry a minimum 90-DAY GUARANTEE
(Kits carry a 90-day parts-only guarantee)

See Page 152 For Terms

TELEDYNE
SANYO AKAI
 KOSS PIONEER
 Fisher Garrard Dual
 EMPIRE JVC
 AR Wollensak 3M
 SHURE
 ElectroVoice Jensen
 And Many Other Famous Brands

a few simple words about 4-CHANNEL SOUND:

4-Channel Sound is the latest innovation in high-fidelity recording and playback. It promises a new dimension in listening enjoyment. In the present state of the art, 3 basic types of 4-Channel sound have emerged, and all of them are fully compatible with stereo. Any or all of these are currently available from Olson. To help you understand 4-Channel, we offer this simplified explanation of the 3 types currently offered:

1. DISCRETE 4-CHANNEL: A method in which 4 independent signals, originating from 4 separate recordings, are played back simultaneously through 4 channels of amplification and 4 speakers or 4-Channel headphones. This system is currently limited to 4-Channel tape recordings (reel-to-reel or 8-track cartridges) and the CD-4 4-Channel discs.

2. SQ 4-CHANNEL (MATRIX): This method encodes 4-Channel recordings into 2 channels, for recovery later as a 4-Channel playback. It is primarily a disc system. The SQ system is the preferred matrix system, but *all* matrix material can be decoded reasonably well with the decoders sold by Olson. SQ recordings can also be broadcast via FM Stereo. Both the recordings and broadcasts are reproduced by playback equipment with SQ circuitry, which decodes the original 4 channels and plays them back simultaneously through 4 separate amplifiers and 4 speakers or 4-Channel headphones.

3. PHASE POWER SYNTHESIZED 4-CHANNEL (SIMULATED): This circuit device enhances the quality of 2-Channel recordings played on a 4-speaker system. It recovers the ambient sounds inherent in most stereo records, tapes, and FM broadcasts, (sounds which are "hidden" in conventional 2-Channel system reproduction) and feeds them to the two rear speaker channels. This results in a pleasing listening experience.

REMEMBER: Any 2-Channel Stereo System you buy from Olson can be converted economically at any future time to 4-Channel! Any 4-Channel system is fully compatible with stereo reproduction in all modes—FM, records, tape.

Unlimited System Selection

This catalog offers you the largest selection of complete Stereo hi-fi systems, both 2-channel and 4-channel, you'll find anywhere. You can choose a system at the price you want to pay. You can choose a top-value Teledyne or Olson component system. You can select a famous-brand component system. Simply fill out the hi-fi quote card, bring it to any of our stores or mail it in—and we'll come up with a great money-saving quotation. No one, but no one, gives you a hi-fi system selection that matches Olson's!

COMPLETE—JUST PLUG IN AND PLAY!

Whether you select a simple 2-channel radio-phonograph system or a multi-component "total" 4-channel system including tape recording and playback capabilities, Olson makes it simple to connect. Clearly marked cables are provided for foolproof interconnection of speakers, receiver, turntable, tape components, etc. You just plug in and play—it's that easy!

Big Savings on Olson 4-Channel Systems



Now's the time to "Go 4-channel" the Olson way and pocket BIG system savings. Move out of the "Stereo Concert Hall" and into the "4-Channel Experience."



240-Watt 4-Channel Teledyne RA-632 System
 Enjoy "Living Sound" Twice as Good as Stereo

Save ~~\$128.68~~ **\$656**
 Separate Items Reg. \$784.68

- RA-632 240-Watt FM/AM 4-Channel Receiver Page 8
- Garrard 82 3-Speed Changer with Audio-Technica AT-12E Magnetic Cartridge, Base, Dust Cover Page 38
- Four Teledyne-Olson SS-930 10" Two-Way Speaker Systems Page 56
- All Cables and Plugs Including 100' Speaker Wire

Perfectly matched components ready to deliver any type of 4-channel sound. The powerful and highly sensitive receiver can easily handle all discrete or encoded 4-channel material—records, tapes, or FM. The universal decoder also synthesizes 4-channel sound from regular stereo records and broadcasts. The turntable features adjustable, damped counterweight for flawless tracking. Each Teledyne-Olson speaker has a 10" woofer, 4" tweeter, and a ducted-port enclosure for 40-18,000 Hz response. A superb audio investment you'll enjoy for years to come.

AS-698J. Shpg. wt. 182 lbs. 656.00

80-Watt 4-Channel Teledyne RA-660 System
 True 4-Channel Sound at a 2-Channel Price

Save ~~\$172.89~~ **\$446**
 Separate Items Reg. \$618.89

- RA-660 80-Watt 4-Channel FM/AM Receiver Page 11
- Garrard SLX-2 3-Speed Changer with Base, Dust Cover, Magnetic Stereo Cartridge with Diamond Stylus Page 38
- Four Teledyne-Olson SS-251 10" 2-Way Speaker Systems Page 56
- Teledyne PH-220 4-Channel Headphones Page 53

Olson's 4-channel system for music lovers on a budget. The receiver has a universal matrix circuit that decodes both E-V and SQ 4-channel records, tapes, and FM, plus a 4-channel amplifier for discrete tapes and discs. Also provides synthesized 4-channel sound from ordinary stereo. The changer has a low-mass tubular arm for "feather-light" tracking. The speakers feature "Aperiodic Design" for a close impedance match at all frequencies for deeper, more natural bass. The headphones give you all the 2 or 4 channel "privacy" you need! With all cables, plugs, including 100' speaker wire.

AS-699J. Shpg. wt. 159 lbs. 446.00

RECEIVERS COVERED BY THE FAMOUS OLSON
2-YEAR GUARANTEE
 SEE PAGE 6

SPEAKERS COVERED BY THE FAMOUS OLSON
5-YEAR GUARANTEE
 SEE PAGE 6

Our Best 4-Channel Receiver Does Everything the \$350 to \$500 Models Do



TELEDYNE RA-632 Stereo/Discrete 4-Channel 240-Watt FM-AM Receiver

259⁹⁸

Use Your
Credit Card



COVERED BY THE FAMOUS OLSON
2-YEAR GUARANTEE
SEE PAGE 6

The Teledyne RA-632 is all you need in a receiver today, and it's ready for any kind of sound that comes along tomorrow. Has 4-channel inputs for discrete tapes and matrixed discs, a universal 4-channel decoder that turns your regular stereo to 4-channel at the push of a button, AND lets you play SQ or E-V encoded records and receive 4-channel FM broadcasts. The FM tuner has an IC, an FET and a crystal filter for all the sensitivity and selectivity you can use; the amplifier has a full 240 watts power (that's enough for most any speaker systems) and front panel jacks for stereo or new 4-channel headphones. Combination tuning meter indicates signal-strength for AM, center-channel for FM (the most pre-

- 4-Channel Amplifier for Discrete Q8 and Open-Reel Tape Playback
- Universal Matrix Decoder Circuitry
- Synthesizer for 4-Channel Effect from All 2-Channel Stereo Sources
- 360° "Joystick" Quad-Control for Front-Rear/Left-Right Balancing
- "Command Control" Input Selector/Mode Pushbuttons for Simple Operation
- Walnut-Grain Enclosure Included

cise for each!) The FM muting stops interstation hiss when tuning. Dual-concentric bass and treble controls provide separate, independent adjustment of front and rear channels, special 4-channel "Joystick" control provides 360° balance of left, right, front and rear. Pushbuttons select Tape Monitor, FM Mute, Loudness, Stereo-Mono, and Remote Speakers. You'll like just looking at it too—the RA-632 has machined control knobs, a sleek brushed aluminum front panel, a black-out dial that's an impressive "electric blue-green" when power is "on." The walnut wood grain enclosure is included—value you usually pay extra for. All in all, another superb Olson value.
RA-632J. Shpg. wt. 20 lbs. 259.98



Decode Button
Puts the World of 4-Channel Sound at Your Fingertips.



Headphone Jacks
2 or 4-Channel "Privacy" with All the Volume You Like.



Tape-In Jacks
Use the RA-632 with Discrete 4-Channel Tape Recorders.

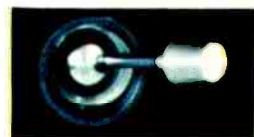

4-Channel Balance
360° "Joystick Control" for Sound the Way You Want It.



Loudness Control
Stops "Bass Fadeout" at Low Volume Levels.

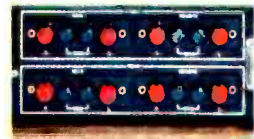

Speaker "Slots"
8 Spring Connectors for Easy Hookup of Main and Remote Speakers.

SPECIFICATIONS

Power Output: 240 watts MP, 60 watts RMS total. **Total Harmonic Distortion:** 0.8%. **Power Bandwidth:** 19-35,000 Hz. **Frequency Response:** 17-20,000 Hz. **S/N Ratio:** Aux., 72 dB; Mag. Phono, 60 dB. **Input Sensitivity:** Aux., 145 mV; Mag. Phono, 1.75 mV. **FM Sensitivity:** 3.0 μ V (IHF). **Harmonic Distortion:** 0.35%. **Signal-to-Noise:** 63 dB. **Selectivity:** 45 dB. **Channel Sep-**

aration: 32 dB at 1 kHz. **Image Rejection:** 55 dB. **AM Sensitivity:** 160 μ V. **Distortion:** 1%. **IF Rejection:** 40 dB. **Image Rejection:** 40 dB. **4-Channel Inputs:** Tape-In/CD-4/Tape Monitor. **2-Channel Inputs:** Mag. Phono, Aux. **Outputs:** 4-16 ohm speakers (4 main, 4 remote); hi-Z headphones, stereo recording. 18½ W x 4 7/8" H x 12" D. For 117 VAC, 50-60 Hz.

For MONEY-SAVING RA-632 Complete 4-Channel Systems see following page

RA-632 4-Channel Systems at Olson-Size Savings

Our Lowest-Priced RA-632 System

Save **\$137.71** **\$470**

Separate
Items Reg.
\$607.71

- RA-632 240-Watt 4-Channel FM/AM Receiver
- Garrard 42M 3-Speed Turntable with Base, Shure M75ECS Magnetic Cartridge Page 40
- Two Utah WD-90 3-Way 12" Acoustic-Suspension Bookshelf Speakers Page 62
- Two Utah AS-2A 2-Way 8" Acoustic-Suspension Bookshelf Speakers Page 62

Hear the "better-than-front-row" realism of true 4-channel at a "stereo-only" price! Good phono, good speakers, and our best 4-channel receiver, so you can update it when you're ready. Includes all cables, plugs, 100' speaker wire for fast 'n easy setup.

AS-702J. Shpg. wt. 146 lbs. 470.00



under \$480

"Music Lover's Special" RA-632 System

Save **\$144.23** **\$720**

Separate
Items Reg.
\$864.23

- RA-632 240-Watt 4-Channel FM/AM Receiver
- Dual 1214 3-Speed Turntable with Base, Cover, Audio-Technica AT-12E Elliptical-Diamond "Dual-Magnet" Cartridge Page 37
- Two Teledyne SS-175 "X-Air" 4-Way 12" Speakers with 40-20,000 Hz Response Page 56
- Two Olson SP-014 3-Way 8" Speakers Page 59

Sounds you'll love at savings you'll love. Our mid-priced system features a precision turntable that "pampers" your records with light tracking and a "bounce-proof" cuing control, exclusive Teledyne-Olson speakers with fretwork wooden grilles, plus all cables and plugs, 100' speaker wire.

AS-701J. Shpg. wt. 163 lbs. 720.00



under \$750

Our Finest RA-632 System

Save **\$153.81** **\$990**

Separate
Items Reg.
\$1143.81

- RA-632 240-Watt 4-Channel FM/AM Receiver
- Dual 1229 Automatic Turntable with Base, Cover, Audio-Technica AT-14S "Dual-Magnet" Elliptical-Stylus Cartridge Page 37
- Four AR-2AX 3-Way 10" Speakers Featuring Independent Level Controls for Mid and High Frequencies, Walnut Cabinets Page 61

Everything you need for a lifetime of 4-channel listening! Our best 4-channel receiver, Dual's best 3-speed turntable, AR's famous 2AX speaker systems. Plus all plugs and cables including 100' speaker wire. Take it home, plug it in, and play it!

AS-703J. Shpg. wt. 201 lbs. 990.00



under \$1000

Enliven "The 4-Channel Experience"

Save **\$27.36** **\$75**

With Any
System Above

Separate
Items Reg.
\$102.36

- Gusdorf 4470 Heavy-Duty Equipment Cart
 - Olson "Pickup Arm Style" Record Cleaner
 - Complete Audio Cable/Adapter Kit
 - Teledyne PH-220 4-Channel Headphones
 - SQ- 4-Channel Setup and Demonstration 12" LP
- AS-704J. Shpg. wt. 33 lbs. . . With Above Systems 75.00

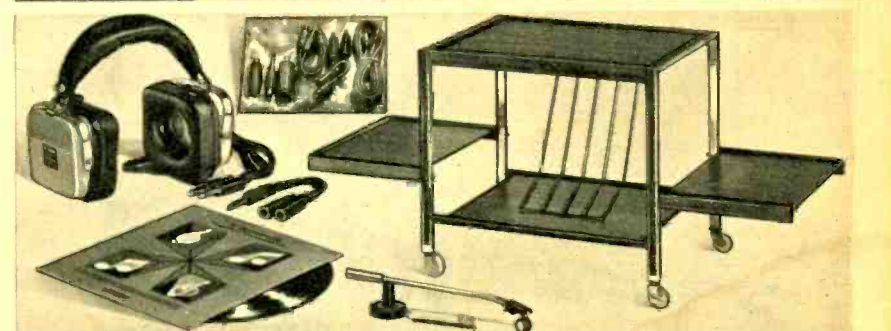

Value Packed RA-660 4-Channel Music Systems

under \$280



4-Channel Sound at an "Un-Heard" of Price

Save **\$77.86** **\$275**

Separate Items Reg. \$352.86

- RA-660 80-Watt 4-Channel FM/AM Receiver
 - Olson RP-438 4-Speed Changer with Base, Dust Cover, and Stereo Cartridge Page 49
 - 4 Olson SP-013 8" Two-Way Speakers Page 59
- One of the finest bargains available in a 4-channel system. The well-designed speaker systems provide deep bass without booming and their compact size makes them excellent for bookshelf placement. Changer is ready to plug in and use (no complicated hook-up necessary). And the 100' speaker wire gives you complete installation ease!
- AS-709J. Shpg. wt. 93 lbs. 275.00

under \$390



More 4-Channel at "Sound" Savings

Save **\$158.68** **\$385**

Separate Items Reg. \$543.68

- RA-660 80-Watt 4-Channel FM/AM Receiver
 - Dual 1214 Changer with Base, Dust Cover, Audio-Technica AT-12E Stereo Cartridge Page 37
 - Four Olson SP-0148" Three-Way Speakers Pg. 59
- Great way to start out in 4-channel sound. Turntable features tracking low as 1 gram, low-mass tubular tone arm, damped-cueing to prevent stylus bounce, attractively styled walnut finished base. Each speaker system features 8" acoustic suspension woofer, 3 3/4" tweeter plus 3" "super-tweeter" for broader and brighter response. All plugs and cables plus 100' speaker wire.
- AS-705J. Shpg. wt. 124 lbs. 385.00

under \$430



4-Channel System with Headphones

Save **\$146.40** **\$425**

Separate Items Reg. \$571.40

- RA-660 80-Watt 4-Channel FM/AM Receiver
 - Garrard 42M 3-Speed Turntable with Base, Pickering V15-ATE-4 Cartridge. Page 40
 - Four Teledyne-Olson SS-177 2-Way Speaker Systems Page 56
 - Teledyne PH-220 4-Channel Phones Page 53
- Surround yourself with exciting 4-channel sound at a price that beats the competition. Turntable has 4-pole motor that minimizes rumble and wow, damped cueing, adjustable anti-skate control. Each speaker system features 6 full-range speakers and 1 "super tweeter". Four-channel headphones for private listening. All plugs, cables, 100' speaker wire.
- AS-708J. Shpg. wt. 158 lbs. 425.00

Our Best RA-660 4-Channel Music System

under \$550



Save **\$126.58** **\$545**

Separate Items Reg. \$671.58

- RA-660 80-Watt 4-Channel FM/AM Receiver
 - Garrard 70 Turntable with Base, Dust Cover, Audio-Technica AT-11 Stereo Cartridge Page 39
 - Four SS-251 Teledyne-Olson 10" Two-Way "Aperiodic" Speakers Page 56
 - Koss 4-Channel Phones • Stereo Cart Pg. 44
- Packed with features for "stimulating" 4-channel sound! Turntable has built-in controls for anti-skate, counterweight, stylus pressure. Speaker systems are enhanced by ducted-port enclosure for deep bass. Walnut-finish cart has room for record storage. Headphones for 2 or 4 channel "privacy". All plugs, cables, 100' speaker wire.
- AS-706J. Shpg. wt. 192 lbs. 545.00

Our Low-Price 4-Channel Receiver

Does Everything the \$250 to \$350 Models Do



TELEDYNE

RA-660 Stereo/Discrete 4-Channel 80-Watt FM-AM Receiver

214⁹⁸

Credit Terms Available



COVERED BY THE FAMOUS OLSON
2-YEAR GUARANTEE
SEE PAGE 6

The RA-660 is another proud member of Olson's Teledyne line. It offers a host of features you won't find in other receivers in this price range. It plays all the 2-channel and 4-channel sound around—discrete 4-channel Q8 cartridges and open-reel tapes, E-V and SQ encoded recordings and FM broadcasts. You also get synthesized 4-channel sound from all regular 2-channel stereo sources. The solid-state circuit combines a highly sensitive FET tuner with a clean-sounding 4-channel audio amplifier. There's a 360° "joystick" Quad-Control for simple left-to-right and front-to-rear channel balancing. Front and rear headphone jacks for 2- or 4-channel listening with all the "privacy" you want. Convenient

- 4-Channel Amplifier for Discrete Q8 Cartridges, Reel-to-Reel Tapes
- Universal Matrix Circuit Decodes Both SQ and E-V Encoded Records and FM Broadcasts, Synthesizes 2-Channel Stereo for 4-Channel Effect
- "Command Control" Pushbutton Mode and Program Selectors
- Handsome Enclosure Included

pushbuttons for Tape Monitor, Loudness, Remote Speakers, Stereo-Mono, Decode, Aux, FM and AM. The RA-660 has an "electric blue-green" black-out dial and tuning meter, FM "STEREO" light, weighted flywheel tuning, and a "no-skip" AM tuner for "long-distance" reception. The rear panel has CD-4/Tape-in jacks for discrete 4-channel tapes and monitoring. The front panel is typical of the Teledyne "look" and has an impressive aluminum finish and machined all-metal control knobs. The walnut-grain enclosure is included at no extra cost. There is just no other 4-channel receiver at this price that even comes close to the "660".

RA-660J. Shpg. wt. 18 lbs. 214.98

SPECIFICATIONS

Power Output: 80 watts MP, 20 watts rms total. **Total Harmonic Distortion:** 0.8%. **Power Bandwidth:** 20-36,000 Hz. **Frequency Response:** 17-20,000 Hz. **S/N Ratio:** Aux., 72 dB; Mag. Phono, 60 dB. **Input Sensitivity:** Aux., 145 mV; Mag. Phono, 1.75 mV. **FM Sensitivity:** 3.0 μ V (IHF). **Harmonic Distortion:** 0.35%. **Signal-to-Noise:** 63 dB. **Selectivity:** 45 dB. **Channel Separation:** 32

dB at 1 kHz. **Image Rejection:** 55 dB. **AM Sensitivity:** 160 μ V. **Distortion:** 1%. **IF Rejection:** 40 dB. **Image Rejection:** 40 dB. **4-Channel Inputs:** Tape-In/CD-4/Tape Monitor. **2-Channel Inputs:** Mag. Phono, Aux. **Outputs:** 4-16 ohm speakers (4 main, 4 remote); hi-Z headphones, stereo recording. 18 1/4 W x 4 3/4 H x 11 1/4 D. For 117 VAC, 50-60 Hz.



AFC Button
"Locks" the RA-660 into Weak or Distant FM Stations—Stops Drift and Fading.



Quad Control
360° "Joystick" for Easiest Possible Left, Right, Front, Rear Balance.

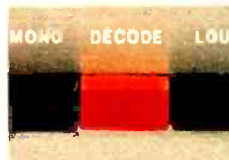

Matrix Decoder
Decodes SQ and E-V Records or FM, Synthesizes Your Regular Stereo.

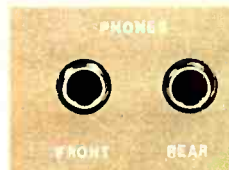

Phone Jacks
Use Stereo or New 4-Channel Phones for "Private Listening" at Any Volume.



Tuning Meter
Combination Meter Shows Signal-Strength for AM, Center-of-Channel for FM.



Tape Monitor
Use with 3-Head Equipment to Monitor Actual Off-Tape Material.

Our Best 2-Channel Receiver



TELEDYNE RA-777 Stereo/Phase-Power 4-Channel 160-Watt FM-AM Receiver

269⁹⁸

Use Your Credit Card



COVERED BY THE FAMOUS OLSON
2-YEAR GUARANTEE
SEE PAGE 6

- Built-in 4-Channel Synthesizer for Quad Effect from Any Stereo Source
- Yellow "Gliding-Light" Dial Pointer and Weighted Flywheel Tuning
- Black-Out Dial Glows "Electric Blue-Green" When Power is On
- Extra-Sensitive AM Tuner Circuit
- Smart Jet-Black Metal Enclosure Included in the Low Price

Our very popular RA-777 is one of the most under-priced stereo components to come along in years. Most competitors' models priced at \$300 or more only "attempt" to match the features and performance of this Olson exclusive. The 777 gives you "Phase Power" circuitry that brings simulated 4-channel sound from all 2-channel stereo recordings and FM broadcasts. Packed with the features you need for great stereo too. FET/IC tuner circuitry for outstanding sensitivity and selectivity, FM (center-of-channel) and AM (signal strength) tuning meters, scratch and rumble filters, FM muting that eliminates interstation noise, FM "STEREO" light, headphone jack, weighted flywheel tuning with a "gliding light" dial pointer for

easy station location. Pushbuttons select Loudness, Power, Tape Monitor and Stereo-Mono. A fully regulated power supply greatly reduces distortion and contributes to higher stability. The "satiny" brushed aluminum finish brings elegance to any stereo setup. The rear panel features protective circuit breakers, push-in terminals for front and rear speakers and antennas, switched and unswitched AC convenience outlets, plus both RCA and DIN jacks for real tape recording/playback versatility. Black "wrinkle finish" metal enclosure. Deluxe enclosure optional, below.

RA-777J. Shpg. wt. 22 lbs. **269.98**
Walnut Grain Enclosure
CA-583J. 6 lbs. **16.98**

SPECIFICATIONS

Power Output: 160 watts MP, 40 watts RMS total. **Total Harmonic Distortion:** 0.8%. **Power Bandwidth:** 20-36,000 Hz. **Frequency Response:** 20-20,000 Hz. **S/N Ratio:** Aux., 72 dB; Mag. Phono, 60 dB. **Input Sensitivity:** Aux., 145 mV; Mag. Phono 2.2 mV. **FM Sensitivity:** 3.0 μ V (IHF). **Harmonic Distortion:** 0.35%. **Signal-to-Noise:** 60 dB. **Selectivity:** 45 dB. **Channel Separation:** 32 dB at

1 kHz. **Image Rejection:** 55 dB. **AM Sensitivity:** 160 μ V. **Distortion:** 1%. **IF Rejection:** 40 dB. **Image Rejection:** 45 dB. **Inputs:** Mag Phono, Aux, Preamplified Tape (RCA-type and DIN jacks) Tape Monitor. **Outputs:** 4-16 ohm speakers (front and rear); hi-Z headphones and recording. 16 1/8" W x 5 7/8" H x 14 3/8" D. For 117 VAC, 50-60 Hz.



Power Pushbutton
No Need to "Fiddle" with Controls Each Time You Turn the Receiver On.



Dual Meters
Center-Channel FM, Signal-Strength AM, for All the Tuning Precision You Need.

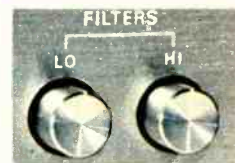

Hi & Lo Filters
Makes "Old" LP's and Scratchy Singles Sound Smooth and Quiet.



FM Muting
Stops "Thumps" and Hisses When Tuning Across the FM Dial.



Speaker "Slots"
Push-In Terminals for Really Easy Hookup of Main and Rear Speakers.



Loudness Control
Provides Plenty of "Bass" Power Even at Low Listening Volume.

RA-777 Systems for Savings That Sound Good

Amazing Low Price for This Quality

Save **\$114.76** **\$410** Separate Items Reg. \$524.76

- RA-777 160-Watt Stereo FM/AM Receiver
- Garrard 70 Turntable with Audio-Technica AT-12E Cartridge, Base, Cover Page 39
- 2 Teledyne "Septette" Speakers Page 56

Here's tremendous value in a component system. The automatic turntable features calibrated anti-skate and counterweight controls for right-on tracking. Each 2-way speaker system has 6 full-range speakers and a super-tweeter for 50-18,000 Hz sound. With all plugs, cable, 100' speaker wire.

AS-710J. Shpg. wt. 125 lbs. 410.00



under \$420

Name Brand Group for Even More Savings

Save **\$117.81** **\$540** Separate Items Reg. \$657.81

- RA-777 160-Watt Stereo FM/AM Receiver
- Garrard 42M3-Speed Turntable with Base, Shure M75ECS Magnetic Cartridge Page 40
- 2 Utah HS4-B 12" 3-Way Speakers Page 62

You'll get fine performance from this stereo component set that fits any decor. Turntable includes low-mass tone arm, damped cueing, pause control. Each speaker system has a 12" woofer, 2" voice coil, midrange horn, dome tweeter with level control. All plugs, cables, 100' speaker wire.

AS-712J. Shpg. wt. 135 lbs. 540.00



under \$550

Our Best RA-777 Stereo Component System

Save **\$155.72** **\$740** Separate Items Reg. \$895.72

- RA-777 160-Watt Stereo FM/AM Receiver
- Garrard ZERO 100 Turntable with Dust Cover, Base, Audio-Technica AT-12E Cartridge Page 2
- 2 Teledyne 4-Way 12" Speakers Page 56

Combination of some of the finest component equipment available! The 2-speed turntable is Garrard's best ever, features articulated tone arm for zero tracking error! Each speaker system has a 12" woofer, 5" midrange cone, 2 1/2" tweeter, 1 1/2" "super"-tweeter, and a stylish fretwork grille. Includes all plugs, cables, and 100' of speaker wire.

AS-711J. Shpg. wt. 130 lbs. 740.00



under \$750



Accessory Groups for RA-777 Systems

Save **\$19.93** **\$80**

Separate Items Reg. \$99.93

- Gusdorf 4470 Entertainment Cabinet Page 44
- Teledyne Electrostatic 219 Stereo Headphones Page 53

The cabinet is ruggedized to take heavy components and its handsome walnut trim and hardboard shelves make it a fine furniture addition. Our finest Teledyne headphones feature electrostatic drivers. 32 lbs. AS-713J. With purchase from this page 80.00



Save **\$19.62** **\$40**

Separate Items Reg. \$59.62

- Gusdorf 3345 Lo-Profile Stereo Cart Page 44
- Teledyne-Olson 173 Headphones Page 53
- HF-144J 20' Headphone Extension Cord

Now you can wheel your system from room-to-room. Cart has speaker supports and walnut-finished shelves. Headphones give you the full impact of "live" performance stereo in complete privacy, with air-filled ear cushions, adjustable headband. 18 lbs. AS-714J. With purchase from this page 40.00

Olson 13

Save Up to \$138.70 on RA-618 Music Systems

under \$320



Just add an extra pair of speakers to any system below for exciting 4-channel "Phase Power."

A Top Value in True Component Stereo

Save \$55.72 **\$319** Separate Items Reg. \$374.72

- RA-618 120-Watt Stereo FM/AM Receiver
- Garrard 70 Turntable with Base, Dust Cover, Audio-Technica AT-12E "Dual-Magnet" Stereo Cartridge with Elliptical Diamond Stylus Page 39
- 2 "Olson-Aire II" 8" Two-Way Speaker Systems in Compact Oiled Walnut Cabinets Page 59

You get plenty of power from a system that's difficult to beat. The turntable features anti-skate and counterweight for sure tracking and longer life for your records. Cartridge has exclusive dual-magnet design for widest stereo separation. Each speaker system includes 8" acoustic-suspension woofer and 3" tweeter. Their heavy wood construction results in good bass without "booming." All plugs and cables included plus 100' speaker wire.

AS-719J. Shpg. wt. 75 lbs. 319.00

under \$490

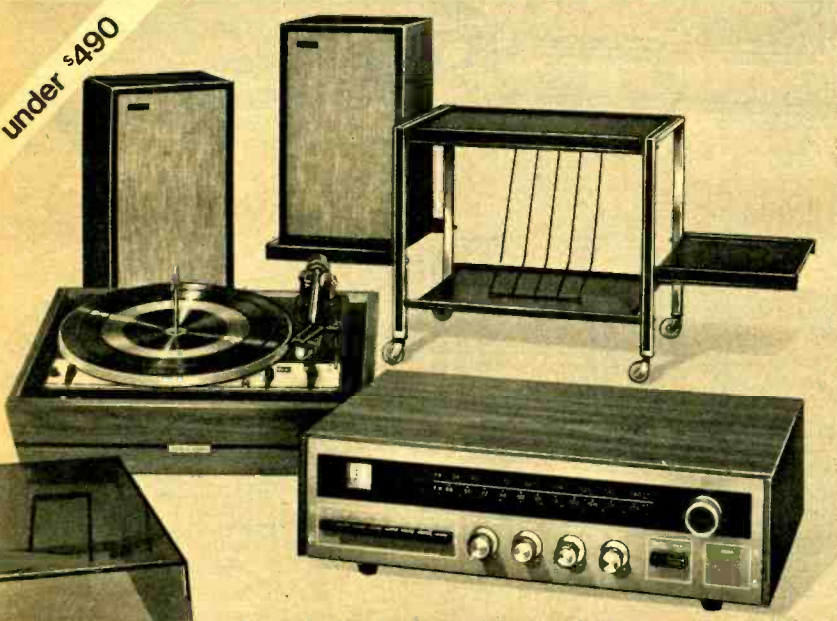

Audio Excellence at Moderate Cost

Save \$87.22 **\$480** Separate Items Reg. \$567.22

- RA-618 120-Watt Stereo FM/AM Receiver
- Dual 1216 Turntable with Base, Dust Cover, Audio-Technica AT-13E "Dual-Magnet" Cartridge with Elliptical Diamond Stylus Page 37
- 2 Teledyne SS-251 10" 2-Way "Aperiodic Design" Speaker Systems Page 56
- Gusdorf 3345 Rollabout Stereo Cart Page 44

A great sounding combination of components. The high-performance turntable features low-mass tubular tone arm, damped cueing to prevent stylus bounce, and 6% variable pitch control. Each speaker has 10" woofer and soft-dome tweeter, special "Aperiodic Design" to assure close impedance match at all frequencies for truer and deeper bass. The walnut-finish stereo cart has room for all components plus records. With all cables, 100' speaker wire.

AS-720J. Shpg. wt. 120 lbs. 480.00

under \$650



Our Finest RA-618 Stereo System

Save \$138.70 **\$647** Separate Items Reg. \$785.70

- RA-618 120-Watt Stereo FM/AM Receiver
- Garrard 82 Turntable with Base, Dust Cover, Audio-Technica AT-14S Elliptical Diamond Stylus "Dual-Magnet" Cartridge Page 38
- 2 Teledyne SS-175 4-Way 12" Speakers Page 56
- Teledyne Model 173 Stereo Headphones Page 53

A fine blend of quality components at tremendous savings! Turntable features ultra-low-mass "floating" tone arm, anti-skate, damped counterweight for flawless tracking. Each speaker has 12" woofer, 5" midrange cone, 2" tweeter and 1½" super-tweeter—plus stylish fretwork grille for good looks in any setup. The headphones provide the full impact of "live performance" stereo in complete privacy. With all plugs, cables, 100' speaker wire.

AS-721J. Shpg. wt. 130 lbs. 647.00

Our "Better" 2-Channel Receiver

Better Than Its Competition—Better Than Its Price



TELEDYNE

189⁹⁸

Use Your
Credit Card



COVERED BY THE FAMOUS OLSON
2-YEAR GUARANTEE
SEE PAGE 6

RA-618 120-Watt Stereo/Phase-Power 4-Channel FM-AM Receiver

- "Phase Power" Synthesizer Enhances Stereo Sources with "Surround Sound" 4-Channel Effect
- Solid-State Circuitry Includes IC's for Exceptional Stability and Performance
- Black-Out Dial Glows "Electric-Blue-Green" with Power "On"
- Handsome Walnut-Finish Enclosure Included

Another example of "Teledyne quality at a better price". You'd be hard pressed to find another receiver with the power and looks of the RA-618 that doesn't "skimp" on quality. It has a very impressive 120 watts of power—plus features which give you even more for your money. It's not only an excellent 2-channel receiver but at the touch of the "Phase Power" button, it extracts "ambience" information from regular stereo broadcasts and recordings. Just add an extra pair of speakers for a rewarding 4-channel effect! Dual tuning meters (signal strength for AM and FM, center-of-channel for FM) plus smooth-action weighted fly-wheel tuning control provide all the tuning

precision you need. Muting circuit eliminates noise and hisses between FM stations. Ceramic filter for sharp FM selectivity. "Instant Action" pushbuttons select Remote Speakers, 4-channel Phase Power, Tape Monitor, Loudness, Stereo-Mono, Mag. Phono, AM, FM, Aux., FM Mute, AFC. There's also a stereo headphone jack, FM "STEREO" light and "Quick-Connect" push-in speaker terminals. When it comes to "looks" this receiver will fit in beautifully with any decor. It has a blackout "electric blue-green" dial, machined all-metal control knobs, a brushed bronze color front panel, and walnut-grain enclosure (included)!
RA-618J. Shpg. wt. 19 lbs. 189.98

SPECIFICATIONS

Power Output: 120 Watts MP, 30 watts RMS total. **Total Harmonic Distortion:** 0.35%. **Power Bandwidth:** 20-36,000 Hz. **Frequency Response:** 17-20,000 Hz. **S/N Ratio:** Aux., 72 dB; Mag. Phono 58 dB. **Input Sensitivity:** Aux., 145 mV; Mag. Phono 1.75 mV. **FM Sensitivity:** 3 μ V (IHF). **Harmonic Distortion:** 0.35%. **Signal-to-Noise:** 63 dB. **Selectivity:** 45 dB. **Channel Separation:** 32

dB at 1 kHz. **Image Rejection:** 55 dB. **AM Sensitivity:** 160 μ V. **Distortion:** 1%. **IF Rejection:** 40 dB. **Image Rejection:** 40 dB. **Inputs:** Mag Phono, Aux, Tape Monitor. **Outputs:** 4-16 ohm speakers (4-channel, or 2-channel plus 2-channel remote); hi-Z headphones and stereo recording. 15% W x 4 $\frac{3}{4}$ " H x 11 $\frac{1}{2}$ " D. For 117 VAC, 50-60 Hz.

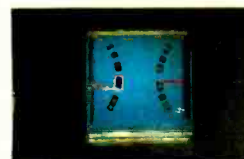

Dual Tuning Meters
Center-Channel FM, Signal-Strength AM/FM. The Most Precise Indicators for Each.



Loudness Button
Provides Balanced Response with Plenty of "Bass Power" at Low Volume Levels.

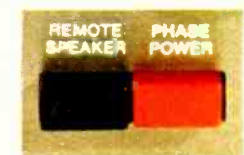

Remote Switch
Selects Main or Remote Speakers in 2-Channel Stereo Systems.



Balance Control
Provides Left to Right Balance Control of Front and Rear Speakers.



Headphone Jack
Listen to Stereo in Full "Privacy" with All the Volume You Like.



Magnetic Input
Use the RA-618 with the Finest Component-Quality Turntables.

Our Lowest-Priced Receiver

Performance That Makes Teledyne the Value Leader



TELEDYNE

RA-655 Stereo/Phase-Power 4-Channel 40-Watt FM-AM Receiver

149⁹⁸



Use Your Credit Card

COVERED BY THE FAMOUS OLSON
2-YEAR GUARANTEE
SEE PAGE 6

The receiver that made Teledyne *the* value leader in the audio industry. Priced low, but built to the same quality standards as our most expensive Teledyne receiver. Compare features, compare specs, and you'll see that nothing can match the RA-655—not even a *kit!* "Phase Power"—with four speakers you can get exciting 4-channel effect from stereo records and FM broadcasts. Ten pushbutton selectors—including Loudness, Remote Speakers, Tape Monitor, Aux., Mono-Stereo, Mag. Phono. "Black-out" "electric-blue-green" dial, 2-in-1 FM-AM tuning meter. Of course there's a stereo headphone jack, FM "STEREO" light and balanced flywheel tuning. The four pairs of speaker terminals and the remote speaker

- "Phase Power" Synthesizer Turns Your Stereo to 4-Channel at the Push of a Button
- "Command Control" Pushbuttons Select Program Source and Mode of Operation
- 2-in-1 Tuning Meter Assures Proper FM and AM Reception
- Good-Looking Walnut-Finish Enclosure Included

pushbutton let you use the RA-655 as either a 2-channel or 4-channel receiver. The back panel has a switched AC convenience outlet, "quick-connect" terminals for four speakers, screw terminals for FM and AM antennas. And quality! Fused output stages, the very latest in integrated solid-state circuitry, a sensitive stereo-FM and AM tuner, a very clean-sounding 2-channel audio amplifier, boost-and-cut bass and treble controls. The machined all-metal control knobs, luxurious walnut-grain enclosure, and "brushed-gold" aluminum front panel make it highly decorative and typically Teledyne. It's the *smart* audio buy for stereo setups where high power is not essential.

RA-655J. Shpg. wt. 18 lbs. 149.98

SPECIFICATIONS

Power Output: 40 watts MP, 10 watts RMS total. **Total Harmonic Distortion:** 0.35%. **Power Bandwidth:** 20-36,000 Hz. **Frequency Response:** 17-20,000 Hz. **S/N Ratio:** Aux., 72 dB. Mag. Phono, 58 dB. **Input Sensitivity:** Aux., 145 mV; Mag. Phono, 1.75 mV. **FM Sensitivity:** 3 μ V. (IHF). **Harmonic Distortion:** 0.35%. **Signal-to-Noise:** 63 dB. **Selectivity:** 45 dB. **Channel Separation:** 32

dB at 1 kHz. **Image Rejection:** 55 dB. **AM Sensitivity:** 160 μ V. **Distortion:** 1%. **IF Rejection:** 40 dB. **Image Rejection:** 40 dB. **Inputs:** Mag Phono, Aux, Tape Monitor. **Outputs:** 4-16 ohm speakers (2 main/front, 2 remote/rear); hi-Z headphones and stereo recording. 15 $\frac{3}{4}$ " W x 4 $\frac{3}{4}$ " H x 11 $\frac{1}{8}$ " D. For 117 VAC, 50-60 Hz.



FM-AM Tuning Meter Shows Signal-Strength for AM, Center-Channel for FM—Very Precise, Very Accurate.



Speaker Connectors Quick-Connect Push Terminals for Main and Remote Speakers—8 Speakers in All.



Tape Monitor For Better Recordings When Used with Three-Head Tape Recorders and Decks.



Loudness Control For Balanced Response and Full Bass Even at Very Low Listening Levels.



Mag. Phono Input Lets You Use the Finest Quality Component Turntables with the RA-655.



AFC Button Prevents Drift or Fading When the RA-655 is Tuned to Weak FM Stations.

Save on RA-655 2-Channel and 4-Channel Systems

Extra-Value "Starter" Stereo System

Save **\$83.03** **\$219** Separate
Items Reg. \$302.03

- RA-655 40-Watt Stereo FM/AM Receiver
- Garrard 42M 3-Speed Turntable with Dust Cover, Base, Shure M75ECS Cartridge Page 40
- Two Olson SP-014 8" 3-Way Speakers Page 59

Priced way below many "compacts" and ready for "Phase Power" synthesized 4-channel sound when you add two more speakers. Turntable features 4-pole motor, damped cueing, low-mass tone arm, anti-skate control. Each speaker has 8" acoustic-suspension woofer, 3/4" tweeter, 3" "super tweeter" for broad response. With all cables, plugs, 50' speaker wire. AS-715J. Shpg. wt. 70 lbs. 219.00



Stereo System That Lets Sound "Roll-On"

Save **\$83.52** **\$270** Separate
Items Reg. \$353.52

- RA-655 40-Watt Stereo FM/AM Receiver
- Garrard SLX-2 3-Speed Turntable with Dust Cover, Base, Magnetic Stereo Cartridge Page 38
- Two Utah AS-2A 8" Speaker Systems Page 62
- Gusdorf 3378 Rollabout Stereo Cart Page 44

Excellent stereo system or add 2 more speakers for "Phase Power" synthesized 4-channel. Turntable features low-mass tubular arm, cueing/pause control, and more. Each acoustic suspension speaker has 8" woofer with 1" voice coil, 3/2" tweeter. Cart has room for all components, plus records. 50' speaker wire. AS-716J. Shpg. wt. 91 lbs. 270.00

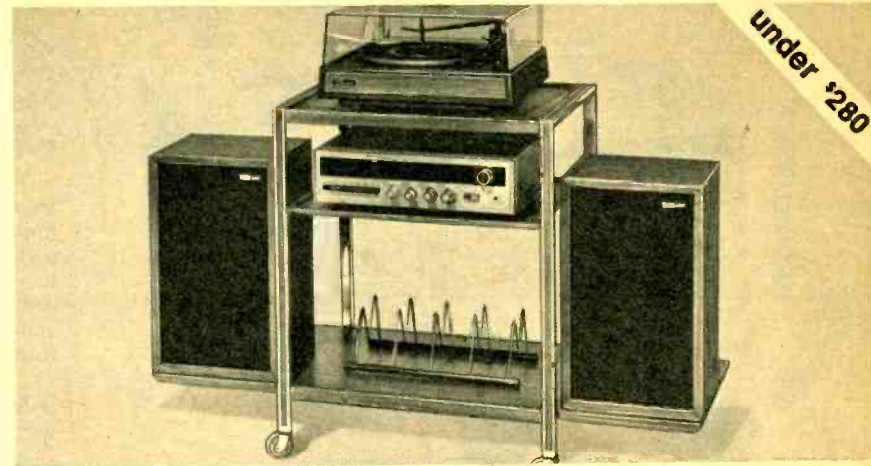

4-Channel "Phase Power" System with Cart

Save **\$85.37** **\$330** Separate
Items Reg. \$415.37

- RA-655 40-Watt Stereo FM/AM Receiver
- Garrard SLX-2 3-Speed Turntable with Dust Cover, Base, Magnetic Stereo Cartridge Page 38
- Gusdorf 3378 Stereo Rollabout Cart Page 44
- Two Teledyne "Septette" Speakers Page 56
- Two "Olsonic-1" Dual Woofer Speakers Page 59

Turntable has adjustable counterweight, cueing/pause control, low-mass tubular arm. The main/front speaker systems each feature 6 full-range speakers and a super-tweeter. The remote/rear speakers provide full sounding "highs" and "lows". Cart holds all 4 speakers, just roll it to listening location, separate rear speakers for best 4-channel effect. All plugs, cables, 100' speaker wire. AS-718J. Shpg. wt. 130 lbs. 330.00



"Phase Power" 4-Channel Music System

Save **\$118.64** **\$410** Separate
Items Reg. \$528.64

- RA-655 40-Watt Stereo FM/AM Receiver
- Garrard 42M 3-Speed Turntable with Dust Cover, Base, Pickering V15-ATE-4 Cartridge Page 40
- Two Utah WD-90 12" 2-Way Speakers Page 62
- Two Utah AS-2A 8" 2-Way Speakers Page 62
- Teledyne PH-222 Stereo Headphones Page 53

Enjoy synthesized 4-channel sound from this fine array of components. Turntable includes low-mass tone arm, adjustable anti-skating, damped cueing, more. Both front and rear speakers are acoustic-suspension design for exciting, natural sound. Headphones bring you "sound realism" with full privacy. All plugs, cables, 100' speaker wire. AS-717J. Shpg. wt. 140 lbs. 410.00



Make Your Present Stereo System "Twice" As Good

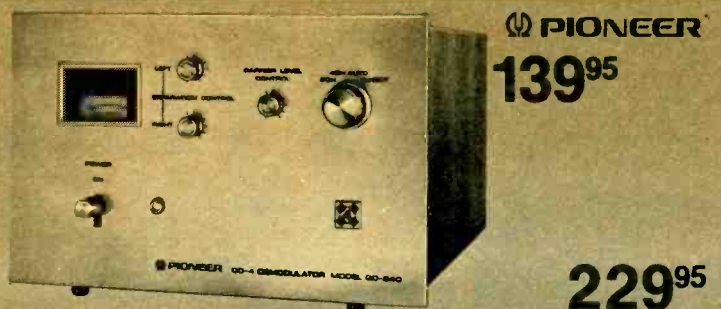

PIONEER
139⁹⁵

229⁹⁵



249⁹⁵



599⁹⁵

Use Your
Master Charge
or BankAmericard

CD-4 4-Channel Discrete Disc Demodulator

- **Advanced Circuitry Insures Optimum Channel Separation** Model QD-240. Easily attaches to your present 4-channel equipment for discrete 4-channel sound from the new CD-4 discs. Individual separation controls for left/right, front/rear channels, channel separation meter, carrier level control, switch for 2/4-channel auto and direct. With 7" 45-rpm CD-4 test record. 200 mV output level. 0.07% Distortion. 20-15,000 Hz Response. 7% x 5 1/4" x 12 25/32". 117 VAC.

RA-086J. Shpg. wt. 11 1/4 lbs. 139.95

RA-088J. QD-210 SQ Decoder.

For encoded 4-channel discs. Wt. 9 lbs. 99.95

4-Channel "Add-On" Decoder/Amplifier

- **Add To 2-Channel System with 2-Additional Speakers**

Model QL-600A. Update your present 2-channel system with exciting 4-channel sound! You get all three types of 4-channel sound including *discrete* tapes, *matrixed* EV and SQ discs and encoded FM broadcasts PLUS *derived* 4-channel from your present 2-channel tapes, discs, and FM broadcasts. With simultaneously adjustable level meters. 44 watts IHF 2-channel amplifier. 16 1/16 x 5 7/16 x 13 1/4". 117 VAC.

RA-654J. Shpg. wt. 22 lbs. 229.95

2/4 Channel 8-Track Playback Deck

- **Hook-Up To 4-Channel Amplifier For Discrete Playback**

Model QT-2100. Plays pre-recorded 8-track stereo cartridges through your present stereo system, play the widely available *discrete* 4-channel Q8 cartridges through a 4-channel amplifier and four speakers. Features low wow and flutter, program repeat switch, 2/4 channel program indicator, front/rear channel headphone jacks, and much more. 16 1/16 x 5 11/16 x 12 1/16". 117 VAC.

RA-089J. Shpg. wt. 28 lbs. 249.95

3-Motor, 3-Head Stereo Tape Record/Play Deck

- **2-Channel Record and Play/Discrete 4-Channel Playback**

Model RT-1020L. Designed for tape enthusiasts seeking professional results. Has wow/flutter of less than 0.8% at 7 1/2 ips, 10 1/2" reel capacity for double tape time. Sound-on-sound and sound-with-sound, 3 position bias control, microphone inputs with mike mixing. Pause control, 4 digit tape counter. With compatible 2/4 channel level meters, headphone monitor direct off head amp for cueing and editing. Switchable front and rear level controls. Speeds of 7 1/2 and 3 3/4 ips. 40-20,000 Hz ± 3 dB response at 7 1/2 ips. More than 55 dB S/N. Less than 1% Distortion. With two NAB hubs. 17 1/16 x 16 3/32 x 8 1/16". 117 VAC.

RA-087J. Shpg. wt. 57 1/2 lbs. 599.95

4-Channel Component Combination with Style and Class!

- **Pioneer QX-949 240-Watt 4-Channel Receiver** Page 19
- **Garrard Zero 100C Automatic Turntable with Dust Cover, Ebony Base** (Page 2) and **Empire 999SE/X 4-D Magnetic Cartridge with Elliptical Diamond Stylus** Page 51
- **4 Pioneer CS-63D 15" Four-Way Speaker Systems** Page 64
- **Koss KO-747Q 4-Channel Headphones** Page 54
- **100 Ft. WR-026 Speaker Wire**

The ultimate in 4-channel systems! It has been designed for the audio perfectionist and combines the best of three hi-fi worlds — Pioneer's BEST Discrete 4-Channel Receiver and Speaker Systems, Garrard's BEST Automatic Turntable. The receiver has a built-in disc demodulator, so along with the widely acclaimed 4-channel Empire cartridge you're ready for discrete LP's. Koss 4-channel headphones too, for privacy with all the volume you want. Buy now and save \$171.53 off separate catalog prices!

AS-773J. Shpg. wt. 412 lbs. 1950.00

Save 171⁵³
\$1950

Separate
Items Reg.
\$2121.53

PIONEER Quality 4-Channel FM/AM Receivers

80-Watt "Totally Equipped"

- **Built-In CD-4 Demodulator for the Discrete 4-Channel Discs**
- **All Matrix Modes • Stereo Mode**

Model QX-646. A complete big power 4-channel receiver that's ready for any kind of "Quad" sound—tape, FM, even discrete discs! Has CD-4 separation controls on front panel, program source illumination including CD-4, SQ, RM (regular matrix). Individual left/right, front/rear as well as master front/rear balance controls. Includes 4-gang variable capacitor and dual gate MOS type FET in the front end, IC's and ceramic filters in the important IF section. Has concentric bass and treble controls with "Flat" response settings, input jacks for turntable, Aux, headphones plus an additional pair of speakers. Includes 45 rpm CD-4 test record. Power at 8 ohms. 80 watts IHF. 10-watts per channel rms. 20-20,000 Hz response. 2.2 μ V FM Sensitivity. 20% x 5% x 14 $\frac{3}{16}$ ". For 117 VAC.

RA-083J. Shpg. wt. 32 $\frac{1}{2}$ lbs. **499.95**

Pioneer has long been "tops" in Stereo High-Fidelity Component Systems. After years of leading the way they have now moved to the major innovation in the high-fidelity world—4-Channel Sound. The styling, craftsmanship, features and overall quality of these receivers prove that they are still in the winners circle. They offer everything in 4-channel while at the same time maintaining complete compatibility with 2-channel stereo.



499⁹⁵

160-Watt with Strapped Output

- **All 4-Channel Capabilities Built-In**
- **Stereo Use Doubles Power Output**
- **4 Individual, 1 Master Volume Controls**

Model QX-747. A do-all 4 or 2 channel performer. Has MOS FET front end, 4-gang variable capacitor, 5 stage limiting, IC in the IF and multiplex section. Complementary direct-coupled OCL circuitry. Four channel indicator on the front panel, individual base/treble for front and rear, loudness, muting, 3 tape monitors (one can be used for 4-channel Dolby* adaptor) Has 2 and 4 channel display Scope dial with 4 position input controls, front and rear headphone jacks. Inputs for phono, tape, aux. Includes 45 rpm CD-4 test record. Power at 8 ohms. 160-watts IHF. 20/20/20/20 watts rms 4-channel; 40/40 watts rms 2-channel (Strapped output). 20-20,000 Hz Response. 1.9 μ V FM Sensitivity (IHF) 20 $\frac{3}{4}$ x 5 $\frac{7}{8}$ x 14 $\frac{3}{16}$ ". 117 VAC

RA-084J. Shpg. wt. 50 lbs. **599.95**



599⁹⁵

240-Watts—Very Versatile

- **4-Channel FM "Discrete" Decoder**
- **Provisions for Two Complete 4-Channel Speaker Systems**

Model QX-949. Loaded with features, power, and class! Has 2 MOS FET's in front end, 4 gang variable capacitor, 6 stage limiting, tuning and signal strength meters. All 4 channel capabilities built-in. Individual bass and treble for front and rear, switches for 4 and 2 channel monitors. Provision for Dolby* adaptor, 4 and 2 channel display 3" scope with 4 position input controls. Has 4 individual volume controls plus master. Front and rear headphone jacks, Hi-Lo filter, multiplex noise filter. Two magnetic phono inputs. With 45 rpm CD-4 test record. Power at 8 ohms. 240-watts IHF. 40/40/40/40 watts rms 4-channel; 80/80 watts rms 2-channel (Strapped Output). 20-20,000 Hz Response. 1.8 μ V FM Sensitivity (IHF). 20 $\frac{3}{4}$ x 5 $\frac{7}{8}$ x 14 $\frac{3}{16}$ ". 117 VAC.

RA-085J. Shpg. wt. 60 lbs. **699.95**



699⁹⁵

*Dolby is a registered trademark of Dolby Laboratories Inc.

AM/FM Stereo Receivers for Critical Listeners

PIONEER®



2 **259⁹⁵**



3 **329⁹⁵**



4 **399⁹⁵**

199⁹⁵

1



1 50-Watts—More of “Everything” for Less

Model SX-424. A great package of performance and features for the budget minded music lover. Includes advanced FET circuitry for smooth, clean performance. Has inputs for a turntable, tape deck, cassette or cartridge player, headphones, microphone, 2 pairs of speakers. Power at 4 ohms: 50 watts IHF. 20-70,000 Hz, ± 3 dB response. $2.3 \mu\text{V}$ FM Sensitivity. Under 1% Distortion. Walnut end panels. $16\frac{3}{4} \times 5\frac{3}{4} \times 13\frac{3}{4}$ ". 117 VAC.

RA-090J. Shpg. wt. 21 lbs. **199.95**

2 72-Watts—Complete Controls and Inputs

Model SX-525. A budget priced receiver featuring FET/IC tuner. Has large tuning meter, “soft-blue” blackout dial. The amplifier has inputs for 2 turntables, 2 tape decks, A-B-Off speaker selector, headphone jack, front panel mike jack. Pushbuttons for mono-stereo and tape monitor 1 & 2. Less than 1% distortion. Power at 4 ohms: 72 watts IHF. Response, 15-30,000 Hz, ± 1 dB. $2.2 \mu\text{V}$ FM Sensitivity. Walnut end-panels. $17\frac{1}{16} \times 5\frac{1}{16} \times 14\frac{3}{16}$ ". For 117 VAC.

RA-701J. Shpg. wt. 20 lbs. **259.95**

3 110-Watts — High Selectivity and Sensitivity

Model SX-626. Has the quality and features of the “expensive” models. With FET FM front end, AGC, click-stop tone controls, Hi/Lo filters, FM muting, loudness, tape monitor 1 & 2, mono-stereo switch. Facilities for 2 phonos, 2 tape decks, 2 mikes, 3 pairs of speakers, headphone. With tuning meter. Power at 4 ohms: 110 watts IHF. Power bandwidth 10-70,000 Hz. 5-80,000 Hz, ± 1 dB response. $2.0 \mu\text{V}$ FM Sensitivity. Over 70 dB FM Selectivity. Less than 1% Distortion. $17\frac{1}{16} \times 5\frac{1}{16} \times 14\frac{3}{16}$ ". 117 VAC.

RA-686J. Shpg. wt. 26½ lbs. **329.95**

4 195-Watts—Direct-Coupled Amplifier Circuitry

Model SX-727. Tremendous versatility! Direct-coupled OCL circuitry eliminates coupling capacitors for cleaner sound and full 10-60,000 Hz power bandwidth. Has AGC, FET amplifier. Inputs for 2 phonos, 2 tape decks, 3 pairs of speakers, mike. Hi/Lo filters, headphone jack, pushbuttons for tape monitor 1 & 2, loudness, mono-stereo, muting. Power at 4 ohms: 195 watts IHF. 7-80-000 Hz, ± 1 dB response. $1.8 \mu\text{V}$ FM Sensitivity. Under 0.5% Distortion. $19\frac{1}{2} \times 5\frac{7}{8} \times 15\frac{3}{8}$ ". For 117 VAC.

RA-685J. Shpg. wt. 38 lbs. **399.95**

270-Watts—Superb Power, Extremely Versatile

Model SX-828. Very impressive and loaded with extras demanded by audio experts! This excellent performer features full power output at all frequencies and excellent reception of weak FM signals with ideal selectivity. Has MOS-TYPE FET's in the front end for outstanding reception, even in fringe areas, with no signal overlap or noise. Other features include FM muting, ceramic filters and AGC on AM, direct-coupled power amplifier, slanted “soft-blue” dial with mood soothing dimmer. With Hi-Lo filters, 2 tape monitor switches, loudness switch, speaker selector, stereo reverse, click-stop tone controls. Has 2 tuning meters, 2 headphone jacks. Preamp and main amplifier may be used separately! Has inputs for 3 pairs of speakers, 2 turntables, and 2 tape decks. Power at 4 ohms: 270-watts IHF. Power bandwidth 10-60,000 Hz. 5-80,000 Hz, ± 1 dB response. $1.7 \mu\text{V}$ FM Sensitivity. 0.5% Harmonic/Intermodulation Distortion. $19\frac{1}{2} \times 5\frac{1}{16} \times 14\frac{3}{4}$ ". 117 VAC.

RA-684J. Shpg. wt. 40 lbs. **469.95**



469⁹⁵

PIONEER Systems-Completing Components



29⁹⁵

"Open Air" Stereo Headphones

- **Dynamic 1½" Speaker In Each Earpiece**

Model SE-L20. Unlike conventional closed-back headphones, these are *extremely light-weight* for many "comfortable" hours of listening. They feature widely dispersed sound with smooth bass. 8 ohms, 6' cord, plug. PH-313J. Shpg. wt. 2 lbs. 29.95

Anti-Skating Prevents Distortion Caused by Uneven Stylus Pressure

99⁹⁵
Cartridge Extra



2-Speed Manual Turntable

- **Includes Dust Cover and Base**

Model PL-12D. Superior hi-fi disc reproduction. Has switchable 33⅓ and 45-rpm speeds, damped cueing, anti-skating, and a balanced S-shaped tone arm. Tracks as low as 0.75 grams. Wow and flutter under 0.1% WRMS. 16⁵/₁₆ x 6¹⁵/₃₂ x 14¹/₄". For 117 VAC. RP-413J. Shpg. wt. 2 lbs. 99.95



129⁹⁵

Stereo Reverb Amplifier

- **5-Way Selector Controls 2 Recorders**

Model SR-202W. Adds extra brilliance and realism to all stereo tapes and recordings. Adds reverb effect to speakers, recorded sounds, or even tapes without altering the original sound. The reverb is variable and indicated visibly in a window. Two pair of recording jacks. 13¹/₁₆ x 5¹/₂ x 10³/₈". 117 VAC. RA-700J. Shpg. wt. 13 lbs. 129.95

40 Watt Stereo System



Save 47⁸³
Sep Reg. Items \$417.83 **\$370**

Low Priced Component System Value

- **Pioneer SX-424 Stereo FM/AM Receiver**
- **Garrard 42M 3-Speed Automatic Turntable with Shure M75ECS Magnetic Cartridge Page 40**
- **2 Olson SS-177 Two-Way Speaker Systems Page 56**
- **Pioneer SE-L20 Stereo Headphones**

A great component system for smaller apartments and other "sound limiting" areas—yet has enough power for full frequency sound reproduction. The receiver is a 40-watt version of the higher powered, more expensive Pioneer models. The Garrard Module is a long time favorite in their family of turntables. The Olson SS-177 "Septette" speaker systems each have six high-compliance speakers for deep bass plus a super tweeter for excellent highs. Pioneer headphones for great listening in privacy. With 100' speaker wire. AS-771J. Shpg. wt. 125 lbs. 370.00

195 Watt Stereo System



Save 43¹³
Sep. Reg. Items \$983.13 **\$940**

High Quality "Super" Component System Value

- **Pioneer SX-727 195-Watt Stereo FM/AM Receiver**
- **Dual 1218 Automatic Turntable with Dust Cover, Base Pg. 37**
- **Empire Deluxe 999EIX Magnetic Cartridge Page 51**
- **2 Pioneer CS-R500 10" 2-Way Speaker Systems Page 64**
- **Pioneer SE-L20 Stereo Headphones**

A great value in a high performance component system that will last a lifetime! The receiver is taken from the "upper echelon" of the fine Pioneer name. It's packed with features, quality, and dependability. And when it comes to turntables, Dual MEANS quality! The 1218 tracks as low as 0.5 grams, has every feature for flawless record play. The speakers deliver smooth bass, dazzling midrange and undistorted highs with a YOU ARE THERE presence and realism; the headphones do it in private. Includes 100 ft. of speaker wire. AS-772J. Shpg. wt. 150 lbs. 940.00



TELEDYNE RA-707 "RA-CEIVER" Stereo Systems

*Good Enough to Be Your
First High-Fidelity System*

*Perfect As a "Second" System
Anywhere in Your Home*

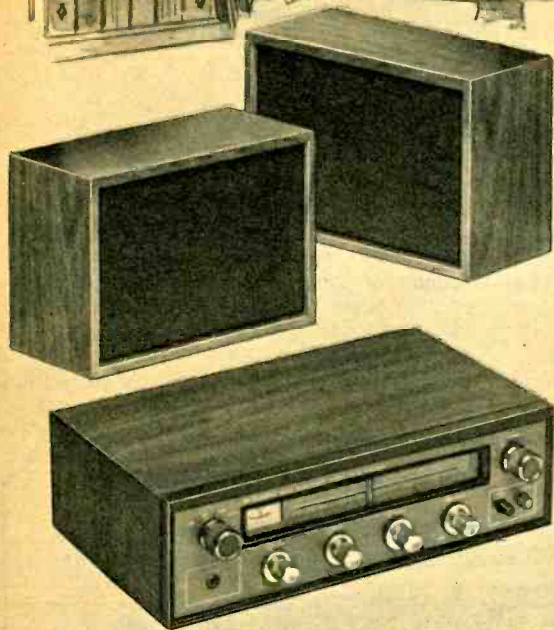

94⁵⁰

Save
18³⁹

Sep. Items
Reg. 112.89

Stereo FM-AM "Ra-ceiver" System

- Teledyne RA-707 Stereo FM-AM "Ra-ceiver"
- Two "Olsonic-1" Compact Speakers
- Two 10' Speaker Cables • FM Dipole Antenna

There's simply no better way to get *high-fidelity* sound at a price this low! The RA-707 "Ra-ceiver" has plenty of power to drive the two "Olsonic-1" speakers to room-filling volume with very low distortion. Each speaker has two 6 x 4" woofers for a full, natural bass—and a 3" tweeter for crisp, clear highs. We've even included an FM dipole antenna so you'll hear more FM stations more clearly, speaker cables too. Ready to connect and play.

AS-790J. Shpg. wt. 25½ lbs. 94.50



Save
34⁷⁴

Sep. Items
Reg. \$194.69



159⁹⁵

Stereo FM-AM Phono/"Ra-ceiver" System

- Teledyne RA-707 Stereo FM-AM "Ra-ceiver"
- Garrard 40B 3-Speed Turntable with Base, Dust Cover, Audio-Technica AT-10 Magnetic Stereo Cartridge
- Two "Olson-Aire II" 8" 2-Way Speakers

An outstanding system value that puts FM-AM and phono sound reproduction in your den, rec room, basement, wherever! The Garrard 40B turntable features 4-pole induction motor, adjustable stylus pressure, viscous cuing and pause. The speakers each have 8" acoustic-suspension woofer and 3" tweeter for amazing sound realism. Speaker cables and an FM dipole antenna make this system ready to plug in and enjoy.

AS-791J. Shpg. wt. 53 lbs. 159.95

22 Olson



Save 38¹⁵

Sep. Items
Reg. \$232.65



194⁵⁰

Stereo FM-AM/Phono/Tape "Ra-ceiver" System

- Teledyne RA-707 Stereo FM-AM "Ra-ceiver"
- Garrard 40B 3-Speed Turntable with Base, Dust Cover, Audio-Technica AT-10 Magnetic Stereo Cartridge
- Two "Olson-Aire II" 8" 2-Way Speakers
- Olson RA-689 8-Track Stereo Cartridge Playback Deck
- Olson PH-204 Lightweight Stereo Headphones

A very *versatile* "Ra-ceiver" system that gives you a lot more than you pay for! Listen to radio, records or tape through the great sounding wide-range speakers, and in complete stereo privacy through the comfortable headphones. Tape player has lighted program indicators, pushbutton program change, easy pop-in loading. Includes all cables, FM dipole antenna.

AS-792J. Shpg. wt. 65 lbs. 194.50

Stereo High-Fidelity with
"Phase Power" for only

69⁹⁵

WITH MAGNETIC PHONO INPUT, TUNING
METER, POWER FOR FULL-SIZE SPEAKERS

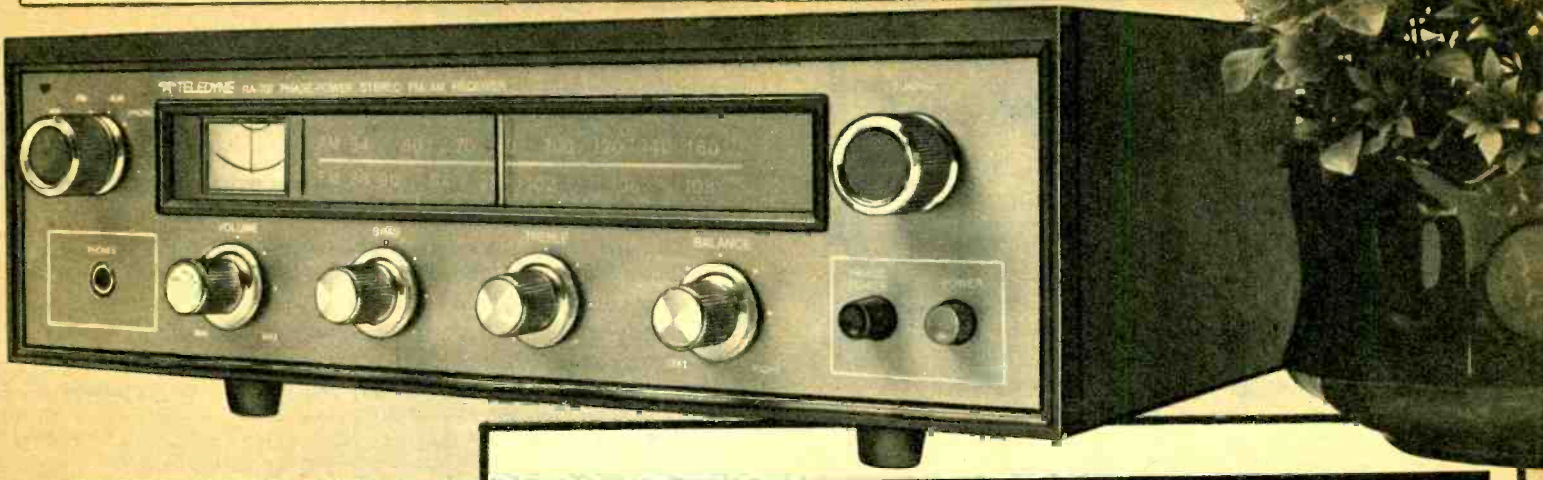

TELEDYNE RA-707 FM-AM STEREO "RA-CEIVER"

Bridges the Gap Between "Low-Fi"
Radios and High-Priced Receivers

COVERED BY THE FAMOUS OLSON
2-YEAR GUARANTEE

See Page 6



Select One of
Our Money-Saving
"Ra-ceiver"
Systems at Left

Use Your BankAmericard or Mastercharge

- 5 Watts rms Audio Output
- Precise FM-AM Tuning Meter
- "Phase Power" 4-Channel Synthesizer

So new, so different—we had to coin a new word for it! Our Teledyne RA-707 "Ra-ceiver" is more than a mere-radio—has the features you need for high-fidelity reproduction at a cost that's way below full-fledged stereo components. There's an FM-AM tuning meter so you can tune stations very precisely, provision for external FM antenna so you can bring in weak stations far more clearly. The magnetic phono preamplifier means you can use a record player with a magnetic phono cartridge—the key to fine record reproduction. You can add an 8-track, cassette or reel-to-reel tape recorder too! And there's "phase power" so you can simulate 4-channel sound (when you use four

speakers). If you've never been able to afford stereo high-fidelity before—the "Ra-ceiver" is your chance to get good sound reproduction at low cost. If you're irritated hearing the hi-fi of your main system change to the "lifeless" sound of your den or rec room radio—our "Ra-ceiver" is just right for you too!

RA-707J. Shpg. wt. 9 lbs. 69.95

SPECIFICATIONS

Power Output: 15 watts M.P., 5 watts rms total. **Total Harmonic Distortion:** less than 1%. **Input Sensitivity:** adequate for medium compliance magnetic stereo cartridges. **FM Sensitivity:** 3 μ V (IHF). **FM Selectivity:** 45 dB. **Stereo Channel Separation:** 25 dB at 1 kHz. **AM Sensitivity:** 130 mV. **Inputs:** magnetic phono, aux tape. **Outputs:** 4-16 ohm speakers, stereo headphones. **Size (WHD):** 13 $\frac{1}{4}$ x 3 $\frac{1}{4}$ x 8 $\frac{1}{2}$ ". **Power:** 117 VAC.

12 High- Performance Features

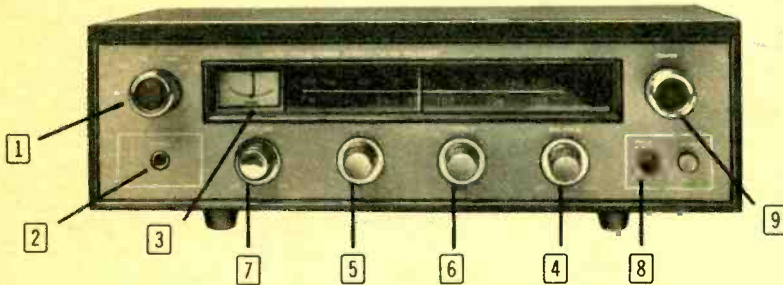

- 1 Mode Selector.** Selects AM, FM, FM Stereo, Phono and Aux. (Tape).
- 2 Headphone Jack.** For "private" listening through stereo headphones.
- 3 Tuning Meter.** Shows signal-strength for both FM and AM broadcasts.
- 4 Balance Control.** Adjusts sound for left and right speakers.

- 5 Bass Control.** Boost-type to accentuate low-frequency response.
- 6 Treble Control.** Intensifies and sharpens high-frequencies.
- 7 Volume Control.** Adjusts from "whisper-quiet" to room-filling sound.
- 8 Phase Power Switch.** Simulates 4-channel sound from 2-channel stereo sources.

- 9 Tuning Knob.** Smooth, accurate flywheel type for tuning ease and precision.
- 10 Magnetic Phono Input.** Lets you use component-quality record players.
- 11 Tape Inputs and Outputs.** Lets you add cassette, reel or cartridge tape recorder.
- 12 Outputs.** Screw terminals for 2 or 4 speakers, external antenna.



SANYO Complete Four-Channel Systems

Save on Sanyo Receivers with Custom-Selected Components



\$430

Sep. Items Reg. \$477.55

1 For Music Lovers on a Budget

- Sanyo DCX-2700K Discrete 4-Channel Receiver
- Garrard 42M 3-Speed Turntable with Base, Shure M75ECS Magnetic Stereo Cartridge Page 40
- Four "Olson-Aire-1" 8" 3-Way Speakers Page 59
- 100' Speaker Wire • FM Stereo Antenna

A low-priced way to the "4-channel experience." Custom-matched components look and sound great — and you save \$47.55!
AS-776J. Shpg. wt. 123 lbs. 430.00

2 Discrete System with Speakers and Headphones

- Sanyo DCX-3300 Discrete 4-Channel Receiver
- Garrard 74M 3-Speed Turntable with Custom Base, Shure M91ED Elliptical Stereo Cartridge Page 40
- Four Teledyne-Olson 10" 2-Way Speakers Page 56
- Teledyne PH-220 Stereo/4-Channel Headphones Page 53
- 100' Speaker Wire • FM Stereo Antenna

Listen to 4-channel sound the way you like it, even in private — and you save \$140.35!
AS-775J. Shpg. wt. 197 lbs. 799.00



\$799

Sep. Items Reg. \$939.35

3 Receiver/Turntable/8-Track Discrete System

- Sanyo 3100K Discrete 4-Channel Receiver
- Garrard 42M 3-Speed Turntable with Base and Pickering V-15-ATE-4 Magnetic Cartridge Page 40
- Sanyo RD8200 2/4-Channel 8-Track Deck Below
- Four Teledyne-Olson "Environmentalist-1" 8" 3-Way Speaker Systems Page 56
- 8-Track Cartridge Storage Case Page 55
- 100' Speaker Wire • FM Stereo Antenna

Everything you need for discrete 4-channel sound from Q8 8-track cartridges — and you save \$106.76!
AS-777J. Shpg. wt. 143 lbs. 838.00

Bonus Specials

Your choice of one of these bonus buys when you purchase a system from this page.

TV-288 Sanyo 12" Black-and-White TV. See page 47. AS-778J. Reg. \$89.98 79.98

RA-999 Philco-Ford FM/AM Portable Radio. See page 225. AS-779J. Reg. \$39.95 29.95

TL-755 Dymo Labelmaker Kit. See page 94. AS-780J. Reg. \$21.99 16.99

CA-599 Gurdorf Walnut-Finish Stereo System Cart. See page 44. AS-781J. Reg. \$39.95 29.95

**SAVE
EVEN
MORE**



\$838

Sep. Items Reg. \$944.76



119⁹⁵

- Plays Stereo and Discrete 4-Channel Cartridges

2 and 4-Channel Cartridge Playback Deck

Model RD8200. THE way to add 8-track to your home music system. Has fast forward, cartridge eject, automatic 2/4-channel sensing, program indicator lights, automatic or manual program change. Handsome walnut wood enclosure with brushed aluminum panel, striking black cartridge insert. 13 x 12³/₈ x 4³/₄". 117 VAC.
RA-039J. Shpg. wt. 12 lbs. 119.95

Discrete Four-Channel Receivers from **SANYO**

Let the "4-Channel Experience" Be a Part of Your Life

1 80-Watt FM/AM with SQ Matrix

- Exclusive Sanyo "Spatial Control"
- Outputs for Discrete 4-Channel Recording

Model DCX-3000K. Hear discrete 4-channel from tapes, matrixed 4-channel from records or FM, synthesized 4-channel from regular stereo. Has master volume, 2/4-channel selector, loudness and tape monitor switches, 2-channel headphone jack, 2/4-channel tape, magnetic and ceramic phono inputs. "Spatial Control" 4-channel balance provides individual adjustment of each channel. Power output: 80 watts IHF, 40 watts rms total. 25-40,000 frequency response. 2.2 uV FM IHF sensitivity. Walnut wood enclosure, 18 $\frac{1}{2}$ x 11 $\frac{1}{8}$ x 4 $\frac{3}{4}$ ". For 117 VAC.

RA-732J. Shpg. wt. 20 lbs. 249.95
RA-034J. DCX 2700K. Above, 60 watts 229.95



1 249⁹⁵

2 Strapped Output 120-Watt FM/AM

- SQ Matrix Decoder/Synthesizer Circuitry
- Master Volume Controls All Four Channels

Model DCX3100K. A receiver that gives you all its power — whether you use it in the two or four-channel modes. Rated rms output: 15/15/15/15 watts 4-channel, 30/30 watts 2-channel! Features Sanyo's exclusive 4-channel spatial control, dual headphone jacks for 2 or 4-channel phones, separate power on-off switch so you can set controls just once for optimum sound. Handles EVERY 2 or 4-channel sound source, even has CD-4 adapter inputs so you can hookup a discrete disc demodulator and play discrete 4-channel records. 2 or 4-channel tape recording outputs, inputs for magnetic or ceramic phono, 2 or 4-channel tape. 20-45,000 Hz response, 2.2 uV FM IHF sensitivity. Walnut case. 19 $\frac{1}{2}$ x 13 $\frac{1}{4}$ x 5". For 117 VAC.

RA-036J. Shpg. wt. 20 lbs. 299.95



2 299⁹⁵

3 2-Way Decoder 160-Watt FM/AM

- Four Level Meters and Volume Controls
- Jacks for 2 or 4-Channel Headphones

Model DCX-3300K. Features special Matrix 1 and Matrix 2 circuits to decode 4-channel information from 2-channel sources—Matrix 1 is especially effective for orchestral arrangements, Matrix-2 for vocals. Has AM/FM FET circuitry, tuning meter, loudness and tape monitor switches, inputs for magnetic or ceramic phono, discrete 4-channel tape inputs and outputs. Plays any kind of 4-channel encoded material too. Front panel mike input with level control for sound mixing. Power output: 160 watts IHF, 80 watts rms. 20-40,000 Hz response, 2.0 uV IHF FM sensitivity. Wood case, 19 $\frac{3}{8}$ x 12 $\frac{3}{4}$ x 6". 117 VAC.

RA-733J. Shpg. wt. 29 lbs. 399.95



3 399⁹⁵

4 CD-4 Capability 160-Watt AM/FM

- Plays Discrete 4-Channel Records
- Strapped Output for FULL Power

Model DCX-3500K. Sanyo's finest! The CD-4 circuit means you can play discrete-4-channel discs without adding an adapter or demodulator, the strapped output means you get full power in 2-channel mode — rated rms output is 15/15/15/15 watts 4-channel, 30/30 watts 2-channel! Has master volume, 2/4-channel selector switch, level meter and volume control for each channel. Has every kind of 2 or 4-channel input and output, front panel mike input with level control, SQ matrix, precision signal strength tuning meter. 18-50,000 Hz response, 2.0 V FM sensitivity. Walnut wood case, 19 $\frac{1}{8}$ x 12 $\frac{3}{4}$ x 6".

RA-037J. Shpg. wt. 34 lbs. 499.95



4 499⁹⁵

Famous-for-Quality Stereo/4-Channel Receivers

Fisher



New
AT OLSON



199⁹⁵

48-Watt Stereo Receiver for Music Lovers on a Budget

Model 170. Famous Fisher features, plus power enough for most any speaker systems. Has silicon-transistor circuit with IC's in the IF strip for really outstanding FM reception, automatic stereo switching, wideband AM circuit, main-remote speaker switches. Full tape inputs and outputs including monitor for use with 3-head tape decks. Front panel stereo headphone jack for "private" listening at any volume. Power at 4 ohms: 48 watts IHF, 32 watts rms. Frequency response, 30-15,000 Hz. FM Sensitivity: 2.5 μ V IHF. Walnut-finish vinyl cabinet, 16½ x 5¼ x 12". For 117 VAC.

RA-795J. Shpg. wt. 18½ lbs. 199.95

299⁹⁵

80-Watt 4-Channel Stereo FM-AM Receiver

- Walnut Case Included at No Extra Cost

Model 4020. Strapped output power, usable FM sensitivity of 2.5 μ V, and a wideband AM tuner section make this a receiver you'll enjoy for years to come. Handles all discrete 4-channel sources, SQ, CD-4 and E-V matrix sources, even synthesizes 4-channel sound from stereo. Strapped rms output power—when you use the 4020 as a stereo receiver, you don't "lose" 2-channels of power as on conventional 4-channel models. 30-20,000 Hz power bandwidth. 80 watts total IHF @ 4 ohms. 40 watts total rms. Output: 10/10/10/10 4-channel—20/20 stereo @ 8 ohms. 17¼ x 5¼ x 12¼". For 117 VAC.

RA-020J. Shpg. wt. 22 lbs. 299.95

369⁹⁵

Deluxe 100-Watt 4-Channel Stereo FM-AM Receiver

- Includes Walnut Wood Case at No Extra Cost

Model 4060. Incorporates the latest advances from Fisher—long renowned for their "electronic expertise"! Features strapped output power, 2.5 μ V usable FM sensitivity, wideband AM tuner section. Has complete 2-channel tape inputs and outputs including monitor, smooth flywheel tuning with center-channel and signal-strength meters for complete tuning precision. Front panel stereo/4-channel headphone jacks. 30-30,000 Hz power bandwidth. 100 watts IHF total @ 4 ohms, 60 watts total rms output: 15/15/15/15 4-channel—30/30 stereo @ 8 ohms. 17¼ x 5¼ x 15¼". For 117 VAC.

RA-021J. Shpg. wt. 28 lbs. 369.95

Fisher Speaker Systems Engineered for Excellence



89⁹⁵

Model XP-56S. 2-way 8" bookshelf system has 8" woofer with 2-lb. magnet structure and special suspension for extra-wide excursion and rich, natural sound. 3" midrange/tweeter with low-mass cone for peak-free high-end response. 35-20,000 Hz, 30 watts, 8 ohms. Walnut vinyl cabinet, sculptured front grille cloth. 21 x 11½ x 9".

SP-005J. Shpg. wt. 20 lbs. 89.95



109⁹⁵

Model XP-65S. The 3-way 10" speaker that's a real winner in sound and style. Premium-quality elements—10" woofer, 5" midrange and 3½" tweeter—plus deluxe crossover deliver the full range of the audio spectrum without a trace of distortion. The elegant sculptured front grille and walnut-finish cabinet add stunning good looks to any setup. 33-20,000 Hz, 30 watts, 8 ohms. 23 x 13 x 10".

SP-006J. Shpg. wt. 27 lbs. 109.95

"Fisher-Featured" Stereo and 4-Channel Systems

48-Watt 2-Channel FM/AM/Phono System

Separate Items
Reg. \$472.76

\$380

Save
\$92.76

- Fisher 170 48-Watt Stereo FM-AM Receiver
- Garrard 42M 3-Speed Turntable with Base, Pickering V15-ATE-4 Stereo Cartridge Page 40
- Two Fisher XP-56S 2-Way 8" Speaker Systems
- Teledyne-Olson 222 "Open-Back" Stereo Headphones Page 53

A fine sounding stereo system that's perfect for apartments, smaller homes, anywhere high power is not needed. The turntable has low-mass tone arm, damped cueing, pause control. The stereo headphones are ultralightweight and comfortable, feature "open-air" design for a "free-floating" spacious sound. We've included 100' speaker hookup wire and all cables—all you have to do is plug it in . . . and enjoy!

AS-760J. Shpg. wt. 76 lbs. 380.00



under \$400

80-Watt Discrete 4-Channel System

Separate Items
Reg. \$859.14

\$700

Save
\$159.15

- Fisher 4020 80-Watt 4-Channel Receiver
- Garrard 42M 3-Speed Turntable with Base and Shure M75ECS Stereo Cartridge Pg. 40
- Four Fisher XP-65S 3-Way 10" Speaker Systems with Custom Sculptured Grilles
- Teledyne-Olson PH-220 4-Channel Headphones Page 53

A first-class way to enjoy the "4-channel" experience! The speakers sound just great and add real style to any setup, the turntable has every fine feature needed for precision record play, the new 4-channel phones feature four high-fidelity drivers, cushioned headband and earcups for 4-channel privacy and comfort. We also include 100' of speaker hookup wire, all cables, and a 4-channel demo record to put your system through its paces.

AS-761J. Shpg. wt. 160 lbs. 700.00



under \$720

100-Watt Discrete 4-Channel System

Separate Items
Reg. \$1060.78

\$800

Save
\$260.78

- Fisher 4060 100-Watt 4-Channel Receiver
- Garrard 74M 3-Speed Turntable with Deluxe Base and Shure M91ED Magnetic Stereo Cartridge Page 40
- Four Olson "Tanglewood" 3-Way 12" Speakers with Walnut-Finish Page 58
- Koss KO-747Q 4-Channel Headphones Pg. 54

A 4-channel system you'll appreciate for years to come! The Garrard turntable has features for flawless record reproduction, the Olson "Music Festival" speakers produce the entire audio spectrum with a cleanliness and clarity that's the equal of any speakers around—the Koss 4-channel headphones bring you all the fidelity and volume you want—in full privacy. 100' speaker hookup wire and an SQ-matrix 4-channel demonstration record too!

AS-762J. Shpg. wt. 170 lbs. 800.00



under \$820

Finco FM Antennas for Super-Reception

Put "the finishing touch" on any of the component systems above with one of these deluxe Finco FM antennas. They'll assure you of top FM performance, even in weak signal areas. Choose the one that's right for you.

1 Model FM-4G. Has twin-driven aluminum elements—provides excellent FM performance from stations up to 125 miles away. 7'9" boom, 55½" radius. Preamsembled. AA-479J. Shpg. wt. 6½ lbs. 17.15

2 Model FMT. "Turnstile" model receives stations from all directions without rotation or aiming.

AA-478J. Shpg. wt. 3 lbs. 6.95

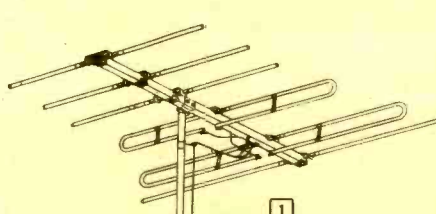

1

17.15

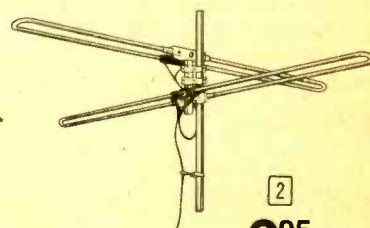

2

6.95

PIONEER Component Excellence For Every Budget



Stereo Amplifier with Real Component Quality

129⁹⁵

Model SA-5200. Especially designed for people who are building their first set of home stereo components. Has the latest circuit technology distinguished by superior stability and quality. RIAA equalization within ± 0.5 dB as well as the ability to handle larger inputs. With SEPP circuit silicon transistors in the power amplifier section. Delivers 13 watts + 13 watts of continuous power, both channels at 1 KHz into 8 ohms. 20-20,000 Hz. Less than 0.8% Harmonic Distortion. Has bass, treble controls, click-stop adjustments for main and remote speakers, tape monitor, power, loudness, stereo/mono. With left and right volume control, function switch for phono, tuner, Aux 1 or 2. With headphone jack. 16¹¹/₃₂ x 5³/₁₆ x 12²⁹/₃₂". For 117 VAC.

AM-475J. Shpg. wt. 18³/₄ lbs. **129.95**

Model SA-7100. Deluxe version of above. 20 watts + 20 watts of continuous power. Muting, tone defeat, 2 tape monitor switches. Choose from speakers A, B, A&B. Has 2 phono selectors. 0.5% Distortion. Has ± 0.2 dB RIAA equalization. 16¹⁵/₁₆ x 5⁷/₁₆ x 13⁷/₁₆".

AM-476J. Shpg. wt. 26³/₄ lbs. **199.95**



Budget Priced Sensitive AM/FM Tuner

129⁹⁵

Model TX-6200. Excellent value! Includes an advanced three-gang variable capacitor in the front end as well as a low-noise junction-type FET in its RF amplifier stage. Performance is exceptional with outstanding spurious rejection and image rejection, and excellent FM sensitivity. Has 5 stage limiter, mode switch for AM, FM, FM Stereo, Noise/Filter, MONO. Has FM muting, separate power switch. Suppresses jamming and noise while offering an astounding degree of station selectivity. Two phase-linear ceramic filters in the IF section assure excellent phase characteristics over the wide frequency bandwidth. Includes a large dual meter that shows signal strength for AM, center-channel for FM. 1.9 μ V (IHF) Sensitivity. 60 dB Selectivity. 70 dB Signal-to-Noise Ratio. Less than 0.4% Distortion. 20-15,000 Hz ± 0.2 , -2.0 dB Response. 16¹/₂ x 5⁵/₁₆ x 13³/₁₆". 117 VAC.

RA-954J. Shpg. wt. 18¹/₂ lbs. **129.95**

Model TX-7100. Deluxe version of above. Twin tuning meters for even greater precision. Image rejection of more than 80 dB. Front panel AM and FM output level controls.

RA-955J. Shpg. wt. 21¹/₂ lbs. **179.95**



Stereo Amplifier with Professional Features

299⁹⁵

Model SA-8100. Has everything in the way of internal circuitry for an all-around distinguished performance. Has plus-minus split power supply for all stages. Equalization within ± 0.2 dB (RIAA). Unique "Twin Tone Control" system combines independent tone control and adjustments for approximately 2000 different kinds of tonal characteristics. Has automatic protection circuit. 40 watts + 40 watts continuous power at 8 ohms. 20-20,000 Hz response. Less than 0.3% Distortion. Volume control has level-set switch that broadens the operational range for controlling at low volume levels. Can handle 2 pairs of speakers, 2 turntables, 2 tape decks, 2 Aux. 16¹/₆ x 5⁵/₁₆ x 13¹/₆". 117 VAC.

AM-477J. Shpg. wt. 31¹/₄ lbs. **299.95**

Model SA-9100. Deluxe version of above. 60 watts + 60 watts continuous power. Less than 0.1% Distortion. Direct-coupled OCL design. Handles up to 3 pairs of speaker systems, 2 microphones. Level-set switch to wider optimum control range for volume level. Subsonic filters for both amp sections, and more. Size as above.

AM-478J. Shpg. wt. 33¹/₄ lbs. **399.95**



Excellent Selectivity AM/FM Stereo Tuner

229⁹⁵

Model TX-8100. Employs dual gate MOS-type FET's in the RF stage and mixing stage, coupled with a frequency linear 4-gang variable capacitor. Features also include FM muting, noise filter for enhancing tonal quality by suppressing irritating high frequency noise in stereo broadcasts, multipath output terminals to permit accurate antenna direction. Separate output level controls for AM and FM. By utilizing the fixed output you can direct-record from the tuner by bypassing your amplifier. There is a headphone output jack with an adjustable level control so that you can enjoy stereo listening with the tuner only. Has 1.8 μ V (IHF) Sensitivity. More than 80 dB (IHF) Selectivity. Capture ratio of 1 dB (IHF). 20-15,000 Hz Response ± 0.2 dB, -2.0 dB. 70 dB Signal-to-Noise ratio. Less than 0.4% Stereo Distortion. 16¹/₆ x 5⁵/₁₆ x 13¹/₂". 117 VAC.

RA-956J. Shpg. wt. 22 lbs. **229.95**

Model TX-9100. Deluxe version of above. Has an incredible 1.5 μ V Sensitivity. 6-stage limiter, 75 dB Signal-to-Noise ratio. With phase-lock-loop to improve stereo function, Pulse Noise Suppressor.

RA-957J. Shpg. wt. 24³/₄ lbs. **299.95**

Quality Hi-Fi Components by **ROTEL**

Features **TWO Tape Inputs/Outputs for Dubbing or Hook Up of Two Decks**



1 149⁹⁵

1 30-Watt IHF Stereo FM-AM Receiver

- **Silicon Output Transistors for Stable Performance**
- **Tuning Dial Changes Color to Indicate FM Stereo**
- **Walnut-Finish Wood Enclosure • Aluminum Front Panel**

Model RX-150A. Perfect for apartments, smaller houses, etc. Its 30 watts IHF power is enough for most high-efficiency speaker systems, and its very low distortion figure of less than 0.5% means it delivers crisp, clear sound from all sources. Has a signal-strength tuning meter, main and remote speaker switches, separate power on-off switch so you don't have to reset controls each time you turn it on. Smooth-action weighted flywheel tuning, front panel stereo headphone jack, tape monitor switch. TWO tape inputs/outputs, mag. phono input, more. FM sensitivity, 5 μ V, stereo separation, 32 dB. 16 $\frac{1}{2}$ x 6 $\frac{1}{2}$ x 5 $\frac{1}{2}$ ". For 117 VAC.

RA-077J. Shpg. wt. 10 lbs. 149.95

4 80-Watt IHF Stereo FM-AM Receiver

Model RX-400A. Has the power and features you need for a first-class stereo setup. Signal-strength AM/center-channel FM tuning meter, pushbutton function selectors, ganged controls. Has stereo indicator light, smooth flywheel tuning, full tape inputs with monitor. Rear panel speaker matrix switch for simulated 4-channel. FM sensitivity, 2.5 μ V, stereo separation 35 dB. 17 $\frac{1}{2}$ x 5 x 12 $\frac{1}{2}$ ". For 117 VAC.

RA-078J. Shpg. wt. 16 lbs. 239.95

5 140-Watt IHF Stereo FM-AM Receiver

Model RX-600A. Plenty of power, TWO tuning meters, speaker selector switch, inputs, outputs, and controls for everything make this a great receiver buy! Has center-channel FM, signal-strength AM/FM tuning meters, speaker matrix switch for simulated 4-channel, hookups for three record players and two tape recorders. FM sensitivity, 2.2 μ V IHF, 30/30 watts rms. THD, less than 0.2%. Walnut-finish wood case. 18 x 5 $\frac{1}{2}$ x 12 $\frac{1}{2}$ ". For 117 VAC.

RA-079J. Shpg. wt. 20 lbs. 349.95

6 80-Watt IHF 4-Channel FM-AM Receiver

Model RX-154A. Complete 4-channel receiver even has *discrete recording outputs*—hook up a 4-channel deck and make your own discrete tapes. Handles all discrete and matrixed 4-channel sources, synthesizes 2-channel stereo too. Strapped power output: 10 watts rms per channel in 4-channel mode; 20-watts rms per channel in 2-channel mode. FM sensitivity: 3 μ V, stereo separation 32 dB. 16 $\frac{3}{4}$ x 5 $\frac{1}{4}$ x 13 $\frac{3}{4}$ ". For 117 VAC.

RA-076J. Shpg. wt. 18 lbs. 289.95



2 159⁹⁵



3 159⁹⁵

2 AM/FM Stereo Tuner "Separate"

- **FET Front End for Precise FM Reception**

Model RT-322. Has four-stage IF for outstanding selectivity, muting pushbutton to eliminate interstation noise, effective multiplex filter, signal-strength tuning meter, more. 2.0 μ V FM sensitivity. Styled to match amplifier below. 13 $\frac{1}{4}$ x 4 $\frac{3}{8}$ x 8 $\frac{1}{16}$ ". For 117 VAC.

RA-080J. Shpg. wt. 11 lbs. 159.95

3 90-Watt IHF Solid State Integrated Amplifier

- **Speaker Switch for Derived 4-Channel Sound**

Model RA-311. Features low-noise silicon output transistors, TWO tape inputs/outputs for easy tape dubbing, loudness and mode switches, high filter. Has pilot light, headphone jack, separate power on-off. 18/18 watts rms (both channels driven). 15-50,000 Hz bandwidth. 0.1% distortion. 13 $\frac{1}{4}$ x 4 $\frac{3}{8}$ x 8 $\frac{1}{16}$ ". For 117 VAC. With walnut-wood enclosure.

AM-483J. Shpg. wt. 14 lbs. 159.95



4 239⁹⁵



5 349⁹⁵



6 289⁹⁵

JVC 2 and 4 Channel System Savings Packages

Save 35⁷³

Separate Items Reg. \$485.73 **\$450** Low Priced Complete Stereo Component System

- VR-5505 40-Watt Stereo FM/AM Receiver
- Garrard 42 M/P Turntable with Base, Pickering V15-ATE-4 Magnetic Cartridge with Elliptical Diamond Stylus Page 40
- 2 JVC VS-5323 12" Three-Way Speaker Systems
- GUSDORF 4520 Series Cart - For Wheeling Around Page 44

A fine component system value. The turntable is a 3-speed model, all ready to plug in and play. Each speaker system has 10" woofer, 3" midrange, and a horn tweeter in tunable vent-type enclosure. All plugs and cables plus 100' speaker wire.

AS-756J. Shpg. wt. 80 lbs. 450.00

Save 77⁸⁴

Separate Items Reg. \$677.84 **\$600** Expensive Sounding Stereo Component System

- VR-5525 110-Watt Stereo FM/AM Receiver
- Garrard 42 M/S Turntable with Base, Shure M75ECS Magnetic Cartridge with Elliptical Diamond Stylus Page 40
- 2 Trusonic JR-100M 10" Three-Way Speaker Systems
- All Plugs, Cables, 100 Feet of Speaker Wire

Offers excellent quality and style in each component. The Trusonic speakers have 10" woofer, 5" midrange, and 1" tweeter for full, profound sound. The entire package is a true bargain with no skimping on quality.

AS-757J. Shpg. wt. 102 lbs. 600.00

Save 141⁶⁵

Separate Items Reg. \$1081.65 **\$940** "4-Channel" Sound System At A "Stereo-Only" Price

- 4VR-5436 140-Watt 4-Channel FM/AM Receiver
- Garrard Zero 92 Turntable with Base, Dust Cover, and Empire 999E/X Magnetic Cartridge with Elliptical Diamond Stylus Page 2
- 4 Teledyne-Olson SS-930 10" Two-Way Speaker Systems Page 56

Now you can move into the world of 4-channel with this fine balanced line of components. The Teledyne speakers each have 10" woofer and 4" tweeter. Garrard's finest automatic turntable has the famous "Zero Tracking Error" tone arm. All plugs and cables plus 100' speaker wire.

AS-758J. Shpg. wt. 190 lbs. 940.00

Save 236⁶⁵

Separate Items Reg. \$1621.65 **\$1385** JVC's Best 4-Channel Component System

- 4VR-5446 170-Watt 4-Channel FM/AM Receiver
- Garrard Zero 100 Turntable with Base, Dust Cover, and Audio Technica CD-4 Magnetic Cartridge with Nude Shibata Elliptical Diamond Stylus Page 50
- 4 Teledyne-Olson SS-175 Deluxe 4-Way 12" Speaker Systems Page 56

One of the best 4-channel systems you can buy! The speakers have 12" woofer, 5" midrange, 2½" tweeter and 1½" super-tweeter. The Garrard turntable is their best and one of the best in industry. All plugs and cables plus 100' speaker wire.

AS-759J. Shpg. wt. 230 lbs. 1385.00

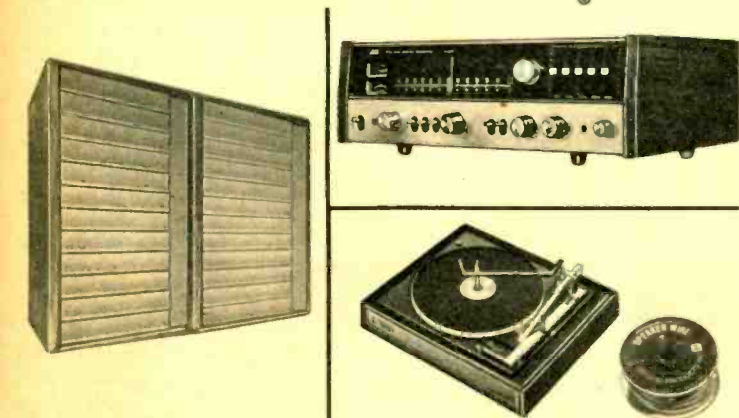

JVC Receivers and Extras



1
349⁹⁵

1 110-Watt AM/FM Stereo Receiver—Many Extras

Model VR-5525. Features S.E.A. panel that provides precise sound control over 5 frequency ranges from your turntable, tape deck or FM broadcasts. Ready for the *future coming* of discrete 4-channel broadcasts. Has FET, 3-gang tuning capacitor, 2 mechanical filters and a pair of IC's, signal-strength/center-channel tuning meters. Inputs for 2 pairs of speakers. Pre- and power amplifiers can be used separately. Power at 4 ohms, 28 watts/ch. rms. 2.2 μ V IHF FM sensitivity. 10-50,000 Hz response. Walnut case, 6 $\frac{1}{2}$ x 18 $\frac{1}{2}$ x 12 $\frac{3}{4}$ ". For 117 VAC.
RA-014J. Shpg. wt. 22 lbs. 349.95

3 140-Watt FM/AM Discrete 4-Channel Receiver

Model 4VR-5436. Handles EVERY discrete 4-channel source—Even has a built-in CD-4 demodulator so you can play the new CD-4 discrete 4-channel records. A second decoder circuit decodes EV, QS, or SQ matrix 4-channel records. Also converts 2-channel records into synthesized 4-channel. With S.E.A. tone control system *plus* BTL connections that enable you to double the rated power if 2 speakers are used. Power at 4 ohms; 18 watts/ch. rms. 2.0 μ V IHF FM sensitivity. 20-30,000 Hz response. Walnut case, 6 $\frac{1}{2}$ x 20 x 15 $\frac{3}{8}$ ". For 117 VAC.
RA-015J. Shpg. wt. 31 $\frac{1}{2}$ lbs. 499.95

4 170-Watt Deluxe AM/FM 4-Channel Receiver

Model 4VR-5446. JVC's finest discrete 4-channel receiver! It decodes the new CD-4 4-channel discs, plays all matrix 4-channel material *PLUS* converts 2-channel to synthesized 4-channel. The tuner is prepared for the introduction of 4-channel FM broadcasts with an FM DET Output. Has S.E.A. tone control system, Output Capacitor-Less power amplifier, IC's, twin tuning meters. Inputs for 4 pairs of speakers, 2 discrete 4-channel tape decks. Power at 4 ohms. 26 watts/ch. rms. 2.0 μ V Sensitivity. 10-30,000 Hz Response. Walnut cabinet, 6 $\frac{1}{2}$ x 20 x 15 $\frac{3}{8}$ ". 117 VAC.
RA-016J. Shpg. wt. 34 $\frac{3}{4}$ lbs. 599.95

5 4-Channel Disc Demodulator

Model 4DD-5. This innovative demodulator makes it possible for you to play the new 4-channel discrete discs. All it requires is simple hook-up to your present 4-channel amplifier or receiver. Just plug it into the special output jack or the Aux jack and you're ready. Has a 2/4 channel switch. 7 x 3 $\frac{1}{2}$ x 13". For 117 VAC.
RA-851J. Shpg wt. 6 lbs. 119.95

6 Radar Screen Reverberation Amplifier

Model ECA-102. Enrich your sound system! Hooks up to tape recording and playback terminals of amplifier or receiver. Has mixing control circuit, 0-3 second reverb time. Colorful reverb indicator blinks out a kaleidoscopic pattern as reverberation intensifies. 5 $\frac{1}{2}$ x 9 $\frac{1}{2}$ x 13 $\frac{1}{2}$ ". 20-40,000 Hz. For 117 VAC.
AM-482J. Shpg. wt. 11 lbs. 129.95

7 Automatic Noise Reduction System

Model NR-1020. Great extra to incorporate into an existing stereo system to help eliminate annoying tape hiss and noise while enhancing sound reproduction. Improves S/N by 5dB at 1kHz and 10dB at 10kHz without adding noise to your stereo tapes. Built-in 400 Hz signal generator. 3 $\frac{1}{2}$ x 13 $\frac{1}{2}$ x 7 $\frac{1}{2}$ ". For 117 VAC.
RA-012J. Shpg. wt. 5 $\frac{1}{2}$ lbs. 149.95



2
179⁹⁵

2 40-Watt AM/FM Stereo Receiver

Model VR-5505. Stylish model has many features found in more expensive receivers. The FM tuner section has 3-gang tuning capacitor, FET silicon transistor front end, 4-stage IF filter. With easy-to-read linear dial, precision tuning meter, bass, treble and balance controls, loudness button. Power at 4 ohms, 11 watts/ch. rms. 2.2 μ V IHF FM sensitivity, 20-40,000 Hz response, 33 dB Stereo Separation. Handsome walnut-finish cabinet. 5 $\frac{1}{2}$ x 18 $\frac{1}{2}$ x 13". 117 VAC.
RA-013J. Shpg. wt. 17 $\frac{1}{2}$ lbs. 179.95



3
499⁹⁵



4
599⁹⁵



5
119⁹⁵



6
129⁹⁵

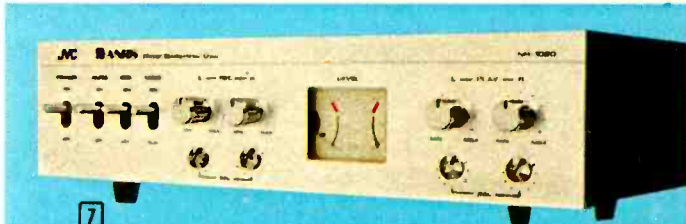

7
149⁹⁵

PHILCO

Studio-Console-Design Stereo/Phono/Tape Hi-Fi- Systems

Stereo FM-AM Receiver with "System IV" Derived 4-Channel

- Matched Air-Suspension Speakers
- Deluxe 4-Speed Stereo Turntable
- 50 Watt (EIA) Stereo FM-AM Receiver

Model M4780BWA. "Space-Age" style, full controls, a deluxe 4-speed changer with magnetic stereo cartridge and two wide-range speakers make this a receiver you'll be proud to own. Features slide-type controls with visible, lighted level indication, slide-rule FM-AM tuning, inputs for an extra pair of speakers so you can get derived 4-channel sound from all stereo sources. Special "Positone" indicator with switchable AFC, FM stereo light, "black-out" tuning dial. Turntable features cue control, hinged tinted dust cover. FM Sensitivity: $6\mu\text{V}$ for 30 dB S/N; stereo separation, 30 dB at 1 kHz, 25 watts rms total power. Receiver/turntable, $32\frac{3}{4} \times 7\frac{3}{4} \times 13\frac{3}{4}$ ", each speaker, $11\frac{1}{2} \times 22\frac{1}{2} \times 11$ ". For 117 VAC.

RA-987J. Shpg. wt. 98 lbs. 349.95
RA-993J. Optional Stand (Shown) 13 lbs. 12.98



349⁹⁵ stand extra

(Includes 2-speakers)



379⁹⁵



249⁹⁵

Stereo Receiver with Cassette Deck

- Pushbutton Record / Play Stereo Cassette Deck
- 50-Watt (EIA) Stereo FM-AM Receiver

Model M5780BWA. Here's the great way to listen to AM, FM or FM stereo and build yourself a library of your favorite music on full-fidelity stereo cassettes. Radio has all the features of Model M4780BWA above, including System IV derived four-channel capability (simply add two more speakers), plus magnetic phono input. Built-in cassette deck has push-button function controls, pop-up loading slot, 3-digit record counter, dual record level meters with slide-type level controls for each channel. Separate stereo headphone jack lets you monitor actual recorded signal as it goes on your cassette. Radio and amplifier specs same as above, cassette recorder response, 50-12,000 Hz. $23\frac{1}{16} \times 5\frac{5}{16} \times 13\frac{3}{4}$ ", each speaker, $11\frac{1}{2} \times 22\frac{1}{2} \times 11$ ". For 117 VAC.

RA-010J. Shpg. wt. 86 lbs. 379.95

Stereo Receiver with 8-Track Record/Play Deck

- Make Your Own Stereo Cartridges for Playback on Your Car Stereo 8-Track Player

Model M5712EWA. Has all you need to make your own exciting 8-track cartridges from FM, FM stereo, AM, even includes two mikes for "live" stereo recordings. Receiver has slide-rule tuning dial, with lighted pointer, stereo indicator light, modern slide-type controls for bass, treble, balance and loudness. Special FM/mono/FM stereo circuit automatically compensates for weakened stereo signals. 8-track tape player has lighted program indicators, automatic-level-control circuit, pop-in cartridge loading. Includes two 6" full-range speakers (simply add 2 more for System IV derived 4-channel). FM sensitivity: $8\mu\text{V}$ for 30 dB quieting; stereo separation, 25 dB at 1000 Hz, 5 watts EIA, 40 watts IPP power. Receiver/recorder, $25\frac{3}{8} \times 4\frac{1}{16} \times 13\frac{3}{8}$ ", each speaker, $10 \times 16 \times 7\frac{5}{16}$ ". For 117 VAC.

RA-989J. Shpg. wt. 53 lbs. 249.95

Stereo and 4-Channel Systems from



Stereo FM-AM/8-Track/Phono System

- 4-Speed Record Changer with Magnetic Cartridge
- Record and Play 8-Track Stereo Cartridge Deck

Model M5714EWA. Here's "total entertainment" from records, 8-track tape, stereo FM and AM in a stylish combination unit that's modern as tomorrow. Even has Philco-Ford's System IV 4-channel speaker matrix circuit so you can add an extra pair of speakers and enjoy deep-dimensional 4-channel effect from all your stereo sources. Features "black-out" receiver tuning dial, slide-type bass, treble balance and loudness controls, AFC switch for FM. The 8-track record/play deck has lighted channel indicators, easy pop-in loading, even includes two mikes for "live" recordings. Full-size 4-speed record changer includes cue control, tinted dust cover. Two 6" full-range air-suspension speakers for great stereo sound. Walnut veneer cabinetry with brushed aluminum trim. FM sensitivity, 8 μ V for 30 dB S/N. Separation, 25 dB at 1 kHz. Power: 5 watts EIA, 40 watts IPP. Receiver, 25 $\frac{3}{8}$ x 7 x 19 $\frac{5}{8}$ "; speakers, 10 x 16 x 7 $\frac{5}{16}$ ".
RA-990J. Shpg. wt. 59 lbs. 299.95



299⁹⁵

Discrete 4-Channel Receiver/Turntable System

- "System IV" 4-Channel Discrete and Matrix Modes
- Includes Four Air-Suspension Speaker Systems

Model M4724EWA. Hear the exciting "sound of the 70's" from this truly deluxe receiver/turntable system. Has 4 separate amplifiers and four speakers for *discrete* 4-channel sound from tapes, delivers matrixed 4-channel sound from encoded records and FM broadcasts, synthesizes 4-channel sound from regular stereo. Has slide-rule tuning dial, FM stereo light, AFC switch for drift-free FM. Record player features magnetic stereo cartridge, cue control, tinted dust cover. Has jacks for discrete 4-channel tape player, external speakers, AC outlet, front panel stereo headphones. Wide-range speaker systems feature air-suspension design with 6" woofer and 2 $\frac{5}{8}$ " midrange/tweeter. FM sensitivity: 6 μ V for 30 dB S/N; stereo separation, 22 dB at 1 kHz. Power: 25 watts EIA, 100 watts IPP. Receiver, 32 $\frac{7}{8}$ x 7 $\frac{5}{8}$ x 13 $\frac{3}{4}$ "; speakers 10 x 19 x 9 $\frac{3}{16}$ ". For 117 VAC.
RA-991J. Shpg. wt. 105 lbs. 339.95



339⁹⁵

Discrete 4-Channel Receiver/8-Track Combination

- 8-Track Player for Discrete Q8 Cartridges
- Receives Encoded 4-Channel FM Broadcasts

Model M5724EWA. Deluxe unit has 4 separate-amplifier-circuit for discrete playback of Q8 4-channel cartridges, delivers matrixed four-channel sound from FM broadcasts or encoded records (when you add a stereo turntable). Receiver has illuminated slide-rule tuning, FM stereo light, AFC. Tape player features program indicator lights, automatic or manual program change, stereo/4-channel switch, easy pop-in cartridge loading. Each speaker has a 6" woofer and 2 $\frac{5}{8}$ " midrange/tweeter with air-suspension design for full, natural wide-range sound. Good-looking walnut veneer finish cabinetry with brushed aluminum "space-age" slant-front panel and black-out tuning dial. Receiver specs same as above. Receiver, 23 $\frac{13}{16}$ x 5 $\frac{5}{8}$ x 13 $\frac{3}{4}$ "; speakers, 10 x 19 x 19 $\frac{3}{16}$ ". For 117 VAC.
RA-992J. Shpg. wt. 88 lbs. 339.95



339⁹⁵

Pedestal Base

Use with all units on these two pages. Offers "studio-type" control of program and playback functions. Stands 22 $\frac{1}{2}$ " high, has walnut-veneer platform and base, aluminum legs. No-tip design. Wt. 13 lbs.
RA-993J. 12.98

12⁹⁸



High-Quality Manual Turntables For Audio Perfectionists

AR



96⁵⁰

The Famous AR Two Speed Turntable

- Mounted On Walnut Base with Dust Cover
- Stylus Pressure Gauge • Color-Coded Cables

The design and performance of this famous model PROVE the excellence of simplicity! Miniature synchronous motor and belt drive are totally quiet. Incredible stability — the top plate can be struck by vertical hammer blows without interrupting the music. Insensitive to floor vibrations or acoustical feedback. Tone arm has internal adjustable viscous damping. Mounted on oiled walnut base. Operates at 33 $\frac{1}{3}$ and 45 rpm. Less cartridge; with plug-in cartridge shell, hardware. 16 $\frac{3}{4}$ x 5 $\frac{1}{4}$ x 12 $\frac{3}{4}$ ". For 117 VAC.

RP-407J. Shpg. wt. 20 lbs. 96.50

PIONEER



249⁹⁵

Professional Direct-Drive Stereo Turntable

- Brushless DC Servo Motor For Quiet, Stable Rotation
- S-Shaped Tonearm—Perfect For Light-Tracking—4-Channel

Model PL-51. This highly advanced turntable employs an ultra-slow, quiet running motor. The turntable platter is directly connected to the shaft of the drive motor — no belts, idlers, etc. Highly-sensitive and stable S-shaped tonearm makes it ideal for CD-4 records. Less than 0.06% wow and flutter. Damped cueing, low-stray-capacity output cable. Better than 55 dB S/N. Solidly constructed wood cabinet and metal base with large insulators. 18 $\frac{29}{32}$ x 7 $\frac{9}{32}$ x 16 $\frac{5}{32}$ ". 2-speed. Less cartridge.

RP-477J. Shpg. wt. 23 $\frac{1}{2}$ lbs. 249.95



349⁹⁵

"Troubador" Turntable System

- Dust Cover, Base, 1000 ZIEX Cartridge

Model 598-2. "Broadcast quality," crafted for ultimate audio performance. Designed for low-tracking-force cartridges down to 0.1 gram! Empire 990 tone arm with *Dyna Lift* has precision fool-proof adjustments, full balancing with front and rear pivots. Motor reaches full speed in less than $\frac{1}{3}$ revolution. Adjustable stylus force, cueing, anti-skate. Plays 33 $\frac{1}{3}$, 45, 78 rpm. .01% wow & flutter. 17 $\frac{1}{2}$ x 15 $\frac{1}{8}$ x 8". 117 VAC.

RP-452J. Shpg. wt. 30 lbs. 349.95

Dual



\$350

The Steady N' Quiet 2-Speed

- Operates Manually Or Automatically

Model 701. Simple in appearance — sophisticated in design! Vibration-free, all electronic low-speed DC motor has feedback controlled speed precision. Unique counterbalance with two anti-resonance filters, gimbal suspension tonearm, 8% pitch-control range. With anti-skate and pitch controls, direct-dial pressure, tracks low as $\frac{1}{2}$ to 1.5 grams. Dust cover and Base. 17 $\frac{1}{2}$ x 14 x 6". 117 VAC. Less cartridge.

RP-476J. Shpg. wt. 28 lbs. 350.00
See Cartridges Page 50-51.

JVC



109⁹⁵

2-Speed Professional Model

- Walnut Wood Base and Dust Cover

Model VL-5. Designed for precision play of the new CD-4 discs (with CD-4 equipped systems), flawless 2-channel record reproduction too! Has belt driven motor, factory pre-set anti-skate, damped cueing, automatic tone arm lift and stop. Less than 0.10% (WRMS) wow and flutter, rumble down to 46 dB. Stylus pressure gauge. Recommended tracking force from 1.5 to 2.0 grams. 33 $\frac{1}{3}$ and 45 rpm. 7 $\frac{1}{2}$ x 19 $\frac{3}{8}$ x 16 $\frac{1}{4}$ ". 117 VAC. Less cartridge.

RP-463J. Shpg. wt. 15 $\frac{3}{4}$ lbs. 109.95

Dual Top Performance—3-Speed Turntables

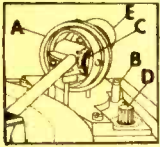

- A Twin-Ring Gimbal Suspension
- B Special Setting For Perfect Tracking
- C Stylus Pressure Control
- D Anti-Skate Provision
- E Damped Counter Balance

1¢
Cartridge
Offer with
All Models

All 4 Models Feature

- 6% Pitch Control
- Separate Antiskating Conical and Elliptical Styli Controls—except with Model 1214
- Damped Cue-Control

1 New! "Mid-Priced" Automatic Turntable

- Includes Adjustable Anti-Skating Control
- Tracks As Low As 0.5 Gram

Model 1216. Offers excellent overall performance with a full list of features. Includes synchronous/hi-torque motor to reduce rumble, wow and flutter. Also has low-mass tubular arm to reduce record wear, pitch control to tune-in "off-pitch" records. Silicone-damped cue-control prevents stylus bounce. 12 $\frac{1}{8}$ x 10 $\frac{3}{4}$ ". Req. 5" above, 2 $\frac{3}{8}$ " below mtg. board. Order custom base below. For 117 VAC.
 RP-462J. Shpg. wt. 15 lbs. 139.50
 AS-745J. Dual 1216 with Reg. \$19.95 Audio Technica AT-11-E Magnetic Stereo Cartridge. 16 lbs. Save \$19.94 139.51



2 New! Dual's Lowest-Priced '74 Model Turntable

- Low-Mass Counterbalanced Tubular Tonearm
- Tracking As Low As 1 $\frac{1}{4}$ Grams • Stylus Pressure Dial

Model 1214. Has many features of the more expensive Models, at a price that makes it practical for inclusion in many "budget" systems. Features include a 6% variable pitch control, silicone-damped cue-control, elevator action changer spindle PLUS factory pre-set anti-skating. Synchronous/hi-torque motor. 12 $\frac{1}{8}$ x 10 $\frac{3}{4}$ ". Req. 5" above, 3" below mtg. board. Base below. 117 VAC.
 RP-461J. Shpg. wt. 15 lbs. 109.50
 AS-744J. Dual 1214 with Reg. \$14.95 Audio Technica AT-11 Magnetic Stereo Cartridge. 16 lbs. Save \$14.94 109.51



3 The Most Popular Dual Ever!

- Tracks "Ever So Lightly" Down to 0.5 Grams
- "Feather-Touch" 2-Way Cue Control • VTA Selector

Model 1218. Long-time favorite, because it plays with the best of them! 12" die-cast platter is driven by a synchronous/continuous pole motor. Has low mass tubular tone arm, damped cueing, anti-skate, pitch control. VTA selector provides precise vertical tracking. Rotating single-play spindle. 13 x 10 $\frac{3}{4}$ ". Req. 5" above, 3" below mounting board. Order custom base below. For 117 VAC.
 RP-443J. Shpg. wt. 14 lbs. 169.50
 AS-746J. Dual 1218 with Reg. \$29.98 Empire 999 PE/X Magnetic Stereo Cartridge. 15 lbs. Save \$29.97 169.51



4 Dual's Best Turntable—For the Perfectionist

- Massive 12" 7 lb. Dynamically Balanced Platter
- Exact Stylus Tracking • Silicone-Damped Cue-Control

Model 1229. Has every feature possible for flawless record play. Synchronous/continuous motor turns platter with speed accuracy and high-torque. Has 15° stylus tracking, 0° vertical tracking error in single play. Elastically damped counterbalance, illuminated stroboscope. Adjustable stylus overhang. 14 $\frac{3}{4}$ x 12". Req. 5" above, 3" below mtg. board. Order custom base below. 117 VAC.
 RP-444J. Shpg. wt. 21 lbs. 225.00
 AS-747J. Dual 1229 with Reg. \$29.95 Audio Technica AT-12E Magnetic Cartridge. 22 lbs. Save \$29.94 225.01



Bases, Dust Covers, 45-rpm Spindle for Above

- CA-519J. WB-12 Walnut Base for 1214, 1216, 1218 2 lbs. 12.95
- CA-520J. DC-4 Dust Cover for Models 1214, 1216, 1218. 1 lb. 12.95
- CA-521J. WB-19 Walnut Base for Model 1229. 2 lbs. 14.95
- CA-522J. DC-9 Dust Cover for Model 1229. 1 lb. 14.95
- RP-448J. 45 Adapter for All Dual Models on This Page $\frac{1}{4}$ lb. 7.95

Garrard®

Precision-Crafted Automatic Turntables

**"Two Zero-Tracking-Error"
Models Available**

See page 2 for full descriptions

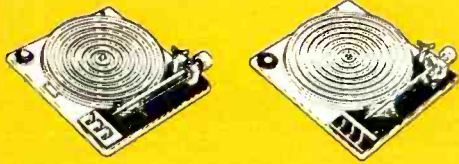

Olson Proudly Introduces the ALL-NEW Garrard "Family"!

These new Garrard 3-speeds are NOT merely updates or additions to older models—they represent an entire new design concept, with significant changes that will make your records sound better than ever, last longer too! Each is designed to provide the MOST-VALUE-FOR-THE-MONEY in its respective price range.

Cartridge Bonus Offers

Reg. \$19.95 Audio-Technica AT-11E.
AS-813J. 1¢ with Model 82 .. Total 119.96
AS-814J. 1¢ with Model 70 .. Total 89.96
AS-815J. 1¢ with Model 62 .. Total 69.96
Reg. \$24.95 Olson/Empire 99E/X.
AS-816J. 1¢ with Model 82 .. Total 119.96
AS-817J. 1¢ with Model 70 .. Total 89.96
AS-818J. 1¢ with Model 62 .. Total 69.96

See pages 50 and 51 for cartridge descriptions.



119⁹⁵ base and
cartridge extra

Save up
to **24⁹⁴**
Cartridge Bonus
Offer at Left.

Model 82

For the audiophile on a budget who still wants record reproduction with exceptional ease and accuracy. Features patented Synchro-Lab motor that maintains constant speed regardless of AC voltage variations, a low-mass extruded aluminum tone arm with full provisions for dynamic counterbalancing, 15° vertical tracking adjustment that lets you adjust tracking precisely—for a single record or for a stack. Slide-weight stylus force setting for really exact fractional tracking forces, lever-type anti-skate control. Has separate control tabs for auto, manual, cue/pause with new two-way damped motion. 15 $\frac{1}{16}$ x 14 $\frac{1}{8}$ ", requires 4 $\frac{3}{4}$ " above and 2 $\frac{7}{8}$ " below mounting board. Base extra (see page 41), cartridge offers at left. For 117 VAC.

RP-459J. Shpg. wt. 15 lbs. **119.95**

The Famous Module Series

READY TO PLUG INTO OTHER COMPONENTS AND PLAY

These quality turntables are perfect for people in tight quarters, dorms or dens, pads or play-rooms. Each includes a magnetic or ceramic stereo cartridge, tinted see-thru dust cover and custom-fitted base — hook 'em up to other components, table radios, recorders, etc. Choose from three value-packed models in a range of styles. Why delay? Great-sounding stereo awaits you at Olson!



79⁵⁰

SLX-2—Sophistication at a Moderate Price

Thousands sold—because it combines famous Garrard quality and precision record handling performance in a convenient ready-to-play package. Has synchro-Lab motor, magnetic stereo cartridge, adjustable counterweight, cueing/pause control. Swing away arm for easy automatic or manual play. 33 $\frac{1}{3}$, 45, and 78 rpms speeds. With three-position dust cover and base. 16 x 8 x 15 $\frac{1}{4}$ ". For 117 VAC.

RP-377J. Shpg. wt. 14 lbs. **79.50**

Garrard®

Turntables with Quality You'll Appreciate

Save up to **29⁹⁴**

Cartridge
Bonus
Offer (left)



89⁹⁵ base and cartridge extra

Model 70

- *Torsion-Spring Anti-Skate*
- *Low-Mass Aluminum Tone Arm*
- *Gentle 2-Point Record Support*

Sets a NEW quality standard for under-\$100 automatic turntables. Resiliently suspended counterweight provides exact tone arm balance, adjustable stylus pressure, slide-in cartridge clip for easy cartridge replacement. Center-spindle 2-point record support eliminates the overarm found on most units at this price—lets you change records in a stack quickly and easily. Has patented synchro-lab motor, "kinetically" matched turntable platter, cue/pause control with downward damping. 15 x 13½", req. 4¾" above, 3" below mtg. board. Base extra (see page 41), cartridge offers page 38.

RP-415J. Shpg. wt. 12 lbs. **89.95**

Model 62—Garrard's Lowest-Priced "New Family" Turntable

- *Heavy-Duty 4-Pole Induction Surge Motor*
- *Controls for Automatic or Manual Operation*
- *Interchangeable Single-Play/Stack Spindles*

As good as you can get in this price range! Has many "expensive model" features that give you precise record play with a minimum of fuss and bother. Two-point record support from the automatic play spindle—no overarm. Extruded aluminum tone arm with fixed counterweight and provision for easy adjustment of stylus pressure, torsion spring adjustable anti-skate. Has full controls for automatic and manual play, cue/pause control with downward damping. 14¾ x 12½", requires 4¾" above, 3" below mounting board. Base extra (see page 41), cartridge offers page 38.

RP-414J. Shpg. wt. 11 lbs. **69.95**



59⁹⁵

X-10—Stack up to 8 Records

A perfect 3-speed for teen gatherings, after-dinner parties, etc. Stacks up to 8 records for hours of carefree music. Has low-mass tubular tone arm, ceramic stereo cartridge with flip-over diamond stylus that's factory pre-set for accurate tracking. With good-looking ebony base, 3-position dust cover, spindles for automatic or manual play. Ideal for 3-piece radios with ceramic phono input. 15 x 8 x 15¼". For 117 VAC.

RP-382J. Shpg. wt. 12 lbs. **59.95**



44⁹⁵

X-11 "Demi"—Garrard's Lowest-Priced Module

A super space saver that plays just like the big ones! Plays all size records at all four speeds (16, 33½, 45 and 78 rpm), stacks up to 8 and shuts off when the last record is over. Swing-away arm for easy manual operation too. Has flip-over ceramic stereo cartridge with diamond needle, custom dust cover and base. Garrard built induction motor. 13¾ x 16½ x 10¼"—perfect for stereo setups where space is a factor. For 117 VAC.

RP-393J. Shpg. wt. 7 lbs. **44.95**

Garrard

Convenient Componentry from Olson

These quality pre-packs bring you component turntables matched with finest Garrard Accessories and NAME-BRAND stereo cartridges that are factory pre-mounted and set. You get the ready-to-play convenience of a module with the performance and premium features of "separates".



109⁹⁵

Garrard's Newest Pre-Pack—the 74M/S

- Damped Cueing in Both Directions for Real Record Protection

- Pre-Mounted Shure M91ED Magnetic Stereo Cartridge

The 74M/S has a host of outstanding features for fine record play, and you'd pay a lot more if you bought the components separately yourself. Features 15° vertical tracking adjustments, sliding weight stylus-force setting, low-mass extruded aluminum tone arm with full provision for counter balancing. Has single-play and automatic spindles, lever-type anti-skate adjustment, kinetically matched turntable. Separate tabs control auto or manual operation, cue and pause. 33½, 45, 78 rpm speeds. Patented Synchro-Lab motor. With Shure M91ED magnetic stereo cartridge with elliptical diamond stylus and Garrard B-2 base. 16¾ x 8¾ x 15¾". For 117 VAC.

RP-464J. Shpg. wt. 16 lbs. 109.95

Turntable + Cartridge + Base = Total Retail Value \$151.85



54⁹⁵

Pre-Pack with Ceramic Cartridge—the 42C

- Offers Higher Output for Ceramic Input Amplifiers
- Deluxe Tetrad Ceramic Cartridge with Diamond LP Stylus

The perfect way to upgrade your radio or console! Gives the mechanical and functional features of true component record play—but features a ceramic stereo cartridge so you can use it with phono consoles, 3-piece radios, etc. Has the same fine features of the 42M below, except for a two-pole induction motor. With custom base, Tetrad 1-43-D ceramic cartridge with flip-over diamond stylus. 15 x 7¾ x 13¾". For 117 VAC.

RP-466J. Shpg. wt. 14 lbs. 54.95

Turntable + Cartridge + Base = Total Retail Value \$73.90



64⁹⁵

The Famous 42M/S and 42M/P Pre-Packs

- 4-Pole "Induction Surge" Motor Stops Rumble and Wow
- Removable Spindle for Automatic or Manual Record Play

For use with medium-priced component stereo systems—offers top performance with outstanding convenience. Plays 33½, 45, 78 rpm records—has damped cueing/pause control, adjustable anti-skate, gimballed counter-weight tone arm. B1 base, your choice of Pickering or Shure cartridge with elliptical diamond stylus. 15 x 7¾ x 13¾". For 117 VAC.

RP-450J. 42M With Shure M75ECS Cartridge. 14 lbs. 64.95

RP-451J. 42M With Pickering V15-ATE-4 Cartridge. 14 lbs. 64.95

Turntable + Shure/Pickering Cartridge + Base = Total Retail Value \$90.85

Garrard

"Compact Series"—for Stereo-on-a-Budget—from Olson

1¢
Cartridge
Bonus
See Below



1
44⁹⁵



2
42⁹⁵



3
49⁹⁵

1 Model 30 Auto Turntable

High-performance auto/manual unit includes an excellent-quality factory installed flip-over ceramic cartridge. Perfect for amplifiers or receivers without "mag. phono" inputs. Plays all four speeds, has automatic operation with size mixing, manual operation too. Stylus pressure adjustment. 14 $\frac{3}{8}$ x 12 $\frac{1}{2}$ ". Req. 4 $\frac{3}{8}$ " above, 3" below mounting board. Base extra, order below. 117 VAC. RP-361J. Shpg. wt. 10 lbs. **44.95**

2 Model SP20B Manual Turntable

Deluxe 4-Speed manual player features low-mass tubular tone arm with fixed counterweight, ratchet stylus-pressure adjustment, arm rest with lock position, full-size turntable. Arm returns to rest position after record has played. Use the SP20B with any fine magnetic or ceramic stereo cartridge, it's a fine choice if you want to play your records singly to preserve record life. 14 $\frac{3}{8}$ x 12 $\frac{1}{2}$ ". Req. 3 $\frac{1}{2}$ " above, 2 $\frac{1}{2}$ " below board. Base extra. 117 VAC. RP-449J. Shpg. wt. 10 lbs. **42.95**

3 Model 40B Auto Turntable

• *With Olson 1¢ Cartridge Bonus!*

Great quality for the money! Has 4-pole shaded "induction surge" motor, adjustable stylus-pressure ratchet, viscous cueing and pause control. Automatic or manual 3-speed play. 14 $\frac{3}{8}$ x 12 $\frac{1}{2}$ ". Req. 4 $\frac{3}{8}$ " above, 3" below motor board. Less base, below. Cartridge bonus below. For 117 VAC.

RP-387J. Shpg. wt. 10 lbs. **49.95**

AS-579J. With Reg. \$29.95 Audio-Technica AT-12E Stereo Cartridge. 10 $\frac{1}{2}$ lbs. . . **49.96**

Deluxe Garrard Turntables and Accessories



Walnut



Ebony



Custom Dust Covers

Tinted molded styrene, can be left on when records are playing. 5 lbs.

Model D1. For base B1. **5.95**

CA-398J. Shpg. wt. 5 lbs. **5.95**

Model D2. For Base B2. **6.95**

CA-399J. Shpg. wt. 5 lbs. **6.95**

Model B1 Turntable Base. For Garrard turntable models 20, 30, 40B, 55, 62, 65 and 70. Pin-seal leather and ebony, black/silver trim. CA-396J. Shpg. wt. 5 lbs. **5.95**
CA-430J. Walnut wood version of above. Wt. 9 lbs. **19.95**
Power Version of Above. Model B1-P. Turns off turntable and cuts power to receiver after last record has played. 117 VAC. Ebony. CA-366J. Shpg. wt. 9 lbs. **14.95**

Model B2. Deluxe Base for Garrard turntable models Zero 100C, Zero 92, 82, 100, 95, 72. Style as above. CA-397J. Shpg. wt. 5 lbs. **6.95**
CA-431J. Walnut wood version of above. wt. 9 lbs. **19.95**
Power Version of Above. Model B2-P. Turns off turntable and cuts power to receiver after last record has played. 117 VAC. Ebony. CA-370J. Shpg. wt. 9 lbs. **15.95**

45-rpm Automatic Play Spindle Adapters

Equip Garrard Turntables for automatic play of 45-rpm singles.

RP-467J. For Zero 100C, 92, 82, 72, SLX-3. 1 lb. **3.80**

RP-468J. For 40B, 30, SLX-2, X10, 65, 55. 1 lb. **2.25**

RP-469J. For Models 70 and 62. 1 lb. **2.25**

RP-470J. For 42 Series. 1 lb. **2.25**

RP-471J. For X-11 Turntable Module. 1 lb. **2.25**

Plug-In Cartridge Clips

Equip Garrard Turntables for all standard-mount cartridges.

RP-472J. For 40B, SP20B, 95, 72, 65, 55. 1/2 lb. **2.25**

RP-473J. For Zero 100C, 90 and 62. 1/2 lb. **3.00**

RP-474J. For Models 70 and 62 **3.00**



GAMBER-JOHNSON Fine Hi-Fi Furniture

"Show Off" Your Components on These Quality Stands



29⁹⁸

"Swingerette" Audio Bench

Model 1068. Just right for smaller stereos, portable TV's, 3-piece radios. Walnut grain vinyl veneer finish, hardwood legs. Speaker supports, 12½" wide x 14" deep, top shelf, 23" wide x 16" deep, lower shelf, 19" wide x 16" deep. Overall, 19 x 48 x 16" (HWD). CA-763J. Shpg. wt. 30 lbs. 29.98

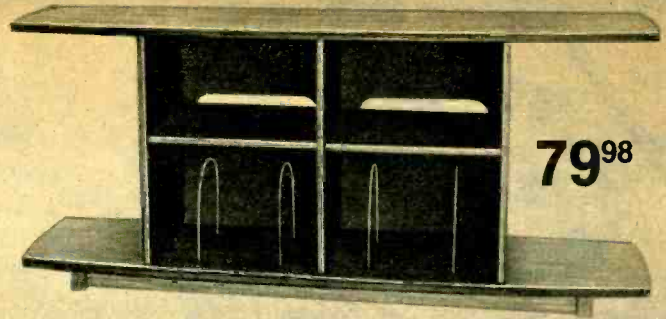

79⁹⁸

"Swinger" Total System Audio Bench

Model 1063. Space aplenty for practically ANY stereo system. Speaker supports, 26 x 14½ x 12", storage section with removable shelf, 26 x 19 x 14", phono section with pullout platform, 14 x 19 x 14". Overall, 30½ x 7½ x 16" (HWD). Easy assembly. Walnut vinyl. CA-762J. Shpg. wt. 99 lbs. Shipped REA or truck. 79.98

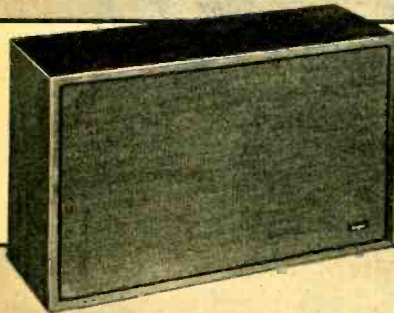

- "Dress Up" Your Custom Built Speakers
- Furniture-Quality Finish, Matching Grille Cloth

Low as 39⁹⁸

Olson. Walnut-Finish Speaker Enclosures

8"/12" Enclosure. Has 12" cutout, adapter for 8" speaker. Size, 25 x 14¼ x 9¾" (WHD). CA-507J. Shpg. wt. 24 lbs. 39.98
 15"/12"/8" Enclosure. 15" cutout with adapters for 12" or 8" speakers. Size, 25 x 17½ x 11½" (WHD). CA-506J. Shpg. wt. 27 lbs. 45.00



ntt Peerless Speakers You Put Together Yourself for Sound That's As Good As "Ready-Mades"

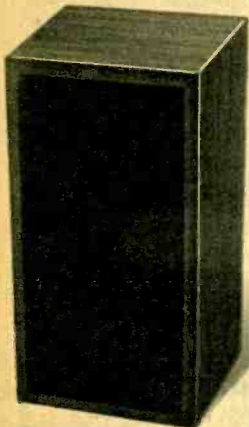

Low as 2 59⁹⁵

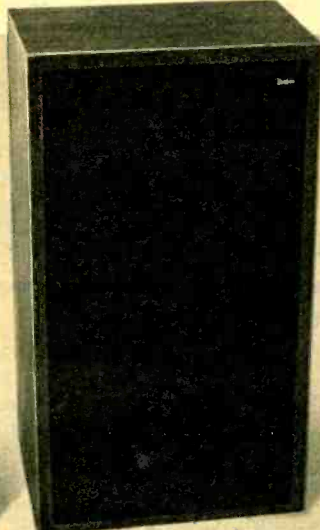

3 99⁹⁵

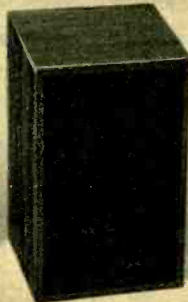

1 34⁹⁵

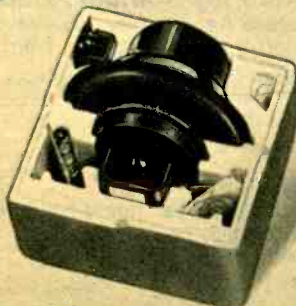

We call these speakers "semi-kits" because there's no cutting, no drilling, no wood finishing—they go together in about 45 minutes and you save because you've done it yourself. World-famous speaker components from Peerless are the same ones that are used in many of the finest assembled systems around too—they feature specially treated cones, heavy-duty Alnico-V magnets, fine magnet wire, aluminum voice coil formers and more. Each is complete with all parts and materials, decorator-styled walnut-finish cabinet and matching grille. Save on a stereo pair!

1 Two-Way 6½" System

Model CK10-2. Perfect for smaller setups. 6½" woofer and 2" tweeter. Has 35-18,000 Hz response, 20 watts (max.) power capacity, 8 ohms impedance. 8 x 13 x 8". SP-126J. Shpg. wt. 12 lbs. Pair 59.95 Each 34.95

2 Two-Way 8" System

Model CK20-2. Popular bookshelf size. 8" woofer and 2¼" tweeter. Has 40-20,000 Hz response, 60 watts (max.) power capacity, 8 ohms impedance. 10¼ x 20 x 9½". SP-127J. Shpg. wt. 22 lbs. Pair 99.95 Each 59.95

2 Three-Way 8" System

Model CK20-3. Features 5" midrange for added presence. 8" woofer, 2¼" tweeter. Has 40-20,000 Hz response, 80 watts (max) power capacity, 8 ohms impedance. 10¼ x 20 x 9½". SP-128J. Shpg. wt. 23 lbs. Pair 119.95 Each 69.95

3 Four-Way 10" System

Model CK50-4. TWO 2½" tweeters for excellent high-frequency dispersion, 10" woofer, 5 x 7" midrange. Has 30-18,000 Hz response, 80 watts (max) power capacity, 8 ohms impedance. 15 x 26½ x 10½". SP-129J. Shpg. wt. 30 lbs. Pair 179.95 Each 99.95

Dress-Up Your Home Entertainment Systems



Ready-to-Assemble Furniture

Presenting practical furniture additions that will make a beautiful home for your stereo hi-fi, TV, and other entertainment "families". Permaneer walnut finish is scuff and mar resistant — cleans like new with just a cloth!



1 Vertical Home Entertainment Center

Model 646. Attractive way to store your stereo and hi-fi components and have plenty of space for tape or album storage. Has handsome smoked lucite doors. The shelves are 16" deep so you can accommodate speakers, tuner, TV, radios—the list of possibilities is practically endless. With adjustable top shelf for larger speakers. Shipped knocked down but assembles in just minutes. Walnut "permaneer" finish. 29 x 68 x 16".
CA-757J. Shpg. wt. 110 lbs. 44.99

2 Low-Profile 48" Record Cabinet

Model 348. Has a slender "console" style with 3 sliding grooved doors. Put your stereo components or TV on top. There is a tremendous amount of storage space inside—enough for up to 300 record albums, countless cassettes and cartridges! The long low look with plenty of top surface makes it ideal as a buffet server or bar top. Walnut "permaneer" finish. Shipped knocked down and easy to assemble. 48 x 19 x 16".
CA-761J. Shpg. wt. 63 lbs. 22.99

All Items Except 3 Shipped Truck or Express Only

3 Compact Record Cabinet

Model 040. Stores up to 50 record albums and tapes. Makes an ideal sewing cabinet, etc. Has 2 sliding doors with brass plated knobs. Molded plastic legs with self leveling tips. Shipped knocked down, easy to assemble. Walnut "permaneer" finish. 23½ x 27 x 15".
CA-760J. Shpg. wt. 31 lbs. 12.99

4 Full Size Stereo Entertainment Center

Model 346. Handsome unit holds speakers wide enough for full stereo effect, has sliding center shelf for record player. Enclosed back with outlet holes. Space for records and tapes, TV, etc. Walnut "permaneer" finish. Knocked down, easy assembly. 65½ x 30½ x 15½".
CA-758J. Shpg. wt. 100 lbs. 44.99

5 Compact Home Entertainment Center

Model 345. Display your entire entertainment system. Sliding shelf, rack for cassettes etc., and stacking space for records. You can place your TV and other items on top. Shipped knocked down, easy assembly. Walnut "permaneer" finish. 47½ x 28 x 15½".
CA-759J. Shpg. wt. 73 lbs. 39.99

GUSDORF—The Style Leader in Hi-Fi Furniture

From their walnut-finish Appalachian HARDWOOD SOLIDS to their rugged ROD-TYPE construction and easy STEP-BY-STEP assembly—these Gusdorf TV and hi-fi carts offer you the BEST QUALITY for the money!

All Dimensions Given WHD

1 "Tubular" Design Stereo Cart Model 1105. Low-priced cart with plenty of style! "Pale" brass tubing provides rigid support for speakers and stereo components, swivel casters for easy mobility. Shelves: 19 $\frac{1}{4}$ x 11 $\frac{3}{4}$ ", speaker supports, 11 $\frac{3}{8}$ x 11 $\frac{3}{4}$ ". Overall: 20 $\frac{3}{4}$ x 19 $\frac{1}{2}$ x 12 $\frac{1}{2}$ ". CA-595J. Shpg. wt. 12 lbs. 14.95

2 Stereo Entertainment Center Model 4470. Extra-sturdy—accepts even the heaviest components. Full back encloses lower shelf, speaker supports fold up for cabinet effect. Adjustable record racks. Supports: 15 $\frac{3}{4}$ x 15 $\frac{3}{8}$ ". 14 $\frac{1}{4}$ " between shelves. Overall: 28 $\frac{3}{4}$ x 24 x 16 $\frac{1}{16}$ ". CA-599J. Shpg. wt. 27 lbs. 39.95

3 Low-Boy Stereo Center Model 4520. Has extra-brace on lower shelf, slide-away speaker supports. Shelves: 15 $\frac{3}{4}$ x 31 $\frac{3}{8}$ " (6" clearance), supports: 12 x 15". Overall: 35 x 22 x 16 $\frac{1}{2}$ ". With rack-type carrier for 8-track cartridges or cassettes. CA-598J. Shpg. wt. 25 lbs. 37.95

4 3-Shelf Stereo Cart Model 3378. Has second shelf that's ideal for cartridge or cassette recorder, adjustable record racks. Speaker supports: 13 $\frac{3}{8}$ x 15 $\frac{3}{8}$ ". Interior panels: 23 $\frac{3}{4}$ x 15 $\frac{3}{8}$ ". Overall: 52 $\frac{1}{2}$ x 29 $\frac{1}{2}$ x 16 $\frac{3}{8}$ ". CA-597J. Shpg. wt. 24 lbs. 22.95

5 2-Tier Roll-About TV Cart Model 3217. TV on top, magazines or whatever on the bottom! "Square" tube leg assemblies with "pale" brass plating and walnut trim, ball-bearing swivel casters. For TV's up to 19" wide. Shelves: 20 $\frac{2}{3}$ x 11 $\frac{3}{4}$ ". Overall: 20 $\frac{3}{4}$ x 23 $\frac{1}{2}$ x 12 $\frac{1}{8}$ ". CA-601J. Shpg. wt. 17 lbs. 18.95
CA-602J. Model 3245. Above, shelves: 27 x 14 $\frac{1}{2}$ ", overall: 27 x 21 x 14 $\frac{1}{2}$ ". 17 lbs. 22.95

6 Ultra-Modern Stereo Cart Model 3345. Streamlined-look square tubing, "warm-look" transparent swivel casters and hi-rise speaker supports make this ideal for a "mod" stereo system. Supports: 13 $\frac{3}{4}$ x 15 $\frac{3}{8}$ ". Overall: 26 x 15 $\frac{3}{8}$ x 13 $\frac{3}{4}$ ". CA-596J. Shpg. wt. 16 lbs. 20.95

"Solid-Support" TV Stands

7 Swivel Pedestal Type Model 6705. Has luxurious wood-grain finish, easy 2-step assembly. Won't tip—turns a full 360°. For 15" to 21" TV's—up to 26" wide. 26 x 19 $\frac{1}{2}$ x 15 $\frac{3}{8}$ ". CA-604J. Shpg. wt. 21 lbs. 32.95

8 "Majorca" Swivel Stand Model 6300. A mobile stand that's loaded with style. Elegantly detailed base and pedestal, ball-bearing swivel casters let you move set easily from room to room. Accepts TV's to 26" wide. 26 x 18 x 15 $\frac{3}{8}$ ". CA-603J. Shpg. wt. 23 lbs. 37.95



1 14⁹⁵
less components



2 37⁹⁵
less records

2 39⁹⁵
less records

4 22⁹⁵

6 20⁹⁵

5 18⁹⁵



7 32⁹⁵
less TV

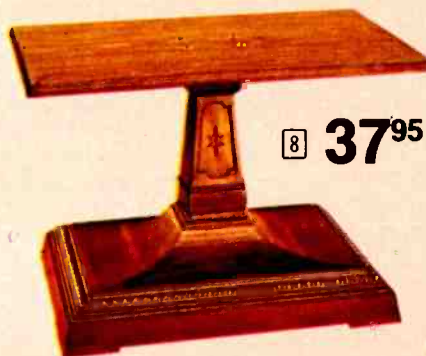

8 37⁹⁵

4-Channel FM/AM Receiver with 8-Track Player



TELEDYNE

239⁹⁸

Credit Terms Available



Discrete 4-Channel FM/AM Receiver With Built-In 8-Track 2/4 Channel Player

- 4-Channel Amplifier With Player For Stereo Or 4 Channel Cartridges
- Matrixed Circuitry Decodes E-V and SQ Discs, FM Broadcasts

- Derived 4-Channel Effect From 2-Channel Discs and Tapes
- "Command Control" Pushbutton Mode and Program Selectors

COVERED BY THE FAMOUS OLSON 2-YEAR GUARANTEE SEE PAGE 6

Here's a close-up view of some of the many features included in the RA-930



Tuning Meter
Combination Meter Shows Signal-Strength for AM, Plus Center-of-Channel for FM.



Matrix Decoder
Decodes SQ and E-V Records or FM, Synthesizes Your Regular Stereo.



Quad Control
360° "Joystick" for Easiest Possible Left, Right, Front, Rear, Balance.



8-Track Player
Plays Discrete 4-Channel Q-8 Cartridges PLUS Derived 4-Channel from Your 2-Channel Tapes.

Model RA-930. Our New Teledyne receiver is yours for the listening. Versatility and performance are definite musts for quality, and this one has both. Enjoy 2-channel records and tapes, while at the same time having the "4-Channel World" available at your fingertips. Completely equipped to handle discrete 4-channel Q-8 cartridges plus E-V and SQ encoded discs and FM broadcasts. You also get derived 4-channel effect from all 2-channel sources. Has FET tuner with a 4-channel audio amplifier. The 8-track player has automatic and manual program selector, repeat function, continuous play, and an automatic shutoff that disengages the tape head, 40-12,000 Hz Frequency Response.

Receiver has a 360 "Joystick" Quad-Control for simple left/right and front/rear channel balancing; inputs for front/rear headphone jacks for 2/4 channel listening. Pushbuttons for Tape Monitor, Loudness, Remote Speakers, Stereo-Mono, Decode, Aux, FM and AM. Has an "electric blue-green" black-out dial and tuning meter, and more. The rear panel has CD-4/tape-in jacks for discrete 4-channel (reel-to-reel) tapes and monitoring. Receiver specifications are same as RA-660, Page 11. Front panel has a stylish aluminum finish and machined all metal control knobs. Walnut-grain enclosure. 18 x 5 7/8 x 10 1/2". 117 VAC.

RA-930J. Shpg. wt. 25 lbs. 239.98

Complete 4-Channel 8-Track FM/AM/Phono System

450⁰⁰ Save **9260** Separate Items Reg. \$542.60

- Teledyne RA-930 4-Channel 8-Track Player/FM/AM Receiver
- Garrard SLX-2 Changer with Dust Cover, Base, Cartridge Page 38
- 2 Teledyne / Olson "Septette" 2-Way Speaker Systems Page 57
- 2 "Olson-Air II" 8" 2-Way Speaker Systems Page 59
- Teledyne PH-220 4-Channel Headphones Page 53

Everything you need for 4-channel tapes, 2-channel discs and FM broadcasts. With FM dipole antenna, all cables and plugs. AS-755J. Shpg. wt. 128 lbs. 450.00



TELEDYNE Top Performing Components for Great Stereo and 4-Channel Sound

All Items On This Page Covered By The Famous Olson 2-YEAR GUARANTEE

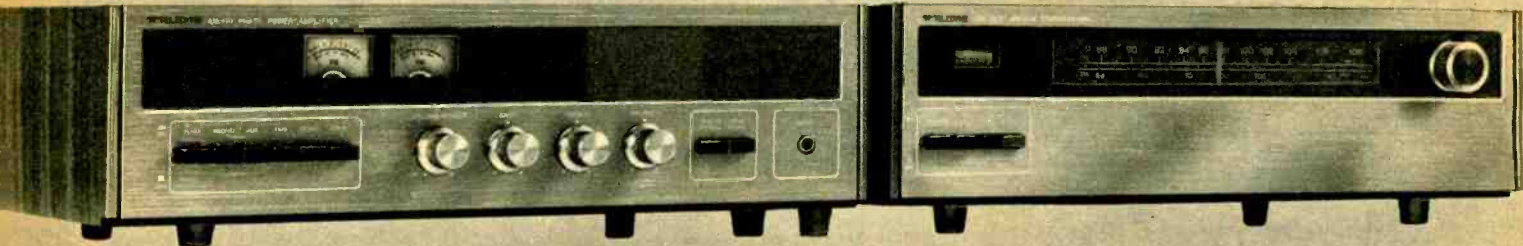

109⁹⁸

90-Watt Stereo Amplifier—Big Amplifier Features at Lowest Price

- *Electrical Performance Never Before Available at This Price*
- *All Inputs and Outputs for Sophisticated System Hookups*

Model AM-479. Versatile, new Teledyne Stereo Amplifier has everything you need in a high performance quality component at a *very reasonable price*. Features include separate power/volume, bass, treble and balance controls, pushbuttons for Phono, Aux, Tape, 4-Channel synthesized Phase Power, Tuner, Tape, Remote Speakers, Loudness, Mono, Headphone Jack. Has pilot indicators for all mode functions (Phono, Aux, Tuner), 2 VU meters for visual indication of output level. Outputs for 4 speakers, tape. 30 watts rms total power. 17-20,000 Hz Frequency Response. 20-36,000 Hz Power Bandwidth. 0.8% Harmonic Distortion. S/N: 58 dB low level inputs, 72 dB high-level inputs. With stylish brushed extruded aluminum front panel, beautiful walnut finished enclosure. 18¼ x 4¾ x 11¼". 117 VAC.

AM-479J. Shpg. wt. 15 lbs. 109.98
 AM-472J. Same, less pilot indicator and meters. 10 watts rms. 79.98

69⁹⁸



Advanced Solid-State Full Fidelity Stereo Tuner

- *FET Front End Provides Excellent Separation of Strong and Weak Signals*
- *Smooth Flywheel Tuning Dial For Easy Station Selection*

Model RA-927. Match this one with the AM-479 at the left and you have a high quality component combination that's hard to beat in terms of value, versatility and performance. Beautiful front panel with soft electric blue-green blackout dial, combination signal strength/center channel tuning meter for tuning precision that compares with the very finest. Has outputs for recording directly from FM or AM broadcasts, FM multiplex filter to eliminate multi-path distortion in crowded broadcast areas, FM Muting for quiet station to station movement. Separate pushbuttons for Stereo/Mono and On-Off Power. 40-15,000 Hz Frequency Response. 3.8 µV IHF Sensitivity. 30 dB FM Stereo Channel Separation. 15¼ x 4¾ x 11½". For 117 VAC.

RA-927J. Shpg. wt. 10 lbs. 69.98



179⁹⁸

180-Watt Discrete 4-Channel Amplifier

- *Has E-V and SQ Matrix Decoder Circuitry*
- *Joystick Balance Control*
- *Doubles RMS Power When Operated In 2-Channel Mode*
- *Low Distortion and Excellent Power Bandwidth Characteristics*

Model AM-473. Teledyne's finest 4-channel amplifier offers top performance at a surprisingly low price! Features *strapped output* that doubles rms power when 2-channel operation is used. Has inputs for Magnetic Phono, Tape, and Aux., separate bass, treble, master volume control. Pushbuttons for Power, Tape, Phono, Aux, Tuner, Loudness. Absolute balance in all modes is assured by smooth operating 4-channel joystick control.

Has positive action pushbuttons for 2-Channel, 4-Channel Discrete, Matrix, A and B speakers, and headphone jacks for 2 or 4-channel phones. Four lighted level meters for precise indication of output level. Extruded aluminum front panel with walnut finished enclosure. Output power: 15/15/15/15 rms 4 channel; 30/30 rms 2-channel. 16½ x 5¾ x 10½". For 117 VAC.

AM-473J. Shpg. wt. 20 lbs. 179.98



\$100

CD-4/Matrix Demodulator

- *Plays the New Discrete 4-Channel Discs*

This new Teledyne easy hookup adapter/demodulator lets you listen to the new discrete 4-channel discs, matrix encoded SQ and E-V records too, with a 4-channel amplifier and 4 speakers. Phono input, 4-channel and 2-channel direct outputs. With power-on/off indicator, rear channel CD-4 adjustment for best 4-channel balance. 9 x 4¾ x 15½".

RA-115J. Shpg. wt. 6 lbs. 100.00

1 12" Solid-State B & W

Model 21T57. Perfect combination of features and performance for the quality conscious. UHF and VHF detent tuners, convenient slide-controls, instant-on picture and sound, keyed AGC, 3-stage video IF, front-mounted speaker. Telescoping VHF, UHF loop antennas. 16½ x 11½ x 13". 117 VAC. TV-307J. Shpg. wt. 19 lbs. **99.98**

12" Diagonal Measure



12" Diagonal Measure



2 Economy 12" B & W

Model 21V65. Great second set at an easy-to-take price. Has separate UHF/VHF tuners, 3-stage video IF for really crisp reception, hybrid chassis with critical circuits transistorized for top performance. Front-mounted 4" speaker, telescoping VHF antenna, UHF loop. 17 x 11½ x 11". 117 VAC. TV-288J. Shpg. wt. 21 lbs. **89.98**

5" Diagonal Measure



19" Diagonal Measure



3 "Trailmaster" AC/DC 5" B & W

Model 50T50. Quality small-screen portable goes where you go for crisp, clean all-channel reception. 100% solid-state chassis, built-in sun screen for excellent reception even in daylight, keyed AGC, 3-stage IF, more. Operates on batteries (included) or 117 VAC. Weighs 9 lbs. 8¾ x 7 x 10½". TV-308J. Shpg. wt. 12 lbs. **139.95**

4 BIG-Screen 19" B & W

Model 91V86. Slim-line design means it sets up just about anywhere, but you still get the picture size of bulkier models. UHF and VHF detent tuning, slide controls, telescoping VHF, circular UHF antennas, provision for external antenna. Up-front uniconic speaker. 23½ x 17¼ x 14¼". 117 VAC. TV-309J. Shpg. wt. 45 lbs. **119.95**

19" Diagonal Measure



19" Solid-State Color TV

Model 91C55S. Features 100% transistorized chassis for instant-on power and super-reliable performance, special "black matrix" picture tube for color clarity that's as good as being there. Pushbutton AFT eliminates fine tuning when you change channels—simply push the button and it's done automatically. Features automatic degaussing—no picture distortion when you move the set from room to room, VHF dipole antenna, UHF loop antenna, slide-type controls for color and tint. Includes earphone so you can watch and listen in private with all the volume you want, special jack for Sanyo's Audiocon wired remote control. Good-looking walnut-grain cabinet, high-contrast black front panel. 23¾ x 17¼ x 20½". For 117 VAC. TV-310J. Shpg. wt. 75 lbs. **359.95**

19" Remote-Control Color TV

Model 91C59S. Wireless remote control, Sanyo's exclusive "Trimatic" automatic tuning system and a deluxe "black matrix" picture tube make this all the color TV you'll EVER need. Three-way remote control turns set on or off, controls volume, even changes VHF or UHF channels right from your easy chair. The Trimatic tuning system automatically sets perfect tint, color contrast and brightness. Unique tint sensor electronically detects changes in flesh tones and compensates for them even when channels are changed. Has 100% solid-state chassis for instant-on picture and power, long-life performance. Two-pole telescoping VHF antenna, UHF loop. Walnut-grain cabinet. 22¾ x 17¼ x 20½". For 117 VAC. TV-287J. Shpg. wt. 80 lbs. **429.95**



Transcription Series Automatic Turntables



149⁵¹
With
Cartridge

810/X 2-Speed Model Offers Top Performance and Dependability

- Sequential Cam System For Smooth Operation
 - Large 12" Dynamically-Balanced Turntable Platter
- BSR's finest automatic turntable—tracks low as ¼ gram! Features include Concentric Gimbal Arm Mount and feather-weight pushbutton operation. Has variable pitch control, viscous-damped cue and pause control with an exclusive friction Cue Clutch to keep the tone arm cued over the exact groove. With integral strobodisc, stylus overhang adjustment, automatic tone arm lock to prevent accidental damage to the stylus or record. 15½ x 8¾ x 12½". Req. 5" above, 3¾" below mtg. board. For 117 VAC. Less base.
- RP-478J. Shpg. wt. 19 lbs. 149.50
 AS-795J. With Audio Technica AT-12E Cartridge .. 149.51
 CA-726J. WB-8 Walnut Base. Shpg. wt. 8 lbs. 20.00
 CA-727J. DC-8 Deluxe Dust Cover. Shpg. wt. 3 lbs. ... 20.00

710/X 2-Speed Model with \$\$\$ More Features and Quality

- Repeat Lets You Play Record Again and Again
 - Tracks Low As ½ Gram • Pushbutton Operation
- A superb turntable featuring BSR's exclusive Sequential Cam drive system combined with a heavy, anti-magnetic platter powered by a synchronous induction motor for truly precise and accurate record play. Has variable pitch control, viscous-damped cue and pause control, dual-range anti-skate control. Automatic tone arm lock, stylus overhang and set down adjustment. 15½ x 8¾ x 12½". Req. 4½" above, 3" below mtg. board. For 117 VAC. Less base.
- RP-475J. Shpg. wt. 19 lbs. 129.95
 AS-796J. With Audio Technica AT-11E Cartridge .. 129.96
 CA-724J. WGB-T Walnut Base. Shpg. wt. 7 lbs. 14.95
 CA-725J. DC-T Deluxe Dust Cover. Shpg. wt. 3 lbs. ... 9.95



129⁹⁶
With
Cartridge

Use Your
Credit Card

Elac/Miracord Precision Automatic Turntables

625 4-Speed with "Expensive Model" Features

- "Light-Touch" Pushbuttons • Adjustable Anti-Skate
 - Dynamically Balanced Arm, Precise Cueing
- Just right for those who want Miracord quality and craftsmanship at a lower price. Has 4-pole synchronous motor, heavy pressure-formed turntable platter. Damped cue and pause control, adjustable tracking from 0-6½ grams. 13¾ x 11¾". Req. 5½" above, 2½" below mtg. board. For 117 VAC. Less base.
- RP-440J. Shpg. wt. 19 lbs. 99.50
 AS-797J. With Audio Technica AT-11E Cartridge 99.51
 CA-516J. Custom Walnut Base. Shpg. wt. 8 lbs. 15.00
 CA-518J. Dust Cover. Shpg. wt. 3 lbs. 4.95

99⁵¹
With
Cartridge



Balanced
Tone Arm

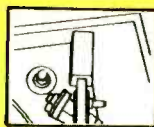

Pushbutton
Controls

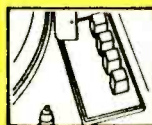

199⁵¹ With
Cartridge

48 Olson

50H Mark II 3-Speed Fully Synchronized

- Hysteresis-Synchronous Motor • 12" "No Vibration" Platter
 - Dynamically-Balanced Tone Arm • Adjustable Anti-Skate
- For true music appreciators. Pushbutton operation for start, stop, even replays one in a stack without dropping the next one. Vernier drive counterweight adjustment, damped cue level, stroboscopic speed indicator. Tracks at less than 1 gram. 14¾ x 12½". Req. 5½" above, 3¾" below mtg. board. For 117 VAC. Less base.
- RP-441J. Shpg. wt. 20 lbs. 199.50
 AS-798J. With Audio Technica AT-12E Cartridge 199.51
 CA-517J. Custom Walnut Base. 8 lbs. 15.00
 CA-518J. Dust Cover. 3 lbs. 4.95

1 289 **2 2498** **3 665** **4 1098**

1 Stereo Phono Arm with Crystal Cartridge. BIG value. Flip-over sapphire styli—one for LP's and 45's, one for 78's. 3 volt output. HF-033J. Shpg. wt. 8 ozs. 2.89
HF-035J. Mono Version of Above. 8 oz. 2.49

2 Professional Stereo-Mono Tone Arm. Fully adjustable, can be used with any manual turntable. Tracks at less than 1 gram. Accepts std. ½" mtg. ctr. cartridges, Anti-skate. 12½" long. HF-171J. Shpg. wt. 2 lbs. 24.98

3 Automatic Record Cleaner. Lightweight, pickup arm style with roller and brush to clean records as they play. Weighted base sets on any changer—NO installation. HF-215J. Shpg. wt. 1½" lbs. 6.65

4 Stereo Magnetic Preamp. Adapts magnetic-cartridge phonos to any stereo amplifier. Use component-quality turntables with consoles, 3-piece radios, etc. 4 x 2½ x 1½" deep. 117 VAC. AM-368J. Shpg. wt. 1 lb. 10.98

5 395 **6 129** **7 64¢**

5 Universal Automatic 45-rpm Adapter. Fits over 90% of today's record changers. Replaces most flat or round types. For Olson, V-M, BSR, Garrard, Others. HF-205J. Wt. ½ lb. 3.95

6 Anti-Static Spray and Cleaner. Really helps preserve record life. Spray away dust 'n dirt, prevent dust pickup. Includes record cleaning cloth. Shpg. wt. ½ lb. TL-471J. 3 for 3.60 Each 1.29

7 Olson Record Cleaning Cloth. Wipes out dust, dirt, static and crackles—wipes in record-preserving lubricant. Really easy to use—really helps too! Shpg. wt. ¼ lb. HF-030J. Pkg. Of 3 . . . 1.50 Each 64¢

8 1.98 **9 1.98** **10 1.49** **11 2.49** **12 2.49** **13 2.29**

Varco Replacement Cartridges

8 TM-3. Mono. Flip-over stylus. 8 gms. PC-177J. 4 oz. 3 for 4.50 Each 1.98

9 TO-55V. Mono. For Varco mono types. PC-182J. 4 oz. 3 for 4.50 Each 1.98

10 CN-65. Mono. Turnover crystal cartridge. PC-181J. 4 oz. 3 for 4.00 Each 1.49

11 TN-4B. Stereo. Turnover ceramic. 500 mV. PC-285J. 4 oz. 3 for 5.50 Each 2.49

12 CN-72. Stereo. Turnover crystal. 900 mV. PC-286J. 4 oz. 3 for 5.50 Each 2.49

13 CN-75. Stereo. Turnover crystal. 2000 mV. PC-287J. 4 oz. 3 for 5.00 Each 2.29

249 Each

Olson Diamond Needles

Precision quality. STS = stereo LP diamond/78 sapphire. ST = single tip stereo LP diamond. ¼ lb.

Mfr.	Cartridge	Type	Fig.	Stock No.	Mfr.	Cartridge	Type	Fig.	Stock No.
Astatic	ST100, 70, 74, 78	ST	G	NN-122J	P'sonic	EPC-34STAD	ST	S	NN-193J
Astatic	133, 137, 139, 233	STS	H	NN-178J	RCA	RMP204, 115726	STS	T	NN-183J
Astatic	140, 142, 146	STS	A	NN-166J	RCA	RMP204-9, 117330	STS	U	NN-189J
BSR	C-1, SC1H	STS	A	NN-168J	RCA	RMP204-15, 126316	ST	V	NN-186J
BSR	X1H, X1HE, X1M	STS	I	NN-184J	Ronette	BF40, 105, 106	ST	F	NN-102J
BSR	SC5M	STS	J	NN-191J	Sonotone	8T and 8TA	STS	D	NN-130J
BSR	SC7M	STS	K	NN-192J		16T	STS	B	NN-158J
E-V	21, 26 series	ST	L	NN-162J	Tetrad	11, 31	STS	W	NN-174J
E-V	117, 131, 148, 154	STS	M	NN-170J	Tetrad	21, 41, E1, G1	STS	W	NN-175J
E-V	132, 163	STS	N	NN-157J	Tetrad	12D, 32D	STS	W	NN-194J
E-V	141, 149, 150	STS	N	NN-180J	Tetrad	13D, 33D	STS	W	NN-195J
E-V	5000, 5005	STS	E	NN-172J	Tetrad	52D, 62D, A2, B2, C2	STS	W	NN-196J
GE	C-200, C-100A	STS	O	NN-159J	Varco	CN series	STS	C	NN-173J
GE	C-500, C-650	STS	P	NN-169J	Varco	TN4	STS	X	NN-187J
GE	C-660	ST	Q	NN-188J	Zenith	142-150, 151, 163, 168	STS	Y	NN-182J
M'vox	560, 337, 38, 45, 50	STS	R	NN-190J					

Isn't It Time You Moved Up to A New Changer from Olson?

4-Speed Automatic Changer

1998

accessories extra

Ceramic Stereo Cartridge Included!
 Enjoy good stereo from this "spring-suspension" changer. Nylon motor suspension, 9½" turntable. 13" W x 6" H x 11¼" D.
 RP-364J. Shpg. wt. 10 lbs. 19.98
 WW-535J. AC Cord (1 req'd). Wt. 4 oz. 99c
 HF-049J. 6' Cable (2 req'd). 4 oz. Ea. 84c
 CA-464J. Tinted Dust Cover. Wt. 4 lbs. 3.98
 CA-318J. Custom Mtg. Base. Wt. 4 lbs. 3.98
 HF-205J. 45 rpm Adapter. Wt. 4 oz. 3.95

2998

accessories extra

Auto/Manual 4-Speed Changer

Ceramic Stereo Cartridge Included!
 Quality-made by a leading turntable manufacturer and Olson-priced to save you money! Plays any popular-size record at 16, 33½, 45 and 78 rpm speeds. Has stylus pressure control for smooth, light tracking. Ceramic stereo cartridge included! 13½" W x 5" H x 11¼" D.
 RP-408J. Shpg. wt. 10 lbs. 29.98
 WW-043J. AC Cord (1 req'd). Wt. 4 oz. 40c
 HF-050J. 3' Cable (2 req'd). 4 oz. Each 79c
 CA-464J. Tinted Dust Cover. Wt. 4 lbs. 3.98
 CA-470J. Custom Mtg. Base. Wt. 4 lbs. 3.98
 RP-468J. 45 rpm Adapter. Wt. 4 oz. 2.25

3498

Complete!

4-Speed Stereo Changer Module

Famed British-made changer ready to plug in 'n play! Ideal for replacing a worn-out console changer or add it to any radio with a phono jack. Low mass tone arm assures a performance level that's hard to match at this low price! Plays all size records at all 4 speeds. Everything is included: ceramic stereo cartridge, stylus pressure adjustment, tinted dust cover, AC cord, audio cables, factory-mounted ebony finish base. 13½" W x 5" H x 11¼" D.
 RP-438J. Shpg. wt. 12 lbs. 34.98
 RP-468J. 45 rpm Adapter. Wt. 4 oz. 2.25



audio-technica® STEREO CARTRIDGES

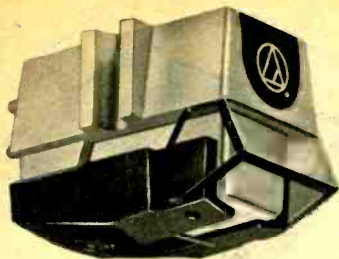

Your phono cartridge is one of the two most important components in your stereo music system. Together with your speakers, it has the greatest effect on the actual sound you hear. A good cartridge also extends record life, thereby protecting your musical investment. So when it comes to cartridges, you owe it to yourself to buy the best, and these Audio-Technica's are the best you can buy!

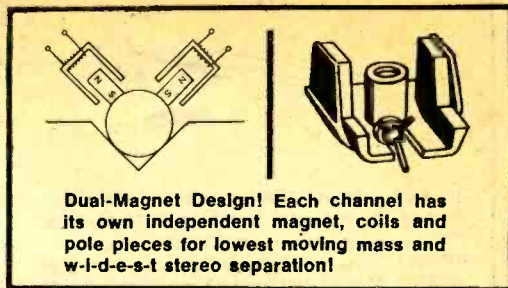

Dual-Magnet Design! Each channel has its own independent magnet, coils and pole pieces for lowest moving mass and w-i-d-e-s-t stereo separation!

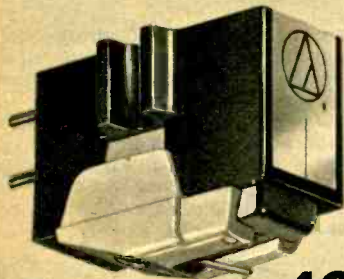

49⁹⁵

NEW! High-Performance Stereo Cartridge with Shibata Stylus

Model AT-12S. A truly outstanding audio buy! Features Audio-Technica's *exclusive* dual moving magnet system—each channel has its own complete magnetic system with the total of both magnets weighing less than a single conventional one. This means lighter tracking, longer record life, widest stereo separation. The Shibata stylus improves the sound of your present records, also tracks the new discrete 4-channel discs. Tracks 1½-2 grams. Response: 15-45,000 Hz. Separation: 25 dB. Balance: 2 dB. PC-275J. Shpg. wt. ½ lb. 49.95



Shibata Shape



Elliptical stylus at 2 grams.

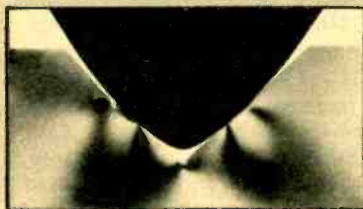

Shibata Stylus at 2 grams.

The Greatest Stylus Advance Since Elliptical!

New Shibata Stylus Now Available on Audio-Technica Cartridges from Olson

Developed for the exact tracking requirements of the new JVC-RCA discrete 4-channel discs—the Shibata stylus improves the tracking capabilities of ANY stereo cartridge. Features asymmetrical "modified-elliptical" shape with *four times* the groove contact of conventional styli. This means less stylus pressure at all points of the record groove—four times *less* record wear! The Shibata stylus tracking at 2 grams is equivalent to a conventional stylus tracking at ½ gram.

This increased groove contact improves S/N ratio with less groove deformation and less wave and phase distortion. When you listen to conventional stereo records, you'll be amazed at the ultra-clean and crisp sound—with particularly exceptional high-frequency stereo separation. Your records will sound *better*, last *longer*—and you're ready for the 4-channel discs available now!

9⁹⁵
Model AT10

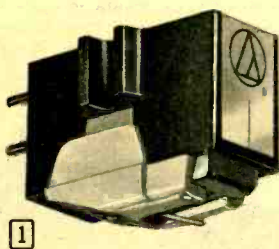

1

1 **Model AT-10.** Low-cost dual magnet cartridge with 0.7 mil diamond stylus. Response: 20-20,000 Hz. Channel Separation: 20 dB. Tracks 2½-4 grams. PC-263J. Shpg. wt. ½ lb. 9.95

49⁹⁵
Model AT13E

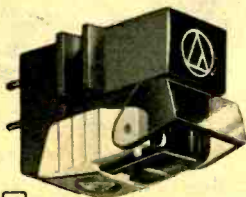

2

1 **Model AT-11.** High-performance spherical for mid-priced turntables. 0.7 mil diamond stylus. Response: 15-25,000 Hz. Separation: 20 dB. Balance: 2 dB. Tracks 2-3 grams. PC-264J. Shpg. wt. ½ lb. 14.95

1 **Model AT-11E.** As above, but with 0.4 x 0.7 mil elliptical diamond stylus for wide response of 15-28,000 Hz. Separation: 20 dB. Balance: 2 dB. Tracks 2-3 grams. PC-265J. Shpg. wt. ½ lb. 19.95

150⁰⁰
Model AT20SL

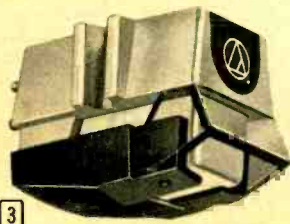

3

1 **Model AT-12E.** Excellent way to upgrade your turntable. 0.4 x 0.7 mil elliptical diamond stylus. Response: 15-30,000 Hz. Channel Separation: 22 dB. Tracks 1¼-2 grams. PC-266J. Shpg. wt. ½ lb. 29.95

2 **Model AT-13E.** Advanced low-mass cartridge with "nude" (direct-mounted) biradial 0.2 x 0.7 mil diamond stylus. Response: 10-45,000 Hz. Separation: 25 dB. Channel balance: 2 dB. Tracks 1-1¼" grams. PC-267J. Shpg. wt. ½ lb. 49.95

2 **Model AT14S.** For quality systems. "Nude" Shibata stylus for wide-range and superb tracking. Flip-stylus guard. Response: 5-45,000 Hz. Separation: 25 dB. Channel Balance: 2 dB. Tracks 1½-2 grams. PC-268J. Shpg. wt. ½ lb. 69.95

3 **Model AT15S.** "Nude" Shibata stylus on tapered cantilever for lowest mass, die-cast alloy body. Response: 5-45,000 Hz. Separation: 25 dB. Balance: 1.5 dB. Tracks 1½-2 grams. With individual response curve. PC-269J. Shpg. wt. ½ lb. 100.00

3 **Model AT20SL.** Limited Edition. Probably the finest cartridge available! As above, but hand-selected after extensive testing. 5-50,000 Hz response. Balance: 1.0 dB. With individual response curve. PC-270J. Shpg. wt. ½ lb. 150.00

Replacement Styli

Stock No.	Model	For	Shpg. Lb.	Each
NE-177J	ATS10	AT10	¼	7.95
NE-178J	ATS11	AT11	¼	10.95
NE-179J	ATS11E	AT11E	¼	14.95
NE-180J	ATS12	AT12E	¼	19.95
NE-186J	ATS12S	AT12S	¼	36.95
NE-181J	ATS13	AT13E	¼	24.95
NE-182J	ATS14	AT14S	¼	39.95
NE-183J	ATS15	AT15S	¼	50.00
NE-184J	ATS20	AT20SL	¼	75.00

EMPIRE Precision Magnetic Stereo Cartridges

Empire cartridges are fully shielded and have four poles, four coils and three magnets for better balance and hum rejection. Each is magnetically balanced with a signal-to-noise ratio of 80 dB and features a moving magnetic element and stylus lever system .1 mil thick.

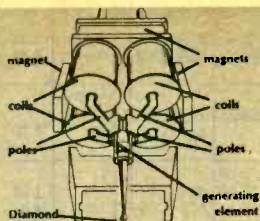

- 1 **Model 909E/X Cartridge.** Perfect for any automatic record changer. Tracks $\frac{3}{4}$ to 2 grams. Response: 12-25,000 Hz. Separation: 35 dB at 1 kHz. $.3 \times .7$ mil bi-radial elliptical diamond stylus. PC-273J. Shpg. wt. $\frac{1}{2}$ lb. **24.98**
- Model 999 PE/X.** As above, 8-32,000 Hz. $\frac{1}{2}$ to $1\frac{1}{2}$ grams. PC-194J. Shpg. wt. $\frac{1}{2}$ lb. **29.95**
- 2 **Model 999SE/X-4D Cartridge.** Designed especially for discrete 4-channel discs with top quality manual and automatic turntables. Tracks 1 to $1\frac{1}{2}$ grams. Response: 8-32,000 Hz. Separation: 35 dB at 1 kHz. $.2 \times .7$ mil bi-radial elliptical polished diamond stylus. PC-272J. Shpg. wt. $\frac{1}{2}$ lb. **59.95**
- 3 **Model 1000ZE/X Cartridge.** For 2 or synthesized 4 channel use. Tracks $\frac{1}{4}$ to $1\frac{1}{4}$ grams. Response: 20-20,000 Hz. ± 1 dB. Separation: 35 dB at 1 kHz. Polished 0.2×0.7 mil elliptical diamond stylus. PC-191J. Shpg. wt. $\frac{1}{2}$ lb. **99.95**
- Model 999VE/X.** As above. 6 to 36,000 Hz. Tracks $\frac{1}{4}$ to $1\frac{1}{4}$ grams. PC-190J. Shpg. wt. $\frac{1}{2}$ lb. **79.95**
- 3 **Model 1000ZEX-4D Cartridge.** Innovatively designed, especially for discrete 4-channel discs with top quality automatic and manual turntables. Tracks $\frac{1}{4}$ to $1\frac{1}{4}$ grams. Response: 4-40,000 Hz. Separation over 30 dB at 1 kHz. $.2 \times .7$ mil micro bi-radial elliptical stylus. PC-271J. Shpg. wt. $\frac{1}{2}$ lb. **109.95**



Tracks $\frac{3}{4}$ -2 grams **24⁹⁸**

59⁹⁵ Tracks 1-1 $\frac{1}{2}$ grams

99⁹⁵ Tracks $\frac{1}{4}$ -1 $\frac{1}{4}$ grams

SHURE

Magnetic Stereo Cartridges

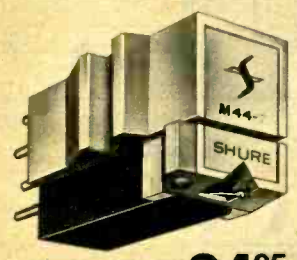

Tracks $1\frac{3}{4}$ -4 grams

24⁹⁵

Long-Time Best-Seller—Model M44E

Combines the advantages of modern design and bi-radial elliptical stylus with tracking high enough to use with older changers—the perfect way to update your system without adding a new changer! 20-20,000 Hz response—covers the audio range of virtually every musical instrument. Channel separation: over 25 dB at 1 kHz. Tracks $1\frac{3}{4}$ to 4 grams. Standard $\frac{1}{2}$ " mounting centers for use with any turntable. PC-143J. Shpg. wt. $\frac{1}{2}$ lb. **24.95**

HI-TRACK AND STANDARD SERIES ELLIPTICAL MAGNETIC CARTRIDGES

4 **Model M55E Standard Series Stereo Dynamic Cartridge.** Good performance, reliability! Tracks $\frac{3}{4}$ to 2 grams. Response: 20-20,000 Hz. Separation: more than 25 dB at 1 kHz. $.2 \times .7$ mil bi-radial diamond stylus. PC-169J. Shpg. wt. $\frac{1}{2}$ lb. **29.95**

5 **Model M93E Hi-Track Cartridge.** For all modern turntables/tone arms. Tracks: $1\frac{1}{2}$ to 3 grams. Response: 20-20,000 Hz. Separation: more than 25 dB at 1 kHz. $.4 \times .7$ mil bi-radial diamond stylus. Easy snap-in mount. PC-163J. Shpg. wt. $\frac{1}{2}$ lb. **39.95**

6 **Model M91E Custom Hi-Track Cartridge.** High-tracking accuracy with low tracking force. Tracks: $\frac{3}{4}$ to $1\frac{1}{2}$ grams. Response: 20-20,000 Hz. Separation: 25 dB at 1 kHz. $.2 \times .7$ mil bi-radial diamond stylus. PC-164J. Shpg. wt. $\frac{1}{2}$ lb. **49.95**



Tracks $\frac{3}{4}$ -1 $\frac{1}{4}$ grams

72⁵⁰

The Shure V-15 Type III—Super-Track "Plus"

The product of more than 7 years intensive development—offers performance characteristics simply not available until now! Laminated core structure for absolutely flat frequency response, new stylus assembly with 25% less mass for highest trackability with no loss of power. Tracks $\frac{3}{4}$ to $1\frac{1}{4}$ grams. Response: 10-25,000 Hz. Separation: 28 dB at 1000 Hz. A "state-of-the-art" cartridge for the record connoisseur! PC-274J. Shpg. wt. $\frac{1}{2}$ lb. **72.50**

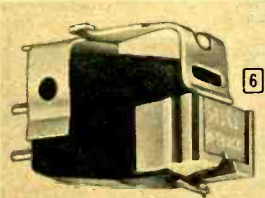

Tracks $\frac{3}{4}$ -1 $\frac{1}{2}$ grams **49⁹⁵**

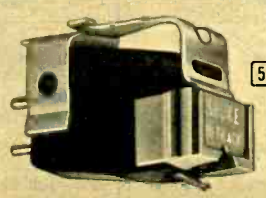

Tracks $1\frac{1}{2}$ -3 grams **39⁹⁵**

Tracks $\frac{3}{4}$ -2 grams **29⁹⁵**

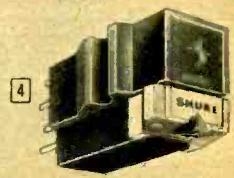



CARTRIDGES

Stock No.	E-V No.	Replaces	Color	Ea.
PC-213J PC-214J	81 89	Astatic 81T Astatic 89T	Blk Gold	2.37 2.97
PC-166J PC-215J	13D 13	Astatic 13TX Astatic 13T	Grn Grn	5.37 3.57
PC-216J PC-233J	148 148D	V-M29286-C, Astatic 142 V-M29286-C, Astatic 142D	Gray Gray	5.37 7.77
PC-217J PC-231J	26 26D	Philco, Magnavox Motorola, Sears, V-M	Gray Gray	6.90 9.90
PC-218J	5178	GE RT1054, Show 'n Tell	Ivory	3.30
PC-176J PC-246J	5026D 5015D	Garrard 30, 1969-70 Garrard 30, 1968-69	Blk Blk	6.90 6.90
PC-219J PC-225J PC-249J	149 149D 150D	EV 132, Astatic 133 EV 132D, Astatic 133D Sonotone 21T Series	Blk Blk Blk Wht/ Blk	5.40 7.77 6.60
PC-220J	38	Sonotone 2T-S	Grn	4.17

Stock No.	E-V No.	Replaces	Color	Ea.
PC-221J PC-237J	272 271	BSR SX1H BSR SX1M	Gray Ivory	3.60 3.60
PC-222J	5080D	Garrard X10 and X11	Blk	7.20
PC-223J PC-230J	120 121	BSR TC8H BSR TC8S	Blk Wht	2.88 4.68
PC-224J	5243	Varco CN-73, CN-75	Blk	3.60
PC-227J PC-226J PC-244J	5547 5548 5549	Astatic 138, 140 Astatic 142 Astatic 146	Blk Blk Blk	4.20 4.20 3.60
PC-227J PC-235J	275 275D	Magnavox 560344-1 Magnavox 560345-1	Wht Wht	5.40 7.50
PC-278J	5546D	GE C-660, EA-2223, EA-0X431	Blk	9.00
PC-279J PC-229J	5363 5344	BSR SC5H BSR SX5H	Gray Blk	4.80 4.20
PC-232J	142	Astatic 76TSB	Blk	4.77
PC-234J	220	Euphonics E-1, U-1, E-2, U-2	Gray	6.57

Stock No.	E-V No.	Replaces	Color	Ea.
PC-236J	5333	GE RT2716, RT2717; Mag 560313-5 Ch. Master, Delmonico, Juliette	Gray	2.67
PC-241J	5331	Ch. Master, Delmonico, Juliette	Wht	2.67
PC-238J	56	Astatic 93T	Blue	2.37
PC-239J PC-280J	133 54	RCA 106771-A 110021	Red Red	6.00 6.00
PC-240J	239D	GE C-650, EA 1013	Dk. Gray	16.00
PC-242J	96	Ronette 106, 208	Gray	4.77
PC-243J	143	Astatic 70TS	Blk	4.35
PC-281J PC-282J	5595 5595D	Astatic 133 Astatic 133D	Blk Blk	5.40 7.50
PC-245J	5146	BSR X5H	Blk	3.00
PC-247J	5126	Varco TN-4A, Morse 221	Blk	6.00
PC-283J PC-284J	5208 5208D	Varco TN-4B Varco TN-4BD	Blk Blk	6.00 7.80
PC-250J	5206	Varco TOH-45, TDH-46, TO-55	Blk	3.00

STYLI

EV3331DS. Varco CN60, CN62, CN65, CN67, CN68, CN70, CN72, CN73, CN75. NE-175J. 3.57
EV2123DS. Astatic 138, 140, 142, 146; Motorola 59C62945A01; Zenith 142-148. NE-138J. 3.57
EV2421DS. BSR C-1, SX1H, SX1M, X1H, X1M, X1HE, X3H, X4H, X5H, X5M. NE-176J. 3.57
EV3000D. Astatic, CBS, Magnavox, Motorola, Philco, Ronette, Varco, Zenith. NE-148J. 2.97
EV2744DS. GE C50, C500, C600, C650, EA80X165, RS6770, EA80, X209, EA1011. NE-139J. 3.57
EV2424DS. BSR SX5H, SC5H, X1H, X3H. All plastic. Zenith 142-165. NE-140J. 3.57
EV3454DS. Zenith 142-150, 142-151, 142-163, 142-166, 142-168. NE-142J. 3.87
EV3009D. Astatic, CBS, BRS, Magnavox, Motorola, Philco, Ronette, Varco, Zenith. NE-141J. 2.97
EV2622DS. EV 141, 149, 150, 157, 158; Magnavox 560310-1; Philco 35-2857-1. NE-143J. 3.57
EV2604D. EV 26D; Magnavox 560232; Motorola 59C643220; Philco, Zenith. NE-144J. 2.97
EV2644DS. EV 168, 198, 199, 199D, 275, 275D, 277D, 282D, 284D, 5166D, 5095D. NE-145J. 3.57
EV2120DS. Astatic 133, 137, 139; Motorola 59C61496A01; Zenith 142-144, 233, 245. NE-146J. 3.57

Electro-Voice gem-quality diamond needles are your best replacement needle value. Feature whole natural diamonds highly polished and precision ground for long playing life. All 78 rpm tips are made from highest quality synthetic sapphires.

EV3005D. CBS BF-40, Magnavox, Philco, Ronette BF-40, Zenith, E-V. NE-147J. 2.97	EV2739DS. EV C-100, EA 97X250, RS 3824. NE-160J. 3.57
EV2679DS. Euphonics U-8, Magnavox 560324-2, Motorola, Zenith 142-133. NE-149J. 3.57	EV2625DS. EV 5000, 5003; Magnavox 560360-2. EV 5005, 5075, 5170, 5800D. NE-161J. 3.57
EV2624DS. EV168, 198, 199, 275, 277; Magnavox 560345-2, 560350-2. Early Models. NE-150J. 3.57	EV3224DS. Sonotone 21T, 22T, 23T, 24T, 31T, 35T, 43T series. NE-162J. 3.57
EV2912DS. RCA RMP-204, 115276, 115277, 115303, 115346, 115347, 115703. NE-151J. 3.57	EV3213DS. Magnavox 560246-2; Motorola 59C645700; Sonotone 8TA. NE-163J. 3.57
EV3332DS. Morse 221, Varco TN-4A, TN-4B Series. NE-152J. 3.57	EV3330DS. Varco TN02H Series. NE-164J. 3.57
EV3310DS. Motorola 59C62971A01; Philco 35-2876-1; Tetrad 2-11D-V4. 11D and 11S Needle Markings. NE-153J. 3.57	EV2427DS. BSR SC5M, SX6H, SX6M, X4M, X5M (New). Rubber couped. NE-187J. 3.57
EV3311DS. Motorola 59C62971A02; Tetrad 2-21D-V6. 21D and 21S Needle Markings. NE-154J. 3.57	EV2428DS. BSR SC7H, SC7M, SC8H, SC8M Series. NE-188J. 3.57
EV2619DS. EV 132, 163; Magnavox 560305-1-2; Philco 325-8076. NE-155J. 3.57	EV2752D. GE C-660, EA2223, EA80X431. NE-189J. 2.97
EV2907DS. RCA RMP-200-8-9, 10677B, 106771B, 110021, 110023, 115196. NE-156J. 3.57	EV2122DS. Astatic 153, 155, 157, 257, 341, 343, 345; Philco 35-2860-1. NE-169J. 3.57
EV3214DS. Philco 325-7075; Sonotone 9T, 9TA, 16T, 916TA Series. NE-157J. 3.57	EV2130DS. Astatic 163, 165, 271, 273, 275, 349, 351; Magnavox 560355-1-2. NE-170J. 3.57
EV2636DS. EV 5026D, 5027D, 5057D, 5080D, 5199D, 5582D. NE-158J. 3.57	EV3452DS. Zenith 142-126, -127, -128, -136, -137, -138, -140, -141, -142, -143. NE-171J. 3.87
EV2641DS. EV 5083, 5084, 5044D, 5045D. NE-166J. 3.57	EV2835DS. Delmonico, JVS CS-1007. Piezo. NE-190J. 3.57
EV3312DS. Motorola 59C60615B01; Tetrad 31D and 31S Needle Markings. NE-159J. 3.57	EV3363DS. Tetrad G2D and G2S Needle Markings. NE-191J. 3.57

NOTE: Type numbers given in description of each needle listed, represent cartridge models in which the needle is used. All above shpg. wt. 4 oz.

Exclusive Olson and Teledyne Hi Fi Headphones

Our own "Private Label" Stereo and 4-Channel Phones—Each Designed for the Best "Private Listening" At Its Price—Each a Tribute to Olson's VALUE Leadership!

1 Our Lowest-Priced Model

Olson Model 204. For starter-stereo, night owls on a budget! Adjustable headband, padded earcups. 8 ohms. 6' cord, plug. PH-204J. Shpg. wt. 2 lbs. 7.98

2 Separate Volume Controls

Olson Model 198. Great for easy-chair listening—volume control on each earcup for individual adjustment. 8 ohms. 6' cord, plug. PH-198J. Shpg. wt. 2 lbs. 13.98

3 "Open-Back" Model

Teledyne Model 222. Lightweight, with poly-foam "open-air" cushions for spacious sound. Wear 'em for hours without fatigue. 25-18,000 Hz. 8 ohms. 10' cord. PH-222J. Shpg. wt. 2 lbs. 24.98

4 Full-Frequency Design

Olson Model 197. Extra soft earcushions, padded headband. Stereo/mono switch, volume controls. 8 ohms. 10' cord. PH-197J. Shpg. wt. 3 lbs. 19.98

5 Our Most Popular Headset

Olson Model 173. A best-seller because it sounds great! Air-filled cushions, adjustable headband. 25-18,000 Hz. Extra-long 20' cord. 4-16 ohms. PH-173J. Shpg. wt. 3 lbs. 32.98

6 Dynamic "Pro"-Quality Model

Olson Model 192. 20-20,000 Hz response, sliding volume controls in each earcup, super-soft cushions. 7' cord. 8 ohms. PH-192J. Shpg. wt. 3 lbs. 39.98

7 Studio-Quality Phones

Olson Model PRO-213. Slide-type volume and tone controls, 20-20,000 Hz response, 10' coiled cord make this a smart buy! 8 ohms. PH-213J. Shpg. wt. 2¼ lbs. 42.98

8 4-Channel Phones with Full-Range Hi-Fi Drivers

Teledyne Model 220. Here's TRUE 4-channel listening at a "stereo-only" price! Comfortable, well-padded phones feature separate FULL-RANGE drivers for extra-wide response on each channel — no "rear-channel fadeout", no balance problems! Extra-soft padded earcushions and adjustable padded headband make 'em easy to wear for hours. 20-20,000 Hz response. 8 ohms impedance. With 6' cord, 2 plugs. PH-220J. Shpg. wt. 3 lbs. 48.49

9 Our Best! Electrostatic Design

Teledyne Model 219. Electrostatic driver elements deliver distortion-free sound a full 3 octaves beyond conventional phones. Fluid-filled earcushions, padded headband. Peak-free 25-19,500 Hz response, 4-16 ohms, 10' coiled cord. Separate energizer has speaker/phones switch, color-coded cables. PH-219J. Shpg. wt. 5 lbs. 59.98

Great Sound, Low Olson Price



"Open Back" Design



Make Stereo Listening a Personal Pleasure

These Deluxe Phones Treat Your Ears to Super Sound and Real Lightweight Comfort!



Enjoy "The 4-Channel Experience" From Your Favorite Easy Chair



Hear Stereo Like You've Never Heard It Before



KOSS Headphone Listening At Its Very Best



Headphones Are a "Must" for Your Stereo or 4-Channel System—They Offer "Live Presence" Sound in Full Comfort and Privacy—with All the Volume You Want!

2-Channel Models

- 1 High-Velocity—2" Elements**
Model HV-1. Low-silhouette design, weigh less than 10 ounces. 20-20,000 Hz. 4-16 ohms. With 10' coiled cord.
PH-232J. Shpg. wt. 2 lbs. 39.95
- 2 Dynamic—Big 1" Voice Coils**
Model PRO-4AA. Koss' most popular phones. Liquid-filled earcups, padded headband. 10-20,000 Hz. 4-16 ohms. 10' cord.
PH-193J. Shpg. wt. 3 lbs. 60.00
- 3 "Easy-Listenin'" Bargain**
Model K-6. 3½" dynamic reproducers. 10-16,000 Hz. 4-16 ohms. 10' coiled cord.
PH-147J. Shpg. wt. 2 lbs. 22.50



- 4 Great-Sounding Best Seller**
Model KO-727B. Soft headband, ear-cups. 10-18,000 Hz. 4-16 ohms. 10' coiled cord.
PH-203J. Shpg. wt. 2 lbs. 34.95
- 5 12-oz.—"Heavy" Performer**
Model KRD-711. PVC ear-cushions. 10-17,000 Hz. 4-16 ohms. 10' coiled cord.
PH-201J. Shpg. wt. 2 lbs. 29.95
- 6 Slide-Control Phones**
Model K-6LC. Slide-type volume/balance. 10-16,000 Hz. 4-16 ohms. 10' coiled cord.
PH-210J. Shpg. wt. 2 lbs. 29.95
- 7 Super Sound—Super Comfort**
Model KO-747. Volume controls, mono switch. 30-20,000 Hz. 4-16 ohms. 10' cord.
PH-216J. Shpg. wt. 3 lbs. 45.00
- 8 Professional Studio Monitor**
Model ESP-9. Koss' finest! 10-19,000 Hz response ±5 dB—a full 10 octaves! Push-pull circuit. 4-16 ohms. With energizer.
PH-228J. Shpg. wt. 6 lbs. 150.00



- 9 Stereophone Remote Box**
Model T-5A. For phone/speaker control from your easy chair. Has two phone jacks, left/right volume controls, on-off switch.
PH-207J. Shpg. wt. 3 lbs. 9.95

2/4-Channel Models



- 10 "Pro"-Quality Quadraphones**
Model PRO/5Q. Fluid-filled earcushions, rotary balance controls. 20-20,000 Hz. 3.2-600 ohms. 10' coiled cord, 2 plugs.
PH-231J. Shpg. wt. 3 lbs. 70.00
- 11 Separate Balance Controls**
Model KO/747Q. 4 dynamic elements. Left/right, front/back balance. 20-19,000 Hz. 3.2-600 ohms. 10' coiled cord, 2 plugs.
PH-230J. Shpg. wt. 3 lbs. 55.00
- 12 Koss's Best Phones**
Model K/2+2. Four matched driver elements, high noise isolation. 10-20,000 Hz. 3.2-600 ohms. 10' coiled cord, 2 plugs.
PH-217J. Shpg. wt. 3 lbs. 85.00
- 13 Low-Priced "Quad" Model**
Model K/6LCQ. Sliding balance control, excellent separation. 20-17,000 Hz. 3.2-600 ohms. 10' coiled cord, 2 plugs.
PH-229J. Shpg. wt. 2 lbs. 39.95

Headphones and Really Useful Accessories



309

2-in-1 Adapter. Two phones from one jack. Two 1/4" jacks. 6" leads. HF-162J. Wt. 1/4 lbs. 3.09



289

"Y" Adapter. Converts 2 speaker jacks to one stereo headset jack. 1/4" plugs, jack. HF-167J. Wt. 1/4 lb. 2.89



505

Headphone and Speaker Junction Box, Volume Controls. 4 3/4 x 1 1/2 x 1 3/4". PH-194J. Wt. 2 lbs. 5.05



569

20' Coiled Stereo Headphone Extension Cord. Listen anywhere in room. 1 1/4" plug. HF-144J. Wt. 1 lb. 5.69
HF-056J. Not Coiled 3.49



579

Headphone Control Left and right volume, stereo/mono switch. 10' cord. 4 1/2 x 1 1/2". PH-199J. Wt. 1 lb. 5.79



329

Speaker/Headset Adapter. Add to amplifier or receiver. Speaker/phone switch. PH-083J. Wt. 1/4 lb. 3.29



"Open-Aire" Stereo Headphones

42⁹⁵

Model HD-414. The new approach to high-fidelity listening. They deliver sound not only through the earpieces, but also through the air around you. So you can enjoy the listening pleasure of headphones without being closed off completely from the rest of the world. Light foam ear cushions for comfortable listening and easy "non-tug" movement. 20-20,000 Hz response. Connect to high or low impedance outputs. With 10 ft. cable and stereo phono plug. PH-310J. Shpg. wt. 1/2 lb. 42.95

recoton® and OLSON Carrying, Storage Cases

1 22⁹⁸



3 7⁹⁸



2 13⁹⁸



5 1⁹⁸



For 8-Track Cartridges.
Your Choice
8⁹⁸
For 30 Cassettes.

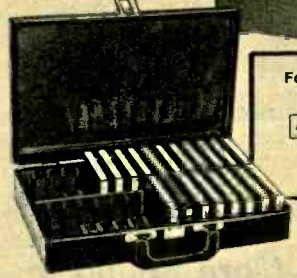

1 **Tape Storage Cabinet.** Stores cartridges, cassettes. Capacity 48 assorted tapes. Walnut finish. CA-611J. Shpg. wt. 8 lbs. 22.98

2 **Phone Valet.** Rest your headphones on it as a stand; Has plug for hook up to receiver and a built-in 10 ft. retracting extension cord. CA-610J. Shpg. wt. 3 lbs. 13.98

3 **Convenient, Attractive Storage Case Kits.** Easy assembly. Walnut finish. Hold 48 tapes. Swivel base. CA-612J. For 8-Track Cartridges. Wt. 4 lbs. 7.98
CA-613J. For Cassettes. Wt. 4 lbs. 7.98

4 **Tape Carrying Case.** Deluxe cases feature wooden construction, alligator vinyl exterior, plush-red interior, lock, key. Individual tape slots. CA-422J. For 24 8-Track Cartridges. 2 lbs. 8.98
CA-423J. For 30 Cassettes. Wt. 2 lbs. 8.98
CA-498J. For 40 Cartridges. Wt. 3 lbs. 15.98

5 **Compact Carrying Cases.** Carry tapes the easy and safe way with this "mini-case". Red insert with individual slots for each tape. CA-534J. For 12 Cassettes. Wt. 2 lbs. 1.98
CA-533J. For 10 Cartridges. Wt. 2 lbs. 1.98

8-Track Storage Album

4⁹⁸

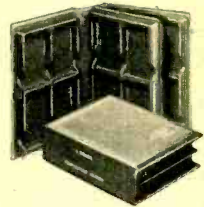

- Holds 16 Cartridges
- Deep-Tooled Gold Engraving

Store and protect your prized recordings with this attractive, decorator-styled album. CA-503J. Shpg. wt. 2 lbs. ... 2 for 9.80 ... Ea. 4.98

Cassette Album

2⁹⁹

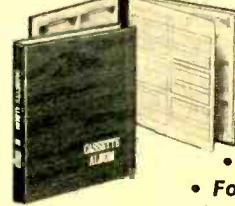

- Easy Storage
- Protects Tapes
- For Carrying or Storage

Your guest will think this album is a book, but inside your cassettes are safe in individual molded compartments. Holds 12 tapes. CA-425J. Shpg. wt. 1/2 lb. 2.99

Cassette Carrying Case

1⁵⁹



"Lifetime" lab-tested case and hinge. Holds 20 tapes. CA-408J. 1 lb. 2 for \$3 Ea. 1.59

Cassette Storage Rack

169



Holds 12 cassettes. Has walnut vinyl-covered finish. Stands vertical or horizontal. Ideal for tape library. CA-438J. Shpg. wt. 1 lb. 1.69

Our Exclusive Teledyne Speaker Systems



The Environmentalists

We call 'em that because these three speaker systems have "Environmental Adjustment" controls for fine-tuning to any room, any audience size. The calibrated controls are mounted right behind the snap-off/snap-on grilles for easy adjustment to a perfect bass-to-treble balance. Custom made for Olson and sold by us alone in the U.S.A.

1 8" 2-Way Bookshelf System

- 8" Woofer, 5" Midrange/Tweeter
- Air-Suspension for Deep Bass
- Environmental Control

106⁹⁸

GOOD

Environmentalist-1. For the cost-conscious audio perfectionist. You can fine-tune it to rooms that are acoustically "hard" or "soft" and even compensate for the audience size of a room. It's tops for 4-channel set-ups since you can "tune" each system independently for 100% perfect sound characteristics. Features a 35-17,000 Hz response for "living audio". Has an impressive walnut finish and custom matched grille that snaps in or out in a second. You can even operate it with the grille permanently removed. 30 watts power capacity, 8 ohms impedance. 10 $\frac{5}{8}$ " x 17 $\frac{1}{2}$ " x 8 $\frac{3}{4}$ ".

SS-052J. Shpg. wt. 20 lbs. 106.98

2 12" 3-Way Floor/Shelf System

- 12" Woofer, 5" Midrange, 2" Tweeter
- Air-Suspension For Boom-Free Bass
- Dual Environmental Controls

249⁹⁸

BETTER

Environmentalist-2. There is no 12" system that will give you a better balance between audio quality and value! The 12" air-suspension woofer belts out growling bass without muddiness or "booms." The mid-range and treble seem to "hang-in-the-air" with a bell-like clarity. And the dual, calibrated "tuning" controls let you custom match this system to any listening conditions. 25-18,000 Hz response, 50 watts power capacity, 8 ohms impedance. Has a look-of-luxury walnut finish and matching grille cloth. 14 $\frac{3}{4}$ " W x 23 $\frac{3}{8}$ " H x 11 $\frac{1}{16}$ " D. One of the finest systems you can buy.

SS-072J. Shpg. wt. 40 lbs. 249.98

3 12" 3-Way System

- 12" Woofer, Midrange VHF Horns
- Air-Suspension for Natural Bass
- Dual Environmental Controls

329⁹⁸

BEST

Environmentalist-3. You could pay more but we seriously doubt if your money would buy you a noticeable improvement. This beauty features a very powerful air-suspension woofer plus two wide-dispersion horns for an even spread mid/treble range across your room. The tuning controls match any audio environment. L-C crossovers at 800 and 5000 Hz for highest efficiency from each speaker. 25-20,000 Hz response, 80 watts power capacity, 8 ohms impedance. Rich, hand-rubbed walnut finish. Really superior sound from a really superior design. 14 $\frac{3}{8}$ " x 23 $\frac{3}{8}$ " x 11 $\frac{1}{16}$ ".

SS-082J. Shpg. wt. 42 lbs. 329.98

5-YEAR GUARANTEE

PARTS AND LABOR

Olson Electronics guarantees the proper electro-mechanical function of Teledyne speaker systems on this page for five years from date of purchase. This guarantee includes parts and labor on internal speaker components—woofer, tweeters, crossovers, etc. This guarantee excludes damage to cabinet or grille cloth, cases where (in our estimation) the speaker has been improperly used, and transportation charges to Olson. All you need is proof of purchase.

Famous "X-Air" Acoustic Suspension Speaker Systems

4 6 $\frac{1}{2}$ " 2-Way Shelf System

67⁹⁸

- 6 $\frac{1}{2}$ " Passive-Radiator for Deep, Natural Bass

Features a 6 $\frac{1}{2}$ " woofer PLUS a 6 $\frac{1}{2}$ " passive radiator for cone area equal to a 13" woofer! 3 $\frac{1}{2}$ " tweeter, too. 60-18,000 Hz frequency response. 20 watts power capacity, 8 ohms impedance. Oiled walnut finish cabinet. 12 $\frac{1}{4}$ x 18 $\frac{3}{4}$ x 9".

SS-171J. Shpg. wt. 15 lbs. 67.98

5 Deluxe 4-Way 12" System

177⁹⁸

- 4 Separate Speakers
- Stylish Fretwork Grille

Great sound and style to match. 12" woofer, 5" midrange cone, 2 $\frac{1}{2}$ " tweeter and 1 $\frac{1}{2}$ " super-tweeter.—L-C crossover. 40-20,000 frequency response. 50 watts power capacity, 8 ohms impedance. Removable fretwork grille. Push-in terminals. 11 $\frac{1}{4}$ x 25 $\frac{1}{2}$ x 11 $\frac{1}{2}$ ".

SS-175J. Shpg. wt. 40 lbs. 177.98

Teledyne Best-Sellers—More Sound for Your Money

6 10" 2-Way with Ducted Port

89⁹⁸

- Perfect Bookshelf Size
- Tweeter Level Control

Best under-\$100 sound you've ever heard. The 10" woofer is acoustically-matched to the ducted port enclosure, the 4" tweeter is designed for extra-wide dispersion. Sharp-cutoff L-C crossover, NOT capacitive-type, distributes frequencies evenly. 40-18,500 Hz response, 35 watts power capacity. 8 ohms impedance. 11 $\frac{1}{2}$ x 22 $\frac{1}{2}$ x 13".

SS-930J. Shpg. wt. 33 lbs. 89.98

7 "Aperiodic" 10" 2-Way

68⁹⁸

- Deep Bass and Natural Sound at Low Cost

Sounds like \$\$\$ more thanks to its "Aperiodic" design that improves sound and widens response because of a perfect impedance match at all frequencies (not just one). Stops "clipping" due to impedance mismatch! Has 10" woofer, soft-dome tweeter. 50-18,000 Hz response, 60 watts capacity, 8 ohms impedance. 11 $\frac{1}{2}$ x 19 $\frac{3}{4}$ x 9 $\frac{3}{4}$ ".

SS-251J. Shpg. wt. 30 lbs. 68.98

8 2-Way with 7 Hi-Fi Speakers

60⁰⁰

- Six Full-Range Speakers
- One Super Tweeter

Our sure-to-be-copied "Septette" is sound value at its very best! Six-high-compliance full-range speakers work in unison to generate deep, powerful bass—the super-tweeter extends highs to the limit of the audio spectrum. 50-18,000 Hz response, 25 watts capacity. 8 ohms impedance. 15 $\frac{1}{2}$ x 24 $\frac{1}{2}$ x 12". Walnut finish cabinet.

SS-177J. Shpg. wt. 30 lbs. 60.00



No Wonder They're Best Sellers!

***They Sound Great!
They Look Great!
They Cost LESS!!!***



Olson. Festival Series

**YOUR BEST BUYS
IN ACOUSTIC
SUSPENSION
SPEAKER SYSTEMS**

ONLY AT OLSON



These 2 and 3-way speaker systems cover the three most-wanted size parameters—at a fraction of the cost of competitive models. This superlative performance/low-price combination is made possible by Olson's tremendous buying power and large production of a limited line. They employ the finest woofers, midrange speakers, and high-frequency tweeters, with precision L-C crossover and level controls. Choose the one that's right for you!



59⁹⁸

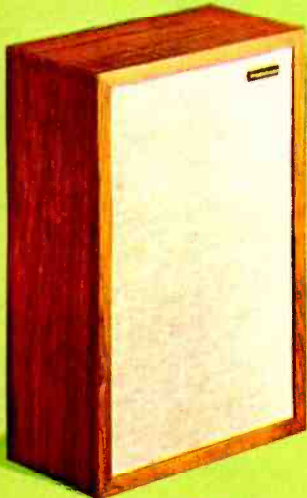
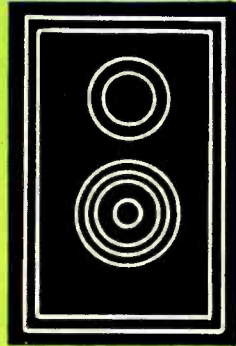

89⁹⁸

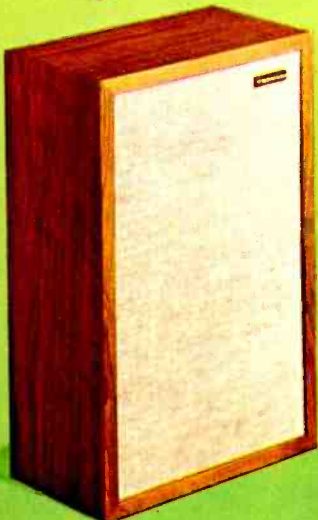
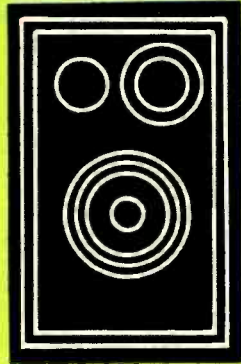

129⁹⁸

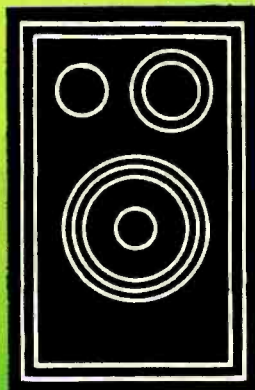

2-Way 8" Bookshelf System—the Blossomland

FREQUENCY IN HZ

- 8" Woofer
- 30-Oz Magnet
- 2 1/4" Tweeter
- 60-20,000 Hz
- 20 Watts (rms) Power Capacity

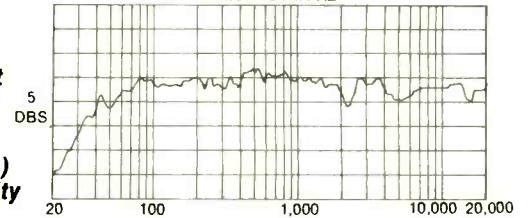

The lowest priced Festival system—for use where minimum space is available. Foam surround 8" woofer delivers accurate reproduction of high energy, low frequency signals. The midrange and tweeter are designed for natural presence and wide dispersion. The L-C crossover assures smooth transition between components. Tweeter level control permits balancing high end to room environment. 3/4" wood enclosure, walnut-grain vinyl finish, off-white grille cloth. Blends tastefully with any decor. 19 x 10 x 9". 8 ohms.

SP-067J. Shpg. wt. 20 lbs. **59.98**

Popular-Size 3-Way 10" System—the Ravina

FREQUENCY IN HZ

- 10" Woofer
- 4" Midrange
- 2 1/4" Tweeter
- 40-20,000 Hz
- 30 Watts (rms) Power Capacity

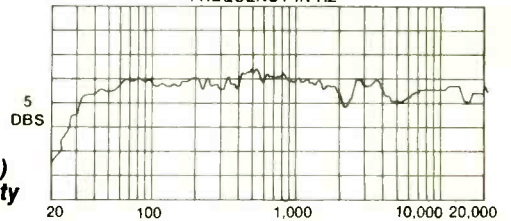

Represents the ideal combination of efficiency and low frequency response. Acoustically-designed 1" thick wood enclosure eliminates cabinet resonance; foam-surround woofer extends bass response to 40 Hz. The 4" midrange driver and dome tweeter insure uniform dispersion and elimination of "hot spots" so placement is not critical in most room environments. Has midrange and tweeter level controls; rich American walnut-grain vinyl finish with stunning off-white grille cloth. 24 x 13 1/2 x 11 1/2". 8 ohms.

SP-068J. Shpg. wt. 38 lbs. **89.98**

Perfectionist 3-Way 12" System—the Tanglewood

FREQUENCY IN HZ

- 12" Woofer
- 4" Midrange
- 2 1/4" Tweeter
- 25-25,000 Hz
- 40 Watts (rms) Power Capacity

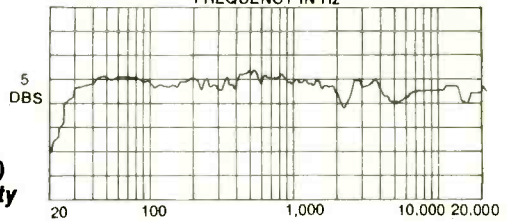

Top of the Festival Series! Features peak-free response, high dispersion, extremely low distortion and widest range. Has the largest woofer of the series for optimum low-frequency reproduction, 1" thick wood enclosure immune to cabinet resonance! 4" midrange and 2 1/4" tweeter provide outstanding dispersion and realism. Midrange and tweeter level controls compensate for room acoustics. The high efficiency of this system makes it practical for use with almost any amplifier or receiver. Stylish walnut-grain vinyl finish and off-white grille cloth. 25 x 14 x 11 1/2". 8 ohms.

SP-069J. Shpg. wt. 48 lbs. **129.98**

"Festival Series" Speaker Systems Carry the Olson 5-Year Guarantee—See Page 6

Low-Cost Olson Speakers Sound Like \$\$\$ More

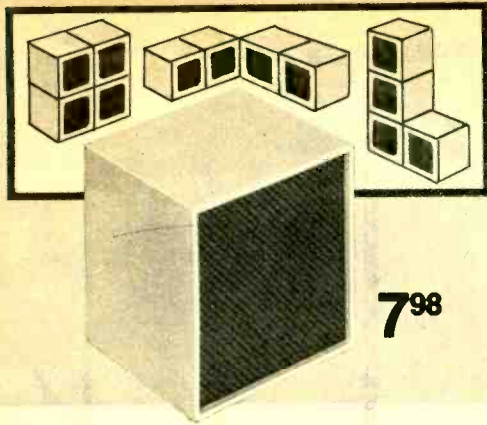

7⁹⁸

Compact "Color Cube"

"Decorate" your listening room. Buy several and arrange them for great sound and a colorful display. Acoustically sealed enclosures are mar-proof and measure just 6 x 6 x 5 $\frac{1}{4}$ ". Spread 'em out, stack 'em, you name it. Great sound, low Olson price. 8 ohms.

SS-257J. Audiphile Orange. 4 lbs. **7.98**
SS-255J. Snow White. 4 lbs. **7.98**
SS-256J. Beautiful Black. 4 lbs. **7.98**



Use It Anywhere!

4⁹⁸

Exclusive "Mini" Speaker

Only 6" square, only 3 $\frac{3}{4}$ " deep, but surprisingly good sound. Use it to "beef" up the sound of portable radios and tape recorders, get a pair for stereo extensions, rear speakers in budget 4-channel setups. Full-range speaker, 1/2" thick enclosure for good bass. Good-looking walnut-finish, contrasting jet-black grille. 8 ohms.

SS-252J. Shpg. wt. 3 lbs. 4.98

"X-Air" 7" Cube Speaker

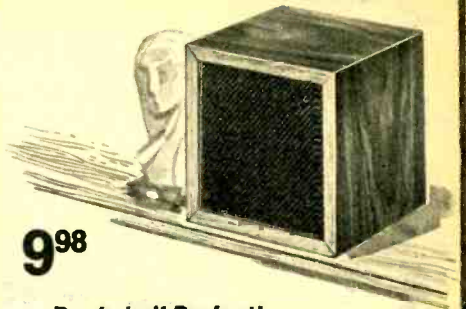

9⁹⁸

• Bookshelf Perfect!

Here's a 5" ACOUSTIC-SUSPENSION speaker for under \$10—real audio value! Use a pair for budget stereo setups, rear speakers in 4-channel systems, low-cost stereo extensions. Ceramic magnet structure for good bass response, stylish walnut-finish enclosure looks good in any setup. 8 watts power capacity, 8 ohms impedance. Perfect for any setup where space is tight!

SS-304J. Shpg. wt. 6 lbs. 9.98

1 "Olsonic-1" Dual-Woofer System

Features two 6 x 4" woofers for natural bass, 3" tweeter for crisp highs. 8 watts power capacity, 8 ohms. Walnut-finish enclosure. 9 x 14 x 5 $\frac{1}{2}$ ".

SP-012J. Shpg. wt. 8 lbs. 19.98

good
19⁹⁸

2 "Olson-Aire II" 8" 2-Way System

Offers 8" acoustic-suspension woofer, 3" tweeter and heavy wood construction for BIG-system sound. 15 watts power capacity, 8 ohms. Walnut. 12 $\frac{1}{2}$ x 12 x 8".

SP-013J. Shpg. wt. 15 lbs. 24.98

better
24⁹⁸

3 "Olson-Aire I" 8" 3-Way System

Has 8" acoustic-suspension woofer, 3 $\frac{3}{4}$ " tweeter PLUS 3" super-tweeter for broad response. 15 watts, 8 ohms. Extra-thick enclosure. 13 $\frac{1}{4}$ x 22 x 7 $\frac{3}{4}$ ".

SP-014J. Shpg. wt. 20 lbs. 39.98

best
39⁹⁸

Good-Looking Speaker Systems
Just Right for Great Sound
on a Budget!

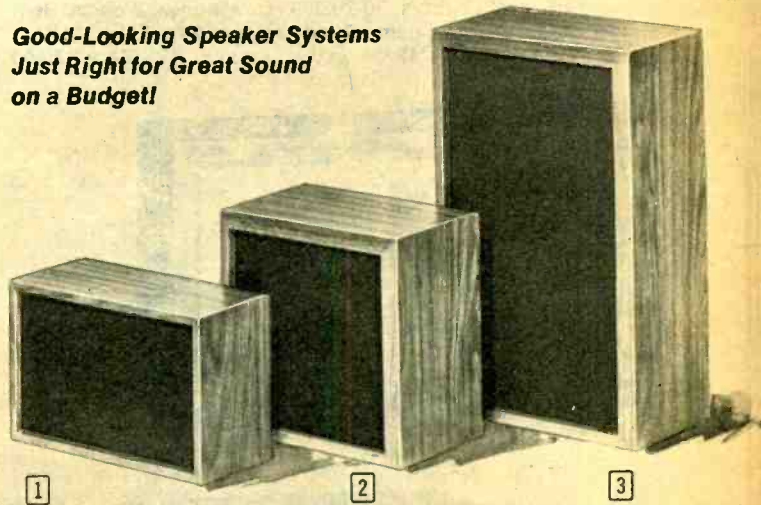

2-Conductor 50-Ft. Speaker Cable

Flexible. Color-coded, gray vinyl jacket.

WW-564J. Shpg. wt. 1/4 lb. 1.19

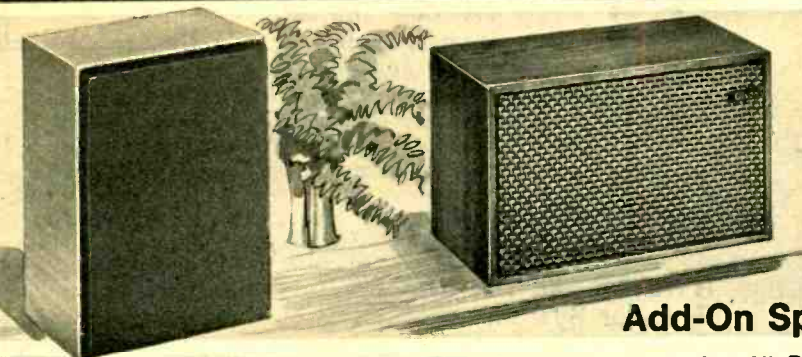

6⁶⁶

Ultra-Compact 2-Speaker System

Improves sound of portable radio, tape recorder, TV, small phono, etc. Has two speakers, each "tuned" to the enclosure. Attractive walnut-grain vinyl finish looks good in any setting. Only 7 $\frac{3}{4}$ x 10 $\frac{1}{4}$ x 5", fits where others don't! 8 ohms.

SS-199J. Shpg. wt. 3 lbs. 6.66



8⁹⁸

6 x 4" Speaker with Alnico-V Magnet

Offers full-range reproduction with "big speaker" sound. Walnut finish enclosure and matching cane-type grille cloth make it a stylish addition to any room decor. Perfect for budget stereo, extensions, etc. 4 watts, 8 ohms. 5 $\frac{1}{2}$ x 9 x 5 $\frac{1}{4}$ ".

SS-033J. Shpg. wt. 3 lbs. 8.98

16⁹⁸

Famous "X-Air" Bookshelf System

Offers great sound from a small enclosure. The 4" speaker has a pliable, cloth-annulus cone acoustically suspended for a full 65-18,000 frequency response. 5 watts rms power capacity (15 watts peak). 8 ohms. Walnut-finish enclosure, only 6 x 9 x 5".

SS-931J. Shpg. wt. 14 lbs. 16.98

Add-On Speakers—VERY Affordable

AR Speaker System for Beginners to Audiophiles



AR-5 Three-Way 10" Speaker System

\$189

- 10" Woofer
- 1½" Mid-Range Dome
- ¾" High-Frequency Dome

A superb system offering *clean* (not overbearing) bass, plus *clear* undistorted highs. 10" woofer features a cone molded by a new vacuum process for greatly reduced coloration. Has urethane polymer suspension for low distortion at low frequencies, hemispherical-dome midrange and tweeter for excellent presence and realism. Independent mid-range and HF level controls. 38-20,000 Hz response. 8 ohms. Req. 20 watts/ch, minimum. Oiled walnut. 24 x 13½ x 11½". SP-019J. Shpg. wt. 42 lbs. Each 189.00

Uses 9
Speakers—
All from
the
AR-3a

\$600

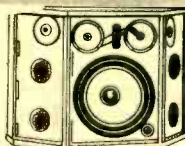
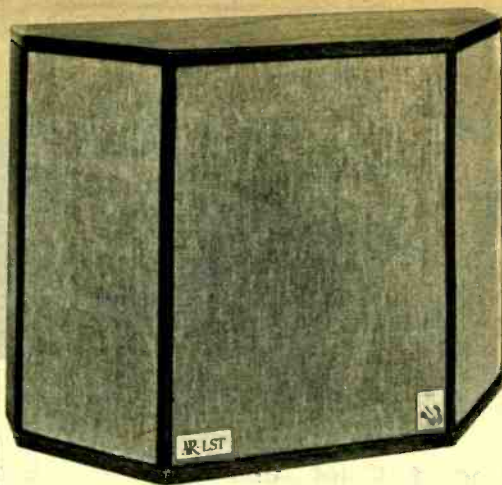

AR's Finest—Laboratory Standard Transducer

- 6-Position Selector Adjusts Output Levels to Any "Acoustic Situation"
- 30-20,000 Hz, ± 2 dB, Audio Response

Offers the design excellence of Professional Monitoring and Studio equipment. Features 12" acoustic suspension woofer, four 1½" midrange hemispherical radiators, and four ¾" hemispherical tweeters with crossovers at 575 and 5,000 Hz. Sensitivity: 89.5 dB SPL average, ±1 dB, with back against rigid wall. 4-32 ohms. Capacity: 180 watts for 10 seconds (with FNM fuse). 27½ x 20 x 9¾". Walnut finish.

SP-024J. Shpg. wt. 95 lbs. Each 600.00

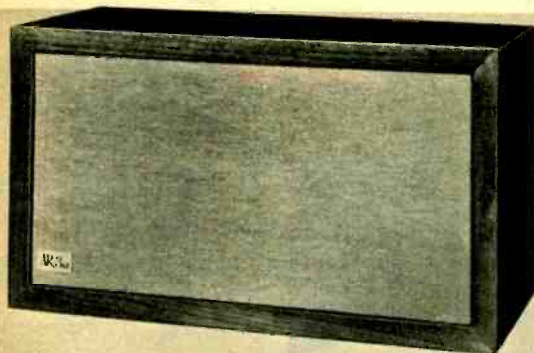

AR-3a Three-Way 12" Speaker System

\$269

- 12" Woofer
- 1½" Mid-range Dome
- ¾" Dome Tweeter

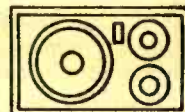

One of the most respected speaker systems in the audio industry! 12" acoustic-suspension woofer assures resonant, pure bass tones, 1½" mid-range and ¾" high-frequency hemispherical domes spread sound evenly. Mid-range and HF level controls. 4 ohms Impedance. Req. 25 watts/ch. minimum. Oiled walnut cabinet. 25 x 14 x 11½".

SP-017J. Shpg. wt. 58 lbs. Each 269.00

**Ideal for
Wall
Mounting—
Fittings
Included!**

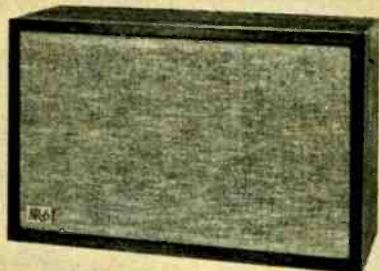

AR-6 Two-Way 8" Speaker System

\$89

- 8" Woofer
- 1½" Cone Tweeter
- Ideal for Shelves

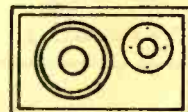

Terrific sound from a compact speaker. 8" acoustic suspension woofer with extended response, 1½" cone tweeter for highs with excellent dispersion. Oiled walnut cabinet is only 7" deep making it ideal for shelf placement or wall mounting (fittings included). HF level adjustment. Req. 20 watts/ch. minimum. 8 ohms. 19½ x 12 x 7".

SP-025J. Shpg. wt. 22 lbs. Each 89.00

New! AR-4Xa Two-Way 8" "Best Seller" Speaker System

\$75

- 8" Woofer
- 2½" Cone Tweeter
- Tweeter Level Control

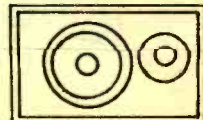

Improved version of AR's most popular speaker! Crafted for superb sound in an enclosure that's bookshelf perfect! Oiled walnut cabinet has 8" acoustic suspension woofer, 1½" wide-dispersion cone tweeter for high frequencies. 8 ohms. Requires 15 watts/channel minimum. 19 x 10 x 9".

SP-071J. Shpg. wt. 20 lbs. Each 75.00

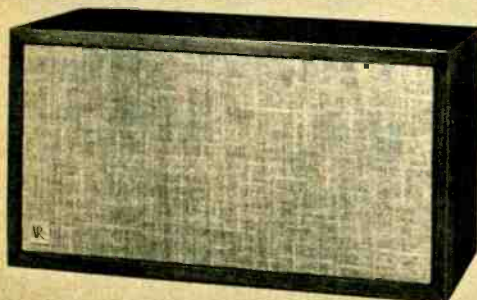

**All AR Speakers Covered by
Mfr's Complete FIVE-YEAR Guarantee**

AR Acoustic Suspension Speaker Systems

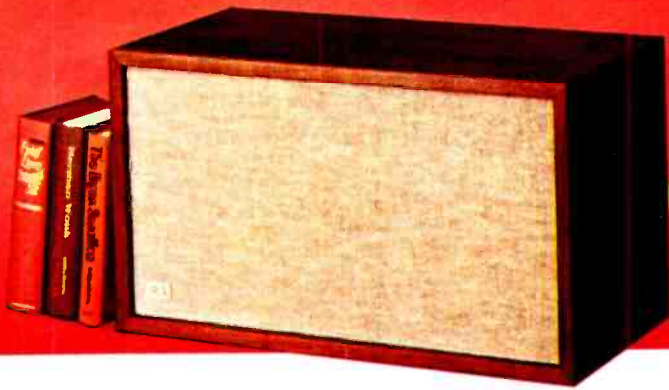

\$119

AR-8 2-Way 10" Speaker

The latest from AR! Designed for floor or shelf use, it has an acoustic-suspension 10" woofer and a 1½" wide-dispersion cone tweeter. Special 3-position switch lets you "tailor" the response to your listening area. L-C type crossover at 1600 Hz distribute frequencies evenly—helps provide the smooth, natural sound that AR is famous for. Power: 15 watts rms per channel minimum. 8 ohms impedance. 23¾ x 13½ x 11½". Good-looking oiled walnut cabinet.
SP-094J. Shpg. wt. 39 lbs. 119.00

Every AR speaker system features a woofer with an extremely loose cone in an air-sealed enclosure. The air acts as a "spring" for deep and powerful bass, but *without coloration*. It's AR's "sound secret".



\$65

AR-7 Compact Speaker

AR's smallest—a mere 9¾ x 15¾ x 6¼"—but still has that "famous" AR sound! 8" woofer, 1½" wide-dispersion tweeter, 2-step level control. 15 watts rms min. 8 ohms.
SP-023J. Shpg. wt. 15 lbs. Each 65.00

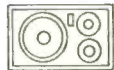

\$139

AR-2AX 3-Way 10" Speaker

Has 10" woofer, 3½" midrange and ¾" tweeter, with independent level controls for mid and high-frequencies. 42-20,000 Hz, 20 watts rms min., 8 ohms. 24 x 13½ x 11½".
SP-020J. Shpg. wt. 39 lbs. Each 139.00



EMPIRE "Shapely" Speakers for "Mod" Listeners



Grenadier 7500M 3-Way 15" System

199⁹⁵

Has a 15" high-compliance woofer, downward facing for best omnidirectional dispersion, powerful midrange radiator. The ultrasonic domed tweeter is coupled to a wide-angle acoustic lens for crisp, clear highs. Satin walnut finish, imported marble top. 25-20,000 Hz response. 20-100 watts/channel. 8 ohms. 20" dia. x 26¾".
SS-247J. Shpg. wt. 75 lbs. Each 199.95

Grenadier 6000M 10" Omnidirectional System

119⁹⁵

Exquisite design! Has a down-facing 10" woofer, mid-range radiator, and wide-angle ultrasonic tweeter, in a non-resonating cylindrical cabinet. Satin walnut finish, imported marble top. Handles up to 75 watts per channel. 30-20,000 Hz. 8 ohms. 13" diameter x 24¾" H.
SP-016J. Shpg. wt. 60 lbs. Each 119.95

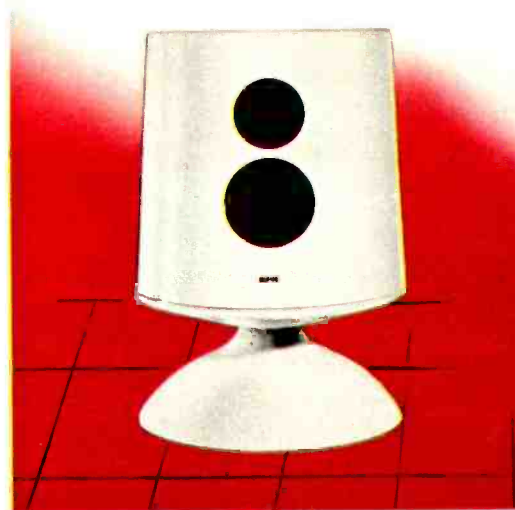

The Newest Addition To Modern Outdoor Musical Living

139⁹⁵

The Futuristic "Jupiter 6500" 3-Way 12" System

- **Omnidirectional—Placement for Stereo is not Critical**
- **Contemporary yet Rugged Enclosure for Today's Style**
- **Totally Weatherproofed – Use Outdoors Too**

Stylish and sophisticated! You get a heavy 12-inch downward facing woofer, powerful mid-range, and ultrasonic tweeter with wide angle dispersion. Uniroyal "Ribicast" gloss white surface, looks and sounds great indoors or out! 30-20,000 Hz response. Impedance 8 ohms. 17¼" dia.; 25½" H.
SP-066J. Shpg. wt. 40 lbs. Each 139.95



Decoratively Different Hi-Fi Speaker Systems



12" 3-Way Bookshelf System

Model WD-90. True shelf system gives you natural sound with really solid bass and outstanding realism. Has a 12" high-compliance woofer with 2¼-lb. magnet and 1½" voice coil, 8" direct-radiator midrange and 3½" tweeter. Tweeter level control lets you "tune" the sound for hard or soft rooms, or to your individual preference. 35-18,000 Hz response, 30 watts power capacity, 8 ohms impedance. Oiled walnut veneer finish with deep-brown contrasting grille cloth—really looks great. 14 x 23 x 10".
SP-029J. Shpg. wt. 33 lbs. **89.95**

8" 2-Way Bookshelf System

Model AS-2AX. Updated version of Utah's famous AS-2A. Has 8" high-compliance woofer with 1¼-lb. ceramic magnet structure, 3½" direct-radiator tweeter. Features a permanently viscous cone-edge treatment that stops speaker "breakup", special phase-coded screw terminal board for easy connections without phasing problems. 45-17,500 Hz response, 12 watts power capacity, 8 ohms impedance. 17¼ x 11¼ x 8¾".
SP-077J. Shpg. wt. 20 lbs. **49.95**



1 Sculpture Foam™ System

Model MP-3000 15" 4-Speaker System. MORE than just a speaker system, a fine furniture addition to your home. Rich blue foam grille cloth with a geometrically striking design enhances just about any decorating motif. Has a high-compliance 15" woofer with 2" voice coil and massive 6¾-lb. magnet structure for bass you can feel! The 5" cloth-roll midrange handles the middle frequencies with a "you-are-there" presence and realism and the TWO dome radiator tweeters provide outstanding high-end reproduction. Full 20-20,000 Hz frequency response, 50 watts power capacity, 8 ohms impedance. 20½ x 27 x 14" (excluding base).
SP-027J. Shpg. wt. 70 lbs. **199.95**

2 Studio-Quality 12" 3-Way

Trusonic JR-200M. A "super-listening" system that combines studio-monitor quality with stunning good looks. Has 12" high-compliance woofer with 2" voice coil and 6¾-lb. magnet structure, edge-damped high-compliance 5" midrange, dome radiator tweeter. 20-20,000 Hz response, 50 watts capacity, 8 ohms . 15¼ x 24 x 12".
SP-031J. Shpg. wt. 46 lbs. **149.95**

3 Sculpture-Foam 12" 3-Way

Model HS4-B. Has the sound and style to satisfy the most serious audiophile. 12" high-compliance woofer, elliptical compression midrange horn, dome radiator tweeter. Ducted port enclosure, tweeter level control. 25-19,000 Hz response, 30 watts power capacity, 8 ohms impedance. 15 x 25¼ x 14".
SP-028J. Shpg. wt. 49 lbs. **149.95**



Sculpture Form™ 12" 3-Way

Model MP-1000. Impressive all the way—from its walnut-veneer hardwood finish to its acoustically-transparent sculptured grille! Has 12" acoustic-suspension woofer with high-compliance cloth cone edges and 1½" voice coil, 8" sealed mid-range speaker, 3½" tweeter. Treble control adjusts high frequencies to the acoustics of your listening room. Woofer has 2¼-lb. magnet structure for easy handling of low frequencies. Air-tight construction lengthens speaker life. Shallow enough for shelf use—just 10" deep, but big enough for floor use—14" wide x 23" high. 32-18,000 Hz response, 30 watts power capacity, 8 ohms impedance.
SP-078J. Shpg. wt. 33 lbs. **99.98**

SPECIAL MONEY-SAVING HI-FI SYSTEM QUOTATION

Select Your Own
Stereo System—
Get the Olson
Discount Price
and
SAVE!

Mail this card
today or bring
to your local
Olson store

Remember . . . at Olson
we service what we sell!

Here's My Selection—Show Me My Savings:

PLEASE PRINT PLAINLY

How Many	Component	Manufacturer's Model	Cat. Page	Stock No.	Reg. Price
	Receiver or Amplifier				
	Tuner				
	Changer or Turntable				
	Cartridge				
	Dust Cover	<input type="checkbox"/> Yes <input type="checkbox"/> No			
	Base	<input type="checkbox"/> Yes <input type="checkbox"/> No			
	Tape Deck or Recorder				
	Speakers				
	Headphones				
	Stereo Cart				
	Other				

Name _____
Address _____ Apt. _____
City _____
State _____ Zip _____

Bring to your nearby store or
mail in—any way you do it you
get **BIG SYSTEM SAVINGS!**

Reg. Price \$ _____
Olson Discount \$ _____
You Pay Only _____

Low-Priced Stereo Add-Ons—Choose 8-Track or Cassette

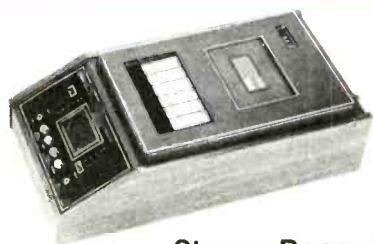

Cassette
89⁹⁸
Olson

Stereo Record/Play Deck

Model 959. Hooks up to your present system to let you record and play great-sounding stereo cassettes. Has pushbutton function controls, slide-type record level controls, 3-digit tape counter for easy editing. Features slant-front "studio style" control panel, pop-up cassette eject mechanism, dual lighted VU meters for precise record levels. Front panel mike jacks for "live" stereo recording. Good-looking walnut-veneer base, 8¼ x 5½ x 16½". For 117 VAC.
RA-959J. Shpg. wt. 11 lbs. **89.98**

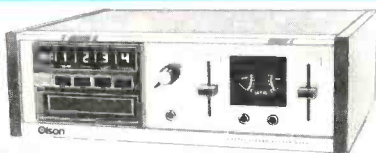

8-Track
129⁹⁸
TELEDYNE
Stereo Record/Play Cartridge Deck

Model 964. Add it to your stereo system for complete 8-track cartridge record and playback facilities. Great way to record your favorite music — in the sequence you desire — for playback on your car tape player. Has pushbutton function controls, slide-type level control and lighted VU meter for each stereo channel, front panel microphone inputs. Tape eject button lets you stop and eject cartridge at end of each program or end of tape. Repeat switch lets you play single programs over and over. Walnut wood cabinet, 4¼ x 14 x 10¼". For 117 VAC.
RA-964J. Shpg. wt. 15 lbs. **129.98**

See Page 239 for Further Details, Page 130 for Blank Tape.

PLACE
STAMP
HERE

fill out other
side for
**SPECIAL
MONEY-SAVING
HI-FI SYSTEM
QUOTATION**

Olson electronics
260 South Forge Street
Akron, Ohio 44327

Attention: AUDIO DIVISION

Show me my
SPECIAL SYSTEM SAVINGS
on the custom system I have
selected on the other side



CHARGE IT too! BankAmericard, Mastercharge, local store plans also available!

See Olson for Electronics Whose "Time" Has Come



NEW Microma
Quartz Crystal
Electronic Watch

\$ 150

The latest in timepieces — a modern miracle of electronics. A quartz crystal vibrates at 32,768 times per second — these vibrations then become electronic pulses that "read-out" the hours and minutes on a liquid crystal. Always on — no buttons to push! Accuracy is 0.5 second a month!
XM-218J. Wt. 1 lb. . . . 150.00

Solitron
LED Display
Electronic Watch

\$ 375

It's a handsome watch with a totally opaque face — press buttons and the hours, minutes, seconds and date "spring to life" in an easy to see bright red readout. Batteries last up to a year with normal use! Accuracy is a minute a year!
XM-217J. Man's. . . . 375.00
XM-219J. Woman's Pendant Model. 375.00



jensen Speakers for the Discriminating Listener

Featuring Jensen's new "Total Energy Response Design" for the best musical balance in your listening area.

Replacement Grilles

Use these grilles to make your speaker an integral part of your home decor. Feature sculptured texture, decorator colors. Snap on easily.

For Speaker Models 1 and 16

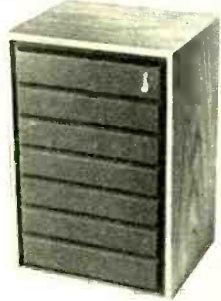

11⁹⁵
Pair

Stock No.	Color	Pair
CA-728J	Lacquer Red	11.95
CA-729J	Black	11.95
CA-730J	China Blue	11.95
CA-731J	Autumn Gold	11.95
CA-732J	Jungle Brown	11.95
CA-733J	Tropical Green	11.95

For Speaker Models 2 and 17

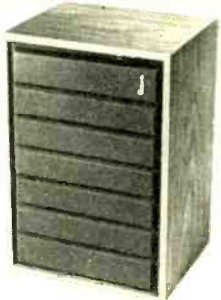

15⁹⁵
Pair

Stock No.	Color	Pair
CA-734J	Lacquer Red	15.95
CA-735J	Black	15.95
CA-736J	China Blue	15.95
CA-737J	Autumn Gold	15.95
CA-738J	Jungle Brown	15.95
CA-739J	Tropical Green	15.95

39⁹⁵
Pair

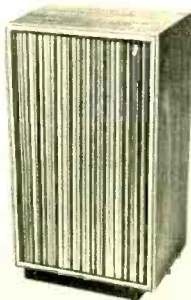

CA-740J. Black pleated grille for Model 5 Pair 39.95
CA-741J. Walnut textured grille for Model 6 Pair 39.95

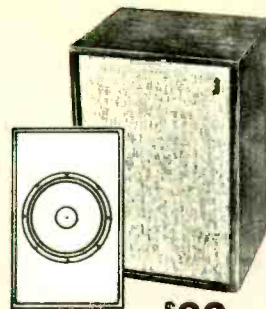

\$33



\$39

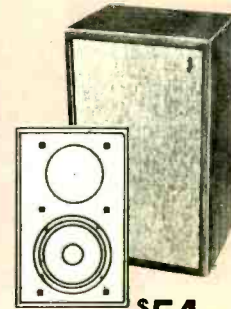

\$54



\$63

8" Dual-Cone with Flexair® Suspension

Model 1. Good performance and quality components at a very reasonable price. 40-18,000 Hz response, 120° dispersion, 30 watts power capacity, 8 ohms. Walnut-grain vinyl cabinet, beige grille. 14¼ x 10 x 8½".

SP-095J. Shpg. wt. 14 lbs. **33.00**

SP-096J. **Model 16.** Above, hand-rubbed walnut cabinet, dark brown sculptured grille **39.00**

8" with Direct Radiating Tweeter

Model 2. Has 8" woofer, with Flexair suspension for greater clarity, 3½" direct-radiating tweeter. 38-25,000 Hz response, 150° dispersion, 35 watt capacity, 8 ohms. 11 x 18¼ x 8¾".

SP-097J. Shpg. wt. 22 lbs. **54.00**

SP-098J. **Model 17.** Above, with hand-rubbed cabinet, sculptured dark brown grille **63.00**



\$84



\$111



\$162

Two-Way 10"

Model 3. 10" woofer with 4-layer coil, 3½" tweeter enclosed in tuned isolation chamber. 36-20,000 Hz response, 150° dispersion, 40-watt capacity, 8 ohms. Hand-rubbed cabinet, 12¼ x 22½ x 10¾".

SP-099J. Shpg. wt. 31 lbs. **84.00**

Three-Way 10"

Model 4. 10" four-layer woofer, 5" direct radiating midrange, Sonodome® ultra-tweeter. 36-30,000 Hz response, 170° dispersion, 50-watt capacity, 8 ohms. Hand-rubbed cabinet. 13 x 24 x 12".

SP-100J. Wt. 46 lbs. ... **111.00**

Three-Way 12"

Model 5. 12" woofer, TWO 5" direct radiating midranges, Sonodome tweeter. 32-30,000 Hz response, 170° dispersion. 60 watts capacity, 8 ohms. Hand-rubbed walnut-cabinet, 15 x 26 x 13".

SP-101J. Wt. 52 lbs. ... **162.00**

\$219

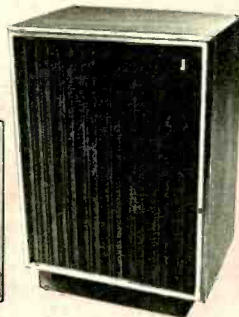
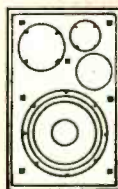

Four-Way 15" Floor Speaker

Model 6. Massive 15" woofer, 8" midrange, 5" direct-radiating tweeter, Sonodome ultra-tweeter—specs that speak for themselves! 27-30,000 Hz response, 170° dispersion, 75 watts power capacity, 8 ohms. Walnut-wood cabinet, removable black-pleated grille. 20½ x 27 x 15".

SP-102J. Shpg. wt. 74 lbs. **219.00**

Jensen's
Finest
\$396

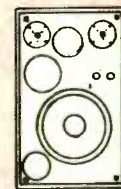

Deluxe Four-Way 15" Floor Speaker

Model 15. You won't find better sound in any speaker at any price. Specs same as Model 6, but this one has TWO Sonodome super-tweeters for 170° sound dispersion in both horizontal and vertical planes. Walnut cabinet, charcoal black fabric grille with black slate top. 23 x 31 x 17".

SP-103J. Shpg. wt. 85 lbs. **396.00**

Speaker Systems with Sound and Style



These "Ear-Opening" Series R Speaker Systems provide you with flawless sound reproduction PLUS style that complements any stereo setup. Pick your size and price!



119⁹⁵



159⁹⁵



229⁹⁵

Two-Way 10" System

Model CSR-300. Bookshelf perfect, but delivers BIG sound. Features an excellent crossover design based on the desirability of high crossover frequency—the higher the frequency, the lower the distortion. Has a large 10" cone woofer for exciting, natural bass, horn tweeter with low-mass cone for crisp, clear highs. Bass-Reflex" enclosure is damped with a special sound absorbing material that "soaks up" distortion—all YOU hear is the music. 45-20,000 Hz response, 40 watts power capacity, 8 ohms impedance. Walnut wood cabinet, sparkling red and black contrasting grille cloth. 13 x 22½ x 11".

SS-326J. Shpg. wt. 29 lbs. . . . Each **119.95**

Three-Way 10" System

Model CSR-500. Delivers smooth bass, mid-range and high frequencies with a YOU-ARE-THERE presence and realism. 10" woofer has large magnet structure and heavy-duty voice coil for bass response without booming. Special aluminum horn tweeter for high frequencies with wide dispersion. Cone midrange has large, completely enclosed back chamber, duralim cap and damping material for smooth clean midrange. Bass Reflex type enclosure. 40-20,000 Hz response, 60 watts power capacity, 8 ohms impedance. Walnut wood cabinet with deep blue and contrasting black grille—looks good with any decor. 13¾ x 24 x 12".

SS-327J. Shpg. wt. 42 lbs. . . . Each **159.95**

Three-Way 12" Floor System

Model CSR-700. A powerhouse of a speaker system that delivers all the sound you need with presence and authority. Big 12" woofer with massive magnet structure and extra-long voice coil assure distortion-free bass. Midrange horn covers the important middle frequencies with ultra-clean tonal quality, multi-cellular Super-Tweeter provides sparkling highs with outstanding dispersion. Two-way crossover distributes frequencies evenly for practically linear response across the entire bandwidth. 35-20,000 Hz response, 75 watts power capacity, 8 ohms impedance. Walnut cabinet, brown/black grille. 15 x 26 x 13¾".

SS-328J. Shpg. wt. 55 lbs. . . . Each **229.95**

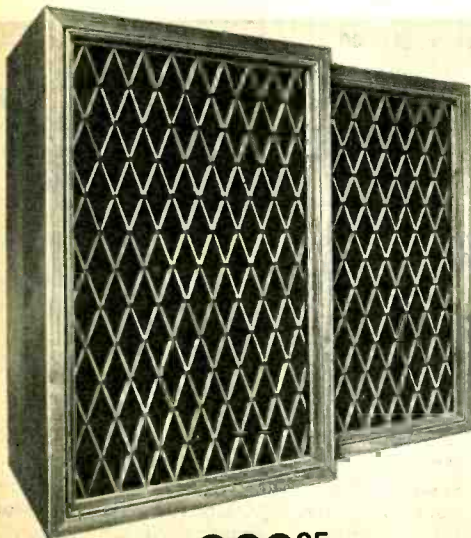

269⁹⁵

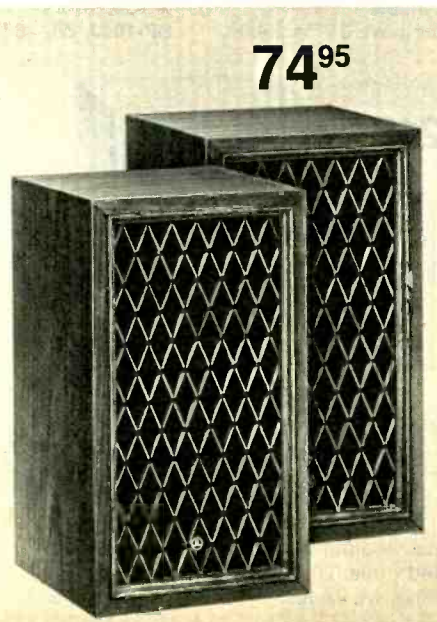

74⁹⁵

Four-Way 15" Floor System

Model CS-63DX. You'd have to hear it "live" to hear it as good as this "reproduction instrument" provides! The 15" woofer has a massive magnet structure and extra-large voice coil for bass you can FEEL, there are 2 midrange speakers and 3 high-frequency tweeters for a thoroughness of sound you have to listen to to appreciate. 20-22,000 Hz response, 80 watts power capacity, 8 ohms impedance. Hand-crafted oiled walnut enclosure with lattice-type wood grille. 18¾ x 28¾ x 13½".

SP-093J. Shpg. wt. 90 lbs. . . . Each **269.95**

Two-Way 8" System

Model CS-44. Designed for excellent performance at moderate cost—this is just the system for smaller rooms, apartments, budget stereo setups. 8" woofer has long-throw voice coil for deep bass, wide-angle 2½" cone-type tweeter for crisp highs. 35-20,000 Hz response, 25 watts power capacity, 8 ohms impedance. Stylish walnut cabinet with matching lattice-type wood grille—makes a "decorator-inspired" stereo setup. 11½ x 9¾ x 10¾".

SS-329J. Shpg. wt. 23 lbs. . . . Each **74.95**

Olson. Raw Speakers—Great Sound, Great Value

**2-Way 12\"/>
Coaxial Speaker**

11⁹⁸

Smart audio buy! Has 12" woofer, 3" tweeter with crossover. For stereo, replacement, PA. 35-15,000 Hz. 8 ohms. 12 watts power capacity. 6¾" deep. SS-311J. Shpg. wt. 8 lbs.**11.98**

"Chrome Dome" 12" Coax Speaker

Wide-response speaker ideal for stereo, PA, any custom use. Fully enclosed chromed back. Smooth, peak-free response, 2" voice coil structure for full-range performance from 40-15,000 Hz. Cloth roll edges. 35 watts power capacity, 8 ohms. 5" deep. SS-308J. Shpg. wt. 10 lbs. **29.98**
 SS-325J. Above, 15" Model. 15 lbs. **39.98**

Low As
29⁹⁸

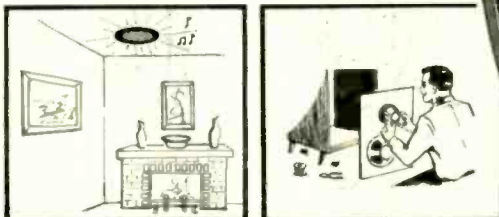

Value-Priced 2-Way Systems

\$18

Good-sounding system ready to mount in your own enclosure. Consists of SS-896 10" speaker, SS-028 Horn Tweeter and TT-294 2-way crossover. 50-ft. hookup wire. Response 50-18,000 Hz. (Not shown). AS-491J. 12 lbs. (Pair \$34) ... Each **18.00**
 AS-492J. With SS-159 Heavy-Duty 10" Speaker in place of SS-896. (Stereo Pair \$40) (Illustrated) Each **22.00**

\$27

Great for low-cost stereo setups. Ready-to-mount system includes SS-181 12" speaker with SS-163 dome tweeter and TT-294 2-way crossover. 50-foot of hookup wire too! Response 40-20,000 Hz. AS-534J. 14 lbs. (Pair \$50) Each **27.00**
 AS-729J. With SS-158 Heavy-Duty 12" Speaker in place of SS-181. (Stereo Pair \$60) Each **31.00**

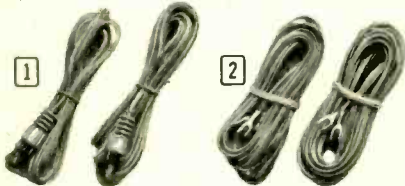

Polarized Speaker Cable

- 1** Two 6' Cables. RCA-type phono plug on one end, stripped and tinned leads other. HF-151J. Shpg. wt. ¼ lb. **1.39**
Heavy-Duty 30-Ft. Cable. Like above. HF-212J. Shpg. wt. ½ lb. **4.29**
- 2** Two 10' Cables. Spade lugs each end. HF-065J. Shpg. wt. ¼ lb. **1.29**

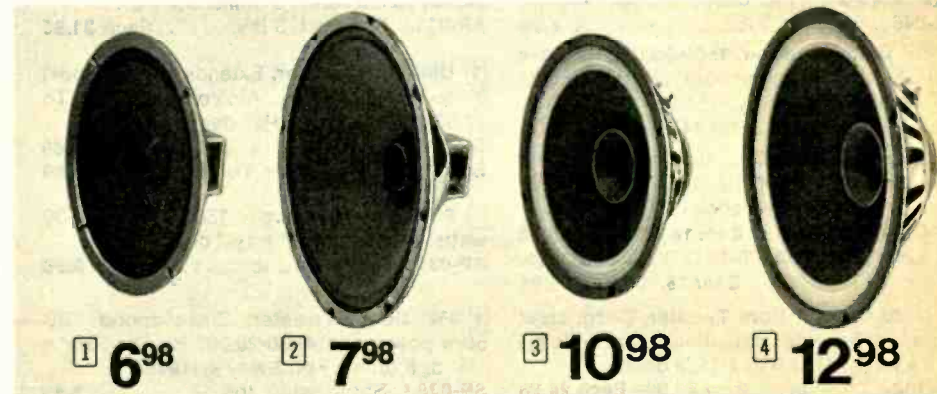

1 10" Full-Range Speaker

Use as a replacement speaker in many consoles or compacts, mount in your own cabinet for extensions, etc. Formed cone for 50-13,000 Hz response. 10 watts. 4 ohms. 3½" deep. SS-896J. 5 lbs. 2 for **13.00** Each **6.98**

2 12" Full-Range Speaker

Extra-low price for sound this good! Full-size 12" woofer provides plenty of bass, clean, crisp highs. 40-13,000 Hz response. 15 watts. 8 ohms. 5" deep. SS-181J. 6 lbs. 2 for **15.00** Each **7.98**

3 10" Heavy-Duty Speaker

Cloth-roll cone suspension, 10-oz. ceramic magnet and precision construction make it a reliable day-in, day-out performer. 35-18,000 Hz, 15 watts. 8 ohms. 4¼" deep. SS-159J. 5 lbs. 2 for **21.00** ... Each **10.98**

4 12" Heavy-Duty Speaker

Has extra-heavy duty cloth-roll suspension for good sound and long life, 10-oz. ceramic magnet for surprising deep bass. 30-18,000 Hz. 32 watts. 8 ohms. 4¼" deep. SS-158J. 7 lbs. 2 for **24.00** ... Each **12.98**

"Olsontone" Decorator Grille Cloth

Latest patterns and colors, won't sag or shrink. Acoustically "Transparent." Shpg. wt. 1 lb.

Size	Description	Fabric	Stock No.	Each
11 x 26"	Walnut 2-Pc.	Cotton	HF-819J	.90
12 x 12"	Mixed 6-Pc.	Cotton	HF-820J (2 Pkgs.)	.98
12 x 24"	Basketweave	Vinyl	HF-117J	1.15
12 x 35"	Universal	Cotton	HF-118J	1.75
20 x 36"	Basketweave	Vinyl	HF-118J	1.80
24 x 36"	Walnut	Cotton	HF-816J	1.89
36 x 36"	Walnut	Cotton	HF-813J	1.98
24 x 36"	Wal /Mahog	Vinyl	HF-122J	2.49
24 x 36"	Mediterranean	Cotton	HF-159J	2.90
36 x 36"	Wal /Mahog	Vinyl	HF-120J	3.29
11 x 26"	Wal /Mahog, 2-Pc.	Vinyl	HF-124J	3.29
36 x 36"	Mediterranean	Vinyl	HF-158J	3.29

Low As

98^c

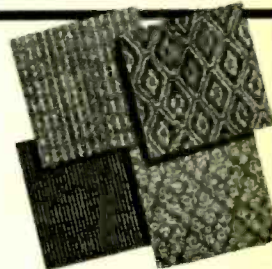

Olson Acoustic Fiberglass

For lining speaker cabinets—easy to cut, glue or staple. 9 sq. ft. package. HF-017J. 2 lbs. 2 for **3.50** Each **2.09**
 Acoustic Foam. 72 x 18 x ½". Wt. 2 lbs. HF-012J. 3 for **7.50** Each **3.09**

Low As

209

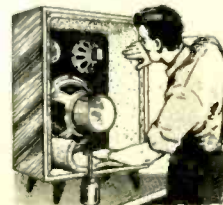

Create Your Own Speaker Systems

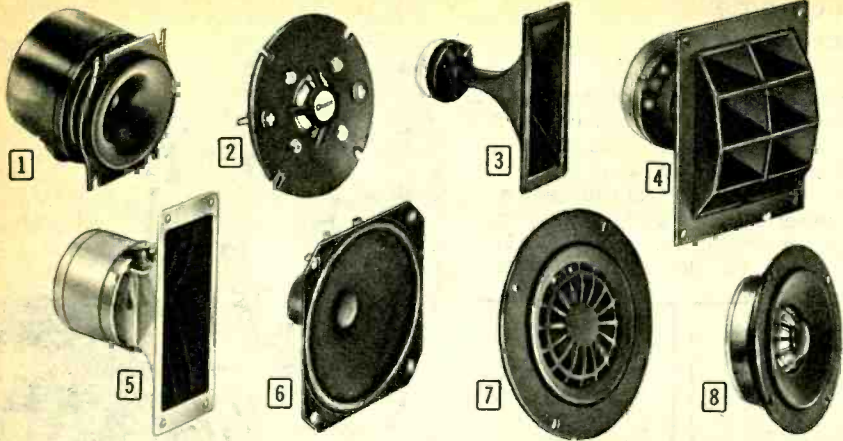

1 2 3/8" Tweeter, 2000-27,000 Hz response, 20-watt capacity. Mounting hole diameter: 2 1/16". 2 3/8" x 2 1/2" x 2 7/8" deep. 8 ohms. SS-846J. Shpg. wt. 2 lbs. 7.98

2 1 1/2" Dome Tweeter. 1500-20,000 Hz, 30 w cap. 2 1/4" dia. mounting hole. 1 1/4" deep x 3 1/2" dia. 8 ohms. For 2-way systems. SS-163J. Wt. 2 lbs. . . 2 for 34.00—Each 17.39

3 Midrange Horn. Cast aluminum, 120° dispersion. 2000-18,000 Hz. 20 watts. 8 ohms. 6 3/4" x 6 1/2". Adds "presence" to woofer. SS-028J. Wt. 4 lbs. . . 2 for 16.00—Each 8.98
 SS-928J. Above, 1000-18,000 Hz response. 10 1/2" x 11" 2 for 18.00—Each 9.98

4 Multi-Cellular Horn Tweeter. Crisp, clear highs, extra-wide dispersion. 3000-20,000 Hz 15 watts, 4 1/2" x 3 7/16" x 1". 8 ohms. SS-162J. Wt. 4 lbs. . . 2 for 45.00—Each 24.98

5 Electro-Voice T35 VHF Compression Driver. Great high-end response. 3500-20,000 Hz. 20 watts. 8 ohms. 5 1/4" x 2". SP-011J. Shpg. wt. 3 lbs. Each 31.95

6 Utah 3 1/2" Tweeter. Extends range of most 8" to 12" speakers. Alnico-V magnet. To 17,500 Hz. 20 watts. 1 1/4" deep. 8 ohms. SS-088J. Wt. 2 lbs. . . . 2 for 5.00—Each 2.69
 SS-165J. 5 1/4" Tweeter. To 20,000 Hz . . . 3.69

7 5" Dome Midrange. 1500-4000 Hz. 30 watts. Diameter, 5 1/8" x 1 1/2" deep. 8 ohms. SP-037J. Shpg. wt. 3 lbs. 9.98

8 3 3/4" Dome Tweeter. Clean sound, BIG 50-w power cap. 4000-20,000 Hz. Dia., 3 3/4" x 1 1/2" d. 8 ohms. For 3-way systems. SP-038J. Shpg. wt. 2 lbs. 8.49

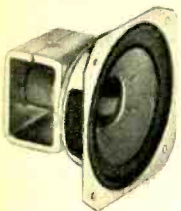

Olson®
Acoustic-Suspension
5" Woofer
9.69

Acoustic-suspension design for deep, rich bass—ready-to-mount in your own custom enclosure. 30-5000 Hz response, 48 Hz resonant frequency. 15 watts. 8 ohms. 5 1/2" x 3 3/8". SS-845J. Shpg. wt. 4 lbs. 9.69



Olson®
8" Woofer/
3 1/2" Tweeter
Combo
9.98

Great sound for the money. 2-way system is complete with crossover capacitors, terminal board and instructions. 60-17,500 Hz response, 24 watts, 8 ohms. Only 2 3/4" deep. SS-288J. Shpg. wt. 4 lbs. 9.98

Olson® "Quad-Flex" 6 x 6" Speaker

10.49

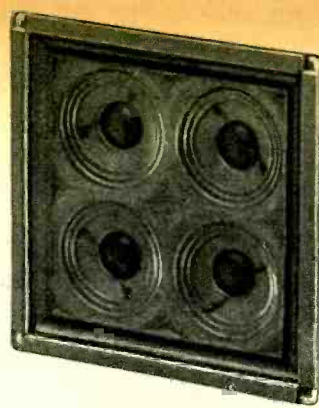

Sounds great! Has four driving coils coupled to a SQUARE cone for deeper bass without sacrificing treble. 60-15,000 Hz response. 10 watts. Only 1 1/16" deep, mounts anywhere. 8 ohms. SS-286J. Shpg. wt. 3 lbs. 10.49

Famous Olson "X-Air" Speakers

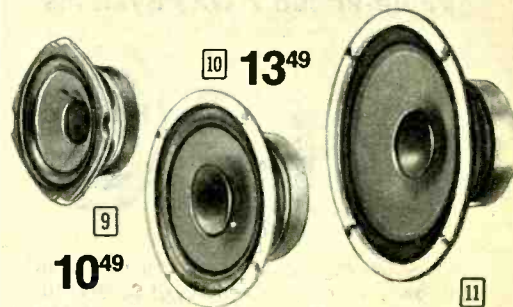

10.49

13.49

16.98

Perfect for custom-mounting! Feature acoustically-suspended cones resulting in wide-range response and undistorted sound. Massive high-compliance ceramic magnet structure.

9 4" Cone. 40-16,000 Hz response, 15 watts, 8 ohms. 2" deep. SS-732J. Shpg. wt. 3 lbs. 10.49

10 6 1/2" Cone. 35-18,000 Hz response, 25 watts, 8 ohms. 2 3/4" deep. SS-755J. Shpg. wt. 4 lbs. 13.49

11 8" Cone. 30-20,000 Hz response, 35 watts, 8 ohms. 3 3/8" deep. SS-786J. Shpg. wt. 5 lbs. 16.98



Easy Hookup Accessories

12 Screw-type Terminal Strips. 5/8" x 5/8"—1 1/2", 2 1/4", 2 3/4" lengths. Asst'd 2, 3, 4 lugs. HW-060J. Shpg. wt. 1/4 lb. . . . Kit of 13 1.69

13 Pushbutton Bakelite Terminal Strips. One red, one black. Pkg. of 2. 1/4 lb. HF-170J. 4 Pkgs. for 8.00 Pkg. 2.05

14 50-Ft. Speaker Cable. Flexible, flat—great for under carpets, baseboards. Color-coded wires, grey vinyl jacket. WW-564J. Shpg. wt. 1/4 lb. 1.19

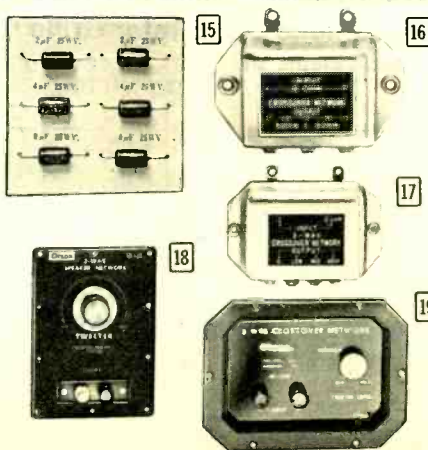

Olson® Crossover Networks

Prevent Speaker Damage, Provide Smoother Response, Better Sound

15 Crossover Capacitors. Pkg. of 6. 2 each: 2, 4 and 8 μF. Non-polarized. CC-240J. Shpg. wt. 1/4 lb. 2.29

16 2-Way L-C Crossover. Distributes hi/lo frequencies. 3000 Hz. 8 ohms. TT-294J. 1/4 lb. 2 for 7.00—Each 3.79

17 3-Way L-C Crossover. For woofer/midrange/tweeter systems. 800, 5000 Hz. HF-177J. Wt. 1/2 lb. . . 2 for 11.00—Each 5.89

18 2-Way L-C Crossover. Sharp cutoff at 3000 Hz. Tweeter level control. 8 ohms. HF-102J. 2 lbs. 2 for 14.00—Each 7.49

19 3-Way L-C Crossover. Sharp cutoff as above, 600 and 2500 Hz. 8 ohms. HF-216J. 3 lbs. 2 for 32.00—Each 17.29

"Customize" Your Stereo with Teledyne Speakers

Mount these components in walls, doors, existing cabinetry, anywhere for fine sound. Remember, you pay only for performance, NOT furniture!

1 Our Finest 12" 3-Way

• 12" Woofer, Whizzer Midrange, Tweeter

High-efficiency multi-element speaker has 1½-lb. ceramic magnet structure, 2" voice coil, die-cast frame and cloth roll edges.

20-20,000 Hz response, 25 Hz free air resonance 35 watts. 8 ohms. 6½" deep. SS-285J. Shpg. wt. 12 lbs. 39.98



2 Low-Cost 12" 3-Way

Has 12" woofer with 1½-lb. ceramic magnet and 1½" voice coil, die-cast frame, cloth roll edges. 23-20,000 Hz response, 25 Hz free-air resonance. 22 watts. 8 ohms. 6½" D. SS-284J. Shpg. wt. 12 lbs. 29.98

3 Full-Range 12" Dual Cone

Two-way system has 12" woofer with 1¼-lb. magnet, 1½" coil, die-cast frame, cloth roll edges. 23-18,000 Hz response, 25 Hz free-air resonance. 22 watts. 8 ohms. 6½" D. SS-282J. Shpg. wt. 12 lbs. 21.98
SS-281J. Above, woofer only. 12 lbs. 19.98



These high-efficiency speakers deliver the most natural sound with the least amplifier power.

Book Bonus

"How to Build Speaker Enclosures." Only \$1.00 with purchase of any speaker on this page. BK-002J. Purchased Alone . 3.50

Save \$2.50

1 39⁹⁸

2 29⁹⁸

3 21⁹⁸

Model 15TRX-MKII
15" 3-Way Hi-Fi Speaker
99⁹⁸

Built-in midrange radiator, VHF compression horn tweeter with level control. 20-20,000 Hz. 60 W. 16 ohms. 8¼" D. SS-161J. Shpg. wt. 27 lbs. 99.98

TELEDYNE OLSON
Component-Matched Speaker Systems
Save up to 27%

2-Way 12" System 25¹⁰ Sep. Items Reg. \$32.26
Features Teledyne SS-281 12" woofer, plus the new SP-038 high-frequency tweeter. 2-Way L-C crossover distributes frequencies evenly. 20-20,000 Hz response. 8 ohms. AS-727J. Shpg. wt. 15 lbs. 25.10

3-Way 12" System 40⁸⁰ Sep. Items Reg. \$55.74
Teledyne SS-281 12" woofer, SP-038 high-frequency tweeter, plus SP-037 midrange speaker for enhanced presence and dispersion. 3-Way L-C crossover. 20-20,000 Hz. AS-728J. Shpg. wt. 22 lbs. 40.80

4 8" Replacement Speaker

Surprising good sound, surprising low price! Cloth-roll cone edges, 10-oz. magnet, 15 watt power capacity. 8 ohms. 3" deep. SS-146J. Shpg. wt. 4 lbs. 8.98

5 8" 3-Way Coaxial

3" tweeter with level control, midrange radiator, woofer with 10 oz. ceramic magnet and 1" voice coil. Die-cast frame. 32-20,000 Hz. 15 watts. 8 ohms. 3¾" D. SS-283J. Shpg. wt. 5 lbs. 19.98

6 8" Dual-Cone Model

Has 10-oz. ceramic magnet, 1" voice coil, cloth-roll edges. 32-18,000 Hz response, 15 watts (program). 8 ohms. 3¾" D. SS-287J. Shpg. wt. 4½ lbs. 13.98

50' Speaker Wire. For easy hookup.

WW-564J. Shpg. wt. ¼ lb. 1.19

These speakers are ideal for replacements in consoles and phonos, as low-cost extensions, rear-channel speakers in "quad" 4-channel setups.

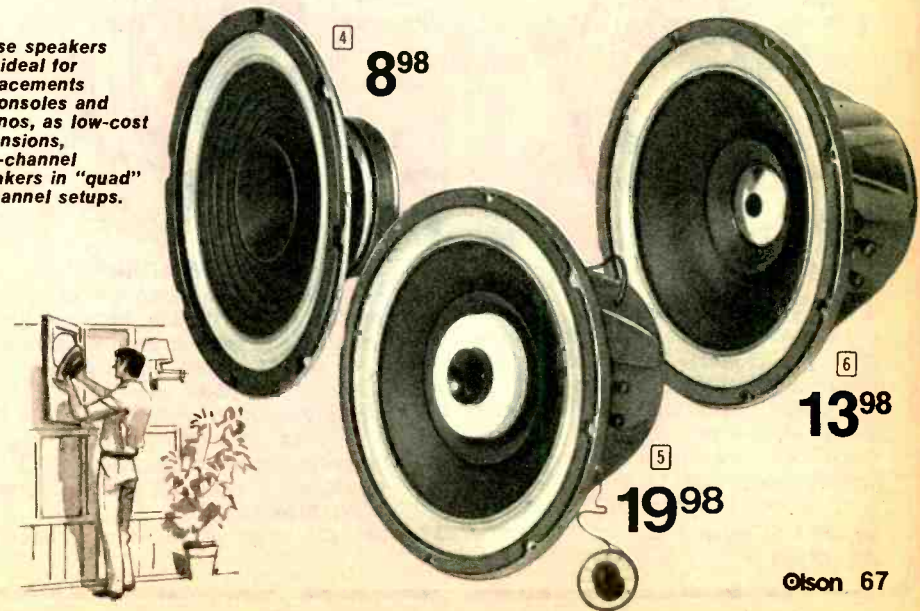

4 8⁹⁸

6 13⁹⁸

5 19⁹⁸

See Page 42 for Speaker Enclosures

Utah

CASCADE High Fidelity Speakers

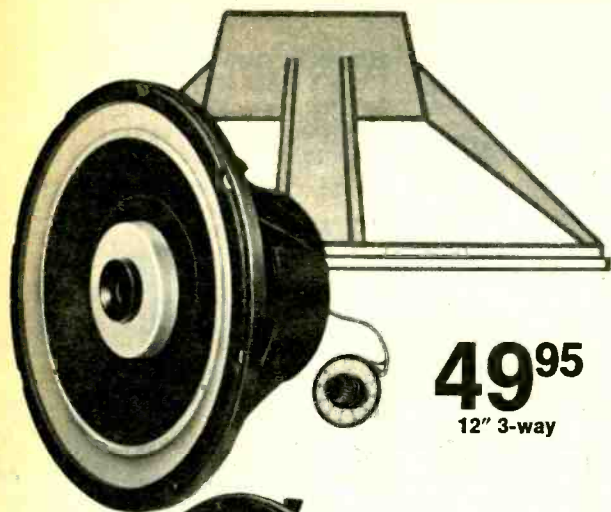

49⁹⁵
12" 3-way

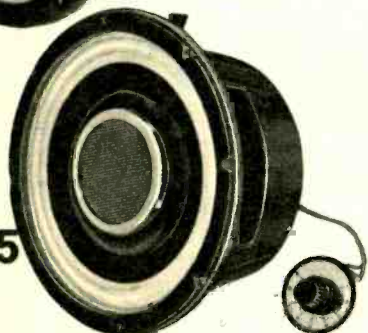

29⁹⁵
8" 3-way

Natural Sound for Custom Sound Systems

- Pure, Natural Sound Reproduction with Powerful, Flat Response
- Perfect for Custom Systems, or Expanding Present System
- Build Them Into Furniture, Mount in Walls, Use Anywhere

Full-range and woofer speakers designed for the audio enthusiast—the one who seeks the most natural sound available. You can build your entire sound system around these Cascade speakers, or use them to improve your present arrangement. The powerful, flat response is the result of a variety of innovations. Larger magnet assemblies and voice coils are used for highest efficiency, power and response. New chemically treated woven fabric suspension maintains high cone compliance, extending bass response down beyond the lowest recorded frequency. In full-range models, co-axial diffusers and tweeters smoothly disperse the higher frequencies to beyond audibility—a "must" for natural sound. Die-cast frame has open design for long, free cone excursions; elements maintain precise alignment. Frame can be front or rear mounted on a baffle.

Three-way speakers have co-axially mounted diffuser with mechanical crossover. Two-way speakers have co-axially mounted tweeter cone. SP-084J has cone-type tweeter; SP-086J has horn amplified high frequency compression unit. 8" models have 1½" voice coil, 12" models have 2" voice coil. Insulated, spring-loaded terminals for easy wiring; phase-coded.

Stock No.	Type	Magnet Assembly (lbs.)	Peak Audio (Watts)	Resonance (Hz)	Frequency Response (Hz)	Shpg. Wt. (lbs.)	Price
SP-083J.	8" 2-way	4	35	53	28-17,000	6	24.95
SP-084J.	8" 3-way	4	35	53	28-19,500	6½	29.95
SP-085J.	12" 2-way	7¾	85	25	18-19,000	16½	39.95
SP-086J.	12" 3-way	7¾	85	25	18-20,000	17½	49.95
SP-087J.	12" Woofer	7¾	60	25	18-5,000	16½	39.95

Free Cone Full-Range Speakers

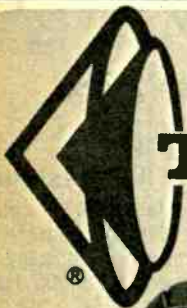

TRUSONIC

Big Edge-Wound Voice Coils

30 Watts Program



8" **39⁹⁵**

8" Full-Range Speaker

Loaded with features, including low free air resonance (50 Hz). Has 2" voice coil with edge-wound aluminum ribbon, free cone suspension, large spider diameter. One-piece magnetic return path for 10,500 gauss flux density. 4¼-lb. Alnico V magnet structure. Response, 40-15,000 Hz. 30 watts program (60 peak). 8 ohms. 8¾" dia. x 4" deep. SP-088J. Shpg. wt. 7 lbs. Each 39.95

68 Olson

35 Watts Program

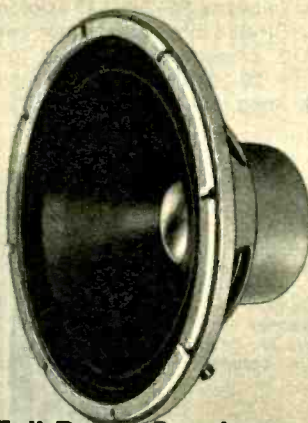

12" **\$ 75**

12" Full-Range Speaker

A unique blend of design elements, offering freedom from distortion, excellent transient response and smooth musical balance. 2½" voice coil of edge-wound aluminum ribbon operates in 11,500 gauss magnetic field. Alnico V magnet structure weighs 9.75 lbs. Free cone suspension, precision die-cast frame, low resonant frequency (30 Hz). 25-15,000 Hz. 8 ohms. 35 watts program (70 peak). Size, 12½" dia. x 6½" deep. SP-089J. Shpg. wt. 15 lbs. Each 75.00

Handles 45 Watts Program



15" **\$ 99**

15" Full-Range Speaker

The ultimate in smooth, powerful bass . . . and reproduction of frequencies up to 14,000 Hz. Has a 3" diameter voice coil, edge-wound of aluminum ribbon, working in 13,000 gauss flux field. Alnico V magnet structure weighs 17½ lbs. Free cone suspension, die-cast frame. Free air resonance, only 23 Hz. Handles 45 watts program (90 watts peak). Frequency response, 20-14,000 Hz. 8 ohms. Size, 15¾" dia. x 7¾" deep. SP-090J. Shpg. wt. 25 lbs. Each 99.00



Argos Speaker Systems

Solve Your Sound Problems!

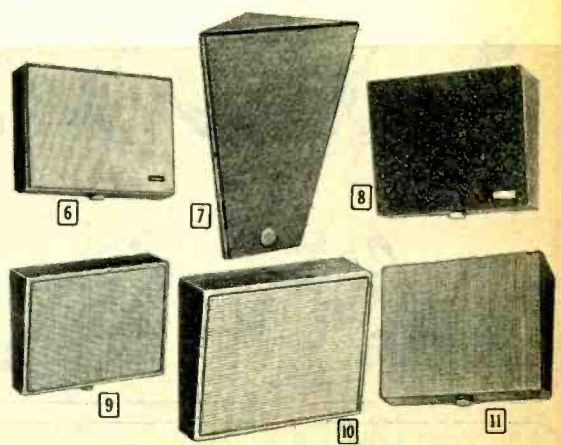
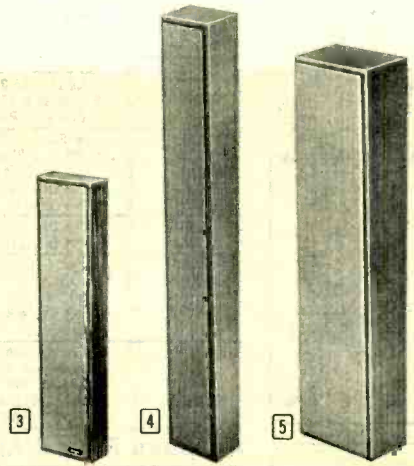
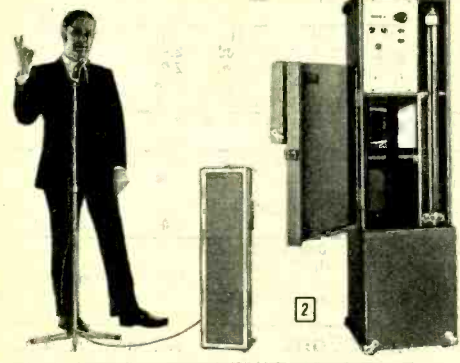

Portable Systems

Sound Columns

Extension Speakers, PA Speaker/Baffles

1 "Speech Director" Lectern
 • *Portable Amplifier, Sound Column And Mike All-in-One—Covers 500 People!*
Model LSD-6040A. Everything you're looking for in a sound system, in one case, ready to use on batteries or AC. Solid-state amplifier, built-in Sound-Column speaker system, dynamic microphone with volume control. Jacks for aux. input, extra mike, tape output, and aux. speaker output. Gray vinyl covered case. Folds to 16" W x 21" H x 7⁵/₈" D. Less battery.
 SS-331J. Shpg. wt. 25 lbs. 259.95

2 "Voice Director II" Sound System
 • *Combines the Power of a Built-In System with the Size and Weight of a Portable*
Model PVD-5060A. Covers audiences of 50-3000. Has a six-speaker sound column, new-design power amplifier with 15 watts continuous power output (EIA) and a frequency range of 200-10,000 Hz for maximum voice intelligibility. Has two low-impedance microphone inputs, aux. for phono or tape. 12V battery-operated—no wires or plugs. With mike, mike cable, stand. Single fitted case, 9¹/₄ x 32¹/₄ x 7¹/₄". Total weight—25 lbs.
 SP-092J. Shpg. wt. 28 lbs. 225.00

A Brute of A Speaker System
 • *Extra Power for Tough Jobs*
 • *Built Tough to "Take It"*
Model MSD-4060. Designed to project 60 watts of sound power with full frequency, 70-15,000 Hz., this system focuses six 8" speakers to cover the largest auditorium. Finished in rugged vinyl with metal corners, heavy duty handle. Vertical sound angle 30° for best coverage. Impedance 16 ohms. 10³/₄" W x 50¹/₂" H x 8¹/₄" D. Ready to go anywhere!
 SS-333J. Shpg. wt. 44 lbs. 116.60



3 6-Speaker, 30-Watt Column
 • *Perfect for Speeches, Sales Meetings*
 • *Clear, Crisp Reproduction*
Model SD-1064. Directs sound at proper audience height. Projects up to 150', 75' optimum. Response 200-10,000 Hz for best voice quality. Dispersion angle 120° hor., 30° vert. Impedance 16 ohms. Finished in walnut clear-guard vinyl, cane grille. 6¹/₂ x 30¹/₂ x 3¹/₂".
 SS-334J. Shpg. wt. 11 lbs. 47.50

4 10-Speaker, 50-Watt Column
 • *Adjustable for Difficult Installations*
 • *Licks Feedback, Even Covers Balconies*
Model SD-1100. Ten 5¹/₂" speakers are specially designed and balanced within the column to prevent high-frequency "beaming." Unique, variable-angle feature permits adjusting vertical sound angle. 200-10,000 Hz. Up to 300' coverage, 200' optimum. Walnut vinyl. 7 x 49¹/₄ x 6"—16 ohms.
 SS-231J. Shpg. wt. 27 lbs. 79.95

5 Full-Range, 60-Watt Column
 • *Ideal for Musical Theatre and Singers*
 • *True, Life-Like Reproduction*
Model MSD-1060. Full-range sound, 70-15,000 Hz., with 60 watts of power for finest voice and instrument amplification. Six special design 8" wide-range speakers project up to 350', 60 to 200' optimum. Dispersion angle: 120° hor., 30° vert. 16 ohm. Walnut vinyl. 10³/₄ x 50 x 8¹/₄".
 SS-232J. Shpg. wt. 50 lbs. 94.50

10-Watt "Mini-Column"
 • *It's New, It's Different*
 • *Works Where Others Won't*
Model MIN-1. Only 17" high! For voice or background music. Six 2¹/₂" speakers "focus" sound like full-size models. Outperform single-cone speakers in small areas. 200-3000 Hz. 10 watt cap. 8 ohms. 3¹/₂" W, 2³/₄" D.
 SS-237J. Wt. 3³/₄ lbs. . . 19.95



6 Outdoor Speaker System
 • *Ideal Speaker for Patio, Yard, Garden*
Model PAT-10. California Redwood Baffle, with moisture-resistant 8" speaker. 10 watts. Volume control. 8 ohm. 14 x 10¹/₂ x 3¹/₂".
 SS-235J. Shpg. wt. 5¹/₂ lbs. 17.95

7 Two-Way Corner Speaker
 • *Uses Room Walls to Extend Dispersion*
 • *Wood-Grain Vinyl for Lasting Beauty*
Model CS-1. 8" woofer & 3¹/₂" tweeter give broad response, Volume control. Walnut grain. Brown grille. 15 watt. 8 ohm. 12¹/₂ x 18 x 7".
 SS-344J. Shpg. wt. 6¹/₂ lbs. 22.95

8 10-Watt Extension Speaker
 • *Heavily-Grained Walnut Finish*
 • *Hangs As Easily As A Picture*
Model ESP-800. Full-range 8" dual-cone speaker 10 watt capacity. Volume control. 8 ohm. 20' hook-up wire. 12¹/₂ x 9¹/₂ x 4¹/₂".
 SS-236J. Shpg. wt. 4³/₄ lbs. 16.95

9 "Thinline" 8" Speaker
Model WB-108CS. Low volume type. 8 ohms. Wood-grain vinyl, cane grille. 9¹/₄ x 12¹/₄ x 4¹/₂".
 SS-342J. Shpg. wt. 4¹/₄ lbs. 9.35
Model WB-108CSV. Above, with volume control.
 SS-343J. Shpg. wt. 4¹/₂ lbs. 11.75

10 Dual-Cone 8" "Thinline"
Model WB-408CS. Wide response. 4.8-oz. magnet, 10-watt cap. 8 ohms. 9³/₄ x 12¹/₄ x 4¹/₂".
 SS-337J. Shpg. wt. 4¹/₂ lbs. 11.85
 SS-338J. Above, with volume control. 13.50
Model WB-408CSV. With vol. cont., 70-v. xformer.
 SS-339J. Shpg. wt. 5 lbs. 16.50

11 Dual-Voltage 8" "Trimline"
Model TL-7025ST. Has 8" speaker with 10-watt capacity and 25/70.7-volt transformer pre-wired to 7-tap terminals. 12¹/₂ x 9¹/₂ x 4¹/₂".
 SS-228J. Shpg. wt. 4³/₄ lbs. 17.25
 SS-341J. Above, with volume control. 18.30

Olson Cables, Cable Kits, Adapters, Plugs & Jacks

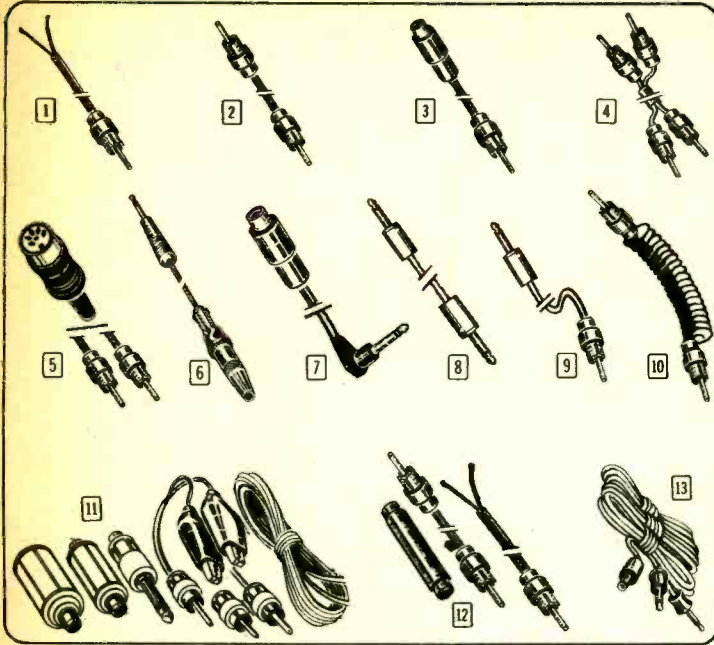

Audio Cables for Every Purpose

Av. shpg. wt. 1/4 lb.

Stock No.	Fig.	Description	Each	More Than One
HF-050J	1	Phono Pin Plug to Stripped, Tinned Ends. 3 Ft.	.79	4 for 2.60
HF-287J	1	RCA 90° Pin Plug to Tinned Ends. 42"—2 pcs.	.89	4 for 3.20
HF-288J	1	As Above but Pkg. of 4. (2) Red (2) Grey.	1.69	4 for 5.00
HF-049J	2	Phono Pin Plug on Each End of 5 Ft. Cable	.84	3 for 2.10
HF-064J	2	RCA 90° Phono Pin Plug Each End. 5 Ft.	1.29	4 for 5.00
HF-051J	3	Phono Pin Plug to Jack Extension. 5 Ft.	1.19	3 for 3.00
HF-166J	3	Dual Phono Cable. RCA Pin Plugs to Pin Jacks. 6 Ft.	1.69	2 for 3.00
HF-055J	4	Dual Phono Cable. Pin Plugs Each End. 6 Ft.	1.69	3 for 4.50
HF-169J	6	Adapter Cable. Mini-Plug (3.5mm) to 1/4" in-line Jack. 18"	1.49	4 for 5.00
HF-179J	8	Audio Cable. 2 Mini-Plugs (3.5mm). 6 Ft.	1.39	3 for 3.90
HF-206J	7	Audio Cable. 1/4" Standard Plug to RCA Phono Jack. 6 Ft.	1.05	3 for 3.00
HF-089J	9	Mini-Phone Plug and RCA Phono Plug. 12 Ft.	1.19	4 for 4.40
HF-060J	10	Retractable 36" Audio Cable. RCA-type Plugs. (Red Color.) HF-061J (Green); HF-063J (Gray)	1.39	4 for 5.00
HF-085J	10	Retractable 10 Ft. Audio Cord (Gray). HF-086J (Black). RCA-type Plugs.	2.69	2 for 5.00
HF-136J	5	DIN Patch Cable, 3-pin DIN to Dual RCA Plug. 6 Ft.	2.31	2 for 4.50
HF-135J	5	5-Pin DIN Plug to 4 RCA Phono Plugs. 6 Ft. Shielded	2.98	2 for 5.80
HF-219J	5	5-Pin DIN Jack to 5-Pin DIN Jack. 6 Ft. Shielded	2.98	2 for 5.80
HF-220J	5	5-Pin DIN Jack to 4 RCA Phono Plugs. 6 Ft. Shielded	2.98	2 for 5.80
HF-185J	5	5-Pin DIN to 4 Mini Plugs (3.5mm). 6 Ft. Shielded	1.29	2 for 2.40
HF-286J	5	3-Pin DIN Jack to 3-Pin DIN Plug. 6 Ft. Shielded	2.49	2 for 4.50
HF-285J	5	5-Pin DIN Jack to 5-Pin DIN Plug. 6 Ft. Shielded	2.98	2 for 5.80
HF-057J	2	Kit of 4-36" Audio Cables. Phono Pin Plugs Both Ends.	1.89	2 for 3.50
HF-087J	9	Kit of 2-12 Ft. Phono Cables. RCA Phono Plug to 1/4" 90° Plug	2.98	2 for 5.50
HF-011J	12	Audio Cable Kit. 3 Ft. & 6 Ft. Leads. Tinned, Stripped. Pin Plugs. 1 In-line Jack.	2.09	2 for 4.00
HF-143J	13	Universal Cable Kit. Includes 3-6 Ft. Cables. "Mini" Phone to Tinned Leads; inverted "Mini" Phone to Leads; "Micro" Phone to Leads.	1.69	4 for 6.00
HF-052J	11	Adapter Cable Kit. Includes Phono and Phono-type Plugs, Clips and Adapters.	4.29	2 for 8.00

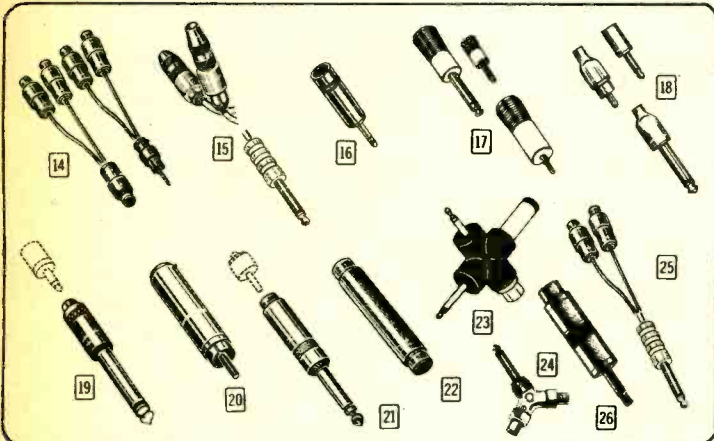

Adapters For All Audio Connections

Av. shpg. wt. 1/4 lb.

Stock No.	Fig.	Description	Each	More Than One
HF-069J	14	"Y" Adapter Kit. 1 with 3 Female Phono Connectors; Other has 2 Female. 1 Male. Length. 5 1/2"	1.69	4 for 6.00
HF-053J	14	Similar to HF-069J, above. 1 Male, 2 Female on Both. Kit of 2.	1.79	3 for 4.80
HF-116J	15	"Y" Adapter Kit. 2-1/4" Phone Jacks to 1-1/4" Phone Plug.	1.79	3 for 4.80
HF-129J	16	Adapter Plug. 1/4" Plug to "Mini" Phone Plug (3.5mm. tip) Kit of 2.	1.79	3 for 4.80
HF-142J	17	Adapter Plug Kit. 3 Types: 1/4" Phone Plug to "Micro" Plug; "Micro" to "Mini"; "Mini" to 1/4" Phone. Pkg. of 3.	1.98	4 for 7.00
HF-025J	18	Adapter Plug Kit. Phone to Phono; Phono to "Mini"; "Mini" to 1/4" Phone. Pkg. of 3.	1.89	4 for 7.00
XX-213J	18	Plug Adapter "Surprise" Kit. 12, Assorted	3.98	2 for 7.00
HF-099J	19	Micro Plug 1/4" Adapter. Pkg. of 2 "Tiny" Phone Plugs to 1/4" Standard Phone Plugs.	1.69	4 for 6.00
HF-008J	20	1/4" Phone Plugs to RCA-type Phone Plug.	1.59	4 for 6.00
HF-007J	21	Phono Plug Adapters. Kit of 3 converts RCA-type Phono Plug to Standard 1/4" Phone Plug. 1/2" dia. x 2 1/4"	1.79	4 for 6.00
HF-009J	22	Dual In-Line Phono Jacks. 1/2" x 1 1/2". Kit of 4.	1.69	4 for 6.00
HF-174J	23	4-in-1 Adapter Plug for 4 Most Popular Plugs. 3.5mm. "Mini" Plug, 2.5mm. "Micro" Plug, 2.5mm. Power Jack and Extra-Long 2.5mm Inverted Power Plug.	1.79	4 for 7.00
HF-275J	24	Y-Adapter. 1/4" Plug to 2 Phono Jacks	1.29	4 for 4.00
HF-279J	25	Flexible Y-Adapter. 1/4" Plug to 2 Phono Jacks	1.59	3 for 4.50
HF-276J	26	Mini 3.5mm to Phono Jack Adapter	1.29	2 for 2.50

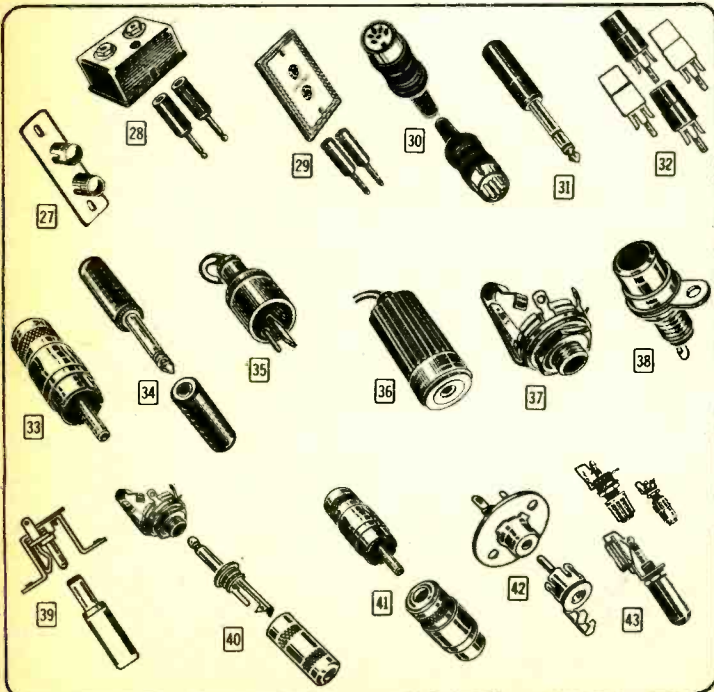

Plugs & Jacks for Every Audio Application

Av. shpg. wt. 1/4 lb.

Stock No.	Fig.	Description	Each	More Than One
HF-170J	27	Pushbutton Bakelite Terminal Strips. One Red. One Black. Pkg. of 2.	2.05	4 for 8.00
PL-152J	28	Junction Box with Two Closed-Circuit Jacks for Miniature Phone Plugs, and 2 Plugs.	1.49	4 for 5.00
HF-023J	29	Stereo Speaker Wall Jack. 2—1/4" Jacks on Standard Wall Plate. 2—1/4" Phone Plugs Included. Size 2 1/4" x 4 1/2"	2.29	3 for 6.00
HF-026J	30	DIN Audio Plugs. One Plug, One Jack per Pkg. Shielded Insulated. HF-026J (3-pin). HF-027J (5-pin).	1.69	4 for 6.00
XX-253J	31	Plugs for 1/4" Phone Jack. Pkg. of 4.	1.79	4 for 6.00
PL-146J	31	3-circuit 1/4" Plugs for Mikes and Stereo Headphones. Standard 1/4" barrel. Pkg. of 3.	2.98	4 for 10.00
HF-010J	31	Shielded 1/4" Phone Plug. Plated All-Metal Barrel. Screw Terminals. 1 1/4" x 1/2". Kit of 2.	1.50	4 for 5.12
HF-003J	32	Insulated, Color-Coded Phono Plugs. Pkg. of 5.	1.79	4 for 6.00
HF-021J	33	All Metal Phono Pin Plugs. 3/4" dia. x 1 1/4" L. Kit of 5.	1.89	4 for 7.00
HF-022J	34	Phone Plug Sets. Two Pairs Male and Female 1/4" Phone Plugs and Jacks.	1.69	4 for 6.00
HF-153J	35	DIN Speaker Plugs Used on European Tape Recorders and Radios. Has One Flat and One Round Pin. Pkg. of Two.	1.79	4 for 6.00
HF-168J	35	Same as HF-153J, Above. But Has One Plug, One In-Line Jack.	1.98	2 for 3.60
HF-154J	36	Standard 2-Circuit 1/4" In-Line Jacks. Pkg. of 2.	1.19	2 for 2.20
HF-155J	36	3-Circuit 1/4" In-Line Jacks. Pkg. of 3.	1.19	2 for 2.20
HF-006J	37	1/4" Phone Jacks. Open and Closed Circuit. Kit of 5.	1.79	4 for 6.00
HF-101J	37	Standard 3-Circuit 1/4" Phone Jacks. Pkg. of 3.	1.69	4 for 6.00
HF-005J	38	Plated Phono Pin Jacks. Mount In Single 1/4" Hole. 1/2" x 3/8". Kit of 6.	1.98	4 for 7.00
HF-077J	39	Mini-Power Plug and Jack. Inverted Contacts. 1" Long x 3/4" Dia. with 3/4" Dia. Barrel. Chassis Mtg. Jack has 1/4" Mtg. Centers. Pkg. of 2.	1.79	4 for 7.00
JJ-002J	40	3 Pairs Miniature. Shielded Phone Type Plugs, and Shorting Jacks.	1.59	4 for 6.00
HF-004J	41	Phono Pin Plugs and Jacks for Audio. 3 Pairs	1.98	4 for 7.00
HF-024J	42	RCA-type Phono Plugs and Jacks. Round Chassis Mtg. Jacks. Plugs Mount on End of Shielded Cable. 10 Pairs	1.69	4 for 5.00
JJ-001J	43	6 Pairs Assdtd. Miniature Phone Plugs & Jacks	1.49	4 for 6.00



All-American Quality Components

Switchcraft audio accessories offer top value, high reliability & dependability. This complete line of audio mixers, plugs, jacks, connectors, adapters and molded cable assemblies

semblies is backed by more than 25 years of experience in audio engineering and design. Choose these components for fine audio.

QUALITY MOLDED CABLE ASSEMBLIES

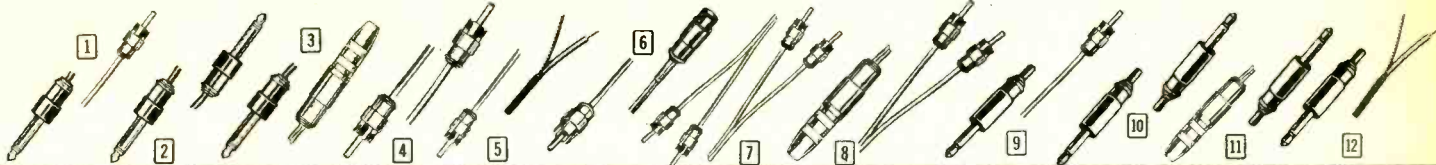

All connections soldered and/or crimped. Av. shpg. wt. 4 oz.

- 1 Straight Standard 1/4" Phone Plug to straight phono plug. Shielded cable. HF-222J. 6 feet 1.79
- 2 Straight Standard 1/4" Phone Plug at each end. Shielded cable. HF-223J. 10 feet 3.15
- 3 Straight 3-Cond. Phone Plug to 3-cond. "EXTENSION JAX." Shielded. HF-224J. 25 feet 7.81

- 4 Straight Phono Plug each end. HF-225J. 36 inches. Shielded 1.09
- 5 Straight Phono Plug to stripped tinned ends. Shielded cable. HF-228J. 36 inches88
- 6 Straight Phono Plug to phono "EXTENSION JAX." Shielded cable. HF-230J. 10 feet 1.82

- 7 Stereo Assembly. Two straight phono plugs on each end of shielded stereo cable. HF-231J. 36 inches 2.91
- 8 Standard 3-Cond. Extension Phone Jack to 2 phono plugs. Shielded stereo. HF-232J. 4 feet 3.36
- 9 Straight 2-Cond. "TINI-PLUG" (3/4" O.D. finger) to straight phono plug. HF-234J. 6 feet. Shielded cable .. 2.24

- 10 Straight 2-Cond. "TINI-PLUG" (3/4" O.D. finger) to straight 2-cond. "TINI-PLUG." Shielded. HF-235J. 6 feet 1.72
- 11 Straight 2-Cond. "TINI-PLUG" (3/4" O.D. finger) to 2-cond. phone "EXTENSION JAX." Shielded cable. HF-236J. 6 feet 2.45
- 12 Straight 2-Cond. "TINI-PLUG" (3/4" O.D. finger) to stripped, tinned ends. HF-237J. 6 feet. Shielded 1.79

QUALITY ADAPTERS Av. shpg. wt. 4 oz.

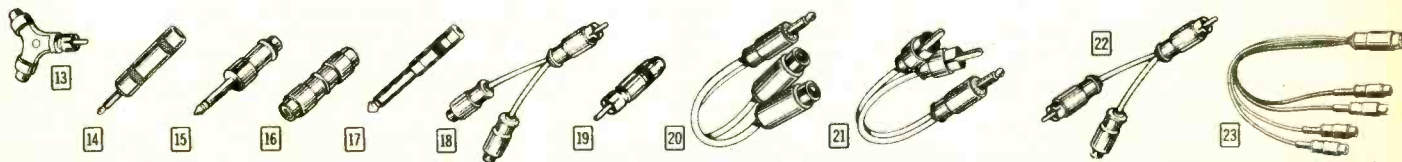

- 13 "Y-Adapter." Two phono jacks connected in parallel to standard phono plug. Shielded. HF-238J. 1.61
- 14 Standard Phone Jack input to a 2-cond. "TINI-PLUG" (3/4" dia.) plug. HF-239J. 1.58
- 15 Phone Plug input to standard 2-cond. phone plug output. Shielded. HF-240J. 1.19

- 16 Phono Plug Coupler. "EXTENSION JAX" input/output. Shielded. HF-241J. 1.02
- 17 2-Cond. "TINI-JAX" (3/4" I.D.) phone jack input to 1/4" 2-cond. output. HF-242J, Shielded 1.40
- 18 Flexible "Y" Connector. Phono plug connected in parallel to 2 phono jacks. 4" gray shielded cable. HF-243J. 1.88

- 19 2-Cond. "TINI-JAX" (3/4" I.D.) phone jack input to phono plug output. HF-244J. 1.40
- 20 "Y-Adapter," 6" long. Interconnects 2-cond "TINI-PLUG" phone plug (3/4" dia. finger) with 2 phono jacks. HF-245J. Shielded. 1.75
- 21 "Y-Adapter," 6" long. "TINI-PLUG" phone. (3/4" dia. finger) to 2 phono. HF-246J. 1.75

- 22 Phono Plug connected in parallel to 1 phono plug and 1 phono jack, 4" long cable. Shielded. HF-247J. 1.86
- 23 Stereo Adapter Cable. DIN1 plug to 4" phono "EXTENSION JAX." 1" Shielded. HF-248J. 4.97
- 24 2-Cond. "TINI-JAX" input (3/4" I.D.) to "TINI JAX" output. HF-249J. 1.58

Big Selection of Plugs, Jacks & Connectors Av. shpg. wt. 4 oz.

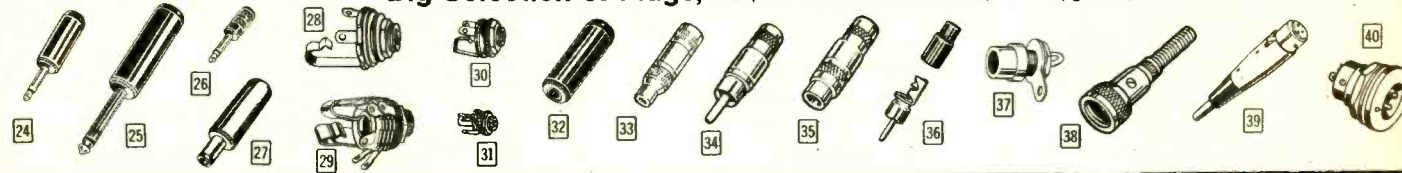

- ### PLUGS
- 24 "TINI-PLUG" miniature phone plug. 3/4" dia. finger. 1 1/4" long handle. Mates with "TINI-JAX" phone jack. HF-250J. 2-cond., screw term. 2 for 1.44
 - 25 "LITTEL-PLUG" phone plug fits standard 1/4" phone jacks. Black Handles. Mates with "LITTEL-JAX." HF-251J. 2-cond., screw term. 2 for 1.51
 - 26 "MICRO-PLUG" subminiature phone plug, 1 1/4" long. .097" dia. finger. For "MICRO-JAX." Screw-on handle. HF-253J. 2-cond., solder term. 2 for 1.33
 - 27 "POWER-PLUG" 2-cond. battery charger plug. For transistorized portable radios, etc., which feature AC adapters. HF-254J. 1.51

- ### JACKS
- 28 "LITTEL-JAX" phone jacks mate with 1/4" phone plug. Mount in 3/8" hole, panels up to 3/32" thick. HF-255J. 2-cond., open circuit 2 for .88
 - 29 STEREO "LITTEL-JAX" phone jack. Switches out speakers when connecting stereo headphones. Accepts std. 1/4" 3-cond. phone plug. 3-cond., dual closed circuit. HF-257J. 2 for 1.82
 - 30 "TINI-JAX" miniature phone jack. Mate with "TINI-PLUG" and all miniature phone plugs with 3/4" dia. finger. HF-258J. 2-cond., open circuit. 2 for .88
 - 31 "MICRO-JAX" subminiature phone jack. Mates with "MICRO-PLUG" or phone plugs with .097" dia. finger. HF-260J. 2-cond., closed cir. 2 for 1.02

- 32 "EXTENSION JAX" for std. 1/4" phone plugs. Screw-on handle. HF-261J. 3-cond., screw term. .. 1.44
- 33 "TINI-EXTENSION JAX" mates with "TINI-PLUG" and miniature plugs with 3/4" dia. finger. 2-cond., solder term., shielded handle. HF-262J. 1.16
- 34 Phono Plug with shielded screw-on handle, cable clamp. HF-263J. 2-cond. 2 for .88
- 35 Phono "EXTENSION JAX," shielded, screw-on handle, cable clamp. HF-264J. 2-cond. 2 for 1.09
- 36 Phono Plugs with snap-on handles. cable clamp. Red, black and white. HF-265J. 2-cond. 4 for .81
- 37 Phono Chassis Jack for front panel mount in 1/4" hole. HF-266J. 2 for .67

- ### CONNECTORS
- 38 Standard Female Microphone Connector with 3/8" -27 thread. Use with single conductor cable with 3/32" max. O.D. Converts to male type. HF-267J. Female connector67
 - 39 Professional "Q-G" Audio Connectors with exclusive "Ground Terminal." Mate with connectors with similar contacts — Canon, Amphenol, Qwiks, etc. Die-cast zinc body, satin nickel finish. HF-268J. Female Plug, 3 Contacts 1.82
 - HF-269J. Male Plug, 3 Pins 1.58
 - HF-272J. Female Conn., 3 Contacts 3.85
 - HF-273J. Male Conn., 3 Pins. 3.57
 - 40 Audio Receptacle, Panel or Chassis Mount. Supplied with 1 1/4"-18 UNEF spanner nut. Mounts in 1 1/4" dia. hole, panels to 3/16" thick. HF-270J. female conn., 3 contacts. 3.50
 - HF-271J. male connector, 3 pins. 2.10

Sound Control Center

Model 641. For stereo sound distribution in home, school, business. Controls 8 stereo speakers (or mono pairs) with individual pushbuttons. DC to 30 kHz, 100 watts. "Glo-Button" selector needs NO external power. HF-291J. Shpg. wt. 6 lbs. 72.60

Stereo Speaker Selector

Model 645. Permits simultaneous use of up to 6 stereo speakers. Frequency response: DC to 30 kHz, low loss. Power handling: 100 watts max. per channel in 4-ohm load. Plug-in connections, compact cabinet. HF-274J. Shpg. wt. 6 lbs. 29.44



72⁶⁰

29⁴⁴



Olson 71

Olson Intercoms For Communication At Its Best

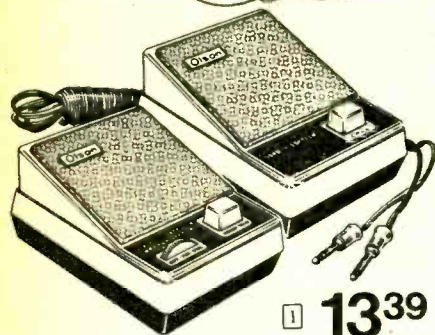

1 Our Low-Cost 2-Station Intercom

Economical to buy—economical to operate—and ready to use! Complete system includes one Master and one Remote, plus 60 ft. of interconnecting cable. Dependable solid-state circuitry, battery powered. Makes an ideal time and step-saver at the office—it's great for room-to-room communication at home, in your workshop-to-house talk, or between camper and vehicle cab when on the road. Each unit, 3 x 1 3/4 x 4". Uses one 9-volt battery.

AM-252J. Shpg. wt. 2 lbs. 13.39
 9-Volt Battery Eliminator/Charger
 BA-106J. Shpg. wt. 1 lb. 4.20

1 13.39

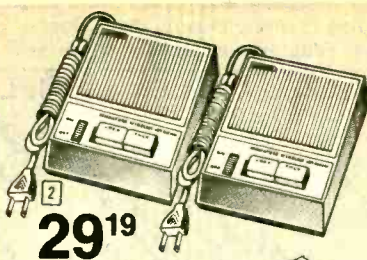

2 29.19

2 Wireless 2-Station Intercom

Just plug each station into the nearest AC wall outlet and your house wiring carries the signal. No cable installation! Solid-state for low power drain. Lock-button for long dictation, monitoring, built-in indicator light. 3 3/8 x 1 3/4 x 5 1/2". 117 VAC.

AM-381J. Shpg. wt. 4 lbs. 29.19

3 Door-/Chime Intercom

Low cost security in the home! Screen visitors before they enter your home. Door chime rings even when power is OFF. Complete 3-piece system. Easy to install. Chime, 3 3/4 x 5 7/8 x 2". Master, 2 1/2 x 1 1/2 x 4 1/2". Remote, 3 3/8". Req. 4 "C" cells below.

AM-401J. Shpg. wt. 5 lbs. 29.98
 BA-190J. Batteries for above 1/4 lb. Ea. 16¢

3 29.98

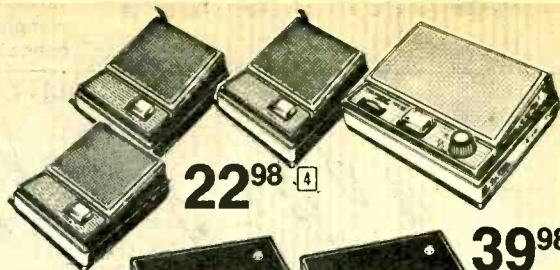

4 22.98

4 4-Station Solid-State Intercom

Step-saving system includes one Master and three Remote stations. Master has On/Off Volume control, 4-way selector switch with "standby" position. 60 ft. cable, 9-volt battery. Master, 4 1/2 x 3 1/2". Remotes, 2 x 4".

AM-308J. Shpg. wt. 3 lbs. 22.98
 BA-106J. AC Power Supply. 1 lb. 4.20

5 2-Station Wireless Intercom

Talk or monitor from kitchen-to-garage, room-to-room, anywhere on the same AC power line. Solid state—very low power drain. Each station has thumbwheel volume control, push-to-talk button, lock button for continuous conversation or monitoring. Each 5 1/2 x 1 1/2 x 5". 117 VAC.

AM-366J. Shpg. wt. 5 lbs. 39.98

5 39.98

For Communication in the Open Or In Private



48.95

Select-Talk All-Master Telephone System

Model ST-10. Advanced telephone-type Master with 10 station capacity for simultaneous conversations, tone calling, master to remote or full intermix, more. 2 wires plus 1 wire for each unit in system required. 12 wires for complete 10 masters.

AM-488J. 4 lbs. Each Station 48.95
 AM-489J. PS-CST Power Supply 5 lbs. 27.00
 AM-490J. Paging Relay 1 lb. 27.00
 WR-152J. 100', 12 Cond. Wire 5 lbs. 17.25

Fanon Power Megaphones—Speak-Up For Themselves!

Low As
38.95

• Sound Reinforcement for Every Purpose—On Land Or Sea



These solid-state units convert a whisper to a roar! They're ideal for either business or social purposes also—construction work, parking lot supervision, company picnics, major sporting events, hiking, boating, you name it! Features include built-in microphone, carrying strap, flared horn for full sound projection, and a "trigger" talk switch. Models MV-3 and MV-4S have noise-cancelling mikes that reject all background noise—just the thing for large audiences and big noisy events. Models MV-4S thru MV-20S have a built-in "Siren Alarm" for emergency use. All are weatherproofed. Model MV-20S has detachable mike. Less batteries. Av. shpg. wt. 5 lbs.

Stock No.	Model No.	Watts	Range	Size	Req. Batts.	Each
AM-451J.	MV-3	3	200 yds.	9 x 13"	4-"D" cells	38.95
AM-452J.	MV-4S	6	300 yds.	7 1/4 x 13"	4-"D" cells	57.95
AM-453J.	MV-8S	10	600 yds.	7 x 13"	6-"C" cells	76.95
AM-454J.	MV-16S	16	800 yds.	9 x 14"	8-"C" cells	87.95
AM-455J.	MV-20S	20	1000 yds	9 x 15"	8-"C" cells	105.95

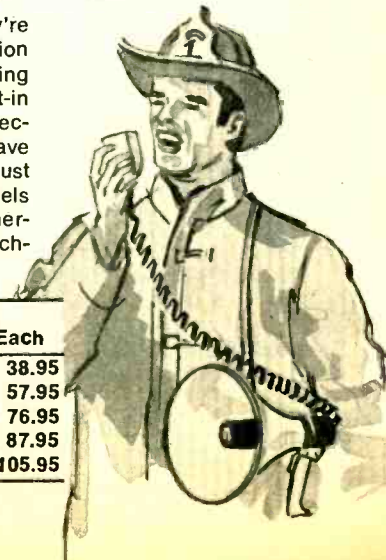

High-Reliability Solid-State Intercoms from



These solid-state intercom systems are a practical investment in convenience, time and step-saving efficiency. They put electronics to work for you throughout your home, office, shop or business. Systems below are designed for

easy setup and easy expansion—they are all solid-state featuring powerful audio output with durable construction and handsome styling.

24⁹⁵



Up to 3 Stations



38⁵⁰



Add Stations As Needed



39⁹⁵



Up to 5 Stations



High-Output 2-Station Intercom

Model IN-302. Basic top-performing system at a really low price. Features integrated circuit design for high output and outstanding sensitivity. Master station can call up to two remote stations, remote stations can signal Master even with system "off." Master has lock button for continuous conversation or dictation, volume control. Remote has press-to-talk bar. Accepts one additional station. Up to 250 feet total range between stations. "Plug-in" cable connections. With Master, Remote 50-ft. cable. Ivory/brown, each 7 x 3½ x 2". For 117 VAC. **AM-392J.** Shpg. wt. 3¼ lbs. 24.95
AM-412J. Extra Station. 1¼ lbs. 10.50
AM-442J. Outdoor Station. 1¼ lbs. 10.50
WW-578J. 100' Cable for Above. 2 lbs. 4.65

2-Channel Wireless Intercom

Model IN-505. Talk between rooms, upstairs to downstairs, even between buildings on the same AC line. No wires to connect—simply plug in each unit and you're ready to talk. 2-channel operation is ideal for monitoring uses—listen to baby's room on one channel, switch over to the other channel for ordinary conversation. Has special filter to screen out background line noise, on/off volume control, talk/listen switch with lock for continuous monitoring or dictation, channel selector switch. System includes two stations, you can add extras as needed. Each station ivory/brown with wood-grain accents. 7 x 3½ x 2". For 117 VAC. **AM-413J.** Shpg. wt. 3¼ lbs. 38.50
AM-414J. Extra Station. IN-500. 2 lbs. 20.80

3-Station Intercom System

Model IN-404. Low-cost, easy-to-install 3-station system consists of Master Station that can call either of two remotes (included). Up to two additional indoor or outdoor remotes can be added to expand the system. Remotes have "Beep call" signal to contact Master even with system "off." Features solid-state circuit with IC's for high power and sensitivity. Master unit has 4 Remote pushbuttons, volume control with lock. Up to 250 ft. range between Master and each remote. Includes 50-ft. connecting cable. Each unit ivory/brown with wood-grain accents. 7 x 3½ x 2". For 117 VAC. **AM-458J.** Shpg. wt. 4¼ lbs. 39.95
AM-412J. Extra Station. 1¼ lbs. 10.50
AM-442J. Outdoor Station. 1¼ lbs. 10.50

"Director Series" Master/ Master or Master/Remote Intercom System

Director 7. The intercom to use for professional installations in doctor's offices, clinics, larger homes, anywhere complete versatility and reliability are demanded. When used as an all Master system, up to 7 "Director 7" intercom units can be connected to selectively communicate with any or all other units—up to three *separate and simultaneous* conversations can be held. Master-to-Remote systems lets "Director 7" unit selectively speak with up to six Remotes. (Remotes cannot speak with each other). Masters have volume control, talk/listen switch with lock, U. L. listed 117 VAC power supply. Remotes operate "hands free", feature privacy switch to "Block out" other stations in system. Requires wire with one more conductor than total number of stations. Master unit, 9½ x 6¾ x 3½".

AM-446J. Shpg. wt. 3 lbs. Each 41.50
AM-448J. Dir. 1 Remote. 2 lbs. Each 11.95

Really Versatile!

41⁵⁰

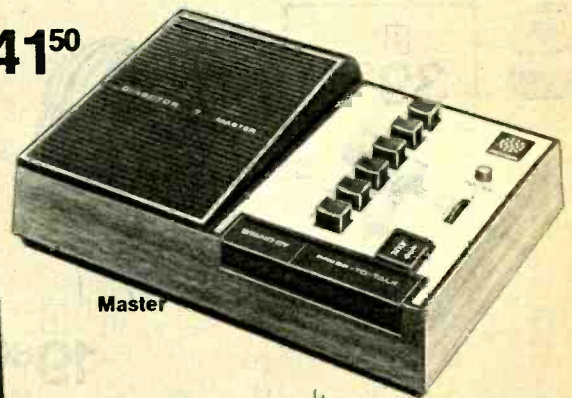

Master

11⁹⁵



Remote



TELEDYNE Quality Microphones for Every Purpose

Enjoy "Freedom of Choice" with the Teledyne microphone line. Pick the exact mike you need to solve your sound reinforcement problems. All feature extended frequency response, peak-free curves, good signal-to-noise ratio, isolation from shock, and uniform pickup patterns. Prices are so reasonable you can use the specific instrument you need for each type pickup.

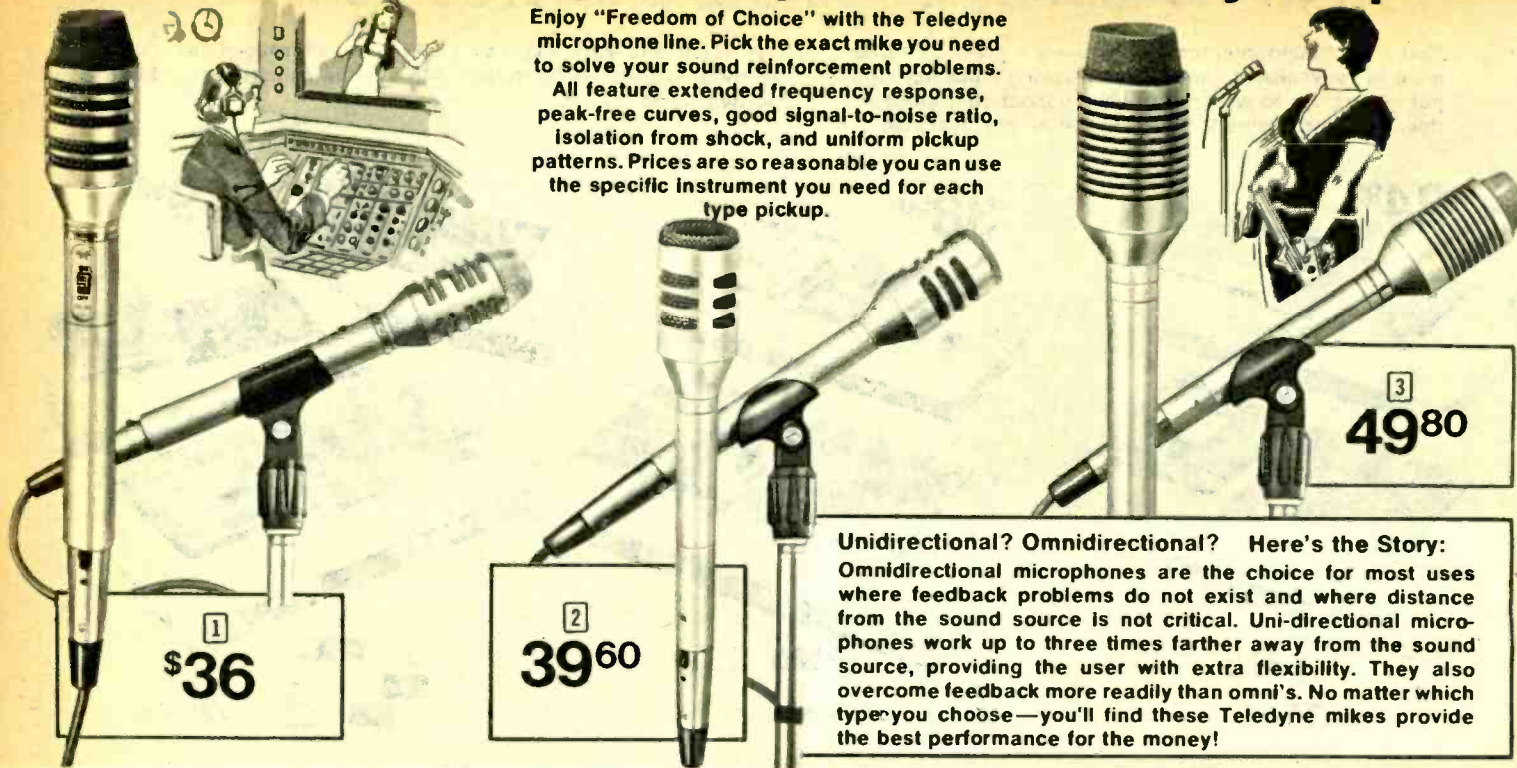

1
\$36

2
39⁶⁰

3
49⁸⁰

Unidirectional? Omnidirectional? Here's the Story:
Omnidirectional microphones are the choice for most uses where feedback problems do not exist and where distance from the sound source is not critical. Uni-directional microphones work up to three times farther away from the sound source, providing the user with extra flexibility. They also overcome feedback more readily than omni's. No matter which type you choose—you'll find these Teledyne mikes provide the best performance for the money!

Teledyne Electret Condenser and Dynamic Unidirectional Microphones

- 1 **Model EC-100.** A hand or stand mounted electret condenser mike for general-purpose use where the advantages of a directional mike are needed. Has FET preamp and battery supply in instrument barrel on-off switch, professional-type XL connector. EC-100J. Shpg. wt. 1 lb. **36.00**
- 2 **Model EC-340.** The logical step-up where professional-level performance is required. Offers enhanced frequency response, high S/N ratio. Has FET preamp, battery storage chamber in instrument, non-reflective gold anodized finish, XL connector. EC-340J. Shpg. wt. 1 lb. **39.60**
- 2 **Model MC-056.** Similar in appearance and construction to the EC-340, but employs a dynamic-type generating element. Does not require a power supply. Extremely rugged, combines robust handling capabilities with excellent audio performance. On-off switch. MK-056J. Shpg. wt. 2 lbs. **39.60**

- 3 **Model MC-057.** Our best unidirectional! Features dynamic element, special acoustic filter grille that protects diaphragm and minimizes pops and hisses. Non-reflective gold anodized finish, on-off switch. Offers professional performance characteristics at a cost no higher than most general-purpose mikes. Close manufacturing tolerances insure all units deliver matched performance. MK-057J. Shpg. wt. 2 lbs. **49.80**

Comparative Specifications	EC-100	EC-340	MC-056	MC-057
Frequency Response in Hz	65-15k	55-16k	80-16k	70-16k
Output Impedance in Ohms*	600	600	600	600
Output Level in dB	-50	-50	-55	-55
Battery Type	"AA"	"AA"	—	—
Battery Life in Hours (Continuous)	600	600	—	—
Diameter x Length in Inches	1½x8¼	1½x8¼	1½x8¼	1½x8¼
Weight in Ounces	6	6	10	10
Cable Length in Feet	18	18	18	18

*Can be used with most medium and high Z inputs also-Dynamic requires MK-060J matching transformer.

Teledyne Omnidirectional Microphones

- 4 **Model EO-200.** Our best omnidirectional! Has electret condenser element, integral low-noise FET preamp, wind and pop filter, excellent shock isolation, non-glare, gold anodized finish, XL connector. Balanced for hand or stand use. Built-in on-off switch. EO-200J. Shpg. wt. 1 lb. **39.60**
- 5 **Model EO-350.** Popular tulip-shaped microphone has electret condenser element, FET preamp and battery supply in barrel. Built-in on-off switch, XL connector. Excellent for hand-held use. EO-350J. Shpg. wt. 1 lb. **30.00**
- Model MK-055. As above, extremely rugged dynamic element. MK-055J. Shpg. wt. 2 lbs. **34.80**
- 6 **Model EO-330.** Our lowest-priced electret condenser microphone. Perfect for those who want condenser characteristics with a minimum investment. On-off switch. For hand or stand use. EO-330J. Shpg. wt. 1 lb. **19.80**

Comparative Specifications	EO-200	EO-350	MK-055	EO-330
Frequency Response in Hz	60-15k	50-15k	70-14k	80-12k
Output Impedance in Ohms*	600	600	600	600
Output Level in dB	-59	-50	-55	-50
Battery Type	"AA"	"AA"	—	"AA"
Battery Life in Hours (Continuous)	600	600	—	600
Diameter x Length in Inches	1¾x8¼	1¾x7	1¾x6¾	¾x7½
Weight in Ounces	6	6	10	6
Cable Length in Feet	18	18	18	18

*Can be used with most medium and high-Z inputs also. Dynamic requires MK-060J matching transformer.

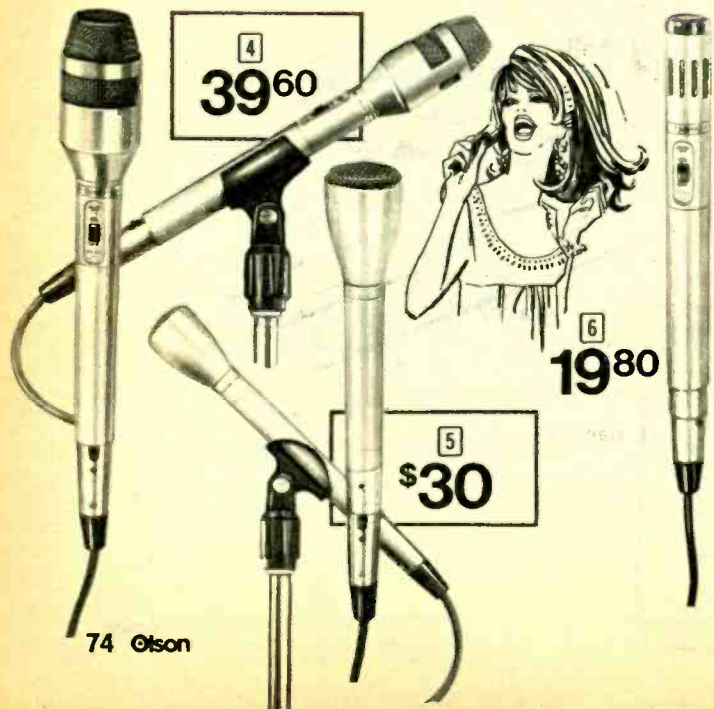

4
39⁶⁰

6
19⁸⁰

5
\$30

World's Smallest Electret Condenser Microphone

The ultimate solution to the search for an unobtrusive microphone to be used by individuals for voice reinforcement. Response and performance characteristics fully equal to large instruments.

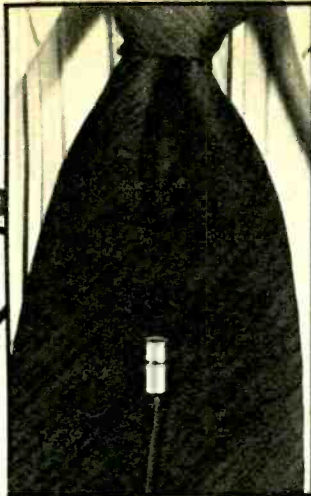

59⁴⁰

NEW!



Model EO-360. 1/4" diameter, 9/16" long — the state-of-the-art electret condenser microphone! The secret of its low-mass is a separate "wearable" case which houses the low-noise FET preamp and mercury battery and is connected to the instrument with a featherweight, thin diameter cable that minimizes mechanical noise. Mike cable has standard phone plug. 70-13,000 Hz response, -70 dB output, 600 ohms impedance. EO-360J. Shpg. wt. 1 lb. 59.40

Electret Condenser Mike with Tie-Clasp Lavalier

\$24

Model EO-300. A microphone you wear like a tie-clasp, but it still gives you pickup features permitting matching with full-size instruments. 70-13,000 Hz response, -55 dB output level. Includes mercury battery in the plug, ultra-thin cord to eliminate mechanical noise.

EO-300J. Shpg. wt. 1 lb. 24.00

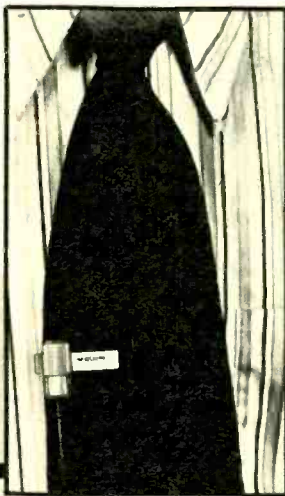

Weights Just 1 oz.
- Has FET Preamp
and Battery Supply
in Plug

NEW! Desk Stand Electret Condenser Microphone with Remote Circuit Control

39⁶⁰

Model EO-310. Omnidirectional, permanently polarized electret condenser mike for desk-top use. Has 1/8" diameter wand, FET preamp and battery supply in base. On-off and PTT switch. 50-13,000 Hz response, -66 dB output. Over 44 dB S/N. Battery life in excess of 600 hours continuous use. EO-310J. Shpg. wt. 1 lb. 39.60

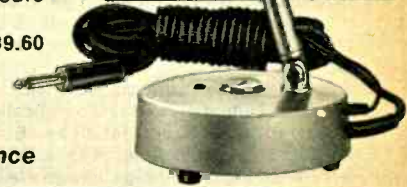

- Swivel-Action - Position Unit for Maximum Convenience

New! Headband Boom Microphone for Hands-Free Applications

49⁸⁰

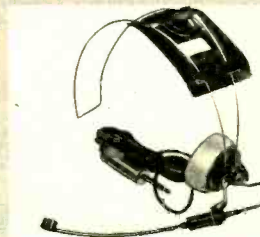

- Omnidirectional Pickup Pattern
- Positioned For Maximum Voice Clarity

Model EO-320. Features electret condenser element, ruggedly mounted boom with good spatial control in two planes for proper positioning. Keeps the user "on mike" at all times. Omnidirectional pickup pattern with response optimized for best voice frequency intelligibility. For studio, intercom uses. 90-7,000 Hz. -60 dB output. Battery housed in plug. 44 dB S/N ratio. EO-320J. Shpg. wt. 2 lbs. 49.80

NEW! Guitar Instrument Mike with Electret Condenser Element

- Ideal for "Natural" Amplified Sound

Model EO-370. One of the first musical pickup mikes to use the electret condenser principle! Designed for simple mounting, it features high level output and excellent signal-to-noise ratio. FET preamp and power supply are built into the plug. 20-15,000 Hz response, -50 dB output, 44 dB S/N. EO-370J. Shpg. wt. 1 lb. 49.80

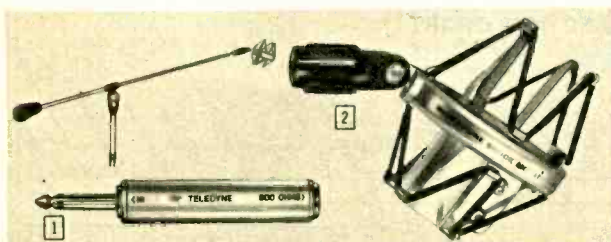

1 Impedance Matching Transformer. Model MA-060. Permits use of low impedance microphones with high-Z inputs. For condenser and dynamic types. Normally not required for condenser types. MK-060J. Shpg. wt. 1 lb. 9.60

2 Shock Mount. Model MA-034. For stand or boom. Use with Teletype mikes, any mikes with barrel diameter of under 13/16". MK-034J. Shpg. wt. 2 lbs. 15.00

Electret Condenser Microphone Batteries

Mercury type for Models EO-360, EO-300, EO-320.
BA-224J. Shpg. wt. 4 oz. Each 60c
Silver Oxide type for Models EO-310, EO-340, EO-350.
BA-237J. Shpg. wt. 4 oz. Each 80c
"AA" cell for Models EC-100, EO-200, EO-330, EO-370.
BA-196J. Shpg. wt. 1/2 lb. Pair 1.08

Electro-Voice Broadcast, PA & Recording Mikes



"Pro-Quality"

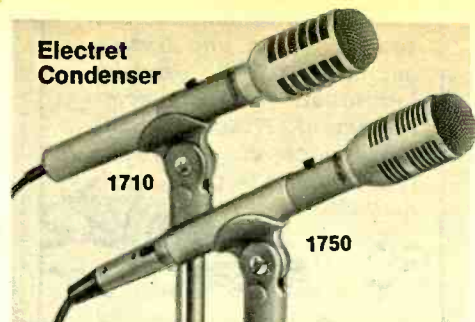

Model 635A. Widely accepted performer's omnidirectional mike for hand or stand use. Four-stage pop & blast filter eliminates need for external windscreen. Stable dynamic element. Smooth, shaped response, 80-13,000 Hz. Low impedance. Output: -55 dB. Magnetically shielded diaphragm, turned-steel case. Built-in XL-connector, stand coupler with a 1/8"-27 thread. Non-reflecting fawn-beige micomatte finish. 18' two-conductor shielded cable. 6" x 1 1/4" dia. **MK-026J.** Shpg. wt. 1 lb. **56.70**

Model RE10. Variable-D assures symmetrical cardioid pattern at all frequencies—prevents "close-up bass boost." Dynamic element, built-in blast filter. 80-13,000 Hz response. Lo-Z im-

pedance. Output: -55 dB. Micomatte finish. 18' 2-conductor shielded cable, stand adapter, metal carry case included. 6 3/4" x 1 1/4" dia. **MK-027J.** Shpg. wt. 1 lb. **99.60**

Model RE11. Dynamic cardioid mike with integral blast filter to shield against wind & "pops." 90-13,000 Hz response. Lo-Z impedance. Output: -55 dB. With 18' cable, stand adapter, carry case. Micomatte finish 7 3/4" x 1 3/4" dia. **MK-028J.** Shpg. wt. 1 lb. **106.50**

Model RE15. Provides maximum rejection of unwanted off-axis noise. 80-15,000 Hz. 150 ohms. -56 dB. Bass-tilt switch, 18' cable, metal case, stand adapter. 6 1/2" x 1 3/8" dia. **MK-025J.** Shpg. wt. 1 lb. **169.80**

Model 1710. Combines a condenser generating element with the ruggedness of a dynamic mike. Omnidirectional for all uses. Built-in blast filter eliminates "popping." 80-13,000 Hz response. Hi-low impedance. Output: -50 dB. With on-off switch. 18' cable, stand adapter, aluminum case. Req. 1 "AA" battery. 8 1/4" x 7/8" dia. **MK-001J.** Shpg. wt. 1 lb. **39.75**

Model 1750. Single-D cardioid condenser mike for serious home recording, high quality PA. On-off switch, blast filter, hi or low impedance. -43 dB output. Response 80-13,000 Hz. Aluminum case. With stand adapter clamp, integral 18' cable. Req. "AA" battery. 8 1/4" x 7/8" dia. **MK-066J.** Shpg. wt. 1 lb. **45.00**

General-Purpose



Model 664. Has "Variable D" feature for quality tape recording, communications, PA. Blast filter minimizes wind effect. 60-15,000 Hz. Dual impedance. Output: -58 dB. On-off switch. With 15' cable, 3/8"-27 thread. Chrome finish. 7 1/4" L x 1 1/4" dia. **MK-020J.** Shpg. wt. 3 lbs. **57.00**

Model 671. "Ball-type" "Single D" cardioid emphasizes low frequencies when used close up. Satin chrome. On/off switch with lock for "on" position. Professional style cable, mike-end connector, and stand clamp. Response: 60-14,000 Hz. Output: -61 dB. Hi or Lo impedance. **MK-067J.** Shpg. wt. 2 lbs. **54.75**

Model 660. Dynamic super cardioid for applications requiring a sharply controlled directional pattern. Continuously Variable D*. Shock resistant. Satin chrome finish. 15' cable, mike-end connector and stand clamp. Dual, selectable Hi or Lo impedance. Response: 90-13,000 Hz. Output: -56 dB. **MK-068J.** Shpg. wt. 3 lbs. **60.00**

Model 670. "Single D" cardioid. Use on a stand or hand hold. Pop filter. Top Brass finish. On/off switch. Professional style cable, mike-end connector, and stand clamp. Response: 60-14,000 Hz. Output: -61 dB. Hi or Lo impedance. **MK-074J.** Shpg. wt. 3 lbs. **45.90**

Model 626A. Single-D hand-or-stand mike. Built-in "pop" & dust filter. With on-off switch, stand adapter, 15' cable. Dual impedance. Response: 70-12,000 Hz. Output: -58 dB. 6 3/4" x 1 1/4" dia. **MK-022J.** Shpg. wt. 3 lbs. **31.50**

Model 631A. Dynamic, omnidirectional. Hand or stand. Magnetic on/off switch. Satin chrome finish. Professional style cable, mike-end connector and stand clamp. Response: 80-13,000 Hz. Output: -55 dB. **MK-069J.** High-Impedance. Wt. 2 lbs. **38.70**
MK-070J. Low-Impedance. Wt. 2 lbs. **38.70**

ACCESSORIES

Model 502C Matching Transformer. Allows Lo-Z microphone to be used into Hi-Z amp input. XLR-type female input and MC1M-type output for inline use. Includes cable connectors. **MK-071J.** Shpg. wt. 2 lbs. **13.20**

Model 502CP. Same as 502C with phone plug output. **MK-072J.** Shpg. wt. 2 lbs. **14.40**

Model 351 Windscreen for 670 and 1700 series mikes. Cuts down on voice-popping or pickup of wind noise outdoors. **MK-073J.** Shpg. wt. 1/2 lb. **4.50**

MICROPHONE SELECTION CHART

MODEL	APPLICATIONS				Sound Reinforcement	Communications	Dynamic Generating Element	Electret Condenser	Cardioid Pickup Pattern	Single-D Cardioid	Variable-D Cardioid	Omnidirectional Pickup Pattern	Dual-Z	Lo-Z Only	On-Off Switch	Separate Cable	Each
	Professional Recording	Home Recording	Broadcast	Stage Performer													
635A	X		X	X		X						X		X		X	56.70
RE10	X		X		X	X		X		X				X		X	99.60
RE11	X		X	X	X	X		X		X				X		X	106.50
RE15	X		X		X	X		X		X				X		X	169.80
664		X			X	X		X		X			X		X	X	57.00
660		X			X	X		X		X			X			X	60.00
671				X	X	X		X	X				X		X	X	54.75
670				X	X	X		X	X				X			X	45.90
626A				X	X	X		X	X				X		X		31.50
631A		X		X		X						X		X	X		38.70
1710		X					X					X		Hi/Lo	X		39.75
1750		X					X	X	X					Hi/Lo	X	X	45.00

Mikes and Accessories at Low Olson Prices



1
4⁹⁸
With Stand

1 **Dynamic Pencil-Type Mike.** Omnidirectional mike with stand for use with most portable tape recorders. On-off switch for remote control, 5' cord and plug. High impedance. 6" x 3/4" dia. MK-041J. Shpg. wt. 1 lb. 4.98



2 low as
24⁹⁸



2 **Complete Stereo Mike Set.** Cardioid Dynamic for recording, PA uses and combos. Has on-off switch, 10,000 ohms impedance. Matched pair complete with desk stands and carrying case. 100-11,000 Hz response. 5 1/2" x 1 1/2" dia. 5' cord, 1/4" plug. MK-063J. Shpg. wt. 1 lb. 24.98



4
15⁹⁵

3 **Complete Stereo Mike Set.** Two dynamic cardioid mikes, each with 10' cable, 1/4" plug, stand with adapter, built-in wind screen, more. On-off switch, dual 600 and 50,000 ohms impedance. 5 1/2" x 1 1/2" dia. Less carrying case. Response 100-12,000 Hz. MM-333J. Shpg. wt. 4 1/2 lbs. 29.98

4 **Tulip-Type Dynamic Mike.** Has on-off switch, 50,000 ohms impedance, 20-ft. shielded cable with 1/4" plug, -60 dB output. 100-10,000 Hz. Clamp-on holder with 3/8"-27 thread. MK-035J. Shpg. wt. 3 lbs. 15.95

For Versatile PA Setups

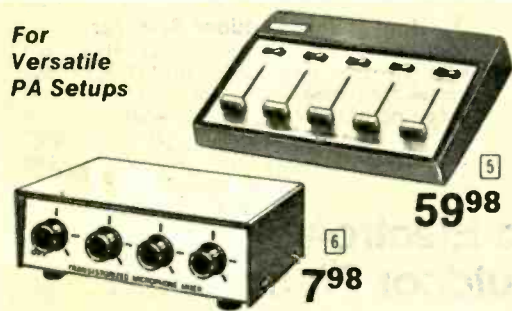

5
59⁹⁸

6
7⁹⁸

5 **6-Input Mixer/Preamp.** Has 4 inputs for mikes, 2 for mag. phono—adds versatility to ANY PA amplifier. Slide-level controls. Uses two 9-volt batteries. 9 1/4" x 1 3/4" x 7". MM-335J. Shpg. wt. 5 lbs. 59.98

6 **4-Input Mike Mixer.** Mixes up to four audio signals and feeds them to a single high-impedance input. 6 x 2 1/4 x 3 1/2". RA-345J. Shpg. wt. 2 lbs. 7.98
BA-192J. Battery. For Either Above. . . 29c



7
18⁹⁸

These unidirectional mikes are ideal for recording and PA situations where extra flexibility is required. They work up to 3 times farther away from the sound source than omnidirectional types.

7 **General-Purpose Cardioid.** Has 50k and 600-ohm impedance, stand adapter, netted ball screen, on-off switch. 100-12,000 Hz. -54 dB (Hi-Z), -73 dB (Lo-Z). 6 1/2" x 1 3/4" dia. MM-301J. Shpg. wt. 3 lbs. 18.98



19⁹⁸

8 **Deluxe Cardioid Mike.** Anti-feedback design, 50k and 600-ohm impedance, 20' cable, 1/4" plug. 60-14,000 Hz, -58 dB output. 7 1/2" x 1 3/8" dia. Chrome finish. MM-308J. Shpg. wt. 3 lbs. 19.98

9 **Our Best Dynamic Mike.** Dual impedance, breath filter, on-off switch, removable stand adapter. 55-14,000 Hz, -56 dB output. 7 1/2" x 1 7/8" dia. 20' cable, plug. 600 & 50k ohm. MM-327J. Shpg. wt. 3 lbs. 22.98



UNI-DIRECTIONAL

9
22⁹⁸



Useful Accessories

10 **31" Baby Boom.** Converts floor stand. 3/8"-27 thread. MM-290J. 3 1/2 lbs. 6.92

11 **Mike Stand Adapter.** For 3/4" dia. mikes. 3/8"-27 thread. 4 oz. MK-039J. 2/1.60. Each 89c
MK-040J. 1 5/16" dia. Each 1.29

12 **Snap-On Stand Adapter.** For pencil mikes 2 5/32" to 1" dia. MM-318J. 2/2.00. Each 1.05

13 **Guitar Cable.** 15', retracts to 22". 1/4" plug to rt-angle plug. WW-571J. 10 for 1.49 ea. Each 1.59
WW-540J. 25', 1/4" plugs. Each 4.98

14 **Mike Floor Stand.** Two-section, 35-63". 3/8"-27 thread. MM-094J. 10 lbs. 8.91

15 **Low-Cost Desk Stand.** 4" high, 6" dia. charcoal base. MM-095J. 2 lbs. 2.99

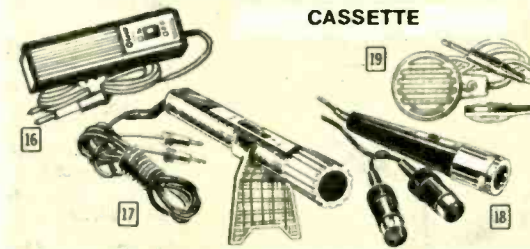

CASSETTE

16 **Dynamic Lavalier Mike.** High output, 200 ohms impedance, omnidirectional pickup. For virtually all cassette recorders. 3.5mm, 2.5mm plugs. MM-351J. Shpg. wt. 1 lb. 4.44

17 **Cassette Replacement Mike.** Has 3.5mm mini-plug, 2.5mm micro-plug for most cassette recorders. 60-12,000 Hz. On-off switch, stand. MM-322J. Shpg. wt. 1 lb. 6.98

18 **DIN Replacement Mike.** Has DIN plug for Ampex, Wollensak, Norelco, many other European-make cassette recorders. 500 ohms impedance. MK-005J. Shpg. wt. 1 lb. 4.49

19 **Cassette Lapel Mike.** High-impedance crystal. -50 dB output, 150-5000 Hz response. Shielded cable, 3.5mm mini-plug. 1 7/16" dia. MM-174J. Wt. 4 oz. 2 for 3.00. Each 1.98

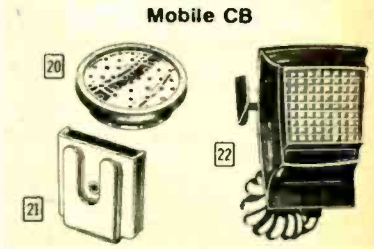

Mobile CB

20 **Carbon Microphone Element.** Replacement element for low-impedance high-output uses. Very rugged—ideal for mobile installations. MM-315J. Wt. 4 oz. Pkg. of 2 for 69c

21 **Magnetic Mike Holder.** Hangs mike on any metal surface. Really handy for car use. 1 1/8 x 1 3/8 x 7/8". CB-048J. Wt. 1/4 lb. 98c

22 **Deluxe Push-to-Talk Mike.** Famous-make, great CB buy. Ceramic element, 50,000 ohms impedance. -54 dB output, relay switching provision, retractable cord. MK-007J. Wt. 1 lb. 8.98



UNIVERSITY SOUND
ALTEC DIVISION OF ALTEC CORPORATION

High-Fidelity and PA Speakers

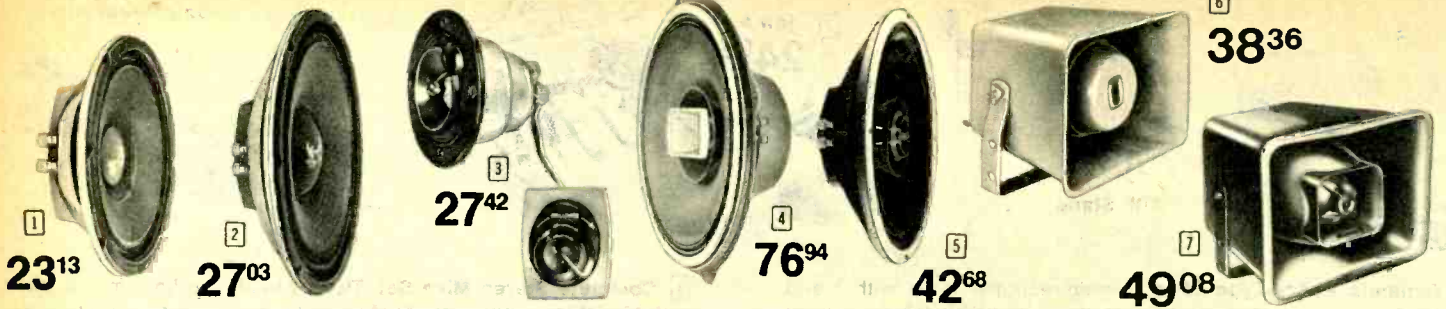

- 1 8" Full-Range Hi-Fi Speaker**
Model M-8. Single-cone unit for custom hi-fi, PA uses. Features die-cast frame, double cone-edge, thin-fine construction. Front/rear baffle mounting. 50-12,000 Hz, 8 ohms, 30 watts. 8 $\frac{1}{2}$ " Dia. x 2 $\frac{1}{2}$ " deep.
SP-107J. Shpg. wt. 7 lbs. 23.13
SP-108J. M-8D. Above, with whizzer cone for 50-15,000 Hz response. 7 lbs. 26.25
- 2 12" Full-Range Hi-Fi Speaker**
Mustang M-12. 12" single-cone speaker has the same fine features as model M-8 above, but with 35-12,000 Hz response, 30 watts, 8 ohms. 12 $\frac{1}{2}$ " dia. x 3 $\frac{3}{8}$ " deep.
SP-109J. Shpg. wt. 8 lbs. 27.03
SP-110J. M-12D. 35-15,000 Hz response .. 29.34

- 3 Sphericon Super Tweeter**
Mustang MS. For use with other Mustang series speakers—extends response to 22,000 Hz. Level control. 3 $\frac{1}{2}$ " dia. 3 $\frac{1}{2}$ " deep.
SP-113J. Shpg. wt. 1 lb. 27.42
- 4 15" 3-Way Speaker**
Mustang M-15T. Similar to other Mustang speakers, but with full-range 30-20,000 Hz response, 35 watts. 15 $\frac{1}{2}$ " dia. x 7 $\frac{1}{2}$ " deep.
SP-112J. Shpg. wt. 17 lbs. 76.94
- 5 12" 3-Way Speaker**
Mustang M-12T. Combines 12" woofer, whizzer midrange and tweeter into a single 3-way. 35-40,000 Hz, 30 watts, 12 $\frac{1}{2}$ " dia. x 3 $\frac{3}{8}$ " deep.
SP-111J. Shpg. wt. 9 lbs. 42.68

- 6 Outdoor Hi-Fi Speaker**
Model ELC. Weatherproof outdoor speaker for music reproduction or Public Address use. Has contour reinforced aluminum center housing, adjustable "U" mounting bracket. 120° dispersion. 150-11,500 Hz, 15 watts, 8 ohms. 12 $\frac{1}{2}$ x 9 $\frac{1}{2}$ x 10 $\frac{1}{2}$ ".
SP-106J. Shpg. wt. 9 lbs. 38.36
- 7 Dual-Range Outdoor Speaker**
Model MLC. Similar to Model ELC above, but with increased response of 150-15,000 Hz. Designed for indoor and outdoor use in any area requiring high-fidelity public address sound distribution. 15 watts, 8 ohms. 12 $\frac{1}{2}$ x 9 $\frac{1}{2}$ x 10 $\frac{1}{2}$ ".
SP-105J. Shpg. wt. 11 lbs. 49.08

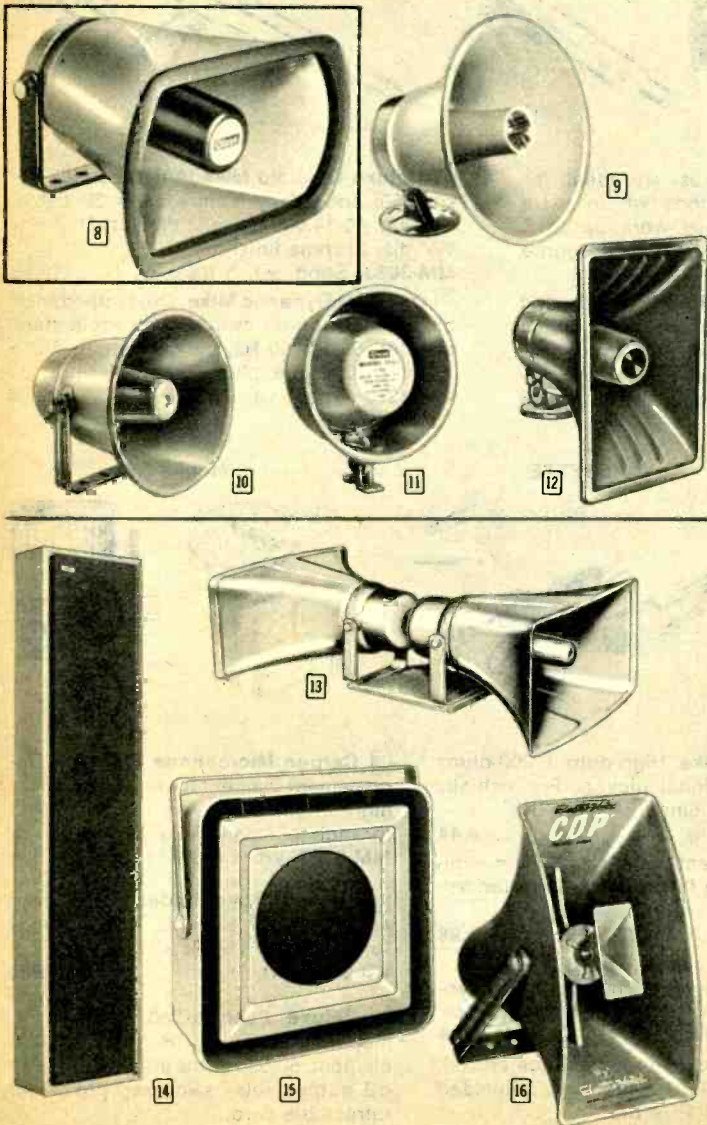

Olson and Electro-Voice Indoor/Outdoor PA Speakers

- 8 Olson Wide-Angle 8" Trumpet**
Wide-dispersion speaker offers far reaching coverage. Has 15-watt driver. Shockproof and rustproof. Response: 340-7,000 Hz. 8 ohms. Size 8" x 5" H x 8" D. Buy a pair and save!
SS-097J. Shpg. wt. 4 lbs. 2 for 52.00 Each 26.49
- 9 Electro-Voice Round Wide-Angle Trumpet**
Model PA12. Offers maximum intelligibility at low cost. Wide 325-14,000 Hz response. Capacity, 12 watts. 8 ohms. 7 $\frac{1}{2}$ " Dia. x 7 $\frac{1}{2}$ " H x 7 $\frac{1}{2}$ " D.
SS-346J. Shpg. wt. 4 lbs. 17.40
- 10 Olson 5" Trumpet with Adjustable Bracket**
Cuts through background noise; 8 ohms, 8 watts; response: 400-8,000 Hz. Adjustable bracket. Size: 5 $\frac{1}{2}$ " Dia. x 5" H.
SS-453J. Shpg. wt. 3 $\frac{1}{4}$ lbs. 2 for 22.00 11.32
- 11 Olson "Page Boy" 5" Trumpet**
Great for paging, fine for music too, with 300-12,000 Hz response. Capacity, 5 watts. 8 ohms. 5 $\frac{3}{4}$ " dia. x 3" D. Sound Olson Value!
SS-880J. Shpg. wt. 4 lbs. 2 for 23.00 11.69
- 12 Electro-Voice Deluxe Wide-Angle**
Model PA-30A. For music or voice. Response: 250-14,000 Hz. Universal swivel mount. Capacity, 30 watts, 8 ohms. 6 $\frac{1}{2}$ " W x 11 $\frac{1}{2}$ " H x 9 $\frac{3}{4}$ " D.
SS-299J. Shpg. wt. 6 lbs. 25.50
- 13 Deluxe Mobile 2-Speaker System**
Twin 12" x 14" wide-angle horns with drivers mounted on a support base with strap. Adjustable, waterproof. 8 ohms. Power capacity 60 watts.
SS-318J. Shpg. wt. 16 lbs. 75.00
- 14 Olson 6-Speaker Indoor Sound Column**
Six wide-range speakers housed in one self-standing unit (can also be wall mounted). Adjustable for uniform sound reinforcement. Cabinet is vinyl-covered, 6 $\frac{1}{2}$ " W x 30" H x 3 $\frac{1}{4}$ " D. 16 ohms. Capacity, 30 watts.
SS-183J. Shpg. wt. 14 lbs. 2 for 80.00 Each 44.98
- 15 Electro-Voice Dual-Cone System**
Musicaster 1A. Weatherproof outdoor speaker with 12" Radax dual-cone, wide-range driver. Power capacity, 60 watts. Response: 80-10,000 Hz. 8 ohms. 21 $\frac{1}{2}$ " H x 21 $\frac{1}{2}$ " W x 8 $\frac{1}{2}$ " D. Great for Music!
SP-026J. Shpg. wt. 17 lbs. 80.25
- 16 Electro-Voice Wide-Angle, Low Distortion System**
Model 848A. Best wide-angle Horn and Driver Combo for highly intelligible voice and music reproduction. Response: 150-10,000 Hz. Impedance, 8 ohms. Power capacity, 30 watts. 20 $\frac{1}{2}$ " H x 10 $\frac{1}{2}$ " W x 20" D.
SS-245JF. Shpg. wt. 17 lbs. Shipped from Buchanan, Mich. 60.75

Teledyne-Olson - The QUALITY Name in PA!

10 people, 1000 people—indoors or out—rain or shine—Olson has the PA equipment you need to do the job right! Check our amplifiers below, our custom designed systems on the next two pages—

there's probably one for you! If not, simply write our PA Consulting Service (260 S. Forge St., Akron, Ohio 44327) and give us your specifications—you'll get just what you want—at a money-saving price!

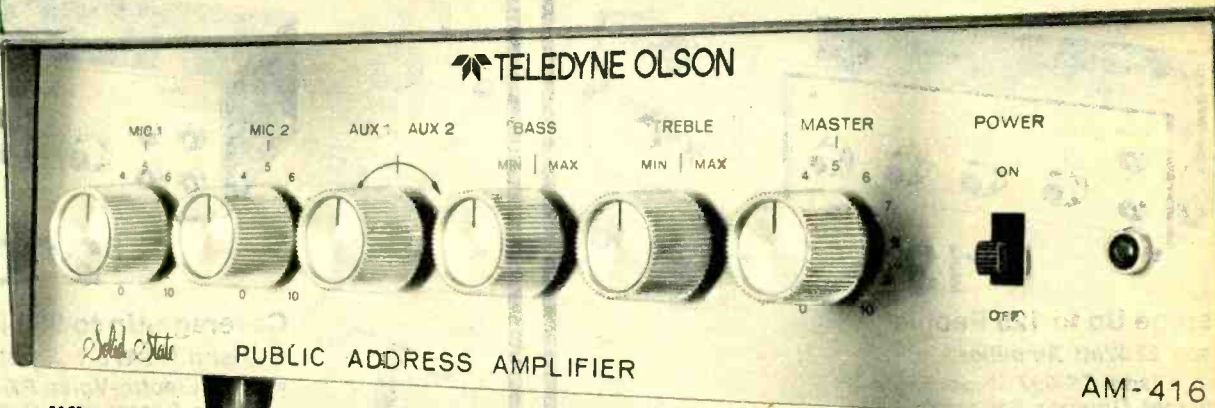

60-Watt Base Amplifier

More sound, more power, more VERSATILITY than many higher-priced models—for audiences of over 400 people! Features simultaneous mixing of up to 3 inputs—full-range bass and treble tone controls, TWO Aux. inputs for phono, tuner or tape; outputs for 8 or 16-ohm speakers, 12.5, 25 and 70.7 volt line transformers. The separate power switch lets you leave controls set for

day-to-day use, the Master volume provides overall level control for ALL sources, there's a pilot light to indicate power "on", plus TWO high-impedance mike inputs. Solid-state circuit with automatic overload protection. Metal case, 14 1/2 x 3 3/4 x 13 3/4". 117 VAC.
AM-416J. Shpg. wt. 16 lbs. 109.95
AM-420J. 100-Watt Version of Above. 20 lbs. 130.00

109⁹⁵

Use Your Credit Card

Made Exclusively for Olson by the No. 1 U.S. Manufacturer of PA Equipment!

22-Watt Base/ Mobile Amplifier

67⁵⁰

Plenty of options at a price that's low—use in mobile or portable systems, use in conference rooms and small halls—covers audiences of up to 250 people with clear, undistorted sound. Has separate volume controls for each input—Mike, Phono and Aux. (tape or tuner), plus a tone control. Outputs for 4, 8, or 16-ohm speakers, 25 and 70.7 volt line. Takes one high, one low-impedance mike. Pilot light indicates power "on", dual power supplies—12 VDC for operation from car, boat or portable power source, 117 VAC for indoor use. 10 x 3 3/4 x 8".

AM-387J. Shpg. wt. 15 lbs. 67.50

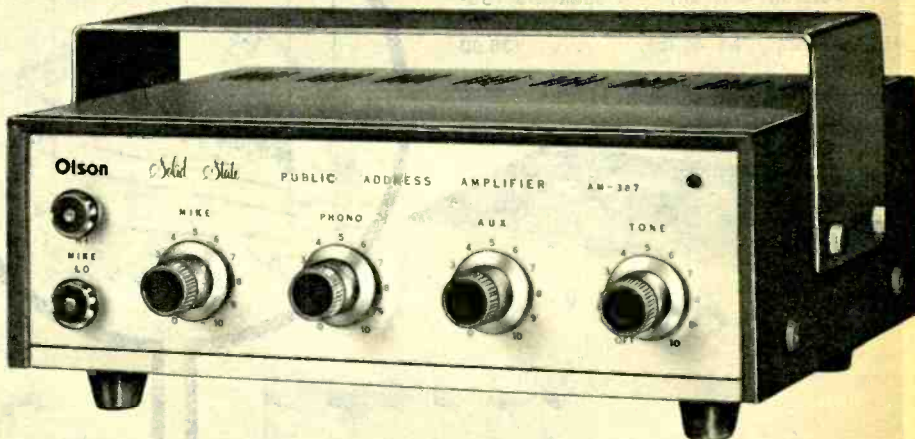

40-Watt Base/ Mobile Amplifier

99⁹⁸

An excellent choice for churches, schools, small auditoriums—anywhere coverage of up to 350 people is needed. There are four mike inputs (two low-impedance and two high-impedance)—use two mikes at the same time for panel discussions, debates, etc. Has volume controls for Mike-1, Mike-2 and Aux. (phono, tuner or tape), tone control. Solid-state circuit with overload protection, pilot light. Outputs for 4, 8, 16-ohm speakers, 25 and 70.7-volt line. With bracket for easy installation in car, truck or boat, dual power supplies for 12 VDC, 117 VAC.

AM-388J. Shpg. wt. 18 lbs. 99.98



Outdoor PA Systems—For Picnics to Parades

We've combined our solid-state PA amplifiers with some of the highest quality mikes and speakers around to bring you PA systems de-

signed to meet your specific outdoor needs ... and **SAVE YOU MONEY** too! Pick the one that's right for You!

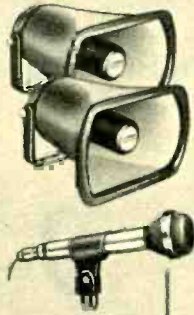

\$130

Coverage Up to 125 People

- Olson 22-Watt Amplifier
- Two Olson SS-097 Wide-Angle 8" Trumpet Outdoor Speakers
- Olson MM-301 Dynamic Mike
- Olson MM-094 Mike Floor Stand

Excellent choice for student picnics, outdoor office parties, patio or pool-side get-togethers. Wide-dispersion speakers are weatherproof, have mounting brackets for permanent installation. The mike has cardioid pickup pattern, windscreen, audio cable and ¼" plug. Tip-proof stand.

AS-536J. Shpg. wt. 40 lbs. 130.00

Hi-Fi Version with different speakers (SS-299J, page 78) and mike (MM-327J, page 77).

AS-782J. Shpg. wt. 44 lbs. 136.00

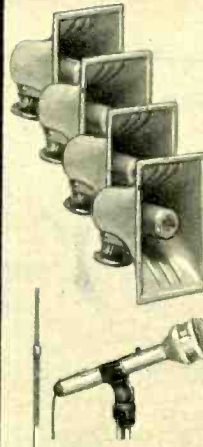

\$220

Coverage Up to 250 People

- Olson 40-Watt Amplifier
- Four Electro-Voice PA-30A Wide-Angle Speakers with Swivel Mounts
- Electro-Voice 626A Dynamic Mike
- Olson MM-094 Mike Floor Stand

For rallies, outdoor clubs, rifle ranges, etc. Speakers feature universal swivel mounts—install easily on posts, trees, etc. Mike has built-in "pop" and dust filter, peak-free response shaped for exceptional voice performance. Includes all cables and plugs and hookup wire for easy setup.

AS-636J. Shpg. wt. 63 lbs. 220.00

Hi-Fi Version with different speakers (SP-106J, page 78) and mike EV-670V.

AS-783J. Shpg. wt. 69 lbs. 269.40

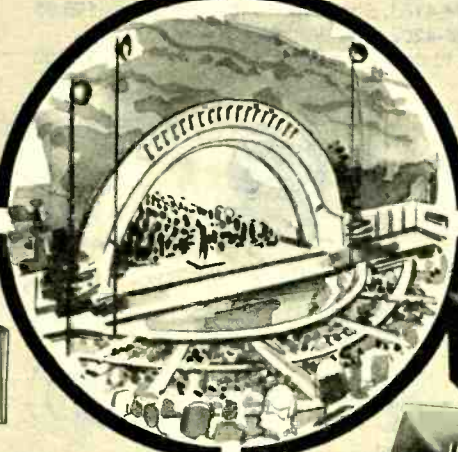

\$273

Coverage Up to 350 People

- Teledyne-Olson 60-Watt Amplifier
- Six Electro-Voice PA-30A Weatherproof Outdoor PA Speakers
- Olson MM-301 Dynamic Mike
- Olson MM-094 Mike Stand

For permanent or semi-permanent installation wherever AC power is available. Ideal for commercial applications—putting courses, outdoor gardens, etc. Distortion-free amplifier is fine for background music, easy-mounting speakers look and sound good anywhere. With cables, plugs, hookup wire.

AS-639J. Shpg. wt. 65 lbs. 273.00

Hi-Fi Version with different speakers (SP-106J, page 78) and mike (MK-022J, page 76).

AS-784J. Shpg. wt. 77 lbs. 365.85



\$400

Our Best! Covers Over 500 People

- Teledyne-Olson 100-Watt Amplifier
- Four Electro-Voice 848A Wide-Angle, Low-Distortion Outdoor Speakers
- Electro-Voice 670V Cardioid Mike
- Olson MM-094 Mike Floor Stand

A powerful system that's perfect for little league ballparks, city playgrounds, anywhere AC power is available. Amplifier has separate power on-off so volume and tone levels can be set and left alone. Speakers are designed for highly intelligible voice or music reproduction.

AS-640J. Shpg. wt. 80 lbs. 400.00

Hi-Fi Version with different speakers (SP-105J, page 78) and mike (MK-021J, page 76).

AS-785J. Shpg. wt. 80 lbs. 475.09

Indoor PA Systems—For Background to “Blanket”

Quality PA systems for permanent or semi-permanent installation in restaurants, schools, churches, small stores. They're ideal for use as

background music systems, paging, store sale announcements, etc. There's one for Your needs and budget!



\$105

250 People—2500 Sq. Ft.

- Olson 22-Watt Amplifier
- Two Olson SS-146/CA-443 Speakers with Wall-Mount Baffles
- Olson MM-301 Dynamic Mike
- Olson MM-094 Mike Floor Stand

Ideal system sets up fast 'n easy in classrooms, waiting rooms, offices, etc. Provides clear sound for background music or paging. Wall-mount speakers with attractive wood-grain baffles, dynamic mike with cardioid pickup pattern that rejects background noises. All cables and plugs.

AS-503J. Shpg. wt. 38 lbs. 105.00
 Hi-Fi Version with different speakers (SS-334J, page 69) and mike (MM-327J, page 77).
 AS-786J. Shpg. wt. 54 lbs. 179.26



\$173

350 People—10,000 Sq. Ft.

- Olson 40-Watt Amplifier
- Two Olson SS-183 6-Speaker Indoor Sound Columns
- Electro-Voice 626A Dynamic Mike
- Olson MM-094 Mike Floor Stand

Just great for lectures, "town hall" meetings, etc. Sound column speakers are designed for uniform output, have good-looking vinyl-covered cabinets. Mike has peak-free response "shaped" for excellent voice reproduction. Tip-proof mike stand adjusts 35" to 63". With plugs, cables, hookup wire.

AS-635J. Shpg. wt. 60 lbs. 173.00
 Hi-Fi Version with different speakers (SS-231J, page 69) and mike (EV-670V).
 AS-787J. Shpg. wt. 78 lbs. 269.80



\$205

425 People—10,000 Sq. Ft.

- Teledyne-Olson 60-Watt Amplifier
- Two Olson SS-183 6-Speaker Indoor Sound Columns
- Olson MM-301 Cardioid Mike
- Olson MM-094 Mike Floor Stand

Has plenty of power even for audience "blanket-type" coverage. Recommended for permanent installation in school meeting halls, small auditoriums, etc. Sound Column speakers may be wall-mounted if desired. Dynamic mike is great for voice reproduction. With cables, plugs, hookup wire.

AS-637J. Shpg. wt. 60 lbs. 205.00
 Hi-Fi Version with different speakers (SS-231J, page 69) and mike (MK-022J, page 76).
 AS-788J. Shpg. wt. 78 lbs. 269.80



\$260

Over 500 People—10,000 Sq. Ft.

- Teledyne-Olson 100-Watt Amplifier
- Four Olson SS-183 6-Speaker Indoor Sound Columns
- Electro-Voice 670V Cardioid Mike
- Olson MM-094 Mike Floor Stand

Our best indoor system! 100-watt amplifier is great for music or voice reproduction—use as a background/paging system in restaurants, stores, etc. Good-looking sound column speakers stand or wall-mount anywhere—sound great. With plugs, cables, hookup wire for easy installation.

AS-638J. Shpg. wt. 80 lbs. 260.00
 Hi-Fi Version with different speakers (SS-231J, page 69) and mike (MK-021J, page 76).
 AS-789J. Shpg. wt. 116 lbs. 448.81

Olson. Proven-Performance Test Equipment . . .

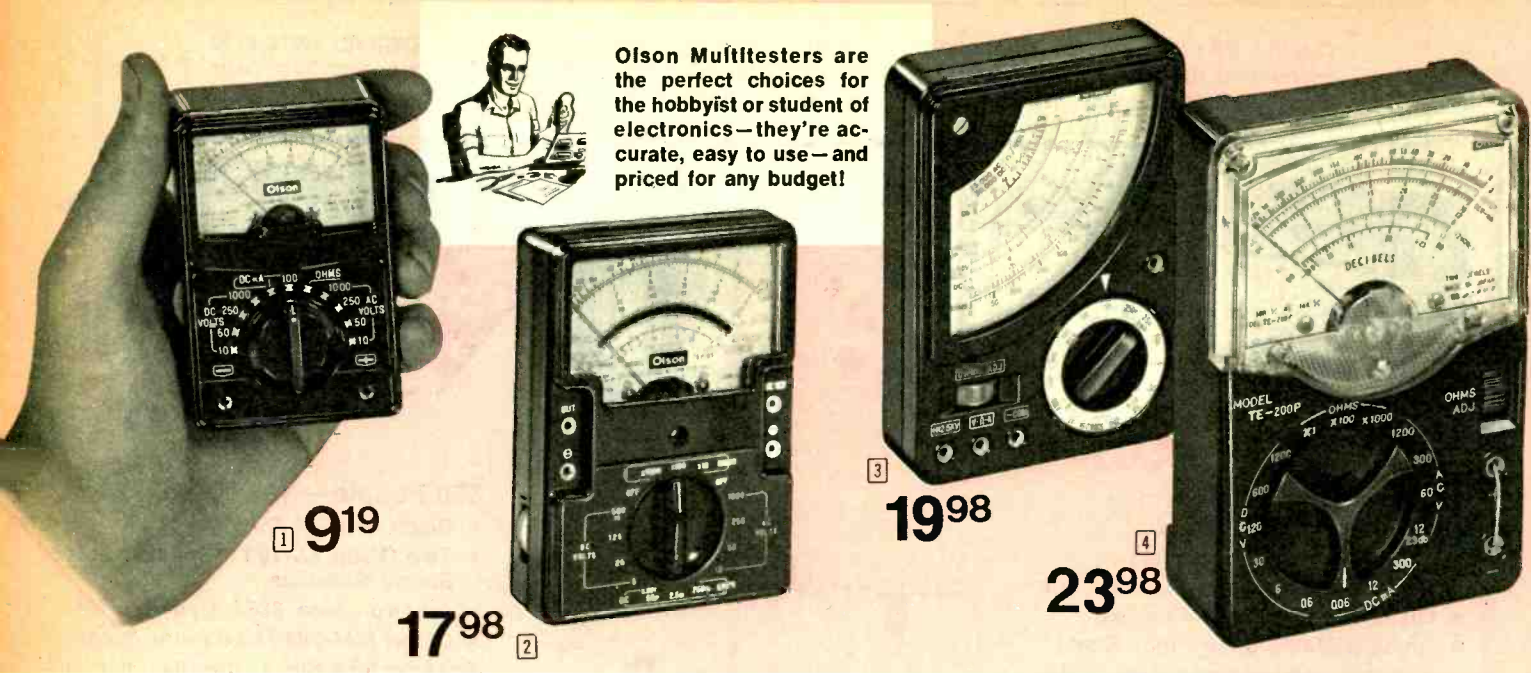

Olson Multitesters are the perfect choices for the hobbyist or student of electronics—they're accurate, easy to use—and priced for any budget!

1 9.19

17.98 2

3 19.98

23.98 4

1 1000 Ohms/Volt Multimeter

- Great for Fast, In-the-Field Tests
- 8 Ranges—AC, DC Volts, Ohms, mA

Pocket-size tester makes quick checks of all types of audio and electrical equipment—it's great for hobbyists, kit builders, students. Color-coded scales, easy to read meter. 8 ranges—AC and DC volts: 0-10-250-1000. DC Current: 0-100 mA. Resistance: 0-100,000 ohms. With leads, battery. 2 3/8 x 3 1/2 x 1".

TE-184J. Shpg. wt. 2 lbs. 3-Up - Each 8.50 Each 9.19

2 20,000 Ohms/Volt Multimeter

- Easy-to-Read Meter Is Burnout-Protected
- 16 Ranges—AC, DC Volts, Ohms, mA, dB

Quality tester at a low Olson price. Reads DC Volts: 0-5-25-50-250-500. AC Volts: 0-10-50-100-500-1000. DC Current: 0-50 μ A-2.5 mA-250 mA. Resistance: 0-60k ohms-6 meg. -20 to +22 dB. Has ohms-adjust knob, recessed range selector, color-coded scales. With test leads and batteries. Only 3 1/4 x 4 1/2 x 1 1/8".

TE-185J. Shpg. wt. 3 lbs. 3-Up - Each 16.98 Each 17.98

3 30,000 Ohms/Volt Multimeter

- Mirrored Scale for Really Precise Reading
- 16 Ranges—AC, DC Volts, Ohms, mA, dB

Here's exceptional quality and versatility in an under \$20 meter. Has overload-protected meter with color-coded scales, ohms adjust, recessed range selector. Reads DC Volts: 0-5-25-500-500-2500. AC Volts: 0-10-50-100-1000. DC Current: 0-60 μ A-2.5 mA-250 mA. Resistance: 0-60k-6 meg. -20 to +22 dB. Leads, battery. 3 3/8 x 4 1/2 x 1".

TE-240J. Shpg. wt. 3 lbs. 3-Up -Each 18.98 Each 19.98

4 30,000 Ohms/Volt Multitester

- Low-Voltage Range for Transistor Testing
- 19-Ranges—AC, DC Volts, Ohms, mA, dB

Features single-knob range selection for great convenience in shop or field, burnout-protected meter. Reads DC Volts: 0-0.6-6-30-100-120-600-1200. AC Volts: 0-12-60-300-1200. DC Current: 0-60 μ A-12 mA-300 mA. Resistance: 0-10k ohms-1 meg-10 meg. -10 to +23 dB. With leads, battery, instructions. 3 3/8 x 5 1/4 x 1 1/2".

TE-200J. Shpg. wt. 2 lbs. 3-Up -Each 22.98 Each 23.98

Olson Test Leads, Clips, Adapters, for Every Service Need



1 12" Leads with Alligator Clips. For quick tests of speakers, components, etc. Color-coded, insulated. Pkg. 10. XX-043J. 4 oz. 4 Pkgs. for 8.00 . . Each 2.19

3 Test Lead Adapter. Changes a probe to a clip—fast 'n easy! Ideal for temporary connections, test setups. 9 3/4" long. TE-224J. 4 oz. 3 Pkgs. for 5.56 . . Each 1.49

5 "Hook On" Test Clip Adapter. Converts test probe to clip-on. Push-to-hook, release-to-grip. Jack for std. probes. TE-265J. 4 oz. 3 Pkgs. for 2.70 . . Each 98¢

2 "Sure-Grip" Clip Leads. Pkg. of 5 insulated leads with "Sure-Grip" clips on each end for easy solderless hookup. Color-coded. BA-165J. 4 oz. 4 Pkgs. for 8.00 . . Each 2.29

4 1-Amp Test Clips. Package of 6 vinyl-insulated clips—3 red, 3 black. For solder or screw terminal connections. Stock up! XX-121J. 4 oz. 3 Pkgs. for 5.37 . . Each 1.98

6 60" Flexible Test Leads. Molded strain relief to eliminate wire breakage. Tip plugs each end fit most testers. TE-212J. 4 oz. 3 Pkgs. for 3.87 . . Each 1.39

Offers You More for Your Test Dollar



Olson Testers are just the Ticket for the "pro" too —excellent sensitivity, "extra-low-voltage" ranges, versatility enough for practically any service job!



5 29⁹⁸



6 26⁹⁸



7 \$40



8 16⁹⁸

5 50,000 Ohms/Volt Multimeter

- 16-mA Meter for All-Range Reliability
- 18 Ranges—AC, DC Volts, Ohms, mA, Amps, dB

Lab-type accuracy at a "hobby" price! ½-volt DC scale for transistor servicing, polarity-reverse switch, ohms adjust, more. Reads DC Volts: 0-0.5-2.5-10-50-250-1000. AC Volts: 0-5-10-50-250-1000. DC Current: 0-25 μA-5 mA-50-mA-10 amps. Resistance: 0-16k-160k-1.6 meg. dB: -20 to +16. With leads, battery. 4¼ x 6 x 2¼".

TE-251J Shpg. wt. 3 lbs. . . . 3-Up . . . Each 28.98 . . . Each 29.98

6 50,000 Ohms/Volt Multimeter

- Burnout-Protected Meter with Mirrored Scale
- 21 Ranges—AC, DC Volts, Ohms, mA, dB

Top-value meter with built-in safeguard to assure long life and trouble-free service. Reads DC Volts: 0-0.6-3-12-60-300-600-1200. AC Volts: 0-6-30-120-200-1200. DC Current: 0-30 μA-6 mA-60-mA-600 mA. Resistance: 0-10k ohms-1 meg-10 meg-100 meg. dB: -20 to +17. With test leads and batteries. 4 x 6 x 7/8".

TE-197J. Shpg. wt. 5 lbs. . . . 3-Up . . . Each 25.98 . . . Each 26.98

7 Our Best 30,000 Ohms/Volt Multimeter

- Pushbutton Range and Function Selectors
- 20 Ranges—AC, DC Volts, Ohms, mA, Amps, dB

Bench-type meter designed for professional use! Mirrored scale, overload protection, ohms adjust control, lots more. Reads DC volts: 0-1-2.5-10-50-250-1000. AC Volts: 0-2.5-10-250-1000 DC Current: 0-50 μA-100 mA-250 mA-10 amps. Resistance: 0-5k-50k-5 meg. dB: -10 to +36. With test leads and battery. 5½ x 8½ x 2½".

TE-235J. Shpg. wt. 4 lbs. . . . 3-Up . . . Each 38.98 . . . Each 40.00

8 In/Out of Circuit Transistor Tester

- GO/NO GO Socket for Instant Checks
- Tests Opens, Shorts, Current Gain

Battery-powered tester is essential for servicemen working on solid-state equipment. Uses alligator-clip leads for in-circuit tests, plug-in sockets for out-of-circuit tests. Identifies PNP and NPN types. Has lamp indicator with on-off switch, base current control, jacks for VTVM or scope. Leads, battery. 3¼ x 6¼ x 2½".

TE-199J. Shpg. wt. 2 lbs. 3-Up . . . Each 15.98 . . . Each 16.98

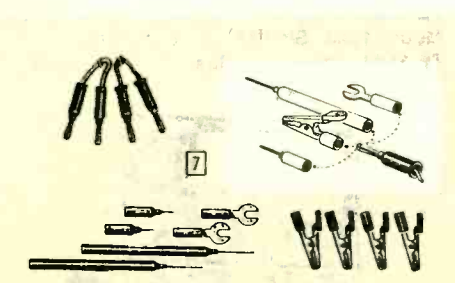

7 12-Piece Test Lead Kit. Adds versatility to any multimeter. Consists of two 5" probes, 3' red and black leads with banana plugs; 2 heavy-duty spade lugs, 2 phone tip plugs, insulated clips, all in convenient storage pouch. Ideal for repairmen, great for hobbyists and experimenters too!

TE-207J. 4 oz. 3 Pkgs. for 9.00 . . . Each 3.59

8 500-Watt Variable Voltage Control. Precision auto-transformer delivers continuously variable 0-130 VAC with negligible voltage variation between no load and full load. Adjusts low line voltages, dims lights, 100's of uses in lab or shop, AC input jack. 117 VAC.

TT-279J. 10 lbs. 3-up Each 19.50 Each 19.98

9 "Under-Load" Battery Checker. Shows true working condition of batteries up to 15 volts, checks batteries above 15 volts under no-load. Ranges: 1.5-3-4.5-6-7.5-9-15-22.5-45-67.5-90 and 240 volts. GOOD-?-REPLACE scale. 24" leads. 3¼ x 5¼ x 2".

TE-237J. 2 lbs. 3-up Each 13.50 Each 13.89

10 Diode and Rectifier Tester. Checks opens, shorts, indicates polarity—even tests low-voltage electrolytics. 3¼ x 2½ x 1¾".

TE-244J. 1 lb. 3-up Each 5.50 . . . Each 5.79
BA-192J. Battery for Above. (use 1) 2 oz. 29c





Test Instruments for the Technician

B & K instruments are precision made and quality engineered for easy and accurate operation. Designed

to speed up service work on color or black-and-white television, stereo equipment, and for lab/industrial use.

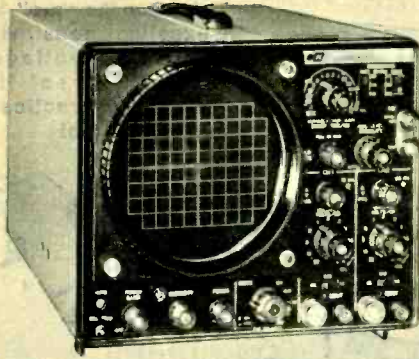

5" Dual-Trace Triggered Sweep Oscilloscope

- Dual Display of All Waveforms
- Compare Inputs and Outputs

529⁹⁵

Model 1470. Perfect for comparing inputs and outputs, or outputs of multiple stages triggered by the same pulse. Provides dual display of waveforms in 6 modes (channel 1, channel 2, chopped, alternate, add and channel 2 invert) for comparison of shape and time duration. Has 10 MHz bandwidth, 10 mV sensitivity, automatic triggered sweep. Permits fast checking of video amplifiers, frequency dividers, all stages keyed off a TV horizontal pulse, differential amplifiers, etc. For 117 VAC. 9" x 10" x 17".

TE-343J. Less probe. Shpg. wt. 30 lbs. 529.95

Model 1460 Triggered Sweep Scope. Similar to above but with single triggered sweep. 19 positions, plus TV-H and TV-V, automatically synchronized. 10 mV/cm sensitivity. Less probe.

TE-344J. Shpg. wt. 28 lbs. 399.95



5" Triggered Oscilloscope with Cali-Brain®

- Precise P-P Measurement
- DC to 10 MHz Bandwidth

379⁹⁵

Model 1465. Exclusive "Cali-Brain" circuit collapses horizontal sweep and provides illuminated numerical readout for fast, accurate peak-to-peak voltage measurements. Built-in sync separator operates in all sweep positions to "lock in" the most complex TV waveforms. Sweep range: 1 μ sec to 20 msec/cm ($\pm 5\%$), plus 5X magnification which increases sweep speed to 0.2 μ sec/cm. Sensitivity: vertical, 0.1 to 200 V full scale (16.6 mV/cm); horiz., 300 mV/cm. Vert. rise time: 35 ns. Front-panel vectorscope capability. Tilt stand. 9" x 10" x 17" D. 117 VAC. Less probe.

TE-345J. Shpg. wt. 25 lbs. 379.95

Model 1440. Similar to above but without triggered sweep. Has "Cali-Brain." With PR-16 combination 10:1/Direct probe.

TE-346J. Shpg. wt. 25 lbs. 299.95



Television Analyst

- Checks Every TV Stage
- 20-48 MHz IF; 0-70 mV

419⁹⁵

Model 1077B. Injects signal at any stage, shows results on picture tube of the TV set. Scanner uses slides of standard test patterns (incl.). Drives solid-state sweeps. For 117 VAC. 9 1/2" x 18" x 12".

TE-347J. Shpg. wt. 30 lbs. 419.95



Sweep/Marker Generator

- 4 Instruments in One
- Exclusive Marker Tilt

419⁹⁵

Model 415. It's a sweep generator, marker generator, marker adder and bias supply. Crystal-controlled IF marker outputs. Markers can be viewed horizontally or vertically. With demod. probe, manual. 17 1/2" x 9" x 10 1/2". 117 VAC.

TE-348J. Shpg. wt. 23 lbs. 419.95



IC Digital Color Generator

149⁹⁵

Model 1246. Produces 9 rock-steady patterns: purity; 9 x 9 dot; 9 x 9, 1 x 9 and 9 x 1 crosshatch; crosshair; gated rainbow; R-Y, B-Y, -(R-Y); center dot. Integrated flip-flop circuits. 2 1/4" x 7" x 10 3/4". Case. 117 VAC.

TE-349J. Shpg. wt. 6 lbs. 149.95

Model 1243. Similar, but 6 patterns.

TE-350J. Shpg. wt. 4 lbs. 109.95



Sine/Square Wave Generator

- 20 Hz to 2 MHz Sine
- 20 Hz to 200 kHz Square

129⁹⁵

Model E310B. Continuously variable output, plus 6-step attenuation. Constant-voltage. Solid state; fully shielded. Easy-to-read 5" dial. 117 VAC. 12 3/4" x 7 1/4" x 8".

TE-352J. Shpg. wt. 12 lbs. 129.95

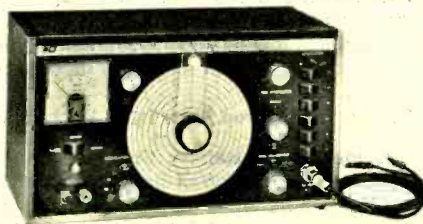

Precision RF Generator

- 100 kHz to 216 MHz
- Crystal Calibration

199⁹⁵

Model E200D. Covers 100 kHz to 54 MHz in 5 bands (to 216 MHz on harmonics). 6 step attenuators, plus variable fine output calibrated to less than 1 μ V. Fully shielded RF output. Two-color 5" vernier dial.

TE-353J. Shpg. wt. 12 lbs. 199.95



RF Signal Generator

- 100 kHz to 30 MHz
- 1.5% Dial Accuracy

99⁹⁵

Model 2050. Has FET's in RF and audio oscillator stages for stability, linearity. 3 outputs: RF, modulated RF (400 Hz), ext. modulated RF. Anti-backlash dial. 117 VAC, 50-60 Hz. 7 1/2 x 6 1/2 x 9 3/4".

TE-351J. Shpg. wt. 8 lbs. 99.95

Outfit Your Test Bench With the Best

These B & K test instruments bring you the latest design concepts to make your TV and electronic

servicing easier, more accurate and faster. They're the choice of professionals the world over.



1 3" Solid-State Oscilloscope

Model 1403. Ultra-compact, lightweight scope goes with you anywhere for servicing in the field; or use it for production line, monitoring or educational applications. Offers bright, steady pattern with smoked acrylic graticule for easy viewing. Direct deflection terminals for waveforms up to 150 MHz. Vertical response: DC to 2 MHz (-3 dB) DC; 2 Hz to 2 MHz (-3 dB) AC; sensitivity, 20 mV/cm or better. Horizontal response: DC to 250 kHz; sensitivity, 500 mV/cm or better. Recurrent sweep with 4 ranges (10 Hz to 100 kHz); continuously variable between ranges. Input impedance: 1 megohm shunted by 30 pF (vertical) or 40 pF (horiz.). Maximum input: 600 V p-p. Synchronization: internal, negative. For 117 VAC, 50-60 Hz. 5 1/4 x 7 3/8 x 11 1/4". With test leads.

TE-338J. Shpg. wt. 11 lbs. **179.95**



2 Precision 3 1/2-Digit Digital Multimeter

Model 282. Solid state, high resolution digital VOM for high speed readings with 0.25% DC accuracy (0.5% or 1% for other ranges). Large, bright, non-blinking 7-segment flat display. Automatic polarity; positive out-of-range indication; 100% over-range capability. 10-meg input impedance. 5-position handle doubles as a stand. Ranges: 0-1,000, 10.00, 100.0, 1000 volts DC or AC rms; 0-1,000, 10.00, 100.0, 1000 mA DC or AC; 0-100.0, 1,000k, 10.00k, 100.0k ohms; 0-1,000, 10.00 megohms. For 105-125 VAC, 50-60 Hz. 3 1/2 x 7 x 9". PR-21 probe has switchable isolation resistor.

TE-336J. Shpg. wt. 5 lbs. **199.95**



3 **169.95**

3 Precision 2 1/2-Digit Digital Multimeter

Model 281. High-sensitivity digital meter measures 100 mV full scale—AC or DC. Positive out-of-range indication, 100% over-range, polarity reversal switch, 5-position handle. Non-blinking display; automatically positioned decimal. Voltage: 0-100 mV; 0-1.00, 10.0, 100 V; 0-1.00 kV DC or AC. Current: 0-100 μ A; 0-1.00, 10, 100 mA; 0-1.00 A DC or AC. 7 ohms ranges. Accuracy: 1% on DC V, 1.5% current and AC V. 3 1/2 x 7 x 9". With probe.

TE-337J. Shpg. wt. 5 lbs. **169.95**

Probes for B&K Scopes On These Pages

Model PR-20 10:1 Probe. Spring-loaded clip-on tip. Input imp.: Low-cap, 10 meg/18pF. Direct, 1 meg/120 pF.

TE-341J. Shpg. wt. 2 lbs. **19.95**

Model PR-16 10:1 Probe. Above, less spring-loaded tip.

TE-342J. Shpg. wt. 2 lbs. **14.95**



139.95

• High Accuracy

Semiconductor Curve Tracer

Model 501-A. Checks gain, leakage, breakdown, output admittance, linearity effects. Generates true current and voltage steps. Compatible with all scopes. 4 x 10 x 9 1/2".

TE-340J. Shpg. wt. 5 lbs. **139.95**

Solid-State Multimeter

139.95

- FET Input
- 74 Ranges
- High and Low Power Ohms Ranges
- PR-21 Probe

Model 290. 7" meter shows AC and DC voltage in 10 ranges from 0-50 mV to 0-1500 V; AC rms voltage in 10 ranges to 4400 V; current in 10 ranges from 0-50 μ A to 0-1.5 A; plus ohms and dB. 7 1/4 x 8 x 3 3/8".

TE-332J. Shpg. wt. 6 lbs. **139.95**

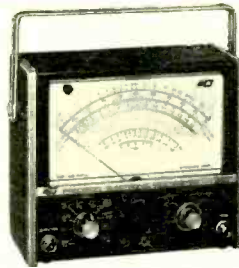

Precision Volt-Ohm-Milliammeter

79.95

- Resettable Overload Protection
- 20,000 Ohms/V DC
- 0.25 V DC Range
- "Transit" Position on Switch

Model 120P. Positive electronic overload protection. Has 8 AC/DC voltage ranges to 1000 V; 4 AC output voltage ranges up to 250 V; 3 ohms ranges; 4 dB ranges. 2% DC, 3% AC. Batteries. 5 1/4 x 7 x 3 1/8".

TE-334J. Shpg. wt. 4 lbs. **79.95**



159.95

Regulated DC Power Supply

• Continuously Variable, 0-50 VDC

Model 1601. Easy-to-use power supply provides fully regulated, continuously variable voltage output; 0-25 and 0-50 V ranges. Current output: 0-50 mA; 0-0.2, 0.5 or 2 A. Fail-safe overload protection with indicator light. Load regulation: 0.07% typical; line, 0.02% typical. Ripple: 5 mV p-p. For 105-125 VAC. 14 1/4 x 3 3/8 x 10".

TE-339J. Shpg. wt. 14 lbs. **159.95**

Solid-State Multimeter

99.95

- High/Low Power Ohms Ranges
- 1 μ A and 0.1 Volt Scales for Semiconductor Tests

Model 277. Reads 0-1000 volts AC or DC in 9 ranges; 0-2800 V p-p AC in 9 ranges; 0-1 amp DC in 9 ranges; ohms in 18 ranges; dB in 9 ranges. 2% accuracy on DC V, 3% on other ranges. PR-21 probe. Needs 9 V and "D" batteries (not incl.). 7 1/2 x 7 3/8 x 3 3/8".

TE-333J. Shpg. wt. 4 lbs. **99.95**



Vacuum Tube Voltmeter

99.95

- 37 Ranges
- 0.5 Volt DC Scale
- DC/AC/Ohms Probe
- 7" Meter

Model 177. Reads 0-1500 VDC in 8 ranges, 0-1500 VAC rms in 7 ranges, 4-4000 V p-p AC in 7 ranges; ohms in 7 ranges. 3% DC, 5% AC accuracy. 7 1/4 x 7 3/8 x 3 3/8". 117 VAC.

TE-335J. Shpg. wt. 8 lbs. **99.95**



B&K CRT and Tube Testers, Substitution Boxes

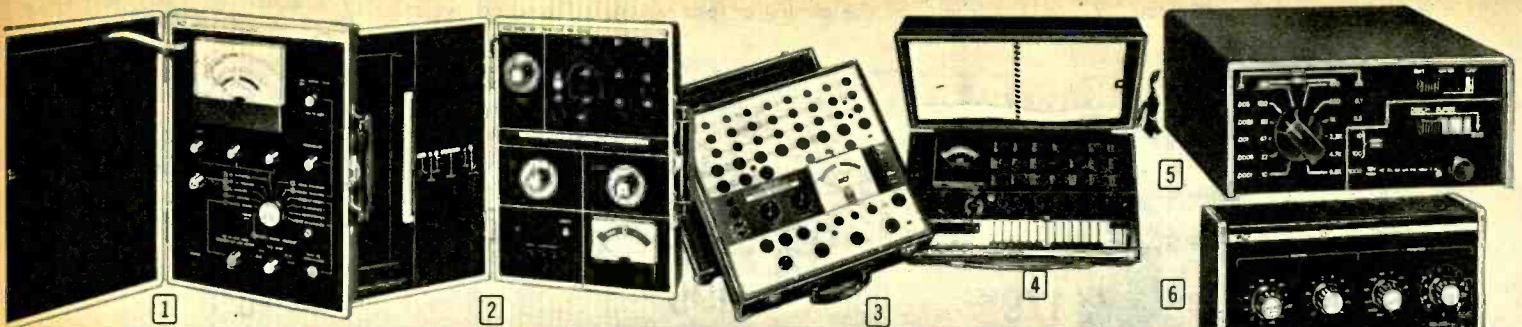

1 CRT Tester & Rejuvenator
Model 466. Tests and rejuvenates all CRT's, including new Trinitrons. Tests for opens, shorts, leakage without removing tube from set; monitors heaters right at tube pins. Separate G-2 control for each gun. "Reserve Power" monitored rejuvenation restores low-emission CRT's, repairs shorted or leaky tubes. "Super Rejuvenation" restores otherwise worthless tubes. Includes 3 adapters. 13½ x 9½ x 5¼". For 105-125 VAC.
TE-356J. Shpg. wt. 8 lbs. **139.95**

2 High Speed Tube Tester
Model 607. "Dyna-Jet" tester checks all tube types, including the latest ones. Gives positive shorts indication, with lockout push-buttons that open any and all multiple-connected pins. Shape-coded symbols and only 3-4 settings assure fast, accurate quality tests. High-sensitivity grid, emission, gas tests. 13½ x 9½ x 4". 105-125 VAC.
TE-358J. Shpg. wt. 6 lbs. **129.95**

3 Dynamic Gm Tube Tester
Model 707. Has 30 Gm sockets, plus "Dyna-Quick" emission test section for fast and reliable testing. Five quick-check sockets for rectifiers. Sensitivity setting is printed next to each socket, for popular tube types. Read Gm directly on 4½" meter — check shorts, grid leakage, gas, life. Only two settings for Gm, three for emission test. 5½ x 15¼ x 16½". 105-125 VAC.
TE-357J. Shpg. wt. 15 lbs. **219.95**

4 Dynamic Gm Tube Tester
Model 747B. Solid-state "Dyna-Jet" model tests all tubes with true dynamic mutual conductance test, also has Jet-Check section for high-speed testing of the most-often-used radio/TV tubes (21 pre-wired sockets with settings shown next to sockets). Dynamic test for VR's; checks shorts, leakage, emission, life. Front panel overload reset. 5½ x 20½ x 11½". 105-125 VAC.
TE-359J. Shpg. wt. 13 lbs. **259.95**

5 36-Unit Substitution Box
Model 2901. Ultra-compact, 36-component box with full protection for components and user. Surge protector prevents arcing. Overload indicator. 24 carbon resistors, 10 ohms-6.8k meg., 9 disc/tubular, 3 electrolytic capacitors. .0001-1000 mfd. 2 x 4¼ x 4".
TE-354J. Shpg. wt. 2 lbs. **39.95**

6 76-Unit Substitution Box
Model 2902. Provides 76 most-needed values, including 20 electrolytics for transistorized circuits—plus a diode rectifier. Surge protection; overload indicator. Select up to 5 components for simultaneous substitution! 24 carbon, 20 power resistors; 12 disc/tubular, 20 elec. capacitors. Ranges: 10 ohms-6.8k meg., .0001-2000 mfd. 10¾ x 7¼ x 3¾".
TE-355J. Shpg. wt. 4 lbs. **74.95**

Mercury Test Equipment for the Pro and Serious Hobbyist

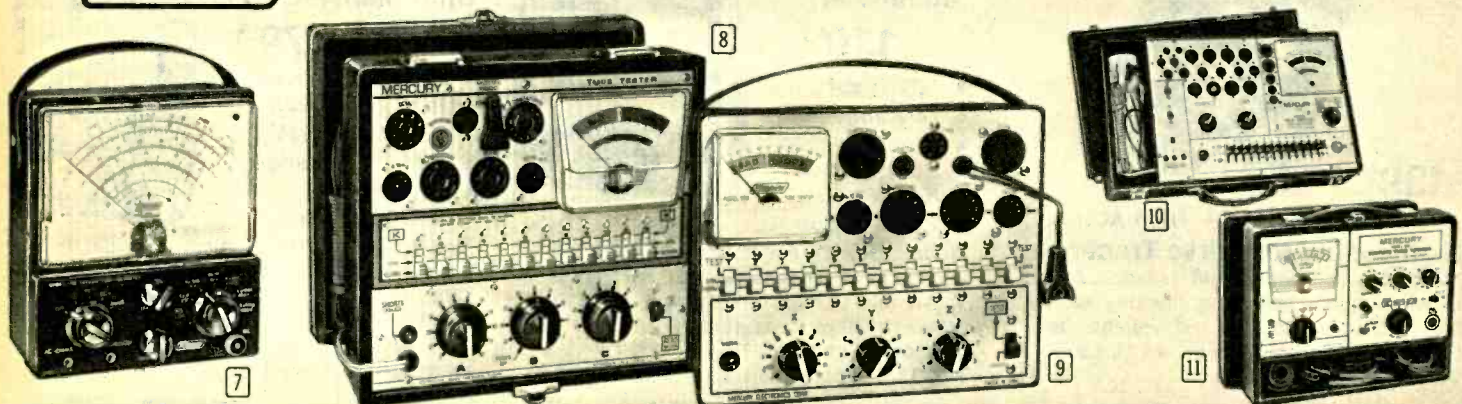

7 New Professional Vacuum Tube Voltmeter
Model 1700C. Advanced-design VTVM meets the rigid requirements of the "pro" technician. Wide-view 6" meter has multi-color mirrored scale. DC/AC Ranges: 0-1.5, 5, 15, 50, 150, 500, 1500 volts. AC p-p Ranges: 0-4, 14, 40, 140, 400, 1400, 4000 V. Resistance: 0-1k, 10k, 100k, 1 meg, 10 megs, 100 megs, 1000 megs. Decibels: -20 to +66. Accuracy: ±3% DC, ±5% AC. DC input: 11 meg. With DC probe. 8½ x 6¾ x 4¾". 105-125 VAC. 5 lbs.
TE-328J. Wired 54.95
KB-216J. Kit Form 39.95
86 Olson

8 Obsolescence-Proof Tube Tester
Model 1100C. This tester will be up-to-date years from now because it has all the latest sockets, universal wiring and a 12-circuit distribution system. Tests all tubes for dynamic cathode emission, checks each section of multi-section tubes separately, detects any shorts or leakage. Heavy-gauge aluminum panel; leatherette case. 9 x 8¼ x 3¾". 110 VAC. Shpg. wt. 7 lbs.
KB-218J. Kit Form . . . 39.95 **TE-229J. Wired . . . 54.95**

9 Miniature-Sized Tube Tester
Model 990. It's small but has all the latest sockets and makes full cathode conductance test on all tubes. Important cathode-to-G₁ and cathode-to-filament opens and/or shorts are quickly indicated. Regulated filament voltage supply. 6½ x 7½ x 3½". 110 VAC. Wt. 5 lbs.
KB-219J. Kit Form . . . 27.95 **TE-233J. Wired . . . 39.95**

10 Tube/Transistor Tester
Model 2000. A dynamic mutual conductance tube tester and grid circuit analyzer. Tests all tube types—old and new—as well as semiconductors. Tests true dynamic mutual conductance, shorts, leakage, gas. 18¼ x 10¾ x 4½". 110 VAC. Shpg. wt. 10 lbs.
TE-246J. Wired 139.95

11 CRT Tester/Rejuvenator
Model 880. Tests all color TV picture tubes, analyzes gun tracking, restores low-brightness tubes, rewelds most elements. 9 x 8¼ x 3¾". For 110 VAC. Shpg. wt. 4 lbs.
TE-278J. Wired 89.95

New Concepts in Test Equipment from LEE

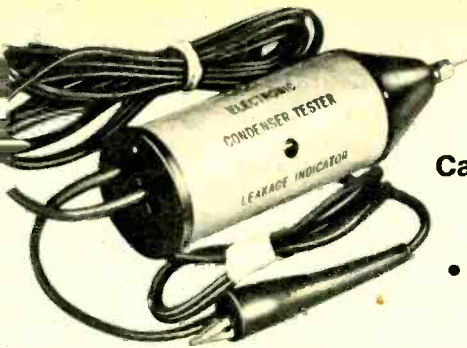

Model CT-1 Dynamic Capacitor Tester

16⁹⁵

- **Dynamic Testing for All Types of Capacitors**

Built-in power supply provides both AC and DC test voltages, for testing capacitors under actual circuit conditions. Permits quick, accurate testing for leakage or shorts with DC voltage applied; quick testing for intermittent open capacitors with AC applied. Highly sensitive neon-type leakage indicator. Self-regulating power supply provides tapered forming current to suit requirements of capacitor under test. Capacitance range: .00025 to 1000 μ F. Sensitivity: over 200 megohms.

TE-327J. Shpg. wt. 2 lbs. 16.95

"Resdeck 1" Resistance Decade Substitutor

10% step decade of 100, 1k, 10k, 100k, 1 megohm and 11 megohms—plus voltage divider capabilities—complete within three leads. Compact tester is complete and ready to use, lets you substitute resistance values into any type of electrical circuit.

TE-331J. Wt. 1½ lbs. 19.95

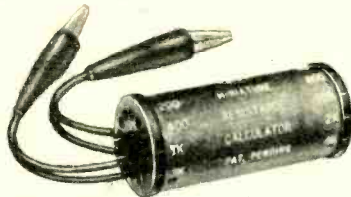

19⁹⁵

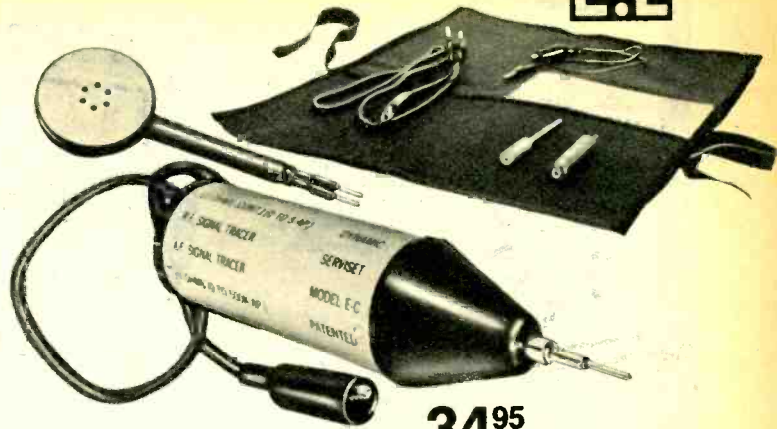

34⁹⁵

The Remarkable "Serviset" E/C Electronic Test Lab

- **Permits Troubleshooting from Antenna to Speaker, as well as in Individual Components or Stages**

Probe-type all-purpose test unit for troubleshooting all types of TV and audio equipment. Use it as an RF/AF signal tracer, RF/AF signal injector, AC/DC voltage indicator, capacitor and resistor tester, or substitution unit for resistance/capacitance. Voltage Ranges: 0-60-550-20,000 volts. Resistance Ranges: Low, 0-5 ohms; High, 0-500k-20 megohms. Capacitance Test Range: .00025 to 12 μ F. Two capacitance substitution ranges: .01 to .1 and 4 to 40 μ F. Three resistance substitution ranges: 50-500 ohms, 5k-25k, and 100k-1 meg. Ready-to-use tester comes with leads and batteries. Compact and versatile—it does so many things, you'll wonder how you ever got along without it!

TE-326J. Shpg. wt. 2 lbs. 34.95

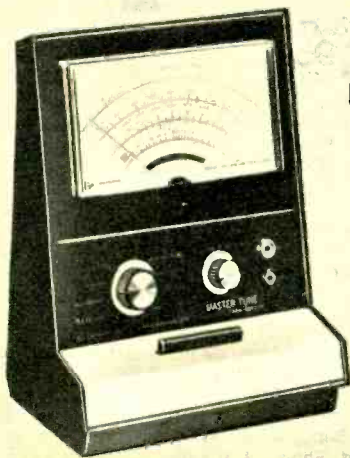

GRAYMARK 5403 Portable Engine Analyzer

Meets
Professional
Specifications

49⁹⁵

- **Save Money—Do Your Own Tune-Ups**
- **Reads Cam Dwell, Engine RPM, Voltage, Point Resistance**
- **±3% Accuracy**

Now you can do your own tune-ups, on any car, more easily than you ever imagined possible! The Graymark Engine Analyzer is the one test instrument you need for professional-type motor analysis and tuning. It's easy to operate and completely portable, for use in the garage or on the street. Works perfectly with any car—4, 6 or 8 cylinders; with any ignition system—6 or 12 volts, positive or negative ground. Comes with a comprehensive operator's manual that describes each test, and an engine specification manual that gives specs for both domestic and foreign cars.

Solid-state circuit; overload protection; large, easy-to-read, color-coded meter face. Unique storage compartment for test leads and manual. Tachometer scales show engine rpm, 0-1600 and 0-8000 rpm, for setting idle speed and mixture. Dwell angle scale reads 0-90° with calibrations for 4, 6 and 8 cylinder engines, for setting points and determining distributor condition. Voltmeter reads 0-1.6, 0-8 and 0-16 volts. Ohmmeter has three scales with center of 10, 100 or 1000 ohms. Point resistance scale. Accuracy: ±3% of full scale. Uses 3 "D" batteries.

TE-330J. Shpg. wt. 6½ lbs. 49.95

Kester Solder & Copper-Nu



Famous for
Fast-Melting,
"Pro-Quality"



1 One-Pound Bench-Pak Solder

For every type of electronic soldering. Melts fast—"44" resin flux core provides low viscosity for easy handling. Non-corrosive—makes strong bonds. .062" dia.; 60% tin/40% lead. Conforms to federal specs. U.L. listed.

XX-027J. Wt. 2 lbs. Lots of 10-Up—Each 2.99 . . . Each 3.19

2 Kwik-Draw Solder Dispenser

Low viscosity for easy handling. Non-corrosive, non-conductive "44" resin core. 60% tin/40% lead. Wire feeds from top or bottom of Servi-Tube dispenser.

XM-031J. Wt. 1 lb. Lots of 10-up—Each 49c. . Each 59c

3 Pocket-Pak Solder Dispenser

Non-corrosive, non-conductive "44" resin core, quick-melting. 60% tin/40% lead. Servi-Tube dispenser/pocket clip.

XX-203J. Wt. 1 lb. Lots of 10-Up—Each 49c. . Each 59c

Kester Copper-Nu Cleaner

Non-fuming liquid for removing oxides, sulfides, carbonates, etch residue and other contaminants from copper or gold plated surfaces to facilitate soldering. Minimal etching.

XM-199J. Shpg. wt. 1 lb. 98c



Eico Test Instruments - Kit Or Wired



**Model 232
Peak-to-Peak
VTVM**

- AC/DC Uni-Probe
- Calibration with Cabinet In Place
- 7 Non-Skip Ranges On Each Function

3495
Kit

Gives true peak-to-peak and rms measurements. Stable balance bridge circuit; burnout-proof 4½" meter. Voltage: 0-1500 V AC/DC, 0-4200 V p-p AC, in 7 ranges each. Resistance: 0.2 ohm to 1000 meg in 7 ranges. 110 VAC. Uni-Probe. 5" W x 8½" H x 5" D. Wt. 5 lbs.
KB-267 J. Kit Form. 34.95
TE-296 J. Fully Wired. 49.95



**Model 242
Solid-State
FET TVOM**

- 6½" Meter
- Low Voltage Ohmmeter
- Single Uni-Probe for All Ranges

7495
Kit

FET input for 11-megohm DC impedance. Low 1-volt scale for semiconductor tests. 1% resistors. Battery/AC powered. Ranges: AC/DC volts to 1000; AC p-p volts to 2800; 0.2 ohm to 1000 megohms; AC/DC current to 1000 mA. 8½" W x 7½" H x 5" D. Shpg. wt. 6 lbs.
KB-269 J. Kit Form. 74.95
TE-298 J. Fully Wired. 99.95



**Model 239
Solid-State
FET TVM**

- Single Uni-Probe Handles All Measurements
- Battery Power
- FET Input for 11 Megohms DC

3995
Kit

Precision 1-volt scale for accurate readings as low as 0.05 V. 4½" meter. Reads AC/DC voltage to 1000 V in 7 ranges; AC p-p to 2800 V in 7 ranges; 0.2 ohm to 1000 megohms in 7 ranges (low voltage). Requires three 9V, one "D" battery. 5¾" W x 8½" H x 5" D. Shpg. wt. 4 lbs.
KB-268 J. Kit Form 39.95
TE-297 J. Fully Wired. 59.95

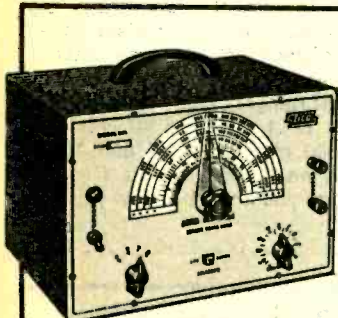

1 4995
Kit



3 6295
Kit



2 3995
Kit

1 Model 377 Sine/Square Wave Generator. Features R-C (Wien Bridge) oscillator, 1% resistors. Excellent stability, purity; 3% or 1 Hz accuracy. Frequency: sine wave, 20-200,000 Hz in 4 bands; square wave, 60-30,000 Hz. 110 VAC. 11½" W x 7½" H x 7¾" D. Shpg. wt. 14 lbs.
KB-274 J. Kit Form. 49.95
TE-305 J. Fully Wired. 64.95



4 6995
Kit

3 Model 330 RF Signal Generator. Solid-state, wide-range RF source covers 100 kHz to 54 MHz in 5 bands. Coarse and fine level controls. 0-100% internal 400 Hz modulation. Coarse, fine attenuation. Output: over 300,000 μV. 110 VAC. 8½" W x 7½" H x 5" D. Shpg. wt. 8¼ lbs.
KB-273 J. Kit Form. 62.95
TE-304 J. Fully Wired. 94.95

2 Model 324 RF Signal Generator. Provides modulated or unmodulated RF signal from 150 kHz to 145 MHz on fundamentals in 6 bands; 111-435 MHz on harmonics. Accuracy: 1.5%. Coarse and fine attenuation. 400 Hz internal modulation. 110 VAC. 10" W x 8" H x 4¾" D. Shpg. wt. 9¼ lbs.
KB-272 J. Kit Form. 39.95
TE-303 J. Fully Wired. 54.95

4 Model 379 Sine/Square Wave Generator. Solid-state unit gives simultaneous sine and square wave outputs. Ranges: sine wave, 20 Hz to 2 MHz in 5 bands; square, 20 Hz to 200 kHz. Output: 0-7.5 V rms, 0-10 V p-p into high imped. 110 VAC. 8½" W x 7½" H x 8½" D. Shpg. wt. 6 lbs.
KB-275 J. Kit Form. 69.95
TE-306 J. Fully Wired. 99.95



5 10995
Kit

5 Model 460 5" Wideband Oscilloscope. Automatic sync. TV-V and TV-H sweeps. Sensitivity: 5 mV rms/cm. DC to 4.5 MHz flat response. Internal calibration. 110 VAC. 8½" W x 13" H x 16" D. Shpg. wt. 30 lbs.
KB-276 J. Kit Form. 109.95 **TE-307 J. Fully Wired 159.95**
Model PSD Demodulator Probe. Fully shielded. Shpg. wt. ½ lb.
KB-277 J. Kit Form. 4.95 **TE-308 J. Fully Wired 6.95**
Model PD Direct Probe, Shielded; swivel action. Shpg. wt. ½ lb.
KB-278 J. Kit Form. 3.95 **TE-309 J. Fully Wired. 4.95**
Model PLC Low Capacity Probe, Shielded; swivel. Shpg. wt. ½ lb.
KB-279 J. Kit Form. 4.95 **TE-310 J. Fully Wired. 6.95**



6 4995
Kit

6 Model 635 Portable Tube Tester. Tests decals, novars, 10-pin, compactrons, magnovals, CRT's, standard types— for emission, grid leakage, gas, shorts. 3½" meter, burnout-protected. Bridge circuit. With tube manual. Scuff-proof. 12½" W x 4" H x 9" D. 110 VAC.
KB-280 J. Kit Form. Shpg. wt. 8¾ lbs. 49.95
TE-311 J. Fully Wired. Shpg. wt. 8¾ lbs. 79.95



7 1095
Kit



8 1295
Kit



9 1995
Kit

7 Model 1120 Capacitance Substitution Box. Fast, accurate substitution of any of 18 values from .0001 to .22 μF. Capacitors rated 400-600 V. 5-way terminals; jackpot binding posts. Less leads. 6½" W x 3¾" H x 3½" D. Shpg. wt. 2 lbs.
KB-281 J. Kit Form. 10.95
TE-312 J. Fully Wired. 16.95

8 Model 1100 Resistance Substitution Box. Substitutes all values that are decade multiples of 15, 22, 33, 47, 68 and 100 ohms. Overall range, 15 ohms to 10 megohms. Uses 1-watt ±10% resistors. Less leads. 6½" W x 3¾" H x 3½" D.
KB-282 J. Kit Form. Shpg. wt. 2 lbs. 12.95
TE-313 J. Fully Wired. Shpg. wt. 2 lbs. 19.95

9 Model 1140 Series/Parallel R-C Combination Box. Substitutes resistance values from 15 ohms to 15 megohms (decade multiples of 15, 22, 33, 47, 68, 100 ohms); capacitance values from .0001 to .22 μF; or 1350 R-C combinations, in series or parallel 5¼" W x 6¾" H x 2¾" D.
KB-283 J. Kit Form. Shpg. wt. 3 lbs. 19.95
TE-314 J. Fully Wired. Shpg. wt. 3 lbs. 29.95

Eico Engine Analyzers



30,000-Volt Probe with Built-In Meter



Model HVP-5
22⁹⁵

Barriers isolate high voltage tip from handle and meter. 14½" long. Shpg. wt. 2 lbs.
TE-299J. Wired. 22.95

49⁹⁵
Wired

Model 230 FET TVOM

Battery-powered VOM goes anywhere, has all the characteristics of a VTVM. 11-megohm DC input, 1-meg AC. 4½" meter. Ranges: 0-0.3, 1.2, 12, 30, 120, 300, 1200 VDC; 0-3, 30, 120, 300 VAC; 0-8, 80, 320, 800 VAC p-p; 4 ohms ranges; -20 to +51 dB. Batteries. 5½" W x 4½" H x 2½" D. Shpg. wt. 5 lbs.
TE-321J. Fully Wired. 49.95

Model PRF-11 RF Probe. Measures voltage up to 250 MHz. Use with 11-meg VTVM. Shpg. ½ lb.
KB-270J. Kit Form. 4.95
TE-300J. Wired. 6.95

Uni-Probe. DC or AC-ohms.
KB-271J. Kit. Shpg. ½ lb. 5.95
TE-301J. Wired. 7.95

Model HVP-2 HV Probe. Measures 30 kV DC with 11-meg VTVM.
TE-302J. Wired. 1 lb. 9.95



49⁹⁵
Wired

Model 887 Solid-State Engine Analyzer. Battery powered—does over 30 tests on any engine. Shows distributor dwell angle; rpm (0-1200-6000); current (0-90 A); resistance (0-100k); spark test; substitute condenser. Batteries, manual. 5½" W x 4½" H x 2½" D. Shpg. wt. 1½ lbs.
TE-316J. Fully Wired. 49.95



54⁹⁵
Kit Form

Model 888 Deluxe Universal Engine Analyzer. Portable solid-state tester is perfect for tune-ups and trouble-shooting any engine. Performs over 30 tests on 4, 6, or 8-cylinder engines; 6 or 12-volt; negative or positive ground. 6" meter has 10 easy-to-read scales for volts, rpm, dwell angle, amps, ohms, spark output, diode/leakage. Requires 4 "D" cells. With manuals, leads. 11½" W x 5¾" H x 5" D. Shpg. wt. 5 lbs.
KB-291J. Kit Form. 54.95
TE-324J. Fully Wired. 79.95

Eico Test Instruments - Kit Form or Wired

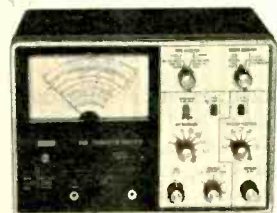

29⁹⁵
Kit Form

Model 685 Transistor Analyzer. Checks semiconductors in or out of circuit. Performs four basic tests on all types of FET's, including pinchoff; three basic tests on all bipolar transistors. Tests for true transconductance and AC Beta. Tests all diodes; measures zener voltage. Checks SCR's, Triacs, UJT's. Has DC voltmeter, ohmmeter. 110 VAC. 8½" W x 12½" H x 6" D. Shpg. wt. 6 lbs.
KB-292J. Kit Form. 99.95
TE-325J. Fully Wired. 149.95

Model 1070 110-Watt Inverter. Changes output from any 12-volt storage battery into 110-volt AC power. Perfect for use in car, boat or camper; provides power for small appliances, electric shavers, etc. Plugs into standard cigar lighter. Fused. 6" W x 4" H x 5¾" D. Shpg. wt. 4 lbs.
KB-290J. Kit Form. 29.95
TE-323J. Fully Wired. 39.95



99⁹⁵
Kit Form

Model 710 Grid-Dip Meter. Determines frequency of oscillators or tuned circuits; has sensitivity control and phone jack for "zero beat" listening. Use to tune transmitters, trim antennas, locate parasitics, etc. Covers all broadcasts, FM, Ham and TV bands in 8 overlapping ranges with accurate (±1%) plug-in coils. Range: 400 kHz to 250 MHz. Thumb-tunes with one hand. 110 VAC. 2¾" W x 2¼" H x 6¾" D. Shpg. wt. 3 lbs.
KB-285J. Kit Form. 39.95
TE-317J. Fully Wired. 59.95

Model 950B R-C Bridge and R-C-L Comparator. Four capacity ranges, four resistance ranges. Comparator range permits measurement of resistances, capacitances and inductances with a complementary component as a standard. Direct reading scale—no complex computations. Measures 10 pF to 5000 uF in 4 ranges, 0.5 ohm to 500 megohms in 4 ranges. Comparator range: .05 to 20 (400 to 1). DC polarizing: 0-500 VDC. For 110 VAC. 10" W x 8" H x 4¾" D. Shpg. wt. 8 lbs.
KB-286J. Kit Form. 34.95
TE-318J. Fully Wired. 49.95

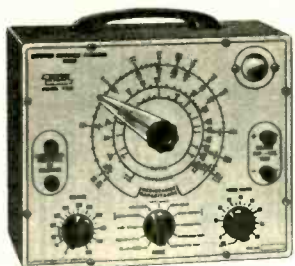

34⁹⁵
Kit Form

Model 1064S Battery Eliminator and Charger. Delivers smooth, undistorted DC power for servicing transistorized and other equipment; charges 6 or 12-volt storage batteries. Extra-low ripple output with special L-C filter. Output: 0-8 volts at 10 amps continuous, 20 amps intermittent; 0-16 V at 6 amps cont., 10 amps intermittent. Meters. 110 VAC. 5¾" W x 8½" H x 7½" D. Shpg. wt. 10 lbs.
KB-284J. Kit Form. 59.95
TE-315J. Fully Wired. 79.95

Model PSI-1 Solid-State Signal Injector Probe. Pen-size, self-contained generator covers 1000 Hz with harmonics to 30 MHz. Perfect for on-the-spot signal tracing. Output: 50 V p-p, open circuit, 10k capacitive. Uses two 1.5-V batteries. 5¾" long x ½" dia. Shpg. wt. ½ lb.
KB-289J. Kit Form. 5.95
TE-322J. Fully Wired. 9.95



59⁹⁵
Kit Form



5⁹⁵
Kit Form

Eico Kits Contain All Parts for Easy Assembly. Wired Units Are Fully Tested.



49⁹⁵
Kit Form



39⁹⁵
Kit Form

Eico Signal Tracers

Model 150 Signal Tracer. Solid state instrument has two shielded probes for fast tracing of RF and audio circuits. High gain, low noise, low distortion amplifiers delivers 400 mW to 8-ohm speaker. Input: RF, 1 mV; audio, 63 mV. 110 VAC. 8½" W x 7½" H x 5" D. Shpg. wt. 8¾ lbs.
KB-288J. Kit Form. 49.95
TE-320J. Fully Wired. 79.95

Model 147 Deluxe Multi-Signal Tracer. Two separate input channels for RF and audio. High RF gain lets you trace right up to antenna terminals. Eye tube and speaker for aural and visual monitoring. Noise locator. Two probes, 110 VAC. 10" W x 8" H x 4¾" D. Shpg. wt. 11 lbs.
KB-287J. Kit Form. 39.95
TE-319J. Fully Wired. 59.95



Quality Tools for The Hobbyist

19⁹⁵

Less
Moto-Tool

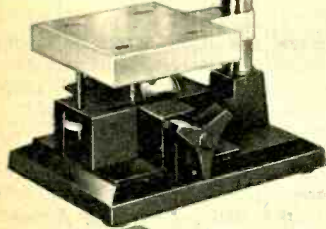

Drill Press

- 12" High, 3" Throat
- Smooth Action Table Lifting Mechanism

Model 210. Ideal for drilling, routing, dove-tailing, and other precision wood workings. Great for hobbyists and craftsmen, and it's easy to operate. Table slotted for guides, hold-downs. With 4 x 4" table, 1" table travel. For use with Moto-Tool Models 260, 270 and 280. TL-701J. Wt. 3 lbs. . . 19.95

Moto-Tool Workshop Kits

Low as **34⁹⁵**

- 34 Accessories

Model 261..5-amp motor with no-load speed of 30,000 rpm. With cutters, grinders, more. 117 V AC/DC.

- TL-685J. Shpg. wt. 2½ lbs. 34.95
- Model 271. Same but .8-amp motor.
- TL-686J. Shpg. wt. 3 lbs. 39.95
- Model 280. Same but .9-amp motor.
- TL-700J. Shpg. wt. 3 lbs. 49.95



16⁹⁵

Portable Speed Control

Model 219. Dial any speed from 0 to full rpm. Use with Moto-Tool drills, saws. Use as a light dimmer. Solid-state. Controlled, full-wave output. 117 VAC.

TL-684J. Wt. 2 lbs. 16.95



12-Piece Emery Wheel Point Set

7²⁰

Model 206. For Moto-Tools. Consists of 12 wheel points of the highest quality with long abrasive life. ½" Shanks. In vinyl, fold-up pouch.

TL-703J. Wt. 2 lbs. 7.20

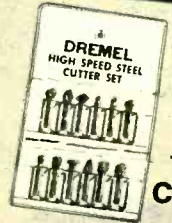

12-Piece Cutter Set

16²⁰

Model 220. Use with Moto-Tools for cutting, and shaping most metals, plastics, and woods. ½" Shanks.

TL-702J. Wt. 2 lbs. 16.20



AKRO-MILS TOOL TOTES AND CABINETS

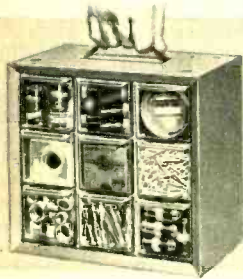

9
Drawer
6³⁰

Model 11-709. Hobby Cabinet. Steel frame. For hobby items, etc. "See-thru" drawers, 2½ x 2½ x 5¾". Cabinet: 10 x 9½ x 6½".

CA-615J. Wt. 4¾ lbs. 6.30



18
Drawer
6³⁰

Model 11-118. "Nut & Bolt Cabinet". Steel frame. Great for small parts. Chip-resistant finish. Drawers: 2¾ x 5¾ x 1¼".

CA-540J. Wt. 4¾ lbs. 6.30



8²⁵ 24 Drawer

Model 11-124. Do-It-Yourself Cabinet. Steel frame. Heavy Duty. Drawers subdivide. Stack or mount. 2¾ x 1¼ x 5¾".

CA-541J. Wt. 7 lbs. 8.25



12²⁵ 36 Drawer

Model 11-636. Full Size Parts Cabinet. Steel frame. Dividers for partitioning. Drawers: 2¾ x 5¾". Overall 13 x 6½ x 13½".

CA-614J. Wt. 7¾ lbs. . . . 12.25

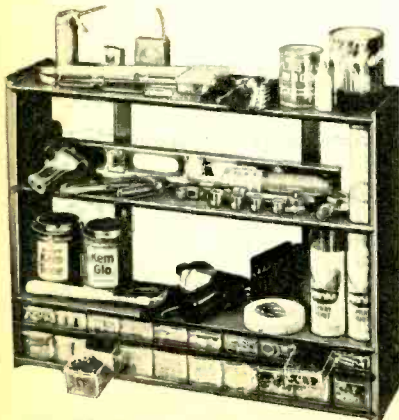

"Bench-Mate" Storage Shelf

13⁶⁵ • 3 Shelves
• 20 Drawers

Model 12-420. Just right for hobbyists. Holds most every repair and fix-up item orderly and within easy reach. Has three shelves each 28½ x 7" plus 20 drawers. For bench or wall. Takes only 4½ square feet. Steel frame. 30 x 22½ x 7".

CA-543J. Wt. 6 lbs. . . 13.65

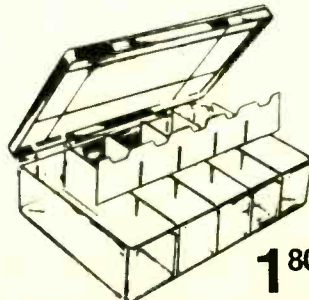

1⁸⁰

Model 05-505. "Keep-Box." Plastic see-thru box. 5 compartments divide to 15. Unbreakable hinges. 11¼ x 6½ x 2¾".

CA-537J. Wt. 1 lb. 1.80

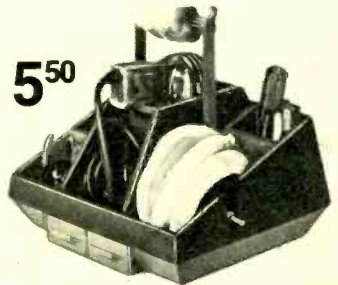

5⁵⁰

Drill Mate. Holds ¼ or ⅜" drill, 25 drill bits. Has tool pocket plus 2 spill-proof drawers. Handle retracts.

CA-539J. Wt. 3¾ lb. 5.50

**Double-Insulated
3/8" Power Drill**



12⁹⁵
less bit

- **Powerful 1/2-HP No-Burnout Motor**
- **Precision Balance for Easy Handling**

Model 800. Features shockproof high-impact housing, unitized motor construction, compact design for tight areas, Develops 1200 rpm no-load speed. 2.6 amps. 8 3/4" long.

TL-605J. Shpg. wt. 3 1/2 lbs. **12.95**

Model 802. Same as above, with variable speed and reverse.
TL-606J. Shpg. wt. 3 1/2 lbs. **27.95**

**Deluxe Variable-Speed
1/2" Reversing Drill**

34⁹⁵
less bit

Model 953. For the tough jobs! Squeeze trigger for speeds to 600 rpm. Double insulated, reversing switch, heavy-duty gears. 4-amp motor. With 6' cord, 2-prong plug.
TL-614J. Shpg. wt. 5 1/2 lbs. **34.95**

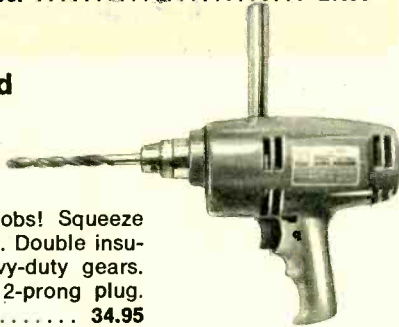

1 Model 961 7 1/4" Circular Saw. Cuts to 2 3/8" at 90°, 1 1/8" at 45°. 2-hp, 11-amp motor. Lifetime lubricated bearings, heavy-duty precision gears, shock-proof high-impact housing. With shoe-plate, calibrated rip fence.
TL-610J. Wt. 11 lbs. **29.95**

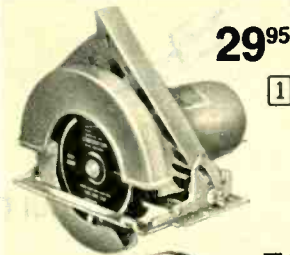

29⁹⁵

2 Model 1000 7 1/4" Heavy-Duty Circular Saw. "Perfect-balance" design for construction, small commercial jobs, etc. 2 1/2-hp, 12-amp air-cooled motor. Cuts to 2 1/2" at 90°, 1 1/8" at 45°. Blower cleans away dust and chips. With rip guide, outboard shoe extension, 3-wire AC cord, adapter.
TL-615J. Wt. 16 lbs. **59.95**

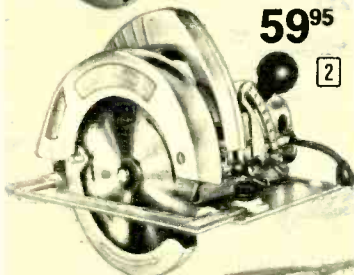

59⁹⁵

3 Model 501 2-Speed Jig-Saw. Cuts 3000 or 2400 3/4" strokes per minute. Shoe plate tilts 45° for plunge or flush cuts. 1/2-hp, 2.6-amp motor. Double insulated. 7 3/8" long. With rip guide, 3 blades.
TL-608J. Shpg. wt. 4 lbs. **19.95**



19⁹⁵

4 Model 531 Variable-Speed Scroll-Saber Saw. Cuts circles, 4 x 4's at 45°, 2" pipe, 1/2" steel, more. 2800 1" strokes per minute. With shoe-plate, rip guide, 7 blades.
TL-611J. Wt. 5 1/2 lbs. **39.95**



39⁹⁵

5 Model 920D 2-Speed Zipp Saw. Cuts 6" log, wall or cut-out, even flush cuts! 1/2-hp, 4 1/2-amp motor for 3200 1" strokes per minute. 9" long. With 7 blades, 8' 3-wire cord, adapter.
TL-617J. Shpg. wt. 7 lbs. . **49.95**



49⁹⁵

**WEN Power Tools for
Pros and Home Handymen**

*All Power Tools on This Page Are U.L. Listed
For 117 VAC Operation*

**Lightweight 10"
Electric Chain Saw**

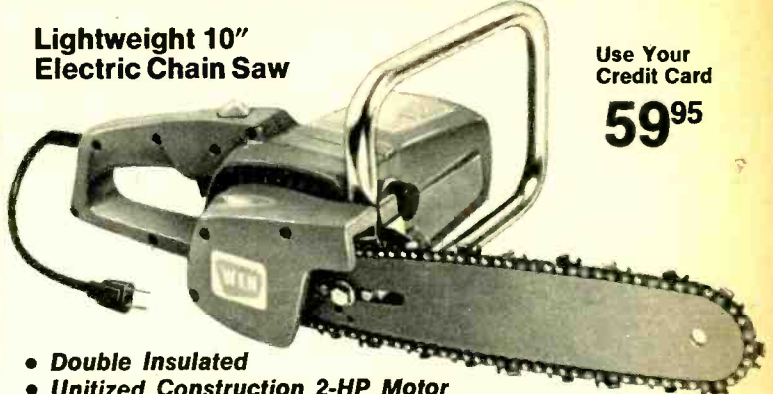

Use Your
Credit Card

59⁹⁵

- **Double Insulated**
- **Unitized Construction 2-HP Motor**

Model 1100. An 8-lb. lightweight that's "heavy" with the power right where you need it—trim trees, prune, fell trees to 2-ft. diameter, cut firewood—fast, safe and easy! Has double-insulated unbreakable high-impact plastic housing, heavy-duty gear drive with anti-kickback clutch, built-in 4 oz. manual oiler with level indicator. 5200 rpm no-load sprocket speed, 2 HP motor. Non-slip grip handle, wrap-around auxiliary handle and cutter bar are precisely balanced for really easy handling. With 10" Oregon reversible guide bar and micro-chisel chain. For 117 VAC, standard 2-prong plug.

TL-698J. Shpg. wt. 9 lbs. **59.95**

6 Electric Pencil Engraver. Protect your valuables with permanent identification (even register items with police in many areas for speedy recovery if your goods are stolen). Engraver writes on anything, even metal and glass. Variable stroke adjustment, high-impact, 8 1/2" long.
TL-475J. Wt. 1 lb. **6.95**

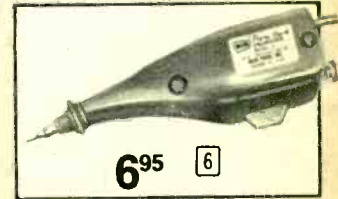

6⁹⁵

7 Model 300 Dual-Action Sander. Has 4000 stroke-per-minute orbital or straight-line action for fast removal and smooth finishing. Enclosed handle with built-in front guide grip. Lightweight, easy-to-use. 9" long.
TL-609J. Wt. 4 lbs. **19.95**



19⁹⁵

8 Model 919 3" Belt Sander. For the tough sanding and finishing jobs. Double insulation, unitized construction, special tension design for quick 'n easy belt change. Heavy-duty gears, bronze bearings. Includes 3 sanding belts.
TL-613J. Wt. 8 lbs. **34.95**



34⁹⁵

9 Model 941 2-Speed 7" Sander/Polisher. Use as a sander at 1550 rpm no-load, a polisher at 1200 rpm no-load to 900 rpm under load. 1/2-hp, 4-amp burnout-proof motor, needle-point bearings, double insulation. With 2 sanding discs, polishing bonnet, aux. handle.
TL-612J. Wt. 6 lbs. **29.95**
Model 942 6" Sander/Polisher. 1/2-hp, 2.6 A motor, 1220 rpm.
TL-699 J. Wt. 4 lbs. **14.95**



29⁹⁵



Precision Tools for Every Project

Note: Individual Tools on this page may be assorted for quantity price.

Superbly crafted tools for the serviceman, experimenter or technician. Low in price, tops in quality for dependable long-life performance. Made in USA.

Precision Pliers and Cutters

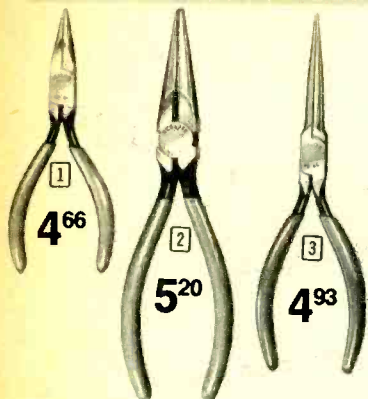

Forged alloy steel construction. Clean-milled, perfectly aligned jaws grip tightly. Plastic-coated "Cushion-Grip" handles.

1 4" Midget Long Nose Plier. TL-722J. Wt. 1 lb. 4.66
Lots of 4-Up Each 4.31

2 6" Long Nose Pliers. With side cutters. TL-723J. Wt. 1 lb. 5.20
Lots of 4-Up Each 4.81

3 6" Needle Nose Pliers. Long, slim jaws for tight areas. TL-724J. Wt. 1 lb. 4.93
Lots of 4-Up Each 4.56

4 4" Midget Diagonal Cutters. For fine wires in tight areas. TL-725J. Wt. 1 lb. 6.12
Lots of 4-Up Each 5.66

5 6" Diagonal Cutting Pliers. TL-726J. Wt. 1 lb. 5.37
Lots of 4-Up Each 4.97

Service Master Tool Kit

29⁶³

Versatile 23-piece quick-change tool set in roll-up plastic-coated canvas case. Includes: 6" long nose, 5" diagonal pliers; 6" adj. wrench; regular and stubby handles; 9 nutdrivers; 3 stubby nutdrivers; 2 slotted and 1 Phillips screwdriver; 2 reamers; extension blade. Nickel chrome finish, high carbon steel blades. TL-719J. Wt. 4 lbs. 29.63

Attache-Style Tool Set

89⁵⁰



A wide array of tools for the technician; in 18½ x 13½ x 4¾" black Durahyde-covered case. Space for additional tools and instruments in lower part of case. Roomy file pocket in lid. Includes: 26 interchangeable Series 99 screwdrivers and nutdrivers, each of which can be used with straight or tee handle; plus 10 asstd. snips, pliers, cutters, wrench, knife. TL-721J. Wt. 12 lbs. 89.50

Wire Stripper

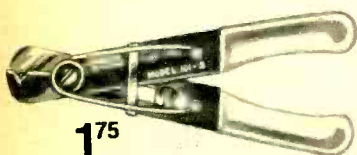

Self-opening spring handles, adjustable stop, cushion grip. TL-728J. Wt. 1 lb. 1.75
Lots of 4-Up Each 1.62

6" Adjustable Wrench

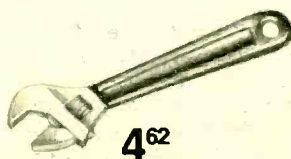

Thin-pattern design; cushion grip. 6" long; ¾" opening. TL-727J. Wt. 1 lb. 4.62
Lots of 4-Up Each 4.27

Screwdrivers

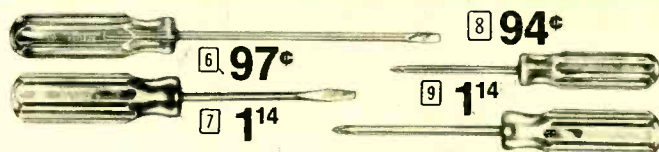

6 Slotted ¾" x 6" Blade. TL-713J. Wt. 4 oz. 97¢
Lots of 4-Up Each 90¢

7 Slotted ¼" x 4" Blade. TL-714J. Wt. 4 oz. 1.14
Lots of 4-Up Each 1.06

8 ⅜" Phillips with 3" Blade. TL-715J. Wt. 4 oz. 94¢
Lots of 4-Up Each 87¢

9 ¼" Phillips with 4" Blade. TL-716J. Wt. 4 oz. 1.14
Lots of 4-Up Each 1.06

6-Pc. Screwdriver Set

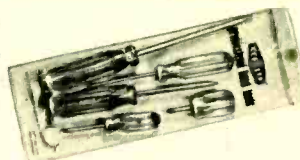

5⁸⁵

Includes four drivers for slotted screws (¼" x 4" blade, ⅜" x 6" blade, ¼" x 4" blade, and ⅜" x 6" blade) plus #1 Phillips/3" blade and #2 Phillips/4" blade. TL-712J. Wt. 2 lbs. 5.85

Nut Drivers

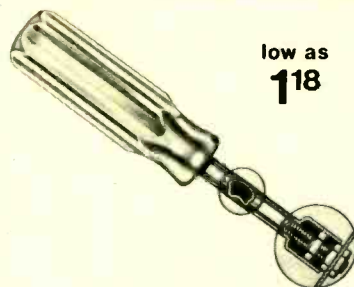

low as 1¹⁸

Steel shafts; precision cold-drawn, case-hardened sockets. Full hollow shaft. Blades 3⅜" long; 7¼" overall. Wt. 1 lb.

Stock No.	Size	EACH	
		1-3	4-Up
TL-704J	¼"	1.18	1.10
TL-705J	⅜"	1.18	1.10
TL-706J	1½"	1.18	1.10
TL-707J	⅝"	1.18	1.10
TL-708J	⅞"	1.38	1.30

7-pc. Nut Driver Set

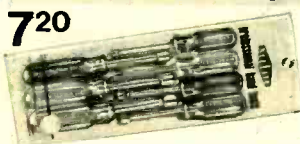

7²⁰

Seven drivers with 1¼" clearance hole depth. Includes: ⅜", ¼", ⅜", 1½", ⅝", ⅞" and ½" sizes. Plastic case. TL-711J. Wt. 2 lbs. 7.20

Magnetic Nut Drivers

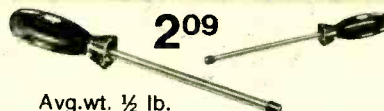

2⁰⁹

Avg. wt. ½ lb.

Stock No.	Hex Blade	EACH	
		1-3	4-Up
TL-709J.	¼" 6"	2.09	1.94
TL-710J.	⅜" 6"	2.09	1.94

Pocket Driver Sets



6⁴⁵

2⁵³

4⁶⁵

10 Nut Driver Set. 10 sizes, ⅜" thru ⅝". Special "piggyback" torque amplifier handle slips over top of color coded tools to provide increased driving power. Overall length, 3½". Plastic case. TL-718J. Wt. 1 lb. 6.45

11 Mini-Driver Kit. 5 slotted (.040" to .100"), ⅜" Phillips, torque amplifier handle. TL-720J. Wt. 1 lb. 2.53

12 Screwdriver Set. Five slotted, 3 Phillips, torque handle. TL-717J. Wt. 1 lb. 4.65

Tools For The Handyman Or Handywoman

Oneida

**NEW
Improved**

**Instant
Weld
Adhesive**

- One Component Only—No Mixing Required
- Economical—One Drop Covers A Sq. Inch

\$2

Hundreds of uses around home, shop or office! So versatile — bonds metal, glass, phenolics, rubber, ceramics and plastics. Sets at room temperature in seconds! So strong that it will hold up to 5000 lbs/in² tensile strength, but applies with fingertip pressure only (no clamps or fixtures). No heat needed. Does not use solvents.

TL-580J. Shpg. wt. ¼ lb. 4 Oz. Tube 2.00



Tape Drive Belt Kits

- With Ample Rubber Stock

All you need to make easy repairs on 8-tracks, cassettes, whether drive belt is round, flat, or square. With Instant-Weld Adhesive, jig for controlling cuts, razor blade and special cleaning compound.

Round Belts
XX-211J. Shpg. wt. 2 lbs. 19.95
Flat and Square Belts
XM-172J. Shpg. wt. 2 lbs. 19.95

19⁹⁵

Most-Used Service Aid Tool Kits

**12 WRENCHES
FOR ONLY
1⁵⁹**



**G-C Hex/Spline
Wrench Kit**

A complete wrench kit for both hex and spline type screws, used in the electronic field. Twelve wrenches all put up in a leatherette case. Will fit No. 2 to ¾" screws.
TL-631J. Shpg. wt. 1 lb. ... 1.59

**5 TOOLS
FOR ONLY
2⁴⁹**

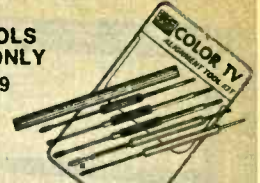

G-C

**Universal Color TV
Alignment Tool Kit**

Five different alignment tools for all standard adjustments in color TV. Made of Delrin in various colors for easy I.D. "Extend-it" to make long-reach aligners. Shpg. wt. 4 oz.
TL-632J. 2.49

6-Piece TV Alignment Tool Kit

Handy kit contains six of the most-wanted alignment tools for both color and black-and-white TV's. Each nylon tool has 2 working ends—you get 10 hex ends and 2 screwdriver tips in all. Fits most all IF & RF transformers. Designed for long, dependable use.
TL-683J. Shpg. wt. 2 oz. 1.69

1⁶⁹

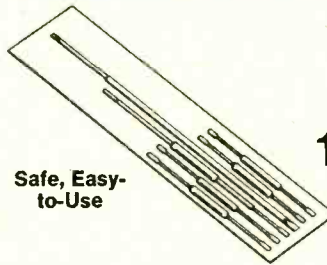

**Safe, Easy-
to-Use**

5²⁵

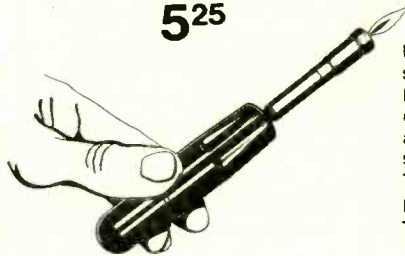

Mini Torch

Use for soldering, brazing, pipe, sweating, most light metal working. Has 3500° pinpoint flame, ½ hour fuel charge. Includes two fuel cartridges and a supply of solder. Complete with soldering tip. 5/8 x 7/8".

TL-515J. Shpg. wt. 1 lb. 5.25
Extra Fuel Cartridges, Pkg. of 4
TL-516J. 1.59

Here's How to "Tape-It-Easy"

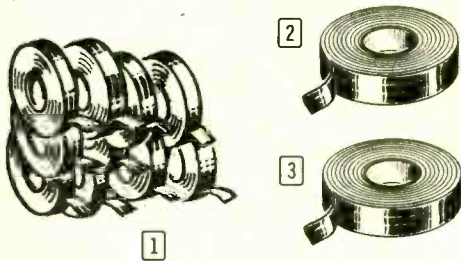

- Extra-Strong Adhesive
- Extra-Low Prices

1 10-Roll "Color-Pak"

Ten rolls of tape in ten different colors: yellow, orange, red, blue, green, navy, brown, black, gray & white. Over 330-ft. in all. Ideal for color-coding.
TA-584J. Shpg. wt. 1 lb. 4.56

2 PVC Electrical Tape

Vinyl tape with strong adhesive backing. Heavy-duty, industrial strength. Use for insulating wire. Comes in 66-ft. roll, ¾" wide. Stock up and save!
TL-268J. Wt. 4 oz. 4 for 6.00 Ea. 1.59

3 Tape With-A-Grip

Two-faced pressure-sensitive tape—fastens anything to any smooth, clean surface fast 'n' easily! You'll be assured of a long-lasting, firm bond.
TA-520J. Shpg. wt. 4 oz. 99¢

Olson Tools "Get It Together"!

4 7-Pc. Nutdriver Kit

A must for repairmen! Includes: 3/16", ¼", 5/16", 11/32", 3/8", 7/16", & ½" hex sockets. A bargain!
TL-174J. Shpg. wt. 4 oz. 3.98

5 Jewelers' Screwdriver Kit

Precision kit with easy-grip chuck handle, 5 interchangeable "mini" blades—3 standard, 1 Phillips & awl. With storage case.
TL-539J. Shpg. wt. 1 lb. 3.29

6 5-Pc. "Mini" Tool Kit

Popular tools for electronics and small repairs. Two screwdrivers—one with wire stripper, 1 Phillips, drill & awl. Ea. 4" L.
TL-474J. Shpg. wt. 4 oz. 2.00

7 6" Diagonal Cutter

Cuts all commonly used standard wire—from the finest to the toughest. Heavy-duty.
TL-007J. Shpg. wt. 8 oz. 1.49

8 6" Needle Nose Pliers

For radio & TV repair. With side cutters.
TL-005J. Shpg. wt. 4 oz. 1.49

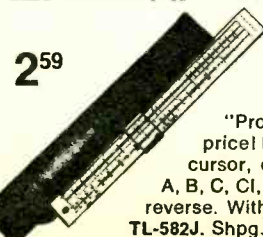
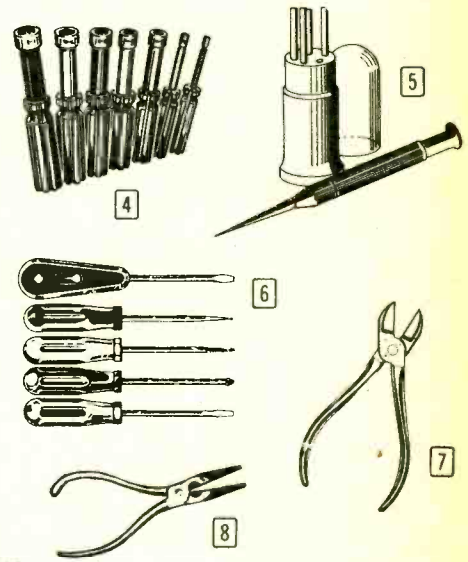

2⁵⁹

POST 10" Slide Rule

"Pro" features—student priced! High-accuracy glass cursor, engraved scales for A, B, C, Cl, D, K, plus S, L, T on reverse. With case, instructions.
TL-582J. Shpg. wt. 1 lb. 2.59



3⁹⁸

CONCISE Pocket Rule

VERY handy! Scale length equals 10". Has many conversion tables. Only 3 3/16" dia. With case. 4 oz.
TL-397J. 3.98

Automotive Test Equipment

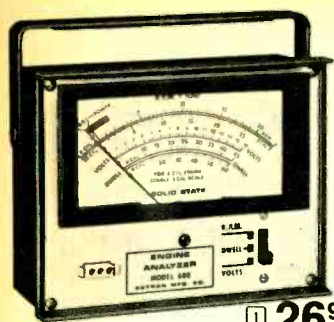

1 **26⁹⁸**

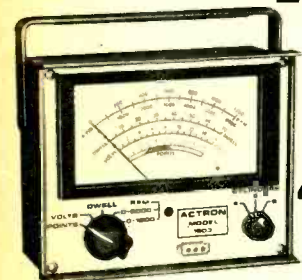

2 **44⁹⁸**

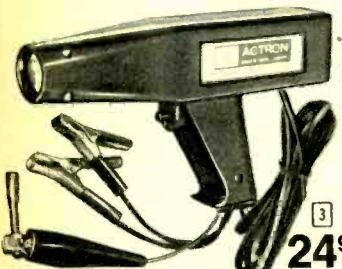

3 **24⁹⁵**

1 Dwell Tachometer
Model 600. Three instruments in one—dwell meter, tachometer and voltmeter. Checks engine rpm to 2500, idling, dwell to 60°, alternator and regulator operation, battery condition to 16 volts. Needs only 3-wire hook-up to battery and coil—powered by car battery. 5" meter. Solid state. 5¼" x 6¾" x 2½".
TE-250J. Wt. 5 lbs. 26.98

2 Universal Dwell/Tach
Model 1503. Professional quality tune-up tester gives direct readings on 4, 6 and 8-cylinder engines. Has 0-1200 and 0-6000 rpm scales, 0-70° dwell scale, 0-2 and 0-16 volt scales, plus point condition color zone scale. Wide-view 5" meter. Plug-in test leads. 5¼" x 6¾" x 2½"
TE-361J. Wt. 5 lbs. 44.98

3 DC Timing Light
Model L-100P. Checks ignition timing and distributor advance on 12-volt conventional, transistor or capacitive discharge systems. Xenon tube emits extra-bright blue-white flash—shows timing mark even in bright sunlight. Shock-proof Cyclocac case w/on-off switch. Solid State. With spark plug adapter.
AU-396J. Wt. 5 lbs. 24.95



Ersin Multicore 5-Core Solder

For any electronic soldering job! Made from pure virgin metals with 5 cores of extra-active, non-corrosive Ersin flux. The 5 cores are close to each other and at the perimeter, so there is only an ultra-thin wall of solder between the flux and the work . . . keeps the flux near the heat source for faster melting and more effective soldering. Delivers uninterrupted and vigorous fluxing action for evenly spread, reliable joints. The flux prewets the work and the wall of solder becomes instantly fluid, flowing rapidly and consistently onto the wire or metal. And the flux has loosened and removed the oxides that prevent efficient adhesion.



4 **4.19**



5 **79¢**



6 **79¢**

4 1-Pound Roll of Solder

Standard tin/lead alloy solder with 5 cores as described above. 60/40. TL-756J. Wt. 1 lb. 4.19

5 Dispenser Pak Solder
Flameproof aluminum dispenser pak lets you place the solder close to the heat for easy soldering. 18 gauge, 60/40 alloy, with 5 Ersin cores. TL-757J. Wt. 4 oz. 79¢

6 Printed Circuit Pak
Extra-thin 22-gauge (.028") solder in 60/40 alloy for PC boards, diodes and transistor work. Flameproof aluminum dispenser pak. 5 rosin cores. TL-758J. Wt. 4 oz. 79¢

Labelmakers and Kits for Home and Business



99¢



1⁴⁹

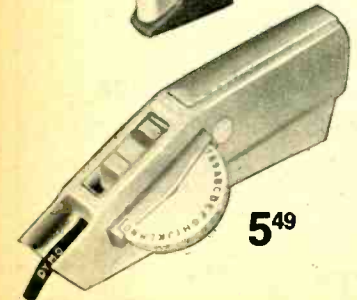

5⁴⁹

Mini Labelmaker
Model 1860. Pocket-size Labelmaker of durable Cyclocac. Has built-in cutter and special magazine holder for continuous labeling. Includes A-Z, 1-9 embossing wheel, ¾" x 12' vinyl tape. TL-751J. Wt. 1 lbs. 99¢

Home Labelmaker
Model 1800. Makes raised-letter labels that stick on wood, glass, metal, cement—almost anything! Uses ¾" vinyl or cloth tape. Easy loading; built-in cutter. Includes .180" high horizontal letter A-Z, 2-9 wheel. TL-752J. Wt. 2 lbs. 1.49

Home Labelmaker Kit
Model 1006-03. Mark VI Labelmaker is made of rugged Cyclocac, takes both ¼" and ¾" tape, has variable letter spacing. Kit includes .150" Dymo style horizontal letter wheel, vertical character embossing wheel, Script letter embossing wheel, plus a magazine of ¾" x 12' vinyl embossing tape. TL-753J. Wt. 2 lbs. 5.49



8⁴⁹

Deluxe Kit
Model 1006-05. Mark VI Labelmaker with horizontal, vertical and Script letter embossing wheels; 3 magazines vinyl and 1 cloth tape; carrying case. TL-754-J. Wt. 2 lbs. 8.49



21⁹⁹

Deluxe Tapewriter Kit
Model 1550-01. Includes chrome finish embossing tool; 2 tape magazines (¾" x 12' black and ¼" x 12' red); 3 letter wheels (.180" and .145" horizontal, .160" vertical); carry case. TL-755J. Wt. 3 lbs. 21.99

Cloth Marking Tape
Now you can make on-the-spot labels for soft things like shirts, socks, jackets. Durable cloth tape takes the heaviest washing. Easy "iron-on" or "sew-on." ¾" W x 72" L. TL-601J. Shpg. wt. 8 oz. 1.25

Vinyl Labeling Tape

Stock No.	Width	Lgth.	Color	Wt.	Each
TL-417J	¼"	6-ft.	Black	4 oz.	49¢
TL-418J	¼"	6-ft.	Red	4 oz.	49¢
TL-536J	¾"	12-ft.	Red	8 oz.	89¢
TL-537J	¾"	12-ft.	Black	8 oz.	89¢
TL-584J	¾"	12-ft.	Blue	8 oz.	89¢

LEADER Test Instruments for the Serviceman and Technician

Leader

Test Equipment



1 34⁹⁵



2 64⁹⁵



3 69⁹⁵

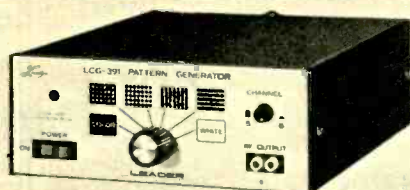

4 129⁹⁵

5 89⁹⁵



6 199⁹⁵

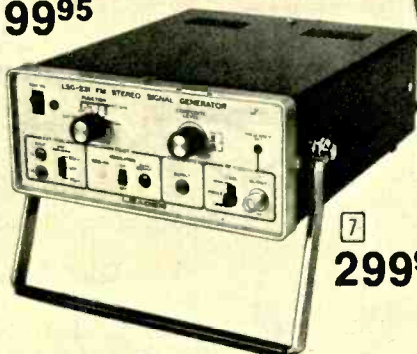

7 299⁹⁵



29⁹⁵

CRT High Voltage Test Probe

- No Batteries
- No External Power Source

Model LHM-80. Self-contained High Voltage Probe measures up to 30 kV, on any color or black-and-white TV set. Hi-impact polystyrene molded body has special safety divider. Input impedance: 20,000 ohms/V (50 μ A movement). Range: 30,000 volts. Accuracy: \pm 3% full scale. Multiplier resistance: 600 megohms. 14" long. With ground wire and heavy-duty test clip.

TE-287J. Shpg. wt. 1 lb. 29.95

Model LHM-81 Dual-Scale mA/HV Test Probe. Same as above, but also has 600 mA current measurement capability.

TE-288J. Shpg. wt. 1 lb. 34.95

1 Model LT-70 VOM. Offers unexpected accuracy and sensitivity. Reads as low as 0.25 V and 75 μ A full scale for measuring small, solid state DC voltage and current. Sensitivity is 20,000 ohms/V DC, 8000 ohms/V AC. Voltage: 0-0.25, 1, 5, 15, 50, 250, 1000 V DC; 0-10, 50, 250 V AC. Current: 0-75, 250, 750 μ A; 0-2.5, 7.5, 50, 75 mA; 0-2.5 A DC; 0-2.5 A AC. Resistance: 0-4k-40k-400k-4 meg-40 meg. Output: -20 to +22 and +20 to +36 dB. 4" W x 5 $\frac{3}{4}$ " H x 2 $\frac{1}{4}$ " D. Includes test leads and alligator clip adapters.

TE-368J. Shpg. wt. 2 lbs. 34.95

2 Model LV-71 FET VOM. Battery-operated VOM with polarity reversal and battery condition switches. Dual FET circuitry; diode overload meter protection. DC impedance, 10 megohms; AC, 1 megohm. 4 $\frac{1}{2}$ " taut-band meter. Voltage: 0-0.3, 3, 12, 30, 120, 600, 1200 V DC; 0-6, 30, 120, 300, 600 V AC. Current: 0-0.3, 3, 30, 300 mA DC. Resistance: Rx1, Rx100, Rx10k, Rx1 meg. Output: -20 to +17, +15 to +31 dB. 4" W x 6 $\frac{1}{2}$ " H x 2" D. With leads.

TE-369J. Shpg. wt. 2 lbs. 64.95

3 Model LSB-41 RC Substitution Box. Easy switch selection of 24 EIA standard 10% 1-watt resistors from 10 ohms to 10 megs; or 22 standard capacitors from 100 pF to 0.47 μ F at 500 WV, 100 μ F to 1000 μ F at 50 WV. 9 $\frac{1}{2}$ " W x 3 $\frac{1}{2}$ " H x 6 $\frac{3}{4}$ " D.

TE-370J. Shpg. wt. 5 lbs. 69.95

4 Model LCG-391 Color Bar Pattern Generator. Six extra-sharp patterns — color bars, dots, crosshatch, vertical and horizontal lines, and white raster for checking purity and white balance. Binary clock, digital circuitry for unmatched accuracy and stability. RF output: channel 5 or 6, switch selectable; 10 mV p-p. 6" W x 2 $\frac{1}{2}$ " H x 8" D. 117 VAC.

TE-367J. Shpg. wt. 3 lbs. 129.95

5 Model LDM-815 Transistorized Dip Meter. Battery operated; for rapid check of receivers, transmitters, antennas in 1.5-250 MHz range. Six plug-in coils, meter, earphone. 2 $\frac{3}{8}$ " W x 2" H x 7" D.

TE-371J. Shpg. wt. 2 lbs. 89.95

6 Model LBO-310 Solid State 3" Oscilloscope. General-purpose scope monitors waveforms to 100 MHz with direct connection. 300 mV p-p/division horizontal selection with 10 Hz to 100 kHz sweep (4 ranges), continuously adjustable. DC to 1 MHz vert. bandwidth; to 200 kHz horizontal. 117 VAC. 5" x 7 $\frac{7}{8}$ " x 12".

TE-365J. Shpg. wt. 10 lbs. 199.95

7 Model LSG-231 FM Stereo Generator. For checking separation, balance, alignment. Pilot signal of 19 kHz; \pm 2 kHz accuracy. 1 kHz audio signal is accurate to \pm 1% with separation at 50 dB. Output voltage: 0-3 V rms, continuously variable. 117 VAC. 8" W x 3 $\frac{1}{2}$ " H x 12" D.

TE-372J. Shpg. wt. 6 lbs. 299.95



349⁹⁵

5" Wideband Oscilloscope

Model LBO-511. Solid state oscilloscope/vectoroscope features recurrent high-linearity sweep with automatic synchronization; 0-140° phasing control; calibrated vertical input; high sensitivity. FET input stages assure rock-like stability; DC coupling and push-pull amplifiers for distortion-free displays. Vert. sensitivity: 20 mV/cm to 10 V/cm; bandwidth, DC or 2 Hz to 10 MHz. Horiz. sensitivity: 300 mV/cm with continuous adjuster. 117 VAC. 9 $\frac{7}{8}$ " W x 7 $\frac{3}{8}$ " H x 16 $\frac{1}{2}$ " D.

TE-366J. Shpg. wt. 15 lbs. 349.95

Olson Has Builder's and Experimenter's Supplies

Olson "Surprise-Pak" Bargains

A Ton of Value For **4.98**

A 20-lb. box of electronic goodies that is worth way more than we're selling it for. It contains most-wanted parts and hardware needed by the kit-maker, hobbyist, etc. Has resistors, knobs, hardware, capacitors, more.
XX-197J. Wt. 20 lbs. **4.98**
5-Lb. "Surprise" Kit.
XX-196J. Wt. 5 lbs. **2.49**



Save On These Hardware Assortments

Special Hardware Kit Buy

You'll find hundreds of applications for them at home in your workshop, or while on the job. Use for metal and wood workings, building chassis cabinets, just about anything. Generous assortment of screws, nuts, washers, bolts and more.
HW-076J. Wt. 1 lb. **79¢**

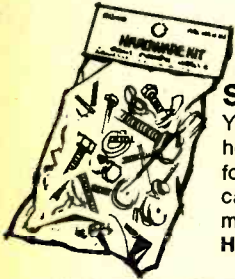

2.49

Screw and Nut Assortment

A must for every workbench! Generous supply of 1/4", 1/2", and 3/4" screws with matching nuts in case.
HW-073J. Shpg. wt. 1 lb. **2.49**

1.99

Sheet Metal Screw Assortment

Kit of 275 assorted screws used in radio and TV. Some Phillips, some hex head.
HW-074J. Shpg. wt. 1 lb. **1.99**

1.99

5-Lb. Hardware Kit

Generous assortment of screws, washers, nuts, clips, springs and more.
HW-075J. Shpg. wt. 6 lbs. **1.99**

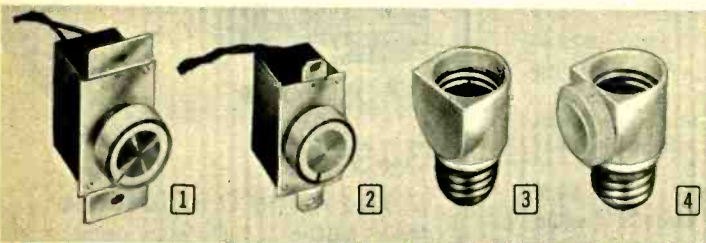

I.R. Solid-State Light Dimmers

You will find these dimmers an exciting addition to your home or office. Adds "atmosphere" at a flick of the wrist.

Stock No.	Fig	Type	Description	Watt	Each
XM-087J	4	CP102	Full-range lamp dimmer	150	5.85
XM-088J	4	CP104	Converts lamp to 3-way	150	5.40
XM-089J	3	CP106	Use reg. bulbs in 3-way lamp	150	3.75
XM-090J	1	CP212	Full-range, on-off switch	600	5.85
XM-091J	1	CP214	Full-range, rotary-switch	600	5.40
XM-092J	2	CP216	3-level dimmer	600	4.15
XM-093J	2	CP218	2-level dimmer	600	3.75
XM-094J	1	CP220	Full range, for lights controlled by 2 or more switches	600	8.25

Av. shpg. wt. 1 lb. each

2.98



Color TV Purifier Coil

Removes stray color impurities and fuzziness from picture. Just plug in to wall outlet next to TV. 117 VAC.
TV-143J. Wt. 1 lb. **2.98**

6-Ft. Line Cord



40¢

Two prong plug. 6' AC line cord.
WW-043J. Wt. 2 oz. **40¢**
3-Wire Heavy-Duty 8' Cord. For many uses where an electrical ground is desired. 18-gauge wire, vinyl jacket. 3 prong.
WW-567J. Wt. 1/4 lb. **1.05**

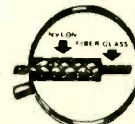

Calectro Nylon Drive Dial Cord

83¢

• **0.40" Dia.**
25-Ft. Spool

Exactly the same cord as used on RCA, Philco, and many other brands. Made of braided nylon over a spun glass core. Tough, long wearing. Pre-stretched and treated for long life.
XM-032J. Shpg. wt. 1/2 lb. **83¢**

Top Quality Universal Casters



1.29

Makes almost anything "rollable". Rugged construction, 1 3/16" mounting hole. 1 1/2" dia. 2 lbs.
XM-111J. . . Pkg. of 4, **1.29**
4 Packages **5.00**

Bargain Value 6-Digit Counter



2.99

Ideal for photoelectric systems. For any continuous counting situation—monitoring store customers, items coming off production line. Counts from 0 to 999,999. Mounts with 4 screws. Not resettable. 3 1/2" x 2 1/2" x 1 3/8". 117 VAC. Used.
XX-083J. 1 lb. **2.99**

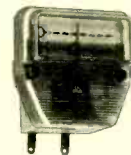

5 1.98



6 1.98

Popular Meter Values

These meters make ideal replacements for your present hi-fi, HAM or CB equipment.

5 Tuning Meter. For center-of-channel or maximum strength. 75-0-75 1/2 A For FM/AM radios, tuners. 1 3/8" x 1 1/4" x 7/8". Wt. 1 lb.
ME-184J. **Each 1.98**
3 for **Each 1.75**

6 Recording Level Meter. Just perfect for replacement on 8-track, reel-to-reel recorders. 0-150 μA; 1000 ohms/.V. 1 1/2" x 1 1/4" x 7/8". Wt. 1 lb.
ME-183J. **Each 1.98**
3 for **Each 1.75**

Keep Tapes "Fingertip Handy" with These Cabinets

crestmark
INDUSTRIES



Tape Cabinets Kustom Kreations

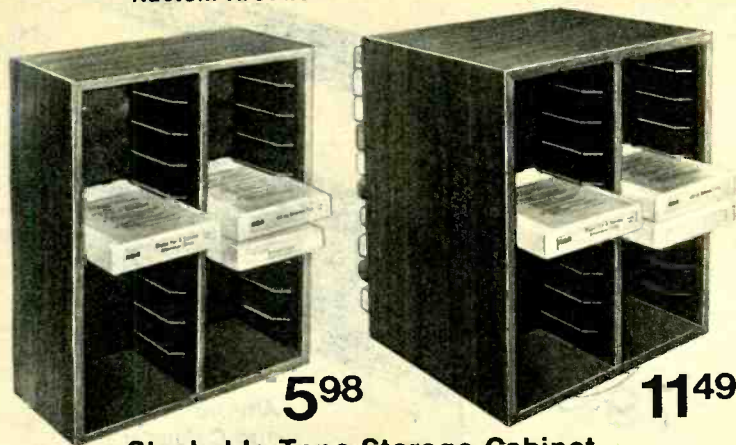

598

1149

Stackable Tape Storage Cabinet

Model 655. The ideal way for storing and handsomely displaying your tape library. The attractive cabinet has a furniture walnut vinyl finish. Holds 20 8-track cartridges. 11 x 10 $\frac{1}{8}$ x 2 $\frac{1}{4}$ "

CA-751J. Shpg. wt. 2 $\frac{1}{2}$ lbs. 5.98

CA-752J. **Model 665.** Above holds 24 Cassettes. wt. 3 lbs. 5.98

Lazy Susan Home Tape Entertainment Cabinet

Model 650. Holds 40 8-track cartridges. Just swivel-it-around on the polished stainless steel base (8 $\frac{1}{8}$ " dia.) and get the tape you're looking for in seconds. Walnut vinyl finish. 11 x 10 $\frac{1}{2}$ x 3 $\frac{3}{4}$ ".

AU-296J. Shpg. wt. 5 lbs. 11.49

CA-754J. **Model 660.** Above, holds 48 Cassettes. 6 lbs. 11.49

Holds 48
Cartridges

888



- Swivel Base
- Durable and Scuff Resistant

"Tape Carousel" Storage and Display Cabinet

The convenient way to maintain your home tape library. Same as used in many professional recording studios. Just turn the swivel base and you'll be listening within seconds to the music of your choice. Holds 48 8-track cartridges. Shipped knocked down and ready for easy assembly within minutes.

CA-756J. Shpg. wt. 4 lbs. 8.88

CA-755J. Above, holds 48 Cassettes. 8.88



Tape Storage For Carry or Home Use

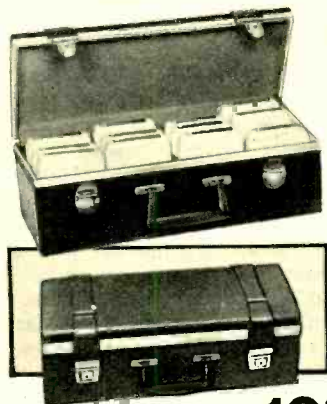

10.90

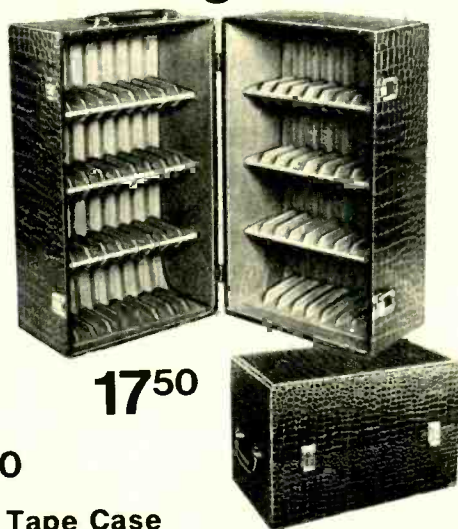

17.50

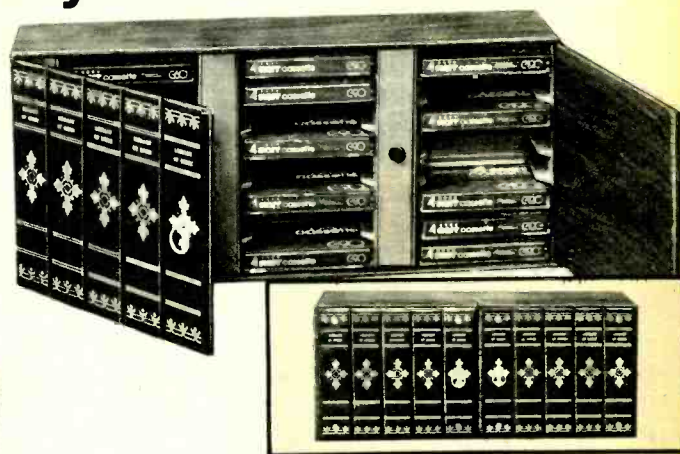

9.50

Contemporary Designed Tape Case

- Carry-Handle For Easy Portability
- Great For Use Between Home and Car

Model TA-114. Carry your tapes in style while protecting them from dust, dirt 'n' damage. Holds 24 8-track cartridges in individual red velvet flocked compartments. Black vinyl casing. Aluminum trim.

CA-748J. Shpg. wt. 4 $\frac{1}{2}$ lbs. 10.90

CA-747J. **Model TA-112.**

Holds 15 8-tracks. Shpg. wt. 4 $\frac{1}{2}$ lbs. 8.80

CA-749J. **Model TA-116.**

Holds 30 8-tracks. Shpg. wt. 5 $\frac{1}{2}$ lbs. 12.80

CA-750J. **Model TA-118.**

Holds 30 Cassettes. Shpg. wt. 5 $\frac{1}{2}$ lbs. 10.20

Portable 8-Track Cabinet

- Holds 72 8-Track Cartridges
- Carry-Handle For Easy Moving

Model TA-126. A very versatile companion to have with you when traveling or partying. Easily portable but holds 72 cartridges — enough music for ANY occasion! Display it upright as a shelf storage cabinet at home. The black alligator exterior and velvet flocked interior make it as pretty as it's practical.

CA-746J. Shpg. wt. 6 lbs. 17.50

Home Tape Storage Cabinet

- Sturdy Construction
- Walnut Vinyl Covering

Model TA-142. Makes not only a great storage cabinet for your tapes, but also a proud addition to your room decor. Holds 24 cassette tapes. With simulated leatherette front, gold lettering and trim. 18 x 6 $\frac{3}{4}$ x 3 $\frac{3}{4}$ ".

CA-745J. Shpg. wt. 6 $\frac{1}{2}$ lbs. 9.50

CA-744J. **Model TA-144.** Same as above, holds 24 8-track cartridges. 9.50

mits

Build-'em Yourself "Information" Kits

Kit Savings + Versatility + Accuracy = VALUE!

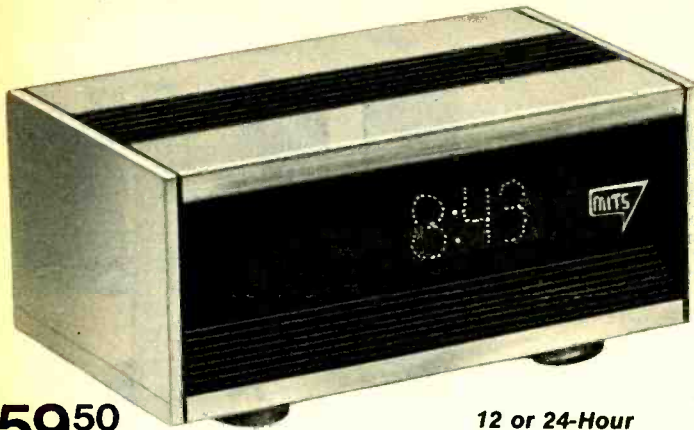
**59⁵⁰****12 or 24-Hour
Operation**

6-Digit LED Electronic Clock Kit

Model DC-6. A "space-age" device that's easy and fun to build — gives you a digital LED readout of the hours, minutes and seconds — with "computer-like" accuracy thanks to its *totally silent* all-electronic movement. Has large numerals for easy visibility at home or office, large-scale integrated circuits and double sided-fiberglass PC boards that make assembly really easy, 1/8" brushed and anodized aluminum case. 3 time set buttons, 12-hour operation with leading zero suppression, standard 24-hour operation. 4 x 3 x 5". For 117 VAC, 50 or 60 Hz.

KB-304J. Shpg. wt. 2 lbs. **59.50**

XM-097J. Factory Assembled Version of Above. Wt. 2 lbs. **89.95**

**79⁹⁵****Alternates Time
and Calendar Date**

Electronic Day/Date Clock Kit with Alarm

Model DC-100. Really versatile instrument shows the time and date in a bright 6-digit LED (light emitting diode) display. Has built-in alarm circuit with auxiliary timer — use as regular alarm clock, turn appliances on or off at pre-set times. Unique sequential display shows time (hours, minutes and seconds) for 8 seconds, date for 2 seconds continuously. Has a "snooze alarm" — type 10-minute alarm reset, 12 or 24-hour operation. Provision for external oscillator on one-chip 60 Hz back-up clock. Stylish brushed and anodized aluminum case. 4 x 3 x 5". For 117 VAC, 50 or 60 Hz.

KB-347J. Shpg. wt. 2 lbs. **79.95**

**199⁹⁵**

These kits include pre-cut and pre-stripped wire, IC with sockets, full instructions with exploded views and schematics for fool-proof assembly.

"Pro" Capability 14-Digit Desk Calculator Kit

Model 1440. For the person who needs fast and accurate answers to complex problems — here's the calculator that's got them! 14-digit readout means you can handle large-figure problems. Four arithmetic functions PLUS square and square root cover geometrics, logs, formulas etc. Has constant AND independent memories, exchange operations key, decimal and negative number entry. It's one of the most versatile calculators you can buy — and the price is really low because you build it yourself! 8 3/4 x 4 x 12 3/4". For 117 VAC.

KB-300J. Shpg. wt. 5 lbs. **199.95**

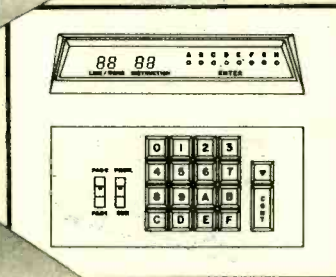
**EASY Assembly!**

Computer Programmer Kit

Turn either of these calculator kits into a desk-top computer. Accessory device lets you enter up to 256 program steps for automatic operation of complex calculations. Has instructions for assembly, branching, transfer, return — 16-key array for hexa-decimal entering, 8 annunciator lights for identification of programmed pauses. Use expansion device below for 512 steps.

XM-246J. Model 1440P. For 1440 above. Wt. 5 lbs. **199.95**

XM-247J. Model 816J. For 816 below. Wt. 5 lbs. **199.95**

XM-248J. Expansion Device. For either above. 5 lbs. **79.95**

**139⁹⁵**

4-Function Calculator Kit with 16-Digit Readout

Model 816. Buy it, build it and figure on big savings — because this calculator will pay for itself in time, trouble and error-elimination! Features big 16-digit answer capacity and 8-digit readout — has keys for equals, decimal point, clear entry, clear, decimal select and alternate display, numbers and arithmetic functions. Stored constant for series calculations with a single figure. Easy-to-read display with error indication. 8 3/4 x 4 x 12 3/4". For 117 VAC.

KB-301J. Shpg. wt. 4 1/2-lbs. **139.95**

Electronic "Tools of Knowledge" from **MITs**

Hand-Held 8-Function Calculator

Model 150. About the size of a paperback, but filled with the answers you need for even very complex calculations. It's the pocket calculator for engineers, math majors, scientists, accountants, people who NEED fast answers. Features selectable floating or fixed decimal (with entry at any of seven positions), algebraic logic for automatic negative-number answers, big 16-digit answer capacity with 8-digit readout. Has memory register for instant storage and retrieval of figures (also can be used as stored constant), automatic roundoff in fixed decimal mode, lots more. Special display blanks after 60 seconds to conserve battery life (restores instantly at the push of a button). Low battery indicator too. Operates on four penlight batteries (order below), AC with optional adapter. High-impact case, 3¼ x 5¾ x 1½".

XM-244J. Fully Assembled. 1½ lbs. **119.95**
KB-346J. Above, Kit Form. 1½ lbs. **99.95**
BA-219J. AC Adapter for Above. 1 lb. **7.95**

119⁹⁵ Fully Assembled
8 Math Functions!

- \sqrt{x} **Calculates Square Root of Any Number**
- x^2 **Multiplies a Number By Itself with Single Entry**
- $\frac{1}{x}$ **Instant Reciprocals for Fraction Problems**
- % **Figures Percentages for Interest, Mortgages, Taxes, Etc.**
- + **Addition**
- - **Subtraction**
- X **Multiplication**
- ÷ **Division**



Pocket Calculators with 12-Digit Capacity

Model 1206. The ideal calculator for students, housewives, businessmen. Adds, subtracts, multiplies, divides — instantly, accurately, electronically. Has pre-set decimal with automatic roundoff, clear key to erase previous entry only, clear entry key to erase all entries. Display cutoff saves batteries. Does chain and mixed calculations, shows true credit balance. A practical work saver for just about everyone! Order five batteries and AC adapter below. 5¼ x 3¼ x 1½".

XM-108J. With 6-Digit Display. Shpg. wt. 1 lb. **59.95**

Model 1212. Same fine features as above, but has 12-digit answer capacity with 12-digit display.

XM-110J. Shpg. wt. 1 lb. **99.95**

59⁹⁵ 6-Digit Display

99⁹⁵ 12-Digit Display

- **Easy-to-Use Telephone-Type Keyboard**
- **Bright, Easy-to-Read Digital Display**
- **Special Battery-Saver Display Cutoff**
- **Compact Size — Goes Just About Anywhere**



Carrying Case

Rugged, velvet-lined case for all calculators above. Offers protection from dust and dirt, cushioning if dropped. Wt. 1 lb.
CA-607J. 2.49

Calculator Batteries

Long-life penlight batteries for use with calculators above. Use five for models 1206 and 1212, four for Model 150 (kit or wired).
BA-196J. ½ lb. Pair 1.08



AC Adapter

Permits operation of Models 1206 and 1212 from standard 117 VAC house current. Has jack and plug for calculators, AC line cord.
BA-219J. 1 lb. 7.95

calculators by **TEXAS INSTRUMENTS**

11 Function 10-Digit Model

- **Fixed or Floating Decimal**
- **Positive and Negative Number Entry**
- **11 Full Functions**
- **Entry and Overflow Indicators**

179⁹⁵



Model SR-20. Engineering desk-top calculator — versatile enough for the most complex calculations, simple enough for anyone to use. Adds, subtracts, multiplies, divides, figures square roots, percentages, reciprocals, and squares. Has special process keys for INT-X, X², \sqrt{x} , X^{1/x}, $\frac{1}{x}$, π , and e logo. 6¼ x 8¼ x 2¾". For 117 VAC. With dust cover.
XM-252J. Shpg. wt. 2 lbs. **179.95**

10-Digit Desk Model

- **Chain/Constant Switch**
- **3-Position Decimal**
- **Automatic Roundoff**
- **Shows True Credit Balance**
- **Eliminates Zeroes at Left of Answer**

84⁹⁵

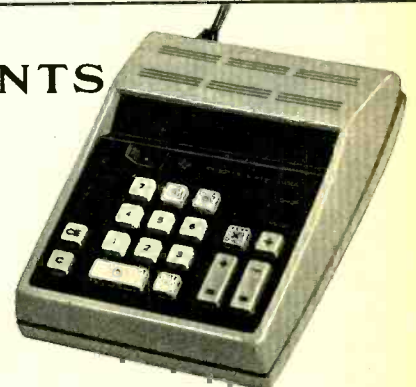

Model TI-3500. Low-priced desk calculator has full four-function capability including chain and mixed calculations, floating or pre-set decimal, easy-to-read 10-digit display. Latest circuitry, streamlined styling. 6¼ x 2¾ x 8¼". For 117 VAC. With dust cover.
XM-145J. Shpg. wt. 2 lbs. **84.95**
XM-253J. Above, with 12-Digit Display, memory and % Keys. **169.95**

Portable and Desk Model Calculators

UDM UNIVERSAL DATA MACHINE



1 **69⁹⁵**



2 **84⁹⁵**



3 **99⁹⁵**

1 9-Digit Hand Held Model

Model 9V9. Students, accountants, housewives, here's a model that's on-the-job anywhere. Use it at home with the 117 VAC adapter, "in-the-field" with 9-volt transistor radio battery (included). Has big 9-digit capacity—adds, subtracts, multiplies, divides—instantly, silently, electronically! Performs chain and mixed calculations, shows true credit balance, has a clear entry key to erase last entry, clear key to clear machine completely. 2-position decimal, easy-to-read bright red display. High impact plastic case, 3¼ x 6 x 1½". With vinyl carrying case. **XM-143J.** Shpg. wt. 2 lbs. **69.95**

2 Stored Component Model

Model TKB02. Offers the most advanced method of handling calculations that exceed its 8-digit capacity—features stored component and floating decimal to allow numbers in the range of 10^{79} to 10^{-20} to be entered and handled! When doing large number calculations, the absence of a decimal point shows that the answer exceeds 8 digits—simply divide by 10 until the decimal point appears to establish how many digits are in your answer. Has all other standard features including stored constant for series calculations with the same number. 3¼ x 6 x 2". With batteries and AC adapter. **XM-233J.** Shpg. wt. 2 lbs. **84.95**

3 8-Digit with Floating Decimal

Model TKB-001. Very easy to read—boasts a visual field approximately three times the size of others! Features automatic display cutoff after 20 seconds (restores immediately at the touch of a button) really helps conserve battery life. Floating decimal point with automatic roundoff of answers over 8 digits, automatic entry and result overflow indication, automatic credit balance and constant or chain capabilities. Includes built-in rechargeable NiCad battery pack, 117 VAC adapter/charger. It's the one you need for tax work, grocery list checking, any arithmetic work. 3¼ x 6 x 2". **XM-231J.** Shpg. wt. 2 lbs. **99.95**

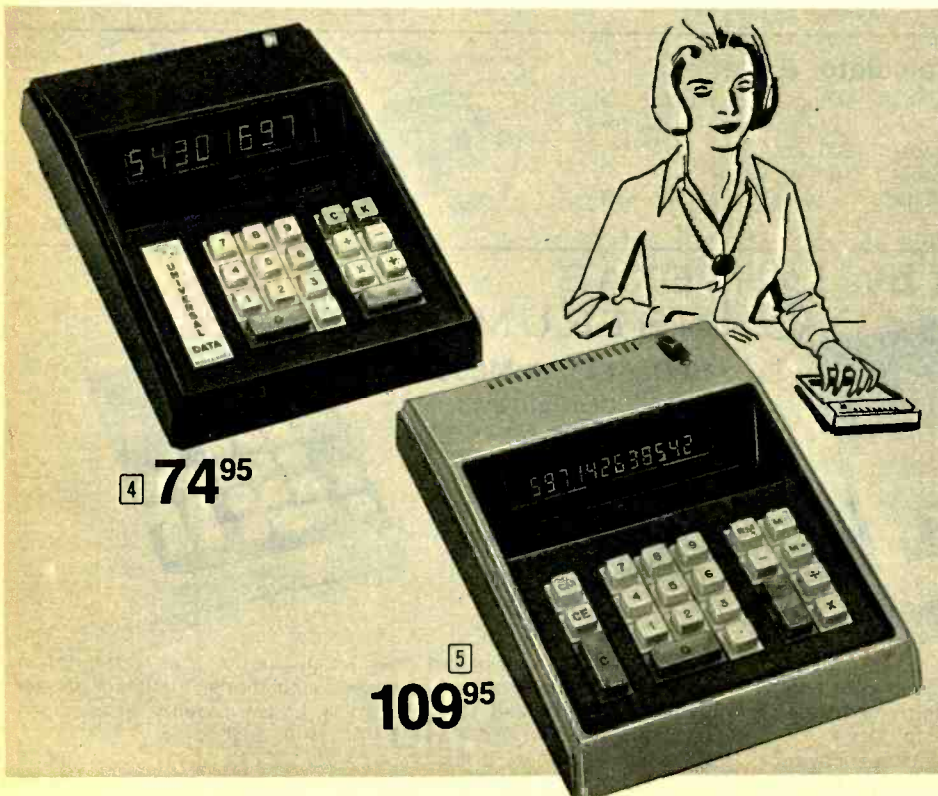

4 **74⁹⁵**

5 **109⁹⁵**

4 8-Digit Desk-Top Calculator

Model 8TK-1. Ideal for all kinds of general office work — price calculations, invoicing, purchasing — features a brilliant large display area with numbers slanted upward for really easy reading. Has stored component feature — handles numbers from 10^{-20} to 10^{76} ! Has individual function keys, separate key, single key for Clear and Clear entry functions. Large, raised keys for easy operation without fatigue. Stored constant function for series calculations with the same number. Negative indication for true credit balance, floating decimal system. 3 x 7 x 10". With dust cover. For 117 VAC. **XM-232J.** Shpg. wt. 4 lbs. **74.95**

5 12-Digit with Memory Feature

Model 12-TM12. The perfect businessman's calculator. Memory capability lets you store sub-totals for use in further calculations—ideal for computing commissions, payroll applications such as overtime and deductions, etc. *Stores and recalls both plus and minus totals!* Has pre-set decimal entry (any position from 0-5), decimal entry for floating decimal system, easy-to-use raised function keys and brilliant easy to read display. Big 12-digit answer capacity. 7 x 3 x 10". For 117 VAC. With dust cover. **XM-234J.** Shpg. wt. 5 lbs. **109.95**

"Space-Age" All-Electronic Digital Calculators



These machines give you the answers, lightning fast, to all your arithmetic questions. They add, subtract, multiply, divide, show credit balance, more. They're perfect for income tax figuring, checking grocery lists, balancing bank accounts, etc. There's one here for you!

1 Shirt-Pocket Size with 8-Digit Readout

Model K16. A marvel of modern electronics measuring a mere 2½ x 4 x 1½" and weighing just 8¼ ounces. Performs standard arithmetic functions plus chain and mixed calculations, algebraic problems with automatically correct number sign, constant calculations with pre-set multiplier or divider. 16-digit calculating capacity with 8 digit readout. Has automatic zero suppression (zeroes to left of answer are cancelled), large, easy-to-use keyboard, clear entry and clear key, constant switch, on-off switch, decimal entry key.

XM-151J. Shpg. wt. 9 oz. 3-Up .. Each 87.00 .. Each 89.95



89⁹⁵

1



119⁹⁵

2

2 Truly Tiny with 10-Digit Readout

Model MB-10. Slim-line style lets this one go anywhere with ease—just 5/8" deep, 2½ x 3¾". Weighs a scant 5½ ounces. Performs standard functions PLUS constant multiplication or division, chain or mixed calculations. Special sign indicators show overflow, error, battery condition, credit balance—minus key serves both as subtraction key, negative number multiplier. Has clear entry key for erasing previous entry, clear key for clearing entire machine (including stored constant), decimal entry key. Floating decimal. Easy to read LED 10-digit display. Uses 6 "AA" penlight cells.

XM-183J. Shpg. wt. 6 oz. 3-Up .. Each 117.00 .. Each 119.95



AC Adapter/Charger, Carry Pouch, Included with All Portable Models Except 2

3 8-Digit Readout with Memory

Model K08M. Advanced calculator features memory storage and retrieval, % key for fully automatic percentage figuring, decimal entry key to pre-set decimal in any of eight positions with automatic roundoff or in conventional floating system. Has eight-digit entry and readout with 16-digit calculating capacity: error, low-battery indicators, unwanted zero suppression, more. Performs mixed and chain calculations, shows true credit balance automatically. Measures just 2½ x 4 x 1½", weighs just 8¼ ounces. Fully functional on AC or DC power.

XM-184J. Shpg. wt. 9 oz. 3-Up .. Each 97.00 .. Each 99.95

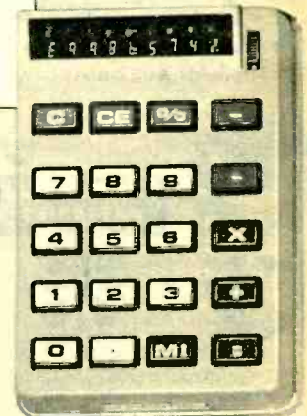

99⁹⁵

3

4 8-Digit Readout with Square Root Function

Model SE88M. For engineers, chemists, anyone who requires 16-digit arithmetic functions PLUS memory, squares, square roots and reciprocals—instantly, electronically, accurately. Has preset decimal positioning with automatic roundoff, memory storage and retrieval, algebraic entry, direct negative entry, suppression of unwanted zeroes in floating decimal mode. Has magnified LED display for easy reading, easy-to-use telephone type entry keys, automatic overflow protection, low battery indicator. 2½ x 4 x 1½", weighs 8¼ oz.

XM-185J. Shpg. wt. 9 oz. 3-Up .. Each 135.00 .. Each 139.95

XM-239J. Model SRQ-16M. Above, less percentage key.

3-Up .. Each 115.00 .. Each 119.95



139⁹⁵

4

5 Desk-Top Model for Professional Users—12-Digit Readout with Memory

Model S1224. Especially designed for all-around office use—accounting, sales invoicing, estimating, more. Features memory storage and retrieval with special *memory modification*—add or subtract from stored numbers without clearing memory! Has basic function keys with minus doubling as negative entry key, constant storage of multiplier or divider, special "EX" key lets you recall the last entry in a chain calculation to regain your place. % key for instant percentage calculations, "AM" switch for automatic accumulation of totals even when running a series of mixed or chain calculations—decimal key for entry of decimal numbers. Automatic overflow protection—keyboard locks when entries exceed capacity. Has easy-to-operate keyboard with finger-contoured keys, large 12-digit readout with automatic zero suppression, minus and overflow indicators. 10 x 7½ x 2¾". For 117 VAC.

XM-186J. Shpg. wt. 3 lbs. 3-Up .. Each 240.00 .. Each 249.95



249⁹⁵

5

Long-Life Batteries for Every Use

BATTERY SELECTION TIPS: These batteries are carefully engineered to provide maximum performance in electronic products, flashlights and toys. If you are a substantial battery user, your greatest economy is with rechargeable nickel-cadmium cells. Keep

one set charging while the other is in use. Where reliability and high retention of power during storage is required, use alkaline energy batteries. For all other purposes, general purpose or heavy-duty supercells will give excellent value in terms of cost per hour.

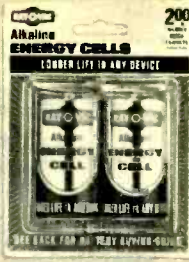

"D" Cell

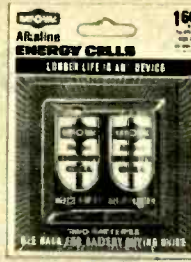

"C" Cell

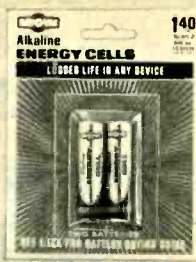

"AA" Penlight

Alkaline Energy Cells You'll be amazed at the extra hours of service you'll get from these long-life cells. Longer life in any device than ordinary batteries. Use with virtually anything that's battery-powered.



"D" Cell



"C" Cell



"AA" Penlight



9V Transistor

Heavy-Duty "Super Cells" You'll get up to 110% longer service life than general-purpose batteries for instant power when you need it! Sealed to provide protection in handling and against leakage. Fit popular-size flashlights and battery-powered devices.



"D" Cell



"C" Cell



"AA" Penlight



Battery Charger

Rechargeable Nickel-Cadmium Cells Eliminate constant replacing of dead or weak batteries. Nickel-Cadmium cells can be used over & over—up to 3 years in normal use! Recharge up to 1000 times with battery charger at right. Available in standard sizes.



"D" Cell



"C" Cell



"AA" Penlight



9V Transistor

General Purpose The standard of the industry! Regular zinc-carbon batteries sealed in steel to provide long, long shelf life plus protection against corrosive leakage. Fit most portable radios, flashlights, etc.

Stock No.	Description	Replaces Mallory	Shpg. Wt.	Price
BA-194J	Two 1½-Volt "D" Alkaline High-Energy Cells. Guaranteed Against Leakage.	MN1300	½ lb.	Pair, 1.53
BA-195J	Two 1½-Volt "C" Alkaline High-Energy Cells. Guaranteed Against Leakage In Any Device!	MN1400	½ lb.	Pair, 1.23
BA-196J	Two 1½-Volt "AA" Alkaline Energy Cells.	MN1500	½ lb.	Pair, 1.08

Stock No.	Description	Replaces Mallory	Shpg. Wt.	Price
BA-205J	Two "D" Cells. Guaranteed Against Leakage.	—	½ lb.	Pair, 63¢
BA-206J	Two "C" Cells. Guaranteed Against Leakage.	—	½ lb.	Pair, 63¢
BA-207J	Four "AA" Penlight Cells.	—	1 lb.	4-Pak, 90¢
BA-193J	9-Volt Rectangular Transistor Radio Battery. Anti-Corrosive Caps.	—	¼ lb.	Each, 73¢

Stock No.	Description	Replaces Mallory	Shpg. Wt.	Price
BA-197J	Two Rechargeable Nickel Cadmium "D" Batteries	—	½ lb.	Pair, 5.52
BA-198J	Two Rechargeable Nickel Cadmium "C" Batteries	—	½ lb.	Pair, 5.52
BA-199J	Two Rechargeable Nickel Cadmium "AA" Penlight Cells.	—	½ lb.	Pair, 5.52
BA-200J	Deluxe Battery Charger for Nickel Cadmium Batteries. Charges different sizes at same time. U.L. listed.	—	3 lbs.	9.82

Stock No.	Description	Replaces Mallory	Shpg. Wt.	Price
BA-201J	Two "D" Cells. Guaranteed Against Leakage In Flashlights.	M13F	½ lb.	Pair, 48¢
BA-202J	Two "C" Cells. Guaranteed Against Leakage In Flashlights.	M14F	½ lb.	Pair, 48¢
BA-203J	Two "AA" Cells.	M15F	½ lb.	Pair, 42¢
BA-204J	9-Volt Rectangular Transistor Radio Battery. Anti-Corrosive Caps.	M1604	¼ lb.	Each, 66¢



Battery Chargers That Give Your Cells "A New Lease On Life"

Home Battery Charger

- Charges 4 Batteries At Once

Model PNC-12. Charges any combination — to 4 batteries — AA, C, D, 9-volt transistor. With battery tester. 9 1/2" x 3 5/8" x 2 1/8". U.L. listed, for 117 VAC. BA-103J. Shpg. wt. 3 lbs. 4.98



Automatic Home Battery Charger

- Cannot Overcharge

Model PNC-13. Automatically reduces charging rate. Charges 4 batteries at a time. Transistor compartment, batt. tester. UL listed. For 117 VAC. 11" x 4 1/8" x 2" AA, C, D, 9V. BA-154J. Shpg. wt. 3 lbs. 8.98

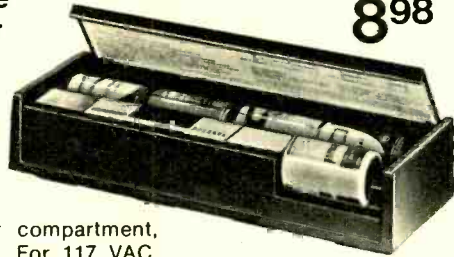

Lantern Battery Charger

Model PNC-11M. Ideal for outdoor equipment, etc. Recharges 6-7 1/2 volt lantern batteries automatically. Cannot overcharge! UL listed. 2 1/2" x 2 1/2" x 2". BA-225J. Shpg. wt. 2 lbs. 6.95

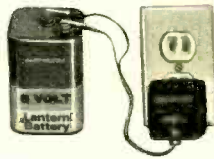

4.98

8.98



Power Packed Batteries for Best Performance, Extra-Long Life!

Stock Up and

SAVE

Low As

8c

Each



Toshiba batteries are definitely NOT ordinary batteries. They are made with extra care to stay fresher longer and deliver absolute maximum power! They are available in the four most popular sizes. Stock up and economize!

Stock No.	Size	Volts	Shpg. Wt.	Each	Quantity Price
BA-189J	"D"	1.5	4 oz.	18c	2 for 35c
BA-190J	"C"	1.5	4 oz.	16c	2 for 30c
BA-191J	"AA"	1.5	2 oz.	8c	10 for 75c
BA-192J	9V Rect.	9	4 oz.	29c	3 for 75c

Mercury "Button" Batteries

These miniature sized batteries provide high energy and constant voltage



Stock No.	Toshiba	Replaces	Shpg. Wt.	Each
BA-224J.	H-C	RM-675	3 oz.	60c
BA-228J.	H-B	RM-400	3 oz.	60c
BA-226J.	H-D	RM-625	3 oz.	70c
BA-227J.	H-P	RM-IR	3 oz.	1.50
BA-237J.	H-S-D	PX-13	3 oz.	.88

Voltage Converters and Adapters

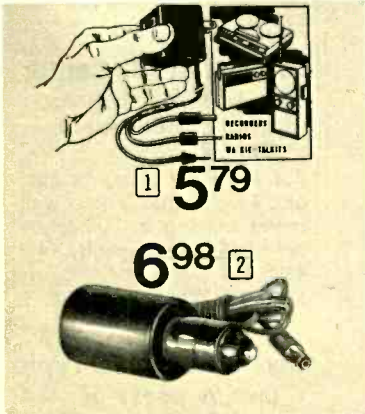

1 5.79

6.98 2

1 AC to 6/9 VDC Adapter. Run battery-powered equipment from regular house current. Adapters for mini, micro, coaxial types. Output, 6 V at 200 mA, 9 V at 150 mA. 2 1/4 x 1 1/4 x 1 1/2".

BA-159J. Wt. 1 lb. 5.79
4.5, 6, 7.5, 9, 12 VDC ver. 300mA.
BA-170J. Wt. 1 lb. 8.88

2 DC Power Converter. Lets you operate 6 or 9-volt transistor radios, recorders, etc. from 12 volt car battery. Plugs into cigar lighter receptacle for constant full power — saves batteries. 300 mA. 12 VDC neg. grd.

BA-166J. Wt. 1/2 lb. 6.98



4.98

AC-To-6 VDC Adapter

Converts 117 VAC to 6 VDC. Powers 6 VDC transistor radios, walkie-talkies, recorders from standard house current. Has 3-way plug — 2.5 mm, 3.5 mm and inverted power. 300 mA output. Positive or negative ground. Small enough to use anywhere, great for travellers. 2 x 2 3/4 x 1 5/8". BA-186J. Wt. 8 oz. 4.98

Olson Authentic Battery Checker

- Reads From 0-240 Volts in 12 Ranges

Much more than an ordinary battery checker because it does more than measure voltage or current. This instrument determines the true working condition of any battery under actual-load conditions, on 7 different ranges, up to 15 volts. Above 15 volts, the checker tests under no-load conditions. DC Ranges: 1.5, 3, 4.5, 6, 7.5, 9, 15, 22.5, 45, 67.5 and 240 volts. Has GOOD-?-REPLACE scale. Two-jewel meter movement. 24" leads. 3 5/8 x 5 1/4 x 2".

TE-237J. Wt. 2 lbs. 13.89

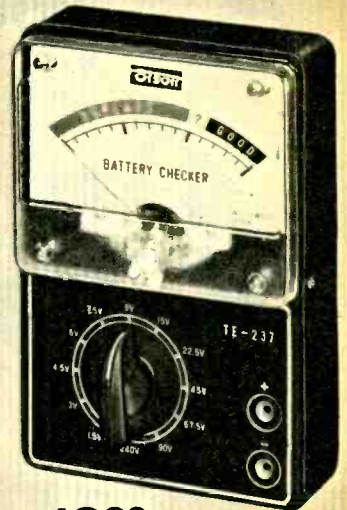

13.89

4.20

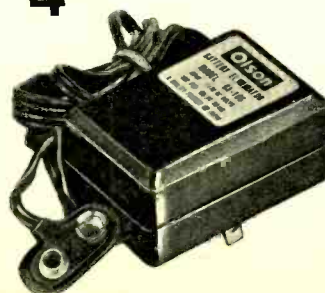

9-Volt Battery Charger Eliminator

Converts 9-volt transistor portables to standard AC operation. Recharges weak AC batteries so they can be used over and over again. Plugs directly into wall outlet. Replaces 2U6, VS-213, 216, 1604 and Toshiba BA192. 2 1/2 x 1 1/4 x 3/8".

BA-106J. Wt. 1 lb. 4.20

Olson The Place for Top Value Power Supplies



29⁹⁸ 1 Variable Voltage DC Supply

Great for the handyman or professional. Provides reliable power for any type solid-state device. Use as battery eliminator too. 0-24 VDC output at 1 ampere. Has adjustable output voltage control, power on/off, 0-12V and 12-24V selector switches, voltage/current meter. Fuse protected. Binding post terminals, 7 1/4 x 3 3/4 x 5 1/2". 117 VAC. BA-145J. Shpg. wt. 5 lbs. 29.98



22⁹⁸ 2 Highly Filtered DC Supply

12 VDC output at 2 amps. Ideal for servicing car tape players, radios, CB units at home. Well filtered DC output for steady power with no harmful current surges. Solid-state, stabilized with fuse protected circuitry. On/off switch, binding post terminals. Metal enclosure has "workshop" durability. 4 1/4 x 3 3/4 x 7". For 117 VAC. BA-161J. Shpg. wt. 5 lbs. 22.98



10⁹⁸ 3 Universal AC-to-DC Converter

Converts 117 VAC to 4.5, 6, 9, or 12 VDC Powers battery items from house current. Pilot light, alligator clip leads. 3 1/4 x 2 x 4". (not for car tape players.) 400 mA. BA-155J. Shpg. wt. 3 lbs. 10.98



8⁷⁷ 4 Low-Current DC Power Supply

Battery eliminator too! 4.5, 6, 9, 12 VDC at 140 mA. Binding post terminals, AC cord. (Not for car tape players) 5 1/8 x 2-3/8 x 2 3/8" BA-133J. Shpg. wt. 3 lbs. 8.77

Franzus

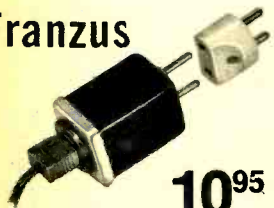

"International" Voltage Converters

Pocket size! 220-240 VAC to 110-120 VAC 50 or 60 Hz. Adapts U.S. heating & motorized appliances worldwide. 1000-watt capacity. 3 1/2" long. XM-009J. Shpg. wt. 8 oz. 10.95
Same as above, for strobes, battery packs, etc. With British adapter. 90-watts. XM-095J. Shpg. wt. 8 oz. 10.95

10⁹⁵



6/12 Volt Battery Charger

Fully charges any 6 or 12 volt battery. Just connect charger to battery, plug into AC outlet. Charges at 1 amp (12 volts) AU-140J. Wt. 3 lbs. 5.59

5⁵⁹



Versatile 12 VDC to 117 VAC Power Inverters

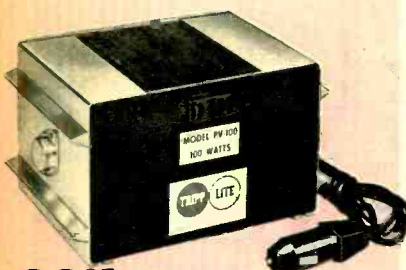

Solid State Inverter

- Plugs Into Car Lighter Socket
- Converts 12 VDC to 117 VAC

Model PV-100. Instant AC power! Delivers 100 watts continuous, 125 watts intermittent. Has car lighter plug, standard AC outlet. Uses 2 power switching transistors. 4 3/4 x 4 3/4 x 3". AU-342J. Shpg. wt. 6 1/4 lbs. 29.95

29⁹⁵



Ideal "Camping" Inverter

- Converts Any 12 VDC Input to 117 VAC Output

Use with AC-powered appliances—small power tools, portable TV, etc., or as battery charger. 200 watts continuous, 220 intermittent. Not for heavy-current devices. 5 1/2 x 3 1/2 x 5". AU-324J. Shpg. wt. 7 1/4 lbs. 49.95

49⁹⁵



500 Watt Combination Inverter/Battery Charger

Model PV-500. Converts 12 VDC to 117 VAC, 10-amp battery charger delivers tapering charge to prevent overload. 500 watts continuous power, 550 intermittent. Hash-free TV-FM-AM reception. 5 1/4 x 9 1/4 x 9". AU-343J. Shpg. wt. 19 1/4 lbs. 109.95

109⁹⁵

Olson Has Electrical Outlets

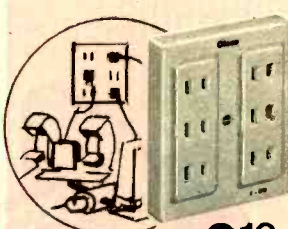

Six-Outlet AC Center

- Now Have 6 Outlets Where There Were Only 2

For kitchen, office, garage, etc. Plugs directly into wall outlet leaving no unsightly cord. 15-amp capacity. 4 x 4 3/4 x 1". XX-085J. Wt. 1 lb. 2.19

2¹⁹

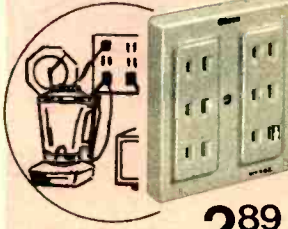

Six-Outlet Cord Type

- Installs Easily in Just Seconds

Converts one AC outlet to six—great where outlets are scarce. Has 15-amp capacity. With 6' heavy-duty extension cord. 4 x 4 3/4 x 1". WW-568J. Wt. 1 lb. 2.89

2⁸⁹

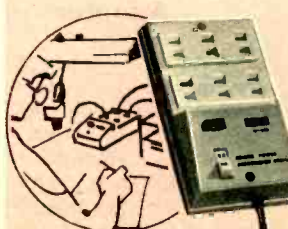

Our Best Six-Outlet Center

- Master On-Off Switch

Ideal for extending AC power to wherever you need it. Top-mounted switch for instant turn-on and turn-off with indicator lamp. 6-ft. electrical cord. 4 x 1 1/2 x 7". SW-397J. Wt. 1 lb. 6.19

6¹⁹

International Rectifier Fiber Optics

"Lights Fantastic" for Fun and Decoration—Use Your Imagination

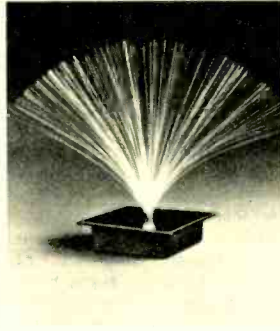
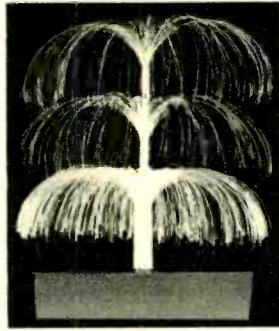
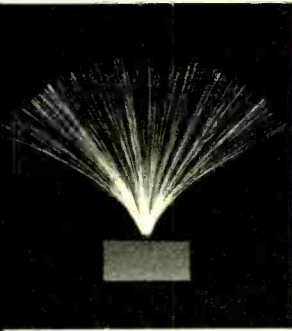

Model OP2050. Single-tier fan preformed spray includes 160 20-mil optical fibers. Create your own display or use with OP8002 lamp base below.
XM-188J. Wt. 1 lb. 4.45

Model OP2060. Triple-tier "cascade" preformed spray includes 160 20-mil optical fibers. Use with lamp bases below or create your own display.
XM-189J. Wt. 1 lb. 7.15

Model OP8085. Fiber optic lamp kit complete with base and single-tier fan spray. Easy to follow instructions. Stands 14" high.
XM-191J. Wt. 1 lb. 16.15

Model OP8087. Fiber optic lamp kit complete with base and 3-tier "cascade" spray. Easy to follow instructions. Stands 14" high.
XM-192J. Wt. 1 lb. 18.85

Model OP8083. Fiber Optic Lamp Kit complete with Base & 2-tier "fountain" spray. Easy to follow instructions. Stands 14" high.
XM-067J. Wt. 2 lbs. 8.98

Expand Your Optics Display With More Fibers!

1 Mono Fibers

Stock No.	Mfr's Type	Dia., Mil	Total Length	Shpg. Wt.	Each
XM-074J	OP1060	10	360'	1 lb.	4.49
XM-076J	OP2016	20	64'	1/2 lb.	4.49
XM-078J	OP3006	30	36'	1/2 lb.	4.79
XM-080J	OP4506	40	36'	1/2 lb.	6.89

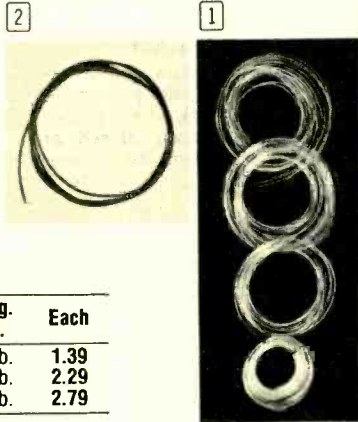

2 Jacketed Light Guides

Stock No.	Mfr's Type	Fiber Qty.	Dia.	Total Length	Shpg. Wt.	Each
XM-081J	OP7073	7	0.087"	3'	1/4 lb.	1.39
XM-083J	OP7193	19	0.120"	3'	1/4 lb.	2.29
XM-085J	OP7373	37	0.152"	3'	1/4 lb.	2.79

Fiber Optic Accessories

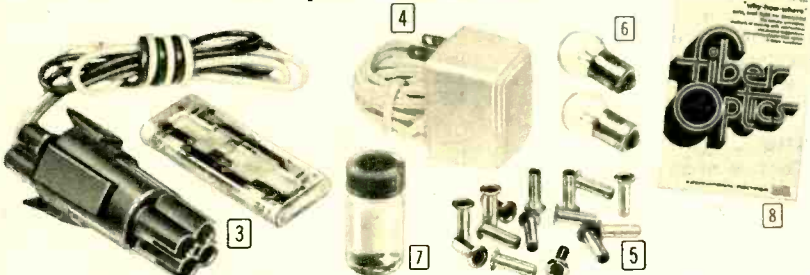

Enjoy Experimenting with "Internal Light Reflection" Even More with Safe, Simple-to-Use Accessories

3 Four-Channel Light Head
Model OP8000. For 6-12 volt AC/DC power supply. Consists of 2 wires, bulb & socket, 4-channel lensed center, 2 part connector.
XX-168J. Shpg. wt. 1/2 lb. 2.79

4 Low-Voltage Power Source
Model OP8010. Rated at 7 volts 400 mW. Step-down transformer produces approximately 3 watts.
XX-169J. Shpg. wt. 1 lb. 5.49

5 Eyelet Assortment
Model OP8030. Contains 5 each of 4 different sizes which were selected for use with all IR fibers. Also includes one size specially for the 4-channel light head.
XM-070J. Shpg. wt. 1/4 lb. 79¢

6 Replacement Light Bulbs
Model OP8020. Package of 2 bulbs.
XM-069J. Shpg. wt. 1/4 lb. 59¢

7 Adhesive/End-Treat Compound
Model OP8050. A non-toxic material, 100% safe for anyone to use. Created solely for use with plastic fibers to assure greater light transfer. Will not damage fibers! Cures in 10 to 15 minutes.
XM-071J. Shpg. wt. 1/4 lb. 2.49

8 "Why-How-Where" Handbook
Model OP8060. Contains the history, principle methods of working with fiber optics, and many applications, project suggestions to help you enjoy fiber optics more.
XM-072J. Shpg. wt. 1/2 lb. 69¢

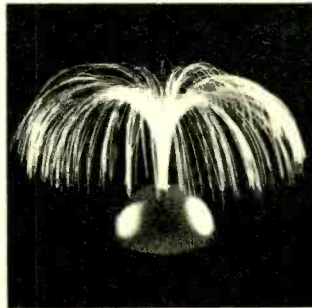

Model OP2030. Single-tier spray creates "umbrella" effect. Contains 165 11" lengths of 20-mil optical fibers. Use with OP8002 Lamp Base.
XM-065J. Wt. 1 lb. 3.70

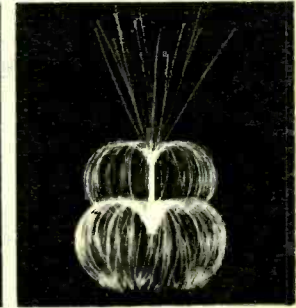

Model OP2040. Double-tier "fountain" preformed spray includes 160 20-mil optical fibers. Use with OP8002 Lamp or your own creation.
XM-066J. Wt. 1 lb. 4.05

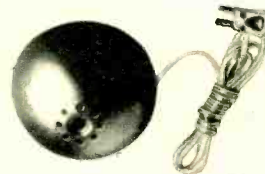

Model OP8002. Lamp base kit for fiber optic displays. Measures 2 1/2" H x 5" dia. Includes bulb, cord, in-line switch. For all IR displays.
XM-063J. Wt. 1 lb. 4.95

Model OP8004. Lamp base. Square shape like XM-191J. and XM-192J above.
XM-190J. Wt. 1 lb. 11.65



Model OP2020. "Do-it-yourself" spray includes 175 12", 20-mil optical fibers, bundling tubes, eyelets, 18" of 0.152" light guide & instructions.
XM-064J. Wt. 1 lb. 3.15



Fiber Optics Master Assortment
If Bought Separately, \$30.57
23⁹⁵

Model OP8080-C. 264' mono fiber, 9 jacketed light guides, 4-channel light head, low-voltage power source, compound, eyelets, spare bulbs, instruction booklet.
XM-068J. Wt. 4 lbs. 23.95



Starter Kit
If Bought Sep. \$12.10
8⁸⁵
Model OP8070-C. 228' mono fibers, 3' light guides, 20 eyelets, adhesive end-treat compound, handbook. All you need to get started in a rewarding fiber optics hobby.
XX-167J. Wt. 2 lbs. 8.85



Bowman MOD-U-KITS For Hobbyists, Experimenters, School Projects—Olson Priced from 4⁹⁵ to 24⁹⁵

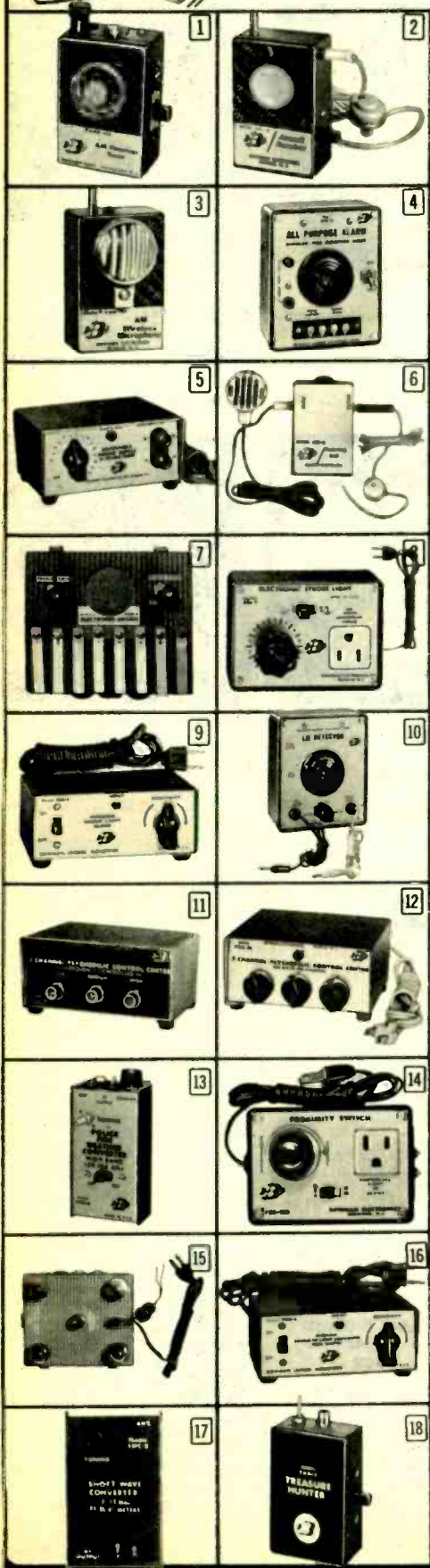

1 AM Broadcast Radio Kit
 Model AMR-102. Basic two-transistor AM receiver. RF is detected by a diode, amplified by a novel audio circuit. Adjustable coil; fixed capacitor. Fixed gain. With matching transformer. Requires one 9-volt battery.
 KB-239J. Shpg. wt. 1½ lbs. 4.95

2 Aircraft Receiver Kit
 Model AIR-3. Picks up strong signals in the 100-200 MHz frequency range—the range used by aircraft. Has a 2-stage super high gain amplifier. Safe to carry aboard an airplane. With wire antenna. Requires 9-volt battery.
 KB-238J. Shpg. wt. 1 lb. 5.95

3 AM Wireless Mike Kit
 Model AMW-103. Talk into the microphone and it plays through any AM radio, up to 50 feet away. Tunable coil sets the operating frequency. Transistorized. With antenna wire and crystal-type mike. Requires one 9-volt battery.
 KB-240J. Shpg. wt. 1 lb. 7.95

4 All-Purpose Alarm Kit
 Model APA-2. Use as a fire alarm (with external thermostat), a light alarm (with photocell), a burglar alarm (with switches), or a moisture detector. Built-in horn. Normally closed or open switch. Battery test. Uses 6V battery.
 KB-241J. Shpg. wt. 1½ lbs. 14.95

5 Adjustable Power Supply Kit
 Model APS-12. Plugs into 110VAC outlet; supplies 0-12 VDC output, at current drain of 500 mA. Can power almost any equipment requiring 1.5 to 12 volts. Full wave bridge circuit 2-transistor filter/regulator. Control adjusts base voltage. Neon power indicator.
 KB-242J. Shpg. wt. 2 lbs. 12.95

6 Hearing Aid Kit
 Model HA-3. Efficient audio amplifier can act as an aid for the hard of hearing, in many situations. Includes case and earphone. Battery powered; requires one 9-volt battery.
 KB-245J. Shpg. wt. 1 lb. 9.95

7 Electronic Organ Kit
 Model EOA-3. Consists of an audio oscillator and amplifier circuit. When a key is depressed individually, or in combination with others, various musical tones are produced. Polyethylene case, speaker. Requires 9-volt battery.
 KB-243J. Shpg. wt. 1¼ lbs. 6.95

8 Electronic Strobe Kit
 Model ESL-1. Converts an ordinary incandescent lamp (up to 100-watt) into a pulsating strobe unit. Variable control sets the strobe rate. Three semiconductor circuit. Custom plastic case with brushed gold plate. 117 VAC.
 KB-244J. Shpg. wt. 1 lb. 9.95

9 Intruder Sound-Light Alarm
 Model ISA-5K. Input microphone picks up sound in one room or in the entire house, causes light to come on or alarm to sound. Lets you know when an intruder is present. High gain amp. Req. crystal mike. 117 VAC.
 KB-246J. Shpg. wt. 1 lb. 19.95

10 Lie Detector Kit
 Model LDT-2. Detects "lies" by the amount of hand perspiration produced by the subject. Sensitivity control, built-in horn. With right and left hand probes. Requires 6 volt battery.
 KB-248J. Shpg. wt. 1 lb. 9.95

11 Frequency Controlled 3-Channel Color Control Center
 Model PCC-3L. Feed in the sound from your hi-fi, phono or radio... lights respond to volume and frequency changes. Three independent channels with sensitivity controls to adjust color prominence. 117 VAC.
 KB-252J. Shpg. wt. 1¼ lbs. 24.95

12 3-Channel Psychedelic Color Control Center Kit
 Model PSA-3L. Turns your hi-fi, phono or radio sound variations into psychedelic light variations. Three channels with separate sensitivity controls: each handles up to 500 watts of external lights. 117 VAC.
 KB-257J. Shpg. wt. 1½ lbs. 12.95

13 Police/Fire/Weather/Marine VHF Converter Kit
 Model PFW-3. Tunes fire, marine, police and weather broadcasts in 150-164 MHz band. Just connect it to any FM radio tuned to a quiet spot on the band. Requires 9-volt battery.
 KB-254J. Shpg. wt. 1 lb. 7.95

14 Proximity Switch Kit
 Model PRS-100. Use it as a light alarm or as a night light, illuminating your outside light when you touch the doorknob. Also can be used to trigger an alarm, in connection with transformer and AC supply circuit.
 KB-255J. Shpg. wt. 1 lb. 6.95

15 Sound to Light Converter
 Model PSA-1. Connects easily to your radio, hi-fi or phono system; changes the audio output to light keying signals. Sensitivity control. Controls up to 100 watts.
 KB-256J. Shpg. wt. 1 lb. 5.95

16 Wireless Sound to Light Converter Kit
 Model PSW-5. Special mike picks up any sound in the room, changes it to light variations. Controls up to 500 watts in external lights. Extremely sensitive circuit. Less 9V battery and crystal microphone.
 KB-258J. Shpg. wt. 2 lbs. 12.95

17 Shortwave Converter Kit
 Model SWC-3. Receive worldwide signals on 25.31 and 41 meter bands. Just connect to any AM radio, tuned to 1600 kHz. Tunes 7-12 MHz, plays through AM radio. Req. 9V battery.
 KB-260J. Shpg. wt. 1 lb. 6.95

18 Metal Locator Kit
 Model THA-3. Produces an audio beat that you can hear in any transistor radio. When pickup coil is near metal the beat will be heard. Requires 9-volt battery and wooden rod.
 KB-261J. Shpg. wt. 1 lb. 6.95

Bowman MOD-U-KITS

Fast, Easy Assembly

2⁹⁵ to 12⁹⁵

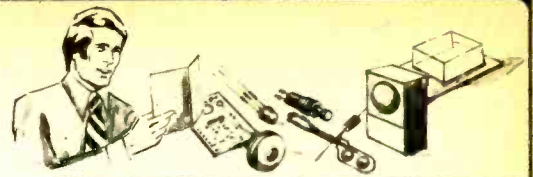

19 Universal Amplifier Kit

Model UA-5. 3-transistor circuit gives up to 5 watts music power. Input accepts almost any type of pickup device. Volume control. Output accepts 3-16 ohms speaker. Requires 6-volt battery or power supply.

KB-262J. Shpg. wt. 1 lb. 5.95

20 FM Wireless Mike Kit

Model WM-103. Speak into the microphone and your voice plays through a nearby FM receiver. Range up to 200 feet (within FCC specifications). Two-transistor circuit. Requires one 9-volt battery.

KB-264J. Shpg. wt. 1 lb. 8.95

21 Auto Light Reminder Kit

Model ALR-1. Signals when you leave your car headlights on. Prevents a run-down or dead battery. Installs quickly in any car. Powered by car's battery.

KB-293J. Shpg. wt. 1 lb. 6.95

22 Aircraft Converter Kit

Model VAC-1. Tunes aircraft and airport tower broadcasts in the 118-130 MHz VHF band. Operates through your standard AM radio, tuned to 1600 kHz. Requires 9-volt battery.

KB-263J. Shpg. wt. 1 lb. 6.95

23 Police/Fire Converter Kit

Model PFC-2. Connects to any standard AM radio, tuned to 1600 kHz. Receives police and fire calls in the 30-50 MHz band, playing them through the radio speaker. Requires 9-V battery.

KB-253J. Shpg. wt. 1 lb. 6.95

24 Mobile Power Amplifier

Model MPA-5. Produces up to 5 watts of audio output when driven with high-output microphone. Powered by 12-volt auto battery with cigarette lighter cord (included). Three-transistor power circuit. Easy assembly.

KB-249J. Shpg. wt. 1 1/4 lbs. 8.95

25 Car Radio Booster Kit

Model AMB-100. Produces a powerful signal from your AM auto radio. Lets you tune in those hard-to-reach stations. Easy to assemble and install. Powered by 9-volt battery.

KB-294J. Shpg. wt. 1 lb. 5.95

26 High-Gain Amplifier Kit

Model EST-3. 3-transistor amplifier with sensitivity control has stethoscope type earphone. Hundreds of uses around home or shop. Requires 9-volt battery.

KB-265J. Shpg. wt. 1 lb. 9.95

27 Light Beam Alarm Kit

Model LBA-2. Contains a photocell circuit. Light is changed into a resistance change to activate an SCR circuit and produce voltage. Can be adapted to a light target device where a beam of light from a light rifle (pencil flashlight) will make the unit control.

KB-247J. Shpg. wt. 1 lb. 5.95

28 No-Battery AM Radio

Model NBR-1. Tunes AM broadcast stations—NO batteries needed! High-gain transistor serves as a regenerative type detector. Input coil is wound in feedback configuration for increased sensitivity. Tunable antenna coil. Requires long wire antenna and ground.

KB-250J. Shpg. wt. 1 lb. 2.95

29 Pool Alarm Kit

Model PAL-2. Built-in horn goes off if someone should fall into the pool; keeps sounding until power is turned off. Sensor probe detects increase in water level. On-off switch; battery test. Requires 6-volt battery.

KB-251J. Shpg. wt. 1 lb. 12.95

30 Photocell Music-Maker Kit

Model PMM-2. Turns light energy into unique and fascinating musical sounds. Easy to assemble kit is perfect for experimental and entertainment uses. Requires 9 volt battery and 8-16 ohm speaker.

KB-297J. Shpg. wt. 1 lb. 5.95

31 Power Supply Kit

Model PS-6. Plugs into any standard 110 VAC outlet. Provides 6-volts DC output up to 500mA for powering a variety of devices—transistor radios, amplifiers, light devices.

KB-295J. Shpg. wt. 1 1/2 lbs. 5.95

32 Sequential Blinker Kit

Model SEB-2. Five neon lights flash in a controlled pattern. Fascinating to watch—useful as a night light. AC-powered long-life circuit. On-off switch. With all parts.

KB-259J. Shpg. wt. 1 lb. 6.95

33 Metronome Kit

Model MT-2. Two-transistor circuit has frequency control that gives smooth adjustment of the audio clicks. Rate of clicks is adjustable from one per half-minute to 10 per second. Self-contained. Requires 9-volt battery.

KB-266J. Shpg. wt. 1 lb. 2.95

34 Regulated Power Supply Kit

Model PS-12Z. Plugs into standard 110 volt AC outlet. Produces output of 12 volts DC @ 2 amps with zener regulation for constant voltage. For powering transistor devices where a stable power source is needed.

KB-298J. Shpg. wt. 1 lb. 10.95

35 Power Converter Kit

Model PC-129. Converts 12 VDC input to 9 VDC output @ 150 mA. Permits operation of transistor radios and similar equipment from a 12-volt battery or other power source.

KB-296J. Shpg. wt. 1 lb. 4.95

36 Multi-Band Radio Booster

Model MBB-1. Increases sensitivity and performance of any radio—500 kHz to 2 MHz. Easy-to-assemble kit includes all parts. Requires 9 volt battery.

KB-299J. Shpg. wt. 1 lb. 5.95

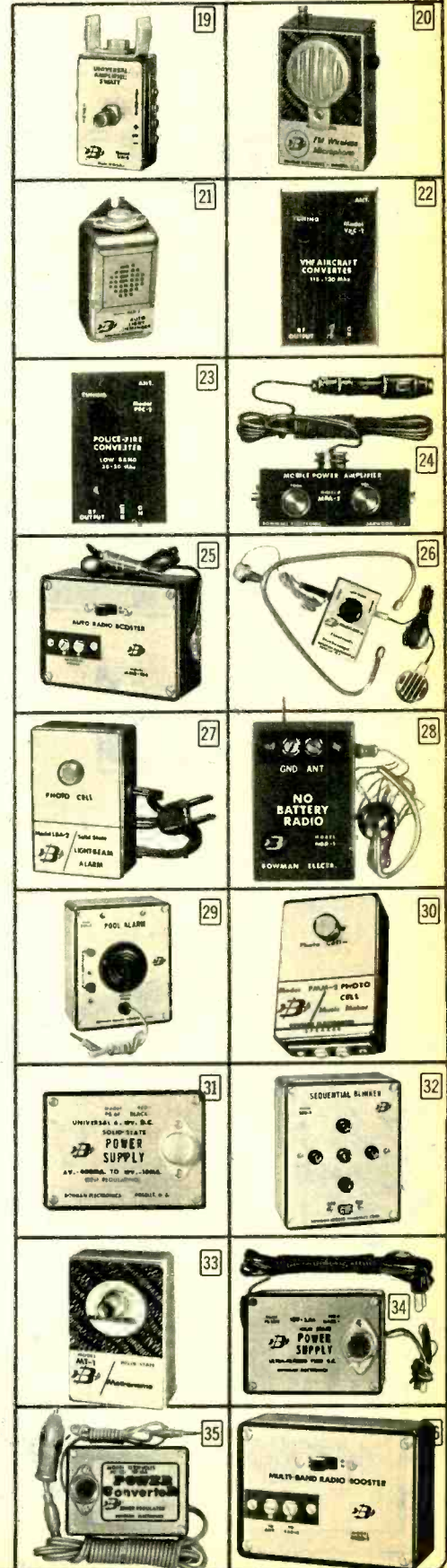

Latest Testers for "Space-Age" Electronics

MIT'S

Waveform Generator/ Frequency Meter Kit

Model WG-1700. An essential instrument for precision servicing of today's sophisticated electronic devices. Combines two instruments in a single compact unit — waveform generator produces 6 stable forms including sine, triangle, square, ramp, sawtooth and pulse carrier waves from 1 Hz to 1500 kHz in 12 overlapping ranges; sine, triangle and square AM or FM modulation waves from 100 Hz to 150 kHz in 6 overlapping ranges. Frequency meter has digital display — reads 1 Hz to beyond 10 MHz. Ideal for use in audio and other electronics servicing, testing and calibrating digital systems, etc. Has separate modulator and "signal" (modulated or unmodulated carrier) outputs, amplitude controls, internal or external AM/FM modulation. Frequency meter has adjustable sensitivity, 4-digit neon display with 0.55" high characters for really easy reading. Easy to build kit with all-electronic IC construction. Regulated power supply. 13 x 5½ x 6". For 117 VAC. **KB-348J.** Shpg. wt. 9 lbs. **139.95**

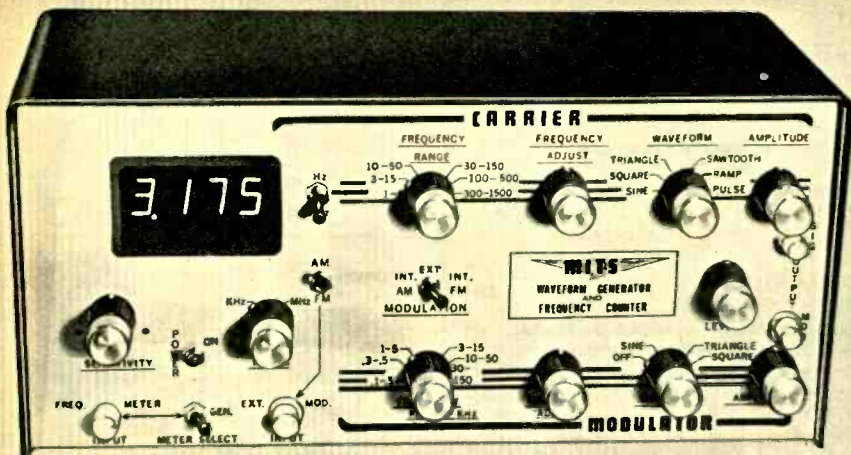

139⁹⁵

Kit Form



89⁹⁵

Kit Form

Digital Voltmeter Kit

Model DV-1600. THE essential for the modern service bench. Provides accurate measurements of voltage, current and resistance in an easy-to-read digital-readout display — shows the exact measurement — stops interpolating, errors resulting from different viewing angles, etc. Reads AC volts: 0-1-10-100-1000. DC volts: 0-1-10-100-1000. DC current: 0-.1, 1, 10, 100 mA, 1 amp. Resistance: 0-100, 1k, 10k, 100k, 1 meg, 10 meg ohms. 100% overrange capability on all ranges gives extended versatility. Accuracy is ± 1% on all ranges except DC volts, ± 0.5%. Input impedance: 10 meg DC, 1 meg AC. Regulated power supply with overtemperature and over-current shutdown capabilities. 8 x 3½ x 6". For 117 VAC. **KB-349J.** Shpg. wt. 5 lbs. **.89.95**

5-Volt DC Power Supply

Model PS-500. Ideal for powering TTL, DTL and other IC's. Has internal current limiting, over-temperature protection. Load regulation: 0.6%, line regulation: 0.005%. Temperature stability: 0.4%. Has LED power indicator, front panel binding posts. Output voltage: 5 volts ± 0.2 V. 4 x 3 x 5". 117 VAC. **XM-099J.** Shpg. wt. 2 lbs. **29.95**

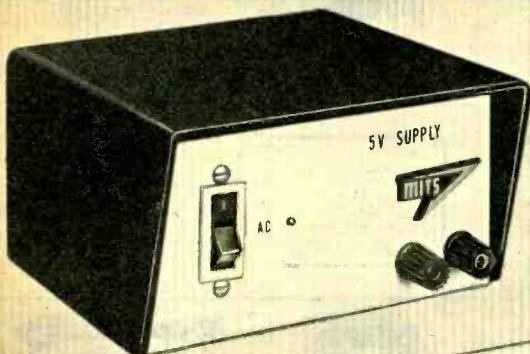

29⁹⁵

Factory
Wired

169⁹⁵

Factory
Wired

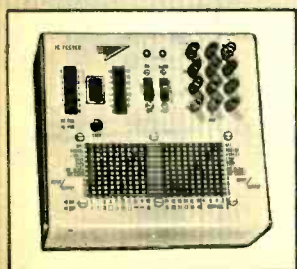

Complete Controls

IC Tester with 18 LED Indicators

Model ICT-1800. For testing all types of IC's, breadboarding while developing new designs—outstanding aid for servicemen and experimenters. LED indicators show condition of IC's at a glance, full controls let you program the unit exactly to the IC under test. Has internal 2-speed clock, 5-volt 1-amp power supply, 4 remote outputs and 4 remote inputs. Single-step capability. Panel is clearly labeled for fast 'n easy setup. 8 x 3½ x 9". With detailed manual including diagrams of all common digital IC's. For 117 VAC. **XM-100J.** Shpg. wt. 9 lbs. **169.95**

Graymark Educational Kits— Really Easy to Build—Really Fun to Use

1 Model 503R. Morse Code Kit. Helps you learn International Morse Code. Professional style adjustable hand key, variable tone control, built-in loudspeaker. Uses 2 "AA" cells. Modern transistorized circuit.
KB-333J. Shpg. wt. 2 lbs. 9.95

2 Model 505R. Transmitter Kit. Broadcasts through any AM radio. 100 mW output, no license required. Has volume control, frequency control, easy PC board construction. Telescoping antenna, crystal mike. 117 VAC.
KB-334J. Shpg. wt. 4 lbs. 24.95

3 Model 511R. AM/SW Radio Kit. Tube-type multi-band radio tunes Amateur and foreign broadcasts, standard AM. Regenerative circuit, de-coupled antenna for top sensitivity and selectivity. 820 kHz to 28 MHz. 117 VAC.
KB-336J. Shpg. wt. 4 lbs. 24.95

4 Model 523R. Strobe Light Kit. "Freezes" action with "old-time-movie" effect. Adjustable flash rate, (1 to 5 flashes per second). Long life xenon tube. For parties, dances, photography, etc. 117 VAC.
KB-338J. Shpg. wt. 3 lbs. 24.95

5 Model 528R. Color Organ Kit. Flashing lamps create unique effect—hook it up to your amplifier for music syhch, or use alone. Sensitivity control, walnut vinyl cabinet. With shadow film to create your own display.
KB-339J. Shpg. wt. 8 lbs. 39.95

6 Model 501R. Crystal Tuner Kit. Perfect intro to radio and electronics. Hi-Q coil tunes entire AM band, needs no batteries or AC power. With crystal earphone for private listening. Great beginners kit.
KB-332J. Shpg. wt. 3 lbs. 7.95

7 Model 521R. One-Tube Radio Kit. Tunes AM stations, shows principles of tube amplification, Hi-Q antenna and diode detection. With antenna, tube, crystal earphone, 22.5 V battery. Requires 1.5 V battery.
KB-337J. Shpg. wt. 3 lbs. 14.95

8 Model 510R. Table Radio Kit. Basic 5-tube superhet circuit, easy to follow stage-by-stage assembly. Features direct dial tuning, high sensitivity and selectivity. With tubes, high-Q antenna. For 117 VAC.
KB-335J. Shpg. wt. 4 lbs. 24.95

9 Model 401R. Tachometer Kit. Reads 0-8000 rpm with 2% accuracy. Shows when to up-shift and down-shift for best mileage and fuel economy. Universal mounting, illuminated dial. For 6, 12 VDC, pos./neg. grd.
KB-331J. Shpg. wt. 3 lbs. 29.95

10 Model 529R. Burglar Alarm Kit. Infra-red invisible light beam with range to 75 ft. Built-in alarm, intermittent switch. Lamp unit for 117 VAC, detector requires 3 "AA" batteries. Compare with units costing much more!
KB-340J. Shpg. wt. 4½ lbs. 39.95

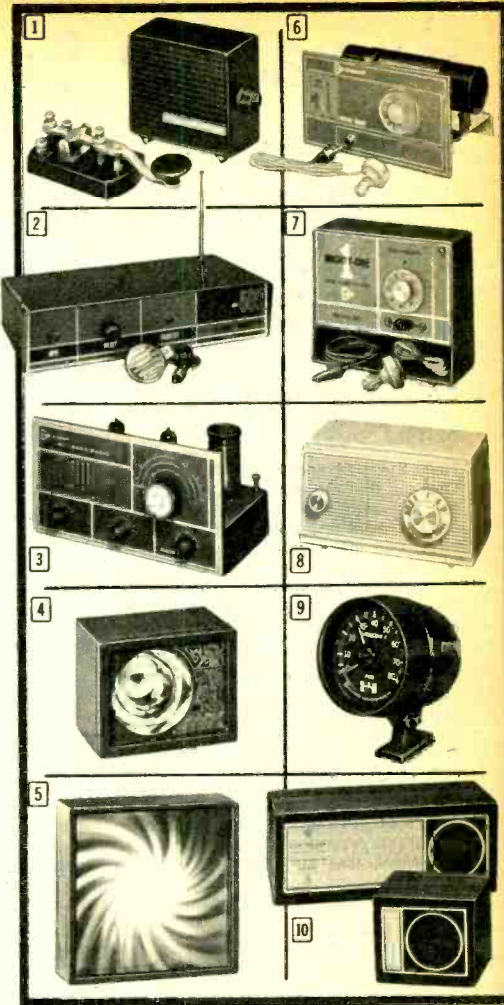

Publications of Interest for Radio Amateurs

11 Radio Amateur's Mini-Log. Pocket-size log book has space for calls received, frequencies, distance, etc. 50 pages.
BK-186J. Shpg. wt. ½ lb. 50¢

12 Full-Size Log. Keeps a complete record of all transmissions and receptions required by law. THE Amateur's standard.
BK-185J. Shpg. wt. ¼ lb. 75¢

13 Radio Amateur's VHF Manual. All you need to know about VHF—history, principles, antenna systems, hints and kinks, more.
BK-184J. Shpg. wt. ½ lb. 2.50

14 Gateway to Amateur Radio. Famous set of 4 basic books for the beginning Ham. License manual, code book, two "How to" books.
BK-038J. Shpg. wt. 1½ lbs. 2.50

15 Antenna Book. Covers theory, wave propagation, transmission lines, antenna construction for 160 meters and up.
BK-036J. Shpg. wt. ½ lb. 2.50

16 FM and Repeaters. Useful and informative guide to FM and repeater operation. History, installations, rigs, more.
BK-183J. Shpg. wt. ½ lb. 3.00

17 SSB for the Radio Amateur. Analyzes theory, applications and building SSB equipment. Articles from QST magazine.
BK-037J. Shpg. wt. ¼ lb. 3.00

18 Radio Amateur's Handbook. The reference for Hams the world over. Covers UHF, VHF, HF, CW, antennas, more. Over 700 pages.
BK-035J. Shpg. wt. ½ lb. 4.50

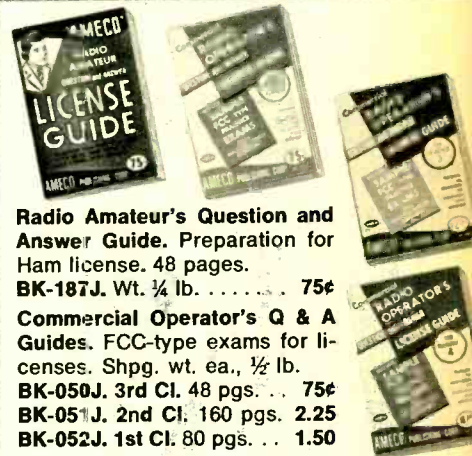

Radio Amateur's Question and Answer Guide. Preparation for Ham license. 48 pages.
BK-187J. Wt. ¼ lb. 75¢

Commercial Operator's Q & A Guides. FCC-type exams for licenses. Shpg. wt. ea., ½ lb.
BK-050J. 3rd Cl. 48 pgs. . . . 75¢
BK-051J. 2nd Cl. 160 pgs. . . . 2.25
BK-052J. 1st Cl. 80 pgs. . . . 1.50

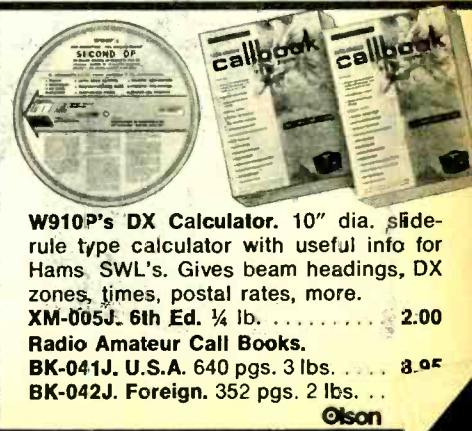

W910P's DX Calculator. 10" dia. slide-rule type calculator with useful info for Hams. SWL's. Gives beam headings, DX zones, times, postal rates, more.
XM-005J. 6th Ed. ¼ lb. 2.00

Radio Amateur Call Books.
BK-041J. U.S.A. 640 pgs. 3 lbs. . . . 3.95
BK-042J. Foreign. 352 pgs. 2 lbs. . . . 3.95

Olson



**Educational!
Informative!
Up-to-Date!**

Howard W. Sams Books—for Everything You

AUDIO & HI-FI

Four-Channel Sound

Covers all aspects of four-channel sound from the reasons for it to the selection of equipment. Chapters are devoted to four-channel FM broadcasting, four-channel sound on tape, etc. 144 pages.

BK-177J. Shpg. wt. ½ lb. 4.50

FM Multiplexing For Stereo (3rd Edition)

Gives all the newest developments in FM stereo broadcasting. Covers various circuits unique to stereo—multiplex decoders, stereo indication lights, automatic stereo switching, etc. Servicing, test equipment, and various manufacturers circuits are all included. 176 pages.

BK-158J. Shpg. wt. ½ lb. 4.95

Hi-Fi Stereo Handbook (4th Edition)

One of the classic texts on high fidelity. Newly revised with all the latest information on stereo stylus, headphones, tape cartridge units, FM multiplex, and much more. New transistor circuits are included, with preamps, amplifiers, and stereo control units. Also stereo recording, compact hi-fi units, cartridge players. A great reference work you'll use often. 288 pages.

BK-034J. Shpg. wt. 1 lb. 5.95

99 Ways to Improve Your Hi-Fi

This book includes 99 helpful and simple items and projects which can be used to enhance hi-fi enjoyment. Covers installation, FM stereo, phonos and turntables, amplifiers, tape equipment, speakers, etc. 128 pages.

BK-159J. Shpg. wt. ½ lb. 3.50

ABC's of Hi-Fi and Stereo (2nd Edition)

All about sound and high-fidelity, including how to select, use and maintain equipment, requirements of amplifiers, tuners, turntables. How to set up your system and get the most from it. 128 pages.

BK-009J. Shpg. wt. ½ lb. 2.75

ABC's Of Tape Recording (Third Edition)

Updated illustrations & info covering latest equipment and techniques, including cartridge and cassette recorders & playback units. 112 pages.

BK-022J. Shpg. wt. ½ lb. 2.95

Tape Recording For The Hobbyist (2nd Edition)

How to get the most from your recorder with party games, "detective work", sound effects, editing—even home video recording! 144 pages.

BK-011J. Shpg. wt. ½ lb. 3.95

Tape Recorders—How They Work (2nd Edition)

The book technicians and recorder owners want

most! Tells how tape recorders work, explains principles of magnetic recording, the equipment and components. Includes charts, illustrations on adjusting & servicing & testing recorders. 224 pages.

BK-008J. Shpg. wt. ½ lb. 4.50

101 Questions About Auto Tape Units

Popular units are discussed in "question-and-answer" format. Includes installation, circuits, trouble-shooting and maintenance. 72 pages.

BK-014J. Shpg. wt. ½ lb. 1.75

101 Questions About Hi-Fi and Stereo

This is the popular "question-and-answer" format, written for anyone interested in listening to music. Stereo is explained in simple no-nonsense language by authors with long experience in the field of sound. Great for beginners! 128 pages.

BK-017J. Shpg. wt. ½ lb. 3.50

AUTOMOTIVE

Easi-Guide To Your Automobile

A pictorial guide that covers fundamentals, equipment selection, and servicing. 160 pages.

BK-172J. Shpg. wt. ½ lb. 3.50

Auto Engine Tune-Up (2nd Edition)

Revised how-to-do-it guide for tuning your car's engine for extra power, economy, fewer repair bills. Explains how engine works in simple, easy-to-follow language. Hardbound. 376 pages.

BK-032J. Shpg. wt. 1 lb. 5.95

Automobile Guide

Tells about today's automobiles—from ignition system to shock absorbers. Tells how cars operate, how to service & repair them. Helps anyone find car troubles, fix them. Hardbound. 736 pages.

BK-033J. Shpg. wt. 2½ lbs. 8.95

BASIC & HOBBYIST

Easi-Guide To Color TV

Complete coverage of fundamentals, equipment selection, and servicing your color TV. Photos support all descriptive information. 144 pages.

BK-173J. Shpg. wt. ½ lb. 3.50

Easi-Guide To Shortwave Listening

Covers the fundamentals, equipment selection, and service, and gives you the information needed for an above-average knowledge of shortwave listening. 160 pages.

BK-174J. Shpg. wt. ½ lb. 3.50

Building and Installing Electronic Intrusion Alarms

For anyone who wants to build and install his own system or enter this field commercially. Covers alarms to fit all types of applications.

BK-175J. Shpg. wt. ½ lb. 3.50

Solid-State Electronic Projects

Chapters one to three contain all the necessary information for building and installing a variety of burglar alarm systems. A number of metal locator circuits are featured in chapter four, and chapter five provides many unique circuits for the electronic music enthusiast. The final chapter offers construction details for building a long-range listening device and a transistor curve tracer. 128 pages.

BK-160J. Shpg. wt. ½ lb. 3.95

Hi-Fi Projects For The Hobbyist (2nd Edition)

Tells how to improve your present tuner, amplifier, turntable and tape recorder with easy-to-follow instructions, clear diagrams and photos. Many easy-built attachments including rumble filter, mike preamp, many more. 128 pages.

BK-027J. Shpg. wt. ½ lb. 3.95

North American Radio-TV Station Guide (9th Edition)

Contains all you need to know to find out about all commercial broadcast stations in North America. Lists frequencies, call letters, etc. Compiled by computer for accuracy. A must for DX-ers. 160 pages.

BK-031J. Shpg. wt. ½ lb. 3.95

ABC's of Short Wave Listening (3rd Edition)

Read all about the exciting world of shortwave listening. Amateur radio operators learn how to hear police & fire emergency calls, ships at sea—even satellites in orbit! Practical, understandable, advice about receivers & antennas. 96 pages.

BK-019J. Shpg. wt. ½ lb. 2.95

Electronic Games & Toys You Can Build

You won't find any complex electronics theory anywhere—just step-by-step instructions, construction photos, and detailed wiring-construction diagrams that show you how to build 15 fascinating electronic games and toys, many of them in one evening. 128 pages.

BK-161J. Shpg. wt. ½ lb. 2.95

How to Hear Police, Fire, and Aircraft Radio

Complete guide to VHF police, fire, and aircraft receiving. Tells what you can hear and what you need to hear it, including converters, receivers, and antennas. 128 pages.

BK-018J. Shpg. wt. ½ lb. 3.50



Always Wanted to Know About Electronics

How to Read Schematic Diagrams (2nd Edition)
Explains types of electronic diagrams, symbols for various circuit parts, how they are connected, and how to follow a complete circuit diagram. Includes sample signal tracing through a receiver. 160 pages.
BK-028J. Shpg. wt. 1/2 lb. 3.50

Short-Wave Listeners Guide (5th Edition)
Updated and enlarged edition of the guide short-wave listeners depend on. Includes shortwave stations by country, call-letters, city, frequency, transmission time. Maps and charts for time conversion, plus a log for listing stations. 104 pages.
BK-020J. Shpg. wt. 1/2 lb. 2.95

99 Ways to Improve Your TV Reception
Shows you how to get a brighter clearer picture, better, fuzz-free sound from each station. Plenty of practical suggestions on simple adjustments that often give BIG improvements in viewing. Tells how to adjust antenna and lead in for best results, and what to do when *nothing* seems to help. Easy-to-understand, NON-technical language. 128 pages.
BK-015J. Shpg. wt. 1/2 lb. 3.50

101 Easy Audio Projects
You'll learn ways to have fun using spare parts found in many home appliances to build projects like intercoms, wireless microphones, telephone amplifiers, tuners. This book contains complete instructions, plus materials from the "junk box", or the garage sale that can mean enjoyable hours. 168 pages.
BK-012J. Shpg. wt. 1/2 lb. 3.50

Solid-State Circuits for Hobbyists and Experimenters
This book gives the serious electronics hobbyist or experimenter enough information to allow him to design the circuitry for many useful projects. This is an informative and helpful book for the person with imagination, knowledge of basic electronics, and a desire to do creative design. 208 pages.
BK-162J. Shpg. wt. 1/2 lb. 5.95

How to Wire Hi-Fi Extension Speakers
The selection, design, installation, and troubleshooting of hi-fi extension speakers are presented with step-by-step instructions. Only very simple tools and equipment, plus a basic knowledge of electronics, are needed to implement the suggestions given. 96 pages.
BK-163J. Shpg. wt. 1/2 lb. 3.95

Easi-Guide to Hi-Fi Stereo
The book aids the hi-fi novice in planning the home music system arrangement and offers directions in search for the right equipment. Discusses what the music system is, its various components, antennas, system installation, troubleshooting, etc. 160 pages.
BK-164J. Shpg. wt. 1/2 lb. 3.50

CB & COMMUNICATIONS

Question & Answers About CB Operations (2nd Edition)
Provides answers to questions most often asked about various aspects of CB radio. Up-to-date information on new FCC rulings is included. There is information on all four classes of CB radio and their uses, licensing, operation, and equipment. 112 pages.
BK-165J. Shpg. wt. 1/2 lb. 2.95

101 Questions & Answers About AM, FM, & SSB
Each of the three parts of the book—AM, FM, and SSB—contains answers to questions concerning

the advantages and disadvantages of each modulation method, as well as the basic circuits that are used. 96 pages.
BK-166J. Shpg. wt. 1/2 lb. 3.95

Easi-Guide To Citizens Band Radio
A guide every CBER should own. Descriptive information and accompanying photos on all aspects of CB radio—fundamentals, equipment selection, etc. 144 pages.
BK-176J. Shpg. wt. 1/2 lb. 3.50

ABC's of Citizen Band Radio (2nd Edition)
Explains functions, principles, regulations of CB operation, how to set up, license, and operate your own CB station. With lots of pictures and schematics that make it easy. 96 pages.
BK-004J. Shpg. wt. 1/2 lb. 2.50

Citizens Band Radio Handbook (4th Edition)
Updated edition covers ALL aspects of CB operating procedures. Has complete servicing data on transceivers, transmitters, fixed mobile antenna installations, plus FCC rules/regulations, U.S. radio districts and glossary. 192 pages.
BK-024J. Shpg. wt. 1/2 lb. 4.95

1st-Class Radiotelephone License Handbook (3rd Edition)
Includes latest Study Guide material for FCC exam, plus latest rules & regulations you need to know. Covers transmitting equipment, studio, master control, remote equipment. Three sample exams & evaluations. 416 pages.
BK-021J. Shpg. wt. 1 lb. 6.50

2nd-Class Radiotelephone License Handbook (4th Edition)
Provides study materials needed to pass FCC exam. Includes servicing 2-way radio equipment, latest solid-state circuits. A valuable reference you'll want to keep handy—even after passing the test! 360 pages.
BK-023J. Shpg. wt. 1 lb. 6.50

ELECTRONICS

Automotive Electronics
Explains the starting system, the charging system, the ignition system, lighting and signaling systems, test equipment, and more. Also includes sections on the future of automation, and the outlook for electric cars. 320 pages.
BK-167J. Shpg. wt. 1 lb. 6.95

ABC's Of Electronics (2nd Edition)
This is the book that teaches basic electronic principles in a brand-new way. Explains all about electronic circuits, magnetic forces, electron theory, how electronic devices work, using everyday concepts familiar to everyone, yet not just a surface treatment. Includes questions and review quizzes on each chapter. 96 pages.
BK-030J. Shpg. wt. 1/2 lb. 3.95

RADIO & TELEVISION

Questions & Answers About Color TV (2nd Edition)
Arranged by subjects the book is divided in four parts—theory of operation, installation, servicing, and modification to equipment. Within each part a wide variety of topics ranging from what is compatible color TV, to how to eliminate interference and how to install a picture tube or antenna are included. 96 pages.
BK-168J. Shpg. wt. 1/2 lb. 3.95

Color TV Training Manual (3rd Edition)
Considered one of the finest books ever written on color TV. The most up-to-date guide available for those who want to master color TV servicing, including color TV theory, how circuits work, solid state, setup, alignment, all service, and

more. A "must" for every technician and shop. 240 pages.
BK-029J. Shpg. wt. 1/2 lb. 6.95

FM From Antenna to Audio
Begins with basics of FM broadcasting and receiving, then goes step-by-step through the FM receiver. Tells how each stage works, and includes chapters on receiver measurements and how to align FM receivers for best reception, in home and car. 160 pages.
BK-016J. Shpg. wt. 1/2 lb. 3.95

SEMICONDUCTORS & TUBES

Transistor Specifications Manual (6th Edition)
A listing of the electrical and physical parameters along with the manufacturers of nearly 10,000 bipolar transistors. Gives the maximum voltage power, current and temperature limits that should not be surpassed, as well as the polarity, leakage, gain, and frequency parameters for each transistor. 160 pages.
BK-169J. Shpg. wt. 1/2 lb. 4.50

Transistor Substitution Handbook (13th Edition)
Updated! Over 100,000 substitutions. Includes manufacturer's recommendations for popular replacements and when you should follow exact types. Computer-compiled for accuracy! 160 pages.
BK-025J. Shpg. wt. 1/2 lb. 2.95

SERVICING

Solid-State Servicing
The book is divided in two sections. In the first, several basic statements of semiconductor theory are given. Then, the theory is explained in a practical manner which can be directly applied to the solution of real service problems. In Part 2, a cross section of circuits used in home entertainment electronic products are given and explained in terms of the function they perform. 160 pages.
BK-170J. Shpg. wt. 1/2 lb. 4.95

Transistor Radio Servicing Course
All aspects of the transistor, and its use in modern AM and FM radios are discussed, section by section. The basic DC and AC theory is also included wherever necessary to aid in the understanding of the material. 288 pages.
BK-171J. Shpg. wt. 1 lb. 6.95

TV Servicing Guide
Over 100,000 technicians have used this book, which is now updated and even more complete. Helps you find TV troubles with a guide to trouble symptoms. Includes hundreds of photos of TV screens showing problems, then tells where to find the difficulty and how to fix it. 132 pages.
BK-007J. Shpg. wt. 1/2 lb. 3.25

Color TV Servicing Guide
A valuable TV service tool, written and arranged to help you identify the trouble by symptom. Contains many full-color illustrations of color TV screens showing the problems, and how to correct them. Includes proper trouble-shooting procedures in easy-to-follow language. 112 pages.
BK-006J. Shpg. wt. 1/2 lb. 4.25

TELEDYNE/OLSON BOOKS

Security Electronics
Presents a thorough background for the understanding of electronic security devices. Covers design, operation, application of equipment used in alarms, detection, signaling, etc. 160 pages.
BK-001J. Shpg. wt. 1/4 lb. 4.50

How To Build Speaker Enclosures
Covers the "hows" and "whys" of building quality speaker enclosures. Contains detailed instructions on how to build various types of enclosures. Tells about speaker parts, their operation and how to get maximum enjoyment from speakers. Illustrated. 114 pages.
BK-002J. Shpg. wt. 1/4 lb. 3.50

Tube Substitution Guide
Most complete, up-to-date DIRECT guide available! Contains listing of about 12,000 direct substitutions. Covers all conventional tubes plus all subminiature and industrial types. Also includes listing of European types. 96 pages.
BK-003J. Shpg. wt. 1/4 lb. 1.75

Do-It-Yourself Encyclopedia



Here's a time-, labor-, and money-saver for the do-it-yourself person. Contains thousands of how-to-do-it photos and step-by-step plans for home improvement and home maintenance projects. You need no special background to understand everything presented. The alphabetical arrangement makes it easy to find the answers to an infinite number of perplexing how-to problems. 1024 pages.
BK-157J. Shpg. wt. 3 lbs. 10.50

PARTIAL CONTENTS:
Air Conditioning • Brick • Built-ins • Ceiling Tiles • Doors • Electrical • Fireplaces • Floors • Furniture • Hi-Fi • Insulation • Kitchen • Lighting • Painting • Tile • Wallpaper



The Finest in Amateur Radio and Short Wave Listening Equipment



R. L. Drake brings you the very best in communications equipment for the Short Wave Listener or Ham operator — at a surprisingly low price for such fine quality. "Tune in" to the fascination of International broadcasts from the far corners of the globe. Super-sensitive and selective, Drake receivers are your gateway to the airwaves.

Model SW-4A International Short Wave Broadcast Receiver

- Ultra-Precision Tuning Dial Accuracy
- Dual Conversation • Crystal Lattice Filter
- Preselector Assures Superb Sensitivity
- Solid-State, Low-Distortion Audio Output

\$335

Designed expressly for the Short Wave Listener, with Direct Frequency Dialing that eliminates guesswork in identifying stations. Crystal lattice filter gives top adjacent station rejection and fine audio response. Crystal-controlled HF oscillator for exceptional stability on all ranges. Frequency Coverage: .15-.5, .5-1.0, 1.0-1.5, 6.0-6.5, 7.0-7.5, 9.5-10.0, 11.5-12.0, 15.0-15.5, 17.5-18.0,

21.5-22.0 and 25.5-26.0 MHz with crystals supplied. Selectivity: 5 kHz at -16 dB, 16 kHz at -60 dB. Sensitivity: AM S/N ratio of 10 dB with less than 2 μ V input signal modulated 30%. Main dial calibrated in 5 kHz divisions; vernier dial in 1 kHz divisions. Calibration accuracy: ± 2 kHz. 120/240 VAC. 5½ x 10¾ x 12¾".
DX-060J. Shpg. wt. 17 lbs. 335.00

\$357 Shortwave Listener's Outfit

Includes Drake SW-4A Receiver plus matching MS-4 speaker, shortwave wire antenna and Shortwave Listener's Guide Book.
AS-765J. Wt. 22 lbs. 357.00



2 \$499⁹⁵



3 \$530

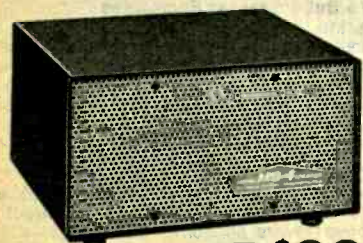

4 \$22



1 \$395

1 C-4 Station Console

Makes any Ham station more efficient. Contains a 24-hour Digital Clock; separate Power Master heavy-duty contactor for complete station power control; Remote Antenna Switch that selects any of 5 antennas; solid-state Timer; Wattmeter; Equipment Control; Rotor Control; Transmit Tape setting for driving transmitter by tape recorder; recording capability. 5½ x 10¾ x 12¾".
DX-061J. Shpg. wt. 15 lbs. 395.00

2 R-4C Amateur Receiver

Covers 80, 40, 20 and 15 meter bands plus 28.5-29.0 MHz with crystals furnished; fifteen 500 kHz ranges between 1.5 and 30 MHz with additional crystals. Super selectivity with 2.4 kHz 8-pole filter in SSB, 8.0 kHz 6-pole in AM. Solid state linear permeability-tuned VFO has 1 kHz dial divisions. Tunable notch filter; switchable AGC; crystal lattice filter; noise blanker; 25 kHz calibrator. 120/240 VAC. 5½ x 10¾ x 12¾".
DX-059J. Shpg. wt. 17 lbs. 499.95

3 T-4XC Transmitter

Covers 80, 40, 20 and 15 meters plus 28.5-29.0 MHz with crystals furnished. Solid state

TV-1000-LP Low Pass Filter



18⁷⁵

Eliminates TV Interference

Rated 1000 watts (200 W on 6 meters). Four pi sections for sharp cut-off between 6 meters and Channel 2. 52-ohms.
DX-063J. Shpg. wt. 3 lbs. 18.75



6⁹⁵

TV-300-HP 40 dB High-Pass Filter

Protects TV set from Amateur transmitters 6 to 160 meters. For 52 MHz and lower.
DX-064J. Shpg. wt. 1 lb. 6.95

permeability-tuned VFO identical to R-4C receiver; frequency control can be supplied by either transmitter or receiver for Transceive operation. Two 8-pole crystal lattice filters for sideband selection. Transmits in USB, LSB, AM and CW. Requires 650 VDC at 330 mA max., 250 VDC at 120 mA, -45 to -65 VDC bias and 12.6 volts AC/DC at 3 amps. 5½ x 10¾ x 12¾".
DX-058J. Shpg. wt. 15 lbs. 530.00

DX-093J. 110/220 VAC power supply. Model AC-4 for all Drake Transmitters. 99.95

4 MS-4 Matching Speaker

Space for transmitter power supply inside.
DX-062J. Shpg. wt. 3 lbs. 22.00

Modern Equipment for the Advanced Amateur

Sophisticated electronic equipment for the Radio Amateur who wants to add TRUE professional capabilities to his rig. Take advantage of these latest solid-state devices and technological improvements to update your Ham shack today.

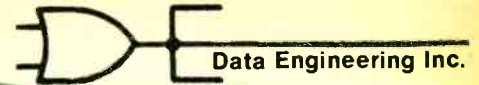

Touch-Tone Phone Pad **44⁵⁰**

Model TTP-2. Make telephone calls from your base station or mobile rig through AUTO PATCH-equipped repeaters in your area. Uses latest phase locked loop circuitry for extreme stability, built-in speaker for monitoring each tone as it's generated. Complete PTT operation with one-second transmitter hold to prevent accidental on/off operation of your TR switch. Has tone level output adjustment. Smoked gray cover, blue panels. 3 x 5½ x 1½". 12 VDC. **DX-076J.** Shpg. wt. 1 lb. ... **44.50**
KB-342J. TTP-2K. Kit form. **34.50**

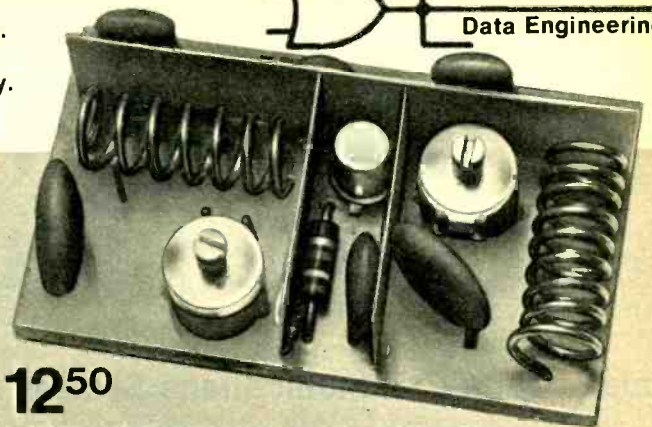

12⁵⁰

2-Meter FM Preamp

Increases the sensitivity of most 2-meter rigs to 0.1 μ V while maintaining a low receiver noise figure. Extremely compact, can be mounted right in most transceiver or receiver cases. 20 dB gain. 2.5 dB NF. 1¾ x ½ x 1". For 12 VDC operation.

DX-077J. Shpg. wt. 1 lb. **12.50**
KB-343J. Above, in easy-to-build kit form. 1 lb. **9.50**

1 Model FMS-5 VHF Frequency Standard. Designed to give the FM'er exact channel spacing and deviation. Allows precise calibration of all crystals in the 10, 6, 2 and 1¼-meter FM bands. Can be calibrated to WWV or WWVH, produces a signal with usable harmonics beyond 220 MHz. Front panel switch selects markers at 5, 10, 15, 20, 30, 40, 60 and 120 MHz intervals. High noise level immunity amplifier. Battery operated. 5 x 3½ x 5".

DX-079J. Shpg. wt. 2 lbs. **44.50**
KB-345J. Model FMS-5K. Above, kit form. 2 lbs. **37.50**

2 Model FMS-3 High-Frequency Marker Standard. Uses precision 400 kHz crystal to produce sharp, clear markers at 5, 10, 25, 50, 100, 200 and 400 kHz. Features extremely fast rise and fall time—harmonics are usable beyond 150 MHz. Front panel adjustment calibrates crystal to WWV or WWVH. Use to calibrate your receiver or transmitter, drive logic circuits, etc. High-frequency phono jack output. Battery operated. 5 x 3½ x 5".

DX-078J. Shpg. wt. 2 lbs. **33.95**
KB-344J. Model FMS-3K. Above, kit form. 2 lbs. **29.95**

3 Cricket-1 Integrated Circuit Morse Code Keyer. Solid-state code keyer designed for novices and pros. Features jam-proof spacing, self-completing dots and dashes, "full control" variable weight ratio. For 3.5 to 50 wpm. Has auto-semi-auto switch, transmitter output jack, 12 VDC input jack. 3½ x 2½ x 8½".

DX-074J. Shpg. wt. 3 lbs. **49.95**

4 Model APC-4 Automobile Phone Patch Console. Patch your mobile rig into AUTO-PATCH-equipped repeaters in your area and use the telephone from your vehicle. Has a host of outstanding features: PRE-programming of five numbers for fully automatic sending, phase locked loop circuitry for extremely stable operation, touch-tone pad operation, adjustable high tone, low tone and audio output. 6¼ x 2½ x 3½". For 12 VDC.

DX-075J. Shpg. wt. 2 lbs. **98.50**

KB-341J. Model APC-4K. Above, kit form. 2 lbs. **84.50**

5 Space-Matic 21B Selectable Input Morse Code Keyer. The only non-reprogrammable keyer on the market that lets you select your input keying reference. Selects keyer with "no dot or dash" memory, "dot" memory, "dash" memory. Has controlled character and word spacing, twin or single level paddle, provision for manual keying. 5½ x 3¼ x 7¼". 117 VAC/12 VDC.

DX-073J. Shpg. wt. 4 lbs. **89.50**

6 Memory-Matic 8000 Programmable Morse Code Keyer and Memory. Automate your CW! The Memory-Matic is an advanced electronic keyer with storage capacity of up to 19,200 information bits in eight separate memories. Lets you pre-program CW messages for automatic "push-of-a-button" sending. Has memory start and stop, controlled character and word spacing, monitor with speaker, self-test switch. Provision for manual keying, instant start time base. 10 x 5½ x 8". 117 VAC. Memories below.

DX-068J. Shpg. wt. 9 lbs. **249.50**

DX-069J. 500-Bit Memory **19.50** **DX-070J.** 1000-Bit Memory **29.50**

DX-071J. 1200-Bit Memory **39.50** **DX-072J.** 2400-Bit Memory **69.50**



1 44⁵⁰

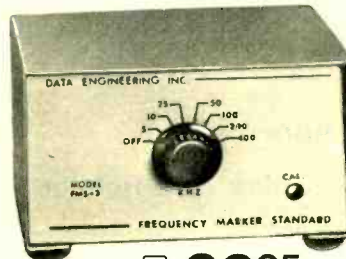

2 33⁹⁵



4 98⁵⁰

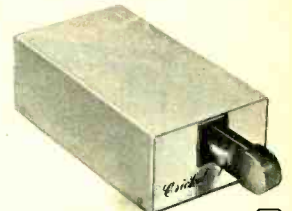

3 49⁹⁵



5 89⁵⁰



6 249⁵⁰

hugain

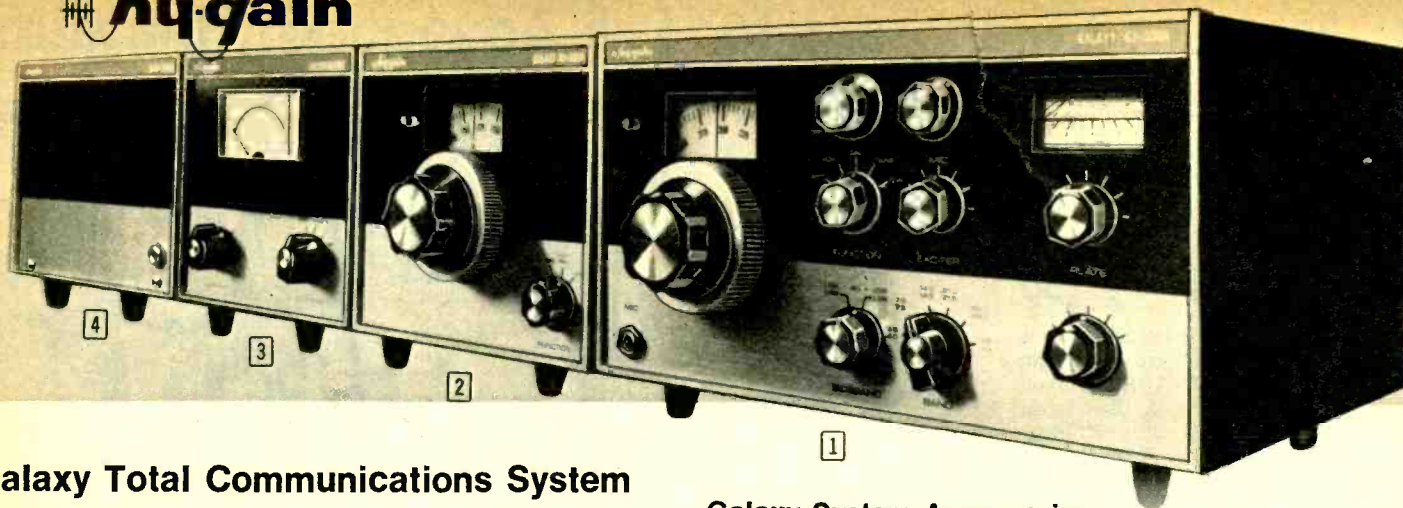

Galaxy Total Communications System

An outstanding combination of reliability, features and value in Ham gear. Start with the basic Transceiver . . . add accessories to meet your requirements as you need them.

1 SSB-CW-RTTY 5-Band Transceiver

595⁰⁰

- 80 to 10 Meter Coverage
- 550 Watts PEP on SSB
- 50-Ohm Variable Output

Model GT-550A. Unrivald for mobile or fixed-station operation! A solid 550 watts of "talk power" and top sensitivity for the weakest DX. Band coverage: 3.5-4, 7-7.5, 14-14.5, 21-21.5, and 28-29 MHz. VFO is double voltage regulated. Built-in 1000 Hz sidetone for CW monitoring, no-jump selectable sideband, offset carrier CW, 2.1 kHz filter, AGC, more. Requires 800 VDC at 700 mA and 350 VDC at 400mA (both with 10% regulation); 100 VDC at 45 mA, 12 VDC at 6/1.5 amps. 11 1/4" W x 7 1/4" H x 12 1/2" D. Use AC-400, right. DX-009J. Shpg. wt. 19 lbs. 595.00

Galaxy System Accessories

- 2 **Model RV-550A Remote VFO.** Solid-state VFO like that in the GT-550A Transceiver. With cables. 7 1/4" W x 7" H x 6 1/2" D. DX-003J. Shpg. wt. 5 lbs. 95.00
- 3 **Model RF-550A RF Console.** Precision wattmeter has 400/4000 watt scales; accurate in 3.5-30 MHz range. Switch selects one of 5 antennas, dummy load (not supplied). 7" W x 7 1/4" H x 6 1/2" D. DX-004J. Shpg. wt. 5 1/2 lbs. 75.00
- 4 **Model SC-550A Matching Speaker Console.** Communication-type 5 x 7" speaker; headphone jack. 8 ohms. Has space inside for AC-400 power supply. With cable. 10" W x 7 1/4" H x 9 1/2" D. DX-006J. Shpg. wt. 6 lbs. 29.95
- Model AC-400 AC Power Supply.** Heavy-duty solid-state unit. Switch selection of 115/230 VAC input. With cable and plug. DX-012J. Shpg. wt. 20 lbs. 99.95
- Model G-1000 DC Mobile Power Supply.** Solid-state. With cables. For 12/14 VDC neg. ground. 8" W x 3" H x 3 3/4" D. DX-013J. Shpg. wt. 7 lbs. 129.95

CDE Antenna Rotators

Cornell-Dubilier Ham Rotator

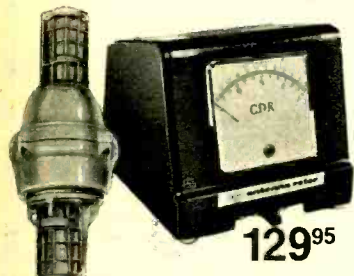

- Supports Heavy Beams
- Mast or Tower Mounting
- Built-in Braking System

CDR HAM-M. A popular rotator that handles the heaviest Ham antennas. Supports 1000 lbs. of dead weight. Has 98 steel ball bearings on rotator in two 6" diameter races. Solenoid-actuated braking system. Rotates 360° in 50 seconds. Meter indicator on control box is accurate with 5° of true compass direction. For masts to 2 1/16" diameter. 117 VAC. AA-704J. Shpg. wt. 26 lbs. 129.95

129⁹⁵

WR-033J. 100' 8-cond. cable for above. Wt. 5 lbs. 14.98

Cornell-Dubilier CB/Ham Rotator

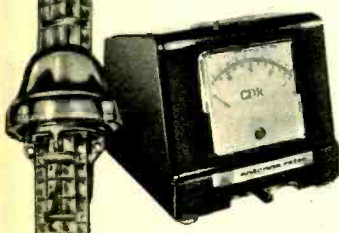

- Rotates 360° in 50 Seconds
- Zener Regulated Meter Accurate Within 5° of True Compass

CDR TR-44. Ideal for light-weight tribander and CB beams. Has 50 steel ball bearings on rotator in two 6" dia. races. Built-in braking system holds antenna in position against high winds. For masts to 2 1/16" dia. 117 VAC. AA-703J. Shpg. wt. 19 1/4 lbs. 79.95

79⁹⁵

WR-033J. 100' 8-cond. cable for above. Wt. 5 lbs. 14.98



Tri-Ex Antenna Support Towers

5 Tri-Ex Crank-Up Tower

- All Steel Construction
- Crank-up Convenience

Galvanized finish inside and out. Supports 4 sq. ft. of antenna in 50 mph winds with top section ungyed. Extended height, 37'. Mounting stub for rotator. AA-598JF. Shpg. wt. 120 lbs. 119.50

6 Variable Height Towers

Crank-up towers with twist-resistant "W" bracing. Fully galvanized finish. Mount-stud for rotator. Upper sections self-supporting; bottom secured with guy cables. Hinge and wall bracket included.

Stock No.	Model	Height	Shpg. Wt.	Each
AA-599JF	MW-35	35'	145 lbs.	173.00
AA-600JF	MW-50	50'	234 lbs.	295.00
AA-601JF	MW-65	65'	330 lbs.	390.00

7 Freestanding Towers

Aerodynamic design of high-strength steel tubing with solid-rod steel bracing in "W" configuration. Galvanized finish. 20' sections. Support 9 sq. ft. antenna area in 50 mph wind. Meets ASTM specs.

Stock No.	Model	Height	Shpg. Wt.	Each
AA-602JF	W-36	36'	215 lbs.	328.50
AA-603JF	W-51	51'	355 lbs.	454.50
AA-604JF	W-67	67'	650 lbs.	983.50

NOTE: All Towers are Shipped Disassembled from Visalia, Cal.—Freight Collect via truck or Express. Allow 3-4 weeks.

Hy-gain Amateur Antennas & Accessories

Super Thunderbird DX SIX ELEMENTS!

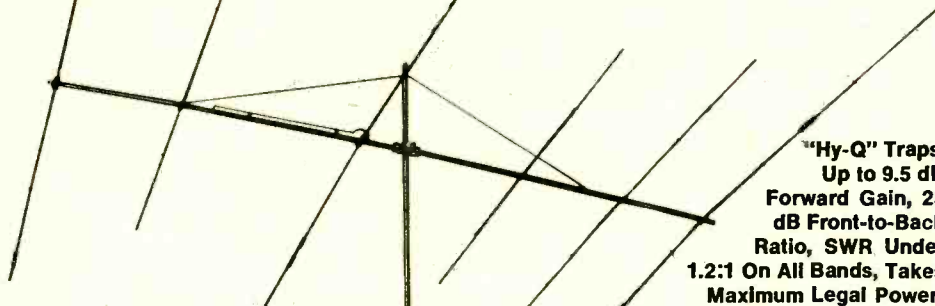

Model TH6DX. Spectacular performance on 10, 15 & 20 meters. Average 8.7 dB gain, 50 ohms, 1 kW AM input (maximum). Beta match. Longest element, 31.1'. Turning radius, 20'. Mast dia. 1 1/4"-2 1/2".
AA-567J. 65 lbs. REA Exp. only ... 189.95

"Hy-Q" Traps,
Up to 9.5 dB
Forward Gain, 25
dB Front-to-Back
Ratio, SWR Under
1.2:1 On All Bands, Takes
Maximum Legal Power!

Model TH 3MK3 3-Element Beam. For 10, 15, 20 meters. Av. gain, 8 dB. 1 kW AM. 52 ohms. Longest element, 27'. Turn rad., 15.7'. 1 1/4"-2 1/2" mast dia.
AA-571J. 40 lbs. REA Exp. only 154.95
Model TH3JR 2-Element Beam. 300 watts AM. Turn rad., 14.3'. 1 1/4"-1 1/2" mast.
AA-572J. 23 lbs. REA Exp. only 109.95

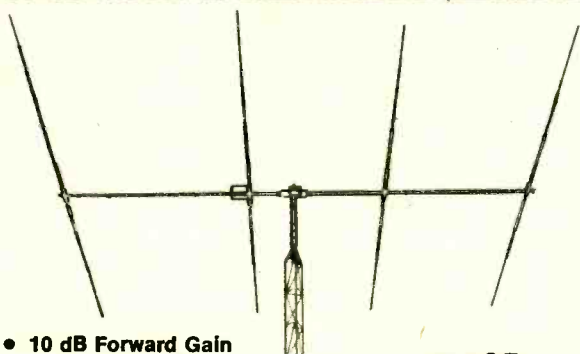

- 10 dB Forward Gain
- SWR Under 1.12:1
- Up to 28 dB Front-to-Back Ratio

159⁹⁵

Model 204BA 20-Meter DX Beam. Usable with lightweight tower & standard Ham rotator! Four full-spaced elements, Beta matched, 52 ohms. Longest element, 36 1/2'. Wind load at 80 mph, 99.8 lbs. Max. input, 1 kW AM. Mast dia., 1 1/4"-2 1/2".

AA-581J. Shpg. wt. 52 lbs. REA Express only 159.95
AA-580J. DB10-15A 10 & 15-Meter Beam 3 elements. 8.3 dB gain. Longest element, 23'. 30 lbs. REA only. 119.95

14⁹⁵

Ferrite Balun

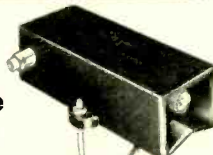

Model BN-86. Couples a 52-ohm unbalanced line into a 52-ohm balanced beam or doublet. For 3-30 MHz. SO-239 input, terminal lug outputs. Rated 1 kW DC. 3 1/4" x 6 1/4".
AA-579J. Shpg. wt. 2 lbs. ... 14.95

HAMCAT LINE

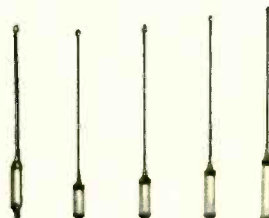

Coil & Tip Rod
Assemblies

Model 257. This Hamcat Mast Assembly has a sleeve clutch that releases a fold-over hinge & the base swivels. For easy band changing and garaging. 5/8" rod. 52 ohms. Order Coil & Tip Rods below.
AA-591J. Wt. 6 lbs. ... 17.95

Coils & Tip Rods

Model 252. 75 meters.
AA-592J. Wt. 3.5 lbs. ... 19.95
Model 256. 40 meters.
AA-593J. Wt. 3.5 lbs. ... 17.95
Model 255. 20 meters.
AA-594J. Wt. 3 lbs. ... 15.95
Model 254. 15 meters.
AA-595J. Wt. 3 lbs. ... 12.95
Model 253. 10 meters.
AA-596J. Wt. 3 lbs. ... 11.95

Trapless Fan Doublet

- For 15, 40 and 80 Meters

Delivers outstanding performance on unlimited power! Features HyGain's superbly constructed center and end insulators with super-strength aluminum clad single-strand wire elements. Will not stretch. Built to last!

DX-032J. Wt. 4 1/2 lbs. 30.00

Accessories

Trunk Lip Ant. Mount.
AA-577J. 1 1/2 lbs. 6.95
H-D Bumper Mount.
AA-573J. 1 1/2 lbs. 9.95
Deluxe Gutter Clip.
AA-578J. 1 lb. ... 1.95
Deluxe Antenna Spring.
AA-574J. 2 1/2 lbs. 6.95
Heavy-Duty Spring.
AA-575J. 3 1/2 lbs. 9.95
Miniature Spring.
AA-576J. 1 1/2 lbs. 4.95

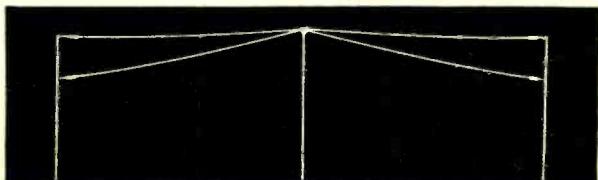

Hy-gain

MULTIBAND VERTICALS

1 Model 18HT

The "Hy-Tower" offers excellent omnidirectional performance and installs on 4 square feet of land! Just about indestructible, it has automatic band selection on 80 thru 10 meters by means of stub coupling which isolates various sections of the antenna so that an electrical 1/4 wavelength exists on all bands. Fed with 52-ohm coax, it takes maximum legal power. The galvanized 24-ft. tower requires no guyed supports! Top mast, which extends to a height of 50', is 6061ST6 tapered aluminum. All hardware iridite-treated to MIL specs. The hinged base allows complete assembly of antenna at ground level, permits easy raising and lowering of antenna. Shipped REA or Truck.
AA-569JF. 97 lbs. 219.95

2 Model 18AVT/WB

Self-supporting, automatic, band-switching vertical that delivers omnidirectional performance on 80 thru 10 meters. Three Hy-Q traps permit a true 1/4-wave resonance on all bands. Low-angle radiation for superior DX and long-haul contacts. Has heavy-duty construction with double-grip bracket for maximum rigidity in roof-top or ground mounts. Top loading coil. SWR of 1.25:1 at resonance. Overall height, 25'. **NO GUYING NEEDED!** Shipped REA only.
AA-570J. 16 1/2 lbs. 79.95
Model 14AVQ/WB. Similar to above, but covers 40 thru 10 meters only. For portable or permanent installation. Overall height, 18'.
AA-568J. 9 1/2 lbs. 55.00

It's Rugged!

The 18AVT/WB is made of ruggedized, tapered, swaged seamless aluminum tubing with full-circumference, corrosion-resistant compression clamps at slotted tubing joints. No guy wires required! Built to last and last and last ...

Useful Station Accessories for the Amateur and CB Operator

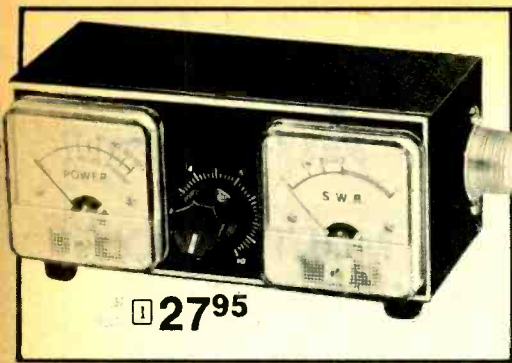

1 2795

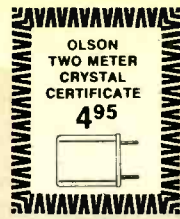

OLSON
TWO METER
CRYSTAL
CERTIFICATE
495



AMATEUR
RADIO
CRYSTAL
CERTIFICATE
295

2-Meter FM Crystal Certificate. You fill out card, receive crystal from Mfr. DX-041J. Each 4.95

Amateur Crystal Certificate. As above, F-243 Type Holder. Supplied +5 kHz; ± 0.1%. DX-028J. Shpg. wt. 4 oz. Each 2.95



11 Shure Hand-Held Heavy-Duty Mikes. For mobile or fixed station. Omnidirectional. Hi-impact case. Response 200-8000 Hz; -52 dB. Mtg. bracket, 5½' cord. Shpg. wt. 1 lb.

MK-029J. Shure 404B. Low-Z. 22.80
MK-030J. Shure 404C. High-Z. 22.80

12 Shure Amateur Base Station Mike. Adjustable stand raises or lowers for best talking position. Push-to-talk switch with lock. 300-3000 Hz. Output -53 dB. 7-ft. cable.

MK-031J. Shure 444. Wt. 2 lbs. 29.40

13 Shure Transistorized Mike. For amateur or CB base station. Built-in 2-transistor preamp with volume control. Push-to-talk bar. Adjustable level. 200-6000 Hz. 5-ft. cord.

MK-032J. Shure 444T. Wt. 2 lbs. 33.60



2 1498



3 895



4 2995



5 1495



6 13995

1 Dual SWR & Power Meter. Reads output, reflected power. 100 µA movements, 2" meters. Low insertion loss, good thru 175 MHz. Safe in-line to 2000 W. 4¼ x 2¼ x 2½". DX-047J. Shpg. wt. 2 lbs. 27.95

2 Olson Field-Strength Meter. Measures SWR for precise tuning of communication antennas. Measures SWR to 1.1 to 1. Covers 2-30 MHz. 52 ohms. Easy hook-up. 1¼" x 5¾" x 2¼". CB-067J. Shpg. wt. ½ lb. 14.98

3 Ten/Tec Model AC-5-205 Antenna Tuner. Matches unbalanced output of 50-75 ohms in balanced feedlines, random length or long-wire. Works with up to 10 watts RF output. DX-025J. Shpg. wt. 4 lbs. 8.95

4 4-Amp Power Supply. Regulated supply for most transceivers. CB rigs, etc. 117 VAC input, 12 VDC, 4-amp output. 4¾ x 3 x 5¾". BA-234J. Shpg. wt. 5 lbs. 29.95

5 Ten-Tec Model AC4-104 SWR Bridge. Handles 250 watts, yet measures as little as ¼ watt forward or reflected power. With meter. DX-024J. Shpg. wt. 5 lbs. 14.95

6 B&W Dummy Load Wattmeter. Frequency range, DC to 300 MHz. Non-inductive, oil cooled load; 52 ohms. VSWR, less than 1.3:1 up to 230 MHz. Power: 50 watts continuous, 1000 watts intermittent. Four scales: 0-10/100/300/1000 watts. Accuracy: ±5%. 2-30 MHz; 10%, 30-150 MHz; 20%, 150-230 MHz. 4¾" x 9" x 10¼". DX-090J. Shpg. wt. 12 lbs. 139.95

7 B&W Portable Whip Antenna. Covers 2-20 meters plus CB band. 360 watts. 57" extended. DX-089J. Shpg. wt. 2 lbs. 24.95

8 B&W Wall Mount Coax Switch. 6 position. DX-085J. Shpg. wt. 2 lbs. 14.95

9 B&W Protax Antenna Switch. 6-position; automatic sounding. 1000 watts. DX-086J. Shpg. wt. 2 lbs. 17.50

10 B&W 2-Position Antenna Switch. 1-pole. DX-087J. Shpg. wt. 2 lbs. 7.43

B&W Coax Antenna Relay. Automatic operation from VOX or relay. 2 kW PEP, 1 kW on CW. DX-088J. Shpg. wt. 3 lbs. 11.95



14



15

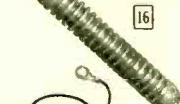

16



17



18

14 Telephone Dial. Standard marked dial, ideal for building phone autopatch encoders. PH-163J. Wt. 1 lb. 2.98

15 Hy-Gain Type C1 Center Insulator. For doublet antennas. Accepts small or large coax. Heavy-duty! WR-027J. Wt. 1 lb. 5.95

16 Hy-Gain Type EI End Insulator. Rugged hi-impact Cyclocac insulator, 7" long. Sold in pairs only. Wt. 1 lb. WR-028J. Per Pair 3.95

17 Alternator Filter. Filters out noise generated by 12 volt vehicle alternators. For most Amateur, CB rigs. CD-112J. Wt. ¼ lb. 3.88

18 Brass-Pounder's Straight Key. The classic brass key with heavy polished, solid base. Ball-bearing pivots for fast action. Heavy knob. Circuit-closing switch. DX-021J. Wt. 2 lbs. 3.79

Coaxial Connectors and Adapters for Ham and CB Applications

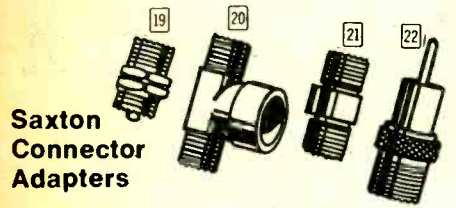

Saxton Connector Adapters

For use with UHF coax connectors. ¼ lb.

Stock No.	Fig.	Description	Each
CB-295J	19	Single hole receptacle (SO-239SH)	.89
CB-296J	20	T-Adapter (M358)	3.98
CB-292J	22	SO-239 to Motorola plug (RG-59/U)	1.69
CB-291J	21	Double female (PL-258)	1.20

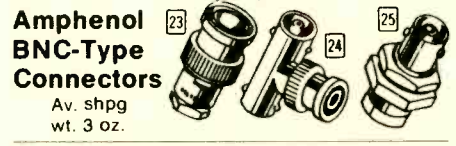

Amphenol BNC-Type Connectors

Av. shpg wt. 3 oz.

Fig.	Type	Use With	Descrip.	Stk. No.	Each
23	UG/U88	RG-58/U	Plug	CB-276J	1.19
24	UG/U274A	—	T-Adapter	CB-277J	2.69
25	UG/U909	RG-58/U	Chas. Jack	CB-278J	1.69



Type N Coax Connectors

Av. wt. 3 oz.

26	UG/U21B	RG-8/U	Plug	CB-279J	1.59
27	UG/U23B	RG-8/U	Chas. Jack	CB-280J	1.69

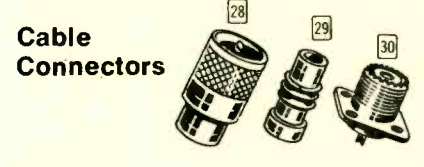

Cable Connectors

28 PL-259 Type Coax Connector. CB-046J. Shpg. wt. ¼ lb. Each 79c
2 for \$1.50

29 UG-176U Reducer. For RG-59 U cable. CB-047J. Shpg. wt. ¼ lb. Each 29c
2 for 50c

UG-175U Reducer. For RG-58 U coax cable. CB-026J. Shpg. wt. ¼ lb. Each 29c
2 for 50c

30 Panel Mount Receptacle. SO-239 type. CB-027J. Shpg. wt. ¼ lb. Each 70c

Hand-Held and Mobile Units with Famous Midland Reliability

1 12-Channel Mobile 2-Meter FM

Model 13-500. Power control lets you adjust output from 1 to FULL 15 watts. FET front end with high Q resonator filter—sensitivity of 0.3 μ V for 20 dB quieting, and ceramic filters. S/RF meter, instantaneous final protection circuit, ADL control. Crystals for .16/.76, .34/.94 and .94 simplex supplied. With mike, mtg. hardware, accessory connector for tone burst and discriminator meter. 2 1/4 x 6 3/8 x 8 7/8". 12 VDC neg. grd. DX-043J. Shpg. wt. 4 1/2 lbs. 249.95

2 220 MHz FM Mobile Compact

Model 13-509. Has 10-watt RF output, low power switch for 1-watt. 12 Channel capability with crystals for 223.00 MHz simplex. S/RF meter, ADL circuit, FET front end, high Q resonator filter gives 0.5 μ V nominal for 20 dB quieting, ceramic filter. With mtg. bracket and hardware, mike, accessory connector for tone burst, discriminator meter. 2 1/4 x 6 3/8 x 8 7/8". 12 VDC neg. grd. DX-044J. Shpg. wt. 4 1/2 lbs. 219.95

3 2-Meter 6-Channel Hand-Held

Model 13-520. Full 2-watt output. Dual conversion receiver with mechanical filters, IC and MOSFET. Operates on eight "AA" penlight batteries. Has built-in mike, antenna, battery/S meter, squelch, carrying case. Jacks for external antenna, PTT mike, power, speaker. 0.5 μ V for 20 dB quieting. Crystals for .16/.76, .34/.94, .94/.94. 3 x 9 x 1 7/8". DX-045J. Shpg. wt. 2 lbs. 299.95

1 **249⁹⁵**

2 **219⁹⁵**

3 **299⁹⁵**

Get "Full-Quiting" reports through your local repeater with these high quality VHF FM transceivers that feature more power where it counts.

2-Meter Crystal Certificate. DX-041J. 4.95

REPEATER LINE from *high gain*



4 **12⁹⁵**

5 **\$23**

6 **9⁹⁵**

7 **\$80**

8 **\$6**

9 **21⁹⁵**

10 **21⁹⁵**

11 **7⁵⁰**

12 **\$18**

Mobile VHF Antennas

• All have 17-7 ph Stainless Steel Whip

- 8 **Model 269.** Completely insulated with vinyl coating, fully flexible, shortproof. With 5/16 x 32 base. Fits most portables. DX-051J. Shpg. wt. 5 lbs. 6.00
- 9 **Model 264.** Claw mounted. 5/8 wave, 3 dB gain vertically polarized omni-directional mobile. DX-053J. Shpg. wt. 2 1/2 lbs. 21.95
- 10 **Model 263.** Trunk lip mounted. 5/8 wave 3 dB gain, 2 meter antenna. With 16' of coax. For 130-174 MHz. DX-054J. Shpg. wt. 2 1/4 lbs. 21.95
- 11 **Model 261.** Commercial duty 1/4 wave, claw mounted roof-top whip. Tunable to 108-470 MHz discrete frequency. 18' coax and connector. DX-055J. Shpg. wt. 2 lbs. 7.50
- 12 **Model 262.** Magnetic mount whip. Great for temporary no-hole installation. For 108-470 MHz. With coax and connector. DX-056J. Shpg. wt. 2 lbs. 18.00

- 4 **Model 340.** 3 element, 2 meter beam for vertical or horizontal polarization. Boom length 3 ft. Furnished with coaxial balun. DX-048J. Shpg. wt. 3 1/2 lbs. 12.95
- 5 **Model 341.** 8 element, 2 meter beam, 14.5 dB gain. 14 ft. boom, furnished with coaxial balun. DX-049J. Shpg. wt. 6 3/4 lbs. 23.00
- 6 **Model 231.** 15 element. 17.8 dB gain. 16 1/4 lbs. 46.00
- 6 **Model 267.** 1/4 wave ground plane. Pre-tuned for 2 motor use. Complete with cutting chart for 108-470 MHz. DX-052J. Shpg. wt. 1 1/2 lbs. 9.95
- 7 **Model 362.** 4 element high performance stacked array. Vertically polarized, 5.9 dB gain. FCC approved for repeater use. DX-057J. Shpg. wt. 26 1/2 lbs. 80.00

IC-21 24-Channel AC/DC 2-Meter FM Transceiver

- Front Panel Final-Output Tuning Control
- Built-In SWR Bridge for Antenna Matching
- RIT Control for Off-Frequency Signals
- Netting Switch for Self-Calibration
- Front Panel Discriminator Meter
- Dual-Power Range for Close-In Working

When we at Olson decided to make products available to Radio Amateurs, we searched the market for the very best we could locate. Quite simply, this is it. There is nothing available on the market—even transceivers with separate accessory units—that matches the versatility and reliability of the ICOM IC-21! Dual power supplies for fixed or mobile use, FET/IC circuit, dual-conversion superhet receiver, front panel mic deviation control, 24-crystal-controlled channel capacity for the 144-148 MHz VHF band. 5 helical resonators virtually eliminate cross-channel interference. The functional beauty of this rig extends to its insides too—totally modular construction means that should you need service, you can simply replace a circuit module without taking apart the entire unit. And full service parts inventories are available in the U. S. A.—no long waits! With same crystals as IC-22 plus .22/.82, mike, tilt-up desk stand, AC and DC power cords. 9 $\frac{1}{16}$ x 4 $\frac{3}{4}$ x 10 $\frac{1}{4}$ ".

DX-100J. Shpg. wt. 16 lbs. 399.95

DX-103J. Deluxe mobile mount for above. 2 lbs.
..... 15.95

The Finest 2-Meter
Rig You Can Buy—Period!



399⁹⁵

General Performance Specs

IC-21. Circuit Devices: 39 Transistors, 7 FET's, 1 IC, 28 diodes. **Phase Modulation:** Variable reactance. **Sensitivity:** better than 0.4 μ V. for 20 dB quieting. **Spurious Response,** -60 dB or less. **Squelch:** noise operated, +5 to -15 dB. **Bandwidth:** \pm 15 kHz/-6 dB point; \pm 25kHz, -50 dB point. **Audio Output Power:** 1.5 watts. **IC-22, Circuit Devices:** 33 Transistors, 5 FET's, 1 IC, 19 Diodes. **Transmitter Current Drain, High Power,** 2.1A; Low Power, 1.2A. **Supply Voltage:** 13.5 volts DC. Other specs as above.

IC-22 22-Channel Mobile 2-Meter FM Transceiver



\$289

Has the same general circuit features of the IC-21 above, but is designed specifically for 12 VDC negative ground operation. Has provision for 22 transmit and receive crystal controlled channels in the 144-148 MHz band. It is supplied ready-to-go on .94/.94, .52/.52, .34/.94, .16/.76, .34/.34, .76/.76. Features for mobile operation include: modular construction in which the modules are housed in an aluminum frame with a rigid

metal chassis providing extreme ruggedness and reliability. Carefully regulated internal DC voltages and a DC input filter effectively suppress vehicle-generated noise. Has large, easy-to-read "S" meter, lighted channel selector, large built-in speaker. Includes dynamic microphone with coiled cord, mike clip, DC power cable. 6 $\frac{1}{2}$ x 2 $\frac{1}{2}$ x 8 $\frac{1}{2}$ ", mounts easily in your car. **DX-110J.** Shpg. wt. 6 lbs. 289.00

Includes Ceramic
PTT Mike with
Coiled Cord

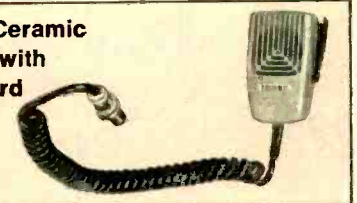

- Totally Modular Construction for Easy Servicing If Needed
- 1 or 10-Watt Dual Power
- Separate Light Indicators for Squelch Break and Transmit

See Pages 117 and 208 for
2-Meter FM Antennas
and Accessories

ICOM Accessories

Advanced
Solid-State
Design

119⁹⁵

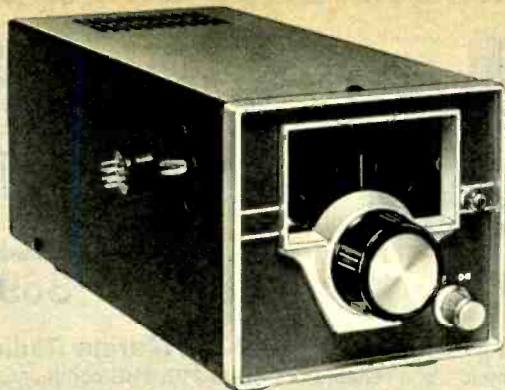

Variable Frequency Oscillator for IC-21

Model IC-21VFO. Converts IC-21 (opposite page) into a continuously tunable 144-148 MHz receiver. Lets you operate crystal-controlled transmit while manually tuning the rest of the band. 4 1/4" x 4 1/4" x 10 1/4". Styled to match IC-21. With connector.

DX-101J. Shpg. wt. 4 lbs. 119.95

Crystal Certificates. For IC-21 or IC-22. Fill out with desired transmit or receive frequency, send to mfr. He then sends you crystals postpaid. Good for a single crystal.

DX-041J. Each 4.95

Both for **\$505**
Save **\$14.90**

IC-21 AS-793J. Shpg. wt. 12 lbs. 505.00

Both for **\$399**
Save **\$9.95**

IC-22 AS-794J. Shpg. wt. 12 lbs. 399.00

IC-5P

Base Station Power Supply

For Fixed
Operation of
Mobile
Transceiver
IC-22

119⁹⁵



Model IC-5P. Fully regulated DC power supply permits operation of the IC-22 mobile transceiver from a fixed position. Delivers 13.5 VDC with output current of 4 amps (continuous load). Has full protection circuitry, output regulation of ±3% for extremely stable operation. 6-transistor, 5-diode circuit for operation over a temperature range of -10° C to +50° C. Has built-in speaker for "big rig" sound, pilot lights to indicate power on, normal operation, warning, current drain. Power on-off switch. With connecting cable, fuse, all necessary hardware. 6 1/2" x 3 1/2" x 8 1/4".

DX-102J. Shpg. wt. 6 lbs. 119.95

Telex "Pro-Quality" Headsets Let You Hear More Clearly, More Dependably

Ordinary speakers are satisfactory for monitoring or clear-channel communications in a single operator set-up. However, in multiple operator set-ups, or where control of incoming signals is wanted, there is NO substitute for headphones. They are comfortable and add to the effectiveness of your rig. Remember—if you can't hear 'em, you can't work 'em!



Combination Headphone/Boom Mike Sets



1 Model CM-600. Lightweight, comfortable—use with any mobile or base station requiring high Z mike input and 3.2-20 ohm audio output. Includes push-to-talk switch, 10' flexible cord. Mike output: -55 dB. PH-241J. Shpg. wt. 2 lbs. 26.95

2 Model C-1210. Extremely rugged, high reliability. Offers good reception with noise attenuation cushions. Close-talking dynamic mike limits ambient noise pick-up. Mike output: -55 dB. With 10' flexible cord, push-to-talk switch. 3.2-20 ohms impedance. PH-242J. Shpg. wt. 2 lbs. 39.95

3 Model C-1320. Earpieces have heavy-duty magnets for clear voice reproduction. Removable cushions, vinyl headband. Sensitive ceramic mike with -55 dB output. 3.2-20 ohms impedance. 10' coiled cord, push-to-talk switch. PH-243J. Shpg. wt. 2 lbs. 49.95

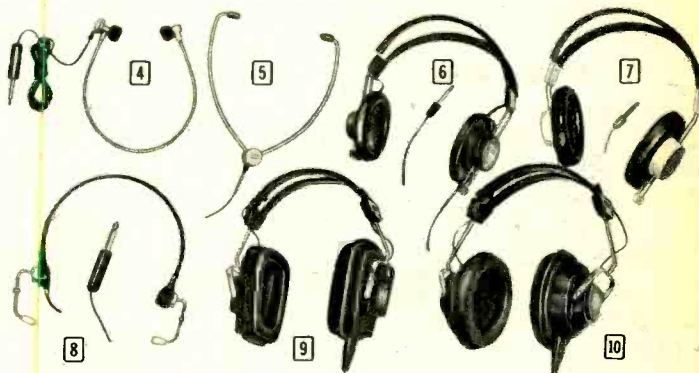

Amateur And CB Communications Headsets

4 Tele-Fi® Ultra Lightweight HFC-91. Single element, under-chin acoustic tube. With ear loop, 1/4" plug. 3.2-20 ohms impedance. PH-234J. Shpg. wt. 5 oz. 5.95

5 Monoset® Under-Chin HMC-2. Weighs only 1.2 oz. Magnetic driver, adjustable tone arms. 1/4" plug, 5' cord. 3.2-20 ohms impedance. PH-237J. Shpg. wt. 6 oz. 9.95

6 Dual Magnetic Headphones C-160. Soft, washable earcushions, 1/4" plug, 5' flexible cord. 3.2-20 ohms impedance. PH-236J. Shpg. wt. 2 lbs. 6.95

7 High-Impedance Headphones SWL-610. Ideal for SW receivers requiring 2000 ohms impedance. Flexible 5' cord, 1/4" plug. Washable ear cushions. Lightweight. PH-235J. Shpg. wt. 2 lbs. 8.95

8 Twinset® Dual Magnet HTC-2. Adjustable sound arms mounted on ball & socket. Detachable 5' cord, 1/4" plug. 3.2-20 ohms impedance. PH-238J. Shpg. wt. 5 oz. 15.95

9 Deluxe Dynamic Headphones C-1210. Digs out weak signals under difficult conditions! Vinyl covered foam cushions, flexible 5' cord, 1/4" plug. 3.2-20 ohms impedance. PH-239J. Shpg. wt. 2 lbs. 21.95

10 C-1320. Audiometric "Lab-Standard" dynamic drivers, luxurious vinyl covered foam cushions. Outstanding sensitivity & frequency response. 5' coiled cord, standard 1/4" plug. 3.2-20 ohms impedance. PH-240J. Shpg. wt. 2 lbs. 29.95

VHF FM Communicators for Land or Sea



259⁹⁵

12-Channel 2-Meter FM Transceiver

Model SB-144. 10-watt audio output, 12-channel capability, double conversion receiver and FET/IC solid-state design make this one of the best 2-meter rigs around! Has power/volume and squelch controls, full-view panel meter for relative signal strength on receive and % modulation on transmit, instrument-type channel selector with back-lighted channel indicators. Special low-current circuit delivers full output power with a current drain of less than 1.9 amps. Receiver sensitivity, less than 1.0 μ V for 20 dB quieting. Selectivity: better than ± 12.5 kHz @ -6 dB. Supplied ready to go on .34/.94, .94/.94, .16/.76 MHz. Covers 144-148 MHz. 6 $\frac{1}{16}$ x 2 $\frac{3}{8}$ x 9 $\frac{1}{16}$ ". For 12 VDC neg. grd.
DX-080J. Shpg. wt. 5 lbs. 259.95

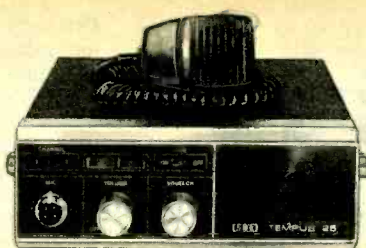

480⁰⁰

148-174 MHz VHF/FM Radio

Model SB-T25. The "Tempus" is a reliable business band communicator that's perfect for mobile-to-mobile FM over long range. High-quality, industrial-grade construction throughout, "book-size" compact for mounting anywhere. 2-channel capability. Less than 0.5 μ V for 20 dB quieting. Selectivity: 6 dB at 6 kHz. RF output, 25 watts. 8 x 2 $\frac{3}{4}$ x 9". 12 VDC neg. grd.
DX-081J. Shpg. wt. 4 lbs. 480.00

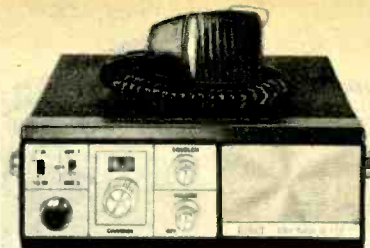

369⁹⁵

12-Ch. Marine Radiotelephone

SB-M-210. THE communicator for any boat! Weather-resistant coatings on bezel and cabinet, heavy-duty mounting cradle. Full 10 watts out for maximum range, 1-watt for close-in. 12-channel capacity with 2 weather channels. Supplied with crystals for channels 6, 16, and 162.55 MHz Weather. 8 x 2 $\frac{3}{4}$ x 9". 12 VDC negative ground.
DX-082J. Shpg. wt. 4 lbs. 369.95
AS-774J. With AA-685 Antenna below 400.00
DX-083J. SB-M225. Above, 25W ... 449.95

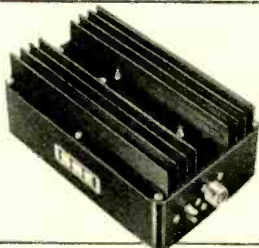

2-Meter Linear Amplifier

189⁹⁵

Model SB-1PA. The "Cruncher"—commercial-quality Class C amplifier that gives your two-meter rig the power you need for longer range, difficult terrain, etc. Delivers 70-90 watts output power when driven by FM transceivers from 7 to 12 watts. Frequency range, 143-149 MHz. 4 $\frac{3}{8}$ x 3 $\frac{1}{8}$ x 7 $\frac{3}{8}$ ". For 12 VDC negative ground.
DX-084J. Shpg. wt. 2 lbs. 189.95

((P)) PACE Marine and Mobile VHF Outfits



Radio
149⁹⁵

Amplifier
129⁹⁵

Business Band VHF Mobile

Model 2000-35. Full 5-watt input power in 25-30 MHz band. Under-dash mounting, FCC Type Accepted. Add \$9.95 for transmit/receive crystal pair and tuning to frequency (specify) at factory. Shipped from Harbor City, Calif. Allow 30 days. 6 $\frac{1}{2}$ x 2 $\frac{3}{8}$ x 8 $\frac{1}{2}$ ". 12 VDC.
DX-001JF. Shpg. wt. 6 lbs. 149.95
PX-100. Linear Amplifier for Above. (Shown.) Increases power up to 10 times.
DX-002JF. Shpg. wt. 4 lbs. 129.95
CB-290J. AC Power Supply. Operate units above as base station. Wt. 6 lbs. 34.95

399⁹⁵

With 2 Crystals,
Antenna



439⁹⁵

With 8 Crystals,
Antenna

VHF Radiotelephone Outfits

Complete marine-ready VHF FM two-way-radio outfits feature PACE M-2500 12-channel 25-watt VHF Marine transceiver, plus antenna and factory-installed and tuned transmit/receive crystals. Radio has loud hailer feature, 5-watt continuous audio, more. 6 $\frac{3}{8}$ x 2 $\frac{3}{8}$ x 10 $\frac{1}{2}$ ". 100% solid-state.
DX-091JF. Pace M-2500 with crystals for Channels 6, 16, and 3 dB gain antenna. 7 lbs. Allow 30 days. 399.95
DX-092JF. Pace M-2500 with crystals for Channels 6, 12, 16, 26, 28, 68, 70 plus Weather (162.55 MHz), 3 dB gain antenna. 7 lbs. Allow 30 days. 439.95

Hy-Gain Marine VHF Antennas

1 Model 770. The ultimate in VHF marine antennas. 9 dB omnidirectional gain! 21' high. Pre-tuned. With 20' coax cable, PL-259 connector. 11 lbs.
AA-687J. 150.00

2 Model 769. Features two $\frac{3}{8}$ -wave colinear antennas phased to provide 6 dB gain. Vertical radiation pattern is compressed to concentrate radiated energy close to horizon. 9'3" long, fiberglass body. Pre-tuned for 156-163 MHz. Less mount. With 20' coax cable, PL-259 connector.
AA-686J. 4 lbs. 60.00

3 Model 768M. Only 54" high, but offers a full 3 dB gain. One-piece design, $\frac{3}{8}$ -wave in unique configuration. Pre-tuned. Includes 20' coax cable, PL-259 connector, laydown mount for deck or bulkhead mounting with no ground plate. Fiberglass. Wt. 3 lbs.
AA-685J. 45.00

Marcel Watches for Communicators—from Olson

Wide selection of precise time-telling instruments for those special people who demand accuracy as well as style and sophistication. Most supply day and date info too, plus support information for Hams and CB'ers. Each wrist-watch below is guaranteed two full years from date of purchase.*

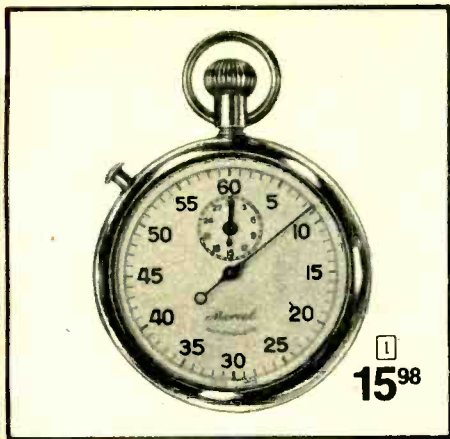

1 Swiss-Made Precision Watch

For sportsmen, referees, umpires—has outer dial with scale divided into 1/10 second up to 30 seconds. Inner dial registers up to 15 minutes. Pushbutton side and crown for convenient stopping and resetting. Jewelled movement for high accuracy and dependability. 1 3/4" circular dial.

XX-531J. Shpg. wt. 1/2 lb. 15.98



2 17-Jewel Double-Button Chronograph. Use as tachometer for speed, telemeter for sound distance, 60-second interval timer with 45-min. register. Waterproof, lizard strap. XM-041J. Shpg. wt. 14 oz. 44.98

3 Double-Button Chronograph. Has tach, telemeter features as above, sweep second hand, stainless steel band. Waterproof. XM-039J. Shpg. wt. 14 oz. 18.98

4 17-Jewel Multi-Year Classic. Unique calendar gives day & month of any year through 2015. Date changes each midnight. Sweep second hand, genuine lizard wrist strap. XM-036J. Shpg. wt. 13 oz. 28.98

***GUARANTEE.** Movements are guaranteed for 2 years from date of purchase against defects in material or workmanship. Movements that become defective within guarantee period will be repaired or replaced at mfr's option provided watch is returned to mfr. with \$3.50 to cover handling, packing and return postage.



5 Man's Calendar Watch. Day and date change automatically each midnight. Easy-to-read raised numerals. Sweep second hand. Gold tone case. XM-037J. Shpg. wt. 14 oz. 16.98

6 Lady's Calendar Watch. "Petite" version watch above, with smaller dial face, stylish lizard wrist strap. Low-priced, highly accurate time keeper. She'll love it! XM-043J. Shpg. wt. 14 oz. 16.98

7 Lady's Watch. Delightfully styled wrist watch has easy-to-read luminous dial set in molded clear lucite case with lucite strap. Shock resistant. Sweep second hand. XM-167J. Shpg. wt. 8 oz. 12.98

8 Man's Wrist Alarm. Buzzes at pre-set time to remind wearer of appointments, meetings, etc. Sweep second hand, gold tone case, genuine lizard wrist strap. XM-040J. Shpg. wt. 12 oz. 15.98



9 Shock Resistant Sports Model Features precision Swiss-crafted movement. Revolving outer bezel shows elapsed time up to 60 minutes—ideal for hikers, bikers, flyers, athletes. Time zone bezel shows time in 12 different cities throughout the world. Water and shock resistant, antimagnetic, unbreakable mainspring, sweep second hand. Calendar changes date at midnight each night. Stainless steel band. XM-034J. Shpg. wt. 13 oz. 14.98

10 Man's Digital Readout Watch The modern new look in time-telling. Instead of the usual dial and hands arrangement, this new watch shows the hours and minutes in large, bold numerals. Also includes a sweep second hand for exact time-keeping. Stylish gold tone case, genuine leather wrist strap. Truly a watch whose "time" has come! XM-166J. Shpg. wt. 14 oz. 14.98

11 Lady's Uniquely Styled Bubble Watch Most distinctive watch design in years. The crystal is raised to form a bubble which not only looks quite attractive, but also makes for easier dial reading. Movement is set in a molded fiber glass case with matching waterproof wrist strap. XM-168J. Clear Case. Shpg. wt. 8 oz. 9.98
 XM-169J. Red Case. Shpg. wt. 8 oz. 9.98
 XM-170J. White-on-White Case. Shpg. wt. 8 oz. 9.98



Treasure Finders For "Fun Lovers" or "Profitters"



Treasure Finding is one of America's fastest growing pastimes! Every member of the family can enjoy it. Uncover buried valuables, coins, anything that's metal. You can Treasure Hunt everywhere: parks, beaches, ghost towns, playgrounds, vacant lots. You name it!

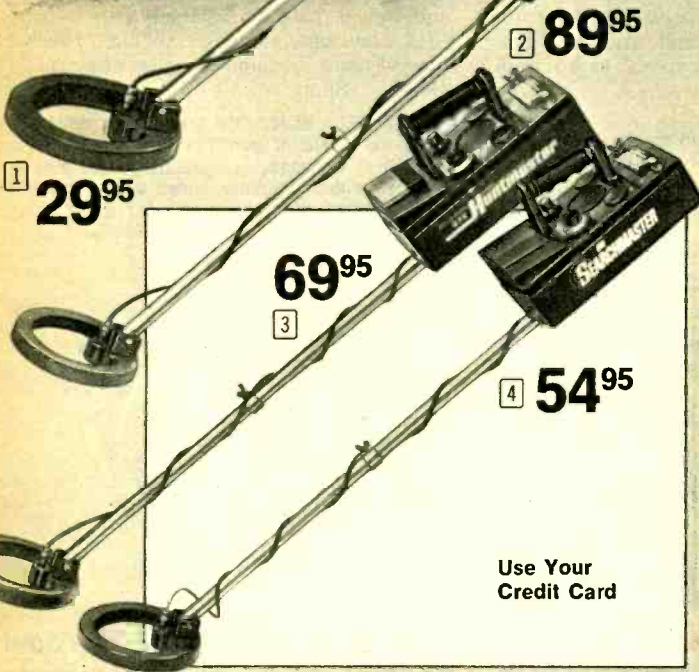

1 Mustang "330"—Fun Each Outing

Take it along on camping and outdoor trips, vacations, anywhere. Detects a penny buried up to 5", larger items much deeper. The circular pick-up coil gives accurate response, built-in speaker gives clear, audible indication when approaching metal object. Also includes positive tuner control—no "drift." Solid-state circuitry, lightweight and very portable. Length, 35".

XX-130J. Shpg. wt. 4 lbs. **29.95**

2 Treasure Hawk "990"—Professional Quality

Designed to meet the needs of the professional and serious treasure and relic hunter. Powerful, yet durable and easy to handle. So sensitive it spots a penny up to 8" deep. Features view meter, battery tester button, speaker sensitivity selector, tuning and volume control, unbreakable cabinet PLUS the advantage of fully transistorized solid state dependability. Stem adjusts from 30-40".

XM-011J. Shpg. wt. 5 lbs. **89.95**

3 Huntmaster "770"—For Serious Hunters

It's practical too! Use at home to locate plumbing inside walls, or in yard to find pipes before digging. Lightweight, easy to use. Over-size circular coil has increased sensitivity—prevents false indications. Detects a penny buried up to 7". Includes view meter, waterproof search coil, loud speaker. Pitch increases as operator draws nearer to buried metal. Solid-state. Stem adjusts 30-40".

XX-131J. Shpg. wt. 4½ lbs. **69.95**

4 Searchmaster "550"—Low-Cost Adventure

Sensitive enough to detect a coin buried 6" underground—locates larger items much deeper! Features vernier-tuning control for detecting "fringe" items. Also includes cleartone loudspeaker, waterproof search coil. You'll find 100's of uses! Fully transistorized for dependable operation. The durable injection molded cabinet has been manufactured to withstand rough treatment. Stem adjusts from 30-40".

XM-020J. Shpg. wt. 4 lbs. **54.95**

Use Your Credit Card

For Better Fishing, Safer Boating!



JETCO Marine Equipment

5 "Sea Scope" Fish Finder/Depth Finder

Model 100G. Low price for famous Jetco quality! Spots one school of fish in any water with thin "flashes" on the dial. It also indicate water depth up to 100 ft.—with 3% accuracy. Sound wave volume control, easy-to-read Brite Lite signal. Can be made portable with two 6 volt lantern batteries. Also can be gimbal mounted to operate off a 12-volt power source, bracket included. Solid-state circuitry. 7¾ x 6½ x 3¾".

XM-010J. Shpg. wt. 5 lbs. **69.95**

6 The Deluxe "Sound Scope" Fish Detector

Model 169. Operates on a sonic wave "beep" that alerts you to fish or obstacles below. Just set the Sound scan-range at any pre-determined depth up to 200-ft.—with 3% accuracy. Features include Interference Rejector Control, so you can run your boat at any speed without interference on the Sound Scope dial. Easy-to-read Brite Lite signal. Portable, self-contained power source uses two standard 6 volt lantern batteries. 12 VDC. 7½ x 11¾ x 8".

XM-021J. Shpg. wt. 6 lbs. **119.95**

69.95 5

119.95 6

Scotch Functional, Fascinating Fasteners

Spra-Ment Craft/Display Adhesive

159

Model 605B. A strong, translucent adhesive that bonds a great variety of materials more quickly and easily than ever before. Mounts signs, lettering, fabrics, fibrous glass, etc. 7 oz. TL-738J. 3/4.50 Ea. 1.59



Super Strength Epoxy Adhesive

98¢

Model 6006. Joins aluminum, steel, brass, etc. Use to mend furniture, china, broken toys, etc. 6 oz. TL-743J. . . . Each 98¢
3 for 2.90 . . . 6 for 5.50



Adhesive Mounting Squares

49¢

Model 111. Use on walls or any surface that is clean, dry and smooth. Use 4 squares for each pound of weight to be held. 16-1" squares. TL-746J. 4 oz. 3/1.40, 6/2.70 Each 49¢

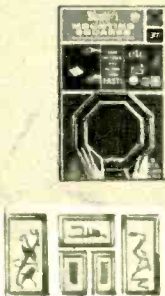

Snap-Type Disc Fasteners

For "no show" mounting almost anywhere. Hold 1-50 lbs. tensile, 150 lbs. shear. Withstands 50,000 closures! XM-135J. 8 oz. 3/4.25, 6/8.30 Each 1.49



Hedlok II

149

Pkg. of 10

- Wire Connectors.** No installation! #18-14 wire. 4 oz. Pkg. of 4. TL-692J. . . 3/1.69, 6/3.35 . . . Ea. 59¢
- Auto / Trailer Connector.** 4 connectors, 4 receptacles. #18-14 wire. 8 oz. TL-691J. . . 3/2.65, 6/5.19 . . . Ea. 93¢

Plastic Tape with Hundreds of Uses

39¢

Model 190. Use as temporary leak seal, identify tags, repair hose, etc. ¾" tape, 125" length. 4 oz. TL-739J. Yellow
TL-740J. White
TL-741J. Green
TL-742J. Red
Your Choice . . . Each 39¢
3 for 1.10 6 for 2.10



Sun Set® Repair Patch

98¢

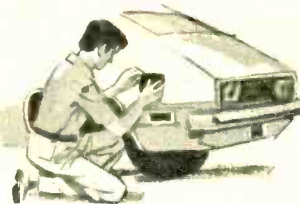

Model R-1546. This self-adhering patch is just the thing for on-the-spot repairs either around the home, camping, traveling. Sets in direct sunlight. One 4 x 6" patch. 10 oz. TL-747J. 6 for 5.50, 3 for 2.80. . . . Ea. 98¢



- Quick
- Easy
- Durable



Rubber Bonded Magnetic Strip

Model SJ8033X. Self-sticking. Weatherproof. Pkg. of 8 strips. 8 oz. TL-749J. 3 for 2.55, 6 for 4.74 Ea. 89¢



Durable Reinforced Strapping Tape

79¢

Model 44. Just the tape to have with you for heavy duty packing and repairs. Use to repair tool handles, banding heavy cartons or odd-shaped items, and for reinforcing containers, worn canvas, and leather straps and luggage. Sticks instantly. Won't stretch and it's very strong. Wt. 6 oz. ½" x 350". TL-745J. 3 for 2.25, 6 for 4.40 . . . Each 79¢

Super Strength Adhesive

98¢

Model 6004. Will handle most bonding at home or at work! Bonds plastic, wood, metal, glass, ceramics, leather, cork, felt, vinyl, rubber, cloth, paper, etc. 1½ oz. tube. Wt. 6 oz. TL-744J. Each 98¢
3 for 2.80 6 for 5.50



Molded Rubber "Feet"

69¢

Protect furniture from scratches and knicks from radios, TV's, hi-fi, etc. Assortment of 16 round and square small feet. Wt. 8 oz. Self sticking. TL-748J. 3 for 1.95, 6 for 3.85 Ea. 69¢

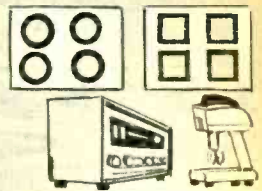

Scotchmate®

Fastens Just About Anything

188

Hook-and-Loop Fasteners

For clothing, pictures, signs, etc. Won't jam or rust, reusable to 50,000 times. Ten ¾ x 2" strips. Wt. 8 oz. XM-128J. 3/5.35, 6/10.50 Ea. 1.88
Five ¾" x 2", Five 1 x 2" Strip Ass't. XM-136J. 3/5.60, 6/11.05 Ea. 1.98

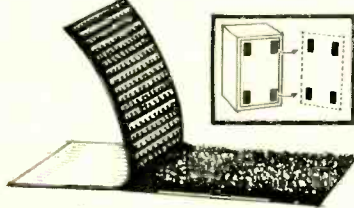

169

Electrical Tape. Vinyl, 100's of uses! ¾", 750" roll, dispenser. 8 oz. TL-690J. . . . Each 1.69
3 for 4.80 6 for 9.30

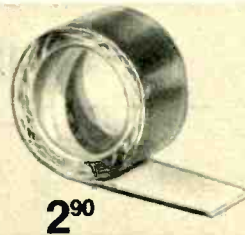

290

Sealer Tape. For auto, electrical uses. 2½", 10' Vinyl backing. 8 oz. TL-693J. . . . Each 2.90
3 for 8.25 6 for 16.20

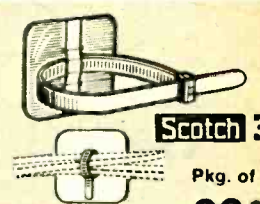

Pkg. of 8
88¢

Harness and Buckle. No clips, drilling. For up to 1½" dia. bundle. 8 oz. TL-694J. . . . Each 88¢
3 for 2.50 6 for 4.90

TELEDYNE POST Tools for Engineers and Draftsmen

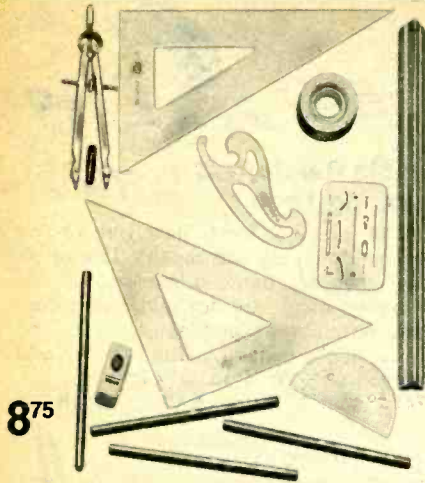

8⁷⁵

Mechanical Drawing Kit

Model 38QC-050. Has all the beginner's tools—the perfect starter set. Includes: 12" triangular scale, 6½" compass, 10"-30°, 60° triangle, 8"-45° triangle, 4" protractor, 35°-½" drafting tape, curve, 2H and 4H pencils, pink pearl eraser, erasing shield.

TL-729J. Shpg. wt. 2 lbs. 8.75

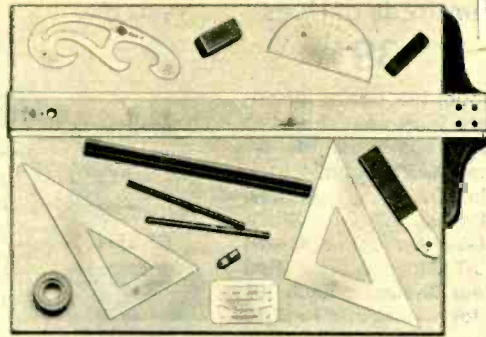

16⁵⁰

Advanced Drawing Set

Model 38QC-070. Intermediate set includes everything at left (except compass) plus metal-edge drawing board, 24" Lok-Tite T-square, pointer, 6" protractor, 350", ¾" drawing tape, Nile green eraser. For advertising layout, schematics, etc.

TL-730J. Shpg. wt. 3¾ lbs. 16.50



16⁷⁵

Paratilt® Drawing Table

Model 38GA-01G. Portable 18" x 24" drawing board has clear Tedlar surface that wipes clean even of ballpoint ink, parallel attached rule that moves across entire board, fold-away handle and non-skid feet. Basswood, light-green no-glare finish.

TL-737J. Shpg. wt. 4 lbs. 16.75

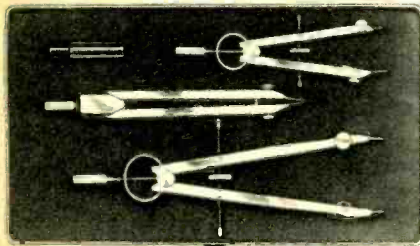

12⁷⁵

Pencil Drafting Set

Model 38JG-120. Has big bow and small bow pencil compasses, friction divider and leads, in gray plastic foam-lined fitted case.

TL-731J. Shpg. wt. 1½ lbs. 12.75

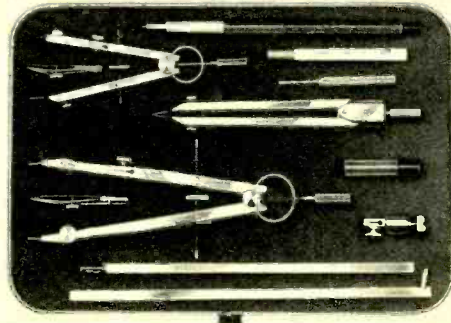

23⁵⁰

Deluxe Drafting Set

Model 38JG-160. Small, big bow compasses, 6" friction divider, 14" two-piece extension beam, screwdriver, lead holder, repair vial.

TL-733J. Shpg. wt. 2½ lbs. 23.50

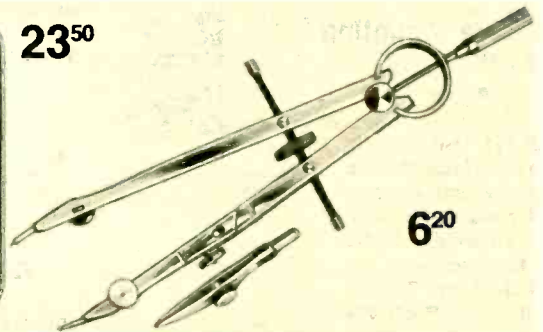

6²⁰

6½" Large-Bow Compass

Model 38JJ-040. Makes circles to 11" diameter. Removable divider points, single-knee action, pen attachment.

TL-732J. Shpg. wt. 4 oz. 6.20



1 8⁵⁵

Deluxe Bamboo Slide Rules. The professional-quality rules because bamboo retains its dimensional characteristics no matter how hot or moist the weather. All include Mfr's Lifetime Guarantee!

1 Beginner's Programmed Instruction Rule

Model 44BA-47N. Includes 10" Mannheim slide-rule with A, B, C, C1, D and K scales—programmed instruction manual that lets you proceed at your own learning pace. The easy, effective way for students to learn the use of the slide-rule.

TL-734J. Shpg. wt. 1 lb. 8.55

2 Pocket-Size Versalog® II

Model 44DA-610. 5" version of Versalog II slide-rule described below. With case, pocket clip, instructions.

TL-735J. Shpg. wt. 1 lb. 19.75

3 Versalog II — THE Rule for the Professional

Model 44CA-60J. 24-scale 10" rule logically arranged to make a remarkable number of calculations easy to perform and read. Has LL/O, K, A, DF, CF, C1, C, D, R1, R2, LLO scales on front. L, LL1, LL2, LL3, TT, SRT, CosS, C, D, LL3, LL2, LL1, on back. Color-coded. With specially prepared 201 page manual.

TL-736J. Shpg. wt. 2 lbs. 32.75

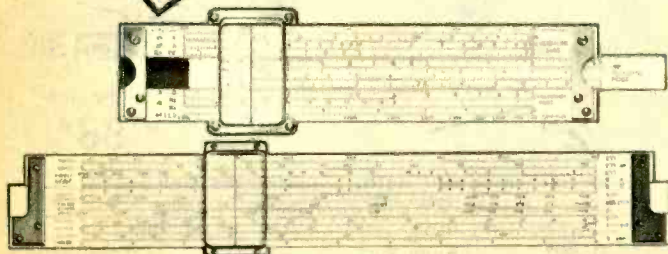

3 32⁷⁵

Kendall Time Tellers

Desk/Table Model with Alarm

39⁹⁵

- 12-Hour Alarm with 10-Minute Setting

Model K-100. "Space-Age" design digital clock with easy-reading 2" numbers you can see anywhere. Has noiseless electric clock movement, chrome/rosewood accent case that's a compliment to your good taste. 9¼ x 3⅞ x 4". For 117 VAC. U.L. listed.

XM-290J, Shpg. wt. 2 lbs. 39.95



Wall-Plaque Digital Clock

49⁹⁵

- "Timely" Good Looks for Home or Office

Model K-115. It's a stunning rosewood and satin aluminum wall plaque that adds style to any room—it's a digital readout electric clock with 2" high red numbers that can be read from anywhere in the room. Has noiseless electric clock movement, fast forward or reverse time change. 14¾ x 7¾ x 3". 117 VAC. U. L. listed.

XM-254J. Shpg. wt. 2 lbs. 49.95



tensor Phone Recorder

Hooks Up Instantly to Your Telephone

\$170

- Uses Standard Cassettes
- Records Incoming Messages up to 60-Minutes Long
- Lets You Monitor Calls As They're Recorded



Model 4900A. The best thing next to your telephone—lets you keep a record of incoming calls and tape phone messages—keeps your phone "on duty" 24 hours a day! Uses standard cassettes—with a C-120 cassette you'll have up to 1 hour message capacity! Even works with multi-line phones too—you can use it in the office with no special adapters. Has connection test circuit, monitor so you hear messages as they're recorded, more. With 30-second message tape, 60-minute cassette (30 minute message capacity), connecting cable. 7 x 4½ x 11". For 117 VAC.

PH-317J. Shpg. wt. 14 lbs. 170.00

TA-827J. 30-Second Announcement Tape for Above. 1 lb. . . . 4.00

TA-828J. 1-Minute Announcement Tape for Above. 1 lb. . . . 5.00

TA-829J. 3-Minute Announcement Tape for Above. 1 lb. . . . 7.00

INTERNATIONAL MARKETING AND MFG.—Phone Accessories



Cuts Background Noises!

4⁹⁵

Telephone Censor

- Lets You Talk to Others in the Room While Still Maintaining Contact on the Phone

Model 771. Stop covering your phone mouthpiece with your hand while you talk to others! Simply press a button on the phone censor and no transmission goes out over telephone—great for noisy areas, parties, etc. Also can be used as hold button. For Western Electric and Bell phones. PH-318J. Shpg. wt. 1 lb. 4.95
PH-319J. Model 871. For General Telephone, Automatic Electric 4.95



Lightweight, Compact, Installs Easily

- Needs No Batteries or AC Power
- Non-Polarized for Instant Installation
- Connects to Any Point on Telephone

Make Your Tape Recorder Even More Versatile

24⁹⁵

Automatic Telephone "Secretary"

Model TMD-1. Lightweight compact device hooks up instantly to your portable tape recorder, and your telephone, to make a record of all telephone conversations—incoming and outgoing—even when you're not by the phone. Starts your tape recorder when phone rings, stops it when the phone is hung up—use it to keep a record of all conversations on your phone—by you, by

your employees, by your answering service. Hooks up at any point in the telephone line—installation is so easy you can move it from phone to phone instantly. Completely self-contained, does not require batteries or AC power. Works with all makes and models of phones and tape recorders. 2 x 2 x 1". PH-320J. Shpg. wt. 1 lb. 24.95

USE WITH ANY STANDARD PORTABLE TAPE RECORDER



Telephone Accessories at Low Olson Prices

Dial-Type Wall Telephone

6⁹⁹

Perfect for
Intercoms,
Extensions,
"Private"
Phone Systems



Removed from service, but perform like new. Standard black color, bake-lite body and handset. Less bell.

PH-188J. Shpg. wt. 10 lbs. 6.99

12⁹⁸

Hands-Free Telephone Amplifier

Ready to use—NOT a kit! Simply place telephone handset in cradle and work or write as you talk—listen from anywhere in the room, too. Great for the hard-of-hearing, family-type "conference calls, etc." Battery powered. Separate speaker (3½ x 2½ x 4") may be wall mounted.

PH-196J. Shpg. wt. 4 lbs. 12.98

BA-192J. 9-Volt Battery for above 29¢



8 Standard Phone Handset

Popular style. With receiver, transmitter, plastic 4-conductor coiled cord.

PH-160J. Shpg. wt. 2 lbs. 8.98

9 Telephone Cradle

Rugged black thermoplastic withstands shocks and vibrations. Built-in switch.

PH-161J. Shpg. wt. 2 lbs. 6.98

10 50-Ft. Telephone Wire

3-conductor beige hookup wire with color-coded conductors, vinyl insulation.

WR-129J. Shpg. wt. 1 lb. 2.98

11 Standard Telephone Dial

Transparent plastic dial face. Marked with letter and numbers. Metal finger stop.

PH-163J. Shpg. wt. 1 lb. 2.98

12 Operator's Headset

Keeps hands free for switchboard work. 3-ft. coiled cord, mike and earphone.

PH-157J. Shpg. wt. 3 lbs. 34.98

13 Slip-On Phone Amplifier

Overcomes home, factory noise instantly. Just slip over phone for 5 times more volume than normal phone use.

PH-294J. Shpg. wt. 2 lbs. 8.95

14 Extension Coil Cord

Extend telephone handset up to 15-ft. away from cradle. Easy screwdriver installation.

PH-297J. Shpg. wt. 1 lb. 6.75

15 Coiled Handset Cord

4-conductor cord expands to 6-ft. Insulated.

WW-572J. Shpg. wt. ¾ lb. 69¢

3-Conductor Cord. With terminal lugs.

WW-580J. Shpg. wt. ¾ lb. 99¢

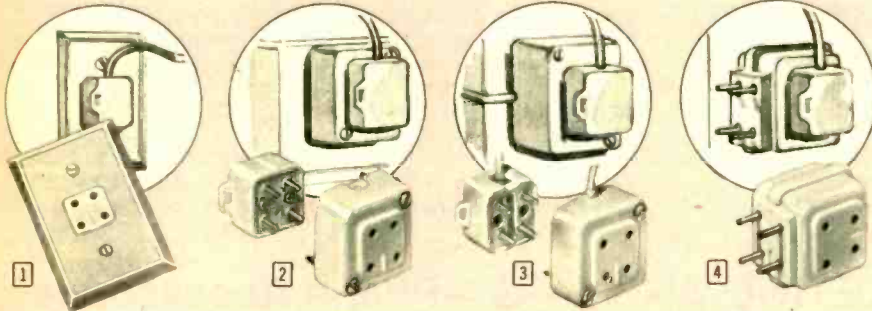

1 Phone Wall Jack

Fits standard wall conduit boxes. Takes PH-121 plug below. For 2, 3, 4-wire systems.

PH-118J. Shpg. wt. ½ lb. 1.35

3 25-Ft. Extension Cable

Adds flexibility to phone or intercom systems. Vinyl insulation, 4-prong plug, jack.

WW-442J. Shpg. wt. 1 lb. 2.69

2 Plugs and Jacks

Standard 4-prong type. Jack matches plug.

PH-121J. Phone Plug. Wt. ½ lb. 89¢

PH-120J. Phone Jack. Wt. ½ lb. 89¢

4 Wireless "2-in-1" Adapter

Connects 2 standard phones to a single jack. No wiring needed—just plug it in!

PH-200J. Shpg. wt. 1 lb. 2.09

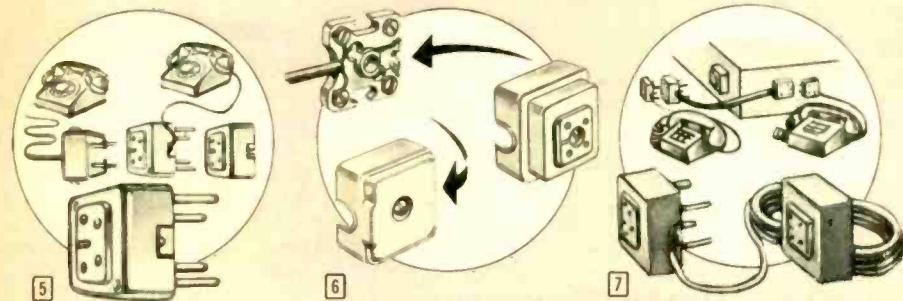

5 Telephone "Jack-In-A-Plug"

Lets you connect one or more phones to a single jack without loss of sound.

PH-195J. Shpg. wt. 1 lb. 1.49

6 "Quick-Jack" Phone Outlet

Instantly converts any single line phone outlet into a phone jack without disconnecting phone or rewiring. No power loss.

PH-214J. Shpg. wt. ½ lb. 1.98

7 2-Phone Extension Cord

25-ft. extension cord has standard telephone jack at one end plus "jack-in-a-plug" at other. Lets you install two phones up to 25-ft. away from a single wall outlet. Excellent for setting up conference calls, meetings, etc. Use additional jacks-in-a-plug to operate more than two phones from a single jack. No loss of power.

WW-583J. Shpg. wt. 2 lbs. 3.98

Tired of the Same Old Phone? Update at Olson!



"Bonnie 'N Clyde" Phone
59⁹⁸

Adds a touch of the good old days to den, rec room or bar. Upright phone designed with a true feel of the "roaring 20's." Beautiful all brass finish. Plug into any standard phone jack. Shpg. wt. 7 lbs.



PH-158J. 59.98

1 "Slim-Line" Desk Phones

Dial-in-handset type. Includes "recall" button, dial and bell. Used, but fully reconditioned and tested.

PH-247J, Red PH-248J, Yellow
PH-249J, Green PH-250J, White
PH-251J, Blue PH-252J, Beige
YOUR CHOICE. Shpg. wt. 6 lbs. 39.98

2 "Contempra" Phones

Sleek, stylish, ultra-modern—a tribute to your good taste. Features easy dial-in-hand convenience and "recall" button—make as many calls as you like without replacing the handset. It's perfect for desk top use, or it can be wall mounted. Easy to keep clean too, no dust-collecting "nooks and crannies." With hanger and cord, less plug. Beige color looks good in any setting.

PH-307J. Shpg. wt. 7 lbs. 64.98

3 The Years-Ahead Ericofon

Slim 'n trim one-piece design adds a modern look to any installation. Electronic tone-type "ring," dial and induction coil, 7-ft. coiled cord. White. 3 7/8 x 8 3/8 x 4 1/2".

PH-176J. Shpg. wt. 2 lbs. 69.98

4 Standard Dial Desk Phone

Factory reconditioned and tested. Ideal for extensions, intercoms, "private systems", etc. With base, dial, coil—no bell.

PH-061J. Wt. 8 lbs. 2 for 17.00. 8.98

PH-117J. Deluxe Version of above 10.98

5 Modern Desk-Type Telephone

Handsome, functional phone for desk or home. Reconditioned and ready to install. With handset, bell and 4' cord. For intercoms and extension use. Styles vary.

PH-225J. Shpg. wt. 10 lbs. 19.98



29⁹⁸

Real Value!

"Petite" Extension Phone

Nicely-styled dial-phone for kitchen, bedroom, just about anywhere. Lightweight, trim size and fully compatible with any phone system. Used, but factory tested to work like new. With coiled cord, handset, dial. No bell and plug. She'll love it! White only.

PH-064J. Wt. 5 lbs. Styles may vary. 29.98

"Look of Luxury" Telephones by Saxton

"Period" Pieces You'll Love Talking With!

6 French Mandarin Telephone

Has a beautiful teakwood cabinet with brass ornamentation, hinged doors, brass dial, bell volume control. Trimmed in ivory and gold. Ready to use—complete with standard 4-prong telephone plug.

PH-290J. Shpg. wt. 9 lbs. 99.95

7 Continental Favorite

Model 90150S. A reproduction of the famous turn-of-the-century cradle phone, long admired for its unique decorative effect. Ivory, with gold trim, silk cord, dial. Just plug it in and start talking!

PH-289J. Shpg. wt. 6 lbs. 69.95

8 "Elegance" Model for Special Beauty

Model 90160S. Specially designed continental phone features a delicately embossed cast metal housing for a rich, stylish look. An ideal period accent for living room or den. Brass, ivory trim. With plug.

PH-291J. Shpg. wt. 6 lbs. 79.95

99⁹⁵

69⁹⁵

79⁹⁵





Recorders That "Give You The Message"



79⁹⁵



24⁹⁸



Answerer and Recorder
\$99

Complete telephone answering system combining the RA-350 Recorder and PH-165 Telephone Valet. Wt. 17 lbs.
AS-763J. 99.00

Telephone Answerer/Recorder

Model 4100. An ideal *full-time secretary* that works when you're away from home or the office. Records messages for up to 1 minute with the use of any tape recorder equipped with a remote control mike input. Repeat your own pre-recorded messages for incoming calls too. Includes AC/DC remote control terminal, recording switch, and built-in mike. 60 Hz. 117 VAC.

PH-165J. Shpg. wt. 11 lbs. 79.95

TA-807J. 60 Second Message Tape. 4.95

TA-808J. 30 Second Message Tape. 4.95

TA-809J. 120 Second Message Tape. 4.95

Battery/AC Cassette Recorder

A great value in a portable cassette recorder — use it in conjunction with phone valet at right for complete telephone answering and recording capabilities. Single function knob control for on-off, record, play, and fast forward modes. *Automatic Level Control* that smooths out fading and blasting for even volumed voice recordings. Also includes a remote control microphone, BIG built-in speaker, earphone for private listening, and more. 5¼ x 10 x 2¾". For "C" batteries, 117 VAC. Styles may vary.

RA-350J. Shpg. wt. 6 lbs. 24.98



19⁹⁵

Direct Line Adapter

Model RC-4. Makes it possible for you to equip your entire phone system with telephone answering and recording services. Plug the RC-4 into the answering system's phonenumber and you're ready to record, play back pre-recorded tapes, make all your telephones *full time employees!*

PH-309J. Shpg. wt. ¾ lb. 19.95



99⁹⁵

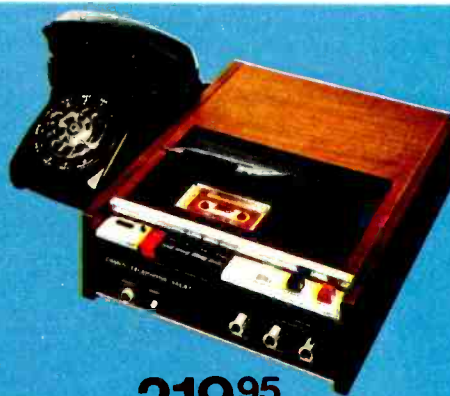

219⁹⁵



259⁹⁵

Automatic Dialing System

Model CAD-8. Makes a very useful addition in your home or at work. The "memory cell" absorbs up to 26 telephone numbers (as much as 13 digits for each number). Just choose the code numbers, push the button and you have it! No reason to even pick up the handset until the call goes through. Includes a built-in telephone amplifier for incoming calls. Just a flick-of-the-switch activates it for business conferences, family messages, etc. Telephone operates normally except for your selected coded numbers. Codes can be changed instantly. Good-looking walnut cabinet. 14⁷/₁₆" x 2³/₄" x 9¹/₁₆". For 117 VAC.

PH-212J. Shpg. wt. 1½ lbs. 99.95

Automatic Answerer/Recorder

Model CTA-4400. You'll never miss a phone message again! Besides answering the phone when it rings the CTA-4400 plays your recorded message for up to 23 seconds from the loop cartridge. The caller's message is then recorded on a cassette for playback when you return. Easily hooks up direct to phone-line — doesn't interfere with regular phone functions. The 3-digit counter tells you the number of calls that were received. Automatic Recording Level smooths out fading and blasting for even volume voice recordings. Walnut grain cabinet. Includes earphone, microphone, cassette. 12¹³/₁₆" x 3³/₈" x 11³/₁₆". For 117 VAC.

PH-227J. Shpg. wt. 20 lbs. 219.95

Deluxe Answerer/Recorder

Model CTA-4450. A real feature packed "operator" equipped with a built-in cassette recorder. Completely pushbutton operated and mounted in an attractive wood grained cabinet. Has Automatic Level Control, and 3 digit tape counter with reset button. The "beeper" assures the caller of positive recording of *incoming* messages which can be set at 30, 60, or 90 seconds. The 4450 can also be used for *outgoing* messages on a separate 23 second tape (included), or as a message repeater. Plugs directly into phone-line or connects with the phone itself (accessory phone cradle included). 15³/₄" x 11" x 4⁵/₁₆". For 117 VAC.

PH-321J. Shpg. wt. 18 lbs. 259.95

Telephone Improvements from General Telephone

Automatic Telephone "Secretary"

- Records Incoming Messages up to 60 Seconds
- 2-Channel Recording System Records Both Sides of a Conversation
- Built-In Speaker Lets You Listen to Incoming Messages As They Are Recorded
- Accepts Up to Five Separate Telephones

Model AT-S1. Put your telephone to work for you—24 hours a day, seven days a week—even if you're not around. Deluxe answering device features a 2-channel recording system—one channel accepts incoming messages up to 60 seconds long—the second channel replies with your message. If you're around but too busy to answer the phone, simply push the Absent button, turn on the speaker switch and you can hear the incoming message as it's recorded. You can record both sides of the conversation too, even reply to the incoming message while it's recorded! It's perfect for small offices where order taking can go on even when no one's there! Erase button lets you erase incoming calls after you've heard them, helps conserve tape. Use standard cassettes. Includes microphone with case, telephone connecting cord. 2½ x 10¾ x 15½". For 117 VAC.

PH-315J. Shpg. wt. 6½ lbs. **349.00**

Model AT-R2. Includes telephone secretary above, remote control device (described at right).

PH-316J. Shpg. wt. 7 lbs. **650.00**



\$349

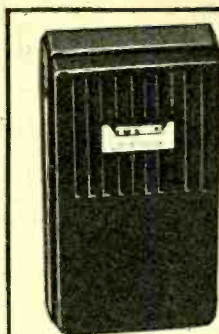

Remote Control Unit for Above

Check Your Phone for Messages Even When You're Away

Use with telephone answering device above to activate incoming messages from a remote location. Simply call your phone number—put remote device up to receiver—"Beep" signal activates answering system—plays incoming messages for you! Has "repeat" button so you can re-play messages, release button to open line.

Let Your Telephone Do the Dialing

Macom

"Name-Caller" Automatic Telephone Dialer Accepts up to 38 Separate Numbers

- Instant, Accurate, Error-Free Dialing
- Numbers Can be Changed Quick 'N Easy
- Computer-Type Programming System
- Can Be Programmed for Long Distance

Model 2001. A convenience you'll really appreciate—turns your ordinary telephone into a "mini" computer that does the dialing for you—on up to 38 local or long-distance numbers. Ends searching through cards, phone books, "little black books" for that not-quite-remembered number, mis-dialing or calling another party by mistake. Simply slide the pointer on the index plate to the name you want to call, pick up the receiver and push a button—that's it. Programming is easy and fast too—just fill in the squares on the "memory bank" roller with the special IBM marker (included!). Numbers can be changed and restored instantly. Hooks up easily to your present phone. 11¾ x 2½ x 10". Uses 4 "D" cells.

PH-303J. Shpg. wt. 12 lbs. **59.95**

BA-194J. "D" Batteries for Above. **Pair 1.53**

Model 3001. Add automatic dialing convenience and accuracy to your office phone system too—it's the ideal way to save time (and money!) by programming often-used numbers—suppliers, business associates, field offices, etc.—so anyone can call them instantly and accurately. Has the same fine features of Model 2001 above, but accepts telephones with more than one line. Has hold button to keep a line you have dialed open while you make another call. Order batteries above.

PH-304J. Shpg. wt. 14 lbs. **69.95**



59⁹⁵

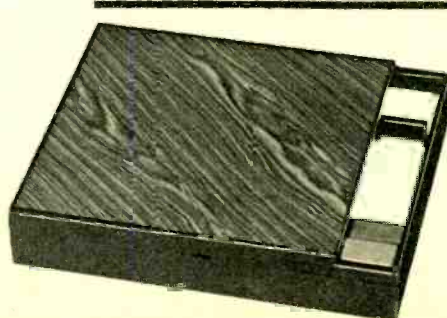

69⁹⁵

For Multi-Line Executive Phones

Tape, Accessories, Stereo Cartridge Deck

CASSETTES

Low As **71¢**

Quality tape designed for wide response recordings. Non-jamming.



Lubricated to reduce wear on tape heads. 4 oz.

Type	Stock No.	Each		
		1-11	12-23	24-Up
40 Min.	TA-750J	.94	.82	.71
60 Min.	TA-604J	.99	.84	.74
90 Min.	TA-605J	1.59	1.35	1.20
120 Min.	TA-606J	1.89	1.60	1.44



Low As **1.30**

Teledyne-Olson. Low-noise. Designed for critical recording uses. Made by Scotch 3M! 4 oz.

Type	Stock No.	Each		
		1-11	12-23	24-Up
45 Min.	TA-797J	1.60	1.40	1.30
60 Min.	TA-798J	1.70	1.50	1.40
90 Min.	TA-799J	2.50	2.25	2.15
120 Min.	TA-800J	3.00	2.75	2.65

TELEDYNE OLSON

8-TRACK CARTRIDGES

Made Exclusively for Olson by Scotch 3M Company!

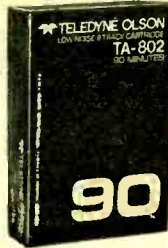

Low As **1.90**

Teledyne-Olson. Low-noise 8-track cartridges designed for wide response, ultra-quiet and smooth stereo recordings. Non-jamming continuous-loop mechanism stands up to heavy-duty use in car or home players. Special lubrication reduces wear on tape heads, prevents sticking and pulling. Av. wt. 1/2 lb.

TA-801J. 45-Min.10 for 19.00. Each 1.98
TA-802J. 90-Min.10 for 29.00. Each 2.98

8-Track and Low-Noise Cassette Special

Each tape you buy has a special coupon enclosed. 12 coupons and \$1 buy you a C-90 cassette or 90-Minute 8-Track Cartridge.

REEL-TO-REEL

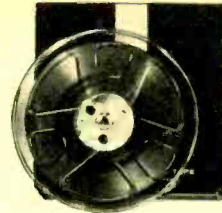

Excellent-Quality Tape for General-Purpose Recording

Low As **99¢**

Olson. Mylar base recording tape for wide-response recordings. Stock up now at these low, low prices. Av. wt. 1 lb.

Length	Reel Size	Mil	Stock No.	Each	Lots of 3 Ea.	Lots of 12 Ea.
1200'	5"	0.5	TA-222J	1.75	1.58	1.49
1200'	7"	1.5	TA-542J	1.29	1.10	.99
1800'	7"	1.0	TA-544J	1.79	1.60	1.39
2400'	7"	0.5	TA-160J	2.05	1.98	1.69

"Shamrock" Tape

Low As **1.49**
1-mil polyester tape made by Ampex. 7" reels, hi-fi specs. For serious recordists. Av. wt. 1 lb.

Length	Stock No.	Each	Lots of 3 Ea.	Lots of 12 Ea.	Lots of 25 Ea.
1200'	TA-075J	1.79	1.69	1.59	1.49
1800'	TA-110J	2.59	2.49	2.39	2.15

TELEX

249⁹⁵



Automatic 8-Track Stereo Changer Deck

Model 48D. Plays 8-track stereo tapes through your hi-fi system. Easy-load rotary magazine accepts up to 12 cartridges for hours of listening pleasure. Pushbutton mode selectors for automatic play of all tapes in order; intermix for playing one program on each tape; random selection or cartridge repeat. Pre-amp output—use with any stereo amplifier. 40-12,000 Hz response. Handsome walnut finish cabinet. Dust cover included. 18 1/4" W x 9" H x 16 1/4" D. 110 VAC. RA-883J. Shpg. wt. 35 lbs. **249.95**

A-4 With the Automatic 4-Program Button the changer plays all 4 programs on all 12 tapes in order. The mode repeats automatically.

Play 48 Programs In 4 Automatic Modes
A-1 The Intermix Button adds variety to your listening pleasure. The changer automatically plays the first program of tape 1, through tape 12. Then it plays the second program of each tape, followed by the third & fourth. This pattern continues automatically.

REP Repeat Button permits changer to hold and repeat all 4 programs of the playing tape cartridge.

SEL Press the select button and the changer advances automatically to any program on any tape you select. Complete random selection!

130 Olson

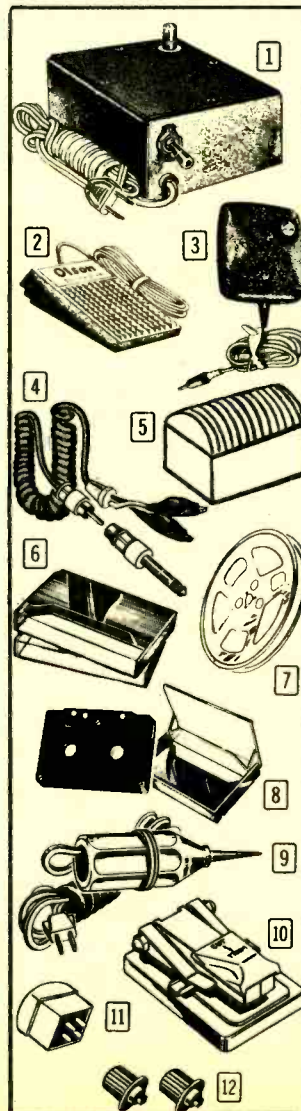

1 Bulk Tape Eraser. For reels, cassettes, cartridges. Quiets tapes 3 to 6 dB. 5 1/2 x 4 1/4 x 2 1/2". For 117 VAC.

TA-147J. 10 lbs. 14.59

2 Remote Control Footswitch. For recorders with remote jack. Easy to use. With 5' cable, 2.5mm plug. 2 1/2 x 3/4 x 3 1/2".

SW-518J. 1 lb. 3.98

3 Deluxe Pillow Speaker. For private listening. Volume control, 5' cable, 3.5mm mini-plug. 3 1/2 x 1 x 3 1/4".

SS-100J. 1 lb. 5.19

4 Retractable Patch Cord. Extends to 6 ft. Clip, 1/4"-phono plug adapter.

HF-115J. 4 oz. 2.19

5 Empty 7" Reel Storage Can. Baked enamel finish. "Reel" tape protection! 8 oz.

TA-193J. 3 for 1.50. Each 59c

Storage Chest for Above Cans. Holds 12.

TA-194J. 6 lbs. 5.19

6 Recoton Cassette Storage Boxes. 4 snap-open plastic boxes with clear hinged cover for easy identification. 4 1/2 x 2 3/4 x 5/8".

TA-601J. 4 oz. 99c

7 Empty 1/4" Tape Reel. Sturdy break-resistant plastic. Wt. 4 oz. each.

TA-192J, 7" Reel. TA-191J, 5" Reel. Your Choice: 30c ea. 10-up, 25c ea. 100-Up, 20c ea.

TA-571J. Tape Reel Holders. 12 oz. 2 Pair 1.19

8 20-Minute Automatic Repeater. For mono or stereo recorder. Repeats endlessly—for sleep learning, background music, etc.

TA-633J 8 oz. 9.98

9 Tape Head Demagnetizer. Move tip against tape head to remove magnetism. Prevents accidental tape erasures. 117 VAC.

HF-038J. 1 lb. 4.49

HF-147J. Above, slim-line design for car tape players. 4 oz. 3.98

10 Precision Tape Splicers. Cut and trim blades, built-in dispenser. 2 x 1 1/4 x 3".

TA-587J. Cassette. 1 lb. 2.04

TA-588J. Reel. 1 lb. 2.95

TA-661J. 1/4 x 108" Splicing Tape. 4 oz. 69c

TA-583J. 1/4 x 100" Leader Tape. 4 oz. 73c

TA-664J. 7/32 x 150" Sensing Tape. 4 oz. 1.98

11 8-Track Tape Head. Replacement head fits most records and players.

HF-283J. 6 oz. 3 for 13.50. Each 4.98

12 Tape Winder. Frees up jammed cassettes.

HF-284J. 3 oz. 89c

Cassettes are the convenient way to record a library of your favorite music. They're easy to store, they're protected from dust and dirt, you can play them over and over without loss of sound quality. And now—with Dolby System Noise Reduction, advanced tape materials, more versatile recorders—you can make cassette recordings that sound **BETTER** than ever!

COUPON OFFER
 Bonus Coupon given away with purchase of each 3M cassette. Five coupons and \$1.00 buys you an extra cassette!

With "POSI-TRAK"



High Energy—For the Perfectionist!

- *Distinctive Magnetic Coating Provides Fidelity Comparable to Many Open-Reel Tapes at 7½ ips*
- *"POSI-TRAK" Backing to Improve Tape Winding*

A cassette that is noticeably superior in every respect, it offers wide dynamic range and great output across the entire frequency spectrum. Uses 3M's newly developed cobalt-energized oxide particle magnetic coating. Completely different from normal low noise oxides, it offers every low-noise advantage without the need for special bias switches. "POSI-TRAK" backing means less possibility of tape sticking and jamming, less "wow" even with extended use. Average Shpg. wt. 4 oz.

TA-763J. 45-Min.	12-Up . . .	Each 2.08	Each 2.19
TA-764J. 60-Min.	12-Up . . .	Each 2.27	Each 2.39
TA-765J. 90-Min.	12-Up . . .	Each 3.42	Each 3.59



Low Noise/High Density—For Great Sound

- *"True" Low Noise Oxide for Balanced Sound*
- *"POSI-TRAK" Backing for Reliable Operation*
- *Precision-Built Housing for Long, Trouble-Free Life*

This is the high quality cassette for every recording application. Excellent for music, fine for speech, it is normally compared with the premium quality line of other brands. Its true low noise oxide provides balanced sound from one end of the frequency range to the other. Features outstanding mechanical performance as well—"POSI-TRAK" backing assures smooth winding with reduced capstan slippage, less sticking and jamming. Av. Shpg. wt. 4 oz.

TA-759J. 45-Min.	12-Up . . .	Each 1.70	Each 1.79
TA-760J. 60-Min.	12-Up . . .	Each 1.89	Each 1.99
TA-761J. 90-Min.	12-Up . . .	Each 2.84	Each 2.99
TA-762J. 120-Min.	12-Up . . .	Each 3.79	Each 3.99

With "POSI-TRAK"



Highlander®/Low Noise—Quality at A Low Price

- *Designed for Top Performance and Dependability*
- *Special Low-Noise Oxide Plus Polyester Base*
- *Plastic Housing Protects Tape from Dust 'N Dirt*

Record it and know you've got it! That's what you can say about this cassette that offers dependability not commonly associated with such fine economy. For voice and music recordings. Especially recommended for dictation, classroom lectures, voice letters, etc. It boasts low-noise oxide and tough polyester base. Use it with confidence, at home, at school, at office, on-the-move. Average Shpg. wt. 4 oz.

POLYESTER

TA-767J. 45-Min.	12-Up . . .	Each 94¢	Each 99¢
TA-768J. 60-Min.	12-Up . . .	Each 1.03	Each 1.09
TA-769J. 90-Min.	12-Up . . .	Each 1.70	Each 1.79
TA-770J. 120-Min.	12-Up . . .	Each 2.84	Each 2.99



3M BRAND Scotch Reel-To-Reel Recording Tape from Olson

POSI-TRAK
Backing to assure
jam-free, wow-free
performance

Open reel tape has been the choice of recording professionals for years. This is because it gives the best results in full-fidelity recordings for amateurs to audiophiles. You get the widest frequency response, lowest hiss and noise levels of any tape format, plus more versatility and "special-effects" capabilities when you use the latest reel-to-reel recording equipment.

High Output/Low Noise—3M's Finest!

- 50% More Output Than "Premium" Low-Noise Tapes
- Captures the Nuances and Subtleties of Even the Most Difficult Musical Passages

The tape used in recording studios throughout the world! It can be counted on for the most demanding recording applications. A 50% increase in output over premium low-noise tapes yields an improvement in dynamic range of a full 3 dB. The "POSI-TRAK" backing is tougher and more scratch-resistant than conventional backings—resulting in complete compatibility with transport mechanisms and recorder heads. It assures accurate tape travel and optimum head-to-tape contact. The Polyester base resists shrinking, stretching or breakage. Average Shpg. wt. 1 lb.

TA-778J. 7" Reel. 1.5 Mil—1200 Ft. 12-Up. Each 4.65. . Each 4.89
TA-779J. 7" Reel. 1-Mil—1800 Ft. 12-Up. . Each 5.69. . Each 5.99

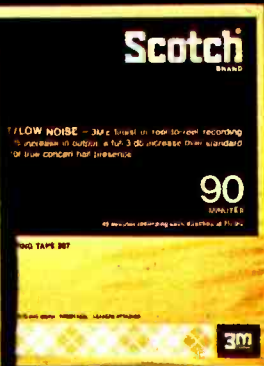

Low Noise/Dynarange®—Clean, Crisp Sound

- Oxide Formula Improves Signal-To-Noise Ratio
- Long-Lasting Polyester Base Won't Stretch or Shrink
- Tinted Plastic Reels with Leaders Attached

Whether you're a seasoned audiophile or a confused neophyte this tape is an excellent choice. When compared to tapes with ordinary oxide, a dramatic 4 to 6 dB improvement in signal-to-noise ratio is heard. This results in sound so pure that users can now record at half the speed of standard tape, and still get a truly balanced sound. 5" reel tape (15 Min./side). Av. Shpg. wt. 1 lb.

TA-780J. 5" Reel. 1.5-Mil—600 Ft. 12-Up. . Each 1.89. . Each 1.99
TA-781J. 7" Reel. 1.5-Mil—1200 Ft. 12-Up. . Each 2.84. . Each 2.99
TA-783J. 7" Reel. 1-Mil —1800 Ft. 12-Up. . Each 4.74. . Each 4.99
TA-784J. 7" Reel. .5-Mil—2400 Ft. 12-Up. . Each 7.21. . Each 7.49
TA-786J. 7" Reel. .5-Mil—3600 Ft. 12-Up. . Each 8.45. . Each 8.99

POLYESTER



Highlander®/Low Noise—A "Reel" Bargain

- Low-Noise Oxide Coating for Good Sound
- Ideal for Many Voice and Music Uses
- Polyester Base for Long-Life and Dependability

Fine general purpose tape for use where professional results are not necessary. Use for a variety of voice and music recordings—Start your own "oldies" collection by recording old 45 discs; use at parties, or for lectures, dictation, speeches, voice letters, etc. It is an economical tape that will perform with exceptional dependability. Even though it's Scotch's lowest priced tape you still get the low-noise oxide coating and tough polyester base which assure years of reliable service. Average Shpg. wt. 1 lb.

TA-787J. 7" Reel. 1.5-Mil—1200 Ft. 12-Up. . Each 2.17. . Each 2.29
TA-788J. 7" Reel. 1-Mil—1800 Ft. 12-Up. . Each 3.56. . Each 3.75

3M BRAND Scotch 8-Track Tapes for the Car or Home

BONUS Book — "Recording Basics"

Written by people who know magnetic tape. BONUS with \$10.00 order of Scotch 8-Track, Cassette or Reel-to-Reel Tapes.
BK-178J. Shpg. wt. ½ lb. Purchased Alone 1.00



High Output/Low Noise—For Full, Balanced Sound

3M's finest 8-track cartridges! Bring you reel-to-reel sound in the convenient cartridge format. Specially designed for flat frequency response—results in distortion-free playback of anything you record with greater output and less tape hiss. Special binder reduces oxide ruboff and eliminates sound interruption due to "head clogging"—adds life to your tapes by reducing recorder head wear. The lubricated coating reduces tension inside the cartridges, prevents jamming. Polyester base resists shrinking, stretching or breakage. Average shpg. wt. ½ lb.

TA-774J. 45-Min. 12-up. Each 2.17 Each 2.29
TA-775J. 90-Min. 12-up. Each 2.62 Each 2.76

Low Noise/"Dynarange"—Fine Quality, Low Price

Here's excellent quality in a 3M 8-track cartridge that's perfect for general-purpose voice or music uses. You get a clean sound, with lowered tape hiss and background noise. The heavy duty binder provides longer tape life by reducing oxide ruboff, which eliminates signal interruption due to "head clogging," PLUS reducing recorder head wear. The lubricated coating insures smooth, constant tape-to-recorder head contact for faithful sound reproduction and greater reliability. Average shpg. wt. ½ lb.

TA-776J. 45-Min. 12-up. Each 1.78 Each 1.88
TA-777J. 90-Min. 12-up. Each 2.17 Each 2.29

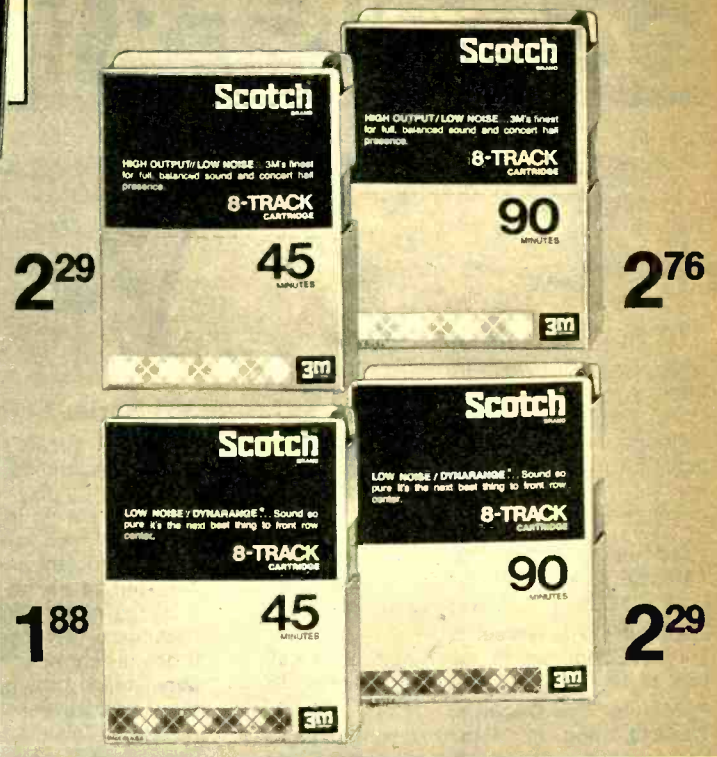

Accessories for Reel, Cartridge or Cassette



1 Tape Splicing Kit

Model SK. You can edit your own tape productions, or be ready for tape repairs when the situation arises. Kit includes a splicing block and 12.5 ft. of polyester splicing tape in handy dispenser.
TA-789J. Shpg. wt. 1 lb. 1.39

2 Aluminized Sensing Tape

Model 51. Excellent for use with automatic reverse recorders, and recorders with electronic sensing controls. Sensing tape activates automatic "reverse" system. 7/32 x 150".
TA-790J. Shpg. wt. ¼ lb. 1.43

3 Leader and Timing Tape

Model 24. Easy threading. Use at beginning or end of tape to prevent sudden starts or stops. Use as timing tape for filler space in time allotted programming situations. White. 100 ft.
TA-791J. Shpg. wt. ¼ lb. 60¢

4 Empty Self Threading Reel

Model PRST-7. Eliminates reel threading. Seals out dust, makes reel "self-storing." Place any tape or leader on reel hub and let recorder do the rest. 7" reel with plastic collar and labels.
TA-792J. Shpg. wt. ½ lb. 1.00

5 Splicing Tape

Model 41. Ideal for tape editing purposes or for repairing broken tape. Use it when rearranging musical compositions. Great for shortening-up speeches, lectures or meeting notes. 7/32 x 66".
TA-795J. Shpg. wt. ¼ lb. 71¢

6 Deluxe Splicing Tape

Model 620. This type of tape may be used to splice ALL Scotch Brand Recording Tapes. Always use this type when splicing tapes with "POSI-TRAK" backing. 7/32 x 66".
TA-796J. Shpg. wt. ¼ lb. 2.60

7 Cassette Storage Box

Organize your cassettes for easy reference and compact storage purposes. Keeps your collection free from dust and dirt. Includes index labels. Long lasting and durable plastic for all standard cassettes.
TA-794J. Shpg. wt. ¼ lb. 12-up. Each 24¢ 26¢

8 7" Reel Storage Box

Hinged front for vertical storage with easy access. Black plastic case. Excellent way to store 7" tapes while at the same time keeping them free from dust and dirt. Only 1 3/16" wide.
TA-793J. Shpg. wt. 1 lb. 12 for 12.00 Each 1.19

AMPEX Top Quality Recording Tape

cassette

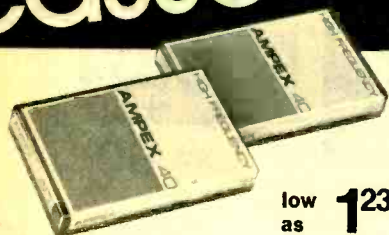

low
as **1.23**

370 Series Tape Cassettes

Superior quality high-frequency cassettes bring you brilliant clarity in your recordings. You get deep, rich lows... clear, sparkling highs... for sound you'll love to hear. Each cassette is packaged in an individual, hinged mailer box. It's so modest in price—so fine in performance!

40-Minute Tape Cassette.

TA-682J. Shpg. wt. ½ lb. Each 1.34
Lots of 12 Each 1.23

60-Minute Tape Cassette.

TA-683J. Shpg. wt. ½ lb. Each 1.69
Lots of 12 Each 1.55

90-Minute Tape Cassette.

TA-684J. Shpg. wt. ½ lb. Each 2.25
Lots of 12 Each 2.04

120-Minute Tape Cassette.

TA-685J. Shpg. wt. ½ lb. Each 3.29
Lots of 12 Each 2.97

Chromium Dioxide Cassettes

For use with recorders having CRO₂ bias switch. Ultra-low-noise and wide response!

60-Minute Tape Cassette.

TA-654J. Shpg. wt. ½ lb. Each 2.98
Lots of 12 Each 2.70

90-Minute Tape Cassette.

TA-655J. Shpg. wt. ½ lb. Each 3.98
Lots of 12 Each 3.50



20/20+ Series Cassettes

Cassette tapes for the true audiophile. New magnetic coating assures superb recording through the entire frequency spectrum. You get wider frequency response, greater signal-to-noise ratio, and 3½ dB more output than any conventional cassette. No bias adjustment or special electronics is required.

42-Minute Tape Cassette.

TA-803J. Shpg. wt. ½ lb. Each 2.40
Lots of 12 Each 2.20

60-Minute Tape Cassette.

TA-804J. Shpg. wt. ½ lb. Each 2.70
Lots of 12 Each 2.50

90-Minute Tape Cassette.

TA-805J. Shpg. wt. ½ lb. Each 4.10
Lots of 12 Each 3.70

120-Minute Tape Cassette.

TA-806J. Shpg. wt. ½ lb. Each 5.40
Lots of 12 Each 5.00

8 track

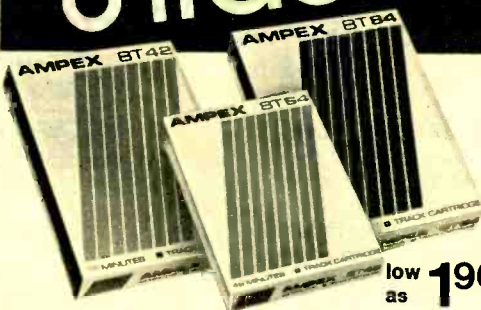

low
as **1.90**

381 Series 8-Track Cartridges

These fine quality 8-track cartridges let you make outstanding, full-fidelity stereo recordings for playback through your home system or in your car stereo player. Specially designed tape offers wide range response, brilliant highs and resonant lows—the kind of sound you've come to expect from the name Ampex. Exclusive patented-by-Ampex cartridge platform—continuous-loop mechanism is designed to stop jamming, and the tape itself is specially lubricated to prevent sticking or slipping which results in distortion-causing speed variations. Both tape and plastics are custom manufactured by Ampex, your assurance of outstanding quality control throughout.

42-Minute 8-Track Cartridge.

TA-753J. Shpg. wt. ½ lb. Each 2.19
Lots of 12 Each 1.90

64-Minute 8-Track Cartridge.

TA-639J. Shpg. wt. ½ lb. Each 2.49
Lots of 12 Each 2.10

84-Minute 8-Track Cartridge.

TA-754J. Shpg. wt. ½ lb. Each 2.98
Lots of 12 Each 2.60

reel to reel



low
as **1.75**

Reel-to-Reel Polyester Tape

High frequency polyester reel-to-reel tape for the enthusiast. Black library storage box with removable foil sleeve.

600 Feet on 5" Reel.

TA-642J. Shpg. wt. 1 lb. Each 1.98
Lots of 12 Each 1.75

900 Feet on 5" Reel.

TA-574J. Shpg. wt. 1 lb. Each 2.39
Lots of 12 Each 2.20

1800 Feet on 7" Reel.

TA-578J. Shpg. wt. 1½ lbs. Each 4.40
Lots of 12 Each 4.00

2400 Feet on 7" Reel.

TA-579J. Shpg. wt. 2 lbs. Each 6.60
Lots of 12 Each 6.00

3600 Feet on 7" Reel.

TA-580J. Shpg. wt. 2 lbs. Each 8.80
Lots of 12 Each 8.00

345 Series High Output Tape

High output, low noise polyester reel-to-reel tape. Virtually eliminates tape hiss, with exceptional frequency response and full fidelity across the entire sound spectrum. 1800 feet on a 7" reel. Black library box with removable foil sleeve.

TA-648J. Shpg. wt. 1½ lbs. Each 5.49
Lots of 12 Each 5.00

Tape Accessories

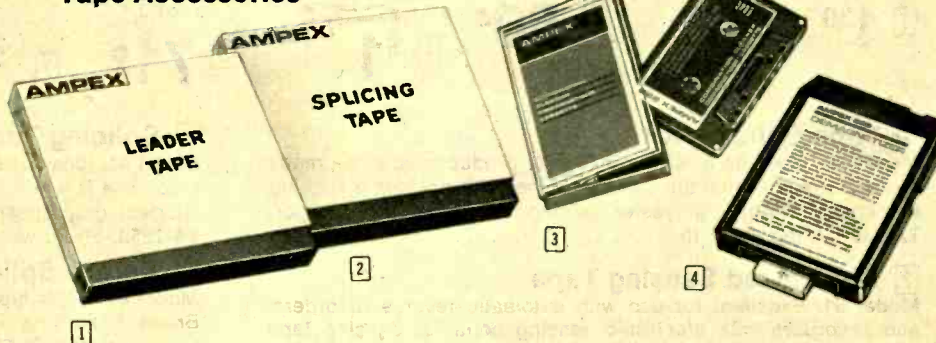

1 White Leader Tape. Can be attached to ends of recorded tapes to prevent breakage; or used between recorded selections for identification and timing. Can be written on. Size, ¼" x 150 feet.
TA-756J. Shpg. wt. ½ lb. Each 1.19
Lots of 12 Each 1.00

2 Splicing Tape. Perfect for splicing broken tapes, or for creating and editing full tape programs. Easy to use. Size, ½" wide x 100 feet long.
TA-757J. Shpg. wt. ½ lb. Each 99¢
Lots of 12 Each 80¢

3 Cassette Demagnetizer/Cleaner. Cordless unit demagnetizes your cassette units, and cleans them at the same time. Unique design patented by Ampex. Requires maximum of 40 seconds for full operation.
HF-172J. Shpg. wt. ½ lb. Each 4.95
Lots of 3 Each 4.20

4 8-Track Cartridge Demagnetizer/Cleaner. Requires approximately 18 seconds to completely demagnetize and clean any 8-track tape cartridge player or deck.
TA-711J. Shpg. wt. 1 lb. Each 5.95
Lots of 3 Each 5.50



These Capitol 2 Tapes will provide you with endless hours of recording and listening pleasure. They are some of the most advanced in the industry and are available to you only after extensive and stringent testing. The results of this thorough procedure will be appreciated by you when you hear and record with them. Choose from dependable, "studio quality" reel-to-reel tapes, convenient and versatile 8-track cartridges, or full fidelity cassettes.



1 Stak-Pak™ Tape Cassettes

If you've ever tried to locate a cassette in a hurry, or pick one from the bottom of a pile, or put one away in an orderly fashion, you'll appreciate the Stak-Pak™. It's a double drawer that holds a pair of Capitol 2 cassettes. The cassettes themselves are high-output, low-noise, Cushion-Aire backcoated tapes that combine the best in electrical performance and mechanical operation, and feature high-efficiency, iron-oxide coating for extra-wide response. Just slide or snap the Stak-Paks together to form a complete chest of drawers, with each cassette neatly filed away and labeled. Stak-Paks are only available with two Capitol 2 cassettes. Av. Shpg. wt. 1 lb.

TA-814J. 40 Min.	Stak-Pak 3.39
TA-815J. 60 Min.	Stak-Pak 3.98
TA-816J. 90 Min.	Stak-Pak 5.98
TA-817J. 120 Min.	Stak-Pak 7.98

2 High-Output/Low Noise Cassettes

Capitol 2 iron-oxide cassettes are at least 6 dB more sensitive than other conventional cassettes. They have a frequency response of 20-22,000 Hz, and are guaranteed jam-proof. Like the best reel tape, the "2" has Cushion-Aire backcoating for improved handling characteristics. Special high-sensitivity iron-oxide formulation—does NOT require recorders with special bias switches. These cassettes are available in pairs in the above listed Stak-Paks and singly in the below listed conventional plastic storage boxes. Wt. ½ lb.

TA-810J. 40 Min. 12-Up Ea. 1.52 Each 1.69
TA-811J. 60 Min. 12-Up Ea. 1.79 Each 1.98
TA-812J. 90 Min. 12-Up Ea. 2.68 Each 2.98
TA-813J. 120 Min. 12-Up Ea. 3.58 Each 3.98

3 Audiopak™ 8-Track Cartridges

The 8-track cartridge is a convenient way to listen to full-fidelity stereo in your car or at home, even in the office! This is one of the most popular cartridges on the market and a longtime favorite with consumers, broadcast studios and duplicators. The cartridge tape is a special formulation of iron-oxide that's lubricated for perfect handling and a longer life. Wt. 1 lb.

TA-818J. 40 Min. 12-Up Ea. 1.78 Each 1.98
TA-819J. 80 Min. 12-Up Ea. 2.15 Each 2.39



3
Low As
178

2
Low As
152

4 5
Low As
178

1
Low As
339

4 High-Performance Reel Tape

Just the tape for general, but critical, reel-to-reel recordings. Compatible with all recorders, particularly those which are biased for standard tapes. Has 4 dB greater sensitivity (7500 Hz at 3¾ ips) and 2.5 dB improvement in output at no increase in distortion, resulting in corresponding increase in dynamic range. Av. shpg. wt. 1 lb.

TA-820J. 5" Reel. 600' Acetate	12-Up Ea. 1.78	... Ea. 1.98
TA-821J. 7" Reel. 1200' Acetate	12-Up Ea. 2.87	... Ea. 3.19
TA-822J. 7" Reel. 1800' Polyester	12-Up Ea. 3.59	... Ea. 3.99
TA-823J. 7" Reel. 2400' Polyester	12-Up Ea. 5.38	... Ea. 5.98
TA-824J. 7" Reel. 3600' Polyester	12-Up Ea. 6.56	... Ea. 7.29

5 Ultra-High Output/Low Noise Reel Tape

Reel tape has long been known for professional results. This is the perfected reel tape recommended for those who demand widest response and truest fidelity in home stereo recordings. At 15,000 Hz (at 3¾ ips) this new tape is, on the average, 4.5 dB more sensitive than the top tape made by the best known brands. Cushion-Aire backcoating greatly improves handling and provides excellent winding properties under all conditions thus preventing deterioration in storage. Av. shpg. wt. 1 lb.

TA-825J. 7" Reel. 1200' Polyester	12-Up Ea. 4.04	... Ea. 4.49
TA-826J. 7" Reel. 1800' Polyester	12-Up Ea. 5.12	... Ea. 5.69



ELECTRO-LIFT Automatic Garage Door Openers...

1 **169⁹⁸**

For Safety, Security, Convenience

2 **129⁹⁸**

It's Like Having Your Own "Electronic" Butler!

3

1 **Deluxe Model—Handles Doors to 250 Pounds**

- **Ruggedly Constructed T-Bar Drive Rail**
- **Automatically Turns Lights On When Activated**

Model G-6440. Handles even the heaviest garage doors with ease! Features automatic reverse in both directions—if the door encounters any obstacle it reverses direction—a truly important safety feature. Constant speed 1/2-hp motor is preset for one-piece or sectional doors, has automatic reset circuit breaker for extra protection against burnout. Solid-state radio controls with wall-mount receiver and built-in security switch. Shock absorbing door arm. Includes transmitter, receiver, everything for easy installation. Full mfr's one-year parts and workmanship warranty. 117 VAC. U. L. listed.

XM-163J. Shpg. wt. 65 lbs. **169.98**

2 **Standard Model—For Doors Up To 160 Pounds**

- **Automatic Reconnect for Emergency Release Arm**
- **Protective Circuit Breaker with Automatic Reset**

Model G-6450. An excellent, economical model with many fine features. 1/4-hp universal motor, rugged T-bar drive rail, dependable gear head direct drive, multi-wave FM solid-state radio controls, automatic stop on obstruction, solid-state transmitter and receiver. Operates at distances of up to 100 ft. Includes transmitter, receiver, everything needed for easy installation. Full mfr's one-year parts and workmanship warranty. For 117 VAC. U. L. listed.

XM-164J. Shpg. wt. 55 lbs. **129.98**

NOTE: Garage Door Openers Shipped Truck or Express Only

3 **Extra Solid-State FM Transmitter**

Model G-3440. Additional FM transmitter unit for use with either model above. Use in second car, etc.

XM-165J. Shpg. wt. 1 lb. **22.88**

DYN For Stereo or 4-Channel Travelin' Music

129⁹⁵ speakers extra

4

64⁹⁸ speakers extra

5

54⁹⁵ speakers extra

6

4 **In-Dash 8-Track Player/AM/FM Stereo Radio**

- **Adjustable Shafts for Mounting In Any Car**
- **Fine Tuning Control for Tape Head Adjustment**

Model DS-620. Complete 8-track and radio entertainment from a single compact unit. Has stereo indicator light; volume, balance and tone controls, local distance switch, accessible antenna trimmer to peak reception. Tape player has program lights, auto/manual program change, more. 7 1/4 x 2 1/2 x 8". 12 VDC.

AU-393J. Shpg. wt. 7 lbs. **129.95**

5 **4-Channel "Quatro"® 8-Track Player**

- **Built-In Burglar Alarm Stops Tampering**
- **Fast Forward for Easy Location of Selections**

Model DS-905. Enjoy derived 4-channel sound from regular 2-channel stereo cartridges. Has slide-type volume, balance, tone controls, automatic/manual program change with program repeat. Separate remote-control unit permits on-off and program changing for safety while driving. 7 1/2 x 2 x 7 1/2". For 12 VDC. With mobile mounting bracket.

AU-395J. Shpg. wt. 7 lbs. **64.98**

6 **Low-Cost 8-Track Car Stereo Player**

- **Slide-Type Balance Control for Easy Mobile Use**
- **Automatic Channel Repeat Switch**

Model DS-903. Quality stereo cartridge player features remote on-off control, automatic/manual pushbutton channel selector, recessed volume and tone controls. Illuminated program indicator light, easy front-load cartridge door. Built-in burglar alarm. With mobile mounting bracket. 6 1/8 x 2 x 7 1/8". 12 VDC.

AU-394J. Shpg. wt. 6 lbs. **54.95**

See Speakers Pages 138, 139, 163

Make Your Car Stereo Tape Player More Versatile, More FUN



Kustom Kreation

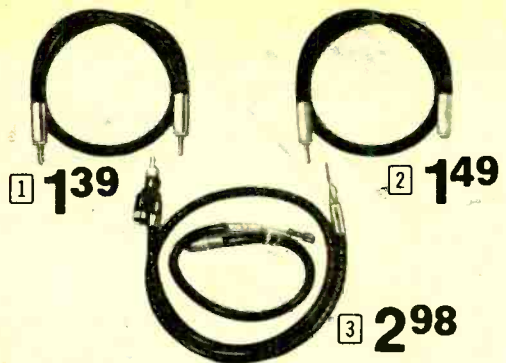

All items on this page offer full 1-year guarantee*

Car Antenna Extension & Leads

- 1 FM/AM Antenna Leads.** Couples car antenna to FM radio. Shielded. 2 male conn. AU-253J. 18" Long. Shpg. wt. ½ lb. . . 1.39
- AU-254J. 40" Long. Shpg. wt. ½ lb. . . 1.98
- 2 FM/AM Antenna Extensions.** Use existing antenna—no new leads required. Shielded. Standard connectors. AU-255J. 18" Long. Shpg. wt. ½ lb. . . 1.49
- AU-256J. 40" Long. Shpg. wt. ½ lb. . . 1.98
- 3 FM Antenna Leads.** For "Lock-Mount" or "Mini-Mount" assemblies. 18" long. AU-294J. Shpg. wt. ½ lb. 2.98

9 Home Converter

Use your 12-VDC car stereo player at home. Has two 5" speakers, external FM antenna/speaker connector, dust cover. Walnut-grain. 21½ x 6 x 10¼. 117 VAC. U.L. listed. AU-258J. Shpg. wt. 18 lbs. 44.95

10 Under Dash "Lock-Mount"

Model 122. Provides the portability and anti-theft protection you need for your valuable tape player! Locks player in place securely, lets you slide-it in or out instantly. Use with above (9) for home/car portability—get an extra 123 bracket below and transfer player from car to car. 6 x 1½ x 7" (with 123 bracket). 6/12 VDC. AU-149J. Shpg. wt. 2 lbs. 6.99

AU-209J. Extra 123 Bracket. 1 lb. . . . 3.98

11 "Mini" Under-Dash Bracket

Model 150. Compact, but holds full-size players firmly. 5½ x 3½ x 1". 6/12 VDC. AU-248J. Shpg. wt. 1½ lbs. 5.49

12 "Mini" Floor Mount Bracket

Model 154. As above, but attaches easily to floor or console. For 6/12 VDC. AU-210J. Shpg. wt. 2 lbs. 6.49

13 Universal "L" Brackets

Model 190. Fit under dash of any car, hold player or radio securely. Non-locking. AU-249J. Shpg. wt. ½ lb. Pair 1.49

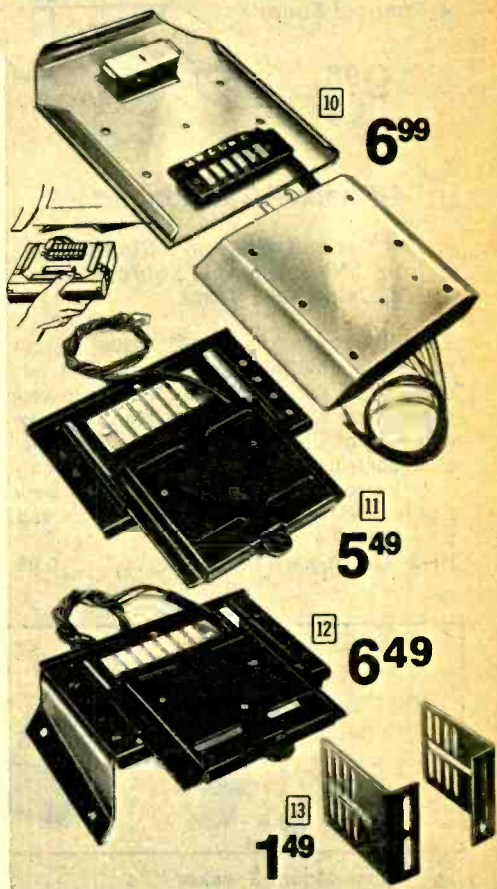

4 Car Stereo Headphone Jack

For any car! Connects easily to speaker leads. Mounts under dash. 2½ x 1 x 7/8". AU-295J. Shpg. wt. ½ lb. 2.98

5 Car Stereo Speaker Switch

Safely switches power and speakers from tape player to radio. 3 pole, double throw. AU-251J. Shpg. wt. ¼ lb. 3.98

6 AM/FM "Y" Connector

Connect FM radio to standard AM radio jack. Two ant. jacks connected to ant. plug. AU-252J. Shpg. wt. ¼ lb. 1.98

7 "Anti-Theft" Door Lock Knobs

For all domestic cars! Prevent using hangers or tools to unlock doors. Chrome plated. AU-257J. Shpg. wt. ¼ lb. . . . Set of 2 For 1.39

8 Car Stereo Lock with Key

Protects car stereo player or radio from theft. Easy installation. 1½ x ¾". AU-259J. Shpg. wt. ½ lb. 3.98

POWER ACCESSORIES

14 AC-to-DC Power Converter

Model XK-12. Operate your car stereo tape player, radio, or other mobile units from house current. Also fine for CB and HAM gear, or as a power supply when testing 12 volt equipment. Delivers 12 volts at 3 amps constant, 5 amps surge current. Built-in red pilot light, on-off switch, external 3-amp "slow-blow" fuse. 5½ x 3½ x 2¾". CB-077J. Shpg. wt. 3 lbs. 19.95



15 6-12 Volt Power Converter

Model 540. Lets you use 12 VDC tape players, radios, and CB equipment in a car having 6 VDC negative ground system. Full 3 amps continuous output. Mounts easily in minutes. 5½ x 3½ x 1¾". AU-297J. Shpg. wt. 1½ lbs. 15.98



Olson Makes ANY Car System Sound Better

"Phase Power" 4-Channel Adapter



Simple, Low-Cost Way to Derived 4-Channel Sound

1 9⁹⁸

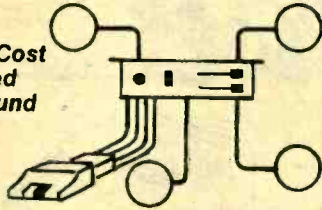

34⁹⁸ 3



2 19⁹⁹

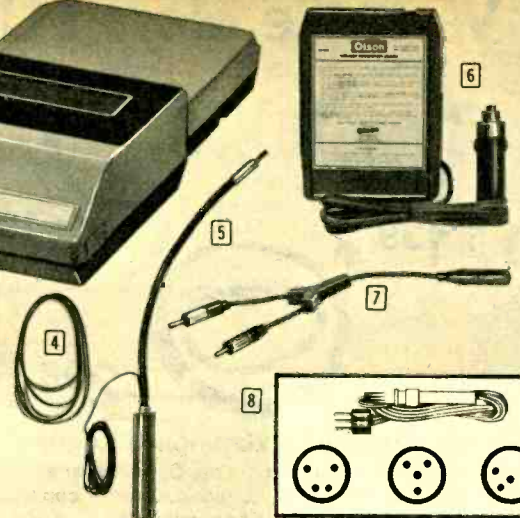

4 8-Track Drive Belts

Set of 5 popular sizes. Replaces over 80% of belt sizes used in 8-track players. Buy now, be ready when you need one! AU-241J. Shpg. wt. ¼ lb. 2.29

5 Auto Antenna Booster

Really works! Provides extra gain for crisp, clear AM, FM, FM-stereo. Great for windshield "wire" antennas. AA-448J. Shpg. wt. 1 lb. 5.98

6 8-Track Demagnetizer/Cleaner

Slides into tape player like a cartridge—restores highs, cuts hiss, keeps it sounding like new. With 12 VDC car cord. HF-160J. Shpg. wt. ½ lb. 6.98

7 Auto Antenna "Y" Adapter

Connects 2 radios to a single antenna. AA-447J. Shpg. wt. ½ lb. 2.29

8 Wiring Harnesses

For 8-track or cassette players. Wt. 1 lb. AU-173J. 4-Pin. Muntz, Audio Stereo. . . 3.99
AU-174J. 4-Pin. Tenna, Ranger, Kraco 3.99
AU-175J. 5-Pin. Muntz, Craig, 3.99
AU-197J. Universal 4 or 5-Pin. For brands not mentioned above 4.98

1 4-Channel Car Adapter

• Get Derived 4-Channel Sound from ANY 2-Channel Source—FM, Cassette, 8-Track

Easiest way we know of to really improve your auto entertainment system. Just add our adapter and two more speakers to your present car stereo for the exciting new experience of derived 4-channel sound. Has slide-controls for front speakers, rotary controls for rear. Mounts under dash—installs easily—NO electrical rewiring involved. 5¾ x 1¾ x 2½".

HF-213J. Shpg. wt. 1 lb. 9.98

2 Derived 4-Channel System

A minimum investment in time and money puts derived "quad" sound in your car. Consists of our 4-channel adapter at left, two surface-mount speakers in vinyl enclosures. AS-566J. Shpg. wt. 4 lbs. 19.99

3 8-Track to Cassette Adapter

DOUBLES the value of your 8-track tape player. Loads just like a cartridge—lets you play pre-recorded stereo cassettes through your player. NO electrical connections to make. 4½ x 1½ x 10". A real audio bargain! AU-198J. Shpg. wt. 2 lbs. 34.98

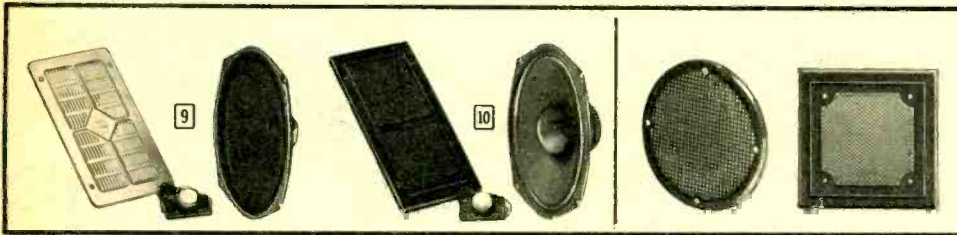

Flush-Mount Speaker Kits

Include everything you need for "factory look" mounting.

Stock No.	Fig.	Description	Mag. Oz.	Grille	Ohms	Wt. Lbs.	Each
SS-188J	9	6 x 9" with 3-Pos. selector switch	1.47	Chrome	4-10	3	6.98
SS-152J	9	6 x 9" with 5" woofer, 3½" tweeter	1.47	Chrome	10-40	5	10.49
SS-189J	10	6 x 9" with high frequency radiator	5.5	Black	10-40	4	10.98
SS-151J	10	6 x 9" 2-way with 2½" tweeter	10	Black	10-40	5	18.98

Speakers Alone

SS-187J	9	6 x 9"	1.47	—	10-40	2	5.49
SS-186J	9	4 x 10"	1.47	—	10-40	2	5.49
SS-312J	10	6 x 9" with dual voice coil	10	—	8-10	2	10.98

Speaker Grilles

With Mounting Hardware Wt. ¼ lb.

Stock No.	Size	Description	Each
CA-471J	5"	2 Round, Black	1.69
CA-467J	5½"	2 Round, Soft-Padded, Black	3.98
CA-504J	6"	1 Square, Black	1.89
CA-511J	5 x 7"	1 Square, Satin Chrome	1.29
CA-327J	6 x 9"	1 Oval, Satin Chrome	1.39
CA-456J	6 x 9"	1 Square, Black	1.98
CA-514J	6 x 9"	1 Die-Cast, Black	2.49

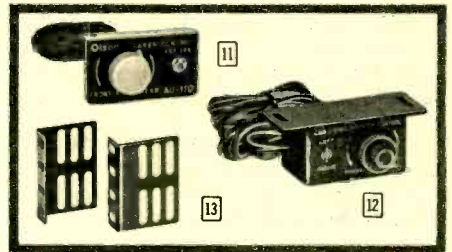

11 Speaker Volume Control

Balances front/rear speakers together. SW-133J. Shpg. wt. ½ lb. 1.09
AU-110J. With jack for 3.5 mm plug. . . 1.29

12 4-Channel Volume Control

For underdash mounting. With cable. AU-172J. Shpg. wt. ¼ 3.49
SW-561J. Above, with slide controls . . 5.49

13 Universal Bracket

Mounts any car tape player in any car. Replaces any bracket now in use. AU-260J. Shpg. wt. ½ lb. 1.98

Tape Cleaning Accessories from Recoton

Cleaning Kit. Has head cleaner, lubricant, brush, swabs, etc. HF-098J. ½ lb. 1.99
Head Cleaning Cartridge. Extends head life. Built-in timer. TA-457J. ¼ lb. 98¢
Save! Cleaning Kit and Tape Head Cartridge. AS-764J. Only 2.49
138 Olson

1⁹⁹



98¢

Tape Service Cartridge. Cleans, demagnetizes tape head in all track positions. Cleans capstan, too. Insert just like a cartridge—takes only 10 seconds. TA-708J. 1 lb. 3.95

3⁹⁵



Olson Has a Vast Selection of Car Speakers

Why pay more? Our stereo speakers cost less and they sound just great with any tape player or radio. They include wire, hardware and instructions—everything for easy installation. Choose from easy-to-install *Surface Mount*, or "custom fit" *Flush Mount* types.

Easy-to-Install Surface Speakers



1 **19⁹⁸**

2 **4⁷⁹**
Each

3 **9⁶⁹**

4 **16⁹⁸**

1 "Tach Styled"—Mount-Anywhere

Fine-sounding speakers for mounting anywhere in your car, truck, boat—feature a *streamlined* look. Each speaker has an 8-oz. ceramic magnet, 15 watts power capacity, 4" diameter housing with non-glare black matte finish. With all hardware. 8 ohms. 4" dia x 6". **SP-058J**. Shpg. wt. 5 lbs. **Pair 19.98**

2 3 x 5" Surface Mounts

Very versatile oval speakers for easy surface mounting anywhere. Wide-range audio response and excellent tonal quality for distortion-free listening. Black scuff-resistant molded enclosure. With full instructions and cable. 8 ohms. 7 x 3½ x 8¾". **SS-979J**. Shpg. wt. 2 lbs. **Pair 9.00** **Each 4.79**

3 3 x 5¼" Rear Mounts

Low in cost, yet deliver fine sound from all car stereo equipment! Perfect for rear deck mounting. Attractive mar-resistant molded enclosures. Impedance 8 ohms. With wire and hardware for easy installation. 7¾ x 5½ x 3¾". **SS-270J**. Shpg. wt. 2 lbs. **Pair 9.69**

4 5¼" High-Compliance Surface Mount

These fine quality speakers have cloth-roll, high-compliance suspension for extra-deep bass response. Easy to mount—under the seats, on kick panels, etc. 10-watt power capacity each. 8 ohms. Complete with full instructions and cables. 7¾ x 2½ x 5¾". **SS-190J**. Shpg. wt. 3 lbs. **Pair 16.98**

"Custom Fit" Flush Mount Speakers

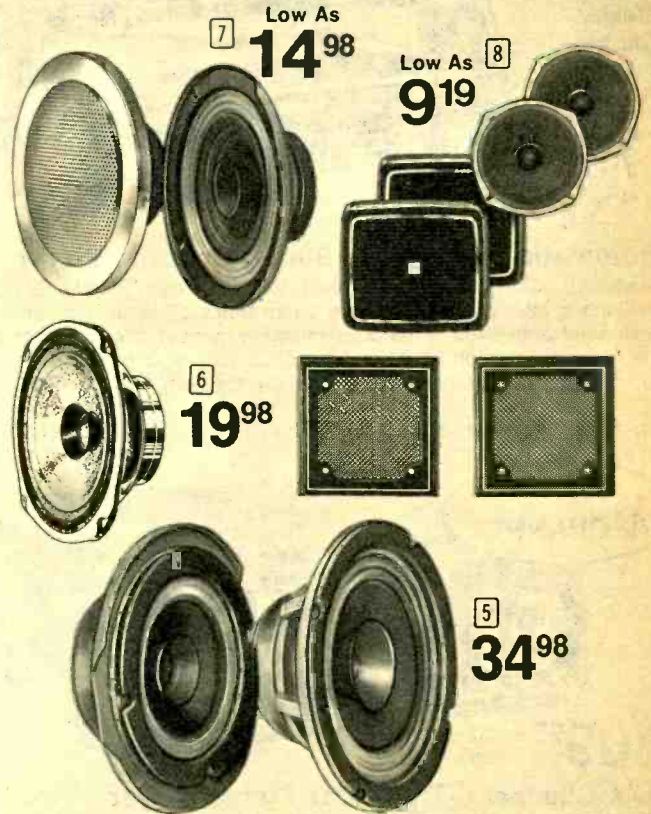

7 **Low As 14⁹⁸**

8 **Low As 9¹⁹**

6 **19⁹⁸**

5 **34⁹⁸**

5 Our Finest—"Tru Sonic" Flush Mounts

For on-the-go music lovers. Massive ceramic magnets for excellent sound. Wide range response. Moisture-proof cones. Snap-on chrome grilles, wire, template, instructions. 5" speaker, 12-watts. 1¾" D. **SS-148J**. Shpg. wt. 8 lbs. **2 Pairs 60.00** **1 Pair 34.98**
SS-149J. 5" Speaker Alone. Wt. 4 lbs. **Each 16.98**
SS-264J. 6", 15-watt, 2¼" D. 10 lbs. **2 Pairs 95.00** **1 Pair 50.00**
SS-265J. 6" Speaker Alone. Wt. 5 lbs. **Each 24.98**

6 Chrome-Back 5" Stereo Speakers

Sound improving dual-cones, 10-oz. magnets. 15-watts. 8 ohms. **SP-073-J**. Shpg. wt. 7 lbs. **Pair 19.98**
CA-472J. 2 Square Black Grilles for Above Shown. Wt. 1 lb. **.198**

7 High-Performance "X-Air" Flush Mounts

All models feature cloth-roll suspension and heavy ceramic magnets for a powerful, rich sound! With wire, instructions.

Stock No.	Size	Watts	Mag. Oz.	Grille	Depth	Pair Price
SS-273J	5"	12	10	Sq. Black	2½"	15.98
SS-275J	5¼"	10	6	Rnd. Chrome	2¼"	14.98
SS-276J	5¼"	12	10	Rnd. Black	2¼"	19.98
SS-277J	6"	15	10	Sq. Black	2¾"	25.98

8 5¼" Ceramic Magnet Flush-Mounts

Stylish molded grilles. Hardware, instructions. 8 ohms. **SS-271J**. Shpg. wt. 3 lbs. **Pair 9.19**
SS-272J. Deluxe Version of Above. Shpg. wt. 3 lbs. **Pair 12.79**
Flush Mount 5¼" Speakers with Snap-On Grilles. 8 watts each. 3-oz. ceramic magnets. High frequency radiator. Round black grilles. **SS-274J**. Shpg. wt. 5 lbs. **Pair 12.98**

PIONEER® Music Systems for Your Car

For years the name Pioneer has been famous in stereo hi-fi components for the home. Now they bring their quality and design excellence to the auto entertainment field.

CASSETTE

Use Your Master Charge or Bank Americard

79⁹⁵
speakers extra



Automatic Reverse Car Stereo Cassette Player

Model KP-333. Has a very compact design for easy installation, yet delivers a total of 7.6 watts rms audio output. Features automatic reverse at both ends of the tape. Includes manual direction change, illuminated direction lights, and an eject button. Separate volume/ tone, and balance controls. Mounting bracket. 5 1/2" x 2" x 7 1/4". 12 VDC neg. grd.

AU-365J. Shpg. wt. 3 1/2 lbs. **79.95**



124⁹⁵ speakers extra

Auto Reverse Cassette Player/ FM Stereo Radio

Model KP-300. Enjoy stereo listening through cassettes, or tune-in your favorite FM stations. Features solid-state circuit with IC's, illuminated direction indicator, stereo mono switch, FM stereo indicator. Has eject button, separate volume, tone, and balance controls, FET front end, mounting bracket. 7.6 watts rms audio output. 7 1/2" x 2" x 7 1/2". 12 VDC neg. grd.

AU-364J. Shpg. wt. 6 1/2 lbs. **124.95**

8-Track 4 CHANNEL

109⁹⁵ speakers extra



2/4 Channel 8-Track Car Stereo Player

Model QP-444. Enjoy 4-channel auto listening! Separate left-right balance, front-rear volume controls. Automatic 2 to 4 channel selection. Mounting bracket. 15 watt rms audio output. 7 3/4" x 2 1/2" x 7 1/2". 12 VDC neg. grd.

AU-368J. Shpg. wt. 5 1/2 lbs. **109.95**

149⁹⁵ speakers extra

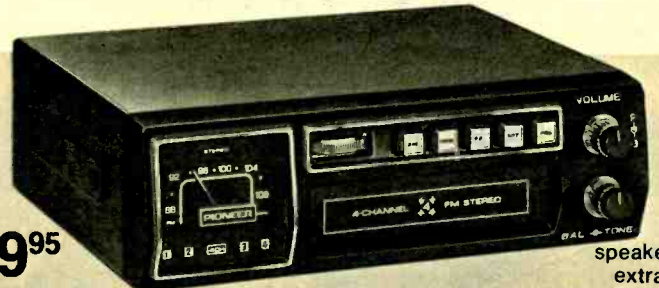

2/4 Channel 8-Track Player with Stereo FM Radio

Model QP-400. Enjoy "discrete" 4 channel or 2 channel 8-track tapes PLUS stereo FM listening. Includes stereo/4-channel indicators, left/right balance control, separate front and rear volume controls, 2 or 4 channel selector, fast forward, more. 15 watts rms audio output. 8 1/4" x 2 1/2" x 7". 12 VDC neg. grd.

AU-367J. Shpg. wt. 5 lbs. **149.95**

8-Track 2 CHANNEL

49⁹⁵ speakers extra



"Mini" 8-Track Stereo Player

Model TP-222. Has the quality and performance features of larger, more expensive units. Includes auto and manual program change, tone/volume, and balance controls, and track indicator lights. Mounting bracket. 7.6-watts rms audio output. 12 VDC neg. grd. Only 4 3/4" x 2" x 6 1/2".

AU-369J. Shpg. wt. 3 lbs. **49.95**

134⁹⁵ speakers extra



"In Dash" 8-Track AM/FM Stereo

Model TP-6000. Enjoy the convenience of 8-track cartridges PLUS the versatility of AM/FM stereo radio. Features include stereo/mono switch for selecting the best FM reception in weak signal areas, stereo indicator light, volume/tone, tuning and balance controls. 7.6-watts rms audio output. 12 VDC neg. grd. 7 1/2" x 2" x 7 1/2". Mounts in dash in most cars.

AU-366J. Wt. 5 lbs. **134.95**

114⁹⁵ speakers extra Deluxe 8-Track Player with FM Stereo Radio

Model TP-700. Features include repeat button for "instant replay", fast forward for easy selection location. Sliding controls, program indicator lights, auto and manual program change. Stereo/mono switch and stereo indicator. Mounting bracket. 7.6-watts rms audio output. 7 1/2" x 2 1/2" x 7". 12 VDC neg. grd.

AU-370J. Shpg. wt. 6 1/2 lbs. **114.95**

AU-371J. Model TP-777 Less Radio. Wt. 4 1/2 lbs. **74.95**

AU-372J. Model TP-8000. with AM/FM Radio. Wt. 6 1/2 lbs. **134.95**

Exclusive Olson Auto Music Makers



Sounds
Just Great!

1 49⁹⁸

Play Cassettes
Through Your
Car Radio



2 29⁹⁸



3 49⁹⁸

Speakers
Extra

New For '74 —
Latest
Solid-State
Circuitry

1 Stereo Cassette Auto Player

- Compact for Easy Installation
- Solid-State "Trouble-Free" Circuitry

Just slide-in a pre-recorded cassette and listen to the music of your choice while driving. Features include convenient slide-type volume, tone, and balance controls, pushbutton eject. With mounting bracket. 3-watts rms audio output. 12 VDC neg. grd. 4 1/4 x 2 3/4 x 6".

AU-261J. Shpg. wt. 6 lbs. 49.98

2 Compact Cassette Converter

- Complete with All Mounting Hardware
- Installs Easily Under-Dash

Play standard cassette tapes monophonically, through your AM car radio. Attach under dash and connect to car radio with simple plug-installation. Features IC circuitry, fast forward and easy slot-load for one-hand operation. Mounting bracket. 12 VDC neg. grd. 4 1/4 x 2 x 6".

AU-262J. Shpg. wt. 4 lbs. 29.98

3 Micro 8-Track Player

- Fine Sounding Compact
- Easy Under-Dash Installation

This is our latest *little one* in 8-track players. Features convenient sliding volume, tone and balance controls, automatic or manual program selector. Fine tuning control prevents crosstalk. Mounting bracket. 3-watt rms audio output. 12 VDC neg. grd. 4 7/8 x 2 1/8 x 6 1/2".

AU332J. Shpg. wt. 6 lbs. 49.98

4 8-Track / FM Stereo Radio

- Installs Easily Under-the-Dash
- Fine Tuning Prevents Crosstalk

Our newest *complete auto system*. Has sliding volume, tone, and balance controls, automatic and manual program selection, FM stereo indicator, mode selector, tape track indicator lights. Mounting bracket included. 3-watts rms audio output. 12 VDC neg. grd. 6 1/8 x 2 1/4 x 7 1/16".

AU-334J. Shpg. wt. 7 lbs. 109.98

5 "Mini" FM Auto Converter

- DX Switch for Distant FM Stations
- Very Compact—Mounts Anywhere

Easily hooks up to your present AM car radio. Includes lighted dial, on-off pilot light. Convenient switch lets you choose between AM, DX for distant FM listening, and higher sensitivity or LO for local FM tuning. Mounting bracket. Solid state circuitry. 12 VDC neg. grd. Only 4 7/8 x 1 5/8 x 4 3/4".

AU-333J. Shpg. wt. 3 lbs. 39.98

6 "Trim Line" Stereo FM Radio

- Excellent Reception and Response
- Recessed Thumbwheel Controls

Enjoy the hi-fi quality of many home FM stereo units in your car. Features 55-14,000 Hz amplifier response for *great sound*. Stereo indicator light shows reception of stereo-FM broadcasts. Stereo-mono switch. Includes mounting bracket. 5-watts IHF audio output. 12 VDC neg. grd. 8 x 2 x 5 3/4".

RA-140J. Style may vary. 6 lbs. 49.98

7 Auto Reverb Unit

- Adds Stereo Effect to A Car Radio

If your car already has a rear seat speaker this is all you'll need to add a "stereo" effect to your AM or FM radio. Thumbwheel front/rear balance control for great tuning ease when driving. Includes mounting bracket. 12 VDC neg. grd. 6 3/4 x 1 1/2 x 3 1/2".

RA-749J. Shpg. wt. 2 lbs. 4.99

AU-129J. Above Reverb with 6 x 9" speaker and chrome grille. 3 lbs. 6.99



4 109⁹⁸

Speakers
Extra



5 39⁹⁸



6 49⁹⁸ Speakers
Extra



7 4⁹⁹

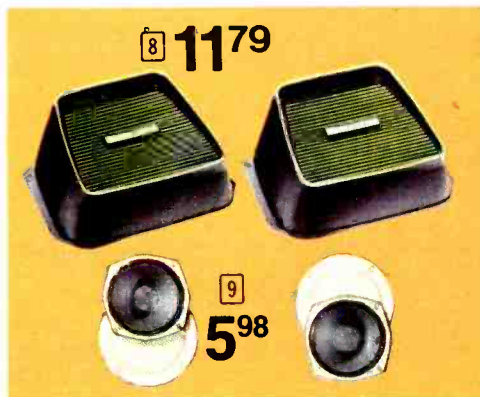

8 11⁷⁹

9 5⁹⁸

8 5" Surface Mount Speakers

Heavy-duty speakers each have a 5" cone and efficient ceramic magnet for superior tone. Two 10' cables included. 7 x 3 3/4 x 4".

SS-218J. Shpg. wt. 2 lbs. Pair 11.79

9 5" Flush Mount Speakers

Perfectly matched speakers mount easily in door panels. 8 ohms. With grilles, wire.

SS-254J. Shpg. wt. 6 lbs. Pair 5.98

Deluxe Version. Above, with heavy-duty speakers and snap-on chromed grilles.

SS-730J. Shpg. wt. 5 lbs. Pair 8.98

See pages 138 and 139 for additional Car Speaker Systems and Accessories

SANYO 8-Track "Over-The-Road" Tape Decks



1 **44⁹⁵** Speakers extra



2 **59⁹⁵** Speakers extra



3 **69⁹⁵** Speakers extra



4 **79⁹⁵** Speakers extra



5 **119⁹⁵** Speakers extra

1 Low-Cost 8-Track Stereo Player

Model FT-818. A dependable, high quality player at a very economical price. Features automatic program change for continuous stereo enjoyment, slide-type left/right volume control, Hi-Lo tone switch, lighted program indicators. 12 watt (IHF) output. Mounting hardware included. 5 1/4 x 8 x 3". For 12 VDC neg. grd.

AU-277J. Shpg. wt. 7 lbs. **44.95**

2 8-Track Stereo/Derived 4-Channel Player

Model FT-883M. Play your stereo cartridges in 2-channel or derived 4-channel when four speakers are connected. Features automatic channel repeat, continuous tone control, auto or manual channel selection, fast forward, lighted channel indicators. 15 watt (IHF) output. Mounting hardware included. 5 1/4 x 3 x 8". 12 VDC neg. grd.

AU-278J. Shpg. wt. 7 lbs. **59.95**

3 Ultra-Compact 2-Channel 8-Track Player

Model FT-888M. Slide this unit into the FTB-200 home adapter (page 146) for continued listening enjoyment. With separate volume, balance/tone controls, automatic/manual program repeat, lighted program indicators. Integrated circuitry. 15 watt (IHF) output. Mounting hardware included. 4 1/2 x 6 1/2 x 2". For 12 VDC neg. grd.

AU-280J. Shpg. wt. 5 lbs. **69.95**

4 Discrete 4-Channel/2-Channel 8-Track Player

Model FT-862. Enjoy the "live presence" sound of discrete 4-channel in your car when four speakers are connected. You can also get derived 4-channel effects from regular 2-channel stereo cartridges. Has 2/4 channel tape head, 4 preamplifiers, 4 power amplifiers, channel indicator lights, auto/manual channel selection. With switches for Hi-Lo tone, 2/4 Channel, and discrete or derived play. Has sliding left/right front/rear volume controls for *studio control* in an auto music system. 25 watt output. Mounting hardware included. 7 x 2 x 7 3/8". 12 VDC neg. grd.

AU-376J. Shpg. wt. 7 lbs. **79.95**

5 Console-Mount Discrete 4-Channel Player

Model FT-864. Ultra-compact for easy mounting in your car. Listen to discrete 8-track cartridges for the excitement of 4-channel surround sound when four speakers are connected. Also plays conventional 2-channel tapes with derived 4-channel effect. Features include 2/4 channel tape head, slide-type front/rear volume controls, automatic/manual program change, lighted channel indicators, fast forward, eject, tone control. Has 4 preamplifiers, 4 power amplifiers. 35 watt (IHF) output. Mounting hardware included. 6 x 4 x 8 1/2". 12 VDC neg. grd.

AU-283J. Shpg. wt. 10 lbs. **119.95**

Tuneful Travelers from AUDIOVOX



1

99⁹⁸ speakers extra
With Under-Dash Bracket



49⁹⁸ speakers extra

2 With Under-Dash Bracket



119⁹⁸ speakers extra

3

1 8-Track Cartridge/FM Stereo Player
Model C-980. All the car stereo you need for under \$100! Has slant-front FM tuning dial, hinged cartridge door, slide-type controls, local-distance switch, stereo light, AFC. Exclusive "channel-repeat" switch. 7 3/4" x 2 1/4" x 7 3/4". 12 VDC.

AU-345J. Shpg. wt. 9 lbs. 99.98

2 8-Track Derived 4-Channel Player
Model C-910. Play pre-recorded stereo tapes with exciting 4-channel effect. Has slide-type volume and tone, thumbwheel balance, track selector, repeat switch. 6 3/4" x 2 1/2" x 8 1/2". 12 VDC.

AU-347J. Shpg. wt. 5 1/2 lbs. 49.98

3 8-Track Player/AM/FM Stereo Radio
Model C-977. Mounts right in most car dashes—virtually theft-proof. Has 6-IC amplifier, radio/tape and mono/stereo switches, lighted tuning dial, more. 7 x 2 1/4 x 6 1/2". 12 VDC.

AU-348J. Shpg. wt. 7 lbs. 119.98



59⁹⁵ speakers extra

Deluxe 8-Track Player Under-Dash Mount

Model C-920. Has powerful 10-watt amplifier, slide-type tone control, repeat switch that lets you play your favorite selections again and again. 6 1/2" x 2 1/2" x 7 1/2". 12 VDC.

AU-346J. Shpg. wt. 7 lbs. 59.95



"Double Duty" 8-Track Player

Why buy separates? This custom-matched unit does the job at home and in your car. If you're getting into 8-track stereo—do it right!

Model AX-CP. Deluxe 12 VDC tape player with slide-in/slide-out car mounting bracket, walnut-finish home unit with matching wide-range speakers. Player features thumbwheel controls, motor on/off switch, lighted program indicators, 10-watt amplifier. 117 VAC home adapter has power-on-off, pilot, pushbutton eject, more.

AU-352J. Wt. 16 lbs. 129.95



129⁹⁵

Enjoy Smooth 'N Soothing FM As You Drive



34⁹⁵

Micro-FM Converter

Model FMC-IC. Smallest converter we know of—a mere 4 1/4" x 1 1/2" x 5"—instantly turns your AM car radio into an FM car radio! Has lighted dial, pushbutton AM-FM selector, tuning control. Installs under dash with "Grip-Tight" adhesive mounting strip. Includes connecting cable for AM radio.

AU-349J. Shpg. wt. 1 1/2 lbs. 34.95



speakers extra 74⁹⁵

FM Stereo Car Radio

Model FMX-20. Under-dash-mounting radio brings in FM and FM stereo with great sound and excellent separation. Has slide-type balance and tone controls, stereo/mono switch, lighted tuning dial. Solid-state, with IC's for compact design. Only 6 x 1 1/2 x 5". Easy adhesive-strip mounting—NO drilling. 12 VDC.

AU-321J. Shpg. wt. 3 lbs. 74.95



39⁹⁵

8-Track to Stereo-FM Converter

Model FM8. The fastest, easiest, most convenient way to add FM capabilities to your 8-track car stereo player. Simply insert the FM8 as you would a cartridge, and tune in FM and FM stereo with full fidelity!

AU-351J. Shpg. wt. 1 lb. 39.95

1 129⁹⁵ Speakers extra



2 219⁹⁵ Speakers extra



UNDER \$250

Complete auto entertainment systems with the latest in Craig solid-state design. Their many deluxe features provide the utmost in stereo listening enjoyment, no matter where your travels take you.

See Speakers Pages 138, 139, 163

1 Stereo Player/AM-FM Radio

Model 3128. Complete stereo entertainment system mounts in the dash of your car. The adjustable-control mounting centers and compact size make it adaptable to most cars. Features instant radio/tape program change, sensitive AM/FM radio with push-buttons for stereo/mono, FM and AM, separate controls for tuning, volume, tone, and stereo balance, AFC. 16-watt audio output. 7¼ x 2 x 6½". For 12 VDC neg. grd. AU-353J. Shpg. wt. 4¼ lbs. 129.95

2 4-Channel Player/FM Radio

Model 3133. Designed for TRUE 4-channel, "matrix" 4-channel, or stereo listening with four amplifiers for Q8 8-track cartridges, matrix pushbutton for stereo or synthesized 4-channel from cartridges or FM broadcasts. Pre-set "5-button" FM stereo tuning, instant radio/tape mode change, "eject" button, automatic stereo switching, AFC. Includes floor mount bracket. 24-watt audio output. 6½ x 8½ x 9¾". 12 VDC neg. grd. AU-354J. Shpg. wt. 9¼ lbs. 219.95

3 Stereo Player/FM Radio

Model 3136. Excellent value for your auto listening enjoyment. The under-the-dash mounting system has a quick release bracket for your convenience and theft protection. Features fast forward for easy location of tape selections. Multicolored program indicator lights and balance controls. Manual tuning dial for FM radio, lighted dial. 14-watt audio output. 8½ x 2¾ x 8¾". 12 VDC neg. grd. AU-356J. Shpg. wt. 6 lbs. 89.95

4 Stereo Player/FM Radio

Model 3137. Many features! Plays 8-track stereo cartridges—includes 3-pushbuttons for pre-set stereo or mono FM stations of your choice, PLUS manual tuning. Secure under-dash mounting with quick release bracket. Also includes sliding-type tone, volume, and balance controls, multicolored program indicator lights. Fast forward. 14-watt audio output. 7½ x 2¾ x 7¾". 12 VDC neg. grd. AU-357J. Shpg. wt. 9 lbs. 109.95

5 8-Track Stereo Player

Model 3144. Enjoy the listening pleasures of stereo in the privacy of your own car and with the convenience of 8-track. Features include under-dash mount for easy installation, quick release bracket for take it with you protection. Also includes program indicator lights, tone switch, separate slide volume controls, manual channel selector and IC circuitry. 14-watt audio output. 6 x 2¼ x 6¾". 12 VDC neg. grd. AU-358J. Shpg. wt. 6 lbs. 45.95

6 8-Track "Deluxe" Player

Model 3135. You get the auto entertainment of 8-track with many of the features found in more expensive models. The fast forward control enables you to locate your favorite cartridge recordings easily and quickly. Secure under-dash mounting with quick release bracket. Also includes sliding-type volume and tone controls, multicolored program lights. 14-watt audio output. 4¾ x 2½ x 6½". 12 VDC neg. grd. AU-355J. Shpg. wt. 9 lbs. 54.95

3 89⁹⁵ Speakers extra



4 109⁹⁵ Speakers extra



UNDER \$125

These systems are a great value and you won't have to sacrifice in quality. Experience the enjoyment of 8-track and FM stereo with excellent fidelity. They will make driving a more enjoyable experience.

5 45⁹⁵ Speakers extra



UNDER \$65

These are Craig's lowest priced 8-track players. They're great values for the budget-minded individual who still wants excellent sound and cartridge convenience in his own car.

6 54⁹⁵ Speakers extra

8-Track 2/4-Channel Car Tape Players from



Quadraline™ Discrete 4-Channel Player

- Slide-Controls for Safe Mobile Use
- Left, Right, Front and Rear Balance

Model TM912S. Drive with "the 4-channel experience"! Deluxe 4-channel 8-track cartridge player handles the new Q8 discrete 4-channel cartridges, 2-channel stereo cartridges as well. Puts you in the "middle of the music" with realism and presence you have to listen to to appreciate. Has automatic 2/4-channel tape sensing, volume, tone and 4-way balance slide controls, program indicator light. 6¾" x 2½" x 7¾". For 12 VDC negative ground. With mounting bracket. RA-024J. Shpg. wt. 9 lbs. 99.95



4 CHANNEL

99⁹⁵
speakers
extra

Super-Compact 8-Track Player

- Indicator "Window" Shows Program
- Easy-Access Knob-Type Controls

Model TM213S. Famous Motorola quality, ultra-compact size for easy mounting even in foreign or sportscars, and plenty of power for really excellent stereo sound make this a great way to go 8-track. Has volume, balance and tone controls, manual program selector, hinged cartridge door. A mere 5½" x 2½" x 7¾", it mounts anywhere space is tight. With universal bracket. For 12 VDC neg. grd. RA-028J. Shpg. wt. 7 lbs. 36.95



36⁹⁵
speakers
extra

Deluxe "Mini" 8-Track

- Walnut-Grain Vinyl Accents
- Lighted Program Indicators

Model TM204S. Small in size, but has a voice big enough for most any car! Has balance, loudness and treble controls, program indicators, hinged cartridge door. Well-built solid-state chassis takes the bumps and jolts of everyday driving. 6¼" x 2½" x 6¼". With mounting bracket. For 12 VDC neg. grd. RA-027J. Shpg. wt. 7 lbs. 39.95



39⁹⁵
speakers
extra

"Midi" 8-Track Player

- Repeat Feature Lets You Replay a Single Program Again and Again

Model TM413S. Good-looking 8-track player has slide-type volume, tone and balance controls, repeat button, tambour door. Simply insert a cartridge to turn it on, remove to turn it off. Lighted program indicator, rugged solid-state chassis. 7¾" x 2½" x 9¾". For 12 VDC negative ground. RA-026J. Shpg. wt. 8 lbs. 69.95



69⁹⁵ speakers
extra



These models feature striking tambour doors which completely cover front of units, even with cartridge inserted!

8-Track Player / FM Stereo Radio

- Hinged Cartridge Door
- Thumbwheel FM Station Selector

Model TF752S. Here's real car entertainment versatility! 8-track stereo tape player plus great-sounding FM Stereo radio gives you your choice of two entertainment worlds! Has slide-controls for tone, volume and balance, eject control, radio on/off switch. Tambour door. 7¾" x 2½" x 9¾". With bracket. For 12 VDC negative ground. RA-025J. Shpg. wt. 9 lbs. 99.95

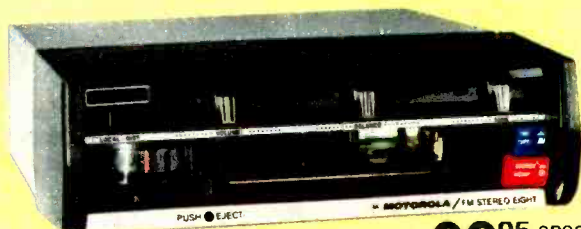

99⁹⁵ speakers
extra

Tenna

Car Stereo Tape Players Make

These 12 VDC neg. grd. Tenna Car Stereo Tape Players lead the way in value and quality. They all feature volume, balance and tone controls, the

8-tracks have lighted channel indicators and automatic replay feature that lets you play the cartridge as many times as you wish.



1 **59⁹⁵**
Speakers
Extra



2 **69⁹⁵**
Speakers
Extra



3 **119⁹⁵**
Speakers
Extra



4 **139⁹⁵** Speakers
Extra

1 Mini-8® 8-Track Player

Model TC-80T. A compact player designed for mounting anywhere space is limited—even fits nicely in the glove compartment of most cars. Features built-in head cleaner that automatically cleans tape heads each time a cartridge is inserted or removed, easy-to-use thumbwheel controls, Tenna's patented fine tuning that stops program-to-program crosstalk. 40-12,000 Hz response, 6 watts rms total. With mobile mounting bracket. 5 3/8 x 3 3/8 x 7 1/2".

AU-388J. Shpg. wt. 6 lbs. 59.95



2 Matrix 4-Channel Player

Model TC-68T. Plays all pre-recorded 8-track cartridges in 2-channel stereo, has built-in matrix system that gives you derived 4-channel sound (when you add two more speakers). Has built-in cartridge head cleaner, full-range controls, hinged cartridge door to protect tape heads and mechanism, fine tuning control to prevent crosstalk. 40-12,000 Hz response, 6 watts rms total. With mounting bracket. 5 1/2 x 2 x 6 1/2".

AU-389J. Shpg. wt. 4 1/2 lbs. 69.95

3 Discrete 4-Channel Player

Model TC-77T. Plays standard pre-recorded 8-track stereo cartridges, plus the new Q8 discrete 4-channel cartridges. Has four separate amplifiers that generate a whopping 20 watts of power output. Special lighted indicator shows whether 2 or 4-channel cartridge is being played, has both front-to-rear and left-to-right channel balance controls for precise sound adjustment. Fine tune control, built-in head cleaner. 40-12,000 response. With bracket. 8 x 2 1/8 x 6 3/4".

AU-391J. Shpg. wt. 6 lbs. 119.95

4 In-Dash Cassette/Radio

Model TC-112CMX. It's a deluxe stereo cassette player, it's a full-fidelity FM/AM and FM stereo radio—and it mounts right in your dash like a custom-built! Safety-load mechanism locks cassette in place, has fast forward and reverse, end-of-tape indicator, tape eject. Radio has slide-rule tuning, built-in AFC, lights for AM, FM and stereo FM. Solid-state, with IC's. 40-12,000 Hz response, 7 watts rms total. Adjustable mounting shafts. 7x2x7 1/2".

AU-392J. Shpg. wt. 6 lbs. 139.95

Motoring More Musical

Players on these two pages feature built-in burglar alarms for theft prevention—your car's horn blows if any attempt to tamper with player is made.

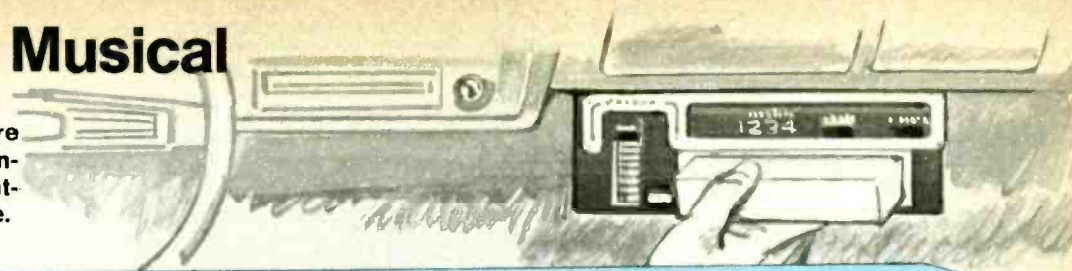

5 **34⁹⁵** Speakers Extra



6 **44⁹⁵** Speakers Extra

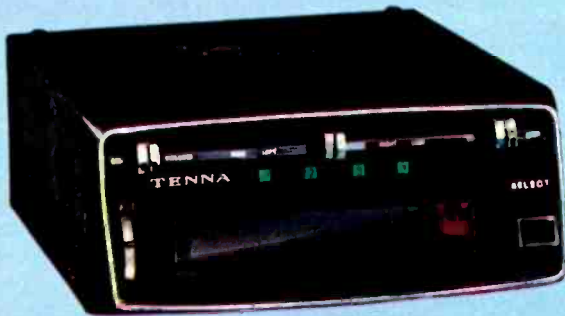

7 **49⁹⁵** Speakers Extra



8 **109⁹⁵** Speakers Extra

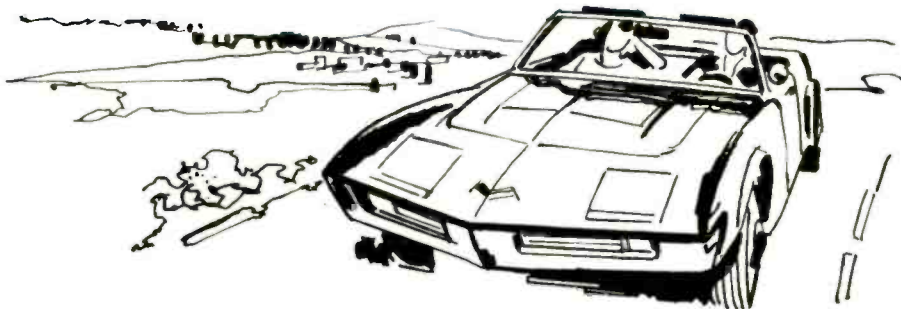

5 Low-Priced Stereo Player

Model TC-70T. Even Tenna's lowest-priced player gives you many features for great-sounding playback of pre-recorded 8-track stereo cartridges . . . it's great for music lovers on a budget. Has lighted channel selector, knob-type controls, hinged cartridge door that protects tape head and mechanism during playback. Simply insert cartridge and player's on. 40-12,000 Hz response, 6 watts rms total. No burglar alarm. With bracket. 5 $\frac{1}{2}$ x 3 x 8". AU-385J. Shpg. wt. 7 lbs. 34.95

6 Compact 8-Track Player

Model TC-67T. Newly designed 8-track cartridge player mounts just about anywhere in your 12-volt vehicle—plays pre-recorded stereo tapes with outstanding fidelity. Has slide-type volume controls for each stereo channel—lets you balance the sound exactly to your preference. 3-position tone control switch. Easy pop-in cartridge loading, hinged cartridge door. 40-12,000 Hz response, 7 watts rms total. With mounting bracket. 6x2 $\frac{1}{4}$ x6 $\frac{1}{4}$ ". AU-386J. Shpg. wt. 5 lbs. 44.95

7 "Micro" 8-Track Tape Player

Model TC-73T. Has really excellent features for an 8-track player priced this low! Special *lighted cartridge door* is just what you need if you do much night driving—lets you insert and remove cartridges without fumbling around in a dimly lit area and taking your eyes off the road! Fine tuning, repeat switch, slide controls. Slim styling for easy underdash mounting with bracket included. 40-12,000 Hz response. 12 watts peak power. 5 $\frac{1}{2}$ x2 $\frac{1}{4}$ x7 $\frac{1}{4}$ ". AU-387J. Shpg. wt. 5 lbs. 49.95

8 Derived "Quad" Player/Radio

Model TC-95MPX. 8-track and radio entertainment at its best. Plays standard stereo cartridges in 2-channel or derived 4-channel, synthesizes FM stereo broadcasts for 4-channel effect. Has fine-tuning control, built-in head cleaner. Radio features mono-stereo switch for best FM reception even in fringe areas, stereo indicator light, slide-rule tuning. Solid-state wth IC's. 40-12,000 Hz response, 8 watts rms total. With mobile mounting bracket. 5 $\frac{1}{2}$ x3x8". AU-390J. Shpg. wt. 7 lbs. 109.95

See Pages 138, 139, 163 for Exciting Car Stereo Accessories

Sanyo Car Radios for "Tunes When Traveling"



These car radios are an "Auto Music Listener's Delight"! They're all equipped for easy in-dash mounting for most automobiles—the theft-proof way to mount a car radio. Another big advantage is the tremendous value you get when you install it yourself. You would probably pay twice the price for most comparable factory installed models. So there you have it—great values, superb design, and most of all—quality performance.



2 **69⁹⁵** less speaker



1 **34⁹⁵** less speaker



3 **79⁹⁵** less speaker



4 **99⁹⁵** less speakers

1 AM Pushbutton—for Driving Pleasure

Model F-8270. Enjoy the comforts of reliable AM radio. Keep informed to-and-from work with the latest news, weather, and traffic reports—or just for 'plain ole' music enjoyment during a trip around the countryside. Has push-button and manual tuning, tone control. Mounts in dash of most automobiles. 6-watts. Includes mounting hardware. 7 $\frac{1}{8}$ x 2 x 4 $\frac{1}{16}$ ". 12 VDC neg. ground.

AU-380J. Shpg. wt. 4 lbs. **34.95**

2 FM/AM Pushbutton—with Front & Rear Fader

Model F-8571. Move up to "The Great Alternative" in car radio listening! Sensitive FM/AM sound will make your car a versatile music system. Includes the convenience of pushbutton or conventional manual tuning, tone control, front-rear fader. 6 watt output. Mounting hardware. Adjustable shaft, mounts in dash in most cars. 7 $\frac{1}{8}$ x 2 x 4 $\frac{1}{16}$ ". 12 VDC neg. ground.

AU-381J. Shpg. wt. 4 lbs. **69.95**

3 FM/AM Weathermatic—Music, Rain or Shine

Model F-8572. An important companion for any driver! Just push a button to get the 24 hour U.S. Government weather station (162.55 MHz) for up to the minute reports. Enjoy your favorite FM or AM programs too! Has Front-rear fader control, tone control, adjustable shafts for in-dash mounting in most cars. 6 watts. With hardware. 7 $\frac{1}{8}$ x 2 x 4 $\frac{1}{16}$ ". 12 VDC neg. grd.

AU-382J. Shpg. wt. 5 lbs. **79.95**

4 Deluxe AM/FM Stereo—"Sound Studio"

Model F-8573. Enjoy the "live" sound of stereo right in your own car at about half the price of many similar factory installed models! Includes pushbutton and manual tuning, balance and tone controls. Adjustable shafts for easy in-dash mounting in most cars. 6-watts. With mounting hardware. 7 $\frac{1}{8}$ x 2 x 4 $\frac{1}{16}$ ". 12 VDC neg. grd.

AU-383J. Shpg. wt. 5 lbs. **99.95**

5 Stylish "Tachometer-Design" FM/AM Car Radio

- Stylish Addition for Your Car's Interior
- Includes Windshield Antenna System, High-Fidelity Speaker

Model Tachrad F-8410. Installs with NO cutting or drilling of holes in dash, struggling with mounting hardware, or connecting an outside antenna. Mounts under dash or on floor with self-tapping screws and a single wire connection. Has lighted dial, tone control and "anti-theft" locking system with key. Speaker unit has a handsome cabinet that's designed to fit anywhere in the car. 3 $\frac{1}{2}$ " W x 6 $\frac{1}{4}$ " D. 12 VDC negative ground.

AU-288J. Shpg. wt. 3 lbs. **69.95**

Model F-8411. AM/FM/FM Stereo Car Radio Same as above, but stereo FM. Less speakers. 3 $\frac{1}{8}$ x 6 $\frac{1}{8}$ ".

AU-378J. Shpg. wt. 3 lbs. **99.95**

Model FT-8412. AM/FM/FM Stereo Car Radio Same as above, with 2 wide-response speakers. 3 $\frac{1}{8}$ x 8 $\frac{1}{2}$ ".

AU-379J. Shpg. wt. 4 lbs. **115.95**

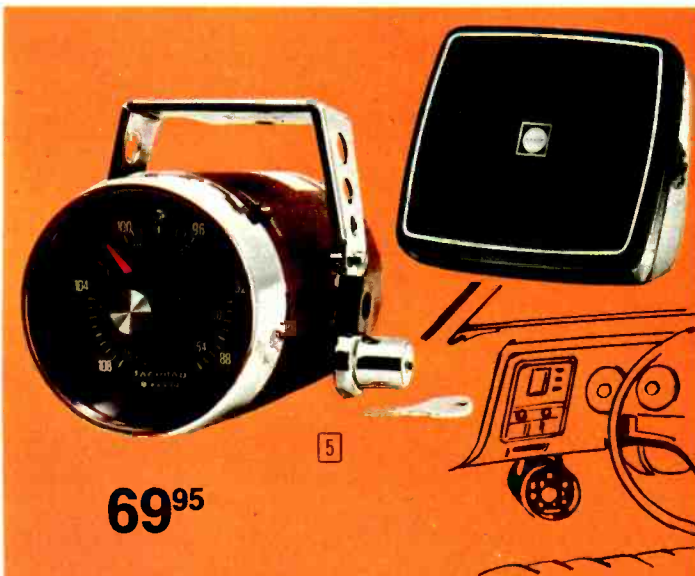

5 **69⁹⁵**

General Catalog Index

<p>A</p> <p>Acoustic Insulation 65</p> <p>Adapters, Audio 70, 71</p> <p>Adhesives 93, 123, 170</p> <p>Alarms 156-162, 166</p> <p>Alignment Tools 93</p> <p>AMATEUR EQUIPMENT</p> <p>112-120, 206, 209, 213</p> <p>AMPLIFIERS</p> <p>Antenna 195, 198, 199</p> <p>Hi-Fi 18, 28, 29, 33, 46</p> <p>Linear 120, 211, 213</p> <p>Public Address 79, 230</p> <p>ANTENNA EQUIPMENT</p> <p>Amateur 114-117, 209, 213</p> <p>Amplifiers 195, 198, 199</p> <p>Connectors 199, 201</p> <p>Couplers 181, 199</p> <p>..... 201, 206</p> <p>Installation Equip. 201</p> <p>Lightning Arrestors 155, 181, 206</p> <p>Marine 120</p> <p>Masts & Towers 114, 115</p> <p>Matchers 201, 206, 209</p> <p>Mounts 201, 209</p> <p>Outlets 199, 201</p> <p>Rotators 114, 192, 200</p> <p>Splitters 155, 181, 199, 201</p> <p>Systems 196, 197</p> <p>Twin Lead 181, 201</p> <p>Wire & Cable 180, 181, 201</p> <p>ANTENNAS</p> <p>Amateur/SWL 114, 115, 209, 213</p> <p>Auto 155</p> <p>Citizens Band 204, 208</p> <p>FM 27, 192-197, 201</p> <p>Indoor Antennas 198, 201</p> <p>Marine 120</p> <p>Monitor 209, 217, 219</p> <p>Telescoping 171</p> <p>TV 155, 192-198, 201</p> <p>Audio Cables 65, 66, 70, 71, 181</p> <p>Audio Generators 84, 88</p> <p>AUTO EQUIPMENT & ACCESSORIES</p> <p>..... 87, 89</p> <p>94, 137-139, 155, 159, 162, 163, 165, 166</p> <p>Auto Analyzers 87, 89</p> <p>Kit 89</p> <p>Auto Radios 141, 143-147, 150, 165</p> <p>Stereo FM 144-149</p> <p>Auto Speakers 138, 139, 163</p> <p>Auto Tape</p> <p>Accessories 137, 138</p> <p>Auto Tape</p> <p>Players 136, 140-149, 165</p> <p>B</p> <p>Baffles, Speaker 42</p> <p>BATTERIES</p> <p>..... 102, 103</p> <p>BATTERY SUPPLIES</p> <p>Chargers, Eliminators 89, 103, 104</p> <p>Holders 185</p> <p>Testers 83, 103</p> <p>Black Lights 229</p> <p>BOOKS</p> <p>..... 109-111, 168, 171, 175</p> <p>Bulbs 186</p> <p>Burglar Alarms 156-162, 166</p>	<p>C</p> <p>CABINETS</p> <p>Hardware & Utility 90, 169</p> <p>Hi-Fi 42, 43</p> <p>Speakers 42</p> <p>CABLE</p> <p>Assemblies 70, 71, 180, 201</p> <p>Connectors 70, 71, 116, 180, 185, 199</p> <p>Cables, Audio 65, 66, 70, 71, 181</p> <p>..... 98-101</p> <p>CALCULATORS</p> <p>CAPACITORS</p> <p>..... 167, 168, 173</p> <p>Tester 87, 89</p> <p>Cartridge</p> <p>Players 24, 34, 35, 45</p> <p>..... 238, 239, 243</p> <p>Recorders 235, 238, 239, 243</p> <p>CARTRIDGES PHONO</p> <p>Four-Channel 51</p> <p>Cartridges, Tape</p> <p>Blank 130-135</p> <p>Pre-recorded 154</p> <p>Carts, Equipment 44</p> <p>Cassette Decks 231, 232, 234, 236-239</p> <p>..... 241, 242, 243</p> <p>Recorders 34, 234-236-243</p> <p>Cassettes, Tape 130, 131-135</p> <p>Casters 96</p> <p>Cements 93, 123, 170</p> <p>Chassis Boxes 169, 184</p> <p>Cheater Cord 96</p> <p>Chemicals 170</p> <p>CITIZENS BAND (CB) RADIO EQUIPMENT</p> <p>202-208, 210-212</p> <p>Antennas 204, 208</p> <p>SWR Meters 116, 117, 206</p> <p>Testers 206, 210</p> <p>Two-way Radios 202-205, 207, 210-212, 214</p> <p>Walkie-Talkies 161, 203, 207</p> <p>Cleaners, Chemical 170</p> <p>Clock-Radios 154, 222-227</p> <p>Clocks 98, 125, 227</p> <p>Closed-Circuit</p> <p>TV 156, 157</p> <p>Coaxial Cable 180, 201</p> <p>Code Equipment 113, 116</p> <p>Coils & Forms 178</p> <p>Color Bar</p> <p>Generators 84, 95</p> <p>Color Organs 228, 229</p> <p>CONNECTORS</p> <p>Antenna 199, 201</p> <p>Audio 70, 71</p> <p>Cable 71, 116, 180, 185, 199</p> <p>Coaxial 116, 180</p> <p>Converters, Power 89, 103, 104, 137, 165, 177</p> <p>Cords, Appliance 96</p> <p>Counter 96</p> <p>CRYSTALS</p> <p>..... 116, 210, 217</p> <p>Cutters, Wire 92, 93</p>	<p>D</p> <p>Demagnetizers, Tape</p> <p>Head 130, 134</p> <p>Depth Indicators 122</p> <p>Dials & Access. 168</p> <p>Dial Cord 96</p> <p>Dimmers, Light 96</p> <p>Diodes 174, 175, 179</p> <p>Drafting Sets 124</p> <p>Drills 90, 91</p> <p>Drive Belts 93, 138</p> <p>Dwell Tach 87, 89, 94, 166</p> <p>E</p> <p>Earphones 119</p> <p>Educational Kits 105-109</p> <p>Electric Eye Equip. 156</p> <p>Engravers 90, 91</p> <p>Erasers, Tape 130</p> <p>Experimenters Kits 105-109</p> <p>Equipment</p> <p>Cabinets 42, 43</p> <p>Extension Cords 180</p> <p>F</p> <p>Fasteners 123</p> <p>Fiber Optics 105, 229</p> <p>Field Strength</p> <p>Meters 116, 117, 206</p> <p>Filters 112, 116, 199, 201</p> <p>Fire Alarms 158-161</p> <p>Fish Locators 122</p> <p>Flashlights 166, 185</p> <p>FM-AM RADIOS, RECEIVERS, TUNERS: See Item Wanted</p> <p>FOUR-CHANNEL HI-FI</p> <p>7-12, 15-21</p> <p>24-35, 45, 46, 240</p> <p>Furniture, Hi-Fi 42-44</p> <p>Fuses & Holders 185</p> <p>G</p> <p>Garage Door</p> <p>Opener 136</p> <p>Grid Dip</p> <p>Meter 89</p> <p>Grillie Cloth 65</p> <p>Grinders 90, 91</p> <p>GUARANTEES</p> <p>..... 3, 6, 152</p> <p>H</p> <p>Ham Equipment —</p> <p>See Amateur Equip.</p> <p>Hardware 96, 123</p> <p>HEADPHONES</p> <p>Adapter 55</p> <p>Communications 119</p> <p>Four-Channel 53, 54, 164</p> <p>Hearing Protector 171</p> <p>Remote Control 55</p> <p>Stereo Hi-Fi 21, 53-55</p> <p>Heat Sinks 174, 179</p> <p>HI-FI EQUIPMENT</p> <p>See Item Wanted</p> <p>HI-FI SYSTEMS</p> <p>7, 9, 10</p> <p>13, 14, 17, 18, 21, 22, 24, 27, 30-32, 34-35, 45, 240</p> <p>Hobby Tools 90-94</p> <p>Horns 66, 72, 78, 188</p>	<p>I</p> <p>IC's 174, 175, 179</p> <p>IF Transformers 178</p> <p>Ignition</p> <p>Systems 162, 165, 166</p> <p>Indoor Antennas 198, 201</p> <p>INTERCOMS & ACCESS.</p> <p>..... 72, 73</p> <p>Inverters 89, 104, 177</p> <p>J</p> <p>JACKS</p> <p>Microphone 71</p> <p>Phone & Phono 70, 71</p> <p>K</p> <p>Keys, Code 113, 116</p> <p>KITS, BUILDERS</p> <p>..... 88, 89, 105-109</p> <p>Knobs 168</p> <p>L</p> <p>Labelmakers 94</p> <p>Tape 186</p> <p>LAMP BULBS</p> <p>..... 179</p> <p>L.E.D.'s 179</p> <p>Light Dimmers 96</p> <p>Lights,</p> <p>Musical 228, 229</p> <p>Line Cords 96</p> <p>M</p> <p>Marine Radios 120</p> <p>Masts, Antenna 114, 115</p> <p>Megaphones 72</p> <p>Metal Goods 169</p> <p>Metal Chactors 106, 122</p> <p>Meters 96, 174</p> <p>MICROPHONES</p> <p>Stands 74-77, 116</p> <p>..... 77</p> <p>Mixers, Audio 71, 77</p> <p>Monitors 205, 215-219</p> <p>Motors & Fans 187</p> <p>Motor Speed Control 90</p> <p>Multi-Meters 82, 83</p> <p>..... 85, 86, 88, 89, 95</p> <p>MUSIC SYSTEMS</p> <p>See Hi-Fi Systems</p> <p>N</p> <p>Needles, Phono 49, 52</p> <p>Noise Suppressors 116, 201, 206</p> <p>Nutdrivers 92, 93</p> <p>O</p> <p>Oscilloscopes 84, 85, 88, 95</p> <p>Outlets</p> <p>AC 104</p> <p>Antenna 199, 201</p> <p>Panel Meters 96, 174</p> <p>Parts Cabinets 90</p> <p>Perf Boards 184</p> <p>Photograph 222</p> <p>PhotoCells 168</p> <p>Photoelectric</p> <p>Equipment 156</p> <p>Psychedelic Lights 105, 228, 229</p>	<p>Pilot Lights 186</p> <p>Pliers 92, 93</p> <p>PLUGS</p> <p>Microphone 71</p> <p>Phone & Phono 70, 71</p> <p>Telephone 126</p> <p>Potentiometers 170</p> <p>Power Horns 72, 78</p> <p>Power Supplies 104, 108</p> <p>..... 116, 117, 119, 137, 177</p> <p>Power Tools 90, 91</p> <p>Preamplifiers 49</p> <p>PRINTED CIRCUIT</p> <p>Components 184</p> <p>Probes 82, 83, 85, 89, 95</p> <p>PUBLIC ADDRESS EQUIP.</p> <p>..... 69, 72, 78-81, 230</p> <p>Q</p> <p>QUADRAPHONIC EQUIP.</p> <p>See 4-Channel Hi-Fi</p> <p>R</p> <p>Radar Detector 166</p> <p>RADIOS</p> <p>Auto 141, 143-147, 150, 165</p> <p>Clock 154, 222-227</p> <p>Headphone 227</p> <p>Multi-Band 220</p> <p>Novelty 223, 227</p> <p>Portable 154, 220, 221, 224-226</p> <p>Table 222, 224, 225, 227</p> <p>Weather 220</p> <p>RECEIVERS</p> <p>Amateur 112, 114, 117-119</p> <p>Four-Channel 8, 11, 12, 15, 16, 19, 25, 26, 29, 33, 35, 45</p> <p>Scanners 205, 215-219</p> <p>Stereo 19, 20, 23, 26, 29, 33, 34, 35</p> <p>VHF Monitors 215-219</p> <p>Record Care 49, 170</p> <p>RECORD CHANGERS & SUPPLIES</p> <p>..... 2, 21</p> <p>36-41, 48, 49</p> <p>Record Demodulators</p> <p>4-Ch. 18, 33, 46</p> <p>Recorders / See Tape Equip.</p> <p>Recording Tape 130-135</p> <p>Rectifiers 174, 175</p> <p>Reel-to-Reel Tape Decks & Recorders 233-236</p> <p>Relays 182, 183</p> <p>Resistors 172</p> <p>Reverb Systems 21, 141</p> <p>RF Generator 84, 85, 88</p> <p>Rotators, Antenna 114, 192, 200</p> <p>S</p> <p>Sanders 91</p> <p>Saws & Access. 91</p> <p>Screwdrivers 92, 93</p> <p>SECURITY EQUIP.</p> <p>..... 156-162, 166</p> <p>Semiconductors 174, 175, 179</p>	<p>Signal Generators 84, 85, 88</p> <p>Signal Tracers 87, 89</p> <p>Slide-Rules 93, 124</p> <p>Siren 159</p> <p>Smoke Detector 160</p> <p>Socket Wrenches 92, 93</p> <p>Soldering Irons & Supplies 87, 93, 94, 183</p> <p>Solenoids 182</p> <p>SPEAKER</p> <p>Auto 138, 139, 163</p> <p>Baffles 42</p> <p>Controls 138</p> <p>Crossovers 66</p> <p>Drivers 65, 66</p> <p>Enclosures 42</p> <p>Extension 59, 69</p> <p>Grilles, Auto 138</p> <p>Grille Cloth 65</p> <p>Hi-Fi 26, 56-69, 78</p> <p>Midrange 65, 66</p> <p>Musical 78, 164, 188</p> <p>Outdoor 69, 78</p> <p>Public Address 69, 78, 230</p> <p>Replacement 188</p> <p>Switches 71</p> <p> Tweeters 65, 66, 78</p> <p>Wire 66, 181</p> <p>Woofers 65, 68</p> <p>SPEAKER SYSTEMS</p> <p>Hi-Fi 26, 56-69, 235</p> <p>P A 78</p> <p>STEREO EQUIPMENT</p> <p>See Item Wanted, and Hi-Fi Systems</p> <p>Strobe Lights 109, 228</p> <p>Styli, Phono 49, 52</p> <p>Sweep Generators 84</p> <p>SWITCHES</p> <p>..... 116</p> <p>SWR Meter 176, 206, 116, 117, 206</p> <p>T</p> <p>Tachometers 94, 109, 166</p> <p>TAPE</p> <p>Adhesive 123</p> <p>Electrical 93, 123</p> <p>Labeling 94</p> <p>Pre-recorded 154</p> <p>Recording 130-135</p> <p>Tape Decks 18, 24, 130-235</p> <p>..... 235, 237, 238-239, 242, 243</p> <p>Four-Channel 18, 24</p> <p>TAPE PLAYERS</p> <p>Auto 136, 140-149, 165</p> <p>Home 24, 34, 35, 130, 231-243</p> <p>TAPE RECORDERS</p> <p>..... 34, 35, 231-243</p> <p>Tape Recorders-Radios</p> <p>..... 237, 240, 242, 243</p> <p>Tape Recording Accessories</p> <p>..... 55, 97, 125, 130, 133, 134</p> <p>Telegraph Keys 113, 116</p> <p>Telephones & Access. 125-129</p> <p>Telephone Amplifier 126</p> <p>Telephone Answerers 125, 128, 129</p> <p>Telephone Dialers 128, 129</p> <p>Telephone Recording</p> <p>Adapt. 125</p>	<p>TELEVISION</p> <p>Antennas 155, 192-198</p> <p>Antennas/Rotators 196, 197</p> <p>Boosters 198, 199</p> <p>Cats 44</p> <p>Closed Circuit 156, 157</p> <p>Distrib</p> <p>Amplifiers 199</p> <p>TELEVISION SETS</p> <p>Terminals 66, 70, 184</p> <p>Test Clips & Leads 82</p> <p>TEST EQUIPMENT</p> <p>..... 82, 89, 95, 171, 177, 183</p> <p>Test Probes 82, 83, 89, 95</p> <p>Timers 186, 189</p> <p>Timing Lights 94, 166</p> <p>Tone Arms 49</p> <p>Tool Chests 90</p> <p>TOOLS</p> <p>90-94, 124, 183</p> <p>Torch 93</p> <p>Towers Antenna 114, 115</p> <p>Transceivers — See Two-Way Radios</p> <p>TRANSFORMERS</p> <p>..... 83, 178</p> <p>Transistor Testers 83, 85, 89, 183</p> <p>Transistors 174, 175</p> <p>Transmitters Amateur</p> <p>..... 112, 114, 117, 118</p> <p>Treasure Finders 122</p> <p>TUBES</p> <p>..... 189-191</p> <p>Brighteners 177, 186</p> <p>Caddy 189</p> <p>Tube Testers 86, 88, 177</p> <p>Tubing, Plastic 184</p> <p>Heat Shrinkable 184</p> <p>TUNERS</p> <p>..... 28, 29, 46</p> <p>Turntables 2, 21, 36-41, 48, 49</p> <p>Tweeters 65-66</p> <p>TWO-WAY RADIOS</p> <p>Amateur 112, 114, 117-120</p> <p>Business Band 120</p> <p>Citizens Band (CB)</p> <p>202-205, 207, 210-212, 214</p> <p>Marine 120</p> <p>U</p> <p>Ultrasonic Alarms 156, 162, 166</p> <p>V</p> <p>Vacuum Tube Volt-Meters (VTVM) 85, 86, 88, 95</p> <p>Voltage Regulators 83</p> <p>Volt-Ohm-Milliameters (VOM) 82, 83, 88, 89, 95</p> <p>Volume Controls 170</p> <p>W</p> <p>Walkie-Talkies (CB)</p> <p>..... 161, 203, 207</p> <p>Watches preceding 63, 121, 166</p> <p>Wattmeters 116, 206</p> <p>WIRE & CABLE</p> <p>..... 180, 181, 201</p> <p>Woofers 65-68</p> <p>Wrenches 92, 93</p>
--	--	--	--	--	---	--

Index to Manufacturers

<p>Actron 94</p> <p>Akai 233-235</p> <p>Akro-Mils 90</p> <p>Alliance 192, 196</p> <p>Ameco 109</p> <p>Ampex 134</p> <p>Antenna Specialists 204, 217</p> <p>A-R 36, 60, 61</p> <p>Argos 69</p> <p>ARRL 109</p> <p>Audio</p> <p>Technica 50, 171</p> <p>Audiovox 143</p> <p>B & K 84-86</p> <p>Bowman 106, 107, 228</p> <p>Brightco 229</p> <p>BSR 48</p> <p>Burgess 103</p> <p>Capitol 135</p> <p>CDE 183</p> <p>Circuit-Stik 184</p> <p>Cobra 204</p> <p>Comm 163</p> <p>Concord 231, 232</p>	<p>Cornell-Dubilier 114, 173, 183, 196, 197, 200</p> <p>Courier 211</p> <p>Craig 144, 147</p> <p>Crestmark 97</p> <p>Crown 128</p> <p>Data Eng. 113</p> <p>David Clark 164, 171</p> <p>Delta 69</p> <p>Drake 112</p> <p>Dremel 90</p> <p>Dual 36, 37</p> <p>Dymo 94</p> <p>Dyn 136, 224</p> <p>Eico 88, 89</p> <p>Electra 224</p> <p>Electra Bearcat 217</p> <p>Electro-Lift 136</p> <p>Electro-Voice 66, 67, 76, 78, 188</p> <p>E-V/Game 52</p> <p>Empire 36, 50, 51, 60</p> <p>Fanon 72, 73, 161</p>	<p>Finco 155, 194, 195, 197-199, 201</p> <p>Fisher 26, 27</p> <p>Franzrus 104</p> <p>Gamber Johnson 42</p> <p>Garrard 2, 38-41</p> <p>GC 168, 170, 176, 178, 179, 182, 185, 186</p> <p>General</p> <p>Telephone 129</p> <p>Goldline 206</p> <p>Graymark 87, 109</p> <p>Great Western 171</p> <p>Gusdorf 44</p> <p>Herald Eminence 164</p> <p>Hy-Gain 114, 115, 117, 120, 202, 213, 219</p> <p>ICOM 118, 119</p> <p>Id Elect. 154</p> <p>Inland Dynatronics 165</p> <p>Intermatic 186</p> <p>International</p> <p>Mktg. 125</p> <p>Internat. Rect. 96, 105</p>	<p>Jensen 63</p> <p>Jetco 122</p> <p>JFD 155</p> <p>Johnson 210</p> <p>JVC 32, 33, 36</p> <p>Kendall 125</p> <p>Kester 87</p> <p>Koss 54</p> <p>Kustom Kreations . 97, 137</p> <p>Leader 95</p> <p>Le Bo 97</p> <p>Lee 87</p> <p>LMB 169</p> <p>Ma-Com 129</p> <p>Marcel Watch 121</p> <p>Mercury 86</p> <p>Metrotec 165</p> <p>Midland 203, 216</p> <p>Miracord 48</p> <p>MITS 88, 98, 108</p> <p>Motorola 145, 175</p> <p>Multicore 94</p> <p>Newtronics 208, 209</p>	<p>Nordmende 226</p> <p>NPC 177</p> <p>N.T.T. Peerless 42</p> <p>OLSON 49, 53, 55-59, 65-67, 70, 72, 77-83, 93, 96, 103, 104, 116, 117, 126, 127, 130, 138, 139, 141, 156, 157, 160, 161, 166, 168, 172, 174, 176, 182, 186-188, 192, 193, 201, 239</p> <p>Onaida 93</p> <p>Pace 120</p> <p>214, 215</p> <p>Permaneer 43</p> <p>Philco 34, 35, 225</p> <p>Pickwick 154</p> <p>Pioneer 18-21, 28, 36, 64, 140</p> <p>Production Devices 183</p> <p>Radatron 166</p> <p>Ray-O-Vac 102, 185</p> <p>Rawn 170</p> <p>Recoton 55, 138</p>	<p>Regency 117</p> <p>Rotel 29</p> <p>Royce 207</p> <p>Sams, H.W. 110, 111, 171</p> <p>Sanyo 24, 25, 30, 31, 47, 142, 146, 150, 220-223, 240-243</p> <p>Saxton 127, 180, 181</p> <p>SBE 120, 205</p> <p>Scotch 123, 131-133</p> <p>Sennheiser 55</p> <p>Shield 189</p> <p>Shure 51, 116</p> <p>Soundlite 227</p> <p>Sprague 167</p> <p>Summit 101</p> <p>Switchcraft 71</p> <p>Teberry 212</p> <p>Tedyne 7-17, 22, 23, 45, 46, 53, 56-59, 74, 75, 79-81, 211</p>	<p>Teledyne Post 93, 124</p> <p>Telematic 177</p> <p>Telex 119, 130</p> <p>Tenna 148, 149</p> <p>Tennelec 218</p> <p>Tensor 125</p> <p>Ten-Tec 116</p> <p>Texas Instruments 99</p> <p>Toshiba 103</p> <p>Tri-Ex 114</p> <p>Tripp Lite 104</p> <p>Triumph 227</p> <p>United Audio 36, 37</p> <p>Universal Data 100</p> <p>Universal</p> <p>Security 158, 159</p> <p>University</p> <p>Sound 78, 230</p> <p>Utah 62, 68</p> <p>Wahl 183</p> <p>Wen 91</p> <p>Westinghouse 189-191</p> <p>Wollensak 236-238</p> <p>Xcelite 92</p>
---	---	--	---	---	---	--

IMPORTANT ORDERING INFORMATION

Use Your Zip Code to Find Your Parcel Post or UPS Zone

To determine your Parcel Post or UPS Zone, locate the first 3 numbers of your Zip Code on the chart below. Example: If your Zip Code is 60022, use the first 3 numbers (600); look for 600 in the chart below which shows your Zone is 3.

Zip Code Prefixes	Zone	Zip Code Prefixes	Zone	Zip Code Prefixes	Zone	Zip Code Prefixes	Zone	Zip Code Prefixes	Zone
006-009	8	220-229	3	400-406	3	520-539	4	739	6
010-041	4	230-239	4	407-409	4	540	5	740-759	5
042-049	5	240-259	3	410-418	3	541-549	4	760-761	6
050-098	4	260-261	2	420-424	4	550-558	5	762	5
100-129	4	262	3	425-427	3	559	4	763-797	6
130-132	3	263-265	2	430-439	2	560-576	5	798-799	7
133-139	4	266-268	3	440-443	1	577	6	800-814	6
140-146	3	270-298	4	444-445	2	580-584	5	815	7
147	2	299	5	446-447	1	585-593	6	816-828	6
148-149	3	300-312	4	448-449	2	594-599	7	829-865	7
150-158	2	313-329	5	450-452	3	600-609	3	870-871	6
159	3	330-333	6	453-458	2	610-639	4	873-874	7
160-165	2	334-339	5	460-474	3	640-648	5	875-877	6
166	3	350-352	4	475-478	4	650-652	4	878-880	7
167	2	354	5	479	3	653	5	881-884	6
168-179	3	355-359	4	480-482	2	654-655	4	890-891	8
180-181	4	360-361	5	484-491	3	656-676	5	893	7
182	3	362	4	492	2	677	6	894-897	8
183	4	363-367	5	493-496	3	678	5	898	7
184-188	3	368	4	497-499	4	679	6	900-978	8
189-199	4	369	5	500-503	5	680-692	5	979	7
200-215	3	370-386	4	504	4	693	6	980-989	8
216	4	387	5	505	5	700-722	5	990-992	7
217	3	388	4	506-507	4	723-724	4	993	8
218-219	4	389-397	5	508-516	5	725-738	5	994	7
								995-999	8

Parcel Post and/or UPS Shipping Rates

Whenever possible, we will ship your order via United Parcel Service or Parcel Post. Items exceeding 50 lbs. each, or measuring over 108" in length plus girth, must be shipped by Express or Motor Freight (see rate charges at right.)

Shipping Weight	1st & 2nd Zone	3rd Zone	4th Zone	5th Zone	6th Zone	7th Zone	8th Zone
to 2 lbs.	\$.60	\$.64	\$.69	\$.74	\$.90	\$1.00	\$1.05
3 lbs.	.65	.71	.79	.86	.10	1.20	1.35
4 lbs.	.70	.78	.88	.98	1.30	1.40	1.60
5 lbs.	.75	.85	.98	1.10	1.45	1.65	1.90
6 lbs.	.80	.92	1.07	1.22	1.60	1.85	2.10
7 lbs.	.85	.99	1.17	1.34	1.75	2.10	2.35
8 lbs.	.90	1.06	1.26	1.46	1.90	2.30	2.60
9 lbs.	.95	1.13	1.36	1.58	2.05	2.45	2.85
10 lbs.	1.00	1.20	1.45	1.70	2.20	2.65	3.10
11 lbs.	1.05	1.27	1.55	1.82	2.30	2.85	3.35
12 lbs.	1.10	1.34	1.64	1.94	2.45	3.05	3.55
13 lbs.	1.15	1.41	1.74	2.06	2.60	3.25	3.80
14 lbs.	1.20	1.48	1.83	2.18	2.75	3.45	4.00
15 lbs.	1.25	1.55	1.93	2.30	2.85	3.60	4.20
16 lbs.	1.30	1.62	2.02	2.42	2.95	3.80	4.40
17 lbs.	1.35	1.69	2.21	2.54	3.10	3.95	4.60
18 lbs.	1.40	1.76	2.21	2.66	3.20	4.15	4.80
19 lbs.	1.45	1.83	2.31	2.78	3.35	4.30	5.00
20 lbs.	1.50	1.90	2.40	2.90	3.50	4.50	5.20
21 lbs.	1.55	1.97	2.50	3.02	3.65	4.65	5.40
22 lbs.	1.60	2.04	2.59	3.14	3.75	4.85	5.60
23 lbs.	1.65	2.11	2.69	3.26	3.90	5.00	5.80
24 lbs.	1.70	2.18	2.78	3.38	4.05	5.15	6.00
25 lbs.	1.75	2.25	2.88	3.50	4.15	5.35	6.20
For Each Extra Lb.	Add 5¢	Add 7¢	Add 10¢	Add 12¢	Add 14¢	Add 15¢	Add 20¢

Packing and Shipping Insurance Rate Chart

Value of your order	Insurance Fee
Up to \$15.00	20¢
\$15.01 to \$50.00	30¢
\$50.01 to \$100.00	40¢
\$100.01 to \$150.00	50¢
\$150.01 to \$200.00	60¢

C.O.D. Fees

\$10.01 to \$25.00 - \$1.15	\$50.00 to \$100.00 - \$1.40
\$25.00 to \$50.00 - \$1.25	\$100.01 to \$200.00 - \$1.85

FOR YOUR CONVENIENCE: You do not have to estimate postage if you pay by check. Make your check out to Olson Electronics and leave the amount blank; we will fill in the exact cost for goods and delivery. This eliminates billing you for small balances and sending you Refund Vouchers.

About Non-Mailable Merchandise

Whenever possible, we will ship your order via United Parcel Service or Parcel Post.

Parcels weighing over 50 pounds or measuring over 108 inches in length plus girth, will be shipped via REA Express or Motor Freight. All such items are identified in our catalog by "SHIPPED REA EXPRESS ONLY" after the description of the item. Specify nearest Express office if there is no agent in your town.

Chart for Estimating Express or Truck Charges

Weight	150 Miles	300 Miles	600 Miles	1000 Miles	1400 Miles	1800 Miles	2000 Miles
Up to 125 lbs.	9.50	10.00	10.50	11.75	14.00	14.00	14.00
126 to 200 lbs.	9.50	10.00	10.50	13.75	15.00	18.00	21.00
201 to 300 lbs.	12.50	15.00	17.00	22.00	24.00	29.00	34.00

Express or truck shipping charges collected by carrier upon delivery. Most truck lines charge an additional \$6.00 for delivery to your residence. For actual charges call your local express or truck agent.

NOTE: All Carrier Rates Subject To Change Without Notice.

About Items Sent Direct From Factory

Items with a stock number ending in "F" are sent direct to you from the factory by motor freight or express. They cannot be sent C.O.D. Please remit in full for the value of the merchandise. The shipping charges will be collected by the carrier upon delivery. The location of the factory is given below the catalog stock number identifying the factory-shipped item. Please allow 3 to 4 weeks for delivery.

IT'S EASY TO BUY FROM OLSON

ORDER BY MAIL

Use the handy order form on the opposite page for fast, reliable mail order service

ORDER BY PHONE

Area Code 216
535-1800
24-hour service.
Ask for our personal service shopper.

SHOP IN PERSON

at your nearest Olson store—and also use our Catalog Order Desk Service—see p. 4

Olson's Double Guarantee

1. Olson's Policy of Satisfaction

If, for any reason, you are not satisfied with your purchase, return it to us within 30 days for exchange or credit (less transportation charges.) The only exceptions are kits, equipment which has been altered or abused, wood cabinetry, or items subject to wear. Returns must be made in the original factory carton, complete with all accessories.

2. Olson's Extended Service Policy

All the goods we sell are guaranteed to be free of defects in materials and workmanship, from date of purchase for the periods of time specified. During these periods, you are guaranteed repair or replacement (at our option) without charge for parts or labor, but excluding transportation charges to and from the repair location.

These guarantees are honored nationwide at all Olson stores. All you need is your original receipt or a copy.

If there is no Olson store near you, or if there is no manufacturer's local service facility, write to the Olson Service Dept., 260 S. Forge St., Akron, Ohio 44327. Be sure to state the problem clearly and include all the original papers. Our instructions for return will be sent promptly.

Olson guarantees are specifically set forth above, and there are no other express warranties, or warranties of merchantability or fitness for particular purpose.

Olson's obligations and liabilities shall be limited to those set forth above.

PRINTING AND TYPOGRAPHICAL ERRORS Olson is not responsible for printing and typographical errors of specifications and prices occurred during the printing of this catalog. We refund on any item returned due to printing errors.

FOR OUR SPECIAL HI-FI GUARANTEES, SEE PAGE 6

THIS CATALOG REMAINS IN EFFECT THROUGH JULY 31, 1974.



Good Looking Portable and Clock Radios



6⁹⁸

Use Your Credit Card

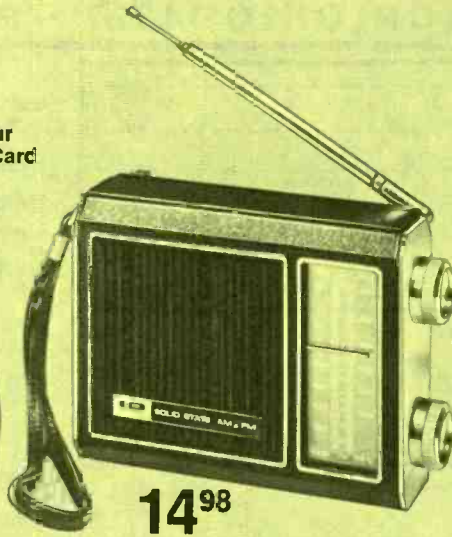

14⁹⁸



26⁹⁸

AM Pocket Portable Radio

Model PA-101. Very compact and will make an excellent companion no matter where you take it. Features easy-to-read tuning dial with station indicator, earphone, convenient carry strap and built-in ferrite bar antenna. Dependable solid-state circuitry. Includes a standard 9-volt battery. Hand-some case with silver trim. 4 x 2 $\frac{3}{4}$ x 1 $\frac{1}{4}$ ". RA-108J. Shpg. wt. 1 lb. 6.98

"Easy Carry" FM/AM Portable

Model PF-200. Now you can enjoy your favorite AM or FM music around the house or while on the go. Features slide-rule vernier tuning with log scale. Has telescoping FM antenna, built-in AM, earphone jack, and convenient carry strap. Solid-state circuit. Includes a standard 9-volt battery. Has jack for AC adapter. 5 x 3 $\frac{1}{2}$ x 1 $\frac{1}{2}$ ". RA-109J. Shpg. wt. 1 $\frac{1}{2}$ lbs. 14.98

Full Size AC/DC—FM/AM Portable

Model PF-204. Take it along—boating, beaching, or backyarding! Features Cross-Hair tuning with separate AM/FM log scale up-down dials. Sliding volume control, push-button on-off, hi-lo tone control. With earphone, battery, built-in AC line cord. 8 $\frac{1}{2}$ x 6 $\frac{1}{2}$ x 2 $\frac{1}{2}$ ". RA-110J. Shpg. wt. 2 $\frac{1}{2}$ lbs. 26.98

High Quality Clock Radios



1 12⁹⁸

1 Deluxe AM Version

Model CA-401. Wake to music or news! Telechron clock, luminous face, thumbwheel front tuning controls. On-off-60-min. control. Solid-state, walnut trim. 8 $\frac{3}{8}$ x 4 $\frac{1}{4}$ x 3 $\frac{3}{8}$ ". 117 VAC.

RA-111J. Shpg. wt. 1 $\frac{1}{2}$ lbs. . . 12.98



2 26⁹⁸

2 Slim Upright FM/AM

Model CF-501. You can wake to music and/or buzzer. Luminous Telechron clock, radar scope radio dial, 60-minute sleep switch. Walnut case, with chrome trim. 7 $\frac{1}{4}$ x 5 $\frac{1}{2}$ x 3". For 117 VAC.

RA-112J. Shpg. wt. 2 $\frac{1}{2}$ lb. . . 26.98

3 FM/AM Digital

Model CF-603. Wake to music, news, and buzzer. Has Cross-Hair dial with separate AM/FM log scales, hi-lo tone control, luminous numerals. Walnut grain wood cabinet. 12 x 5 $\frac{1}{4}$ x 3 $\frac{1}{2}$ ". 117 VAC.

RA-113J. Shpg. wt. 2 $\frac{1}{2}$ lbs. . . 39.98



3 39⁹⁸

- Stylish Slimline Wood Cabinet with Beveled Brushed Chrome and Black Face

NEW! PICKWICK 8 TRACK TAPES



ONLY \$2.99 EACH

- Choose from SOUND TRACKS, SURF, SOUL, & SADDLE (Country Western) just to name a few. A diversified selection for any musical taste at only \$2.99 per tape. Wt. 1 lb.
- XM-258J. FRANK SINATRA—My Cole Porter—Night & Day
 - XM-259J. BILLIE HOLIDAY—Billie Holiday Sings The Blues
 - XM-260J. CANDYMAN—Popcorn, Sugar Sugar more.
 - XM-261J. DIONNE WARWICK—Allie, Other Great Hits!
 - XM-262J. TOMMY—Excerpts from the Rock Opera
 - XM-263J. DUELING BANJOS—From the Movie Deliverance
 - XM-264J. ROGER MILLER/Little Green Apples.
 - XM-265J. FREDDIE HART—Please Don't Tell Her
 - XM-266J. GEORGE JONES—Oh Lonesome Me
 - XM-267J. SIX DAYS ON THE ROAD—6 Trucker Stars
 - XM-268J. SUPERCHARGED ROCK 'N' ROLL ORIGINALS
 - XM-269J. CHUCK BERRY—Johnny B. Goode
 - XM-270J. IKE & TINA TURNER—Get It, Get It!
 - XM-271J. SUPERFLY—Freddie's Dead
 - XM-272J. DEAN MARTIN—I Have But One Heart
 - XM-273J. TENNESSEE ERNIE FORD—Amazing Grace
 - XM-274J. THE BEACH BOYS—Great Concert
 - XM-275J. THE ORIGINAL—Chantilly Lace, and More.
 - XM-276J. HAIR—The Tribal Love Rock Musical
 - XM-277J. LOUIS ARMSTRONG—Mame
 - XM-278J. ORIGINAL BIG BAND THEME SONGS
 - XM-279J. JESUS CHRIST SUPERSTAR—Excerpts
 - XM-280J. THE BEACH BOYS—Good Vibrations
 - XM-281J. THE GLEN CAMPBELL ALBUM
 - XM-282J. LYNN ANDERSON—It Makes You Happy
 - XM-283J. GODSPELL—Excerpts from the Rock Musical
 - XM-284J. FLICK THEMES '72'
 - XM-285J. JERRY LEE LEWIS—Rural Route #1
 - XM-286J. THE BUCK OWENS SHOW—Live In Las Vegas
 - XM-287J. JOHNNY CASH—I Walk The Line
 - XM-288J. MERLE HAGGARD & BONNIE OWENS—THAT MAKES TWO OF US

Travel with the "At Home" Comfort of All-Channel TV

FINCO "Travel Safe" R. V. All-Channel TV Antenna

- For Campers, Travel Trailers, Motor Coaches, Any R-V's
- Snaps Up to Position In Less Than 5 Seconds
- Designed for Long-Range Reception of Color or Black-and-White

Model USA-RV-1. For those who like travel and TV too! Advanced electronic design antenna uses special coax cable transmission line instead of the usual flat-line—provides clear, strong, interference-free pictures even in aluminum-clad vehicles when motors and generators are operating. The "travel-safe" position is down below the roof-line of your vehicle—stops worrying about snags. Extends a mere 3 inches from wall of vehicle too—ends clearance problems. First-quality construction and material—resists weather and road-grime for years to come. Includes all hardware for easy installation, coax cable, VHF-UHF signal splitter. Sets up in minutes with simple hand tools.

AA-481J. Shpg. wt. 4¾ lbs. 24.98

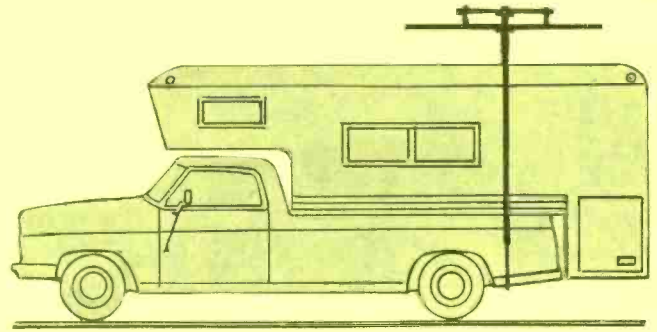

Enjoy "Picture Perfect" Color or B&W Reception—Even on the Road

SNAPS UP AND DOWN in LESS than 5 seconds

24⁹⁸



JFD®

Antennas and Accessories to Make Your Watching or Listening Better Than Ever

Rotator Lightning Arrester

Model AT-106S. "Lightning-proofs" 5-wire automatic rotator installations—when lightning strikes rotator or antenna it will dissipate before being transmitted to your TV set and causing possible damage. No wire cutting or stripping necessary—simply place wire in slot and tighten cover over it for positive, sure electrical contact. Complete with strap for mounting on pipe or mast, all necessary hardware.

AA-725J. Shpg. wt. ½ lb. 3.98

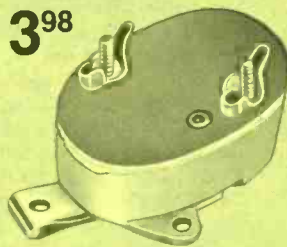

3⁹⁸



24⁹⁸

Automobile VHF Television Antenna

Model ATV-111. Omni-directional vee-dipole antenna. 6-position picture switch, shielded coax cable, spring tension clamp for secure mounting. For VHF channels 2-13, great for FM too. 10-ft. cable included.

AA-726J. Shpg. wt. 4 lbs. 24.98

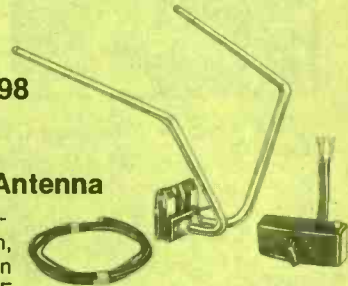

Two-Set Cable TV Coupler

Model SC42-730. Splits a single 75-ohm coax cable output into two 300-ohm twin lead outputs—enables you to hook up more than one TV in MATV and CATV installation. Eliminates need for indoor antennas — does not deteriorate signals from one TV to another. Helps you get outstanding reception on all channels, color or black-and-white. No need to pay for additional cable connections! Insta-mount adhesive backing lets you set it up anywhere—simply press-on, hold firmly for a few seconds—and its mounted!

AA-727J. Shpg. wt. 1 lb. 6.98



6⁹⁸

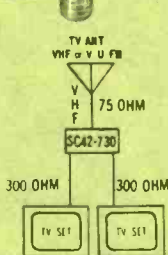

AM-FM Antennas

1 **Model 6773.** Ford, Mercury Top Mount. For '71-'73 models. Stainless steel, extends 30". 72" cable.

AA-728J. 1 lb. 4.98

2 **Model 6509.** Universal mount antenna with built-in booster coil, 54" cable.

AA-729J. 1 lb. 6.98

3 **Model VA-71.** Quick-change replacement mast with stainless steel rod. Universal mount. 26½".

AA-730J. 1 lb. 1.98

4 **Model 6254.** Deluxe wide-base top cowl mount extends 21-5/8". With 54" cable.

AA-731J. 1 lb. 3.98

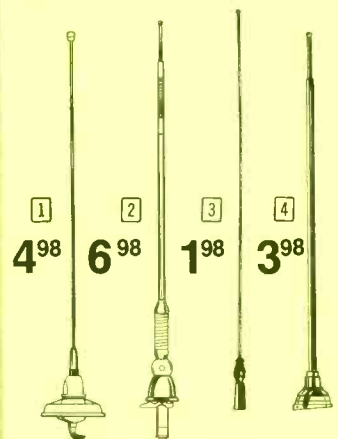

4⁹⁸

6⁹⁸

1⁹⁸

3⁹⁸

Security Accessories

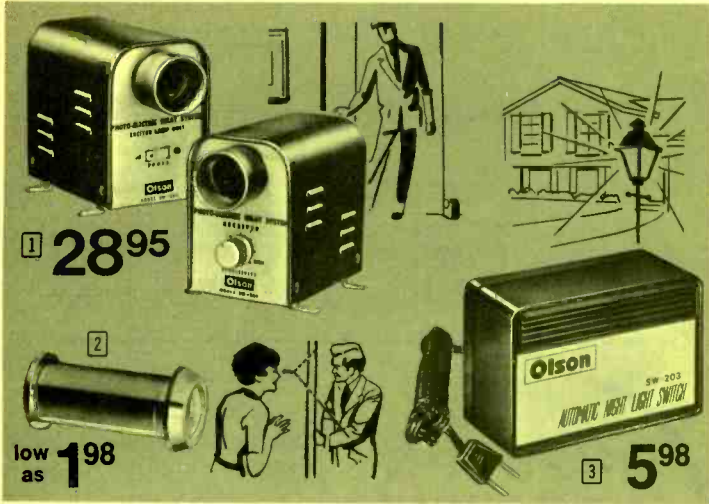

1 Photoelectric Eye. Any object breaking the invisible beam of light triggers a continuous alarm (up to 300 watts). Also can be set for shut-off and automatic reset. Just set units up to 49' apart and aim toward each other. 3 x 4½ x 6". 117 VAC.

SW-364J. Shpg. wt. 6 lbs. **28.95**

2 Door Scope. One way viewing only for thru-the-door identification. Wide-angle. Mounts in ½" dia. hole. Weatherproof.

XX-129J. Wt. 8 oz. 1-1¾" thick, 160° view angle, chrome. **Each 2.09**

XM-123J. Wt. 8 oz. 1½-2¼" thick, 180° view angle, brass. **Each 3.49**

XM-124J. Wt. 8 oz. 1½-2¼" thick, 160° view angle, brass. **Each 1.98**

3 Indoor Photoelectric Light Switch. Turns lights on at dusk, off at dawn. Place unit near window so it can "see" outdoor light level. For lamp(s) up to 600 watts. For 117 VAC. 3½ x 2½ x 1¾".

SW-203J. Shpg. wt. 2½ lbs. **5.98**



Olson "Ultrasonic" Security System

49.98 • **Intruders Can't Avoid It—Or Detect It**
• **Set It to Guard An Entire Room or Entranceway**

Generates ultrasonic waves that, when altered by a human size object, sound the loud built-in alarm. Continuous alarm or automatic shut-off and reset. Has sensitivity control, socket for remote 117-VAC (up to 1 amp) bell, buzzer or lamp. 10 x 2¼ x 4". 117 VAC.

SW-548J. Shpg. wt. 3 lbs. **49.98**



Light-Operated Siren Alarm

- Any Movement Sets Off Loud Built-In Siren
- "Flicker Filter" Prevents False Alarm
- 60/20 Second Delay Lets You Leave or Enter

89.98

Great for home and office. Has 2-digit "electronic lock" so only you can control it. Battery indicator, jacks for remote alarm, external 6 VDC power source, manual trigger. Req. 4 "D" cells. 10 x 3¼ x 8½". **SW-575J.** Shpg. wt. 4 lbs. See Accessories Pg. 160 **89.98**

156 Olson

"Multi-Purpose"



\$300

Olson TV/Intercom Security System

Use Your Credit Card

- See & Talk to Visitors from a Remote Location
- Includes TV Camera, Lens, Monitor, 2-Way Intercom

A complete transistorized audio/video security system ideal for home or business use. Place the camera and intercom substation at the entrance and the TV monitor/master intercom at any convenient location—see and talk to persons up to 95 feet away. When the "Call" button is pushed, either at the substation or the monitor, the camera's picture appears on the monitor, instantly and automatically, and 2-way conversations can be held. Monitor has "Stand-By" switch for 30-second operation followed by automatic shut-off and a "High" position for continuous monitoring. System may be connected so that a doorbell automatically activates it or when the door is opened an alarm sounds through the master intercom. Camera has fully automatic light control, standard 16mm F/1.6 lens, 250-line horizontal resolution. With 30' cable. Camera, 2¼ x 3½ x 5¾". Monitor, 9¼ x 4½ x 7½". For 117 VAC.

TV-300J. Shpg. wt. 20 lbs. **System 300.00**

TV-202J. 65-ft. Extension Cable. Camera-to-monitor. 3 lbs. **30.00**



Security "Shock Rod"

9.25 • Gives Hi-Voltage Electrical Shock

NOT harmful but gives strong shock on contact. Voltage-booster circuit. Wrist strap, 3 "C" cells. Extra batteries below.

SR-005J. Wt. 3 lbs. **9.25**

BA-190J. Batt. 2 for 30¢. **Each 16¢**

Headlight Delay Control

3.99 • Walk in Safety to Your Door at Night

Keeps car headlights ON, then turns them OFF automatically. Switchable delay of ½, 1, 1½, and 2 min. Installs in minutes. 4¾ x 1⅞ x 2¼". 12 VDC.

AU-311J. Shpg. wt. 2 lbs. **3.99**

Closed Circuit TV Equipment and Systems



89⁹⁸

A TV Camera with NO Complicated Adjustments and that Connects to Any Receiver with Just a Screwdriver . . .

209⁹⁸ lens extra



1 Olson Closed-Circuit Automatic TV Camera

- Automatic Light Compensator • Solid-State Circuitry
- Hooks Up to TV Antenna Terminals—One Simple Connection

The latest in security systems for stores, offices, schools, warehouses, homes—anywhere. Works with any TV set without interfering with regular use. The compact camera operates with available light thanks to the built-in "Automatic Light Compensator." Easy hook-up. Horizontal resolution of 500 lines. Output level of 1.5 volts, peak-to-peak video. 20 ft. cable for hook-up to TV set for surveillance of remote locations. Accessories are also available, including a 2-way intercom for voice communications between camera location and monitor. Requires one of the four lenses at right. 3 3/8 x 5 3/8 x 9 1/2". 117 VAC. **TV-132J.** Shpg. wt. 7 lbs. **209.98**

2 Sanyo 12" Diagonal Black & White TV

- Use As A Closed-Circuit Monitor or Regular TV
- 75-Square Inch Viewing Area

Model 21V65. New circuit insures bright, clear picture. Separate UHF/VHF tuners, Built-in VHF, loop UHF antennas. 4" front mounted speaker, earphone. 12 1/4 x 11 x 11 3/4". 117 VAC. **TV-288J.** Shpg. wt. 24 lbs. **89.98**

3 Automatic 360° Scanner

79⁹⁵ Automatically sweeps back and forth. Adjustable scanning degree. 1/4-20 screw mount. **TV-184J.** Shpg. wt. 13 lbs. **79.95**

Scanner With TV-132 Camera and Standard Lens. Save \$23.82 off total individual prices. **AS-307J.** Shpg. wt. 22 lbs. . . . **322.00**

4 Adjustable Tripod Mount

19⁹⁸ Pans and tilts and is adjustable to 54" high. Legs fold for carrying/storage. **TV-189J.** Shpg. wt. 5 lbs. **19.98**

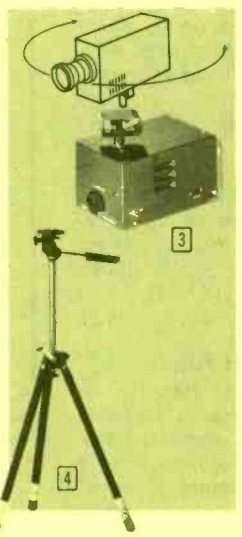

Olson TV Camera Accessories

- | | |
|---|---|
| Standard Lens. 25mm F1.4 to F-22. For normal usage. TV-117J. Shpg. wt. 2 lbs. . . 55.89 | Replacement Vidicon Tube. For any camera using Type 7735A Vidicon pick-up tube. TV-129J. Shpg. wt. 1 lb. . . 39.97 |
| Telephoto Lens. 50mm. F1.4 to F-22. For distant areas. TV-116J. Shpg. wt. 2 lbs. . . 79.98 | RG59U. Coax Cable. For camera to TV set. 55 feet long. WW-414J. Shpg. wt. 2 lbs. . . 3.49 |
| Telephoto Lens. 75mm. TV-123J. Shpg. wt. 2 lbs. 119.98 | Universal Camera Wall Mount. TV-125J. Shpg. wt. 5 lbs. . . 24.95 |
| Wide-Angle Lens. 12mm. F1.4 to F-22. Covers larger area. TV-115J. Shpg. wt. 2 lbs. 118.59 | Coaxial Video Selector Switch. CB-204J. Shpg. wt. 8 oz. . . 7.95 |

Save 40⁸³ Off Total Individual Prices

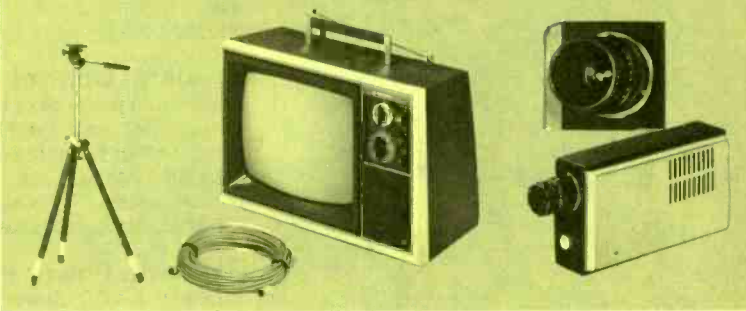

\$335 Camera/Monitor/Tripod System

Closed circuit TV security system ready to plug in and watch. For business, schools, warehouses, home. Use it to watch over any entranceway, exit, driveway, yard, lobby, etc. The VHF-UHF monitor can be used for regular TV programming too. Includes Olson TV-132 Camera, 25mm Standard Lens, Adjustable Tripod, TV-288 Sanyo 12" Monitor, 20' Coax Cable. **AS-726J.** Shpg. wt. 32 lbs. . . . **4-Pc. System 335.00**

Security You Need at Prices You Can Afford



Protect Your Home, Family or Business with

Universal Security Instruments

The home burglar/fire alarms provide that "extra measure" of protection that helps keep your home and property safe 'n secure.



6-Way Burglar Alarm

- Protects 6 Doors or Windows
- Weatherproof Outdoor Bell

Great protection! Bell is actuated by 6 switches you place at doors or windows. Burglar can't deactivate alarm. With key-lock switch, 150' wire, manual "panic" switch. Requires battery below.

XX-221J. Shpg. wt. 15 lbs. 59.98
BA-169J. 12 V Battery. 1 lb. 2.79

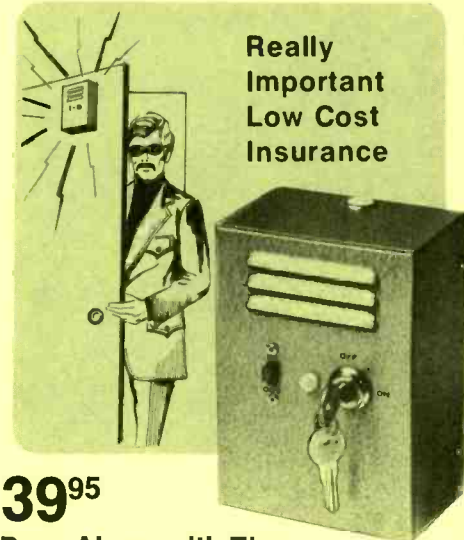

Really Important Low Cost Insurance

39⁹⁵

Door Alarm with Timer

- Easy 5-Minute Installation
- Battery-Powered—Set Up Anywhere

For houses, mobile homes, apartments, campers. Mounts on inside of door, no large holes to drill. Alarm rings when door starts to open. Key controlled on-off switch, "delay" timer for entry without sounding alarm. 4½ x 6¾ x 3¾". With battery.

XX-223J. Shpg. wt. 5 lbs. 39.95

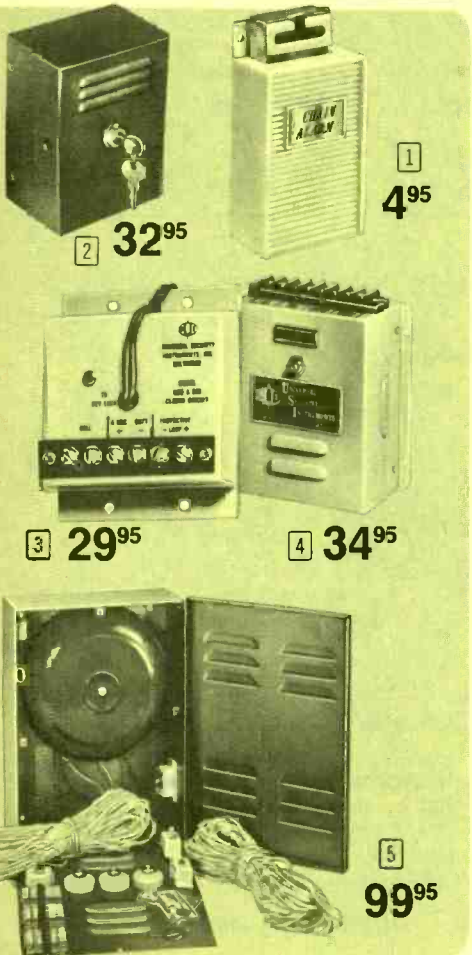

1 Door Alarm with Chain

Buzzer alarm mounts on door, chain bracket on frame—sounds instantly when door is opened. Screwdriver installation. On-off switch. 2¾ x 4½ x 1¾". Uses 2 "AA" cells. XX-226J. Shpg. wt. 18 lbs. 4.95

2 3-Point Fire Alarm

For home, office, industry. Battery-powered, key-controlled on-off, built-in dual horns, 3 fire sensors for hazard areas. With 100' hookup wire. Uses 1 Eveready 510. 4½ x 6½ x 3".

XX-222J. Shpg. wt. 5 lbs. 32.95

3 Alarm Control Center

Wall-mount metal case takes sensors for fire or burglary, can be hooked up to 6-volt alarm bell or buzzer. Screw terminals. 4½ x 6¾ x 3¾". Make it the "heart" of your protection system. 117 VAC.

XX-228J. Shpg. wt. 3 lbs. 29.95

4 Alarm Power Pack

Supplies 6-VDC power to bell-ringing circuit, or 1½-VDC to protective circuit (if required). Automatically transfers to battery power during AC power failure. Ventilated metal case, 4¾ x 5¾ x 2½". 117 VAC.

XX-227J. Shpg. wt. 3 lbs. 34.95

5 8-Point Residential Alarm

Finest burglar/fire protection. Has 10" diameter bell, weatherproof housing. Includes 4 magnetic contacts, 4 fire sensors, panic switch, on-off switch, 200' hookup wire, 2 keys, all hardware. Less batteries.

XX-229J. Shpg. wt. 18 lbs. 99.95

ACCESSORIES

For your home alarm system.

Description	Wt. Lbs.	Stock No.	EACH
117-VAC Buzzer	¼	SW-416J	2.98
3" Dia. 117 VAC Bell	¼	SW-415J	4.29
8" Dia. 6-12 VDC Bell	5	XX-230J	14.95
6-12 VDC Indoor Horns	2	XX-231J	9.95
117 VAC heavy-duty Siren	3½	XX-135J	19.98
Window Foil, 250' x ¾" self-sticking type	1½	XX-239J	3.95
Self-sticking window-foil connectors. Pkg. of 6	¾	XX-238J	3.95
Door cord, carries current from frame to door	1	XX-247J	1.95
4-wire Door Cord	½	XM-054J	2.95
Door/Window Magnetic Switches, SPST-NC, pkg. of 2	¼	XX-241J	4.95
Spring-loaded Trap Switch for window or door. Closed ckt.	¼	XX-248J	1.95
Tamper Switch, protects alarms from vandals	¼	XX-242J	1.95
Pushbutton Door/Window Switch NO	¼	XX-243J	1.95
Panic Test Switch. Closed ckt.	¼	XX-245J	1.50
Closed-circuit Leaf Switch. For sliding windows, doors.	¼	XX-244J	2.25
140° Fire Sensor, pkg. of 2	½	SW-521J	1.89
135° Fire Sensor, pkg. of 2 open circuit	½	XX-232J	5.95
135° Fire Sensor, closed circuit, pkg. of 2	½	XX-233J	5.95
190° Fire Sensor, open circuit, pkg. of 2	½	XX-234J	5.95
190° Fire Sensor, closed circuit, pkg. of 2	½	XX-235J	5.95
Shunt Key Lock w/Keys	½	XX-240J	6.95
100' Alarm System Wire	½	XX-236J	4.95
Wire Nails, pkg. of 50	¼	XX-237J	.95
Self-stick Window Decals pkg. of 6	¼	XX-249J	1.49

Drive and Park in Safety and Security

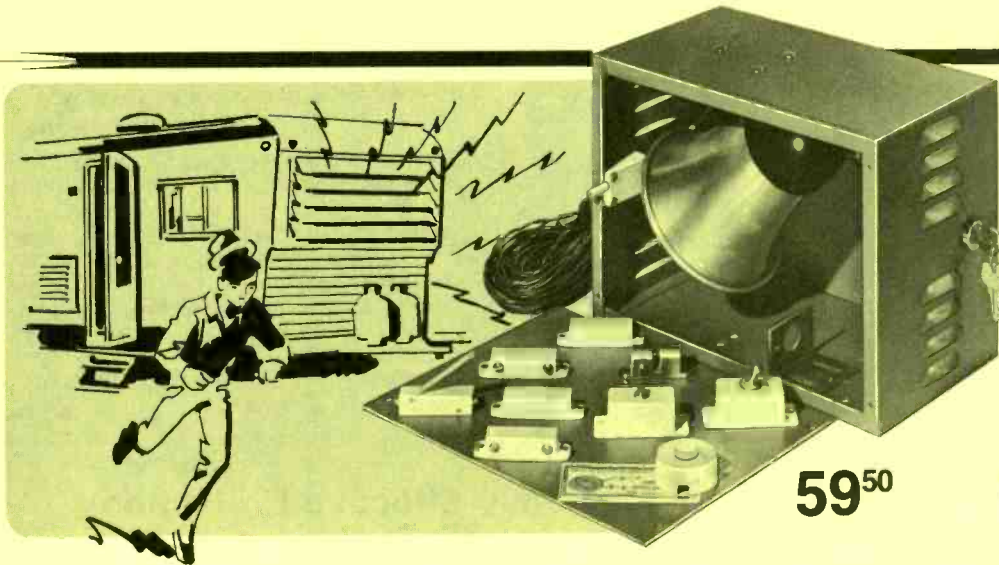

59⁵⁰

Auto Alarms from Universal Security Instruments



Why worry about car theft? These low-cost alarms provide plenty of protection by drawing attention to your car and anyone tampering with it.



"Total Protection" Mobile Alarm System

Enjoy your summer outings in safety! This top-reliability alarm system is perfect for campers, trailers, mobile homes, any RV's. Has electronic siren with modern "whoop-whoop" police-type sound. Sounds when any switch is activated or wires cut. Includes 2 magnetic contacts, sliding window leaf contact, window trap switch, fire alarm

thermostat, panic switch, inside toggle switch for setting inside and outside alarms, key to activate system when you leave. Also has 50' hookup wire, all nails, mounting hardware, decals. Weatherproof cabinet. Takes additional contact and fire switches.

XM-154J. Shpg. wt. 15 lbs. 59.50
BA-169J. Battery. Use 1 2.79

"Loud-Mouth" Electronic Siren

34⁹⁵



Produces a repetitive "whoop-whoop" sound like the newest police sirens. Weatherproof AND waterproof, great for outside hookup on cars, boats, RV's. Solid-state. With all hardware. For 12 VDC systems.

XX-224J. Shpg. wt. 5 lbs. 34.95

NOTE: These sirens prohibited in California and some other states. Check your locality.

Effective Car Siren Alarms Scare Away Would-Be Thieves

Car Alarm with Sensor

- Installs in Minutes
- Blasting Siren-Type Alarm

Complete alarm system installs easily with NO wiring required to doors or trunk. Special sensing circuit activates alarm if any intrusion is made through door, hood, trunk, windows, etc. Sealed 9500-rpm motor gives loud siren-type blast. Hooks up easily to any 12 VDC vehicle—no extensive rewiring needed. With all parts, including key-lock so only YOU can arm the alarm, mounting hardware, sensing switches, wire, etc.

XX-220J. Shpg. wt. 6 lbs. 34.95

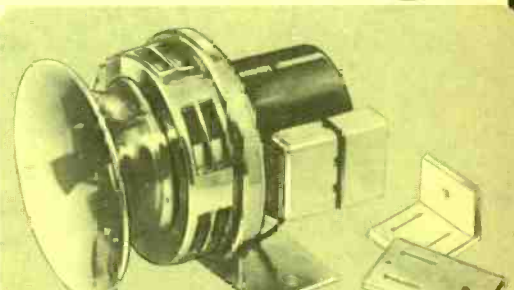

34⁹⁵

Low-Cost Car Siren Alarm

- Can Be Heard for Blocks
- Do-It-Yourself Hookup

Budget-priced system provides good protection for any 12-volt vehicles. Has heavy-duty police type siren with rugged metal finish, contacts and switches to protect doors, hood, trunk, windows, etc. Includes all parts, full instructions, key-locking on-off switch, hookup wire—all you need for fast and easy installation.

XX-250J. Shpg. wt. 6 lbs. 21.98

Horn-Type Alarm. As above, but circuit activates horn. No siren. (Legal in all states).

XX-251J. Shpg. wt. 2 lbs. 7.99

NOTE: These sirens prohibited in California and some other states. Check your locality.



21⁹⁸

ACCESSORIES — auto alarm system.

Description	Wt. Lbs.	Stock No.	EACH
12-VDC police-type Siren	3½	XX-147J	19.98
Door Pin Switch	¼	XM-055J	1.10
Long Hood, Trunk Switch	¼	XM-056J	1.25
Trunk, Hood Pin Switch	¼	XM-057J	1.10
Round Key Switch Jack w/Keys	½	SW-585J	6.98
Vibration Contact Switch, adjustable, closed circuit	¼	XX-246J	7.95
Key Lock Cover Reflector	¼	XM-017J	2.49
Wheel Locks—specify car make, model and year. Pkg. of 4.	3	XM-103J	5.95
2-Min. Headlight Delay	2	XX-225J	8.95
Electronic Hood, Trunk Lock	¼	AU-267J	8.98
Trunk or Hood Light	¼	AU-268J	2.49
Auto Alarm 2-Minute Timer	½	AU-269J	8.98
Vehicle Shaker Switch (prevents jacking, towing, etc.)	¼	SW-583J	8.98

Security Devices You Simply Plug In



Protective Devices That Keep Your Property Safe 'n Secure Wireless "At-Home" Simulator

Teledyne-Challenger. Keeps intruders away by simulating persons in the house. Turns on lights, appliances at random intervals throughout the house. Features one Master unit, two slave units—all of which can be setup anywhere. No adjustments or installation—simply plug units into AC outlets, lamps or appliances into units. Features complete compatibility with other Teledyne Challenger units on this page. Solid-state. XM-220J. Shpg. wt. 3 lbs. **59.98**

Compatible Alarm Units — Use 'Em All for Really Effective Protection

MASTER ALARM

1 89.98



AC ADAPTOR

2 24.98

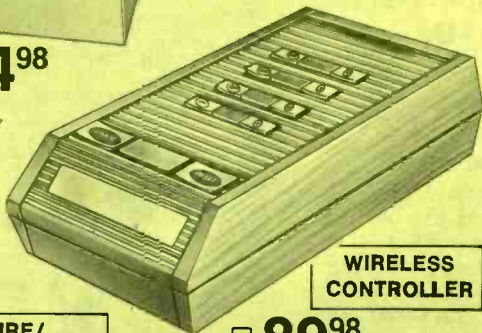
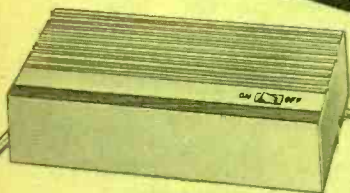

WIRELESS CONTROLLER

3 89.98

FIRE/ SMOKE DETECTOR

4 39.98



PANIC BUTTON

5 9.98



REMOTE ALARM

6 29.98



ABSOLUTELY NO INSTALLATION REQUIRED!

These Teledyne-Challenger Units Plug Into AC Outlets to Give You Professional-Quality Protection with ALL Essential Features. Protect One Room or Your Entire House.

1 Light-Operated "Master" Siren Alarm

Model SD-001. Put this battery-powered unit anywhere in the area you want protected and no intruder can escape without triggering the loud, built-in siren. Has "Flicker-Filter" to prevent false alarms, automatic 60-second delay so you can exit room once alarm is set, 20-second delay for returning. 2-digit electronic lock—only YOU can turn it on or off. Has jacks for remote-alarm and external 6 VDC power source, panic button for manual triggering. Uses 4 "D" cells. 10 x 3 3/4 x 8 1/2" Use with AC adaptor (Model SD-008) for full compatibility with all units on this page.

SW-575J. Shpg. wt. 4 lbs. **89.98**

2 AC Adaptor for All Alarm Units

Model SD-008. Plugs into AC outlet, acts as transmitter and receiver to provide "interface" between Master Alarm (Model SD-001) and other alarm and light devices.

XM-223J. Shpg. wt. 2 lbs. **24.98**

3 Wireless Alarm/Remote-Control System

Model SD-011. Five-channel remote-control device which turns lights and appliances on or off throughout your home through 4 single-channel slave units (included). Has a fifth channel for use as panic button. When used with alarm devices, any initiation of alarm turns on all lights and sounds all alarms. Complete outfit includes controller, four remote-slave units.

XM-225J. Shpg. wt. 4 lbs. **89.98**

4 Fire and Smoke Detector

Model SD-010. Features special electronic detector that sounds alarm when temperature goes above 135° F, or when smoke concentrations are detected. Has LED pulsating pilot light, "push-to-test" button. Use in conjunction with other systems on this page.

XM-224J. Shpg. wt. 2 lbs. 2 for 70.00 **Each 39.98**

5 Palm-Sized Portable "Panic Button"

Manually activates alarm system when used in association with Wireless Alarm Controller (XM-225J above). Plugs into AC outlet and uses AC power lines for transmission.

XM-222J. Shpg. wt. 1 lb. **9.98**

6 Remote Alarm System

Model SD-005. Operates as a slave unit to any of the alarm actuating devices above. Use as many as needed for all points in your home. Has built-in electronic siren, electronic combination lock, "push-to-test" button.

XM-221J. Shpg. wt. 2 lbs. **29.98**

Save 18%
160.00
Separate Items
Reg. \$154.90

Complete System. Consists of one each SW-575, XM-221, XM-222, XM-223, XM-224 above. **AS-811J.** Wt. 11 lbs. **160.00**

TELEDYNE House-Wide Burglar Alarm System



WIRELESS — REQUIRES NO HOUSE WIRING!

Provides REAL Security at
up to 8 Points Throughout Your Home

- With Extra-Loud 10" Diameter Alarm Bell
- 8 Wireless FM Transmitters—7 for Doors and Windows, One for Use as Panic Switch
- AC Operated FM Receiver with Battery-Power Standby for Emergency Use If AC Power Fails

Here's a complete protection system that provides effective alarm warning in case of any unwarranted intrusion through the doors and windows of your home. Simply locate the FM receiver unit at a central position in your home, mount the FM wireless transmitters at any points up to 125 feet away from it. If any intrusion is made through a protected door or window, a loud alarm sounds, scaring off the would-be intruder and calling attention to your home so neighbors can call police. Includes panic button transmitter so you can activate alarm manually. Battery-operated wireless FM transmitters operate just like radios—no need to plug into AC outlets—ideal for remote locations where outlets may not be available. Alarm has 10-second delay so you can arm it and leave the protected area without setting it off. A 12-volt mercury battery power supply is included, so you'll still be protected even if AC power fails—receiver unit switches automatically to battery power! Key-lock arming system—only you can turn it on or off. Receiver, 10½ x 4 x 6½", each transmitter, 2¼ x 4¾ x 1"

SW-635J. Shpg. wt. 15 lbs. 249.98
BA-253J. Battery for transmitter (2 req'd). 4 oz. Ea. 2.70

249⁹⁸



FCC Approved FM Transmitters with
Effective Range to 125 Ft!

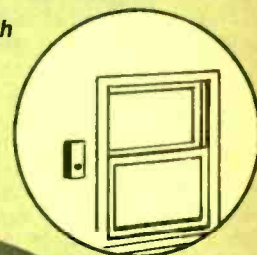

10" Diameter Alarm Bell

See Other Alarm Systems and
Security Devices on pages 156, 157, 160, 162

Ranger VI
100-mW
1-Channel

20²⁵ Pair

Dependable 6-transistor single-channel models have super-regen receivers, 40" telescoping antennas, built-in speakers and volume control, crystals for CB channel 15. 5½ x 2½ x 1¾". Uses 9-volt battery (not included).

CB-363J. Wt. 2 lbs. Pair 20.25
CB-364J. Above, superhet. Pr. 35.95



Voyager
100-mW
3-Channel

41⁷⁵ Pair

Model T-091-2. 3-channel models with AGC, "Call-Tone" for signalling without voice transmission, telescoping antenna with loading coil. "Camera styled" units are compact, go-anywhere in pocket or purse. 6½ x 1¾ x 3". With crystals for Ch. 15. Req. 9V batt. CB-188J. Wt. 2 lbs. Pair 41.75

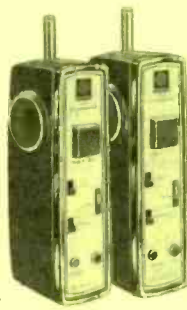

Tempest
5-Watt
6-Channel

109⁵⁰ Each

Model T-909. Has FET/IC circuit, AGC, ANL, squelch, delta-tune to peak receiver, detachable battery pack, battery saver with test button, RF amplifier with ceramic filter. Includes crystals for CB channel 15, ear-phone, strap. Requires 10 "AA" or 12 NiCad cells. 2 x 10¼ x 10½". CB-229J. Shpg. wt. 4 lbs. Each 109.50



Triumph
5-Watt
23-Channel

174⁷⁵ Each

Model T-1000. Fanon's finest! For commercial or professional uses. Dual-conversion receiver, detachable battery pack, other features same as "Tempest" at left. With all crystals. Less batteries. 2 x 10¼ x 3½". 3½ lbs. CB-187J. Ea 174.75





Famous Delta C-D Type Ignition Systems

MARK 10
The
Industry
Standard

29⁹⁵
Kit

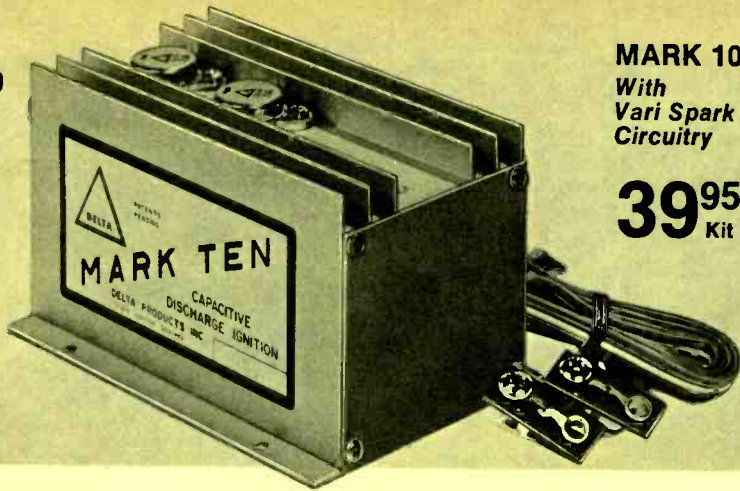

MARK 10 "B"
With
Vari Spark
Circuitry

39⁹⁵
Kit



For Greater Car, Boat or Truck Efficiency

- Up To 20% Increase In Gasoline Mileage
- Spark Plugs Last 3 to 10 Times Longer

The true electronic solution to one of the major problems of engine operation! The use of SCR (Silicon Controlled Rectifier) Switching provides dramatic new levels of engine performance and economy. Designed for cars prior to 1971 and those limited production models that do not have emission controls. It does not have the quick change-over switch of the deluxe model at right, but is readily switched with the thumb nuts included. Increases spark plug life 3 to 10 times, and gas mileage 10 to 20 per cent, while decreasing ignition maintenance from 60 to 80 per cent PLUS less frequent tune-ups. Each unit is tested at motor speeds of more than 10,000 rpm to insure accurate ignition control and proper operation. The unit is not affected by extremes of temperature, altitude, or humidity. Installs easily in car, boat, or truck in minutes. 3 x 5½ x 3½". For 12 VDC neg. grd.

AU-398J. Kit. Shpg. wt. 3 lbs. 29.95
AU-137J. Assembled. Shpg. wt. 3 lbs. 39.95

The Dynamic New Improvement in Ignition Systems

- Reduces Combustion Contaminants—Less Pollution
- Restores Power Lost By Use of Smog Control Devices

By combining the new Vari Spark circuitry with the popular Mark Ten system, Delta introduces a really improved solid state ignition system. Designed for 1971 and later automobiles with emission controls. Vari Spark circuitry provides better gas mileage, smoother idling and a dramatic increase in overall performance. It also incorporates a quick changeover switch for fast return to regular ignition if desired, and instant performance comparisons. Install the Mark 10 "B" in minutes without rewiring your present coil. Provides instant starts in all weather, less frequent tune-ups. Two piece housing with neoprene seals provides dust and moisture protection. Use with any 12 volt negative ground engine. 3 x 5½ x 3½".

AU-400J. Kit. Shpg. wt. 3 lbs. 39.95
AU-399J. Assembled. Shpg. wt. 3 lbs. 54.95

Use Either One of These Kits for REAL Performance "Pick-Up"!



DeltAlert Ultrasonic Detection Systems

DeltaHorn
29⁹⁵



DeltAlert
69⁹⁵

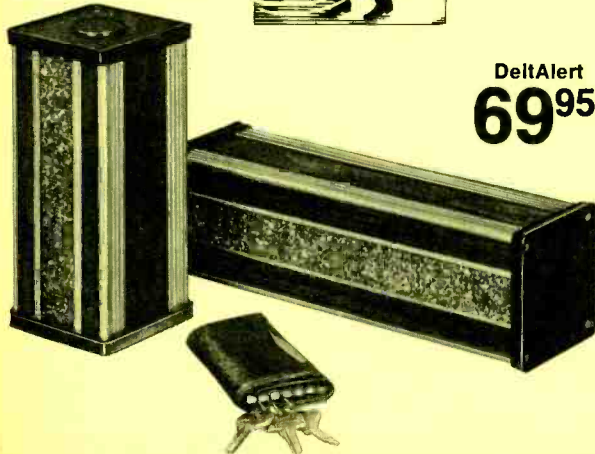

Completely Factory Assembled for Easy Installation

The DeltAlert monitors and blankets up to 300 square feet of space in your home, business etc., utilizing the sonar principle to pick up any motion within range. It sends out continuous high frequency ultrasonic sound waves—When these waves are distributed by any movement, the alert unit is activated.

DeltAlert. Use with lights, prevents dangerous falls in the dark, one of the major home accidents. Effectively monitors entrances, hallways and other critical areas. Anything entering sound wave area (200-300 sq. ft.) trips the Alert. Has "delay switch," adjustable timing control of up to 3 minutes with automatic re-set following. It will repeat cycle indefinitely while sound wave disturbance continues. "Persistence Control" to prevent false alarms. Walnut finish. 10¾ x 3¾ x 3¾". 2 plugs for external alarm up to 5 amps. 117 VAC.

SW-502J. Shpg. wt. 3 lbs. 69.95

DeltaHorn. Accessory device for DeltAlert above. Built-in horn "sounds off" when the ultrasonic sound waves put out by the DeltAlert are disturbed. Electronic delay lets you leave or enter without setting off the alarm. 7 x 3¾ x 3¾". For 117 VAC.

SW-649J. Shpg. wt. 2 lbs. 29.95

Update Your Car Stereo!

comm

BIG BRUTE® Series

These heavy-duty car stereo speakers are built to "take it"—the punishing power of heavy rock, the smooth and majestic passages of your favorite classical music—anything you choose. Pick the pair that's right for you and turn your car into a stereo "Concert Hall".

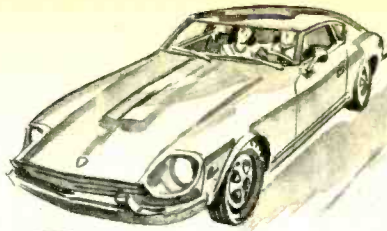

21⁹⁸
Pair

Heavy-Duty 6 x 9" Speaker with 30-Oz. Ceramic Magnets

Model A-6X930. Really deluxe car stereo speakers designed for mounting in rear deck of most cars. Provide true high-fidelity tone quality when used in conjunction with a good car stereo radio or tape player—buy one for outstanding monophonic reproduction too. Features cloth-roll cone suspension for long life, air-suspension design for wide-range realistic reproduction, 2" whizzer cone for mid and high frequencies with excellent realism and dispersion. 8 ohms impedance.

SP-057J. 4 lbs. Each 21.98 Pair 40.00

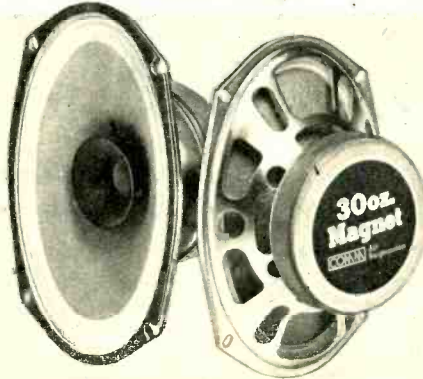

\$40
Pair

Mount-Anywhere Car Stereo Speakers with Tachometer-Type Design

Model 708. Fine-sounding speakers mount anywhere in your car, truck or boat, feature sleek tachometer styling for a streamlined look. Each speaker has 8-oz. ceramic magnet, 4" diameter housing with non-glare black matte finish. With all hardware. 8 ohms impedance.

SP-056J. Shpg. wt. 5 lbs. Pair 21.98



Padded Grille for 6 x 9" Car Speakers

\$ 8 Pair

Acoustic-padded, non-breakable grille features non-glare black finish that neatly enhances rear deck or in-door speaker installations. For flush-mount speakers.

CA-590J. 1 lb. Each 4.49 Pair 8.00

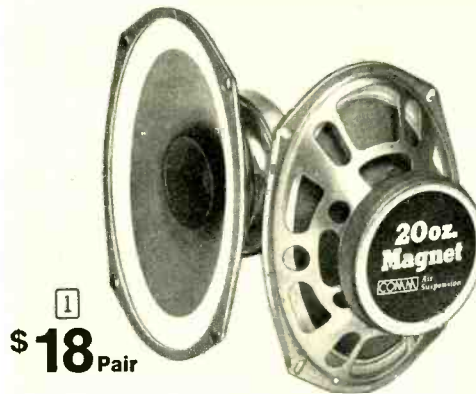

1
\$18 Pair



2
\$40 Pair

1 6 x 9" Two-Way Speakers

Model P6X920. Designed for flush-mount installation and really great sound in car, truck, boat — even has enough "room-filling" power for R-V's! Big 20-oz. ceramic magnet. Air-suspension design for wide-range response, cloth-roll cone prevents speaker "breakup" with high-power amplifiers. Whizzer cone midrange/tweeter provides sparkling highs. 8 ohms.

SP-054J. 3 lbs. Each 9.98 Pair 18.00

2 Heavy-Duty 8" Speakers

Model 820. Has all you need for a handsome, custom flush-mount installation in just about any vehicle. Speakers feature air-suspension cone and 20-oz. ceramic magnet for wide-ranging high-fidelity sound. Acoustically padded snap-on grilles (included) are designed for fast 'n easy mounting. Especially recommended for in-door flush-mount installations. 8 ohms impedance.

SP-055J. 3 lbs. Each 21.98 Pair 40.00

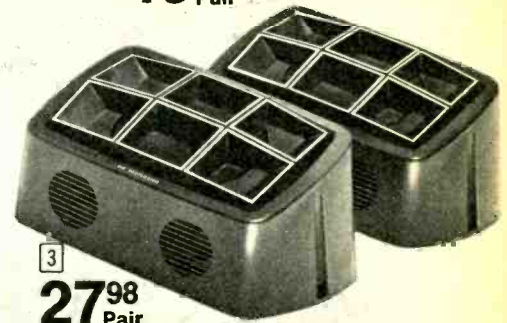

3
27⁹⁸
Pair

3 5" Surface-Mount Speakers

Model 920. Feature specially engineered sounding boards that fill your vehicle with rich, full response. Ideal for use with just about any stereo player—buy four for really great 4-channel sound. Each speaker has cloth-roll suspension cone, big 20-oz. ceramic magnet. 8 ohms impedance. Mount 'em anywhere for great car stereo.

SP-053J. Shpg. wt. 6 lbs. Pair 27.98

4 5 1/4" Flush-Mount Speakers

Model 420. Popular-size speakers are ideal for custom-mounting in sportscars, smaller foreign cars, anywhere space is tight. Air-suspension 2-way design, 20-oz. ceramic magnet, Whizzer cone for extra-wide response. Acoustically-cushioned chrome grilles make a neat, modern-looking installation. Pre-wired, ready to install. 8 ohms.

SP-052J. Shpg. wt. 4 lbs. Pair 27.98



4
27⁹⁸
Pair

See Pages 140-150 for our Wide Selection of Car Stereo Tape Players and Radios

Herald/Eminence Music Instrument Super-Speakers



The Eminence Story

Each Eminence speaker is made to the toughest specifications for professionals who can't risk burn-out. In verified demonstrations, the speaker voice coil has produced enough heat to char the cone — with NO damage to the speaker or deterioration of performance.

For High-Level Sound Over Sustained Periods of Time, These Speakers Simply Can't Be Matched In Value or Ruggedness!

1 40 Watts RMS 10"

Expensive design! Has 4 lb. magnet assembly, 10 oz. dual diameter Alnico V magnet (equals 20 oz. ferrite). 1½" voice coil. 8 ohms. 10 lbs.

SP-124J. Pair for 36.00. Each 19.98

2 80 Watts RMS 12"

Built to take it! Has brawny 2" voice coil. 6 lb. magnet assembly, 20 oz. dual diameter Alnico V magnet. 8 ohms. 12 lbs.

SP-121J. Pair for 52.00. Each 27.98

SP-125J. 12", 7 lb. mag. assembly, 2" coil. 38 oz. magnet. 12 lbs. Pair 60.00 Ea. 32.98

3 80 Watts RMS 15"

For pros with the really "heavy" sounds! Has 6 lb. magnet assembly, 20 oz. dual diameter Alnico V magnet (equals 32 oz. ferrite). 2" diameter voice coil. 8 ohms. 15 lbs.

SP-122J. Pair for 65.00. Each 34.98

4 The Ultimate 80-Watt RMS 15"

Super instrument speaker. Huge 13-lb. magnet assembly and 54 oz. ferrite magnet results in greater efficiency — doubles the sound output for the same power input! 8 ohms. 17 lbs.

SP-123J. Pair for 110.00. Each 59.98

Clark 4-Channel Headset and Decoder

Four Channel listening is the latest addition to the high fidelity spectrum—and with these Clark headphones you can hear it in private with all the volume you want. If you own a discrete 4-channel system, you can use the phones directly. Or use the decoder to make matrixed and derived 4-channel "come alive" from your present stereo equipment with no add-ons or extras!



- Handles Every Kind of 4-Channel Material
- Includes DC-2A Derived Ambience Decoder
- Lets You Listen to Derived 4-Channel Sound From Conventional 2-Channel Stereo Sources

\$95

Model 4CH-4 and DC-2A Decoder. The complete headphone set that provides private listening in stereo, discrete 4-channel or derived 4-channel — one of the biggest innovations since the initial presentation of stereo headphones on the market more than 15 years ago! This complete 4-channel system has been designed to utilize your present (2-channel) stereo equipment to bring you the exciting world of derived 4-channel sound. Just plug the DC-2A Decoder into your amplifier phone jack, plug the Clark/4CH-A headset into the Decoder and listen to your favorite encoded 4-channel records or FM broadcasts. For additional enjoyment the Derived Ambience Decoder provides a 4-channel effect from your regular 2-channel sources. If you presently have matrixed or discrete 4-channel equipment, just plug the headphones directly into your amplifier for complete 4-channel enjoyment. They offer greater spatial depth, 25-21,000 Hz Transducer Frequency Response. 8 ohms. With 6 conductor retractile type cord, color-coded phone plugs.

PH-314J. Shpg. wt. 1½ lbs. 95.00



Add A New Auto Music System To Your Car **idi**

- 1 8-Track Stereo Tape Player. Model S-705A.** Has automatic or manual program selection, thumbwheel controls for left/right volume, tone, power light. 5 $\frac{1}{4}$ x 2 $\frac{1}{2}$ x 7 $\frac{1}{16}$ ". For 12 VDC neg. ground. AU-402J. Shpg. wt. 4 lbs. **34.99**
- 2 8-Track Stereo/Quad Tape Player. Model S-100.** Has the same features as in the above S-705A. PLUS quad "effect"—plays 2-channel tapes with derived 4-channel sound. 5 $\frac{1}{4}$ x 1 $\frac{15}{16}$ x 7 $\frac{1}{2}$ ". AU-403J. Shpg. wt. 4 lbs. **44.99**
- 3 Complete 8-Track Home Adapter—With Speakers. Model HU-4.** Use the S-85 (below) at home. Slips out of dash and into adapter. All wire and jacks for speaker connections. Has AC power switch and pilot light, 2 full range walnut grain speakers. 117 VAC. AU-405J. Shpg. wt. 8 lbs. **54.95**
- 4 8-Track Car Stereo Player. Model S-85.** Has automatic change, thumbwheel controls for volume, tone. Sliding balance control. Easily slides out of dash bracket for theft proof protection, and converts to home player. 6 $\frac{7}{8}$ x 4 x 8 $\frac{3}{4}$ ". 12 VDC neg. ground. AU-404J. Shpg. wt. 3 lbs. **59.95**
- 5 Combination FM Car Radio/8-Track Player. Model MPT-801.** Has AFC, automatic program change, thumbwheel left/right volume/tuning controls, bass/treble control, fine tuner for 8-track. 6 $\frac{1}{2}$ x 2 $\frac{3}{4}$ x 7 $\frac{1}{16}$ ". 12 VDC neg. ground. AU-406J. Shpg. wt. 6 lbs. **99.99**
- 6 Combination AM/FM Car Stereo Radio with 8-Track Player. Model AXT-838.** Has program indicator lights, automatic program change, tuning, balance, volume, tone controls, stereo light, AFC. Has radio on-off pushbutton, AM-FM pushbutton. Mounts easily under dash, With brackets. 7 $\frac{1}{2}$ x 2 $\frac{1}{4}$ x 7". 12 VDC neg. ground. AU-407J. Shpg. wt. 7 lbs. **119.99**



Save 4⁹⁵ On AU-404/405 Home/Car Combination
 Save when you purchase car stereo player and home adapter.
 AS-812J. Shpg. wt. 7 lbs. Reg. \$114.90 **109.95**

See pages 138, 139, 163 for Speakers for Above

MetroTec SCR "Electronically Fired Spark" Ignition System

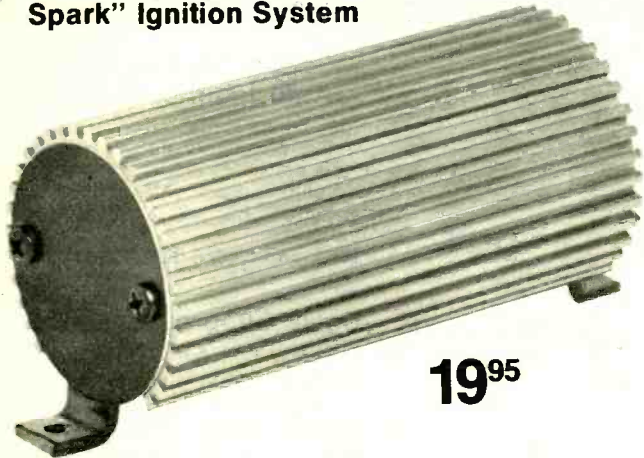

19⁹⁵

- Substantially Reduces Exhaust Emissions
- Prolongs Plug and Point Life

Add this electronic ignition system to your car and get a smoother "run for your money". Offers fast starts in any weather, dramatic performance improvement. Less pollutants too, because of the increased efficiency in your gas consumption. Provides an electronically-controlled precision fired spark with 65%-95% more power for reduced engine fouling. Gives you a longer break between tuneups! Fully assembled and wired. Easily installs to ignition coil without wire removal. Operates from -45° to +212°F. For 6 or 12 volt systems, positive or negative ground. 4 $\frac{1}{2}$ x 4 $\frac{1}{2}$ x 5 $\frac{3}{4}$ ". AU-408J. Shpg. wt. 1 lb. **19.95**

Use AC Appliances In Your Car with This 12V to 117V DC Converter



19⁹⁸

- Hooks Up and Works Directly
Off of Car Alternator

Makes a very practical added extra for your 12 VDC vehicle—lets you use a variety of AC power tools and appliances in the field. Has on-off switch, front panel DC output meter, two 3-wire AC outlets. Use the converter for your power tools, (drills, saws, etc.) or any other appliances with AC/DC motor ratings. Since power tools are series wound and equipped with brushes, they operate as well on DC as on AC. 3000 watts continuous. Not for use with induction motor AC appliances, TV's, radios, etc. AU-266J. Shpg. wt. 3 lbs. **19.98**

Quality Electronic Security and Auto Accessories

by RADATRON



31⁹⁵
Assembled

"Stay-Alert" Radar Detector

Model 1414. Keeps you alert to speed limits. Clips onto sun visor. Includes 2 mercury cells that last 600-1000 hrs. 3½" x 2¼" x 2¼". (Prohibited in some states.)

AU-303J. Shpg. wt. 1 lb. 31.95
AU-304J. Radar Detector Kit. 1 lb. . . . 23.95



29⁹⁵
Assembled

Auto Sentry Alarm Stops Theft

Model 8535. Solid-state unit installs in minutes in 6 or 12 VDC autos. Car starts only when pushbutton combination is activated. Horn alarm has automatic time delay. Current drain also triggers alarm.

AU-309J. Shpg. wt. 4 lbs. 29.95
AU-310J. Model 8534 Alarm Kit. 24.95



24⁷⁵

Dwell Tach

Model 7070. Chrome plated metal tester for 4, 6 or 8 cylinder engines—6 or 12 volt. Factory calibrated with zero adjust. Measures rpm from 0-3000 (0-4000 for 6-cylinder engines); shows cam dwell. No battery needed. Shpg. wt. 2 lbs.

AU-375J. 24.75



24⁹⁵

Universal Tachometer

- For 4, 6 or 8 Cylinder Engines—6 or 12 Volts
- 2% Full Scale

Model 1905. Fits top of dash, or on steering column. Shift pointer; zero adjust. 0-8000 rpm. 3¼" dia. x 3½". Black/chrome.

AU-305J. Shpg. wt. 4 lbs. 24.95
AU-306J. Model 1907 Tach Kit. 19.95

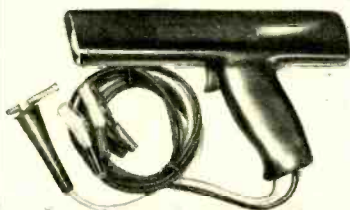

23⁹⁵

Assembled

Ultra-Sonic Alarm System

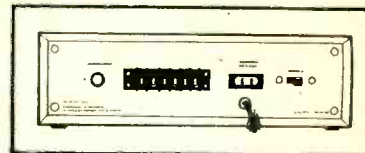
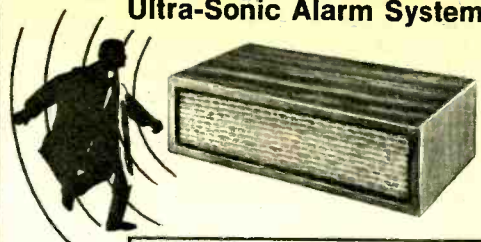

79⁹⁵ • Protects Your Home or Office from Intruders
• Plugs Into AC Outlet

Model 8502. Emits ultrasonic sound waves to blanket an area of approximately 300 sq. ft. If an intruder moves within this area, he interrupts the wave pattern and triggers the alarm. No installation—just plug into 115 VAC outlet. Sensitivity control. 10½" W x 3" H x 5½" D. Less alarm.

SW-648J. Shpg. wt. 4 lbs. 79.95

DC Powered Auto Timing Light

Model 6010. For the auto professional or hobbyist. Ultra-bright xenon flashtube in heat-resistant reflector. Heavy-duty shock-proof case; trigger switch. For 6 or 12 volt systems. Solid-state.

AU-373J. Shpg. wt. 1½ lbs. 23.95
AU-374J. Timing Light Kit. 1½ lbs. . . . 19.95

More Auto Accessories at Low, Low Olson Prices

TELEDYNE Big Beam Lights Plug into Car Cigarette Lighter Socket



19⁹⁵

Extension Spotlight

Develops a full 200,000 candlepower brilliance—throws beam up to 2 miles. Operates from auto cigarette lighter. Includes 15' cord and plug, bulb guard. For 12 VDC negative ground systems. 6¼" dia. x 9½" L.

XX-193J. Shpg. wt. 1 lb. 19.95

Rooftop Emergency Flasher

Red lens provides full 360° coverage. Suction cup mounting. Comes with 10' car cigarette lighter cord and plug. For 12 VDC systems. (Not sold in states where prohibited.)

XX-194J. Shpg. wt. 1 lb. 3.45

3⁴⁵



29⁹⁸

Capacitive-Discharge Auto Ignition System

You get faster starts in any weather with capacitive discharge. Boosts gas mileage and cuts pollution. Works electronically to extend plug and point life, improve overall performance. For all 12 VDC negative ground cars.

AU-186J. Shpg. wt. 4 lbs. 29.98

Noise Suppressor Values

① **Universal Splice-in Type.** For use on distributor or spark plugs where snap-in types will not fit.

AU-300J. Shpg. wt. 4 oz. 59¢

② **Distributor Type.** Snap-in type fits top of distributor to suppress noise.

AU-301J. Shpg. wt. 4 oz. 49¢

③ **Spark Plug Type.** Snaps on top of spark plug. One required for each plug.

AU-302J. Shpg. wt. 4 oz. 79¢

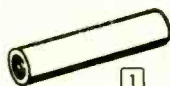

59¢

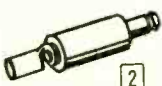

49¢



79¢

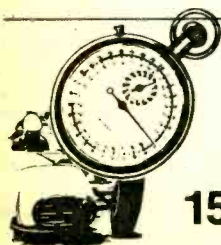

15⁹⁸

Swiss-Made Stop Watch

Jeweled for accuracy and dependability. Scale is divided in 1/10 seconds up to 30 seconds on outer dial. Inner dial registers up to 15 minutes. Side and crown pushbuttons. 1¾" dial. A practical, unique gift!

XX-531J. Shpg. wt. ½ lb. 15.98



1¹⁹

Package of 2 Lighter Plugs

Fit all standard auto cigarette lighter receptacles. 32" cord attached. The easy way to power all 12-VDC equipment from your car—perfect for extension lights, CB gear, PA equipment, etc. Only about 60¢ each for two!

XX-995J. Shpg. wt. ¼ lb. 1.19

Fused Lighter Plug. 5' cord.

XX-122J. Shpg. wt. ¼ lb. Each 1.10

Olson & SPRAGUE Capacitors for Every Use

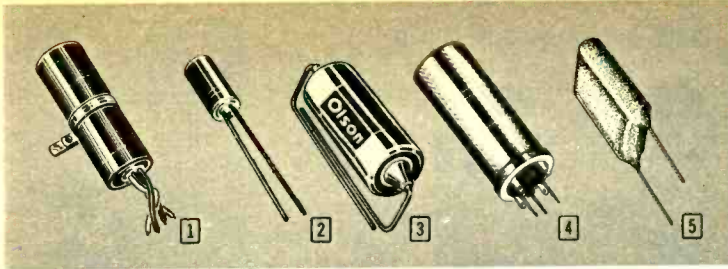

1 Olson Tubular Electrolytic Capacitors

Full insulation. Size approx. 2 1/4" x 7/8" dia. Shpg. wt. 1/4 lb. ea.

Stock No.	uF	WVDC	Each
CC-149 J	50-30	150	.45
CC-213 J	100-150	150/50	.69
CC-144 J	80-40-20	150	.69
CC-224 J	80-50	150	.69

3 Olson Low-Voltage Electrolytic Capacitors

Ideal for replacement use or for hobbyists and builders. Shpg. wt. 1 oz.

Stock No.	uF	WVDC	Pkg. Of
CC-216 J	100	50	3
CC-217 J	500	50	2
CC-218 J	1000	50	1
CC-225 J	2000	50	1

Your Choice. Shpg. wt. 1/4 lb. Ea. 1.79

2 Olson Miniature Electrolytic Capacitors

Five of a type per package. Each measures 1/4" dia. x 1/2" L. Wt. 1/4 lb.

Stock No.	uF	WVDC
CC-966 J	5	10
CC-967 J	10	25
CC-968 J	30	25
CC-969 J	50	25
CC-970 J	100	10

5 Pkgs. for 6.50 Each Pkg. 1.49

4 Sprague 3-Section Electrolytic Capacitor

100's of uses. Dual polyester-paper di-electric—combines the best qualities and performance of both polyester film and paper capacitors. Solid impregnated construction—will NOT leak or drip. Easy twistprong mounting with solder terminals. Rated 200 uF at 150 WVDC, 100 uF at 175 WVDC, 30 uF at 150 WVDC. 3 1/2" long x 1 1/4" diameter. CC-236J. Shpg. wt. 1/2 lb. 99¢

5 Miniature Mylar Kit

27 popular values! Rated 50 WVDC. Contains 3 each: .001, .002, .005, .01, .02, .05, .1, .2, & .5. Min. 3/16" x 3/16", Max. 5/8" x 3/4". Shpg. wt. 4 oz.

CC-232J. 4 Paks for 14.00 Ea. 4.29

Olson "Value-Pak" Capacitor Kits

100-Piece Tubular Kit

Values may range from .001 uF to 0.5 uF at 100-600 WVDC. Ideal for servicemen and hobbyists. Pay less than 2c apiece. CC-229 J. Shpg. wt. 2 lbs. 1.98

Only **1.98**



20-Piece Electrolytic Kit

F.P. and twist-lock, assorted. Single double & triple capacity at an average of 15c each. What a buy! CC-214 J. Shpg. wt. 7 lbs. 2.99
40-Pc. Kit. Asst'd. can & tubular. CC-238 J. Shpg. wt. 7 lbs. 3.98

2.99

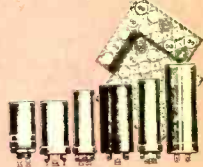

100-Piece Ceramic Type Kit

Big assortment of high-quality disc types. Most are rated at 600 volts or more. Standard color code. CC-210 J. Shpg. wt. 1/4 lb. 99c
100-Piece Tubular Ceramics. CC-211 J. Shpg. wt. 1/4 lb. 99c

Only **99c**

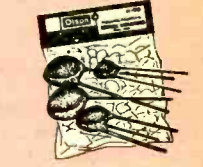

Deluxe 100-Piece Tubular Kit

Top-quality 600 WVDC capacitors with insulated jackets, long & flexible leads. 10 each: .001, .002, .005, .1 uF; 20 each: .01, .02, .05 uF
CC-206 J. Shpg. wt. 2 lbs. 7.49

7.49

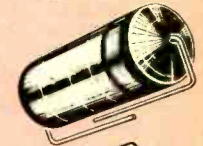

Olson Miniature Polystyrene Capacitors

Very high insulation resistance. Rated at 125 WVDC. 3/8" L x 1/4" dia. Wt. 1/4 lb. CC-234J. 500 pF.
4 Pkgs. for 4.00 Pkg. of 5 1.29
CC-235J. 1000 pF.
4 Pkgs. for 4.00 Pkg. of 5 1.29

1.29
Pkg. of 5

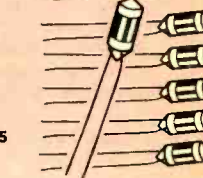

Famous-Quality Sprague Capacitors

Vertical Mount Electrolytics



"Mini" capacitors for high-density printed wiring boards. High stability, low leakage, welded terminal connections. Metal encased, insulated sleeve. Av. shpg. wt. 2 oz. each.

Axial-Lead Electrolytics

Long considered the "standard of the industry" Sealed in tubular aluminum cases—they won't dry out nor are they susceptible to moisture. All welded construction. Av. shpg. wt. 2 oz.

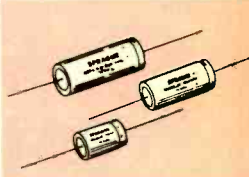

Stock No.	Mfr's Type	uF	WVDC	Each
CD-066 J	QV1-9	1	25	.45
CD-067 J	QV1-11	1	63	.45
CD-068 J	QV1-19	2.2	50	.45
CD-069 J	QV1-29	4.7	50	.45
CD-070 J	QV1-43	10	25	.45
CD-071 J	QV1-45	10	63	.48
CD-072 J	QV1-51	15	50	.48
CD-073 J	QV1-57	22	25	.48
CD-074 J	QV1-59	22	63	.49
CD-075 J	QV1-71	47	6.3	.45
CD-076 J	QV1-75	47	25	.49
CD-077 J	QV1-79	47	63	.52
CD-078 J	QV1-91	100	6.3	.48
CD-079 J	QV1-95	100	16	.52
CD-080 J	QV1-97	100	25	.52
CD-081 J	QV1-99	100	50	.54

Stock No.	Mfr's Type	uF	WVDC	Each
CD-082 J	QV1-101	100	63	.56
CD-083 J	QV1-115	220	10	.52
CD-084 J	QV1-119	220	25	.54
CD-085 J	QV1-123	220	50	.76
CD-086 J	QV1-135	330	25	.60
CD-087 J	QV1-141	330	50	.79
CD-088 J	QV1-147	470	6.3	.52
CD-089 J	QV1-153	470	25	.78
CD-090 J	QV1-159	470	50	.94
CD-091 J	QV1-173	680	35	.89
CD-092 J	QV1-177	1000	6.3	.60
CD-093 J	QV1-179	1000	10	.78
CD-094 J	QV1-185	1000	25	.89
CD-095 J	QV1-193	1500	16	.94
CD-096 J	QV1-201	2200	10	.89
CD-097 J	QV1-203	3300	6.3	.94

Film Capacitors

Compact yet dependable under high heat & humidity. Leads are crimped to assure neat parallel-to-board mtg. or point-to-point wiring. Leakproof. Dual dielectric. Av. shpg. wt. 1 oz.



Stock No.	Mfr's Type	uF	WVDC	Each
CD-050 J	QF1-1	.001	100	.29
CD-051 J	QF1-57	.0047	100	.29
CD-052 J	QF1-63	.0047	600	.29
CD-053 J	QF1-91	.01	100	.29
CD-054 J	QF1-97	.01	600	.29
CD-055 J	QF1-125	.02	600	.31
CD-056 J	QF1-127	.022	100	.29
CD-057 J	QF1-133	.022	600	.31

Stock No.	Mfr's Type	uF	WVDC	Each
CD-058 J	QF1-171	.047	100	.31
CD-059 J	QF1-177	.047	600	.32
CD-060 J	QF1-183	.05	600	.32
CD-061 J	QF1-215	.1	100	.32
CD-062 J	QF1-221	.1	600	.46
CD-063 J	QF1-231	.15	100	.42
CD-064 J	QF1-253	.22	100	.46
CD-065 J	QF1-287	.47	100	.60

Stock No.	Mfr's Type	uF	WVDC	Each
CD-027 J	QE1-11	1	50	.45
CD-028 J	QE1-31	2	25	.45
CD-029 J	QE1-35	2	50	.45
CD-030 J	QE1-107	5	25	.45
CD-031 J	QE1-111	5	50	.48
CD-032 J	QE1-179	10	25	.48
CD-033 J	QE1-185	10	50	.48
CD-034 J	QE1-293	25	25	.48
CD-035 J	QE1-295	25	50	.49
CD-036 J	QE1-353	50	25	.49
CD-037 J	QE1-357	50	50	.52
CD-038 J	QE1-419	100	12	.49

Stock No.	Mfr's Type	uF	WVDC	Each
CD-039 J	QE1-425	100	25	.52
CD-040 J	QE1-429	100	50	.56
CD-041 J	QE1-477	200	12	.52
CD-042 J	QE1-481	200	25	.56
CD-043 J	QE1-497	250	25	.82
CD-044 J	QE1-609	1500	16	1.68
CD-045 J	QE1-629	2000	25	3.00
CD-046 J	QE1-675	5000	16	2.58
CD-047 J	QE1-677	5000	25	3.49
CD-048 J	QE1-679	5000	50	4.28
CD-049 J	QE1-685	10000	16	3.63

Ceramic Capacitors

Designed to meet the small size, high capacitance demands of low voltage circuitry. Non-polarized construction. Covered with a tough phenolic resin. Av. shpg. wt. 1 oz.

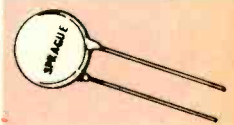

Stock No.	Mfr's Type	uF	WVDC	Each
CD-003 J	QC1-43	.0001	1000	.24
CD-004 J	QC1-81	.001	1000	.24
CD-005 J	QC1-117	.0047	25	.28
CD-006 J	QC1-123	.005	100	.24
CD-007 J	QC1-137	.01	16	.24
CD-008 J	QC1-139	.01	25	.26
CD-009 J	QC1-141	.01	100	.24
CD-010 J	QC1-149	.01	1000	.24
CD-011 J	QC1-157	.02	100	.24
CD-012 J	QC1-169	.022	16	.24
CD-013 J	QC1-173	.022	25	.26
CD-014 J	QC1-201	.047	16	.26

Stock No.	Mfr's Type	uF	WVDC	Each
CD-015 J	QC1-205	.047	25	.28
CD-016 J	QC1-207	.05	100	.40
CD-017 J	QC1-227	.1	16	.28
CD-018 J	QC1-231	.1	25	.30
CD-019 J	QC1-233	.1	100	.49
CD-020 J	QC1-235	.1	500	.76
CD-021 J	QC1-245	.2	16	.36
CD-022 J	QC1-249	.22	16	.36
CD-023 J	QC1-251	.22	25	.46
CD-024 J	QC1-255	.33	16	.46
CD-025 J	QC1-257	.47	12	.52
CD-026 J	QC1-261	500pF	20kV	3.00

Olson "New Design" Knobs

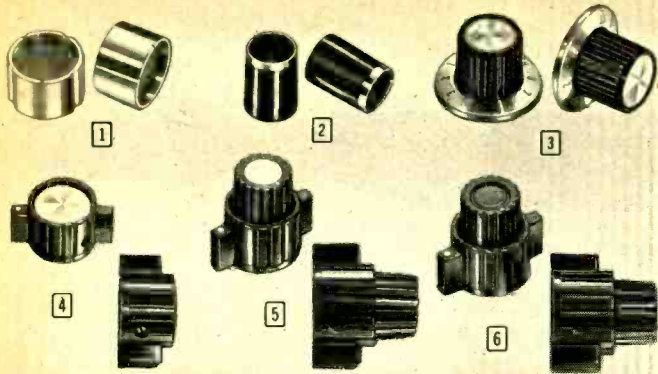

1 Metal Knobs. Two brushed aluminum knobs with walnut insert. For $\frac{3}{8}$ " shafts. 1" dia., $\frac{3}{8}$ " deep. Wt. 4 oz. KN-037J. 4 Pkgs. 5.00 Pkg. 1.49

2 Tapered Knobs. 5 brown plastic knobs with metal trim. Brass insert with set screw. For $\frac{1}{4}$ " shafts. Wt. 4 oz. KN-032J. 4 Pkgs. 5.00 Pkg. 1.49

3 Calibrated Knobs. Two black plastic with nos. 0-10 etched on silver plate. Knurled grip. Brass inset with set screw. For $\frac{1}{4}$ " shafts. 4 oz. KN-038J. 4 Pkgs. 5.00 Pkg. 1.49

4 White Dot Pointer Knobs. Pkg. of 2 black bakelite with aluminum inlay. Knurled grip. $\frac{3}{8}$ " dia. x $\frac{3}{8}$ " deep. $\frac{1}{4}$ " shafts. 4 oz. KN-039J. 4 Pkgs. 6.00 Pkg. 1.69

5 Dual Concentric Knobs. Pkg. of 2 black bakelite knobs with white dot, silver inset and screws. $\frac{3}{8}$ " dia., $1\frac{1}{2}$ " deep. KB-329J. 4 Pkgs. 7.56 Pkg. 1.99

6 Dual Concentric Knobs. Pkg. of 2. Above, without silver inset. Shpg. wt. 4 oz. KB-330J. 4 Pkgs. 7.56 Pkg. 1.99

Assorted Knob Kit. For any TV, radio, hobby equipment. Assorted shapes, sizes, colors—fluted and grooved types. Black, clear plastic, chrome. Pkg. of 25. KN-030J. Wt. 1 lb. 79¢

GC Knobs and Dials



Big Selection of Calectro Quality Knobs & Dials

Fit standard $\frac{1}{4}$ " shafts.

Stock No.	Mfr's. Type	Fig.	Type	Color	Size	Each
KN-040J	E2-705	7	General Purpose	Black	$\frac{3}{4}$ " D x $\frac{7}{16}$ " H	.44
KN-041J	E2-707	8	General Purpose	Black	$1\frac{1}{8}$ " D x $1\frac{1}{16}$ " H	.59
KN-042J	E2-710	9	Pointer	Black	$1\frac{1}{2}$ " L x $\frac{3}{8}$ " H	.44
KN-043J	E2-715	10	Calibrated: 0-9	Black	$1\frac{1}{2}$ " D x $1\frac{1}{8}$ " H	.79
KN-044J	E2-716	11	High-Style	Silver	$1\frac{1}{2}$ " D x $1\frac{1}{8}$ " H	.79
KN-045J	E2-717	12	High-Style	Silver	$1\frac{1}{2}$ " D x $\frac{7}{8}$ " H	1.19
KN-046J	E2-718	13	Calibrated: 0-10	Black	$1\frac{1}{8}$ " D x $\frac{7}{8}$ " H	1.19
KN-047J	E2-720	14	Audio Hi-Fi	Ivory	1" D x $1\frac{1}{16}$ " H	.40
KN-048J	E2-721	15	Audio Hi-Fi	Ivory	$1\frac{1}{8}$ " D x $1\frac{1}{16}$ " H	.45
KN-049J	E2-724	16	Audio Hi-Fi	Black	1" D x $1\frac{1}{16}$ " H	.44
KN-050J	E2-725	19	Audio Hi-Fi	Black	$1\frac{1}{8}$ " D x $1\frac{1}{16}$ " H	.59
KN-051J	E2-750	17	Calibrated Dial, gold etched 1-10			.59
KN-052J	E2-751	17	Calibrated Dial: 1-10 with "Volume" Heading			.59
KN-053J	E2-744	18	Vernier dial, 8 to 1 turn ratio. $1\frac{1}{2}$ " dia.			2.25
KN-054J	E2-745	18	Same as above, but 2" dia.			2.50

Shpg. wt. 4 oz. each.

Calectro Variable Capacitors, Trimmers



VARIABLE CAPACITORS

20 Miniatures. Ideal for shortwave, VHF. $\frac{3}{4}$ " shaft. Wt. 1 lb. CD-099J. 30 pF (min. 2.9) 2.55
CD-100J. 100 pF (min. 5) 2.95

21 Broadcast Receiver Type. Single-gang midjet. About $1\frac{1}{2}$ " square x $\frac{7}{8}$ " deep. 1 lb. CD-101J. 365 pF (10 min.) 3.25

TRIMMER CAPACITORS

Low-loss ceramic bases, mica insulation. $\frac{3}{8}$ " x $\frac{5}{8}$ " (CD-105/106) or $\frac{7}{8}$ " (CD-107/108/109). 1 lb.

Stk. No.	pF	Each
CD-105J.	7 (0.9 min.)	.70
CD-106J.	40 (4 min.)	.80
CD-107J.	60 (7 min.)	.70
CD-108J.	300 (55 min.)	.99
CD-109J.	600 (170 min.)	1.20

SOLID DIELECTRICS

23 Single Gang. For simple receivers, science projects. Dual calibrated for AM broadcast band. 1" sq., $\frac{1}{2}$ " deep. 365 pF (13 pF min.) CD-102J. Wt. 6 oz. 1.35

24 Single Gang. As above, but has $\frac{1}{4}$ " dia. shaft $\frac{3}{4}$ " long. Without dial. CD-103J. Wt. 4 oz. 1.10

25 Dual Gang. Transistor radio type. Complete with $1\frac{3}{16}$ " dia. dial. Only $1\frac{3}{16}$ " square x $\frac{7}{16}$ " deep. Has trimmers. 138/62 pF. For replacement use or experimenters. CD-104J. Wt. 6 oz. 1.55

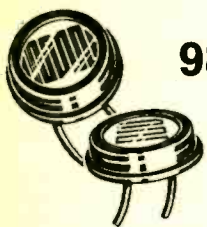
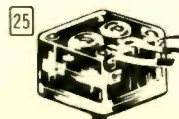

98¢

Olson Cadmium Photocell

Light-sensitive resistor for use in operating relays, counting devices, turning on lights, etc. Dark Resistance Range, 200 ohms to 1 meg. Sensitivity: 500-600 Angstroms. Max. VDC: 150. Max. dissipation: 75 mW. $\frac{3}{8}$ " dia. x $\frac{1}{8}$ ". With 1" leads. 2 per package—stock up! TR-091J. Shpg. wt. $\frac{1}{4}$ lb. 98¢



MOTOROLA

125
Transistor Project Books

Build Your Own Home and Car Security Systems. Has full instructions for using Motorola HEP transistors (page 175) to build 11 useful and protective alarm circuits for your home and car. For intermediate or advanced hobbyist/experimenter. Includes introduction to alarm systems, builders hints. BK-079J. Wt. 4 oz. 1.25

Other Motorola HEP Project Books. Contain instructions for useful and interesting projects using Motorola HEP semiconductors. (See page 175 for complete listing).

BK-180J. 9 Transistor Projects. 50¢
BK-181J. 6 Integrated Circuit Projects. 1.00
BK-182J. 6 FET Projects. 1.00

L M B[®] Boxes for Hobbyists and Experimenters

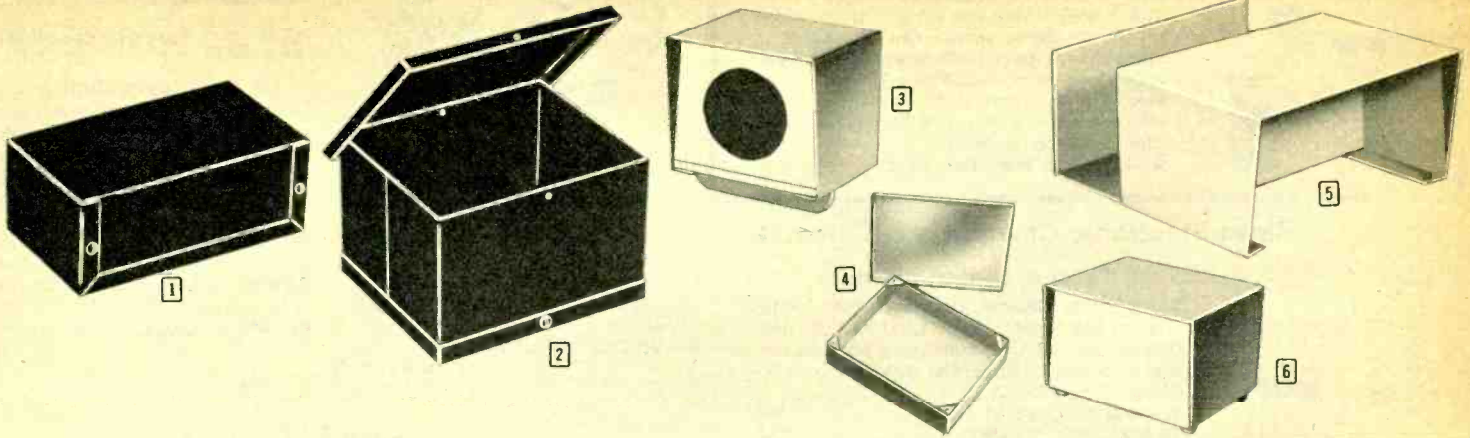

Quality metal chassis boxes with hundreds of uses
—experimenter circuits' equipment cabinetry, etc.

1 TITE-FIT BOX CHASSIS

Mfr's Part No.	Size (DWH)	Stock No.	Each, Plain	Stock No.	Each, Gray
T-F 770	2¼ x 2½ x 1⅞"	CA-616J	.68	CA-617J	.89
T-F 771	2¼ x 2½ x 2¾"	CA-618J	.75	CA-619J	1.05
T-F 772	3¼ x 2½ x 1⅞"	CA-620J	.68	CA-621J	.92
T-F 773	3½ x 2½ x 1⅞"	CA-622J	.68	CA-623J	.92
T-F 774	4 x 2½ x 1⅞"	CA-624J	.68	CA-625J	1.05
T-F 775	4 x 2¼ x 2¼"	CA-626J	.83	CA-627J	1.07
T-F 776	4 x 2 x 2¾"	CA-628J	.83	CA-629J	1.10
T-F 777	4¼ x 2¼ x 1½"	CA-630J	.79	CA-631J	1.10
T-F 778	5 x 2¼ x 2¼"	CA-632J	.86	CA-633J	1.13
T-F 779	5 x 4 x 3"	CA-634J	1.03	CA-635J	1.45
T-F 780	5½ x 3 x 2½"	CA-636J	1.10	CA-637J	1.23
T-F 781	6 x 5 x 4"	CA-638J	1.62	CA-639J	2.01
T-F 782	7 x 5 x 3"	CA-640J	1.54	CA-641J	2.05
T-F 783	8 x 6 x 3½"	CA-642J	1.89	CA-643J	2.48

2 UTILITY BOXES WITH CAP COVERS

Mfr's No.	Size (DWH)	Gauge Alum.	Stock No.	Each (Plain)	Stock No.	Each (Gray)
U-C 970	4 x 4 x 2"	.040"	CA-644J	1.73	CA-645J	2.00
U-C 971	5 x 4 x 3"	.040"	CA-646J	1.86	CA-647J	2.18
U-C 972	6 x 5 x 4"	.040"	CA-648J	2.40	CA-649J	2.78
U-C 973	6 x 6 x 6"	.040"	CA-650J	2.81	CA-651J	3.32
U-C 973A	6 x 6 x 3"	.040"	CA-652J	2.43	CA-653J	2.97
U-C 974	7 x 5 x 3"	.040"	CA-654J	3.28	CA-655J	3.83
U-C 975	9 x 6 x 5"	.051"	CA-656J	3.72	CA-657J	4.28
U-C 976	10 x 8 x 7"	.051"	CA-658J	5.09	CA-659J	5.89
U-C 977	12 x 7 x 6"	.051"	CA-660J	4.91	CA-661J	5.83

3 METER CASES

Mfr's No.	Size (DWH)	Stock No.	Each Plain	Stock No.	Each Gray
W-2AP	3½ x 4 x 3" w/holes	CA-697J	2.13	CA-698J	2.48
W-2A	3½ x 4 x 3½" wo/holes	CA-699J	2.18	CA-700J	2.51
W-2BP	3 x 7 x 3½" w/holes	CA-701J	2.48	CA-702J	2.94
W-2B	3 x 7 x 3½" wo/holes	CA-703J	2.48	CA-704J	2.94
W-2C	3¾ x 7 x 3½" wo/holes	CA-705J	3.22	CA-706J	3.73
W-2E	4½ x 4½ x 3½" wo/holes	CA-707J	2.59	CA-708J	2.86

4 CAP COVER ALUMINUM CHASSIS

Mfr's No.	Size (DWH)	Stock No.	Each
553C	5 x 5 x 3"	CA-709J	1.79
572C	5 x 7 x 2"	CA-710J	2.08
573C	5 x 7 x 3"	CA-711J	2.34
5952C	5 x 9½ x 2"	CA-712J	2.25
5103C	5 x 10 x 3"	CA-713J	2.77
5133C	5 x 13 x 3"	CA-714J	3.42
642C	6 x 4 x 2"	CA-715J	2.59
643C	6 x 4 x 3"	CA-716J	2.91
664C	6 x 6 x 4"	CA-717J	3.44
6173C	6 x 17 x 3"	CA-718J	3.74
772C	7 x 7 x 2"	CA-719J	2.65
792C	7 x 9 x 2"	CA-720J	2.87
7102C	7 x 9 x 3"	CA-721J	2.48
7103C	7 x 10 x 3"	CA-722J	3.30

5 SMALL CABINETS

Mfr's No.	Size (DWH)	Stock No.	Each, Plain	Stock No.	Each, Gray
275N	2¾ x 3 x 4"	CA-662J	1.74	CA-663J	2.07
2754N	2¾ x 2¾ x 4"	CA-664J	1.80	CA-665J	2.07
342N	3 x 4¼ x 2¾"	CA-666J	1.75	CA-667J	2.09
442N	4 x 4½ x 2¾"	CA-668J	1.88	CA-669J	2.15
444N	4 x 4 x 4"	CA-670J	1.97	CA-671J	2.23
453N	4 x 5 x 3"	CA-672J	2.04	CA-673J	2.39
463N	4 x 6 x 3"	CA-674J	2.07	CA-675J	2.48
555N	5 x 5 x 5"	CA-676J	2.64	CA-677J	3.14
564N	5 x 6 x 4"	CA-678J	2.44	CA-679J	2.90
685N	6 x 8 x 5"	CA-680J	3.66	CA-681J	4.24

6 NEW SERIES IN GLAMOR COLORS

Mfr's No.	Color	Size (DWH)	Stock No.	Each
275	Ivory	2¾ x 3 x 4"	CA-682J	2.19
2754	Gold	2¾ x 2¾ x 4"	CA-683J	2.32
342	Green	3 x 4¼ x 2¾"	CA-684J	2.35
442	Red	4 x 4½ x 2¾"	CA-685J	2.53
442RG	Red/Gold	4 x 4½ x 2¾"	CA-686J	2.97
442RB	Red/Black	4 x 4½ x 2¾"	CA-687J	2.97
444	Black	4 x 4 x 4"	CA-688J	2.62
444BG	Black/Gold	4 x 4 x 4"	CA-689J	3.06
453	Blue	4 x 5 x 3"	CA-690J	2.65
453BG	Blue/Gold	4 x 5 x 3"	CA-691J	3.09
463GB	Gold/Beige	4 x 6 x 3"	CA-692J	3.30
463	Beige	4 x 6 x 3"	CA-693J	2.87
555	Earth Green	5 x 5 x 5"	CA-694J	3.41
564	Biscayne Blue	5 x 6 x 4"	CA-695J	3.25
685	Bronze	6 x 8 x 5"	CA-696J	4.51

Money-Saving "Service Master" Chemical Assortment

Four of our most popular service chemicals at a money-saving low price. Just the thing for the on-the-go serviceman who wants to complete his tool kit with really useful chemicals. Consists of: 6-oz. Space Tuner Cleaner, 6-oz. Circuit Freeze coolant, 3-oz. E-Z Slip silicon lubricant and 6-oz. Tape Head Cleaner. Shpg. wt. 3 1/2 lbs. AS-799J. Sep. Items Reg. \$4.20 3.77



Rawn Electronic Chemicals & Cleaners

Tuner & Control Cleaners

Space Tuner Cleaner. Deluxe cleaner formulated of high-grade solvents, oil and silicone. Cleans, lubricates & permanently protects tuners, switches, controls. Net weight, 6 oz. (TL-642J), 16 oz. (TL-643J).
 TL-642J. Shpg. wt. 11 oz. 98¢
 TL-643J. Shpg. wt. 1 1/4 lb. 1.98

Black-Magic Tuner Cleaner. Thick, concentrated cleaner & lube with TF Solvent. Will not dry out or run off. Net weight, 8 oz.
 TL-644J. Shpg. wt. 13 oz. 1.79

Saturn Tuner & Control Cleaner. High-grade, specially formulated for cleaning & lubricating COLOR tuners. Net weight, 3 oz.
 TL-651J. Shpg. wt. 6 oz. 89¢

Freezer Coolers

Freeze Circuit Cooler. Extra-fast coolant helps you pinpoint thermally defective capacitors, resistors and coils quickly and easily. Net wt. 6 oz. (TL-645J), 16 oz. (TL-646J).
 TL-645J. Shpg. wt. 11 oz. 98¢
 TL-646J. Shpg. wt. 1 1/4 lb. 2.25

Lubricants

E-Z-Slip Lubricant-Silicone. Stops squeaks, prevents rust, lubricates all at the same time. Use on metal, wood, glass, rubber, chrome, leather, etc. Net weight, 3 oz.
 TL-652J. Shpg. wt. 6 oz. 89¢

E-Z Lube White Oil. A highly refined white oil formulated for electronic equipment, office machines, household appliances. Will not gum or tarnish! Net weight, 3 oz.
 TL-653J. Shpg. wt. 6 oz. 84¢

Cements

Service Cement. Specially formulated for repairing speakers. Use on torn cones, voice coils and spiders. Fast drying, waterproof, non-shrinking! Net weight, 2 oz.
 TL-654J. Shpg. wt. 5 oz. 54¢

E-Z-Bond Contact Cement. Can be used to bond almost any material. Wood, rubber, metal, glass, paper, plaster, leather, ceramic, cloth, plastics. Net weight, 3 oz.
 TL-655J. Shpg. wt. 6 oz. 81¢

Tape & Tape Head Cleaners

T-F Cleaner. For tapes & recording heads. Net: 6 oz. (TL-647J), 16 oz. (TL-648J)
 TL-647J. Shpg. wt. 11 oz. 1.35
 TL-648J. Shpg. wt. 1 1/4 lb. 2.20

Power-Spray Cleaner. Leaves no residue, has a low surface tension, high density and high dielectric strength. Net wt., 24 oz.
 TL-650J. Shpg. wt. 2 1/2 lb. 2.98

Anti-Static Record Cleaner

Increases record and needle life. Sprays away static which prevents future dust pickup! Net weight, 6 oz.
 TL-649J. Shpg. wt. 11 oz. 1.15

Plastic Repair Kit

"Plas-T-Pair" contains everything you need to make repairs on all plastic items.
 TL-656J. Shpg. wt. 10 oz. 1.85

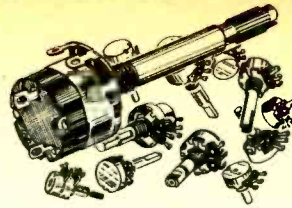

12 for Only **79¢**

Volume Control Package

Assortment of 12 most popular values. Includes various lengths, diameters. Some have switches. Carbon and wirewound types. BIG value!
 VC-274J. Shpg. wt. 1 lb. 79¢



1.29



\$2

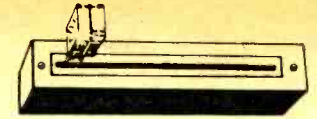

3.49 Each Any 2 for \$6—Save!

Olson Sliding Controls

Update your audio equipment with a stylish "professional" look! Handsome controls work smoothly, accurately. Use for volume or tone. Easy-to-install—screws are included. 3 1/2" W x 1/2" H x 1/2" D.
 RR-089J. 10,000 Ohms. Shpg. wt. 1/2 lb. 3.49
 RR-090J. 100,000 Ohms. Shpg. wt. 1/2 lb. 3.49
 RR-091J. 500,000 Ohms. Shpg. wt. 1/2 lb. 3.49

Color TV Tuner Cleaner/Lube

• Quiets Noisy TV Controls

Spray away noise! Cleans, lubricates contact points on TV tuners, relays, switches, generators, carbon controls. Contains no carbon tet—100% safe.
 TL-459J. Shpg. wt. 8 oz. 1.29

"Perma-Bond" Glue

• Sets Hard In A Minute

Industrial strength. Bonds most plastics, rubber, metal easily & quickly. Transparent, colorless. Requires no messy mixing with hardeners. Made by Oneida.
 TL-580J. Shpg. wt. 4 oz. 2.00



Replace That Worn or Defective Volume or Tone Control Now!

Quality Potentiometers & Volume Controls



1 CALECTRO STANDARD TYPE POTENTIOMETERS

Popular control used in radios, TV's and other electronic equipment. Rated 1/2 watt min., 2 watt max. Fit knobs with spring or set-screw. 2 1/2" long, 3/8" dia. shaft. Shpg. wt. 4 oz.

Stock No.	Mfr's. Type	Ohms	Taper	Switch	Each
VC-286J	B1-680	5k	Linear	No	1.25
VC-287J	B1-681	5k	Audio	No	1.25
VC-288J	B1-682	5k	Audio	Yes	1.85
VC-289J	B1-683	10k	Linear	No	1.25
VC-290J	B1-685	50k	Linear	No	1.25
VC-291J	B1-686	100k	Linear	No	1.25
VC-292J	B1-687	500k	Linear	No	1.25
VC-293J	B1-688	500k	Audio	No	1.25
VC-294J	B1-689	500k	Audio	Yes	1.85
VC-295J	B1-690	1 meg	Linear	No	1.25
VC-296J	B1-691	1 meg	Audio	No	1.25
VC-297J	B1-692	1 meg	Audio	Yes	1.85
VC-298J	B1-693	5 meg	Linear	No	1.25

2 MINIATURE POTENTIOMETERS WITH SWITCHES

For uses requiring a "mini" control. Only 1 1/2" dia. x 3/8" deep including switch. Linear taper, rated 1/4 watt. Switch handles 1 amp @ 12V; 1/4 amp @ 48V. Shaft extends to 3/8"—fits knurled, set-screw knobs. Wt. 4 oz.

Stock No.	Mfr's. Type	Ohms
VC-301J	B1-660	1k
VC-302J	B1-661	5k
VC-303J	B1-662	10k
VC-304J	B1-664	50k
VC-305J	B1-665	100k
VC-306J	B1-666	500k

3 TRANSISTOR RADIO VOLUME CONTROLS

Ideal for hobby projects requiring small, flat control. Built-in on/off switch, 1 1/2" dia. dial. Size: 5/8" dia. x 3/8" deep. Wt. 4 oz.

Stock No.	Ohms
VC-299J	5k
VC-300J	10k

Each **110**

Each **85¢**

See Olson for Useful and Unusual Products

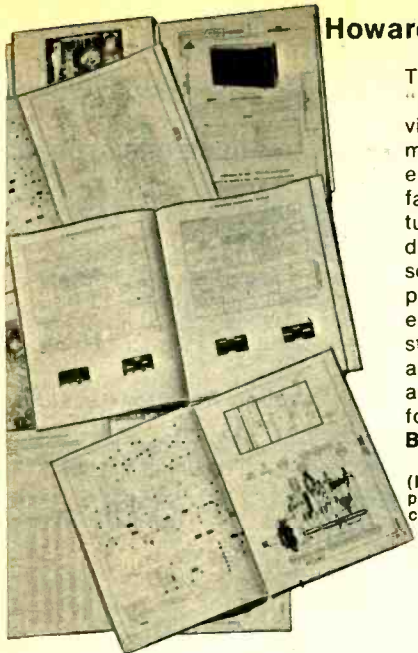

Howard W. Sams Photofacts®

The radio and TV technician's "bible" — covers complete servicing data for over 91,000 models of home entertainment/electronic equipment manufactured after 1946. Includes tube and transistor check charts, disassembly instructions, field servicing note, replacement parts lists, alternate tuner data, exploded views, plus the famous standard notation schematic and much more. Specify make and model of set, allow 2 weeks for delivery. Shpg. wt. 1/2 lb.

BK-190J. Each Set 4.00

(Includes regular \$3.30 per set charge plus \$.70 handling and transportation charges)

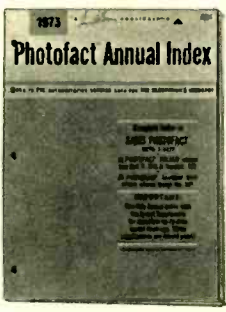

Photofact Annual Index

A complete index to Photofact data available on virtually every model of electronic entertainment equipment produced since 1946. Shpg. wt. 1/2 lb.
BK-189J. Available at No Charge

David Clark Universal Hearing Protector



Really Effective!

750

Model E-310. For farmers, mill and foundry workers, anyone who needs dependable protection against harmful noise. Lightweight hearing protector can be worn with support over or behind the head, under the chin. Has large, comfortable ear-seals, adjustable support strap. Gives excellent protection against high and low frequency noises, allows normal conversation. Meets the provisions of the new Occupational Safety and Health act. Only hearing protector qualified by U.S.A.F.
XM-294J. Shpg. wt. 2 lbs. 7.50

Audio-Technica Audio-Graphic Chart Recorder

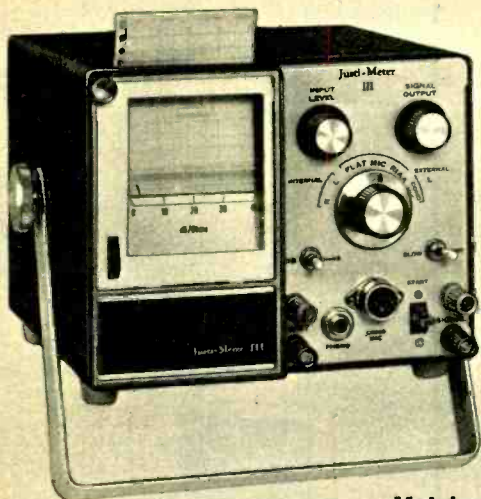

595⁰⁰

Matches the "Big" Machines at 1/5th the Cost!

Justi-Meter III

Generates and records high-accuracy frequency response curves for measuring response of phono cartridges, calibrating other audio equipment (when used in conjunction with Audio-Technica's AT15S or AT20S calibrated phono cartridges), measuring speaker response, etc. Signal source is the standard B&K 20-20,000 Hz sweep frequency record (included). An essential aid for the service technician, audio or broadcast engineer, serious audiophile. With two rolls chart paper, phono input adapter.
TE-329J. Shpg. wt. 15 lbs. 595.00

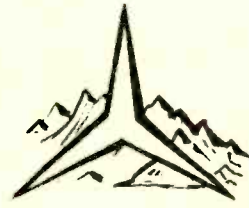

Universal Replacement Antenna Rods

Great Western Aviation Company

There's One For Your Needs!

Precision-made quality replacement rods for all types of antennas. All are constructed of heavy walled brass tubing, dipped and etched and triple-chrome plated for steady, reliable use day in and day out. Put "new life" in your old equipment with one of these antenna replacements—they really work! Ave. Shpg. wt. 1/2 lb.

Stock No.	No. Sections	Base Dia. Inches	Collapse Inches	Extend Inches	EACH — May Be Assorted for Quantity Price	
AA-764J	6	.326	8.5	42	1.99	3 @ 1.79
AA-765J	4	.238	9.5	29	3.59	3 @ 3.24
AA-766J	5	.275	9.0	38	1.99	3 @ 1.79
AA-767J	6	.235	8.5	39	1.99	3 @ 1.79
AA-768J	8	.315	8.5	45	3.79	3 @ 3.42
AA-769J	4	.281	10.0	38	1.39	3 @ 1.26
AA-770J	10	.357	5.0	33	3.59	3 @ 3.24
AA-771J	11	.433	7.0	60	3.99	3 @ 3.60
AA-772J	6	.375	5.5	25	3.39	3 @ 3.06
AA-773J	5	.281	6.5	29	1.79	3 @ 1.62
AA-774J	7	.275	7.0	30	3.49	3 @ 3.15
AA-775J	5	.281	8.5	38	1.69	3 @ 1.53
AA-776J	7	.243	7.0	42	1.99	3 @ 1.79

Antenna rods are guaranteed for the life of the rod, to be free of defects in material and workmanship.

Hard-to-Find Resistors and Assortments

1/2 Watt Pack of 2
10% 19¢

Stock No.	Ohms
RS-002J	10
RS-003J	15
RS-004J	27
RS-005J	47
RS-006J	100
RS-007J	150
RS-008J	220
RS-009J	330
RS-010J	470
RS-011J	1k
RS-012J	1.5k
RS-013J	2.2k
RS-014J	2.7k
RS-015J	3.3k
RS-016J	4.7k
RS-017J	6.8k
RS-018J	8.2k
RS-019J	10k
RS-020J	15k
RS-021J	22k
RS-022J	27k
RS-023J	33k
RS-024J	47k
RS-025J	68k
RS-026J	100k
RS-027J	150k
RS-028J	220k
RS-029J	270k
RS-030J	330k
RS-031J	470k
RS-032J	1 meg
RS-033J	2.2 meg
RS-034J	3.3 meg
RS-035J	4.7 meg
RS-036J	10 meg

Carbon Resistors in Most-Used Values

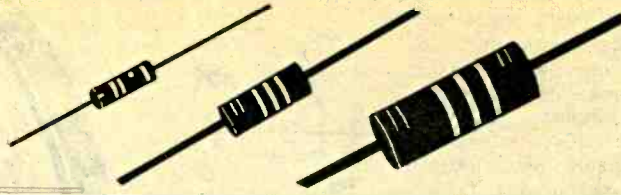

1 Watt 10%		19¢ Each	2-Watt 10%		25¢ Each
Stock No.	Ohms		Stock No.	Ohms	
RS-037J	10		RS-059J	10	
RS-038J	47		RS-060J	22	
RS-039J	100		RS-061J	47	
RS-040J	220		RS-062J	82	
RS-041J	470		RS-063J	100	
RS-042J	1k		RS-064J	150	
RS-043J	2.2k		RS-065J	220	
RS-044J	2.7k		RS-066J	270	
RS-045J	3.3k		RS-067J	330	
RS-046J	4.7k		RS-068J	470	
RS-047J	10k		RS-069J	1k	
RS-048J	15k		RS-070J	1.5k	
RS-049J	22k		RS-071J	2.2k	
RS-050J	33k		RS-072J	3.3k	
RS-051J	39k		RS-073J	4.7k	
RS-052J	47k		RS-074J	6.8k	
RS-053J	68k		RS-075J	8.2k	
RS-054J	100k		RS-076J	10k	
RS-055J	150k		RS-077J	15k	
RS-056J	270k		RS-078J	22k	
RS-057J	470k		RS-079J	27k	
RS-058J	1 meg		RS-080J	47k	
			RS-081J	100k	

Popular Carbon Resistors in Money-Saving Assortments!



100-PIECE RESISTOR KIT

179

What a value! Big assortment of 1/4, 1/2, 1 and 2-watt sizes. Standard color codes.

RR-077J. Shpg. wt. 2 lbs. 1.79
RR-088J. 50-Piece Kit. Wt. 1 lb. 99¢

1/2-Watt Carbon Resistor Pack



30 OF THE MOST POPULAR VALUES

225

10	100	1k	10k	68k	470k
15	150	1.5k	15k	100k	1 meg
22	220	2.2k	22k	150k	1.5 meg
33	330	4.7k	33k	220k	2.2 meg
47	470	6.8k	47k	330k	10 meg

Shpg. wt. 1/2 lb. each pack.
RR-062J. 1-5 ... Ea. 2.25 6-Up ... Ea. 2.00

1/4-Watt Carbon Resistor Pack

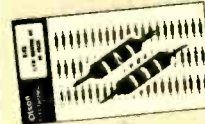

60 OF THE MOST POPULAR VALUES

269

Super value! Assortment of 10-ohm to 2-meg ohm resistors for solid-state devices.

RR-093J. Shpg. wt. 1/2 lb. 2.69

Power Resistor Pack

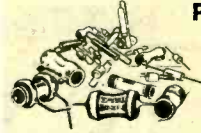

SAVE ON THIS 20-PIECE ASSORTMENT

99¢

Generous selection of vitreous, cand-ohm & wirewound types. Power ratings range from 3 to 25 watts. Worth \$\$\$ but penny-priced—less than 5¢ each. Stock up!

RR-082J. Shpg. wt. 2 lbs. 99¢

2-Watt Wirewound Resistors—Low Values

• Popular Value Bias Resistors for Solid-State Circuits.

Stock No.	Ohms	Stock No.	Ohms	Stock No.	Ohms
RS-105J	.27	RS-112J	1.0	RS-119J	3.9
RS-106J	.33	RS-113J	1.2	RS-120J	4.7
RS-107J	.39	RS-114J	1.5	RS-121J	5.6
RS-108J	.47	RS-115J	1.8	RS-122J	6.8
RS-109J	.56	RS-116J	2.2	RS-123J	8.2
RS-110J	.68	RS-117J	2.7	RS-124J	10.0
RS-111J	.82	RS-118J	3.3		

YOUR CHOICE

39¢ Each
3 for \$1

10-Watt Wirewound Resistors—10% Tolerance

Stock No.	Ohms	Stock No.	Ohms	Stock No.	Ohms
RS-082J	10	RS-089J	500	RS-096J	5k
RS-083J	50	RS-090J	750	RS-097J	5.6k
RS-084J	75	RS-091J	1k	RS-098J	6.8k
RS-085J	100	RS-092J	1.5k	RS-099J	7.5k
RS-086J	175	RS-093J	2.5k	RS-100J	8.2k
RS-087J	250	RS-094J	3k	RS-101J	10k
RS-088J	400	RS-095J	4k	RS-102J	15k

YOUR CHOICE

39¢ Each
3 for \$1

25-Watt Wirewound Resistors



59¢ Each
2 for \$1

• Popular Values

Av. Shpg. Wt. 4 oz.

Stock No.	Ohms
RS-127J	10
RS-128J	25
RS-129J	51
RS-130J	100
RS-131J	200
RS-132J	500
RS-133J	1000

Assorted Fuse Resistors



Low As

198

Now's the time to take advantage of these low Olson prices and stock up on these popular resistors. Designed for hundreds of uses in critical radio and TV circuits. Feature long wire leads for easy soldering connections—5 watt power rating. Package of 10 with the following assorted values: 7.5, 5.6, and 4.7 ohms.

In clear plastic box for convenient storage and handy access.

RS-134J. Shpg. wt. 4 oz. 1.98
RS-135J. Above, heavy-duty 3A types .. 2.50

Precision Resistor Kit



488

Kit of 50 resistors in most wanted and used values—at a fraction of their cost if you bought them separately. All are precision manufactured to high-quality standards, designed for long life even under tough use. All are color coded or marked with resistance value. Assorted tolerances and power ratings. Hobbyists, experimenters, servicemen, stock up today!

RS-103J. Wt. 1 lb. 2 for 8.00 4.88

Capacitors for Hobbyists, Experimenters, Servicemen

CDE

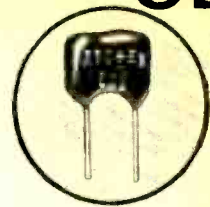
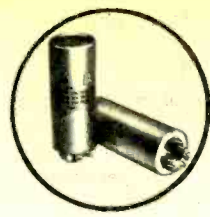
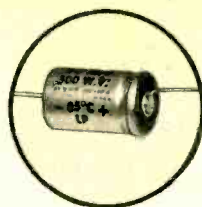
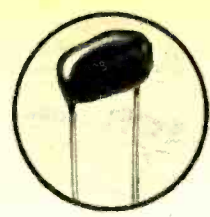

TWIST-PRONG ELECTROLYTICS

SINGLE SECTIONS					
Mfd.	Volts DC	Length Inches	Stock No.	Range Rating	Each
1500	50	2	CD-234J	750 to 1500	2.90
160	250	2 1/2	CD-235J	100 to 160	2.02
160	250	3	CD-236J	100 to 160	2.02
200	300	2	CD-237J	120 to 200	2.45
350	350	3 1/2	CD-238J	275 to 350	4.04
125	450	2 1/2	CD-239J	100 to 125	2.60
80	500	2	CD-240J	60 to 80	2.45
DUAL SECTIONS					
2 x 100	150	2	CD-241J	2 x 60-100	1.87
2 x 200	250	3	CD-242J	2 x 120-200	3.67
2 x 300	350	2	CD-243J	2 x 20-30	1.81
2 x 20	500	2 1/2	CD-244J	2 x 15-20	1.93
2 x 50	450	2 1/2	CD-245J	2 x 30-50	2.54
2 x 80	500	3 1/2	CD-246J	60-80	3.15
2 x 40	500	2	CD-247J	30-40	2.63
80	450			60-80	
2	350	2 1/2	CD-248J	1-2	2.60
80	500			60-80	
160	250	3 1/2	CD-249J	100-160	3.49
TRIPLE SECTIONS					
3 x 50	150	1 3/4	CD-250J	3 x 30-50	1.93
2 x 200	200			120-200	
150	200	3 1/2	CD-251J	100-150	4.31
40	250			30-40	
2 x 20	250	1 3/4	CD-252J	2 x 15-20	2.02
80	350			50-80	
3 x 40	450	3	CD-253J	2 x 40-60	3.49
2 x 80	450			2 x 30-40	3.00
30	450	4	CD-255J	2 x 60-80	
40	500			20-30	3.64
2 x 20	500	2 1/2	CD-256J	2 x 15-20	2.91
100	450			70-100	
80	450			60-80	
2 x 100	450	3 1/2	CD-257J	15-20	3.70
QUADRUPLE SECTIONS					
4 x 1000	25	2	CD-258J	4 x 500-1000	3.86
4 x 500	50	2	CD-259J	4 x 250-500	3.58
4 x 1000	50	4	CD-260J	4 x 500-1000	5.88
4 x 50	150	2	CD-261J	4 x 30-50	2.58
4 x 100	150	2	CD-262J	4 x 60-100	2.91
4 x 40	450	3 1/2	CD-263J	4 x 30-40	3.58
4 x 20	500	2	CD-264J	4 x 15-20	3.00
2 x 100	450			2 x 80-100	
80	450			60-80	
40	450	5 1/2	CD-265J	30-40	5.39

Dipped Paper Mylar and Mylar Wrapped

Cap. Mfd.	Stock No.	Size Inches	WVDC	Each
.1	CD-266J	.52 x 1.180	400	.33
.22	CD-267J	.62 x 1.56	400	.42
.5	CD-268J	.85 x 1.6	400	.69
.001	CD-269J	.34 x .66	600	.24
.0015	CD-270J	.34 x .66	600	.24
.0022	CD-271J	.34 x .66	600	.24
.0033	CD-272J	.37 x .66	600	.24
.0039	CD-273J	.37 x .66	600	.24
.0047	CD-274J	.4 x .69	600	.24
.005	CD-275J	.4 x .69	600	.24
.0068	CD-276J	.43 x .69	600	.24
.01	CD-277J	.39 x .87	600	.24
.012	CD-278J	.4 x .87	600	.24
.015	CD-279J	.415 x .87	600	.24
.02	CD-280J	.445 x .87	600	.24
.022	CD-281J	.47 x .87	600	.24
.025	CD-282J	.5 x .87	600	.24
.033	CD-283J	.43 x 1.15	600	.27
.039	CD-284J	.47 x 1.15	600	.30
.047	CD-285J	.49 x 1.15	600	.33
.05	CD-286J	.49 x 1.15	600	.33
.1	CD-287J	.64 x 1.3	600	.39
.22	CD-288J	.75 x 1.56	600	.60
.25	CD-289J	.83 x 1.56	600	.66
.01	CD-290J	.525 x 1.18	1600	.33
.033	CD-291J	.695 x 1.6	1600	.48
.047	CD-292J	.785 x 1.6	1600	.54
.001	CD-293J	.36 x .87	2000	.30
.0047	CD-294J	.495 x 1.187	2000	.42
.012	CD-295J	.6 x 1.25	2000	.54
.027	CD-296J	.625 x 1.25	2000	.69
.05	CD-297J	.8 x 1.75	2000	.84

Av. shgp. wt. 4 oz.

PRINTED CIRCUIT ELECTROLYTICS

Stock No.	Mfd.	WVDC	Size Inches	Each
CD-211J	300	6	3/8 x 3/8	.42
CD-212J	400	6	3/8 x 1 1/8	.45
CD-213J	1000	6	1/2 x 1	.75
CD-214J	100	10	3/8 x 1 1/2	.36
CD-215J	250	10	3/8 x 5/8	.42
CD-216J	300	10	3/8 x 1 3/8	.45
CD-217J	200	16	3/8 x 1 3/8	.45
CD-218J	500	16	1/2 x 1	.75
CD-219J	1000	16	5/8 x 1 1/4	1.05
CD-220J	50	25	3/8 x 1/2	.36
CD-221J	100	25	3/8 x 5/8	.45
CD-222J	150	25	3/8 x 1 1/8	.60
CD-223J	250	25	1/2 x 1 3/8	.69
CD-224J	30	35	3/8 x 1/2	.36
CD-225J	200	35	1/2 x 1	.72
CD-226J	10	50	5/16 x 1/2	.30
CD-227J	20	50	3/8 x 1/2	.33
CD-228J	30	50	3/8 x 3/8	.39
CD-229J	50	50	3/8 x 3/8	.45
CD-230J	100	50	1/2 x 1	.60
CD-231J	1	100	3/8 x 1/2	.27
CD-232J	2	100	3/8 x 1/2	.27
CD-233J	5	100	3/8 x 1/2	.30

SILVERED-DIPPED MICAS—500 WVDC

Stock No.	Cap. Pf.	Size (Inches) L x W x T	Each
CD-114J	5	.450 x .360 x .170	.24
CD-115J	10	.450 x .360 x .170	.24
CD-116J	18	.450 x .360 x .170	.22
CD-117J	22	.450 x .360 x .170	.22
CD-118J	27	.450 x .360 x .170	.22
CD-119J	33	.450 x .360 x .170	.22
CD-120J	39	.450 x .360 x .170	.22
CD-121J	43	.450 x .360 x .170	.22
CD-122J	47	.450 x .360 x .170	.22
CD-123J	51	.450 x .360 x .170	.22
CD-124J	56	.450 x .360 x .170	.22
CD-125J	68	.450 x .360 x .180	.22
CD-126J	75	.450 x .360 x .180	.22
CD-127J	82	.450 x .360 x .180	.22
CD-128J	100	.460 x .360 x .180	.22
CD-129J	120	.460 x .370 x .180	.22
CD-130J	150	.460 x .370 x .190	.24
CD-131J	180	.460 x .370 x .190	.24
CD-132J	200	.460 x .380 x .190	.24
CD-133J	220	.460 x .380 x .200	.24
CD-134J	240	.460 x .380 x .200	.24
CD-135J	270	.470 x .390 x .210	.27
CD-136J	300	.470 x .390 x .210	.30
CD-137J	330	.470 x .390 x .210	.30
CD-138J	360	.470 x .400 x .220	.33
CD-139J	390	.470 x .400 x .220	.33
CD-140J	430	.480 x .400 x .230	.33
CD-141J	470	.480 x .410 x .230	.36
CD-142J	510	.490 x .420 x .240	.39
CD-144J	560	.550 x .510 x .200	.43
CD-145J	620	.650 x .510 x .200	.47
CD-146J	680	.650 x .510 x .210	.51
CD-147J	750	.650 x .510 x .210	.51
CD-148J	820	.650 x .510 x .210	.51
CD-149J	1000	.650 x .520 x .220	.56
CD-150J	1100	.650 x .520 x .220	.57
CD-151J	1500	.660 x .520 x .230	.68
CD-152J	1800	.670 x .530 x .240	.77
CD-153J	2000	.670 x .530 x .240	.83
CD-154J	2200	.670 x .530 x .250	.87
CD-155J	2400	.670 x .540 x .260	.95
CD-156J	2700	.680 x .540 x .270	1.05
CD-157J	3300	.680 x .550 x .290	1.23
CD-158J	3900	.690 x .560 x .310	1.50
CD-159J	4700	.700 x .580 x .350	1.85
CD-160J	5100	.710 x .590 x .370	1.90

TUBULAR ELECTROLYTICS

Cap. Mfd.	WVDC	Stock No.	Size Inches	Replaces Values	Each
10,000	10	CD-161J	1 x 2 1/16	5-10,000	4.14
1000	16	CD-162J	5/8 x 1 1/8	500-1000	1.47
5000	16	CD-163J	1 x 2 3/8	2500-5000	3.36
10	25	CD-164J	3/4 x 1 1/2	5-10	.60
25	25	CD-165J	5/8 x 5/8	12-25	.63
50	25	CD-166J	3/8 x 3/4	25-50	.66
100	25	CD-167J	3/8 x 3/4	50-100	.78
250	25	CD-168J	1/2 x 1 1/8	125-150	1.08
100	35	CD-169J	3/8 x 1	50-100	.78
500	35	CD-170J	5/8 x 1 1/8	250-500	1.47
1000	35	CD-171J	3/4 x 1 1/8	500-1000	2.46
2	50	CD-172J	1/2 x 1/2	1-2	.54
5	50	CD-173J	1/4 x 1/2	3-5	.57
10	50	CD-174J	3/8 x 5/8	5-10	.60
25	50	CD-175J	3/8 x 5/8	12-25	.63
50	50	CD-176J	3/8 x 1	30-60	.75
100	50	CD-177J	1/2 x 1 1/8	50-100	.81
250	50	CD-178J	5/8 x 1 1/8	125-250	1.14
500	50	CD-179J	3/4 x 1 1/8	250-500	1.50
1000	50	CD-180J	7/8 x 2	500-1000	2.52
1500	50	CD-181J	1 x 2 3/8	700-1500	3.09
2000	50	CD-182J	1 x 2 1/8	1000-2000	3.51
5000	50	CD-183J	1 3/8 x 3 3/8	2500-5000	5.97
500	75	CD-184J	7/8 x 2	300-500	2.25
5	150	CD-185J	3/8 x 5/8	3-5	.60
10	150	CD-186J	3/8 x 7/8	6-10	.63
30	150	CD-187J	5/8 x 1 1/2	20-30	.75
60	150	CD-188J	5/8 x 1 1/8	40-60	.87
100	150	CD-189J	3/4 x 1 1/8	60-100	1.02
250	150	CD-190J	1 x 1 1/8	200-250	1.69
500	150	CD-191J	1 1/8 x 2 1/2	300-500	3.21
160	250	CD-192J	5/8 x 1 1/8	30-40	1.02
160	250	CD-193J	1 x 2 3/8	100-160	1.71
225	250	CD-194J	1 x 2 1/8	175-225	2.16
40	350	CD-195J	3/4 x 1 1/8	30-40	1.11
60	350	CD-196J	3/4 x 2 1/2	50-60	1.23
160	350	CD-197J	1 1/8 x 2 1/2	120-160	2.40
10	450	CD-198J	3/8 x 1 1/8	7-10	.81
20	450	CD-199J	3/8 x 1 1/8	15-20	.99
40	450	CD-200J	7/8 x 2	30-40	1.14
80	450	CD-201J	1 x 2 1/8	60-80	1.71
100	450	CD-202J	1 x 3 3/8	70-100	2.01
120	450	CD-203J	1 1/8 x 3 1/8	100-120	2.13
5	500	CD-204J	5/8 x 1 1/8	3-5	.87
10	500	CD-205J	5/8 x 1 1/8	7-10	.87
20	500	CD-206J	3/4 x 2	15-20	1.02
40	500	CD-207J	3/8 x 2 1/2	30-40	1.59
60	500	CD-208J	1 x 2 1/2	50-60	1.95
10	600	CD-209J	1 3/8 x 3 3/8	7-10	1.83
10	700	CD-210J	1 1/8 x 3 3/8	7-10	1.89

Olson Has Parts You Need at Prices You Like!

Rectifiers, Diodes, Heat Sinks from Olson

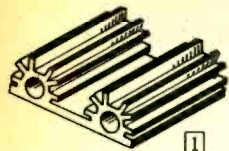

1 Aluminum Heat Sink. 1 1/4" Sq. x 1/2".
XM-027J. Wt. 2 oz. 3 for 1.20 Each 49¢

2 4-Amp Silicon Controlled Rectifier. 200 V.
0.8V gate trigger sensitivity.
TR-195J. Wt. 4 oz. 3 up @ 90¢ Ea... Each 99¢

3 2-12 Amp SCR's. In TO-66, TO-64 or TO-5.
RE-126J. Wt. 4 oz. Pkg. of 10 for 1.19
Top Hat Silicon Rectifier. 750 mA. 280V input.
400 PIV. (Not illustrated).
RE-032J. Wt. 4 oz. 3 for 2.10 Each 84¢

4 Wide Assortment of Diodes. Zener. 25 to
pkg. 400 mW. Your Choice, 1.29 3 pkgs. for 3.57
DI-032J. 4-20 Volt DI-034J. 30-39 Volt
DI-033J. 20-29 Volt DI-035J. 40-49 Volt

Germanium. Replaces 1N34A, 1N60, 1N61
DI-018J. Wt. 4 oz. Pkg. of 10 for 1.05
Silicon. 500 mA. 400 PIV. Pkg. of 4.
RE-076J. Wt. 12 oz. 3 for 3.00 Each 1.05
1-Amp Silicon Miniature Epoxy Type. Pkg. of 8.
DI-028J. 50 PIV. 1N4001. Wt. 4 oz. 1.09
DI-029J. 100 PIV. 1N4002. Wt. 4 oz. 1.49
DI-030J. 200 PIV. 1N4003. Wt. 4 oz. 1.79
DI-031J. 400 PIV. 1N4004. Wt. 4 oz. 1.99

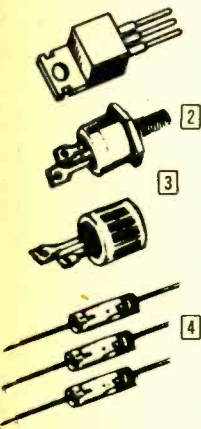

Bridge Rectifiers

Full wave. Only 3/16" Sq. x 3/16" H. 4 oz.
DI-036J. 4A, 200 PIV. Each 1.39
4 for 5.00
DI-037J. 4A, 400 PIV. Each 1.49
4 for 5.60
DI-038J. 4A, 600 PIV. Each 1.59
4 for 6.00
6-Amp types. 200, 400, or 600 PIV.
DI-039J. 200 V. 4 for 6.60 Each 1.79
DI-040J. 400 V. 4 for 7.00 Each 1.89
DI-041J. 600 V. 4 for 7.40 Each 1.99

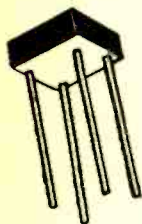

Special Transistor Bargains

Power Transistor. For high, medium
& low-power types such as 2N234,
2N234A, 2N235, 2N235A, 2N235B,
2N236, 2N36A, 2N36B, 2N342, 2N285A,
2N353, 2N400, 2N669. 4 oz.
TR-015J. 3 for 1.00 Each 39¢

2SB474 PNP Medium Power. Germa-
nium type commonly used in im-
ported amplifiers & receivers. TO-66
case.
TR-147J. Shpg. wt. 4 oz. 3.79



Power Transistor Sockets. For TO-3
case. For 6-32 mtg. holes. 4 oz.
TR-150J. Pkg. of 2 for 1.19



PNP Audio Transistors. General pur-
pose, audio type. Made in USA.
Shpg. wt. 1 lb.
TR-025J. Pkg. of 12 for 1.00



IC Operational Amplifier. TO-5 case.
Hi-Z input. Max. 250 mA at 18 V.
8 pins. Usage diagrams included.
TR-190J. Shpg. wt. 4 oz. 1.29

VALUE PAK

10 Per Package YOUR CHOICE 1¹⁹ Each



FET Silicon Transistors. Similar to 2N3819. High
frequency, high impedance. Untested.
TR-192J. Shpg. wt. 4 oz. Pkg. of 10 for 1.19
Triacs. Gate controlled, full wave. Various volt-
ages. Stock up at this low price!
TR-193J. Shpg. wt. 4 oz. Pkg. of 10 for 1.19

Integrated Circuits. Dual in-line. For low-cost
digital use.
TR-194J. Shpg. wt. 4 oz. Pkg. of 10 for 1.19
14-Pin DIP IC Socket. Press-mount types for
dual in-line packages. Flat or round pins.
Barnes 041 Series.
SC-007J. Shpg. wt. 1 oz. 3 for 1.20 .. Each 49¢

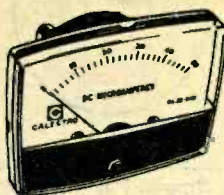

Meters That Measure For Hobbyists & Pros Alike

Calectro Panel Meters

Economical, high-quality meters with re-
freshing, modern styling. Each one fea-
tures 2% accuracy, hand calibration, lin-
ear dial scales, genuine D'Arsonval
movement with jeweled bearings, and a
crystal clear plastic coverplate. Top
width, 2 1/2"; bottom width, 2 5/8". Height
2 1/4". Depth, 1 1/4" (1 1/8" including termi-
nals). Av. shpg. wt. 1 lb.

DC CURRENT

Stk. No.	Range	Each	Stk. No.	Range	Each
ME-166J	0-50 µA	9.95	ME-170J	0-500 mA	6.50
ME-167J	0-1 mA	6.50	ME-171J	0-10 A	6.50
ME-168J	0-50 mA	6.50	ME-172J	0-3 A	6.95
ME-169J	0-100 mA	6.50

DC VOLTS

Stk. No.	Range	Each	Stk. No.	Range	Each
ME-174J	0-25 V	6.95	ME-175J	0-150 V	6.95
ME-173J	0-120 V	6.95

AC VOLTS

VU AND "S" METERS

VU Meter. Calibrated from -20
to +3 volume units. Sensitivity,
80 µA DC. Internal res. 16k.
ME-176J. Shpg. wt. 1 lb. .. 8.95

"S" Meter. Calibrated from 0 to
10. Sensitivity, 1mA. Internal re-
sistance is 100 ohms.
ME-177J. Shpg. wt. 1 lb. .. 6.95

Miniature Edgewise Meters

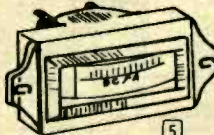

2 Panel Meter, 0-200 Microamp DC. Features
jeweled bearings, D'Arsonval movement, hand
calibration. Requires 3/8 x 1 1/2" mounting hole.
ME-178J. Shpg. wt. 4 oz. 3.95

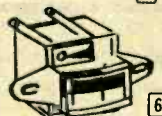

3 Panel Meter, 0-1 Milliamp DC. Features jew-
eled bearings, D'Arsonval movement, hand cali-
bration. Requires 3/8 x 1 1/2" mounting hole.
ME-180J. Shpg. wt. 4 oz. 3.35
4 Level/Battery Meter. D'Arsonval movement,
jeweled bearings. Requires 1 1/2" sq. hole.
Instructions.
ME-179J. Shpg. wt. 4 oz. 2.55

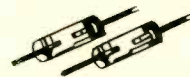

3 Pkgs. 2¹⁰

Silicon Rectifier. 1 amp silicon rectifier; 200
PIV. Replaces 1N4384. Pks. of 2.
RE-125J. Wt. 4 oz. 3 for 2.10 Each 79¢



10 For 1⁷⁹

1R 1-Amp Silicon Rectifiers. Epoxy type, only
.15 x .14" dia. Replace 1N2071. 600 PIV.
DI-044J. Wt. 4 oz. Pkg. of 10 for 1.79



12 For 2¹⁹

IR 6-Amp Silicon Rectifiers. Rugged stud
mounting. 50 PIV. In DO-4 case.
RE-129J. Wt. 4 oz. Pkg. of 12 for 2.19



3 For 1⁷⁹

IR 4-Amp SCR's. Plastic tab type. 15 volt. 1/2"
mtg. tab.
RE-128J. Wt. 4 oz. Pkg. of 3 for 1.79

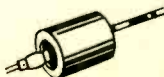

5 For 99¢

IR 1-Watt Zener Diodes. Five assorted volt-
ages from 4 to 25 volts.
RE-127J. Wt. 4 oz. Pkg. of 5 for 99¢



Quality Switches

Calectro Is A Division of G-C Electronics
All Types—for the Amateur or Professional

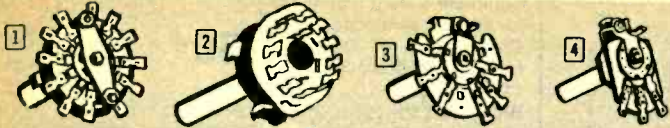

Calectro Rotary Switches for Every Need

Top quality for long service life. Silver plated contacts. Positive indexing & stops. Bushings $\frac{3}{8}$ " x $\frac{5}{16}$ " L. x $\frac{1}{8}$ " dia. Brass shaft, min. 1" L. Shpg. wt. 4 oz. each.

Stock No.	Mfr's. Type	Flg.	Number Posi.	Poles	Type	Rating	Dia.	Each
SW-601J	E2-159	1	2	1	Shorting	1A-100V	1 $\frac{1}{2}$ "	79c
SW-602J	E2-160	2	2	2	Non-Shorting	1A-100V	1 $\frac{1}{2}$ "	99c
SW-603J	E2-161	4	11	1	Non-Shorting	$\frac{1}{2}$ A-100V	1 $\frac{1}{2}$ "	1.39
SW-604J	E2-162	3	12	1	Shorting	$\frac{1}{2}$ A-100V	1 $\frac{1}{2}$ "	1.39
SW-605J	E2-163	4	5	2	Non-Shorting	$\frac{1}{2}$ A-100V	1 $\frac{1}{2}$ "	1.39
SW-606J	E2-164	3	6	2	Shorting	$\frac{1}{2}$ A-100V	1 $\frac{1}{2}$ "	1.39
SW-607J	E2-165	3	3	3	Non-Shorting	$\frac{1}{2}$ A-100V	1 $\frac{1}{2}$ "	1.39
SW-608J	E2-166	4	4	3	Shorting	$\frac{1}{2}$ A-100V	1 $\frac{1}{2}$ "	1.39
SW-609J	E2-167	4	2	4	Non-Shorting	$\frac{1}{2}$ A-100V	1 $\frac{1}{2}$ "	1.39
SW-610J	E2-168	3	3	4	Shorting	$\frac{1}{2}$ A-100V	1 $\frac{1}{2}$ "	1.39
SW-611J	E2-169	3	2	6	Shorting	$\frac{1}{2}$ A-100V	1 $\frac{1}{2}$ "	1.39

Calectro Slide Switches

5 SUBMINIATURE

Very tiny—suitable for all miniaturized equipment. Rated $\frac{1}{2}$ amp @ 50 volt. Shpg. wt. 4 oz. each.
SW-590J. SPDT. $\frac{1}{16}$ " W x $\frac{5}{16}$ " mtg. ctr. 39c
SW-591J. DPDT. $\frac{3}{32}$ " W x $\frac{3}{4}$ " mtg. ctr. 59c

6 STANDARD

Rated 3 amp @ 125 VAC. $\frac{1}{32}$ " W x $1\frac{1}{4}$ " mtg. ctr.
SW-592J. SPST. U.L. Listed. Wt. 4 oz. 29¢
SW-593J. SPDT. U.L. Listed. Wt. 4 oz. 29¢
SW-594J. DPDT. U.L. Listed. Wt. 4 oz. 35¢

7 SPRING RETURN

Ideal for use on intercoms, etc. Rated 6 amp @ 125 VAC. $\frac{1}{32}$ " W x $1\frac{1}{8}$ " mtg. ctr. U.L. Listed.
SW-595J. DPDT Type. Wt. 4 oz. 70¢

Calectro Amazing Reed Switch Kits

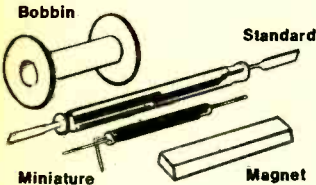

HOBBYIST SPST

Standard size with Alnico magnet. 1 amp @ up to 150 VAC/100 VDC. SW-598J. Shpg. wt. 4 oz. 99¢

PRECISION SPST

Standard size with Alnico magnet and nylon bobbin for winding relay coil. Rated $\frac{1}{2}$ amp up to 150 VDC/250 VAC. 25 watt max. capacity. Sensitivity: 40-60 AT. Activating Time: $2\frac{1}{2}$ millisecond. SW-599J. Shpg. wt. 4 oz. 1.49

MINIATURE SPDT

"Mini" switch with magnet and bobbin. Contacts rated $\frac{1}{2}$ amp up to 100 volts AC/DC. 10 watts. SW-600J. Shpg. wt. 4 oz. 1.95

Calectro Knife Switches With Screw Terminals

Ideal for switching antennas, batteries and other low-voltage applications. Has low loss, high dielectric insulating Bakelite base and handle. Spring plated brass contacts, screw connections. Smooth action. Rated 5 amps, 150 VAC. SW-596J, SPDT. Wt. 4 oz. 45c
SW-597J. DPDT. Wt. 4 oz. 50c

Olson Switches and Kits

Olson's Own Brand—Top-Quality—Low Prices

1 Miniature Toggles. SPST. 3A contacts. $\frac{1}{4}$ " mtg. hole. $\frac{1}{2}$ " x $\frac{1}{8}$ " x $\frac{1}{16}$ ". SW-423J. Wt. 4 oz. 3 For 4.50 Each 1.69

DPDT. Toggle, 3A Contacts. SW-406J. Wt. 4 oz. 3 For 4.80 Each 1.79

DPDT. Center-Off. Spring ret. 1 way. SW-424J. Wt. 4 oz. 3 For 6.00 Each 2.19

2 Toggle Switch. SPST, 6A @ 250 volts. $\frac{7}{8}$ x $1\frac{1}{2}$ ". SW-412J. Wt. 4 oz. 4 For 5.00 Each 1.29
Same as above but DPDT. SW-413J. Wt. 4 oz. 4 For 6.00 Each 1.79

3 KIT Of 3 Toggles. SPST and DPDT. 3 amps @ 125 volts. $\frac{3}{4}$ x $1\frac{3}{4}$ x $\frac{3}{4}$ ". Wt. 4 oz. SW-154J. 10 @ 1.99 Each 2.19

4 Center-Off Toggles. Kit of two DPDT. 6A @ 125 V or 3A @ 250 V. $\frac{3}{4}$ x $1\frac{1}{2}$ x $\frac{3}{4}$ ". Wt. 4 oz. SW-156J. 10 @ 1.99 Each 2.09

5 "Long Handle" Toggle. $1\frac{1}{2}$ " handle, SPST brass spring loaded contacts. $1\frac{1}{2}$ x $1\frac{1}{8}$ x $\frac{1}{2}$ ". SW-539J. Wt. 4 oz. 4 For 6.80 Each 1.98

6 Snap Action Toggle. N.O. or N.C. SPDT. 5A @ 125 VAC. $\frac{1}{4}$ x $\frac{3}{4}$ x $\frac{1}{2}$ ". Used, but like new! SW-567J. Wt. 4 oz. 4 For 3.60 Each 99c

7 Package of 2 SPST Tab Switches. 10 amps at 117 VAC. $\frac{1}{2}$ x $1\frac{1}{8}$ x $1\frac{1}{4}$ ". SW-384J. Wt. 4 oz. 4 For 4.40 Each 1.29

8 Pushbutton Switches. SPST momentary contact type. Kit of 5 miniature. $\frac{3}{8}$ x $\frac{1}{4}$ " dia. SW-452J. Wt. 4 oz. 4 For 5.00 Each 1.49

9 Package of 2 Pushbutton Switches. SPST, 3 Amp @ 250 Volts. With mounting hardware. SW-420J. Wt. 4 oz. 4 For 6.00 Each 1.59

10 Phone-Type Lever Switch. 3 locking positions, 4 SPST contacts. $1\frac{1}{16}$ x $2\frac{1}{2}$ x $\frac{3}{16}$ ". SW-431J. Wt. 1 lb. 4 For 5.00 Each 1.39

11 KIT Of 6 Slide Switches. Assorted SPST, SPDT, DPST & DPDT. 1A @ 125 V. $\frac{1}{2}$ x $\frac{7}{8}$ x $1\frac{1}{4}$ ". SW-153J. Wt. 4 oz. 4 For 6.00 Each 1.79

Kit of 10 slide switches. Used. SW-436J. Wt. 4 oz. 4 For 4.40 Each 1.19

12 5-Amp Mercury Switch. SPST, N.O. or N.C. SW-586J. Wt. 5 oz. 3 For 4.80 Each 1.69

13 See-Saw Switch. DPDT. 3A @ 250 V. For $\frac{3}{4}$ " Dia. hole. SW-409J. Wt. 4 oz. 4 For 4.00 Each 1.09

14 N.O. or N.C. SPDT Contacts. 10 amps @ 125 VAC. 1" lever actuator. $1\frac{1}{8}$ x $\frac{1}{2}$ x $\frac{3}{8}$ ". SW-441J. Wt. 4 oz. 4 For 2.80 Each 79c

15 Unimax SPDT Lever Action Switch. N.O. or N.C. contacts. 20 amps at 125 VAC. UL listed. $1\frac{1}{8}$ x $\frac{3}{4}$ x $\frac{3}{8}$ ". $\frac{1}{2}$ " lever. SW-579J. Wt. 4 oz. 4 For 3.60 Each 98¢

16 Spring-Loaded Contacts. SPST N.O. and rated 10A @ 125 volts AC. $2\frac{1}{8}$ x $\frac{1}{8}$ ". SW-454J. Wt. 1 lb. Pkg. of 4 For 1.09

17 Assortment of 12 SPST, SPDT. Hard to find types. Handles, levers, buttons. Snap action. SW-564J. Wt. 1 lb. Each 2.99

Assortment of 12 "Mini" Switches. SPST, SPDT types. With/without levers. Snap action. SW-563J. Wt. 1 lb. Each 2.99

18 Switch "Snap-Action" Kit. New/Used. Seven assorted types. Single and multipole. SW-430J. Wt. 1 lb. Each 1.69

19 Dry Reed Switches. SPST-NO. Pkg. of 10 hermetically sealed, high sensitivity. SW-632J. Wt. 4 oz. Each 2.49

20 Thermostat Control. SPST-NC contacts open on heat rise. Bi-metal sensing element. SW-629J. Wt. 4 oz. Each 1.29

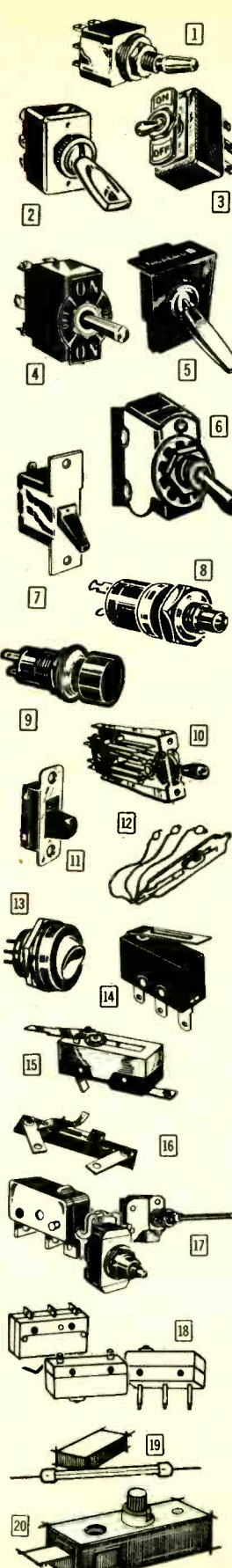



2⁹⁹

Duodecal CR-69. Black-and-white. Series-parallel. XM-194J. ½ lb. 2.99



2⁹⁹

110° Button CR-154. RCA-type. Series - parallel. Black-and-white. XM-195J. ½ lb. 2.99



2⁹⁹

110° Shell. CR-159. Syl- vania- type. Series- paral- lel. B & W. XM-196J. ½ lb. 2.99



2⁹⁹

Miniature. CR-12. 7-pin. Black-and-white. Series- parallel. XM-193J. ½ lb. 2.99



7⁹⁹ Color

CR-200. Autoformer type. XM-197J. 70° Rd. Tube 7.99. XM-198J. CR-250. 90° Button 7.99



54⁹⁵

“Econo” Picture Tube Test Rig
Model EJ-190. Service color or black-and-white TV chassis without pulling the picture tube or yoke assembly. Has universal and convergence yokes; 4-ft. anode, CRT and yoke extensions, blue lateral magnet. Compact metal case. Less tube.
TE-378J. Shpg. wt. 10 lbs. 54.95



44⁹⁸

Portable Color CRT Tester
Model KP-710. Tests color CRT's for emission, leakage and shorts. Has switches for each color gun, line adjust, easy to read scale. For 90° CRT's. 8¼ x 5 x 4". For 117 VAC.
TE-362J. Shpg. wt. 6 lbs. 44.98
XM-215J. Adapter for 70° CRT's. ½ lb. 2.99

50⁰⁰
Battery Operated

Instant Tuner Checks



“Tuner Substitution” Tester
Model KT-730. Pinpoints trouble in antenna, tuner or IF section of 40 MHz black-and-white or color TV's. Tests all VHF channels, checks output of UHF channels. Pays for itself!
TE-364J. Battery Model. 6 lbs 50.00
TE-363J. KTE-725. Above, for 117 VAC 54.98



Nucleonic Products Co. Power Supplies

Make All Your Appliances Do “Double Duty”—Home to Car, Car to Home

1 12 VDC Negative Ground Power Inverter

Model 612. Operate 12 VDC negative ground mobile equipment in VW's, trucks, tractors, other vehicles with either 6 volt negative ground or 12-volt positive ground systems. Rated 3 amps continuous, 10 amp surge. Solid-state circuit with two power transistors, shock-resistant coils. Fused line cord. 2½ x 3 x 5".
AU-401J. Shpg. wt. 3 lbs. 19.95

2 12 VDC to 117 VAC Power Inverter

Model 12-115. Operate all types of AC appliances—even television or tape recorders—in your 12 VDC negative ground vehicle. Rated 200 watts continuous, 240 watts peak. Has high-reliability silicon-transistor circuit, power on-off switch, pilot light. Short circuit and overload protected. Withstands high temperatures without failing. Metal case, 7½ x 4 x 5½".
AU-326J. Shpg. wt. 7½ lbs. 49.95

3 117 VAC to 12 VDC Power Converter

Model 102. Lets you operate your mobile cassette or cartridge tape player from AC house current. Has special circuit breaker component that instantly shuts off 12 VDC output in case of overload, (restores power within 60 seconds after overload is corrected) heavy-duty binding posts, neon indicator light, on-off switch. Rated at 4 amps. 4¾ x 3 x 5¾". U.L. Listed.
BA-235J. Shpg. wt. 4 lbs. 19.95

4 117 VAC to 12 VDC Regulated Power Converter

Model 104R. Deluxe performer quietly converts 117 VAC to 12 VDC for mobile equipment operation in the home. Full regulation means you can even operate CB or Ham rigs without fear of burnout when switching from transmit (heavy-current-draw) to receive (low-current draw). Has other features same as Model 102 above. 4 amp current rating. U. L. Listed.
BA-234J. Shpg. wt. 4 lbs. 29.95

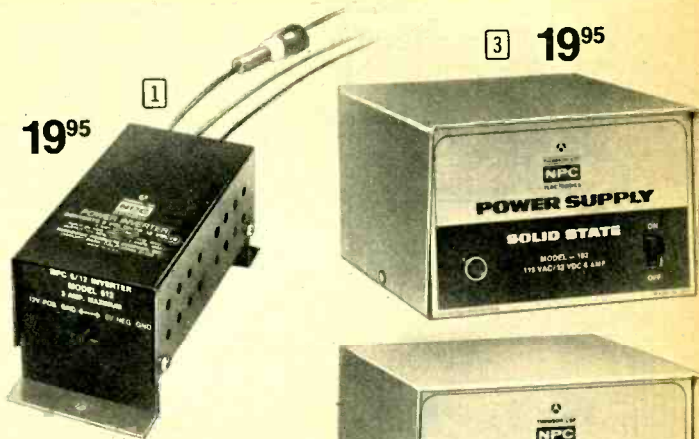

19⁹⁵

3 19⁹⁵

All These Power Supplies Are U.S. Made



2 49⁹⁵

4 29⁹⁵



First-Quality Transformers, Coils and Coil Forms

Calectro Compact Transformers for Every Job

Olson stocks a complete line of Calectro transformers for every need. Subminiature and miniature audio, transistor audio, transistor driver, output (tube type), power supply and filament, power (tube type).



SUBMINIATURE AUDIO TRANSFORMERS

For ultra compact transistor radios, subminiature amplifiers, hearing aids, etc., improved design using special alloy cores and nylon bobbins. Shpg. wt. ¼ lb.

Fig.	Type	IMPEDANCE IN OHMS		SIZE IN INCHES			Stock	
		Prim.	Sec.	MW*	H	D	No.	Each
1	Input	100,000	1,000	19/32	½	½	TF-002J	.95
1	Driver	10,000	2,000 CT	19/32	½	½	TF-003J	.95
1	Output (0.1W)	500 CT	8	19/32	½	½	TF-004J	.95

MINIATURE AUDIO TRANSFORMERS

These transformers fit most transistor radios. Excellent for replacement or for building experimental circuits, science projects, etc. Shpg. wt. ¼ lb.

Fig.	Type	IMPEDANCE IN OHMS		SIZE IN INCHES			Stock	
		Prim.	Sec.	MW*	H	D	No.	Each
1	Input	150,000	1,000	¾	¾	¾	TF-005J	1.10
1	Input	20,000	1,000	¾	¾	¾	TF-006J	1.10
1	Driver	10,000	2,000 CT	¾	¾	¾	TF-007J	1.10
1	Output (0.2W)	1200 CT	3.2 & 8	¾	¾	¾	TF-008J	1.10
1	Output (0.2W)	500 CT	3.2 & 8	¾	¾	¾	TF-009J	1.10

TRANSISTOR AUDIO TRANSFORMERS

This type is used extensively in larger transistor radios, tape recorders and phono amplifiers. Exceptional quality for their size and price. Shpg. wt. ¼ lb.

Fig.	Type	IMPEDANCE IN OHMS		SIZE IN INCHES			Stock	
		Prim.	Sec.	MW*	H	D	No.	Each
1	Driver	1000 CT	500 CT	1	¾	¾	TF-010J	1.25
1	Output (0.4W)	2000 CT	3.2 & 8	1	¾	¾	TF-011J	1.25
1	Output (0.5W)	500 CT	3.2 & 8	1	¾	¾	TF-012J	1.25

TRANSISTOR DRIVER TRANSFORMERS

For construction of amplifiers with or without output transformers. TF-013J is furnished with schematic for typical 10-watt low cost, easy-to-build amplifier. Shpg. wt. ½ lb.

Fig.	Type	IMPEDANCE IN OHMS		SIZE IN INCHES			Stock		
		Prim.	Sec.	MW*	W	H	D	No.	Each
2	Push-pull Split Second 0.5W	35 (100mA DC)	2 ohm ea. ratio: 6.7:1:1	1¾	2¾	1¾	1¾	TF-013J	2.40

OUTPUT TRANSFORMERS, TUBE TYPE

Universal transformers for all tube type single or push-pull amplifiers up to 8 watts. Depending on connections, these transformers will match all standard tube types. Shpg. wt. 1 lb.

Fig.	Type	IMPEDANCE IN OHMS		SIZE IN INCHES			Stock		
		Prim.	Sec.	MW*	W	H	D	No.	Each
3	4 WATT	1000 to 4500	3.2 & 8	2	2¾	1¾	1¾	TF-014J	2.95
3	8 WATT	2500 to 10,000	3.2 & 8	2¾	2¾	1¾	1¾	TF-015J	3.50

POWER SUPPLY AND FILAMENT TRANSFORMERS

For constructing power supplies for transistorized devices, battery chargers, filament supplies for tubes, etc. Highest quality; conservatively rated. Shpg. wt. 4½ lbs.

Fig.	Primary	SECONDARY		SIZE IN INCHES			Stock		
		Volt	Amp.	MW*	W	H	D	No.	Each
2	117 V-60Hz	6.3 CT	1.2	2¾	2¾	1¾	2	TF-016J	2.80
2	117 V-60Hz	12.6 CT	2	2¾	3¾	1¾	1¾	TF-017J	4.30
2	117 V-60Hz	12.6 CT	0.1	2¾	2¾	1¾	1¾	TF-018J	2.50
2	117 V-60Hz	25.2 CT	0.5	2¾	3¾	2	1¾	TF-019J	3.95
2	117 V-60Hz	25.2 CT	2	3¾	4	2¾	2¾	TF-020J	5.90
2	117 V-60Hz	36VAC CT	1.3	3¾	4	2¾	2¾	TF-021J	6.95

POWER TRANSFORMERS, TUBE TYPE

For radios, amplifiers and other electronic equipment using tubes. Shpg. wt. 3 lbs.

Fig.	Primary	Secondaries		SIZE IN INCHES			Stock		
		Volt	Amp.	MW*	W	H	D	No.	Each
2	117 V-60Hz	1. 125V-15mA 2. 6.3V-600mA		2¾	2¾	1¾	1¾	TF-022J	\$3.49
4	117 V-60Hz	1. 500V CT (250-250) @ 40mA 2. 6.3V CT @ 2A		1¾	2¾	2¾	2¾	TF-023J	6.50

*Spacing between mounting lugs.

Calectro Coils & Coil Forms

Ferrite Coils BAR ANTENNA

Ideal for construction of broadcast band transistor radios or as replacements. Separate primary and secondary windings permit use in any standard circuit. Inductance, 235 µH. Cap., 350-380 pF. Length: 3¼".

LS-003J. Shpg. wt. 4 oz. ... 95¢

TUNABLE ANTENNA

"Loop-Stick." Universal, tunable, tube or transistor circuits. Unlimited applications—from crystal set to hi-fi tuner. Mtg. bracket included. ½" dia. x 2¾" L. Wt. ¼ lb.

LS-001J. 250-450 pF. 1.10
LS-002J. 100-250 pF. 1.10

Coil Forms HORIZONTAL MOUNTING PC TYPE

Tunable ferrite slug. 4 terminals. Diam.: ½". Length: 1½". For coil frequencies to 25 MHz.

LS-004J. Shpg. wt. 4 oz. ... 85¢

VERTICAL MOUNTING PC TYPE

Ferrite slug tuned. Frequency range to 25 MHz. 4 terminals. Diam.: ½". Length: ¾".

LS-008J. Shpg. wt. 4 oz. ... 75¢

CERAMIC, SINGLE HOLE MOUNTING TYPE

Supplied with tunable ferrite core, adjustable from top or bottom. Freq. range to 25 MHz. Av. shpg. wt. ¼ lb.

LS-005J. ½" x 1½" 1.30
LS-006J. ¾" x 1" 1.42
LS-007J. ½" x ½" 1.60

PLUG-IN STYLE

Perfect for winding all types of coils for experimental circuits and hobby or science projects. Excellent for short-wave sets, wavemeters, etc. Low-loss phenolic with 4 pin base. Diam.: ¾". Length: 1¼". Shpg. wt. 4 oz.

LS-009J. 1 form, 1 socket 79¢
LS-010J. 1 form only. 45¢

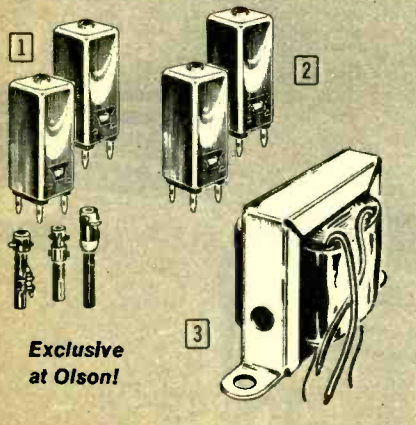
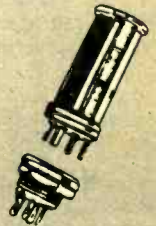
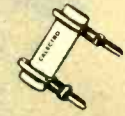

Exclusive at Olson!

Olson Transformers and Coils

- IF Types.** Package of 10 contains IF transformers, RF and peaking coils. LL-077J. Shpg. wt. ¼ lb. Kit 59¢
- IF 455 kHz.** One each input and output transformer. ¾ x 2 x ¾". Instructions. LL-083J. Shpg. wt. ¼ lb. Pkg. 1.98
- 70.7 V Line.** Primary: 500 to 2000 ohms. Secondary: 4-16 ohms. 10 watts. 2 x 1½ x 1½". TT-110J. Shpg. wt. 1¾ lbs. Each 2.35
3-11 Each 2.00 12-Up Each 1.75
- Power.** Primary: 110-125 VAC. Secondary: 24 V at 1 amp. 2¾ x 2¾ x 2¾". TT-290J. Shpg. wt. 1¾ lbs. 2.49

- Audio Output.** Primary: 2500 ohms, 3W. Sec.: 4-8 ohms. For 50C5, 50L6, etc. 1½ x 2 x ½". TT-092J. Shpg. wt. ½ lb. 1.05
- Audio Output.** Primary: 5000 ohms. 5 W. Secondary: 4-8 ohms. For 6V6, 6L6, etc. 1½ x 2 x 1½". TT-448J. Shpg. wt. ¼ lb. 1.14
- Filament.** Primary: 110-125 VAC. Secondary: 6.3 V at 0.5 A. Approx. Size 2¾ x 1¾ x 1½". TT-444J. Shpg. wt. 1 lb. 1.05
TT-076J. 6.3 V @ 1 A. 1.98
TT-304J. 12.6 V @ 1 A. 2.09
TF-027J. 12 V @ .7A. 3 for 5.40. Each 1.98

IC's and Solid-State Devices from G-C Calectro

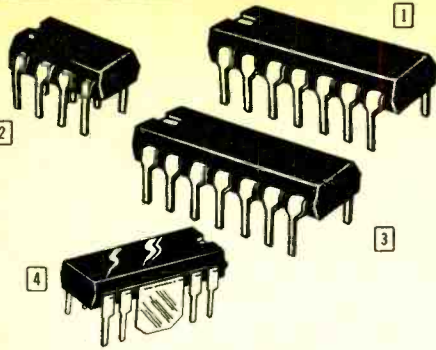

1 TTL Integrated Circuits

Quadruple 2-Input Positive NAND Gate. (7400 equivalent). VCC: 5 volts \pm 0.25 V. ICC: Logic 0 = 12 mA typ., 22 mA max. Logic 1 = 4 mA typ., 8 mA max. TR-405J. Shpg. wt. ¼ lb. 2/1.88. Each 98c

Quadruple 2-Input Positive NOR Gate. (7402 equivalent). VCC: 5 volts \pm 0.25 V. ICC: Logic 0 = 14 mA typ., 27 mA max. Logic 1 = 8 mA typ., 16 mA max. TR-406J. Shpg. wt. ¼ lb. 2/1.88. Each 98c

Hex Inverter. (7404 equivalent). VCC: 5 volts, \pm 0.25 V. ICC: Logic 0 = 18 mA typ., 33 mA max., Logic 1 = 6 mA typ., 12 mA max. TR-407J. Wt. ¼ lb. 2/2.20. Each 1.19

Triple 3-Input Positive NAND Gate. (7410 equivalent). VCC: 5 volts \pm 0.25 V. ICC: Logic 0 = 9 mA typ., 16 mA max. Logic 1 = 3 mA typ., 6 mA max. TR-408J. Wt. ¼ lb. 2/1.88. Each 98c

BCD-to-7 Segment Decoder/Driver. (7447 equivalent). Voltage at outputs: 15 volts max. VCC: 5 volts \pm 0.25 V. ICC: 53 mA typ., 90 mA max. TR-409J. Wt. ¼ lb. 2/6.60. Each 3.45

Quadruple Bistable Latch. (7475 equivalent). VCC: 5 volts \pm 0.25 V. ICC Supply current: 32 mA typ., 53 mA max. TR-410J. Wt. ¼ lb. 2/5.60. Each 2.95

Dual J-K Master/Slave Flip-Flop with Pre-Set and Clear. (7476 equivalent). VCC: 5 volts \pm 0.25 V. ICC Supply current (for each flip-flop) 20 mA typ., 40 mA max. TR-411J. Wt. ¼ lb. 2/3.38. Each 1.79

Decade Counter. (+ 2, + 3, + 10). (7490 equivalent). VCC: 5 volts \pm 0.25 V. ICC: 35 mA typ., 58 mA max. TR-412J. Wt. ¼ lb. 2/5.10. Each 2.69

Divide-By-12 Counter. (+ 2, + 3, + 6, + 12). (7492 equivalent). VCC: 5 volts \pm 0.25 V. ICC: 31 mA typ., 51 mA max. TR-413J. Wt. ¼ lb. 2/5.10. Each 2.69

Monostable Multivibrator. (74121 equivalent). VCC: 5 volts \pm 0.25 V. ICC: in unfired state, 13 mA typ., 25 mA max. Fired state: 23 mA typ., 40 mA max. TR-414J. Wt. ¼ lb. 2/3.38. Each 1.79

LINEAR INTEGRATED CIRCUIT. Time-Oscillator-Modulator. (NE555 equivalent). Power diss.: 600 mW. Current output: 20 mA. VCC: 4.5 volt min., 15 volt max. ICC: 3 mA typ., 6 mA max. 10 mA typ., 15 mA max. TR-415J. Wt. ¼ lb. 2/5.60. Each 2.95

2 Operational Amplifier

Type 741. Frequency compensated, low power input-output offset. Popular mini "dip" case fits standard DIP socket. Typical circuits included. TR-416J. Wt. ¼ lb. 2/3.38. Each 1.75

3 1-Watt Audio Amplifier

Output: 1 watt rms into 8 ohm speaker. Response: 50-20,000 Hz. Input: 3-18 V at 50k ohms. Power: 6-12 VDC at 60 mA. TR-417J. Wt. ¼ lb. 2/6.60. Each 3.45

4 4-Watt Audio Amplifier

4 watts rms into 8-ohm speaker. 35-75,000 Hz response. Input: 30-46 mV at 50k ohms. TR-418J. Wt. ½ lb. 2/11.60. Each 5.95

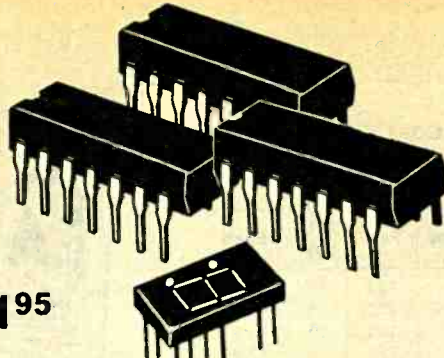

1195

Digital Counter LED Kit

All you need to build complete decade counter (0-9) including negative for PC board. Operates from 5-volt DC supply. Includes counter, latch, decoder/driver, LED 7 segment display; 150 ohm, ¼ watt resistors. TR-404J. Shpg. wt. ¼ lb. 11.95

Field Effect Transistors

5 N-Channel, J-FET. For general purpose audio, medium-frequency amplifier use, requiring low input current and low noise figure. Cross references included. TR-419J. Wt. ¼ lb. 2/2.58. Each 1.39

5 N-Channel J-FET. For VHF/UHF amp/mixer/oscillator uses. Cross references. TR-420J. Wt. ¼ lb. 2/2.58. Each 1.39

6 Matched Dual FET's. For wideband differential amps, small and moderate signal amps requiring high transconductance and low input capacitance. TR-421J. Wt. ¼ lb. 2/5.50. Each 2.95

Diodes/Rectifiers

7 Triac/Diac Kit. 6 amp, 200 VAC. For light dimmers, motor speed controls, etc. Triac tab electronically isolated. With one triac, one diac, typical circuit. DI-048J. Wt. ¼ lb. 2/5.60. Each 2.95

8 Silicon-Controlled Rectifier. For AC control circuits, DC triggers, etc. 4 amps at 200 V peak. ½ to 1½ volt gate triggering. Gate sensitivity: 0.2 mA to 0.5 mA. DI-047J. Wt. ¼ lb. 6/7.74. Each 1.39

9 Zener Diode Assortment. One each 6, 9, and 12-volt zener diodes. 1 watt, 10%. DI-046J. Wt. ¼ lb. 6/6.00. Each 1.19

10 Light Emitting Diode. 1.5-3 VDC, 30-50 mA. Low-power consumption, almost infinite life. Excellent for use as pilot light in battery-powered devices. DI-045J. Wt. ¼ lb. 6/3.90. Each 89c

Heat Sinks/Insulation

11 Heat Sink. For all flat pack, thermo-tab transistors. Diss., 16°C per watt temp. rise. HW-122J. Wt. ¼ lb. 2/90c. Each 49c

12 Semiconductor Insulation Kit. Has all insulators and spacers for mounting power transistors, stud mount diodes, rectifiers, zeners, SCR's. Fits TO-3, 36, 66, others. HW-120J. Wt. ¼ lb. 2/1.08. Each 59c

13 Heat Sink. For TO-66 power transistors. Diss., 18°C per watt temp. rise. HW-123J. Wt. ¼ lb. 2/1.08. Each 59c

13 Heat Sink. For TO-3 type power transistors. Diss., 11°C per watt temp. rise. HW-124J. Wt. ¼ lb. 2/1.08. Each 59c

14 Heat Sink for transistor types TO-5/TO-18. Diss., 45°C per watt temp. rise. HW-121J. Wt. ¼ lb. 2/1.08. Each 59c

15 Heat Sink. Universal hole pattern for TO-3, 36, 66, 220 transistors, SCR's, stud-mounted rectifiers. Diss. 2½°C. HW-125J. Wt. ¼ lb. 2/4.50. Each 2.39

16 Heat Sink Compound. Silicon base. For heat transfer from semiconductors to heat sink. HW-126J. Wt. ¼ lb. 2/1.30. Each 69c

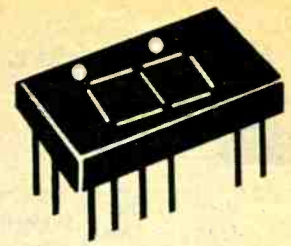

556 Each

7 Segment LED Display

Can be driven by standard TTL-7 segment decoder/driver. Plugs into standard IC socket. Anode voltage: 5.5 max, cathode current, 40 mA per cathode. Character size: .334 x .210". TR-403J. Wt. ¼ lb. 2/10.80. Each 5.56

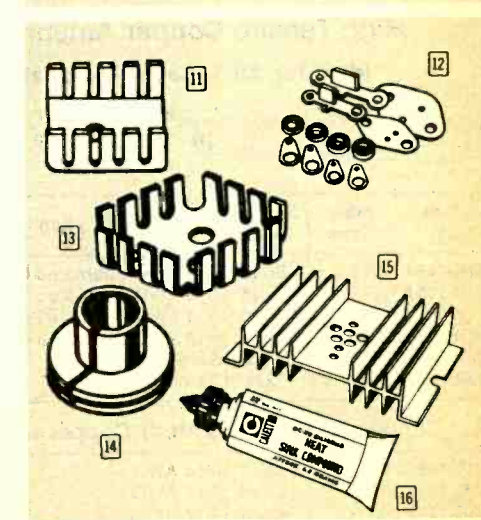
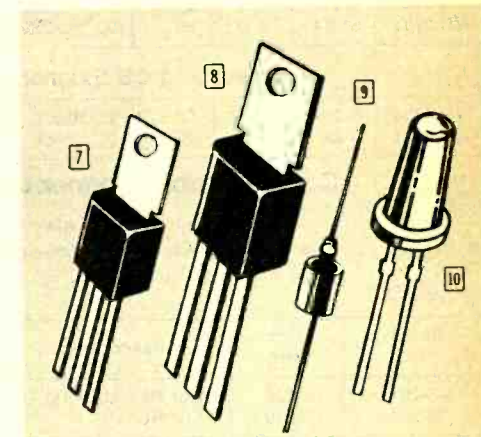
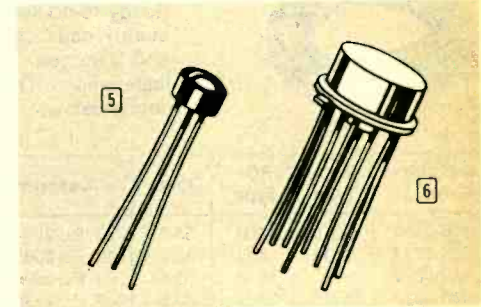

Saxton Wire and Cable for Ham, CB, General Uses

For Amateur and CB Applications



Coax Cable
PVC Jacketed Type

Stock No.	Mfr's Type	RG Type	Dielectric	Ohms	Feet	Wt. Lbs.	Each
WR-094J	1582	8/U	PE	52	100	10	17.95
WR-095J	1582	8/U	PE	52	250	25	42.50
WR-096J	1583	8/U	Foam	50	100	10	18.98
WR-097J	1583	8/U	Foam	50	250	25	43.95
WR-098J	1589	58/U	PE	53.5	100	5	6.49
WR-099J	1589	58/U	PE	53.5	250	13	16.39
WR-100J	1600	58A/U	Foam	53.5	100	5	7.99
WR-101J	1600	58A/U	Foam	53.5	250	13	18.49

Coaxial Cable Assemblies



Ready-to-connect assemblies of quality coax cable. Use with CB and Ham gear, in base or mobile installations. There's one for your needs below.

Stock No.	Mfr's Type	RG-Type	Ohms	Description	Wt. Lbs.	Each
WR-076J	S-810	58/U	53.5	20' PL-259/Lugs	1	3.98
WR-077J	S-811	58/U	53.5	20' PL-259/PL-259	1	4.49
WR-080J	S-915	58/U	53.5	50' PL-259/PL-259	3	6.98
WR-081J	S-916	58/U	53.5	100' PL-259/PL-259	5	9.98
WR-078J	S-913	8/U	50	50' PL-259/PL-259	5	9.98
WR-079J	S-914	8/U	50	100' PL-259/PL-259	10	19.98

Amateur and CB Extensions

WR-008J	S-234	58/U	53.5	22' Black	1	1.69
WR-075J	S-235	59/U	72	22' Black	1	1.69

Coaxial Cable Connectors

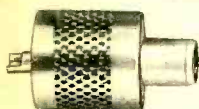

Form tight, positive electrical connections with little signal loss. Semi-solderless PL-259 connectors. Card of two.

Stock No.	Mfr's Type	Description	Wt. Lb.	Each
CB-297J	S-629	For RG8/U, RG11/U	1/2	1.79
CB-299J	S-630	For RG58/U	1/2	1.79

High Tensile Copper Antenna Wire

Ideal for All Types of Installations



High-strength wire for indoor or outdoor antenna hookups. Stock up now.

Stock No.	Mfr's Type	Strand-ing	Description	Ft.	Wt. Lbs.	Each
WR-102J	1275	Solid	#12 AWG Enameled Copper	100	1 1/2	5.19
WR-103J	1275	Solid	#12 AWG Enameled Copper	250	3	12.79
WR-104J	1280	Solid	#14 AWG Enameled Copper	100	1	3.89
WR-105J	1280	Solid	#14 AWG Enameled Copper	250	2	9.79
WR-106J	1286/100	7x22	Bare Copper	100	2	3.49
WR-107J	1288/100	7x24	Bare Copper	100	2	2.49

Copperweld (Uninsulated) Copper Clad Steel Core

WR-108J	5302	Solid	#14 AWG	100	1	3.65
WR-109J	5302	Solid	#14 AWG	250	2	9.19
WR-110J	5303	Solid	#12 AWG	100	1 1/2	4.79
WR-111J	5303	Solid	#12 AWG	250	3	11.98

All-Purpose Hookup Wire on Self-Dispensing Wire Banks

Insulated, High-Conductivity Type



Ideal electrical wire for hobbyists, experimenters, servicemen—anyone who needs reliable high-conductivity electrical connections. Use for speaker hookup, wiring in experimental circuits, more. Handy self-dispensing wire bank—take just the wire you need, the rest stays stored away neatly.

Stock No.	Mfr's Type	Gauge	Feet	Solid	Stranded	Color	Wt. Lbs.	Each
WR-034J	WS-115	18	55	x		Single	1/4	1.29
WR-035J	WS-115B	18	52		x	Single	1/4	1.29
WR-036J	WS-116	20	72	x		Single	1/2	1.29
WR-037J	WS-116B	20	70		x	Single	1/2	1.29
WR-038J	WS-117	22	90	x		Single	1/2	1.29
WR-039J	WS-117B	22	85		x	Single	1/2	1.29
WR-040J	WBS-115	18	51	x		3 Asst.	1/4	1.29
WR-041J	WBS-115B	18	48		x	3 Asst.	1/4	1.29
WR-013J	WBS-116	20	66	x		3 Asst.	1/2	1.29
WR-010J	WBS-116B	20	48		x	3 Asst.	1/4	1.29
WR-014J	WBS-117	22	81	x		3 Asst.	1/2	1.29
WR-011J	WBS-117B	22	72		x	3 Asst.	1/2	1.29
WR-015J	WBS-119	24	108	x		3 Asst.	1/2	1.29
WR-012J	WBS-120	24	96		x	3 Asst.	1/2	1.29

Electrical Extension Cords



Strong, dependable cords for use anywhere in home or shop. Increase the versatility of your power tools, appliances, etc. All are UL listed.

Stock No.	Mfr's Type	Color	Description	Feet	Wt.	Each
WR-084J	1006B	Brown	3-way cube tap	6'	4 oz.	.99
WR-135J	1006D	White	3-way cube tap	6'	4 oz.	.99
WR-085J	1012B	Brown	3-way cube tap	12'	4 oz.	1.39
WR-136J	1012D	White	3-way cube tap	12'	4 oz.	1.39
WR-086J	1017	Gray	Air conditioner type	6'	4 oz.	2.39
WR-087J	1019	Gray	Air conditioner type	12'	6 oz.	3.69
WR-088J	1020	Gray	Air conditioner type	15'	8 oz.	3.99
WR-089J	1021	Yellow	Heavy-duty 16 ga. with 3-prong plug	25'	1 lb.	4.99
WR-090J	1022	Yellow	Heavy-duty 16 ga. with 3-prong plug	50'	2 lbs.	7.59
WR-091J	1023	Yellow	Heavy-duty 16 ga. with 3-prong plug	100'	4 lbs.	13.39
WR-092J	1024	Yellow	Heavy-duty 14-ga. with 3-prong plug	25'	1 lb.	6.19
WR-093J	1025	Yellow	Heavy-duty 14-ga. with 3-prong plug	50'	2 lbs.	9.98

Guy Wire For Any Type of Installation

Stock No.	Mfr's Type	Description	Test Strength	Strength Held	Ft.	Wt. Lbs.	Each
WR-112J	5103	6W-6/18 Galv. Steel	515PSI	3%	100	2	2.39
WR-113J	5103	6W-6/18 Galv. Steel	515PSI	3%	250	5	5.79
WR-114J	5105	AL-7/18 Aluminum	370PSI	4.5%	100	2	3.39
WR-115J	5105	AL-7/18 Aluminum	370PSI	4.5%	250	5	8.59
WR-116J	7002	Fiberglass	1000PSI	—	100	2	5.98
WR-117J	7002	Fiberglass	1000PSI	—	250	5	14.98

Solid Aluminum Ground Wire

WR-118J	1240	#8 AWG, Dead Soft Alum.			100	2	2.59
WR-119J	1240	#8 AWG, Dead Soft Alum.			250	5	6.39

Saxton Twin Lead, TV Accessories, Speaker Cable

Television Installation Accessories

Lightning Arrestors

Model S-308. Universal lightning arrester gives good protection in any outdoor antenna installation. U. L. listed.

AA-235J. Shpg. wt. ½ lb.98

Model S-309. Fused lightning arrester. If lightning strikes antenna, fuse will blow—use again by simply replacing fuse.

WR-067J. Shpg. wt. ½ lb.2.98

300-Ohm Couplers

Model S-310. Hook up two TV sets or 1 TV and 1 FM set from a single downlead from your outdoor antenna. No signal loss!

WR-068J. Shpg. wt. ½ lbs.1.90

Model S-311. Use up to three TV or FM sets from a single antenna downlead. Easy hook-up—low-loss circuit.

WR-069J. Shpg. wt. ½ lb.2.29

Model S-316. Use four TV or FM sets in any combination from single antenna downlead. Makes your antenna really versatile.

WR-070J. Shpg. wt. ½ lb.2.98

Signal Splitters

Model S-313. Connects antenna lead-in to UHF and VHF antenna terminals. Essential for just about any antenna hookup.

AA-247J. Shpg. wt. ½ lbs.1.59

Model S-314. 72-to-300-ohm splitter/transformer matches 72-ohm foam coax lead-in to 300-ohm VHF-UHF terminals.

AA-392J. Shpg. wt. 1 lb.2.79

Guy and Ground Wire for Every Need

Stock No.	Mfr's Type	Description	Wt. Lbs.	Each
WR-061J	S-127	40' Aluminum Guy Wire	2	1.49
WR-062J	S-128	70' Steel Guy Wire	4	1.69
WR-063J	S-129	35' Aluminum Ground Wire	2	1.25
WR-064J	S-131	40' Plastic-Coated Guy Wire	2	1.29
WR-065J	S-132	100' Aluminum Guy Wire	5	3.49

Top-Quality Speaker Connector Wire For All 2 or 4-Channel Sound Systems

Premium quality wire lets you increase the distance between your speakers for more true-to-life stereo or 4-channel sound. It's also ideal for hooking up extension speakers anywhere in your home. Low-loss design—even lengthy hookups will not affect sound quality. NOTE: Come to your nearby Olson store for a FREE wire selection booklet.

Stock No.	Mfr's Type	Gauge	Feet	Wt. Lbs.	EACH
WR-024J	1437A	24	50	2	1.19
WR-133J	1437A	24	100	4	1.89
WR-026J	1438A	20	100	4	3.89
WR-134J	1439A	18	100	4	4.99
WR-049J	1441A	16	75	3	7.59
WR-050J	1443A	14	75	3	8.89

300-Ohm Twin-Lead for all TV and FM Antenna Installations



Premium-quality flat twin lead ideal for installation along baseboards, under rugs, etc.

Clear color for indoor use—self-dispensing pack

Stock No.	Mfr's Type	Feet	Wt. Lbs.	Each
WR-051J	TS-25C	25'	1	.79
WR-053J	TS-50C	50'	1	1.29
WR-055J	TS-100C	100'	2	1.99

Brown for indoor/outdoor use—self-dispensing pack

WR-052J	TS-25B	25'	1	.79
WR-054J	TS-50B	50'	1	1.29
WR-056J	TS-100B	100'	2	1.99

Super Twin-Foam for Color or Black-and-White TV



Weatherproof, ultra-violet resistant jacket, polyethylene foam protected conductors. For VHF or UHF.

WR-057J	1037	50'	4	2.49
WW-541J.	1037	100'	4	4.98

Color Foam Cable with 100% Foil Shielding



Especially recommended for color TV installation where interference might be present. Really helps!

WR-059J.	1041	50'	4	6.99
WW-543J.	1041	100'	4	11.98

100' 5-Conductor Cable



For antenna installations with directional rotators that require 5-conductor cable.

Heavy-duty 20-gauge stranded copper.

WW-533J. Shpg. wt. 2 lbs.4.98

Deluxe Intercom Cable



Model S-104. 3-conductor cable for 2-station intercom installations. 40', no jacket.

WR-022. Shpg. wt. 2 lbs.1.29

Model S-105. 3-conductor, with vinyl jacket. 24'.

WR-155J Shpg. wt. 2 lbs.1.29

Model S-161. 4-conductor cable for interconnecting up to three separate intercom units. 20'.

WR-023J Shpg. wt. 2½ lbs.1.29

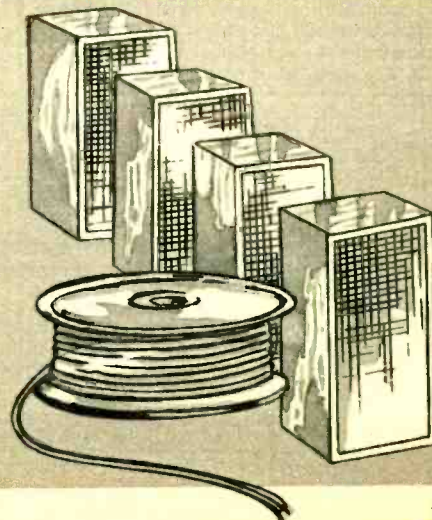

Relays and Solenoids at Low Olson Prices

Hobbyists, Experimenters, Servicemen, Stock Up Now!

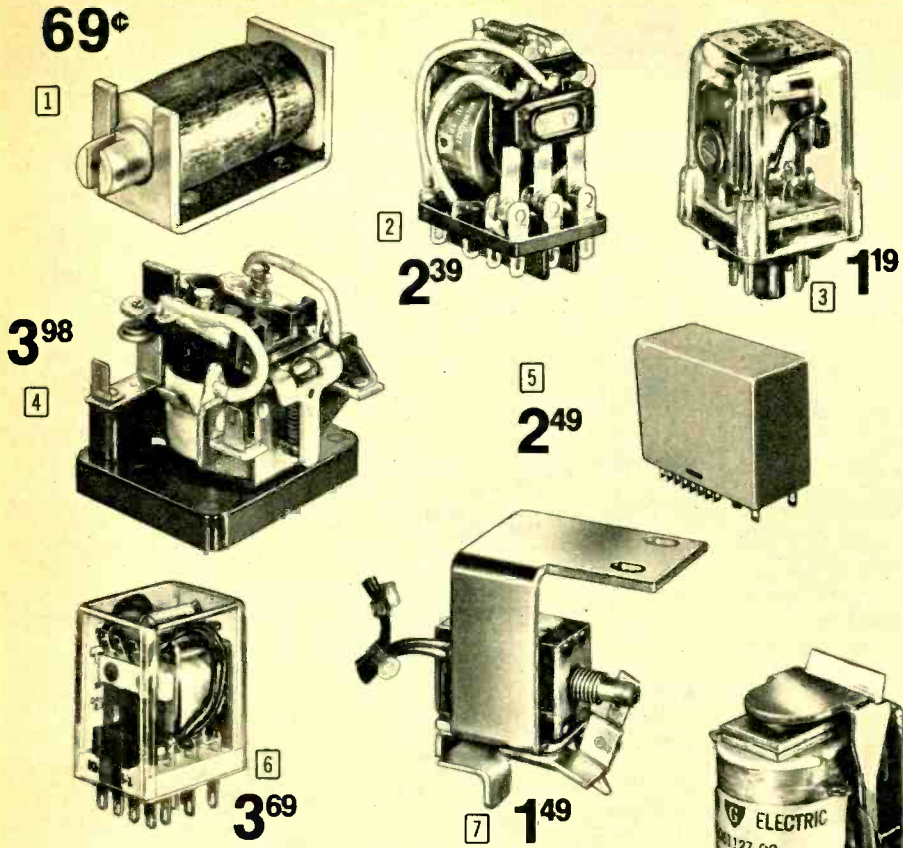

1 **Miniature 12 VDC Solenoid.** Operates switches, levers, etc. $\frac{1}{8}$ " travel. Threaded mtg. holes. Size: $1\frac{3}{4}$ " W x $\frac{3}{4}$ " H x 1" D. Shpg. wt. $\frac{3}{4}$ lb.
SW-373J. 2 for 1.20 Each 69¢

2 **Delta Controls 12-VDC Relays.** 3PDT contacts; 10 amp. Wt. $\frac{1}{4}$ lb.
SW-587J. 3-up, Ea. 2.29 Ea. 2.39
2PST contacts; 10 amp. Wt. $\frac{1}{4}$ lb.
SW-588J. 3-up, Ea. 1.79 Ea. 1.98

3 **Plug-In Relays.** 5 amp contacts; standard octal plug base. Enclosed.
SPDT; 110-VAC. $2\frac{1}{2}$ " H x $1\frac{1}{8}$ " sq. $\frac{1}{4}$ lb.
SW-417J. 3-up, Ea. 99¢ 1.19
SPDT; 90-VAC. OK for 110-120 VAC.
SW-555J. 3-up, Ea. 99¢ 1.19
3PDT; 12-VDC.
SW-557J. 3-up, Ea. 2.39 2.59

4 **117 VAC Power Relay.** Heavy-duty. 25-amp, silver-plated DPST contacts for switching heavy loads. Quality-made by Potter & Brumfield. Bakelite mounting board. UL listed. Size: $2\frac{1}{2}$ " W x $2\frac{1}{4}$ " H x 2" D. Wt. $\frac{1}{2}$ lb.
SW-580J. 3 for 11.10 Each 3.98

5 **Miniature 117 VDC Relay.** General purpose relay for all applications. 8PDT 2 amp contacts. 9,000-ohm coil. Plug-in or solder base. $1\frac{1}{2}$ " W x 1" H x $\frac{3}{8}$ " D. Shpg. wt. $\frac{1}{4}$ lb.
SW-573J. 3 for 6.00 Each 2.49

6 **4PDT Miniature Plug-In Relay.** 4PDT contacts rated 3 amps and 110-120 VAC coil sealed inside see-thru plastic case. Only 1" W x $1\frac{1}{4}$ " H x $\frac{3}{4}$ " D. Made by Potter & Brumfield, KH series. $\frac{1}{2}$ lb.
SW-543J. 3-up, Ea. 3.50 Each 3.69

7 **117 VAC Solenoid.** Operate switches, levers, etc., without adding a relay to circuit. Has $\frac{3}{4}$ " travel. Mounted on removable bracket. Size: 1" W x $1\frac{1}{4}$ " H x $1\frac{1}{4}$ " D. For 117 VAC, 60 Hz operation. Made by Comar. Shpg. wt. 1 lb.
SW-581J. 3-up, Ea. 1.29 Each 1.49

8 **Guardian 117 VAC Miniature SPDT Relay.** General-purpose relay for a variety of uses in audio and electrical systems. Contacts rated 2 amps at 117 VAC. Solder terminals for easy, permanent mounting to PC boards, chassis, etc. $1\frac{1}{4}$ x $\frac{3}{4}$ x 1". Wt. 4 oz.
SW-641J. 3-up, Ea. 1.75 Each 1.98

9 **"Mini" 117 VAC Solenoid.** Perfect for operating valves, switches, mechanical controls, etc. Has moisture-proof coil molded in epoxy plastic, screw terminals. Maximum plunger stroke, $\frac{1}{2}$ ". VERY compact—only $\frac{7}{8}$ x 1 x $1\frac{1}{8}$ ". For 117 VAC.
SW-637J. Shpg. wt. 4 oz. 79¢

10 **12-VDC DPDT Enclosed Relay.** Ideal for chassis and PC board mounting. Double-pole, double-throw contacts rated 3 amps. Resistance, 120 ohms. With solder lug terminals, plastic housing and socket, hold-down clips. $1\frac{3}{8}$ x $2\frac{1}{4}$ x $1\frac{3}{8}$ ".
SW-634J. Shpg. wt. 4 oz. 2.49

Calectro by G-C—Relays for Many Uses

SUBMINIATURE RELAYS

The ideal relays for radio-controlled model planes, cars and boats—or wherever an ultra-compact, extra-sensitive (10 mW) relay is required. Mounting screw included. Contacts: SPDT, $\frac{1}{2}$ amp at 3 VDC/12 VAC or $\frac{1}{4}$ amp at 12 VDC/36 VAC. Size: $\frac{1}{2}$ " W x $\frac{1}{16}$ " H x $1\frac{1}{16}$ " D. Shpg. wt. 3 oz.

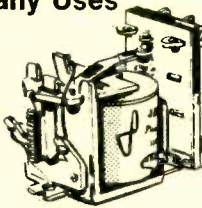

Stock No.	Coil (DC Only)				Each
	Ohms	Volts	mA		
SW-612J	100	1.5	10.0		3.75
SW-613J	1000	4.5	3.5		3.75
SW-614J	5000	12.0	1.5		4.50

SMALL PRECISION RELAYS

A universal relay combining compactness, great reliability, long life and good sensitivity. For conventional or printed circuit wiring. Contacts: SPDT, 3 amps at 117 volts AC/DC. $1\frac{1}{2}$ " W x $1\frac{1}{8}$ " H x $1\frac{1}{2}$ " D. Av. shpg. wt. 4 oz.

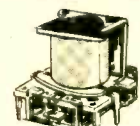

Stock No.	Coil						Each
	Type	Volts	mA	Ohms	Watts		
SW-615J	DC	3	25	105	0.05		3.95
SW-616J	DC	6	10	440	0.05		3.95
SW-617J	DC	12	5	1760	0.05		3.95
SW-618J	AC	6	75	26	...		6.95
SW-619J	AC	115	6.5	7k	...		6.95

POWER RELAYS

For switching heavy loads like motors, power supplies, etc. Mounting screw included. Contacts, DPDT rated 10 amps at 117 volts AC/DC ($\frac{1}{2}$ hp). 1" W x $1\frac{3}{4}$ " H x $2\frac{1}{2}$ " D. Av. shpg. wt. 6 oz.

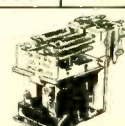

SW-620J	DC	6	500	12	3	3.95
SW-621J	DC	12	250	50	3	3.95
SW-622J	AC	24	...	24	...	3.95
SW-623J	AC	115	...	550	...	3.95

Relays, Transistor Tester, Soldering Tool

Cornell-Dubilier Relays

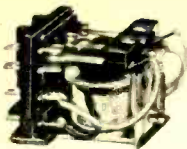

30 Series Open Relays

Designed for small motor control and general appliances applications. 10-ampere contacts. U.L. recognized. Size: 1¹³/₁₆" x 1³/₈" x 1¹/₈".

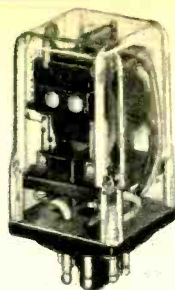

31 Series Enclosed Relays

For light industrial, heavy communications applications. 10 ampere contacts. U.L. recognized. Size: 2¹³/₁₆" x 1³/₈" x 1³/₈".

Stock No.	CDE No.	Coil Volts	Pol.	Coil Ohms	Contacts	Each
SW-668J	311D10-6	6	DC	32	SPDT	6.50
SW-669J	311D10-12	12	DC	110	SPDT	6.50
SW-670J	312D10-6	6	DC	32	DPDT	7.35
SW-671J	312D10-12	12	DC	110	DPDT	7.35
SW-672J	323D10-6	6	DC	32	3PDT	9.10
SW-673J	323D10-12	12	DC	110	3PDT	9.10
SW-674J	311A10-6	6	AC	5.3	SPDT	6.60
SW-675J	311A10-12	12	AC	24	SPDT	6.60
SW-676J	311A10-24	24	AC	86	SPDT	6.60
SW-677J	311A10-115	115	AC	2000	SPDT	6.60
SW-678J	312A10-6	6	AC	5.3	DPDT	7.40
SW-679J	312A10-12	12	AC	24	DPDT	7.40
SW-680J	312A10-24	24	AC	86	DPDT	7.40
SW-681J	312A10-115	115	AC	2000	DPDT	7.40
SW-682J	323A10-6	6	AC	5.3	3PDT	9.15
SW-683J	323A10-12	12	AC	24	3PDT	9.15
SW-684J	323A10-24	24	AC	86	3PDT	9.15
SW-685J	323A10-115	115	AC	2000	3PDT	9.15

Stock No.	CDE No.	Coil Volt.	Pol.	Coil Ohms	Contacts	Each
SW-650J	301D10-6	6	DC	32	SPDT	3.75
SW-651J	301D10-12	12	DC	110	SPDT	3.75
SW-652J	302D10-6	6	DC	32	DPDT	4.30
SW-653J	302D10-12	12	DC	110	DPDT	4.30
SW-654J	303D10-6	6	DC	32	3PDT	4.85
SW-655J	303D10-12	12	DC	110	3PDT	4.85
SW-656J	301A10-6	6	AC	5.3	SPDT	3.90
SW-657J	301A10-12	12	AC	24	SPDT	3.90
SW-658J	301A10-24	24	AC	86	SPDT	3.90
SW-659J	301A10-115	115	AC	2000	SPDT	3.90
SW-660J	302A10-6	6	AC	5.3	DPDT	4.80
SW-661J	302A10-12	12	AC	24	DPDT	4.80
SW-662J	302A10-24	24	AC	86	DPDT	4.80
SW-663J	302A10-115	115	AC	2000	DPDT	4.80
SW-664J	303A10-6	6	AC	5.3	3PDT	5.30
SW-665J	303A10-12	12	AC	24	3PDT	5.30
SW-666J	303A10-24	24	AC	86	3PDT	5.30
SW-667J	303A10-115	115	AC	2000	3PDT	5.30

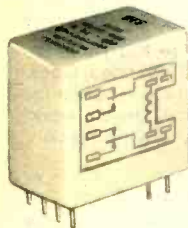

600 Series PC Board Relays

For use in radio controls, TV switching, tape transport systems, etc. Fully enclosed by nylon cover. Size: 1⁷/₈" x 1¹/₄" x ³/₄".

Stock No.	CDE No.	Coil Volts	Pol.	Coil Ohms	Contacts	Each
SW-686J	603-3	3	DC	80	SPDT	2.10
SW-687J	603-6	6	DC	340	SPDT	2.30
SW-688J	603-9	9	DC	750	SPDT	2.65
SW-689J	603-12	12	DC	1350	SPDT	2.65
SW-690J	643-3	3	DC	30	DPDT	4.30
SW-691J	643-6	6	DC	130	DPDT	4.30
SW-692J	643-9	9	DC	300	DPDT	4.35
SW-693J	643-12	12	DC	500	DPDT	4.35
SW-694J	623-12	12	AC	35	SPDT	3.05
SW-695J	623-24	24	AC	135	SPDT	3.05
SW-696J	623-115	115	AC	2900	SPDT	3.30

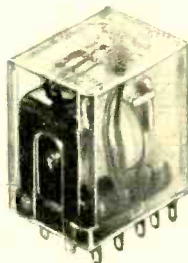

100 Series Enclosed Relays

Multi-contact relays for computer systems, alarm controls, audio programming, many other multi-relay bank applications. Size: 1⁵/₁₆" x 1¹/₈" x ⁷/₈".

Stock No.	CDE No.	Coil Volts	Pol.	Coil Ohms	Contacts	Each
SW-697J	104D0-6	6	DC	40	4PDT	5.10
SW-698J	104D0-12	12	DC	160	4PDT	5.10
SW-700J	104A0-6	6	AC	8.5	4PDT	5.75
SW-701J	104A0-12	12	AC	43	4PDT	5.75
SW-702J	204A0-24	24	AC	170	4PDT	5.75
SW-703J	104A0-115	115	AC	5100	4PDT	6.25

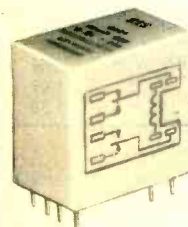

662 Series Enclosed Relays

For a variety of applications in sequential control functions such as TV channel switching, audio on/off switching, light sensitive control units — any application where devices are cycled frequently through a pre-set function. Size: 1⁷/₁₆" x 1³/₁₆" x ³/₄".

Stock No.	CDE No.	Coil Volts	Pol.	Coil Ohms	Contacts	Each
SW-708J	662-6	6	DC	100	SPST	3.60
SW-709J	662-12	12	DC	400	SPST	3.65
SW-710J	662-24	24	DC	1600	SPST	3.70



5000 Series Open Relays

Feature outstanding sensitivity and switching capacity — ideal for TV remote control, model aircraft, warning systems, tape recorders, light dimming devices, other light industrial and commercial uses. Size: 1³/₁₆" x 1¹/₃₂" x 1⁵/₁₆".

Stock No.	CDE No.	Coil Volts	Pol.	Coil Ohms	Contacts	Each
SW-704J	5212-3	3	DC	75	SPDT	2.30
SW-705J	5212-6	6	DC	300	SPDT	2.30
SW-706J	5212-12	12	DC	1250	SPDT	2.65
SW-707J	5212-24	24	DC	5000	SPDT	3.10

Hand-Held Transistor Tester Production Devices

1745



Really handy in-circuit transistor tester designed for operation in hard-to-get-at areas. Operates immediately upon contact — places transistor into actual operation — indicates working condition by clear speaker tone, shorts or open by absence of tone. Has selector switch for NPN or PNP types. Battery operated, no wires or cords.

TE-373J. Wt. 1 lb. 17.45

Wahl "Iso-Tip" Cordless Soldering Iron

1995



Completely portable soldering iron is perfect for electrical work anywhere. Heats up in 5 seconds, solders up to 150 joints per charge. Has built-in battery — recharges automatically in its own AC-operated stand. Ideal for production line work, TV and radio servicemen, hobbyists and experimenters. No AC leakage or induced current to delicate components. Includes iron, recharging stand, fine tip, instructions.

TE-374J. Shpg. wt. 2 lbs. 19.95

Fine Solder Tip for Above. For PC work, etc. .070" dia.
TE-375J. 4 oz. 2.00

General-Purpose Solder Tip for Above. .156" dia.
TE-376J. 4 oz. 2.50

Heavy-Duty Solder Tip for Above. ³/₁₆" dia.
TE-377J. 4 oz. 2.50

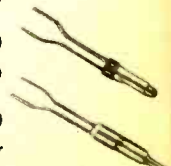

Quik-Circuits™

Product by CIRCUIT-STIK, INC. ®

FOR HOBBYISTS & EXPERIMENTERS
ADHESIVE BACKED COPPER PATTERNS
 U.S. PATENT 3,538,389 & Other Patents Pending

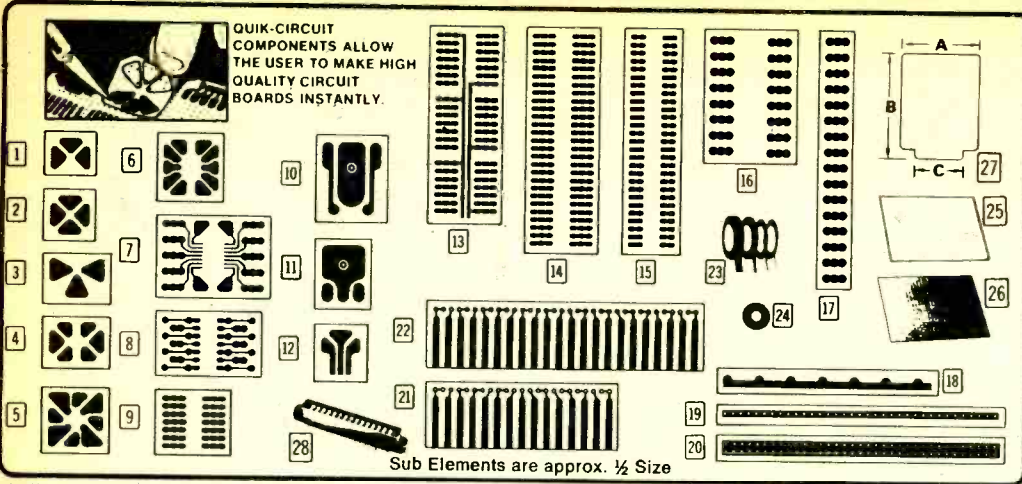

This "space-age" circuit design concept is the fastest and easiest way we know to assemble printed circuit boards directly from schematics or logic diagrams. Features pre-drilled and spaced sub-element conductors ready for soldering. Etched copper sub-elements have high-

strength adhesive backing. All you do is "tape down" the desired circuit path, solder conductors together, and you're done. Circuits can be changed quick 'n easy, with NO harm to board.

QUIK-CIRCUIT™ SUB-ELEMENTS ARE PRE-DRILLED ON .100-INCH GRID TO MATCH PRE-PUNCHED BOARD MATERIAL—REQUIRE NO DRILLING AND NO TERMINALS

Stock No.	Mfr's Type	Fig.	Pcs. Per Pkg.	Description	Price
QUIK-CIRCUIT™ Sub-Elements					
HW-078J	3001-003	1	3	TO-18 or TO-5, 3 lead	\$.95
HW-079J	3002-003	2	3	TO-18 or TO-5, 4 lead	.95
HW-080J	3021-003	3	3	TO-5, 3 lead	.95
HW-081J	3033-003	4	3	TO-5, 6 lead	1.09
HW-082J	3034-003	5	3	TO-5, 8 lead	1.19
HW-083J	3035-003	6	3	TO-5, 10 lead	1.19
HW-084J	3062-003	7	3	Flat Pack, 14 lead	1.49
HW-085J	3101-003	8	3	Dual-In-Line, 14 Lead	1.29
HW-086J	3102-005	9	5	Dual-In-Line, 14 Lead	1.95
HW-087J	3404-002	10	2	TO-3 Pkg. Flange Mtg.	.95
HW-088J	3405-004	11	4	Rectifier, SCR, Triac (Stud Mtg. Pkg.)	1.99
HW-089J	3406-005	12	5	SCR & Transistor Flat Plastic Pkg.	1.49
HW-090J	3214-002	13	2	Dual-In-Line Strip, 14 Lead	1.69
HW-091J	3216-002	14	2	Universal DIP Strip, 14 or 16 Lead	1.89
HW-092J	3227-002	15	2	Universal DIP Strip, 14 or 16 Lead	1.69
HW-093J	3302-002	16	2	Discrete Component Strip	1.29
HW-094J	3312-002	17	2	Universal Strip	1.19
HW-095J	3321-006	18	6	Distribution Strips, .100 wide, 7 pads, 400 sp.	1.49
HW-096J	3325-006	19	6	Distribution Strips, Single Row, .100 sp. holes	1.69
HW-097J	3326-004	20	4	Double Row, .100 sp. holes	1.69
HW-098J	3376-002	21	2	15 Pin Edge Connector	2.19
HW-099J	3396-002	22	2	.156 pin center spacing Hard Gold Plated	2.95
				22 Pin Edge Connector Hard Gold Plated	
Pressure Sensitive Copper Tape Rolls					
HW-100J	9105	23	1	031 x 48" long	\$.95
HW-101J	9106	23	1	040 x 48" long	.95
HW-102J	9101	23	1	062 x 48" long	.95
HW-103J	9102	23	1	100 x 48" long	1.19
HW-104J	9103	23	1	125 x 48" long	1.29
HW-105J	9104	23	1	250 x 48" long	2.29
Pressure Sensitive Insulation Tape Rolls					
HW-106J	9151	23	1	100 x 10 ft. long	\$.95
HW-107J	9153	23	1	200 x 10 ft. long	1.29
Pressure Sensitive Copper Donuts Pads					
HW-108J	9202	24	100	125 OD x 040 ID	\$1.49

Stock No.	Mfr's Type	Fig.	Pcs. Per Pkg.	Description	Price
HW-109J	9203	24	100	187 OD x .040 ID	\$ 1.69
HW-110J	9204	24	100	250 OD x .040 ID	1.89
HW-111J	9209	24	100	Assortment	1.79
Pressure Sensitive Copper Sheets (not shown)					
HW-112J	9252	—	2	3" x 4"	\$ 1.29
HW-113J	9251	—	2	5" x 6"	2.59
Epoxy-Glass Pressure Sensitive Insulation Sheets (micro-thin)					
KP-001J	9262	25	2	3" x 4"	\$ 1.29
KP-002J	9261	25	2	5" x 6"	2.59
Pre-Punched Epoxy-Glass Board Material					
KP-003J	9301	26	1	8.5" x 17" x .062	\$ 8.95
KP-004J	9302	26	1	4.25" x 8.5" x .062	3.29
KP-005J	9303	26	1	4.5" x 5" x .062	2.29
KP-006J	9304	26	1	2.5" x 4.5" x .062	1.49
Pre-Punched Phenolic					
KP-007J	9343	26	1	4.5" x 5" x .062	\$ 1.19
KP-008J	9345	26	1	4.5" x 17" x .062	2.29
KP-009J	9346	26	1	6" x 17" x .062	2.95
Pre-Punched/Pre-Shaped Epoxy-Glass Boards					
KP-010J	9402	27	1	"A"-4.5, "B"-6.5, "C"-22 pins	\$ 5.29
KP-011J	9405	27	1	"A"-4.0, "B"-4.5, "C"-15 pins	4.29
Plain/Pre-Shaped Epoxy Glass Boards					
KP-012J	9452	27	1	"A"-4.5, "B"-6.5, "C"-22 pins	\$ 2.95
KP-013J	9455	27	1	"A"-4.0, "B"-4.5, "C"-15 pins	2.39
Unpunched Epoxy-Glass Board Material (not shown)					
KP-014J	9351	—	1	6" x 12" x .062	\$ 2.95
KP-015J	9352	—	1	12" x 18" x .062	6.95
KP-016J	9353	—	1	4" x 6" x .062	1.39
KP-017J	9354	—	1	2" x 4" x .062	1.39
Connectors—.156" spacing					
HW-114J	9501	28	1	15 pins	\$ 2.59
HW-115J	9503	28	1	22 pins	3.29
Proto-type Kits (not shown)					
HW-116J	9952	—	1	Mini-Kit	\$ 3.95
HW-117J	9953	—	1	Mid-Kit	5.95
HW-118J	9954	—	1	Maxi-Kit	12.95
HW-119J	9955	—	1	Super-Kit	24.95

Perf-Board Solderless Circuit Components

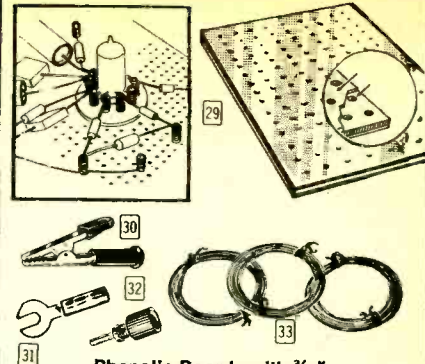

Phenolic Boards with 3/32" holes punched on 0.265" centers 1/16" thick.

- 29 Copper Clad (Punched) Perfboard. KK-120J. 3 1/16 x 6 3/8" 49¢
- KK-122J. 6 3/8 x 9 3/8" 99¢
- Unclad (Punched) Perfboard. 3 1/2 x 6 3/8". KK-116J. 4 oz. Each 49¢ 3 for 1.25
- 30 Alligator Lugs With Jacks. Color coded: 5 red, 5 black. 1 1/4" long. 1/4 lb. HW-032J. Pkg. of 10 1.49
- 31 Spade Lugs With Jacks. Color coded: 5 red, 5 black. 3/8" long. 1/4 lb. HW-033J. Pkg. of 10 1.49
- 32 Binding Posts With Jacks. Color coded: 5 red, 5 black. 3/8" long. HW-034J. Wt. 1/4 lb. Pkg. of 10 1.49
- 33 Printed-Circuit Wire Kit. Three 50-foot rolls. Solid and stranded types. Ideal for solid-state circuits. Great for kit builders, hobbyists, repair work. Brand new, with vinyl covered jacket. Stock up and save! WW-575J. Shpg. wt. 1 lb. 1.79
- 500-Foot Hook-Up Wire Kit. WW-579J. Shpg. wt. 2 lbs. 3.98
- Tape Resist. (Not illustrated). Use to protect area of printed circuit board from etchant. 1/16 x 320". TA-016J. Shpg. wt. 1/4 lb. 79¢
- Etchant Solution, 16-oz. Bottle. XX-919J. Shpg. wt. 1 lb. 1.29

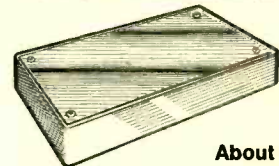

Low As 98¢
Builder's Boxes for Just About Any Project

Sturdy bakelite boxes with removable aluminum covers. For 100's of electronics projects. Use 'em with or without cover.
 CA-355J. 3 1/4 x 2 1/4 x 1 1/8". 1/4 lb. 98¢
 CA-356J. 4 x 2 1/2 x 1 1/8". 1/4 lb. 1.09
 CA-324J. 6 1/4 x 3 3/4 x 2". 1/2 lb. 1.39

Cable Clamps, Grommets and Lugs

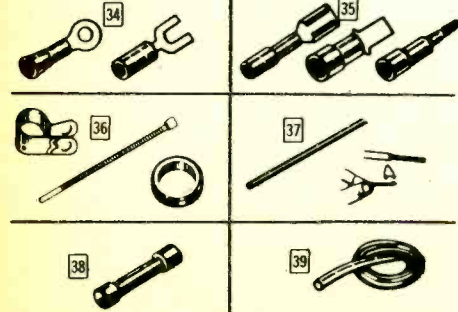

- 34 Solderless Insulated Terminals. Package of 46 assorted spade & ring lugs. For wire size 22-16, stud size 6-10. TL-588J. Shpg. wt. 1/4 lb. Pkg. of 46 1.96
- Package of 38. Wire size 16-14, stud size 6-10. TL-587J. Shpg. wt. 1/4 lb. Pkg. 1.96
- Package of 29. Wire size 12-10, stud size 6-10. TL-589J. Shpg. wt. 1/4 lb. Pkg. 1.96
- 35 Automotive-Type Solderless Terminals. Package of 34 assorted male and female quick-disconnects. For wire from 22 thru 10 gauge. Color coded (red, blue, yellow) by wire size. NO soldering, just slide 'em together. Under 6¢ apiece! TL-590J. Wt. 1/4 lb. Pkg. of 34 1.96
- 36 Clamps, Ties and Grommets. Package of 67 assorted clamps, grommets, ties. TL-593J. Shpg. wt. 1/4 lb. Pkg. 1.96
- Package of 102 Grommets Only. 1/4" to 1" inside diameter. TL-594J. Shpg. wt. 1/4 lb. Pkg. 1.96
- Package of 64 Wire Ties Only. 4" to 6 3/4". TL-595J. Shpg. wt. 1/4 lb. Pkg. 1.96
- 37 Package of 45 Cable Clamps Only. 3/8" to 1" inside diameter. TL-592J. Shpg. wt. 1/4 lb. Pkg. 1.96
- 38 Shrinkable Tubing. Package of 8 pieces of heat-shrinkable tubing. In 6" lengths and assorted sizes for 1/16" to 1/2" inside diameter. For insulating, protecting, identifying wire. Just apply heat from match, candle, lighter, torch or heat gun. TL-598J. Shpg. wt. 1/4 lb. Pkg. of 8 1.00
- 39 Butt Connectors. Package of 25 insulated solderless types. Great for wire splicing without soldering. Coded by color (red, blue, yellow) for wire sizes 22-16, 16-14, 12-10. Well-insulated. Pay less than 8¢ each — stock up! TL-591J. Wt. 1/4 lb. Pkg. of 25 1.96
- 40 Vinyl Sleeving. Total of 32 feet of "spaghetti" in four different colors. For wire sizes 6 to 10. TL-597J. Shpg. wt. 1/4 lb. Pkg. 1.00
- Total of 40 feet of "spaghetti" in sizes for wire gauges of 24 to 18. Four different colors. TL-596J. Shpg. wt. 1/4 lb. Pkg. 1.00

Lighting for Home, Shop, Outdoors

Never Be "In the Dark" Again—Famous-for-Dependability For Any Use



1 Sportsman® Lantern with Built-In Flasher
Model 303. Great for outdoors, automotive uses. Built-in red flasher is a real "life-saver" during road emergencies. Sealed lamp for piercing long-range beam. Heavy-gauge triple chrome plated steel construction. Swiveling spotlight head, shock absorber mounting. Knurled barrel for firm grip. Separate control for red flasher. With 6-volt long-life lantern battery. **XM-227J.** Shpg. wt. 5 lbs. **17.95**

2 Sportsman's Outdoor 6-Volt Lantern
Model 301. Same fine features as above, does not have red flasher. With 6-volt lantern battery. Great to have around in case of AC power failure. **XM-228J.** Shpg. wt. 5 lbs. **15.95**

3 Sportsman Portable Fluorescent Lantern
Model 360-S. Two fluorescent bulbs in sealed clear case provide all the light you need for tents, picnic areas, etc. *An essential during AC power failure.* High-impact plastic ABS case, solid-state low-current drain circuitry. 360° illumination with no shadows or dark spots. Fluorescent tubes last about 1000 hours with normal use. With long-life heavy-duty batteries. **XM-226J.** Shpg. wt. 16 lbs. **37.95**

4 Nylon-Body Flashlight with Continuity Tester
Model N22T. Rugged heavy-duty flashlight is perfect for use around factories, warehouses, storage depots, etc.—makes a really reliable home flashlight too! Built-in continuity tester checks wiring circuits, fuses, switches, etc. Ring-hanger end cap. Made of non-breakable nylon—resists heat, cold, gas, oil, chemicals. Powerful beam. **XM-230J.** Shpg. wt. 1½ lbs. **8.50**

5 Industrial Flashlight with Continuity Tester
Model WF22T. Same as above, high-impact plastic body. Lock switch prevents accidental turn-on. **XM-229J.** Shpg. wt. 1½ lbs. **6.50**

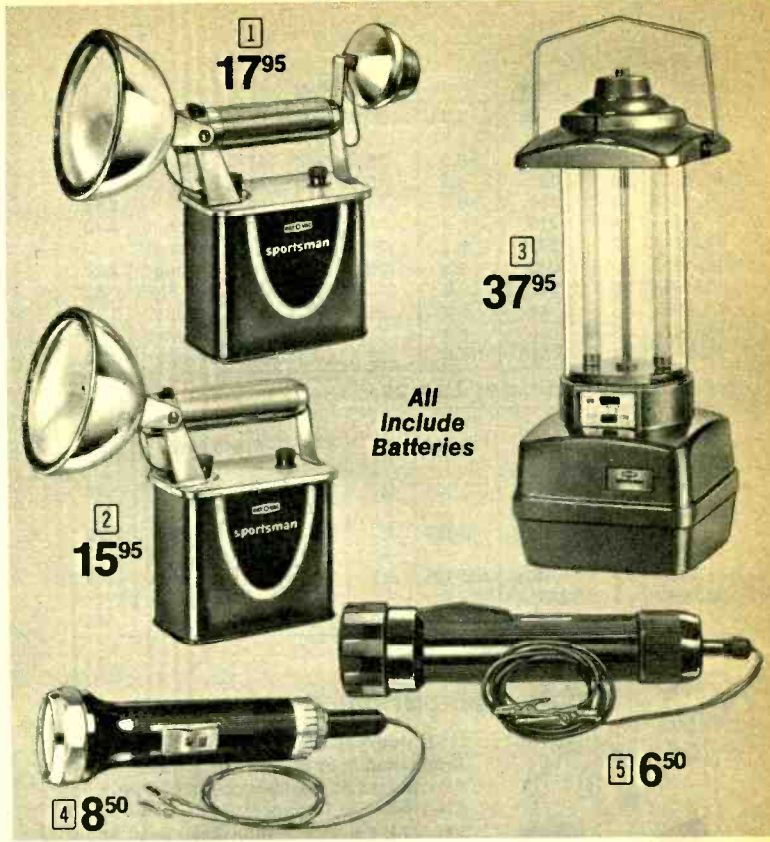

All Include Batteries

Stock Up Now on Useful Electrical Accessories

Highway Traffic Safety Reflector

Important safety aid for travelers. Warns traffic of trouble. 12" high, triangular shape is easy to see for up to 1000'. Folds flat for easy storage. Shpg. wt. 2 lbs. **AU-338J.** 2 for 2.70 **Each 1.49** 2 for \$2.70

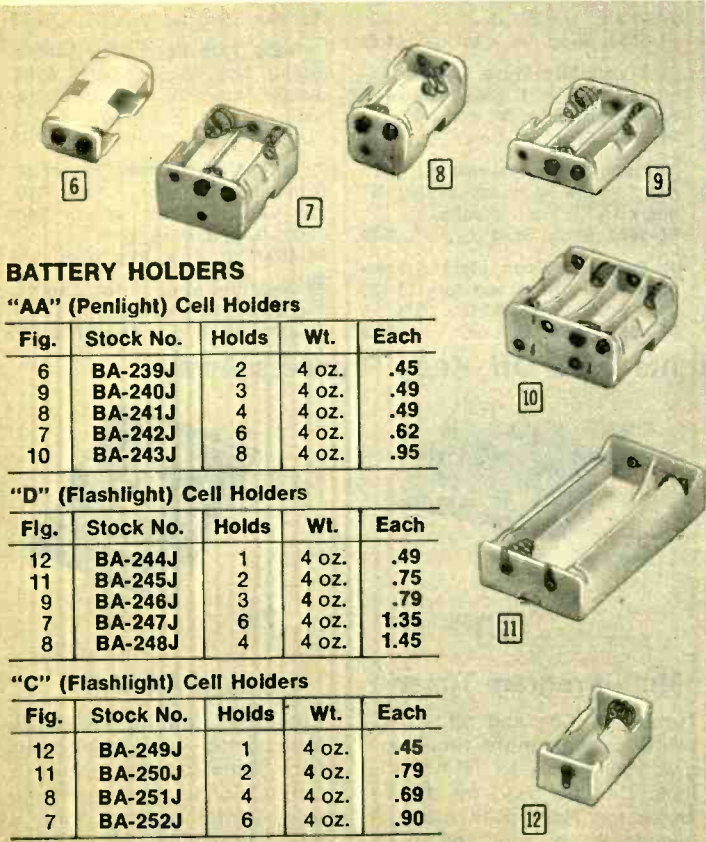
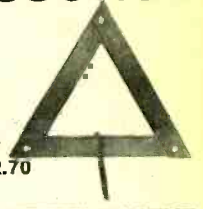

BATTERY HOLDERS

"AA" (Penlight) Cell Holders

Fig.	Stock No.	Holds	Wt.	Each
6	BA-239J	2	4 oz.	.45
9	BA-240J	3	4 oz.	.49
8	BA-241J	4	4 oz.	.49
7	BA-242J	6	4 oz.	.62
10	BA-243J	8	4 oz.	.95

"D" (Flashlight) Cell Holders

Fig.	Stock No.	Holds	Wt.	Each
12	BA-244J	1	4 oz.	.49
11	BA-245J	2	4 oz.	.75
9	BA-246J	3	4 oz.	.79
7	BA-247J	6	4 oz.	1.35
8	BA-248J	4	4 oz.	1.45

"C" (Flashlight) Cell Holders

Fig.	Stock No.	Holds	Wt.	Each
12	BA-249J	1	4 oz.	.45
11	BA-250J	2	4 oz.	.79
8	BA-251J	4	4 oz.	.69
7	BA-252J	6	4 oz.	.90

Calectro Cord & Chassis Connectors

For all electronic/electrical uses. Shells are attached with screws. Pins are "indexed," plugs of one type won't fit socket of another. Rated 500V, 7½ amp, 1800 watt. Wt. 4 oz.

13 Male Cord Types		
Stk. No.	Pins	Each
PL-166J	2	.79
PL-167J	3	.89
PL-168J	4	.99
PL-169J	6	1.19
PL-170J	8	1.49

14 Female Cord Types		
Stk. No.	Pins	Each
PL-171J	2	.79
PL-172J	3	1.19
PL-173J	4	1.29
PL-174J	6	1.39
PL-175J	8	1.49

15 Chassis Mount Types		
Stk. No.	Pins	Each
PL-176J	2	.59
PL-177J	3	.64
PL-178J	4	.69
PL-179J	6	.79
PL-180J	8	.89

Calectro Fuse Holders

16 Clip Type. For all standard ¼" and 1¼" fuses. Plated spring brass clips. Plastic insulated base. **FU-113J.** Shpg. wt. 4 oz. **44¢**

17 Panel Mount Type. Front loading, bayonet holder for panels to ⅜" thick. Requires ½" diameter hole. For all ¼ x 1¼" fuses. **FU-114J.** Shpg. wt. 4 oz. **79¢**

18 In-Line Type. For all standard ¼" diameter fuses. With lead wires and three springs to take all auto/electrical fuses ⅝" - 1¼" long. **FU-115J.** Shpg. wt. 4 oz. **79¢**

Miniature Replacement Lamps

GC Calectro Pilot Light Sockets & Assemblies

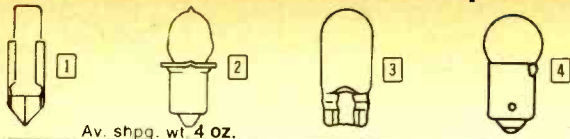

Av. shpg. wt. 4 oz.

Stock No.	Fig.	Type	Volts	Amps	Bulb	Base	PKG. OF 10
PL-190J	2	PR2	2.38	.50	B-3½	S.C. Min. Fig.	1.50
PL-191J	2	PR3	3.57	.50	B-3½	S.C. Min. Fig.	1.50
PL-192J	4	12	6.3	.15	G-3½	Min. 2-pin	2.10
PL-193J	4	130	6.3	.15	G-3½	Min. Bayonet	1.70
PL-194J	3	159	6.3	.15	T-3½	Wedge	2.10
PL-195J	4	219	6.3	.25	G-3½	Min. Bayonet	3.40
PL-196J	3	239	6.3	.36	T-3½	Min. Bayonet	2.50
PL-197J	3	240	6.3	.36	T-3½	Min. Bayonet	2.20
PL-198J	3	327	28.0	.04	T-1½	S.C. Min. Fig.	.52*
PL-199J	3	44	6.3	.25	T-3½	Min. Bayonet	1.10
PL-087J	3	47	6.3	.15	T-3½	Min. Bayonet	1.10
PL-200J	4	51	7.5	.22	G-3½	Min. Bayonet	1.10

Neon Glow Indicator Lamps

PL-201J	1	A1A (NE-2)	105-125	0.5	T-2	Wire Term.	2.20
PL-202J	1	A9A (NE-2E)	105-125	0.7	T-2	Wire Term.	2.20
PL-203J	1	C2A (NE-2H)	105-125	1.9	T-2	Wire Term.	2.20
PL-204J	3	B1A (NE-51)	105-125	0.3	T-3½	Min. Bayonet	.48*
PL-205J	3	B2A (NE-51H)	105-125	2.0	T-3½	Min. Bayonet	.48*

*Price Each.



Picture Tube Brighteners



5 Universal Black-and-White TV Tube Brightener. For series or parallel wired sets. Serves as boost or no-boost type. ½ lb. **XM-176J. For Duodecal Base Sets... 4.10** **XM-177J. For 110° Button Base Sets.** Shpg. wt. ½ lb. 4.40

6 Boost Brightener for color TV's. Increases filament voltage to restore brightness and contrast. No switching or wiring—just plug it in between color tube and color socket. **XM-178J. For 70° Shell Round Color Tubes.** Neodheptal 12-pin base. 1 lb. 7.40 **XM-179J. For 90° Rectangular Tubes.** Diheptal 12-pin base. 1 lb. 7.80

7 Isolation Brightener for Color TV's. No-boost type corrects cathode-to-filament shorts to restore black-and-white information and original color picture quality. **XM-180J. For 70° Shell Round Color Tubes.** Neodheptal 12-pin base, 1 lb. 8.80 **XM-181J. For 90° Rectangular Tubes.** Diheptal 12-pin base. 1 lb. 9.20

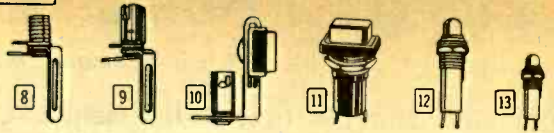

UNIVERSAL TYPES

8 9 Sockets with Universal Brackets. Brackets are bendable into many shapes. Wt. 4 oz. **PL-181J. Min. Screw Base. ... 39¢** **PL-182J. Min. Bayonet Base. . 35¢** **PL-183J. 115V Candelabra. ... 39¢**

11 Modern Square Style. Plastic lens, front-replaceable lamp. Fits ½" dia. hole in panels to ⅝" thick. Min. screw base. 4 oz. **PL-186J. Red Lens. 99¢** **PL-187J. Green Lens. 99¢**

JEWELLED TYPES

10 Jewel Faceted Pilot Lamp Assembly. Jewel is set in polished chrome rim. Adjusts for any type of lamp. Mounts in ⅝" dia. hole. Miniature bayonet base. Wt. 4 oz. **PL-184J. Red Lens. 79¢** **PL-185J. Green Lens. 79¢**

12 Dome Style. Indicator light assembly. One each red, green, white lens. Front-replaceable lamps. For ⅝" dia. hole in panels to ⅝" thick. Miniature bayonet base. **PL-188J. Shpg. wt. 4 oz. 1.19** **13 Neon Lamp Assembly.** One red, one clear lens. For ½" hole in panels to ⅝". 110V AC/DC. **PL-189J. Shpg. wt. 4 oz. 1.19**

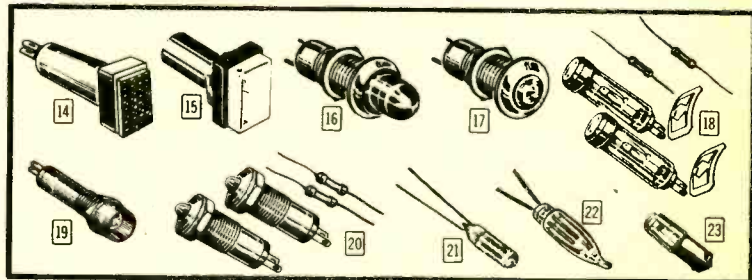

Most Used Panel Lamps, Assemblies & Bulbs

14 Neon Pilot Lamps. Includes 2 red, 1 yellow; built-in jewel front, 3 dropping resistors. 120 VAC. **PL-148J. Shpg. wt. 4 oz. 2.19**

19 Neon Lamp Assemblies. Set of two—1 red, 1 yellow. Fully enclosed. 117 VAC. Requires ¼" hole. **PL-159J. Shpg. wt. 4 oz. 1.79**

15 Screw Base Pilot Lights. Set of two—1 red, 1 green. Requires ⅜" mounting hole. Less bulbs. ⅝" W x ¾" H x 2½" D. **PL-155J. Shpg. wt. 4 oz. 1.79**

20 Neon Lamps with Resistors. Set of two—1 yellow, 1 red. For 110-120 VAC. ¼" dia. x 1" L. **PL-158J. Shpg. wt. 4 oz. 1.79**

16 6-Volt Miniature Lamps. Includes 1 red, 1 green screw-in type 6-volt bulbs. ⅝" dia. x 1". **PL-065J. Shpg. wt 4 oz. 2.15**

21 NE-2 Type Neon Glow Lamps. Built-in lens. Use for panel & indicator. 110-120V with series resistor (not incl.). Min. 60V. **PL-160J. Wt. 4 oz. Pkg. of 5 1.79**

17 Neon Lamp Assemblies. Two red, 1 yellow jewel assemblies. ⅝" dia. x 1¼" L. For 115 volts. **PL-147J. Shpg. wt. 4 oz. 2.49**

22 NE-2 Neon Lamps. Pkg. of 10. Withstands vibration, shock. 110-120 VAC w/series resistor (not incl.). ¾ watt. Wire term. **PL-153J. Wt. 4 oz. Pkg. of 10 1.49**

18 Enclosed Neon Light Assemblies. 1 yellow, 1 red for 110-120 VAC. Snap-clamp. ⅝" D x 1½" L. **PL-157J. Shpg. wt. 4 oz. 1.79**

23 Westinghouse Pilot Lamps. Pkg. of 10. #47. 1.5 amps, 6-8V. **PL-087J. Wt. 4 oz. ... Pkg. of 10 1.10**

Intermatic Automatic Timers Turn Lights On & Off, Keep Prowlers Away

Plug-in Lamp Timer



7⁹⁹

Turns house lights on and off automatically when you're away. Just set desired times, plug into AC outlet. Resets itself. Handles 1875 watts.

XM-292J. Wt. 2½ lbs. 7.99

186 Olson

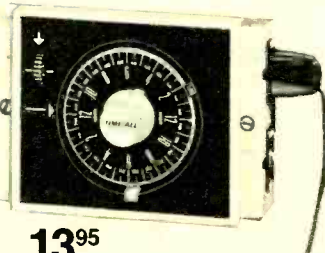

13⁹⁵

In-Wall Timer

Fits in baseboard-type outlet box... turns lights or appliances on and off automatically. Easy do-it-yourself installation. Built-in override for manual control. Handles 1875 watts. Repeats cycle every 24 hours. **XM-173J. Wt. 2½ lbs. 13.95**

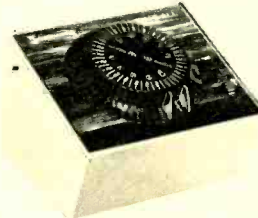

10⁹⁵

Multi-Program Timer

Turns lights on and off once, twice... even more times to give your house an "at-home" look. Can be used for appliances, too. Handles 1875 watts. Includes 2 "on" and 2 "off" trippers—extra trippers available. **XM-175J. Wt. 3 lbs. 10.95**



7⁹⁸

Guard-All Timer

Automatic lighting and appliance control—perfect for radio, baby bottle warmer, lights, etc. Controls on top for easy operation. Minimum "on" time ½ hour; maximum 22½ hours. Handles 1875 watts total. **XM-174J. Wt. 2½ lbs. 7.98**

Replacement and Hobby Motors, Cooling Fans

Stock up on motors for toys, recorders, phonos—Keep your Hi-Fi and Ham Gear running cool for longer life!

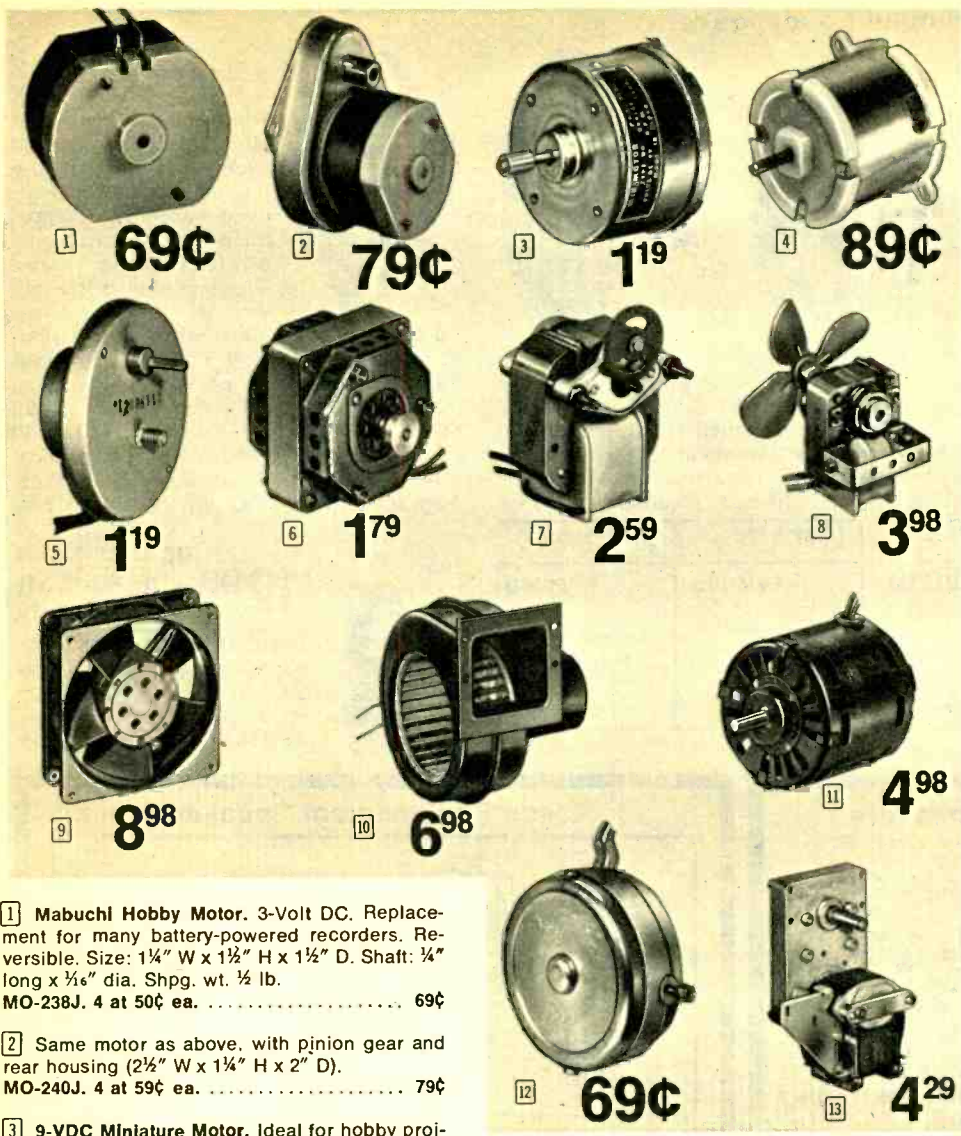

- 1 Mabuchi Hobby Motor.** 3-Volt DC. Replacement for many battery-powered recorders. Reversible. Size: 1 1/4" W x 1 1/2" H x 1 1/2" D. Shaft: 1/8" long x 1/16" dia. Shpg. wt. 1/2 lb. MO-238J. 4 at 50¢ ea. 69¢
- 2** Same motor as above, with pinion gear and rear housing (2 1/2" W x 1 1/4" H x 2" D). MO-240J. 4 at 59¢ ea. 79¢
- 3 9-VDC Miniature Motor.** Ideal for hobby projects or replacement in some battery-operated recorders. Size: 1 1/2" dia. x 1" D. Shaft: 1/2" x 1/8" dia. Shpg. wt. 1/4 lb. MO-266J. 3 for 3.27 1.19
- 4 Pack of 10 DC Hobby Motors.** Perfect for those toys that need fixin'! High-rpm, 1 1/2-3 VDC. 1 x 1" diameter, 3/8" long shaft. MO-250J. Shpg. wt. 2 lbs. 89¢
- 5 8-RPM Timing Motor.** Made by Borg. Synchronous. Permanently lubricated. High torque, low noise. 110 VAC. 3/8" dia. x 1 1/4". Wt. 1/4 lb. MO-248J. 3 for 3.27 1.19
MO-260J. 1 RPH Telechron Motor. 1/4 lb. 1.59
- 6 GI 4-Pole Motor.** Quiet, smooth running; for recorders, turntables. Bronze bearings. 110-120 VAC. 2 3/4" W x 2 3/4" H x 2 1/2" D. Wt. 3 lbs. MO-257J. 3 for 4.95 1.79
- 7 Shaded Pole Motor.** Open frame. 280 RPM. 2" W x 2 1/2" H x 1 1/8" D; 3/16" dia. shaft. 110-120 VAC. 60 Hz. Wt. 2 lbs. MO-256J. 3 for 7.50 2.59
- 8 Olson Ventilation Fan.** Rugged motor of laminated steel with permanently-lubricated type bearings. Universal mounting bracket. 3" blade. 110-120 VAC, 60 Hz. Shpg. wt. 2 lbs. MO-083J. 3 for 11.40 3.98
- 9 Ultra-Quiet Muffin Fan.** Keeps electronic equipment cool. Very low noise. 100 CFM. Only 4 3/8" W x 4 3/8" H x 1 1/2" D. Used. 110 VAC. MO-211J. Shpg. wt. 3 lbs. 8.98
- 10 Heavy-Duty Blower.** Delivers 160 cubic feet per minute for cooling equipment. Size: air flow duct, 3 3/4" x 3"; intake, 5 1/4" dia.; overall, 8 1/4" x 6 3/4". For intermittent duty. Used. 110-120 VAC, 60 Hz. Shpg. wt. 7 lbs. MO-252J. 2 for 12.00 6.98
- 11 Fasco 2-Speed 110 VAC Motor.** Continuous duty at low speed: 2990 rpm with .24 oz./in. torque. High speed, intermittent, 3490 rpm. For oil burner use. 4" x 3 1/4" dia. Shaft, 3/16" x 1 1/8". MO-336J. Shpg. wt. 6 lbs. 4.98
- 12 340-rpm Motor.** High-torque. For model cars, other motor-driven toys. 1 1/2-6 volts. 1 1/2" diameter x 6" deep. 1/2 lb. MO-340J. 4 for 2.00 Each 69¢
- 13 6-rpm 117 VAC Motor.** Heavy-duty—ideal for displays in shops, schools, etc. Dust-proof gear housing—gears may be removed for higher speeds. 3/16" diameter x 1" shaft. 5 x 2 1/2 x 3". Shpg. wt. 3 lbs. MO-344J. 2 for 8.00 Each 4.29

Hobby Motor SPECTACULAR

Low As **1⁹⁹** per kit

3 Kits to Choose From—Stock Up Now!

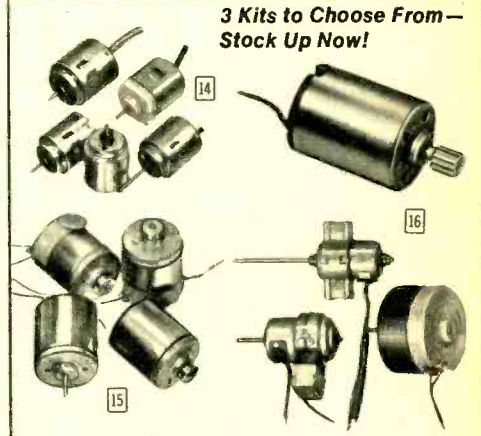

- Priced Lower Than Mfr's Cost
- SPECIAL—All 3 Kits for \$4!

Complete selection of "hard-to-find" toy motors at an almost "giveaway" price! Each heavy-duty motor is compact yet highly efficient to provide reliable power for toys (especially slot cars!) and other motor-powered devices. Work from DC power up to 6 volts. The greater the voltage, the greater the speed—1200-12,000 rpm. Save more—all 3 for \$4. AS-800J.

- 14 Kit of 5 "Mini" Motors.** MO-333J. Shpg. wt. 1/2 lb. 1.99
- 15 Kit of 4 Medium-Size Motors.** MO-334J. Shpg. wt. 1 lb. 1.99
- 16 Kit of 4 Assorted Sizes.** MO-335J. Shpg. wt. 2 lbs. 2.99

TIMING MOTORS



89¢ each 3 for 2.55

- 5" Leads • Self Starting
- Dustproof Gear Housing

International Register. Precision motors as used in clocks, timers, etc. Features sealed gear housing, brass gears. Overall, 2 1/2" W x 1 1/4" H x 2" D behind shaft. For 125 volt AC, 60 Hz. Av. shpg. wt. 4 oz.

Stock No.	Type	Stock No.	Type
MO-277J	1/4 rpm	MO-296J	1/30 rpm
MO-299J	1/2 rpm	MO-279J	1/45 rpm
MO-273J	1/5 rpm	MO-313J	1/240 rpm
MO-310J	1/15 rpm	MO-289J	1 rpm
MO-285J	1/22.5 rpm	MO-276J	5 rpm
MO-315J	1/25 rpm	MO-275J	48 rpm

Fine-Quality Olson Speakers for Most Every Need

E-V SRO Type Music Instrument Loudspeakers

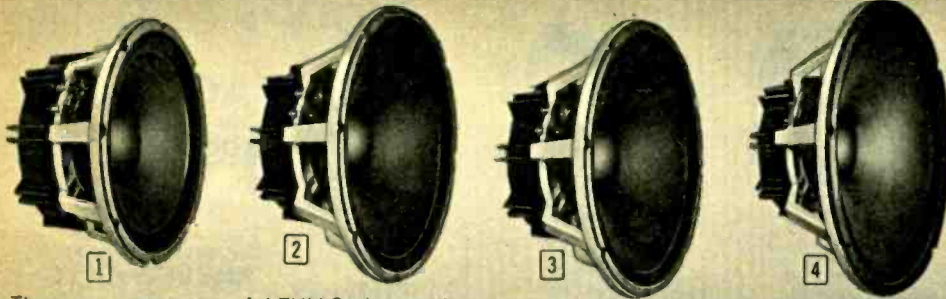

These new more powerful EVM Series music instrument speakers greatly improve sound projection and offer a higher power handling capacity — they're built for today's *really* heavy sounds. Speakers have rigid die-cast aluminum frames for precise alignment of moving parts — even at full power output.

Designed for 40° cooler, more reliable operation at full power. All EVM Series units are rated for 100 watts RMS input. 8 ohms. All have 16 lb. magnet structure with a 4 lb. 13 oz. ceramic magnet. Power capacity is 100 watts. The 12L and 15L have resonance of 55 Hz. The 15B and 18B have resonance of 40 Hz.

Stock No.	1 SP-115J	2 SP-116J	3 SP-117J	4 SP-118J
E-V Model No.	EVM/12L	EVM/15L	EVM/15B	EVM/18B
Diameter	12"	15"	15"	18"
Application	Lead	Lead	Bass	Bass
Mounting Depth	6"	7"	7"	8"
Shpg. Wt.	23 lbs.	25 lbs.	25 lbs.	27 lbs.
Price	105.00	110.00	120.00	175.00

Music Instrument Speakers

Low As **19⁹⁸**



For electronic music instruments. Get correct "voicing" required for the instrument, power handling capacity to reproduce the instrument's characteristic wave shapes without distortion. 8 ohms.

SS-266J. 12" F. Range, Accordion, guitar. 20 oz. mag. 60 watts. 1½" V.C. 10 lbs. **19.98**
 SS-268J. 12" Bass. Organ, Bass guitar. 40 oz. mag. 85 watts. 2" V.C. Wt. 11 lbs. . . **29.98**
 SS-267J. 15" F Range. Accordion, guitar. 30 oz. mag. 75 watts. 1½" V.C. 11 lbs. . **26.98**
 SS-269J. 15" Bass. Organ, Bass guitar. 40 oz. mag. 90 watts. 2" V.C. Wt. 12 lbs. . . **32.98**



Amplifier Horn
12⁹⁸ with 50-Watt Capacity

Restores highs lost with paper-cone or bass speakers. 2.8 oz. cer. mag. 2000-20,000 Hz. 8 x 3½ x 8½". 8-16 ohms. SS-150J. Wt. 2 lbs. . . **12.98**

Olson Low-Cost Replacement Speakers

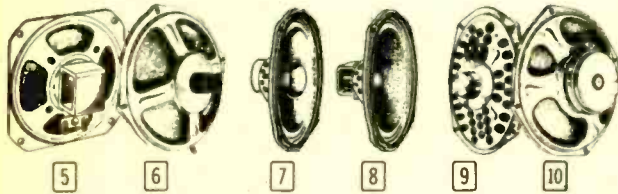

• For Radios, Phonos, Cars, Boats — Anywhere!
 HF types feature a high-frequency radiator. HD types feature a heavy-duty ceramic magnet. Av. shpg. wt. 3 lbs.

Fig.	Size	Magnet Oz.	Imp., Ohms	Watts	Stock No.	Each	Lots of 4, Each
6	5"	.68	3.2	2	SS-133J	2.98	2.89
6	6"	.68	3.2	2	SS-007J	1.89	1.67
6	6"	.68	3.2	3	SS-134J	3.19	3.09
8	5 x 7"	1.47	8	4.5	SS-135J	3.49	3.39
8	4 x 8"	.65	34	2	SS-167J	1.79	1.69
9	4 x 8"	1.0	8	3	SS-166J	1.89	1.75
9	6 x 9"	1.47	8	5	SS-136J	3.79	3.69
10	3½"	2.35	8	4	SS-279J	4.98	4.59
10	4"	2.35 HD	8	5	SS-137J	3.39	3.29
7	4 x 6"	5.5 HD	8	9	SS-310J	4.49	4.39
10	5"	2.35 HD	8	5	SS-138J	3.69	3.59
8	5 x 7"	2.10	40	5	SS-126J	2.59	2.39
10	5¼"	2.35 HD	8	6	SS-139J	3.89	3.79
10	6"	2.35 HD	8	7	SS-140J	3.98	3.89
7	5 x 7"	5.5 HD	8	10	SS-141J	4.98	4.89
10	6"	2.25	8	6	SS-758J	3.69	3.49
10	6"	5.5 HD	8	10	SS-185J	4.98	4.89
5	6¼"	2.15	8	6	SS-064J	2.19	1.90
5	6½"	1.47	8	3	SS-063J	1.99	1.89
7	6 x 9" HF	5.5 HD	8	10	SS-142J	5.29	5.19
7	6 x 9"	10 HD	8	12	SS-760J	7.98	7.65
7	6 x 9" HF	16 HD	8	20	SS-291J	10.98	10.79
10	8" HF	5.5 HD	8	10	SS-262J	5.98	5.89
7	4 x 10" HF	5.5 HD	8	12	SS-143J	5.29	5.19
7	5 x 7" HF	10 HD	8	15	SS-144J	8.98	8.89
7	6 x 9" HF	10 HD	8	15	SS-145J	8.98	8.89
7	4 x 10" HF	10 HD	8	15	SS-263J	9.98	9.79
10	8" HF	10 HD	8	15	SS-146J	8.98	8.79
6	12"	5.5	8	10	SS-079J	5.79	4.90

Olson Replacement Speakers

6⁹⁸ Bargain "Surprise Kit"

Get 10 popular Olson loudspeakers at a fraction of their original cost! Variety of types — in sizes ranging from 1¾" to 4 x 6". "Beef-up" your replacement speaker inventory & save! Wt. 6 lbs.
 SS-294J. . . Pkg. of 10 for 6.98

Olson Quality PM Speakers

Transistor & Table Radios! Portable Recorders & Phonos!

Square Yoke
Square Frame

BUY IN QUANTITY AND SAVE

Round Yoke
Round Frame

Size	Ohms	Frame	Yoke	Shpg. Wt.	Stock No.	Each	Lots of 50 Each	Lots of 100 Each
1¾ x 2¼"	8-10	Sq.	Rd.	6 oz.	SS-954J	65c	49c	46c
2¼"	8	Rd.	Rd.	6 oz.	SS-296J	65c	49c	46c
2½"	8	Rd.	Rd.	6 oz.	SS-297J	65c	49c	46c
2 x 4"	8	Sq.	Rd.	6 oz.	SS-811J	65c	49c	46c
2¼"	3-4	Rd.	Rd.	6 oz.	SS-891J	65c	49c	46c
2 x 6"	35	Sq.	Rd.	6 oz.	SS-119J	65c	49c	46c
2¾ x 4"	8-10	Sq.	Sq.	6 oz.	SS-810J	65c	49c	46c
3"	8	Rd.	Rd.	6 oz.	SS-298J	65c	49c	46c
3"	25	Rd.	Rd.	6 oz.	SS-104J	65c	49c	46c
2¼ x 3½"	8-10	Sq.	Rd.	8 oz.	SS-099J	95c	75c	69c
3½"	8-12	Rd.	Rd.	8 oz.	SS-114J	95c	75c	69c
4"	8-10	Sq.	Rd.	8 oz.	SS-650J	95c	75c	69c
4 x 6"	3-4	Sq.	Sq.	1 lb.	SS-102J	1.49	1.19	1.15
4 x 6"	8-10	Sq.	Sq.	1 lb.	SS-656J	1.49	1.19	1.15
4 x 6"	16	Sq.	Sq.	1 lb.	SS-027J	1.49	1.19	1.15

Tubes 'N Timers at Low Olson Prices

1 AC-DC 5-Tube Package

• Replaces Tubes Used in 95% of All Table Radios **5.25**

No one but Olson offers a tube bargain like this! Five popular types: 12AV6, 12BA6, 12BE6, 50C5 and 35W4 rectifier. Purchased separately, they would cost \$\$\$ more.
XX-198J. Shpg. wt. 1/4 lb. 5.25

2 Nixie Readout Tube **2.98**

• Alpha-Numeric Configuration **2**
• Easy-to-Read Bright Red Display

Ideal for practically any readout application. Min. supply voltage: 170 VDC. Character size: 1 1/2 x 2 1/2". Tube: 4 1/4 x 1 3/4" dia. Removed from service. With specs and pin connections. Made by Borroughs!
XX-170J. Shpg. wt. 1/2 lb. 2.98

3 "Miniature" Nixie Readout Tube

• Can Be Read in Any Light **3.95**
• With Decimal Point

Provides sharp, numeric display of digits 1 thru 9. Minimum voltage supply: 170 VDC. Numerical size, 3/16 x 3/16". Tube size, 1 3/4 x 5/16" dia. 10-pin base. Made by NEC. 1/4 lb.
XM-107J. 1-5 Each 3.95
6-11 Each 3.50 12-Up Each 3.00

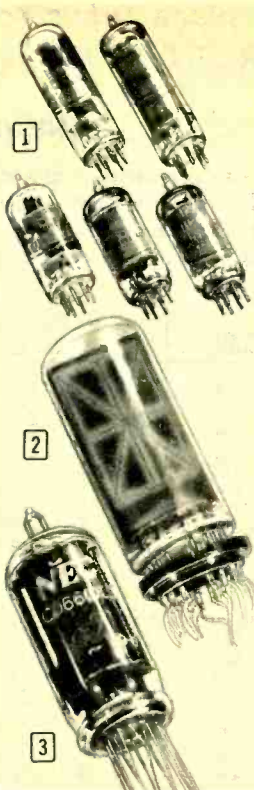

SHIELD Quality Tubes From Olson



1-YEAR GUARANTEE from purchase date on ALL Shield Tubes! Excludes broken tubes, burned out filaments, shipping charges.

Save 81¢

Get the popular 6GH8 Tube for only 59¢ with any other Shield Tube you purchase!

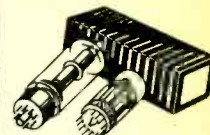

Tube Type	Each	Tube Type	Each	Tube Type	Each	Tube Type	Each	Tube Type	Each
1AD2	1.85	6AV6	1.18	6DT6A	1.43	6KT8	2.28	12BE6	1.35
1B3/1G3	1.75	6AW8A	1.95	6DW4	1.65	6KZ8	1.80	12BH7A	1.48
1BC2	1.63	6AX3	1.78	6DX8	1.58	6L6GC	2.60	12BY7A	1.40
1J3	1.75	6A4GT	1.83	6E4	1.73	6LB6	2.65	12DQ6B	2.35
1K3	1.75	6AY3	1.63	6EH7	1.68	6LE8	2.40	12GN7	2.23
1R5	1.93	6BA6	1.35	6EJ7	1.55	6LF8	2.20	12HG7	2.43
1U5	1.23	6BA11	2.15	6EM5	1.95	6LJ8	1.93	12HL7	2.28
1V2	1.20	6BC5/6CES	1.45	6EW7	2.28	6LQ6/6JE6	4.20	12SN7GT	1.88
1X2	1.65	6BE5	1.35	6EWS	1.48	6LW8	2.40	12X4	.98
2AV2	1.38	6BH6	1.75	6FG7	2.03	6LY8	1.95		
2CY5	1.75	6BJ6	1.78	6FM7	2.13	6ME8	2.48	13EM7	2.28
3AC3/3AW3/3B2	1.85	6BK4C	3.58	6FOT	1.30	6S4	1.63	13FM7	1.68
3AT2	1.85	6BL7GT	2.65	6GE5	2.53	6SN7GT	1.78	13GF7	2.28
3BU8	1.63	6BL8	1.23	6GF7	2.33	6T8A	2.05	13Z10	2.55
3BZ6	1.20	6BM8	1.55	6GH8	1.40	6U8A	1.63	15KY8	2.52
3CB6	1.18	6BN4	1.60	6GJ7	1.85	6V6GT	1.93	17AY3	1.63
3DC4	2.43	6BN6	1.98	6GK5	1.90	6W4GT	1.45	17B11	2.60
3GK5	1.68	6BN8	1.73	6GM6	1.53	6X4	1.33	17DQ6B	1.78
3HM5/3HA5	1.68	6BQ5	1.70	6GN8	2.18	6X5GT	1.58	17JM6	2.90
3HQ5	1.75	6BQ6GT	2.48	6GU7	1.58				
4CB6	1.18	6B07	1.93	6GX6/6GY6	1.40	6X8	1.95	17JN6	2.33
4BZ6	1.20	6BU8	2.18	6H4S/6HM5	1.68	6X10/6J10	2.83	17JZ8	1.90
4DT6	1.40	6BZ6	1.20	6HB7	1.76	7AU7	1.50	19AU4	1.90
5AT8	2.13	6BZ7	1.93	6HE5	1.83	8AW8A	1.98	21CY5	2.45
5CC8	1.75	6C4	1.63	6HQ5	1.85	8F07/8CG7	1.30	22AF6	3.08
5GH8	1.95	6CB6	1.20	6HS8	1.83	8JVB	1.73	23Z9	2.33
5KE8	2.65	6CQ8	3.73	6HZ6	1.40	10DE7	1.98	25B06	2.20
5U4GB	1.48	6CG3/6CD3	1.85	6JA	1.70	10KQ5	1.68	25L6GT	1.73
5048	1.70	6CG7	1.30	6JB6	2.80	10GH8	1.95	33GY7	3.95
						12A05	1.55	35C5	1.40
5Y3GT	1.45	6CG8A	1.70	6JC6	1.75	12AT7	1.50	35W4	1.05
6AB4	1.58	6CL6	1.83	6JD6	1.78	12AU6	1.30	35Z5GT	1.48
6AF3	1.75	6CL8A	1.95	6JE6	4.20	12AU7A	1.35	38HE7	3.45
6AF4/6DZ4	2.15	6CM7	1.58	6JH6	1.55	12AV6	1.03	50C5	1.35
6AG5	1.88	6CN7	1.95	6JH8	2.43	12AV7	2.03	50EH5	1.95
6AH6	2.30	6CQ8	1.78	6JM6	2.53	12AX4	1.60	50L6GT	1.55
6AK5	2.08	6CU5	1.55	6JN6	2.28	12AX7A	1.40		
6AL5	1.05	6CV5	1.98	6JS6	4.13	12AZ7	1.75		
6AM8A	2.03	6DA4A	1.83	6JTB	1.95	12B4	1.75		
6AN8A	2.20	6DE4	1.83	6JUB	1.95	12BA6	1.25		
8AQ5A	1.48	6DE6	1.55	6K8	2.15				
6AS5	1.75	6DE7	1.95	6KD6	4.20				
6AUMGT	2.13	6DK6	1.30	6KD8	1.70				
6AU6A	1.30	6DQ5	4.25	6KE8	2.30				
6AU8	2.23	6DQ6B	2.43	6KM6	3.90				

"Carry-All" Tube Caddy

Indispensable for service calls! Holds up to 143 tubes, plus service tools and meters. Scuff-resistant vinyl covering, sturdy clasp lock. 14 3/4 x 12 1/2 x 8".
CA-125J. Shpg. wt. 8 lbs. 13.98

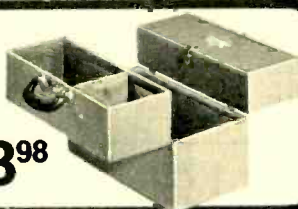

Automatic Timing Switches

Safety, Security and Convenience

"Easy-Time" Plug-In Timer

• 1320-Watt Capacity **6.99**
• 24-Hour Timing Cycle

It's the easy convenient way to give your house a "lived in" appearance when your away, get coffee started in the morning, even turn on small air conditioners at preset times during hot weather. Simply plug "Easy-Time" in 117 VAC outlet, appliance into "Easy-Time". 2 1/2 x 3 1/2 x 1 1/4". U.L. listed.

XX-166J. Shpg. wt. 2 1/2 lbs. 6.99

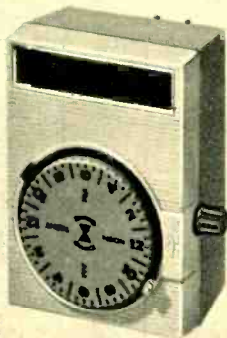

Intermatic "Time-All" Time Switch

• 875-Watt Capacity **7.77**
• With 6-Ft. AC Cord

Convenient timer for applications where high power capacity is not required. Min. "on" time, 15 minutes, max. "on" time, 23 hours. Plug device into timer, timer into 117 VAC outlet. 5 x 4 x 2 3/4". U.L. listed.

XX-090J. Shpg. wt. 2 1/2 lbs. 7.77



Buy at Way Below Installer's Prices!

Westinghouse Tubes

Choose from Olson's stock of Power and Special-Purpose tubes. Includes hard-to-find tubes for import sets and Amateur equipment. 1/4 lb. More tubes 190-191.

Tube Type	Each	Tube Type	Each
WL-OA2	1.55	WL-6360	5.25
WL-OB2	1.70	WL-4-400 A/8438	53.50
WL-5R4GYB	2.58	WL-4-1000 A/8166	135.00
WL-807	5.35	6HF5	4.78
WL-811A	9.05	6LB6	5.11
WL-813	24.50	6LQ6	4.86
WL-614A	4.70	6GJ5A	3.65
WL-6146B	5.21	6JB6A	3.85
		6JS6C	4.45

Telechron Timer *It's a Timer!* *It's a Clock!*

144

- 4-Ampere Switch
- Function Selector
- Slumber Switch & Buzzer

The same highly-regarded timing mechanism that's used in major-brand clock radios! Use as a timer for electrical appliances, or as a regular clock. Great for "custom-building" into walls, around kitchen, etc. 3 1/2 x 3 1/2 x 2". For 117 VAC. Hands extra.
XX-124J. Wt. 1/4 lb. Style May Vary 1.44
XX-158J. 10 Asst'd Clock Hands. 1/4 lb. 99¢



Westinghouse 50% Off Installer's

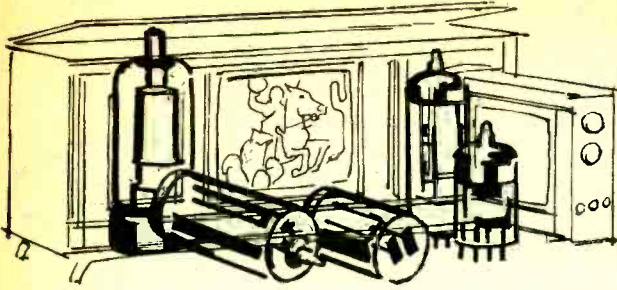

- **Replace Tubes Yourself and SAVE!!**
- **FREE Tube Testing At Your Nearest Olson Store!**

ONE YEAR GUARANTEE!

All tubes are brand new and guaranteed a full 12 months from the date of purchase. Olson will replace, free of charge (except postal costs), any defective tube due to faulty workmanship or material within the **GUARANTEE PERIOD**. This does not apply to broken or burned-out filaments.

Tube Type	Installer's Resale	Olson Price	
		1-5	6 & Up
OZ4A	\$4.30	2.36	2.15
1A02	3.90	2.14	1.95
1AY2	4.05	2.22	2.02
1B02	4.05	2.22	2.02
1G3GT/1B3GT	4.35	2.39	2.17
1K3/1J3	4.35	2.39	2.17
1R5	5.70	3.13	2.85
1S2A/DY87	2.55	1.40	1.27
1U4	4.25	2.33	2.12
1U5	3.75	2.06	1.87
1V2	2.55	1.40	1.27
1X2A/1X2B	4.10	2.25	2.05
2AF4B/2DZ4	4.50	2.47	2.25
2AV2	3.45	1.89	1.72
2BN4A	3.90	2.14	1.95
2BU2/2AS2A	4.25	2.33	2.12
2CV5	5.35	2.94	2.67
2EG4	6.80	3.74	3.40
2FS5	5.30	2.91	2.65
2GK5/2FQ5A	4.20	2.31	2.10
3A3C	4.40	2.42	2.20
3AF4B/3DZ4	4.50	2.47	2.25
3AT2B	4.25	2.33	2.12
3AW2A	4.40	2.42	2.20
3BN2A	4.00	2.20	2.00
3BN6	5.20	2.86	2.60
3BW2/3BS2A/3BT2	4.65	2.55	2.32
3BZ6	4.10	2.25	2.05
3CA3	4.05	2.22	2.02
3CB6/3CF6	2.95	1.62	1.47
3CN3B	4.60	2.53	2.30
3CU3A	5.35	2.94	2.67
3CY5	3.75	2.06	1.87
3CZ3	4.75	2.61	2.37
3DB3/3CY3	4.80	2.64	2.40
3DC3	5.05	2.77	2.52
3DG4	6.35	3.49	3.17
3DK6	3.90	2.14	1.95
3GK5	4.20	2.31	2.10
3GS8/3BU8	5.30	2.91	2.65
3HM5/3HA5	4.20	2.31	2.10
3HQ5	6.25	3.43	3.12
3JC5A	5.90	3.24	2.95
3KT6	4.15	2.28	2.07
3V4	4.45	2.44	2.22
4AU6	3.85	2.11	1.92
4BQ7A/4BZ7	4.45	2.44	2.22
4BZ6	4.10	2.25	2.05
4CB6	2.95	1.62	1.47
4CS6	4.05	2.22	2.02
4DT6A	4.30	2.36	2.15
4E7H	3.90	2.14	1.95
4EJ7	3.90	2.14	1.95
4GK5	4.20	2.31	2.10
4HS8	4.05	2.22	2.02
4JC6A	5.75	3.16	2.87
4JD6	5.05	2.77	2.52
4KE8	6.65	3.65	3.32
5A05	4.10	2.25	2.05
5AR4/GZ34	4.65	2.55	2.32
5BC3A	3.75	2.06	1.87
5BR8	5.35	2.94	2.67
5CG8	4.40	2.42	2.20
5CL8A	5.35	2.94	2.67
5EA8	5.65	3.10	2.82
5EW6	4.00	2.20	2.00
5FG7	5.05	2.77	2.52
5GH8A	5.15	2.83	2.57
5GJ7/LCE801	3.25	1.78	1.62
5GM6	3.60	1.98	1.80
5GX7	5.05	2.77	2.52
5HZ6	3.60	1.98	1.80
5KE8	6.65	3.65	3.32
5LJ8	4.80	2.64	2.40
5MB8	3.65	2.00	1.82
5U4GB/5AS4A	3.35	1.84	1.67
5U8	5.15	2.83	2.57
5V3A/5AU4	4.15	2.28	2.07
5V4GA/G	4.70	2.58	2.35
5Y3GT	3.25	1.78	1.62
6AB4	4.00	2.20	2.00
6AC7	6.30	3.46	3.15
6AC10	4.65	2.55	2.32
6AD10	8.85	4.86	4.42
6AF3	4.35	2.39	2.17

Tube Type	Installer's Resale	Olson Price	
		1-5	6 & Up
6AF4A/6DZ4	\$4.90	2.69	2.45
6AF9	3.50	1.92	1.75
6AF11	5.70	3.13	2.85
6AG5	4.30	2.36	2.15
6AG7	7.70	4.23	3.85
6AH6	5.80	3.19	2.90
6AK5/EF95	4.80	2.64	2.40
6AL3/EY88	2.60	1.43	1.30
6AL5	3.10	1.70	1.55
6AM8A/6AM8	5.05	2.77	2.52
6AN8A	5.50	3.02	2.75
6AQ5A/6HG5	3.70	2.03	1.85
6AQ8/ECC85	3.00	1.65	1.50
6AR11	5.75	3.16	2.87
6ASS	4.45	2.44	2.22
6AS8	5.70	3.13	2.85
6AT6	2.05	1.12	1.02
6AU4GT/GT	5.90	2.91	2.65
6AU5GT	5.70	3.13	2.85
6AU6A/8425	3.25	1.78	1.62
6AU8A	6.20	3.41	3.10
6AV6	2.95	1.62	1.47
6AW8A/6AW8	4.90	2.69	2.45
6AX3	3.75	2.06	1.87
6AX4GTB	4.05	2.22	2.02
6AX5GT	4.25	2.33	2.12
6AY3B/6BS3A	4.05	2.22	2.02
6AZ8	6.00	3.30	3.00
6B10	4.90	2.69	2.45
6BA6/EF93	3.60	1.98	1.80
6BA8A	5.20	2.86	2.60
6BA11	5.35	2.94	2.67
6BC4	5.90	3.24	2.95
6BC8/6BZ8	5.35	2.94	2.67
6BE3	4.90	2.69	2.45
6BE6	3.80	2.09	1.90
6BG6GA/G	7.15	3.93	3.57
6BH6	4.45	2.44	2.22
6BH8	5.05	2.77	2.52
6BH11	5.15	2.83	2.57
6BJ6A	4.45	2.44	2.22
6BJ8	4.75	2.61	2.37
6BK4C/6EL4A	8.15	4.48	4.07
6BK7B	5.20	2.86	2.60
6BL7GTA	6.65	3.65	3.32
6BL8/ECF80	2.70	1.48	1.35
6BM8/ECL82	2.90	1.59	1.45
6BN4A	3.95	2.17	1.97
6BN6/6KS6	4.95	2.72	2.47
6BN8	4.30	2.36	2.15
6BN11	5.65	3.10	2.82
6BQ5/EL84	4.25	2.33	2.12
6BO6GTB/6CU6	5.90	3.24	2.95
6BX7A/6BZ7	5.45	2.99	2.72
6BR8A/6FV8A	5.20	2.86	2.60
6BS8	5.35	2.94	2.67
6BU8	5.55	3.05	2.77
6BV11	5.40	2.97	2.70
6BW11	5.65	3.10	2.82
6BX7GT	6.50	3.57	3.25
6BY6	3.75	2.06	1.87
6BY8	2.70	1.48	1.35
6BZ6	3.40	1.87	1.70
6C4	4.05	2.22	2.02
6CA4	3.75	2.06	1.87
6CA7/EL34	5.90	3.24	2.95
6CB5A	9.85	5.41	4.92
6CB6A/6CF6	3.60	1.98	1.80
6CD6GA/G	7.30	4.01	3.65
6CE5/6BC5	3.60	1.98	1.80
6CG3	4.30	2.36	2.15
6CG8A	4.70	2.58	2.35
6CH3	4.10	2.25	2.05
6CJ3/6DW4B/6CL3	4.10	2.25	2.05
6CK3	4.10	2.25	2.05
6CL6	5.20	2.86	2.60
6CL8A	4.90	2.69	2.45
6CM6	4.25	2.33	2.12
6CM7	4.55	2.50	2.27
6CN7	4.90	2.69	2.45
6CQ4	4.15	2.28	2.07
6CQ8	5.05	2.77	2.52
6CS6	4.10	2.25	2.05
6CS7	4.15	2.28	2.07
6CU5	4.40	2.42	2.20

Tube Type	Installer's Resale	Olson Price	
		1-5	6 & Up
6CU8	\$5.05	2.77	2.52
6CW4	6.20	3.41	3.10
6CW5/EL86	2.75	1.51	1.37
6CX8	5.60	3.08	2.80
6CY5	5.35	2.94	2.67
6CY7	3.05	1.67	1.52
6CZ5	5.20	2.86	2.60
6DA4A	4.05	2.22	2.02
6DC8	4.25	2.33	2.12
6DE4	4.15	2.28	2.07
6DE6	3.60	1.98	1.80
6DE7	4.90	2.69	2.45
6DN7	5.05	2.77	2.52
6DQ5	8.75	4.81	4.37
6DR7	5.55	3.05	2.77
6DS4	5.90	3.24	2.95
6DT5	3.55	1.95	1.77
6DT6A	3.55	1.95	1.77
6DX8/ECL84	2.95	1.62	1.47
6EAB	4.30	2.36	2.15
6EB8/6GN8	5.65	3.10	2.82
6ER5	3.90	2.14	1.95
6EH7/EF183	4.20	2.31	2.10
6EJ7/EF184	3.90	2.14	1.95
6EM5	4.90	2.69	2.45
6EM7/6EA7	6.10	3.35	3.05
6ER5	4.65	2.55	2.32
6ES8/ECC189	5.45	2.99	2.72
6EU7	4.40	2.42	2.20
6EV5	4.25	2.33	2.12
6EW6	3.85	2.11	1.92
6EW7	6.50	3.75	3.25
6FG5	5.35	2.94	2.67
6FG7	5.05	2.77	2.52
6FH5	5.00	2.75	2.50
6FM7	5.05	2.77	2.52
6FQ7/6CG7	3.25	1.78	1.62
6FS5	4.55	2.50	2.27
6FV6	4.90	2.69	2.45
6FY5	2.75	1.51	1.37
6FY7	3.85	2.11	1.92
6GC5	5.65	3.10	2.82
6GC5	6.30	3.46	3.15
6G7A	5.80	3.19	2.90
6GH8A	3.50	1.92	1.75
6GJ7/ECF801	3.10	1.70	1.55
6GK5/6FQ5A	5.05	2.77	2.52
6GK6	4.05	2.22	2.02
6GM6	4.25	2.33	2.12
6GT5	6.35	3.49	3.17
6GU7	4.55	2.50	2.27
6GV5	4.50	2.47	2.25
6GWB/ECL86	3.05	1.67	1.52
6GX7	5.90	3.24	2.95
6GY6/6GX6	3.75	2.06	1.87
6H6	6.05	3.32	3.02
6HB5	5.05	2.77	2.52
6HB7	4.75	2.61	2.37
6HE5	5.55	3.05	2.77
6HF5	8.70	4.78	4.35
6HF8	5.90	3.24	2.95
6HL8	3.35	1.84	1.67
6HMS/6HA5	4.20	2.31	2.10
6HO5	5.55	3.05	2.77
6HS5	8.50	4.67	4.25
6HS8	5.20	2.86	2.60
6HV5	10.25	5.63	5.12
6HZ6	3.50	1.92	1.75
6J5	5.05	2.77	2.52
6J6A	4.90	2.69	2.45
6J7	6.95	3.82	3.47
6JB6A	7.00	3.85	3.50
6JCB6A	4.90	2.69	2.45
6JD6	4.60	2.53	2.30
6JF6	7.25	3.98	3.62
6JG6A	7.15	3.93	3.57
6JH6	3.90	2.14	1.95
6JH8	5.90	3.24	2.95
6JM6	6.30	3.46	3.15
6JN6	5.85	3.21	2.92
6JN8	4.00	2.20	2.00
6JO6	4.25	2.33	2.12
6JSC8	8.10	4.45	4.05
6JTB6A	5.85	3.21	2.92
6JT8	4.90	2.69	2.45

Prices When You Buy 6 Or More! Tubes May Be Assorted For Quantity Pricing

Tube Type	Installer's Resale	Olson Price	
		1-5	6 & Up
6JU8A	\$4.85	2.66	2.42
6JWB/ECF802	3.40	1.87	1.70
6JZ8	3.85	2.11	1.92
6K6GT	4.40	2.42	2.20
6KA8	5.35	2.94	2.67
6KD6	9.75	5.36	4.87
6KE8	6.70	3.54	3.35
6KM6	8.85	4.86	4.42
6KN6	8.00	4.40	4.00
6KT6	4.90	2.69	2.45
6KT8	5.90	3.24	2.95
6KV8	6.45	3.54	3.22
6KY8A	8.15	4.48	4.07
6KZ8	4.50	2.47	2.25
6L6	10.20	5.61	5.10
6L6GC	6.50	3.57	3.25
6LB6	9.30	5.11	4.65
6LC8	5.20	2.86	2.60
6LE8	6.10	3.35	3.05
6LF6	8.45	4.64	4.22
6LF8	5.65	3.10	2.82
6LJ6A/6LH6A	8.85	4.86	4.42
6LJ8	4.80	2.64	2.40
6LM8	5.35	2.94	2.67
6LN8	2.40	1.32	1.20
6LQ6/6JE6C	9.10	5.00	4.55
6LQ8	6.05	3.32	3.02
6LR6	8.85	4.86	4.42
6LR8	4.75	2.61	2.37
6LU8	5.25	2.88	2.62
6LY8	4.25	2.33	2.12
6M11	6.35	3.49	3.17
6MB8	3.65	2.00	1.82
6MD8	5.80	3.19	2.90
6ME8	6.20	3.41	3.10
6MG8	2.45	1.34	1.22
6MJ8	5.05	2.77	2.52
6MN8	5.30	2.91	2.65
6N7	5.55	3.05	2.77
6S4A/6S4	3.70	2.03	1.85
6SH7	6.15	3.38	3.07
6SJ7	5.85	3.21	2.92
6SK7	5.45	2.99	2.72
6SL7GT	5.40	2.97	2.70
6SN7GTB	4.40	2.42	2.20
6S07	5.40	2.97	2.70
6T8A	5.15	2.83	2.57
6T10	5.90	3.24	2.95
6U8A/6KD8/5KD8	4.25	2.33	2.12
6U10	4.45	2.44	2.22
6V6	7.40	4.07	3.70
6V6GTA	4.90	2.69	2.45
6W6GT	4.60	2.53	2.30
6X4	3.75	2.06	1.87
6X5GT	3.95	2.17	1.97
6Y6A	4.45	2.44	2.22
6Y6GT	3.55	1.95	1.77
6Y9	3.40	1.87	1.70
6Z0/6UJ10	6.65	3.65	3.32
7AU7	3.10	1.70	1.55
8AW8A	5.85	3.21	2.92
8B10	4.80	2.64	2.40
8BA11	6.05	3.32	3.05
8BQ5	4.10	2.25	2.02
8CS7	3.95	2.17	1.97
8CV5	2.55	1.40	1.27
8FQ7/8CG7	3.25	1.78	1.62
8JU8A	3.70	2.03	1.85
8JV8	4.70	2.58	2.35

Tube Type	Installer's Resale	Olson Price	
		1-5	6 & Up
8KA8	\$5.10	2.80	2.55
8LC8	5.25	2.88	2.62
8LT8	4.40	2.42	2.20
9AB/8AB/PCF80	2.65	1.45	1.32
10CW5/LL86	2.55	1.40	1.27
10DE7	5.40	2.97	2.70
10D8/LLCL84	2.75	1.51	1.37
10GF7A	5.45	2.99	2.72
10GK6	4.45	2.44	2.22
10GN8	5.35	2.94	2.67
10HF8	5.90	3.24	2.95
10JT8	4.70	2.58	2.35
10JY8	4.00	2.20	2.00
10LZ8/10JA8	4.55	2.50	2.27
11BQ11	5.85	3.21	2.92
11BT11	7.15	3.93	3.57
11FY7	4.05	2.22	2.02
11KV8	6.50	3.57	3.25
11LQ8	6.50	3.57	3.25
11LT8	4.25	2.33	2.12
12AB5	4.25	2.33	2.12
12AD6	3.85	2.11	1.92
12AE10	6.30	3.46	3.15
12AF3	4.25	2.33	2.12
12AL5	3.00	1.65	1.50
12AL11	5.65	3.10	2.82
12AQ5	3.85	2.11	1.92
12AT6	3.05	1.67	1.52
12AT7/ECC81	3.75	2.06	1.87
12AU6	3.85	2.11	1.92
12AU6/8426A	3.85	2.11	1.92
12AU7A/ECC82	3.35	1.84	1.67
12AV6	2.55	1.40	1.27
12AV7	5.05	2.77	2.52
12AX4GTB	3.70	2.03	1.85
12AX7A/ECC83	3.05	1.67	1.52
12AZ7A	4.45	2.44	2.22
12B4A	4.40	2.42	2.20
12BA6	3.10	1.70	1.55
12BE3	3.75	2.06	1.87
12BE6	3.40	1.87	1.70
12BH7A	4.30	2.36	2.15
12BL6	4.05	2.22	2.02
12BY7A/12BY7	3.90	2.14	1.95
12CA5	4.35	2.39	2.17
12CU5/12C5	4.75	2.61	2.37
12DQ6B/12GW6	5.65	3.10	2.82
12DT5	3.40	1.87	1.70
12DT8	3.90	2.14	1.95
12FX5	3.60	1.98	1.80
12GE5	5.70	3.13	2.85
12GN7A	6.05	3.32	3.02
12HG7	6.05	3.32	3.02
12HL7	5.35	2.94	2.67
12SA7	5.50	3.02	2.75
12SK7	5.80	3.19	2.90
12SL7GT	4.95	2.72	2.47
12SN7GTA	4.70	2.58	2.35
12SQ7	5.50	3.02	2.75
12W6GT	5.35	2.94	2.67
13CW4	5.55	3.05	2.77
13DE7	5.25	2.88	2.62
13EN7	5.70	3.13	2.85
13EN7/15EA7	6.70	3.68	3.35
13FD7	5.90	3.24	2.95
13GF7A	5.70	3.13	2.85
13JV10	6.50	3.57	3.25
13Z10/13J10	6.85	3.76	3.42
14BL11	8.00	4.40	4.00
14BR11	6.35	3.49	3.17

Tube Type	Installer's Resale	Olson Price	
		1-5	6 & Up
15BD11A	\$6.00	3.30	3.00
15FM7/13FM7	4.45	2.44	2.22
15KY8A	6.95	3.82	3.47
16AQ3/XY88	2.70	1.48	1.35
17AX4GTA	3.70	2.03	1.85
17AY3	4.05	2.22	2.02
17BE3	4.05	2.22	2.02
17BF11	6.50	3.57	3.25
17BS3A	4.05	2.22	2.02
17BW3	3.20	1.76	1.60
17BZ3	4.05	2.22	2.02
17C5/17CU5	3.40	1.87	1.70
17CK3	3.55	1.95	1.77
17D4/17DMA4	4.45	2.44	2.22
17D06B/17GW6	6.05	3.32	3.02
17EW8/HCC85	3.00	1.65	1.50
17GJ5	6.65	3.65	3.32
17GJ5A	6.05	3.32	3.02
17JBEA	6.45	3.54	3.22
17JM6	6.50	3.57	3.25
17JN6	5.80	3.19	2.90
17JT6A	6.20	3.41	3.10
17JZ8	3.90	2.14	1.95
17KV6A	8.60	4.73	4.30
18AJ10	5.90	3.24	2.95
19AU4GTA	4.35	2.39	2.17
19CG3	4.00	2.20	2.00
19T8	5.35	2.94	2.67
20AQ3/LY88	3.30	1.81	1.65
21GY5	5.05	2.77	2.52
21HB5A	5.25	2.88	2.62
21JZ6	5.35	2.94	2.67
21LR8	5.00	2.75	2.50
21LU8	5.00	2.75	2.50
22BW3	4.45	2.44	2.22
22DE4	4.60	2.53	2.30
22JF6	7.70	4.23	3.85
22JG6A	6.75	3.71	3.37
22JR6	6.80	3.74	3.40
22JU6	6.80	3.74	3.40
23Z9	5.20	2.86	2.60
24LQ6/24JE6A	9.25	5.08	4.62
25C5	4.05	2.22	2.02
25CG3	3.40	1.87	1.70
25CK3	3.40	1.87	1.70
25EH5	4.05	2.22	2.02
25L6GT	4.05	2.22	2.02
27GB5/PL500	3.70	2.03	1.85
33GY7A	7.00	3.85	3.50
34CE3	4.30	2.36	2.15
35C5	3.50	1.92	1.75
35L6GT	4.25	2.33	2.12
35LR6	8.85	4.86	4.42
35W4	2.25	1.23	1.12
35ZSGT	3.70	2.03	1.85
38HE7	8.00	4.40	4.00
38HK7	8.00	4.40	4.00
40KD6	9.70	5.33	4.85
42KN6	8.00	4.40	4.00
50C5	3.35	1.84	1.67
50EH5	3.90	2.14	1.95
50HK6	2.35	1.29	1.17
50L6GT	4.90	2.69	2.45
6973	5.05	2.77	2.52
70Z5	3.10	1.70	1.55
70Z7A	4.40	4.07	3.70
7189A	7.65	2.55	2.32
7199	5.65	3.10	2.82
7581A	2.80	1.54	1.40
7858	5.65	3.10	2.82
8417	5.65	3.10	2.82

We Stock A Wide Selection of Tubes for Imported Equipment, Too.

• 12-Month Guarantee!* • Money-Saving Prices! • All Are Brand-New, Top Quality!

Tube Type	Installer's Resale	Olson Price	
		1-5	6 & Up
1DK29	\$2.95	1.62	1.47
3DHH13	7.15	3.93	3.57
3EH7/XF183	2.55	1.40	1.27
3EJ7/XF184	2.55	1.40	1.27
4BL8/XCF80	2.40	1.32	1.20
4GS7	3.70	2.03	1.85
4HAS/PC900	2.30	1.26	1.15
4MP12	4.30	2.36	2.15
4RH12	4.45	2.44	2.22
5GS7	3.65	2.00	1.82
5HG8/LCF86	3.70	2.03	1.85
5U9/LCF201	3.10	1.70	1.55
6AB8/ECL80	3.85	2.11	1.92
6BR3/6RK19	4.85	2.66	2.42
6DHH12	3.75	2.06	1.87
6DHH13	7.30	4.01	3.65
6DJ9/ECC88	4.95	2.72	2.47
6DL4/EC88	7.95	4.37	3.97
6DL5/EL85	3.25	1.78	1.62
6EH4A	8.60	4.73	4.30
6FG6/EM84	3.65	2.00	1.82
6GB3A ORDER 6BQ6GTB/6CU6			
6GB6 ORDER 6DQ6B/6GW6			
6GB7 ORDER 6DQ6B/6GW6			
6GK17	5.25	2.88	2.62
6GM8/ECC86	4.95	2.72	2.47
6GS7	3.85	2.11	1.92
6HG8/ECF86	3.70	2.03	1.85
6HU6/EM87	4.85	2.66	2.42
6HUB/ELL80	6.15	3.38	3.07

Tube Type	Installer's Resale	Olson Price	
		1-5	6 & Up
6GK5/PL505	\$9.60	5.28	4.80
6LX8/LCF802	2.60	1.43	1.30
6MHH3	4.90	2.69	2.45
6MP17	5.50	3.02	2.75
6MP18	5.35	2.94	2.67
6RA6	6.80	3.74	3.40
6RRH2	5.35	2.94	2.67
6RK19 ORDER 6BR3/6RK19			
6RP15	4.65	2.55	2.32
6RP22	9.95	5.47	4.97
6V4/EZ80	1.70	0.93	0.85
6X9/ECF200	3.25	1.78	1.62
7GS7	4.55	2.50	2.27
7HG8/PCF86	3.05	1.67	1.52
7MP18	5.30	2.91	2.65
8B8	5.45	2.99	2.72
8GJ7/PCF801	3.15	1.73	1.57
8KR8	6.20	3.41	3.10
9AQ8/PCC85	7.15	3.93	3.57
9BJ11	5.85	3.21	2.92
9GH8A	4.10	2.25	2.05
9JW8	3.90	2.14	1.95
9MHH3	4.15	2.28	2.07
9MP12	4.30	2.36	2.15
9RAL1 ORDER 10DE7			
9RA6	7.65	4.20	3.82
10GV8	3.90	2.14	1.95
11BM8	5.75	3.16	2.87
11Y9/LFL200	3.70	2.03	1.85
12AC10A	5.30	2.91	2.65

Tube Type	Installer's Resale	Olson Price	
		1-5	6 & Up
12AU6	\$3.85	2.11	1.92
12BB14	10.50	5.77	5.25
12B3 ORDER 12AF3			
12DWA4	5.60	3.08	2.80
12GB3	9.3		

Olson Low-Cost, Hi-Value VHF-UHF-FM Antennas

Olson "All-Channel" Antennas Feature . . .

- ✓ High Front-to-Back Ratios and Sharp Directivity to Fight Ghosts & Snow!
- ✓ Heavy-Duty Aluminum Construction!

Wherever you live, there's an Olson, patented antenna for your area! Each is built for "hi-fi" color or black & white reception and preassembled for fast, error-proof mounting. All have "No-Tilt" U-bolt assembly that firmly mounts antenna to mast. VHF-UHF signal splitter included—only one 300-ohm lead-in required.

For Color or Black & White!

Three-in-One design provides brilliant movie-clear TV pictures plus full-range hi-fi stereo FM listening!

"Gold-Protecto" Finish

Exclusive "Gold Protecto" finish protects all parts (inside and out!) from corrosion and deterioration!

VHF-UHF "All-Channel" Design

Get near-perfect signals from each station. All include VHF-UHF signal splitter at NO extra cost!

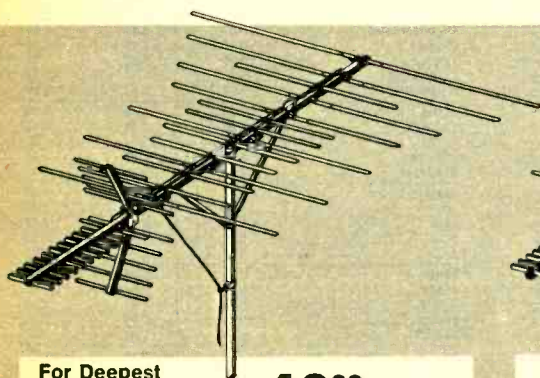

For Deepest Fringe-Area Reception

40⁹⁸
26-Element

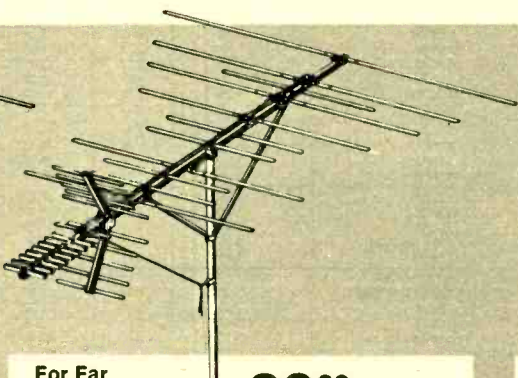

For Far Fringe-Area Reception

33⁹⁸
21-Element

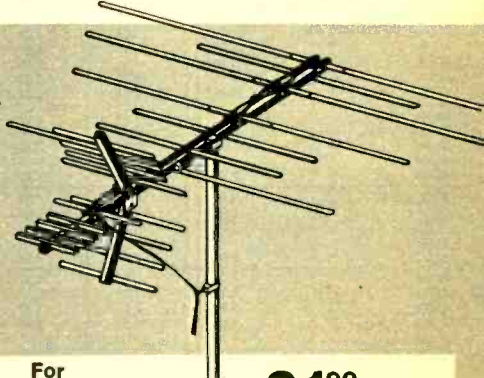

For Suburban Reception

21⁹⁸
13-Element

Super Deluxe VHF-UHF-FM Antenna

Model 3C26. Top-quality, all-channel model with special "corner-reflector" for deepest fringe area reception. Highly directional characteristics. Boom length: 150 1/4". Turning Radius: 89". AA-467J. Shpg. wt. 11 1/4 lbs. 40.98

Deluxe All Channel Antenna

Model 3C21. Pulls in distant stations clearly with special "corner reflector." Highly directional characteristics reject unwanted signals. Boom length: 118 1/4". Turning radius: 72". AA-466J. Shpg. wt. 10 1/2 lbs. 33.98

Low-Cost VHF-UHF-FM Antenna

Model 3C13. "Corner reflector" design for excellent suburban reception of all channels. "Gold Protecto" finish. Preassembled, ready for instant installation. Boom length: 63". Turning radius: 60". AA-464J. Shpg. wt. 6 1/2 lbs. 21.98

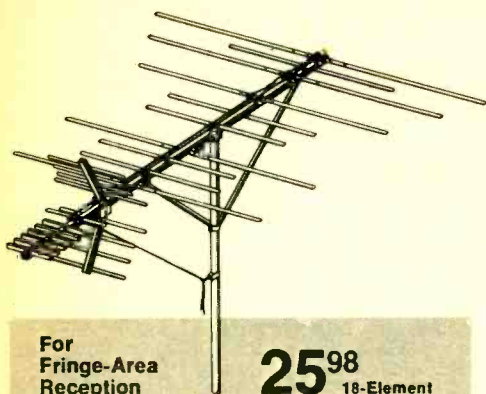

For Fringe-Area Reception

25⁹⁸
18-Element

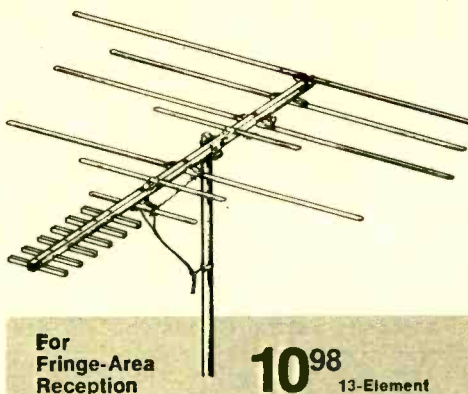

For Fringe-Area Reception

10⁹⁸
13-Element

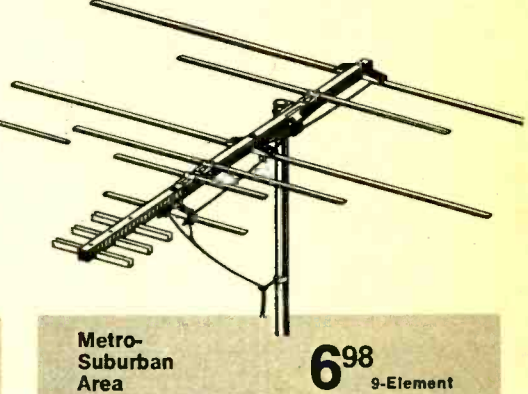

Metro-Suburban Area

6⁹⁸
9-Element

High-Performance Antenna

Model 3C18. Provides "high fidelity" VHF-UHF-FM reception in fringe areas. Top features include "Gold Protecto" finish, highly directional design. Boom length: 93". Turning radius: 60". AA-465J. Shpg. wt. 8 1/4 lbs. 25.98

Value-Plus VHF-UHF-FM Antenna

Model CA-13. Has the features of other brands costing much more. Includes VHF-UHF signal splitter. Corrosion-resistant "Gold Protecto" finish. Boom length: 69 3/4". Turning radius: 61 1/2". AA-463J. Shpg. wt. 4 1/2 lbs. 10.98

Metro-Suburban Area Antenna

Model CA9. If you live in a good signal area, why pay more? Heavy-duty, preassembled design with "Gold Protecto" finish. Boom length: 30". Turning radius: 55". AA-462J. Shpg. wt. 3 1/4 lbs. 6.98

ALL These Antennas Shipped REA Express Only.

Antenna Rotator Systems for Really Improved Reception

1 Budget-Priced Manual System

- Locks in Distant Stations for Maximum Signal Strength
- Fingertip Antenna Control

Model K-22. Really makes a difference in crowded signal areas. Gives you precise directional control of your outdoor antenna. Simply push the top-of-set control bar and "aim" toward the desired station. Indicator light signals end of rotation. Requires 4-wire cable. 117 VAC. AA-239J. Shpg. wt. 9 lbs. 19.98

2 Deluxe Manual Rotator System

- Weatherproof Die-Cast Housing
- Control Unit Has Easy-View Directional Indicator

Model T-45. Just touch the control bar to "zero in" on the best available signal. Rotator has lifetime lubricated bearings, positive brake to prevent overshoot. Requires 5-wire cable. 117 VAC. AA-168J. Shpg. wt. 12 lbs. 25.75
AA-167J. Bearing Bracket. Minimizes strain. For large antennas, high wind areas, etc. 2 lbs. 3.49



1 19⁹⁸

ALLIANCE

2 25⁷⁵

Olson. VHF-TV/FM Antennas at Sensible Prices!

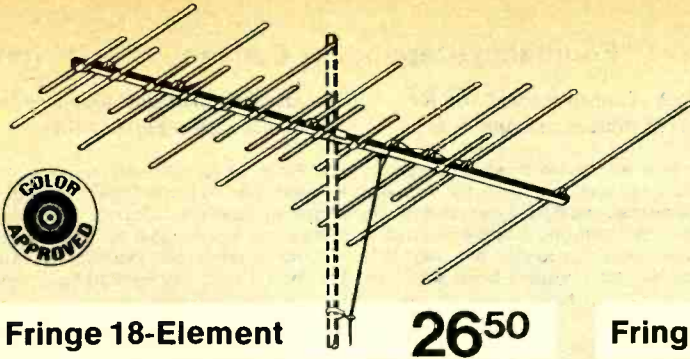

Deepest Fringe 18-Element

26⁵⁰

Model 218. Ideal for any deep-fringe area where no UHF reception is needed. Highly directional to chase away ghosts, deliver true-to-life color and black-and-white reception. Provides outstanding FM and Stereo FM from distant stations. Preassembled! "Gold Protecto" finish will give you years of trouble-free service. U-bolt and saddle assembly assure no-tilt mounting. Boom length: 138³/₄". Turning radius: 82".
AA-367J. Shpg. wt. 8³/₄ lbs. REA Express Only. 26.50

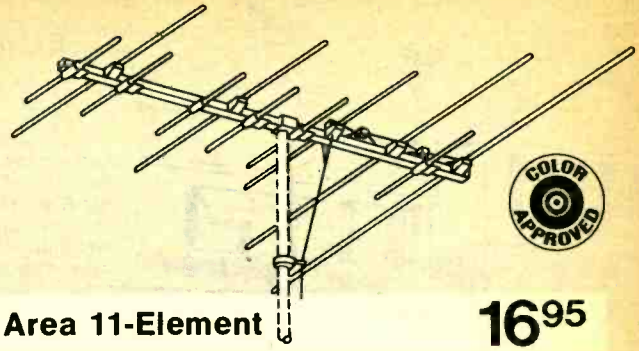

Fringe Area 11-Element

16⁹⁵

Model 211. Provides maximum VHF-FM performance in fringe areas. Covers VHF channels 2 through 13 with movie-clear color or black-and-white pictures. Pulls in distant FM stations with amazing clarity and stereo separation. Preassembled snap-out construction with "Gold Protecto" finish. Easily installed using ordinary household tools. Detailed mounting instructions included. Boom length: 69³/₄". Turning radius: 60".
AA-474J. Shpg. wt. 5³/₄ lbs. REA Express Only. 16.95

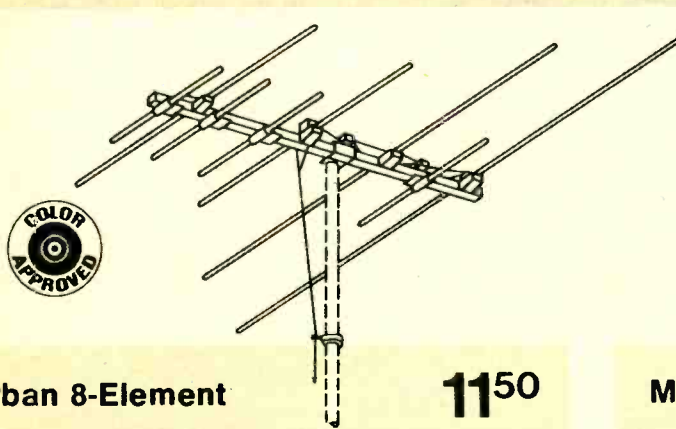

Suburban 8-Element

11⁵⁰

Model 28. Deluxe antenna that "brings in the signal while keeping out the interference." Especially designed for suburban area reception where no UHF reception is needed. Compact and easily installed, yet provides the movie-quality color and black-and-white TV pictures of many larger, more expensive models. Heavy-duty, preassembled construction for long life. Boom length: 48". Turning radius: 55".
AA-365J. Shpg. wt. 5 lbs. REA Express Only. 11.50

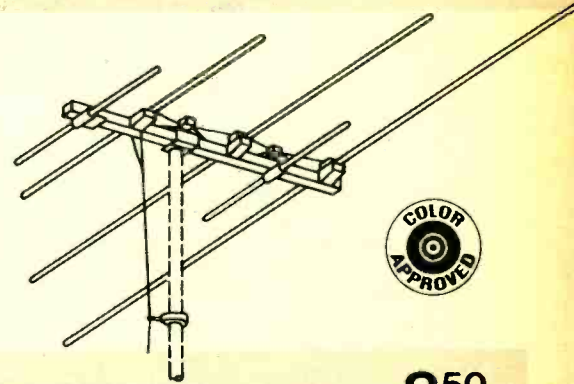

Metropolitan 5-Element

8⁵⁰

Model 25. Takes the high cost out of VHF-FM interference-free reception. Tune VHF channels 2 through 13 for brilliant color and black-and-white TV pictures; select your favorite FM stations for concert-hall clarity and separation. Preassembled construction with snap-open elements. "Gold Protecto" finish fights corrosion and deterioration. Easily installed with household tools. Boom length: 31³/₄". Turning radius: 55".
AA-473J. Shpg. wt. 4 lbs. REA Express Only. 8.50

Color Approved UHF Television Antennas

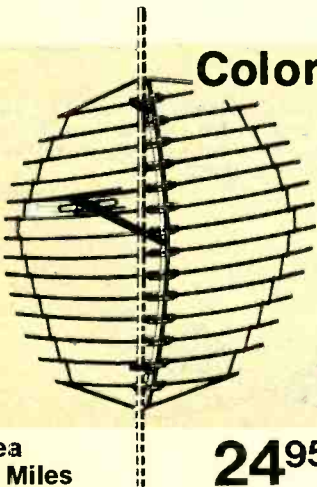

5 ft Parabolic

Fringe Area UHF to 80 Miles

24⁹⁵

Model P-5. Boasts the same type of configuration used for satellite tracking. Parabolic UHF TV antenna has 5-ft. diameter, radar-type design for extremely sharp directivity up to 80 miles away. Gain ranges from 14 dB to 18.6 dB. 300 ohms. Use foam-type lead-in.
AA-175J. Shpg. wt. 8 lbs. 24.95

Stacked Array 4-Bow-tie

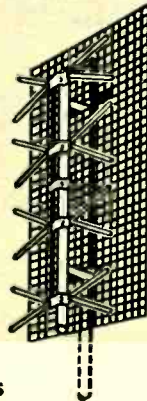

Fringe Area UHF to 50 Miles

5⁹⁵

Model 4BT. Low priced 4-bay bow-tie antenna for excellent color and black-and-white TV reception of channels 14 through 83. Range to 50 miles. Mounts to top or side of any mast with U-bolts (included). Aluminum. 300 ohms. Foam-type lead-in recommended.
AA-151J. Shpg. wt. 5 lbs. 5.95

Hi-Gain Corner Reflector

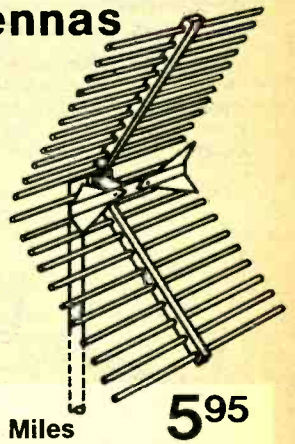

Fringe Area UHF up to 45 Miles

5⁹⁵

Model CRB. All-aluminum "corner reflector" design for fringe areas. High gain, sharp horizontal and vertical directivity fights "ghosts" and "snow." Range up to 45 miles. Gold corodized finish. 300 ohms. Use foam-type lead-in.
AA-098J. Shpg. wt. 3 lbs. 5.95

Finco Quality VHF-UHF-FM Antennas from Olson



Exclusive "Frequency-Dependent Concept" TV-FM Antennas

- High Front-to-Back Ratio for Sharp Pictures in Any Area
- Flat Response on Every Channel
- Isolation Stub Fights "Ghosts"

Capture the rainbow with these powerful antennas from Finco. Frequency-dependent concept for superb reception of color and black-and-white TV. Increased element spacing toward the high frequency end of the band, where it's needed most, assures highest signal pulling power on highest channels. Preassembled snap-out construction featuring one-piece drive line pedestals for positive spacing, triple thick sleeved elements. Non-breakable side-to-side red-color terminals, metal reinforced insulators with insert cups and heavy-duty rivets. Rugged 1" square boom with "lock-tite" no-tilt saddle bracket to fight high winds.

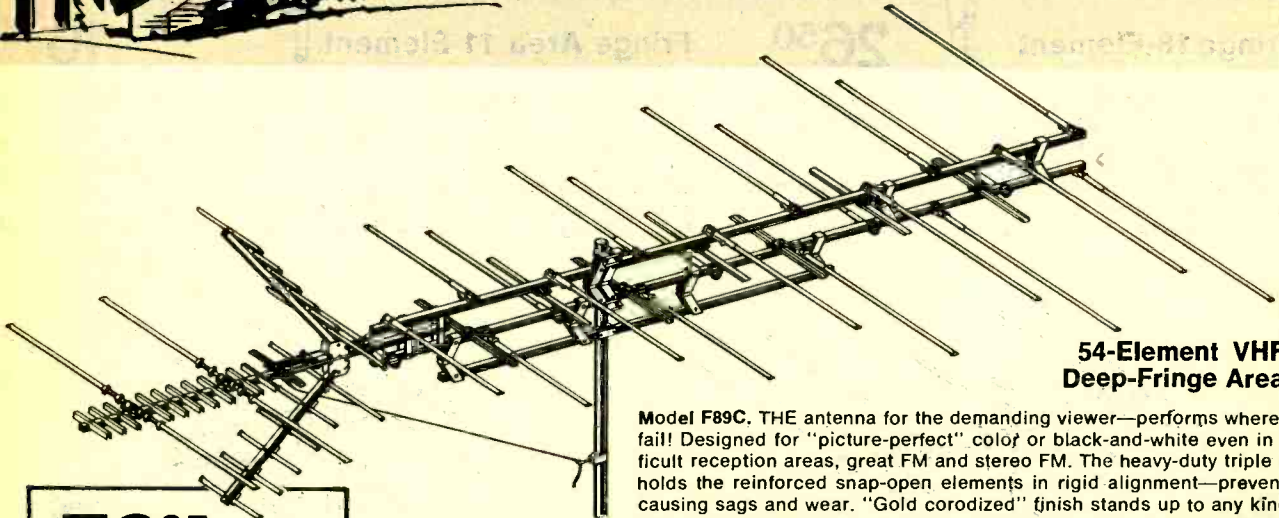

54-Element VHF-UHF-FM Deep-Fringe Area Antenna

Model F89C. THE antenna for the demanding viewer—performs where many others fail! Designed for "picture-perfect" color or black-and-white even in the most difficult reception areas, great FM and stereo FM. The heavy-duty triple square boom holds the reinforced snap-open elements in rigid alignment—prevents distortion-causing sags and wear. "Gold corodized" finish stands up to any kind of weather. Has sleeved VHF driver elements seated in backed-up, sure-lock brackets; twin u-bolt and saddle assembly for no-tilt mounting, self-aligning corner reflector brackets. Low-loss drive line with exclusive isolating stub. Includes VHF-UHF signal splitter. Boom length: 172 $\frac{1}{2}$ ". Turn radius: 96 $\frac{1}{2}$ ".

AA-732J. Shpg. wt. 16 lbs. 73.95

73⁹⁵ For Deep Fringe Areas

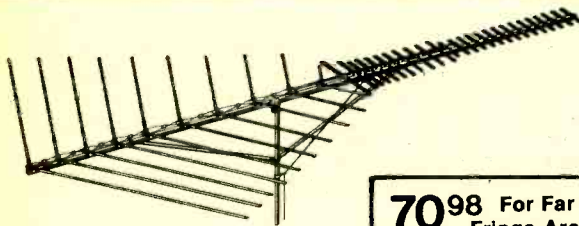

36-Element VHF-UHF-FM Far-Fringe Antenna

Model CS-D3. Offers excellent color and black-and-white TV, plus fine FM reception. Especially designed for very weak VHF and UHF signal areas. Increased spacing toward the high end of bands for flat response. With signal splitter. Boom length: 204 $\frac{1}{4}$ ". Turning radius: 106".

AA-471J. Shpg. wt. 14 lbs. 70.98

70⁹⁸ For Far Fringe Areas

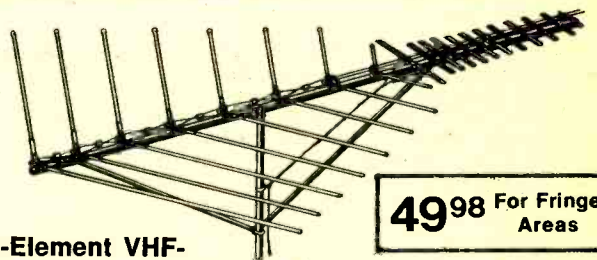

20-Element VHF-UHF-FM Antenna

Model CS-C2. Ve-Log antenna for weak VHF and UHF signal areas. High front-to-back ratio, plus built-in isolation stub for movie-clear color, black-and-white TV. Behind-the-set signal splitter included. Boom length: 138 $\frac{1}{4}$ ". Turning radius: 80".

AA-470J. Shpg. wt. 9 lbs. 49.98

49⁹⁸ For Fringe Areas

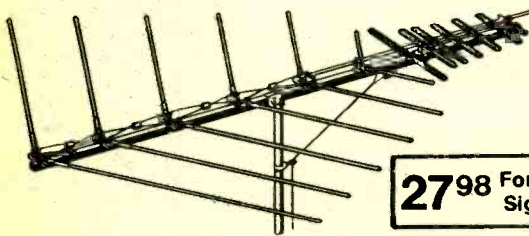

Deluxe 13-Element VHF-UHF-FM Antenna

Model CS-B1. Delivers maximum reception for moderate VHF and strong UHF signal areas. Famous Finco quality features include frequency-dependent design with preassembled snap-out construction. Behind-the-set signal splitter incl. Boom length: 93". Turning radius: 48".

AA-469J. Shpg. wt. 6 lbs. 27.98

27⁹⁸ For Moderate Signal Areas

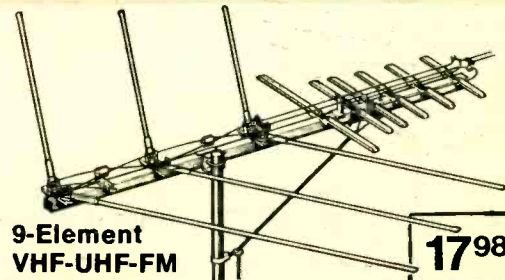

9-Element VHF-UHF-FM Antenna

Model CS-A1. For use where VHF and UHF signals are strong. Features the same premium features Finco is famous for including preassembled snap-out construction, high front-to-back ratio, "gold corodized" finish. Signal splitter incl. Boom length: 54 $\frac{1}{8}$ ". Radius: 45".

AA-468J. Shpg. wt. 4 $\frac{1}{2}$ lbs. 17.98

17⁹⁸ For Strong Signal Areas

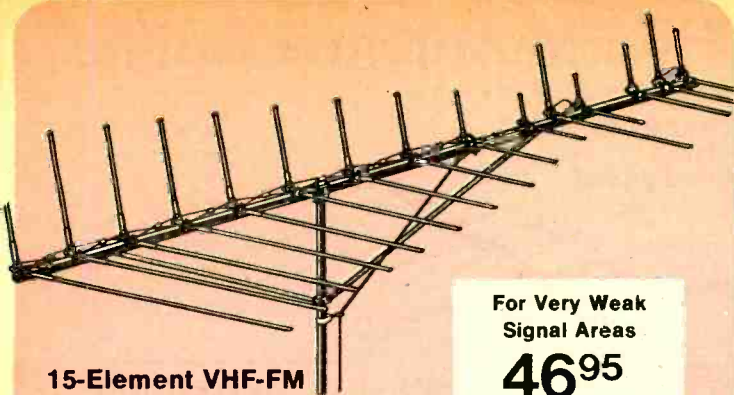

**15-Element VHF-FM
Deep-Fringe Area Antenna**

For Very Weak
Signal Areas
46⁹⁵

Model CS-V15. Frequency Dependent design for highest power, flat response in very weak signal areas. One-piece drive line with isolating stub rejects "ghosting," interference. High front-to-back ratio for sharp color and black-and-white TV picture, outstanding FM. Boom length: 154 $\frac{1}{2}$ ". Turning radius: 96". Foam-type lead-in recommended.

AA-477J. Shpg. wt. 14 lbs. 46.95

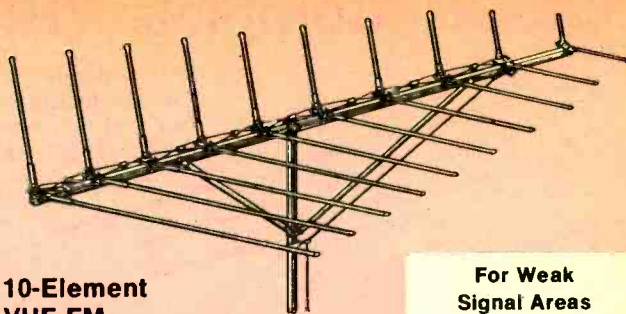

**10-Element
VHF-FM
Fringe-Area
Antenna**

For Weak
Signal Areas
34⁹⁵

Model CS-V10. For extra sharp color and black-and-white TV pictures and excellent FM reception in weak signal areas. Features famous Frequency-dependent design with high front-to-back ratio for high signal capture on channels 2—13. Preassembled snap-out construction for easy installation. Boom length: 118 $\frac{3}{4}$ ". Radius: 80".

AA-476J. Shpg. wt. 10 lbs. 34.95

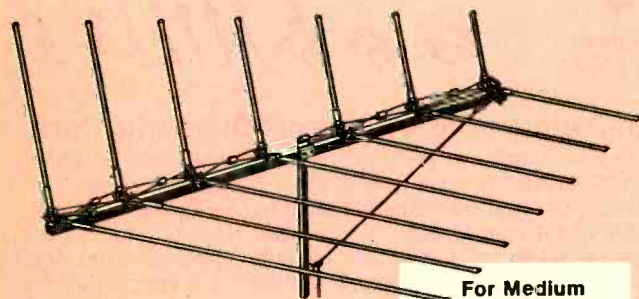

**7-Element
VHF-FM
Medium Area
Antenna**

For Medium
Signal Areas
20⁹⁵

Model CS-V7. Delivers crisp, clear color and black-and-white TV pictures, outstanding FM in medium strength signal areas. One-piece drive line with isolating stub rejects unwanted signals. Gold corodized boom and elements fight corrosion. Completely preassembled. Boom length: 80 $\frac{1}{2}$ ". Turning radius: 54".

AA-475J. Shpg. wt. 7 lbs. 20.95

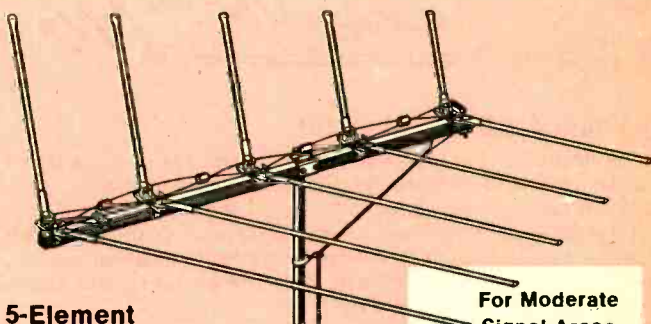

**5-Element
VHF-FM
Moderate
Antenna**

For Moderate
Signal Areas
15⁹⁵

Model CS-V5. Finco full-feature antenna for finest reception in moderate signal areas. You get extra sharp black-and-white, brilliant color, plus outstanding FM reception with exclusive Frequency Dependent concept. Preassembled, gold corodized finish. Foam-type lead-in recomm. Boom length: 53 $\frac{1}{8}$ ". Turning radius: 48".

AA-344J. Shpg. wt. 5 lbs. 15.95

Finco FM Antennas for "Concert Hall" Reception

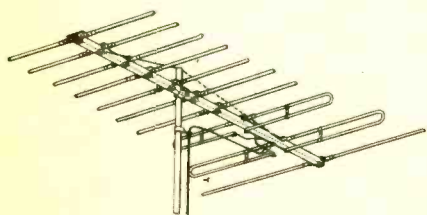

25¹⁰ FM Up to 175 Miles

10-Element FM Antenna

- For Peak FM Reception
- Twin Driven Elements

Model FM-5. Listen to superb FM and FM stereo from up to 175 miles. Special "Geomatic" design with precision-spaced directors for highest gain. 10' long boom with suspension-type bracing holds elements steady even in high winds. Reinforced elements, "gold-corodized" finish fights rust and corrosion. Boom 10'. Radius: 71".

AA-480J. Shpg. wt. 8 $\frac{1}{2}$ lbs. 25.10

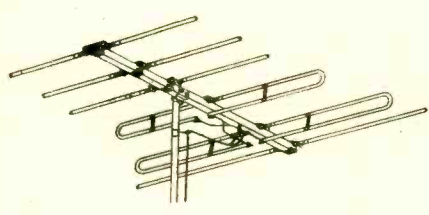

17¹⁵ Up to 125 Miles

6-Element FM Antenna

- Exceptional Performance
- Instant Snap-Out Design

Model FM-4G. Receives FM, FM stereo to 125 miles. "Gold-corodized" finish, aluminum elements. 7' 9" square boom; 55 $\frac{1}{2}$ " radius.

AA-479J. Shpg. wt. 6 $\frac{1}{2}$ lbs. 17.15

Model 3007 FM Purifier. (Not shown.) Use with any FM, all-channel TV antenna. Attenuates all signals except those in the 88-108 MHz FM band.

AA-504J. Shpg. wt. $\frac{1}{2}$ lb. 4.98

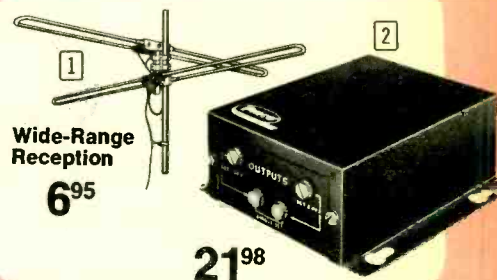

**Wide-Range
Reception
6⁹⁵**

21⁹⁸

1 All Directional FM Antenna

Model FMT. Provides good reception from all directions without rotating or aiming. Two elements, $\frac{1}{4}$ -wave phasing. Preassembled.

AA-478J. Shpg. wt. 3 lbs. 6.95

2 Indoor FM Amplifier

Model 65-7. High-gain, low noise. For deep or medium fringe areas. 300 ohms input, two FM outputs. Easy mounting. 20 dB nominal gain.

AA-515J. Shpg. wt. 1 $\frac{1}{2}$ lbs. 21.98

ALL EXCEPT (1) AND (2) SHIPPED REA EXPRESS ONLY

Olson Complete VHF-UHF-FM Antenna Outfits

The antenna outfits on these two pages include everything needed for fast and easy installation. Save \$\$\$ off dealer-installed prices!

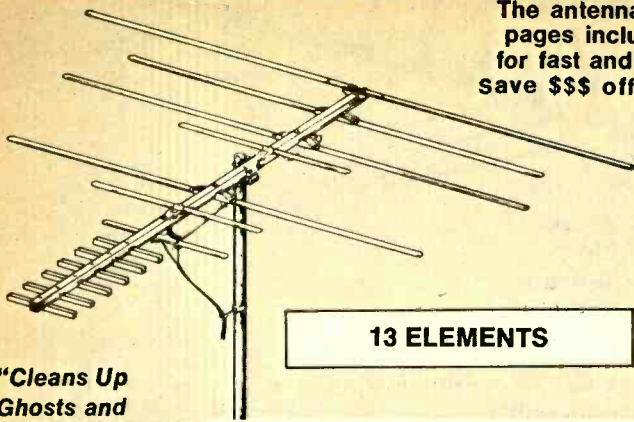

13 ELEMENTS

"Cleans Up Ghosts and Snow in Strong Signal Areas"

15⁹⁵

Sep. Items
Reg. \$18.43

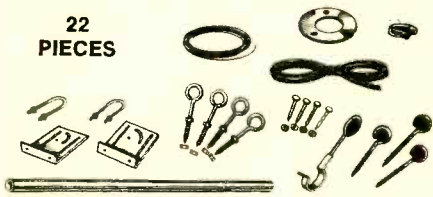

**22
PIECES**

Big-Value All-Channel Outfit

Just the ticket for *real* improvement of TV and FM in good signal areas. Olson CA-13 antenna has corrosion-resistant finish, easy-installation snap-out elements. Includes all the mounting accessories you need—50' transmission line, 5' steel mast, snap-on standoff insulator, three 3½" wood screw eye standoffs, 2 universal mounts, U-bolts, 40' guy wire, all hardware, UHF-VHF signal splitter. Boom length, 69¾". Turning radius, 61½".

AS-730J. Shpg. wt. 12½ lbs. **15.95**

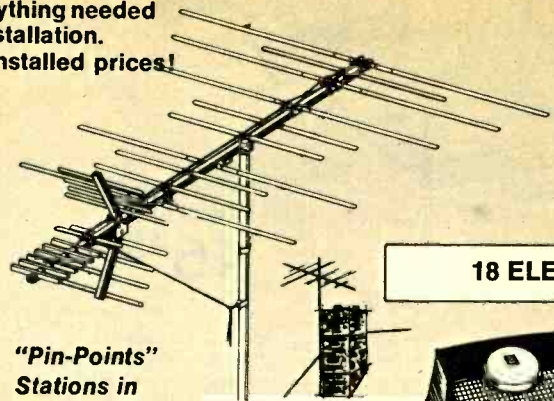

18 ELEMENTS

"Pin-Points" Stations in Near-Fringe, Suburban Areas

49⁹⁸

Sep. Items
Reg. \$58.54



**15
PIECES**

High-Performance All-Channel Outfit with Rotator

Rotate your antenna to "zero-in" on the strongest available signal! Olson 3C-18 antenna has highly directional design, corrosion-resistant finish. Alliance K-22 rotator system turns antenna accurately—has top-of-set control box, weatherproof rotor housing. With 50' transmission line, rotor cable, 5' steel mast, chimney-mount kit with all hardware, and VHF-UHF signal-splitter. Boom length, 93". Turning radius, 60". Includes rotor cable.

AS-731J. Shpg. wt. 30 lbs. **49.98**

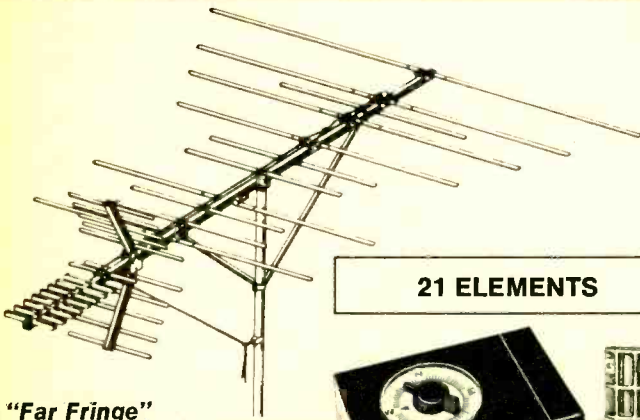

21 ELEMENTS

"Far Fringe" Area Antenna with Deluxe Rotator

59⁹⁸

Sep. Items
Reg. \$81.39

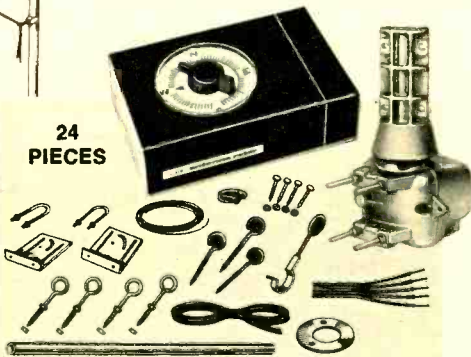

**24
PIECES**

Superb All-Channel Outfit with Rotator

Enjoy "hi-fi" TV and FM for years to come. Olson 3C21 "corner reflector" design antenna really pulls in the signals, has rust-resistant finish, snap-out elements. The Cornell-Dubilier AR-20 rotator turns it a full 360° in just 45 seconds—"zero in" for finest reception. Includes rotator cable, 50' transmission line, 5' steel mast, all standoffs, hardware and accessories for easy mounting. Boom length, 118¾". Turning radius, 72". Includes rotor cable

AS-732J. Shpg. wt. 34 lbs. **59.98**

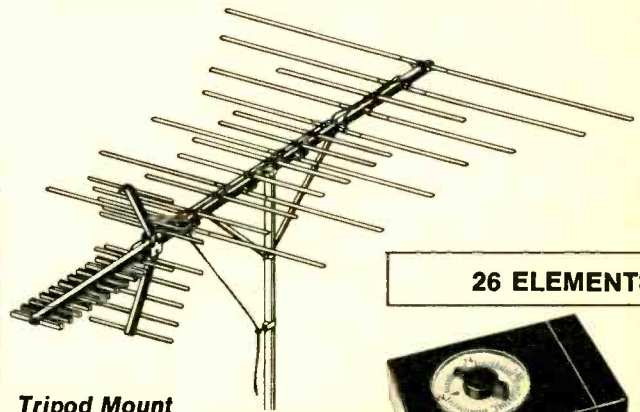

26 ELEMENTS

Tripod Mount Perfect for Any Type of Surface

79⁹⁸

Sep. Items
Reg. \$94.09

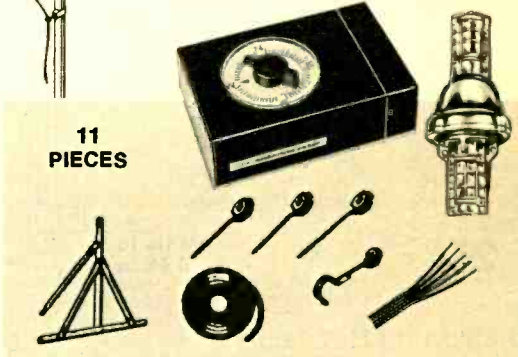

**11
PIECES**

Our Best Olson Antenna with Heavy-Duty Rotator

Offers improvement so good you have to see it to believe it! Olson 3C26 antenna has "corner-reflector" design with highly directional characteristics to stop unwanted signals. Cornell-Dubilier AR-22R rotator has reinforced weatherproof bell housing, magnetic brake and high-torque motor. Tripod mounting kit with antenna mast, 50' transmission line and rotor cable. VHF-UHF signal splitter. Boom Length; 150¼". Turning Radius, 89". Includes rotor cable.

AS-733J. Shpg. wt. 42 lbs. **79.98**

Professional-Quality Antenna/Rotator Systems

Your color TV is a BIG investment, and you should take steps to make it operate to its full potential. These antenna systems make ANY set perform better—and when you think of the hours and hours you spend watching TV—you'll see they cost only pennies a day!

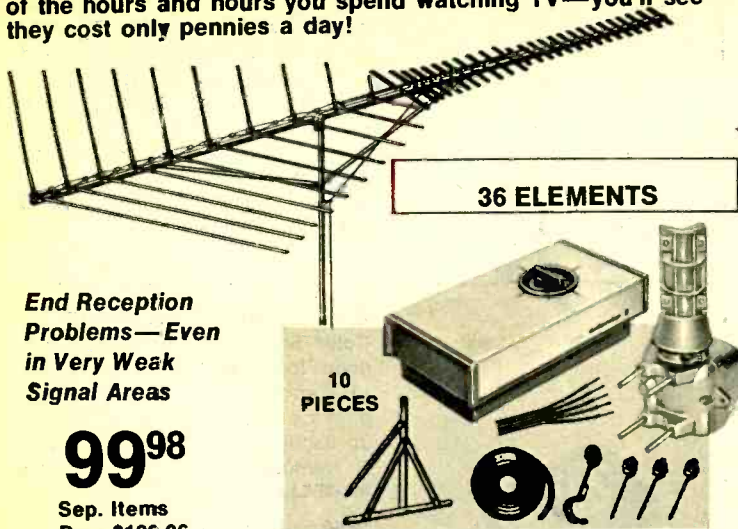

End Reception Problems—Even in Very Weak Signal Areas

99⁹⁸

Sep. Items
Reg. \$129.06

Far-Fringe Outfit with Heavy-Duty Rotator

City, Suburb, or country — you'll SEE the difference and you'll appreciate it! Finco CS-D3 antenna has increased element spacing for fully flat response. Cornell-Dubilier solid-state rotor has heavy-duty weatherproof housing, noise-free control unit, high-torque motor that won't stall out even in the worst weather. With complete tripod mount installation accessories, VHF-UHF signal splitter, everything! Boom length: 204½". Turning radius, 106". AS-734J. Shpg. wt. 41 lbs. 99.98



"Seeks Out" Your Favorite Stations at the Push of a Button!

129⁹⁸

Sep. Items
Reg. \$147.06

Our Best All-Channel Outfit—Pushbutton Rotator

You won't find a better antenna/rotator buy! Finco F89C antenna features "Frequency-Dependent" design for ultra-flat response on every channel. Cornell-Dubilier's best rotator system (Model AR-33) lets you PRE-SELECT your five favorite stations — then "aim" your antenna automatically — also has compass dial for manual control. Includes EVERYTHING for easy installation — deluxe tripod mount. Boom Length, 195½". Turn radius, 100¼". AS-735J. Shpg. wt. 45½ lbs. 129.98

Antenna Systems Shipped REA Express Only

Olson VHF-TV/FM Antenna/Rotator Systems

For areas where UHF is not available — these systems are your best values. They include specially designed VHF-only antennas and precision rotators.

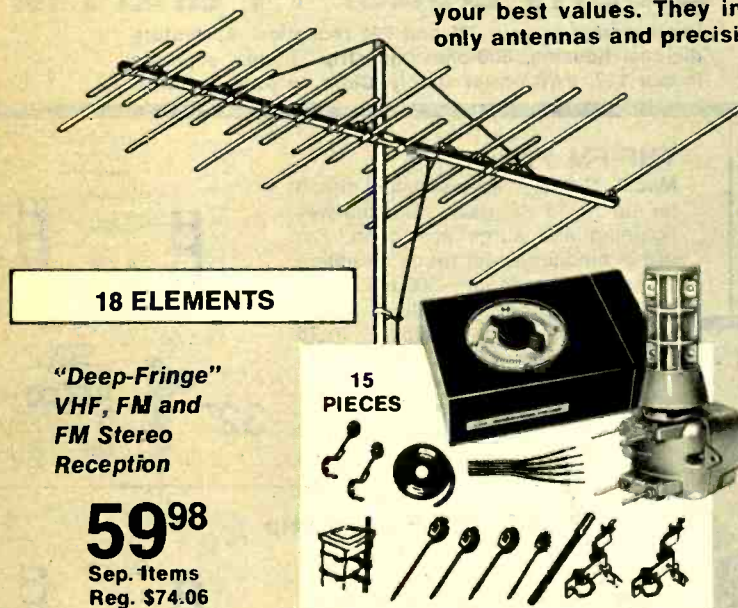

"Deep-Fringe" VHF, FM and FM Stereo Reception

59⁹⁸

Sep. Items
Reg. \$74.06

Deluxe System with Compass-Dial Rotator

For true-to-life color, sharp black-and-white, FM and FM stereo with brilliance and separation. Olson 218 antenna has "Gold-Protecto" finish that fights rust and corrosion, U-bolt and saddle assembly for ultra-stable no-tilt mounting. Cornell-Dubilier AR-20 Rotator has weather-protected high-torque motor, aims antenna to 6° accuracy. Includes 5' mast, complete chimney-mount outfit for easy installation. Boom length, 138¼". Turning radius, 82". Cable included. AS-736J. Shpg. wt. 34¼ lbs. 59.98

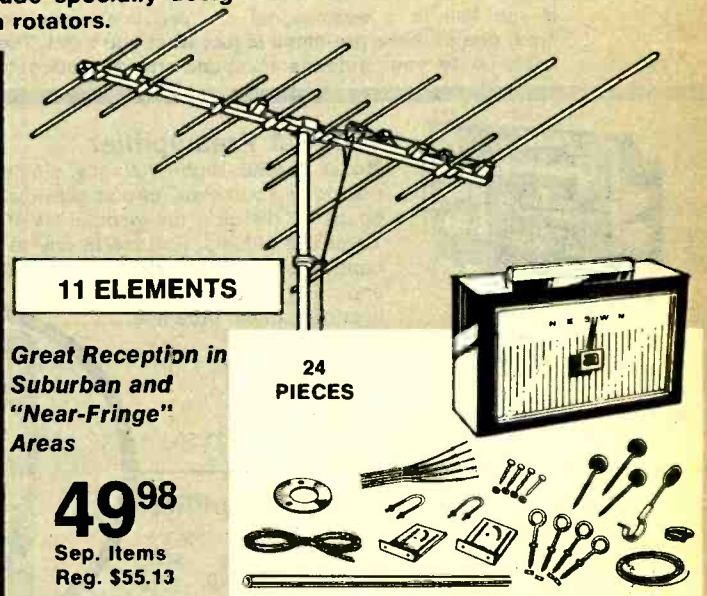

Great Reception in Suburban and "Near-Fringe" Areas

49⁹⁸

Sep. Items
Reg. \$55.13



Antenna System with "Touch-Bar" Rotor Control

Really helps reception in medium-signal areas! Olson 211 antenna has wide-spaced elements for best signal-pulling power. Alliance T-45 rotator has weatherproof die-cast housing, "touch-bar" manual control unit that turns antenna in either direction. Universal mounting kit has all the wires, standoffs, insulators, brackets you need. Antenna is pre-assembled with snap-out elements. Boom length, 69¾". Turning radius, 60". Cable included. AS-737J. Shpg. wt. 28 lbs. 49.98

Finco "Color Set" Indoor UHF-VHF TV Antennas

Eliminate large and more costly outdoor antennas in many signal areas with one of these quality decorator-styled indoor models. All adjust for best reception on

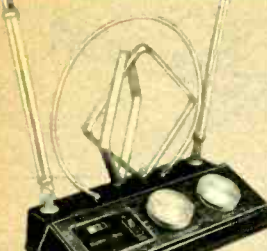
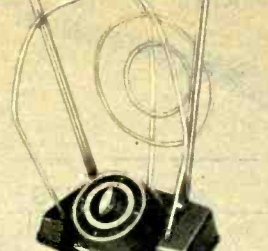
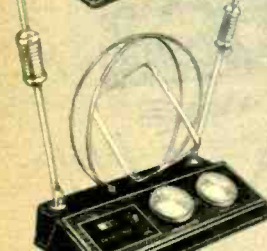

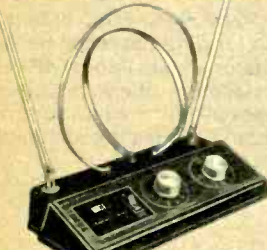
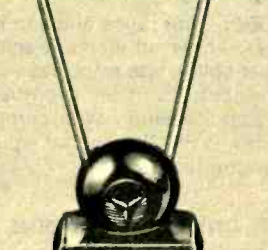
each channel and include all you need for fast 'n easy hookup to your set. There's one for you—and the price is right!

	<p>Our Best Indoor Color Set 6. Finest indoor antenna you can own. Has 12-position tune control, electro-plated UHF loops, "power-boost" swivel arms. UHF-VHF switch, 6' air-dielectric transmission line, more. AA-452J. Wt. 3¼ lbs. 22.95</p> <p>22⁹⁵</p>	 <p>Full-Channel Coverage Color Set 3. Just what you need to clean up ghosts and snow on Channels 2-83. 12-position picture control, "radar" coiled cross design UHF loops. Telescoping arms, 6' transmission line. AA-455J. Wt. 2 lbs. 9.50</p> <p>9⁵⁰</p>
	<p>Extra-Feature Model Color Set 5. Excellent antenna buy! 12-position tune control, VHF-UHF switch, electro-plated UHF loops, telescoping arms, rotating "power quadrangle" for color adjustments. 6' line. AA-453J. Wt. 3¼ lbs. 18.95</p> <p>18⁹⁵</p>	 <p>Quality at a Low Price Color Set 2. Top performer with good looks too! 4-section brass VHF arms, parallel UHF loop, 12-position picture control. Hooks up easily with just a screwdriver. 6' low-loss line. AA-456J. Wt. 2 lbs. 7.50</p> <p>7⁵⁰</p>
	<p>Advance-Design All-Channel Color Set 4. Really low price for an antenna that performs this well. Offers superb all-channel reception. Has 12-position picture control, VHF-UHF switch, UHF "power loop", 6' line, more! AA-454J. Wt. 3¼ lbs. 13.95</p> <p>13⁹⁵</p>	 <p>Low-Cost VHF Antenna Model 854. The basic, hard-working "rabbit ears" that have served so well over the years. Heavy-gauge aluminum elements, tip-proof base. Provides real improvement in most good signal areas. AA-510J. Wt. 1 lb. 1.39</p> <p>1³⁹</p>

Broadband Pre-Amps for Clearly Better TV and FM

If you live in a weak-signal or "problem" reception area, one of these pre-amps is just what you need. They hook up to your antenna mast and provide noticeable

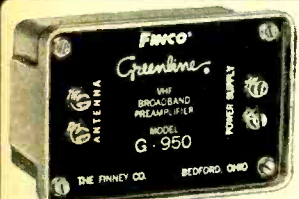
improvement in your TV and FM reception. All feature die-cast housing, 300-ohm "no strip" inputs, separate indoor 117 VAC power supply. Clear up your TV today!

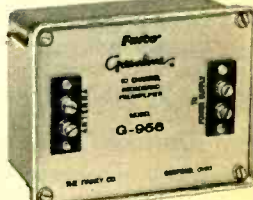
 <p>21⁵⁰</p>	<p>VHF FM Preamplifier Model G-950. High-efficiency single transistor solid-state circuit provides up to 13 dB gain on incoming VHF TV or FM signals. For use in any reception area where strong local TV and FM stations would overload most preamps. 300-ohm input, 300-ohm outputs for 1 or 2-set operation. Shpg. wt. 3 lbs. AA-733J 21.50</p>	 <p>32⁷⁵</p>
 <p>32⁷⁵</p>	<p>UHF Preamplifier Model G-954. High-gain low-noise two-transistor circuit provides up to 13 dB gain on UHF channels 14-83. For use in medium to far fringe reception areas. 300 ohm input—300 ohm outputs for 1 or 2-set operation. AA-736J. Shpg. wt. 3 lbs. 32.75</p> <p>Model G-955 Above, with 300-ohm input to single 75-ohm output AA-737J Shpg. wt. 3 lbs. 36.00</p>	 <p>41⁷⁵</p>

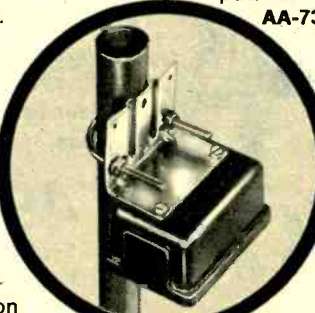

VHF-FM Preamp
Model G-952. Two-transistor circuit for up to 16 dB gain. Has four-way lightning and surge protection. For use in medium or far fringe reception areas. 300-ohm input—300 ohm outputs for 1 or 2-set operation.
AA-734J. Shpg. wt. 3 lbs. . . 32.75

Model G-953. Above, with 300-ohm input, to single 75-ohm output.
AA-735J. Shpg. wt. 3 lbs. 36.00

UHF-VHF-FM Preamp
Model G-956. All-channel preamp has high-efficiency 4-transistor circuit for up to 14 dB gain on VHF and FM, 12 dB UHF. For use in medium to far fringe reception areas. 300 ohm input—300-ohm outputs for 1 or 2-set operation.
AA-738J. Shpg. wt. 3 lbs. 41.75

Model G-957. Above, with 300-ohm input to single 75-ohm output.
AA-739J. Shpg. wt. 3 lbs. 45.50

Finco Accessories for Clearly Better TV-FM

Smeary, snowy and "ghosty" pictures spoil TV viewing. Noise, interference and fading degrade FM, especially stereo. Finco accessories can clear up all these prob-

lems. Select the amplifier, coupler, splitter or outlet you need for strong, noise-free signals to your receiver and make it work like NEW again!

FINCO TV/FM AMPLIFIERS SHARPEN RECEPTION WITH SOLID-STATE CIRCUITRY

- 1 VHF TV-FM 4-Set 300-Ohm Solid-State Amplifier**
Model G-920. For indoor, home use. Feeds signal from one antenna to 4 sets with 6-10.8 dB boost to each. With hardware. For 110 VAC. AA-511J. Shpg. wt. 1 3/4 lbs. 24.98
- 2 VHF TV-FM 4-Set 75-Ohm Solid-State Amplifier**
Model G-921. For indoor, home use. Feeds signal from one antenna to 4 sets, strengthens each by 6-7 dB. Will not overload. For 110 VAC. AA-512J. Shpg. wt. 1 3/4 lbs. 29.98
- 3 VHF-UHF-FM 4-Set 300-Ohm Solid-State Amplifier**
Model G-922. Feeds signal from one antenna to 4 sets strengthening each by 6-7 dB. Use indoors. For any signal area. For 110 VAC. AA-443J. Shpg. wt. 1 3/4 lbs. 29.98
- 4 VHF-UHF-FM 4-Set 75-Ohm Solid-State Amplifier**
Model G-923. Feeds signal from one antenna to 4 sets strengthening each by 6-7 dB. For highest quality signals. Use indoors. For 110 VAC. AA-513J. Shpg. wt. 1 3/4 lbs. 32.98

24⁹⁸



29⁹⁸

29⁹⁸

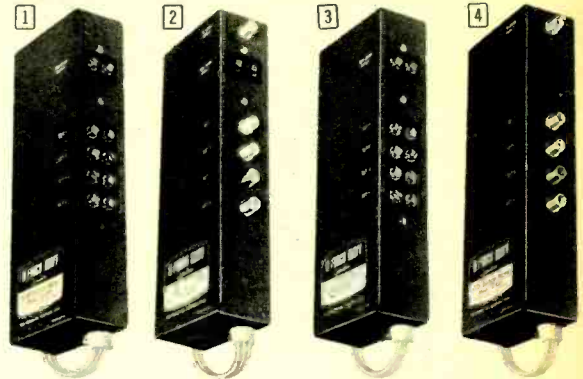
32⁹⁸



SIGNAL SPLITTERS, COUPLERS, TRANSFORMERS FOR EVERY NEED

 <p>VHF-UHF 2-Way Splitter Model G-200. For TV or FM. Splits one 75-ohm input into two 75-ohm outputs. For indoor use. Takes "F" type coax connectors. Low loss. AA-491J. Wt. 1 lb. 6.98</p>	 <p>VHF-UHF 4-Way Splitter Model G-204. For TV or FM. Splits one 75-ohm input into four 75-ohm outputs. For indoor use. Takes "F" type coax connector. Low loss. AA-492J. Wt. 1 lb. 11.98</p>	 <p>UHF-VHF Coupler/Splitter Model G-520. Indoor 75-ohm coax input-output unit. Combines separate UHF & VHF signals into single coax cable. For "F" type connectors. AA-494J. Wt. 1 lb. 6.98</p>	 <p>Model 3001 2-Set Coupler. Use 2 sets with one antenna. 300 ohms. For indoors. AA-696J. Wt. 1 lb. 2.98</p>	 <p>Model 3003 4-Set Coupler. Use 4 sets with one antenna. 300 ohms. For indoors. AA-496J. Wt. 1 lb. 4.49</p>
 <p>Model 3020 UHF-VHF Splitter. Splits the 2 signals from a single 300-ohm lead-in. AA-697J. Wt. 1 lb. 2.50</p>	 <p>Model 3030 VHF-UHF-FM Splitter. Splits signals from 300-ohm lead-in. Back-of-set mtg. AA-498J. Wt. 1 lb. 3.89</p>	 <p>Model 7512-B 75 to 300-Ohm Matching Transformer. With "F" type coax fittings. AA-507J. Wt. 1 lb. 1.98</p>	 <p>Model 3009/2-13 Attenuator. Eliminates adjacent-channel VHF interf. 1 lb. AA-506J. Specify chan. 4.95</p>	 <p>Model 3008/2-13 Coupler. Couples one VHF channel to broadband antenna. 1 lb. AA-505J. Specify chan. 5.50</p>
 <p>Model 7520 Transformer/Splitter. 75-ohm "F" type input, VHF & UHF 300-ohm outputs. AA-499J. Wt. 1 lb. 3.49</p>	 <p>Model 7530 Transformer/Splitter. 75Ω "F" type input, 300Ω VHF-UHF-FM outputs. AA-500J. Wt. 1 lb. 4.98</p>	 <p>Model 3007 FM Purifier. Attenuates all signals except 88-108 MHz FM band. AA-504J. Wt. 5 oz. 4.98</p>	 <p>Model 3018 VHF-UHF-FM Splitter. Splits signals 3 ways. For long 300-ohm lead-in runs. AA-698J. Wt. 1 lb. 6.98</p>	 <p>Model 7514 Transformer/Splitter. Couples 300Ω VHF & UHF antennas to one 75Ω coax. AA-545J. Wt. 1 lb. 6.98</p>

WALL TAPS FOR "PRO" INSTALLATIONS

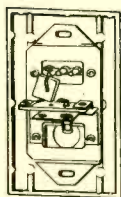

3⁹⁸

75-Ohm to 300-Ohm
Model G-350-0. 75-ohm input, one 300-ohm output. For std. electrical flush-mount box or usable with Plastic Ears included. Ivory plastic color. Cover plate. AA-520J. Wt. 1 lb. 3.98

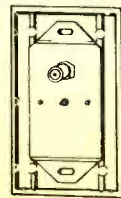

2⁹⁸

75-Ohm Input and Output
Model G-354-0. As above, but 75-ohm input and output with "F" type fittings. Professional quality, complete. AA-521J. Wt. 1 lb. 2.98

FM/TV CABLE CONNECTORS



85¢ **Cable-End Connector**
Model F-59. Accepts all RG/59U size coax. Separate ferrule. Mates any female "F" connector. Pks. of 3. AA-517J. Shpg. wt. 1 lb.85



1⁰⁸ **Coax Cable Bushing**
Model F-81B. Couples two coaxial cables together. Use any "F" type connector. AA-518J. Shpg. wt. 1 lb. ... 1.08



59¢ **Terminator for Outlets**
Model TP-75F. Terminates unused outputs on 75-ohm amplifier or wall outlet. AA-519J. Shpg. wt. 1 lb.59

Long Life Automatic Antenna Rotators

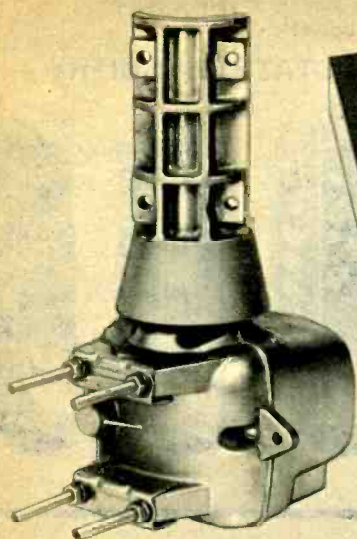

34⁹⁵

Low-Cost Antenna Rotator Turns 360° in 45 Seconds

Model AR-20. Just add an antenna and you're on the way to great reception. Simply turn pointer on control unit to desired direction and the rotator takes over. "Aims" the antenna within 6°. Has die-cast weather-protected rotator housing with lifetime lubricated bearings, stylish control unit with compass-type dial. For antenna masts from 7/8" to 2 1/16" outside diameter. Requires 4-wire rotator cable. For 117 VAC. AA-404J. Shpg. wt. 13 1/2 lbs. 34.95

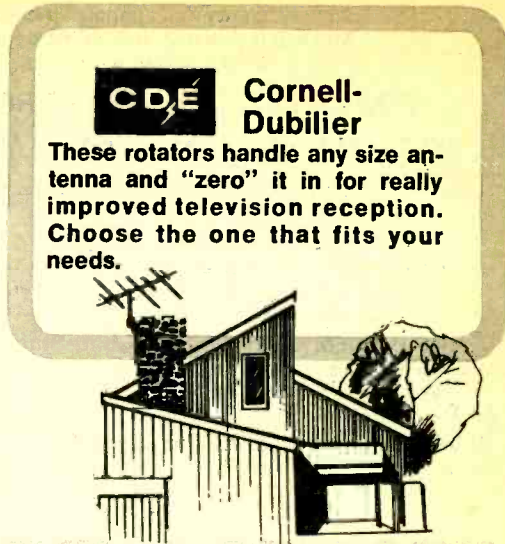

CDE Cornell-Dubilier

These rotators handle any size antenna and "zero" it in for really improved television reception. Choose the one that fits your needs.

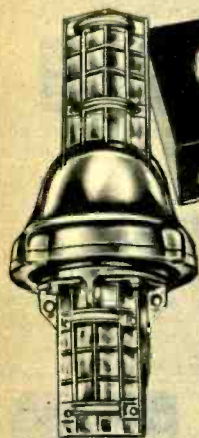

1
39⁹⁵

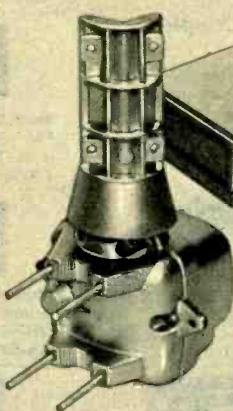

2
44⁹⁵

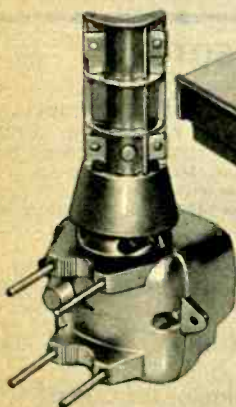

3
49⁹⁵



4
59⁹⁵

1 Heavy-Duty—For the BIG ones

Model AR-22R. Automatically turns and positions even heavy antenna arrays. Features reinforced "bell" housing with precision ball bearings and gears, high-torque motor that positions antenna accurately within 6°. Magnetic braking system prevents over-travel. Lifetime lubricated planetary gear system. For masts 7/8" to 2 1/16" outside diameter, stylish compass-dial control box. Requires 4-wire rotator cable. For 117 VAC. AA-701J. Shpg. wt. 15 1/2 lbs. 39.95

2 "Intermediate" System

Model AR-30. Features high-torque motor that keeps going even when the going gets rough — snow, ice, rain, wind. Die-cast zinc rotator housing, worm gear drive, Nylon thrust bearings, weatherproof neoprene seal. Mast clamp mounting for best distribution of antenna weight. Turns antenna 360° in 45 seconds. Stylish solid-state control unit has directional dial, on-off light. Requires 5-wire rotator cable. For 117 VAC. AA-699J. Shpg. wt. 13 lbs. 44.95

3 Deluxe Heavy-Duty System

Model AR-40. Supports heavy antenna arrays, deep-fringe area antennas. Has weather-proof heavy-duty bell housing with high torque motor and magnetic braking to prevent overshoot. Planetary gear drive system positions antenna within 6°. Deluxe solid-state control box has easy-to-read compass dial, on-off light. Accepts antenna masts from 7/8" to 2 1/16" outside diameter. Requires 5-wire rotator cable. For 117 VAC. AA-742J. Shpg. wt. 15 lbs. 49.95

4 Pre-Set "Auto-Rotor"

Model AR-33. The ultimate in antenna rotators! Has CDE's best rotator housing (same as AR-40 above) and a solid-state control unit that you can pre-set for up to five TV and FM stations. Simply determine the best reception position for your favorite stations —then push a button and the antenna rotates to it—completely automatic. Control unit also has compass dial for manual rotation. Requires 5-wire rotator cable. For 117 VAC. AA-700J. Shpg. wt. 16 lbs. 59.95

Do-It-Yourself Antenna Accessories

Olson Cable & Wire for Best Reception

Olson High-Quality, Low-Cost Accessories

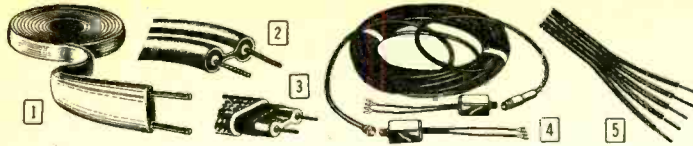

- 1** **300-Ohm Lead-In.** 22-gauge stranded copper core for good reception—even on long hook-ups! Tough poly jacket. 100-ft. **WW-073J.** Shpg. wt. 2 lbs. ... **1.89**
- 2** **"Prime-Line" Lead-In.** Low-loss foam insulation. Poly jacket resists abrasion, sun & extreme weather conditions. 300-ohm UHF-VHF-FM. 100-feet. **WW-541J.** Shpg. wt. 2 lbs. ... **4.98**
- 3** **Shielded "Prime-Line."** For ultimate color reception. 300-ohm noise-free signal. Solid copper conductor, foam insulation, abrasion-proof vinyl coating. 100-feet. **WW-582J.** Shpg. wt. 3 lbs. ... **6.99**

- 4** **Coax Cable Kit.** Ultra-low loss foam-filled cable reduces picture interference, eliminates line losses for noise-free signal to TV set. Includes fitted type "F" connector, weather boot, two 72-ohm to 300-ohm matching transformers. 100-ft. **WW-563J.** Shpg. wt. 3 lbs. ... **14.98**
- 5** **5-Cond. Rotor Cable.** Heavy-duty 20-gauge stranded copper wire for antenna rotor system. Provides excellent reception on all channels. Very flexible—easy to handle and install. 100-ft. **WW-533J.** Shpg. wt. 2 lbs. ... **4.98**

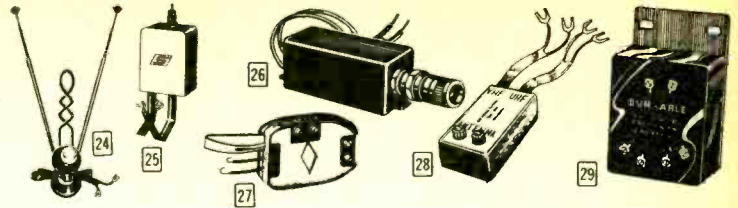

- 24** **Top-of-Set Antenna.** For all TV channels & FM. 6-way "anti-ghost" switch. With lead-in. **AA-025J.** Wt. 3 lbs. ... **2.59**
- 25** **VHF-UHF-FM Splitter.** Splits signal lead 3 ways. Maintains proper impedance match with 300-ohm antenna. 2" W x 2 1/4" H x 7/8" D. **AA-445J.** Wt. 4 oz. ... **3.59**
- 26** **72-to-300-Ohm Splitter.** Matches 72-ohm coax lead-in to 300-ohm antenna. 2 1/2" W x 2" H x 7/8" D. **AA-392J.** Wt. 4 oz. ... **2.79**
- 27** **72-to-300-Ohm Matcher.** Converts 72-ohm coax lead-in to 300-ohm input. 3" W x 1" H x 1" D. **AA-198J.** Wt. 4 oz. ... **1.98**
- 28** **VHF-UHF 2-Way Splitter.** Connects one lead-in to 2 antenna terminals. 1 1/2" W x 2 1/4" H x 3/4" D. **AA-247J.** Wt. 4 oz. ... **1.59**
- 29** **Two-Set Coupler.** Couples 2 TV or FM sets to one 300-ohm antenna. Balun-coil operation. Low loss! 1 1/2" W x 2 1/4" H x 3/4" D. **AA-358J.** Wt. 4 oz. ... **1.39**

Finco Do-It-Yourself Installation Accessories

Accessories & hardware for sturdier, safer installation.



TV Wire Guides — VHF or UHF Lead-In

Fig.	Stock No.	Mfr's Type	Description	Shpg. Wt.	Each
6	AA-522J	4008	4 Screw-in type—3 1/2"	1/4 lb.	.96
6	AA-523J	4009	4 Stainless-type—3 1/2"	1/4 lb.	.48
7	AA-524J	4010	2 Masonry type	1/4 lb.	.60
7	AA-525J	4011	2 Nail-in type	1/4 lb.	.44
9	AA-526J	4012	2 Snap-grip type	1/4 lb.	.50
8	AA-527J	4013	2 Strap-on type	1/2 lb.	.64
6	AA-528J	4019	4 Screw-in type—7 1/2"	1/2 lb.	.88
10	AA-529J	4024	2 Double w/straps—7 1/2"	3/4 lb.	1.58
10	AA-530J	4025	4 Inline double—7 1/2"	3/4 lb.	1.70

Antenna Mounts

11	AA-531J	4020	Wall bracket	1 1/2 lbs.	1.40
12	AA-532J	4017	Universal roof mount	2 lbs.	1.36
13	AA-533J	4021	Chimney, galv. straps	2 1/2 lbs.	3.82
13	AA-534J	4022	Chimney, stainless straps	2 1/2 lbs.	4.76
13	AA-709J	4023	4 Way universal kit	2 lbs.	3.02

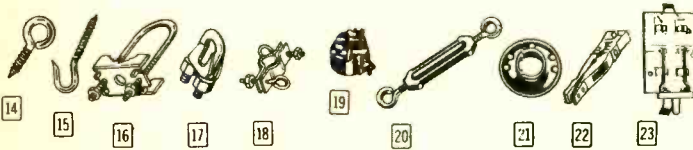

Hardware Accessories

14	AA-535J	4014	3 Guy wire anchors—3" S.E.	1/2 lb.	.60
15	AA-536J	4015	3 Guy wire anchors—4" S.E.	1/2 lb.	.58
16	AA-537J	4016	U-bolt clamp assembly	1/2 lb.	.50
18	AA-538J	4001	Guy wire clamp	1/2 lb.	.74
17	AA-539J	4002	3 Cable clamps—CC 1/4	1/2 lb.	1.28
17	AA-540J	4003	3 Cable clamps—CC 3/16	1/2 lb.	1.28
19	AA-710J	4004	Lightning arrester	1/2 lb.	1.16
20	AA-542J	4018	2 Turnbuckles	1/2 lb.	.92
21	AA-543J	4005	Guy ring & collar	1/4 lb.	.84
22	AA-544J	4006	2 TV lead wire clips	1/4 lb.	.74
23	AA-706J	4007	TV lead wire switch	1/2 lb.	1.44

Finco Antenna Installation Masts. Made of electrically welded steel. Baked four times with an acrylic lacquer finish for extra protection. Locking device on fitted ends keeps mast from turning in high winds.

- AA-546J.** 5 Foot. 1 1/4" Diameter. 18-Gauge. Shpg. wt. 4 lbs. ... **2.25**
- AA-547J.** 10 Foot. 1 1/4" Diameter. 18-Gauge. Shpg. wt. 9 lbs. ... **4.35**

OLSON Low-Cost Accessories — Why Pay More?

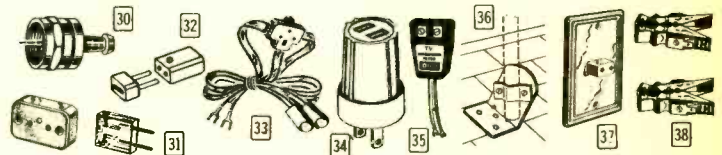

- 30** **Coax Connectors.** Solderless. F-59-type. For RG-59U. Wt. 8 oz. **AA-446J.** 2 male, 2 female. ... **1.49**
- 31** **Plug/Socket Sets.** For TV, FM or speakers. Plug: 1 1/2" W x 3/4" D. Socket: 1 1/4" W x 1" H x 7/16" D. **AA-170J.** Wt. 4 oz. ... **3 Pairs 1.69**
- 32** **TV Plug/Socket Sets.** Extends TV lead-in or speaker leads. Solderless. 3/4" W x 1/4" H x 1" D. **AA-357J.** Wt. 4 oz. ... **3 Pairs 1.49**
- 33** **FM Dipole Antenna.** Wire lugs for easy hook-up. Flexible. **AA-211J.** Wt. 4 oz. ... **1.69**
- 34** **Plug-In Noise Filter.** Stops line interference to radio or TV. **PL-151J.** Wt. 4 oz. ... **2.49**
- 35** **TV Noise Filter.** Connects between antenna & TV. Reduces picture interference. **AA-145J.** Wt. 4 oz. ... **2.19**
- 36** **Antenna Mast Mount.** Adjusts to nearly any roof angle or peak. Strong, durable, rustproof. **AA-403J.** Wt. 1 lb. ... **69c**
- 37** **TV-FM Wall Plate.** For flat TV lead-in. With plug. **AA-051J.** Wt. 4 oz. ... **1.19**
With Antenna Jack, 5-Pin Rotor Jack. **AA-179J.** Wt. 8 oz. ... **1.69**
- 38** **TV Antenna Clips.** Solderless for easy hook-up or disconnect of 300-ohm line to TV or FM. **AA-395J.** Wt. 4 oz. ... **2 for 54c**

Finco Antenna Mounting Kits

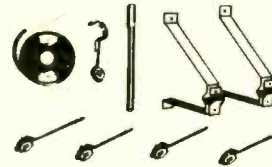

- 570** **Wall Mount.** 50' foam transmission line, 5' steel mast, snap-on standoff, one 7 1/2" & three 3 1/2" wood screw eye standoffs, and instructions. **AA-553J.** Wt. 5 lbs. ... **5.70**



- 745** **Universal Mount.** 50' transmission line, 5' 16-ga. 1 1/4" steel mast, snap-on standoff, three 3 1/2" screw eye standoffs, 2 mounts, U-bolts, 40' guy wire, hardware. **AA-551J.** Wt. 8 lbs. ... **7.45**

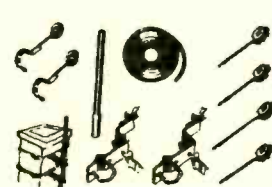

- 760** **Chimney Mount.** 50' foam transmission line, 5' steel mast, 2 snap-on standoffs, one 7 1/2" & three 3 1/2" wood screw eye standoffs. **AA-552J.** Wt. 10 lbs. ... **7.60**

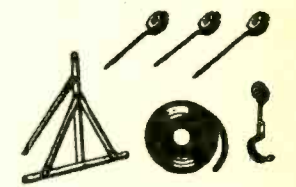

- 815** **Tri-Pod Outfit.** Tri-pod, 1 1/4" mast, 50' foam transmission line, snap-on standoff, one 7 1/2", three 3 1/2" wood screws, neoprene sealing washers, more. **AA-554J.** Wt. 12 lbs. ... **8.15**

Hy-gain 23-Channel Base and Mobile CB 2-Way Radios

Low-Priced Mobile Model Performs with the BIG Ones

Model 670. Has the features and performance characteristics of many higher priced models. Built-in automatic noise limiter stops ignition interference, automatic modulation control provides steady modulation regardless of mike position, built-in mike preamp. Dual conversion receiver, full 5-watt

transmitter. Sensitivity: $0.5 \mu\text{V}$ for 10 dB S+N/N. Lighted channel selector, squelch control, push-to-talk mike included. Very compact—only $6\frac{3}{8} \times 2\frac{1}{4} \times 7\frac{5}{8}$ ". Includes all crystals, mike holder, mounting bracket. For 12 VDC pos. or neg. ground. **CB-357J.** Shpg. wt. 6 lbs. 114.95



114⁹⁵



149⁹⁵

Mobile Model with Continuous Delta Tune Circuit

Model 671. All-around performer! Continuous delta-tune circuit lets you "zero in" on off-frequency stations, external speaker jack and PA switch let you add a speaker to use it as a mobile PA system. Also has illuminated channel selector and S/RF meter, switchable automatic noise limiter, built-in

mike preamp with automatic modulation control. Frequency synthesis circuit, 5-watt transmitter. Sensitivity: $0.5 \mu\text{V}$ for 10 dB S+N/N. With all crystals, plug-in mike and holder, mobile mounting bracket. $6\frac{3}{8} \times 2\frac{1}{4} \times 7\frac{5}{8}$ ". 12 VDC positive or negative ground. **CB-358J.** Shpg. wt. 6 lbs. 149.95

Hy-Gain's BEST AM Mobile Model— Every Fine Feature

Model 672. A truly outstanding mobile CB rig. Has *true* noise blanker with built-in automatic noise limiter for really quiet operation, delta-tune circuit for off-frequency stations, built-in adjustable antenna matcher, receive and modulation indicator lights, automatic modulation control, built-in mike preamp. Lighted S/RF meter and chan-

nel selector. Mechanical filter provides outstanding selectivity, full 5-watt transmitter. High-power output transistors operate at about half-rating for exceptional stability. Sensitivity: $0.5 \mu\text{V}$ for 10 dB S+N/N. $7\frac{1}{2} \times 2\frac{1}{4} \times 9\frac{5}{8}$ ". 12 VDC positive or negative ground. **CB-359J.** Shpg. wt. 6 lbs. 199.95

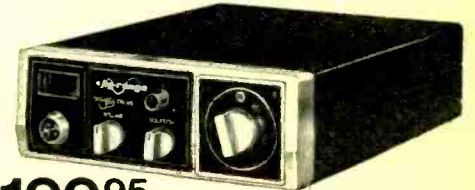

199⁹⁵



199⁹⁵

Full-Feature Base Station with Variable Antenna Tuning

Model 673. A superb CB performer with all the great features needed to get your signal out in style. Has tunable TVI filter that really cleans up interference, switchable ANL, automatic modulation control with modulation indicator light. 23-channel frequency synthesis circuit, 5-watt transmitter. Sensitivity:

$0.5 \mu\text{V}$ for 10 dB S+N/N. Lighted channel selector and RF/S meter, continuous delta-tune circuit. Built-in mike preamp, antenna tuning control for precise impedance matching. With all crystals, plug-in mike. $13\frac{1}{2} \times 5 \times 11$ ". For 117 VAC. **CB-360J.** Shpg. wt. 18 lbs. 199.95

AM/SSB Mobile Model with 69-Channel Capability

Model 674. "Total Communication" mobile CB two-way radio—23 channels AM, 23 channels upper sideband and 23 channels lower sideband. Has every fine feature for really outstanding communications—"extras" that make it one of the very best around. Antenna tune and load control, with built-in bridge detector, full-range clarifier

for easy and accurate "net" operation, RF gain control for "precision power" at all times. Also PA provision, noise blanker and ANL, modulation control, built-in mike preamp, more. $0.5 \mu\text{V}$ sensitivity for 10 dB S+N/N. $8\frac{5}{8} \times 2\frac{3}{4} \times 10\frac{3}{8}$ ". 12 VDC positive or negative ground. **CB-361J.** Shpg. wt. 8 lbs. 329.95

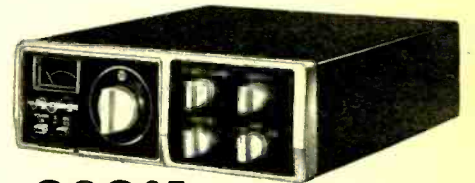

329⁹⁵

"THE SLIDER" Remote VFO

Model 675. (Not Shown). Just hook it up with any of the CB two-way radios on this page and tune in ALL the CB action! Picks up the hard-to-get signals that would nor-

mally require extremely precise fine tuning. Operates with AM or SSB radios by simply plugging into real panel. $6\frac{3}{8} \times 2\frac{1}{4} \times 7\frac{5}{8}$ ". **CB-362J.** Shpg. wt. 3 lbs. 79.95



\$495

Hy-gain's Finest—AM/SSB 69-Channel Capability Base Station

Model 623. As good as you'll get on the CB market! Operates 23 channels AM, 46 channels upper and lower single sideband. Features high-level AM plate modulation, crystal-controlled VXO, built-in noise blanker, S/RF/SWR meter. Audio and RF gain controls for really exact power control, FIVE-

TURN fine tune control to "zero in" on signals. Hybrid circuit uses tubes where they work best, transistors where they work best—for power and performance that won't be beat. Base or mobile operation. With all crystals, cables. $11\frac{7}{8} \times 5\frac{1}{2} \times 10\frac{1}{2}$ ". **CB-310J.** Shpg. wt. 18 lbs. 495.00

Walkie-Talkies for Business and Pleasure

MIDLAND

These Walkie-Talkies are ready-to-use, hand held 2-way radios that operate on the Citizens Band and can be used for business or personal communications. Ideal for hunting, fishing, camping, or emergencies. Great for industry or "at home."



1
34⁹⁵



2
44⁹⁵



3
59⁹⁵



4
15⁹⁵



1 Dual-Channel 100-mW

- Midland's Best No-License Model
- Handy "Call Signal" Alert System

Model 13-123. Low cost but feature packed. Crystal controlled transmit, superhetrodyne receiver. On/off volume, squelch, channel selector, combination speaker/mike. Jacks for AC adapter, battery charger, earphone. Includes Channel 11 crystals, texon carrying case. 2½ x 7¾ x 2½".
CB-333J. Wt. 2 lbs. 2 for 60.00 Each 34.95

2 Two Channel, One-Watt

- Tuned RF, 3 IF Stages
- Automatic Gain Control

Model 13-700. Has superhet receiver with tuned RF stage to improve sensitivity and image rejection. Features Call Signal, squelch, on/off volume, push-to-talk. Jacks for AC adapter, battery charger, earphone. 60" antenna. Includes Channel 11 crystals. Requires 8 "AA" cells. 2½ x 7¾ x 2½".
CB-236J. Wt. 2 lbs. 2 for 80.00 Each 44.95

3 Three-Channel, Two-Watt

- IC Circuit For Dependability
- Call Signal Alerts Other Units

Model 13-724. Sensitive superhet receiver features separate speaker and mike for maximum clarity and range. Tuned RF stage and high-level push-pull audio modulation. Has battery level meter, adjustable squelch, 60" antenna, earphone, carrying case/shoulder strap. Req. 8 "AA" cells. 2¾ x 7¼ x 2¾".
CB-228J. Wt. 3 lbs. 2 for 110.00 Each 59.95

7 Lightweight Compact 3-Channel, 5-Watt I.C. Transceiver

- Weighs 50% Less
- 25% Smaller
- Accessory Jacks For Versatility
- Isolated Chassis For Mobile Use

Model 13-785. Features combination 3-way meter for battery condition, relative power output and signal-strength, high and low power outputs. Also includes squelch control, on/off volume, channel selector, charger/AC power, push-to-talk switch.

4 Low Cost 2-Channel, 100 mW

- No License • 3-Stage Transmitter
- Convenient Call Signal Alert System

Model 13-427. This lowest cost Midland model features superhet receiver and high efficiency transmitter. Has speaker/mike combination, on/off volume control, push-to-talk button, earphone jack, 44½" telescoping antenna, case, carry strap. With battery, Ch. 14 crystals. 2½ x 6¼ x 1¾".
CB-286J. Wt. 1¼ lbs. 2 for 30.00 Each 15.95

5 3-Channel, 5-Watt

- Hi/Lo Power Switch Saves Batteries
- Isolated Chassis For Mobile Use

Model 13-762. Real quality, priced low! High level modulation for greater transmitting range. Superhet receiver with tuned RF stage. Includes on/off volume, squelch, push-to-talk, earphone. Jacks for external speaker, antenna, and power. Operates on 8 "AA" cells. 3¼ x 9½ x 2".
CB-235J. Wt. 5 lbs. 2 for 140.00 Each 74.95

6 6-Channel, 5-Watt

- IC Circuit For Dependability
- Hi/Lo Power Switch • Call Signal

Model 13-770. Versatile—Provides long range communications on up to 6 channels. Includes speaker/mike, squelch, charge/power switch, battery/RF meter, earphone, AGC. Has jacks for AC adapter, battery charger, external mike, P.A. speaker, antenna. Req. 8 "AA" cells. 3 x 9¾ x 2¾".
CB-235J. Wt. 6 lbs. 2 for 170.00 Each 89.95

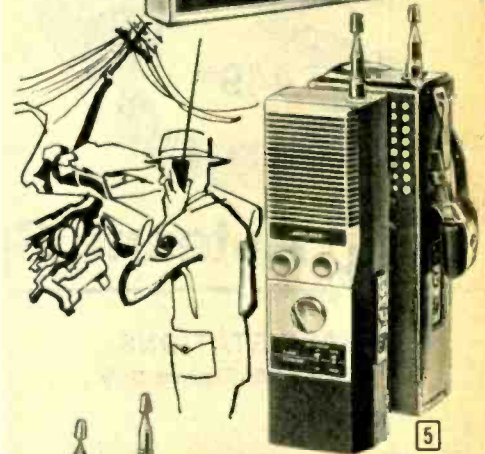

5
74⁹⁵

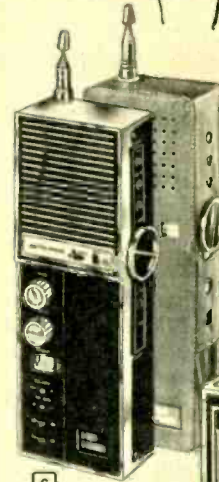

6

89⁹⁵

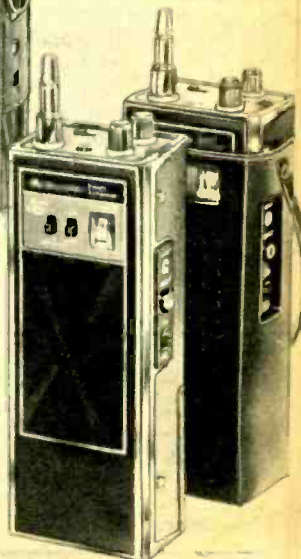

7

99⁹⁵



COBRA 23-Channel CB Two-Way Radios

Ruggedly reliable AM and SSB two-way radios from the name that MEANS CB quality and value!



1 129⁹⁵



3 179⁹⁵



4 339⁹⁵

Coiled Cord PTT Mike



2 449⁹⁵

1 Model 21. Low-priced, but ready-to-go on all channels. 5-watt transmitter, dyna-mike gain control for 100% modulation at all times, volume, squelch, switchable ANL, S/RF meter. PA provision. Sensitivity: less than 1 μ V for 10 dB S+N/N. 6 x 2½ x 7½". With all crystals, mike, mounting bracket. 12 VDC. CB-353J. Shpg. wt. 4 lbs. 129.95

2 Model 135. The one that does it ALL! 23 channels AM, 23 USB, 23 LSB! Digital clock timer, noise blanker, ANL, crystal and ceramic filters, AGC, S/RF/SWR meter, RF gain and voice lock controls, squelch, lots more! Sensitivity: SSB, 0.25 μ V; AM, 0.5 μ V for 10 dB S+N/N. 13¾ x 5¾ x 12". With all crystals, mike, AC and DC power cords. CB-356J. Shpg. wt. 15 lbs. 449.95

3 Model 28. Features channel-9 scan-alert—emergency transmissions override regular operation, flip a switch and you can transmit on channel 9 *independently* of the channel selector. All other famous Cobra features too, including Delta tune circuit. Sensitivity: less than .5 μ V for 10 dB S+N/N. 6 x 2¾ x 8½". 12 VDC. CB-354J. Shpg. wt. 5 lbs. 179.95

4 Model 132. "Total communications" mobile model—23 channels, AM, USB, LSB. Has voice lock, RF gain control, AGC, noise blanker, S/RF meter, transmit light, lighted channel selector, more. Dyna-boost voice compression circuit. Sensitivity: SSB, under 0.25 μ V; AM, less than 0.5 μ V for 10 dB S+N/N. 7½ x 2¾ x 10¾". 12 VDC. CB-355J. Shpg. wt. 8 lbs. 339.95



Antenna Specialists CB Antennas

BASE STATIONS

Shipped REA Express Only



5 99⁹⁵

7 159⁹⁵

5 Model MS199. Super-scanner has selectable phased elements for 8.75 dB directional gain, 5.75 dB omni! With rotator. 6' dia., for 1½" pipe. AA-751J. 20 lbs. 99.95

6 Model M-400. "Starduster" omni with reduced radiation angle for 5 dB gain over conventional ground planes. 100 mph plus wind loading! AA-753J. 8 lbs. 39.95

7 Model M-216. "Big Daddy" yagi with 5 horizontal and 5 vertical elements for 24 dB F/B ratio, 30 dB side rejection. 22' tapered boom. AA-752J. 41 lbs. 159.95

6 39⁹⁵

MOBILES

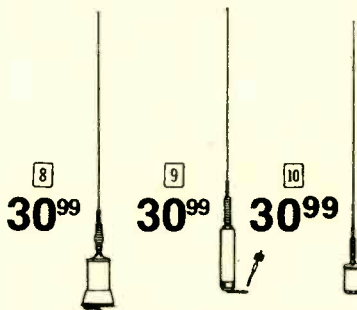

8 30⁹⁹

9 30⁹⁹

10 30⁹⁹

"Big Momma" Series won't burn out! Gives you superior transmit and receive capabilities no matter where you're operating. All have copper-nickel plated stainless steel whips, 17' coax and connectors.

8 Model M-410. Quick-grip trunk-lip mount. 46" high. AA-754J. Shpg. wt. 2 lbs. 30.99

9 Model M-411. ¾" hole mount for roof or trunk, stainless steel shock springs. AA-755J. Shpg. wt. 2 lbs. 30.99

10 Model M-412. ¾" hole mount for roof or trunk, shock springs. AA-756J. Shpg. wt. 2 lbs. 30.99

SPECIAL PURPOSE



11 29⁹⁵

12 34⁶⁹

13 30⁸⁹

11 Model M-246. Camper antenna mounts on any flat surface, has stainless steel tapered whip, weatherproof loading, matching coil, 20' coax and connector. AA-757J. Shpg. wt. 2 lbs. 29.95

12 Model M-223. For motor homes, marine setups. 9' center loaded stainless steel whip. Needs no ground plane, can even be used on fiberglass boats. Hardware. AA-758J. Shpg. wt. 3 lbs. 34.69

13 Model ASM-94. Marine antenna designed for smaller fiberglass or wood boats. Fiberglass tunable 4' whip, SO-239 receptacle. Removable whip. AA-759J. Shpg. wt. 2 lbs. 30.89

CB For Home and Car Communications



149⁹⁵



- SBE "Super Shape" Filter Provides Maximum Channel Selectivity

"Cortez" 23-Channel 5-Watt AM Mobile Station

Model SBE-21CB. Has a double conversion receiver to stop image interference. With FET's, IC's, AGC, squelch, and front panel-switchable noise blanker. Jacks for PA and receiver speakers. Signal strength meter. With dynamic microphone and plug. 1 μ V Sensitivity for 10 dB S+N/N @ 2W output. 6 dB @ \pm 6 kHz, 60 dB @ \pm 20 kHz Selectivity. With mounting bracket. 2 $\frac{1}{2}$ x 5 $\frac{1}{2}$ x 8 $\frac{3}{4}$ ". 12 VDC positive or negative ground. Includes all crystals.

CB-346J. Shpg. wt. 4 lbs. 149.95

289⁹⁵



- Greater Range Than Many AM Sets

23-Channel 15 Watt P.E.P. SSB CB Mobile Station

Model SBE-18CB. Deluxe "Sidebander III" features SSB exclusive operation—eliminates the noise and interference of conventional AM CB radios. Has double the number of channels too—46 using both USB and LSB. With ALC, IF circuitry, double conversion receiver, AGC, switchable limiter, and signal meter. Includes mounting bracket, microphone, 4-conductor plug. 0.5 μ V for 10 dB S+N/N @ 2W output Sensitivity. 6 dB @ \pm 3.5 kHz Selectivity. 12 VDC neg. ground. 2 $\frac{1}{2}$ x 5 $\frac{1}{2}$ x 8 $\frac{3}{4}$ ". With all crystals

CB-347J. Shpg. wt. 4 lbs. 289.95

359⁹⁵



- "Power Pump" Increases Talk Power to 15 Watts P.E.P.

"Sidebander II" 23-Channel SSB/AM Mobile

Model SBE-12CB. You get all the advantages of Sideband, AM too. 69 channels total! Features include electronic antenna switching, signal strength meter, noise blanker, RF gain control, PA paging, mike, more. Has jacks for PA or receiver speakers. 0.5 V for 15 db S + N/N Sensitivity. 6 dB @ 2.1 kHz, 50 db @ 5.5 kHz Selectivity. 2 $\frac{1}{4}$ x 7 $\frac{1}{2}$ x 9 $\frac{1}{2}$ ". 12 VDC neg. ground. With all crystals.

CB-348J. Shpg. wt. 7 $\frac{1}{4}$ lbs. 359.95

399⁹⁵



- Operates On 117 VAC Or 12 VDC Negative Ground

23-Channel 15 Watt P.E.P. SSB/AM Base Station

Model SBE-16CB. The "Console II"—with 69-channel capability on LSB, USB, plus AM! Has 3-way power output meter, VSWR. ALC and AGC are self-adjusting internal functions. With clarifier, microphone. Dual power operation—switches automatically to 12 VDC if power fails. 0.5 V for 15 dB S + N/N Sensitivity. 6 dB @ 2.1 kHz, 50 dB @ 5.5 kHz Selectivity. 5 x 12 x 10 $\frac{1}{4}$ ". With all crystals.

CB-349J. Shpg. wt. 12 $\frac{1}{4}$ lbs. 399.95

Sentinel Series Scanning Monitor Receivers

SBE communications equipment now offers a series of fine scanning monitor receivers. This series includes models for the most widely used individual and combination VHF/UHF bands. For example, FM reception and scanning is available for business, industrial, law enforcement, just to name a few, operating on assigned channels within 30-470 MHz. They all have features such as 8-channel continuous scan, priority channel feature, channel lock-out pushbuttons, manual advance switch, base or mobile operation, squelch, built-in speaker, rear jack for external speaker. 2 $\frac{1}{4}$ x 6 x 7 $\frac{1}{2}$ ". 117 VAC or 12 VDC negative ground.

Sentinel II—SBE-2SM. 144-171 MHz Frequency Range.

RA-095J. Shpg. wt. 4 lbs. 149.95

Sentinel I—SBE-1SM. 30-51 MHz, 144-171 MHz VHF.

RA-096J. Shpg. wt. 4 lbs. 169.95

Sentinel V—SBE-5SM. 450-470 MHz UHF Frequency Range.

RA-097J. Shpg. wt. 4 lbs. 159.95

Sentinel VI—SBE-6SM. VHF: 144-171 MHz, UHF: 450-470 MHz.

RA-098J. Shpg. wt. 4 lbs. 189.95



Low As
149⁹⁵

- Operates On 117 VAC Or 12 VDC Negative Ground
- 8-Channels Scanned Continuously and Sequentially
- Priority Channel Shifts To "Assignment" When Carrier Appears



39⁹⁵

1 1000 Watt Inline Watt Meter

- 3 Scales
- VSWR Function

Model GLC 1052B. This single instrument provides all you need to get the most out of your transmitter. Inline unit measures radiated power, but draws very little power from your own rig. The range selector switch allows monitoring on ranges of 0-10 watts, 0-100 watts, or 0-1000 watts. Get quick VSWR measurements with the easy-to-use chart included. For maximum efficiency, we recommend a matched line between your rig and antenna. 50-ohm impedance.

CB-176J. Shpg. wt. ¼ lb. 39.95

2 60 Amp Alternator and Generator Filter

- Eliminates Generator and Alternator Whine Through Your Receiver

Model GLC 1076. An effective ferromagnetic filter that wipes out nearly all annoying electrical noise, provides clearer CB, HAM reception. Tuning is unnecessary—the circuit attenuates noise at all radio frequencies. Installs easily. Range 2.2 to 400 MHz.

CB-326J. Shpg. wt. ¼ lb. 7.95

Model GLC 1080. Above, for 100 amps.

CB-329J. Shpg. wt. ½ lb. 12.95

3 Multi-Band Antenna Coupler

- Low Loss
- Impedance Matched

Model GLC 1079. Now you can convert your present auto antenna to five different models. This unit allows the use of 20-70 MHz, 148-175 MHz, Police/Fire and special service monitors PLUS your AM/FM car radio from your standard windshield or radio-type antenna. Couples up to 5 bands without requiring a new or special antenna. Includes a standard auto antenna jack and standard SO-239 connectors.

CB-328J. Shpg. wt. ¼ lb. 12.95

Coaxial Switches

4 Grounded 5 Position

Model GLC 1042A. Ideal addition for the serious HAM or CBER! Low loss, audio frequency to 50 MHz, 52-75 ohm impedance, positive ground to all unused positions. Power rating 1 KW, ceramic switch for long life. Great for wall or panel mounting. SO-239 connectors.

CB-177J. Shpg. wt. 1 lb. 12.95

5 3 Position Coaxial Switch

Model GLC 1070. Great for switching from Directional to Omnidirectional antenna. Rated at 1 KW AM, 2 kW PEP for SSB. SO-239 conn.

CB-323J. Shpg. wt. ¼ lb. 6.95

6 2 Position Coaxial Switch

Model GLC 1048. A flip of the switch changes one antenna to another. Rated at 1 kW AM or 2 kW PEP for SSB. SO-239 connectors.

CB-109J. Shpg. wt. ½ lb. 6.59

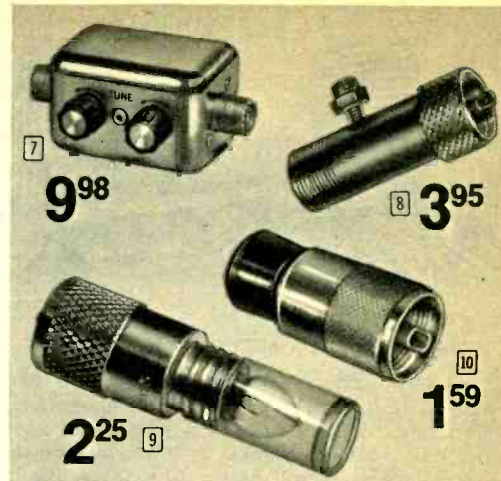

7 CB Matcher

Model GLC 1046. Gives perfect VSWR match for full power at all times. Easy installation. 13-78 MHz. 100 Watts.

CB-078J. Shpg. wt. ½ lb. 9.98

8 Lightning Arrestor

Model GLC 1047. Positive gap principle protects valuable equipment against lightning. Eliminates static build-up.

CB-141J. Shpg. wt. ½ lb. 3.95

9 Power Light Modulation Indicator

Model GLC 1057. Substitutes for antenna. Lights up to indicate output power. 52 ohm load, VSWR 1.1:1. Also dummy load.

CB-322J. Shpg. wt. ¼ lb. 2.25

10 Sponge Dummy Load

Model GLC 1072. Soaks up power and stops illegal output when servicing rig. 52 ohm load. VSWR 1.1:1. For 5 watts.

CB-324J. Shpg. wt. ¼ lb. 1.59

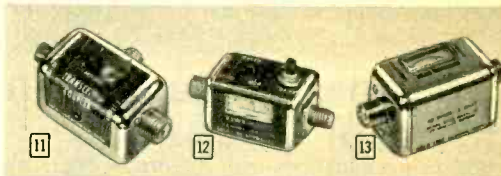

11 Twin Rig Coupler

Model GLC 1075. Operate 2 transceivers with one antenna, both to 5 watts. 50 ohms. 19-30 MHz. Less than ½ dB insertion loss.

CB-325J. Shpg. wt. ¼ lb. 9.95

12 SWR Mini-Bridge

Model GLC 1049A. Handles 750 watts average power in matched 500 ohm line. Mounting bracket. Negligible insertion loss.

CB-321J. Shpg. wt. ¼ lb. 14.95

13 CB Inline Watt Meter

Model GLC 1056. Reads TRUE output power. 5 watts continuous. Stays in line for constant monitoring. Negligible insertion loss.

CB-143J. Shpg. wt. ¼ lb. 14.95

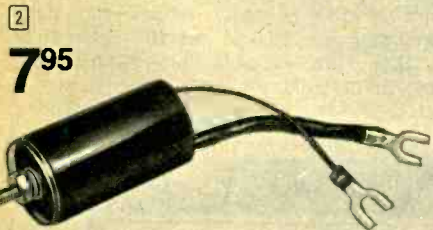

7⁹⁵



12⁹⁵

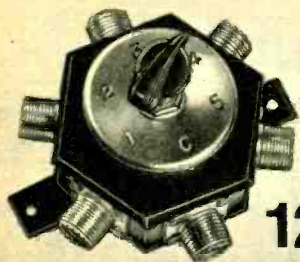

12⁹⁵

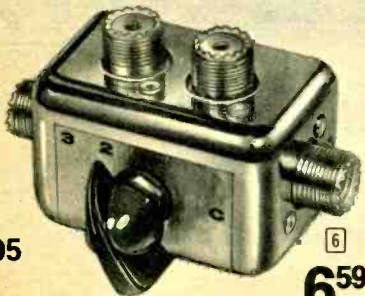

6⁹⁵

6⁵⁹

Citizens Band Rigs for Car, Truck, or at Home

Royce



The Two-Way Radios with Hundreds of Applications

Citizens band two-way radios. Use them for practical as well as enjoyment purposes. CB is exactly for you—the citizen. It's yours for use in your business, community organizations, volunteer groups, emergency situations.



59⁹⁸

3-Channel 5-Watt Mobile

Model 1-590. Fits almost any area yet provides superb communications. Receiver features "sensitivity" tuned RF stage, and 3 IF's. AVC circuit, Automatic noise limiter, squelch. High level modulation system with 3 stage transmitter. Solid state with IC's. With channel 9 crystals, mike, mounting bracket. 12 VDC neg. grd. 2½ x 4½".

CB-341J. Shpg. wt. 2½ lbs. 59.98
CB-345J. AC Power Supply 4 lbs. 32.98



109⁹⁸

Compact Mobile 23 Channel

Model 1-600. Receiver features tuned RF stage for superior reception (0.5µV for 10dB S+N/N). Dual conversion with ceramic filter for sharp selectivity. Automatic noise limiter, AGC, and squelch. Has large S-RF meter with transmit light. With PA feature, TVI filter. Includes all crystals, mike, mounting bracket, illuminated channel selector. 5-watts. 12 VDC neg. grd. 2½ x 6 x 6½".

CB-342J. Shpg. wt. 4 lbs. 109.98



149⁹⁸

Deluxe 23 Channel Transceiver

Model 1-605. Has dual conversion receiver with ceramic filters, electrical fine tune control, large S-RF meter, switchable ANL. With variable tone control, PA capability, AGC, high efficiency transmitter with compressed audio. Low noise RF stage. Sensitivity of 0.5µV for 10dB S+N/N. Built-in TVI trap. Jacks for remote speaker, antenna. With all crystals, mike, mounting bracket. 12 VDC neg. grd. 2¼ x 6¼ x 6¾".

CB-343J. Shpg. wt. 5 lbs. 149.98

Complete Base Station Converter Kit

\$83

- CB-345 Power Supply
- Antenna • Wire
- Connectors



Convert your CB Mobile Rig into a Home Base Station in just minutes.

AS-753J. 28 lbs. 83.00

Save On A Complete Mobile System for Each of the Above Units

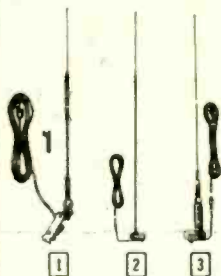

- 1 Sep. Items Reg. \$94.83. Hustler RTG-27-L Ant., 2 crystal certificates with CB-341J, above. AS-751J. Shpg. wt. 4½-lbs. 75.00
- 2 Separate items Reg. \$129.93. Hustler TLA-27-L Fiberglass Antenna, with CB-342J, above. AS-752J. Shpg. wt. 6½ lbs. 120.00
- 3 Separate items Reg. \$171.23. Hustler XBLT-4 Antenna with CB-343J, above. AS-754J. Shpg. wt. 8 lbs. 150.00

\$75

\$120

\$150

Versatile CB Walkie Talkies

2-Channel 1-Watt Walkie-Talkie

39⁹⁸ Each

- Squelch
- Automatic Noise Limiter

Model 1-400. Has superhet receiver with tuned RF stage. Three IF's, and three stage transmitter. Jacks for external speaker, AC adapter, battery charger and external power. Carrystrap, earphone, channel 11 crystals. Req. 8 "AA" cells, 7½ x 2½ x 2¼". 1¼ lbs.

CB-344J. Pr. 75.00 Ea. 39.98



3-Channel 2-Watt Walkie-Talkie

49⁹⁸ Each

- Call Alert
- Noise Limiter
- Lightweight

Model 1-402. A professional transceiver for everyday or occasional use. Includes RF stage, 3 IF's, AVC, squelch. Jacks for external speaker, AC adapter, battery charger, 12 V neg. grd. With earphone. Ch. 11 crystals. Req. 8 "AA" cells. 8 x 3 x 2¾". 2 lbs.

CB-338J. Pr. 95.00 Ea. 49.98



3-Channel 5-Watt/2-Watt Walkie-Talkie

79⁹⁸ Each

- Speaker and Microphone
- Call Alert
- Carrying Case

Model 1-406. Selector switch for 3 stage transmitter. 5 or 2 watts. Tuned RF stage, 3 IF's. ANL, AFC, Jacks for external speaker, AC adapter, 12 V neg. grd. With earphone, Ch. 11 crystals. Req. 8 "AA" cells. 9¼ x 3¼ x 2¾". 3½ lbs.

CB-339J. Pr. 155.00 Ea. 79.98



6-Channel 5-Watt Walkie-Talkie

99⁹⁸ Each

- 5/2 Watt Power
- Battery / RF
- PA System

Model 1-408. Special circuit for conversion to 5 watt PA system. Call Alert Signal, 3 IF's, AVC, automatic noise limiter, squelch. Jacks for external speaker, mike, AC, 12 VDC neg. grd. With earphone, Ch. 11 crystals. Req. 8 "AA" cells. 9¼ x 3¼ x 2¾". 4¼ lbs.

CB-340J. Pr. 190.00 Ea. 99.98



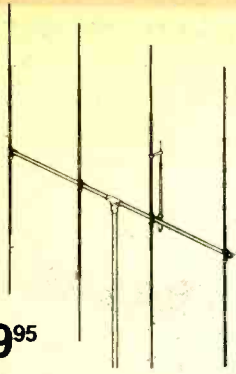

49⁹⁵

Top-performing "Power Multiplier" Base Antennas

Model 11-M-4. 4 elements, 9.4 dB forward gain, 28 dB F/B ratio. Use with any rotator to beam your signal out. Boom length, 17'6". Shipped REA only.
AA-417J. Shpg. wt. 12½ lbs. 49.95
Model 11-M-3. 3 elements, 8 dB gain, 25 dB F/B. 11'1" boom. **AA-619J.** 10 lbs. 37.95

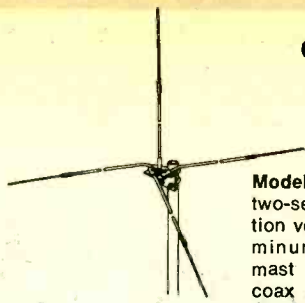

CB Base Antenna

9⁹⁸

Model GP-1. Three "drooping" two-section 108" radials, two-section vertical radiator, all solid aluminum. Cadmium-plated steel mast bracket. Includes SO-239 coax connector, "U" clamp for 1¼" masts.
AA-121J. Shpg. wt. 4 lbs. 9.98

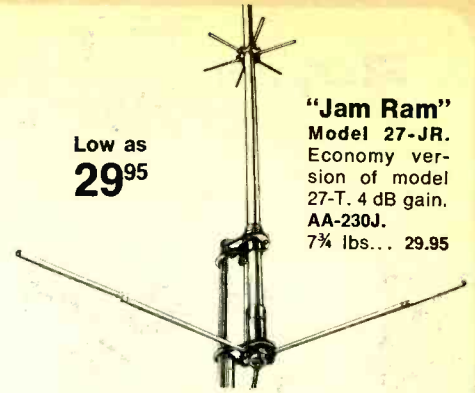

"Jam Ram"
Model 27-JR. Economy version of model 27-T. 4 dB gain. **AA-230J.** 7½ lbs... 29.95

Low as
29⁹⁵

84⁹

102" Whip Mobile Antenna

Model CB-102. For 27 MHz mobile rigs. Mounts easily to trunk, cowl or fender. With ball mt, spring and flexible stainless steel whip. **Shipped REA only.**
AA-091J. Shpg. wt. 7 lbs. 8.49
20-ft. Coaxial Cable. For use with mobile antenna above. With plug. **WW-574J.** Shpg. wt. 1 lb. 4.25

Super Gain Base Antenna

Model 27-T. "Trumpet" model offers better than 4 dB gain with superior omnidirectional colinear design. 19' 10¼" vertical radiator, 108" radials. Sealed RF power "step up" transformer, DC grounding and SO-239 coax connector. For masts to 1½" dia.
AA-620J. REA only. 9½ lbs. 39.95

"Optimized Performance" CB Antennas by Hustler

Top Performing Mobile Antenna

One of the finest CB mobile antennas available. Here is the power rated antenna used by all CB'ers where performance and reliability are foremost. Features large signal capture area plus center loading for 50 ohm base impedance, adjustable stainless steel tip rod for lowest SWR and fold over mast for easy garaging. Stays tuned, stays vertical at any highway speed. Operational height, 83". The ¾" - 24 stainless steel base fits ball mount or bumper mount (not included).

- 1** Model CB-111. For fender or deck mounting. Folds at roof line. **AA-420J.** Shpg. wt. 2¼ lbs. 22.95
- 2** Model CB-211. Similar to above, but for bumper mounting. Folds at roof line. **AA-421J.** Shpg. wt. 2¼ lbs. 22.95

Trunk/Roof Mount Mobile Antennas

- 5** Model XBLT-4 Trunk Lip Mount. 48" commercial power rated CB antenna attaches to side or edge of trunk lid without drilling. Has 180° swivel ball, stainless steel spring, adjust. and tapered stainless steel radiator. 17' RG-58-U coax and PL-259 connector included. **AA-436J.** Shpg. wt. 2¾ lbs. 24.95
- 6** Model XBL-3 Roof Mount. For mounting on any flat surface in ¾" hole. 48" antenna includes stainless steel impact spring, 17' RG-58-U. All connectors installed. **AA-434J.** Shpg. wt. 2½ lbs. 18.95
- 7** Model RTS-27-L Roof Mount. This 30" roof top antenna has a low-profile base, installs in ¾" hole. With stainless steel impact spring, center resonator, adjustable tip rod. With 17' RG-58-U, PL-259. **AA-426J.** Shpg. wt. 1¾ lbs. 16.95

"Double-Talk" Mobile Antennas

- 8** Model SDT. Fiberglass system. Pair of 48" white fiberglass antennas with trunk groove mounts. 180° swivels and special 17' dual RG-58-U harness. **AA-427J.** Wt. 3½ lbs. 27.95
- 9** Model DTG. Install on rain gutters—no drilling or soldering. Adjustable for lowest SWR. Two 25" antennas. 12' dual phasing harness, 180° swivel balls, stainless steel springs. **AA-422J.** Wt. 2¾ lbs. 24.95

Rain Gutter/Cowl Mount Antennas

- 3** Model RTG-27-L Gutter Mount. Only 25" high. Mount fits all gutters and installs in moments—no drilling. Includes mount, swivel ball, stainless steel spring, center resonator, adjust. tip rod. With 12' RG-58-U and PL-259. **AA-425J.** Wt. 1¾ lbs. 16.95
- 4** Model TCS-27-M CB/AM/FM Antenna. Two-section telescopic antenna with center resonator, adjustable top rod. Operational height, 48". Automotive "8-ball" mount fits 1½ to 1¾" hole. With matching harness, cable assemblies. **AA-428J.** wt. 2 lbs. 19.25

Budget-Pleasing CB Mobile Antennas

- 10** Model TLA-27-L. Fiberglass Trunk Lip Mount. Center loaded 48" white fiberglass antenna for side or rear trunk lip installation. Adjustable stainless steel tip rod. 17' RG-58-U included. **AA-350J.** Shpg. wt. 2¹/₁₀ lbs. 19.25
- 11** Model FG-27 Fiberglass 48" CB Antenna. Flexible fiberglass antenna with copper braid. Weather-proofed with white vinyl cover. Center resonator, adjust. stainless steel tip rod. 50 ohm nominal impedance. ¾" - 24 base. **AA-621J.** Shpg. wt. ½ lb. 8.95
- 12** Model TMR-27 CB Portable Base Antenna. For direct attachment to any CB transceiver. With right angle PL-259 connector, stainless steel tip rod. Overall length, 21". Pretuned. **AA-432J.** Shpg. wt. ¾ lbs. 8.95



Monitor Radio Antennas and Mobile Mounts

Improve the Performance of ANY UHF/VHF Equipment

Monitor-Match for the Car



Monitor Everything With One Antenna

14⁹⁵

Model 5M5. Use up to five different monitors with a single antenna. Separate outputs for car radio and 25-50 MHz, 140-175 MHz and 300-500 MHz bands. Matched impedance; no detectable insertion loss. With cables for FM/AM or AM radio and one monitor receiver.

AA-638J. Shpg. wt. 1 lb. 14.95

AA-639J. 24" Cable for additional monitors 1.00

VHF and UHF Antennas

1 Model THF Mobile. For 140-500 MHz. Installs on trunk lip. 20" stainless element. 17' RG-58U coax. AA-429J. Wt. 1 1/2 lbs. 14.95

2 Model HFT HI/Lo Trunk Lip Mount Antenna. 25-50 and 140-174 MHz. 4-section. 17' RG-58U coax. AA-637J. Wt. 2 lbs. ... 19.95

3 Model DCX Discone Antenna. Covers 40-700 MHz. No adjustments. Omnidirectional. SO-239 connector. AA-635J. Wt. 2 1/2 lbs. 14.95

Model DCL. As above, with 50' coax, connectors. AA-636J. Wt. 4 1/2 lbs. 21.95

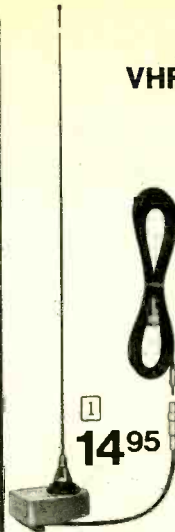

14⁹⁵



19⁹⁵

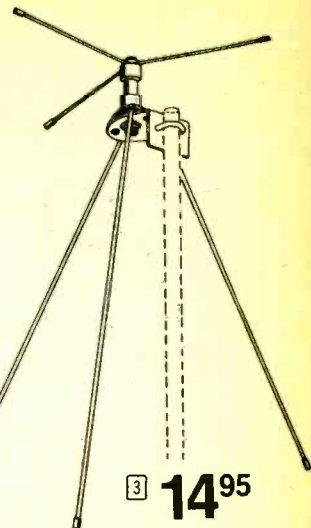

14⁹⁵

Mobile Antenna Mounts and Accessories by HUSTLER

Model GCM-1 Rain Gutter Mount. Attaches securely to gutter without drilling or special tools. 180° swivel for full adjustment. Accepts antenna up to 50" long with 3/8"-24 base. Chromed. AA-643J. Wt. 1 lb. 5.95



5⁹⁵

Model C-30-32 Ball Mount & Spring. Chrome plated 180° swivel ball and spring. Gray cyclac base. Rubber pad, steel back-up plate, hdwre., wrench. AA-640J. Wt. 2 lbs. 7.85
AA-641J. Spring only. 1 1/4 lb. 3.95
AA-642J. Mount only. 1 lb. . 3.95



Model TGM-1 Trunk Groove Mount. Installs easily in hidden area of trunk groove. 180° swivel ball. Accepts any antenna to 60" long with 3/8"-24 thread. 3/8" lb. AA-645J. 6.50

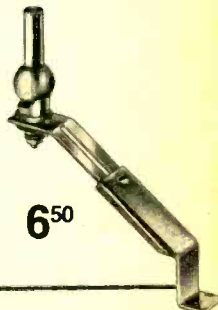

6⁵⁰

Model TLM Trunk Lip Mount

Easiest of all to install. Attaches to side or edge of trunk lid. Accepts antennas to 72" with 3/8"-24 base. With 17' RG-58U coax, connectors. AA-431J. 2 lbs. ... 11.25

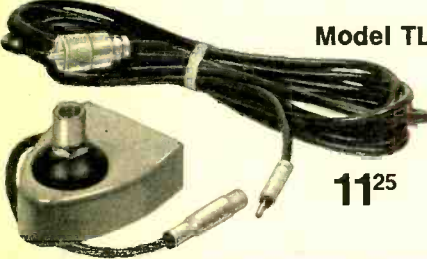

11²⁵

Model BM-1 Bumper Mount. Stainless steel strap fits any bumper. 180° swivel ball mount. 2 3/4 lbs. AA-419J. 9.95



9⁹⁵

Quick Disconnect All Stainless Steel

Model QD-1. Easy press-and-twist removal of antenna from mount. 3/8"-24 thread for all mobile antennas. AA-705J. Wt. 1/2 lb. ... 10.95



Two-Meter Amateur Band Antennas

For Fixed or Mobile Operation

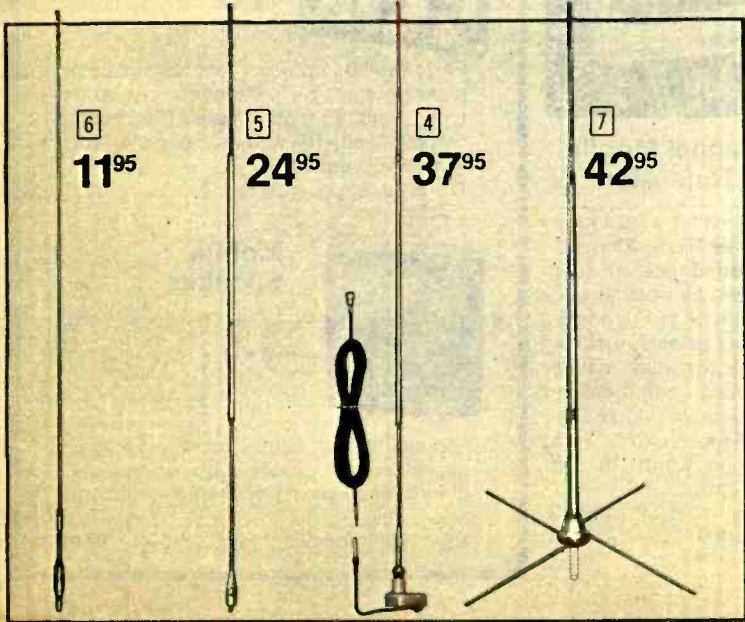

6
11⁹⁵

5
24⁹⁵

4
37⁹⁵

7
42⁹⁵

4 83" Super-Gain Colinear for Mobile

Model CGT-144. Offers superior performance for both receive and transmit modes of operation. Installs easily on side or edge of trunk lip without drilling. Offers 5.2 dB gain, typical SWR rating of 1.1:1. Power rating—200 watts FM. Frequency coverage: 143-149 MHz. With 17' RG-58/U cable, PL-259 connector. AA-760J. Shpg. wt. 3 1/2 lbs. 37.95

5 Ball-Mount 81 3/4" Colinear

Model CG-144. Same characteristics and specifications of Model CGT-144 above, but supplied with 3/8"-24 base to fit all mobile mounts. 81 3/4" long. Mount not included. AA-761J. Shpg. wt. 1 3/4 lbs. 24.95

6 Low-Priced Top Performing Model

Model SF-2. Offers 3.4 dB gain over 1/4-wave mobile antennas. 3/4-wave, 51" stainless steel radiator. Rated at 100 watts FM. With 3/8"-24 base for most mobile mounts. Mount not included. AA-644J. Shpg. wt. 1 3/4 lbs. 11.95

7 Base Station Two-Meter Antenna

Model G6-144. Two meter colinear features extremely low radiation angle achieved through optimum phasing of 3/4 and 1/4 wave radiating sections—provides up to 6 dB gain over 1/4-wave antennae! 126" high, 250 watts FM, 1.1:1 typical SWR at resonance. AA-763J. Shpg. wt. 4 1/2 lbs. 42.95

JOHNSON The Name That MEANS CB Dependability

23-Channel "Hybrid" Base Station CB Two-Way Radio

Messenger 223. Makes use of tubes where they work best, transistors where they work best—for the high-reliability performance you expect from Johnson. Features reserve-gain audio preamplifier, high-level Class AB₁ modulation, plus automatic clipping and filtering for a signal that really gets through. Has illuminated meter for signal-strength and relative output power. Big "full-view" channel selector, on-off indicator light. Sensitivity: 0.5 μ V. Includes deluxe base station mike with push-to-talk bar, crystals for all 23 CB channels. Circuit employs 10 tubes, 11 diodes and 12 transistors in all. Metal case, 11 x 5 $\frac{1}{16}$ x 9 $\frac{1}{16}$ ". For 117 VAC. CB-246J. Shpg. wt. 17 lbs. 199.95

Low-Cost Full-Power Ultra-Compact 5-Channel Mobile CB Two-Way Radio

Messenger 125. Small but mighty! Has the features you need for full 5-watt CB communications on up to 5 channels. Pushbutton channel selection, slide controls for easy adjustment of volume and squelch. Has lighted channel numbers, standby and transmit lights, high-level modulation for increased "talk power." Built-in noise limiter prevents ignition interference. Sensitivity: 0.5 μ V for 10 dB S+N/N. With Channel 11 crystals, coiled cord microphone, mounting bracket. It's small size, only 4 $\frac{1}{2}$ x 1 $\frac{1}{16}$ x 7", makes it ideal for use in any car—even the newest compacts and sub-compacts. 12 VDC neg. grd. CB-256J. Shpg. wt. 4 lbs. 99.95
CB-185J. Crystal Certificate. See left . . . 4.95

10-Way CB Transceiver Tester

49.95

Performs 10 important functions! Checks power output, % modulation, crystal activity, field strength, more. Has built-in dummy load, RF and audio generators. With 9-volt battery. CB-263J. Shpg. wt. 3 lbs. 49.95

Mobile Speaker

\$13

Fits all Johnson mobile two-way radios—improves intelligibility in poor signal conditions such as noisy traffic. With cord and plug. SS-330J. Shpg. wt. 2 lbs. 13.00



AC Base Station Power Supply

32.95

Solid-state supply lets you operate Messenger 120, 123A or 125 mobile units from 117 VAC house current. CB-267J. Shpg. wt. 5 lbs. 32.95

4.95

CB Crystal Certificate

Good for a pair of CB crystals of your choice. You fill out card and send it to mfr., your crystals shipped by return mail, postpaid. CB-185J. 4.95

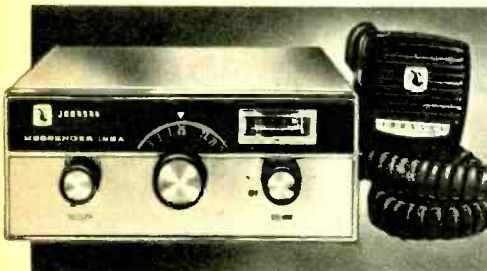

Best-Seller Update

149.95

Messenger 123A. Improved version of Johnson's famous 23-channel mobile unit. Has a ceramic filter for sharper selectivity (30 kHz at -60 dB), advanced audio system and wide-range speaker for good sound. Also has illuminated meter, speech compression circuitry, volume and squelch controls. All solid-state. Special AGC circuits provide really quiet operation. Sensitivity: 0.5 μ V. With crystals for all 23 channels, microphone and mobile mounting bracket. 6 $\frac{1}{16}$ x 2 $\frac{1}{2}$ x 9 $\frac{1}{16}$ ". Mounts easily in any 12 VDC neg. grd. vehicle. CB-252J. Shpg. wt. 6 lbs. 149.95

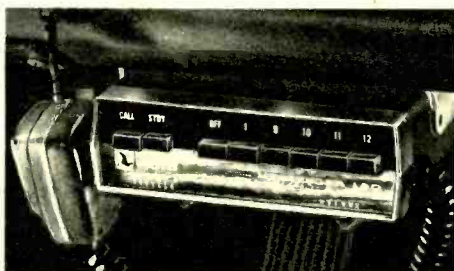

5-Channel Mobile with Tone Alert® V

149.95

Messenger 120. The radio that acts like a private telephone! Features Tone-Alert selective calling—special coded receiver does not activate until it is called by another unit with the same code—then it rings like a telephone! Pushbutton channel selection, slide-type volume and squelch for easy mobile use. Full 5-watt input, speech compression circuit, ceramic filter, series gate noise limiter. Very compact—4 $\frac{1}{2}$ x 1 $\frac{1}{16}$ x 7". With Channel 11 crystals, Tone Code, mobile bracket. For 12 VDC neg. grd. CB-254J. Shpg. wt. 4 lbs. 149.95
CB-185J. Crystal Certificate 4.95

Teledyne Quality "Zeroes In" On the CB Field



TELEDYNE

349⁹⁸

Our Own Exclusive 23-Channel CB SSB/AM Transceiver

- Can Be Used For Base or Mobile Operation
- 5 Watts AM and 15 Watts PEP SSB INPUT Power
- Ready for 23-Channel Operation

Model RA-510. Offers excellent performance with all the features necessary for top notch 2-way voice communications on up to 69 channels (23 AM, 23 upper sideband, and 23 lower sideband.) Has dual conversion receiver, frequency-synthesis circuit, low noise RF stage, adjustable squelch. Noise blanker cuts impulse-type interference. Jacks for external speaker and PA. RF power meter for

visual control of transmitter and receiver. The clarifier works as a fine tuning control and is especially useful in network operations. RF gain control increases sensitivity for clearer distant reception. Also includes a receive/transmit indicator light. 11 x 2 1/2 x 12 3/16". With 117 VAC/12 VDC power cords, mike, mounting bracket.

RA-510J. Shpg. wt. 10 lbs. **349.98**

SPECIFICATIONS

RECEIVER. Sensitivity: SSB—less than 0.2µV for 10dB S+N/N. AM—less than 0.6µV for 10dB S+N/N. **Selectivity:** SSB, 6 dB at 2.1 kHz., 60 dB at 5.5 kHz. AM—6dB at 5 kHz., 50 dB at 20 kHz. **IF Frequencies:** 7.8 MHz and 455 kHz. **Clarifier Range:** ± 60 Hz. **TRANSMITTER.** Input: 5 watts AM, 15 watts PEP. **Modulation:** AM 100%. **Output:** SSB, 8 watts PEP; AM, 3.5 watts. **Frequency Response:** SSB 350 Hz to 2,500 Hz. AM 250 Hz to 2,000 Hz. **SSB Filter:** 7.8 MHz, crystal lattice type. 6 dB at 2.1 kHz., 60 dB at 5.5 kHz. **GENERAL.** **Frequency Range:** 26.965 MHz to 27.255 MHz. **Antenna Impedance:** 52 Ohms. **Frequency Tolerance:** 0.025%.

"Pro-Quality" CB Units and Linear Amplifiers



399⁹⁵

Gladiator SSB—For Those Who Really Know

A rig that's real quality! Has 15 watts PEP, 5 watts AM. Crystal lattice filter on SSB, mechanical ceramic filter on AM. 80 dB adjacent channel selectivity at 10kHz., noise blanker, S/RF/power meter. PA-CB switch, more. 10 1/2 x 2 3/4 x 11 1/2". For 12 VDC. **CB-315J.** Shpg. wt. 12 lbs. **399.95**



499⁹⁵

Centurion SSB—When Being On Isn't Enough

Offers superior 23-channel performance with digital clock and alarm, mechanical AM ceramic filter, crystal filter on SSB. Adjacent channel selectivity 80 dB at 10KHz. 15 watts PEP, 5 watts AM. With noise blanker, PA-CB switch, and much more. 13 1/4 x 4 3/4 x 12". 117 VAC/12 VDC. **CB-314J.** Shpg. wt. 22 lbs. **499.95**



\$115

ML-100 Mobile Linear

Use with SSB, and FM transmitters. 100 watts input, 25-50 MHz. FCC type accepted parts 89,91,93. 6 1/2 x 2 1/2 x 8 1/2". 12 VDC. **CB-319J.** Shpg. wt. 14 lbs. **115.00**
BL-100 Base Linear. W/meter. 7 1/2 x 5 x 7 1/4". For 117 VAC. **CB-320J.** Shpg. wt. 7 lbs. **130.00**



184⁹⁵

The "Comet" 23 Channel

Work out on all 23 CB channels with this powerful, yet very quiet rig. Features include plug in mike, PA-CB switch, S/RF meter, noise limiter, final output safety circuit. Aux. speaker jack, 12 VDC positive or negative ground power supply 7 x 2 3/4 x 9 1/2". **CB-316J.** Shpg. wt. 7 lbs. **184.95**



Tradesman Transceiver

5-channel transceiver ready-to-use on Business Band 27. 265 and 27.275 MHz. 5 1/4 x 1 3/4 x 6 1/4". 12 VDC. **CB-318J.** Shpg. wt. 6 lbs. **135.00**



149⁹⁵

CB Traveller II

Ultra-compact 23-channel! Plug in mike, S/RF meter, automatic noise limiter, PA-CB switch. Final output safety circuit. 12 VDC pos. or neg. grd. 5 1/4 x 1 1/4 x 6 1/4". **CB-317J.** Shpg. wt. 5 lbs. **149.95**



CB Radios for Mobile and Base Station Use

Use CB 2-way radio communications for business or personal use—it's the fast, easy way to keep in touch.

Talk from home to car or boat, from office to vehicle or between vehicles. No special skills are required to use it!



1 \$229

Use Your Credit Card

1 23-Channel CB Base Station

- RF Gain Switch For Precise Transmitting
- High-Sensitivity Dual Conversion Receiver

Model "T". This is the base station designed to make you Number 1 on the air. Features include an S/RF lighted meter that shows incoming signal strength, plus percentage of modulation during transmission. Has volume/on-off switch, variable squelch for silent standby, and a fine tuning control for bringing in off-frequency stations. RF gain switch for increased percentage of modulation while transmitting. Has a large built-in up-front speaker for clear sound, desk-top heavy duty microphone with stand and coiled cord. Sensitivity, $0.3 \mu\text{V}$ for 10 dB S + N/N. Includes all crystals, power cables. $12 \times 5 \times 8\frac{1}{4}$ ". For 117 VAC. CB-350J. Shpg. wt. 15 lbs. 229.00



2 \$329

2 SSB/AM Base or Mobile 2-Way CB Radio

- Transmits/Receives On All 23 AM Channels And All 46 Single Sideband Channels

Professional Twin "T". Compatible with all AM-only CB sets. FET front end and IC circuitry insure fine sensitivity and selectivity. Upper/lower sideband selectable on SSB. Clarifier circuit. Includes RF gain control, noise blanker, PA facilities, more. 15-watt PEP on SSB, 5-watts on AM. $0.5 \mu\text{V}$ @ 6 dB AM Sensitivity. $0.5 \mu\text{V}$ @ 6 dB SSB. Push-to-talk mike, coiled cord included. $13 \times 5\frac{1}{2} \times 9\frac{1}{2}$ ". For 117 VAC or 12 VDC pos. or neg. ground. With all crystals. CB-234J. Shpg. wt. 20 lbs. 329.00



3 \$129

3 Top Performance 23-Channel Mobile CB Radio

- Transmits/Receives On All 23 AM Channels

TB 73. Gets your signal out in style! Lightweight and compact but doesn't sacrifice features or performance in giving you 23 fully synthesized crystal-controlled channels. Includes dual conversion receiver, tuned RF and AGC. Has IC circuitry, Automatic Noise Limiter, and variable squelch. Sensitivity, $1 \mu\text{V}$ for 10 dB S + N/N. All crystals, push-to-talk mike and coiled cord included. $5\frac{1}{16} \times 2\frac{1}{4} \times 9\frac{1}{2}$ ". For 12 VDC neg. ground. CB-352J. Shpg. wt. 6 lbs. 129.00

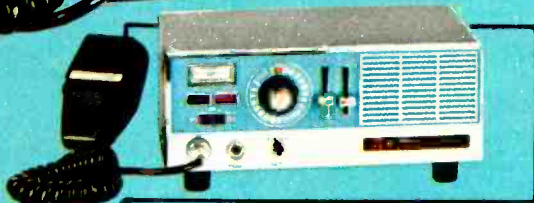

4 \$179

4 23-Channel Base/Mobile 2-Way CB Radio

- Built-In AC/12 VDC Power Supplies

Big "T". Features dual conversion receiver, mechanical IF filter, FET front end, ANL, TVI filter. Has modulation/transmit lights, S/RF meter, mike and headphone jacks. 3.2 watt output. Sensitivity, $3 \mu\text{V}$ for 10 dB S + N/N. With all crystals, mike, coiled cord, mtg. bracket, cables. $9\frac{1}{2} \times 3\frac{3}{4} \times 8$ ". 117 VAC or 12 VDC pos. neg. grd. CB-210J. Shpg. wt. 15 lbs. 179.00



5 \$169

5 Compact 23-Channel Mobile CB Transceiver

- Built-In TVI Filter That Really Works

"Five-by-Five". Transmits and receives on all 23 Channels. One of the most dependable mobile CB units around. Contains the latest FET's and IC circuitry for reliable service. $0.3 \mu\text{V}$ for 10 dB Sensitivity S + N/N. With ANL, mtg. bracket, push-to-talk mike, 12 VDC power cord. $7 \times 2\frac{1}{2} \times 9$ ". 12 VDC pos. or neg. ground. CB-351J. Shpg. wt. 6 lbs. 169.00



6 \$79

6 Compact 6-Channel 2-Way CB Mobile

- Silicon Transistor Circuitry Assures Stable Operation

Mini "T" II. Its 5 watts power is enough to compete with the biggest mobile transceivers. Has Channel 9 crystal for "HELP" calls, RF Stage, illuminated "S" meter, transmit/receive indicator lights. Sensitivity, $2 \mu\text{V}$ for 10 dB S + N/N. 12 VDC power cord, mtg. bracket, mike hanger. $4\frac{3}{4} \times 1\frac{3}{8} \times 6\frac{1}{2}$ ". For 12 VDC neg. ground. CB-237J. Shpg. wt. 3 lbs. 79.00

hy-gain Base And Mobile Antennas, Amplifiers

The "Long John" 24' Boom

\$65

Model 410. Here's REAL quality in a beam antenna. Scientifically spaced elements for maximum power gain. More energy transfer than all others. 12.3 dB power gain with 31 dB F/B ratio. VSWR at resonance is 1.05:1. Feedpoint is 52 ohm match. Heavy duty aluminum with taper swaged elements and Mil. Spec. plated hardware. Longest element is 21', heavy duty mast bracket handles from 1 1/4" to 2 1/2" masts. Wind survival, 90 mph. AA-748J. Wt. 24 lbs. 65.00

Shipped REA Express Only

17' Boom—5 Element Beam

\$43⁵⁰

Model 411. Good value — with close spaced elements for 10 dB power gain. Perfectly matched 52 ohms with Beta Match for most efficient energy transfer. Gives you 22 dB F/B ratio. VSWR at resonance is 1.5:1. Longest element is 21', mounts on 1 1/2" diameter mast. AA-749J. Wt. 13 lbs. 43.50

Shipped REA Express Only

3-Element Rotatable Beam

Model 533. A reasonably priced yet top performing 3-element beam for limited space installations. Has 8.2 dB gain with 20 dB F/B ratio. VSWR at resonance 1.05:1. Longest element is 21' with 8' boom. Mounts on 1 1/4" to 1 1/2" O.D. masts. AA-750J. Wt. 6 1/2 lbs. 39.95

\$39⁹⁵

Shipped REA Express Only

Hellcat CB Antennas For Mobile Installations

- 1 **Hellcat 1 Roof-Top Antenna.** 17-7PH stainless steel whip and spring. Low profile; 54" high. Pre-tuned. 52 ohms. With 18' coax and connector. AA-638J. Shpg. wt. 3 lbs. 18.50
- 2 **Hellcat 4 Trunk Lip Mount Antenna.** Installs with 2 set screws (no holes req.). 17-7PH stainless steel whip. 54" high. 52 ohms. 20' coax and connector. AA-747J. Shpg. wt. 3 1/4 lbs. 22.95
- 3 **Hellcat 3 Magnet Mount Antenna.** Alnico magnet base mount—no holes to drill, no tools needed. 17-7PH stainless steel whip. 35" high. 52 ohms. 16' coax. AA-690J. Shpg. wt. 2 1/4 lbs. 19.95

\$18⁵⁰

\$22⁹⁵

\$19⁹⁵

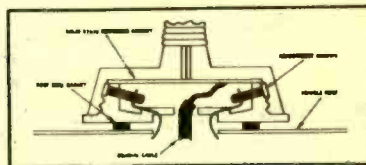

Colinear Base Antennas

- 4 **"The Penetrator Super CLR."** Full (22'9 1/2") radiator. 1500 watts in 30-50 MHz band. Double-matching-tuning and linear phasing for low SWR. 4 radials. 52 ohms. AA-693J. Shpg. wt. 9 lbs. 39.95
- 5 **"The Goldenrod."** Vertically polarized and omnidirectional. 3.8 dB gain. 1/2 wave radiator; short arcuate radials. Gold iridite treated. 212" H. 52 ohms. AA-692J. Shpg. wt. 5 1/2 lbs. 22.95
- 6 **Model CLR2.** Top hat static arrester, 5/8 wave radiator. 4 dB gain on CB band. Seamless alum. radiator, 9' radials. Matching transformer. 19' 10"H. 50 ohms. AA-691J. Shpg. wt. 7 1/2 lbs. 32.95

\$39⁹⁵

\$22⁹⁵

\$32⁹⁵

More "Talk Power" to You!

\$145



"Footwarmer" 300-W Base Linear Amp

\$269⁹⁵

Model 644. Has grid driven, neutralized and stabilized tuned plate circuitry for AM, FM, CW and SSB signals. Positive control over tube destruction during tune up, drive control produces correct levels during operation. 14 x 5 9/16 x 11 1/2". For 117 VAC. DX-065J. Shpg. wt. 15 lbs. 269.95

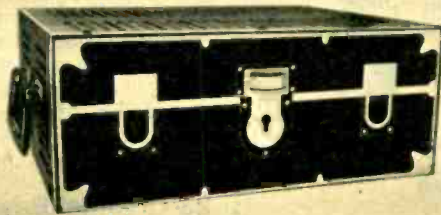

"Footlocker" 300-W Mobile Linear Amp

\$279⁹⁵

Model 640. Has grid driven, neutralized and stabilized tuned plate circuitry for AM, FM, CW, SSB signals. Positive control over tube destruction during tune-up, drive control produces correct levels during operation. 14 x 5 9/16 x 11 1/2". 12 VDC neg. grd. DX-066J. Shpg. wt. 10 lbs. 279.95



Base/Mobile Linear Amplifiers

Model 482 Base Amplifier. 160 W input; 100 W SSB/DSB output. 25-40 MHz. Transistor keying. -65 dB spurious/harmonic. 117 VAC. DX-037J. Shpg. wt. 14 lbs. 145.00

Model 483 Mobile Amplifier. 12 VDC. DX-038J. Shpg. wt. 10 lbs. 165.00

Model 407. Remote Switch for 483. DX-040J. Shpg. wt. 1 1/4 lbs. 9.95

(((P))) Base and Mobile CB Two-Way Radios

PACE

CB Communication is increasingly important as more people take to the road. If you're CB equipped and you run into trouble—accident, bad weather, stallout, etc.—help is as near as your dash. At home too—it's easy to use as a phone.



1
69⁹⁵



1 3-Channel Emergency Two-Way Radio

Model CB10-2. A "must" for travelers! Ready-to-use on CB channel 9 (Highway Emergency Locating Plan), with provision for two other CB channels. Small enough to fit in glove box, under seat, etc.—stays out of the way 'til you need it. Has 5-watt transmitter, plug-in dynamic mike, superhet receiver, squelch. 1 7/8" x 4 3/4" x 6". For 12 VDC negative ground. With mounting bracket, all hardware.

CB-332J. Shpg. wt. 3 lbs. **69.95**

CB-214J. Model 100-SA. 5-Channel Version of above. With crystals for channels 9, 11, 12, 13, 14. 4 3/4" x 1 3/4" x 6". 4 lbs. **109.95**

CB-290J. AC Power Supply. For either model above. 6 lbs. **34.95**

CB-238J. Battery Pack/Antenna. For units above. 3 lbs. **18.95**



2
119⁹⁵

2 Low-Priced 23-Channel Mobile Model

Model 223. Pace's lowest-priced 23-channel model! Has dual-conversion receiver with 6-section tuned filter network, 5-watt transmitter with "Pace plus" modulation for real talk-power. Squelch control, ceramic push-to-talk mike. With ALL crystals, mobile mounting bracket. 6 3/4" x 2 1/2" x 8 1/2". For 12 VDC neg. grd.

CB-223J. Shpg wt. 6 lbs. **119.95**

CB-290J. AC Power Supply. Wt. 6 lbs. **34.95**



3
149⁹⁵

3 Mobile 23-Channel with Dual Conversion

Model 123. Top performance, low price! Frequency synthesis circuit for 23-channel crystal control, 5-watt transmitter, squelch control, PA provision. Local/distance switch assures best range, city or country. Combined RF output/"S" meter, 0.4 μ v sensitivity at 10 DB S+N/N ratio, transmit and receive lights. With all crystals, mtg. bracket. 7 x 2 x 6 1/2". 12 VDC neg. grd.

CB-221J. Shpg. wt. 5 lbs. **149.95**

CB-202J. Model 2376A. Deluxe version of above. 6-section tuned filter, silicon output transistor. 6 3/4" x 2 1/2" x 8 1/2". 6 lbs. **169.95**

CB-290J. AC Power Supply. Wt. 6 lbs. **34.95**



4
199⁹⁵

4 Full-Feature 23-Channel Mobile Model

Model 2300. Loaded with the features you NEED for ultra-reliable long-range CB communications. 5-watt transmitter, dual-conversion receiver with 0.5 μ v sensitivity at 6 dB S+N/N. "S" meter, PA output, squelch control. Has connector for tone calling or SSB accessories, provision for direct connection of Pace CB monitor, deluxe 6-section tuned filter. Silicon transistor circuit. With all crystals, positive lock mobile mount. 6 3/4" x 2 1/2" x 8 1/2", 12 VDC neg. grd.

CB-080J. Shpg. wt. 5 lbs. **199.95**

CB-290J. AC Power Supply. Wt. 6 lbs. **34.95**



5
189⁹⁵

5 23-Channel Base with Tuned Filters

Model CB-76. Ready-to-operate on all 23 CB channels! Special PACE Class A extra modulation boost on transmit plus super-sensitive dual conversion receiver assure extra range. Has volume and squelch controls, lighted channel indicator, "S" meter, local/distance switch. Full 5-watt transmitter input, 2.5 watt audio output. Special TVI shielding circuit, series-gate noise limiter. With all crystals, high level ceramic mike. 12 x 3 1/2" x 8 1/4". For 117 VAC.

CB-331J. Shpg. wt. 11 lbs. **189.95**

CB-173J. Model DX-2300B. Deluxe version of above, with Delta-tune circuit, CB-9 monitor connector, on-the-air light. Sensitivity:

0.35 μ v for 10 dB S+N/N. 12 x 3 3/4" x 8 1/4". 15 lbs. **239.95**





PACE VHF and UHF Scanning Monitors

These monitors help you stay on top of local events. They're practical—avoid unnecessary traffic tie-ups, listen to continuous Weather broadcasts, etc. They're interesting—hear your local police and firemen in action—they're FUN—tune in on all the "action."

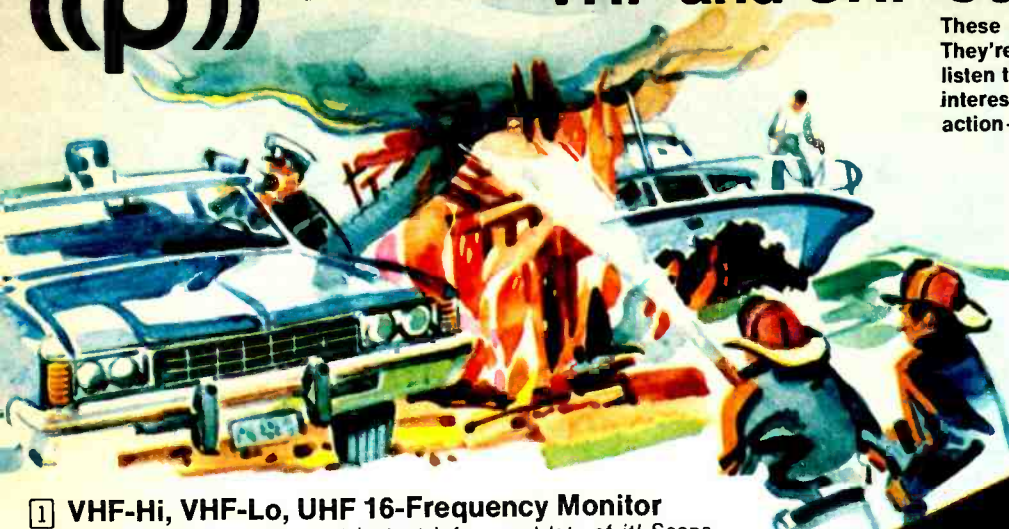

1 VHF-Hi, VHF-Lo, UHF 16-Frequency Monitor
Scan 308. For those who want instant info—and lots of it! Scans up to 16 frequencies in any combination of public service bands using 8 "channel-lockout" controls and alternate band switches on rear panel. Covers 25-50 MHz low VHF band, 140-174 MHz high VHF band, and 450-470 MHz UHF band (see note below). Squelch control holds on active channel, channel lockout buttons bypass unneeded channels, manual switch lets you stop scan and stay tuned on a single channel. Scan rate: 20 channels per second. Has solid-state circuit with IC's and FET's, AFC for UHF, sockets for up to 16 crystals. Sensitivity: 0.5 μ V for 20 dB quieting. With VHF-UHF telescoping antennas, power supplies for 12 VDC and 117 VAC, under-dash lock-mount bracket, desk mount adapter. 6 x 2½ x 8".
RA-759J. Shpg. wt. 6 lbs. **199.95**

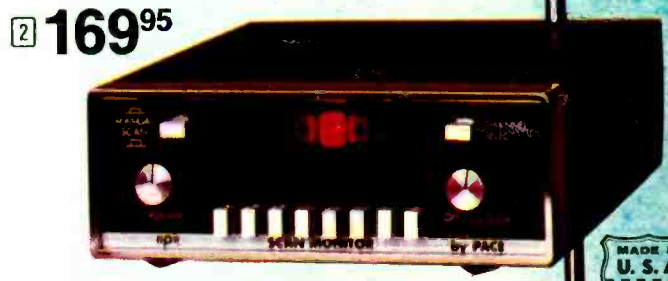

1 High VHF, UHF 16-Frequency Monitor
Scan 216. Keeps an "electronic eye" out for dramatic police and fire calls. Has 16 crystal sockets, scans any combination of 8 frequencies. Covers 140-174 MHz high, 450-470 MHz UHF (see note below). Other features same as Scan 308. 6 x 2½ x 8".
RA-971J. Shpg. wt. 6 lbs. **179.95**

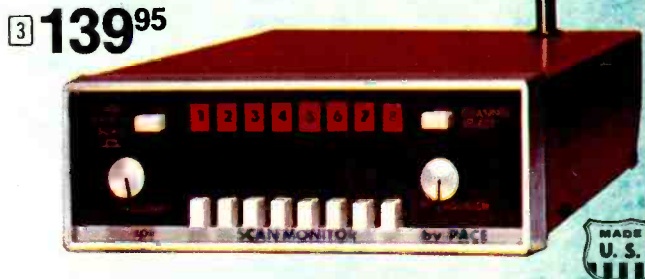

2 High VHF, Low VHF 8-Frequency Monitor
Scan 208. For top performance where no UHF monitoring is required. Has sockets for 8 crystals—automatically scans any combination of VHF high and VHF low bands. Circuit features same as 1 above, has single VHF telescoping antenna. Covers 25-50 MHz VHF low, 140-174 MHz VHF high. (See note below). 6 x 2½ x 8".
RA-758J. Shpg. wt. 4½ lbs. **169.95**

3 Single-Band Scanning Monitors
Same circuit features of units above, but for one band only.
RA-755J. Scan 108L. 25-50 MHz low VHF. 6 lbs. **139.95**
RA-756J. Scan 108H. 140-174 MHz high VHF. 6 lbs. **139.95**
RA-757J. Scan 108U. 450-470 MHz UHF. 6 lbs. **139.95**
CB-205J. Crystal Certificate. Use with above monitors. Order one for each frequency desired. See page 217. **4.95**

Note: These Scanning Monitors are factory-tuned to the most-frequently used portions of their respective bands. Thus, 450-470 MHz UHF models are tuned to 454-466 MHz, 30-50 MHz VHF models are tuned to 37-47 MHz, and 140-174 MHz models are tuned to 151-163 MHz. Check frequencies in the area you wish to monitor, and specify if different frequency coverage is needed.

4 "Side-Talk 23" Mobile AM/SSB CB Transceiver
Pace's best! Meets the most demanding CB requirements. Delivers 15 watts PEP on single sideband, with high-level modulation to really push your signal through. Clarifier control for easy net operation. Lattice filter with temperature compensation circuitry. Ready to use on 23 AM channels, 23 upper or lower single sideband channels. Sensitivity: AM, .5 μ V; SSB, .3 μ V for 10 dB S+N/N. With push-to-talk mike, mounting bracket, power cord. 8½ x 2½ x 10½". For 12 VDC negative ground.
CB-224J. Shpg. wt. 8 lbs. **359.95**



5 Channel-9 Monitor Receiver
Model CB-9. Has channel-9 crystal installed, provision for additional channel. Use alone, or with existing CB unit.
CB-216J. Shpg. wt. 4 lbs. **49.95**
CB-215J. Adapter. Connects CB-9 to transceiver antenna **8.95**

These Monitors keep you in tune to important local police and fire channels, lets you hear business, Weather, other services. They're fun to listen to, practical too—advance warning in an emergency could prevent tragedy.



1



2

1 129⁹⁵ Pocket-Size 4-Channel High-Band VHF

Model 13-906. Put the news in your pocket with this super-compact 4-band monitor. Covers 150-174 MHz, lets you in on local police, business, even 24-hour U.S. Gov't Weathercasts on 162.55 MHz. Scans 4 channels at a rate of 8 channels per second. Has volume and squelch controls, built-in antenna, automatic or manual scanning modes, dual-conversion superhet receiver for excellent selectivity even in crowded areas. Sensitivity, 0.5 μ V for 20 dB queting. LED indicator lights. Only 3 x 6 $\frac{1}{2}$ x $\frac{7}{8}$ ". Requires 9-volt battery. **RA-978J.** Shpg. wt. 1 lb. **129.95**

2 99⁹⁵ Mobile/Portable 4-Channel VHF High-Band

Model 13-912. Scans any four channels in the 152-174 MHz range—has dual-conversion receiver, squelch, scan indicator lights. Moves through four-channels in 1 $\frac{1}{2}$ seconds—no chance for missed calls. Has priority channel, bypass, automatic or manual scan switches. Sensitivity: 0.5 μ V for 20 dB S+N/N. Very compact—6 $\frac{1}{8}$ x 1 $\frac{1}{2}$ x 7 $\frac{1}{8}$ "—mounts easily in any 12 VDC car, boat or truck. **RA-705J.** Shpg. wt. 3 lbs. **99.95**
RA-972J. Model 13-914. Above, 452.5-467.5 MHz UHF. 3 lbs. **119.95**
CA-513J. Portable Carrying Case. With 8 batteries. 2 lbs. **14.95**

3 8-Channel VHF-High/VHF-Low Band

Model 13-930. Offers complete VHF coverage in a single unit that's "at home" at home or on the road. Programmable "rangematic" circuit lets you monitor any 8 VHF frequencies in any combination—all high, all low, or mixed. Has electronic tuning circuit, ceramic filters for excellent sensitivity (0.5 μ V for 10 dB S+N/N), individual channel lock-out buttons, program indicator lights. Adjustable scan rate (8 to 24 channels per second), automatic or manual channel selection, telescoping antenna. Covers 144-173 and 30-50 MHz. 117 VAC/12 VDC power supplies. 6 x 2 $\frac{1}{4}$ x 9 $\frac{1}{4}$ ". **RA-973J.** Shpg. wt. 4 $\frac{1}{2}$ lbs. **179.95**
RA-974J. Model 13-934. Above, VHF-High/UHF. 4 $\frac{1}{2}$ lbs. **179.95**

4 Deluxe 8-Channel VHF High/VHF Low Band

Model 13-940. Sleek, functional styling and top performance make this an excellent choice for a dual band scanner. Has two integrated circuits for high reliability, automatic or manual channel scanning, "rangematic" feature for combination high-band/low-band scanning. Automatic electronic tuning circuit, individual channel lock-out buttons, adjustable scanning rate (8 to 24 channels per second). Sensitivity: 0.5 μ V for 10 dB S+N/N. Combination 117 VAC and 12 VDC power supplies. Telescoping antenna. 8 $\frac{1}{2}$ x 3 $\frac{3}{4}$ x 9 $\frac{1}{4}$ ". **RA-975J.** 30-50 MHz and 144-173 MHz. Shpg. wt. 5 $\frac{1}{4}$ lbs. **199.95**
RA-976J. Model 13-944. Above, 144-173 and 450-470 MHz. VHF High/UHF bands. 5 $\frac{1}{4}$ lbs. **199.95**

5 Midland's Best! 16 Channels—All 3 Bands

Model 13-950. A "pro"-quality unit that's perfect for police and fire stations, news rooms, anywhere complete coverage of local emergency services is needed! Scan any combination of 16 channels in all 3 bands—8 UHF, plus a mix of high and low VHF. Scan rate adjustable from 8 to 24 channels per second. Special "memory" circuit locks in low-level signals for $\frac{1}{2}$ -2 seconds—you won't miss calls even on weak channels. Has exclusive "Mona-meter" signal-strength meter, automatic electronic tuning, individual channel lockout buttons and indicator lights. Variable squelch control, two telescoping antennas, combination 117 VAC/12 VDC power supplies. Sensitivity: 0.5 μ V for 10 dB S+N/N. Covers 450-470 MHz UHF, 30-50 and 152-174 MHz. VHF. 10 x 3 $\frac{3}{4}$ x 9 $\frac{1}{4}$ ". **RA-977J.** Shpg. wt. 6 $\frac{1}{2}$ lbs. **249.95**
CB-205J. Crystal Certificate. For all monitors on this page. Order one for each frequency desired. See page 217. **4.95**



179⁹⁵

3

199⁹⁵

4

249⁹⁵

5

Electra Listen to Police and Firemen in Action



"Jolly Roger" AM/Monitor Radio

Model JR-1H. Here's a take-along entertainer that brings you the "hard news" too—hear dramatic police and fire action AS IT happens! Has provision for crystal-controlled monitoring of two channels in the 152-174 MHz VHF band, plus regular AM radio. Operates as a 2-channel scanner with automatic switching to AM, channel A or channel B only, AM broadcast with automatic police override. Has volume and tuning controls, squelch circuit, telescoping antenna, earphone jack, big 3½" speaker. 6 x 8 x 3½". Includes AC power supply, earphone. Order 4 "D" batteries, crystal certificate below.

RA-980J. Shpg. wt. 6 lbs. 79.95
 RA-981J. Above, 450-470 MHz UHF 79.95
 BA-189J. Batteries. Wt. ¼ lb. . . Each 18c



Bearcat III UHF/VHF Monitor

Model BC3-H/U. The most advanced version of the *original* scanning monitor! Scans 8 channels in any combination of 146-174 MHz high-VHF and 450-470 MHz UHF Bands. Has quartz crystal IF filters, LED channel indicators, big 3 x 5" front-facing speaker, channel lockout buttons, volume and squelch controls, auto/manual scan switch. Scan rate: 25 channels per second. All-band telescoping antenna increases sensitivity. With universal mobile mounting bracket, 117 VAC and 12 VDC neg. grd. power cords. 9 x 3½ x 6½".

RA-979J. Shpg. wt. 8 lbs. 169.95

79⁹⁵

169⁹⁵

VHF Converters and Antennas from Antenna Specialists



Ascom CB-to-Monitor Converters

Doubles the usefulness of your present CB rig! These two-channel "translators" hook up to your CB unit and provide crystal-controlled monitoring of two channels in your choice of bands. Works through channel 9—does not interfere with normal CB operation when off. Includes mobile mounting bracket, cable to CB unit. 4 x 1½ x 4¼". Shpg. wt. 1½ lbs. Order crystal certificates below.

CB-335J. Mon-40. 30-50 MHz VHF 39.95
 CB-336J. Mon-41. 152-174 MHz VHF 39.95
 CB-337J. Mon-42. 450-470 MHz UHF 44.95



low as 39⁹⁵

Antennas for Improved Monitor Performance

Hear more calls more clearly with these easy to install base and mobile monitor antennas. All are designed for increased signal power on all monitor bands: 30-50 and 152-174 MHz VHF—450-470 MHz UHF.

- 1 Mon-32 "Quick-Grip" Trunk Mount. Attaches to trunk lip with NO drilling. Has stainless steel whip with weatherproof phasing coil, low profile base. 21" high. With 17' cable, connector. AA-722J. Shpg. wt. 4 lbs. 18.95
- 2 AA-723J. MON-33. Above, for roof, trunk deck mounting. Req. ¾" hole. 3 lbs. 18.95
- 3 MON-31 Base. For up to 1½" diameter masts. 18" radials. AA-721J. Shpg. wt. 6 lbs. 21.95
- 4 MON-50 with Preamp. Provides minimum 13 dB gain on all bands. Built-in antenna, receiver leads. For 117 VAC. AA-724J. Shpg. wt. 10 lbs. 49.95

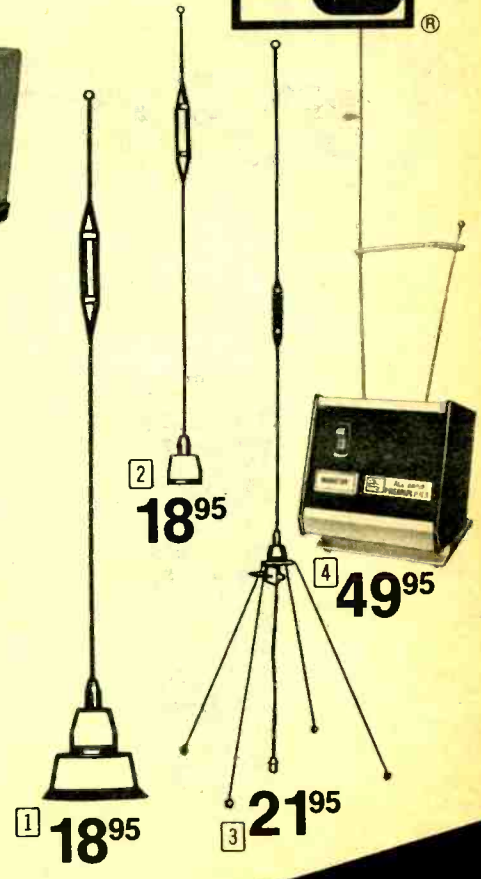

Olson
Crystal
Certificate

495

For all popular monitors. Fill out card and send to mfr., he then sends you a crystal. Order one for each frequency desired. Allow 30 days.

CB-205J. ... Each 4.95

TENNELEC Automatic Scanning Monitors

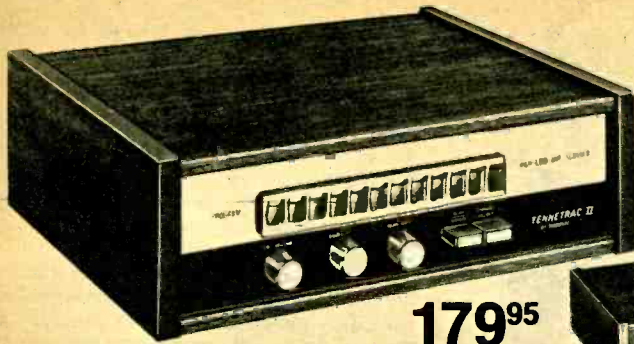

179⁹⁵

12-Channel High/Low VHF and UHF

Tennetrac II. Covers all the action... automatically... and you can program it for ANY combination of VHF high or low or UHF bands! Has 3-second scan delay, adjustable scan rate from 12-40 channels per second, lighted pushbutton switches that let you "by-pass" any channel in the scan. Factory aligned for 33-50 MHz low VHF, 151-163 MHz high VHF, 450-462 MHz UHF. 12 x 3 3/8 x 8 1/2". 117 VAC/12V. RA-102J. Shpg. wt. 6 lbs. **179.95**

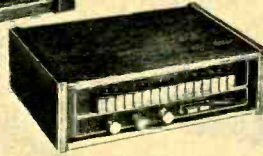

199⁹⁵

Deluxe Version of Above

Tennetrac III. Has all the features of above, covers 16 channels in three bands. RA-105J. Shpg. wt. 6 lbs. **199.95**

16-Channel 3-Band with Local/Distance Switch

Tennetrac IV. Totally programmable "news-action center" keeps you informed on local law enforcement, fire, business, weather, mobile phones, etc. Scans ANY combination of any channels in the 33-50 MHz VHF-low, 151-163 MHz VHF-high, or 450-462 MHz UHF public service and information bands. Has scan speed control, program pushbuttons for each channel, back-lighted channel display. Local/distance switch increases sensitivity for distant station reception, tone control clears up distorted voice transmissions. Overall sensitivity: .6 μ V for 20 dB quieting. Has volume and squelch controls, separate power on-off button, scan delay switch. Fine furniture walnut wood cabinet, 15 x 4 1/4 x 9". 117 VAC.

RA-101J. Shpg. wt. 8 lbs. **219.95**



219⁹⁵



249⁹⁵

12-Channel 3-Band Monitor with FM Radio

Tennetrac V. Superb "reception instrument" is more than a scanner, more than a radio—it's BOTH! Automatically scans high/low VHF and UHF bands, plus brings you your favorite music on the 88-108 MHz FM radio band. Has selector switch for Scanner only, FM only, FM broadcast with scanner override. Separate volume controls for scanner and FM radio, back-lighted scanner channel display, "black-out" front panel. Features ceramic filters in both FM and scanner circuits, push-buttons for each scan channel, scan speed control, scan delay. Excellent overall sensitivity. External speaker and antenna terminals. Furniture-style walnut finish wood cabinet, 15 x 4 1/4 x 9". 117 VAC.

RA-106J. Shpg. wt. 10 lbs. **249.95**

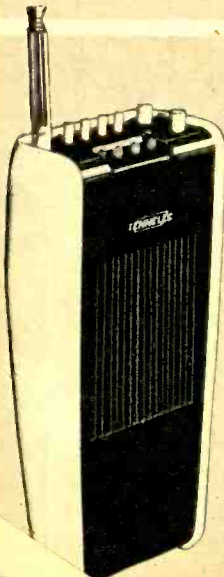

119⁹⁵

Portable, Hand-Held or Table Top 4-Channel Monitors

Keep up with the action, even if you're away from home or your car with one of these solid-state 4-channel portable scanning monitors. Features program switches for each channel, LED (light emitting diode) indicators, built-in 2-second scan delay. Has dual-conversion receiver circuit, ceramic filters to eliminate interference, earphone and external speaker jacks, squelch and volume control, telescoping antenna. Scan rate: 25 channels per second. Uses six "AA" pen-light batteries. 7 1/2 x 3 3/4 x 2".

Model TN-150. Covers 151-163 MHz VHF high band. 0.7 μ V sensitivity.

RA-104J. Shpg. wt. 2 lbs. **119.95**

Model TN-450. Covers 452-462 MHz UHF band. 1.0 μ V sensitivity.

RA-103J. Shpg. wt. 2 lbs. **119.95**

AC Adapter. For either model above. BA-236J. Shpg. wt. 2 lbs. **24.95**

Monitor Accessories

Remote Terminal. Operate scan, channel select functions on monitors above from a remote location. Includes built-in speaker, muting control, necessary cable.

RA-114J. Shpg. wt. 6 lbs. **24.95**

12 VDC Mobile Power Cord. Car lighter socket cord for Tennetracs II and III above.

WR-151J. Shpg. wt. 1 lb. **2.95**



Monitor Crystal Certificate

4⁹⁵

Lets you order single crystal, shipped direct from mfr. Use one for each frequency needed.

CB-205J. Each **4.95**

Put Excitement in Your Pocket with . . . **hy-gain**

4-Frequency Pocket Scanning Monitor



- 2½ x 5½ x 1¼" — **Smallest Around**
- **Professional Features and Specs**
- **Automatic or Manual Scan**
- **Channel 1 Lock-Out Button**
- **Built-In Telescoping Antenna**
- **External Antenna Provision**
- **Weighs Just 9½ Ounces**



Check with Local Authorities for Frequencies Used in Your Area



149⁹⁵

**Instant-Info—
Pocket
Sized!**



The smallest full-feature scanners available! Ideal for police, detectives, volunteer firemen, anyone who wants to know what's happenin' in his local area. Scans 4 crystal-controlled channels of your choice—features dual conversion receiver with 0.5 μ V sensitivity for 20 dB quieting, selectivity of 60 dB at 20 kHz, more than 60 dB adjacent channel rejection. Uses standard AA or rechargeable batteries.

RA-082J. Model 626. Covers 450-470 MHz UHF. Shpg. wt. 1 lb. **149.95**
RA-081J. Model 625. Covers 150-170 MHz VHF. Shpg. wt. 1 lb. **149.95**

Useful Accessories for Above Scanners

- CA-723J. Model 637 Leather Carrying Case.** Shpg. wt. 1 lb. **4.95**
- AA-744J. Model 744 Flexible VHF Antenna.** For 625. Shpg. wt. 1 lb. **6.00**
- AA-745J. Model 796 Flexible UHF Antenna.** For 626. Shpg. wt. 1 lb. **6.00**
- BA-232J. Model 636 Battery Eliminator/Charger.** 117 VAC. Shpg. wt. 1 lb. **14.95**
- PH-312J. Model 609 Earphone.** Shpg. wt. 1 lb. **3.95**
- AA-746J. Model 650 Antenna Adapter (SO-239).** Shpg. wt. 1 lb. **3.95**
- CB-205J. Crystal Certificate Card.** **Each 4.95**

hy-gain Monitor Radio Antennas

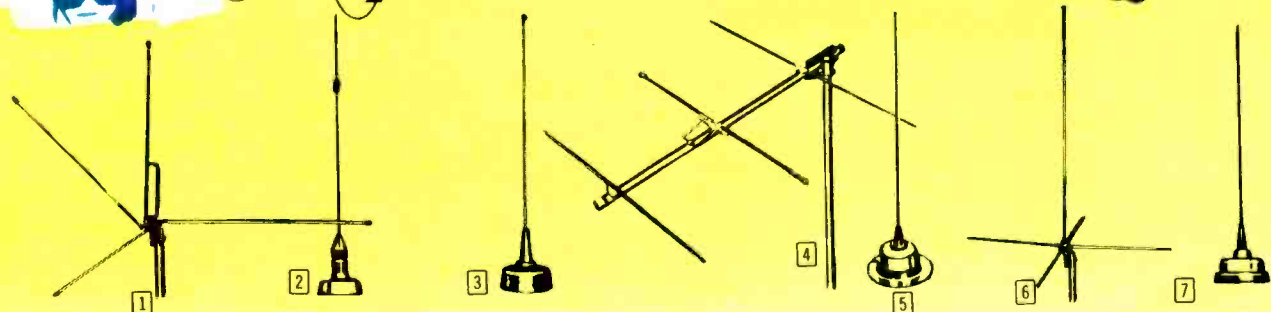

VHF High-Band (150-174 MHz)

- 1 Model 585.** Colinear base with 3 dB gain. Omnidirectional. Mounts on 1-1½" dia. **AA-675J.** Shpg. wt. 1¾ lbs. **15.95**
- 2 Model 594.** Roof-Mounted Mobile. Unity gain. With cable, connector, adapter. **AA-670J.** Shpg. wt. 1½ lbs. **8.95**
- 3 Model 581.** Trunk-Lip Mobile. No-hole mount. Unity gain, coax cable, connector. **AA-671J.** Shpg. wt. 1¾ lbs. **14.95**
- 3 Model 563.** Trunk-lip mobile. 3 dB gain. With coax cable and connector. **AA-673J.** Shpg. wt. 2 lbs. **22.95**
- 4 Model 584.** Advanced yagi design for fringe reception. For 1-1½" dia. **AA-674J.** Shpg. wt. 3¼ lbs. **15.95**
- 5 Model 578.** Magnetic Mount mobile. Unity gain. With coax cable, connector. **AA-672J.** Shpg. wt. 2¼ lbs. **16.95**
- 5 Model 562.** Magnetic mount mobile. 3 dB gain. With coax cable and connector. **AA-743J.** Shpg. wt. 2½ lbs. **26.95**

Model 583. (Not shown.) Receiver-mounted whip base antenna. With connector, adapter. **AA-676J.** Shpg. wt. 2 lbs. **1.98**

VHF Low-Band (25-50 MHz)

- 1 Model 589.** Omnidirectional base antenna for mounting on 1-1½" dia. base. **AA-684J.** Shpg. wt. 2½ lbs. **10.95**
- 3 Model 588.** No-hole, trunk-lip mobile. With coax cable, connector, adapter. **AA-683J.** Shpg. wt. 2½ lbs. **17.95**

UHF (450-470 MHz)

- 3 Model 550.** Trunk-lip mobile mount. 5 dB gain. With coax cable, connector, adapter. **AA-678J.** Shpg. wt. 2.1 lbs. **26.95**
- 4 Model 527.** Five-element yagi base. For fringe areas. 1-1½" dia. masts. **AA-681J.** Shpg. wt. 3½ lbs. **15.95**
- 5 Model 536.** Magnetic mount mobile. 5 dB gain. With cable, connector, adapter. **AA-677J.** Shpg. wt. 2½ lbs. **26.95**

6 Model 528. Ground plane omnidirectional. All hardware. For 1-1½" dia. masts. **AA-682J.** Shpg. wt. 1¾ lbs. **29.95**

7 Model 560. Trunk-lip mobile. 3 dB gain. With coax cable, connector, adapter. **AA-679J.** Shpg. wt. 1½ lbs. **15.95**

Model 526. (Not shown.) ¼-wave whip antenna mounts on receiver. With connector, adapter. **AA-680J.** Shpg. wt. 2 lbs. **1.98**

TRI-BAND (Lo-VHF, Hi-VHF, UHF)

- 3 Model 591.** Trunk-lip mount mobile. With coaxial cable, connector, adapter. **AA-648J.** Shpg. wt. 1½ lbs. **17.95**
- 6 Model 597.** Base antenna for outdoor use. Mounts on 1-1½" dia. masts. **AA-647J.** Shpg. wt. 3 lbs. **19.95**
- Model 595.** (Not shown.) Receiver-mounted base antenna. With connector, adapter. **AA-649J.** Shpg. wt. ¾ lbs. **10.95**
- Model 582.** (Not shown.) Antenna coupler. Use antenna for AM, FM and Monitor. **AA-646J.** Shpg. wt. 1.3 lbs.



39⁹⁵



AM/FM with Stereocast and Weather

Model RP-9420. A take-along you'll appreciate because it's AM, FM and FM stereo entertainment, plus instant weather at a touch of the button. Includes Sanyo's famous stereocast adapter which lets you listen to FM stereo broadcasts through headphones (also included), a pushbutton which tunes you into 24-hour U.S. Gov't Weathercasts on 162.55 MHz. Has accurate slide-rule tuning, 3 1/2" unicone speaker for wide-response sound, rugged case with carrying handle, top-mounted slide-type volume and tone controls, lighted tuning dial. Operates on AC or four penlight batteries. 9 1/2 x 5 3/4 x 2 1/4".

RA-714J. Shpg. wt. 4 lbs. 39.95

The FUN Radios



These Radios go where you go to bring you information and entertainment and make your outdoor scene more pleasant. They're ruggedly built to "take it" at beach, barbecue, picnic or poolside. Happy listening!



59⁹⁵

"Timetran Weathermatic" AM / FM

Model RP-8120. Brings you AM for news, weather and sports, FM for your favorite music (FM stereo with optional adapter, page 222), plus instant weather info on 162.55 MHz and instant time checks from U. S. Gov't station WWV. Has AFC for drift-free FM, easy-tuning slide-rule dial, hi-power amplifier and unicone speaker for good sound. Top-mounted slide-controls for volume and tone, telescoping antenna. 9 x 6 x 3 1/2". Plays on batteries or AC. RA-717J. Shpg. wt. 3 1/4 lbs. 59.95



69⁹⁵

"Trailmaster" AM / FM / SW Stereocast

Model RP-7220. A portable that's as practical and entertaining as all outdoors! Special direction finder switch—flip the switch and the tuning meter doubles as a "null meter", for navigation on land or at sea. Includes AM transmitter. Enjoy AM, FM (FM stereo with optional adapter, page 222), 4-12 MHz Shortwave for foreign broadcasts. Has 60-minute timer for automatic shut-off. Has 5 and 10 MHz markers. 9 1/2 x 5 1/2 x 2 1/2". For batteries or AC. RA-718J. Shpg. wt. 4 lbs. 69.95



79⁹⁵

AM / FM / TV Band Battery / AC Portable

Model RP-8220. Brings you standard FM (stereo with optional adapter, page 222), AM radio, plus the audio portion of all VHF TV channels. Perfect for listening in on specials when there's no TV around, late-night viewing without disturbing others. Has tuning / battery meter, switchable AFC, unicone speaker, earphone and recording jacks. Special "Memoriode" 0-60 minute timer—shuts radio off automatically at the time you select. Telescoping antenna, top-mounted slide-controls, more. 10 1/4 x 5 1/4 x 2 1/4". Batteries or AC. RA-719J. Shpg. wt. 4 lbs. 79.95

8.55
Oct 219

SANYO Portables You'll Love To Listen To

1
19⁹⁵



1 "Personal" Portable—"Easy-to-Take" Price

Model RP-5210. Easy on the pocketbook and easy on the ears, this AM and FM entertainer is small and light in weight, but has a BIG-set sound thanks to its advanced-design 2½" unicone speaker. Even has an output for adding the Sanyo stereocast adapter, page 222, so you can listen to FM stereo with headphones. Has slide-rule tuning for precise station selection, telescoping rod antenna for FM, built-in ferrite antenna for AM, handy carrying strap, and earphone. Requires 4 "AA" cells. 6 x 4 x 1¾".

RA-401J. Shpg. wt. 2 lbs. 19.95

2 Deluxe Personal FM-AM Portable

Model RP-5310. Take it along for easy FM-AM listening outdoors on batteries. Has jack for adding the stereocast adapter, page 222, big up-front 3¼" unicone speaker for wide-range sound. Easy-tune slide-rule dial, top-mounted slide-type controls for tone, volume and balance (when used for stereo). Has earphone jack, telescoping FM, built-in AM antennas, well-built case with carrying handle. Operates on 4 penlight cells. Has AC adapter jack 7¼ x 4¾ x 2¼".

RA-710J. Shpg. wt. 2 lbs. 24.95

3 "Geometric Tuning" FM-AM Portable

Model RP-5000. "Space-age" design geometric tuning gives you the most precise station selection we know of in a radio priced this low. Operates on four penlight batteries, even has a provision for an AC adapter, so you can use it as a table radio at home. Has output level indicator, jack for adding Sanyo's stereocast adapter (page 222) so you can hear stereo through headphones, volume and tone controls, telescoping FM antenna, more. Handy wrist strap. 7¼ x 3¾ x 2".

RA-711J. Shpg. wt. 2 lbs. 29.95

4 AM/FM/FM Stereo Portable

Model RP-9210. Listen to AM and FM monophonically through the built-in 2¼" wide-range unicone speaker, or plug in the stereocast adapter and headphones for full-fidelity FM stereo listening! *It's all included.* Has slide-rule dial with precise vernier tuning, slide-type volume, tone and balance controls, telescoping FM antenna that really pulls in stations, AM ferrite antenna. Rugged case with handy carrying strap—it's built to "take it"! Operates on 4 penlight batteries, has jack for AC adapter. 6 x 4 x 1¾".

RA-712J. Shpg. wt. 4 lbs. 29.95

5 AM/FM Portable with "Timetran" Pushbutton

Model RP-5350. It's a portable FM-AM radio, and an electronic time-keeper all in one! Simply push the "Timetran" button for instant, *officially accurate* time from U. S. Gov't station WWV. Has provision for adding the stereocast adapter, page 222, telescoping FM antenna, ferrite AM antenna, BIG sounding 3¼" unicone speaker. Operates on four penlight cells or AC so you can plug it in at home. Has precise slide-rule tuning, volume and tone controls, sturdy case with carrying handle. 7¾ x 5 x 2".

RA-713J. Shpg. wt. 4 lbs. 34.95

2
24⁹⁵



3
29⁹⁵

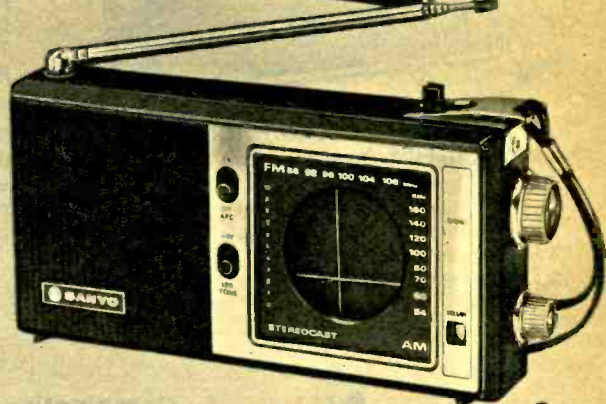

4
29⁹⁵



5
34⁹⁵



39⁹⁵



*Ideal
for
Teens and
Preteens!*

Combination Stereo Phonograph/PA System

Model SPT-1100. Good sound with solid-state dependability. Has 2-speed turntable (33½ & 45 rpm), separate channel volume controls, and mike-mixing that lets you *sing-along* or use as a PA system. With hinged dust cover, 45 rpm adapter. 16¼ x 5½ x 11". 117 VAC.

RA-057J. Shpg. wt. 11 lbs. 39.95



39⁹⁵

AM/FM Digital Clock Radio

- **FM Stereo Compatibility**

Model RM-5320. Attractive model that will wake you each day to an alarm or the FM or AM music, weather, any program of your choice. Get FM Stereo by simply adding on the stereocast adaptor (below). Has contemporary easy to read digital numerals, luminous clock face for time checks during the night. With tone control, earphone jack for complete privacy if desired. Big sounding 3½" top mounted speaker. 10¼ x 3½ x 7". 117 VAC. RA-721J. Shpg. wt. 5 lbs. 39.95



**Combination
Radio/Phonograph**

39⁹⁵

- **Built-In "Light Show"**
- **Globe Shaped 12" Diameter**

Model RPT-1200. Great "conversation-piece" phono for den, rec room, just about anywhere. The radio and phonograph combination is surrounded by a "see

through" spherical globe with a built-in *light show*—thanks to its Kinetic light projection. Appreciate the splendor of your favorite music even more because the light actually gives a visual interpretation of the musical beat. Has slide-type controls. 2-speeds (33½ & 45 rpm), sapphire stylus. 117 VAC.

RA-058J. Shpg. wt. 10 lbs. 39.95



47⁹⁵

FM/AM "Weathermatic" Digital Clock Radio

- **Can Be Adapted For FM Stereo**

Model RM-7320. Dramatically styled! Gives you the time of day plus news and AM/FM music (including FM Stereo with Adapter below). Brings you continuous U.S. Gov't. Weather Reports at the touch of a button too! Has wake-to-music or alarm, slide-type volume and tone control, earphone jack. With 0-60 minute automatic shutoff so you can lull yourself to sleep at night with your favorite late night listening. 10¼ x 3½ x 7". 117 VAC.

RA-722J. Shpg. wt. 5 lbs. 47.95

Stereocast Adapter

- **Built-In Headphones**
- **For all Sanyo Stereocast Radios**

Model RB-9000. Get Stereo in a low-cost portable! Comfortable, built-in, lightweight headphone. Just plug in the Stereocast Adapter—Amplifier into the special input jack on your Sanyo radio and you're ready for thrilling Stereo listening.

RA-059J. Shpg. wt. 1 lb. . . . 11.95



11⁹⁵

Deluxe Stereocast Adapter

- **Input for Stereo Headphones**
- **For all Sanyo Stereocast Radios**

Model RB-9090. Use your present stereo headphones with any Sanyo Stereocast radio for true Hi-Fi sound. This high-powered adapter is equipped to handle any 8-ohm headphone set, without special power or connections.

RA-725J. Shpg. wt. 1 lb. . . . 11.95



11⁹⁵

Oscon 221

SANYO Out-of-the Ordinary AM Portables

1 Solid State "Dice-Cube" AM Radio

• *Unique Design—Fine Sound*

Model RP-1711. Ideal for the office, den, recreation room, just to name a few. A perfect replica of a red Las Vegas die, in a 3" cube that's actually a solid-state AM radio. Vernier tuning "disc-dial" for quick station scanning and precise selection. Rotary volume/on-off switch. 2 1/4" speaker. Requires 2 penlite batteries. Includes earphone for private listening. See batteries page 103.

RA-709J. Shpg. wt. 1 lb. 11.95



1
11⁹⁵



2
11⁹⁵

2 "Bubble-Top" AM Radio

• *Looks Great Anywhere*

Model RP-1750. The design is so unique that you won't even know that it's a radio! But this inconspicuous compact has enough volume to make itself heard in any setting. Has vernier tuning, unicone speaker, and thumb-wheel controls. Requires 2 penlight batteries. 4 x 5 1/2 x 3 1/2". See batteries Page 103.

RA-054J. Shpg. wt. 2 lb. 11.95

3 AM Analog Clock Radio

• *Take Anywhere Because It's Battery Operated*

Model RM-1800. A very practical radio you can add to your travelling plans. Great for everyday use at home too. "Program" the Analog to wake you in the mornings. Has unicone speaker, volume control. Requires 3 penlight batteries. 5 3/4 x 6 1/2". See batteries Page 103.

RA-056J. Shpg. wt. 2 lbs. 29.95



3
29⁹⁵



4
19⁹⁵

4 AM Analog Radio

• *Contemporary and So Carryable*

Model RL-1600. A design so unusual it's the 'talk of the town' or wherever you take it. Great for picnics, partying, or just playing! Has convenient vernier tuning, disc dial, volume control, and unicone speaker. Requires 2 penlight batteries. 5 3/4 x 6 3/4 x 6 1/2". See batteries Page 103.

RA-055J. Shpg. wt. 2 lbs. 19.95

Electras Multi-Band, Multi-Powered Portable Radios

Radio Corporation

3
31⁹⁵



38⁹⁵



39⁹⁵



4
19⁹⁵

1 5-Band AC/DC

Model PB-707. Take it *anywhere* and keep up with almost *anything!* Listen to U.S. weather on 162.55 MHz, or 2 police bands (29-51 MHz, 145-175 MHz) PLUS AM/FM. Has accurate slide-rule tuning, squelch, AFC, built-in AM and telescopic FM antennas, earphone jack. 9 x 11 $\frac{1}{8}$ x 4 $\frac{3}{4}$ ". For four "C" cells, 117 VAC.

RA-062J. Shpg. wt. 3 $\frac{3}{4}$ lbs. **38.95**

2 Deluxe 4-Band AC/DC

Model PB-606. A truly informative radio! Besides enjoying your favorite AM and FM music, weather, etc., you can also listen to "ship talk" on the Marine Band and "shop-talk" on the International Short Wave Band. Includes built-in AM and telescoping FM antennas, AFC, squelch, earphone jack. For 4 "C" cells, 117 VAC. 9 x 11 $\frac{1}{8}$ x 4 $\frac{3}{4}$ ".

RA-061J. Shpg. wt. 3 $\frac{3}{4}$ lbs. **39.95**

3 Stylish 4-Band AC/DC

Model MB-401. Now you can *monitor the airways.* The official U.S. Weather Bureau reports will keep you abreast with the atmosphere on 162.55 MHz, hear AM and FM PLUS 152-174 MHz Police and Fire broadcasts. Built-in AM, telescopic FM antennas, AFC. With 3" speaker, earphone jack. For 4 "C" batteries, 117 VAC. 8 $\frac{5}{8}$ x 6 x 3 $\frac{1}{2}$ ".

RA-060J. Shpg. wt. 4 lbs. **31.95**

4 High Performance AM/FM

Model FM-90N. This compact receives both AM and FM bands for your listening enjoyment. It's small in size but big in precision craftsmanship and quality. Uses 4 "C" batteries. Excellent sound quality thanks to the balanced speaker output system with a 3" speaker. Includes earphone for private listening. 7 x 5 $\frac{1}{4}$ x 2 $\frac{1}{4}$ ".

RA-063J. Shpg. wt. 3 lbs. **19.95**

Popular Digital Clock Radios For Every Budget

DYN



18⁹⁸



34⁹⁸



59⁹⁸

Low Cost AM Digital

Model DS-4530. Here's your chance to move into the contemporary world of digital clocks while at the same time adding a new dimension to your table decor. You'll awaken 'bright and chipper' to music in the morning and go to sleep at night 'smooth and soothed' thanks to the 60 minute sleep switch. It's so attractive that it looks great anywhere, even at the office. With luminous digitals for night time checks, and precision tuning for quick, easy station location. Good-looking high impact cabinet simulated wood grain. 11 $\frac{1}{2}$ x 5 x 3 $\frac{1}{2}$ ". For 117 VAC.

RA-091J. Shpg. wt. 4 lbs. **18.98**

Versatile Digilite® FM/AM

Model DS-4540. Truly deluxe full feature digital clock, along with the versatile *double-play* option of AM and FM radio! Move from FM at night and "catch" AM in the morning. Perfect when at "home" or in your "field" of business. The clock includes back-up light with snooze bar for extra "sack time" in the morning. Also has AM/FM top controls, wake-to-alarm and/or music, PLUS a 60 minute timer for music enjoyment while falling asleep. Beautifully designed high impact cabinet, leather finished with chrome sides. 11 $\frac{3}{16}$ x 6 $\frac{1}{8}$ x 3 $\frac{3}{4}$ ". For 117 VAC.

RA-075J. Shpg. wt. 5 lbs. **34.98**

Electronic Compu-lite® FM/AM

Model DS-4550. Dyn's best clock radio is loaded with ultra-modern features. Electronic read-out clock offers the latest in clock-radio advancement and computerized design. It also has many of the features found on the more "traditional" clock radios, including wake-to-alarm and/or music, 60 minute timer that can be used to ease you to sleep with your favorite FM or AM programs. The Compu-lite also includes a dimmer for adjusting the brightness of the lighted dial. High impact case and walnut-grain finish. 12 $\frac{3}{8}$ x 5 $\frac{1}{8}$ x 4 $\frac{1}{4}$ ". For 117 VAC.

RA-074J. Shpg. wt. 6 lbs. **59.98**

Portable, Clock and Table Radios from

1 "Handy" Take-Along FM/AM Model R131. So small and attractive that you can take it anywhere — the beach, camping, picnics, traveling, on the golf course, or just around the home. Includes precision slide-rule vernier tuning dial, telescopic FM antenna, FM/AM slide switch, convenient carry strap for easy listening on the go. Earphone, 2¼" round speaker for BIG radio sound. With 9-volt battery. 5½" x 3½" x 1½".

RA-994J. Shpg. wt. 1 lb. 15.95

2 Versatile AC/DC FM/AM

Model R171BK. Handsome sloped front has vernier-tuning slide rule dial, separate tone, volume controls. The AC/DC slide switch lets you operate on normal house current (117 VAC) or 6 "AA" batteries. (optional) Also includes earphone, telescopic FM antenna, 3" speaker for full rich tone. 5¾" x 8½" x 2¾". Black with chrome trim.

RA-995J. Shpg. wt. 3 lbs. 39.95

3 FM/AM/VHF/Marine

Model R248BK. For instant info and entertainment too! Lighted slide rule tuning dial. Separate window indicates band. Tunes four separate bands including Marine for navigation and weather, 147-175 MHz public service band for Police, Fire, and other emergency broadcasts. Has AFC for drift-free FM. Precision vernier tuning. BIG 6 x 3" front speaker. Tone control. Includes earphone, telescopic FM antenna, 4 "C" batteries. Black with chrome trim. 10¾" x 17½" x 3¾". 117 VAC.

RA-996J. Shpg. wt. 5½ lbs. 59.95

The Practical Portables



1
15⁹⁵



2
39⁹⁵



3
59⁹⁵

"The New Look" Digital Clock Radios

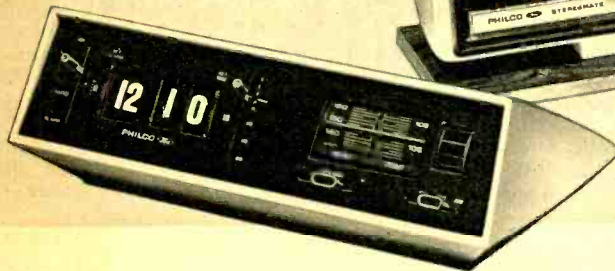

44⁹⁵



59⁹⁵

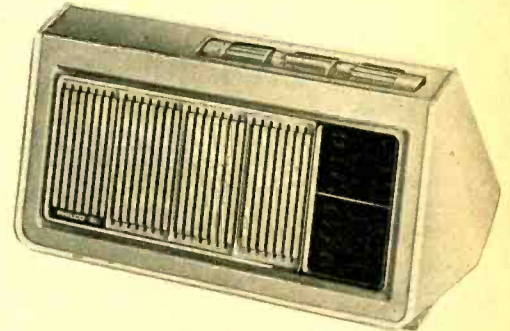

24⁹⁵

Solid-State FM/AM Digital Clock Radio

Model R748HG. The sleek low-profile design makes this one as "eye pleasing" as it is practical. It will look good in any room of your home or apartment. Full features include wake-to-music or music and alarm, PLUS a 0 to 60 minute sleep switch for late evening listening and automatic shutoff. Also includes snooze alarm for those "extra forty winks" in the morning. With BIG sounding 3" speaker, and lighted tape numerals for easy time checks during the day or night. Sliding volume control, AFC switch for drift free FM. Built-in FM and AM antennas. 10 x 4½ x 5½". 117 VAC.

RA-999J. Shpg. wt. 4½ lbs. 44.95

Contemporary Digital FM/AM Clock Radio

Model R768WH. The beautiful design and overall features makes this a truly "deluxe" model. Control board styling features giant tuning dial with sliding volume control, and mode switch. The front panel has luminous digitals, automatic wake to music, sleep switch for "pre-bed" listening and automatic shutoff, PLUS a snooze alarm button. Includes lighted easy-to-read precision slide rule dial with vernier tuning. Has AFC for drift free FM, 3" speaker. With built-in FM, and Magnecor AM antennas. White. Solid-state. High impact enclosure. 12 x 4½ x 9¾". For 117 VAC.

RA-998J. Shpg. wt. 4½ lbs. 59.95

Ultra-Modern FM/AM Table Radio

Model R417. Attractiveness which will fit any setting! Transistorized for instant play and long life. Smart, contemporary design. Features "Finger tip touch" tuning on top for easy, convenient station selection. Slide rule tuning dial with precision vernier tuning. AFC for drift-free FM. Front firing 3" round speaker for a full, rich sound. Built-in FM and Magnecor AM antennas. In white with textured front to match any color scheme 10¾ x 5¾ x 4½". 117 VAC.

RA-997J. Shpg. wt. 3¼ lbs. 24.95



3
22⁹⁵



4
29⁹⁵



2
34⁹⁵



1
12⁹⁵

1 Model PR-112. Pocket Sized AM/FM. Just the thing for keeping music and information close-by no matter where you are. Req. 1 9V. battery. 5" x 3" x 1 3/4". **RA-064J. Wt. 3 lbs. 12.95**

2 Model PR-145. Upright AM/FM/VHF Band Portable. Enjoy AM/FM plus VHF (108-174 MHz) for aircraft, police (high), and weather. 117 VAC. Req. 4-C Batt. 6" x 9" x 3". **RA-099J. Wt. 6 lbs. 34.95**

3 Model PR-122. AM/FM Portable. Has AFC, telescopic antenna, earphone, folding handle. Chrome trim, walnut wood-grained grills. 117 VAC or Batt. (included). 6 x 9 x 1 3/4". **RA-065J. Wt. 2 1/2 lbs. 22.95**

4 Model PR-124. FM/AM "Touring" Portable. Compact traveler with slide-rule tuning, variable tone control. With batteries, earphone for private listening, AC cord. 11 x 6 1/4 x 2 7/8". **RA-864J. Wt. 6 lbs. 29.95**

5 Model PR-156. 5-Band Portable. 30-50 MHz lowband, 152-174 MHz Police/Weather band. 108-136 MHz Aircraft, FM/AM. Map, time schedule in lid. Req. 4-C Batt. 117 VAC. 10 1/2" x 3 3/4" x 7". **RA-066J. Wt. 8 lbs. 44.95**

6 Model PR-160. 10-Band AC/DC World Traveler. With 4.0-24 MHz (3) shortwave bands, 2 VHF police, AM/FM. Has squelch, earphone for privacy, AFC, Telescopic and built-in antennas. Jack for external SW antenna. Carry handle, world map with timing zone locator. Batteries (incl.) or 117 VAC. 13 1/4 x 12 1/2 x 5 1/4". **RA-067J. Wt. 10 1/2 lbs. 99.95**

7 Galaxy 6000. 9-Band AC/DC. You get AM, FM LW (145 to 420 KHz), plus 6 SW bands (5.90 to 6.28 MHz). Continuous 2 watt output, pre-set AM/FM/SW tuning, sliding bass/treble controls, push-buttons for band selection, IC's, dual conversion for shortwave. With batt. 117 VAC. 15 3/4 x 7 3/4 x 3". **RA-859J. Wt. 8 1/2 lbs. ... 149.95**

8 Globetraveler PRO. 16 Bands With BFO. Get Marine, FM, AM, and SW (3.61-22.10 MHz) Bands, BFO lets you tune SSB broadcasts, and code signals. Has IF bandwidth switch, tuning meter, battery tester, bass, treble controls, dual speakers, earphone/headphone jacks. 117 VAC or batt. included. 12 1/4 x 8 x 4". **RA-856J. Wt. 12 lbs. 249.95**



44⁹⁵



6
99⁹⁵



7
149⁹⁵

249⁹⁵



8

Stylish Digital Clock Radios



39⁹⁵



34⁹⁵

Model CLR160. FM/AM Deluxe Digital Clock Radio. Has sleep switch, 24 hour alarm, volume/tone controls, luminous digits. 13" x 4 1/8" x 6 1/2". 117 VAC. **RA-071J. Wt. 5 lbs. 39.95**

Model CLR142. FM/AM Digital Clock Radio. Has 60 min. sleep switch, illuminated numerals. Radio is set into base, slide controls. 6 1/4 x 4 1/4 x 8 1/2". 117 VAC. **RA-863J. Wt. 5 lbs. 34.95**

Look! Radios and Clocks with No Hands



49⁹⁸

FM Stereo "Headhugger"

Model HH-MPX. Listen to your favorite FM stations, *in stereo*, while you go about your business "wearing" this FM stereo headhugger. Has slide on-off power switch, volume, balance and tuning controls on ear-cushion. Lightweight, padded for full comfort. Fully adjustable headband, easy-access battery compartment. Use 9-volt battery.

RA-070J. Shpg. wt. 3 lbs. 49.98

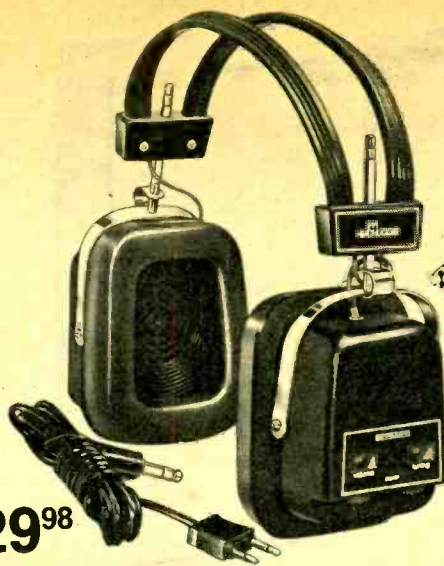

29⁹⁸

FM Mono Headhugger

Model HH-68. It's a monophonic FM radio, but when you use the patch cord (included!), you can plug it into your stereo receiver and use it just like a headphone set! Features BIG-sound 2 1/4" dynamic speakers, flexible adjustable headband, heavily padded ear-cushions for real comfort. Uses 9-volt battery. Easy-access battery compartment.

RA-069J. Shpg. wt. 2 lbs. 29.98



Hear Your Favorite Radio Programs in Private with All the Volume You Want!



16⁹⁸

AM Radio Headhugger

Model HH-66. "Personal" listening at its best—"wear it" with you at the beach, on picnics, anywhere! Features convenient volume and tone controls, handy battery compartment, 2 1/4" dynamic speakers. Flexible headband adjusts to fit anyone, comfortable padded earcushions. Uses 9-volt battery. It's a FUN radio!

RA-398J. Shpg. wt. 2 lbs. 16.98



AM Headphone Radio

Model HR-6. Goes where you go for good sound AM radio listening. Has "mod" style retractable headband, comfortable earcushions. Operates on 3 penlight cells. IC plus 4-transistor circuit.

RA-093J. 2 lbs. 14.95



14⁹⁵

Both Models With Handy Carrying Case



19⁹⁵

FM Headset Radio

Model HR-FM. Provides great-sounding FM radio with "hands-free" mobility. Features high-sensitivity FM circuit, patented retractable headband that fits everyone comfortably, fingertip on-off volume control, rotary tuning knob. Uses 3 penlight batteries.

RA-094J. Shpg. wt. 2 lbs. 19.95

FM-AM Digital Clock Radio

• Easy-to-Read Orange "Computer Style" Numerals

Model DE-137. It's a deluxe FM-AM radio, it's an easy-reading digital clock, it's even a 400-watt AC outlet timer that turns on lights, appliances and radio at times you PRE-SET. Has swivel-type pedestal base, 10-minute drowse button, AFC circuit, built-in AM, line cord FM antennas. Wood-grain finish cabinet. 11 1/2" x 3" x 4 1/2". For 117 VAC.

RA-068J. Shpg. wt. 3 lbs. 37.98



37⁹⁸

Digital Clock/Timer

• Back-Lighted Digital Readout

Model 707. Modern-styled clock shows hours and minutes in high-contrast computer-style display, also features timer switch that lets you turn on lamps, TV, appliances at times you select, turn 'em off at pre-set times too. Has back-panel selector switches for timer operation, sleekly styled case. Rated 15 amps, 1200 watts—even handles color TV's or air conditioners with ease. Black cabinet, 7" x 3" x 3". For 117 VAC.

XM-187J. Shpg. wt. 2 lbs. 21.98

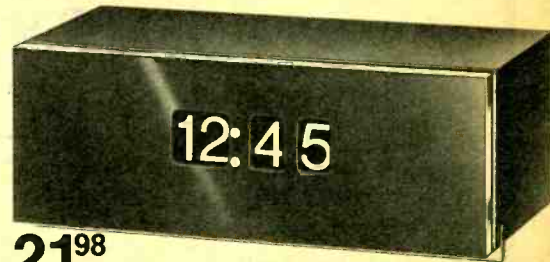

21⁹⁸

Bowman Light Devices Brighten ANY Scene

color organs



1 9⁹⁵



2 16⁹⁵

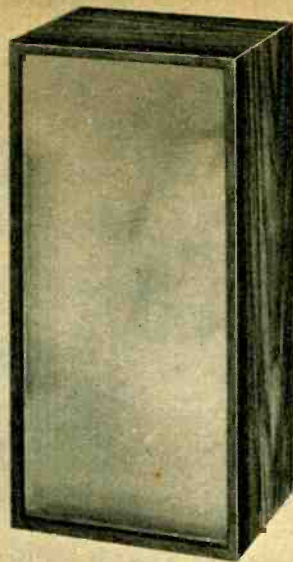

3 39⁹⁹

1 Low-Cost Random Light Display

No amplifier needed—just plug it in to any AC outlet for a “far-out” display of multi-colored flashing lights. It’s just the thing to liven up dens, rec rooms, dorms. Use it alone, in pairs or stacked for even more unusual effects—you’ll never see the same pattern twice! Walnut-grain vinyl cabinet, 12 x 12 x 7½”. For 117 VAC. XX-141J. Shpg. wt. 6 lbs. 9.95

2 Single-Channel Color Organ

Watch reds, greens and blues dance to your tune. Single-channel color organ hooks up to your amplifier, provides a fascinating light show in time to your music. Has prismatic lens for three-dimensional “depth” effect, good-looking walnut-grain vinyl cabinet. 12 x 24 x 9”—fits just right on bookshelf or tabletop. For 117 VAC. XM-250J. Shpg. wt. 11 lbs. 16.95

3 Three-Channel Color Organ

Make your party or get-together a real “happening” as you flash reds, greens and blues to the beat of your favorite music. Has three inputs—each color responds to a different portion of the frequency spectrum for an endlessly deLIGHTful display that changes each time you change your music! Special prismatic lens provides a “spatial” three-dimensional effect for really great viewing. Does not draw any significant power from your amplifier, you can hook it up and enjoy fascinating light patterns even at normal-volume listening levels. Fully assembled—ready to plug in and use for a “brightening” effect in any setting. Good-looking walnut-grain vinyl cabinet is ideal for placement on bookshelf or floor. 12 x 24 x 9”. For 117 VAC. XX-112J. Shpg. wt. 11 lbs. 39.99

Make flashing colors and lights dance to your favorite music with one of these exciting light “shows” from Olson. The color organs are ready to plug in—hook up your room lights to the light controls—“Freeze” the action with the strobes. Light up your life today!



strobe lights



16⁹⁹

Electronic Strobe Light

Creates an “old-time-movie” flicker effect—great for parties and dances. Has variable flash rate of 1 to 10 times per second, brilliant blue xenon bulb. Solid-state. Walnut-finish cabinet, 5¼ x 5¼ x 4¾”. 117 VAC. XX-134J. Shpg. wt. 2 lbs. 16.99

light controls

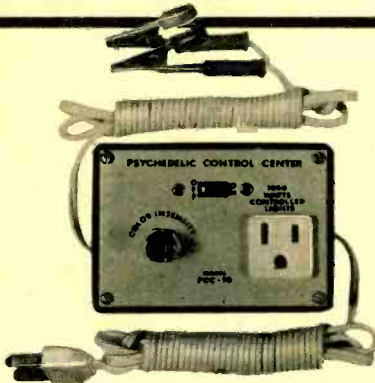

14⁹⁸



42⁵⁰

1000-Watt Controller

Converts sound from hi-fi, radio, phono, etc. to light variations. Takes up to 1000 watts of incandescent lamps—room lights, Christmas tree bulbs, etc. Sensitivity control, on-off switch. 6 x 4 x 2”. 117 VAC. XM-249J. Shpg. wt. 3 lbs. 14.98

4-Channel Light Modulator

Handles up to 500 watts (total) incandescent lamps. Has 4 inputs—each one responding to a different portion of the frequency spectrum. Sensitivity controls, on-off switch. 5¾ x 3¾ x 4½”. 117 VAC. XX-207J. Shpg. wt. 3 lbs. 42.50

24⁹⁵



Audio/Manual Strobe

Operates manually with adjustable flash rate—or hook it up to any sound source and it responds—automatically. Solid-state. High-intensity xenon bulb. Attractive walnut grain vinyl cabinet. 5¼ x 5¼ x 4¾”. 117 VAC. XM-251J. Shpg. wt. 2½ lbs. 24.95

Color Your World with sparkling bright color organs and optical displays. Set the mood, show off your style, enhance your decorating scheme.

black lights

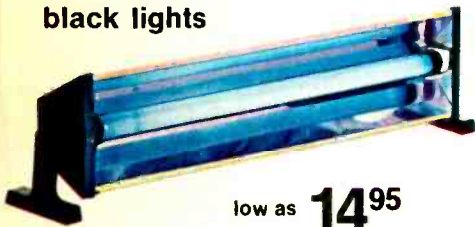

low as **14⁹⁵**

These lights illuminate an unseen universe of color and special effects—they're perfect for posters, paintings, party environments. Units below are U. L. listed, for 117 VAC, have swivel base stands and on/off light controls.

Model BL-12 (Shown). 12", 8-watt bulb.

XM-201J. Shpg. wt. 6 lbs. **17.95**

Model BL-6. 6" wide, 4-watt bulb.

XM-200J. Shpg. wt. 4 lbs. **14.95**

Model BL-18. 18" wide, 15-watt bulb.

XM-202J. Shpg. wt. 8 lbs. **19.95**

Colorful Creations from Olson

color organs ¹

34⁹⁵



² **34⁹⁵**



³ **16⁹⁵**

53⁹⁵

⁵ low as **48⁹⁵**



⁶ **9⁹⁵**



¹ **Model SL-33.** "Stop-Lite" color organ hooks up to your hi-fi and responds to different ranges (red, high; amber, mid; green, low). Lights flash on and off with each note. 6½ x 24 x 4".

XM-205J. Shpg. wt. 5 lbs. **34.95**

² **Model BCO-73.** Three-channel color organ responds to your favorite music with changing colors. 12 x 18 x 7". Wrap-around prismatic plastic, walnut wood base and top. **XM-206J.** Shpg. wt. 6 lbs. **34.95**

³ **Model BC-10.** Simply plug into AC outlet for random light display. Wraparound plastic, walnut base and top. 12 x 12 x 7½". **XM-204J.** Shpg. wt. 5 lbs. **16.95**

⁴ **Model SM-118.** Microphone controlled color organ responds to music, voice, any room sound without hookup. Built-in mike for each color, sensitivity dial. Walnut case. 12 x 18 x 7". For 117 VAC.

XM-289J. Shpg. wt. 13 lbs. **53.95**

⁵ **MC-22.** Above, wrap-around plastic case, 12 x 22 x 7". For 117 VAC.

XM-208J. Shpg. wt. 15 lbs. **53.95**

XM-207J. MC-18. 12 x 8 x 7". 12 lbs. **48.95**

⁶ **Model MB-73.** Random light display of five colored bulbs flashing thru a prismatic lens case. 6½ x 9½ x 6". 117 VAC.

XM-203J. Shpg. wt. 2 lbs. **9.95**

fiber optic designs

⁸



¹⁰



⁹



¹¹



These fully-assembled fiber optic displays compliment your good taste as they decorate your home with satisfying jewel-like beauty. The space-age optical fibers are made of material that "transmits" light from a hidden bulb—the fibers seem to glow with a life of their own. All are U.L. listed, for 117 VAC. Now's the time to "enlighten" your shelves, cabinets, end tables, hi-fi speakers with sparkle and verve!

⁷ **Model F-70 Lifelite.** 3-tier display fully enclosed. Walnut base, 8½ x 15 x 8½".

XM-214J. Shpg. wt. 6 lbs. **48.95**

⁸ **Model F12 Aquarius.** Walnut-enclosed flower-like display. 12x8x12".

XM-211J. Shpg. wt. 6 lbs. **24.95**

⁹ **Model F25. Fantasy.** 3-tier "cascade" with walnut base. 12 x 16 x 12", open

XM-213J. Shpg. wt. 8 lbs. **39.95**

¹⁰ **Model F24 Firefall.** Two tier open display with walnut base. 4 x 14 x 4".

XM-212J. Shpg. wt. 3 lbs. **29.95**

¹¹ **Model F3 Comet.** Two-tier open display with cylindrical base. 14" H x 4" dia.

XM-209J. Shpg. wt. 3 lbs. **13.95**



10⁹⁵

"Sunshine" Fiber Fantasy

Model F7. A light creation with a distinctive decorating appeal. 12" high bouquet of mod blossoms and fiber-optic lights features a unique combination of effects. The minute fiber lights and petals reflect the color and warm glow of the base. Use as night-light, too. A real conversation-piece anywhere in your home. 12" H x 4" dia.

XM-210J. Shpg. wt. 2 lbs. **10.95**

Professional Capability Portable PA Systems



UNIVERSITY SOUND™



Put POWER Where You Need It

- **SCHOOLS** *Blanket Auditoriums, Quadrangles, Football Fields, Etc.*
- **CHURCHES** *Meeting Halls, Chapels, Parking Lots, Outdoor Events*
- **BUSINESSES** *Conference Rooms, Lecture Halls, Trade Shows, Display Areas*
- **PERFORMERS** *No Need to Put Up With Inadequate Locally Supplied Sound Systems*

The extraordinary versatility of solid-state components plus Altec's years of professional expertise have made it possible to build into these PA systems the same kind of ruggedly reliable performance that would have cost far more (even without the versatility and flexibility of these units) just a few years ago. The Control Consoles provide 100 watts of audio power to feed two specially-designed column speakers, each with six loudspeakers in a vertical array. Feature 7 mixable input channels for total signal source versatility — built-in reverb for situations where special musical effects are desired. Manufactured by Altec, the pre-eminent name in commercial sound installations, they incorporate every performance parameter and control feature necessary for the most demanding performances in front of large audiences, yet they're versatile enough to set up in an intimate lounge. THE solution for those who require sound reinforcement for speaking engagements or entertainment of any sort.



\$1098

**Model U-100H
Complete System**

Model U-100H. (Shown.) Complete system including Model U-101 control console, two U-103 column speakers. High-impedance inputs, 98 dB power gain; volume, treble, bass, reverb controls for 6 channels, (aux. MIC/TAPE 7th channel). Control console, 24 1/4 x 9 1/4 x 15", Columns, 14 x 60 x 10 1/4".

AM-484J. Shpg. wt. 109 lbs. **1098.00**

Model U-100L. System as above, but with U-102 Control Console: 103 dB power gain, high and low-impedance inputs. Low-impedance inputs are six XLR-3 type connectors on rear panel.

AM-485J. Shpg. wt. 109 lbs. **1198.00**

Model U-103 Speakers Alone. For use with amplifiers having continuous power rating of up to 75 watts program material. Response, 70-11,000 Hz, impedance 12 ohms. 3/4" plywood cabinets with blue Lavant vinyl covering. With 50' 2-conductor cable with 1/4" phone plugs each end.

SP-114J. Shpg. wt. 66 lbs. **Each 250.00**

Model U-101 Control Console Alone. Has high-impedance inputs, 20-20,000 Hz response, 6 channels with aux. MIC/TAPE 7th channel. 500 mV rms for full power output into 1000 ohms minimum for each output. Dual AC receptacles on rear of chassis. For 117 VAC.

AM-486J. Shpg. wt. 42.5 lbs. **696.00**

Model U-102 Control Console Alone. Above, with high and low-impedance inputs. Luggage style case with blue Lavant vinyl covering and heavy vinyl edge bumpers. For 117 VAC.

AM-487J. Shpg. wt. 42.5 lbs. **798.00**

XM-255J. Console Stand for U-101, U-202. 4 lbs. **44.00**

XM-256J. Console Cover. 3 lbs. **18.00**

XM-257J. Cover For U-103 Speakers. 4 lbs. **Each 24.00**

CONCORD

For "Hiss"-Less Recording

Stereo Record/Play Deck

The Mark IX. For the cassette recordist who *demands* the best! Features Dolby Noise Reduction, ultra-narrow "1-micron-gap" tape head for audio response of 30 to 15,000 Hz, signal to noise ratio of better than 50 dB even *without* Dolby! Has pro-type slide controls for input and output levels, mixing level control, pushbutton tape function controls including pause. End-of-tape stop automatically disengages for longer head life. Dual back-lit VU meters for super-accurate recording levels. Digital tape counter, bias switch for chromium-dioxide cassettes. 16 x 4½ x 10¾". For 117 VAC. RA-583J. Shpg. wt. 16 lbs. 289.95

Compact Record/Play Deck

The Mark 7. Has the features you need for truly excellent cassette recording. Dolby Noise Reduction, "1-micron-gap" tape head, bias switch for standard or new low-noise chromium-dioxide cassettes. "Endmatic" tape shutoff cuts power and disengages tape head at the end of the cassette—reduces head wear, increases tape life. Has pushbutton operation, 3-digit tape counter, lighted VU meters, slide-type level controls. 30-15,000 Hz response, 56 dB S/N with Dolby "On." Walnut base. 7¼ x 3½ x 11¾". For 117 VAC. RA-769J. Shpg. wt. 8½ lbs. 229.95

Universal Dolby Adapter

Model DBA-9. If you already own tape equipment and you're serious about recording—you *NEED* this instrument! Connect it to ANY tape deck—reel, cassette or 8-track—and get the full advantages of Dolby Noise Reduction when you record OR play back. Features line inputs, dual calibration meters, all necessary controls for "Dolby-izing" any tapes. 13½ x 3½ x 7¼". 117 VAC. RA-770J. Shpg. wt. 7 lbs. 114.95

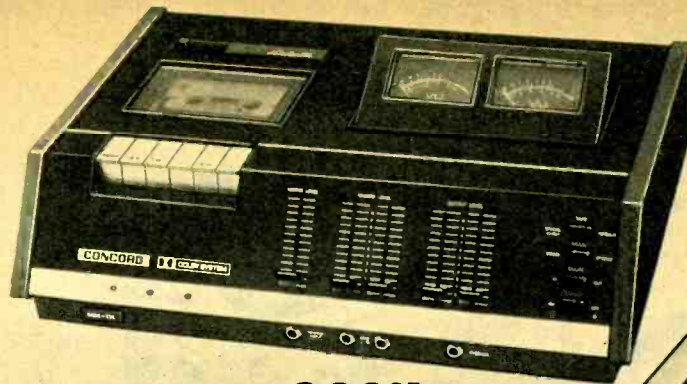

289⁹⁵

229⁹⁵



Dolby Noise Reduction System

These three Concord units feature famous Dolby* Noise Reduction Circuitry—the advance that made cassette recording a *serious musical medium!* The Dolby system boosts high-frequency levels during recording and cuts them to the same degree during playback. In this boost-cut process—tape hiss is "left behind"—and recorded music seems to pop out of a starkly silent background!

*Dolby is a Trademark of Dolby Laboratories, Inc.



114⁹⁵



114⁹⁵

2/4-Channel 8-Track Deck

Model CD-8-4. Add it and two more speakers to your system and listen to "the sound of the 70's" today! Plays DISCRETE 4-channel cartridges, regular 2-channel stereo tapes as well. Has 3-position function switch for automatic or manual eject or continuous repeat-play. Automatically selects proper 2 or 4-channel circuitry. Adjustable output level lets you match volume with the rest of your components. Has 2/4-channel indicator light, walnut-finish cabinet, brushed aluminum front panel. 8¾ x 4 x 10½". 117 VAC.

RA-772J. Shpg. wt. 10 lbs. 114.95

159⁹⁵



Cassette Record/Play Deck

The Mark 6. Add it to your stereo for excellent fidelity and cassette convenience. Has dual record level meters, end-of-tape shutoff that disengages mechanism, large illuminated VU meters, slide-type level controls. Bias selector switch for standard or new chromium dioxide cassettes. 3-digit push-to-reset counter and pause control make tape editing fast 'n easy. Keyboard-type pushbutton tape function controls. Good-looking brushed aluminum front panel with black trim, walnut finish base. 7¼ x 3½ x 11¾". For 117 VAC.

RA-768J. Shpg. wt. 8½ lbs. 159.95

CONCORD

Easy Listenin' Home or Away



131⁹⁵

Cassette/FM/AM/SW Radiocorder®

- Built-In Condenser Mike
- 60-Minute Auto Shutoff
- Pushbutton Function Controls

Model F-115. Take along entertainment that's equally "at home" on the beach, in your car, on porch or patio. Listen to FM, AM or international Shortwave, play pre-recorded cassettes, record your favorite programs directly "off-the-air," make "live" cassette recordings with the built-in condenser mike. Big built-in speaker, slide-rule tuning, telescoping antennas, more. Rugged case with carrying handle, 12½ x 8½ x 3¼". For 117 VAC/12 VDC. Req. 6 "C" cells. Mono.

RA-765J. Shpg. wt. 8½ lbs. 131.95



1 179⁹⁵



4 109⁹⁵



5 82⁹⁵



2 57⁹⁵

1 8-Track Record/Play Stereo Deck

Model F-128. Add it to your present stereo system to record 8-track cartridges for playback at home or in your car. Slide-controls, dual VU meters, fast forward, counter, more. 16½ x 4¾ x 9". 117 VAC.

RA-773J. Shpg. wt. 16 lbs. 179.95

2 Big-Sound Cassette Recorder

Model F-51A. Slim 'n compact—perfect for students, travelers, people on-the-go. Has single-knob function control, automatic record level. With remote control mike. 9 x 3¼ x 11". 117 VAC Req. 6 "C" cells. Mono.

RA-762J. Shpg. wt. 5½ lbs. 57.95

3 "Futuristic" Cassette Recorder

Model F50-A. Features automatic record level circuit that smooths out blasting and fading for steady recordings every time, extra-large speaker for fine sound. 8¾ x 4 x 9". 117 VAC Req. 6 "C" cells. Mono.

RA-092J. Shpg. wt. 5½ lbs. 56.95

4 Cassette/FM/AM Radiocorder®

Model F-110. Smart recorder/radio for travelin' music from FM or AM radio or cassettes. Has built-in condenser mike for recording, vernier tuning for precise station selection, pushbutton tape function controls. 60-minute shutoff switch, VU meter, digital counter. 11⅞ x 10½ x 3½". For 117 VAC/12 VDC Req. 6 "C" cells. Mono.

RA-764J. Shpg. wt. 8 lbs. 109.95

5 Deluxe Cassette Recorder

Model F-65. Full-feature recorder delivers fine sound for voice or music. Has automatic end-of-tape shutoff that disengages mechanism, switchable automatic record level circuit, pushbutton tape function controls. Built-in condenser mike, VU/battery meter. Detachable cover. 9¾ x 2¾ x 9". For 117 VAC Req. 4 "C" cells. Mono.

RA-763J. Shpg. wt. 7¼ lbs. 82.95

See batteries Page 103.

For High Performance Recordings

Three-Head Stereo Tape Deck

- All-Silicon Pre-Amp Cuts Hissing
- One-Micron-Gap Record/Play/Erase Head

Model 4000DS. Gives home systems "professionalism" in tape recording! Sound-on-sound and sound-with-sound capability, shielded head with high S/N ratio. Tape speed 3¾, 7½ ips. Has speed equalizer, instant pause, automatic shut-off. 30-22,000 Hz at 7½ ips. 0.15% Wow/Flutter. Includes 2 spare fuses, reel caps, handsome walnut wood case. 12¾ x 15½ x 7½". For 117 VAC. RA-784J. Shpg. wt. 26 lbs. 269.95

Compact Stereo Tape Recorder

- Two 5x7" Built-In Speakers
- Shield-Type Head for High S/N Ratio

Model 1721W. The "Mignon." Records and plays 4-track stereo or mono at either 3¾ or 7½ ips. S/N ratio better than 50 dB. Silicon transistor circuit, pause control, automatic shutoff. Volume and tone controls for each channel. Headphone jack. 40-15,000 Hz (± 3 dB) at 7½ ips. 0.18% Wow/Flutter. With 7" take-up reel, mikes, stands, fuse. 14¾ x 14¾ x 9¾". Walnut case. 117 VAC.

RA-446J. Shpg. wt. 30 lbs. 299.95

RA-029J. 1721L. Above, with leather-finish case and carrying handle. 30 lbs. . . 299.95



269⁹⁵

AKAI



299⁹⁵



349⁹⁵

Pro Quality Stereo Deck

- Features Tape/Source Monitoring
- Low Noise Tape Selector Switch

Model 4440D. An excellent deck for the serious recordist who wants *studio quality results* at home. The tape source monitoring switch allows instant comparison of the recorded material to signal source. Has three one-micron-gap heads. Self-lubricating hysteresis motor, sound-on-sound, sound with sound and sound mixing. With convenient automatic shut-off, pause control, signal to noise ratio of better than 50 dB. 0.12% Wow/Flutter at 7½ ips. 30-24,000 Hz response (± 3 dB) at 7½ ips. 16¾ x 17½ x 8¾". 117 VAC.

RA-023J. Shpg. wt. 30 lbs. 349.95



399⁹⁵

4-Channel Tape Deck

- 2-Channel and Full Track Erase Heads for Stereo Compatibility

Model 1730D-SS. The enjoyment of *deep dimensional* "discrete" 4-channel sound is yours in this precision crafted deck! Features famous AKAI quality — uses 4 tape heads, 3 motors and 4 pre-amplifiers. Enjoy sound *purity* through hookup with a 4-channel power amp and two pairs of speakers. Completely compatible with 2 channel stereo, too! Has automatic shut-off, pause control, 4 VU meters, stereo headphone jacks. 30-22,000 Hz (± 3 dB) at 7½ ips. 0.18% Wow/Flutter. With 4-channel demo tape, take-up reel, connection cord, fuses. 16½ x 18 x 9½". Walnut case. 117 VAC.

RA-445J. Shpg. wt. 33 lbs. 399.95



579⁹⁵

"Auto-Reverse" Tape Deck

- Glass and Crystal Ferrite Head
- Normal/SRT Tape Selector Switch

Model GX-260D. Combines the latest in reel-to-reel advancements with the versatility of automatic reverse in both *play and record* modes! You can program this deck for continuous play, automatic stop, and repeat play. Glass and crystal ferrite heads result in greater response and clarity. Has 2 playback/record GX heads PLUS erase GX head. With 3 motors, line output volume control, line and mike mixing, sound-on-sound. Automatic stop, headphone jack. 48 dB S/N ratio at 7½ ips. 30-23,000 Hz (± 3 dB) with low-noise tape. 17½ x 18½ x 8¾". 117 VAC.

RA-022J. Shpg. wt. 36 lbs. 579.95

Professional Capability Tape Recorders and Decks—

AKAI



3
159⁹⁵

1
319⁹⁵



2
349⁹⁵



4
269⁹⁵

\$9
with purchase
Cassette Bonus
12 C-60 60-Minute Cassettes —
Half-Price with Purchase of
Any Cassette Recorder on this
Page. TA-798J. ... Reg. \$18.00

16³²
with purchase

Reel-to-Reel Bonus

Six 1800' 7" Reel Ampex Polyester Base Recording Tapes—32% Off with Reel Decks on these two pages. TA-578J. Reg. \$24.00



5
799⁹⁵

1 Dolby System* Cassette Deck

Model GXC-46D. THE deck for the serious home recordist. Features Dolby Noise Reduction circuit that cuts tape hiss to the vanishing point, Akai's famous Automatic Noise Reduction System that virtually stops distortion above 8000 Hz. Has Akai GX-head with focused field for improved response, hysteresis-synchronous motor, dual VU meters, piano-key controls, more. 30-16,000 Hz (± 3 dB) response, 55 dB S/N with Dolby IN. Walnut case. 16 $\frac{1}{4}$ x 5 $\frac{1}{2}$ x 12 $\frac{3}{4}$ ". 117 VAC. RA-790J. Shpg. wt. 28 lbs. **319.95**

2 Invert-O-Matic Dolby* Deck

Model GXC-65D. You won't find a better, more versatile cassette deck for home use! Dolby and ADRS (Automatic Distortion Reduction System) — GX tape head with focused field for really great sound! Invert-O-Matic system lets you play or record *both sides* of the cassette—automatically. Has pushbutton controls, automatic stop, dual VU meters and level controls, more. 30-16,000 Hz (± 3 dB) response, 55 dB S/N with Dolby IN. 11.3 x 7.8 x 14.7". For 117 VAC. RA-791J. Shpg. wt. 28 lbs. **349.95**

3 Low-Priced Cassette Deck

Model CS-30D. An excellent choice for those who are looking for famous Akai excellence on a tight budget. Has "expensive model" features like slide-controls and tilt-up VU meters for each stereo channel, tape counter, bias selector, tape run lamp, pop-up cassette loading. Response: 40-15,000 Hz (with chromium-dioxide tape), S/N, better than 46 dB. Constant speed induction-type motor. Walnut case, black/chrome panel. With DIN cord. 16 x 5 x 8 $\frac{3}{4}$ ". 117 VAC. RA-030J. Shpg. wt. 14 lbs. **159.95**

4 High-Performance Dolby* Deck

Model GXC-38D. Has quality and features to satisfy critical recordists! Akai's famous glass and crystal ferrite head for ultra-wide response and long life, Dolby Noise Reduction System to cut tape hiss, special tape selector for standard or CRO₂ tapes. Has pushbutton controls, slide-type level controls and VU meter for each channel, pause and eject buttons, separate power on-off. 40-16,000 Hz (± 3 dB) with CRO₂ tape. 50 dB S/N with Dolby. 16 $\frac{1}{8}$ x 4 $\frac{1}{4}$ x 8 $\frac{3}{4}$ ". 117 VAC. RA-031J. Shpg. wt. 24 lbs. **269.95**

5 Discrete 4-Channel Reel Deck

Model GX-280DSS. Play and record with the magnificent musical clarity of 4-channel sound! Features Akai glass-ferrite tape heads, three motors including Servo-Control, 4-channel repeat circuit for automatic reverse and continuous playback, tape selector circuit, sound-on-sound and mixing. Has full 2-channel auto-reverse capabilities, 4-channel playback auto-reverse. 20-25,000 Hz (± 3 dB) at 7 $\frac{1}{2}$ ips. S/N, 55 dB. 17 $\frac{1}{2}$ x 20 $\frac{1}{8}$ x 10". 2-Speeds. 117 VAC. RA-033J. Shpg. wt. 50 lbs. **799.95**

6 Auto-Reverse Reel-to-Reel Deck

Model GX-400D. Probably the finest stereo deck available outside a studio! 15, 7 $\frac{1}{2}$, 3 $\frac{1}{4}$ ips speeds, tape equalization, line/mike mixing, sound-on-sound capabilities, auto-reverse in both recording and playback modes with sensing foil. 10 $\frac{1}{2}$ " reel capacity. Frequency response with normal tape—20-26,000 Hz at 15 ips, 30-24,000 Hz at 7 $\frac{1}{2}$ ips. S/N ratio—55 dB at 15 ips. ADR system, automatic shutdown/stop, glass-ferrite heads. 18 x 23 $\frac{3}{4}$ x 9 $\frac{1}{2}$ ". For 117 VAC. RA-032J. Shpg. wt. 60 lbs. **1195.00**

\$1195

6



Choose Cassette, Cartridge, Reel-to-Reel

AKAI



1 **199⁹⁵**

8⁹⁴
with
purchase **8-Track
Bonus**

Six Blank 90-min. 8-Track Cartridges — 50% Off with purchase of 8-Track decks on this page.
TA-802J. Reg. \$17.88



3 **54⁹⁵**
Pair

**"Jet-Stream"
Speaker Systems—
Modern Design,
Great Sound**

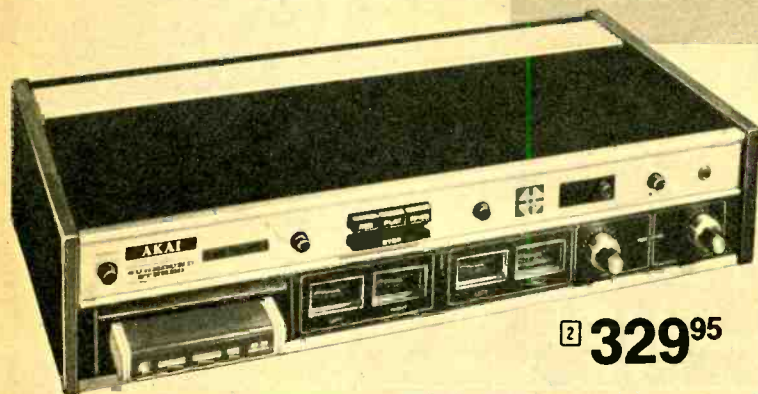
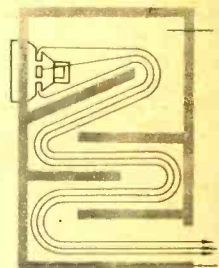

2 **329⁹⁵**

1 8-Track Record/Play Deck

Model CR-81D. Low-cost way to build your own tape library for playback through your home system or car player. Has one-micron-gap head for extra-wide 50-16,000 Hz response (± 1 dB), lighted VU meters, fast forward, automatic stop or continuous play provision. Records an entire cartridge unattended, simply set the controls and forget it. Wow/Flutter, less than 0.25% rms, S/N ratio, better than 47 dB. Aluminum panel, walnut enclosure. 13 $\frac{1}{4}$ x 5 $\frac{1}{4}$ x 10 $\frac{1}{2}$ ". 117 VAC. RA-786J. Shpg. wt. 17 lbs. 199.95

2 4-Channel 8-Track Deck

Model CR-80DSS. Records and plays discrete 4-channel cartridges when used with a 4-channel amplifier and four speakers, fully compatible with 2-channel stereo too! Has automatic-stop/continuous play button, program indicator lights, PA convertibility. One-micron-gap head for 30-16,000 Hz response; wow/flutter, under 0.25% rms. Has automatic 2/4-channel sensing during playback. Four VU meters for really precise recordings. 19 $\frac{1}{2}$ x 5 $\frac{1}{2}$ x 11 $\frac{1}{4}$ ". For 117 VAC. RA-624J. Shpg. wt. 24 lbs. 329.95

3 "Jet-Stream" Speaker Systems

Akai's new speaker systems are small but mighty, designed for tight spaces but FULL hi-fi sound! The secret is in the bass response "jet stream" travel—inside the speaker are 4 staggered boards "guiding" the bass sound over a longer than usual path. This results in big speaker bass from a small enclosure. 50-17,000 Hz response, 10 watts music power, 8 ohms. Walnut-finish cabinet, aluminum grille. 5 $\frac{1}{2}$ x 14 $\frac{1}{2}$ x 10 $\frac{1}{2}$ ". SP-091J. Shpg. wt. 20 lbs. Pair 54.95

4 3-Speed Auto-Reverse Stereo Deck with Three Heads and Three Motors

Model GX-220D. Pro features for magnificent 4-track stereo recordings. Three-head design with dust-free, wear-free, focused field GX (glass and crystal ferrite) record/playback heads that provide 150,000 hours of service. Three motors for maximum stability. Wow/Flutter, 0.08% at 7 $\frac{1}{2}$ ips. Continuous automatic reverse, manual reverse; automatic stop/shutoff, instant pause, button for sound-on-sound. Response: 30-24,000 Hz (± 3 dB) at 7 $\frac{1}{2}$ ips. 1 $\frac{1}{8}$, 3 $\frac{3}{4}$, 7 $\frac{1}{2}$ ips. tape speeds. With take-up reel, cables, sensing tape, fuse. 17 x 17 x 9 $\frac{1}{8}$ ". Walnut case. For 117 VAC. RA-783J. Shpg. wt. 41 $\frac{1}{2}$ lbs. 529.95

5 Reel-to-Reel/8-Track Cartridge Combo

Model X-1810D. Famous Akai quality and features, 8-track and reel-to-reel capability plus automatic reverse make this one of the most versatile and valuable decks around! Transfer material from reel to cartridge, record reels and cartridges simultaneously, even play back reel-to-reel tapes with auto-reverse continuous play! Reel-to-reel section has cross-field tape heads, cartridge section has one-micron-gap head. Has low-noise tape button, VU meters for each stereo channel, automatic stop and continuous-play in cartridge mode. Records/plays at 7 $\frac{1}{2}$, 3 $\frac{3}{4}$, 1 $\frac{1}{8}$ ips. Response: 30-22,000 Hz (± 3 dB) reel at 7 $\frac{1}{2}$ ips. 50-16,000 Hz (± 3 dB) cartridge. Wow/flutter: 0.08% rms reel, 0.25% rms cartridge. Walnut case, 17 $\frac{1}{4}$ x 18 x 9 $\frac{1}{8}$ ". For 117 VAC. RA-793J. Shpg. wt. 47 lbs. 499.95



4 **529⁹⁵**



5 **499⁹⁵**

Cassette Recorder Outfits from Wollensak 3M COMPANY

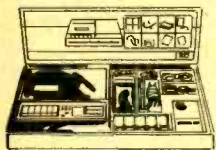

These Wollensak Cassette Packages provide you with all you need for complete recording and playback versatility. They include: earphone, remote control mike with stand, telephone pick-up coil, audio cable for off-the-air recording from radio or phono, 12 VDC car/boat adapter for use nearly anywhere. PLUS batteries, case and a C-60 cassette tape so you can enjoy your recorder immediately!

1 Deluxe Recorder

Model 4060. Quality and dependability no matter where you are! Digital tape counter for easy location and editing. Automatic record level, pushbutton function controls, separate volume/tone controls. End-of-tape shut-off, auto-stop. Built-in condenser mike. Battery/record meter. Mono. $5\frac{1}{2} \times 2\frac{1}{2} \times 10"$. Battery or 117 VAC.

RA-807J. 4060 Alone. Wt. 6 lbs. 69.98
RA-808J. 4060K With Pkg. 8 lbs. 79.98

2 Versatile Recorder Value

Model 4150. Full-feature mono recorder with keyboard controls for rewind, fast forward, stop and eject. Built-in record level control keeps you from recording too soft or loud—automatically! End-of-tape shut-off protects tapes and mechanism while adding convenience to recording and listening. $5\frac{1}{2} \times 10\frac{3}{8} \times 2\frac{3}{4}"$. Battery or 117 VAC.

RA-801J. 4150 Alone. Wt. 8 lbs. 49.98
RA-802J. 4150K With Pkg. 10 lbs. 59.98

3 "Easy-Carry" Compact

Model 4055. Great *non-bulky* model for business conferences, classes, car uses. Has automatic record level, digital tape counter, pushbutton controls, separate volume/tone controls. End-of-tape shut-off, combination battery power/record level meter. Good-sounding built-in speaker. Mono. $5\frac{1}{2} \times 2\frac{1}{2} \times 10"$. Battery or 117 VAC.

RA-805J. 4055 Alone. Wt. 6 lbs. 59.98
RA-806J. 4055K With Pkg. 8 lbs. 69.98

4 Full-Sized "Lightweight"

Model 4155. Easy to use model with extra-wide response. Automatic level control, pushbutton controls for record, play, rewind, fast forward, stop, eject, pause. Sliding tone/volume controls. Built-in condenser mike. Earphone, record indicator light, end-of-tape shut-off. Mono. $10\frac{1}{4} \times 9\frac{1}{8} \times 2\frac{1}{8}"$. Battery or 117 VAC.

RA-803J. 4155 Alone. Wt. 8 lbs. 69.95
RA-804J. 4155K Pkg. NoCase. 10 lbs. 79.95

True Hi-Fi Reel Recorder



194⁹⁵

• Solid-State Circuitry for Dependability!

Model 1500SS. Has powerful 10-watt push-pull amplifier for a *clean, clear* audio output. Special provision permits monitoring and PA system use. Records/plays 2-track mono at $7\frac{1}{2}$ and $3\frac{3}{4}$ ips. Automatic level indicators for flawless mono recording, digital counter enables you to locate specific recorded sections with ease. Automatic head demagnetization. Response: 40-15,000 Hz. Signal-to-Noise, 48 dB. Mike, phono, radio inputs. With dynamic mike, metal case. $11\frac{3}{4} \times 6\frac{1}{2} \times 10\frac{3}{4}"$. For 117 VAC.

RA-817J. Shpg. wt. 20 lbs. 194.95

Stereo Cassette Deck with Dolby* System

Wollensak 3M

* Dolby is a Trademark of Dolby Laboratories, Inc.



Add It to Your Stereo for Great Sound

- 3M's Exclusive Beltless, Dual Direct Drive Cassette Transport
- FM Dolby Switch Provides "Dolbyized" Listening from Dolby Radio Broadcasts
- Mike and Mixer Switch for Sound-on-Sound Mixing and Independent Channel Monitoring
- Standard, CRO₂ Tape Bias Switch
- Microgap Ferrite Heads for Wide Response
- Removable Head Cover for Easy Cleaning

guardian senses defective or stalled cassettes, disengages pinch roller and heads from the cassette, reverts automatically to the "Stop" mode—automatic end-of-tape shut-off too. Headphone and line outputs. Wow/Flutter, less than 0.15% DIN weighted. Distortion, less than 0.1%. Response, 35-15,000 Hz \pm 2 dB with high performance tape. S/N better than 50 dB, with Dolby System off. Noise reduction with Dolby on: 10 dB @ 4,000 Hz, 9 dB @ 2,400 Hz, 6 dB @ 1,200 Hz, 3 dB @ 600 Hz. 17 $\frac{1}{4}$ x 6 $\frac{1}{2}$ x 10 $\frac{1}{4}$ ". For 117 VAC.

329⁹⁵

Use Your
Master Charge
or BankAmericard

Model 4765. Here's sound quality comparable to reel recorders, PLUS cassette convenience! The FM Dolby switch provides Dolby Noise Reduction through any FM tuner for pure "hiss-free" sound from Dolbyized broadcasts. Also has Stereo/mono switch, tape bias switch for standard or chromium dioxide tapes, three-digit index counter, illuminated VU meters. Cassette

RA-967J. Shpg. wt. 20 lbs. 329.95

Wollensak 3M

Cassette Recorders for On-the-Go People

"Mini"
Cassette
Recorder

109⁹⁵



- Includes a Built-In Condenser Mike for Direct Hand-Held Recording
- Measures Only 4 x 6 $\frac{3}{4}$ x 1 $\frac{3}{4}$ " but Has "Full Size" Performance

Model 401K. It's perfect for meetings, lectures or anywhere high-quality mono recordings are needed. Records/plays instantly with single touch. Illuminated end-of-tape indicator, review control, automatic record level, built-in speaker. Includes 4 "AA" cells, telephone pick-up coil, audio cable, Scotch C-60 high-energy cassette, remote-control external mike, 12 VDC and AC adapters.

RA-811J. Shpg. wt. 3 lbs. 109.95

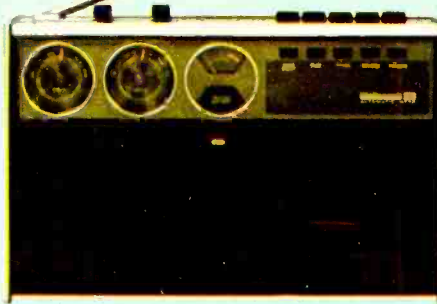

Cassette Recorder with FM/AM

- Records FM or AM Directly Off-the Air
- Battery or AC

89⁹⁸

Model 4515. Plays and records mono cassettes with good fidelity. Built-in condenser mike and automatic record level circuit. Record safety lock, digital tape counter, monitoring provision for quality recordings. Auto-Stop features automatic return to Stop position for greater recording convenience. Large built-in speaker. Response: 80-10,000 Hz. With remote control switch, earphone, power cord. For 117 VAC/4 "C" cells.

RA-809J. Shpg. wt. 9 lbs. 89.98



Battery/AC Cassette Recorder

- Built-In Condenser Microphone
- Sliding Volume and Tone Controls

99⁹⁵

Model 4350. Designed for desk top, yet portable enough to take anywhere. Features include: end-of-tape shut-off with automatic return to stop for ease of operation, monitor switch. All solid-state circuitry. Automatic record level control is defeatable for music recording. Memory rewind, AC power cord, earphone, mike with remote on/off switch and stand included. 13 x 18 $\frac{3}{16}$ x 3". Mono. For 117 VAC/4 "D" cells.

RA-810J. Shpg. wt. 6 lbs. 99.95

Complete Your System With a Wollensak Deck



Wollensak 3M COMPANY

Versatile 8-Track 2/4 Channel Playback Deck

Model 8054. It's ready to handle any kind of 8 track tape and will make a great addition to your present music system. Cartridge deck plays pre-recorded 2-channel stereo, or 4-channel Q-8 tapes (through discrete 4-channel amplifier). Has 2/4 channel selector key, illuminated program indicator lights and track indicator. Compatible with standard stereo: automatic programming for 2-channel/4-channel play. Response: 30-15,000 Hz. Wow/Flutter, 0.25%. Walnut case. 13 $\frac{3}{8}$ x 9 $\frac{3}{4}$ x 4 $\frac{3}{4}$ ". For 117 VAC. **RA-816J.** Shpg. wt. 10 lbs. **119.95**

119⁹⁵



Record/Play 8-Track Stereo Deck

Model 8055. Beautifully designed unit lets you play OR record great sounding stereo cartridges from any stereo receiver, amplifier or "compact" system—makes terrific "live" recordings when you add a pair of mikes. Has record level meter and slide-type level control for each stereo channel, switchable Auto-Level circuit, fast forward and pause, lots more. Digital elapsed time counter shows the exact minutes and seconds used on tape. Response: 30-15,000 Hz. Wow & Flutter: 0.25%. Walnut case, 17 $\frac{3}{8}$ x 4 $\frac{7}{8}$ x 10 $\frac{1}{2}$ ". For 117 VAC. **RA-950J.** Shpg. wt. 15 lbs. **189.95**

189⁹⁵



8-Track 2/4 Channel Play — 2-Channel Record Deck

Model 8060. Plays 4-channel cartridges at the flick of a switch. Handles discrete Q8 or any matrix encoded cartridges. Records and plays standard 2-channel stereo also. Digital time counter assures precise editing of tapes. Features automatic eject, recording level meters, sliding volume controls for each channel for easier recording, fast forward and pause controls. Track indicator lights. Response: 30-15,000 Hz. Wow/Flutter, 0.25%. Walnut case. 17 $\frac{3}{8}$ x 4 $\frac{1}{2}$ x 10 $\frac{1}{2}$ ". For 117 VAC. **RA-814J.** Shpg. wt. 19 lbs. **219.95**

219⁹⁵



Record/Play Stereo Cassette Deck

Model 4770. Has Dynamic Noise Suppression, equalization for standard and high performance tapes, locking pause control, memory rewind, input mixer, plus high-density ferrite heads for response of 50-15,000 Hz (± 3 dB). Wow/Flutter, 0.2%. With audio cables, dust cover. Walnut case. 16 x 5 $\frac{1}{8}$ x 10 $\frac{1}{8}$ ". 117 VAC. **RA-812J.** Shpg. wt. 11 lbs. **219.95**

219⁹⁵



Wollensak 3M COMPANY

High-Performance Cassette Deck with Dolby* System

- **Dolby Noise Reduction Circuit**
- **Equalization for "High-Energy" Tapes**

279⁹⁵

You'll Get Quality Comparable to Reel-to-Reel Tapes!

Model 4780. Dolby Noise Reduction Circuit lets you record with improved response, lower noise. Features equalization switch for standard or high energy tapes. Has master recording level control, individual channel input level control. End-of-tape shut-off, au-

tomatic Stop return. Pause lock, record indicator light, dual VU meters assure recording accuracy. Response: 30-15,000 Hz using high energy tape. Wow/Flutter, 0.18%. With cables, dust cover. Walnut case. 117 VAC. **RA-813J.** Shpg. wt. 23 lbs. **279.95**

*Dolby is a Trademark of Dolby Laboratories, Inc.

Complete Your Stereo with An Olson Add-On

Olson Full-Fidelity Stereo Cassette Record and Play Deck with "Pro" Features and Reliability

- "Studio Style" Slant-Front Panel for Easy Access to All Controls
- Dual VU Meters and Level Controls Assure Precise Recordings
- Front Panel Microphone Jacks for "Live" Stereo Recordings

Model 959. Sensational low price for a stereo cassette record and play deck that's loaded with features like this one! Pushbutton tape function controls for positive action, 3-digit tape counter for really easy editing, pop-up cassette eject mechanism, slide-type level control for each stereo channel. Has a noise filter to assure quiet recordings, a mike/source monitor switch so you can compare the recorded signal with the signal source instantly while you record. Mix switch offers mixing capability in record mode. Separate power on-off button so you can set controls just once and be "record ready" immediately. The "studio style" slant front panel is very impressive, controls are "people" engineered for easy use. Hooks up easily to the "tape in" jacks on your receiver or amplifier. Good-looking walnut veneer base, striking black panel. 8¼ x 5½ x 16½". For 117 VAC.

RA-959J. Shpg. wt. 8½ lbs. **89.98**



89⁹⁸

Dynamic Mikes

For use with 959. With stands and cables. 1 lb. MK-059J. Pr. **6.98**



6⁹⁸ PAIR

Low-Priced Home Stereo 8-Track Cartridge Deck



29⁹⁸

- Easy Hookup, Great Sound

Model 689. Add it to your stereo system for full-fidelity playback of pre-recorded 8-track stereo cartridges. Has automatic or manual program selection, lighted program indicators, hinged cartridge door to protect tape head from dust and dirt. Instant power — insert cartridge to turn it on, remove to turn it off. With cables for easy hookup to the aux. inputs of your stereo system or console. 8½ x 4¾ x 9". For 117 VAC.

RA-689J. Shpg. wt. 10 lbs. **29.98**

Record 8-Track Stereo Cartridges At Home for Playback Through Your System or Car Tape Player

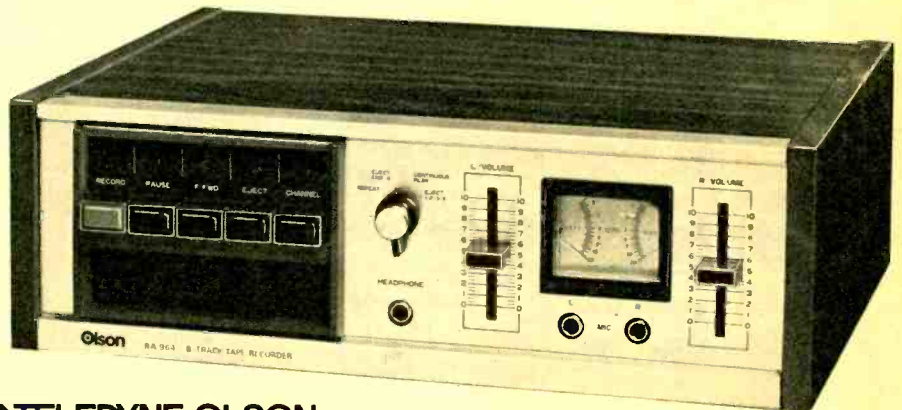

TELEDYNE OLSON

129⁹⁸

- Lighted VU Meters and Slide-Type Level Controls for Each Stereo Channel
- Repeat Switch for Single Program Play

Model 964. Great way to record your favorite music — in just the sequence you desire — for playback through your stereo system or on an 8-track car stereo player. Has pushbutton function controls, slide-type level controls for precise adjustment of record levels, lighted VU meter for each stereo channel. Repeat switch lets you play a single program again and again, also has automatic or manual program change in playback mode. Has tape eject selector for both record and playback

modes — lets you stop and eject cartridge after each individual program or at end of tape. Has front panel microphone inputs for "live" stereo recordings with optional mikes, back-lighted "computer-style" program indicators. Handsome walnut-finish cabinet, and brushed aluminum panel make it a stylish addition to your stereo system. With hookup cables. 4¼ x 14 x 10¼". 117 VAC. RA-964J. Shpg. wt. 11½ lbs. **129.98**
MM-333J. Stereo Mike Kit. Wt. 6 lbs. **29.98**

Compact Stereo and 4-Channel Music Systems



Quality Systems That "Put It All Together," Yet Sound Like "Separates"



- AM/FM Stereo Receiver
- 4-Speed Record Changer
- 8-Track Tape Player
- Two Wide-Range Speakers

179⁹⁵

40-Watt Stereo System

Model DXT-5211. Versatile entertainer brings you great sound and style to match! Has slide-rule volume, balance and tone controls, slide-rule tuning with stereo FM light. Garrard 4-speed record changer has cueing control, stylus pressure adjustment; the 8-track tape player features "performance engineered" tape transport, automatic or manual channel selection, continuous play capability. Each wood-sealed speaker system has 8" woofer, whizzer cone and Sanyo's exclusive multi-directional tweeter. There's even matrix circuitry for derived 4-channel sound when you add a pair of speakers. Tinted dust cover. 17 x 8 x 14", each speaker, 11 $\frac{1}{8}$ x 17 $\frac{3}{8}$ x 7 $\frac{3}{8}$ ". 117 VAC. RA-042J. Shpg. wt. 31 lbs. 179.95



- AM/FM Stereo Receiver
- Record & Play Cassette Deck
- Automatic Record Changer
- Two Wide-Range Speakers

219⁹⁵

25-Watt Stereo System

Model GXT-4510. Listen to AM, FM stereo or records—make great sounding cassette tapes as you do! Has a 4-speed automatic record changer, dual wide-response stereo speakers, even a built-in matrix circuit so you can enjoy derived 4-channel sound when you add a pair of speakers. Pushbutton cassette record/play deck includes record level monitor for exact recordings, automatic stop at end of tape. Also has tone control, stereo headphone jack, AM ferrite and FM line cord antennas, dust cover. Additional inputs and outputs for 8-track or reel-to-reel tape deck. Receiver, 19 $\frac{1}{16}$ x 8 $\frac{1}{16}$ x 14 $\frac{3}{4}$ ", each speaker, 9 $\frac{1}{4}$ x 11 $\frac{3}{8}$ x 5 $\frac{1}{16}$ ". 117 VAC. RA-041J. Shpg. wt. 31 lbs. 219.95



259⁹⁵

- Four Power Amplifiers
- Four Bookshelf Speakers

40-Watt Discrete 4-Channel System

Model GTX-4831. All the 2 and 4-channel entertainment you need, including an 8-track cartridge player that handles the discrete Q8 4-channel cartridges, and a matrix decoder circuit that gives you derived 4-channel sound from all 2-channel sources, plays matrixed SQ records too. Has inputs for 4-channel playback from reel-to-reel tapes—Sanyo stereocast recorders too. The AM/FM stereo receiver has slide-rule tuning and stereo light, the 4-speed record changer has cueing and pause control, the acoustic-suspension speakers fit nicely on bookshelf or floor. Receiver 10 x 15 $\frac{1}{2}$ x 7", each speaker, 11 $\frac{1}{8}$ x 17 $\frac{3}{8}$ x 7 $\frac{3}{8}$ ". 117 VAC. RA-043J. Shpg. wt. 42 lbs. 259.95



279⁹⁵

- 2-Channel Cassette Record/Play Deck
- 4-Way "Spatial Control" Balance

40 Watt Discrete 4-Channel System

Model GXT-4621. Listen to 4-channel sound from any discrete or matrixed source—record full-fidelity 2-channel stereo cassettes for derived 4-channel playback! Has 4-speed record changer, four separate power amplifiers, inputs and outputs for reel-to-reel or 8-track cartridge tape deck, high-sensitivity AM/FM stereo receiver. Pushbutton cassette deck has record level meter and tape counter. There are master volume and tone controls—plus "Spatial Control" for individual adjustment of all four amplifiers. Includes dust cover, mike with stand. Receiver, 19 $\frac{1}{2}$ x 9 $\frac{1}{2}$ x 14 $\frac{1}{2}$ ", each speaker, 9 $\frac{1}{4}$ x 11 $\frac{3}{8}$ x 5 $\frac{1}{16}$ ". 117 VAC. RA-044J. Shpg. wt. 41 lbs. 279.95

Take-Along Cassette Recorders from SANYO



29⁹⁵ speakers
extra

Car Stereo Amplifier

- Use Sanyo's Stereocast Portable Recorders in Your Car

Model FT-800. Mount this compact unit in your car, add a pair of speakers and you'll get "double duty" from any Sanyo stereocast portable tape players. Has separate slide-type volume, tone and balance controls, on-off switch with pilot light. 15 watts power. 5 x 2 x 6 1/4". For 12 VDC neg. ground. RA-051J. Shpg. wt. 2 1/2 lbs. 29.95



1
34⁹⁵

1 Portable Cassette Recorder

Model M-2200. Great choice for the recordist on a budget! Features highly reliable lever-operated control system, earphone monitor jack, built-in 4" speaker. 3-way power—batteries (not included), AC, 12 VDC negative ground. Automatic Recording Control circuit smooths out response for even voice recordings. With remote start-stop mike, blank cassette. 10 x 2 3/4 x 8 1/2". Uses 6 "C" cells. RA-744J. Shpg. wt. 4 lbs. 34.95

2 Recorder with Built-In Condenser Mike

Model M-2212. Compact pushbutton cassette recorder has 3-way power—batteries, AC or 12 VDC neg. grd., Sanyo manufactured precision tape transport for excellent alignment and constant tape speeds, extra-large speaker for outstanding sound quality, automatic end-of-tape shutoff which releases tape mechanism. Built-in condenser mike makes it great for dictation, lectures, etc. Includes AC adapter, blank cassette, 5 3/8 x 2 3/4 x 9 7/8". Uses 4 "C" cells. RA-049J. Shpg. wt. 5 lbs. 39.95

3 Deluxe Battery/AC Condenser-Mike Recorder

Model M-2213. For business-people on-the-go, it's the ideal way to record conferences, meetings, conversations and keep a "living" record of what happens. Has automatic recording control that prevents blasting and fading, precision tape transport that keeps head aligned and recorder "on-speed" at all times, full-range volume and tone controls, input for auxiliary microphone. There's a built-in pause control that stops the tape when you want to—saves tape, lets you be instantly ready to continue recording. Input for aux. mike too! Rugged high-impact case with slide-in/slide-out carrying handle. 5 3/8 x 2 5/8 x 10 3/8". Uses 4 "C" cells. RA-050J. Shpg. wt. 6 lbs. 44.95

4 Stereocast® Portable Cassette Recorder

Model M-4200A. Features Sanyo famous Stereocast output jack — with the addition of the Stereocast adapter (page 222) the M-4200A does all this—plays stereo cassettes through any 8-ohm headset, plays stereo cassettes in your car with the FT-800 above, doubles as a stereo tape deck when used with your home system. Has Automatic Recording Control, pushbutton operation, high/low tone control, automatic shutoff. With remote start-stop bar mike, pouch, blank cassette, AC cord. Uses 4 "C" cells. 10 1/2 x 7 x 3 1/4". RA-747J. Shpg. wt. 4 1/2 lbs. 59.95

5 Deluxe Stereocast Recorder

Model M-4210. Has all the features you need for easy and enjoyable cassette recording—built-in condenser mike, record indicator light, automatic shutoff and pause control, battery level meter. Built-in 4" speaker for excellent sound quality. Has Sanyo's famous stereocast feature, battery, AC or 12 VDC neg. grd. three-way power. With AC cord, carrying pouch, blank cassette. 10 1/4 x 6 x 2 1/2". Uses 4 "C" cells (not included). RA-748J. Shpg. wt. 4 1/2 lbs. 69.95



39⁹⁵



44⁹⁵

Record the FUN
on great-sounding
cassettes!



59⁹⁵



69⁹⁵

SANYO Quality Recorders for Home or "Away"



79⁹⁵

- **Stereocast® Feature**
- **Battery / Home Power, 12 VDC Adaptable**

Cassette Recorder/AM/FM Radio

Model M-4410A. Tunes AM and FM radio (FM stereo with adapter below), makes great sounding cassette tapes. Has Automatic Recording Control circuit, high/low tone control, monitor, auto shutoff, stereo radio and tape outputs. With remote-control mike, blank cassette, AC cord. Less batteries. 11¼ x 8 x 3". Use 4 C cells.

RA-750J. Shpg. wt. 6 lbs. **79.95**
 RA-059J. Stereocast FM Adapter for Above. See page 222. **11.95**



99⁹⁵

- **Stereocast® Feature**
- **Records Directly from Radio or Mike**



8-Track Recorder/FM-AM Radio

Model M-8400. It's a deluxe 8-track cartridge player and recorder, it's a fine-quality AM-FM radio (stereo with adapter below). Plays tapes in mono through the built-in speaker, stereo through the headphones (included!) or your home/car music system. 3-way power—batteries, 12 VDC adaptable, AC. 11½ x 7½ x 3½". Use 6 "D" cells.

RA-753J. Shpg. wt. 6½ lbs. **99.95**
 RA-725J. Stereocast FM Adapter for Above. See page 222 . . **11.95**

Dolby* System Cassette Decks

* Dolby is a Trademark of Dolby Laboratories Inc.



239⁹⁵

High-Performance Cassette Record/Play Deck

- **"Performance Engineered" Servo-Control Tape Drive**
- **"Super-Ferrite" Tape Heads for Flat Response**

Model RD-4250. An excellent choice for the serious home recordist. The Dolby Noise Reduction System cuts tape hiss way down, lets you make stereo cassette recordings with quality that approaches the finest reel-to-reel equipment. Has easy-to-read "Pro-type" VU meters, 7 pushbutton function controls including pause and cue for really easy editing. Adjustable equalization for standard, high energy cobalt or chromium-dioxide cassettes. Automatic end of tape stop disengages mechanism completely. Sanyo's special "Super-Ferrite" tape heads are designed for ultra-flat response of 20-15,000 Hz. Wow/Flutter, .2%. Good looking walnut wood case with aluminum panels. 17 x 5 x 9". For 117 VAC.

Shpg. wt. 12 lbs. **239.95**



259⁹⁵

Deluxe "Studio Style" Record/Play Deck

- **"Tilt Up" VU Meters for Really Easy Reading**
- **Digital Counter with Automatic "Memory" Rewind**

Model RD-4300. Has all the quality features of the model at left, plus the refinements that make it a precision high-fidelity instrument giving you cassette recordings that rival the original signal source. Sanyo's Servo-drive mechanism assures 99.8% speed accuracy regardless of AC line voltage variations. The built-in memory counter lets you program it for rewind to the exact point at which your recording started. Has separate record and playback level controls, adjustable bias equalization, convenient pushbutton function controls including cue and pause. "Super-Ferrite" tape heads. 40-15,000 Hz frequency response; S/N, 50 dB with Dolby "On". Walnut wood case. 17 x 5 x 9". For 117 VAC.

RA-053J. Shpg. wt. 14 lbs. **259.95**

More Sanyo Recorders—Choose Stereo or Mono

49⁹⁵

- Home/Car/Battery Power
- Automatic Record Level

Go-Anywhere Portable Cassette Recorder

Model M-2210A. Convenient pushbutton recorder is great for students, business people—makes fine quality cassette recordings of lectures, meetings, etc. 3-way power—batteries, AC or car adaptable, so you can use it anywhere. Features automatic recording control that smoothes out response for fine voice recordings, ear-phone/extension speaker jack. With remote start-stop mike, mike pouch, cassette. 10½ x 6½ x 2¾".

RA-745J. Shpg. wt. 4¾ lbs. **49.95**



89⁹⁵

- Play-Anywhere Home/Battery/Car adaptable
- ## Deluxe Cassette Recorder/AM/FM Radio

Model M-4420. Has all you need for fine cassette recordings anywhere, FM and AM radio too. Built-in condenser mike, Automatic Recording Control circuit, monitor, pause control, dual output (plays stereo with adapter below), battery meter. Pushbutton tape function controls, easy cassette loading. Operates on batteries 4 "C" cells (not included), AC or 12 VDC adaptable. With cassette, AC cord. 11½ x 7½ x 3¼".

RA-751J. Shpg. wt. 6 lbs. **89.95**

RA-725J. Stereocast FM Adapter for Above. See page 222 . . . **11.95**



59⁹⁵

Car/Home/Battery Power

Portable Mono Player/Home Stereo Deck Stereocast 8-Track Tape Player

Model M-8200. Versatile entertainer lets you enjoy pre-recorded 8-track stereo cartridges monophonically through its built-in speaker, *in stereo* through the headphones (included) or when you hook it up to your home music system. Has dual output level controls, slide-in cartridge loading, rugged high-impact case with fold-down carrying handle. 3-way "play" power—batteries, 6 "D" cells (not included), 117 VAC or 12 VDC adaptable. 11½ x 7½ x 3½".

RA-752J. Shpg. wt. 6¾ lbs. **59.95**



279⁹⁵

- Dolby Noise Reduction System
 - Seven-Button Tape Function Control Panel
- ## Sanyo's BEST Dolby System Cassette Deck

Model RD-4350. Has EVERY feature for "pro-quality" stereo cassette recording. Servo-Drive tape transport mechanism provides 99.8% speed accuracy despite AC line voltage variations. Adjustable recording bias lets you use ANY kind of cassette tape—regular, cobalt-energized, chromium dioxide. There's a separate pushbutton that "tilts up" the VU meters for easy viewing, separate level controls for recording and playback, tape counter with memory wind, cue and pause pushbuttons for real editing convenience. Mechanical auto-stop disengages entire tape mechanism from tape. Sanyo's "Super-Ferrite" tape heads provide ultimate response from 40-15,000 Hz, 50 dB S/N with Dolby noise reduction. Wood enclosure, 17 x 5 x 9". For 117 VAC.

RA-107J. Shpg. wt. 15 lbs.



part
und
than
109-5
244

Prices in catalog 740 are in compliance with government regulations prevailing at the time of its preparation. If a subsequent price reduction is made on any merchandise you order from this catalog, you will promptly receive a refund for the difference in price. In the event of a price increase on any merchandise you order, we will not ship without your consent.

MR. T JONES
716 POLK ST
LYNCHBURG, VIRGINIA 24504

Superstars of 1974 . . . 244 pages of the latest and greatest for the electronics in your life

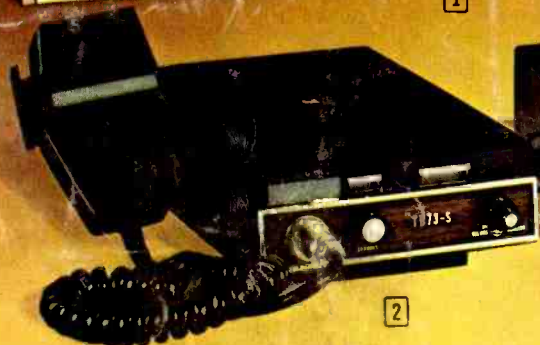

1 Make the **Teledyne AM-473 Discrete 4-Channel Amplifier** the "heart" of your music system. It's the most versatile amplifier-preamplifier in its category. Handles any kind of discrete or matrixed 4-channel sound—provides twice the rms power for stereo. 60 watts rms 4-channel output. **AM-473J, 179.98** See page 46.

2 Install this **23-Channel Mobile CB Radio** in your car for reliable two-way communications. Has volume, adjustable squelch, crystals for all channels, coiled cord mike. Extraordinary performance. 12 VDC negative ground. **CB-366J, Shpg. wt. 6 lbs. 119.98**

3 Put the **Olson 334 8-Track Stereo Cartridge Player/High-Sensitivity FM Stereo Radio** in your car and add a pair of speakers for "Concert-Hall" motoring. It mounts under-dash in most 12 VDC vehicles, and it's easily less than half the price of a factory-installed model. **AU-334J, 119.98. See page 141.**

4 Get beautiful extended-range sound for your custom installation with this **12" Coaxial High-Fidelity Speaker**. Capable of reproducing 23-20,000 Hz in proper enclosure. Unbeatable sound per dollar! **SS-284J, 29.98. See page 67.**

5 The **Summit SE88M Pocket Calculator** is a "little genius" with additional features including floating or fixed decimal, square root function, automatic algebraic logic, sign-change key, memory, 8-digit readout with 16-digit capacity. **XM-185J, 139.95. See page 101.**

6 "Small but smart" is how we describe the all-electronic **MITS 1206 Pocket Calculator**. Performs all four arithmetic functions, shows true credit balance, has preset decimal with automatic round-off, long battery life. 12-digit answer capacity with 6-digit readout. **XM-108J, 59.95. See page 99.**