

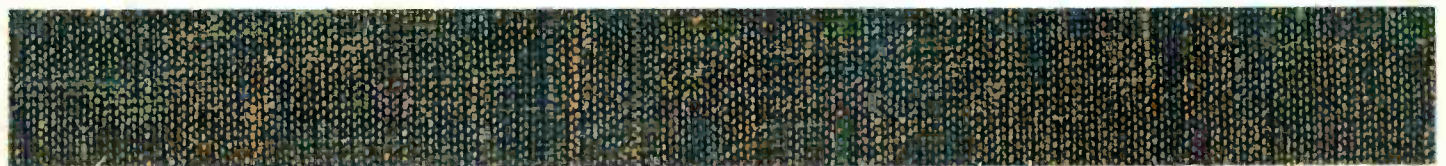

Broadcast Equipment

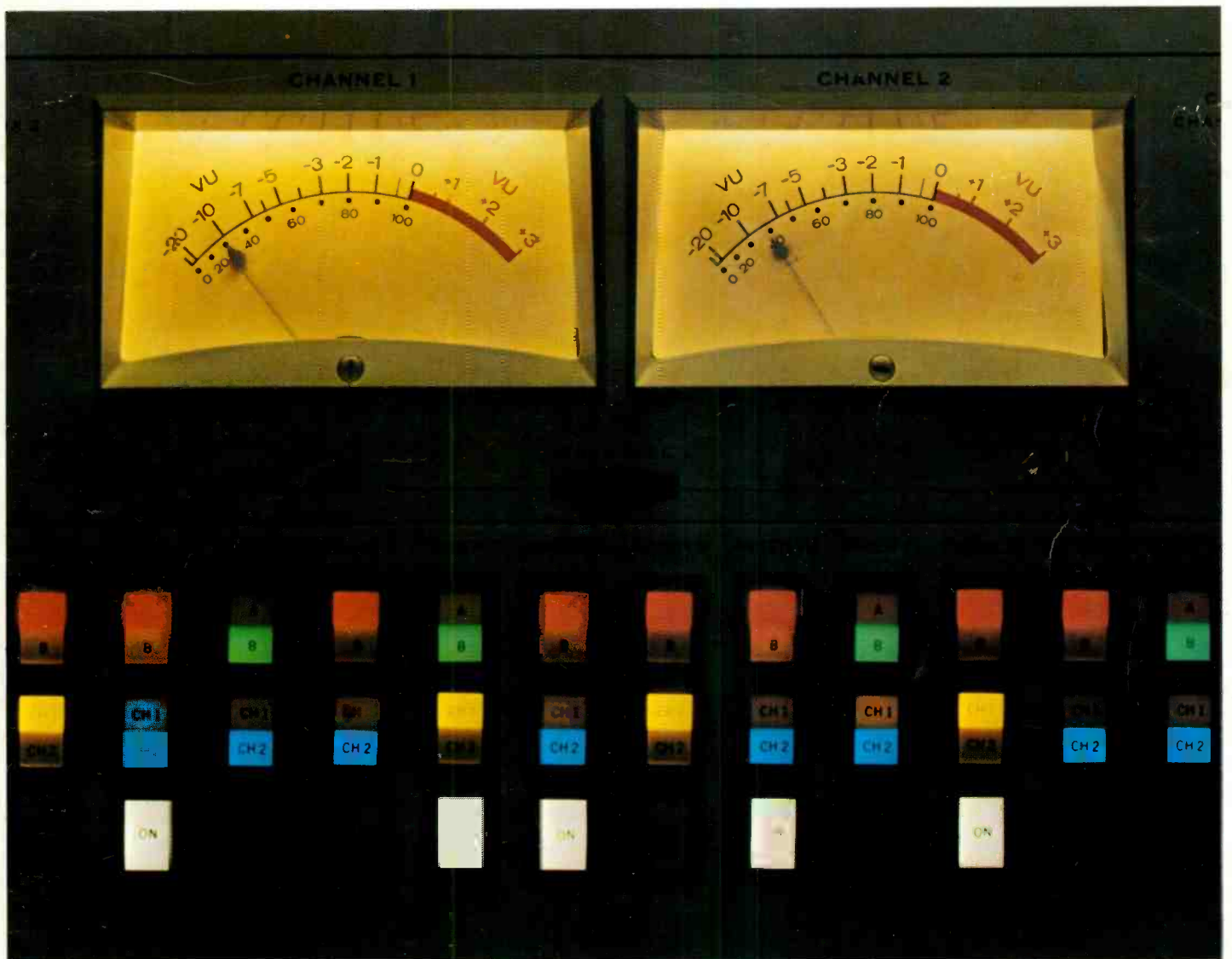
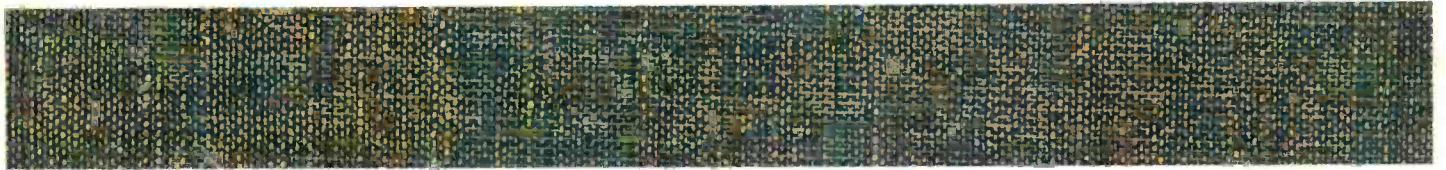

Collins Broadcast Equipment Catalog No. 46

Table of Contents

Collins Radio Company.....	2
AM Transmitters	5
FM Transmitters	13
FM Antennas	30
Audio Equipment	36
Audio Accessories	62
Remote Equipment	71
Measuring-Monitoring-Remote Control	75
Tables-Charts-Graphs	83
Index by Description.....	104
Index by Type Number.....	105
Sales Policy	107



Equipment descriptions in this catalog are condensed so that the complete line of broadcast units supplied by Collins Radio Company can be shown. For more information on any of these units, you are invited to contact your Collins Broadcast Sales Engineer or Collins Radio Company, Broadcast Marketing, Dallas, Texas.

Customers in countries other than the United States are invited to contact the nearest International Sales Office or Collins International Division, Dallas, Texas.

All specifications contained within are subject to change without notice.

Collins Radio Company

Collins Radio Company is an international electronics corporation combining communication, computation and control equipment into total systems which acquire, transfer, store, extract, process and condense information for man's use.

Collins produces more than 1000 products at manufacturing facilities in Dallas, Texas; Cedar Rapids, Iowa; Newport Beach, California; and Toronto, Ontario. Sales and service facilities are maintained at key points throughout the world.

Company activities include research, development, manufacture and product support in the areas of avionics, space tracking and communication, broadcasting, microwave, scatter, high frequency long-range equipment, antennas, components, and computer and data transmission systems.

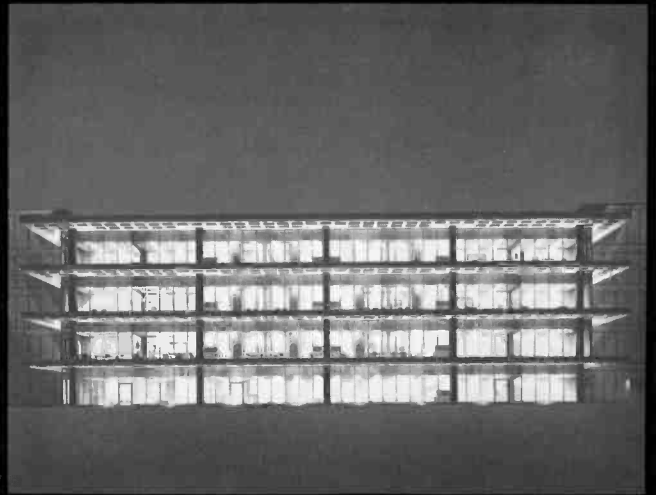

Administration Building and Corporate Offices, Dallas, Texas

To meet worldwide requirements of business, industry and government, Collins produces communication, computation and control systems in the following areas:

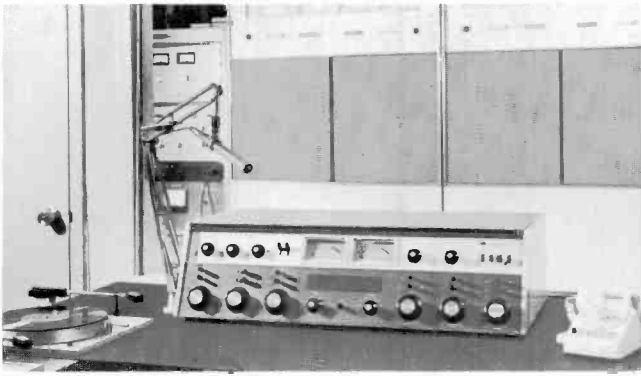

Broadcast

Collins offers a wide range of AM and FM broadcast equipment, including a complete line of transmitters from 250 to 20,000 watts. The Collins broadcast product line includes all equipment needed to go on the air — from microphones to antennas.

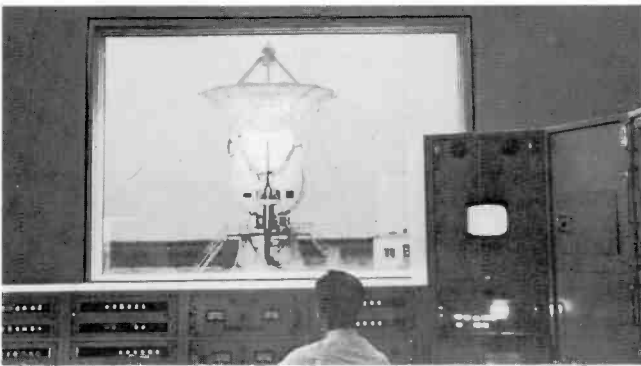

Space Tracking and Communication

Collins contributions to the U. S. space efforts include communication and tracking equipment aboard spacecraft and at ground tracking and range installations.

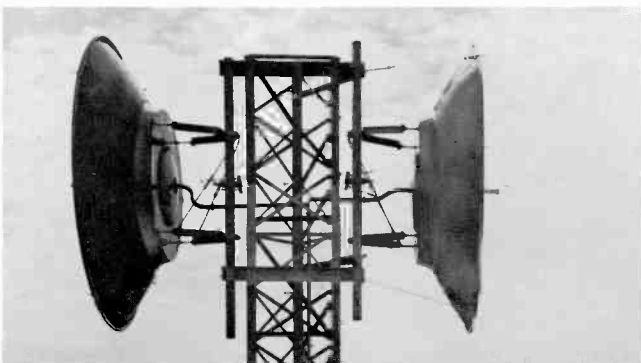

Telecommunication

Collins is one of the largest world suppliers for telecommunication, including microwave and tropospheric scatter systems. Collins total systems engineering capability provides construction of buildings, roads, bridges, towers and antennas, power plants, and other facilities required for the operation of a complete telecommunication system.

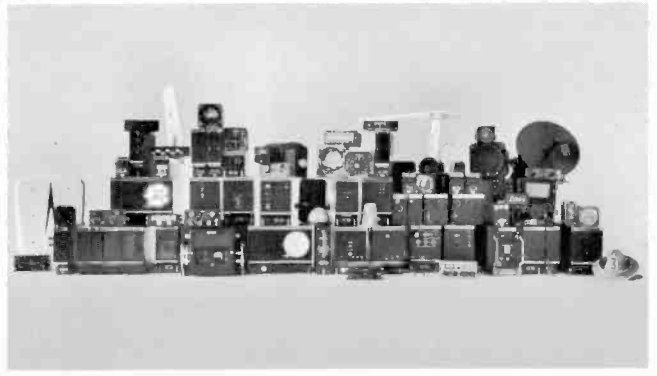

Avionics

Collins supplies the most complete line of avionics equipment and systems available to the aviation industry. More than 75 percent of all aircraft operated by the world's major airlines carry Collins avionics systems.

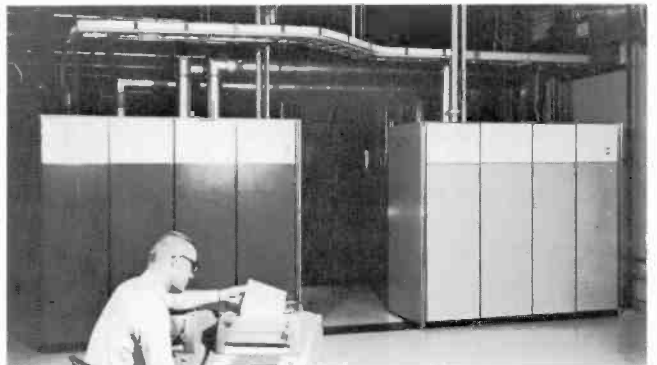

HF Long Range Systems

Collins offers a line of completely integrated, automatic fixed station and transportable single sideband systems for worldwide communication. Both fixed station and transportable single sideband units made by Collins are in use today by free-world industries operating in remote areas.



Data Systems

An important segment of the company's activity includes the design, development and manufacture of data communication and processing equipment and systems for industry. Collins computerized message processing centers are in daily operation around the clock handling message traffic for airlines and railroads in the United States, Canada and Europe.

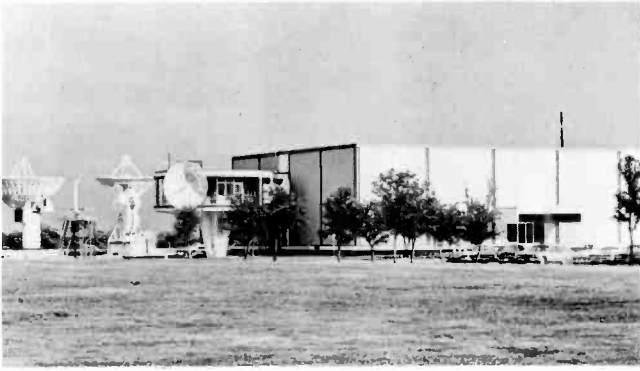

Antennas

Housed in a specially designed laboratory at the company's Dallas, Texas, site to ensure year-round research capability, Collins engineers have developed a complete line of ground, fixed station and transportable, airborne, and space antennas.

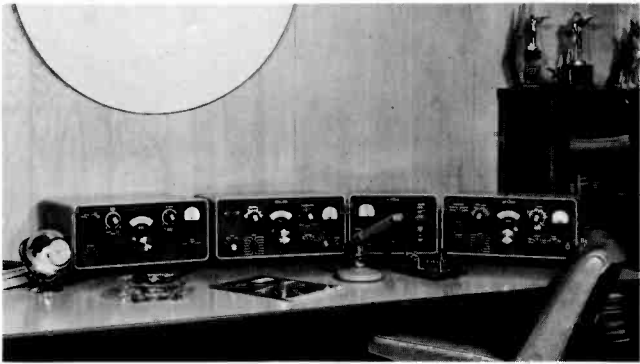

Amateur

Collins continues to offer to the world-wide fraternity of amateur radio operators the best equipment available. Many governmental agencies, including civil defense organizations, specify Collins high quality amateur radio equipment for use in their official operations.

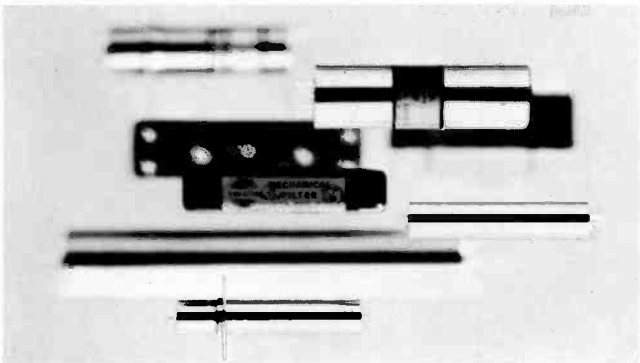

Components

Collins manufactures high quality mechanical filters, crystal filters, and magnetic products.

Collins efforts in all phases of communication have resulted in significant contributions toward advanced and reliable systems. The design and performance of these systems are a direct result of Collins depth of experience and broad diversification in the field of communication.

AM
Transmitters

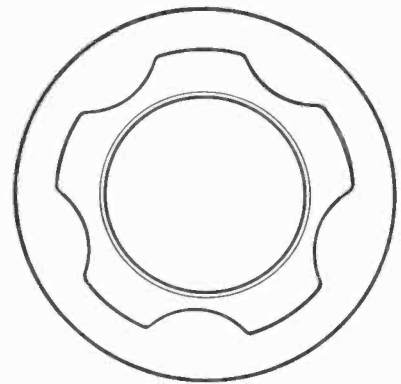

COLLINS 820D-1 1-KW AM TRANSMITTER

The Collins 820D-1 1-kw AM transmitter is designed for reliable high fidelity broadcasting at any specified frequency from 540 to 1600 kHz.

The new 820D-1 has many features that make it one of the most advanced transmitters on the market. Many proven techniques, together with maximum use of silicon semiconductors in the power supplies and low level rf and audio stages, result in a high degree of reliability and a reduction in size, weight, and power consumption.

Frequency source for the 820D-1 is the type 310W-1 Exciter. The rf driver is solid state and consists of a single transistor. The stage is operated class C in a common-emitter configuration for high-gain capability and reasonable input impedance. The power amplifier is designed to deliver 1100 watts at the output terminal. The plates are modulated conventionally by a transformer-coupled modulator in conjunction with a modulation reactor. Power cut-back to either 500 or 250 watts is possible by reduction of plate voltage. The PA uses two 5-500A tubes.

The output network design consists basically of a 3-node filter, with inductive coupling between nodes. The proper bandpass response is attained by the selection of node Q distribution and provides for essential flat response of the modulated transmitter output signal.

Two push-pull driver stages amplify audio signals to drive the modulator. Both stages are common emitter for good gain and high input impedance. Feedback from the plates of the modulator tubes is applied to the input of the first driver stage. Two Eimac 5-500A pentodes are employed in class AB, push-pull operation to supply modulating voltage to the power amplifier.

Maintenance meters are provided for measuring power amplifier plate voltage and power amplifier plate current.

Power supplies are of conventional design and all are silicon solid state.

Control circuits have been simplified as much as possible consistent with safety and reliability. Provisions are made for both direct digital control and optional remote control.

Direct digital control is accomplished with five push-button switches. These are Filament Off, Filament On, Plate Off, High Power On, and Low Power On. Operation of the High or Low Power On switch to apply full or reduced power, respectively, will energize the transmitter completely, including application of rf signal. A separate Filament On function is provided to allow independent filament operation. No time delays are used. Power change between full power (1000 watts) and reduced power (500 watts or 250 watts as customer specifies) is accomplished by depressing the proper control pushbutton. Interlocking is provided to eliminate the necessity of separately deenergizing the transmitter before changing power. The Filament

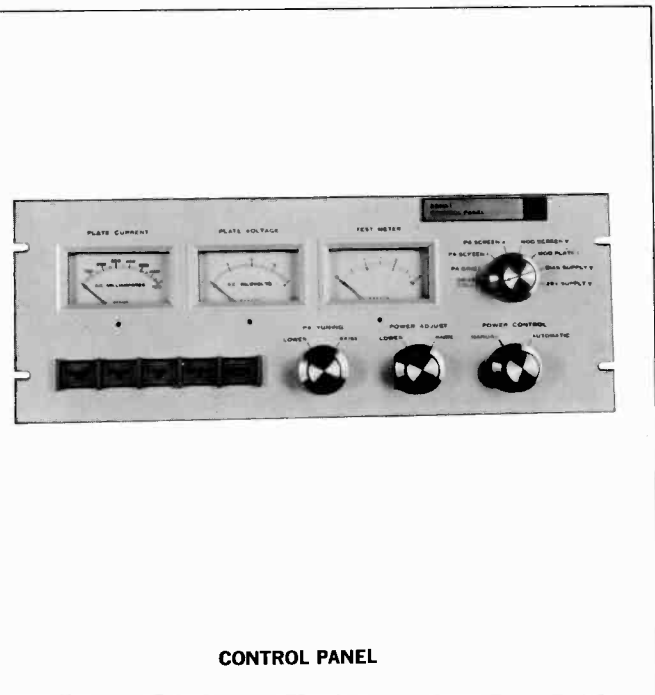

CONTROL PANEL

Off switch, when depressed, deenergizes the transmitter completely, including removal of filament voltage and cooling air. No postoperative tube cooling is necessary. A 50-foot cable is supplied with the control panel, allowing the control panel to be located in a control console or supervisory control room away from the transmitter.

Remote control can perform the following functions: Filament Off, Filament On, Plate Off, High Power On, Power Increase/Decrease, and Remote Control Fail-Safe.

Also provided are samples of plate voltage and current, which are brought out to a terminal board to be used for remote metering.

Options for the 820D-1 include a remote control unit, automatic output-power control, and filament regulation control.

RF Input: 50 ohms unbalanced, 2 watts, 24 volts peak-to-peak, nonsinusoidal from type 310W-1 Exciter

RF Output: Power output capability is 1.1 kw into a 50-ohm unbalanced load. Facilities for reduced power operation are provided at either 550 or 275 watts. Other unbalanced output impedances can be supplied on special order.

Emission: Amplitude modulation (A3)

Harmonics: 73 db below carrier, maximum

Frequency Range: 540 to 1600 kHz

Frequency Stability: Determined by type 310W-1 Exciter, ± 10 Hz, -10° to $+45^\circ\text{C}$

Audio Input: $+10$ dbm ± 2 db

Response: ± 1 db from 100 to 7500 Hz, ± 2 db from 50 to 10,000 Hz (typical ± 1 db from 30 to 1000 Hz)

Distortion: Less than 3% (typical 2%) from 50 to 7500 Hz for 95% modulation

Carrier Shift: Less than 3% from 0 to 100% modulation

Hum and Noise: 60 db below 100% modulation

Type of Service: Continuous duty, attended or unattended, local or remote control

Ambient Temperature Range: -25° to $+45^\circ\text{C}$

Ambient Humidity: Up to 95% relative humidity

Altitude: Up to 7500 feet

Power Requirements: 208/230/240 volts $\pm 5\%$, 50/60 Hz, single phase

Filaments: 0.4 kw, 90% PF

Carrier: 2.2 kw, 90% PF

30% Modulation: 2.5 kw, 90% PF

100% Modulation: 3.4 kw, 90% PF

Size: 69 in. H by 41 in. W by $23\frac{1}{8}$ in. D (175 cm H by 104 cm W by 59 cm D)

Weight: Approx 1100 lb (500 kg)

Part No. 522 3391 (820D-1)

Part No. 771 9085 001 (Automatic Power Control)

Part No. 771 9009 001 (Remote Control Module)

Part No. 771 9008 001 (Filament Voltage Regulator)

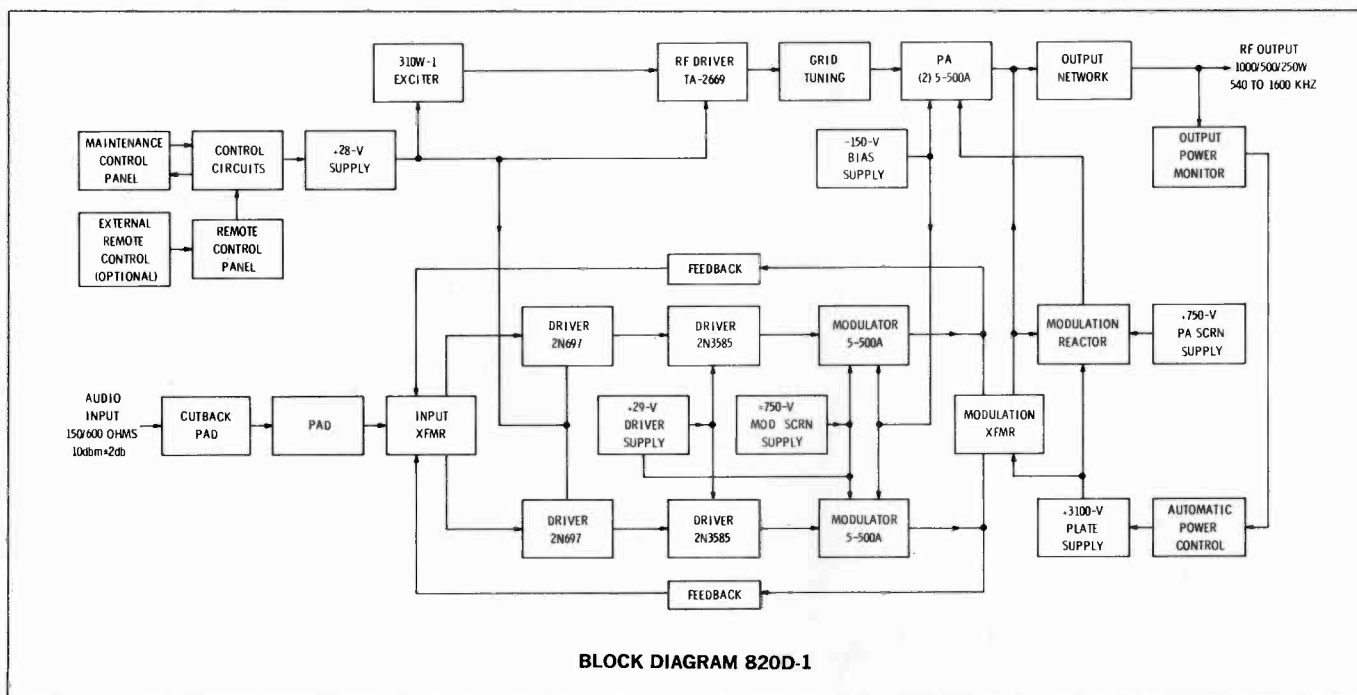

BLOCK DIAGRAM 820D-1

COLLINS 820E/F-1 5/10 KW AM TRANSMITTER

The Collins 820E/F-1 is the most extensively transistorized transmitter in the 5/10 kw power range. It features solid-state devices in the low-level audio and driver, the power supply circuits and the rf exciter.

This new exciter has a highly stable ovenless crystal operating in the 2.1- to 4.3-MHz range, with division to standard broadcast frequency by thin-film components.

The 10-kw model, shown below, uses six tetrode vacuum tubes in the rf driver, power amplifier, and modulator circuits, but requires only two tube types. The 5-kw model uses one less tube in the final rf amplifier.

Tuning of Collins new 820E/F-1 is automatic. A phase-comparator circuit in the power amplifier stage automatically controls the PA tuning as loading is adjusted. Since the tuning capacitor is at a higher network impedance point and since it requires less padding capacitance than the loading capacitor, tuning correction is fast enough to take place well within the time required for loading changes.

Collins designed this new transmitter for easy, space-saving installation, as well as extended reliability. It measures just 69 in. H by 67-7/16 in. W and 32 in. D. All power supply components are completely self-contained.

For attended operation such as a combination station, all metering and control of the transmitter is accomplished from a separate extended control panel, which requires no remote control authorization. All meters, controls, and status indicators necessary for monitoring performance of the transmitter are housed at the extended control panel. When operating rules permit completely unattended operation without transmitter log, the 820E/F-1 will be immediately adaptable to that concept without rebuilding or

modification. It is truly the transmitter for both the present and the future.

EXTENDED CONTROL PANEL

The transmitter is suitable for installation at an unattended site and may be remotely controlled from a distant studio location in the conventional manner. As a convenience for attended operation and maintenance, all meters, operating controls, and status indications are grouped on a 12¼ by 19 inches extended control panel supplied with 50 feet of multiconductor shielded cable for connection to the transmitter. All controls necessary for normal operation of the transmitter can be made from the extended control panel.

RF EXCITER

An all solid-state unit, the type 310W-1 exciter offers increased frequency stability through operation of the oscillator at two or four times the output frequency. Division to standard broadcast frequencies is obtained by digital circuitry employing thin-film components. The exciter is normally located externally to the transmitter and supplies drive through a coaxial cable. Fifty feet of interconnecting cable is furnished with the exciter, but the unit may be located up to 250 feet from the transmitter if desired.

RF DRIVER

The rf driver uses two 6146B tubes in parallel, operating Class C. Tuned-grid, tuned-plate circuits are used, with the frequency monitor sample derived from the plate tank coil. Driver modulation is not employed except for the partial modulation that occurs because of changes in the PA grid impedance over the audio cycle.

OUTPUT NETWORK

Conventional low-pass L-sections transform the 50-ohm nominal output impedance to 1000 ohms plate impedance

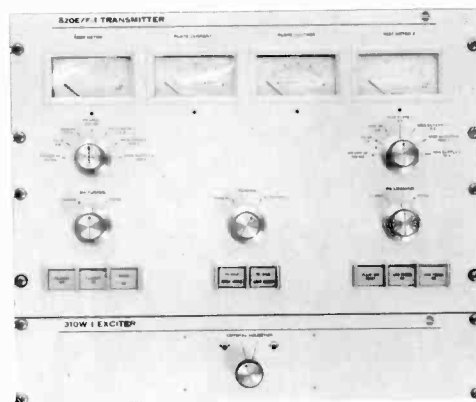

EXTENDED CONTROL PANEL
AND CRYSTAL OSCILLATOR EXCITER

for the 10-kw transmitter, and to 2000 ohms for the 5-kw version.

The combined network consists of three series inductances and three shunt capacitances, plus a second harmonic shunt trap to ground. Overall phase shift through the networks is -360° , giving a favorable plate impedance characteristic when operating into loads within the EIA limit for "normal" loads.

Motor-driven variable vacuum capacitors are provided in the PA tuning and loading positions—controllable from switches on the extended control panel. PA loading is used to adjust transmitter power output and is normally extended to the remote point in remotely controlled installations.

A phase-comparator circuit is used in the PA stage to automatically control the PA tuning motor as loading is adjusted. Because the tuning capacitor is at a higher network impedance point and requires less padding capacitance than does the loading capacitor, tuning correction will occur at a more rapid rate, and within the time required for loading changes. The tuning function is not normally extended to the remote control point, and to assure fail-safe operation, the automatic tuning adjustment is disabled until loading changes take place. A Manual/Automatic Tuning switch is provided on the extended control panel to disable the automatic mode during maintenance checks.

Frequency Range: 540 to 1600 kHz

Power Output: 820E-1 5500 watts (1100 watts reduced power) 820F-1 10,600 watts (5500 watts reduced power)

Frequency Stability:

± 5 Hz, 0° to $+35^\circ\text{C}$

± 10 Hz, -10° to $+45^\circ\text{C}$

± 20 Hz, -25° to $+45^\circ\text{C}$

Output Impedance: 50 ohms, unbalanced

Audio Input Impedance: 150/600 ohms, balanced

Audio Input Level: $+10$ dbm ± 2 db

Audio Frequency Response:

± 1 db, 100 to 7500 Hz (typical ± 1 db, 30 to 1000 Hz)

± 2 db, 50 to 10,000 Hz

Audio Harmonic Distortion: Less than 3%, 50 to 7500 Hz

Carrier Shift: Less than 3%, 0 to 100% modulation

Residual Noise Level: 60 db below 100% modulation

Modulation Type: High-level plate

Ambient Temperature Range: -25° to $+45^\circ\text{C}$

Ambient Humidity Range: Up to 95%

Altitude Range: Up to 7500 feet

Power Source: 208/240 volts, 3-phase, 50/60 Hz

Combined Voltage Variation and Regulation Tolerance: $\pm 5\%$

Power Requirement at 5500 Watts, 100% Modulation: 18.5 kw, 0.98 power factor

Power Requirement at 10,600 Watts, 100% Modulation: 32 kw, 0.97 power factor

Size: 69 in. H by 67-7/16 in. W by 32 in. D (175 cm by 171 cm by 81 cm)

Total Weight Including Transformers: 820E-1, 2000 lb (910 kg); 820F-1, 2450 lb (1115 kg)

Part No. 522 3291 000 (Type 820E-1)

Includes one set of tubes, one crystal and one instruction book

No Part Number

Complete set of spare tubes for 820E-1

No Part Number

FCC set of spare tubes for 820E-1

Part No. 522 3292 000 (Type 820F-1)

Includes one set of tubes, one crystal and one instruction book

No Part Number

Complete set of spare tubes for 820F-1

No Part Number

FCC set of spare tubes for 820F

No Part Number

Spare crystal for 820E/F-1

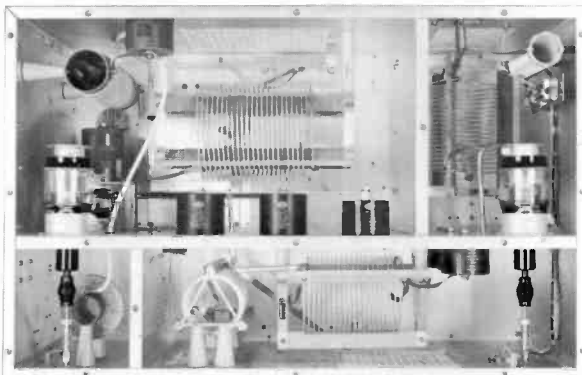

OUTPUT NETWORK COMPARTMENT

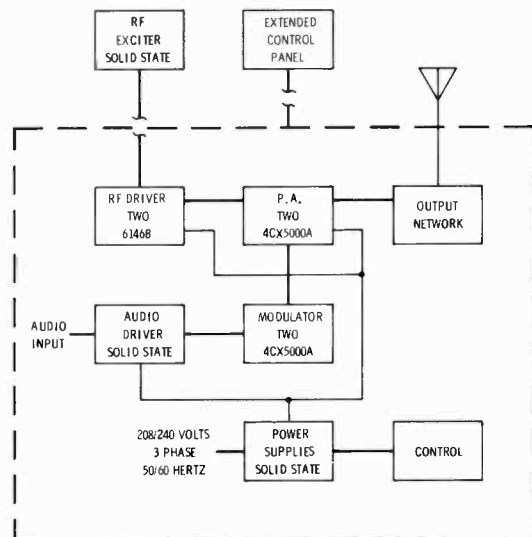

BLOCK DIAGRAM 820F-1

COLLINS 81M PHASOR

Collins Radio Company maintains a research and development staff that devotes its full efforts to custom design and manufacture of phasing and tuning equipment that will meet critical operating parameters with a minimum of maintenance and adjustment. By instituting its own design and construction, Collins can offer fastest possible delivery, maintain its famous standard of quality and sell at the lowest possible cost.

Engineered into each installation are easily-adjusted networks, highest stability, adequate voltage and current safety factors and maximum economy. A customer's requirements, as specified by his consulting engineer, are strictly adhered to and designs are submitted for approval before construction is started.

After the consulting engineer has made channel studies for an available frequency, he will design an array to fit the location, frequency and other requirements. He will determine the pattern shape and size in both the vertical and horizontal planes, the maximum expected operating values of fields in both the nulls (minimum signal areas) and the lobes (maximum signal areas), the proper size, shape, height, spacing, and orientation of the antenna towers, and the phase relationships and amplitude ratios of the radiation fields of the individual antennas. This information is then submitted to the FCC with the application for a construction permit.

A Collins 81M directional antenna phasing and branching system consists of: a branching circuit in which the power is divided in precisely the amounts of power necessary to give the proper ratio of fields from the individual antennas; an impedance matching circuit to match the power divider input impedance to the common point impedance at which the power input is measured; phase-shifting networks in series with each of the transmission lines going to the individual antenna towers; the transmission lines

themselves; and the impedance-matching network between each of the transmission lines and its associated antenna tower.

The power divider in Collins 81M equipment is usually a resonant tank circuit consisting of a large fixed coil tapped with smaller variable coils for power adjustment. An alternate design uses a group of variable coils, each one feeding a tower; this group then becomes the tank coil of the circuit.

For 1 kw or lower, the capacitive arm of the tank circuit is a capacitor and variable coil connected in series. The variable coil provides tuning adjustment by varying the overall negative reactance in this branch of the tank. In higher powers, the tank capacitance is usually a variable vacuum capacitor in parallel with one or more fixed capacitors.

Phase shifting networks are "T" designed, with variable coils mechanically connected in tandem for the series arms and a coil and capacitor in series for a shunt arm. Wherever possible, 90° networks capable of being adjusted $\pm 30^\circ$ from the design value are supplied.

Wherever a phase shift network is not required, a series variable coil and capacitor are used to supply variation of $\pm 20^\circ$ around a 0° setting. They are used for trimming phase shift of current in the towers in which they are used.

"T" networks are also used for impedance matching at the tower base. The network has sufficient latitude of adjustment to match the transmission line impedance to any expected base operating impedance and still permit adjustment of phase shift.

Switching of circuits for day and night operation or directional and nondirectional operation is accomplished by impulse-type, toggle-operated rf relays, energized by pushbutton switches on the front panel. The pushbutton automatically removes the plate voltage of the transmitter before pattern switching and restores it when switching

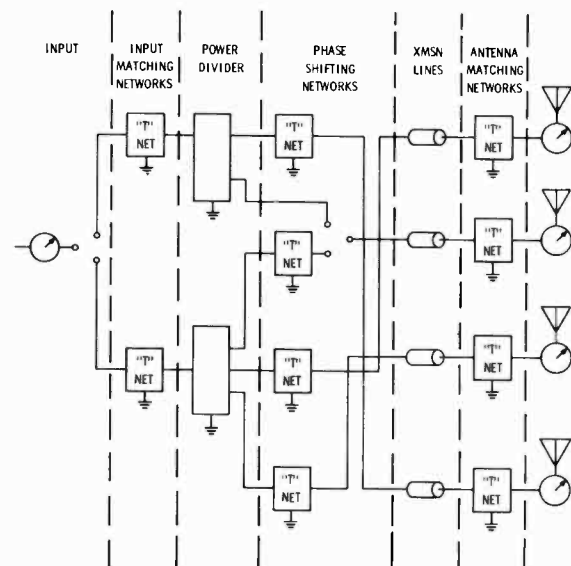
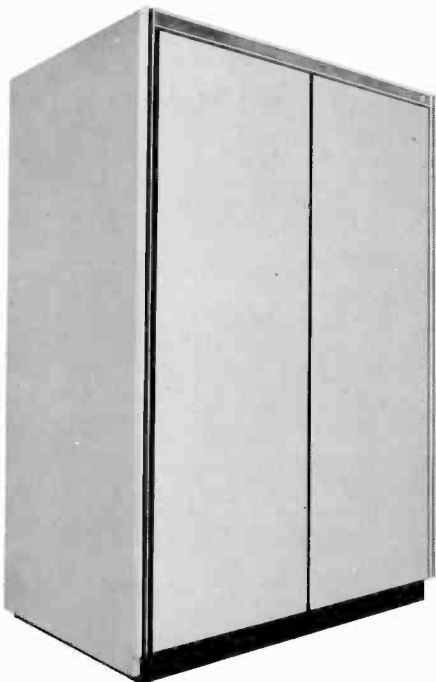

TYPICAL PHASING SYSTEM

is completed. Interlocks on the cabinet doors also remove the plate voltage when doors are opened.

Amplitude and phase controls have counters to assure accurate resettability. In complex arrays requiring additional controls, the controls and counters are behind the tilt-out panel in the lower half of the cabinet.

Power-dividing circuits and phase-shift networks utilize heavy edge-wound copper ribbon inductors and ceramic cased mica capacitors. Vacuum capacitors are used where made necessary by high circulating currents.

Plated 5/16-inch copper tubing is used for all rf busses and insulation is steatite or Mycalex.

Input and output connections are provided at the top of the phasing cabinet unless otherwise specified. Special terminations are provided for solid dielectric cables in both the phasing cabinet and antenna coupling units.

An input common point rf ammeter is supplied along with line current meter jacks. Antenna current meters have make-before-break switches, which can be operated without opening the cabinet door on the weatherproof coupling units.

Power: 1, 5, and 10 kw in 2-, 3-, 4-, 5-, and 6-tower arrays.

Patterns: Directional day and night, same pattern; directional nighttime only; or different pattern day and night. The 820D/E/F style cabinets are available in three sizes to fit the complexity of the system.

25-7/16 in. W, 69 in. H, 32 in. D (65 cm W, 175 cm H, 81 cm D)

47-7/16 in. W, 69 in. H, 32 in. D (119 cm W, 175 cm H, 81 cm D)

67-7/16 in. W, 69 in. H, 32 in. D (171 cm W, 175 cm H, 81 cm D)

COLLINS TOWER LIGHTING FILTER CHOKES

These solenoid wound 2- and 3-wire chokes provide high impedance throughout the broadcast band for isolation of the ac power lines from the antenna. Coils are wound of #10 wire and are rated at 2000 watts, 120 vac, single phase. Provided with mounting brackets and standoff insulators for mounting in 42E-7/8 antenna coupling units.

Part No. 543 3927
Unhoused, 2-wire, 2000 watts

Part No. 543 3926
Unhoused, 3-wire, 2000 watts

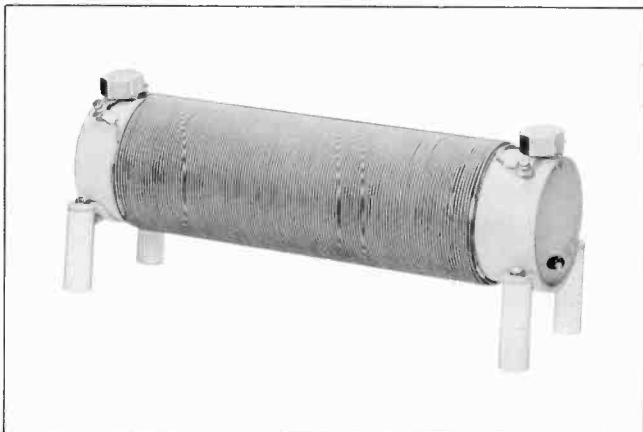

COLLINS 42E ANTENNA COUPLING UNITS

These specially constructed units match a series-fed vertical radiator to an unbalanced transmission line. Intended for continuous, unattended duty in conjunction with transmitters having emission type A0, A1, A2 or A3, the 42E-7 operates with transmitters of carrier power output of 250 to 1000 watts. The 42E-8A operates with transmitters of 5000 watts and the 42E-8B operates with transmitters of 10,000 watts.

The electrical circuit of the 42E Antenna Coupling Units is a low-pass "T" network with good harmonic attenuating properties. A 3-wire or 2-wire tower lighting filter choke and remote antenna current sampling transformer may be mounted in the cabinet, and an antenna current meter and line current meter jack are provided.

A horn gap furnishes lightning protection. The antenna connection is made by an insulated feed-through bushing on the side of the cabinet and the bushing has a hollow stud for the lightning circuit. The transmission line comes through the base of the cabinet. The unit is contained in a gray weatherproof aluminum housing. Remote antenna current metering kit and antenna current transformer for remote reading of antenna current up to 25 A available for all Collins AM transmitters.

Size: 42E-7, 29 in. W, 28 in. H, 18 in. D (74 cm W, 71 cm H, 46 cm D)

Weight: 64 lb (29.03 kg)

Size: 42E-8A/B, 36 in. W, 28 in. H, 22 in. D (91 cm W, 71 cm H, 56 cm D)

Weight: 124 lb, (56 kg)

Part No. 522 1028 (Type 42E-7)

Part No. 522 1029 (Type 42E-8A)

Part No. 522 1029 (Type 42E-8B)

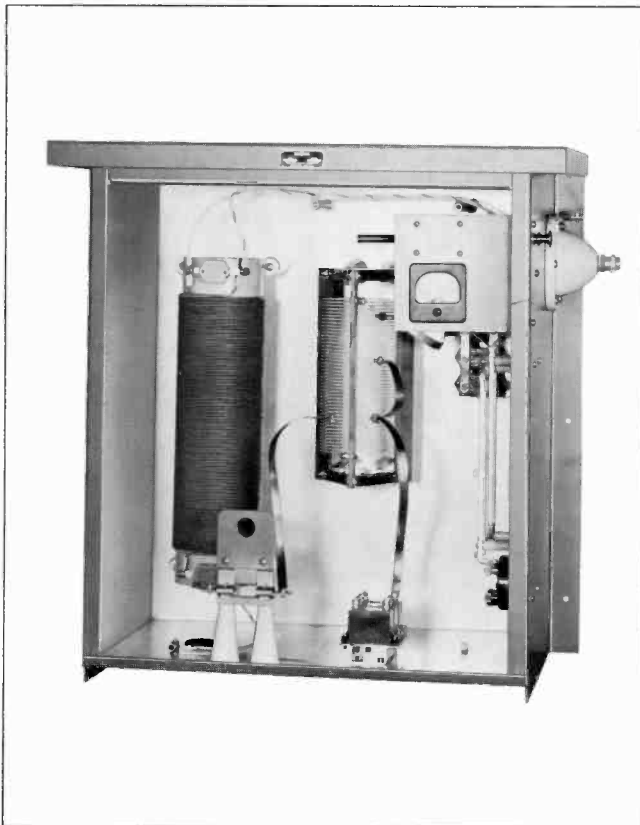

COLLINS 172G-1 DUMMY ANTENNA

This air-cooled unit provides a load to dissipate transmitter output for off-the-air testing. Consisting of eight ferrule type, non-inductive resistors, with insulated end brackets and clips, it may be mounted on the transmitter or adjacent wall. The 172G-1 has an impedance of 52 ohms.

Power Rating: 1 kw

Size: Approx. 6 in. W, 9 in. H, 12½ in. D (15.24 cm W, 22.86 cm H, 31.75 cm D)

Weight: 5 lb (2.27 kg)

Part No. 522 1410 004

STATES WG-50 DUMMY ANTENNA

An air-cooled 50-ohm rf load that will dissipate the output of the Collins 820E/F AM transmitters.

Part No. 124 0061 794 (WG-50) 7.5 kw

Part No. 124 0061 801 (Catalog No. 338-32J) 15 kw

COLLINS 144A-1 ISOLATION COIL

Coil provides isolation for the sampling line in directional arrays, presenting a high impedance for the line across the base insulator. Unit consists of a phenolic coil form which will accommodate 37 turns (approx. 105 ft) of RG8/U or similar solid dielectric sampling line. May be mounted on wall of tuning shack or in housing similar to that pictured.

Inductance: Approx. 180 microhenrys

Size: 10 in. diameter, 18 in. L (25.4 cm diameter, 46 cm L)

Weight: 6 lb (2.7 kg)

Part No. 522 1520 001

COLLINS ANTENNA CURRENT TRANSFORMER

The antenna current transformer is used with remote thermocouple and meter for remote monitoring of antenna current. For currents up to 25 amperes. Thermocouple is not included.

Part No. 543 3917 001

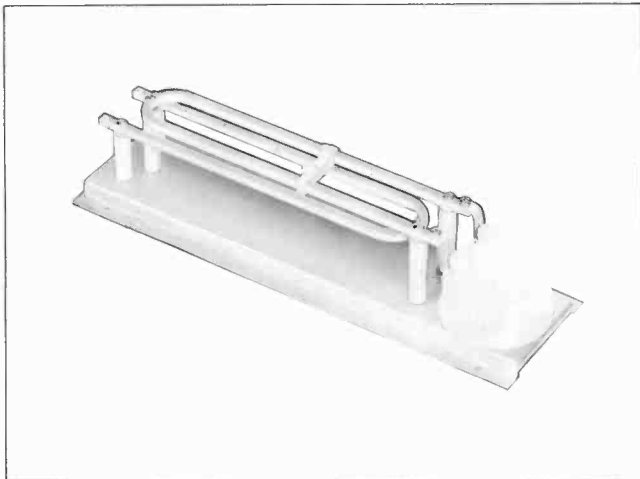

ELECTRONIC RESEARCH 601-96 SAMPLING LOOP

The 601-96 adjustable phase sampling loop samples the phase relationship of rf energy in the 550 to 1600 kHz range. The 12- by 96-inch loop is constructed of heavy galvanized angle iron and terminates in a type "N" female plug.

Part No. 124 0083 381 (Type 601-96)

Part No. 097 6124 000 Hanger adapter for angle power leg (2 required)

Part No. 097 6742 000 Hanger adapter for round power leg (2 required)

Part No. 097 6746 000 Type 14063 insulator (4 required)

Part No. 124 0061 174 Type "N" male plug

JOHNSON FEED-THROUGH BOWL INSULATORS

Designed to carry rf transmission line through a wall. Assembly includes glass bowls, cork gasket, steel mounting with six 3/16 in. mounting holes. Bowl is 6-15/16 in. max. diameter and 4¾ in. high. Mounting flange: 7¾ in. diameter. Fittings include spun aluminum corona shield, ½ in.-13 threaded stud except 135-15-4 which has ⅝ in.-18 threaded stud (hollow), washers, and nuts.

Part No. 097 1501 000 (Type 135-15-1)
One bowl and fittings, 10¼ in. stud.

Part No. 097 6673 000 (Type 135-15-3)
Two bowls and fittings, 16 in. stud. for walls up to 4 in. thick

Part No. 099 1170 000 (Type 135-15-4)
Two bowls and fittings, 24 in. hollow stud I.D. 7/16 in. for walls up to 12 in. thick

Part No. 097 5646 000 (Type 135-15-7)
Two bowls and fittings, 24 in. stud for walls up to 12 in. thick

JOHNSON RF CONTACTORS

The 145-100 and 145-200 contactors are especially designed for high voltage radio frequency switching and dc voltage switching in high voltage rectifier circuits. They require no holding power and will operate with a momentary application of voltage.

Standard contactors are supplied with four auxiliary switches: two normally-closed for control of solenoid voltage and two normally-open for operation of signal lamps or other related functions. Solenoids are wired for 220 v, 50-60 Hz, or can be strapped for 110 v.

	Max. Current	Max. Contact Rating (at 2 MHz)
Part No. 410 0209 00	4 A	17 kv, 25 A
Part No. 410 0210 00	4 A	17 kv, 25 A
Part No. 410 0211 00	8 A	22 kv, 25 A
Part No. 410 0212 00	8 A	22 kv, 25 A

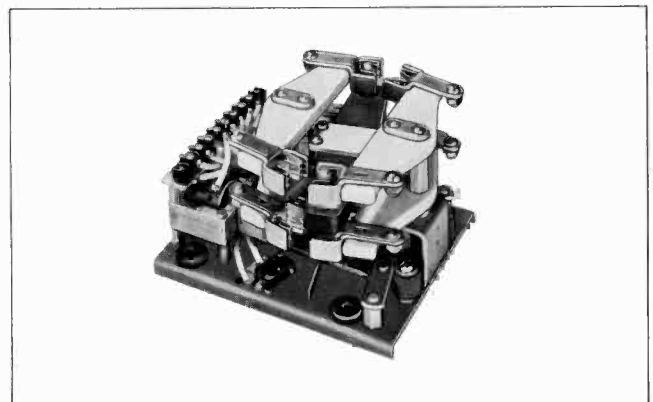

FM
Transmitters

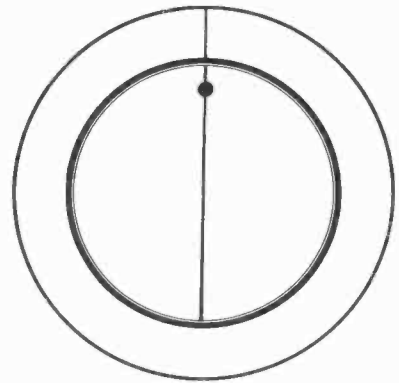

COLLINS 310Z-1 FM EXCITER

The 310Z-1 FM Exciter features the newest concepts in FM broadcast exciter design. The exciter, completely solid state, provides a frequency-modulated 88- to 108-MHz signal suitable for further amplification or direct transmission.

Monophonic, stereophonic, and SCA audio inputs are processed and frequency modulate the carrier with the resultant. It is designed to match a 50-ohm load and will accept frequencies up to 75 kHz. Plug-in circuit card construction makes the exciter compact and easily maintained. The circuit cards may be extended or removed from the transmitter front panel for test and maintenance.

Output power may be manually adjusted between 10 and 20 watts. Accessibility and maintainability are greatly improved through total modular construction, and all circuitry and adequate test points are accessible from the front of the exciter.

A stereo generator and SCA generator are inherent companion modules of the 310Z-1. With the addition of those modules, this unit performs all the functions required of an FM stereo broadcast exciter.

During monaural operation, audio is applied directly to the baseband amplifier through the monaural audio filters. For stereo multiplex or SCA operation, the 786V-1 stereo generator and 786W-1 SCA generator must be employed.

There are two basic methods of FM signal generation, direct FM and phase modulation. The 310Z-1 uses the direct method.

The complete stereo signal (and SCA signal if used) is fed through a baseband amplifier to a frequency-modulated oscillator. The discriminator completes an audio feedback loop that suppresses FM oscillator distortion, incidental FM noise, transient carrier offset, and gain/phase variation in the baseband amplifier and modulator. Automatic frequency control (afc) circuitry is provided to maintain good frequency stability. The output of the modulator is a 14-MHz FM signal with ± 75 -kHz peak deviation. The output frequency is obtained by translating this signal with a stable vhf oscillator. The use of the direct FM system removes the requirement for double modulators, phase delay lines, and baseband amplifiers with a response that changes with frequency.

Power Source: 117 vac $\pm 10\%$, 50 to 60 Hz, single phase
Carrier Frequency Stability: Less than ± 1000 Hz, 117 vac $\pm 15\%$

FM Noise Level: 65 db below 100% modulation (± 75 kHz)

AM Noise Level: 55 db below 100% AM level

Exciter Inputs: Stereophonic, monophonic, and SCA, all 600 ohms, balanced

RF Output: 10 to 20 watts, variable

Output Impedance: 50 to 70 ohms, unbalanced

Frequency Range: 88 to 108 MHz

Modulation: Direct FM

Monaural

Preemphasis: 75 us

Distortion: 0.5%, 50 Hz to 15 kHz; 1.0%, 15 kHz to 75 kHz

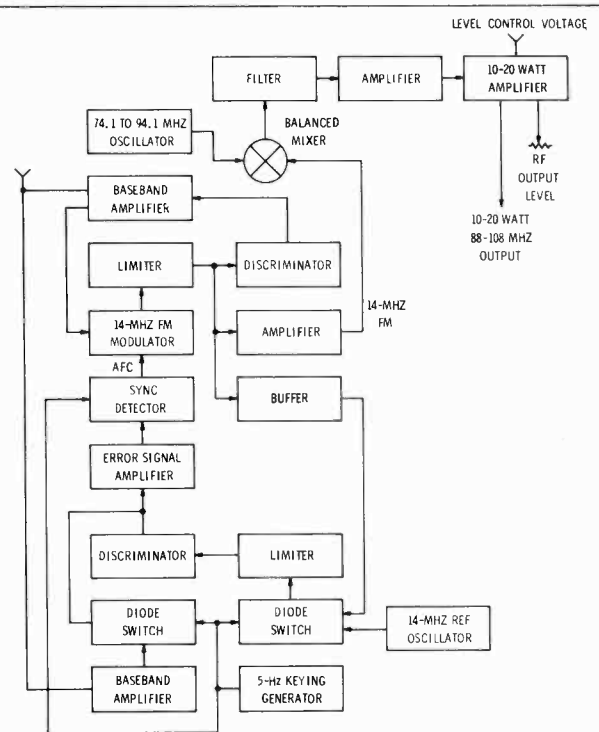

BLOCK DIAGRAM 310Z-1

Frequency Response: Standard 75-microsecond preemphasis for left channel. Deviation from the standard preemphasis curve shall not be more than ± 2.0 db from 50 to 10,000 Hz and ± 2.5 db from 10 to 15 kHz

Size: 10½ in. H by 19 in. W by 15 in. D (27 cm H by 48 cm W by 38 cm D)

Weight: 38 lb (17 kg)

Part No. 522 4687

310Z-1

Stereo — Electrical Characteristics with 786V-1 Stereo FM Generator

Inputs (Left or Right Audio Channel): 600 ohms balanced.

Input for 100% modulation is 10 ± 2 dbm. Frequency range is 50 Hz to 15 kHz

Subcarrier Suppression (38-kHz): The stereophonic subcarrier and its 2nd harmonic in the output are at least 40 db and 60 db respectively below 90% modulation

Stereo Channel Separation: Greater than 35 db, 50 to 15,000 Hz

Type of Emission:

Frequency modulated with:

Main Channel: 50 Hz to 15 kHz

Sub-Channel: 23 kHz to 53 kHz

Pilot Carrier: 19 kHz ± 2 Hz

Pilot Carrier Level: Adjustable from 0 to 15% modulation of main carrier

Crosstalk: When inputs of 10 dbm are applied to both left and right stereophonic channels with the phase relationships $L = R$, output in the stereophonic subchannel, due to crosstalk, is at least 40 db below 90% modulation.

When inputs of 10 dbm are applied to both left and right stereophonic channels with the phase relationship $L = -R$, output in the main channel, due to crosstalk, is at least 40 db below 90% modulation.

Preemphasis: 75 microseconds

Frequency Response: Standard 75-microsecond preemphasis for both left and right channels. Deviation from the standard preemphasis curve shall not be more than ± 2.0 db from 50 to 10,000 Hz and ± 2.5 db from 10 kHz to 15 kHz.

Distortion: 0.5%, 50 Hz to 15 kHz audio modulation

Part No. 772 5336 001

786V-1

Electrical Characteristics with 786W-1 SCA Generator

Input: 600 ohms, balanced input. 6 to 15 dbm for 7.5-kHz deviation of 67-kHz, SCA subcarrier

Frequency Range: 50 Hz to 15,000 Hz

NOTE: Sideband amplitudes are functions of the modulating frequency and carrier frequency deviation. Even though the 310Z-1 can accommodate 15 kHz, a frequency less than 15 kHz must be used to meet FCC regulations for stereo operation. Recommended maximum modulating frequency and 67-kHz subcarrier frequency deviation are 5.0 kHz and 3.5 kHz respectively.

Subcarrier Frequency Deviation: ± 7.5 kHz maximum

SCA Subcarrier Frequency: 67 kHz

SCA Subcarrier Frequency Stability: $\pm 0.2\%$

Part No. 772 5338 001

786W-1



786V-1

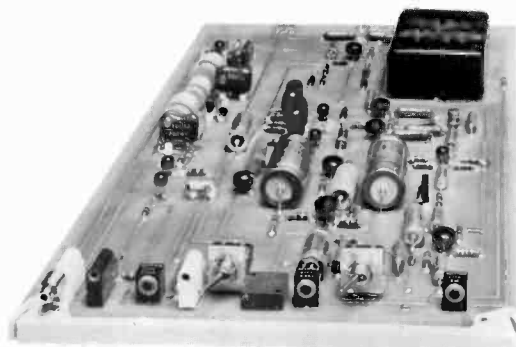

786W-1

786M-1 FM STEREO MULTIPLEX GENERATOR

A stable and reliable method of stereophonic FM broadcasting is now available through the new time division system where both stereo channels are integrated into a composite signal that is fed to a wide-band exciter (Collins A830-2) on a single line.

The Collins 786M-1 FM Stereo Multiplex Generator does away with the inherent instability of the conventional dual channel method of stereo injection.

Instead, the Collins 786M-1 feeds monaural audio and the subchannel, required for stereo operation, to the exciter on a single, composite signal. The time division system eliminates the costly and unstable dual channels that require matrix networks. L + R and L - R outputs of the

matrix networks must be compensated to make up time differences in the two channels. Also, accurate amplitude balance between the two channels must be maintained. In the Collins system, this problem is eliminated by using a wide-band direct FM exciter. With a system of this type, any gain changes or time delays will affect the main and subchannels equally.

The Collins time division system is nothing more than a sampling at a 38-kHz rate of the left and right audio inputs. After transmission, a corresponding component in the FM receiver demodulates the composite signal in synchronism with the sampling, converting it to left and right audio through the respective speakers.

The composite stereo signal (L + R and L - R) is achieved by filtering out unwanted harmonics created in the function of the 4-diode time division switching circuit.

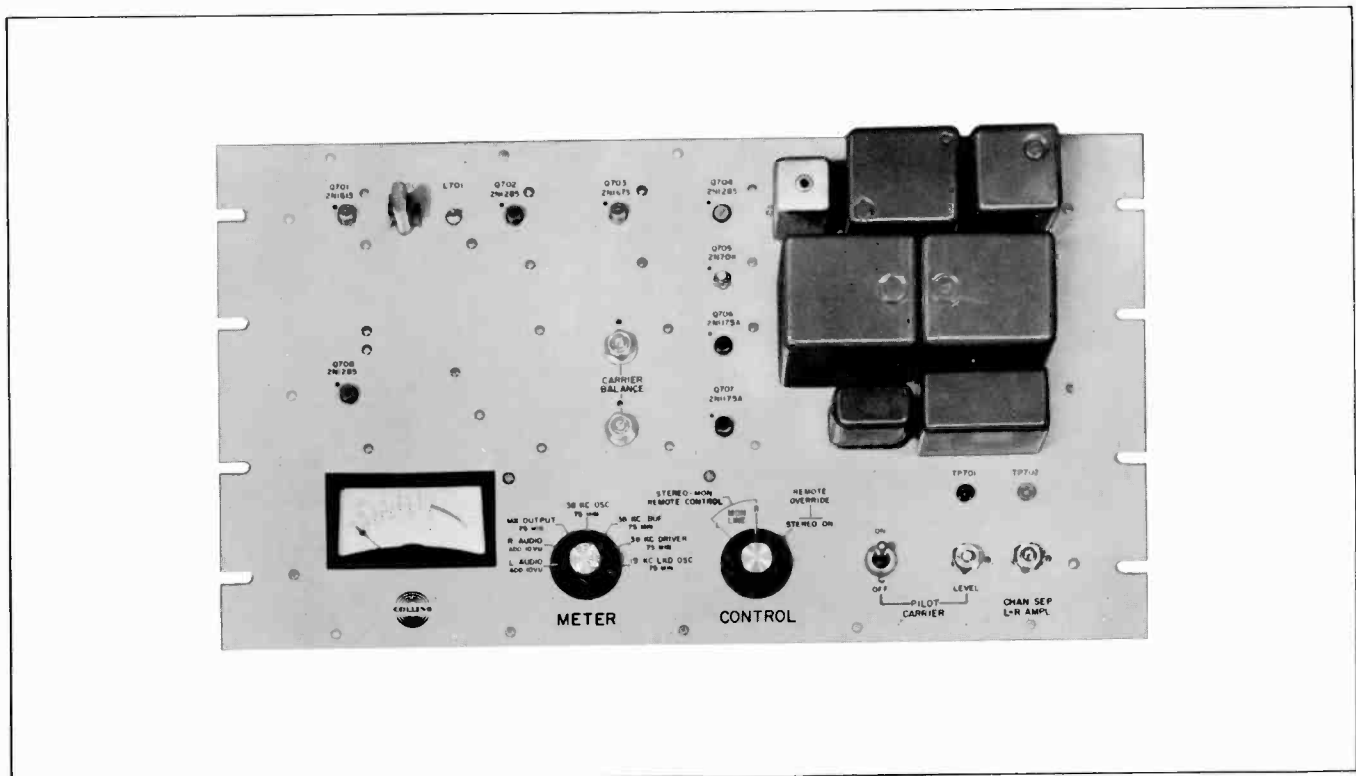

The resulting spectrum shows only the main channel (L + R), which is the monaural signal; a 10 percent 19-kHz pilot carrier; the subchannel (L - R), which is the stereo signal on a 38-kHz carrier. An SCA channel may be placed on a 67-kHz carrier by addition of an auxiliary SCA generator.

Features of the 786M-1 are:

SIMPLE CIRCUITS — The single line, time division system eliminates matrixing components, greatly simplifying circuitry.

STABLE — All components are temperature-compensated to provide long-term stability. The unit is completely transistorized.

SELF-METERED — An audio VU meter monitors both audio inputs and interior circuit points for rapid maintenance.

EASILY INSTALLED — The Collins 786M-1 may be installed in the 830B-1A, 830D-1A or 830E-1A FM, 830F-1A, 830F-2A, 830H-1A, 830N-1A.

Preemphasis networks are plug-in type; can be replaced with a 20-db flat pad for testing. Hi-pass filter and 600-ohm/600-ohm transformers prevent interference with exciter afc circuits by any 5-Hz components in input. Transformers convert from balanced to unbalanced inputs. 15-kHz low-pass filters limit bandwidth to 15 kHz preventing cross-talk between main and subchannels. Filters provide over 60 db of attenuation for frequencies above 19 kHz. Emitter followers provide isolation between left and right audio inputs and stereo switch. A 38-kHz oscillator, buffer, and driver provide the 38-kHz drive signal to the stereo switch. When the 38-kHz carrier goes positive, upper pair of diodes in switch conduct and connect left channel to output; when carrier goes negative, lower pair of diodes connect right channel to output. L + R correction is obtained by feeding left and right signals around switch through two resistors. The 53-kHz low-pass linear phase filter removes high frequency switching components that would fall outside the assigned bandwidth. The filter meets the requirement of constant time delay for all frequencies up to 53 kHz. Main channel audio and subchannel DSB crossings thus occur simultaneously. The filter also has flat frequency response to 53 kHz. These two factors are held to tolerances that provide over 35 db of channel

separation for 50- to 15,000-Hz audio input frequencies rising to 38 db at 5 kHz. The emitter follower and 19-kHz locked oscillator provide a 19-kHz pilot carrier in phase with the 38-kHz subcarrier at the output of the linear phase filter.

Distortion (either channel): Less than 1%, 50 to 15,000 Hz
Channel Separation: 35 db or greater, rising to 38 db at approx. 5 kHz

Pilot Carrier Stability: ± 2 Hz at 19,000 Hz

Output Impedance: 600 ohms unbalanced

Size: 19 in. W, 8 $\frac{3}{4}$ in. H, 3 $\frac{1}{8}$ in. D (48 cm W, 22 cm H, 8 cm D)

Weight: 14 lb (6 kg)

Part No. 522 2914 00

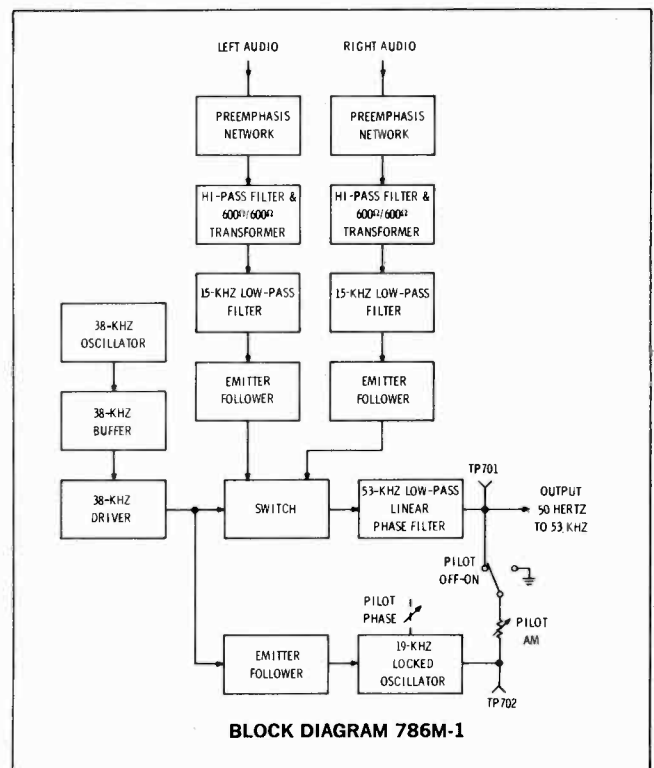

COLLINS 830B-1B FM TRANSMITTER

Designed for top reliability and superior quality sound, the Collins 830B-1B 250-Watt FM Transmitter not only affords the broadcaster an economical, self-contained unit, but also is readily adaptable to a variety of uses, including stereophonic FM and increased station power.

Clean, sharp lines plus "humanized" engineering for both operation and maintenance make the Collins 830B-1B an attractive, integrated unit in the most modern broadcast station.

Other quality features of the Collins 830B-1B that underscore its superior performance include:

SELF-CONTAINED — Transformers for all solid state power supply as well as the harmonic filter are housed inside the cabinet. Self-contained multiplexing equipment, including the Collins 786V-1 Stereo Generator also may be installed inside. This unit is used as a driver for the 830E-1B 5000-watt and 830F-1B and 10,000-watt Transmitters.

SIMPLE OPERATION — The 830B-1B is pushbutton operated, featuring a step-start system in which starting sequences are fully automatic. All rf circuits are tuned from the front panel. Adequate metering is provided for rapid operation analysis. All adjustments can be made while the transmitter is on the air.

DEPENDABLE — The compact transmitter uses space-saving silicon rectifiers, which generate a minimum of heat. Spurious radiation is minimized and the unit has a high degree of stability.

MAINTENANCE EASE — Vertical panel construction eliminates hidden components and allows rapid inspection and maintenance. Cabinet interlocks minimize danger during circuitry inspection and maintenance. A grounded shorting stick is readily accessible to discharge capacitors before transmitter servicing.

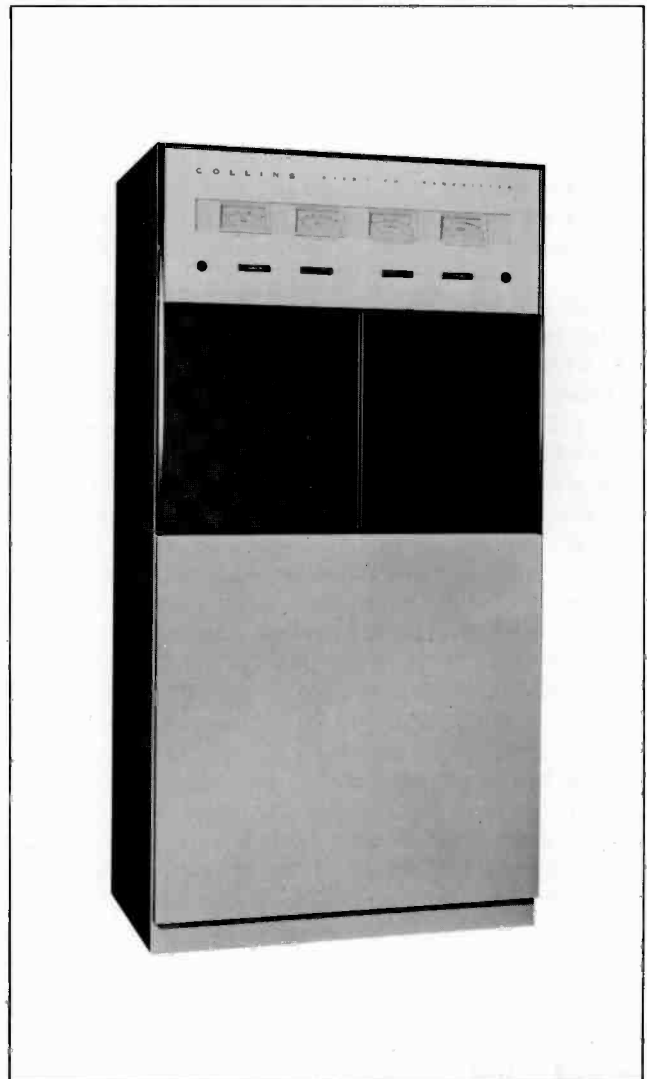

RIGID TESTING — In accordance with rigid Collins standards, the 830B-1B is tested on the broadcaster's channel under proper load conditions prior to shipment.

The 830B-1B can meet a variety of power situations. Only the blower motor need be changed to convert from the nominal 60- to 50-Hz operation.

Frequency Range: 88 to 108 MHz

Power Output: 250 watts

Carrier Frequency Stability: ± 1000 Hz

Audio Frequency Response: ± 1 db, 50 to 15,000 Hz

Distortion: Less than 0.5%, 50 to 15,000 Hz

FM Noise Level: 65 db below ± 75 kHz

AM Noise Level: -55 db rms

Harmonic Attenuation: At least -67 db

Modulation Capability: ± 100 kHz

RF Output Impedance: 50 ohms; SWR not to exceed 2:1

Audio Input Level: +10 dbm, ± 2 db

Power Source: 230 vac nominal, 60 Hz, 1 phase (tapped for 200 to 250 v in 10-v steps)

Input Power Requirement: 860 watts, 90% power factor

Power Line Regulation: 3%

Variations: Slow line, $\pm 5\%$; rapid line, $\pm 3\%$

Tube Complement: One 4CX250B, two OD3

Temperature Range: 15° to 45°C

Humidity: 0% to 95%

Altitude: 7500 ft

Size: 38 in. W, 76 in. H, 27 in. D (97 cm W, 193 cm H, 69 cm D)

Weight: 638 lb (289 kg)

Part No. 777 1783

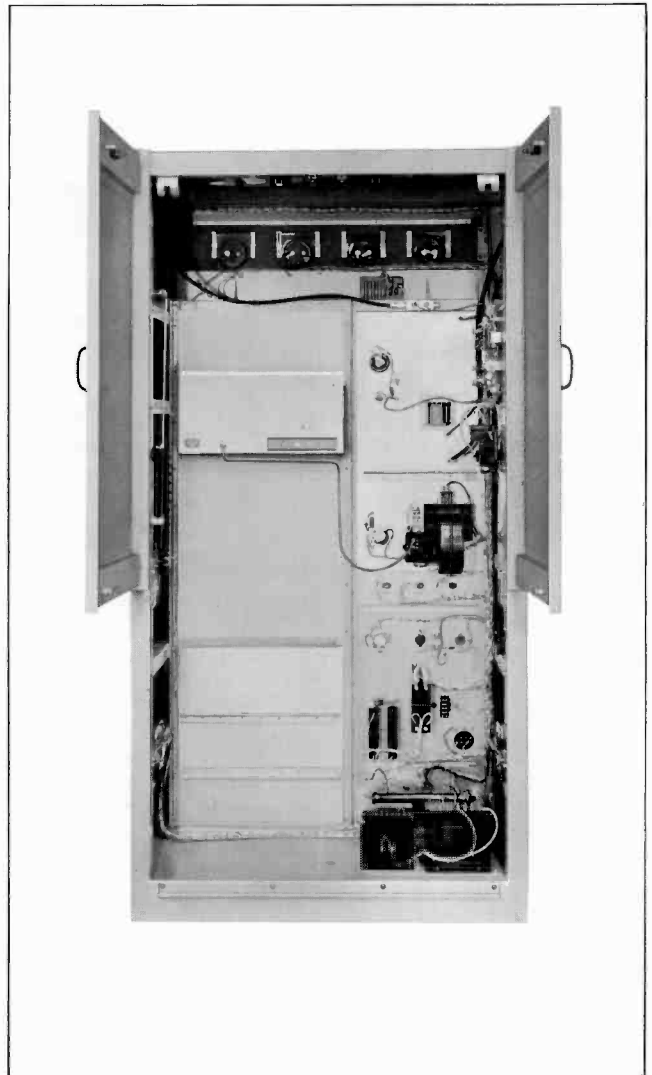

COLLINS 830D-1B FM TRANSMITTER

Carefully engineered design, straight-forward circuitry, and clean-line cabinetry all make the Collins 830D-1B FM Transmitter a powerful and versatile installation in the most modern station.

The self-contained 1000-watt unit achieves a new degree of reliability and operational ease never before obtainable by the FM broadcaster.

The new 310Z-1 Solid-State Exciter is the heart of the 830D-1B. This wide-band direct FM unit accepts a composite stereo signal directly without using auxiliary modulators for either the stereo or SCA channels.

Operation and maintenance of the Collins 830D-1B is simplicity itself. Fewer components and fewer tuned circuits enhance the dependability and operational ease of the transmitter.

Some of its features are:

SELF-CONTAINED — Transformers for the all solid state power supply as well as the harmonic filter are enclosed in the cabinet. Self-contained multiplexing equipment, including the Collins 786V-1 Stereo Generator, also may be mounted inside.

SIMPLE OPERATION — The 830D-1B is pushbutton operated, featuring a step-start system in which starting sequences are fully automatic. All rf circuits are tuned from the front panel. Adequate metering is provided for rapid operational analysis. All adjustments can be made while the transmitter is on the air.

DEPENDABLE — Space-saving silicon rectifiers that generate a minimum of heat are employed. A regulated filament transformer prolongs tube life. Stability is enhanced through the neutralized final power amplifier. Spurious radiation is held to a minimum; the entire unit has a high degree of stability.

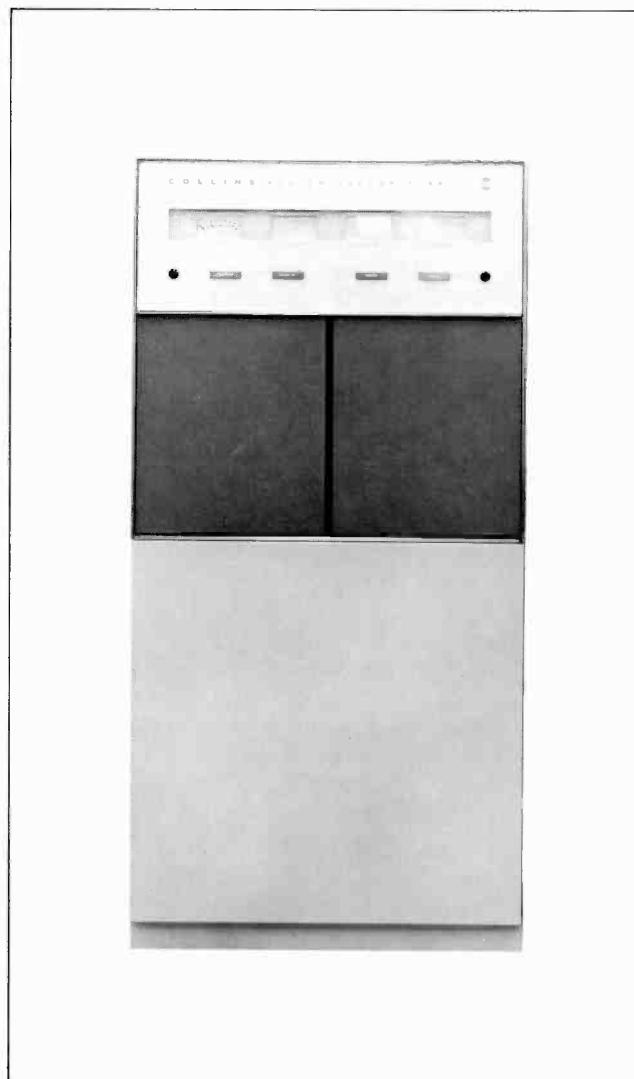

MAINTENANCE EASE — Vertical panel construction eliminates hidden components and allows rapid inspection and maintenance. Cabinet interlocks minimize danger during circuitry inspection and maintenance. A grounded shorting stick is readily accessible to discharge capacitors before transmitter servicing.

RIGID TESTING — In accordance with rigid Collins standards, the 830D-1B is tested on the broadcaster's channel under proper load conditions before shipment is made.

The 830D-1B can meet a variety of power situations. No components need to be changed to operate the transmitter on 60- or 50-Hz power.

Frequency Range: 88 to 108 MHz

Power Output: 1000 watts

Carrier Frequency Stability: ± 1000 Hz

Audio Frequency Response: ± 1 db, 50 to 15,000 Hz

Distortion: Less than 0.5%, 50 to 15,000 Hz

FM Noise Level: 65 db below ± 75 kHz

AM Noise Level: -55 db rms

Harmonic Attenuation: -73 db

Modulation Capability: ± 100 kHz

RF Output Impedance: 50 ohms; swr not to exceed 2:1

Audio Input Level: +10 dbm, ± 2 db

Power Source: 230 vac nominal, 50 to 60 Hz, 1 phase
(tapped for 200-250 v in 10-v steps)

Input Power Requirement: 2300 watts, 90% power factor

Power Line Regulation: 3%

Variations: Slow line, $\pm 5\%$, rapid line, $\pm 3\%$

Tube Complement: One 4CX1000A

Temperature Range: 15° to 45°C

Humidity: 0 to 95%

Altitude: 7500 ft

Size: 38 in. W, 76 in. H, 27 in. D (97 cm W, 193 cm H,
69 cm D)

Weight: 776 lb (352 kg)

Part No. 777 1784

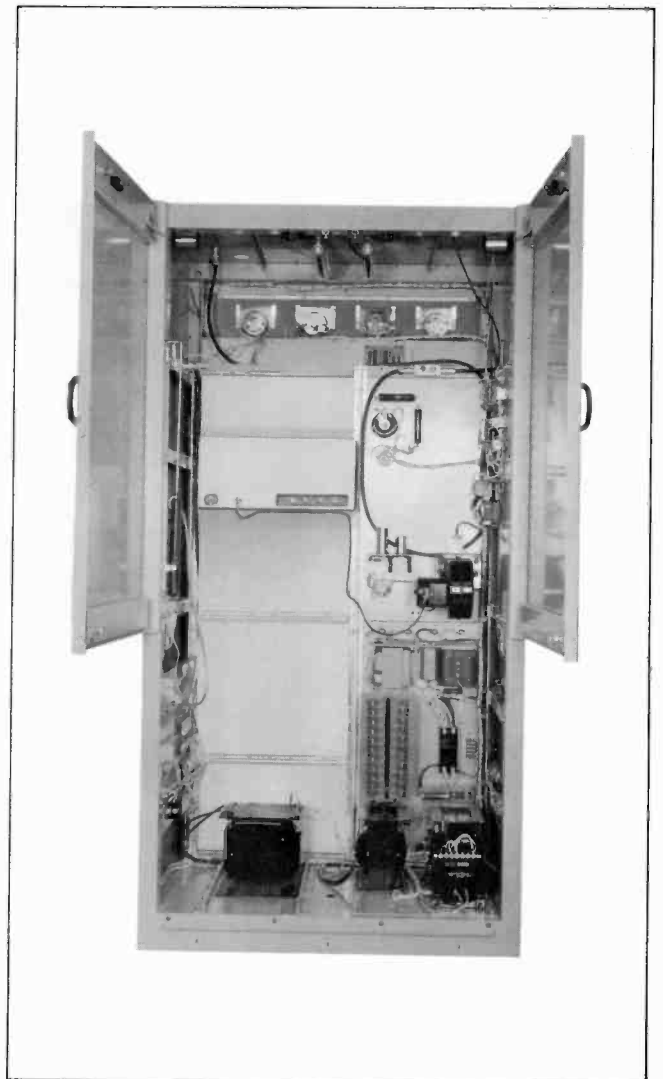

831D-1 2-KW FM TRANSMITTER

The 831D-1, 2-kilowatt frequency-modulated broadcast transmitter is designed to cover the 88- to 108-MHz standard FM broadcast band. A direct FM, all solid-state, 10/20-watt 310Z-1 exciter is used in the transmitter. Optional exciter features include stereo-multiplex and SCA circuits.

This self-monitoring transmitter is provided with automatic power output, fault, overload, and start/stop cycle control and protection circuits. Local and remote control and monitoring is provided by either hard-wire or digital input. Digital control and monitoring circuits of this com-

pletely automatic transmitter make possible a fully automated broadcast station. Through this system, a station processor transmits control commands such as turn-on and turnoff to the transmitter. Monitor information such as fault indications and modulation level is returned to the station processor over the multiplex control system. Thus the station processor can automatically control and monitor the station complex and display the operational status of all station equipment.

SELF-CONTAINED — Every component is housed inside a two-bay cabinet, including the 310Z-1 solid-state exciter, cavity-type power amplifier utilizing a 5CX1500A tube, directional watt-meter, three-node bandpass filter, solid-

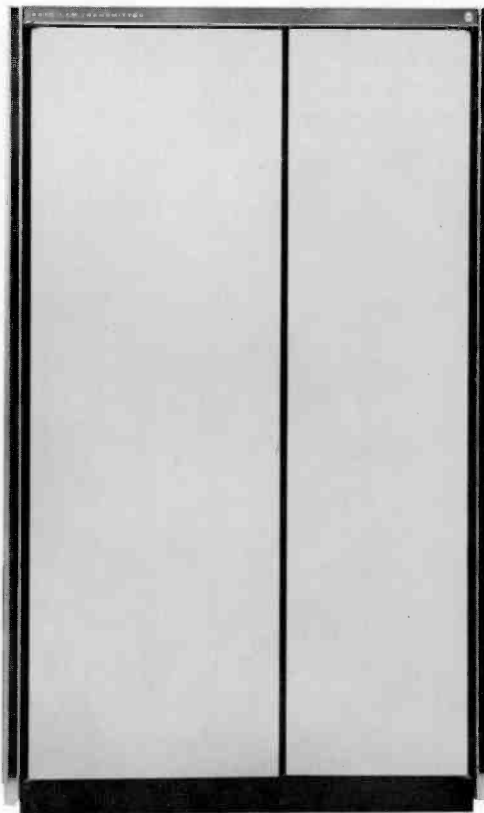

state power supply, and control and monitoring circuits.

DEPENDABLE — Reliability, stability, and dependability are maximized by the all solid-state exciter and power supplies, and by the improved power amplifier cavity. Only one tube is used in the transmitter. Tube replacement costs are, therefore, minimized. The neutralized power amplifier stage improves transmitter stability and minimizes tuning and loading adjustment problems. Component reliability and life are enhanced by the use of filtered cooling air.

MAINTENANCE EASE — Vertical panel construction eliminates hidden components and allows rapid inspection and maintenance. Cabinet interlocks minimize danger during circuitry inspection and maintenance. A grounded shorting stick is readily accessible to discharge capacitors before transmitter servicing.

RIGID TESTING — In keeping with rigid Collins standards, the 830D-1 is tested on the broadcaster's channel under proper load conditions before the unit is shipped.

No components need to be changed to operate the transmitter on 60- or 50-Hz power.

Frequency Range: 88 to 108 MHz

Power Output: 2000 watts

Carrier Frequency Stability: ± 1000 Hz

Audio Frequency Response: ± 1 db, 50 to 15,000 Hz

Distortion: Less than 0.5%, 50 to 15,000 Hz

FM Noise Level: 65 db below ± 75 kHz

AM Noise Level: -55 db rms

Harmonic Attenuation: -76 db maximum

Modulation Capability: ± 100 kHz

RF Output Impedance: 50 ohms; swr not to exceed 2:1

Audio Input Level: Input of +10 dbm ± 2 db required for 100% modulation

Tube Complement: One 5CX1500A

Temperature Range (Operating): +15 to +45°C

Altitude (Operating): 7500 feet at 30°C

Relative Humidity (Operating): 0 to 95%

Size: 69 in. H by 40-13/16 in. W by 22 $\frac{1}{4}$ in. D (175 cm H by 104 cm W by 57 cm D)

Weight: 850 lb (386 kg)

Power Source: 230 vac nominal, 50 to 60 Hz, single-phase (tapped for 200 to 250 volts in 10-volt steps)

Input Power Requirement: 4100 watts (90% power factor)

Power Line Regulation: 5% maximum

Line Voltage Variation: Slow, $\pm 5\%$; rapid, $\pm 3\%$ maximum

Part No. 522 4682



CONTROL PANEL

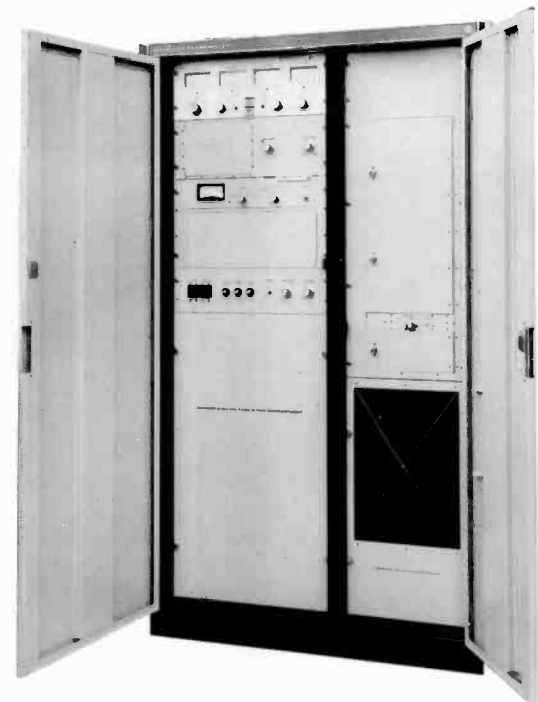

COLLINS 830E-1B 5000-WATT FM TRANSMITTER

Award-winning design and humanized engineering, hallmarks of Collins quality, are reflected in the Collins 830E-1B.

One cabinet houses the 310Z-1 Solid-State Exciter and the 250-watt B830-1 Driver Unit; the other houses the 5000-watt, single-stage amplifier.

Features of the Collins 830E-1B are:

SELF-CONTAINED — Every component is housed inside the two cabinets, including power transformers, harmonic

filter and directional coupler. An accessory, the Collins 786V-1 Stereo Generator, plugs into the 310Z-1 exciter.

SIMPLE OPERATION — The transmitter is pushbutton operated, featuring a step-start system in which starting sequences are fully automatic. Highly stable rf circuits are tuned and metered from the front panel, and all adjustments can be made while the transmitter is on the air. No tuning or trimming of the harmonic filter is required. The PA stage is easily neutralized and is not critical in adjustment.

DEPENDABLE — Grounded screen, eliminating the screen bypass capacitor, does away with a common source of

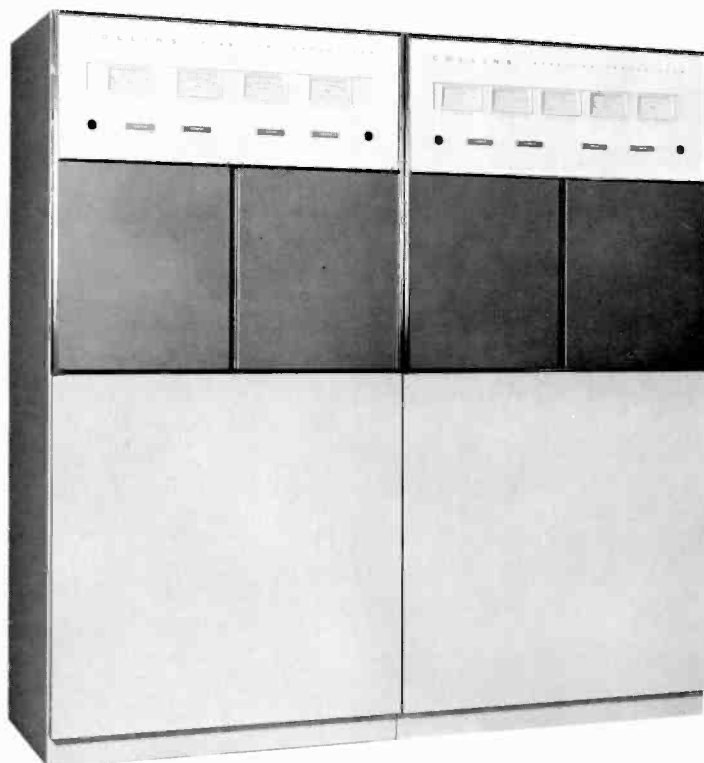

failure. Driver power supply uses silicon rectifiers which take little space and generate a minimum of heat. Efficient blowers force air directly on the 4CX250B and 4CX5000A power amplifier tubes. Power supply is all solid state with the exception of the final amplifier plate voltage supply which uses mercury vapor rectifiers.

MAINTENANCE EASE — Vertical panel construction eliminates hidden components and allows rapid inspection and maintenance. Cabinet interlocks minimize danger during circuitry inspection and maintenance. A grounded shorting stick is readily accessible to discharge capacitors before transmitter servicing.

RIGID TESTING — In keeping with rigid Collins standards, the 830E-1B is tested on the broadcaster's channel under proper load conditions before the unit is shipped.

While the transmitter nominally operates on 60-Hz power, only the two blower motors need be changed to convert to 50-Hz operation.

Frequency Range: 88 to 108 MHz

Power Output: 5000 watts

Carrier Frequency Stability: ± 1000 Hz

Audio Frequency Response: ± 1 db, 50 to 15,000 Hz

Distortion: Less than 0.5%, 50 to 15,000 Hz

FM Noise Level: 65 db below ± 75 Hz

AM Noise Level: -55 db rms

Harmonic Attenuation: -80 db

Modulation Capability: ± 100 kHz

RF Output Impedance: 50 ohms; swr not to exceed 2:1

Audio Input Level: +10 dbm, ± 2 db

Power Source: 230 vac, 60 Hz, 3 phase (tapped for 200 to 250 v in 10-v steps)

Input Power Requirement: 11 kw, 90% power factor

Power Line Regulation: 3%

Variations: Slow line, $\pm 5\%$; rapid line, $\pm 3\%$

Tube Complement: One 4CX250B, *six 872A, one 4CX-5000A, two OD3

Temperature Range: 15° to 45°C

Humidity: 0% to 95%

Altitude: 7500 ft

Size: 76 in. W, 76 in. H, 27 in. D (193 cm W, 193 cm H, 69 cm D)

Weight: 1800 lb (816 kg)

*Not used if silicon diode rectifiers are employed.

Part No. 777 1785

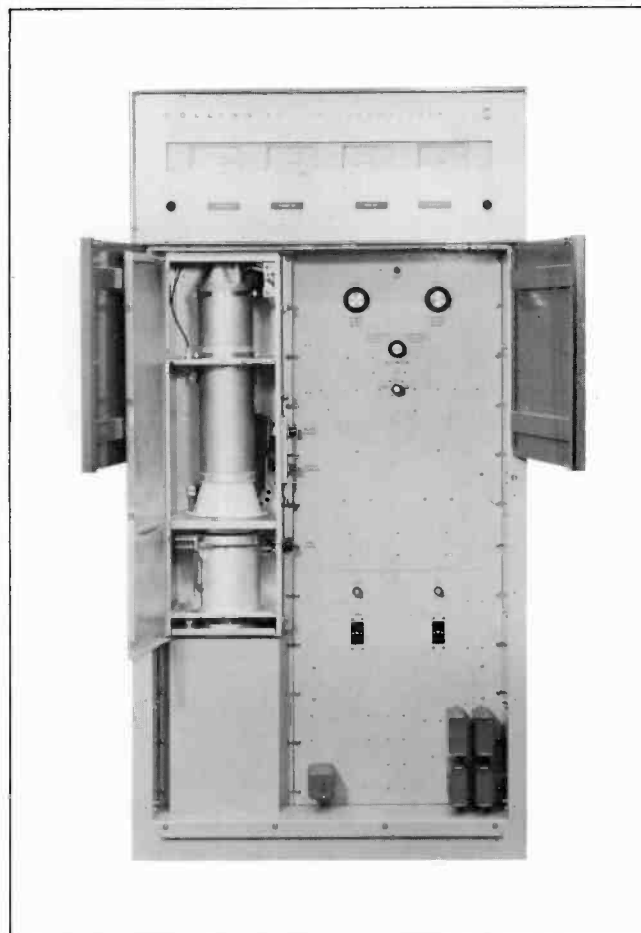

COLLINS 830F-1B 10-KW FM TRANSMITTER

The Collins 830F-1B 10-KW FM Transmitter assures the broadcaster the clean, strong signal he needs to make his programming outstanding in a highly competitive market area and the extended coverage required to build and maintain an audience.

Like all Collins FM transmitters, the 2-cabinet 10,000-watt model is carefully engineered and manufactured to a quality level that is a hallmark at Collins.

SELF-CONTAINED — Every component is housed within the two cabinets, including power transformers, harmonic

filters and directional coupler. An optional feature is the Collins 786V-1 Stereo Generator, which plugs into the 310Z-1' exciter.

EASE OF OPERATION — Pushbutton operated, the transmitter starting sequences are fully automatic by the step-start system. Rf circuits are tuned and metered at the front panel. All adjustments can be made while the transmitter is on the air. No tuning or trimming of the harmonic filter is required. The PA stage is easily neutralized and is non-critical in adjustment.

DEPENDABLE — Grounded screen eliminates the bypass capacitors, doing away with a common source of failure.

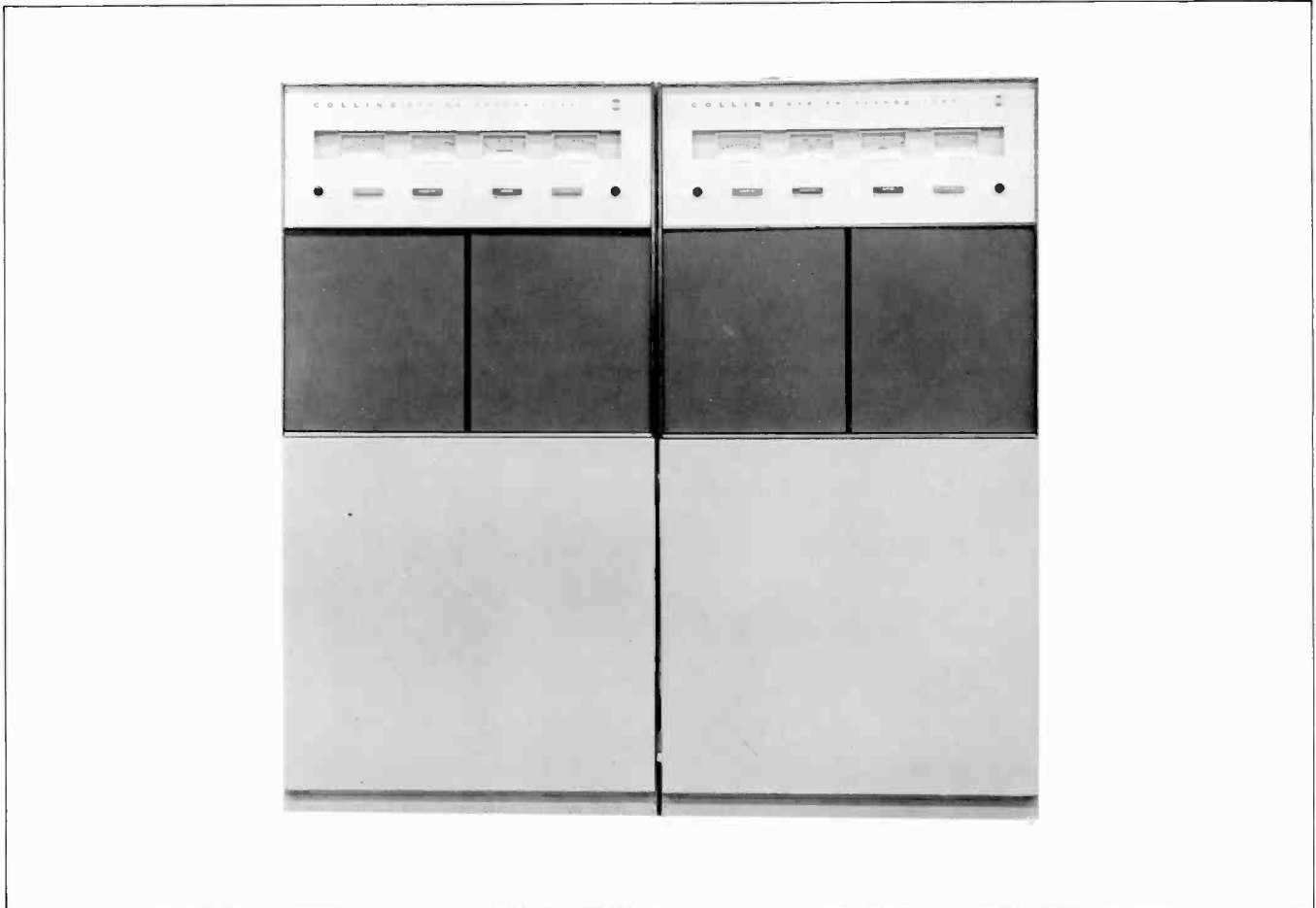

The driver power supply uses solid-state silicon rectifiers that generate little heat and require a minimum of space. The final amplifier plate voltage supply uses silicon diode rectifiers. Efficient blowers force cooling air directly on the power tubes.

MAINTENANCE EASE — All components are easily accessible and may be rapidly inspected through the use of vertical panels. All panels are interlocked for safety; a grounded shorting stick is provided.

RIGID TESTING — In keeping with rigid Collins standards, the transmitter is tested under actual load conditions on the broadcaster's channel before the unit is shipped.

While the transmitter is designed for 60-Hz operation, only the blower motors and plate contactors need be changed for 50-Hz use.

Frequency Range: 88 to 108 MHz

Power Output: 3000 to 10,000 watts nominal

Carrier Frequency Stability: ± 1000 Hz

Audio Frequency Response: ± 1 db, 50 to 15,000 Hz

Distortion: Less than 0.5%, 50 to 15,000 Hz

FM Noise Level: 65 db below ± 75 kHz

AM Noise Level: -55 db rms

Harmonic Attenuation: -80 db

Modulation Capability: ± 100 kHz

RF Output Impedance: 50 ohms; swr not to exceed 2:1

Audio Input Level: +10 dbm, ± 2 db

Power Source: 230 vac, 60 Hz (50 Hz optional), 3 phase
(tapped for 200 to 250 v in 10-v steps)

Input Power Requirement: 20 kw, 90% power factor

Power Line Regulation: 3%

Variations: Slow line, $\pm 5\%$; rapid line, $\pm 3\%$

Tube Complement: One 4CX250B, one 4CX5000A, two OD3

Temperature Range: 10° to 45°C

Humidity: 0% to 95%

Altitude: 7500 ft

Size: 76 in. W, 76 in. H, 27 in. D (193 cm W, 193 cm H, 69 cm D)

Weight: 1900 lb (861.8 kg)

Part No. 777 1786 (Type 830F-1B)

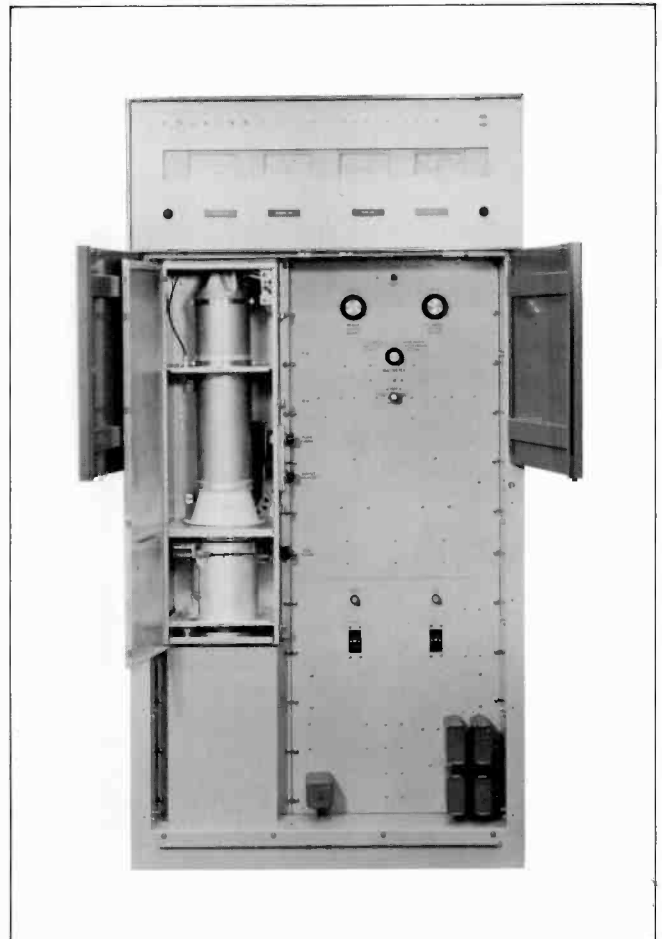

COLLINS 831G-1 20 KW FM TRANSMITTER

For the broadcaster requiring extended coverage in major markets, Collins offers the 20 kilowatt 831G-1 FM Transmitter. This self-monitoring transmitter features careful engineering, conservatively rated components, and precision manufacturing techniques to assure dependable operation.

Components of the 831G-1 are housed in a single, 3-bay cabinet 67½ inches wide, 29 inches deep, and 69 inches high. The left-hand bay contains the rf amplifier, tube-cooling blower, harmonic filter, and directional coupler. A removable extended control panel, the Collins 310Z-1 Exciter, and the printed card cage occupy the center bay. The right-hand bay contains the circuit breaker and fuse panel, cabinet air intake fan, and air filter. Power supply components are located on the floor of all three bays and on the rear and side panels of the center and right-hand bays.

As an integral part of the 831G-1 transmitter, the 310Z-1 exciter enables stereo subcarrier and SCA channels to be fed with the main channel directly to the transmitter modulator on a single, composite signal. The transmitter equipments are designed to operate in the 88-to-108-MHz band, with F3 emission, and at reduced power to 10 kw.

Outstanding features of the 831G-1 transmitter include:
SELF-MONITORING — Complete fault, overload, and start/stop cycle protection is provided along with power output control and optional off-frequency alarm/turn-off circuits. External circuits for remote operation and control may be minimized by this self-monitoring approach. Either hard wire, digital local, or remote control circuits can be used.

CONTROL — Though the transmitter may be self-monitoring and to a certain extent self-controlling, the control, monitoring, fault isolation, and metering/logging of the transmitter may be accomplished by a digital system.

All of the transmitter circuits are tuned from the front panel. Necessary transmitter metering and control facilities are provided by the extended control panel mounted on the transmitter or up to 50 feet from the transmitter cabinet.

SOLID-STATE CIRCUITS — Solid-state circuits are used throughout the exciter, power supply, and control and monitoring equipment. Only three tubes are used: two 4CX250B tetrodes to drive the driver amplifier and one 4CX15,000A tetrode in the power amplifier. Tube life is optimized through regulation of filament voltages to within $\pm 1\%$ of the optimum value.

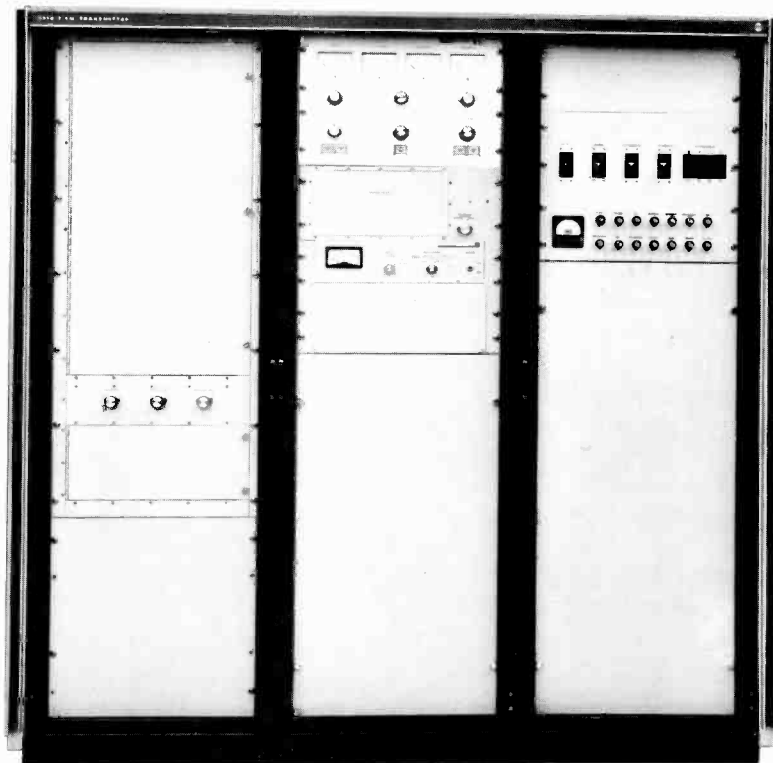

INSTALLATION, MAINTENANCE, SAFETY — The 831G-1 is designed for front access, only, and may be installed with the rear panel against a wall. Its vertical-panel construction assures ease of inspection and maintenance. All access panels and sub-doors are interlocked to remove transmitter control circuit voltage upon opening. Additionally, compartments carrying screen and plate voltages are equipped with high-voltage grounding switches that short-circuit appropriate power supplies as the doors are opened. A grounded shorting stick is provided inside the transmitter front door.

RIGID TESTING — The 831G-1, like all Collins transmitters, is tested on the broadcaster's channels under actual load conditions before shipment. While the transmitter nominally operates on 60 Hz, only the blower motors need be changed for 50-Hz operation.

Output Power: 20,000 watts

Output Impedance: 50 ohms, vswr 2:1 maximum

Frequency Range: 88 to 108 MHz

Frequency Stability: NMT ± 1000 Hz

Modulation Capability: ± 100 kHz

Audio Input Level: 10 dbm ± 2 db

Audio Frequency Response: Complies with FCC standard preemphasis curve

Audio Frequency Distortion: Less than .5%, 50 to 15,000

Hz monaural; less than 1%, 50 to 15,000 Hz stereo

Harmonic Attenuation: -80 db minimum

FM Noise Level: 65 db below 100% modulation (± 75 kHz)

AM Noise Level: -55 db rms

Altitude: Operating, 7500 ft at 30°C; non-operating, 10,000 ft

Power Source: 200 to 250 vac, 50/60 Hz, 3-phase. Available taps on transformers for 200, 210, 220, 230, 240, and 250 volts

Permissible Line Voltage Variations: $\pm 5\%$, each phase must be within 5% of the average of all three phases

Power Requirements: Nominal 20-kw output, 35 kva at .97 power factor

Power Line Regulation: 3%

Variations: Slow line, $\pm 5\%$; rapid line $\pm 3\%$

Tube Complement: Two 4CX250B, one 4CX15,000A

Size: 67½ in. W, 69 in. H, 29 in. D (171.4 cm W, 175.3 cm H, 73.6 cm D)

Weight: 2400 lb (1045 kg)

Part No. 522 4685

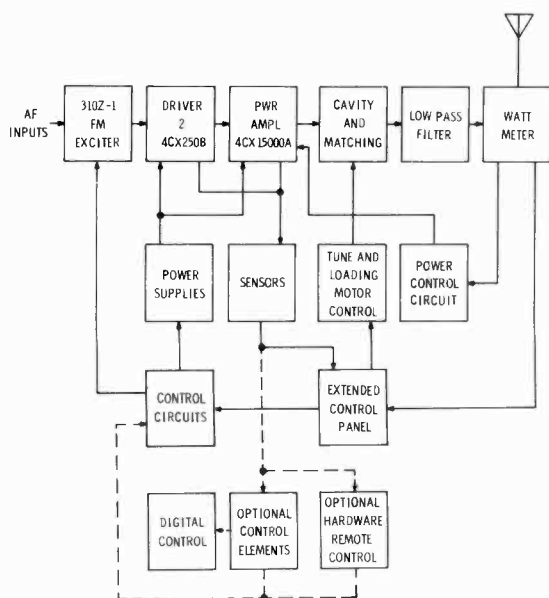

BLOCK DIAGRAM 831G-1

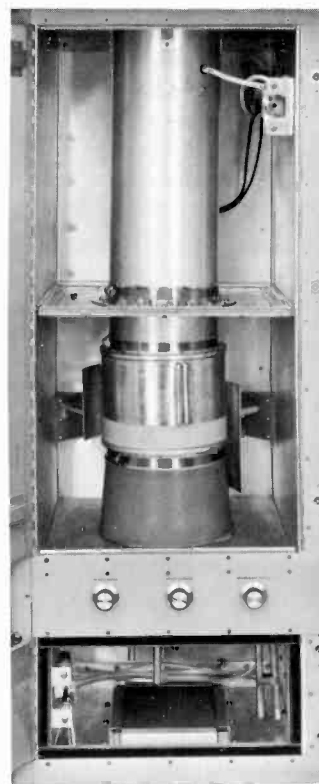

RF CAVITY

Type 37M Antenna — Side Mounted

Collins Type	No. of Rings	Power Gain	Field Gain	db Gain	A** Feet & Inches	On 1 5/8" Line B*** Weight (lb)		On 3 1/8" Line B*** Weight (lb)	
37M-1	1	0.9	.95	— 0.45	2'5"	43	42	81	69
37M-2	2	2.0	1.41	3.01	12'3"	125	91	234	155
37M-3	3	3.0	1.73	4.77	22'1"	206	140	386	241
37M-4	4	4.1	2.02	6.13	31'10"	288	189	538	327
37M-5	5	5.2	2.28	7.16	41'8"	370	238	691	413
37M-6	6	6.3	2.51	7.99	51'5"	451	287	843	499
37M-7	7	7.3	2.70	8.63	61'3"	533	336	996	585
37M-8	8	8.4	2.90	9.24	71'0"	614	385	1148	671
37M-9*	9	9.4	3.07	9.73	80'10"	696	434	1300	757
37M-10*	10	10.5	3.24	10.21	90'7"	778	483	1453	843
37M-12*	12	12.5	3.54	10.97	110'3"	941	581	1758	1015
37M-14*	14	14.5	3.81	11.61	129'10"	1104	679	2062	1187
37M-16*	16	16.5	4.06	12.17	149'5"	1267	777	2367	1359

* Antennas of over 8 bays are center fed.

** Computed for 100 MHz. For other frequencies multiply by 100 divided by frequency in MHz.

*** Wind loads based on 60 pounds on flat surfaces, 40 pounds per square foot on projected areas of cylindrical surfaces with all sections considered round.

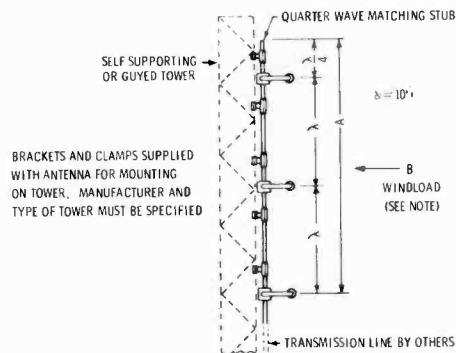

Type 37M Antenna — Top Mounted

Collins Type	No. of Rgs	Pwr Gn	On 1 5/8-in. Line									On 3 1/8-in. Line					
			A Ft	B Ft	C Ft	D Ft	E Dia	F Dia	G Lb	H Ft-Lb	Dead Wt	D Ft	E Dia	F Dia	G Lb	H Ft-Lb	Dead Wt
37M-1	1	0.9	6		3	4.7	3 1/8"	3 1/8"	50	230	223	4-7	3 1/8"	3 1/8"	68	312	250
37M-2	2	2.0	16	10±	4	10	4 1/2"	4 1/2"	239	2,390	305	12-3	4 1/2"	4 1/2"	291	3,565	360
37M-3	3	3.0	26	20±	7	14-5	6 5/8"	6 5/8"	403	5,803	736	14-4	6 5/8"	6 5/8"	486	6,950	825
37M-4	4	4.1	36	30±	10	19	7 5/8"	7 5/8"	564	10,716	1169	18-9	7 5/8"	7 5/8"	678	12,713	1290
37M-5	5	5.2	46	40±	12	23	8 5/8"	7 5/8"	747	17,181	1652	22-8	9 5/8"	9 5/8"	919	20,769	2128
37M-6	6	6.3	56	50±	14	27-2	9 5/8"	8 5/8"	951	25,867	2285	26-7	10 3/4"	9 5/8"	1173	31,260	2770
37M-7	7	7.3	66	60±	15	31	10 3/4"	8 5/8"	1175	36,425	3218	31-3	10 3/4"	8 5/8"	1388	43,375	3485
37M-8*	8	8.4	76	70±	16-6	34-9	11 3/4"	9 5/8"	1417	49,241	4051	34-8	12 3/4"	11 3/4"	1696	58,682	4650

*up to 16 bays on application

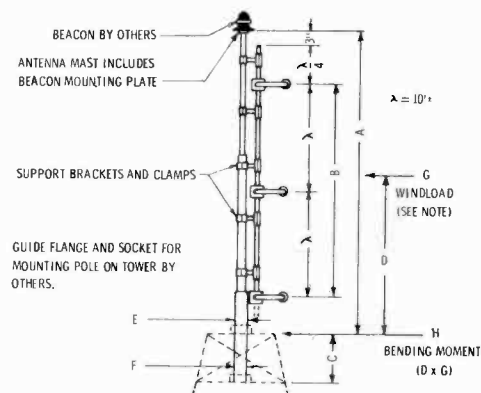

COLLINS 300C VERTICALLY POLARIZED FM ANTENNA

Collins 300C vertically polarized FM antenna can significantly improve your FM coverage. Here's how:

FCC regulations permit simultaneous FM radiation in both horizontal and vertical planes. For example, if your station is authorized for 5-kw ERP horizontal, vertical radiation can be added up to the same power. Stations now operating with greater ERP than specified in new FCC rules for their classification may radiate vertically up to the maximum ERP specified in the rules.

Two methods are commonly used:

(1) A single power amplifier and transmission line to provide power for each antenna.

(2) Two power amplifiers fed from a common exciter-driver and two transmission lines. The antennas are fed separately.

The preferred method will be dictated by your power situation. If min-

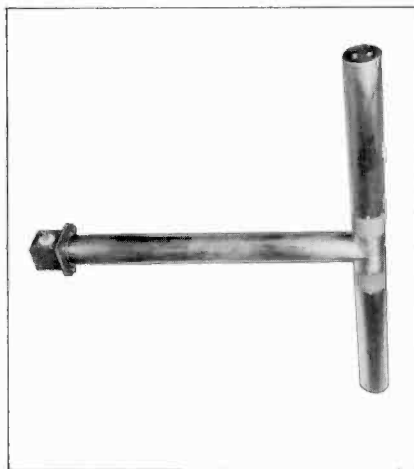

imum initial investment is your primary concern, the first method is preferred. If redundancy is important, the second method permits either amplifier to be operated individually or both simultaneously. The recommended ratio of vertical to horizontal ERP is unity.

Collins Type 300C costs no more than your present horizontal bays, can be installed on your present tower, and is compatible with your FM transmitter.

Vertical polarization with Collins 300C:

- Fills in shadow areas
- Reduces null effects
- Improves fringe area reception
- Vastly improves car FM radio reception
- Maintains FM stereo quality
- Improves SCA operation.

Type 300C Antenna — Side Mounted

Type	No. of Dipoles	Power Gain	Field Gain	db Gain	Power Rating		Length
					1 5/8-in. Line	3 1/8-in. Line	
300-1	1	0.950	0.975	-0.002	3	3	3'9"
300-2	2	1.969	1.400	2.942	6	6	13'7"
300-3	3	3.120	1.767	4.942	9	9	23'4"
300-4	4	4.198	2.045	6.230	10	12	33'2"
300-5	5	5.310	2.305	7.251	10	15	42'11"
300-6	6	6.393	2.528	8.057	10	18	57'9"
300-7	7	7.500	2.738	8.751	10	21	62'7"
300-8*	8	8.571	2.926	9.330	20	24	72'4"
300-9*	9	9.755	3.124	9.892	20	27	82'2"
300-10*	10	10.960	3.311	10.398	20	30	91'11"
300-12*	12	13.195	3.633	11.204	20	36	111'7"
300-14*	14	15.290	3.910	11.844	20	42	131'2"
300-16*	16	17.483	4.181	12.426	20	48	150'9"
Type	Weight		Wind Load**		Over Turning Moment***		
	1 5/8-in. Line	3 1/8-in. Line	1 5/8-in. Line	3 1/8-in. Line	1 5/8-in. Line	3 1/8-in. Line	
300-1	50	55	104	104	0	0	
300-2	111	135	259	307	1,190	1,430	
300-3	171	215	414	510	3,900	4,840	
300-4	232	292	569	713	8,350	10,200	
300-5	292	375	724	916	14,300	17,600	
300-6	353	455	879	1119	21,100	27,000	
300-7	413	535	1034	1322	29,900	38,400	
300-8*	474	615	1189	1525	40,200	51,700	
300-9*	534	695	1344	1728	52,100	67,100	
300-10*	595	775	1499	1931	65,400	84,400	
300-12*	716	935	1809	2337	96,600	125,000	
300-14*	837	1095	2119	2743	133,965	173,000	
300-16*	958	1255	2429	3149	177,000	230,000	

* Antennas of eight bays and over are center fed.

** Wind load in the direction through the mounting toward the tower computed for 60 lb on flat surfaces and 40 lb on projected areas of cylindrical surfaces.

*** For 60-lb wind loading direction through the mounting toward the tower and referred to the centerline of the bottom bay.

COLLINS 37CP CIRCULARLY POLARIZED FM ANTENNA

Collins 37CP series of Circularly Polarized FM Antennas is designed for use in monaural, stereo, and multiplex FM broadcasting. These antennas have a low standing wave ratio over a 200-kHz channel, providing optimum conditions for stereo or multiplex operation.

The 37CP antenna radiates a circularly (clockwise) polarized wave for improved reception in FM automobile radios employing vertical whip antennas and in home receivers employing dipole antennas. In fact, these antennas can be used to advantage in any application that previously required the use of separate vertically and horizontally polarized antennas of equal power gain and equal power input requirements.

Collins 37CP antenna transmits circular polarization as authorized by the FCC rules and regulations. A station's ERP is determined by the signal radiated in the horizontal plane. The ERP is determined by the antenna power gain (see table) in the horizontal plane multiplied by the power fed to the antenna. When using circular polarization instead of horizontal polarization, transmitter power can be doubled without exceeding the licensed horizontal effective radiated power. This is because the additional power radiated is in other planes of polari-

zation. Conversely, for a given transmitter power, the number of antenna bays can be doubled for the same reason. An external power divider or splitter is not required.

Mechanically, the 37CP Antenna is designed for rugged service in all types of weather environment; it will withstand wind velocities of over 100 miles per hour. Any number of antenna elements from 1 to 16 may be used to provide maximum flexibility in selecting gain for any particular installation. The design is flexible and permits ease of installation on the side of an existing tower, or pole mounting on top of towers or buildings.

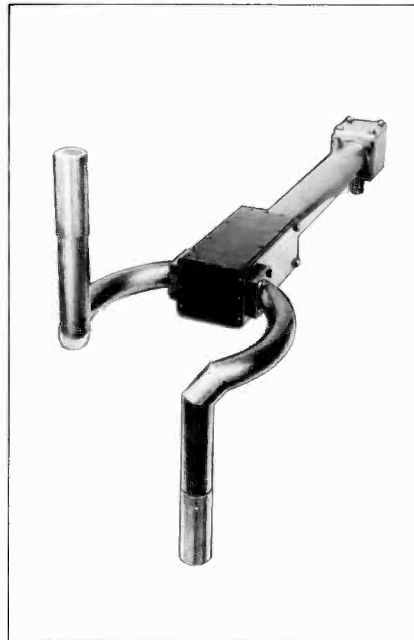

Mounting brackets are supplied with antennas for standard or conventional installation at no extra cost. Custom brackets can be supplied at extra cost for special or unusual types of installations. The antenna can be supplied with standard poles using either pedestal or socket mounts.

Frequency Range: Factory tuned to one frequency in the 88- to 108-MHz band

Polarization: Circular, clockwise

Power Gain:

Horizontal Polarization: See table.

Vertical Polarization: See table.

Azimuthal Pattern:

Horizontal Polarization:

Circular ± 2.0 db in free space

Vertical Polarization:

Circular ± 2.0 db in free space

VSWR at Input (without field trimming):

Top Mounting: 1.1:1 or better

Side Mounting: 1.5:1 or better

Input Connection: 3/8-inch, 50-ohm EIA female flange

Power Input Rating (one bay): 20 kw

Windload: 50 lb/sq ft for flat surfaces;

33 lb/sq ft for cylindrical surfaces

Dimensions: 30 in. high by 45 1/2 in. long

Weight:

Antenna Bay: 41 lb (19 kg)

Interconnecting Feed Line: 27 1/2 lb (12 kg)

Mounting Bracket: 22 lb (10 kg)

Type 37CP Antenna

Type	No. of Elements	Power Gain		Field Gain		DB Gain		Power Rating	Length**	Weight (lb)	Wind Load***
		H	V	H	V	H	V				
37CP-1	1	.438	.438	.662	.662	-3.7	-3.7	20	2' 5"	64	136
37CP-2	2	.947	.947	.973	.973	-.1	-.1	40	12' 3"	186	299
37CP-3	3	1.48	1.48	1.22	1.22	1.7	1.7	40	22' 1"	277	463
37CP-4	4	2.02	2.02	1.42	1.42	3.1	3.1	40	31' 10"	369	626
37CP-5	5	2.58	2.58	1.61	1.61	4.1	4.1	40	41' 8"	460	790
37CP-6	6	3.13	3.13	1.77	1.77	5	5	40	51' 5"	552	953
37CP-7	7	3.69	3.69	1.92	1.92	5.7	5.7	40	61' 3"	643	1117
37CP-8	8	4.26	4.26	2.06	2.06	6.3	6.3	40	71' 0"	735	1280
37CP-9	9	4.82	4.82	2.20	2.20	6.8	6.8	40	80' 10"	826	1444
37CP-10*	10	5.40	5.40	2.33	2.33	7.3	7.3	40	90' 7"	955	1644
37CP-12*	12	6.53	6.53	2.56	2.56	8.2	8.2	40	110' 3"	1138	1971
37CP-14*	14	7.67	7.67	2.77	2.77	8.9	8.9	40	129' 10"	1321	2298
37CP-16*	16	8.81	8.81	2.97	2.97	9.5	9.5	40	149' 5"	1504	2625

* Antennas of 10 bays and over are center fed with even numbers of bays, or at a point 1/2 bay below center with odd number of bays.

** When determining coax line lengths add 6 ft to antenna lengths to allow for matching stub.

*** Wind loading based on 50 psf wind pressure on flat surface, 33 psf on cylindrical surface (110 mph actual wind velocity).

AM AND FM TOWERS

Collins furnishes a wide selection of both self-supporting and guyed antenna towers to meet the requirements of any AM or FM installation.

Towers are normally supplied with a protective coating of rust inhibitive paint prior to shipment, although they can be supplied with a galvanized finish at a slightly higher price. Galvanized is recommended in locations where the tower will be subjected to salt water spray, extreme humidity or other corrosive conditions. The finish coat is normally supplied by the tower erector and is in keeping with FAA requirement.

All hardware, fittings, guy insulators, anchor steel and base insulator (where required) are supplied with each tower. The applicable FCC (FAA) lighting kit and wiring are also provided.

COPPER GROUND WIRE

Bare #10 copper ground wire is used for ground radials. Wire attaches to mesh ground screen.

Weight: 31.8 ft per lb
Part No. 421 1010 000

COPPER GROUND STRAP

This fine quality copper ground strap is available in two sizes: 2 in. by 0.032 in. (4.02 ft per lb.), and 4 in. by 0.032 in. (2.01 ft per lb.).

Part No. 097 1445 00 (2-in. strap)
Part No. 099 2689 00 (3-in. strap)
Part No. 097 0811 00 (4-in. strap)

HUGHEY & PHILLIPS RING TRANSFORMER

For use wherever 60-Hz energy must be transferred across two points with very low capacitance or at very high voltages. Provides a highly reliable, low capacity means of supplying power across base insulator or insulated radio towers employed as radiators. Their relatively large spacing and low capacity between windings make these isolation transformers desirable for use in directional arrays, and especially with radiators that develop very high voltages across the base insulators. No tuning or rf adjustments are necessary. Available in load capacities of 1750 watts (Model TI 2017) and 3500 watts (Model TI 2035) 115/230 volts.

Part No. 097 6920 00 (Type TI 2017)
Part No. 099 0365 00 (Type TI 2035)

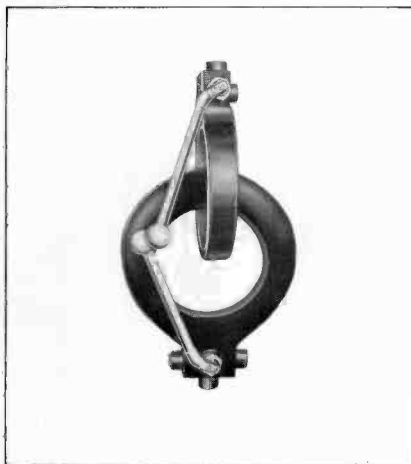

TRUSCON MESH GROUND SCREEN

Expanded copper mesh ground screen is for use beneath base of antenna tower to increase soil conductivity. Available in 8- by 24-ft sheets.

Part No. 013 0107 00

FISHER-PIERCE 63305-DB BEACON LIGHT CONTROL

Designed to mount in a standard commercial meter socket. The 63305-DB will automatically control broadcast tower lights directly or with auxiliary contactors. Adjustable potentiometer allows adjustment for operation from 0 to 50 footcandles.

Power Requirements: 105 to 130 volts, 50/60 Hz

Built-in Load Contactor: Single Pole, Single Throw, Double Break, 30A
Load Rating: 3000 watts

Part No. 124 0032 559

COLLINS TRANSMISSION LINE KIT

Collins Transmission Line Kit contains an assortment of couplings, flanges, elbows, fittings, hardware, etc. for installation of FM antennas and coaxial lines. All items are packed in a sturdy case in which the unused items may be returned to Collins for credit.

Part No. 782 0009 001
(1 $\frac{5}{8}$ -inch kit)

Part No. 782 0008 001
(3 $\frac{1}{8}$ -inch kit)

TRANSMISSION LINES AND ACCESSORIES

Information on Andrew or Prodelin transmission lines, fittings, and accessories will be supplied upon request.

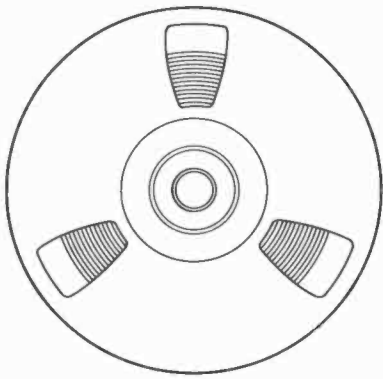

**Audio
Equipment**

COLLINS 212S-1 STEREO SPEECH INPUT CONSOLE

The Collins 212S-1 Speech Input Console features new concepts and techniques to offer broadcasters, recording studios and television studios quality performance with versatility and adaptability.

It's the newest switching technique in speech input consoles. It's noiseless. The switch is made of a photoconductive cell and a lamp in a sealed container. The cell shows a very low resistance when the lamp is on. This makes a switch with no contacts to wear, bounce, or become contaminated.

A similar device for level control of the program material is also used. The photoconductive cell responds to variable voltages from a potentiometer to control attenuation in the signal path. This control eliminates maintenance time normally required for cleaning and relubrication of mixer controls.

The fact that these photoconductive devices can be remotely controlled by dc voltages makes it possible to mount the switching and attenuating components where they are needed rather than on the front panel. This allows complete physical and electrical separation of the two program channels and elimination of all program audio wiring and components from the front panel.

Collins new 212S-1 was designed primarily for stereo, but it can also be used for monaural. It provides monaural output simultaneously on both program channels from a single input, or can handle completely separate monaural material from inputs through two program outputs. One switch controls this function.

Like all other Collins broadcast equipment, the 212S-1 is easy to install and maintain. Simple removal of a protective cover exposes the input/output terminals on the deck. Cable access ports through this deck permit an installation that's free of the "haywire look"! Removal of another protective cover exposes the wiring to the

card box receptacles. And inspection of the cards can be made simply by lifting the hinged card box to the vertical position. An extender card is furnished for troubleshooting at the component level with the cards connected to the rest of the console.

The solid-state amplifiers and the control elements are mounted on the plug-in cards that fit in two card boxes, one box for each program channel. The card box provides space and receptacles for six high-level or low-level pre-amplifiers, one program amplifier, one monitor amplifier and one switch matrix for remote line input switching. Each high-level and low-level card has two balanced inputs selectable from the front panel. Stable, high-quality components and circuits are used throughout the amplifiers to assure reliability and fidelity.

The VU meters may be switched to the channels or to external lines. Switching and terminals are also provided for the connection of the Collins 900C-3 FM Stereo Modulation Monitor outputs to the inputs of monitor amplifiers.

The 212S-1 also includes an intercom amplifier that can be switched to one of four stations or to a selected remote line. The speaker is also used for the intercom microphone. The intercom amplifier can be used as the amplifier for the signals on the cue bus by setting the intercom switch at the cue position. A reverse cue amplifier is also provided so that program material may be sent back to a remote site preceding the start of a remote program.

Switching for warning light and speaker muting is provided by a relay unit with a self-contained 12-volt dc power supply. The power supply is used to power the lamps which illuminate the VU meters. Four relays are included in the unit.

A Dual Channel version of the 212S-1 is available without stereo. It has stereo capability, and if desired later, the stereo configuration can be added by the simple addition of cards.



Maximum Number of Channels: Five stereo inputs from local sources plus one of four remote stereo inputs or one network stereo input. Each local stereo input may have two selectable sources. With each 260S-1 Add-On Unit, two additional local stereo inputs may be used, each having two selectable sources.

Power Source: 115 or 230 vac $\pm 10\%$, 50 to 60 Hz, single phase

Input Impedance: Lower level, 30/150/250/600 ohms balanced or unbalanced; Net/Remote, 600 ohms balanced; Medium level, 600 ohms balanced or unbalanced

Output Impedance: Line, 600 ohms (150 ohms on special order); Monitor, 8 ohms

Input Level: Low, -55 dbm nominal; High, -10 dbm; Net/Remote, +8 dbm

Gain: Low level to program output at least 100 db

Output Level: Program, +8 dbm; Monitor, 10 watts

Frequency Response: ± 1 db, 30 to 15,000 Hz (ref. 1 kHz) on both program and monitor outputs

Harmonic Distortion: Less than 1% at max. program level or max. monitor level

Noise: -120 dbm or less equivalent input noise

Size: 10 $\frac{1}{8}$ in. H by 37-3/16 in. W by 18 $\frac{3}{8}$ in. D (26 cm by 95 cm by 47 cm)

Weight: 114 lb (52 kg)

Color: White and dark gray front panel; terra cotta accent strip, light gray cabinet

Part No. 522 3880 001 (212S-1)
Part No. 522 3880 710 (Dual Channel)

260S-1 Mixer Add-on Units

You can add input capability to the 212S-1 Speech Input Console with the addition of one or more Collins 260S-1 Mixer Add-on Units. You can add two complete stereo input channels for microphones, turntables or tape recorders. Each input amplifier has two selectable inputs. Level and switching control on the 260S-1 units are performed the same as on the 212S-1. The add-on units accommodate either four preamplifiers or four high-level input cards, or two preamplifiers and two high-level cards — depending upon your needs or sources.

Part No. 522 3882 001 (260S-1)

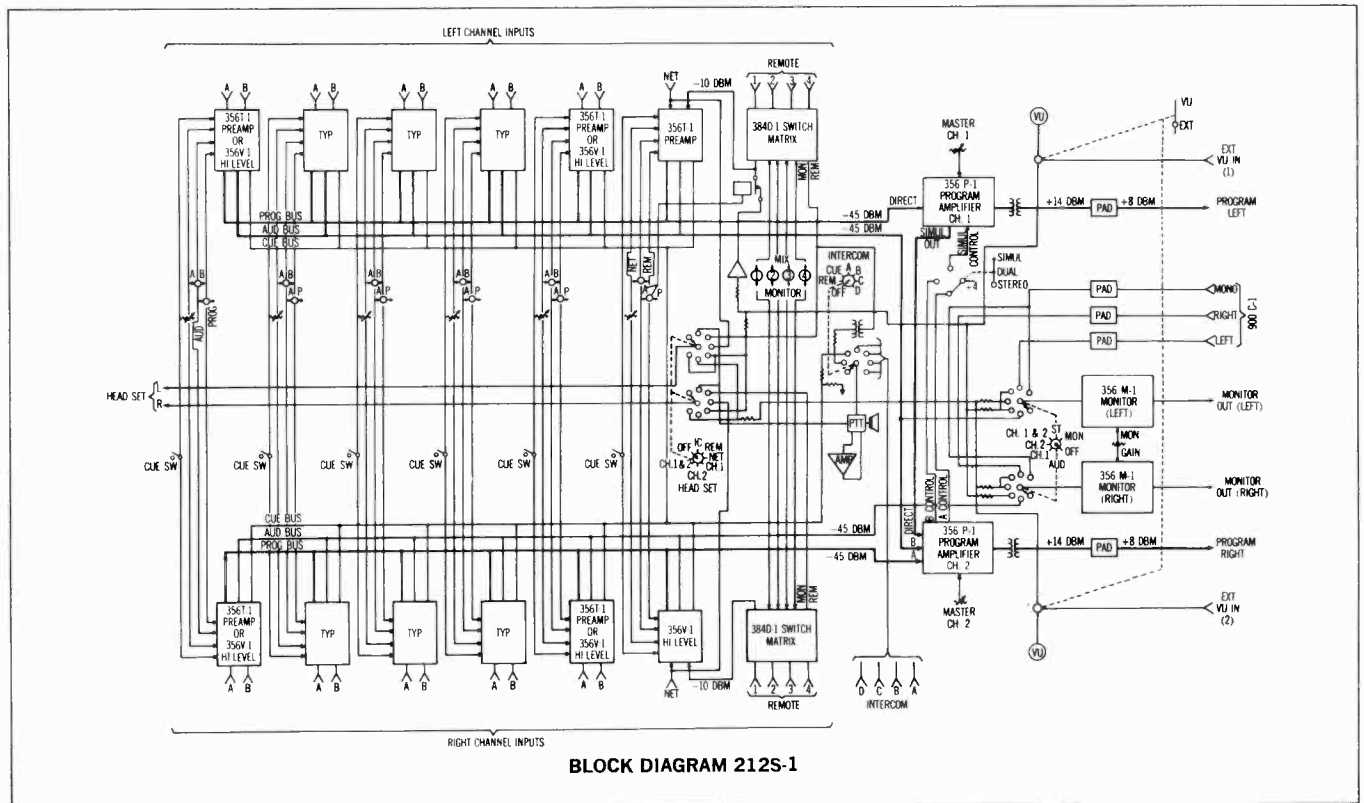
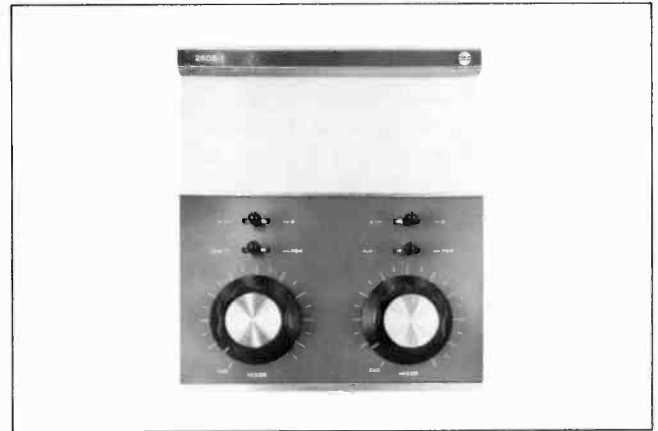

BLOCK DIAGRAM 212S-1

COLLINS 212M-1 SPEECH INPUT CONSOLE

The 212M-1 is the monaural equivalent of the 212S-1 Stereo Console. Utilizing the source modules in a lesser quantity, the broadcaster can realize the same reliability, fidelity and operational features as described above by the 212S-1.

Maximum Number of Channels: Five mono inputs from local sources plus one of four remote inputs or one network input. Each local input may have two selectable sources. With each 260S-1 Add-On Unit, two additional local inputs may be used, each having two selectable sources.

Power Source: 115 or 230 vac $\pm 10\%$, 50 to 60 Hz, single phase

Input Impedance: Low level, 30/150/250/600 ohms balanced or unbalanced; Net/Remote, 600 ohms balanced;

Medium level, 600 ohms balanced or unbalanced
Output Impedance: Line, 600 ohms, (150 ohms on special order); Monitor, 8 ohms
Input Level: Low, -55 dbm nominal; High, -10 dbm; Net/Remote, +8 dbm

Gain: Low level to program output at least 100 db
Output Level: Program, +8 dbm; Monitor, 10 watts
Frequency Response: ± 1 db, 30 to 15,000 Hz (ref. 1 kHz) on both program and monitor outputs

Harmonic Distortion: Less than 1% at max. program level or max. monitor level

Noise: -120 dbm or less equivalent input noise

Size: 10 $\frac{1}{8}$ in. H by 37- $\frac{3}{16}$ in. W by 18 $\frac{3}{8}$ in. D (26 cm by 95 cm by 47 cm)

Color: White and dark gray front panel; terra cotta accent strip. Light gray cabinet

Weight: 107 lb (49 kg)

Part No. 522 3879 001

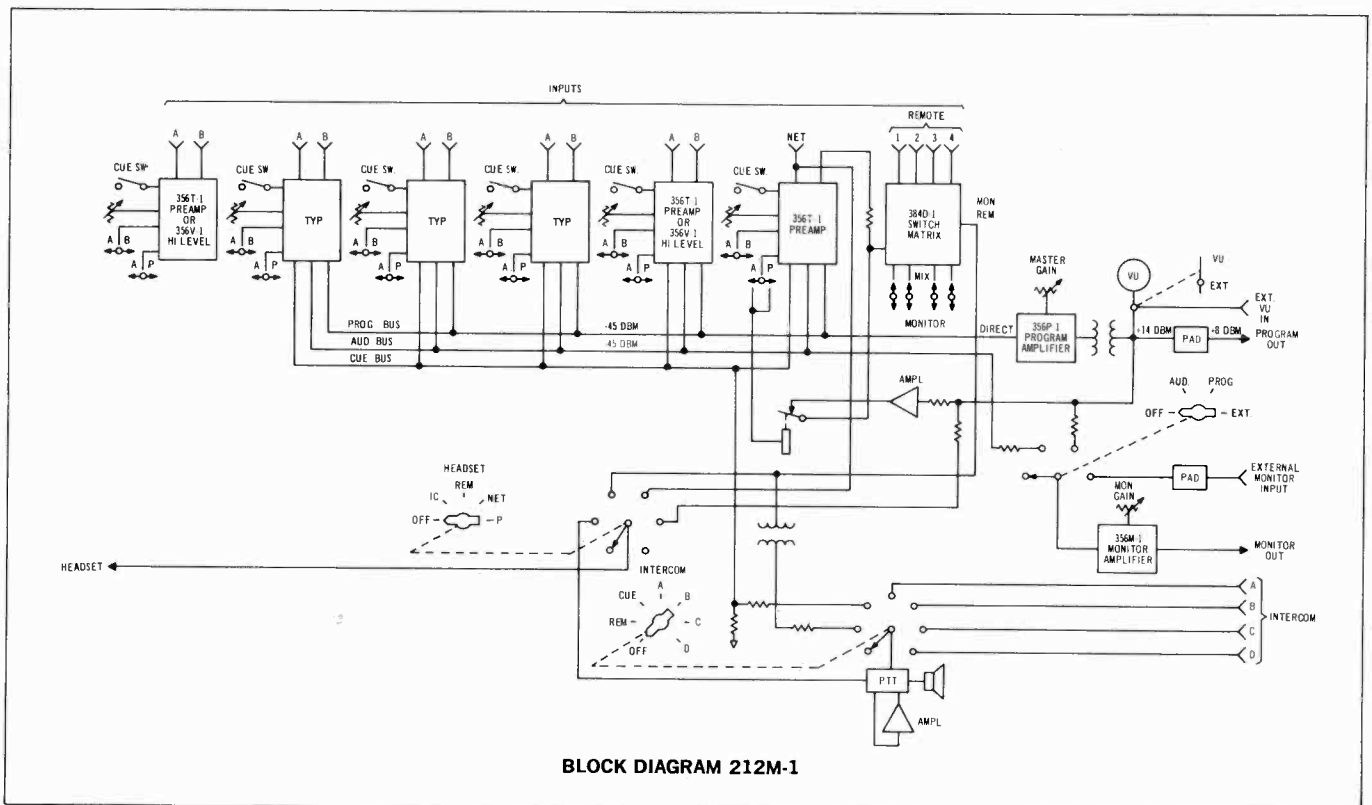
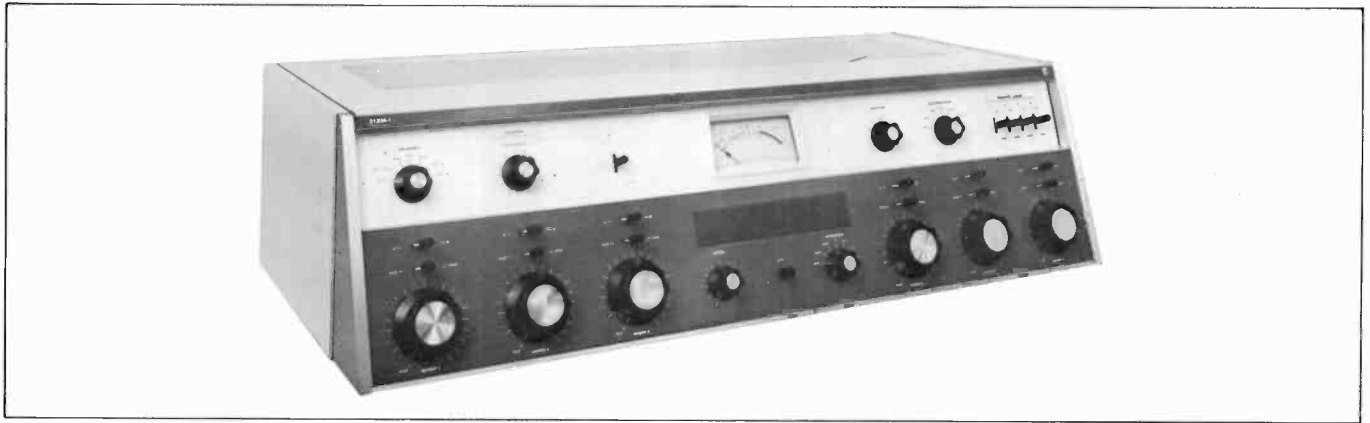

COLLINS 356T-1 PREAMPLIFIER

The 356T-1 is used with the 212S-1 and 212M-1 consoles in input channels where microphones are to be utilized.

Input Impedance: 600/250/150/30 ohms balanced, factory wired for 150 ohms

Gain: Total 50 db voltage gain, -65 dbm from microphone will deliver -45 dbm to input to program amplifier (Includes mixer loss)

Noise: 120 dbm equivalent input noise

Output Impedance: Direct \approx 150 ohms, Program >10 K, 25 db mixing loss

Outputs: Direct, program, audition, and cue

Inputs: MIC 1, Max. input = -30 dbm

MIC 2, Max. input = -30 dbm

Power Requirements: +30 vdc Regulated at 5 ma

Attenuator & Switch Lamps	}	+6 vdc Regulated at 60 ma (1 lamp)
		+4 vdc Regulated at 120 ma (3 lamps)

Frequency Response: ± 0.5 db from 30 Hz to 15 kHz (ref. to 1 kHz)

Harmonic Distortion: 0.5% max. at rated output

Temperature Limits: 0° to 50° C

Size: 4 by 6-inch plug-in card; 1-inch max. component height

Adjustments: Trimpot for tracking attenuators

Attenuator: Photocell lamp unit built into circuit board.

0 vdc to 6 vdc (controlled by external series variable resistor*) attenuates signal over a 55-db range.

Switches: Photocell lamp unit used for all audio circuit switching

*One variable resistor may be used to control attenuation of two preamps. Preamps track within ± 1 db.

Part No. 522 3885 001

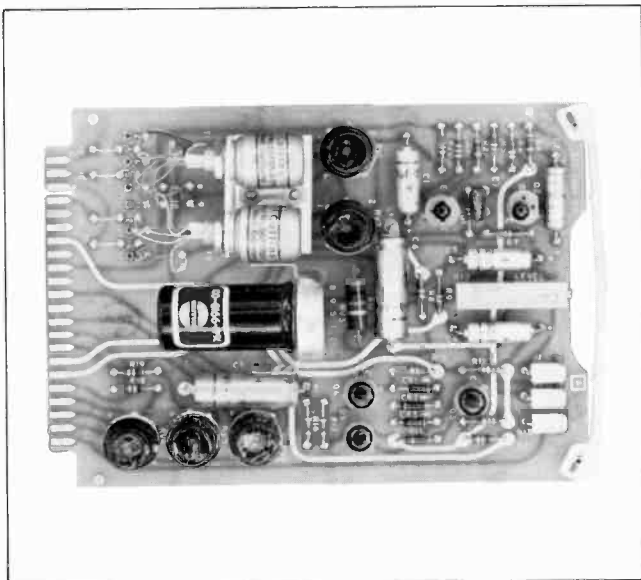

356V-1 HIGH LEVEL INPUT PREAMPLIFIER

The 356V-1 is required for input channels for the 212S-1 and 212M-1 consoles where outputs of the turntable pre-amplifier, tape recorders, and other equipment with audio outputs between -10 dbm and +10 dbm are fed into the console.

Input Impedance: 600 ohms, balanced

Gain: -10 dbm input will deliver -45 dbm to input of program amplifier (Includes mixer loss), 30-db pad on input

Output Impedance: Direct \approx 15 ohms

Program: >10 K, 25-db mixing loss

Outputs: Direct, program, audition, and cue

Inputs: IN 1: Max. input = +10 dbm

Inputs: IN 2: Max. input = +10 dbm

Power Requirements: +30 vdc at 5 ma

Attenuator & Switch Lamps	}	+6 vdc at 60 ma Regulated (1 lamp)
		+4 vdc at 120 ma Regulated (3 lamp)

Frequency Response: ± 0.5 db from 30 Hz to 15 kHz (Ref. to 1 kHz)

Harmonic Distortion: 0.5% maximum at rated output

Temperature Limits: 0° to +50° C

Size: 4 by 6-in. plug-in card; 1-in. maximum component height

Adjustments: Trimpot for tracking attenuators

Attenuator: Photocell lamp unit built into circuit board.

0 vdc to 6 vdc (controlled by external series variable resistor*) attenuates signal over a 55-db range.

Switches: Photocell lamp unit used for all audio circuit switching

*One variable resistor may be used to control attenuation of two hi-level inputs. Tracking is within ± 1 db.

Part No. 522 3887 001

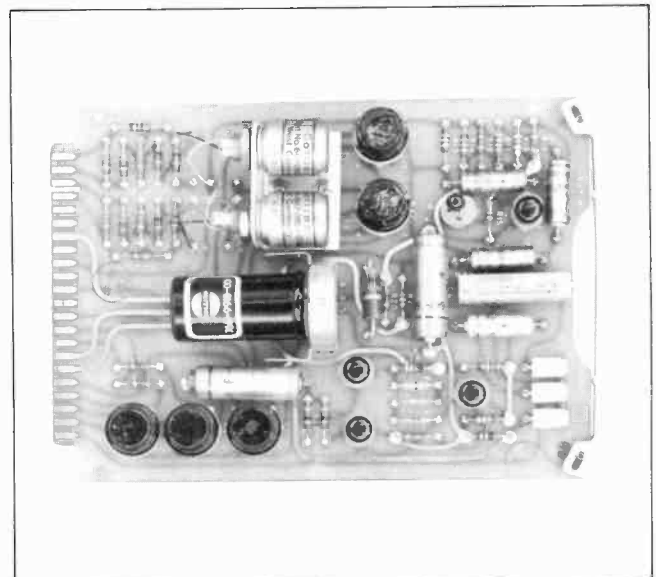

356P-1 PROGRAM AMPLIFIER

The 356P-1 is supplied for use in 212S-1 and 212M-1 consoles as the program output amplifier.

Input Impedance: 600 ohms, balanced or unbalanced

Gain: -45 dbm input will deliver +18 dbm at maximum gain setting; 63-db gain

Output Impedance: 600 ohms (external transformer and capacitor required, not supplied) (direct output impedance less than 30 ohms)

Outputs: Program and Simulcast

Inputs: Switched 1, switched 2, and direct

Power Requirements: +48 vdc at 100 ma (full output)

Attenuator & Switch Lamps $\left\{ \begin{array}{l} +6 \text{ vdc at } 60 \text{ ma regulated} \\ +4 \text{ vdc at } 40 \text{ ma regulated} \end{array} \right.$

Frequency Response: ± 0.5 db from 30 Hz to 15 kHz (ref. to 1 kHz)

Harmonic Distortion: 0.5% maximum at rated output

Temperature Limits: 0° to +50°C

Size: 4 by 6-inch plug-in circuit card; 1-inch maximum component height

Adjustments: Trimpot for Simulcast gain set

Attenuator: Photocell lamp unit built into circuit board.

0 vdc to 6 vdc (controlled by external series variable resistor) attenuates signal over a 50-db range

Simulcast: Simulcast output and photocell switched inputs allow switching for dual, stereo, or Simulcast without level adjustments.

Part No. 522 3884 001

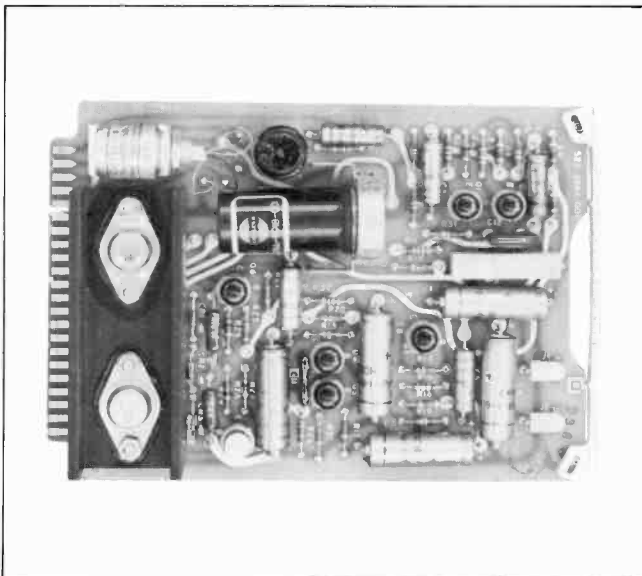

356M-1 MONITOR AMPLIFIER

The 356M-1 is used in 212S-1 and 212M-1 consoles as the monitor amplifier.

Input Impedance: 600 ohms balanced

Gain: 90 db, -50-dbm input will deliver 10 watts to speaker load

Output Impedance: 4, 8, or 16 ohm speakers may be used; 8 ohms optimum (External coupling capacitor required)

Outputs: One to speaker

Inputs: One

Power Requirements: +48 vdc at 750 ma (full output)

Attenuator: +6 vdc at 60 ma regulated

Frequency Response: ± 1 db from 30 Hz to 15 kHz (ref. to 1 kHz)

Harmonic Distortion: Less than 1% at rated output (10 watts rms)

Temperature Limits: 0° to +50° C

Size: 4 by 6-inch plug-in circuit card; 3/8-inch thick (heatsink attached)

Adjustments: Trimpot for tracking attenuator

Attenuator: Photocell lamp unit built into circuit board.

0 vdc to 6 vdc (controlled by external series variable resistor*) attenuates signal over a 50-db range

*One variable resistor may be used to control attenuation of two monitor amplifiers, tracking is within ± 1 db.

Part No. 522 3883 001

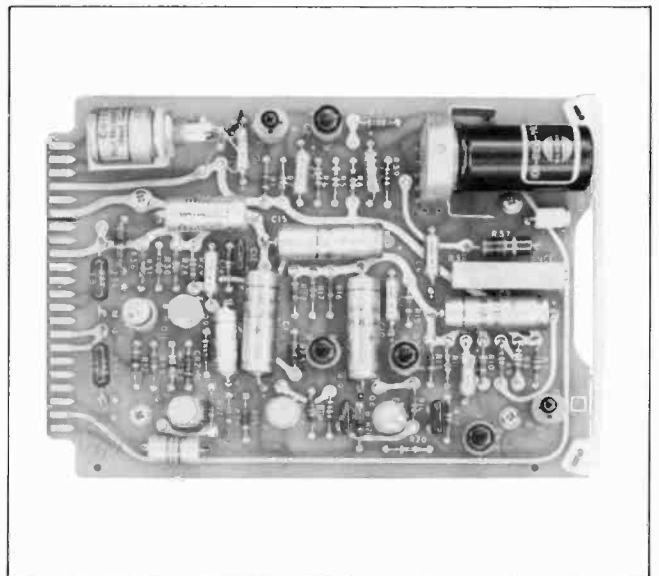

356R-1 MICROPHONE-PHONOGRAPH PREAMPLIFIER

The 356R-1 amplifies and equalizes audio from a magnetic pickup or amplifies audio from a microphone. Two remotely switched inputs, three remotely switched outputs, and one direct output are provided.

Input Impedance:

Microphone: 600/250/150/30 ohms, balanced (wired for 150 ohms)

Phonograph: 50K, nominal at 1 kHz

Output Impedance (Unbalanced): Program and audition greater than 10K

Direct: 600 ohms, approximately

Cue: 1K, approximately

Input Level:

Microphone: -65 dbm, nom -20 dbm, max

Phonograph: 2 mv rms, nom 100 mv rms, max

Output Level: Program and Audition (600-ohm load) -45 dbm, nom -10 dbm, max

Direct: 5 volts, max (10K load)

Cue: 12 mv, nominal (2600-ohm load)

Frequency Response: 30 to 15,000 Hz ± 1.0 db (referred to 1 kHz)

Total Harmonic Distortion: 0.5% max at rated output

Noise: Equivalent input noise, -120 dbm (microphone input)

S/N Ratio: Greater than 60 db with 6-mv input signal (phonograph input)

Equalization of Phonograph Input: Strapping allows:
RIAA

RIAA with 3 db of high-frequency boost

RIAA with 3 db of high-frequency rolloff

Ambient Service Conditions:

Temperature 0° to 50°C

Relative humidity up to 90%

Altitude up to 10,000 feet

Size: 4 by 6 by 1 inch

Part No. 758 5486 001

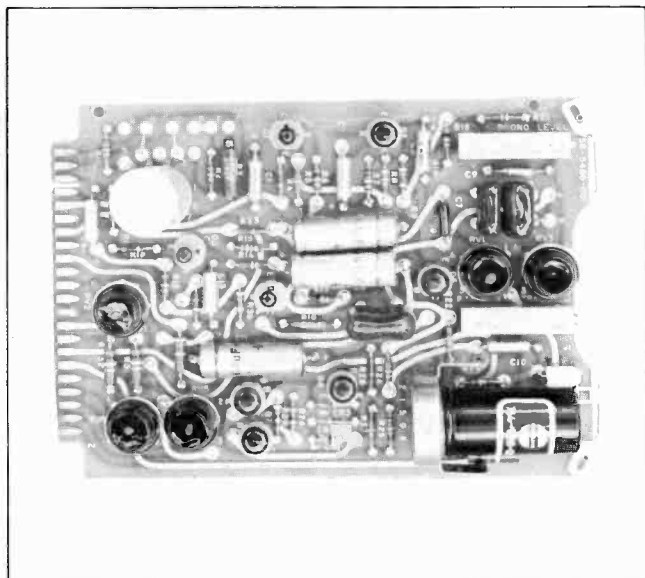

356U-1 BROADCAST AUDIO PREAMPLIFIER

The 356U-1 Broadcast Audio Amplifier amplifies audio signals from two separate high- or low-level inputs. Remotely operated photoconductive devices switch and control audio level of both input and three output channels. One direct output is also available. Four strapping options permit input impedance selection. The card is delivered strapped for 150-ohm inputs.

Microphone Input Impedance: 600, 250, 150, and 30 ohms.

When strapped for high-level input, the input impedance is 600 ohms (terminated) or 100 kilohms (bridging)

Output Impedance:

Unbalanced: Program, Audition, and Cue outputs greater than 10 kilohms

Direct: 600 ohms, unbalanced

Input Level: -65 dbm nominal, -30 dbm maximum; high level, +10 dbm, maximum

Output Level:

Program and Audition (into 600 ohms): -10 dbm, maximum

Cue (into 600 ohms): -40 dbm, -65-dbm microphone input

Direct (into 10 kilohms): 5 volts peak-to-peak, maximum

Frequency Response: ± 1 db, 30 to 15,000 Hz with 1000 Hz as reference level

Total Harmonic Distortion: 0.5% maximum at rated output

Noise:
Equivalent Input Noise: -120 dbm at maximum gain
Signal-to-Noise Ratio (1000-Hz Signal/Wideband Noise Level at Bus Output): Minimum 60 db for -60-dbm input signal

Power Requirements: +30 vdc at 15 ma, 1 mv maximum ripple; +6 vdc at 60 ma, regulated; +4 vdc at 120 ma, regulated

Relative Humidity: Up to 95%

Altitude: Up to 10,000 feet above msl

Type of Service: Continuous

Size: 4-7/16 by 6-3/8 by 1-1/16 inches

Part No. 772 5273 001

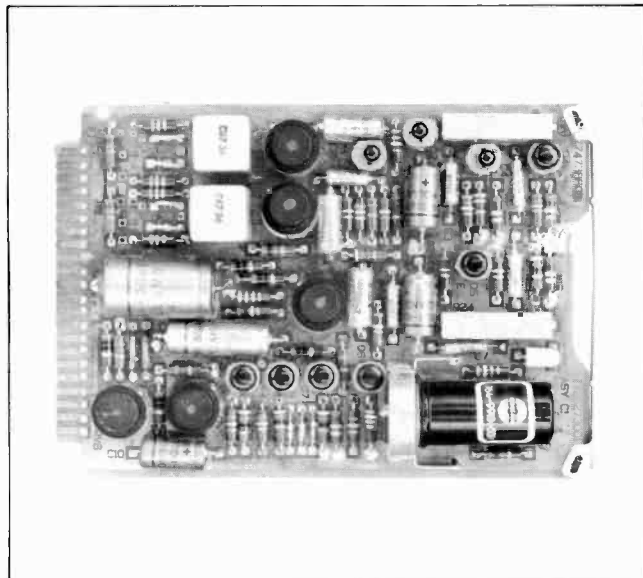

384D-1 SWITCH MATRIX

The 384D-1 is used in the 212S-1 and 212M-1 consoles to switch remote lines coming into the consoles. The 4 x 2 matrix consists of 16 photoconductive switches. Each switch consists of two photocells with 4-volt lamps. The resistance of the photocell is approximately 13 megohms when the lamp is off, and 380 ohms when the lamp is on.

The 384D-1 accepts four balanced inputs with an impedance of 820 ohms.

Outputs: 2 (balanced lines)

Output Impedance: Designed to work into 10K ohms

Power: 4 vdc at 40 ma times number of cells turned on, maximum requirement $16 \times 0.04 = 0.64 \text{ A}$

Ambient Service Conditions:

Temperature: 0° to 50°C

Relative Humidity: Up to 95%

Altitude: Up to 10,000 feet

Switching Control: Eight switching functions

Temperature Limits: 0 to +50°C

Size: 4- by 6-inch plug-in circuit card, 3/4-inch maximum component height

Part No. 522 3888 001



409Z-1 POWER SUPPLY

The 409Z-1 supplies the necessary voltage for the modules of the 212S-1 and 212M-1 consoles.

Power Requirements: 115/220 $\pm 10\%$ vac at 4/2 A, 50/60 Hz, 230 watts maximum

Output Voltages: 48 volts dc at 1 A series regulated, zener reference, less than 5-mv ripple; 48 vdc at 1 A series regulated, zener reference, less than 5-mv ripple; 30 vdc at 50-ma zener regulated, less than 1-mv ripple; 30 vdc at 50-ma zener regulated, less than 1-mv ripple; +6 vdc at 1.5 A, less than 5-mv ripple, adjustable series regulator, temperature compensated; +4 vdc at 2.5 A, less than 5-mv ripple, adjustable series regulator, temperature compensated

Ambient Service Conditions:

Temperature: 0° to 50°C

Relative Humidity: Up to 95%

Altitude: Up to 10,000 feet

Size: 8½ in. H by 8 in. W by 13 in. D

Weight: 30 lb (14 kg)

Part No. 522 3886 001

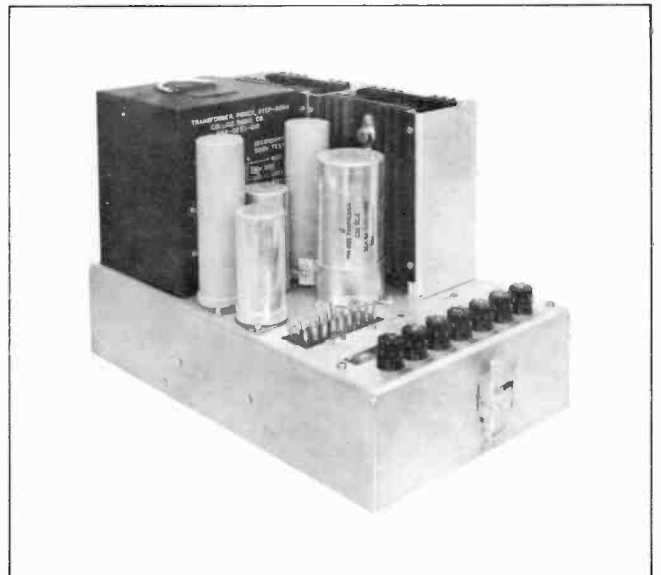

COLLINS 212T-1/2 AUDIO CONTROL CONSOLE

Collins 212T Audio Control Console was designed especially for television, large AM facilities, and recording studios. The 212T-1 and 212T-2 consist of three basic units: a control panel, a rack-mounted assembly containing the amplifiers and input-output terminals, and rack-mounted power supplies. Both systems have many common features; the primary difference is control panel configuration. Two different panel designs provide for a variation in the number of controls available and for flexibility in panel mounting.

All audio and power supply components are common to both the 212T-1 and 212T-2 and are contained in a rack-mounted assembly. This assembly may be located in an area remote from the control room, thus keeping audio leads away from video and sync signal interference present in TV control rooms.

Silicon transistors provide the base for the solid-state 356U-1 Amplifiers. The amplifiers are built on military-grade, etched-epoxy circuit boards. Photocell operation for switching and level control functions are performed within the amplifier cards. A selection of amplifier cards is available to meet all common input levels and impedances.

Program amplifier master gain controls are mounted on the front of the assembly and normally covered to avoid disturbance. Covers for the assembly are hinged and can

be quickly removed for service or adjustment. A test VU meter and selector switch are located on the top of the unit for local audio level monitoring.

Each system has two power supplies. One provides power to control lighting levels for pushbuttons and metering lights, and the other provides power for the audio amplifiers. Both power supply components mount on a 19-inch wide rack shelf and are interconnected to the rack-mounted assembly by plug-in cables.

All rack-mounted assembly wiring is readily accessible. Audio inputs and outputs are connected to terminal strips. Rugged connectors are used to interconnect cables to the front panel. The cable lengths are cut to fit each individual installation.

212T-1 Audio Control

The 212T-1 is a dual-channel console providing 28 inputs to 14 faders, two program output channels, a VU meter for each program output channel, two auxiliary program outputs, two 10-watt monitor outputs, and a built-in cueing speaker.

Each fader is engraved and has illuminated pushbuttons for A and B input selection and channel 1 or 2 selection. These buttons are the push-on, push-off type and are normally preset prior to air time. Two levels of illumination show the status of all switches during operation. The overall level is adjustable by a single control knob on the rack-mounted assembly. This feature is especially useful in dimly lighted areas, such as a TV control room.

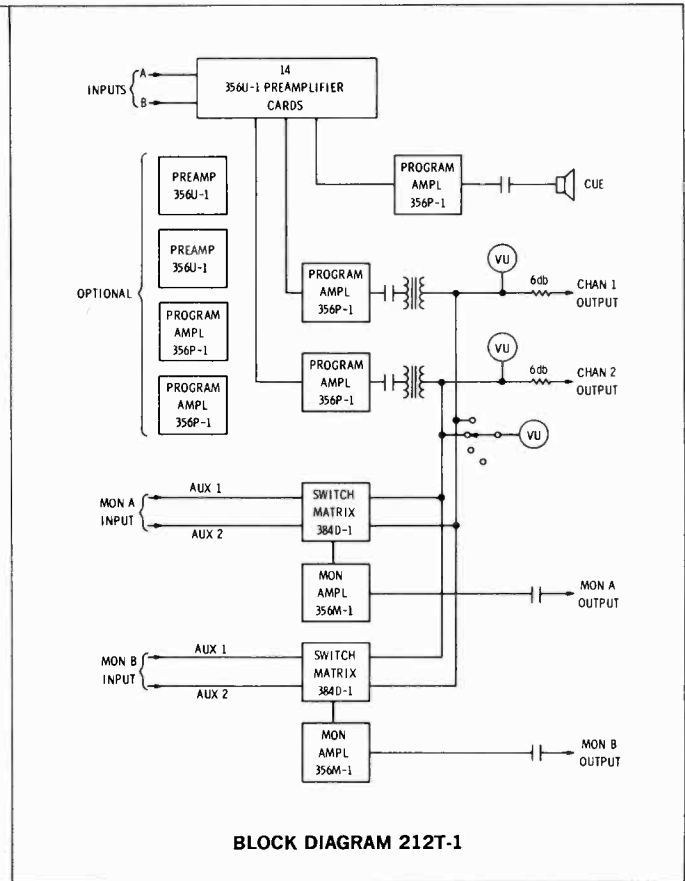
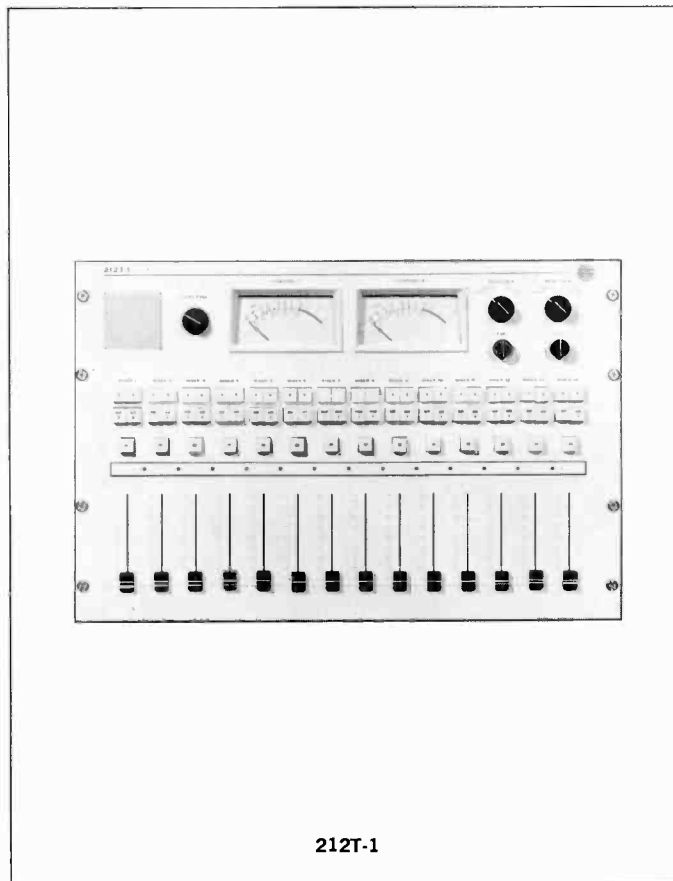

212T-2 Audio Control

The 212T-2 is identical to the 212T-1 except that it provides 32 inputs to 16 faders and has a control panel divided into two separate, functional sections. The top section contains the VU meters and monitoring controls, and the bottom section contains faders and cue switches. Both sections can be rack mounted. The two panels are interconnected by plug-in cable assembly. When desired, the VU meter panel may be mounted at a different angle or location than that of the fader panel.

The pushbuttons are alternate-action types that change color to indicate the position of the switches. The identification letters on each button can be changed at any time to facilitate operator control.

Number of Inputs:

- 212T-1: 28 with 14 faders
- 212T-2: 32 with 16 faders

Input Impedance:

- Low Level: 30/150/250/600 ohms, balanced or unbalanced
- Medium Level: 600 ohms, balanced or unbalanced

Output Impedance:

- Line: 600 ohms (150 ohms on special order)
- Monitor: 8 ohms

Input Level:

- Low: 55 dbm, nominal
- Medium: 10 dbm

Output Level:

- Program: +8 dbm
- Monitor: 10 watts

Frequency Response: ± 1 db, 30 to 15,000 Hz (1-kHz reference) on both program and monitor circuits

Harmonic Distortion: Less than 1% at maximum program level or maximum monitor level

Noise: -65 db below output level (-50-dbm input)

Size:

212T-1 Control Panel: 15 $\frac{3}{4}$ in. H by 24 in. W by 6 in. D (40 cm H by 61 cm W by 15 cm D)

212T-2 Control Panels:

VU Meter and Monitoring Control Panel: 5 $\frac{1}{4}$ in. H by 19 in. W (13 cm H by 48 cm W)

Fader and Cue Switch Panel: 10 $\frac{3}{4}$ in. H by 19 in. W (27 cm H by 48 cm W)

Rack-Mounted Equipment: 21 in. H by 19 in. W by 12 in. D (53 cm H by 48 cm W by 30 cm D)

Power Supply Shelf: 10 $\frac{1}{2}$ in. H by 19 in. W by 14 in. D (27 cm H by 48 cm W by 36 cm D)

Power Source: 115/230 vac $\pm 10\%$, 50/60 Hz

Weight:

- 212T-1/2 Rack: 41 lb (19 kg)
- 212T-1/2 Power Supply: 50 lb (24 kg)
- 212T-1 Control Panel: 32.5 lb (15 kg)
- 212T-2 Control Panel: 19 lb (9 kg)
- 212T-2 Meter Panel: 4.5 lb (2 kg)

Part No. 772 5108 (212T-1)

Part No. 772 5109 (212T-2)

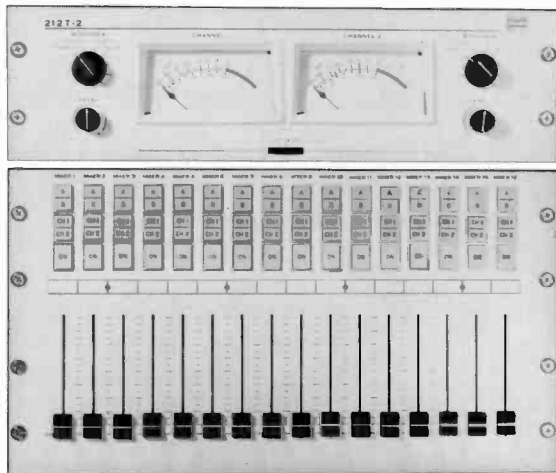

212T-2

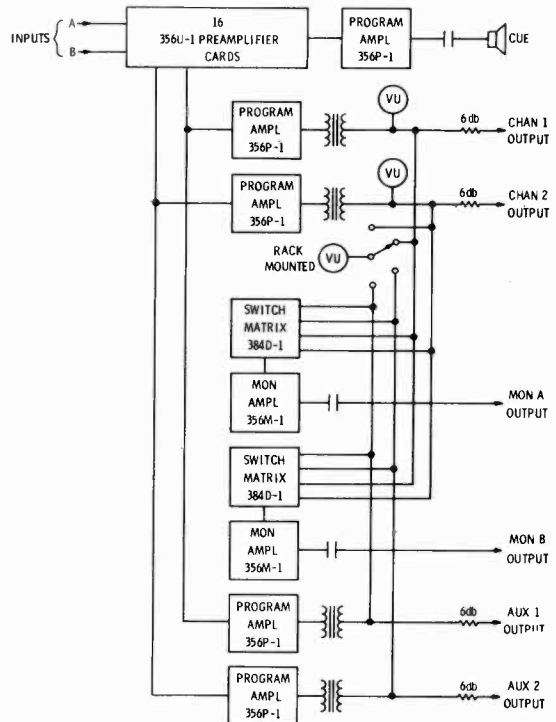

BLOCK DIAGRAM 212T-2

COLLINS 212V-1 BROADCAST AUDIO CONSOLE

The Collins 212V-1 Broadcast Audio Console provides complete, simultaneous control of broadcasting and auditioning from any combination of eight out of 28 possible inputs.

Superior quality, performance, and accessibility are combined in the 212V-1 to make it an outstanding unit for high-fidelity AM, FM, and TV broadcasting or for program control in audio systems. Advanced styling and construction make it an attractive unit with easy accessibility to all cabling, wiring, and subunits. Quality solid-state components give the console top reliability. The hinged front panel tilts forward to facilitate visual inspection or removal of all integral elements.

The 212V-1 console provides six identical preamplifier circuits, each consisting of a flat, low-level amplifier and an equalized phono amplifier. A resistive input pad is also available to reduce a high signal level to near the nominal input level of the flat amplifier. The console has a strapping option for impedances, levels, and equalization on each of the six circuit inputs.

The other two preamplifiers are flat, low-level types with input pads installed to reduce nominal 0 dbm signals to

-60 dbm. Inputs to these pads are connected to 11 position input switches, allowing selection from 22 remote lines or other program sources.

Power Source: 117 vac $\pm 10\%$, 50/60 Hz, single-phase

Input Impedance:

High Level: 600 ohms

Low Level: 600, 150, 30 ohms (factory strapped for 150 ohms)

Phonograph: 50K

Output Impedance:

Program: 600 ohms

Monitor: 8 ohms

Output Level: 8 dbm, nominal

Frequency Response: High- or low-level input, 50 to 15,000 Hz ± 1 db ref 1 kHz; phonograph input, RIAA equalized

Harmonic Distortion: Less than 1% on normal or maximum level

Equivalent Input Noise: -120 dbm or less

Temperature Range: +15 to +40 C

Size: 12 in. H by 42 in. W by 15 in. D (30.5 cm H by 106.7 cm W by 38.1 cm D)

Weight: 40 lb (18.5 kg)

Part No. 777 1504 001

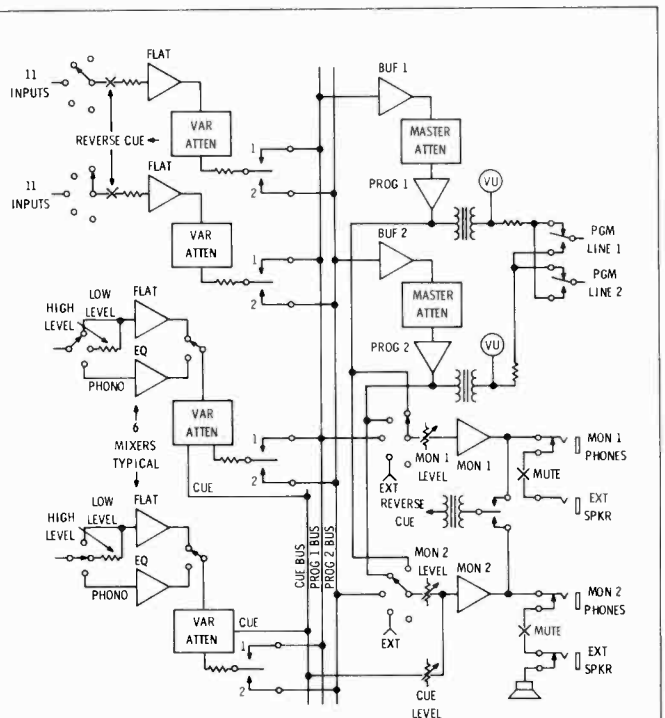
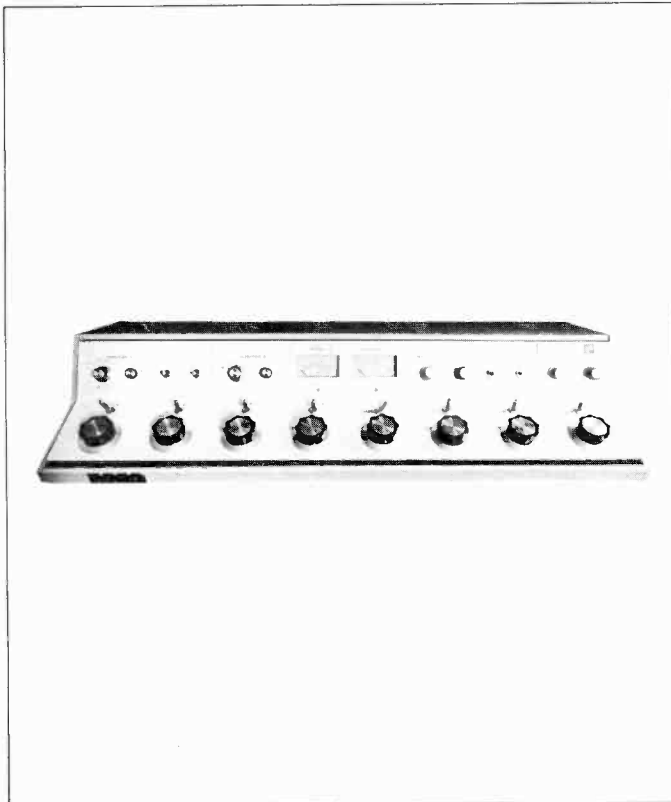

BLOCK DIAGRAM 212V-1

COLLINS 212J-1 BROADCAST AUDIO CONSOLE

Collins 212J-1 Console is a 4-channel monophonic audio mixer for broadcast studios or remote applications. Each of the four mixers controls the gain of a single channel that accepts switched inputs from a microphone, magnetic cartridge, or high-level source. The magnetic cartridge input is RIAA compensated or may be strapped to provide 3 db of treble boost or cut. Console features include 600-ohm public address output, and extremely compact and lightweight design.

Electronics include four mixers and associated amplifiers, a program amplifier, and a monitor amplifier. Mixer outputs may be switched to program or audition bus, or off. The monitor amplifier output switch selects the audition or program bus, or off. Cueing is provided by feeding the mixer cue output to the monitor amplifier in such a manner as to override the switch selected input. A monitor speaker is contained in the console cabinet and provisions are made for head phone or external speakers. An illuminated VU meter displays the program amplifier output and a front-panel jack allows program or talkback monitoring.

Mechanically the unit consists of one printed circuit board, three subassemblies, and a top, bottom, and front cover. When the covers are removed the majority of the console electronics are accessible. Removal of several screws allows lifting of the rear panel and circuit board, making every space accessible while the unit remains operable.

An optional paralleling unit permits connection of two 212J-1 units. In this configuration all eight channels are available for either of two separate outputs.

Power Source: 115 vac $\pm 10\%$, 50/60 Hz, single phase, 170 ma, or 12 to 15 vdc 400 ma max

Input Impedance:

Mike: 150/200 ohms (strappable for 600 ohms) balanced

High Level: 600 ohms, balanced

Phonograph: 100,000 ohms nominal at 1 kHz, unbalanced

Input Level:

Mike: -50 dbm

High Level: -10 dbm

Phonograph: 6 mv

Output Impedance:

Line: 600 ohms

Monitor: Use 8-ohm load (monitor output impedance is less than 1 ohm)

Public Address: Use 600-ohm load

Output Level:

Program: +8 dbm

Monitor: 1/4 watt

Public Address: 0 dbm

Frequency Response: ± 1.5 db on mike or high level, 50 to 15,000 Hz; RIAA compensation, ± 1.5 db, on phonograph input

Harmonic Distortion: Less than 1% on normal or maximum level

Equivalent Input Noise: -120 dbm or less

Temperature Range: 0° to 50°C

Size: 5.5 in. H by 17 in. W by 14 in. D (14 cm H by 43 cm W by 36 cm D)

Weight: 28 pounds (13 kg)

Part No. 777 1428 001 (212J-1)

Part No. 770 5469 001 (Battery Kit)

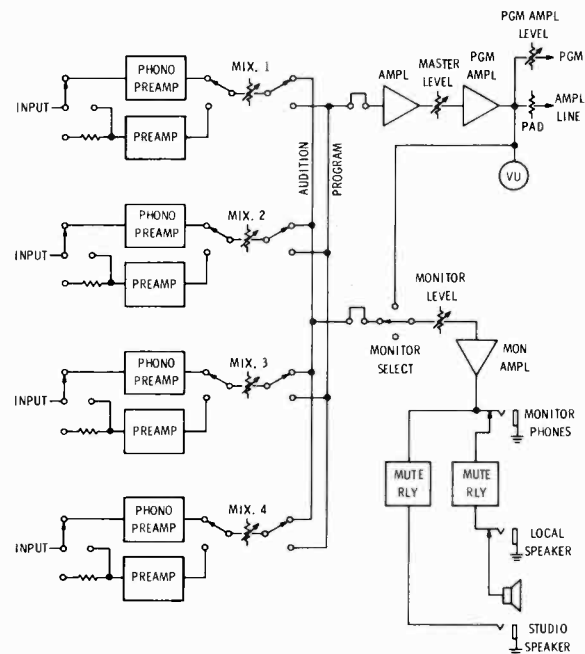
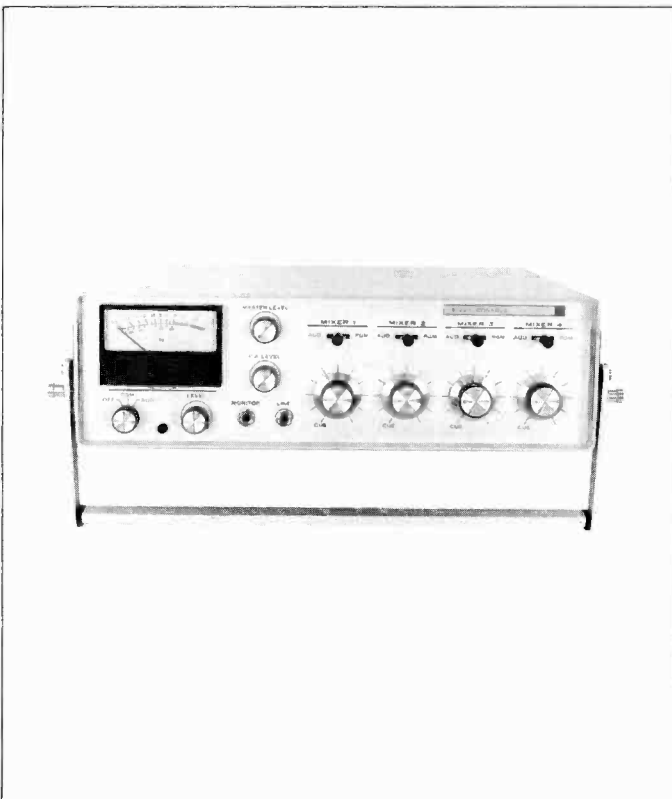

BLOCK DIAGRAM 212J-1

COLLINS 26U-1 LIMITING AMPLIFIER

Designed to achieve maximum modulation with minimum distortion, the Collins 26U-1 Limiting Amplifier provides full tonal range broadcasting with thump-free performance.

The Collins limiting amplifier limits loud audio passages to prevent overmodulation, distortion and adjacent channel interference, while allowing low level passages to be broadcast in their true range.

The transmission range of the station's signal and the overall efficiency of the transmitter are increased through the limiting action, which permits a higher average modulation level.

When used with recording equipment or with a public address system, the 26U-1 prevents overloading, and by allowing a higher average audio level, the limiting amplifier improves the signal-to-noise ratio.

A self-balancing circuit eliminates the need of tube selection or delicate balancing procedures usually associated with peak limiters. The Collins 26U-1 is capable of greater than 30-db compression.

Conventional circuitry, negative feedback, full wave rectification for control voltage and silicon rectifiers in the power supply are incorporated into this unit.

Frequency Response: ± 1.5 db, 50 to 15,000 Hz

Gain: 32 db minimum

Input Impedance: 600 ohms unbalanced

Input Level: -20 dbm to +20 dbm. Note: 0 dbm equals 1 mw across 600 ohms

Output Impedance: 600 ohms unbalanced adjustable, or 600 ohms balanced fixed level

Output Level: -20 dbm to +20 dbm

Distortion: 1.5% maximum

Output Noise: -50 dbm or less

Compression Ratio: 12:1 first 10 db above threshold

Attack Time: Adjustable, 0.5 to 3.0 milliseconds

Release Time: Adjustable, 0.5 to 3.0 seconds for 63% recovery

Power Source: 115 or 230 vac, 50 to 60 Hz, single phase.

Shipped wired for 115 vac

Size: 19 in. W, 10½ in. H, 9 in. D (48.26 cm W, 26.67 cm H, 22.86 cm D)

Weight: 32½ lbs. (15 kg)

Part No. 522 0966 00

No Part Number

100% set of spare tubes

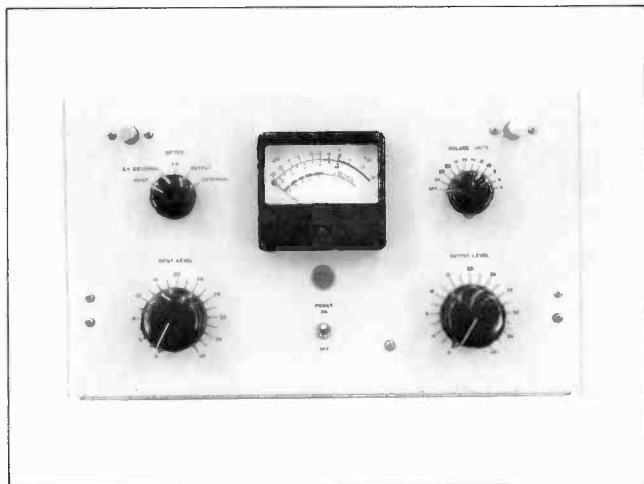

COLLINS 26U-2 STEREO LIMITING AMPLIFIER

Easy to operate and maintain and affording maximum flexibility, the Collins 26U-2 Stereo Limiting Amplifier is designed to permit maximum modulation with minimum distortion. It provides full tonal range broadcasting with thump-free performance.

The 26U-2 limits loud audio passage to prevent overmodulation, distortion and adjacent channel interference, while raising low level passages to be broadcast in their true value.

When used with stereo recording equipment, the Collins stereo limiting amplifier prevents overloading and improves signal-to-noise ratio by allowing a higher average audio level.

Based on the time-proven circuitry of the Collins 26U-1, the stereo limiter has conservatively rated components and long life. Typical mean time between failures: 4 years of continuous service.

The 26U-2 may be used as a single-channel limiter, two monaural channels or for stereo broadcasting. A switch in the subpanel selects either stereo or monaural operation.

Frequency Response: 50 to 15,000 Hz ± 1.5 db

Input: 600 ohm bridged T (ungrounded), -20 dbm to +20 dbm

Output: 600 ohm bridged T (ungrounded), -20 dbm to +20 dbm

Distortion: 1% maximum

Output Noise: -50 dbm or less

Cross-Talk: 60 db minimum

Compression Ratio: 12:1 first 10 db above threshold

Gain: 40 db

Attack Time: Adjustable, 0.5 to 3.0 milliseconds

Release Time: Adjustable, 0.5 to 3.0 seconds

Protection: Overload fuse in primary circuit

Metering: Two 3½ in. voltmeters that can be switched to measure input level, external gain reduction, gain reduction, output level and external level

Power Source: 115 or 230 vac, 50 to 60 Hz, single phase (150 watts at 115 vac)

Size: 19 in. W, 10½ in. H, 10¼ in. total D—9¼ in. behind panel (48 cm W, 27 cm H, 26 cm total D—24 cm behind panel)

Weight: 35 lb (16 kg)

Part No. 522 3237 00



COLLINS 26U-3 PEAK LIMITING AMPLIFIER

The basic purpose of the 26U-3 is to ensure that peak signals are attenuated sufficiently to prevent over-modulation at the transmitter output. Some "soft" means of accomplishing this is desirable to keep distortion due to clipping to a minimum, and yet keep the overall signal level as high as possible. This has been accomplished by utilizing optimum attack and release times of the agc signal. Since the 26U-3 is normally used in connection with the 26J-3 compression amplifier, the limiting required by the 26U-3 is for reasonably short periods.

In the limiting amplifier, symmetrical or unsymmetrical clipping is controlled "behind-the-panel" to prevent inadvertent adjustment. Manual controls engage preemphasis and deemphasis networks for FM transmitter installations. Stereo operation can be established by using two 26U-3's. The 26U-3 provides a truly balanced 600-ohm input and will provide either 600- or 150-ohm operation.

Frequency Response: 50 Hz to 15 kHz

Total Distortion: Less than 1% at maximum output and all compression levels

Automatic Gain Control Range: 10 db dynamic range, minimum

Compression Ratio: 10:1 minimum

Normal Input/Output Levels: 10 dbm

Maximum Output Level: 20 dbm

Attack Time: 2 microseconds

Release Time: 150 milliseconds

Input Impedance: Fully balanced, 600 ohms

Output Impedance: Dual floating 150-ohm secondaries for any 600- or 150-ohm connection

Suggested Input Level Range: +20 to -5 dbm

Power Requirements: 30 watts maximum at 115 to 120 vac, 60 Hz

Weight: 15 lb, maximum

Dimensions: 5¼ in. H by 15¾ in. D, standard 19-inch EIA rack

AM/FM Operation: Either

Part No. 758 5778 001

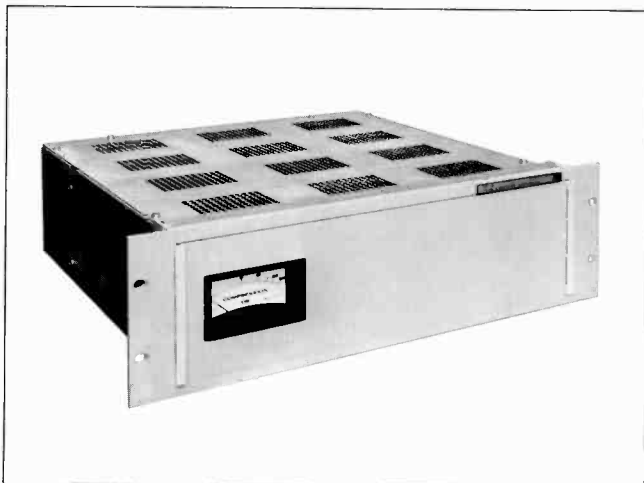

COLLINS 26J-3 AUTO-LEVEL COMPRESSION AMPLIFIER

With the 26J-3 Compression Amplifier, a broadcaster is afforded automatic level control of program material. This compact unit, which provides either 600- or 150-ohm operation in either AM or FM installations, has 10 db more automatic gain control range than comparable models. It can be operated in pairs to achieve stereo broadcasting.

This compression amplifier incorporates the latest solid-state techniques, including maximum use of linear integrated circuits for increased reliability and lower power dissipation. A balanced H-pad network with 600-ohm impedance provides a truly balanced 600-ohm load for operation from a balanced or unbalanced source.

The 26J-3 is normally operated with the Collins 26U-3 Peak Limiting Amplifier. This set of units permits higher average transmitter modulation while minimizing over-modulation.

Frequency Response: 50 Hz to 15 kHz, flat within 1 db

Total Distortion: Less than 1% at maximum output and all compression levels

Automatic Gain Control Range: 30 db dynamic range, minimum

Compression Ratio: 15:1 minimum

Normal Input/Output Level: 10 db

Maximum Output Level: 20 db

Attack Time: 5 milliseconds

Release Time: 9 seconds

Input Impedance: Fully balanced, 600 ohms

Output Impedance: Dual floating 150-ohm secondaries for any 600 or 150-ohm connection

Automatic Gain Control Threshold: 20 db below normal input

Gain Below Threshold: Automatically returns to nominal gain after extended signal pause

Suggested Input Level Range: +30 to -15 dbm

Power Requirements: 30 watts maximum at 115 to 120 vac, 60 Hz

Weight: 15 lb, maximum

Dimensions: 5¼ in. H by 15¾ in. D, standard 19-inch EIA rack mounting

AM/FM Operation: Either

Part No. 758 5776 001

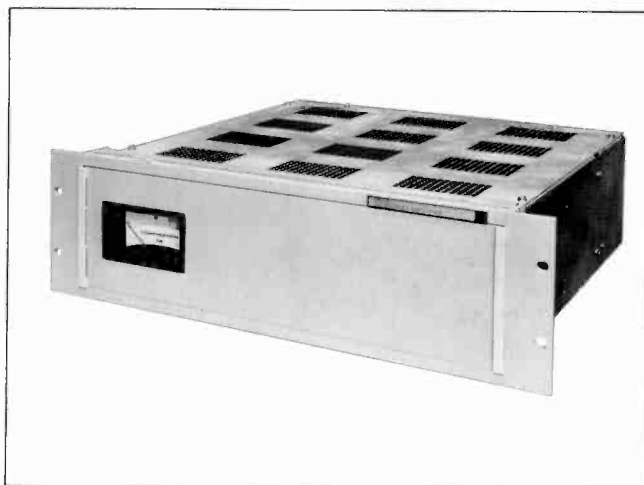

RUSSCO TURNTABLES

The 3-speed Russco Cue-Master or 2-speed Russco Studio-Pro will afford the broadcaster the finest in sound reproduction. These advance-model turntables reflect design simplicity coupled with excellent durability and minimum maintenance requirements.

The Cue-Master, with speeds of 33, 45, and 78 rpm, is powered by a heavy duty synchronous motor or an optional 4-pole induction motor. A neoprene idler wheel drive system transmits power from the stepped capstan on the motor shaft to the inside platter rim, enabling extremely fast acceleration. Its chassis is adaptable to any 12-inch tone arm.

The Studio-Pro, offering speeds of 33 to 45 rpm, is powered by the same heavy duty synchronous motor that operates the Cue-Master, but is not available with the induction motor. A detachable tone arm mounting plate on the chassis allows easy adaptation to any 12-inch tone arm. This model features less than 0.2 of 1 percent wow and flutter and rumble of 38 db down from the standard NAB level.

Oilite bearings are used throughout both units to assure extra long service.

Weight:

Cue-Master: Unit, 16 lb; platter, 5½ lb

Studio-Pro: Unit, 20 lb; platter, 6½ lb

Chassis Dimensions: 15½ by 15½ inches (both units)

Depth Requirement Below Chassis:

Cue-Master: 6½ inches

Studio-Pro: 7½ inches



STUDIO-PRO



CUE-MASTER

Motor:

Heavy-duty synchronous; 4-pole induction optional with Cue-Master

Speeds:

Cue-Master: 33, 45, 78 rpm

Studio-Pro: 33, 45 rpm

Acceleration (Average):

1/16 platter revolution at 33 rpm; 1/10 revolution at 45 rpm; ½ revolution at 78 rpm (Cue-Master, only)

Wow and Flutter:

Cue-Master: Less than 0.3 of 1%

Studio-Pro: Less than 0.2 of 1%

Rumble (Vertical and Lateral):

Cue-Master: 36 db down from standard NAB level

Studio-Pro: 38 db down from standard NAB level

Standard Color:

Pearl grey with grass green felt platter (both units)

Part No. 124 0083 415 (Cue-Master, 4-pole motor)

Part No. 124 0083 416 (Cue-Master, synchronous motor)

Part No. 124 0083 417 (Studio-Pro, synchronous motor)

COLLINS TURNTABLE CABINET

Has front door for accessibility to turntable components. Cutout on top for one Collins TT-900, TT-400 or TT-200 series turntable. Cabinet finished in Regency walnut Formica. Other coverings available on special order. Specify turntable model number.

Size: 24 in. W, 30 in. H, 24 in. D (61 cm W, 76 cm H)

Part No. 124 0032 228 (Type TCW-9Q)

For use with TT-900 series turntables.

Part No. 124 0032 230 (Type TCW-2Q)

For use with TT-200 series turntables.

Part No. 124 0032 229 (Type TCW-4Q)

For use with TT-400 series turntables.

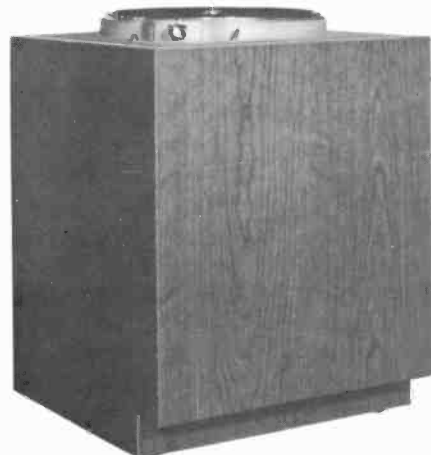



*Professional
Audio
Catalogue
Mini*

MICRO-TRAK



303 - 306 PROFESSIONAL TONE ARMS



303

Micro-Trak's 303 and 306 Tone Arms are the work-horse standard of the broadcast and professional audio business. Thousands of them used in twenty hour a day operations give

reliability and performance second to none. The 12 inch Model 303 and the 16 inch Model 306 are available to satisfy even the most critical and demanding professional audio requirement.....

206 VISCOUS DAMPED TONE ARMS

The 206 design from our Gray Research lineage. This viscous damped model is the ideal for installations where inexperienced operators are



206

the rule. Language Labs, School and industrial applications can take advantage of the rugged cast aluminum structure and the cartridge/stylus protection provided by its viscous damping mechanism. The Model 206 has long been proven as the ultimate in reliability.....

6400 - 6401 PHONO PREAMPLIFIER

Compactness, freedom from RFI, rugged reliability, and optimized low noise performance make the model 6400, stereo in mono out, and the Model 6401, full stereo phono preamplifiers your best investment. These self contained, self powered units pack in 0 dBm of output performance with



6401

headroom to spare. If you need the best going specify Micro-Trak's 6400 for mono, or 6401 for top stereo...

SYSTEM D

The Professional Audio Control Center

A 6440 Audio Console, A pair of 740 Turntables complete with 303 Tone Arms loaded with Stanton 500AL cartridges, all of the interconnecting cabling required, a professional microphone; a choice of one of several different, attractive, special purpose package configurations are the elements of System D.

The System D Compact is packaged for the DJ on the go. This single unit arrangement has the two 740 turntables bracketing the console in a fifty-four inch long formica covered plywood housing. With folding legs, specially designed by our engineering group to be rugged and rigid when set up, and yet small enough to be handled by two men in a station wagon, and reliable enough to stand up to many years of active service, the Compact can also be used with legs folded as a table top if you so desire. How flexible can you get?

The System D Studio Compact is another of the single unit packages, but this one is provided with a fixed leg structure for use in the studio. The layout is exactly the same as the Compact, with the two turntables on either side of the console. Available also for the Studio Compact are your choice of two accessory equipment shelves to hold tape machines and etc. With the optional equipment shelf, and another option, a remote start / stop sequencing control panel for the turntables and two tape machines, and of course the tape machines, the studio Compact becomes a most useful production tool, or on air facility.

The System D Semi, yet another approach includes the same standard operating equipment as above, but puts the console in a specially designed, high style console table, and the turntables in two of our Series L single turntable cabinets which offer additional rack space and better isolation, having each turntable mounted in its own cabinet. Easily moved about inside a nightclub or etc, the D Semi offers performance plus.

The fourth arrangement which is available, is our System D Permanent. This package offers a full classic "U" studio arrangement. A straight eighty inch long console table grouped with two Series L double bay turntable cabinets offer space for virtually everything you might need in a professional broadcast or top disco installation. High isolation of the turntables, one hundred thirty-six inches of rack space for power amps, tape recorders, graphic equalizers, and other processing equipment, the Micro-Trak professional console turntable and tone arms, all of these are part of the System D Permanent.

6440, 6444, 6454 AUDIO CONTROL CONSOLES

Small control consoles designed for broadcast, discoteque, production, or portable installations. These compact units are four channel, seven input full stereo



6444

boards...ten pounds of complete audio control. With its professional panel layout; set up for announce operate use, it has primary controls for two turntables, one operator microphone, three high level auxiliary inputs, and a secondary mike. The inbuilt cue amplifier, with speaker, and full

metering, allow the operator to run a fast moving live show or to mix and match the inputs for production. The broadcast stereo 6444, or mono 6454 sport 600 ohm balanced output and monitor provision, while the 6440 disco has variable bass and treble to deal with room acoustics and program variations. Each of these beauties are available with several different termination arrangements to satisfy you.

TAPE CARTRIDGE RACKS



L-72

Micro-Trak offers you your best buy in tape cartridge storage racks. Two models, the L-90 which holds ninety carts on the wall or on a table top, or the L-72 which can be used at the control console.

These well constructed, Formica covered, high quality cartridge storage racks offer modern attractive styling and low cost. If your working spots are on carts, or if you've got tapes to store, consider the L-90... or the L-72... either one holds more carts for your dollar...



L-90

MODEL 720 AND 740 TURNTABLES

The Micro-Trak Model 720 and 740 turntables provide a basic design which has been proven for over fifteen years of professional, continuous, twenty four hour a day, fast start operation. The 720 offers turntable basics in a three speed configuration, while the 740 is a two speed performance unit.



740

Both are heavy duty rugged equipment using aluminum castings, bronze oilite type bearings, and a minimum of moving parts to reduce wear. Each is equipped with a high torque hysteresis synchronous motor selected for low rumble and fast start. One sixteenth revolution is typical. Wow and flutter are virtually non-existent with six and one half pounds of platter inertia. If you want turntables second to none, at a price you can afford, specify Micro-Trak's Model 720 or 740

SERIES L STUDIO FURNITURE



L DOUBLE

Series L Cabinets and Console Tables are the proven approach to building attractive and durable control centers in broadcast studios. Micro-Trak's mix and match modular construction allows for use of double turntable cabinets, single turntable cabinets, straight console tables, or corner console tables to be arranged to fit virtually any studio or control room from the size of a large coat closet to an open studio installation set up for panel talk shows. The durable Formica brand wood grain vertical surfaces and tops allow great reliability and long life. Tops and side panels can easily be replaced for a change to a different turntable, or should damage be incurred. Series L is color keyed to give any studio an attractive up to date style in tempo with today's operations. Check prices on Series L... you'll be pleasantly surprised.....



THIS CATALOG HAS BEEN PREPARED TO BE A QUICK REFERENCE TO MICRO-TRAK'S LINE OF PROFESSIONAL AUDIO EQUIPMENT. BECAUSE ITS A SHORT FORM, IT DOESN'T TELL THE WHOLE STORY. FOR COMPLETE DATA ABOUT ANY PRODUCT, OR HOW MICRO-TRAK CAN HELP YOU, SEE YOUR LOCAL MICRO-TRAK DEALER OR CONTACT OUR MARKETING DEPARTMENT DIRECTLY. . .

distributed by

COLLINS RADIO
BROADCAST PRODUCTS
DALLAS , TEXAS 75080

Telephone 214 609-5424

MICRO-TRAK CORPORATION

620 RACE ST., HOLYOKE, MASSACHUSETTS 01040

USA

COLLINS 356H-1 PHONOGRAPH EQUALIZER PREAMPLIFIER

An economical unit to equalize and amplify the output signal of a magnetic phono cartridge, this small transistorized unit is used to replace passive equalizers and console or turntable preamplifiers. The housing of the unit is constructed of steel for magnetic shielding.

Control shafts are 3 inches long and may be cut to proper length after mounting the unit in the cabinet. The 356H-1 provides choices between two inputs and between four response curves: (1) Flat, for test purposes, and mike preamp use; (2) Hi-Boost, which has a 4 db rise above normal at 15,000 Hz; (3) Normal, which is the RIAA equalizing curve, and (4) Hi-Cut, which has a 4-db drop below the normal curve at 15,000 Hz.

Frequency Range: 30 to 15,000 Hz (Typical—Flat position ± 1.5 db, 20 to 20,000 Hz)

Frequency Response: ± 1.5 db from RIAA playback equalization response curve

Output Level: -10 dbm, ± 3 db with -50 dbm input at 1000 Hz

Output Impedance: 150/600 ohms, balanced or unbalanced

Input Impedance: High impedance bridging, unbalanced

Distortion: 1.0% maximum, 30 to 15,000 Hz at -10 dbm output

Output Noise: Signal-to-noise ratio, 60 db

Gain: 40 db at 1000 Hz minimum

Power Source: 120/240 vac, $\pm 5\%$, 50/60 Hz

Size: 4 in. W, 2 in. H, $7\frac{3}{4}$ in. D (10 cm W, 5 cm H, 20 cm D)

Weight: 5 lb (2.27 kg)

Part No. 522 2468 00

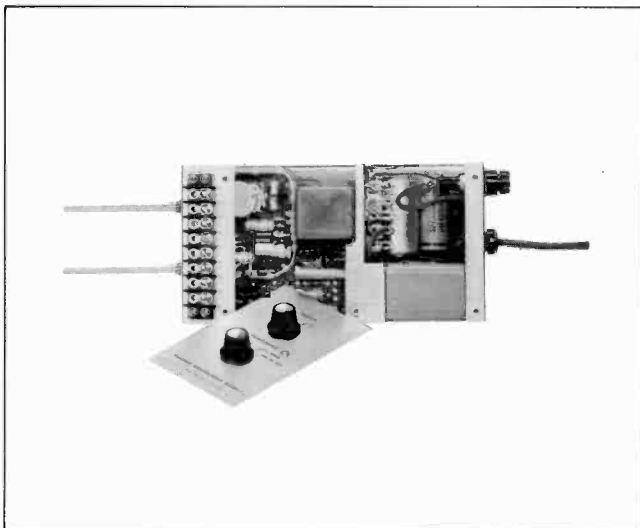

GRAY 208 SERIES PLAYBACK ARMS

The Gray professional stereo tone arm is available in two models that are identical in performance. Model 208-S comes with a slide and modular weights for mounting single play stereo or monophonic cartridges. Model 208-SG has a special slot cut into the front of the tone arm to clear the stem of a GE turnaround cartridge allowing plug-in operation and comes with specific hardware for this application.

Accessory slide kits are available for multiple cartridge operation.

The 8-S accessory slide assembly includes the cartridge slide, modular weights, mounting hardware and impressive spacers for the installation of stereo or monophonic single play cartridges. The 8-S slide assembly with cartridge mounted is usable in either the 208-S or 208-SG interchangeably.

The 8-SG accessory slide assembly is specifically designed to mount the GE turnaround cartridge. With this cartridge installed, it will only fit the 208-SG arm; however, cartridges are interchangeable between arms in this model. Response is ± 1 db from 5 Hz to top end limit imposed by cartridge used.

Part No. 099 0387 000

(Type 208-S) 16-inch arm

Part No. 099 0164 000

(Type 208-SG) 16-inch arm

Part No. 099 0837 000

(Type 8-SG) Sidemount for 208-SG.



GRAY 206-S PLAYBACK ARM

Gray's goal while developing the 206-S was to minimize, to the vanishing point, the effect of a tone arm on reproduced sound while maximizing the number of distortion-free plays that could be obtained from a disc. No attempt was made to limit these stringent requirements to present-day records. All discs produced during this century ranging from 16 $\frac{2}{3}$ rpm to 85 rpm, including all known groove configurations—microgroove, standard, vertical, lateral, and stereo—were included within the scope of the project.

The 206-S is viscous damped and this damping plays a key role in its performance. Silicone fluids tend to resist motion when they are moved rapidly, but have an insignificant amount of resistance when they are moved slowly. Because of viscous damping, the 206-S stands still when the stylus is moved rapidly but can still spiral freely toward the center of a record.

Additional features include minimal tracking error, micrometer damping adjustment, and automatic lateral and vertical balance adjustments.

Part No. 124 0061 222 (206-S) 12-inch arm

Part No. 124 0061 223 (206-SG) 12-inch arm (for GE turnaround)



GRAY 303 PLAYBACK ARM

The Gray 303 arm will provide high compliance for stereo, absolute durability, and is engineered specifically for broadcasting. It has high isolation from resonance, will track distortion-free at micro pressures to 1/10 of a gram, and is free from fragile weights and gadgets.

The 303 arm has been designed to satisfy the need in the industry for micro pressure cartridges and to provide a stereo tone arm suitable to handle the finest distortion-free reproduction.

These arms feature a unique system of clean, modern styling, plug-in memory balance head, and body fabrication from epoxy-impregnated hardwood. Arm mass and resonance are exceptionally low.

All of this engineering effort and careful analysis has enabled Gray to offer the finest tone arm ever to carry the Gray name, and the only tone arm primarily designed for broadcast incorporating these features. Available for 12-inch (303) and 16-inch (306) recordings.

Part No. 124 0061 741

(Gray 303) 12-inch arm

Part No. 124 0061 775

(Gray 306) 16-inch arm



SHURE M44-7 PHONOGRAPH CARTRIDGE

The Model M44-7 Dynetic Phonograph Cartridge has been developed for use in all high fidelity applications. It has been designed to drive magnetic and constant velocity inputs.

Recently, highly technical papers have been published in the leading audio journals to the effect that a hitherto "hidden" source of distortion has finally been identified. It was stated that the difference in the effective angles between the record cutting mechanism's chisel point and the angle of the ball point playback stylus led to an annoying, discernible and measureable distortion. A matching of the vertical tracking angle of the playback stylus to the effective angle at which the record has been cut will eliminate this distortion.

Major recording companies have now begun to use a 15° effective cutting angle and it is the proposed EIA standard (similar in practice and effect to the adoption of the RIAA equalization curve).

The M44 Series of Stereo Dynetic Phono Cartridges has been specifically designed to complement the 15° effective cutting angle now being used on the newest recordings. It also serves to significantly improve the sound obtained from older discs.

The M44-7 is completely compatible. It will play stereo discs stereophonically, monaural discs monaurally, and stereo discs monaurally without excessive wear and distortion.

The Model M44-7 utilizes the Moving Magnet principle and features:

- High needle compliance.
- Low needle talk.
- Low tracking force.
- Wide range frequency response.
- Improved shielding for maximum reduction of hum pickup.
- Exceptional ease in changing stylus assembly.
- No magnetic attraction to steel turntables.

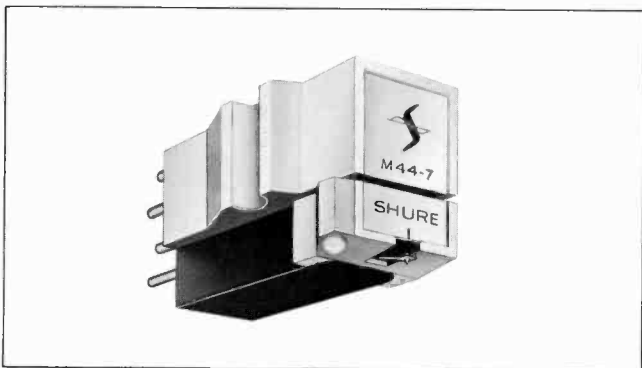

Frequency Response: From 20 to 20,000 Hz
Output Voltage: 9 millivolts per channel at 1000 Hz
Channel Separation: More than 25 db at 1000 Hz
Recommended Load Impedance: 47,000 ohms per channel
Stylus Replacement: Model Number N44-7; Radius, 0.0007 in. (0.018 mm) diamond; stylus grip color, White
Compliance: Vertical-horizontal, 20.0 x 10⁶ cm/dyne
Tracking: 1.5 to 3.0 grams
Stylus: No-scratch retractile feature
Inductance: 680 millihenrys
DC Resistance: 650 ohms
Terminals: 4 terminals
Mounting: Standard ½ in. (12.7 mm) mounting center
Weight: Net Weight: 7 grams

Part No. 099 3018 000 (Type M44-7)
Part No. 124 0032 301 (Type M44-7)
 Special J.O. 198 with .001 needle.
Part No. 124 0032 302 (Type N44-7)
 0.0007 in. needle assembly.
Part No. 124 0032 303 (Type N44-1)
 0.001 in. needle assembly.

SHURE M44-5 PHONOGRAPH CARTRIDGE

Frequency Response: From 20 to 20,000 Hz
Output Voltage: 6 millivolts per channel at 1000 Hz
Channel Separation: More than 25 db at 1000 Hz
Recommended Load Impedance: 47,000 ohms (per channel)
Stylus Replacement: Model Number N44-5, radius, 0.0005 in. (0.013 mm) diamond, stylus grip color, Red
Compliance: Vertical-Horizontal, 25.0 x 10⁶ cm/dyne
Tracking: ¾ gram to 1½ grams
Stylus: No-scratch retractile feature
Inductance: 680 millihenrys
DC Resistance: 650 ohms
Terminals: 4 terminals
Mounting: Standard ½ in. (12.7 mm) mounting center
Weight: 7 grams

*The N44-3 Stylus may be used in the M44 Dynetic Cartridge to reproduce the standard 78-rpm records. The N44-3 is designed for tracking forces of 1.5 to 3.0 grams.

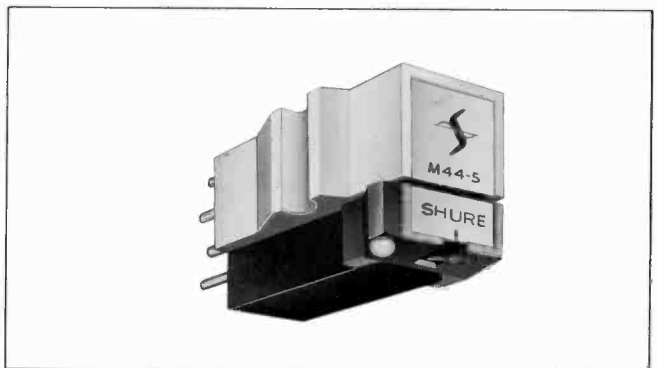

SHURE PLAYBACK ARMS

Accepts stereo and monophonic cartridges. Arm features precision ball bearings at all pivot points, plug-in head with positive alignment lock and variable adjustment. Supplied with arm rest, mounting template, mounting hardware and 4-foot cable assembly.

Size and Weight: 12 in. arm (M232), 12-11/16 in. L, 1 lb (0.45 kg); 16 in. arm (M236), 14½ in. L, 1½ lb (0.48 kg)

Part No. 097 8118 00 (Type M232)
Part No. 097 8122 00 (Type M236)

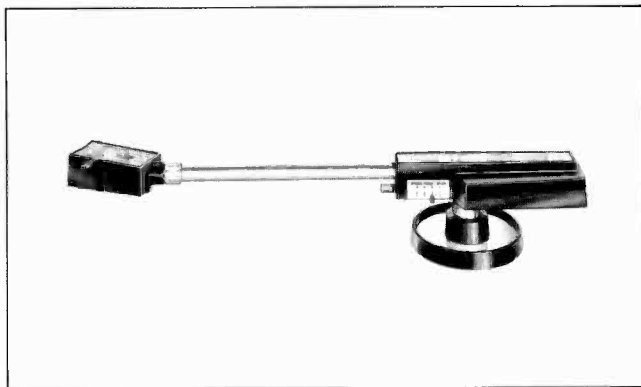

REK-O-KUT PLAYBACK ARMS

Tubular arm body with die cast aluminum cartridge shell. Four-conductor lead accommodates all 3- and 4-wire stereo cartridges. Does not include but uses all standard cartridges. Available for either 16 in. (S-260) or 12 in. (S-320) recordings.

Part No. 099 0242 000 (Type S-260) less balance weight.
Part No. 099 0241 000 (Type S-320) with balance weight.
Part No. 124 0032 094 Balance weight for S-260
Part No. 124 0032 549 (Type PS20-L) cartridge shell.

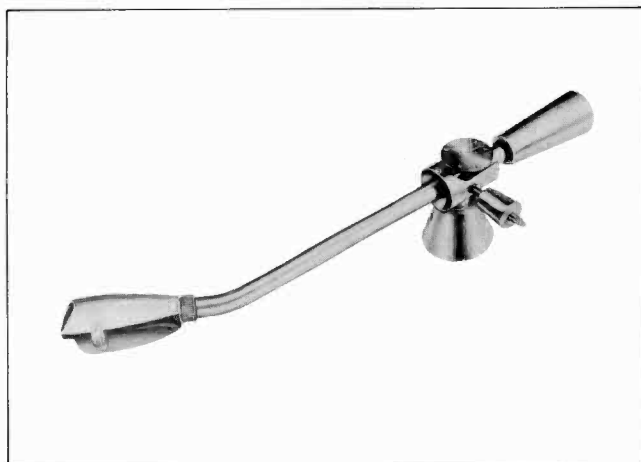

COLLINS 642E-1/2 TWINTAPE PLAYBACK UNITS

The 642E Twintape Playback Unit is the most convenient, flexible, and easy to operate cartridge machine on the market.

Using the 216D Record Amplifier, this twintape system provides simultaneous playback of two cartridges; playback of one cartridge while recording on another; and dubbing from one cartridge to another. The playback unit utilizes two independent tape transports with direct-drive capstan motors. Tape wow and flutter are almost eliminated due to the absence of belts, pulleys, etc. in the transport system.

Modular design concepts are used throughout the twintape system and all circuit cards. Access for service is with utmost ease. Snap-release head-assembly covers permit routine maintenance and head cleaning in seconds.

A highly flexible system, the 642E can be remotely controlled and provides for automatic sequencing of other tape machines, slide projectors, etc.

Other features include separate record and playback heads, heavy-gauge Mu-metal shields over the heads, completely solid-state circuitry all on plug-in military-grade glass-epoxy boards and backplane construction that almost eliminates wiring harnesses.

The 642E-1 alone will perform all the functions of a broadcast cartridge unit except recording. For recording, the 216D Record Amplifier must be used. Monaural operation would require the 642E-1 and the 216D-1. The 642E-2 and the 216D-2 would be required for stereo operation.

Options include 19-inch rack-mounting adapters and cue detector card.



Power Source: 105 to 125 vac, 60 Hz (50-Hz model available on order), single phase

Audio Inputs: Audio to record heads from "mode" switch in 216D-1/2 Record Amplifier

Outputs:

Program Audio:

Unit 1: Nominal 0 dbm into 600 ohms (adjustable)

Unit 2: Nominal 0 dbm into 600 ohms (adjustable)

Cue:

150 Hz: One set of "C" contacts; 0.5 ampere, 115-vac rating

8000 Hz: One set of "C" contacts; 0.5 ampere, 115-vdc rating

Frequency Response Equalized NAB 7-1/2 IPS: ± 2 db, 50 to 12,000 Hz; (1000-Hz reference), ± 4 db, 50 to 15,000 Hz (1000-Hz reference)

Distortion: 2% at 0 VU record level, 400 Hz (record to playback)

Noise: SN ratio -50 db with reproduce amplifier set for 0 dbm, noise level will drop to -50 dbm when signal is removed

Tape Speed: 7-1/2 ips $\pm 0.4\%$ or better

Tape Motion Start and Stop Time: Less than 0.10 second

Wow and Flutter: Less than 0.2% RMS

Size: 7 in. H, 17 $\frac{3}{8}$ in. W, 13 $\frac{1}{8}$ in. D (18 cm H, 44 cm W, 33 cm D); adapter permits 19-inch rack mounting

Weight: 48 lb (22 kg)

Part No. 758 5727 001 (642E-1)

Part No. 777 1423 001 (642E-2)

Part No. 774 7330 001 642E Cue Detector

Part No. 770 5625 001 642E Rack Adapter

COLLINS 216D-1/2 TWINTAPE RECORD AMPLIFIERS

Collins 216D Amplifier offers high quality record capability to the twintape system. Using this unit with the 642E playback unit permits recording on either cartridge or dubbing from one cartridge to another.

Cue tone oscillators, VU metering, operational controls, and a record amplifier are contained in the 216D. One cue tone is standard, with option available for three cue tones. Solid-state design is used throughout, with all circuitry on military-grade glass-epoxy plug-in boards. Monaural (216D-1) or stereo (216D-2) models are available. Power for the amplifier is provided by the 642E playback unit through an interconnecting plug-in cable. The amplifier may be stacked compactly with the playback unit or rack-mounted with an optional adapter.

Power Source: All operating power supplied by 542E-1/2 playback unit

Audio Inputs:

Line Input Impedance: 600/160 ohms (will accommodate levels from -20, ± 15 dbm)

Briding Input: 10K impedance

Input is brought from the left 642E-1/2 playback unit to feed the recording amplifier's dubbing mode operation.

Outputs: Left and right channel record amplifier outputs are brought through mode switch and routed to desired record head in playback unit.

Frequency Response:

50 to 12,000 Hz: ± 2 db (1000-Hz reference)

50 to 15,000 Hz: ± 4 db (1000-Hz reference)

Distortion: 2% at 0 VU record level, 400 Hz (record to playback)

Noise: S/n ratio -50 db with reproduce amplifier set for 0 dbm; noise level will drop to -50 dbm when signal is removed.

Tape Speed: 7 $\frac{1}{2}$ ips $\pm 0.4\%$ or better

Tape Motion Start and Stop Time: Less than 0.10 second

Wow and Flutter: Less than 0.2% rms

Size: 3 $\frac{1}{2}$ in. H by 17 $\frac{3}{8}$ in. W by 13 $\frac{1}{8}$ in. D (9 cm H by 44 cm W by 33 cm D) Adapter available for 19-inch rack mounting

Weight:

216D-1: 11 lb (5kg)

216D-2: 12 lb (5.5 kg)

Part No. 758 5726 001 (216D-1)

Part No. 777 1391 001 (216D-2)

Part No. 774 7528 001 216D Cue Oscillator

Part No. 770 5593 001 Rack Adapter

Exceeds NAB standards for tape cartridge equipment.



216D-1



216D-2

COLLINS TAPE CARTRIDGE RACK

Formica covered wood rack holds 120 of the Series 300 cartridges used with Collins automatic programming equipment. Four rubber cushions allow the rack to be set on top of a programming wing. It also may be hung on the wall. Walnut Formica. Other finishes available on request.

Size: 45¾ in. W, 14¾ in. H, 4 in. D (116 cm W, 37 cm H, 10 cm D)

Weight: 25 lb (11 kg)

Part No. 124 0032 300

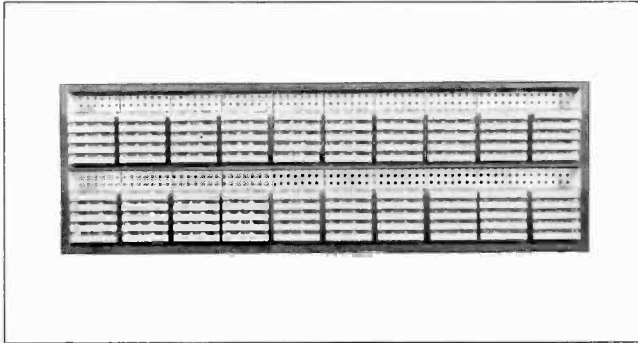

ABCO LAZY SUSAN CARTRIDGE RACK

This sturdy rack holds 500 of the Series 300 Collins automatic programming equipment tape cartridges. Ten chrome-plated racks with 50 slots each make storage and selection of cartridges fast and simple. Revolves easily on roller bearing hub and will not tip regardless of arrangement of cartridges. Cartridges held in wire holders at an angle to prevent slipping out while the rack is being revolved. Shipped knocked down.

Size: Approx. 72 in. H, 36 in. diameter (183 cm H, 91 cm diameter)

Weight: Approx. 50 lb (23 kg)

Part No. 097 7559 00



ABCO WIRE CARTRIDGE RACK

Individual wire rack holding 50 Collins automatic programming equipment cartridges. Identical rack to those used in the Lazy Susan. Includes tapped mounting brackets welded to wire rack.

Size: Approx. 5 in. W, 60 in. H, 7 in. D (12.7 cm W, 152.4 cm H, 8 cm D)

Weight: Approx. 4 lb (1.8 kg)

Part No. 097 7560 00

COLLINS MM-151 AUTOMATIC PROGRAMMING BULK RECORDING TAPE

A fine quality, specially lubricated, Minnesota Mining tape in bulk lengths of 1700 ft on 7-in. reels for use with Collins Automatic Programming blank cartridges.

Part No. 099 2629 000

COLLINS AUTOMATIC PROGRAMMING LOADED CARTRIDGES

Manufactured for Collins automatic programming equipment, these cartridges are loaded with fine quality, specially lubricated tape.

300 Series: Loaded cartridges packed six per box (minimum one box) in following lengths: 40, 70, 90, 100 seconds, 2½, 3, 3½, 5, 5½, 7, 7½, 10, 10½ minutes. Specify length.

Type No.	Part Number	Length
300 Series	124 0032 057	40 Second Tape Cartridges
300 Series	124 0032 058	70 Second
300 Series	124 0032 059	90 Second
300 Series	124 0032 060	100 Second
300 Series	124 0032 061	2½ Minute
300 Series	124 0032 062	3 Minute
300 Series	124 0032 063	3½ minute
300 Series	124 0032 064	5 Minute
300 Series	124 0032 090	5½ Minute
300 Series	124 0032 065	7½ Minute
300 Series	124 0032 066	10 Minute
300 Series	124 0032 067	10½ Minute

600 Series: Loaded cartridges packed two per box (minimum one box) in following lengths: 11, 12½, 15, 16 minutes. Specify length.

600 Series	124 0032 067	11 Minute
600 Series	124 0032 069	13½ Minute
600 Series	124 0032 070	15 Minute
600 Series	124 0032 071	16 Minute

1200 Series: Loaded cartridges packed two per box (minimum one box) in 31 minute lengths.

1200 Series	124 0032 072	31 Minute
-------------	--------------	-----------

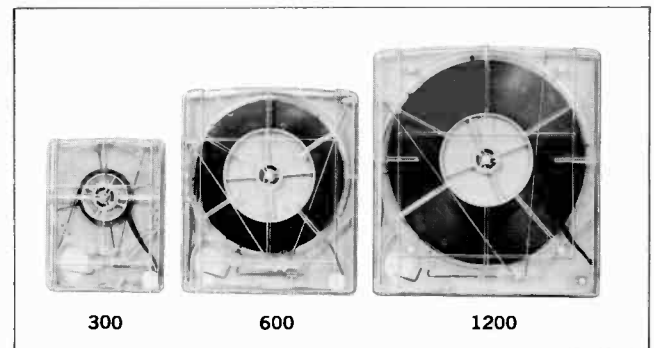

COLLINS AUTOMATIC PROGRAMMING BLANK CARTRIDGES

Identical to above cartridges for custom loading.

300 Series: Blank cartridges packed six per box (minimum one box). Up to 10½ minutes playing time.

Part No. 124 0032 073

600 Series: Blank cartridges packed two per box (minimum one box). From 11 to 16 minutes playing time.

Part No. 124 0032 074

1200 Series: Blank cartridges packed two per box (minimum one box). From 16½ to 31 minutes playing time.

Part No. 124 0032 075

COLLINS AUTOMATIC PROGRAMMING TEST TAPE

Azimuth head alignment test tape for Collins automatic programming playback in 70-second length with 5000-Hz tone on cue track and 10,000-Hz tone on program track.

Part No. 097 6076 00 (for 642A-1/2 only)

AUDIOTAPE AND MM RECORDING TAPES

The following tapes are designed for conventional recorders (see description under Collins Automatic Programming MM-151 Bulk Recording Tape for specially lubricated bulk tape):

111A-12: Minnesota Mining tape, 1200-ft, 7-in. reel.

150-18: Minnesota Mining tape, Mylar, 1800-ft, 7-in. reel.

190-18: Minnesota Mining tape, plastic base, 1800-ft, 7-in. reel.

Part No. 272 1407 00 (Type 111A-12)

Part No. 097 7112 00 (Type 150-18)

Part No. 099 0040 00 (Type 190-181)

ROBINS ST-500 BULK SPLICING TAPE

Robins splicing tape for use with automatic programming equipment and reel to reel recording tape. ½ by 100-inch Mylar tape.

Part No. 124 0032 544

ROBINS TS-8D SPLICER-CUTTER

Used for magnetic recording tape, this unit cuts two rounded indentations in the tape splice, giving the splice a "Gibson Girl" shape and leaving the edges of the tape free of adhesive. The unit can be removed from its base and mounted directly on any tape recorder. It comes complete with a roll of splicing tape and tape feed.

Part No. 124 0032 178

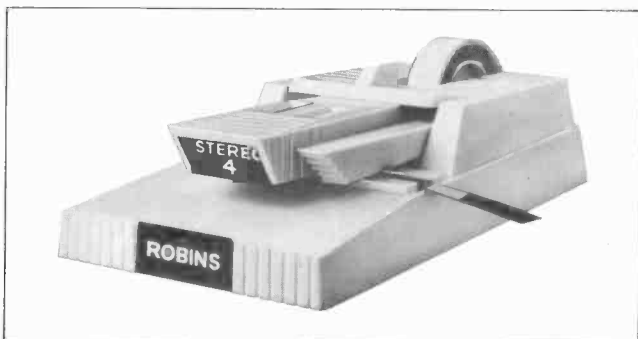

COLLINS HEAD ALIGNMENT GAUGES

Penetration and alignment gauges for aligning heads of Collins tape cartridge units.

Part No. 554 2632 002 Penetration gauge for 642A-1/2 only

Part No. 554 2635 002 Height gauge for 642A-1/2 only

REPLACEMENT PRESSURE PADS

Long lived Polyurethane pad interchangeable with pads in original cartridge in boxes of 50.

Part No. 094 2546 00

MAGNERASER 200C TAPE ERASER

A compact and convenient bulk tape eraser that removes recorded signals from tape up to 35 mm in size and lowers background noise level up to 6 db below that of unused tape. A pushbutton safety switch prevents current from being applied when not in use.

Operating Voltage: 100 to 130 v, 50 to 60 Hz

Size: 2 in. H, 4 in. diameter (5 cm H, 10 cm diameter)

Weight: 2½ lb (1.13 kg)

Part No. 097 5172 00



MICROTRAN HD-11M TAPE ERASER

A bulk tape demagnetizer that develops a high intensity magnetic field to erase signals and noise without rewinding. Spindle mounting of reel permits rapid and thorough coverage.

Reel Size Range: 5 in., 7 in., 10½ in. (spindle removable for use with other size reels).

Adapter Hub: Available for use with 10½ in. reels.

Rating: 117 vac, 5 A

Size: 5 in. W, 3 in. H, 8 in. D (13 cm W, 8 cm H, 20 cm D)

Part No. 099 0371 00 (HD-11M)

Part No. 124 0032 839 (HD-11-AD) 10½-in. Reel adapter



SCULLY 280 RECORDER/REPRODUCER

The Scully 280 professional tape recorder features all heads, reel hubs, relays, and amplifier cards with plug-in design; modular subassembly construction; and MIL-type cables.

Innovations such as automatic tape lifters, scrape filter, and patented disk brakes are standard on the 280. Power transformers are tapped, allowing selection of line voltage for lowest operating temperature, and synchronization for multi-channel over-dub effects is selective.

All control functions are in operations-oriented sequence. Individual reel-size selector switches and edit-control button are Scully design innovations. Calibration and all adjustment controls are accessible from the front of the amplifier control panel. Bias, operating levels, and gain of the amplifiers are totally immune to line voltage variations of up to 20 percent.

Three separate plug-in etched circuit boards contain microphone, record, and playback preamplifiers and erase and bias oscillators. The 280 offers reliable operation in a variety of critical audio applications where exacting performance is essential.

Frequency Response: ± 2 db 30 to 18,000 Hz at 15 ips; ± 2 db 50 to 15,000 Hz at $7\frac{1}{2}$ ips; ± 2 db 50 to 7,500 Hz at $3\frac{3}{4}$ ips

Signal-to-Noise Level: Peak record level to weighted noise (30-Hz to 15-kHz band) $7\frac{1}{2}$ and 15 ips full track . . . 70 db 3 M201 or equivalent

Flutter and Wow: 15 ips, 0.08% rms; $7\frac{1}{2}$ ips, 0.1% rms; $3\frac{3}{4}$ ips, 0.2% rms

Tape Speeds: $3\frac{3}{4}$ to $7\frac{1}{2}$ ips; $7\frac{1}{2}$ to 15 ips; other speeds on special request

Multichannel Configurations: $\frac{1}{4}$ in. — 1 or 2 channels; $\frac{1}{2}$ in. — 3 or 4 channels

Starting Time: Tape reaches full play speed in 0.1 second



Stopping Time: Tape moves less than $1\frac{1}{2}$ inches after depressing stop (15 ips)

Timing Accuracy: 99.9% ± 1.5 seconds for 30-minute tape

Rewind Time: Approximately 75 seconds for 2400-foot NAB reel

Edit Function: Edit button permits tape to move in play mode without winding on takeup reel

Reel Size: Up to $11\frac{1}{8}$ inches

Playback Amplifier Distortion: Less than 0.5% THD at +18 dbm

Equalization: Transport speed switch controls equalization change. NAB curve

Erase Frequency: 60 kHz

Bias Frequency: 180 kHz

Controls: Power On and Off; Record; individual reel size switches; Rewind; Fast Forward; Stop; Play; Speed Change Switch; Edit; all relays and solenoids 24 vdc, relays are plug-in type

Remote Control: On, Off, Record, Rewind, Fast Forward, Stop, Play

Equalization Adjustment and Calibration Controls:

Accessible from front of electronics panel by removing cover plate

Outputs: +4 or +8 dbm (+18 dbm peak) 600-ohm balanced line

Input: Bridging 600-ohm balanced or unbalanced line level, also microphone

Monitoring: Separate record and playback amplifiers permit tape to be monitored while recording

Power Requirement: 117 vac, 50 to 60 Hz, 275 watts

Mounting: All models available unmounted for rack mounting or in console or portable cases

CROWN SX800 RECORDER/REPRODUCER

The Crown SX800 Recorder has the latest in advanced design concepts including patented magnetic braking, computer logic control, straight line threading, and precision micro-gap heads. Integrated circuits are utilized, with advanced computer logic circuitry for simplicity of operation and complete tape handling safety. The logic control unit performs all operating sequences. Lighted pushbuttons display each mode of operation. All new compact, solid-state electronics provide excellent frequency response and low distortion.

Four separate microphone or line inputs feed a 2-input mixer per channel. Each channel has two separate 600-ohm



unbalanced outputs. In addition, the front panel will accommodate two pairs of 600-ohm stereophones.

The SX800 is available in a variety of configurations ranging from full-track monaural to 4-channel in-line or 4-channel, 8-track stereo.

Frequency Response:

7½ ips: ±2 db 30 to 20,000 Hz, 55-db s/n (Scotch 202)

3¾ ips: ±2 db 30 to 10,000 Hz, 50-db s/n (Scotch 202)

Signal-to-Noise Ratio: Record and playback noise referenced to 400 Hz, 3% HD standard tape. Total harmonic distortion noise less than 1.5% for zero record level at 1 kHz. Crosstalk rejection -55 db minimum.

Flutter and Wow:

7½ ips: 0.09%

3¾ ips: 0.18%

Timing Accuracy: 99.8% or 1.8 seconds in 15 minutes (microadjustable to ±0.05% short term)

Record Input:

Microphone: -66 dbm, 0.4 mv minimum for zero level (10K or above)

Line: -25 dbm, 45 mv minimum for zero level (>10K)

Playback Output: 2.5 v, 600-ohm unbalanced, maximum undistorted output is 14 v.

Reel Size: Standard up to 10½-inch NAB.

Power Requirements: 117 vac, 60 Hz (50 Hz available)

MAGNECORD 1021 RECORDER/REPRODUCER

The Magnecord 1021 features fully transistorized electronics with regulated power supply. Switchable equalization (NAB standard).

Tape Speeds: 3.75 and 7.5 ips

Flutter and Wow: 0.25% at 3.75 ips; 0.2% at 7.5 ips

Timing Accuracy: ±0.2%

Reel Size: 5-, 7- and 8-inch EIA hubs

Rewind Time: 1200 feet in 80 seconds

Frequency Response: ±2 db—30 to 8,000 Hz at 3.75 ips. 20 to 15,000 Hz at 7.5 ips

Signal-to-Noise Ratio: 53 db, both speeds

Inputs: Lo-Z microphone, balanced bridge, unbalanced bridge, mixing bridge, and auxiliary bridge

Outputs: 150/600-ohm balanced; unbalanced, auxiliary A and auxiliary B (+8 dbm)

Heads: Full-track erase, record, and half-track play

Weight: 47 lb (21 kg)

Dimensions: 19 in. W, 15¾ in. H, 12 in. D (48 cm W, 40 cm H, 30 cm D)

50-Hz model at no extra cost



MAGNECORD 1028 RECORDER/REPRODUCER

The Magnecord 1028 has advanced circuit design, utilizing latest types, and printed wiring to insure uniform high performance from recorder to recorder.

Tape Speeds: 7.5 and 15 inches per second

Flutter and Wow: 0.15% at 7.5 ips; 0.1% at 15 ips

Timing Accuracy: ±0.2%

Reel Size: 5-, 7- and 10½-inch

Rewind Time: 2400 feet, less than 100 seconds

Frequency Response: ±2 db—40 to 16,000 Hz at 7.5 ips; 40 to 22,000 Hz at 15 ips

Signal-to-Noise Ratio: 56 db per channel

Inputs: Hi-Z mic and Hi-Z unbalanced bridge; Lo-Z mic and Hi-Z balanced bridge. With input transformer

Input Sensitivity: -90 dbm to -30 dbm

Outputs: Cathode follower, 2.0 volts; 150/600-ohm balanced, +4 dbm. With input transformer

Heads: Select Erase, 2-channel Record and 2-channel Play

Weight: 50 lb (23 kg), 60 lb (27 kg) encased

Dimensions: 17½ in. W, 12¾ in. H, 12 in. D. (17½ in. W, 14¼ in. H, 12 in. D encased)

Part No. 099 3013 000

MAGNECORD 1022 RECORDER/REPRODUCER

The Magnecord 1022 features solid-state electronics with regulated power supply and built-in input and output transformers.

Tape Speeds: 7.5 and 15 ips

Flutter and Wow: 0.17% at 7.5 ips; 0.15% at 15 ips

Timing Accuracy: ±0.2%

Reel Size: 5-, 7- and 8-inch EIA hubs

Rewind Time: 1200 feet in 80 seconds

Frequency Response: ±2 db—25 to 18,000 Hz at 7.5 ips; 35 to 22,000 Hz at 15 ips

Signal-to-Noise Ratio: 53 db, both speeds

Inputs Per Channel: Lo-Z microphone, balanced bridge, unbalanced bridge, auxiliary bridge

Outputs Per Channel: 150/600-ohm balanced, auxiliary A and auxiliary B unbalanced (+8 dbm)

Heads: Selectable 2-channel erase, 2-channel record, 2-channel play and ¼-track play

Weight: 47 lb (21 kg)

Dimensions: 19 in. W, 15¾ in. H, 12 in. D (48 cm W, 40 cm H, 30 cm D)

Part No. 124 0032 375



AMPEX AG-440 RECORDER/REPRODUCER

The AG-440 Recorder is a new generation of professional audio recorders with new tape transport rigidity previously limited to higher cost Ampex mastering recorders and Ampex instrumentation and video recorders. New versatility allows rapid conversion to accommodate either 1/2- or 1/4-inch tape. New flexibility permits buildup to as many as four channels. Head assemblies and new solid-state electronics are all plug-in modules.

One-quarter-inch head assemblies are standard on all 1- and 2-channel recorders. One-half-inch head assemblies are standard on all 3- and 4-channel recorders. The cover bridge modular mount easily accepts four or more 3 1/2-inch electronics panels so that a single-channel machine may be expanded to four channels. The AG-440 contains three motors and is relay-solenoid operated. All machines are dual speed with automatic equalization change.

Frequency Response:

15 ips: ± 2 db 30 to 18,000 Hz

7 1/2 ips: ± 2 db 40 to 10,000 Hz, +2 to 4 db 30 to 15,000 Hz

3 3/4 ips: ± 2 db 50 to 7500 Hz

Signal-to-Noise Ratio:

15 ips: Full track, 68 db; 2 track, 60 db; 3 track, 62 db; 4 track, 60 db

7 1/2 ips: Full track, 68 db; 2 track, 60 db; 3 track, 62 db; 4 track, 60 db.

3 3/4 ips: Full track, 63 db; 2 track, 56 db, 3 track, 57 db; 4 track, 56 db (using low-noise tape).

Flutter/Wow (by ASA Standards):

15 ips: Below 0.08% rms

7 1/2 ips: Below 0.1% rms

3 3/4 ips: Below 0.15% rms



Timing Accuracy: 0.2% (± 3.6 seconds in 30-minute recording time)

Record Input: 100k unbalanced bridging with dummy plug supplied or 20k balanced bridging with plug-in transformer supplied with each electronics unit. (-17 dbm to produce recommended operating level)

Playback Output: +8 dbm into 600 ohm load, balanced or unbalanced

Reel Size: Standard, up to 10 1/2 in., adjustable up to 11 1/2 in.

Power Requirements:

Single Channel Models: 2.0 amperes current

2-Channel: 2.5 amperes, 117 volts, 60 Hz

AMPEX AA-620 SPEAKER/AMPLIFIER

A totally new portable 20-watt amplifier/speaker system for use with the Ampex AG-600 Recorder or any other professional equipment. The new AA-620 offers two speakers, solid-state electronics, increased power output, and separate bass and treble equalization. System-matching provides essentially flat acoustical response (in free air) from 65 Hz to 10 kHz.

Overall Frequency Response (in air): Better than 65 Hz to 10 kHz

Speakers: 10-inch woofer, 3 1/2-inch tweeter

Power Output: 20 watts into an 8-ohm resistive load

Equalization: Two switches on front panel -6, -3, 0, +3, +6 db at 100 Hz and 10 kHz

Signal-to-Noise: Amplifier noise (including hum), 80 db below rated output

Input Impedance: 100,000 ohms unbalanced; 0.9-volt rms for full output

Harmonic Distortion: Less than 1% at full rated output

Power Requirement: 117 volts 50/60 Hz; 0.5 A

Dimension:

Portable: 14 3/4 in. H, 20 1/8 in. L, 9 in. D (37 cm H, 51 cm L, 23 cm D)

Rack Mount: 12 1/2 in. H, 19 in. L, 9 in. D (32 cm H, 48 cm L, 23 cm D)

Weight:

Portable: 24 1/2 lb (11 kg)

Rack Mount: 15 lb (7 kg)



AMPEX AG-600 PORTABLE TAPE RECORDER

Now Ampex offers a smaller, all new version of the 600 series; the world's finest low-cost professional audio recorder. The AG-600 recorder/reproducer is available in single channel (full- or half-track mono) or 2-channel (half- or quarter-track stereo/mono).

The new 2-speed transport uses a rugged die-cast aluminum frame. This means a more rigid top plate that maintains critical alignment of heads and tape guides. There's also an improved clutch assembly and a new cooling system to add to reliability. The AG-600 is available in lightweight carrying case, or can be rack mounted with accessory adapter.

The new solid-state electronics package allows extreme versatility in small space. Each channel has one line and one mike input, providing a built-in mixer capability. The line input may be converted to mike input with an accessory plug-in preamplifier.

Frequency Response: 7½ ips, ±2 db from 60 Hz to 10 kHz, +2 to 4 db from 40 Hz to 15 kHz; 3¾ ips, ±2 db from 50 Hz to 7 kHz, +2 to 4 db from 40 Hz to 8 kHz

Signal-to-Noise: 7½ ips, full track 57 db, half track 55 db; 3¾ ips, full track 52 db, half track 50 db

Crosstalk Rejection: Better than 40 db mid-frequency

Flutter and Wow: (Measured by ASA Standards) 7½ ips less than 0.17%; 3¾ ips less than 0.25%

Timing Accuracy: 7½ ips ±0.2% (±3.6 seconds in a 30-minute recording); 3¾ ips ±0.4% (±7.2 seconds in a 30-minute recording)

Fast Forward or Rewind: 90 for 1200-foot reel

Speeds: Dual speed, 3¾ and 7½ ips

Reel Size: 5 and 7 inches

Inputs: Low impedance mike input; and line input (100K unbalanced)

Outputs: Two outputs for each channel. 1. ±4 dbm into 600 ohm balanced or unbalanced load. 2. Headphone monitor jack (on front panel)

Equalization:

117-vac, 60-Hz Models: 3¾ ips, 120 microseconds; 7½ ips, NAB.

115/230-vac, 50-Hz Models: 3¾ ips, 120 or 200 microseconds; 7½ ips, NAB or CCIR

Power Requirements: For 117-vac operation, 0.5 A; for 230-vac operation, 0.3 A



AMPEX AG-500 PORTABLE TAPE RECORDER

AG-500-1

A new versatile 1-channel recorder with full- or half-track head. This single channel unit has input controls that can mix two incoming line signals. Use of mike pre-amplifier accessory converts line inputs to accept low impedance microphones. Narration over music, music/voice mixing or special sound-on-sound capabilities are possible. Recorder feeds 600-ohm remote phone line.

AG-500-2

The 2-channel version provides complete stereo record and reproduce. A 2-track erase head used with the record/safe selector permits half-track recording of either track, sound-on-sound, cut track, and special effects. Input controls are the same as the AG-500-1.

AG-500-4

Offers all functions of AG-500-2 in quarter track stereo/mono version. Recorder has three one-fourth track stereo heads; erase, record, play . . . (tracks 1 and 3 of 4 tracks). Optional versions are available from factory with extra head and head transfer installed.

Speeds: 7½ and 15 ips, or 3¾ and 7½ ips (AG 500-4: 3¾ to 7½ only)

Overall Frequency Response: 30 to 18,000 Hz ±2 db at 15 ips; 30 to 15,000 Hz ±2 db, -4 db at 7½ ips; 40 to 8,000 Hz +2 db at 3¾ ips

Signal-To-Noise Ratio: (Peak record level to unweighted noise. Includes bias, erase, and playback amplifier noise.) 55 db at 15 and 7½ ips (half track or two track); 60 db at 15 and 7½ ips (full track 60 Hz); 57 db at 15 and 7½ ips (full track 50 Hz); 55 db at 3¾ ips (full track); 50 db at 3¾ (half track and quarter track)

Flutter and Wow: Less than 0.15% rms at 15 ips; 0.18% rms at 7½ ips; 0.25% rms at 3¾ ips

Timing Accuracy: ±0.25% at 15 and 7½ ips; ±0.40% at 3¾ ips

Output: +4 dbm into 600-ohm balanced load

Inputs: Two inputs per channel, 2: balanced or unbalanced bridging (bridging transformers supplied)

Power Required: 117 vac — 60 Hz, 1.50 A; 230 vac — 50 Hz, 0.75 A; 3-wire grounded power cable supplied

Rack Space:

Transport: 8¾ by 19 in. (22.2 by 48.3 cm)

Electronics: 3½ by 19 in. (8.9 by 48.3cm)

Minimum Space Required: 6 in. behind panels (15.2 cm)

Portable Units: Mounted in rugged Samsonite cases.



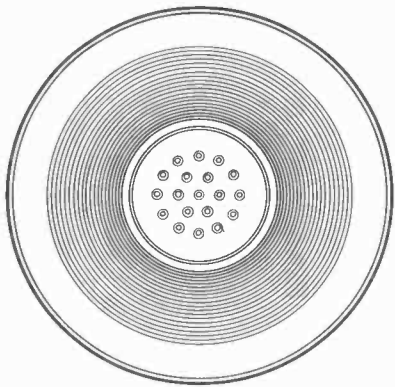

**Audio
Accessories**

COLLINS M-21 MICROPHONE

The small, rugged M-21 lavalier microphone is ideally suited for television and radio broadcasting. Supplied with lavalier, this compact mike can be easily hidden behind the lapel or necktie.

Type: Lavalier, dynamic

Response: 60 to 12000 Hz

Sensitivity: -61 db (0 db = 1 mw/10 microbars)

Polar Pattern: Omnidirectional

Impedance: For use with 50 to 250 ohm inputs

Length: 2 $\frac{3}{8}$ inches

Diameter: $\frac{3}{4}$ inches

Weight: 45 grams, less cable

Cable: 2-conductor, shielded, 25 feet

Part No. 124 0083 377



COLLINS M-70 MICROPHONE

Provides highly directional sound selectivity to double the conventional working distance and to cut out unwanted background sounds. It is especially useful in small booths where

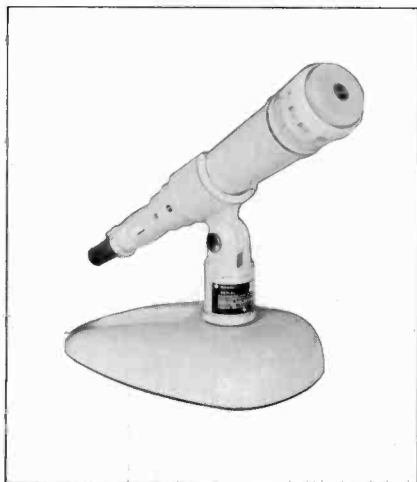

reflecting surfaces could be a problem. Comes equipped with desk stand and a 20-foot, 3-conductor shielded cable.

Impedance: 50 ohms or 200 ohms, selectable

Frequency Response: 40 to 15,000 Hz

Output Level: -55 db below 1 mm/10 dynes/cm²

Size: 6 13/16 in. long, 1 17/32 in. diameter (17 cm long, 3.9 cm diameter)

Weight: 12 ounces, (0.34 kg) (without cable)

Color: Non-reflecting blue-gray

Part No. 099 2402 000

COLLINS M-80 MICROPHONE

The M-80 directional microphone is designed for use in combo, recording, night club, public address, or other applications where background noise is unwanted. The M-80's directional characteristics make it sensitive to sound originating only from the front. A 4-stage blast filter effectively controls undesirable mike "pop", wind noise, and feedback.

Type: Cardioid Dynamic

Impedance: 150 ohms (matches 50 to 250 ohms)

Output Level: -55 db at high impedance

Frequency Response: 50 to 15,000 Hz

Discrimination: Typically 20 to 25 db over the entire frequency range

Cable: 12 ft, 2-conductor, shielded

Case: Die cast zinc alloy (satin chrome)

Mounting: $\frac{5}{8}$ in., 27 thread

Weight: Net, 14 oz; shipping, 3 lb

Dimensions: 1 $\frac{5}{8}$ in. by 6 in. long

Part No. 124 0083 378



COLLINS M-90 MICROPHONE

The M-90 ball screen microphone is especially suited for use in broadcasting, recording, night club, and public address work. Undesirable audience noise, microphone "pop", "squeal", wind noise, and feedback are eliminated by the popstop ball screen and 4-stage blast filter of this highly directional microphone.

Type: Cardioid Dynamic

Impedance: 150 ohms (matches 50 to 250 ohm inputs)

Output Level: -55 db

Frequency Response: 40 to 15000 Hz

Discrimination: Typically 20 db, minimum over the frequency range

Cable: 20 ft, three conductor, shielded, black rubber jacketed, removable

Case: Die cast zinc alloy, steel wire screen

Finish: Satin cast zinc alloy, steel wire screen

Mounting: $\frac{5}{8}$ in., 27 thread

Weight: 20 ounces including cable

Dimensions: 2 in. diameter, 6 in. long

Part No. 124 0083 379



SHURE SM5A AND SM5B MICROPHONES

The Shure SM5 dynamic cardioid provides directivity, minimizes sound coloration due to off axis pickup, and wide range frequency response. Integral windscreen, absence of transformers or response correcting inductors prevents pickup of electrical noise. Especially suited for boom application.

Frequency Response: 50 to 15,000 Hz

Polar Pattern: Unidirectional

Impedance: SM5A, 50 ohms; SM5B, 150 ohms

Output Level: 1000-Hz response

SM5A (50 ohm), open circuit voltage: -84.0 db* (0.063 mv)

Power level into 50 ohms: -57.0 db**

Gm sensitivity (EIA microphone rating): -150.0 db***

SM5B (150 ohm) — open circuit voltage: -79.5 db* (0.103 mv)

Power level into 150 ohms: -57.0 db***

Gm sensitivity (EIA microphone rating): -150.0 db***

Connector: Cannon XLR-3-42 receptacle mounted on microphone

Finish: Textured dark gray enamel, light and dark gray plastic foam wind screens

Mounting: 5/8-27 adapter is supplied, desk mount available as accessory

Weight: 1 lb, 15 oz (879 grams)

Hum Level: -120 dbm with field of 1×10^{-3} gauss at 60 Hz

Part No. 124 0032 551 (Type SM5A)

Part No. 124 0032 552 (Type SM5B)

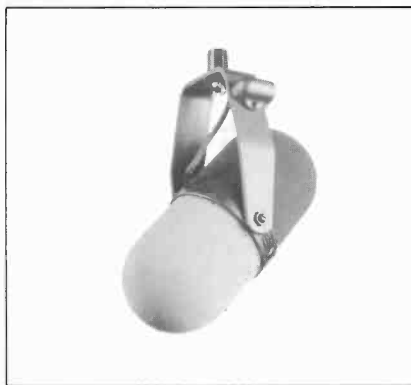

SHURE SM33 MICROPHONE

The model SM33 is a compact and rugged unidirectional ribbon microphone combining wide range response and a super-cardioid directional pattern. This polar pattern is somewhat more directional than the conventional cardioid, providing excellent control of unwanted surrounding noise and reverberation. The performance characteristics are ideal for studio use in broadcasting, recording, and for critical sound reinforcement applications. The SM33 features super-cardioid pickup, wide frequency response, low frequency response adjustable by means of a response selector switch, built in shock mount, and rugged mechanical design.

Type: Ribbon

Frequency Response: 40 to 15,000 Hz

Polar Pattern: Super-cardioid

Impedance: Dual. Choice of 30 to 50 ohms or 150 to 250 ohms (Connected for 150 to 250 ohms)

Output Level: 1000 Hz response

SM33 30 to 50 ohms, open-circuit voltage -87.0 db* (0.049 mv)

Power Level -60.0 db**

Gm sensitivity (EIA microphone rating) -152.5 db***

SM33 150 to 250 ohms, open-circuit voltage -81.0 db* (0.089 mv)

Power Level -58.5 db**

Gm sensitivity (EIA microphone rating): -152.5 db***

Connector: XL-3-12 connector in microphone

Cable: 20 ft, 2-conductor shielded with cannon XLR-3-11-C connector attached (one end)

Finish: Textured light and dark gray enamel

Swivel: Self adjusting lifetime swivel permits tilting the head 45° forward and 70° backward

Shock Mount: Special live rubber vibration isolation unit

Weight: 1 lb 10 oz (736 grams)

Part No. 124 0032 533 (Type SM33)



SHURE SM50 MICROPHONE

The SM50 is a rugged, omnidirectional microphone built to withstand the severest field use. It provides very natural and intelligible voice reproduction and unusual freedom from annoying wind and breath noises. Very comfortable hand-held, or mounted in the slip-in stand adapter, the SM50 is ideally suited to remote interviews, news and sports pickups, and a variety of field and studio applications. The SM50 features natural response from 40 to 15,000 Hz, highly effective built-in wind and breath filter, comfortable size, lightweight, and rugged construction.

Type: Dynamic

Frequency Response: 40 to 15,000 Hz

Polar Pattern: Omnidirectional

Impedance: Dual 30 to 50 ohms and 150 to 250 ohms (connected for 150 to 250 ohms when shipped)

Output Level: 1000-Hz response

SM50 30 to 50 ohms, open-circuit voltage -85.0 db* (0.053 mv)

Power level -58.0 db**

Gm sensitivity (EIA microphone rating) -150 db***

SM50 150 to 250 ohms, open-circuit voltage -79.0 db* (0.111 mv)

Power level -58.0 db**

Gm sensitivity (EIA microphone rating): -150 db***

Connector: Cannon XL-3-12 type in microphone

Cable: 20-ft, 2-conductor shielded with Cannon XLR-3-11C connector (one end)

Finish: Textured dark gray enamel

Swivel Adapter: Positive action 90° swivel to mount microphone to stand on fixture with 5/8-27 thread

Weight: 8 oz (227 gm)

Shipping Weight: 2 lb, 5 oz (1049 gm)

Part No. 124 0032 554 (Type SM50)

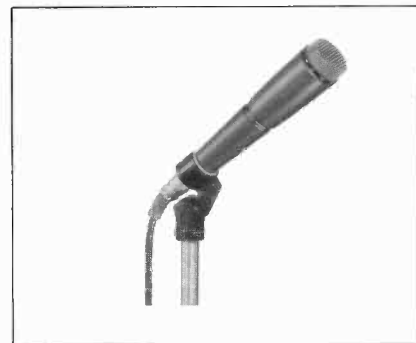

SHURE SM300 MICROPHONE

The model 300 is an unusually compact ribbon microphone. The 300 is an excellent choice for broadcast or recording studio and for critical sound reinforcement applications in which its symmetrical front and rear pickup with greatly reduced side pickup is useful. Ideal for applications such as across-the-table interviews or dialogue. The bidirectional pattern provides the same control of overall surrounding noise and reverberation as an equivalent microphone. The model 300 features warm, smooth sound from wide range front and rear response, low frequency characteristic adjustable by means of a response selector switch, bidirectional polar pattern, built-in shock mount, impedance selection, and rugged mechanical design.

Type: Ribbon

Frequency Response: 40 to 15,000 Hz

Polar Pattern: Bidirectional. Equally sensitive at front and rear. Response at sides down 15 to 20 db from front and rear response

Impedance: Choice of three by switch. "L" 30 to 50 ohms, "M" 150 to 250 ohms, "H" high

Output Level: 1000 cps response

Model 300—30 to 50 ohms "L" position

Open circuit voltage -87.5 db* (0.043 mv)

Power level into 50 ohms -60.5 db**

Gm sensitivity (EIA microphone rating): -153.0 db***

Model 300—150 to 250 ohms "M" position

Open circuit voltage -79.5 db* (0.105 mv)

Power level into 50 ohms -59.0 db**

Gm sensitivity (EIA microphone rating): -151.0 db***



Model 300 High Impedance "H" position

Open circuit voltage -57.5 db* (1.32 mv)

Loaded with 100,000 ohms -60.0 db**

Gm (sensitivity) -154.0 db***

Finish: Textured dark gray enamel

Swivel: Self-adjusting lifetime swivel permits tilting the head 45° forward and 90° backward so that the microphone can be aimed at the source of sound.

Shock Mount: Live-rubber vibration-isolation unit

Connector: Cannon type XLR-3-12 in microphone

Cable: 20-ft 2-conductor shielded with cannon XLR-3-11C (one end)

Stand Thread: 5/8-27 thread

Response Selector: Two position switch to adjust low frequency characteristic

Part No. 124 0032 555 (Type 300)

ELECTRO-VOICE AND ALTEC-LANSING MICROPHONES

A complete line of Electro-Voice and Altec-Lansing general purpose and specialized microphones, stands, call letter plates and accessories is sold by your Collins Broadcast Equipment Sales Engineer.

* 0db = 1 volt per microbar

** 0db = 1 milliwatt with 10 microbars

*** 0db = EIA Standard SE-105, August 1949

ATLAS DS-7 MICROPHONE DESK STAND

A general purpose, chrome plated adjustable desk stand with a base of cast iron and finished in gun metal shrivel finish. Stable base is equipped with pads to prevent damage to desk. Equipped with standard "velvet action" clutch adjustment. Thread size at microphone end is 5/8-27. Adjustable from 8 to 12 inches (20 cm to 30.5 cm)

Weight: 3 lb (1.4 kg)

Part No. 097 1119 00

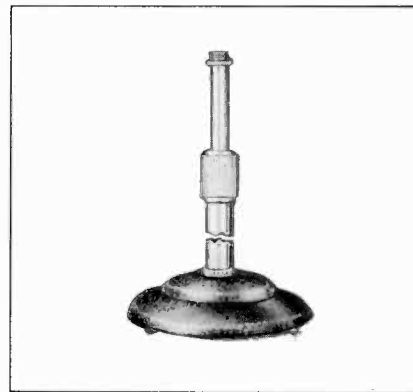

ATLAS BS-36/36W BOOM STAND

Professional Boom Stand features safety air-lock to prevent slippage, 62-inch boom with gyromatic swivel joint for microphone suspension. Vertical adjustment 48 to 72 inches. BS-36W provides ball bearing swivel casters.

Weight: BS-36 36 lb (16.4 kg). BS-36W 40 lb (18.2 kg)

Part No. 097 1500 000 (Type BS-36)
Part No. 097 1790 000 (Type BS-36W)



ATLAS BB-1 MICROPHONE BOOM

This 31-inch microphone boom may be attached to any type of floor stand. All swivel parts are precision die castings resulting in smooth operation and secure positioning. Boom is chrome plated and has 5/8-27 thread.

Weight: 3½ lb (1.6 kg)

Part No. 097 0984 00

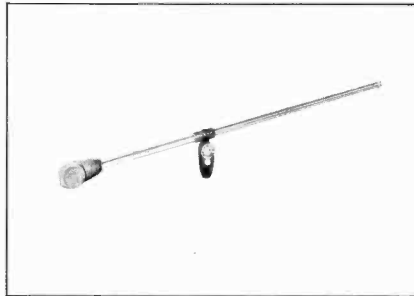

ATLAS MS-11C FLOOR STAND

Features an extended length clutch body, inner lined with a wear-proof locking collet which grips without jamming, slipping or sudden dropping. Includes self-leveling, shock absorbing base pads, plus three additional anti-tip points located between the base pads. Terminates in a 5/8-27 thread.

Finish: Chrome or gray wrinkle (Model MS-10C)

Height Adjust: 35 to 65 in. (89 cm to 165 cm)

Base Diameter: 10 in. (25.4 cm)

Weight: 12 lb (5.5 kg)

Part No. 097 1511 00 (Type MS-11C)

Part No. 097 5729 00 (Type MS-10C)

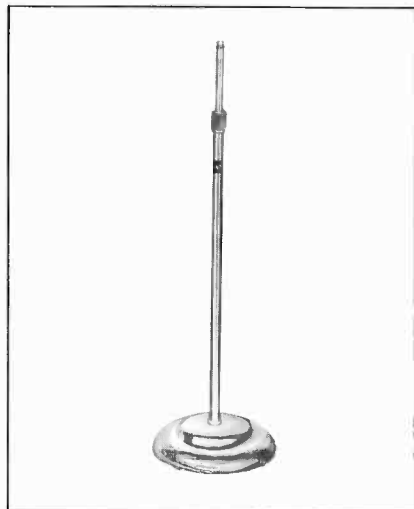

ATLAS MS-25 FLOOR STAND

Features safety air-lock cushion to prevent slippage of telescoping section. Uses a large diameter, oversize telescoping tube (7/8 in. telescoping tube, 1 1/8 in. base tube). Terminated in 5/8-27 thread.

Finish: Chrome and gray wrinkle

Height Adjust: 37 to 66 in. (94 cm to 167 cm)

Base Diameter: 17 in. (43.18 cm)

Weight: 24 lb (11 kg)

Part No. 097 1510 00

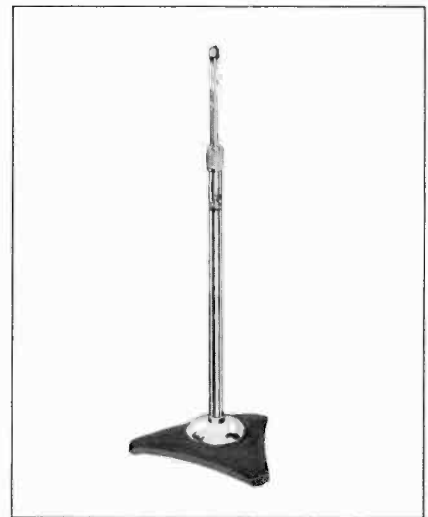

FLEXP MIKESTER FM-1

This arm will handle any mike up to 4 lb. It can be instantly positioned, incorporates a patented enclosed spring-controlled swiveling device, swings out 36 inches in any direction when fully extended. Clamps or screws to any position. Clips hold cable in place.

Weight: 4¾ lb (2.2 kg)

Part No. 097 1499 00

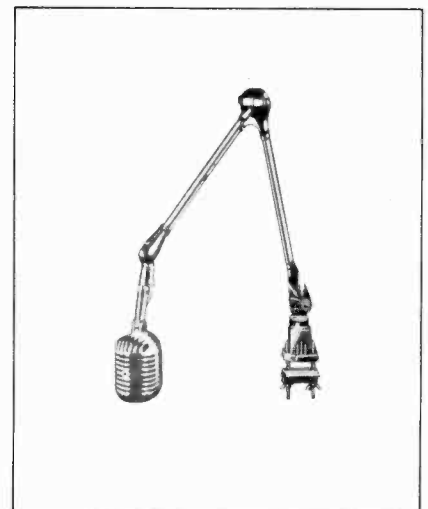

COLLINS CS-12 LOUDSPEAKERS

Producing the very finest in high fidelity sound, the Collins CS-12 loudspeaker produces a consistently stable and precise definition. The speaker is designed to operate equally well at full range or as woofers in multiway systems. The CS-12 features Radax construction, which divides the sound between the two cones. A mechanical crossover, when the small cone responds to the higher frequencies, occurs at 1800 Hz.

A slug-type magnet is used for concentrating flux density into the air gap. This type magnet has the lowest possible leakage and greatest structural strength. The high frequency long throw voice coil remains in the air gap even on the longest of excursions to prevent nonlinear operation.

An edge-wound voice coil, which gains an equivalent of five extra watts from most amplifiers over round-wire coils, is wound with precision, flattened ribbon conductor.

Each speaker is carefully tested and inspected before leaving the factory. An individual frequency response curve check is run on each speaker so that it matches the performance of the laboratory standard.

Frequency Response: 30 to 13,000 Hz

EIA Sensitivity Rating: 43 db

Free-Space Cone Resonance: 40 Hz

Power Handling Capacity:

Program Material: 20 watts

Peak: 40 watts

Critical Damping Factor: 15

Impedance: 8 ohms

Mechanical Crossover: 1800 Hz

Voice Coil Diameter: 2 in.

Total Flux: 70,700 maxwells

Power Required for 100 db level: 12 watts

Mounting: Four ¼ in. holes equally spaced on 11½ in. circle

Baffle Opening: 11 in.

Size: 12¼ in diameter, 3½ in. deep (31 cm diameter, 9 cm deep)

Weight: 5½ lb (2.5 kg)

Part No. 124 0032 017 (Type CS-12)

Part No. 099 2686 000

Stancor A-3818 Speaker Transformer

FRAZIER MANHATTAN LOUDSPEAKER

Now a famous loudspeaker, made especially for built-in systems, is available as a handsomely finished cabinet model. Its unique reproduction qualities for bringing to life the whole musical spectrum of the symphonic orchestra, vividly and brilliantly, are well known.

In actuality, the Manhattan enclosure is the well-known Frazier Black Box I that long has been the leading unit used in the finest built-in systems. The enclosure is a modified Helmholtz type using two slit-type tuning tubes, one on each side with a system consisting of a special full range 8-inch loudspeaker unit, one 3½-inch high frequency unit, and one high-pass filter mounted in a special enclosure. The base stand is a separate unit. The Manhattan mounts horizontally, vertically or can be used book shelf style.

Useable Frequency Response: 40 Hz to beyond 15,000 Hz

Efficiency: According to an independent testing laboratory, 4/10 of one watt provides sufficient power for living room listening level

Impedance: 8 ohms

Dimensions: 23⅞ in. W, 19 in. H, and 11⅞ in. D

Finish: Oil walnut with cane fibre type grille

JENSEN P12-T SPEAKER

This economy speaker is ideal for a high fidelity system to which additional units may be added.

Impedance: 3.2 ohms

Power Rating: 12 watts

Baffle Opening: 10½ in. Jensen transformer (Stancor A-3818 speaker transformer) for P12-T speaker matches to 600 ohms

Part No. 097 2119 00 (Type P12-T)

Part No. 099 2686 00

Stancor A-3818 speaker transformer.

JENSEN LEVEL CONTROLS

Designed for use in voice coil or line circuits of similar nominal impedance, Jensen level controls are of the 2-section L-pad type. They provide continuously adjustable level without disturbance of other circuit levels or total impedance. Single hole panel mounting. Complete with lock nut, pointer knob and flat metal escutcheon plate. Model ST-276, 8 ohm, 15 watts, L pad.

Part No. 124 0032 123 (Type ST-276)

STANCOR A-3818 TRANSFORMER

Transformer for Collins CS-12, Jensen P12-T and P8-TS speakers.

Primary Impedance: 500/1000/150 ohms

Secondary Impedance: 15/8/4 ohms

Power Rating: 25 watts

Part No. 099 2686 00

MIRITEL AIR ALERT

Designed to control visible and/or audible alarm circuits on EBS signal from local or sky-wave stations. Frequency tunable from 550 to 1600 kHz. Built-in speaker operates upon alarm. Relay circuit is voltage regulated. External bell or light control terminals and antenna terminals on rear terminal board. Available for rack mounting only.

Part No. 097 3192 000



ARGOS BAFFLES

Entire front is inset with plastic grille and cloth covered panel. Constructed of plywood and hardboard for good resonant tone. Extra reinforcing blocks and four bolts installed for mounting speakers. Covering is plastic coated leatherette. Available in blonde or walnut. Slanting corner baffle for 8-inch speaker (SCB-8D) or 12-inch speaker (SCB-12D).

Weight: 6 or 8 lb (2.72 kg or 3.63 kg). Wall baffle for 8 in. speaker (WB-8D) or 12 in. speaker (WB-12D)

Weight: 2½ or 4¼ lb (1.13 kg or 1.93 kg)

- Part No. 099 2374 00 (Type SCB-8D)
Walnut finish.
- Part No. 099 2375 00 (Type SCB-8D)
Blonde finish.
- Part No. 099 2376 00 (Type SCB-12D)
Walnut finish.
- Part No. 099 2377 00 (Type SCB-12D)
Blonde finish.
- Part No. 124 0032 295 (Type WB-8D)
Walnut finish.
- Part No. 124 0032 296 (Type WB-8D)
Blonde finish.
- Part No. 124 0032 297 (Type WB-12D)
Walnut finish.
- Part No. 124 0032 298 (Type WB-12D)
Blonde finish.

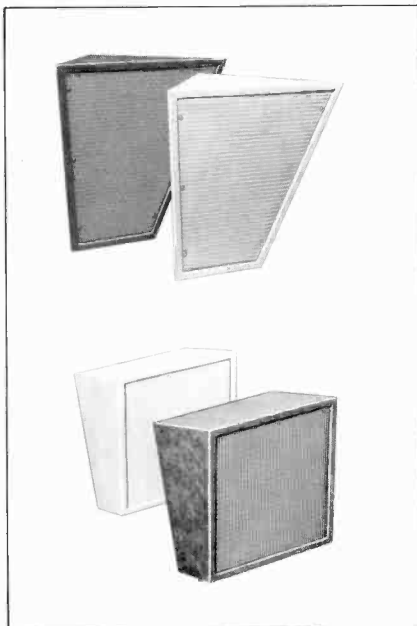

TRIMM HEADPHONES

Lightweight, rugged headphones with black Bakelite shell and cap. Rubber covered headband.

Impedance: 600 ohms (Model 156) or 17,000 ohms (Model 157)

Weight: 5 oz (140 gm)

- Part No. 273 0003 00 (Type 156)
- Part No. 273 0004 00 (Type 157)

BRUSH BA-206 HEADPHONES

The Brush BA-206 headphones have an exceptionally flat response out to 10,000 Hz and create outstanding fidelity of reception. Impedance at 1 kHz is 50K. Their high impedance and negligible power requirements allow monitoring without any effects on associated equipment. The special "Met-alseal" crystal elements provide maximum protection against excessive humidity.

Part No. 099 0495 00



BRUSH BA-200 HEADPHONES

Ideal for general purpose service, the Brush BA-200 headphones have a frequency range from 100 to 5000 Hz. They are especially suitable for general laboratory and studio work as well as for the skilled amateur.

Impedance: 45,000 ohms at 1000 Hz
Weight: 6 oz (170 gm)

- Part No. 099 2488 000 (Type BA-200-1)
45000 ohm with plug.
- Part No. 099 2489 000 (Type BA-200-2)
45000 ohm with eyelet terminals.



PATCH CORDS

The plugs are of the shielded type, with the sleeves tied together and grounded. The circuit is maintained through connections to the plug tips. The following lengths are available: 6, 12, 24, 36, 48, 60, and 120 inches. Other patch plugs, phone jacks and single circuit jacks available.

- Part No. 361 0010 00 (6 in.)
- Part No. 361 0011 00 (12 in.)
- Part No. 361 0012 00 (24 in.)
- Part No. 361 0013 00 (36 in.)
- Part No. 361 0014 00 (48 in.)
- Part No. 361 0015 00 (60 in.)
- Part No. 361 0016 00 (120 in.)

TRIMM JACK PANELS

These panels are available in 12-pair, single row and 24 pair, double row models to fit any standard 19-inch rack and include such features as: solid 5/8-inch thick Bakelite panel with steel reinforcing; heavy gauge, special spring temper nickel/silver alloy leaves; ground lugs aligned to allow single ground bus to be run full length of strip; large palladium silver contacts; connection lugs fanned out for ease of soldering.

- Part No. 097 3561 00
12-pair, single row.
- Part No. 097 4200 00
24-pair, double row.

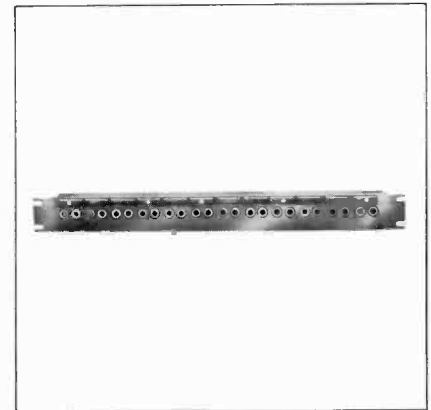

SHIELDED WIRE AND MICROPHONE CABLE

8451—Belden 2-conductor #22, twisted pair, spiral-wrapped shielding, vinyl insulation overall.

8738—Belden 2-conductor (solid copper) #22 vinyl insulated conductors, all shielded with copper braid.

439-5900-00 — Two-conductor #22 stranded, 7 No. 30 conductors, one red and one black conductor with one #22 ground wire. Shield is single right-hand wrap, #30 AWG maximum diameter of stranding. Nylon jacket, maximum outside diameter is 0.140 in.

8422 Belden, shielded microphone cable, 2-conductor #22, rubber covered.

8412 Belden, shielded microphone cable, 2-conductor #20, Neoprene covered.

423-0219-00 High voltage wire, 15-kv breakdown insulation.

425-0061-00 Shielded pair, #16 stranded cotton insulated, 15 A.

425-0151-00 Shielded pair, #12 stranded cotton insulated, 20 A.

Part No. 124 0032 961 (Type 8451)

Part No. 097 6029 00 (Type 8738)

Part No. 097 1142 00 (Type 8422)

In lengths of less than 100 ft.

More than 100 ft., see below.

Part No. 097 1142 00 (Type 8422)

In lengths of 100 ft. or more

Less than 100 ft., see above.

Part No. 425 0250 00 (Type 8412)

In lengths of less than 100 ft.

More than 100 ft., see below.

Part No. 425 0250 00 (Type 8412)

In lengths of 100 ft. or more

Less than 100 ft., see above.

TRIMM 427-6 TERMINAL BOARD

Contains two groups of terminals, each 13 terminals long and 6 terminals high.

Part No. 097 6282 00

BUD RACK CABINETS

A heavy duty rack cabinet that is custom-made for Collins Radio Company. Finished in light gray, this cabinet is made of sturdy steel with a door on the back and provision at the top for mounting a blower fan. CR-1773-B provides 17 inches of panel space. CR-1772 provides 63 inches of panel space. Both are shipped knocked down.

Part No. 099 2474 000 (Type CR-1773-B)

22 in. W, 76 in. H, 17 $\frac{1}{8}$ in. D.

Part No. 124 0032 949 (Type CR-1772)

22 in. W, 69 in. H, 17 $\frac{1}{8}$ in. D.

For use with 820E/F transmitter.

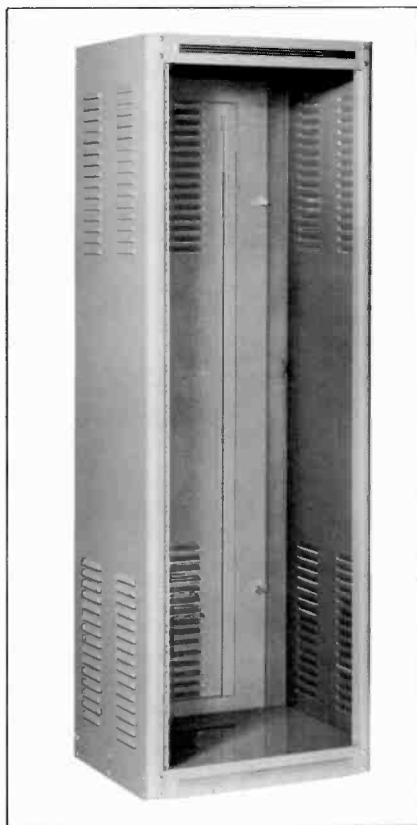

RACK CABINET BLANK PANELS

These blank panels of 3/16-inch aluminum are finished in light gray to match the BUD CR-1773-A Rack Cabinet.

Size: 19 in. W, (48 cm W) and in heights as listed below.

	Inches	Cm.
Part No. 502 8389 123	(1 $\frac{3}{4}$ in.)	(4.45)
Part No. 502 8393 113	(3 $\frac{1}{2}$ in.)	(8.89)
Part No. 502 8397 123	(5 $\frac{1}{4}$ in.)	(13.34)
Part No. 502 8401 113	(7 in.)	(17.78)
Part No. 502 8405 113	(8 $\frac{3}{4}$ in.)	(22.23)
Part No. 502 8409 123	(10 $\frac{1}{2}$ in.)	(26.67)
Part No. 502 8413 113	(12 $\frac{1}{4}$ in.)	(31.12)
Part No. 502 8417 113	(14 in.)	(35.56)

TELECHRON 1H1612 STUDIO CLOCK

The Telechron "Commerce" clock has a 12-inch dial and rich brown case.

Part No. 097 1735 00

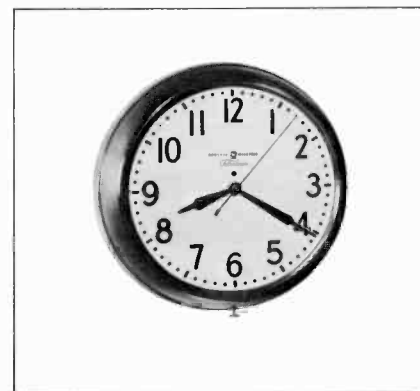

CANNON CONNECTORS

Collins Radio Company is an authorized distributor of the full line of Cannon Connectors. The following is a listing of those connectors most often required in audio applications. All are 3-contact plugs unless otherwise indicated.

P3-CG-11S, Cannon female cable plug.

Part No. 370 2180 00

P3-CG-12S, Cannon male cable plug.

Part No. 370 2190 00

P3-13, Cannon female panel receptacle.

Part No. 370 2060 00

P3-14, Cannon male panel receptacle.

Part No. 370 2090 00

P3-35, Cannon single gang female wall receptacle.

Part No. 370 2150 00

P3-35-2G, Cannon 2 gang female wall receptacle.

Part No. 370 2170 00

XLR-3-11C, Cannon female cable plug.

Part No. 097 5372 00

XLR-3-11SC, Cannon female cable plug with latch-lock cable clamp.

Part No. 097 5371 00

XLR-3-12C, Cannon male cable plug.

Part No. 097 5370 00

XLR-3-12SC, Cannon male cable plug with latch-lock cable clamp.

Part No. 097 5369 00

XLR-3-13, Cannon female panel receptacle, flush mount.

Part No. 097 5368 00

XLR-3-13N, Cannon female panel receptacle with lock nut.

Part No. 097 5367 00

XLR-3-14, Cannon male panel receptacle, flush mount.

Part No. 097 5366 00

XLR-3-14N, Cannon male panel receptacle with lock nut.

Part No. 097 5365 00

XLR-3-35, Cannon single gang female wall receptacle.

Part No. 097 5364 00

XLR-3-35-2G, Cannon 2-gang female wall receptacle.

Part No. 097 5363 00

XLR-3-36, Cannon single gang male wall receptacle.

Part No. 097 5362 00

XLR-3-36-2G, Cannon 2-gang male wall receptacle.

Part No. 097 5361 00

UA-3-11, Cannon female cable plug.

Part No. 370 2082 00

UA-3-12, Cannon male cable plug.

Part No. 370 2081 00

UA-3-13, Cannon female panel receptacle, flush mount.

Part No. 370 2079 00

UA-3-14, Cannon male panel receptacle, flush mount.

Part No. 370 2083 00

UA-3-31, Cannon female wall mount receptacle.

Part No. 099 0463 00

UA-3-32, Cannon male wall mount receptacle.

Part No. 099 0464 00

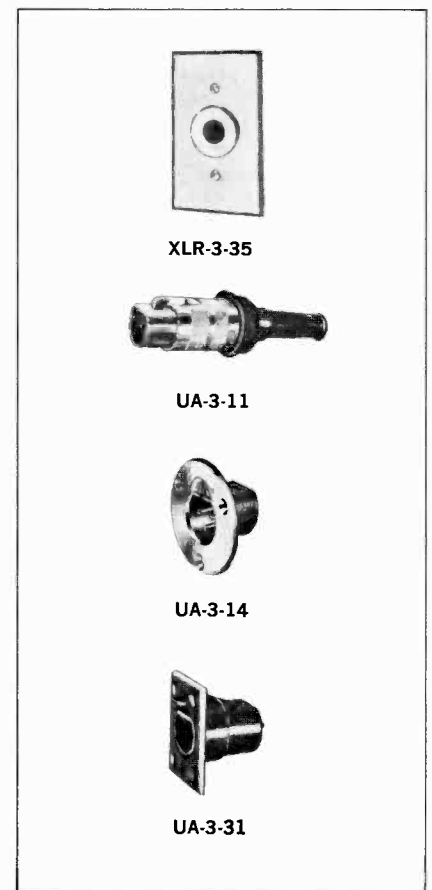
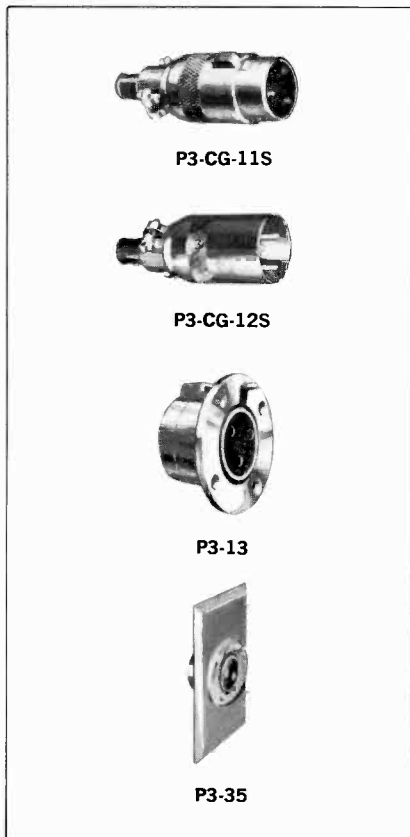

**Remote
Equipment**

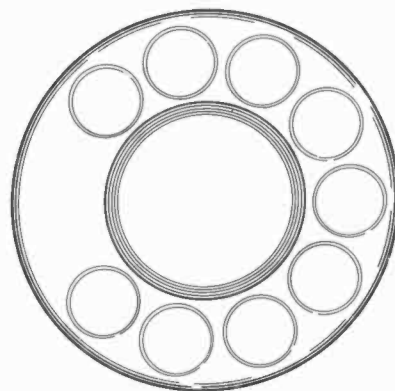

COLLINS 212J-1 BROADCAST AUDIO CONSOLE

The compact, lightweight 212J-1 Console provides 4-channel monophonic audio mixing for broadcast studio and remote applications. Each of the four mixers in the console controls the gain of a single channel, which accepts switched inputs from a microphone, magnetic tape, or high-level source. The phono input may be RIAA compensated or strapped to provide 3 db of treble boost or cut. Also featured on the 212J-1 Console are a 600-ohm public address output, a monitor speaker within the console cabinet, and provisions for a headphone or external speakers. Included with the four mixers and associated amplifiers are a program amplifier and monitor amplifier. Mixer outputs may be switched to program or audition bus, or off. The monitor output switch selects the audition or program bus, or off. Cueing is provided by feeding the mixer output to the monitor amplifier and overriding the switch-selected input. An illuminated VU meter displays the program amplifier output and a front-panel jack allows program or talkback monitoring.

Mechanically the unit consists of one printed circuit board, three subassemblies, and a top, bottom, and front cover. When the covers are removed the majority of the console electronics are accessible. Removal of several screws allows lifting of the rear panel and circuit board, making every space accessible while the unit remains operable.

An optional paralleling unit permits connection of two 212J-1 units. In this configuration all eight channels are available for either of two separate outputs.

Power Source: 115 vac $\pm 10\%$, 50/60 Hz, single-phase, 170 ma, or 12 to 15 vdc 400 ma max

Input Impedance:

Mike: 150/200 ohms (strappable for 600 ohms) balanced

High Level: 600 ohms, balanced

Phonograph: 100,000 ohms nominal at 1 kHz, unbalanced

Input Level:

Mike: -50 dbm

High Level: -10 dbm

Phonograph: 6 mv

Output Impedance:

Line: 600 ohms

Monitor: Use 8-ohm load (monitor output impedance is less than 1 ohm)

Public Address: Use 600-ohm load

Output Level:

Program: +8 dbm

Monitor: $\frac{1}{4}$ watt

Public Address: 0 dbm

Frequency Response: ± 1.5 db on mike or high level, 50 to 15,000 Hz; RIAA compensation, ± 1.5 db, on phonograph input

Harmonic Distortion: Less than 1% on normal or maximum level

Equivalent Input Noise: -120 dbm or less

Temperature Range: 0° to 50°C

Size: 5.5 in. H by 17 in. W by 14 in. D (14 cm H by 43 cm W by 36 cm D)

Weight: 28 pounds (13 kg)

Part No. 777 1504 001

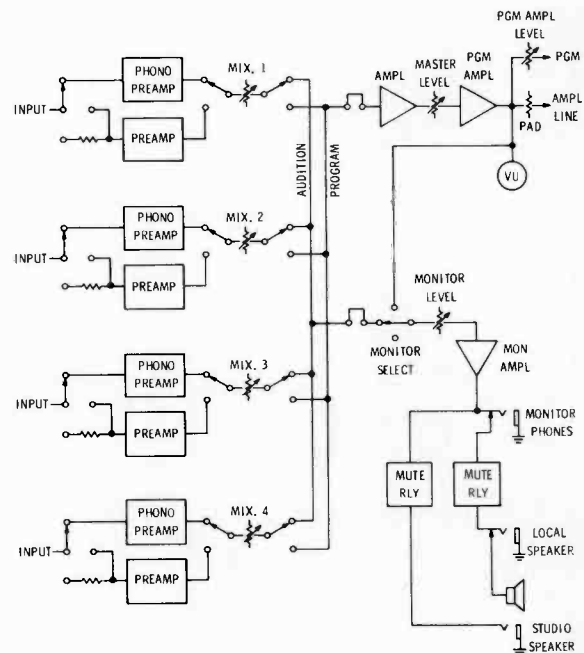

MARTI REMOTE PICK-UP EQUIPMENT

Marti Remote Transmitter and Receiver provide quality transmission of sports, spot news reports and interviews on frequencies assigned for exclusive use by broadcasters. The unit is compact and light enough to be carried into stadiums and press boxes as easily as a multichannel remote amplifier.

The audio quality of the Marti for music or voice transmission is guaranteed to be equal to or better than lines with coverage up to 40 miles radius depending upon the type and location of the transmitting and receiving antennas. The Marti Receiver is equipped with an automatic relay that operates an alarm system in the station to indicate a forthcoming broadcast.

The unit may legally be used instead of lines even where lines are available. Many stations, after installing the Marti system, have standing sponsorship of all their remote programs and have actually paid for the equipment in savings on line charges alone. The equipment also opens new program possibilities that are overlooked because of inconvenience in using other cumbersome and less reliable means.

The Marti Transmitter is operated either by ac or batteries. Designed for continuous duty, the equipment meets the most stringent FCC requirements regarding bandwidth.

It is easily portable and lightweight and does not require frequent tuning. The transmitter and transistorized power supply and associated equipment are easily installed in a car for permanent and immediate use.

MARTI M-30B/TPS MOBILE TRANSMITTER

The M-30B/TPS is a 30-watt base station transmitter for communication with mobile units operating at 152 to 172 MHz. The unit provides frequency stability of $\pm 0.0005\%$ within a temperature range of minus 30 degrees C to plus 60 degrees C. The modulation characteristic is adjusted at the factor for ± 7.5 kHz for 100% modulation at 1000 Hz.

RF Output: 30 watts, continuous

Frequency: 152 to 172 MHz

Crystal Multiplication: 36



Spurious Emission: Spurious radiation attenuated at least 70 db below carrier level, harmonics suppressed at least 60 db

Frequency Stability: $\pm 0.0005\%$

Temperature Range: Minus 30 degrees C to Plus 60 degrees C

Modulation: 30 F3 Maximum (Normally adjusted for Plus or Minus 10 kHz swing)

Audio Inputs: Two (2). Can be adjusted for either 150 or 600 ohms. Use of a 50-, 150-, or 250-ohm microphone will work satisfactorily into the 150-ohm input

Audio Input Level: Minus 70 db

Audio Connectors: Cannon XLR-3-31

Power Requirements: 120 vac or 12.6 vdc

Modulation Control: Push-pull limiter

Noise Level of Transmitter: Better than minus 45 db

Overall Response With Matched Receiver: ± 2 db from 75 to 7500 Hz

Distortion in Transmitter: Less than 3%

Net Weight: 16 lb (7 kg)

Dimensions: 14 in. wide, 10 in. long, and 7 in. high

Part No. 099 1572 000

MARTI MR-30/150-170 RECEIVER

The MR-30/150-170 receiver is used for pickup from a mobile station operating at 150 to 174 MHz. The receiver is sensitive to 0.6 microvolts or less for 20 db quieting, and is selective to -100 db at ± 32 kHz; -6 db or less at ± 15 kHz.

Application: Remote pickup

Frequency Range: 150 to 174 MHz

Spurious Response: All spurious and image responses attenuated at least 100 db

Overall Response: ± 2 db, 60 to 7500 Hz with matching transmitter

Frequency Stability: $\pm 0.0005\%$ with crystal oven

Temperature Range: -40°C to $+70^{\circ}\text{C}$

Audio Output: +8 VU at 600 ohms

Metering: Signal strength and VU brought out to test jacks, visual metering optional

Tube Complement: 6 Nuvistors, 9 tubes

Dimensions: 10½ in. H, 19 in. W, 9 in. D (26 cm H, 48 cm W, 23 cm D) Panel finish, WE hammertone grey

Weight (net): 20 lb (9 kg)

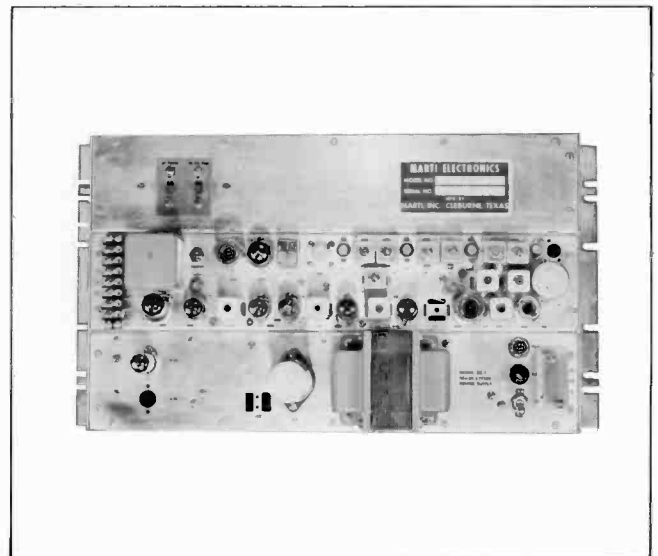

MARTI REMOTE EQUIPMENT ACCESSORIES

MOBILE ASSEMBLAGE—Consists of control unit, all battery and control cables and mounting rack for the M-30B/TPS transmitter (Type TPS-TC).

REMOTE CONTROL CONSOLETTA—For use with M-30B/CD and M250 (Type RMC-1). Constructed of wood cabinet and aluminum anodized front panel, complete with VU meter.

Size: 14 in. W, 9 in. H, 10 in. D (36 cm W, 23 cm H, 25 cm D)

Part No. 099 0542 00

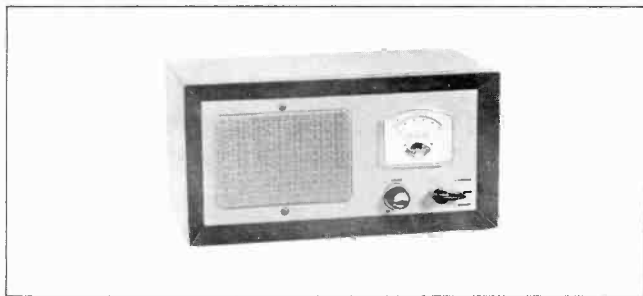

The following antennas are tuned or cut to frequency with a standing wave ratio of less than 1.5:1 and are designed for 50 to 52 ohm transmission lines.

SINGLE RING ANTENNA—Essentially non-directional, horizontally polarized and unity gain.

Specify whether for portable (PA-1) or mobile (MA-1) use.

Part No. 097 6952 (Type PA-1)

Part No. 097 6953 (Type MA-1)

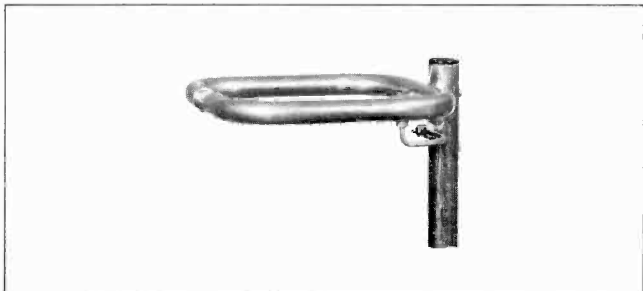

TWO RING ANTENNA—Essentially nondirectional, horizontally polarized. Has a gain of 3 db (Type RA-2).

Part No. 099 0543

ANTENNA BUMPER MOUNT—Chain link bumper mount (Type ASP-143) for use with mobile antenna.

Part No. 097 6880 00

FOUR RING ANTENNA (TYPE RA-4)—Essentially nondirectional, horizontally polarized. Has a gain of 6 db and power gain of 4.

Impedance: 52 ohms

Weight: 11 lb (5 kg)

Part No. 097 6950

FIVE ELEMENT YAGI ANTENNA (TYPE YC)—Unidirectional antenna.

Nominal Impedance: 50 ohms

Average Gain: 9 db

Typical VSWR: Under 1.5

Typical Rear Signal Rejection: 25 db

Power Handling Capacity: 60 watts

Input Connector: Type AN-SO-239 (Amphenol Type 83-1R)

Polarization: Horizontal or vertical

Part No. 099 0177

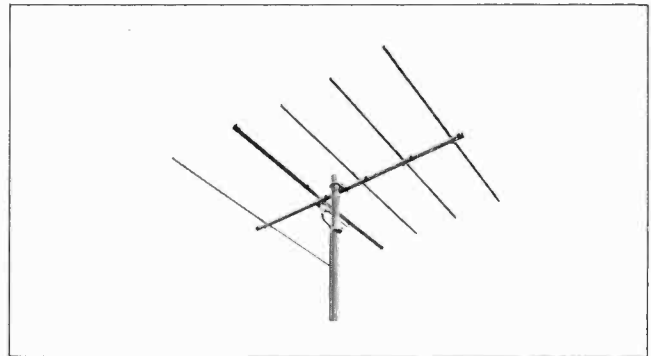

COAXIAL STACKING HARNESS—Required for stacking two, 5-element Yagi antennas. It is made up of two sections of RG-11/U 75-ohm coaxial cable joined at the center by a coaxial T fitting. Each half of the phasing harness is an odd multiple of a quarter wave length and by virtue of its characteristic impedance and length, steps the 50-ohm antenna impedance to 100 ohms. When the two cables are joined at the T connector, the impedance again becomes 50 ohms (Type 2YC).

Part No. 099 0190

KREKO VERTICALLY POLARIZED ANTENNA—This vertically polarized base antenna has a gain of 6 db (Type SC-155-B).

Part No. 099 0544

VEHICLE ROOFTOP ANTENNA—Designed especially for mounting on a vehicle, this antenna has a 3-db gain (Type ASP-177).

Part No. 099 0545

COAXIAL CABLE AND CONNECTORS—The following coaxial cables and connectors may be used with the Marti Remote Pick-Up Equipment:

Part No. 099 0146

RG 8/U coaxial cable, 100 feet

Part No. 099 0137

RG 17/U coaxial cable, 100 feet

Part No. 099 0546 00

RG 8/U connector PL-259 (Type 83-ISP)

Part No. 099 0547 00

RG 8/U straight adapter PL-258 (Type 83-IJ)

Part No. 099 0548 00

RG 17/U to RG 8/U connector (Type GR-6355)

Part No. 097 7023

RG 253/U Spir-O-line cable, 1/2 in., polyethylene jacketed

Part No. 099 0549 00

Spir-O-line RG 253/U to PL-258 connector (Type 87-500)

**Measuring
Monitoring
Remote Control**

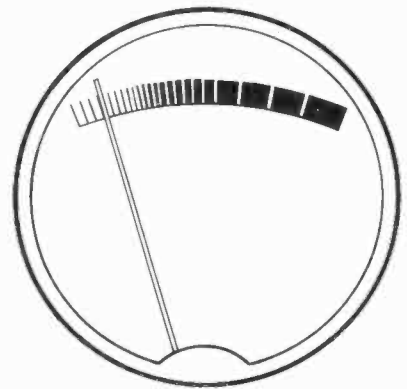

COLLINS 900C-3 FM STEREO MODULATION MONITOR

Collins new 900C-3 Modulation Monitor assures an FM station of conforming with FCC regulations.

The 900C-3 is completely transistorized and operates in the standard FM frequency band of 88 to 108 MHz. The use of plug-in, glass-epoxy circuit cards aids in fault isolation and keeps maintenance time to a minimum.

This new FM modulation monitor has the phase and frequency response and the demodulation circuits necessary to assure accurate stereo demodulation. Internal crosstalk and noise levels are kept within standards specified by the FCC.

The 900C-3 also provides the demodulating circuitry required to measure total percent modulation of the carrier. It measures percent modulation caused by different bands of modulating frequencies; main channel, stereo subchannel, pilot carrier, and sca subcarrier. Total peak modulation is monitored continuously and displayed on the peak indicator. A self-contained voltmeter is used for direct measurement of channel separation, crosstalk, signal-to-noise ratio, and stereo subcarrier suppression. Outputs are available for monitoring monaural or stereo operation.

Frequency Range: 88 to 108 MHz

RF Input Impedance: 50 ohms, unbalanced

RF Input Voltage: 5 to 10 vrms

Intermediate Frequency: 900 kHz

Wideband Output: 400 mv peak-to-peak, 1000 ohms unbalanced

MODULATION METER

Meter Scales: 0 to 13.3%, 0 to 30%, and 0 to 133%

Accuracy: Better than 0.5% in modulation percentage on the 0 to 13.3% scale, 1% on the 0 to 30% scale, and 5% on the 0 to 133% scale

Characteristics: Rise time, decay time, and damping factor as prescribed by FCC

PEAK LIGHT INDICATOR

Range: Threshold adjustable from 50 to 120% modulation

Response: Will flash on modulation peaks of 1-ms duration or greater

MONAURAL OPERATION

Outputs:

Monaural Audio: 0 dbm unbalanced (600 ohms de-emphasized)



Distortion Meter Output: 10 vrms (10,000 ohms de-emphasized)

Frequency Response: Within 1 db of standard 75-us de-emphasis curve

Distortion: 0.25% maximum, 50 to 15,000 Hz at 100% modulation

Signal-to-Noise Ratio: 75 db with 75-us deemphasis

STEREO OPERATION

Outputs:

Left and Right Audio: 0 dbm unbalanced (1200 ohms flat or deemphasized)

Distortion Meter Output: 10 vrms (10,000 ohms de-emphasized)

Frequency Response: ± 1 db from 50 to 15,000 Hz

Distortion: 0.5% maximum, 50 to 15,000 Hz at 90% modulation

Signal-to-Noise Ratio: 55 db with 75-us deemphasis

Channel Separation Measurement Accuracy: 35 ± 3 db with modulating frequencies from 50 to 15,000 Hz

Crosstalk Measurement Capability: 46 db main channel to stereo subchannel, 46 db stereo subchannel to main channel, 66 db SCA subchannel to main channel, 66 db SCA subchannel to stereo subchannel

Subcarrier Suppression Measurement Capability: 46 db with modulating frequencies of 5 to 15 kHz

AC Power: 100 to 125 vac or 200 to 240 vac, 50/60 Hz, 50 watts maximum

Size: 19 inches wide by 10-15/32 inches high by 13-25/32 inches deep

Weight: 38½ pounds maximum (17.5 kg)

Part No. 758 5812 001

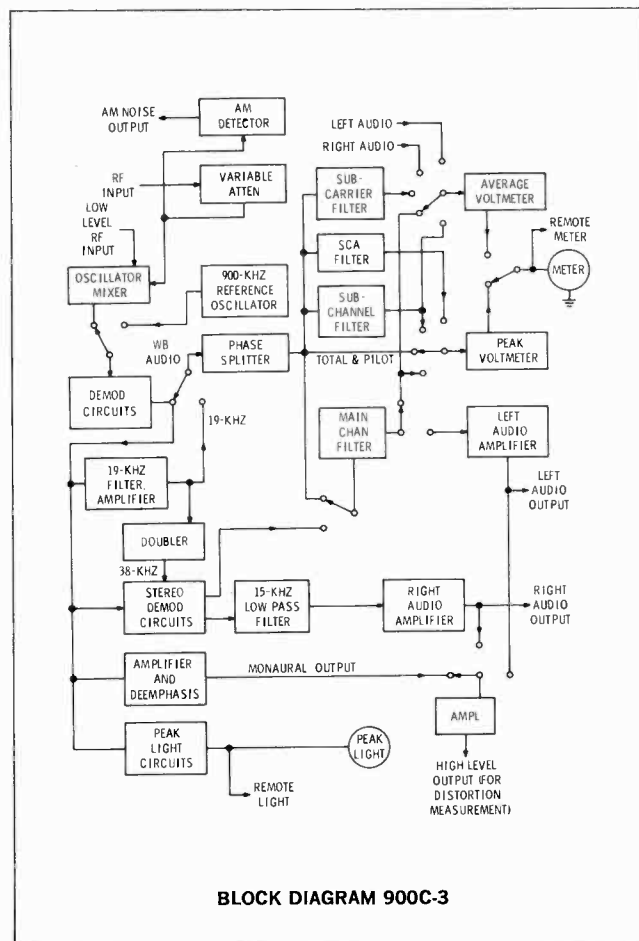

COLLINS 900F-1 SCA MONITOR

The 900F-1 SCA Monitor is capable of monitoring and displaying the modulation characteristics and carrier frequency error of a 67-kHz SCA subcarrier. Frequency error from the desired frequency or peak frequency deviation (modulation level) is clearly displayed by a meter. Two additional monitoring outputs are provided: a 600-ohm audio output for monitoring applications or distortion measurements, and an output to indicate carrier presence.

The easily maintained 900F-1 requires only 5¼ inches of space in a standard 19-inch rack. All circuitry is accessible by removal of the top and bottom panels. Rf inputs and outputs for external monitoring are located on the rear panel. The unit incorporates all solid-state active devices and integrated circuits.

The 900F-1 features a wideband pulse counter for extremely low distortion; dual reference and signal path demodulators for greater frequency measuring accuracy; a true peak reading voltmeter in the monitoring circuit; two deviation ranges calibrated in Hertz; and selectable bandwidth control for monaural and SCA or stereo and SCA operation. It is FCC type-approved for use with Collins 900C-2/3/3A FM Modulation Monitors.

Input Impedance: Greater than 3000 ohms and paralleled by not more than 100 pf capacitance

Input Signal Required: At least 10 mv p-p SCA signal

Modulation Meter Sensitivity: 5 or 10 kHz full scale, depending on switch position

Modulation Meter Accuracy: ± 1 kHz maximum for modulating frequencies between 50 Hz and 5 kHz and peak deviations up to 10 kHz with the input filter switched out; peak deviations up to 5 kHz with filter switched in (typical 0.5 kHz)

Frequency Meter Sensitivity: ± 600 Hz full scale deflection
Frequency Meter Accuracy: ± 50 Hz (calibrate before reading)

Audio Output Level: 10 ± 2 dbm into 600-ohm load at either 5 or 10 kHz peak deviation (switched simultaneously with meter sensitivity)

Audio Output Frequency Response: Either flat or deemphasized. In flat position with filter switched out, modulating frequencies between 50 Hz and 5 kHz and peak deviations up to 10 kHz result in constant output (1 db max variation). With input filter switched in, modulating frequencies between 50 Hz and 5 kHz and peak deviations up to 3.5 kHz result in constant output (2 db max variation)

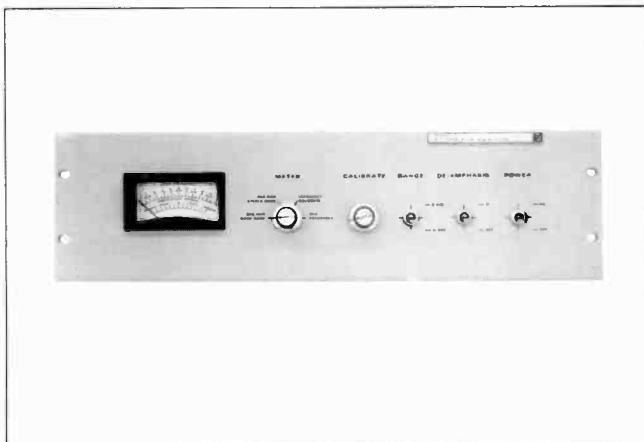

Total Distortion: 1% maximum with input filter switched out and for peak deviations up to 10 kHz

Signal/Crosstalk Ratio: Combined crosstalk from stereo or monaural modulation into the SCA audio output with an SCA injection level of 10% is at least 50 db below 5-kHz peak deviation

Residual Noise Level: 60 db below 5-kHz peak deviation

Controls: METER (SCA Mod., Mono Mode; SCA Mod., Stereo Mode; Frequency Calibrate; SCA Frequency), CALIBRATE, DEEMPHASIS (In, Out), RANGE (5 kHz, 10 kHz), POWER (On, Off)

Indicating Devices: One meter indicating peak deviation and average frequency

Fuses: Ac input is protected by a fuse

Physical Characteristics: 19 in. W, 5¼ in. H, 15 in. D, 15 lb

Power Requirements: 117 vac $\pm 10\%$, 50/60 Hz, single-phase power source; 100 watts maximum input power

Part No. 758 5741 001

54Z-1 FREQUENCY MONITOR

Collins 54Z-1 Frequency Monitor is a special purpose digital counter with numeric display for monitoring frequency error of an AM broadcast transmitter. It offers maximum flexibility and ease of operation and maintenance. The 54Z-1 detects and indicates errors in 1-Hz increments from 1 through ± 20 Hz. Visual alarms and contact closures for operation of external interlocks/alarms are provided when frequency error exceeds ± 10 and ± 20 Hz. Error polarity and magnitude are available for remote sensing.

The monitor is completely solid state. Integrated circuits are used in all digital circuits and discrete components are used for the analog functions. The time base signals are derived from a solid-state, temperature-compensated, crystal oscillator that has a temperature stability of 0.5 part per 10^6 over a range from -25° to $+55^\circ\text{C}$.

All components are mounted on military grade, etched, glass-epoxy circuit boards. Convenient test points are provided on the circuit boards for ease of maintenance, if required.

Signals containing up to 90 percent modulation may be applied to the frequency monitor. Both 2-second and 11-second display intervals provide rapid update of information and high accuracy. Frequency error is continuously displayed on the numeric readout. An optional remote analog output is also available. (Cont. next page)

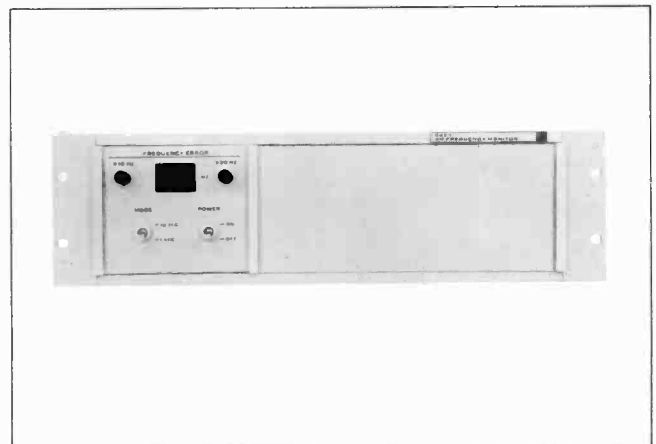

The 54Z-1 requires no adjustments or calibration.

AC Power: 117 vac $\pm 10\%$ single phase, 50/60 Hz, 55 watts maximum

Frequency Range: 540 to 1600 kHz

Minimum Channel Spacing: 1 kHz

Input Voltage Level:

Unmodulated Carrier: 2.0 to 20 volts peak

Amplitude Modulation: 0 to 90% maximum

Input Impedance: 50 ohms $\pm 10\%$

Frequency Standard:

Stability: 0.5 part per 10^6 from -25° to $+55^\circ\text{C}$

Aging: 1 part per 10^6 per year

Error Display: Numeric display, 0 to 20 Hz and polarity

Alarm Presentation: Visual alarm and contact closure when error exceeds ± 10 and ± 20 Hz. Transient conditions will not cause the ± 20 -Hz alarm or interlock to be activated

Accuracy:

10-Second Count: ± 1 Hz

1-Second Count: ± 2 Hz

Size: 5¼ in. H, 19 in. W, 14 in. D (13 cm H, 48 cm W, 36 cm D)

Weight: 21 pounds (9.5 kg)

Part No. 758 5605 003

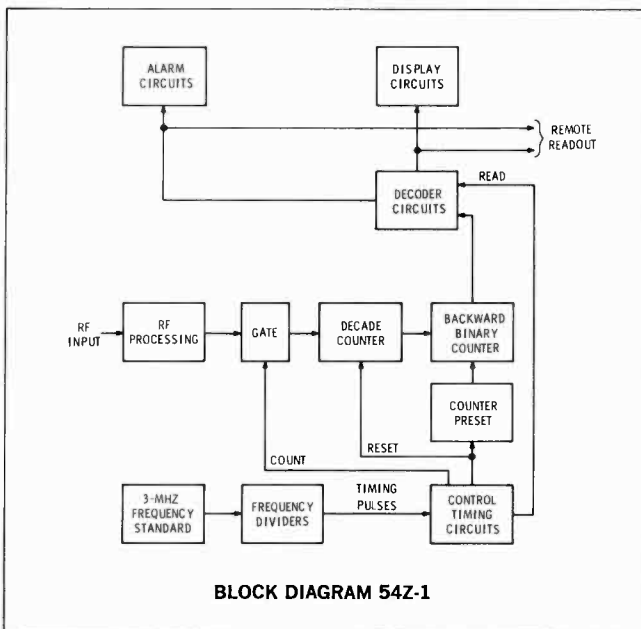

COLLINS 54N-1 FM FREQUENCY MONITOR

The 54N-1 is a special purpose digital counter designed to monitor the carrier frequency of an FM broadcast transmitter. The monitor detects errors in 100-Hz increments, from 0 through ± 2 kHz, and indicates readings on a numeric display.

Visual alarms and contact closures for operation of external interlocks and/or alarms are provided when the frequency error exceeds ± 1 kHz and ± 2 kHz. Error polarity and magnitude are available for remote sensing.

The monitor is completely solid state. Integrated circuits are used in all digital circuits and discrete components are used for the analog functions. The time base signals are derived from a solid-state, temperature-compensated, crystal oscillator that has a temperature stability of 0.5 part per 10^6 over a range from -25° to $+55^\circ\text{C}$.

Provisions have been made in the 54N-1 for measuring the frequency error of the 19-kHz pilot carrier used in stereo multiplex transmission systems. A separate input for the 19-kHz signal is provided. A manually operated switch puts the monitor into this mode of operation. If the error of the 19-kHz signal is greater than ± 1.0 or ± 2.0 Hz, an alarm light lights. Errors from 0 to ± 2.0 Hz will be displayed.

All components are mounted on high-quality, military grade, etched, glass-epoxy boards. Convenient test points offer ease of maintenance.

The 54N-1 requires no adjustments or calibration.

AC Power: 117 $\pm 10\%$ volts single phase ac, 50/60 Hz, 55 watts maximum

Frequency Range:

Carrier: 88 to 108 MHz

Pilot Carrier: 19 kHz

Minimum Channel Spacing: 100 kHz

Input Carrier Signal Specifications:

Voltage Level: 6 ± 3 Vrms

Frequency Modulation: 0 to 100% maximum

Input Impedance: $50 \pm 10\%$ ohms

19-kHz Input Specifications:

Input Impedance: Greater than 30K ohms

Voltage Level: 0.1 volt to 1.0 volt rms

Frequency Standard:

Stability: 0.5 part per 10^6 from -25° to $+55^\circ\text{C}$

Aging: 1 part per 10^6 per year

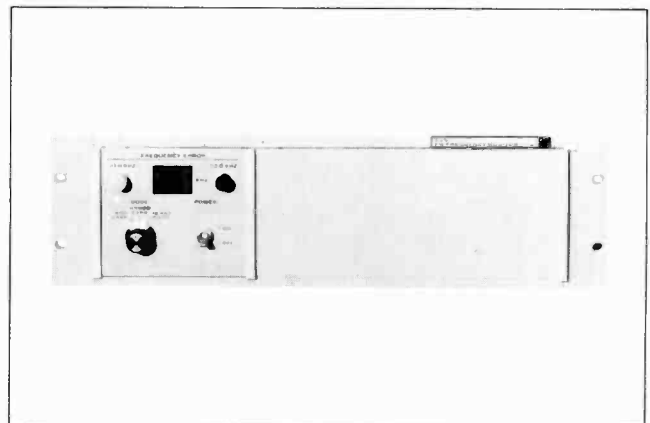

Error Display:

Carrier: Numeric display, 0 to ± 2.0 kHz in 100-Hz increments, with accuracy of ± 200 Hz

19 kHz: Numeric display, 0 to ± 2.0 Hz in 0.1-Hz increments, with accuracy of ± 0.1 Hz

Alarm Presentation:

Carrier: Visual alarm and contact closure when error exceeds ± 1 kHz and ± 2.0 kHz. Transient conditions will not cause ± 2.0 -kHz alarm or interlock to be activated.

19 kHz: Visual alarm when error exceeds ± 1.0 or ± 2.0 kHz

Size: 5 1/4 in. H, 19 in. W, 14 in. D (13 cm H, 48 cm W, 36 cm D)

Weight: 21 pounds (9.5 kg)

Part No. 758 5742 004

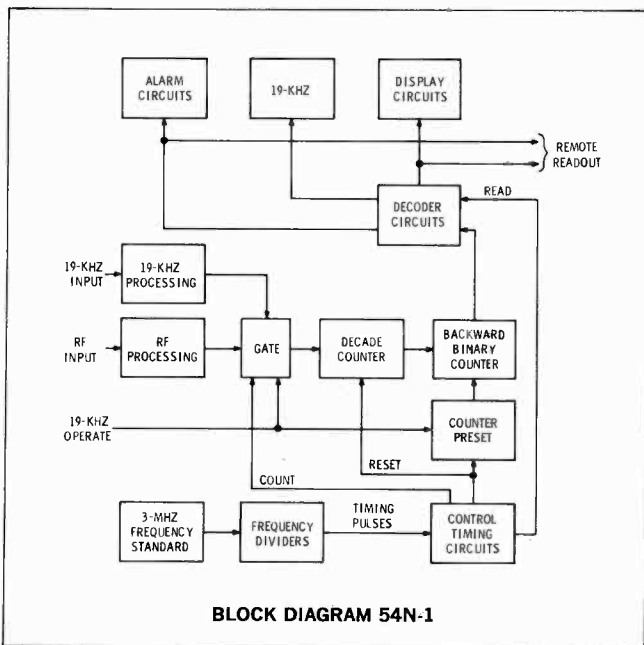

METRON 506B-1 AMPLITUDE MODULATION MONITOR

Occupying only 5 1/4 inches of rack space, the fully transistorized Metron 506B-1 Amplitude Modulation Monitor continuously measures modulation of the AM rf carrier.

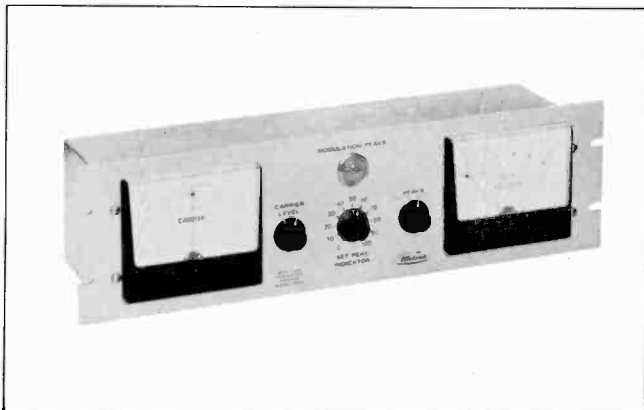

Meeting or exceeding FCC requirements, the 506B-1 mounts in any standard 19-inch rack or cabinet. Frequently used controls are conveniently located on the front panel together with two easy-to-read illuminated meters for monitoring carrier level and percentage modulation.

Modulation peaks are indicated by a flashing lamp. Flashing level is adjustable from 0 to 100 percent modulation. Lamps operate at 60 percent of rated voltage to assure long life.

All external connections are made at the back of the unit. The rf input may be made to either a coaxial receptacle or barrier type terminal strip. A remotely controlled modulation meter and/or remote flasher may be connected to terminals provided and may be switched in or out at will without affecting circuit calibration.

Two auxiliary audio outputs are provided. One of these is a high impedance, high level output for fidelity measurement; the other feeds a 600-ohm audio monitoring circuit.

Input Impedance: 75 ohms

Frequency Range: 0.5 to 1.6 MHz

Rf Power Required: 0.5 watts (6 to 20 vrms)

Power Requirement: 105 to 125 vac, 50 to 60 Hz, 10 watts

Dimensions: 19 in. W, 5 1/4 in. H, 5 in D (48 cm W, 13 cm H, 12.7 cm D)

Weight: 10 lb (4.5 kg)

MODULATION PERCENTAGE METER

Accuracy: $\pm 2\%$ of full scale, modulating frequency 1000 Hz

Response: ± 0.3 db, 30 Hz to 100 kHz

± 0.1 db, 100 Hz to 30 kHz

MODULATION PEAKS FLASHER

Range: Continuously adjustable, 0% to 100%

Flash Point: Flashes when negative modulation exceeds dial set point by more than 2%

Accuracy: $\pm 2\%$ of full scale, 30 to 15,000 Hz

AUDIO MONITORING OUTPUT

Response: ± 0.5 db, 30 Hz to 100 kHz

Distortion: Less than 0.2%, 600-ohm load

Output Voltage: 0.5 vrms, 100% modulation with 600-ohm load

FIDELITY MEASURING OUTPUT

Response: ± 0.5 db, 30 Hz to 100 kHz

Distortion: Less than 0.1%, 600-ohm load

Hum and Noise Level: At least 80 db below 1.5-vrms signal level

Output Voltage: 3.5 vrms at 100% modulation with load resistance exceeding 100,000 ohms shunted by capacitance of less than 500 pf.

Part No. 124 0061 032

NEMS-CLARK 120-E FIELD INTENSITY METER

The compact, lightweight, and portable 120-E Field Intensity Meter measures a wide range of radio signal intensities in the 540- to 1600-kHz broadcast band. With a sensitivity range from 10 volts to 10 microvolts per meter, the 120-E is equally effective for interference studies at low signal strengths and for close-in measurements on high-power directional arrays.

Overall bandwidth of the 120-E is approximately 7 kHz at 1000 kHz for the half voltage response. Image response is approximately 80 db down at all frequencies, and if rejection is approximately 80 db down at all frequencies above 600 kHz and 75 db at 540 kHz.

The 120-E features a direct-reading meter for all ranges, filament tubes that require practically no warmup, a self-contained battery power supply, a front panel switch for an instant battery check, and assured measurement accuracy through a calibration method that compensates for variations in tube characteristics and voltage. Additionally, the 120-E provides both linear and logarithmic indications for continuous observations with recording equipment.

Frequency Range: 540 to 1600 kHz

Field Intensity Range: 10 microvolts per meter to 10 volts per meter

Accuracy of Attenuators: 2%

Output Indicator: Panel meter, direct reading, with logarithmic scale graduated 1 to 10. Provision for recorder

Antenna: Shielded, unbalanced loop

Power Requirements (Batteries): Five, 1½ volts; two, 67½ volts. Provisions for external power supply

Battery Life: 500 indications (approx)

Electron Tube Complement: 4, 1T4; 2, 1R5

Overall Dimensions (Closed): 9 in. H, 13 in. W, 5¾ in. D

Weight (Including Batteries): 12½ lb

Part No. 097 5516 000



NEMS-CLARKE TYPE 112 PHASE MONITOR

This all new solid-state unit offers basically improved indications of the phase relations in directional antenna systems. It also incorporates provisions for indicating the relative amplitudes of the currents in the various antennas. This Phase Monitor can be used with systems containing up to 9 towers.

The phase angle is read out on a panel meter having a continuous 0 to 180° scale. Readings are not affected by modulation and they are presented instantly as each tower is selected, with no adjustment required.

The Model 112 Phase Monitor is simple to operate, easy to read accurately, and incorporates all circuitry necessary to permit future adaptation to remote control.

Absolute Phase Accuracy: ±1.0 degree

Phase Resolution: 0.5 degree

Input Impedance: 51 to 75 ohms

Number of Inputs: Up to 9

Input Level: 1.5 to 20 vrms

Frequency Range: 540 to 1600 kHz

Phase Angle Voltage Output: Adjustable from 0 to 3.5 volts. (Maximum voltage equals 180°)

Loop Current Voltage Output: Adjustable from 0 to 3.0 volts. (Maximum voltage equals 100%)

Loop Current Meter Accuracy: 2%

Loop Current Meter Resolution: 0.5%

Size: 19 in. W, 7 in. H, 14 in. D (48 cm W, 18 cm H, 36 cm D)

Weight: 20 lb (9 kg)

Power Input: 115/230 v, 50 to 60 Hz, 15 watts

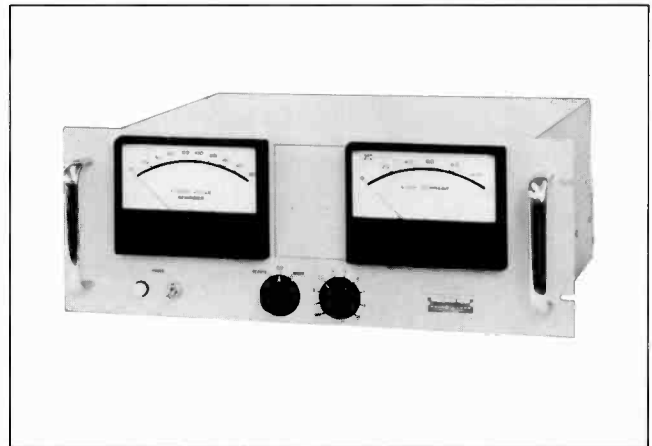

RUST RC-2400D PUSHBUTTON REMOTE CONTROL

The RC-2400D Single DC Pair pushbutton remote control consists of two units — the 2400 (C) studio control and the 2400 (T) transmitter control.

Up to 48 individual functions may be controlled over 24 selected positions. Each position allows selection of two control operations (contact closures). Position selection requires momentary pressure of a pushbutton. Completion of the rapid follow-up is indicated by position light, continually indicating the mode of operation. Control and metering associated with each position are identified at the position selection pushbutton. Discrete signals assure positive synchronization when calibrate is selected.

A most important feature of the RC-2400 is the complete interlocking of control circuitry. This prevents accidental initiated control operation when shifting to a new position and vice-versa.

The RC-2400 offers an exclusive feature, the ability to duplicate all remote control functions and metering at the transmitter site. This is completely independent of studio equipment, and facilitates calibration by one man at the transmitter.

Through the built-in selection system, reading of metering values may be programmed to appear on the desired meter only. If individual parameter meters are desired, external meters can be fed from any of the 24 positions.

Coded pulse width operation, utilizing a simple two-state signal, is a positive means of conveying control information and is neither amplitude nor frequency sensitive. The pulse width signal is converted to FSK (Frequency Shift Keying) for maximum simplicity and excellent noise rejection.

Position Selection: Pushbutton

Control Functions: 48 total (24 Raise or On and 24 Lower or Off)

Control Method: Coded pulse width

Fail-Safe: Meets FCC requirements

Metering: 24 positions plus calibration

Metering Input: 1 v for full-scale reading, 10K impedance

Metering Method: Dc converted to audio voltage whose frequency is controlled by the dc level

Line Requirements: Dc pair 0 to 500 Hz, up to 20-db loss

Power Requirements: 115 vac, 60 Hz, single phase

Dimensions:

Transmitter Unit: 19 by 8¾ inches (48 cm W, 22 cm H)

Control Unit: 19 by 8¾ inches (48 cm wide by 22 cm high)

RC-2400F MICROWAVE/VOICE LINE REMOTE CONTROL

Specifications are the same as the RC-2400D except:

Line Requirements: Voice Line 400-2500 Hz, up to 20 db loss.

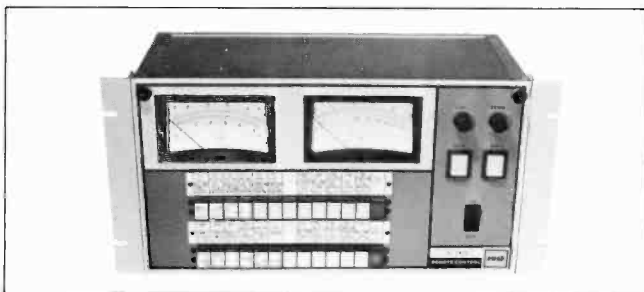

RUST RC-1000 DC REMOTE CONTROL

The Rust RC-1000 Solid-State Single Pair DC Pushbutton Remote Control is designed for operations that require a maximum of 22 control (11 ON/RAISE plus 11 OFF/LOWER) and a maximum of 10 metering positions plus calibrate. The front panel of the 1000C Studio Unit contains a large, 5-inch illuminated bezel mounted, taut band meter with multiple direct reading scales. Provisions are included for external meters such as modulation, frequency, digital readout, etc. A horizontal bank of 11 Interlocked pushbuttons allow easy position selection by the most non-technical personnel. The built-in pushbutton latching feature readily indicates selected position.

The 1000T unit REMOTE/LOCAL switch permits the taking of exclusive control at the transmitter site. When in the LOCAL position, the same switch completes the fail safe circuit. In addition, the transmitter unit contains a POSITION: an ON/RAISE, and an OFF/LOWER pushbutton. These three pushbuttons permit full local control. Provisions for an external meter permit the expansion to a complete one-man calibration system.

The control system utilizes FSK (Frequency Shift Keying) techniques, which result in positive control action. Only a single audio frequency carrier is involved. No narrow band filters are used. The Metering method is a full floating dc phone line system with both sides of the input switched. A built-in dc Isolator isolates the input metering sample from the telephone line so that the telephone line floats from ground. All plug-in solid-state circuit boards are available via the hinged front panel on both units.

Position Selection: 11 Pushbutton Bank

Control Method: Frequency shift carrier

Fail Safe: Meets FCC requirements

Metering: 10 positions plus calibrate position

Metering Input: 1 to 5 volts dc, 10K input pot and 10K load

Metering Method: Floating dc phone line, both sides of input switched

Line Requirements: Single dc pair, 0 to 500 Hz up to 20 db loss, 1-megohm leakage line to line or line to ground

Power Requirement: 115 vac, 60 Hz single phase or 24 vdc

Size: 5¼ in. H by 19 in. W (13 cm H by 48 cm W)

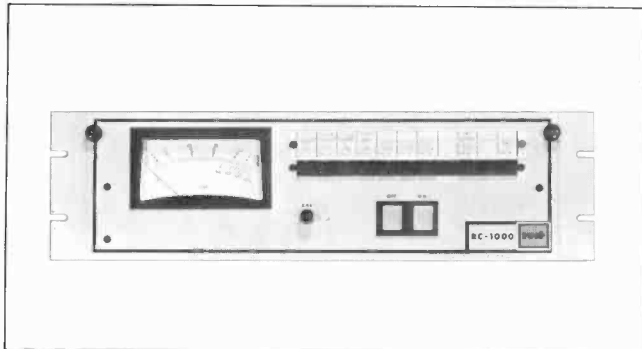

MOSELY PBR-30 TRANSMITTER REMOTE CONTROL SYSTEM

The two-unit PBR-30 remote control system permits use of a single, low-cost, voice-quality line or STL circuit for remote control of broadcast and television transmitters. Line attenuation up to 20 db will not adversely affect system operation. Both the studio and transmitter control units of the PBR-30 feature modular-constructed circuitry and together incorporate 30 metering positions and 60 control functions.

Conversion for wire or radio service is accomplished by simply plugging in the appropriate printed circuit modules. Sockets are provided on the PBR-30 mainframes for sub-carrier generator and detector modules. These are available as options for STL radio remote control operation.

A single stepping switch is used in the transmitter control unit, while computer-type circuitry is utilized in the studio control unit. For ease of calibration and maintenance, a front-panel numerical indication of the stepper relay position is provided. All initial and routine adjustments are made from the front of the units, and swing-away front panels allow total circuit access.

Included with the PBR-30 is a 5-input alarm system. This system can be used for continuous surveillance of critical items at the transmitter site such as temperature, flooding, illegal entry, etc.

Metering: 30 telemetering channels

Control Functions: 30 raise, 30 lower commands (total of 60)

Meters: 3 (expandable to 10 with external meters)

Telemetry Input Requirements: 1 to 10 vdc, zero ground, full-scale deflection. Input impedance, 20,000 ohms

Telemetry Frequencies: Audible, 1280 Hz; subaudible, 22 to 36 Hz

Line Requirements: Full-duplex, voice grade, single telephone line (dc continuity not required), or any 2-way voice quality system; 20 db allowable loss from 650 to 1400 Hz.

Dimensions: Studio control unit, 10½ in. H by 19 in. W by 8 in. D; transmitter control unit, 8¾ in. H by 19 in. W by 10 in. D

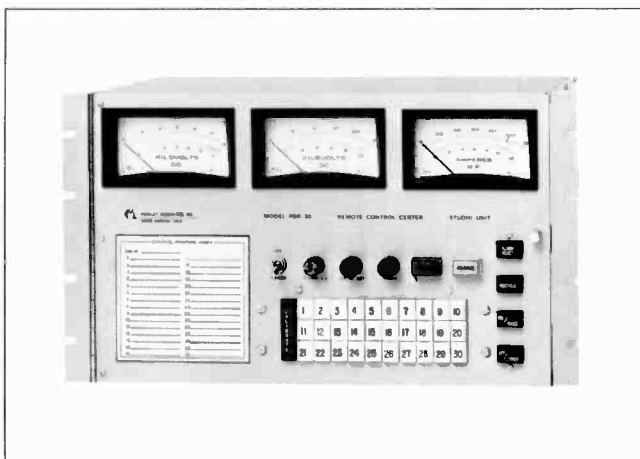

MOSELEY WRC-10T TRANSMITTER CONTROL UNIT

The new Moseley WRC-10T provides single dc pair remote transmitter control with field-proven operational flexibility through 100-percent silicon transistor circuitry. Positive transmitter control is assured at half the typical monthly operating costs because only one dc signal circuit is required between the studio and transmitter.

Fail-safe provisions meet all FCC requirements; the unit will function even if primary power is lost, the signal line is open or shorted, and the equipment itself malfunctions. Low frequencies (670, 790, and 920 Hz) are used for the fail-safe tone because of the inherently poor frequency response of dc lines. Sequenced interruptions of the fail-safe tone for stepper action are keyed by a telephone dial mechanism.

The new pushbutton channel selector allows rapid selection and immediate identification of the operating channel. Two control functions, Lower and Raise, can be performed on each channel selected. A metered indication of the parameter being controlled can be observed simultaneously. Each sampling voltage can be set to the correct level with individual 10,000-ohm multiturn input calibration controls.

High-Q, temperature-stabilized toroidal inductors and capacitors are used in all oscillator and tone detector circuits to assure drift-free operation. Each side of the dc line circuit is fused to protect against line surges.

Control Functions: 10 Raise, 10 Lower commands

Metering: 10 telemetry channels plus calibration

Line Requirements: Single dc pair, 25,000 ohms maximum loop resistance, dc to 1000-Hz response, 20-db allowable loss at any frequency

Meter Sensitivity and Scales: 100 ma; 0 to 140 linear, 0 to 120% logarithmic

Fail-Safe: Protected from system failure exceeding 20 seconds

Power Requirements: 120/240 vac, 50/60 Hz

Part No. 124 0061 026



=====
Tables
Charts
Graphs
=====

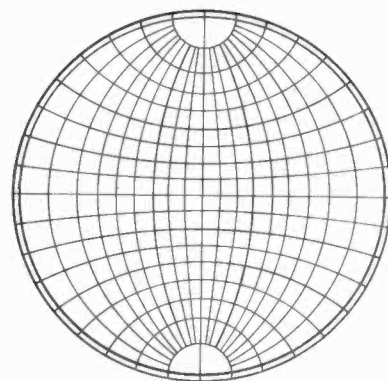

Footage Table for Broadcast Tower Heights

550 KHZ TO 1070 KHZ					1080 KHZ TO 1600 KHZ				
KHZ	METERS	1 WAVE	1/2 WAVE	1/4 WAVE	KHZ	METERS	1 WAVE	1/2 WAVE	1/4 WAVE
550	545	1787.6	893.8	446.8	1080	277.8	911.1	455.5	227.7
560	536	1758.0	879.0	439.5	1090	275.2	902.6	451.3	225.6
570	526	1725.3	862.6	431.3					
580	517	1695.7	847.8	423.9	1100	272.7	894.4	447.2	223.6
590	509	1669.5	834.7	417.3	1110	270.3	886.5	443.2	221.6
					1120	267.9	879.0	439.5	219.7
600	500	1640.0	820.0	410.0	1130	265.5	870.8	435.4	217.7
610	492	1612.7	806.3	403.1	1140	263.2	862.6	431.3	215.6
620	484	1587.5	799.7	396.8	1150	260.9	855.7	427.8	213.9
630	476	1561.2	780.6	390.3	1160	258.6	847.8	423.9	211.9
640	469	1546.3	773.1	386.5	1170	256.4	840.9	420.4	210.2
650	462	1515.3	757.6	378.8	1180	254.2	834.7	417.3	208.6
660	455	1492.4	746.2	373.1	1190	252.1	826.8	413.4	206.7
670	448	1469.4	734.7	367.3					
680	441	1446.4	723.2	361.1	1200	250.0	820.0	410.0	205.0
690	435	1426.8	713.4	356.2	1210	247.9	813.1	406.5	203.2
					1220	245.9	806.3	403.1	201.5
700	429	1407.1	703.5	351.2	1230	243.9	799.1	399.5	199.7
710	423	1387.4	693.7	346.8	1240	241.9	793.7	396.8	198.4
720	417	1367.7	683.8	341.9	1250	240.0	787.2	393.6	196.8
730	411	1348.0	674.0	337.0	1260	238.1	780.9	390.4	195.2
740	405	1328.4	664.2	332.1	1270	236.2	774.7	387.3	193.6
750	400	1312.0	656.0	328.0	1280	234.4	768.8	384.4	192.2
760	395	1295.6	647.8	323.4	1290	232.6	762.9	381.4	190.7
770	390	1279.2	639.6	319.8					
780	385	1262.8	631.4	315.7	1300	230.8	757.0	378.5	189.2
790	380	1246.4	623.2	311.6	1310	229.0	751.1	375.5	187.7
					1320	227.3	746.2	373.1	186.5
800	375	1230.0	615.0	307.5	1330	225.6	739.9	369.9	184.9
810	370	1213.6	606.8	303.4	1340	223.9	734.7	367.3	183.6
820	366	1200.4	600.2	300.1	1350	222.2	728.8	364.4	182.2
830	361	1184.0	592.0	296.0	1360	220.6	723.2	361.1	180.5
840	357	1170.9	585.4	292.7	1370	219.0	718.3	359.1	179.5
850	353	1157.8	578.9	289.4	1380	217.4	713.4	356.2	178.1
860	349	1144.7	572.3	286.1	1390	215.8	707.8	353.1	176.5
870	345	1131.6	565.8	282.9					
880	341	1118.4	559.2	279.6	1400	214.3	703.5	351.2	175.6
890	337	1105.3	552.6	276.3	1410	212.8	696.9	348.4	174.2
					1420	211.3	693.7	346.8	173.4
900	333	1092.2	546.1	273.0	1430	209.8	688.1	344.0	172.0
910	330	1082.4	541.2	270.6	1440	208.3	683.8	341.9	170.9
920	326	1069.2	534.6	267.3	1450	206.9	678.6	339.3	169.6
930	323	1059.4	529.7	264.8	1460	205.5	674.0	337.0	168.5
940	319	1046.3	523.1	261.5	1470	204.1	669.4	334.7	167.3
950	316	1036.4	518.2	259.1	1480	202.7	664.2	332.1	166.5
960	313	1026.6	513.3	256.6	1490	201.3	660.2	330.1	165.0
970	309	1013.5	506.7	253.3					
980	306	1003.6	501.8	250.9	1500	200.0	656.0	328.0	164.0
990	303	993.8	496.9	248.4	1510	198.7	651.7	325.8	162.9
					1520	197.4	647.8	323.4	161.7
1000	300	984.0	492.0	246.0	1530	196.1	643.2	321.6	160.8
1010	297	974.1	487.5	243.7	1540	194.8	639.6	319.8	159.9
1020	294.1	964.6	482.3	241.1	1550	193.5	634.6	317.3	158.6
1030	291.3	955.3	477.6	238.8	1560	192.3	631.4	315.7	157.8
1040	288.5	946.2	473.1	236.5	1570	191.1	626.8	313.4	156.7
1050	285.7	937.1	468.5	234.2	1580	189.9	623.2	311.6	155.8
1060	283.0	928.2	464.1	232.0	1590	188.7	618.9	309.4	154.7
1070	280.4	919.7	459.8	229.9	1600	187.5	615.0	307.5	153.7

**Distance in Miles From an FM Transmitter to
Its 54 dbu (0.5 mv/m) Contour for Various Heights and Powers**

AHAAT IN FT	POWER IN DBK																				
	-20	-18	-16	-14	-12	-10	-8	-6	-4	-2	0	2	4	6	8	10	12	14	16	18	20
3400	20	23	26.5	30	34	38	42	47.5	51.5	55	60	65	69.5	73	78	82	87	91.5	95	100	113.5
3200	19	22	25	29	32.5	37	40.5	45	50	53.5	58.5	63	67	71	75	80	85	90	93	97	100.5
3000	18.5	21.5	24.5	28	31.5	35	40	43	48	52	56.5	60.5	65	69.5	73	77.5	82	86.5	91.5	95	98.5
2800	18	20.5	23	27	30	33.5	38	42	45.5	50	54.5	58.5	63	67	71	75	80	84	89	93	96
2600	17.5	20	22	25.5	29	32	36	40	44.5	48.5	52	56	60	65	69	73	77	81.5	85.5	90	94
2400	17	19	21.5	24.5	28	31	35	38.5	42	46	50.5	54.5	58.5	62	67	70.5	75	78.7	83	88	92
2200	16	18.2	20	23	26.5	29	32.5	36.5	40	44.5	48	52	55.5	60	65	68	72	76.5	80	85	90
2000	15	17.4	19	22	25	28	31	35	38	42	45.5	50	53	57	61.5	65	69.5	73.7	78	82	86
1900	15	17	18.5	21.5	24.5	27	30	33.5	37.5	40.5	45	48.5	52	55.5	60	64	68	72	76	80	85
1800	14	16	18	20.5	23	26.5	29	32.5	36	40	43	47.5	51	55	58.5	62.5	66	70	75	79	83
1700	13.5	15.5	17.5	20	22.5	25	28	31.5	35	38	42	45.5	50	53	57	60.5	65	69	71.5	77	81
1600	13	15	17	19	21.5	24.5	27	30	33	36.5	40.5	44	48	52	55.5	60	63	67	71	75	80
1500	12.5	14.6	16.5	18.5	21	23.5	26.5	28.5	32	35.5	39.5	43	46.5	50	54.5	58	61.5	65	69.5	73	78
1400	12	14	16	18	20	22	25	28	30.5	34.5	38	41.5	45	48.5	52.5	56	60	63	67	71.5	75
1300	11.5	13.4	15.5	17	19	21.5	23.5	27	30	32.5	36	40	43	47	50.5	55	58	61.5	65	70	73.5
1200	11	13	14.5	16.5	18.5	20.5	23	25.5	28	31	35	38	41.7	45	48.5	52.5	56	60	63	67	71.5
1100	10	12	13.5	15.5	17.5	19.5	21.5	24.5	26.5	30	33	36.5	40	43	47	50.5	54.5	58	61.5	65	70
1000	9.1	11.5	13	15	17	18.5	20.5	23	25.5	28	31.2	34.5	38	41	45	48	52	56	58.5	63	68
900	8.7	10.5	12	14	16	18	19.5	21.5	24.5	27	29.6	32.5	35.5	38.5	42.5	46	50	54	57	60.5	65
800	8.2	9.2	11.5	13	15	16.5	18	20	22	25	28	30.5	33.5	37	40	43	47.5	52	55	58.5	63.5
700	7.7	8.7	10.5	12	13.5	15.5	17	18.5	21	23	26	28.5	32	35	38	41	45	49	53	56.5	63
600	7.2	8	9	11	12	14	15.5	17.5	19	21.5	24	26.5	28.7	32	35	38	42	45.5	50	55	60
500	6.5	7.3	8.2	9	11	12.5	14	16	17.5	19	22	24	27	29	32.5	35.5	38.5	43	47	52	57
400	5.8	6.6	7.3	8.3	8.5	11	12.5	14	16	17.5	19	22	24.5	27	29.5	32	35.5	40	43.5	49.5	55
300	5	5.7	6.5	7.2	8	8.7	10.5	12	13.5	15	17	18.5	21	23.5	26.5	28.5	32	35.5	40	45.4	52
200	4	4.6	5.2	5.7	6.5	7.3	8.2	9	11	12	13.7	15.5	17.5	19	22	24.5	28	31.5	35	42	48
100	2.8	3.2	3.7	4.1	4.6	5.2	5.8	6.6	7.4	8.2	9	10.7	12.5	14	16	18.2	21.5	25	30	35.5	45

**Distance in Miles From an FM Transmitter to
Its 60 dbu (1 mv/m) Contour for Various Heights and Powers**

AHAAT IN FT	POWER IN DBK																				
	-20	-18	-16	-14	-12	-10	-8	-6	-4	-2	0	2	4	6	8	10	12	14	16	18	20
3400	11	13	15	17.5	20	22.5	27	30	34	37	40.5	45	49	52	57	60	64	65	65	65	65
3200	11	12.2	14.5	16.5	19.5	22	25	28.5	32	35	39	42.5	47	50.5	55	59	62	64	65	65	65
3000	10.5	12	14	16	19	21.5	24.5	28	31	34	38	41	45	49.5	53	57	60	64	65	65	65
2800	10	11.8	13.5	15.7	18	20.5	24	26.5	30	33	36	40	44	48	51	55	59	62	64	65	65
2600	9.7	11.5	13	15	17	20	22.5	25.5	29	32	35	39	42	46	49.5	53	58	60	63	64	65
2400	9.4	11	12.8	14	16	19	21.5	24.5	28	30.5	34	37	40	44	47.5	51	55	59	61	64	65
2200	9.2	10.8	12	13.5	15.5	18	20.5	23.5	26	29	32	35	39	42	45.5	49	52	56.5	59.5	62	65
2000	9	10.2	11.7	13.1	15	17	20	22	25	28	30	33.5	37	40	44	46.5	50.5	54	57.5	60.5	64
1900	8.7	10	11.2	12.7	14.5	16.5	19	21.5	24.5	27	29.5	33	35.5	39	43.5	45.5	49.5	52.5	55.5	59.5	62
1800	8.5	9.7	11	12.6	14	16	18	20.5	23.5	25.5	29	31.5	35	38.5	43	44.5	48.5	51.5	55	59	61
1700	8.3	9.2	10.5	11.6	13.8	15.5	17.3	20	22.5	25	28	30	33	37	40	43	46.5	50	53	57.5	60
1600	8.1	9	10.3	11.5	13.2	15	17.1	19.2	21.5	24	26.5	29.5	32.5	35.5	39	42	45	49	51.5	55	58
1500	8	9	10	11.4	13	14.9	16.9	18.6	21	23	26	28.5	31.5	35	38	40.5	44	47	50.1	54	57
1400	7.5	8.6	9.7	11.2	12.5	14	16.2	18	20	22	25	27.5	30	33	36	40	43	46	48.5	52	55
1300	7.3	8.2	9.3	10.5	12	13.8	15.5	17.5	19	21.5	24	26.5	29	32.5	35	39	41.5	45	47.5	51	54
1200	7	7.8	9	10	11.5	13	15	17	18	21	23	25.5	28	31	34	37.5	40	44	46	49	52
1100	6.8	7.6	8.5	9.5	11	12.5	14.5	16	17.1	20	22	24.5	26.5	29.5	32	35	38	41	44.5	47	50
1000	6.4	7.2	8	9	10.2	12	14	15.6	17	19	21	23	25.5	28	31	34	36.5	40	43	45.5	49
900	6.2	6.8	7.8	8.8	9.7	11.2	13	14.5	16.4	18	20	21	24.5	26	29	32	35	38	40.5	44	47
800	5.8	6.6	7.3	8.2	9.2	10.3	12	13.5	15.2	17	18.5	20.5	23	25	27.5	30	33	36	39	41.5	45
700	5.4	6.2	7	7.8	8.6	9.7	10.5	13	14	16	17	19.2	21	24	26	28.5	31	33	36	39	42
600	5	5.7	6.5	7.1	8	9	9.8	11.8	12.3	14.5	16	18	19.7	21.5	24	26	29	32	35	36.5	40
500	4.6	5	5.8	6.6	7.3	8.2	9	10	12	13.2	14.5	16.1	17.9	20	22	24.5	27	29.5	31.5	35	37
450	4.2	4.8	5.5	6.2	7.0	7.8	8.6	9.6	10.5	12.5	14.0	15.2	17.0	19.0	20.5	23.0	25.4	28	30	33	36
400	4	4.6	5.1	5.9	6.6	7.4	8.2	9	10	11.8	12.5	14.5	16	17.8	19.8	21.5	24.5	26.5	29	31.5	35
350	3.8	4.2	4.8	5.3	6.1	7.0	7.8	8.6	9.5	10.3	11.0	14.0	15	16.8	18.5	20.2	23	25	27.5	30	33
300	3.6	4	4.5	5	5.7	6.3	7.2	8	8.8	10	10.5	12.6	14	15.6	17	19	21	23	25.5	28	30
250	3.2	3.7	4.0	4.6	5.1	5.9	6.7	7.3	8.0	8.9	9.9	10.6	12.5	14.0	15.8	17.8	19	21.5	24	26	28
200	2.9	3.3	3.7	4.1	4.7	5.1	5.9	6.6	7.4	8.1	9	10	11.3	12.5	14	15.5	17.5	19.5	21.5	24	26
150	2.5	2.8	3.2	3.6	4.0	4.5	5.0	5.7	6.4	7.1	7.9	8.8	9.7	10.8	12	14.0	15.2	17.0	19	21	24
100	2	2.3	2.7	2.9	3.2	3.8	4.1	4.7	5.2	5.9	6.5	7.4	8.3	9	10	11.3	12.9	14.5	16.2	18.1	20

Distance in Miles From an FM Transmitter to Its 80-dbu (10 mv/m) Contour for Various Heights and Powers

AHAAT IN FT	POWER IN DBK																				
	-20	-18	-16	-14	-12	-10	-8	-6	-4	-2	0	2	4	6	8	10	12	14	16	18	20
3400	1.3	1.8	2.1	2.6	3.2	4.0	4.8	6.0	7.3	9	12.5	15	18	20	23	26.5	30	34	38	42	46.5
3200	1.3	1.8	2.1	2.6	3.2	4.0	4.8	6.0	7.3	8.8	12	15	17	19	22	25	29	32.5	36.5	40.5	45
3000	1.3	1.8	2.1	2.6	3.2	4.0	4.8	6.0	7.1	8.5	11.5	14.5	17	18.5	21.5	24.5	28	31.5	35	40	43
2800	1.3	1.8	2.1	2.5	3.2	4.0	4.8	5.9	7.1	8.4	11.3	14	16	18	20	23	26.5	30	34	38	41.5
2600	1.3	1.8	2.1	2.5	3.2	4.0	4.7	5.8	7.0	8.1	11	13	15.5	17.5	19.6	22	25.5	29	32	35.5	40
2400	1.3	1.8	2.1	2.5	3.2	3.9	4.7	5.7	7.0	8.1	10.5	12.5	15	17	19	21.5	24.5	27.5	30.5	35	38.5
2200	1.3	1.8	2.1	2.5	3.2	3.8	4.7	5.6	6.8	8	10	12	14.5	16.5	18	20	23	26.5	29.5	32.5	36.5
2000	1.3	1.8	2.0	2.5	3.1	3.8	4.6	5.4	6.7	7.8	9	11.5	13.5	15	17.5	19.5	21.5	25	28	31	35
1900	1.3	1.8	2.0	2.5	3.0	3.7	4.6	5.3	6.6	7.7	9	11	13	14.8	17	19	21	24.5	27	30	34
1800	1.3	1.8	2.0	2.5	3.0	3.7	4.5	5.3	6.3	7.6	8.7	10.5	12.5	14.5	16.5	18.5	20.5	23	26	29	32.5
1700	1.3	1.8	2.0	2.4	2.9	3.6	4.4	5.2	6.1	7.3	8.4	10	12	14	15.5	18	20	22	25	28	31
1600	1.2	1.7	2.0	2.3	2.9	3.6	4.3	5.1	6	7.0	8.1	9.2	11.8	13.5	15	17.5	19	21.5	24.5	27	30
1500	1.2	1.7	2.0	2.3	2.8	3.6	4.2	5.0	5.9	7.0	8.0	9.0	11	13	14.5	17	18.5	20.5	23	26	29
1400	1.2	1.7	1.9	2.3	2.8	3.5	4.2	5.0	5.7	6.7	7.7	8.7	10.5	12	14	16	18	20	22	25	28
1300	1.2	1.7	1.9	2.2	2.7	3.4	4.1	4.8	5.6	6.4	7.4	8.3	10	11.5	13	15	17	19	21.5	24	26.5
1200	1.2	1.7	1.8	2.2	2.7	3.3	4.0	4.7	5.4	6.2	7.1	8	9.2	11	12.5	14.5	16.5	18	20.5	23	25.5
1100	1.2	1.7	1.8	2.2	2.7	3.2	3.9	4.6	5.2	6	6.8	7.8	8.7	10.2	11.5	14	15.5	17.5	19.5	22	24.5
1000	1.2	1.6	1.8	2.2	2.6	3.1	3.8	4.4	5	5.8	6.4	7.2	8.2	9.2	11	13	15	17	18.5	20.5	23
900	1.2	1.6	1.7	2.1	2.6	3	3.7	4.2	4.8	5.6	6.2	7.0	7.8	8.8	10.5	12	14	16	18	19	22
800	1.2	1.5	1.7	2.1	2.5	2.9	3.4	3.9	4.6	5.1	6.0	6.7	7.4	8.3	9.3	11.5	13	15	16.5	18	20
700	1.2	1.5	1.7	2.0	2.4	2.8	3.2	3.7	4.2	4.8	5.5	6.3	7.0	7.8	8.8	10	12	13.5	15.5	17	18.5
600	1.2	1.4	1.7	1.9	2.3	2.7	3.0	3.4	3.8	4.5	5.0	5.8	6.5	7.2	8	9.0	10.5	12.5	14	15.5	17.5
500	1.1	1.4	1.6	1.8	2.1	2.5	2.8	3.2	3.6	4	4.6	5.2	6	6.7	7.5	8.2	9.2	11	12.5	14.5	15.5
400	1.0	1.3	1.5	1.7	2.0	2.2	2.6	2.8	3.2	3.7	4.1	4.7	5.2	6.0	6.7	7.5	8.2	9.1	11	12.5	14.5
300	0.9	1.2	1.3	1.5	1.8	1.9	2.2	2.6	2.8	3.2	3.6	4	4.5	5.0	5.8	6.2	7.2	7.8	8.9	10.5	12
200	0.8	1.0	1.2	1.3	1.5	1.7	1.8	2	2.3	2.6	3.0	3.3	3.8	4.2	4.7	5.2	6.0	6.7	7.5	8.2	9.0
100	0.5	0.6	0.8	0.9	1.0	1.2	1.3	1.5	1.7	1.9	2.0	2.3	2.7	3.0	3.3	3.7	4.2	4.7	5.2	6.0	6.8

Conversion Table

MULTIPLY NUMBER OF BY TO OBTAIN NUMBER OF	ANGSTROMS	MICRONS	MILS	INCHES	FEET	MILES	MILLIMETERS	CENTIMETERS	KILOMETERS
	ANGSTROMS	1	10 ⁴	2.540 × 10 ⁵	2.540 × 10 ⁶	3.048 × 10 ⁹	1.609 × 10 ¹³	10 ⁷	10 ⁸
MICRONS	10 ⁻⁴	1	2.540 × 10	2.540 × 10 ⁴	3.048 × 10 ⁵	1.609 × 10 ⁹	10 ³	10 ⁴	10 ⁹
MILS	3.937 × 10 ⁻⁶	3.937 × 10 ⁻²	1	10 ³	1.2 × 10 ⁴	6.336 × 10 ⁷	3.937 × 10	3.937 × 10 ²	3.937 × 10 ⁷
INCHES	3.937 × 10 ⁻⁹	3.937 × 10 ⁻⁵	10 ⁻³	1	12	6.336 × 10 ⁴	3.937 × 10 ⁻²	3.937 × 10 ⁻¹	3.937 × 10 ⁴
FEET	3.281 × 10 ⁻¹⁰	3.281 × 10 ⁻⁴	8.333 × 10 ⁻⁵	8.333 × 10 ⁻²	1	5.280 × 10 ³	3.281 × 10 ⁻³	3.281 × 10 ⁻²	3.281 × 10 ³
MILES	6.214 × 10 ⁻¹⁴	6.214 × 10 ⁻¹⁰	1.578 × 10 ⁻⁸	1.578 × 10 ⁻⁵	1.894 × 10 ⁻⁴	1	6.214 × 10 ⁻⁷	6.214 × 10 ⁻⁶	6.214 × 10 ⁻¹
MILLIMETERS	10 ⁻⁷	10 ⁻³	2.540 × 10 ⁻²	2.540 × 10	3.048 × 10 ²	1.609 × 10 ⁶	1	10	10 ⁶
CENTIMETERS	10 ⁻⁸	10 ⁻⁴	2.540 × 10 ⁻³	2.540	3.048 × 10	1.609 × 10 ⁵	0.1	1	10 ⁵
KILOMETERS	10 ⁻¹³	10 ⁻⁹	2.540 × 10 ⁻⁸	2.540 × 10 ⁻⁵	3.048 × 10 ⁻⁴	1.609	10 ⁻⁶	10 ⁻⁵	1
° CENTIGRADE	C = 5/9 (F - 32)								
° FAHRENHEIT	F = 9/5 C + 32								

Frequency Designation of FM Broadcast Channels

Freq. (MHz)	Channel No.	Freq. (MHz)	Channel No.	Freq. (MHz)	Channel No.
88.1	201	94.9	235	101.5	268
88.3	202	95.1	236	101.7	269
88.5	203	95.3	237	101.9	270
88.7	204	95.5	238	102.1	271
88.9	205	95.7	239	102.3	272
89.1	206	95.9	240	102.5	273
89.3	207	96.1	241	102.7	274
89.5	208	96.3	242	102.9	275
89.7	209	96.5	243	103.1	276
89.9	210	96.7	244	103.3	277
90.1	211	96.9	245	103.5	278
90.3	212	97.1	246	103.7	279
90.5	213	97.3	247	103.9	280
90.7	214	97.5	248	104.1	281
90.9	215	97.7	249	104.3	282
91.1	216	97.9	250	104.5	283
91.3	217	98.1	251	104.7	284
91.5	218	98.3	252	104.9	285
91.7	219	98.5	253	105.1	286
91.9	220	98.7	254	105.3	287
92.1	221	98.9	255	105.5	288
92.3	222	99.1	256	105.7	289
92.5	223	99.3	257	105.9	290
92.7	224	99.5	258	106.1	291
92.9	225	99.7	259	106.3	292
93.1	226	99.9	260	106.5	293
93.3	227	100.1	261	106.7	294
93.5	228	100.3	262	106.9	295
93.7	229	100.5	263	107.1	296
93.9	230	100.7	264	107.3	297
94.1	231	100.9	265	107.5	298
94.3	232	101.1	266	107.7	299
94.5	233	101.3	267	107.9	300
94.7	234				

Channels Available for Assignment to Noncommercial Educational FM Stations

Freq. (MHz)	Channel No.	Freq. (MHz)	Channel No.	Freq. (MHz)	Channel No.
88.1	201	89.5	208	90.9	215
88.3	202	89.7	209	91.1	216
88.5	203	89.9	210	91.3	217
88.7	204	90.1	211	91.5	218
88.9	205	90.3	212	91.7	219
89.1*	206	90.5	213	91.9	220
89.3	207	90.7	214		

*The frequency 89.1 MHz in the New York City metropolitan area is reserved for the use of the United Nations.

Convert Electrical Degrees to Feet, or Vice Versa When Frequency and Either Feet or Degrees is Known

From the expression

$$\text{Feet} = \frac{\text{degrees}}{360^\circ} \times \frac{300}{f(\text{MHz})} \times 3.281 = \text{degrees} \times \frac{2.734}{f(\text{MHz})}$$

The following ratio may be set up on the slide rule using C and D scales:

$$\frac{2.734}{f(\text{MHz})} = \frac{\text{feet}}{\text{degrees}}$$

Set 2.734 on scale C over frequency in megahertz on scale D; read feet and degrees on scales C and D, respectively. In some instances it may be convenient to use the folded scales CD and DF.

Metric Conversion

To convert pounds to kilograms, multiply by .4536

To convert inches to centimeters, multiply by 2.54

Telephone Cable Color Code

Pair No.	Color	Mate
1	Blue	White
2	Orange	White
3	Green	White
4	Brown	White
5	Slate	White
6	Blue White	White
7	Blue Orange	White
8	Blue Green	White
9	Blue Brown	White
10	Blue Slate	White
11	Orange White	White
12	Orange Green	White
13	Orange Brown	White
14	Orange Slate	White
15	Green White	White
16	Green Brown	White
17	Green Slate	White
18	Brown White	White
19	Brown Slate	White
20	Slate White	White
21	Blue	Red
22	Orange	Red
23	Green	Red
24	Brown	Red
25	Slate	Red
26	Blue White	Red
27	Blue Orange	Red
28	Blue Green	Red
29	Blue Brown	Red
30	Blue Slate	Red
31	Orange White	Red
32	Orange Green	Red
33	Orange Brown	Red
34	Orange Slate	Red
35	Green White	Red
36	Green Brown	Red
37	Green Slate	Red
38	Brown White	Red
39	Brown Slate	Red
40	Slate White	Red
41	Blue	Black
42	Orange	Black
43	Green	Black
44	Brown	Black
45	Slate	Black
46	Blue White	Black
47	Blue Orange	Black
48	Blue Green	Black
49	Blue Brown	Black
50	Blue Slate	Black

NOTE — The last pair in all cables is a Red with White mate, viz.

6-pair cable	6th pair	Red	White
11-pair cable	11th pair	Red	White
16-pair cable	16th pair	Red	White
26-pair cable	26th pair	Red	White
51-pair cable	51st pair	Red	White

Attenuation — Heliax/Air Dielectric Cables

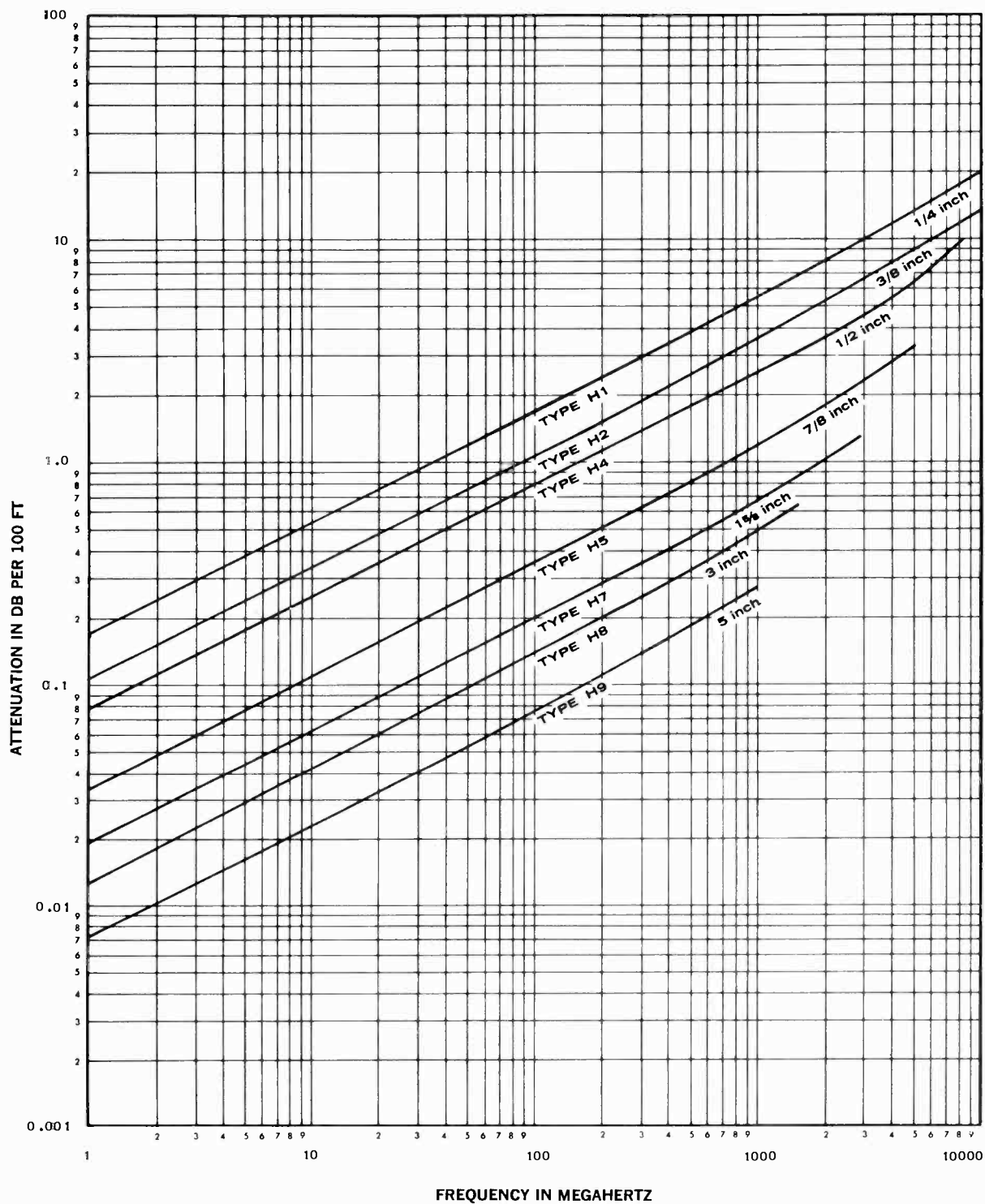

The attenuation curves above are for 50-ohm copper Heliax at unity VSWR. For 75-ohm copper cables the values shown should be reduced 5%. For 50-ohm aluminum (outer conductor) cables the values should be increased 12%.

Power Rating — Heliax/Air Dielectric Cables

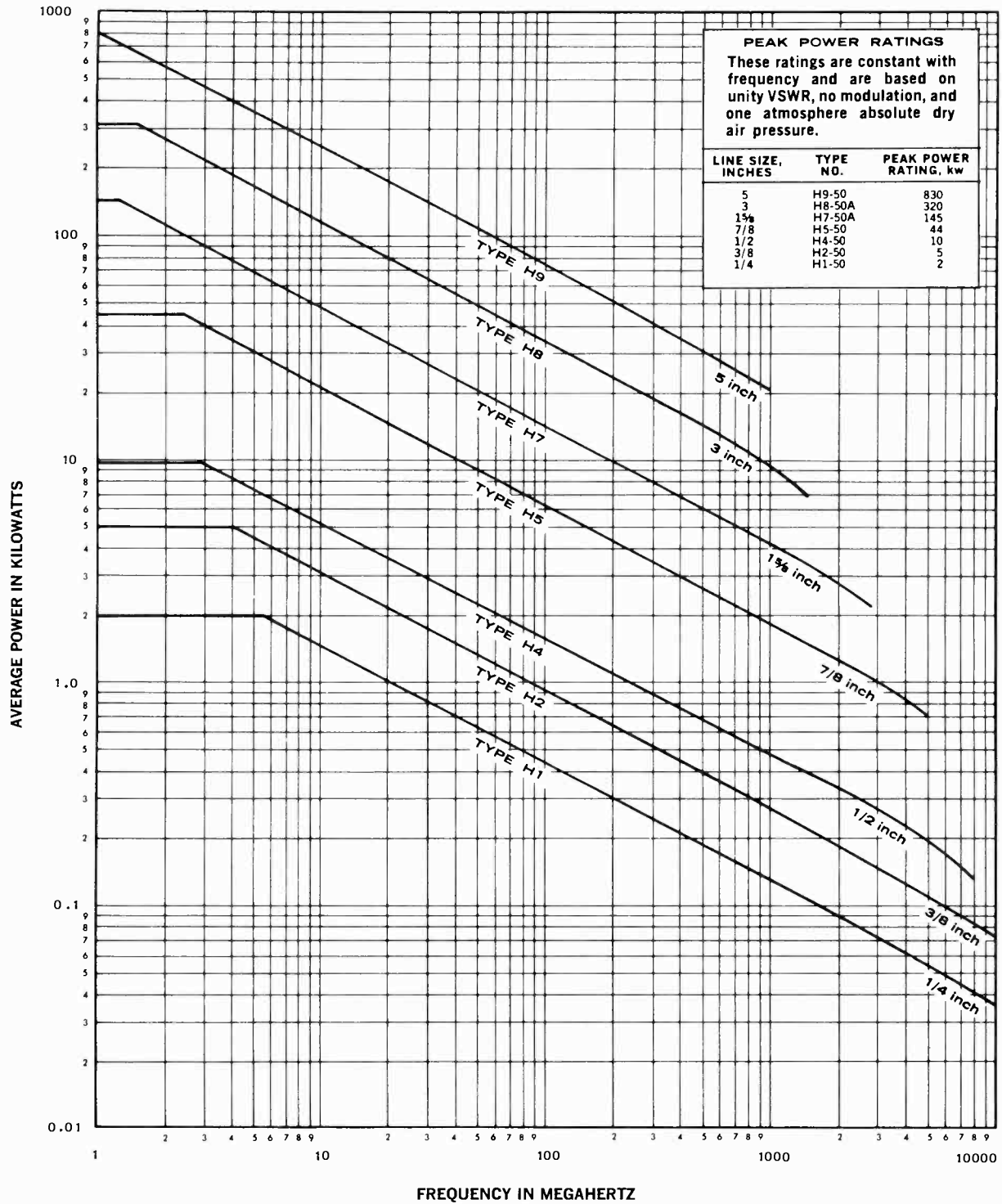

The average power ratings shown above are for 50-ohm copper Heliax and are based on unity VSWR and a maximum inner conductor temperature of 212°F at an ambient temperature of 104°F. For 75-ohm copper cables the values shown should be reduced 30%. For 50-ohm aluminum (outer conductor) cables the values should be reduced 10%. For Teflon insulated cables, average power ratings should be increased by 35%.

Attenuation — Heliax/Foam Dielectric Cables

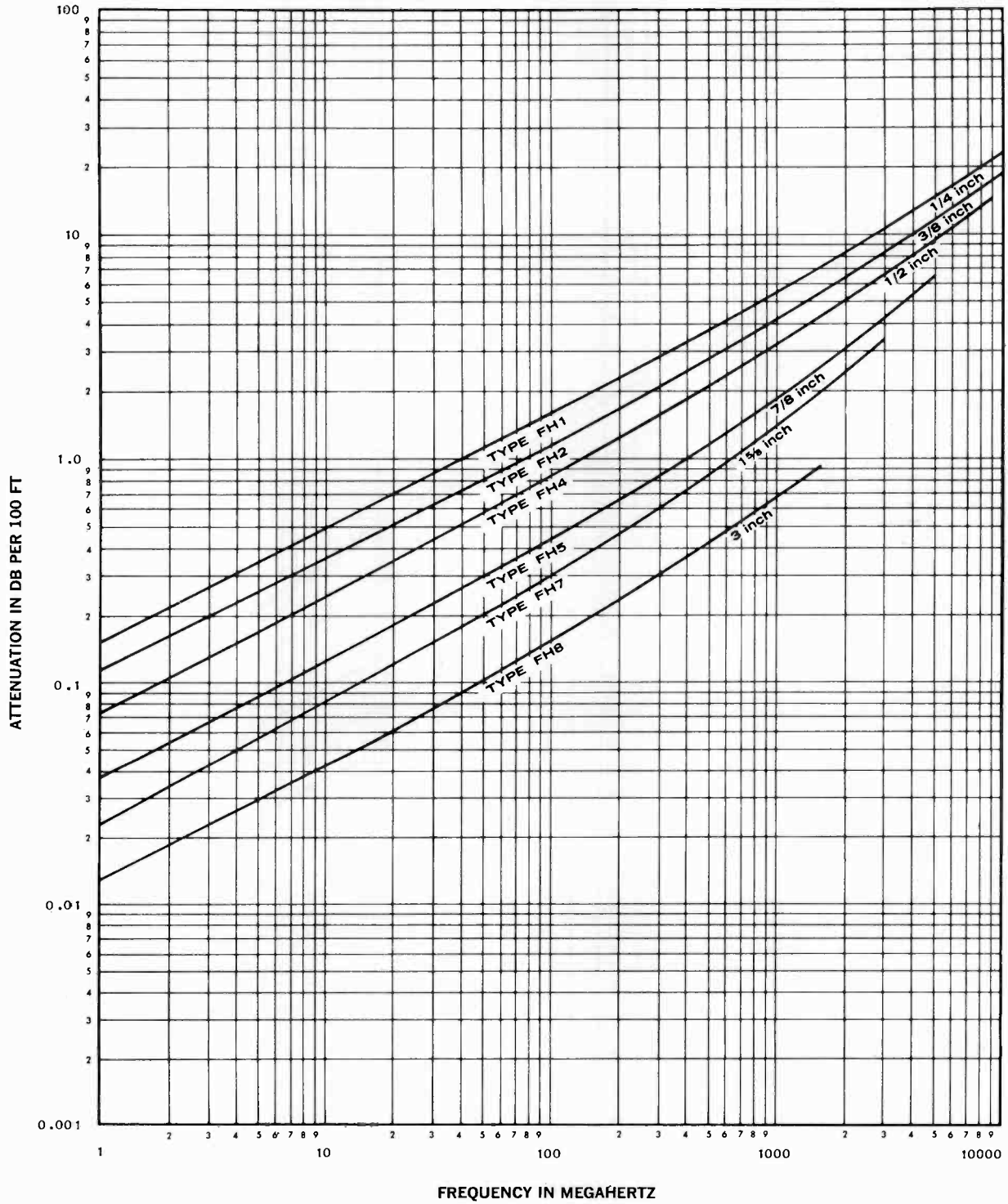

The attenuation curves above are for 50-ohm copper Heliax at unity VSWR. For 75 ohm copper cables the values shown should be reduced 5%. For 50-ohm aluminum (outer conductor) cables the values should be increased 12%.

Power Rating — Heliax/Foam Dielectric Cables

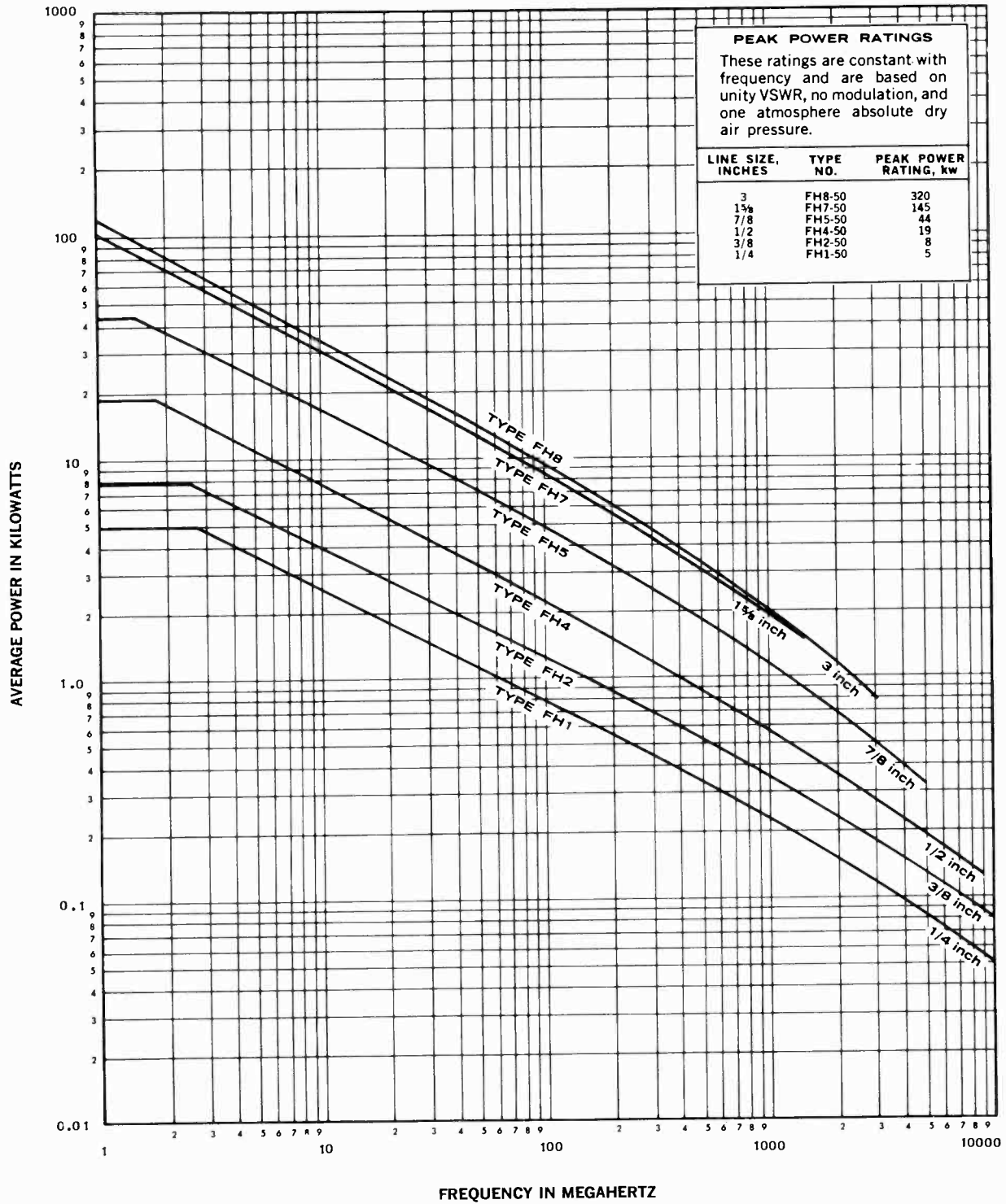

The average power ratings shown above are for 50-ohm copper Heliax and are based on unity VSWR and a maximum inner conductor temperature of 175°F at an ambient temperature of 104°F. For 75-ohm copper cables the values shown should be reduced 30%. For 50-ohm aluminum (outer conductor) cables the values should be reduced 10%.

Attenuation — Rigid Transmission Lines

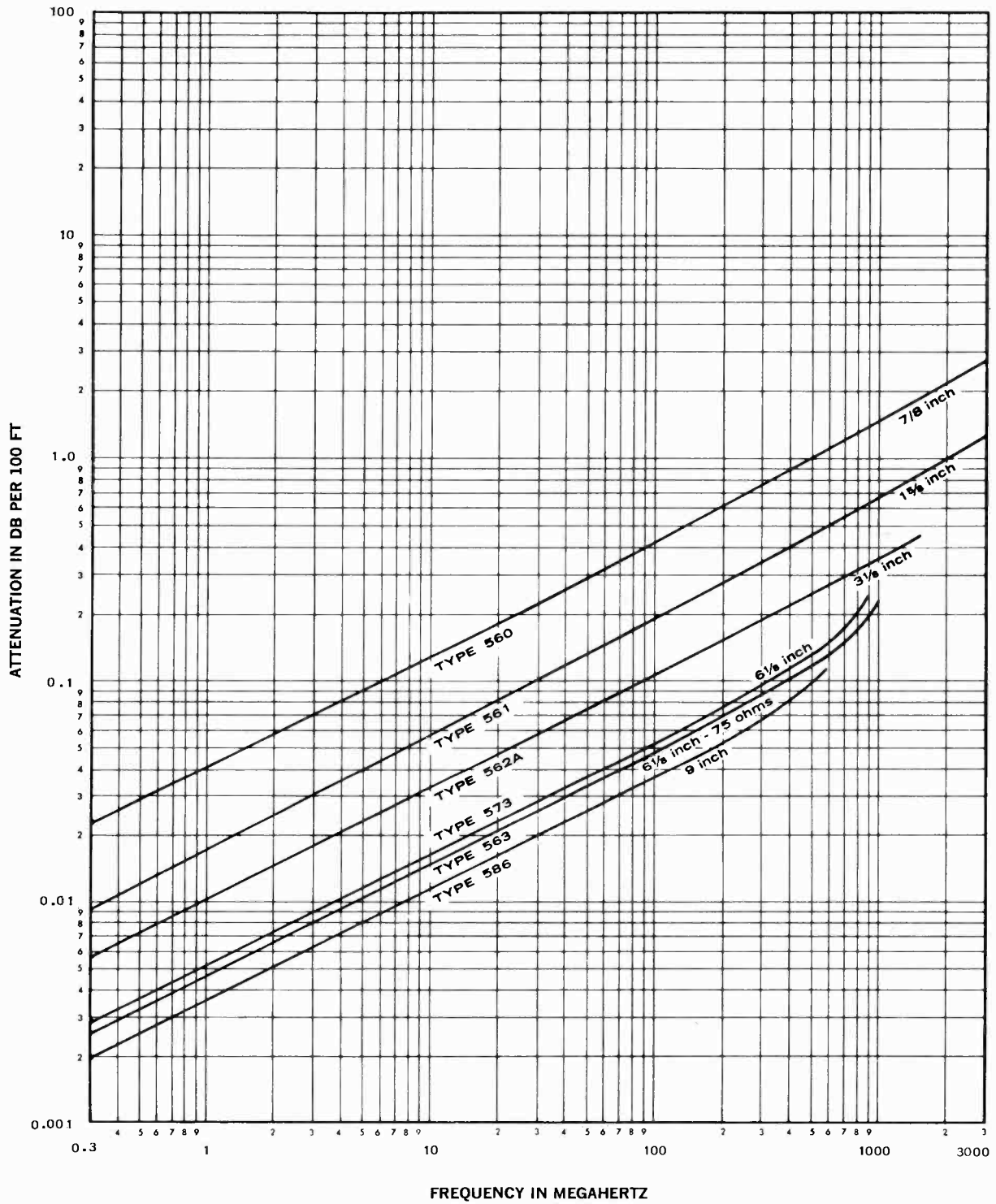

The attenuation curves above are based on unity VSWR.

Power Rating — Rigid Transmission Lines

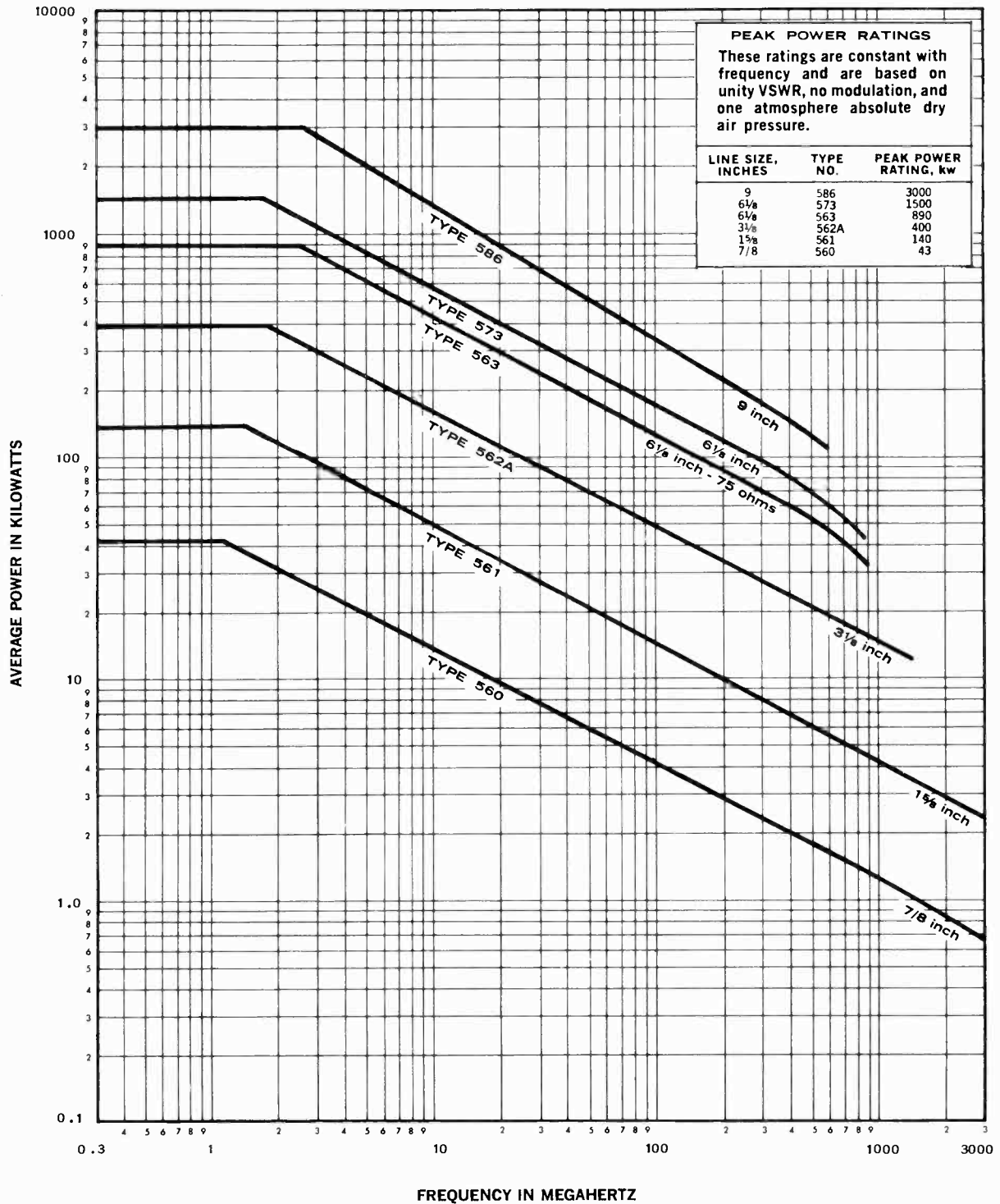

The average power ratings shown above are based on unity VSWR and a maximum inner conductor temperature of 216°F at an ambient temperature of 104°F.

Forward VS Reflected Power

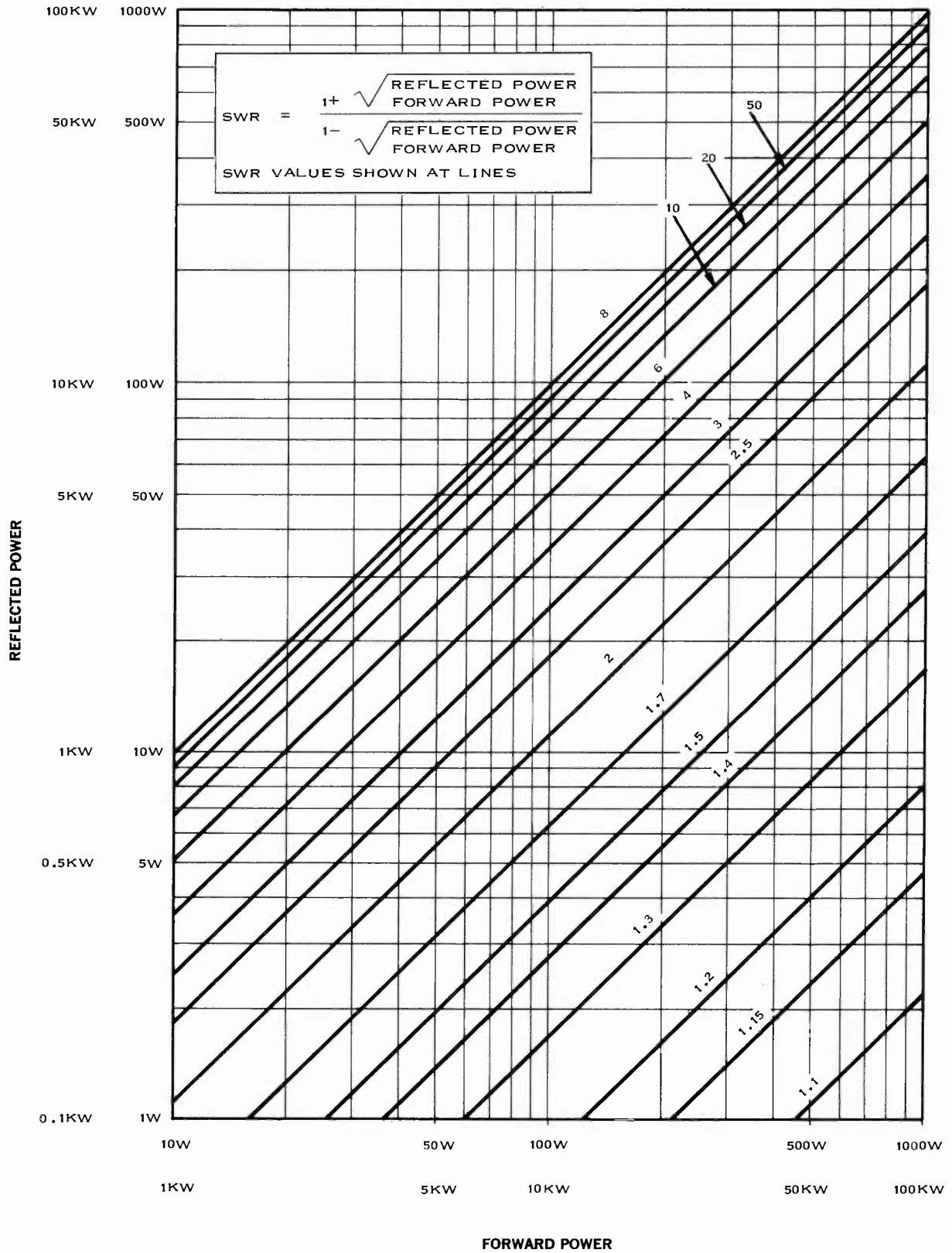

Attenuator Network

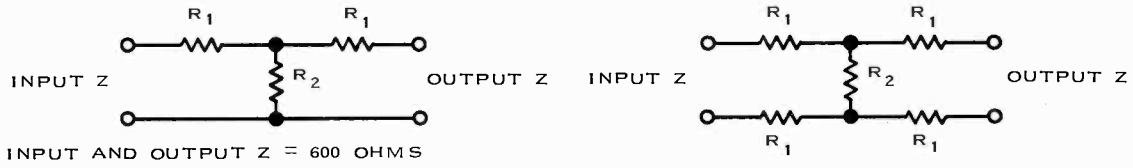

DB LOSS	R ₁	R ₂	DB LOSS	R ₁	R ₂	DB LOSS	R ₁	R ₂	DB LOSS	R ₁	R ₂
0.5	17.2	10464	16	435.8	195.1	0.5	8.6	10464	16	217.9	195.1
1	34.5	5208	17	451.5	172.9	1	17.25	5208	17	225.7	172.9
2	68.8	2582	18	465.8	152.5	2	34.4	2582	18	232.9	152.5
3	102.7	1703	19	479.0	136.4	3	51.3	1703	19	239.5	136.4
4	135.8	1249	20	490.4	121.2	4	67.9	1249	20	245.2	121.2
5	168.1	987.6	22	511.7	95.9	5	84.1	987.6	22	255.9	95.9
6	199.3	803.4	24	528.8	76.0	6	99.7	803.4	24	264.4	76.0
7	229.7	685.2	26	542.7	60.3	7	114.8	685.2	26	271.4	60.3
8	258.4	567.6	28	541.1	47.8	8	129.2	567.6	28	277.0	47.8
9	285.8	487.2	30	563.0	38.0	9	142.9	487.2	30	281.6	38.0
10	312.0	421.6	32	570.6	30.2	10	156.0	421.6	32	285.3	30.2
11	336.1	367.4	34	576.5	24.0	11	168.1	367.4	34	288.3	24.0
12	359.1	321.7	36	581.1	19.0	12	179.5	321.7	36	290.6	19.0
13	380.5	282.8	38	585.1	15.1	13	190.3	282.8	38	292.5	15.1
14	400.4	249.4	40	588.1	12.0	14	200.2	249.4	40	294.1	12.0
15	418.8	220.4				15	209.4	220.4			

Estimated Ground Conductivity

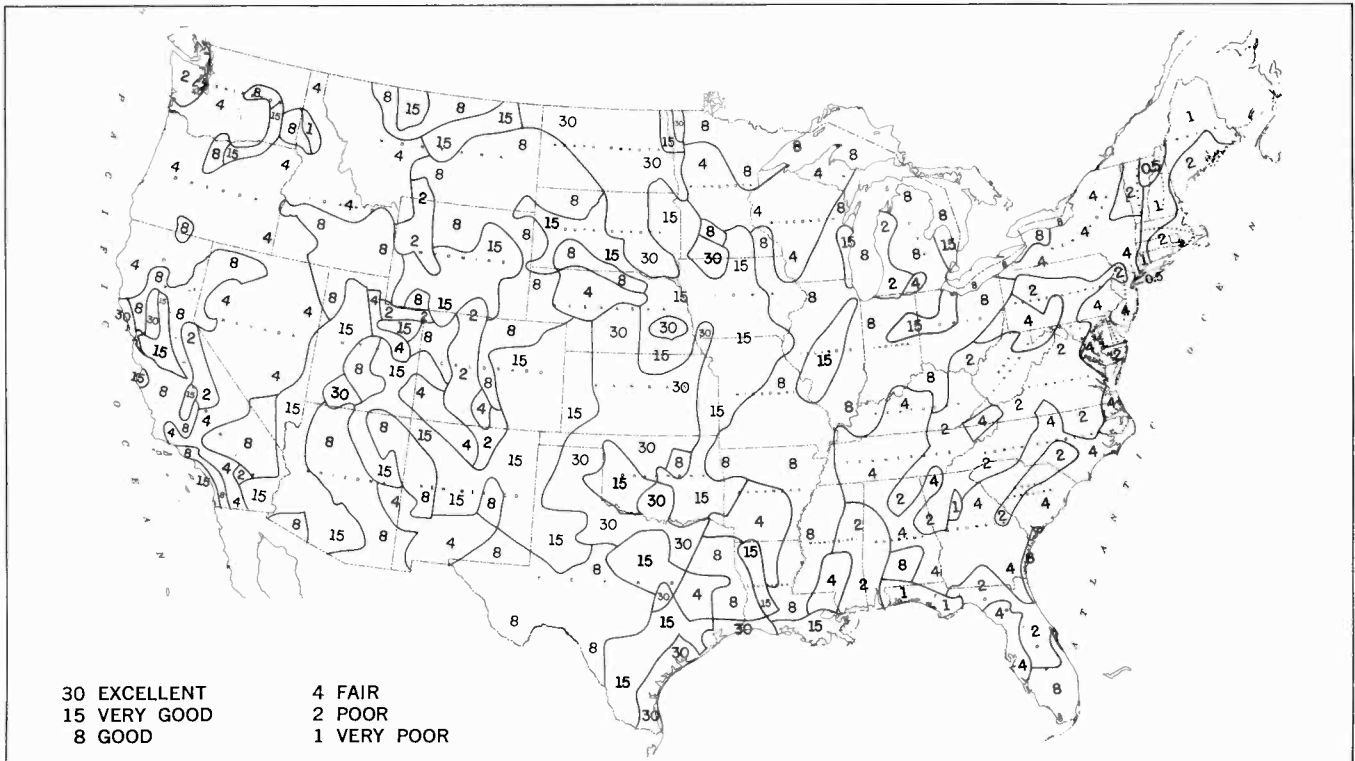

Reactance Chart

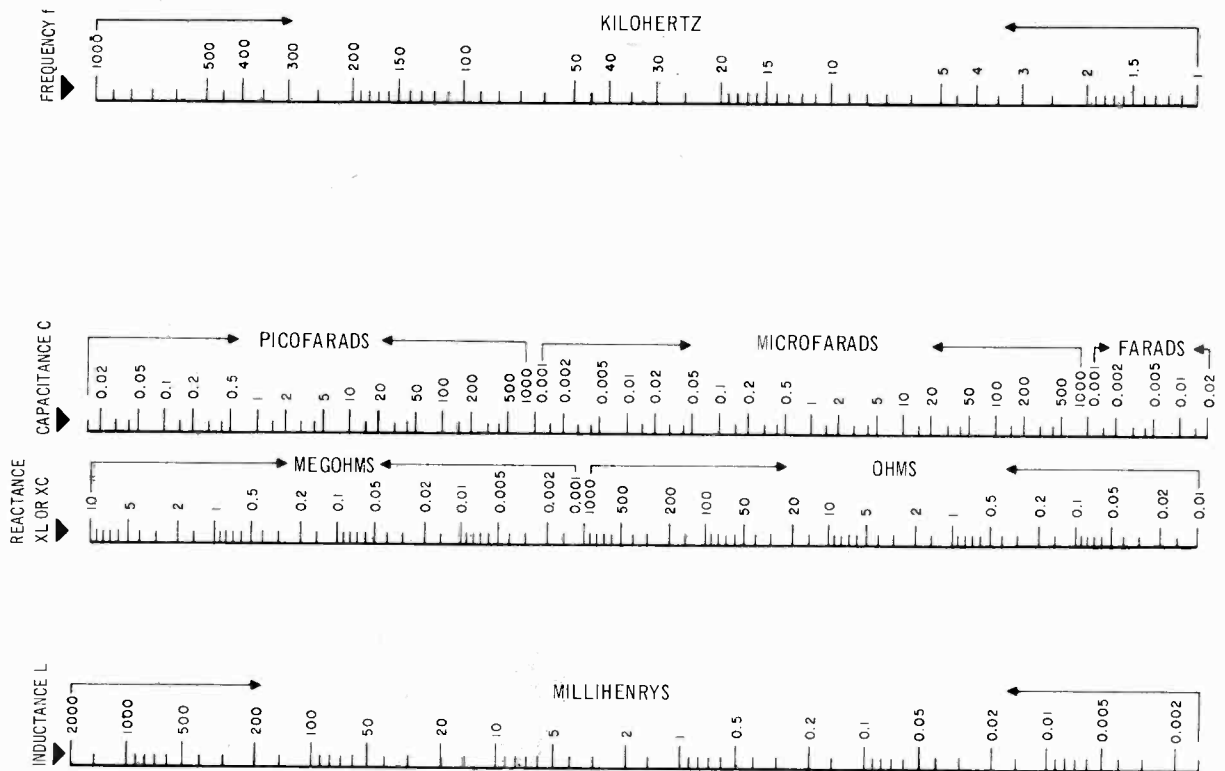
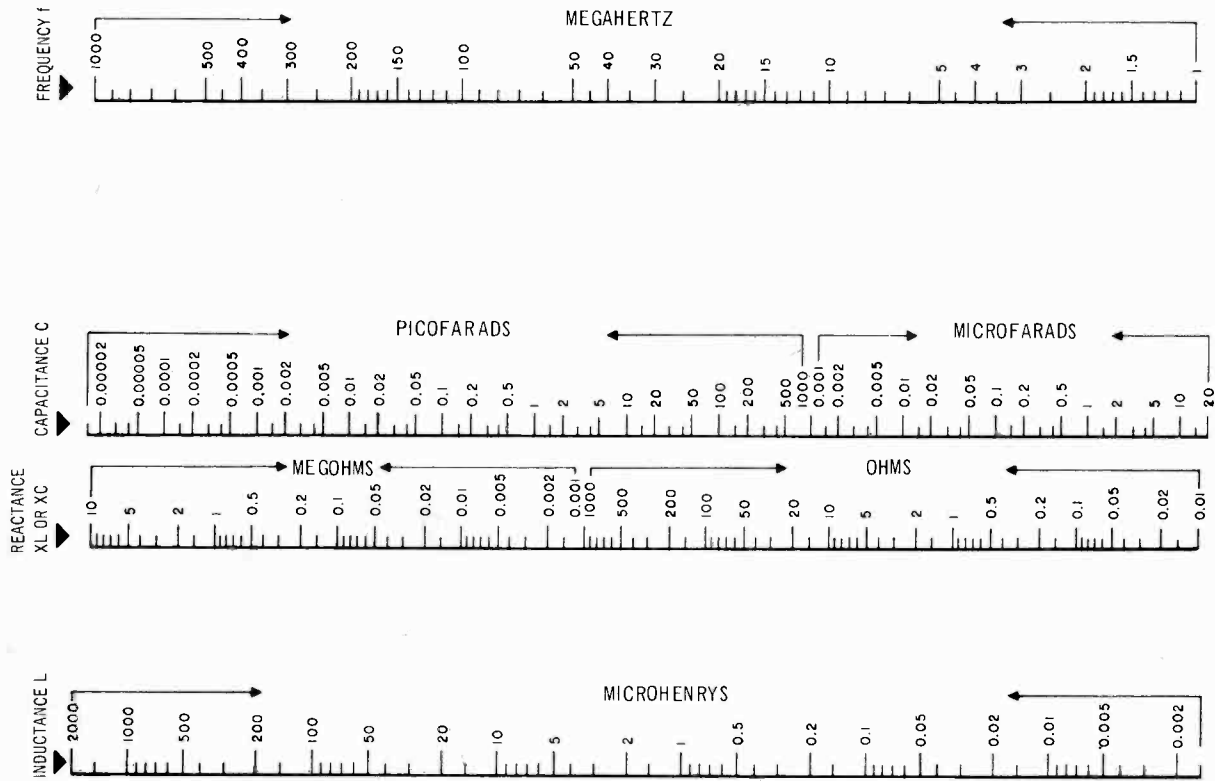

Attenuation Expressed as Efficiency

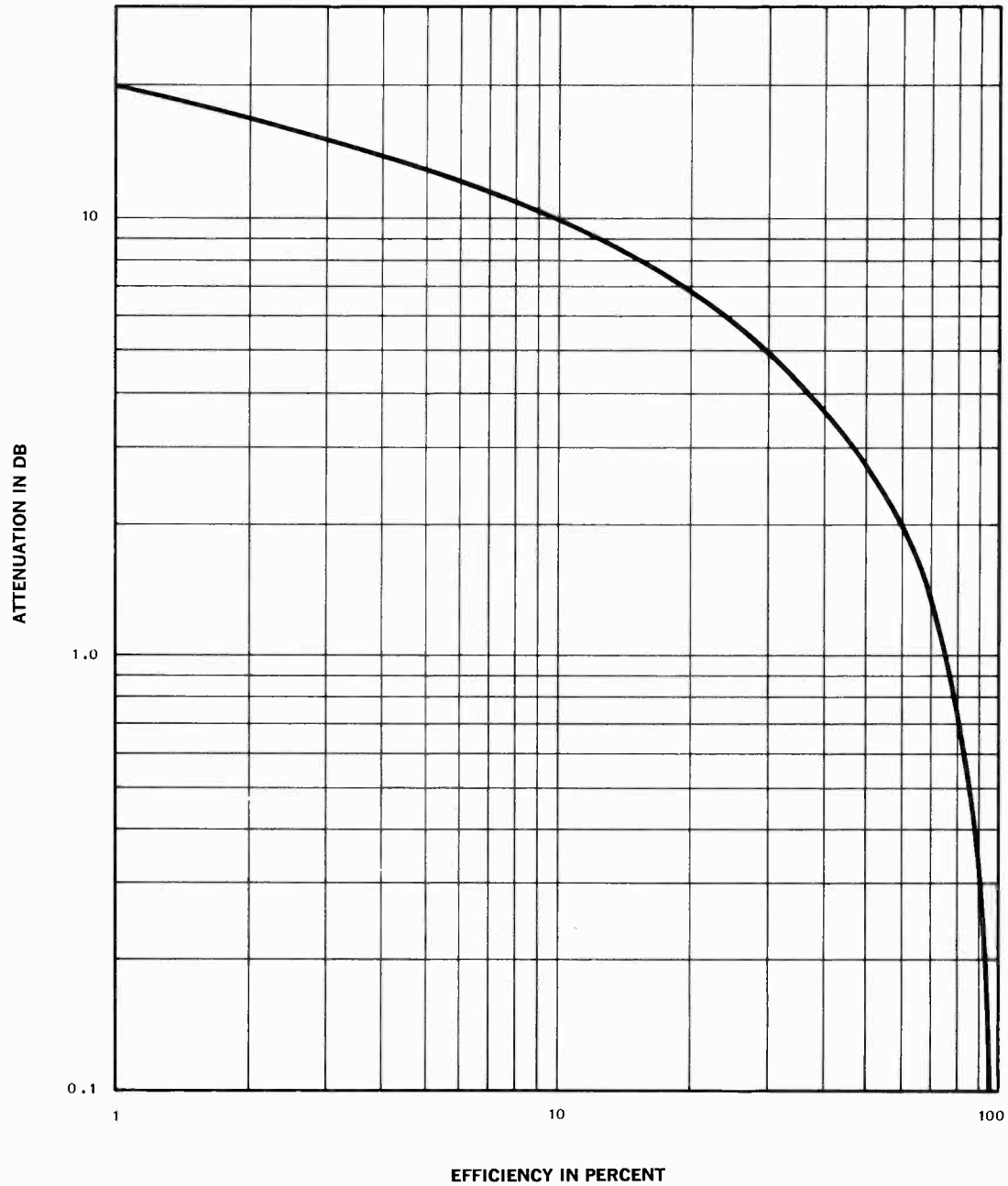

To obtain total loss in a given transmission line, multiply the attenuation in db per 100 ft by the number of 100-foot lengths of line to be used. By referring to the curve on this page, the overall transmission efficiency may be determined.

Station Layouts

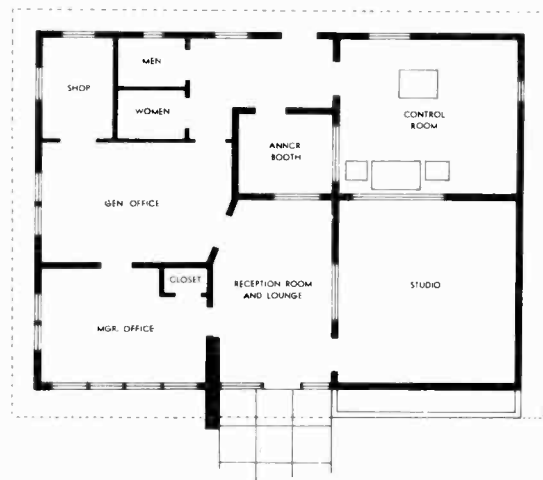
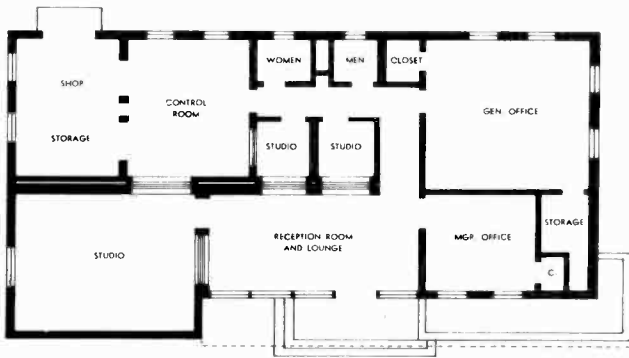
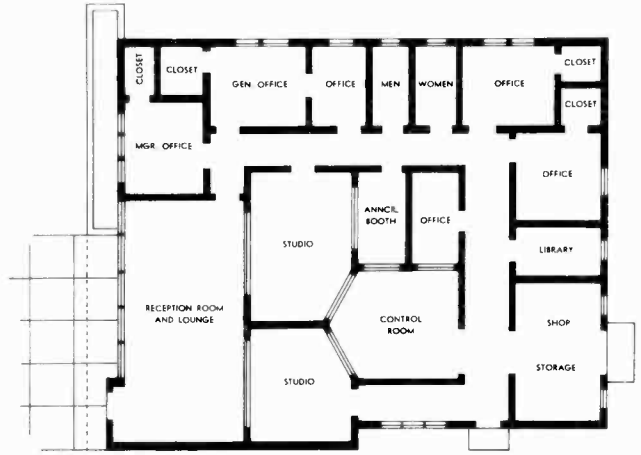
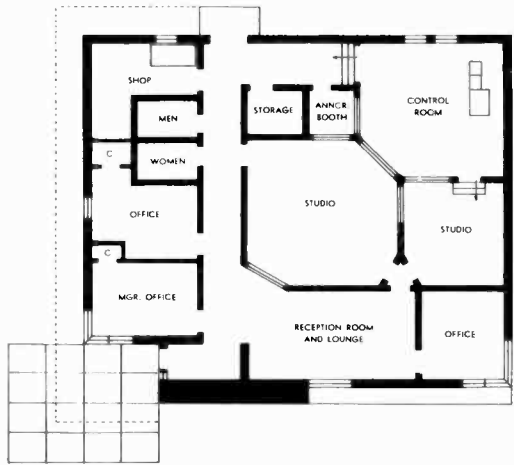

Transformation of Kilowatts to Decibels Above 1 KW

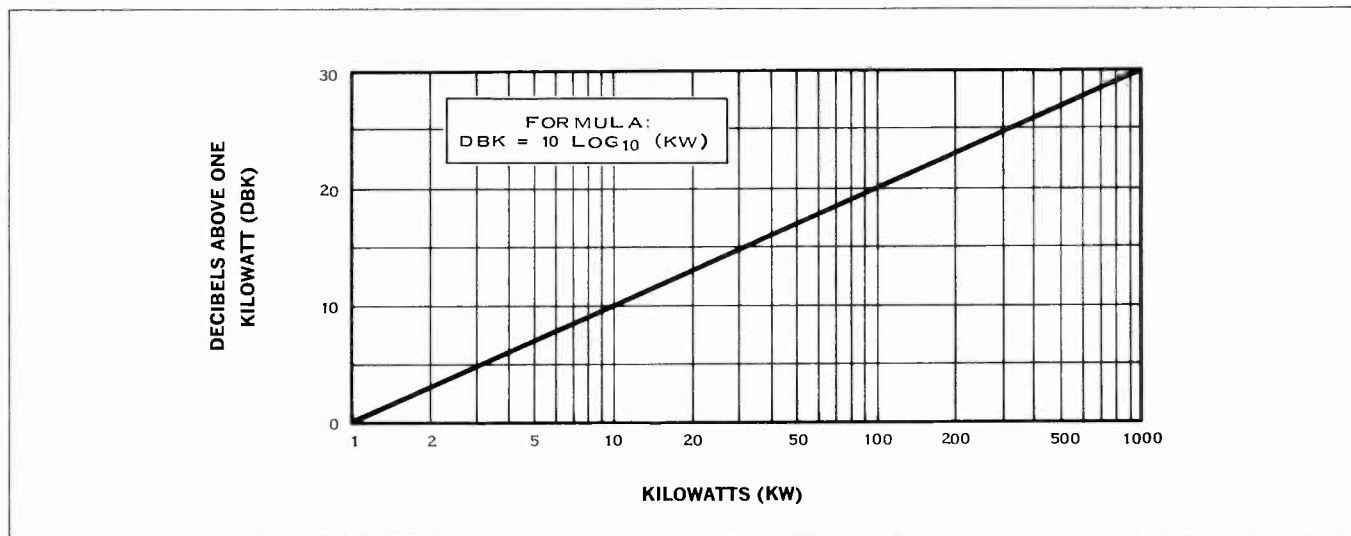

Transformation of Microvolts to Decibels Above 1 μV

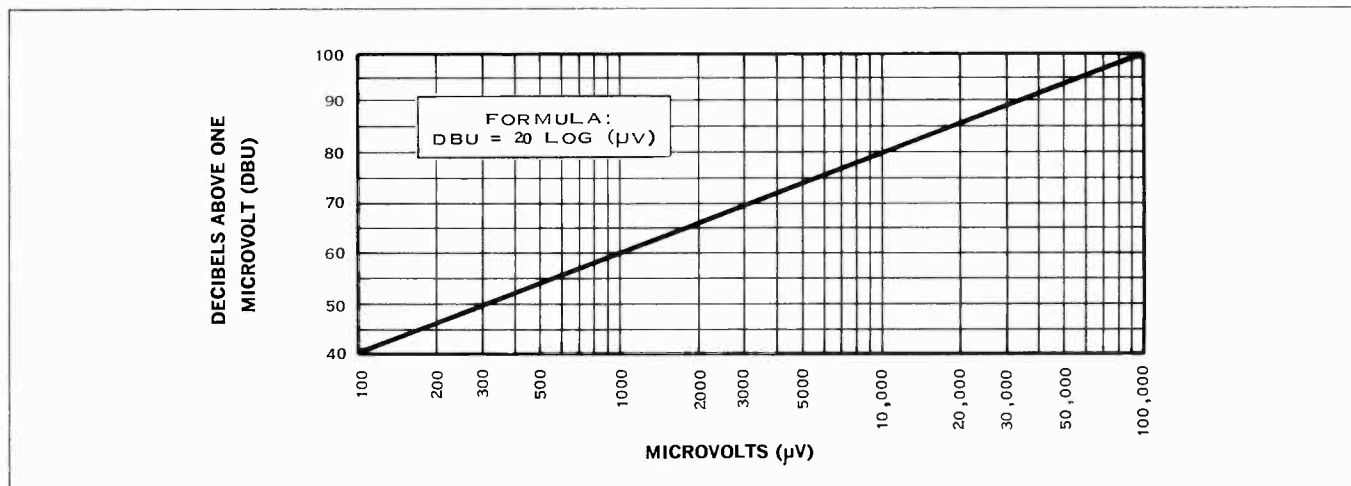

Dbm VS Watts

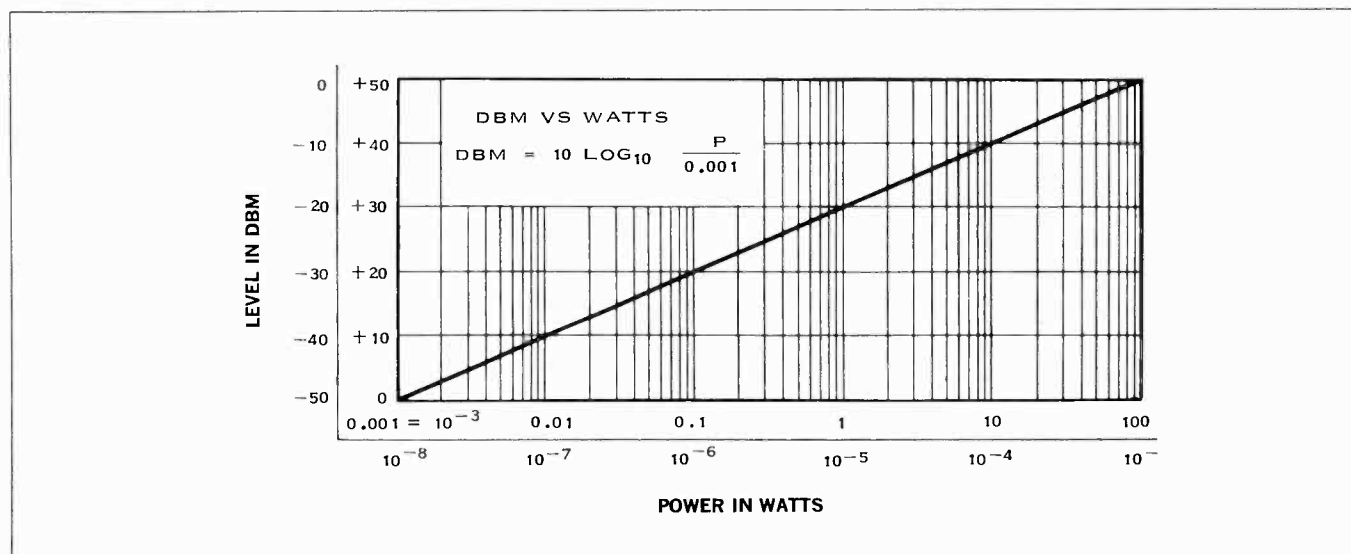

Volume Level to Power and Voltage Conversion

REFERENCE LEVEL: 0 DBM = 1 MW, 600 OHMS					
MILLIWATTS	VOLTS	DBM	WATTS	VOLTS	DBM
0.000001	0.0007746	- 60	0.001000	0.7746	0
0.000010	0.002449	- 50	0.002512	1.228	+ 4
0.000100	0.007746	- 40	0.006310	1.946	+ 8
0.001	0.02449	- 30	0.01000	2.449	+10
0.010	0.07746	- 20	0.1000	7.746	+20
0.100	0.2449	- 10	1.000	24.49	+30
1.000	0.7746	0	10.00	77.46	+40

Decibels VS Ratio

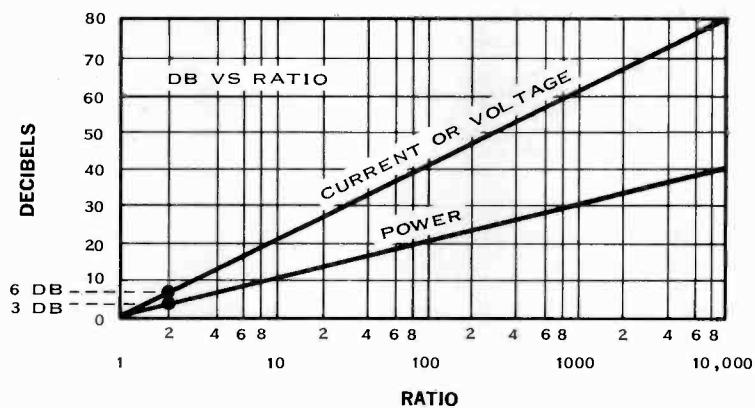

Increase in Attenuation in Line Due to VSWR on Line

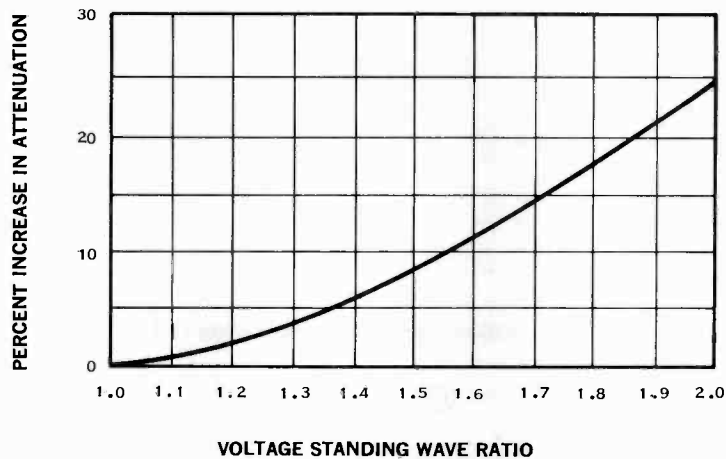

Standard Color Codes — Resistors and Capacitors

INSULATED UNINSULATED COLOR	FIRST RING BODY COLOR FIRST FIGURE	SECOND RING END COLOR SECOND FIGURE	THIRD RING DOT COLOR MULTIPLIER
BLACK	0	0	NONE
BROWN	1	1	0
RED	2	2	.00
ORANGE	3	3	.000
YELLOW	4	4	0.000
GREEN	5	5	00.000
BLUE	6	6	000.000
VIOLET	7	7	0,000.000
GRAY	8	8	00,000.000
WHITE	9	9	000,000.000

JAN 8,
1948
RMA
CODE

MOLDED MICA TYPE CAPACITORS

CURRENT STANDARD CODE

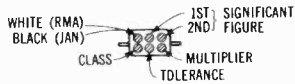

RMA 3-DOT (OBSOLETE) RATED 500 WVDC ±20% TOL.



BUTTON SILVER MICA CAPACITOR



RMA (5-DOT OBSOLETE CODE)

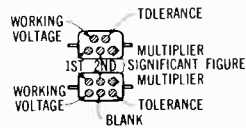
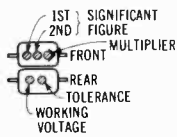

RMA 4-DOT (OBSOLETE)

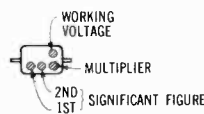

RMA 6-DOT (OBSOLETE)

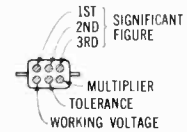

MOLDED PAPER TYPE CAPACITORS

TUBULAR CAPACITOR

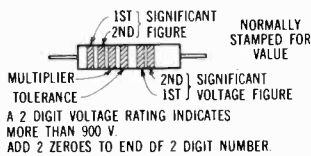

MOLDED FLAT CAPACITOR COMMERCIAL CODE

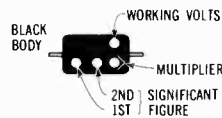

JAN. CODE CAPACITOR

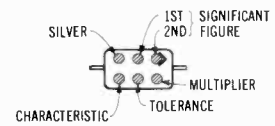

CERAMIC CAPACITORS

5-DOT RADIAL LEAD CERAMIC CAPACITOR



EXTENDED RANGE TC CERAMIC HICAP

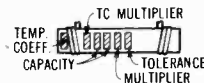

AXIAL LEAD CERAMIC CAPACITOR

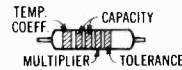

DISC CERAMIC RMA CODE



BY-PASS COUPLING CERAMIC CAPACITOR

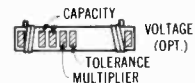

RESISTORS

RADIAL LEAD DOT RESISTOR

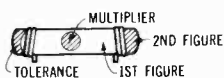

RADIAL LEAD (BAND) RESISTOR

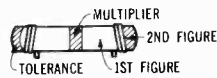

AXIAL LEAD RESISTOR

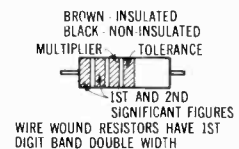

Indexes

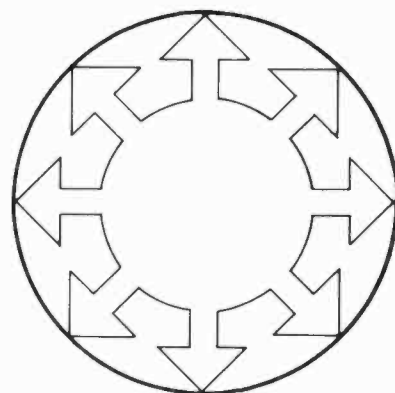

INDEX BY DESCRIPTION

Air Alert	67	Mobile Receiver	73
AM Towers	35	Mobile Transmitter	73
AM Transmitters	5	Monitor, Modulation	76, 79
Amplifier, Auto-Level Compression	49	Monitor, SCA	77
Amplifier, Auto-Level Limiting	48	Pads, Replacement Pressure	57
Amplifier, Console	37-39, 44-47	Patch Cords	68
Amplifier, Peak Limiting	49	Phase Monitor	80
Amplifier, Stereo Limiting	48	Phasing	10
Antennas	31, 74	Phasor	10
Antenna Coupling Unit	11	Phono Equalizer Preamp	51
Antenna Current Transformer	12	Phonograph Cartridge	53
Auto-Level Limiting Amplifier	48	Playback Arms	51, 52
Baffles	68	Power Supply, Console	43
Beacon Light Control	35	Preamplifier	40-42
Cabinet, Turntable	50	Rack Cabinet Panels	69
Cartridges, Automatic Programming	56	Recorders, Tape	54, 58-61
Cartridges & Styli	53	Recorder Accessories	56, 57
Cartridge Racks	56	Recorder/Reproducer	58-60
Choke, Tower Lighting	11	Recording Tapes	56, 57
Clock, Studio	69	Remote Console	72
Connectors	70	Remote Control	81, 82
Console, Speech Input	37-39, 44-47	Remote Control, Tape	58
Contactors	12	Remote Equipment	71
Deicer, Antenna	31	Remote Equipment Accessories	74
Dummy Antenna	31	Replament Pressure Pads	57
Equalizer	51	Ring Transformer	35
Exciter, FM	14	Sampling Loop	12
Field Intensity Meter	80	Speakers	67
FM Antenna	30	Speaker/Amplifier, Tape	60
FM Towers	35	Splicing Tape	57
FM Transmitters	13	Stereo Multiplex Generator	15, 16
Frequency Monitor	77, 78	Studio Clock	69
Generator, Stereo Multiplex	15, 16	Styli	53
Ground Screen	35	Switch Matrix	43
Ground Strap	35	Tape, Automatic Programming Test	57
Ground Wire	35	Tape Cartridge Racks	56
Headphones	68	Tape Cartridge System	54, 55
Heating Element, FM Antenna	31	Tape Erasers	57
Insulator, Feed-Through	12	Tape Recorders	54, 58-61
Isolation Coil	12	Tape Splicer, Cutter	57
Jack Panels	68	Terminal Board	69
Lavaliere Microphone Clip	63	Tone Arms	51-54
Level Controls	67	Towers, AM	35
Loudspeakers	67	Towers, FM	35
Meter, Intensity	80	Tower Lighting Choke	11
Microphones	63-65	Transformer, Speaker	67
Microphone Boom	66	Transformer, Turntable	50
Microphone Boom Stand	66	Transmission Lines and Accessories	35
Microphone Cable	69	Turntables	50
Microphone Stands	65	Turntable Cabinet	50
		Wire, Copper	35
		Wire, Shielded	69

INDEX BY PART NUMBER

1H1612 Studio Clock	69	409Z-1 Power Supply	43
2YC Stacking Harness	74	427-6 Terminal Board	69
26J-3 Amplifier, Auto-Level Compression	49	500 Recorder	61
26U-1 Amplifier, Limiting Console	48	506B Modulation Monitor	76, 79
26U-2 Amplifier, Stereo Limiting	49	600 Cartridge	56
26U-3 Amplifier, Peak Limiting	49	600 Recorders/Accessories	61
37CP FM Antenna	34	601-96 Sampling Loop	12
37M FM Antenna	31	620 Speaker/Amplifier	60
42E-7 Antenna Coupling Unit	11	642E Twintape Playback Unit	54
42E-8A Antenna Coupling Unit	11	786M-1 Generator	16
42E-8B Antenna Coupling Unit	11	786V-1 Stereo Generator	15
54N-1 FM Frequency Monitor	78	786W-1 SCA Generator	15
54Z-1 AM Frequency Monitor	77	820D-1 AM Transmitter	6
81M Phasor	10	820E/F-1 AM Transmitter	8
111A-12 Recording Tape	57	830B-1B FM Transmitter	18
112 Phase Monitors	80	830D-1B FM Transmitter	20
120-E Field Intensity Meter	80	830E-1B FM Transmitter	24
135-15 Feed-Through Insulator	12	830F-1B FM Transmitter	26
144A-1 Isolation Coil	12	831G-1 FM Transmitter	28
150-18 Recording Tape	57	830N-1B FM Transmitter	29
156 Headphones	68	831D-1 FM Transmitter	22
157 Headphones	68	900C-3 Modulation Monitor	76
172G-1 Dummy Antenna	12	900F-1 SCA Monitor	77
172G-2 Dummy Antenna	12	1021 Recorder/Reproducer	59
190-18 Recording Tape	57	1022 Recorder/Reproducer	59
200C Tape Eraser	57	1028 Recorder/Reproducer	59
206 Playback Arms	52	1200 Cartridge	57
208 Playback Arms	51	8412 Microphone Cable	69
216D Twintape Record Amplifier	55	8422 Microphone Cable	69
212J-1 Console	47, 72	8451 Microphone Cable	69
212M-1 Console	39	8738 Microphone Cable	69
212S-1 Console	37	8758 Microphone Cable	69
212T-1 Console	44	63305-DB Beacon Light Control	35
212T-2 Console	45	A-3818 Speaker Transformer	67
212V-1 Console	48	AA-620 Speaker/Amplifier	60
260S-1 Mixer Add-On Unit	38	AG-440 Recorder/Reproducer	61
280 Recorder/Reproducer	58	AG-500 Recorder	60
300 Cartridges	56	AG-600 Recorder	61
300C Antenna	33	ASP 143 Bumper Mount	74
303 Playback Arm	52	ASP-177 Antenna	74
306 Playback Arm	52	BA-200 Headphones	68
310Z-1 FM Exciter	14	BA-206 Headphones	68
356H-1 Phonograph Equalizer Preamplifier	51	BB-1 Microphone Boom	66
356M-1 Monitor Amplifier	41	CR-1772 Rack Cabinet	69
356R-1 Phono Preamplifier	42	CR-1773-B Rack Cabinet	69
356P-1 Program Amplifier	41	CS-12 Loudspeaker	66
356T-1 Preamplifier	40	DS-7 Microphone Desk Stand	65
356U-1 Audio Preamplifier	42	FM-1 Flexo Mikester	66
356V-1 Hi-Level Amplifier	40	GR-6355 Connector	74
384D-1 Switch Matrix	43	M-21 Microphone	63
		M-30B/TPS Mobile Transmitter	73
		M44-5 Phonograph Cartridge	53

M44-7 Phonograph Cartridge	53	SM33 Microphone	64
M-70 Microphone	63	SM50 Microphone	64
M-80 Microphone	63	SM300 Microphone	65
M-90 Microphone	63	ST-276 Level Control	67
M232 Playback Arm	54	ST500 Splicing Tape	57
M236 Playback Arm	54	SX800 Recorder/Reproducer	58
MA-1 Antenna	74	TCW-2Q Turntable Cabinet	50
MM-151 Recording Tape	57	TCW-4Q Turntable Cabinet	50
MR-30/150-170 Remote Receiver	73	TCW-9Q Turntable Cabinet	50
MS-10C Microphone Floor Stand	66	T1-2017 Ring Transformer	35
MS-11C Microphone Floor Stand	66	T1-2035 Ring Transformer	35
MS-25 Microphone Floor Stand	66	TPS-1 Remote Power Supply	74
P12-T Speaker	67	TPS-TC Mobile Assemblage	74
PA-1 Antenna	74	TS-8D Tape Splicer Cutter	57
PBR-30 Transmitter Remote Control System	82	TT-200 Turntable	50
RA-2 Antenna	74	TT-200S Turntable	50
RA-4 Antenna	74	TT-250S Turntable	50
RC-2400D Remote Control	81	TT-400 Turntable	50
RC-2400F Remote Control	81	TT-400S Turntable	50
RMC-1 Remote Control	74	TT-450S Turntable	50
S-260 Playback Arm	54	WB-8D Baffle	68
S-320 Playback Arm	54	WB-12D Baffle	68
SC-155-B Antenna	74	WB-52 Dummy Antenna	12
SCB-8D Baffle	68	WRC-10 Transmitter Control Unit	62
SCB-12D Baffle	68	YC Antenna	74
SM5A Microphone	64		



COLLINS BROADCAST SALES POLICY

How to Order

This catalog has been prepared to make it possible for you to order directly from Collins Broadcast Marketing or your Collins Broadcast Sales Engineer with a minimum of effort and maximum assurance that you will receive the best equipment available. Collins type numbers and part numbers are listed so that you may order by mail, if you wish, and receive the same fast, personal service that is available from your Collins Broadcast Sales Engineer.

Prices

Prices in the price book inside the back cover replace all previous prices and are subject to change without notice. Orders are filled at prices in effect at the time of shipment. If prices are reduced, you receive the advantage of the lower price. Collins customers outside the 50 United States should contact Collins Radio Company, International Division, Dallas, Texas, or Collins Radio Company of Canada, Ltd., Toronto 16, Ontario.

Signed Orders

All orders must be signed by an officer of the purchasing corporation, partnership, or company. All orders, down payment agreements and terms are subject to final acceptance at the Collins Broadcast Marketing office in Dallas, Texas.

Substitution and Modification

Collins reserves the right to modify, without notice, the design and specifications of equipment designed by Collins.

Terms of Sale

Terms of payment for all Collins Radio Company broadcast equipment sales fall into the following categories:

1. Cash in advance or COD
2. Net 30 days
3. 30-60-90 days (no interest or carrying charge)
4. Conditional Sales Contract.

Down Payment

On all firm orders applicable to Conditional Sales Contracts, a minimum down payment of 25 percent is required, with the balance spread equally. In the case of contingent orders, a minimum of 3 percent down is required.

Shipment

In the absence of specific instructions, Collins will select

the carrier to whom delivery will be made for shipment to the purchaser.

Damages in Shipping

Usually, shipments from Collins Radio Company or one of its vendors on a drop ship basis are made "Shipping Charges Collect". As such, the equipment automatically becomes the property of the purchaser when picked up by the carrier. Should damage occur during shipment, the request for inspection and claims for damage must be made by the purchaser with reimbursement paid directly to him. Collins will gladly assist the purchaser with any necessary information he may require to successfully negotiate a claim.

Delivery

Unless otherwise specified, delivery will be made fob from one of Collins various shipping points or from the shipping point of a supplier of Collins. Although Collins makes every effort to expedite shipments, the Company cannot guarantee nor be held responsible for delays in shipments caused by a supplier of Collins or by the carrier.

Field Service

Fast field service is assured owners of Collins broadcast equipment by the Collins Service Division. A staff of selected specialists is maintained to provide Collins customers a level of service consistent with high performance equipment. For service on Collins equipment, which is essential to continued on-the-air operations of the station, contact your Collins Broadcast Sales Engineer. For emergency, after-hours service, Call Dallas, Texas, 214 AD 5-9511. Collins field service engineers are stationed at key points throughout the world. Overseas customers contact your nearest International office.

Returning Goods

All returned goods, whether for repair, replacement, or credit, must be authorized by Collins Radio Company. A return material tag and service report will be enclosed with your authorization for the return of the goods. An accurately completed report will assure prompt handling of repairs, necessary parts, replacements, and adjustments of accounts where required. Address material as follows:

Collins Radio Company
Dallas, Texas 75207

Attention: CRG/Re (Sales Order Number)

Contingent on Collins agreement to accept such returned goods, a restocking charge of 15 percent will be made on all items returned due to customer requested changes or deletions from original orders after shipment is made. All returns must be sent prepaid and properly insured by the customer. If warranted, Collins will adjust issue credit for these shipping expenses.

GUARANTEE

(a) Except as set forth in paragraph (b) of this section, Collins agrees with Buyer to repair or replace, without charge, any properly maintained equipment, parts, or accessories that are defective as to design, materials, or workmanship and that are returned in accordance with Collins instructions by Buyer to Collins factory, transportation prepaid, provided:

(1) Notice of a claimed defect in the design, materials, or workmanship of the equipment manufactured by Collins is given by Buyer to Collins within five (5) years from date of delivery with exception of rotating machinery such as blowers, motors, and fans whereby notice must be given by Buyer to Collins within two (2) years from date of delivery.

(2) Notice of a claimed defect in the design, materials or workmanship of the following described Collins manufactured equipment is given by Buyer to Collins within two (2) years from the date of delivery:

20V-3	81M	216C-2	642A-1	830D-1B
26J-1	144A-1	313T-1	786M-1	830E-1B
26U-1	172G-1	313T-3	820E-1	830F-1B
26U-2	172G-2	313T-4	820F-1	830F-2B
42E-7	212H-1	356H-1	A830-2	830H-1B
42E-8	212Z-1	564A-1	830B-1B	830N-1B

(b) The above guarantee does not extend to other equipment, accessories, tubes, lamps, fuses, and tape heads manufactured by others, which are subject to only adjustment as Collins may obtain from the supplier thereof.

(c) Collins further guarantees that any radio transmitter described herein will deliver full radio frequency power

output at the antenna lead when connected to a suitable load, but such guarantee shall not be construed as a guarantee of any definite coverage or range of said apparatus.

(d) The guarantee of this section is void if:

(1) The equipment malfunctions as a result of alterations or repairs by others than Collins or its authorized service center.

(2) The equipment is exposed to environmental conditions more severe than specified by Collins in equipment manuals.

(e) NO OTHER WARRANTIES, EXPRESSED OR IMPLIED, INCLUDING WARRANTIES OF MERCHANTABILITY OR FITNESS FOR INTENDED PURPOSE, SHALL BE APPLICABLE TO ANY EQUIPMENT SOLD HEREUNDER.

(f) THE FOREGOING SHALL CONSTITUTE THE BUYER'S SOLE RIGHT AND REMEDY UNDER THE AGREEMENTS IN THIS SECTION. IN NO EVENT SHALL COLLINS HAVE ANY LIABILITY FOR CONSEQUENTIAL DAMAGES; OR FOR LOSS, DAMAGE, OR EXPENSE DIRECTLY OR INDIRECTLY ARISING FROM THE USE OF THE PRODUCTS, OR ANY INABILITY TO USE THEM EITHER SEPARATELY OR IN COMBINATION WITH OTHER EQUIPMENT OR MATERIALS, OR FROM ANY OTHER CAUSE.

(g) The guarantees of this section and limitations thereon will also accrue to the benefit of any purchaser of Buyer's FCC license, provided:

(1) Notice of the sale of the FCC license is given by Buyer to Collins in writing within thirty (30) days after the consummation of said sale.

(2) No greater rights are granted to the purchaser of Buyer's FCC license than are granted herein to Buyer.



