

I N S T R U C T I O N B O O K

for

2 1 B - 1

A M B R O A D C A S T T R A N S M I T T E R

Manufactured By
COLLINS RADIO COMPANY
Cedar Rapids, Iowa

520 9308 00

JUL 1949

TABLE OF CONTENTS

Section 1. GENERAL DESCRIPTION

1.1. General	1-1
1.2. Mechanical Description	1-1
1.2.1. General	1-1
1.2.2. Control System.	1-1
1.2.3. Ventilation	1-2
1.3. Electrical Description	1-2
1.3.1. General	1-2
1.3.2. Voltage Supply.	1-2
1.3.3. Audio System.	1-2
1.3.4. R-F Circuits.	1-3
1.4. Reference Data	1-3
1.4.1. Frequency Range	1-3
1.4.2. Character of Emission	1-3
1.4.3. Power Output.	1-3
1.4.4. Power Source and Input Requirement.	1-3
1.4.5. Audio Input	1-3
1.5. Vacuum Tube Complement	1-3

Section 2. INSTALLATION OF TRANSMITTER

2.1. Prime Installation	2-1
2.1.1. Preliminary	2-1
2.1.2. Installation Procedure.	2-1
2.1.3. External Connections.	2-5

Section 3. ADJUSTMENT AND OPERATION

3.1. Initial Adjustments.	3-3
3.1.1. General	3-3
3.1.2. Function of Controls.	3-3
3.1.3. Energizing the Equipment for the First Time	3-6
3.1.4. Filament Circuit Adjustment	3-8
3.1.5. Tuning Adjustment	3-8
3.1.6. Noise Adjustment.	3-13
3.1.7. Adjustment of Differential Relay K414	3-14
3.2. Routine Operation.	3-14
3.2.1. General	3-14
3.2.2. Starting Equipment.	3-14
3.2.3. Stopping Equipment.	3-16
3.2.4. Overload Reset.	3-16
3.2.5. Power Change.	3-16
3.2.6. Oscillator Change	3-16
3.2.7. Blowers	3-16

TABLE OF CONTENTS (Cont.)

Section 4. CIRCUIT DESCRIPTION

4.1. Mechanical Description	4-1
4.1.1. Cabinets	4-1
4.1.2. Ventilation	4-1
4.2. Electrical Description	4-1
4.2.1. Primary Power Circuits	4-1
4.2.2. Control Circuits	4-4
4.2.3. Remote Control Circuits	4-6
4.2.4. Radio Frequency Circuits	4-7
4.2.5. Audio Circuit	4-9
4.2.6. Filament Supplies	4-10
4.2.7. Plate and Bias Supplies	4-10

Section 5. PREVENTIVE MAINTENANCE

5.1. Cleaning	5-1
5.1.1. Transmitter General	5-1
5.2. Routine Checks	5-1
5.2.1. General Inspection	5-1
5.2.2. Tube Check	5-2
5.2.3. Voltage and Current Checks	5-2
5.2.4. Performance Checks	5-2
5.3. Lubrication	5-2
5.3.1. Modulator and PA Blowers	5-2
5.3.2. Rectifier Blower Motor	5-2
5.3.3. Exciter Cabinet Ventilating Blowers	5-2
5.3.4. Tuning Motors and Assemblies	5-3
5.4. Maintenance Tools	5-3
5.5. Relay Maintenance	5-3

Section 6. CORRECTIVE MAINTENANCE

6.1. Trouble Shooting	6-1
6.1.1. Tube Failure	6-1
6.1.2. Location of Trouble	6-1
6.1.3. Cable Trouble	6-1
6.1.4. Servicing the Equipment	6-2

Section 7. PARTS LIST

LIST OF ILLUSTRATIONS

<u>Figure</u>	<u>Title</u>
1-1	21B Transmitter and Simplified Schematic
1-2	Oscillator Unit Removal
2-1	Rectifier Bay, Inside Rear View
2-2	Modulator Bay, Inside Rear View
2-3	Exciter Bay, Inside Rear View
2-4	Inter-cabinet Connecting Panel
2-5	Power Amplifier Bay, Inside Rear View
2-6	Installation Drawing
2-7	Modulation Monitor Connections
2-8	Audio Monitor and Remote Antenna Current Connections
2-9	Frequency Monitor Connections
2-10	Remote Control Schematic
2-11	Average Filament Emission Characteristics For 892R Tube
3-1a,3-1b	Functions of Controls
3-2	Driver Amplifier Plate Tank Inductor
3-3	Neutralizing Coil Adjustment
3-4	Power Amplifier Plate Tank and Output Network Inductors
3-5	845 Cathode Current Balancing Adjustment
3-6	Hum Adjustments
3-7	Capacitor C-810 Adjustment
4-1	Primary Power Circuits
4-2	Control Circuits
4-3	Overload System Block Diagram
4-4	Low Voltage and Fixed Bias System
4-5	Type 297 Crystal Oven
4-6	Type 280A Crystal Adjusting Tool
6-1	40F Frequency Control Unit Parts Arrangement
6-2	Rectifier Bay, Front Open
6-3	Modulator Bay, Front Open
6-4	Exciter Bay, Front Open
6-5	Power Amplifier Bay, Front Open
6-6	Overload Relay Adjustments
6-7	R-F Rectifier Parts Arrangement
6-8a,6-8b	Inter-Cabinet Connecting Panels
8-1	21B Complete Schematic
8-2	Rectifier Bay Cabling Schematic
8-3	Rectifier Bay Cabling Diagram
8-4	Modulator Bay Schematic
8-5	Exciter Bay Schematic
8-6	Power Amplifier Bay Schematic
8-7	Rectifier Front Door Schematic
8-8	Modulator Front Door Schematic
8-9	Exciter Front Door Schematic
8-10	Power Amplifier Front Door Schematic
8-11	External Components Schematic
8-12	40F Oscillator Schematic
8-13	21B to 21L Conversion Schematic

GUARANTEE

The equipment described herein is sold under the following guarantee:

Collins agrees to repair or replace, without charge, any equipment, parts or accessories which are defective as to design, workmanship or material, and which are returned to Collins at its factory in Cedar Rapids, Iowa, transportation prepaid, provided that the foregoing shall not be applicable to:

- (a) Equipment or accessories as to which notice of the claimed defect is not given Collins within one year from date of delivery;
- (b) Equipment and accessories manufactured by others than Collins, tubes and batteries, all of which are subject only to such adjustment as Collins may obtain from supplier thereof;
- (c) Equipment or accessories which shall fail to operate in a normal or proper manner due to exposure to excessive moisture in the atmosphere or otherwise after delivery, any such failure not being deemed a defect within the meaning of the foregoing provisions.

Collins further guarantees that any radio transmitter described herein will deliver full radio frequency power output at the antenna lead when connected to a suitable load, but such guarantee shall not be construed as a guarantee of any definite coverage or range of said apparatus.

The guarantee of these paragraphs is void if equipment is altered or repaired by others than Collins.

Notice of any claimed defect must be given to Collins prior to return of any item. Such notice must give full information as to nature of defect and identification (including part number if possible) of part considered defective. Upon receipt of such notice, Collins will promptly advise respecting return of equipment. Failure to secure our advice prior to the forwarding of goods for return may cause unnecessary delay in the handling of such merchandise.

No other warranties, expressed or implied, shall be applicable to said equipment, and the foregoing shall constitute the Buyer's sole right and remedy under the agreements in this paragraph contained. In no event shall Collins have any liability for consequential damages, or for loss, damage or expense directly or indirectly arising from the use of the products, or any inability to use them, either separately or in combination with other equipment or materials, or from any cause.

HOW TO ORDER REPLACEMENT PARTS

When ordering replacement parts, you should direct your order as indicated below and furnish the following information in so far as applicable:

Address: Collins Radio Company
Sales Service Department
Cedar Rapids, Iowa

Information Needed:

- (A) Quantity required
- (B) Part number of item
- (C) Item number (obtain from Parts List or Schematic Diagram)
- (D) Type number of unit
- (E) Serial number of unit
- (F) Serial number of equipment

HOW TO RETURN MATERIAL OR EQUIPMENT

If, for any reason, you should wish to return material or equipment, whether under the guarantee or otherwise, you should notify us, giving full particulars including the details listed below, in so far as applicable. Upon receipt of such notice, Collins will promptly advise you respecting the return. Failure to secure our advice prior to the forwarding of the goods or failure to provide full particulars may cause unnecessary delay in handling of your returned merchandise.

Address: Collins Radio Company
Sales Service Department
Cedar Rapids, Iowa

Information Needed:

- (A) Date of delivery of equipment
- (B) Date placed in service
- (C) Number of hours in service
- (D) Part number of item
- (E) Item number (obtain from Parts List or Schematic Diagram)
- (F) Type number of unit from which part is removed
- (G) Serial number of unit
- (H) Serial number of the complete equipment
- (I) Nature of failure
- (J) Cause of failure
- (K) Remarks

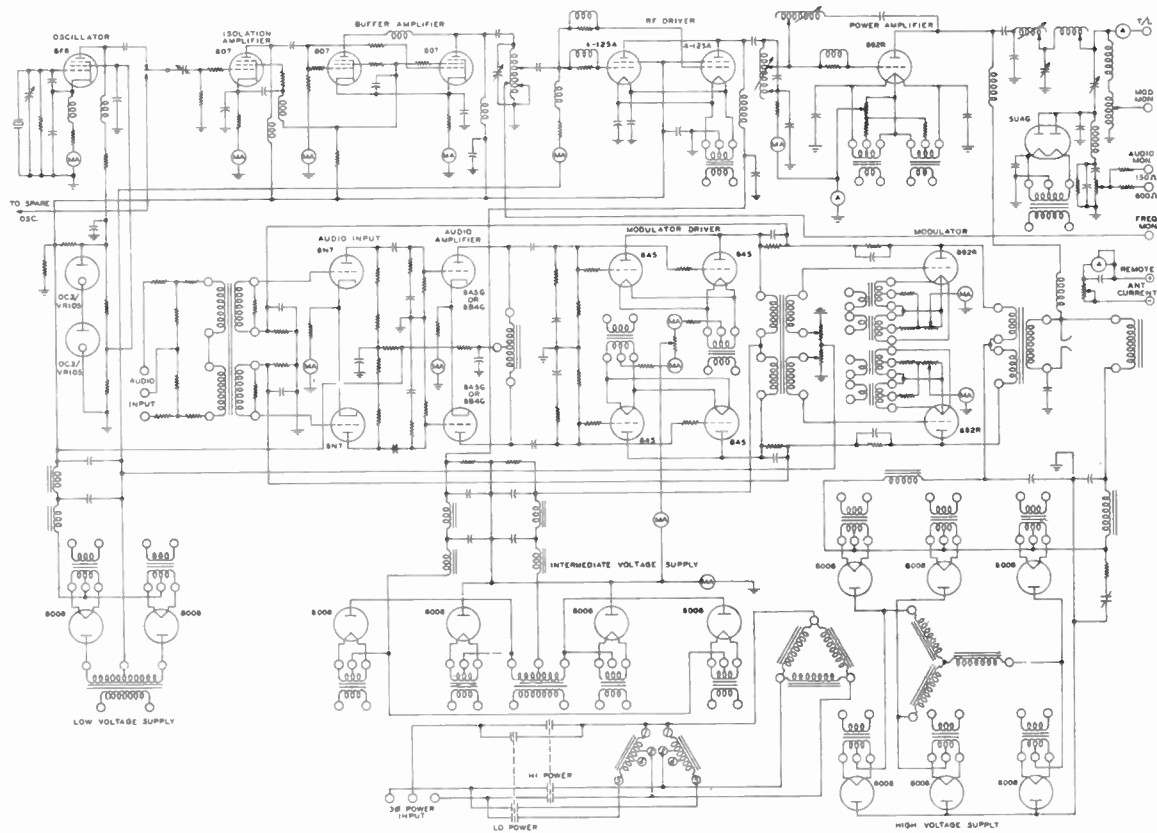
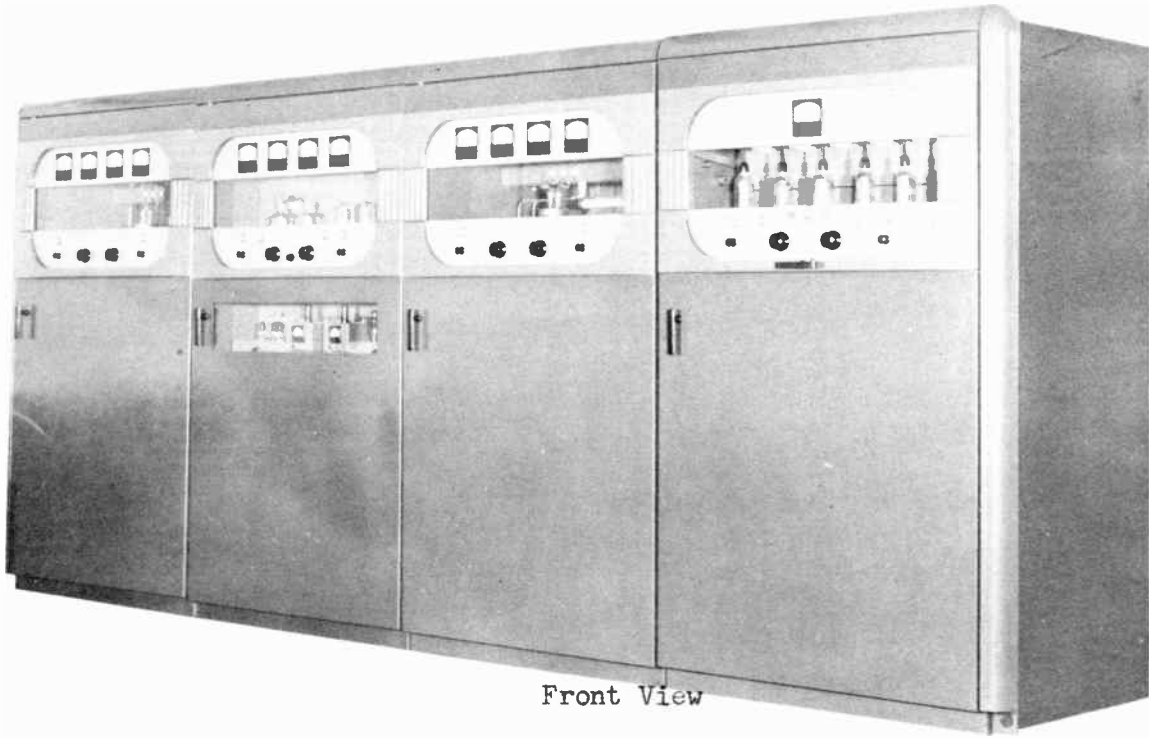

Simplified Schematic
 Figure 1-1 Model 21B Broadcast Transmitter

SECTION 1

GENERAL DESCRIPTION

1.1. GENERAL.

The Collins Type 21B, 5/1 kw standard AM Broadcast Transmitter has been designed particularly for high fidelity



Figure 1-2 Oscillator Unit Removal

broadcast service. Numerous outstanding features are incorporated throughout the equipment to meet the demands for better service that is required of Modern Broadcast Equipment.

1.2. MECHANICAL DESCRIPTION.

1.2.1. GENERAL. - The transmitter is constructed in four cabinets neatly styled for impressive appearance. The complete equipment occupies a space 37-1/2" deep by 15' wide by 79-5/16" high and weighs approximately lbs. For accessibility and serviceability, many component parts are mounted on vertical chassis. With this arrangement it

is a simple matter to gain access to components if necessary. Tube spars have been arranged with a cover that can be easily removed to make all parts thereunder readily accessible. For service and maintenance purposes, large hinged doors are provided. With the transmitter closed, complete tube visibility is procured by means of large glass windows incorporated in the front doors. Each door of the transmitter is arranged with a positive wedge type door switch which removed low voltage as well as high voltage when opened. In addition, a mechanical safety device consisting of a metal plate and three contacts has been incorporated on the front doors as well as on the rear doors. This safety device will short out the high voltages that appear within the particular cabinet when these doors are open. The previously mentioned door switch opens the control circuit prior to the mechanical high voltage shorting operation and upon closing the doors the high voltage shorting plate is removed from the shorting position before the door switch is closed.

All meters are placed in an easily read position on the front doors of the cabinets. Their location enables the operating personnel to operate the tuning controls while observing the meter indications, at or near eye level.

1.2.2. CONTROL SYSTEM. - All operating controls in the 21B transmitter are conveniently located on the front doors of the cabinets. All major tuning controls are motor driven and function through the Adjust Knobs. The three Filament Start-Stop stations as well as the four Plate Start-Stop stations each consist of a single control which is pulled for starting and pushed for stopping opera-

tions. This arrangement enables the operators to promptly find the right switch in case of emergency.

1.2.3. VENTILATION. - The air necessary for ventilating this equipment is drawn in at the bottom rear of each cabinet. Ventilation blowers located in the final amplifier and modulator cabinets are arranged so that their output is directed to the radiator of the air cooled tubes. The air is forced along the front surface of the exciter bay vertical chassis where the tubes are mounted.

This method provides quick elimination of air around the heated tubes. The output of the blower in the rectifier and control bay is directed to the bases of the high voltage rectifier tubes. Components mounted on the rear of these vertical chassis are cooled by convection aided by the draft created by the ventilating blowers. The exhaust air leaves the cabinets through large openings in the roof of each cabinet. Dust traps have been installed at the ventilating opening in the roof to prevent dust from settling on the equipment during the period when the transmitter is not in operation.

1.3. ELECTRICAL DESCRIPTION.

1.3.1. GENERAL. - The 21B Transmitter is provided with A-C overload protection by means of magnetic circuit breakers placed in the control circuit, the blower circuits, the filament circuits and low voltage circuit, the intermediate voltage primary circuit and by means of overload relays in the high voltage primary circuit. The modulator, r-f power amplifier and the r-f driver are equipped with d-c overload protection. The high voltage primary circuit, the modulator and r-f driver overload relays are adjustable and provide visible means of observing which has been tripped due to

an overload. In addition, means is provided to operate the overload circuit should the ratio of r-f carrier current to the final amplifier plate current change appreciably. The overload circuit is equipped with a "3 shot" overload system which, upon an overload, will return the plate power at full power once and at reduced power once before turning the intermediate and HV completely off.

Instantaneous power change is accomplished without any interruption of program, by simply rotating a switch on the front panel.

1.3.2. VOLTAGE SUPPLY. - The transmitter employs three power supplies. The high voltage supply employs six type 8008 half wave mercury vapor rectifiers in a 3 phase full wave circuit and furnishes d-c voltage for application to the plates of the power amplifier and modulator tubes. The intermediate voltage power supply employs four type 8008 tubes in a single phase bridge circuit to obtain two voltages of approximately 1450 and 3000 volts for application to the 845 audio driver plates and to the 4-125A R-F driver plates respectively. The low voltage supply employs two type 8008 mercury vapor rectifier tubes connected in a single phase full wave rectifier circuit. This supply is arranged so that a low voltage of about 500 volts is obtained and a bias of 100 volts is available. This bias is supplied to the modulator tubes and to the r-f driver stage.

1.3.3. AUDIO SYSTEM. - The audio system in the 21B is push-pull triodes throughout the four stages. The first stage employs two type 6N7 tubes, the second, two 6A5G or 6B4G tubes, the driver stage four type 845 tubes and the modulator two type 892R tubes operating Class B. 2 feedback loops are incorporated, from the plates of the modulator tubes to the

the plates of the modulator tubes to the grids of the input stage for stabilization and reduction of noise from the plates of the 845's to the grids of input stage.

1.3.4. R-F CIRCUITS. - The r-f section of this transmitter is a straight forward design. Proper circuit Q's are maintained throughout the entire broadcast band. Inductive tuning is used where it is an advantage, and circuit Q is important.

Two complete plug-in type oscillator units are provided in the equipment. Either one may be chosen for operation by an oscillator selector switch located on the front door. A type 807 beam pentode tube operating Class AB is employed in the isolation stage following the oscillator. The buffer amplifier utilizes two 807's connected in parallel and operating Class C. Following the buffer amplifier is the intermediate amplifier stage employing two 4-125A tubes. The r-f power amplifier utilizes one 892R employing simple coil neutralization. The output network is a combination pi-network followed by an "L" matching section. Provisions have been made in the r-f section for connecting a frequency monitor, audio monitor and modulation monitor.

1.4. REFERENCE DATA

1.4.1. FREQUENCY RANGE.-This transmitter will operate on any one frequency in the range of 540 to 1600 kc. After the frequency of operation has once been set, any substantial change in frequency will require modification of the tank circuit and neutralizing components.

1.4.2. CHARACTER OF EMISSION.-The modulation system of the 21B transmitter is designed to provide full 100% modulation of the carrier at modulating frequencies between 30 and 10,000 cps. The frequency response is constant within

plus or minus 1.5db of the mean value between 30 and 10,000 cps and ± 0.75 db between 100 and 7500 cps. The audio frequency distortion is less than 3% up to 95% modulation. The residual noise level is 60 db below the 100% modulated full power level and 50 db below 100% mod. in one fifth power. The carrier shift with modulation factors up to 1 is less than three per cent.

1.4.3. POWER OUTPUT. - The transmitter will deliver 5500 w. max. of radio frequency power, on any frequency within the range of 540 to 1600 kc, into an essentially resistive load, (75 ohms is standard; other impedances are available). Provision is made for instantaneous reduction to one-fifth power by reducing the plate voltage on the power amplifier and modulator tubes.

1.4.4. POWER SOURCE AND INPUT REQUIREMENT.- This equipment has been designed to operate from a 208 or 230 volt, 3 phase, 60 cycle power system. The maximum power demand at 100% modulation with a modulating frequency of 400 cps is approximately 24 kw at a power factor of 85%

1.4.5. AUDIO INPUT. - An audio input level of approximately 10 dbm is required for full 100% tone modulation. The audio input impedance is 600 ohms standard; and 150 ohms is available.

1.5. VACUUM TUBE COMPLEMENT.

The vacuum tubes employed in the 21B equipment are listed below:

<u>Qty.</u>	<u>Tube Type</u>	<u>Function</u>
2	6F6	R-F Oscillator
1	807	Isolation Amplifier
2	807	Buffer Amplifier
2	4-125A	Intermediate Amplifier
1	892R	R-F Power Amplifier
2	6N7	1st Audio Amplifier
2	6A5G/6B4G	2nd Audio Amplifier

Vacuum Tube Complement (Cont.)

<u>Qty.</u>	<u>TTube Type</u>	<u>Function</u>	<u>Qty.</u>	<u>Tube Type</u>	<u>Function</u>
4	815	Audio Driver			
2	892R	Modulator	2	8008	LV Rectifier
6	8008	HV Rectifier	2	0C/VR105	Voltage Regulators
4	8008	Int. Voltage Rectifier	1	5U4G	R-F Rectifier

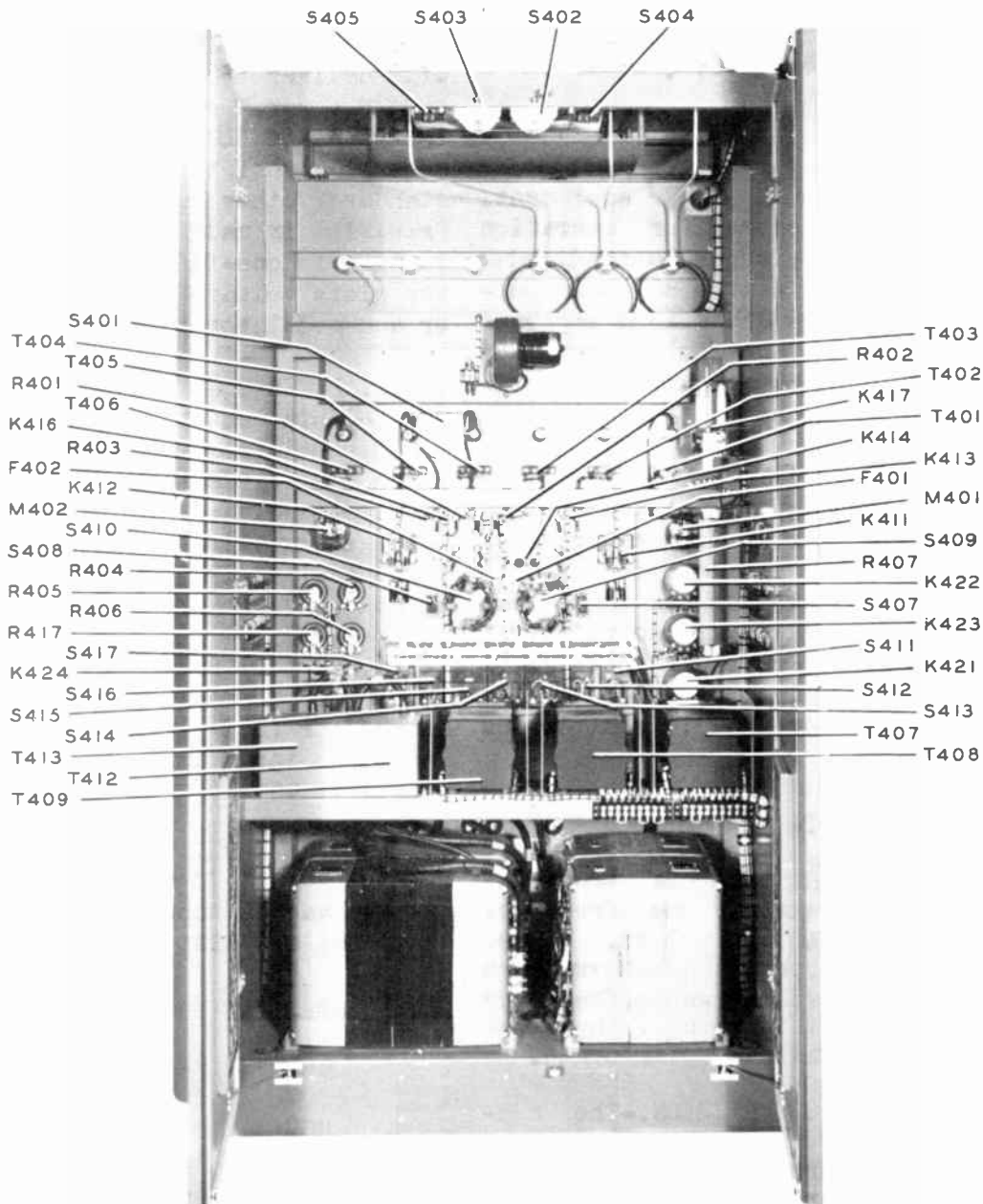

Figure 2-1 Rectifier Bay - Inside Rear View

SECTION 2

INSTALLATION OF TRANSMITTER

2.1. PREPARE INSTALLATION.

2.1.1. PRELIMINARY.

(a) Unpacking. - Caution should be used when uncrating to avoid damage to the equipment. All units should be inspected carefully. Inspect each unit for loose screws and bolts. Check all controls such as switches etc., for proper operation as far as can be determined without the application of power. Inspect cables and wiring and make sure that all cable connections are tight. All claims for damage should be filed promptly with the transportation company.

2.1.2. INSTALLATION PROCEDURE.

(a) 21B Transmitter. - The transmitter is shipped with the heavier iron core units as well as some of the more fragile parts removed from the cabinets. It is recommended that no attempt be made to place these components in position until the cabinets have been permanently placed on the transmitting room floor. If the floor is not extremely level, it may be necessary to make a base from 2 x 6 lumber to set the transmitter on; otherwise, it will be almost impossible to bolt the cabinets together. This base should make contact with all four sides of each cabinet. Refer to figures 2-1 thru 2-6 to simplify placement of components that were removed when the equipment was prepared for shipment. Wires that are removed from the units to which they connect are tagged before shipment. Should any of these tags become lost, refer to the various cabling diagrams for assistance in identifying such leads. The comparatively simple arrangement to accommodate the wiring at the base of the transmitter is outlined in figure 2-6. The requirements

of the illustration may be met by suitably installing the necessary conduit in a concrete floor or by the installation of a conduit trench of sufficient size. Another alternative would be to install a false floor under which the necessary wiring may be placed. A grounding strap should be installed along one edge of the conduit trench to which each cabinet should be connected as it is placed into position.

Adequate clearance should be allowed in front of the units to fully open the doors. There should be a clearance of at least 4 feet at the rear of the transmitter for installing and removing the components in the transmitter. If possible, clearance should be arranged for at the ends of the 21B unit to assist in making the external connections and permit placement of the end covers. Special end covers are furnished for in-the-wall mounting. It is very important that the walls be exactly perpendicular to the floor.

If an antenna phasing unit is necessary, a blank cabinet can be obtained from the Collins Radio Company which will match the transmitter cabinets in size and appearance.

(b) Inter-Unit Wiring. - For the purpose of identification on the cabling diagrams each unit has been assigned an arbitrary letter designation. These unit letters are used as a suffix when referring to the terminals on any unit. Inter-unit wiring on the cabling schematics is indicated by showing at any terminal the type of wire and the terminal and unit to which each wire routes.

The following tabulation lists the unit letters and description of the various units in the transmitter:

INSTALLATION OF TRANSMITTER

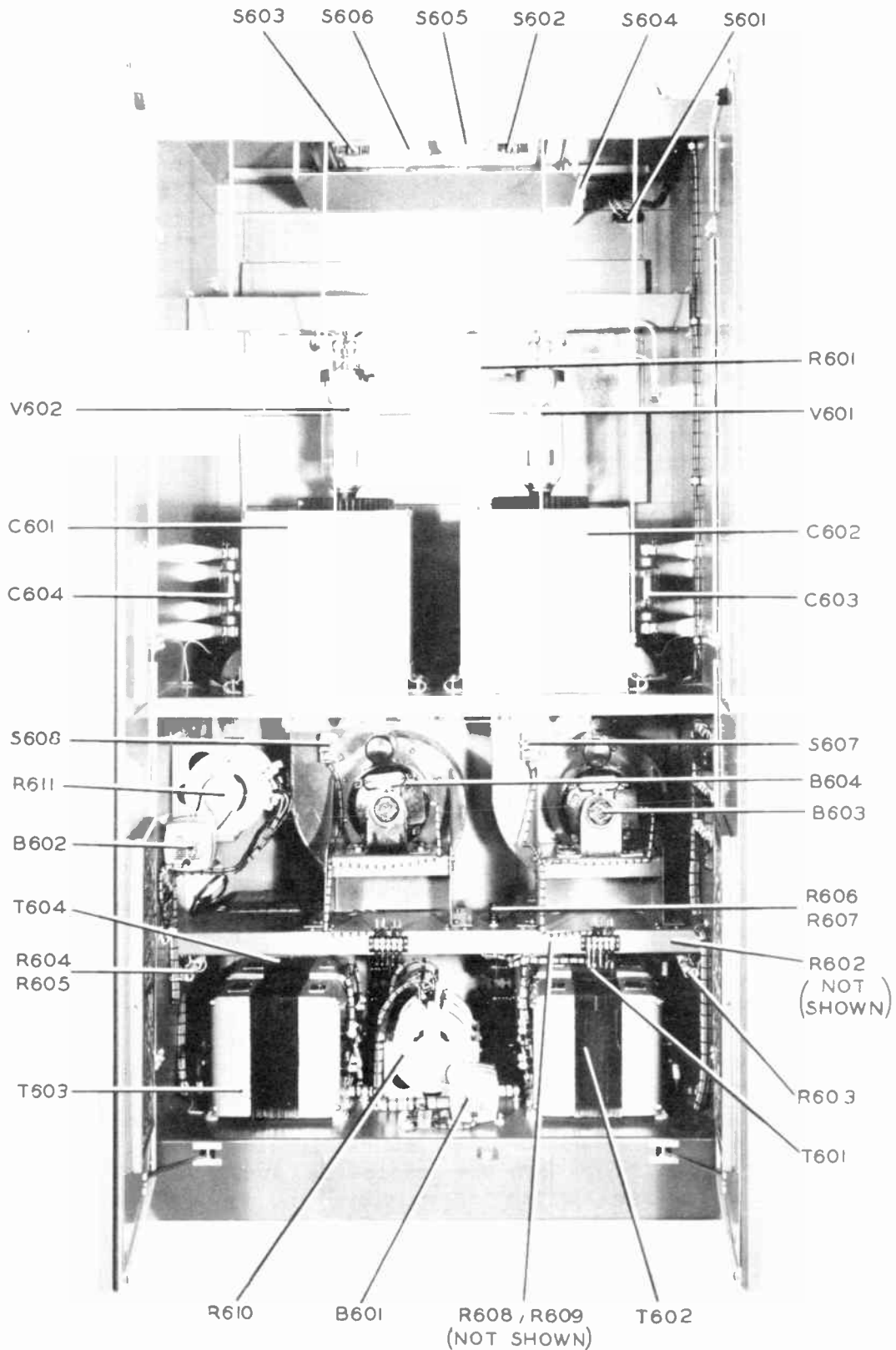

Figure 2-2 Modulator Bay - Inside Rear View

<u>UNIT LETTER DESIGNATION</u>	<u>UNIT DESCRIPTION</u>	<u>UNIT LETTER DESIGNATION</u>	<u>UNIT DESCRIPTION</u>
<u>A</u>	<u>Final Amplifier Bay</u>	<u>F</u>	<u>Modulator Door</u>
AA	Connector for Door Circuits	FA	Door Connector
AB	Connector for Door Circuits	FB	Door Connector
AC	Final RF Amplifier	FC	Instrument Panel
AD	Blower Spar	FD	Control Panel
AE	Overload Rectifier		
AF	Filament Transformer	<u>G</u>	<u>Rectifier Bay</u>
AG	Intercabinet Cable	GA	Connector for Door Circuits
<u>B</u>	<u>Final Amplifier Door</u>	GB	Cabinet Roof
BA	Door Connector	GC	HV Rectifier
BB	Door Connector	GD	Control Unit
BC	Instrument Panel	GE	Transformer Deck
BD	Control Panel	GF	Cabinet Base and Wall
		GG	Remote Cable
		GH	Intercabinet Cable
<u>C</u>	<u>Exciter Bay</u>	<u>H</u>	<u>Rectifier Door</u>
CA	Connector for Door Circuits	HA	Door Connector
CB	Connector for Door Circuits	HB	Instrument Panel
CC	Cabinet Roof	HC	Control Panel
CD	Driver		
CE	Exciter	<u>J</u>	<u>External Components</u>
CF	Power Supply		
CG	Cabinet Base		
CH	Intercabinet Cable		
<u>D</u>	<u>Exciter Door</u>		
DA	Door Connector		
DB	Door Connector		
DC	Instrument Panel		
DD	Control Panel		
<u>E</u>	<u>Modulator Bay</u>		
EA	Connector for Door Circuits		
EB	Connector for Door Circuits		
EC	Modulator		
ED	Blower Spar		
EE	Cabinet Base		
EF	Intercabinet Cable		

The order of designation of inter-unit cabling is as follows: When a wire terminates on a single numbered terminal on a unit, the wire route is from the source to the terminal on the specified unit and is indicated by the terminal number followed by the unit letter designation. There is a wire starting from terminal number 61 on Unit AC which terminates on terminal number 61 of Unit AG. Therefore, an arrow at terminal number 61 on Unit C indicates that the wire routes to terminal 61G, and the arrow is designated 61G. An arrow from terminal number 61 on unit AG indicates that the particular wire in question is terminated on terminal number 61, Unit AC. The designation at the end of the arrow is 61C.

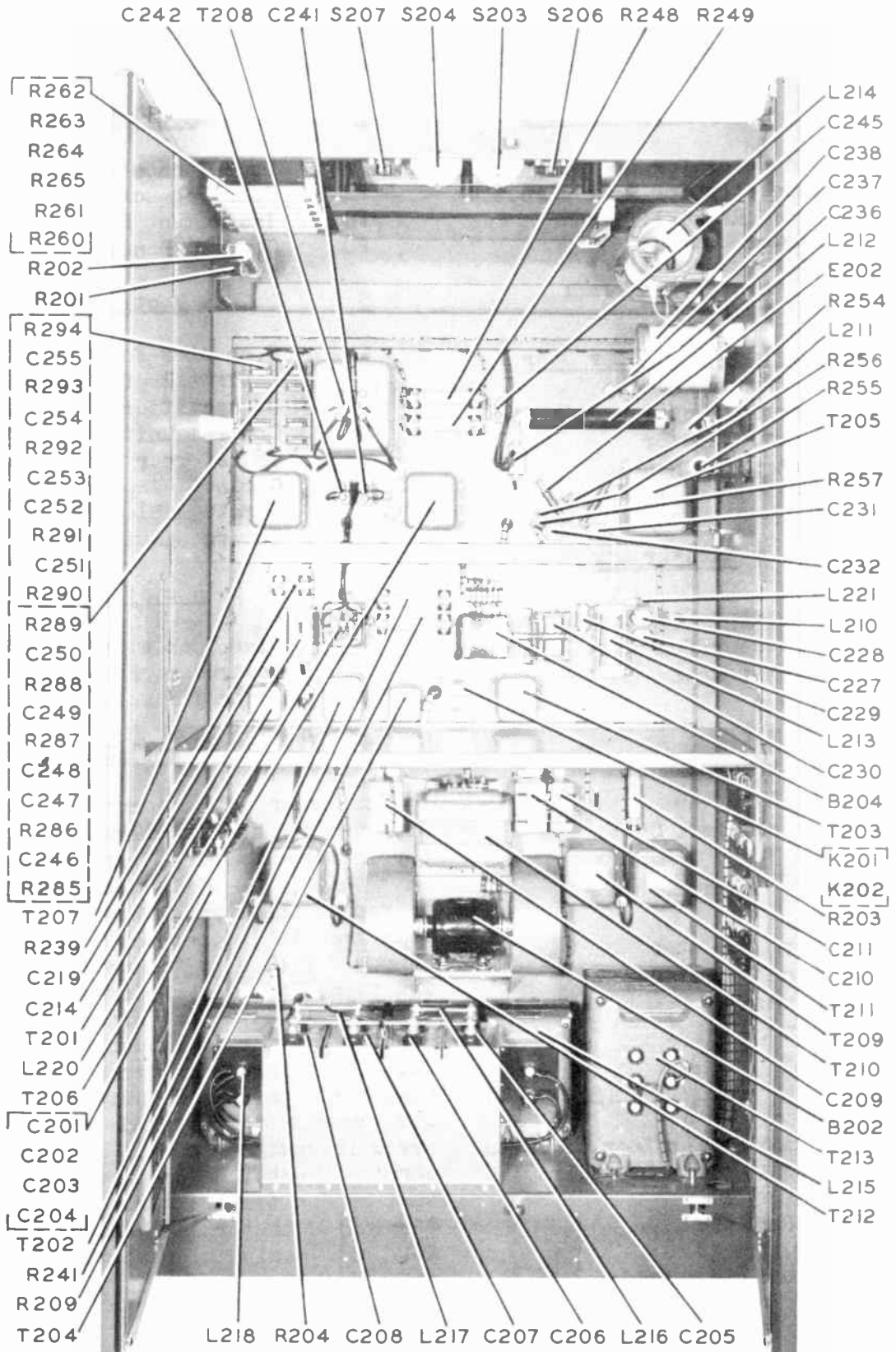

Figure 2-3 Exciter Bay - Inside Rear View

Every wire within the transmitter, going between units or between cabinets, is given a number. Regardless of where this number appears, it is the same wire that carries that number in another unit. This provides easy means of tracing circuits and locating trouble. The cable between cabinets is arranged on easily accessible groups of terminal strips, (refer to figure 2-4) each numbered in accordance with the cabling numbering system. A special terminal strip provides connections for any remote control required or additional control circuits that might be desirable.

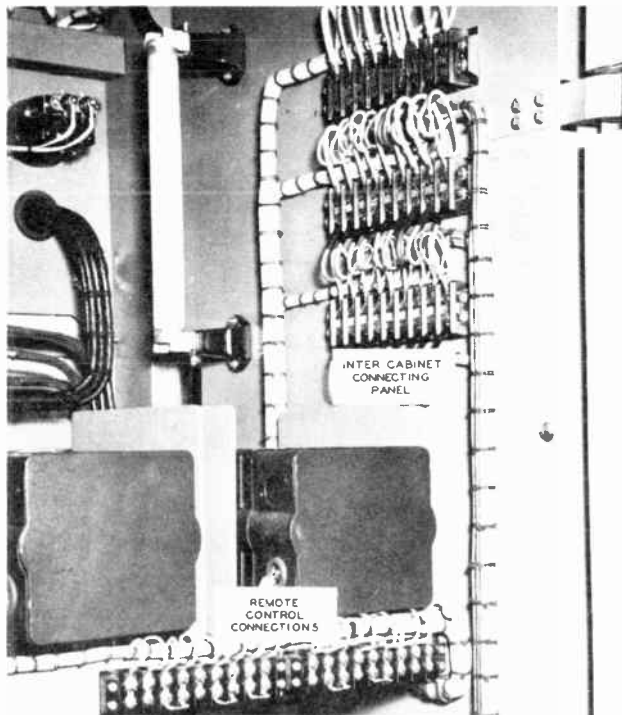
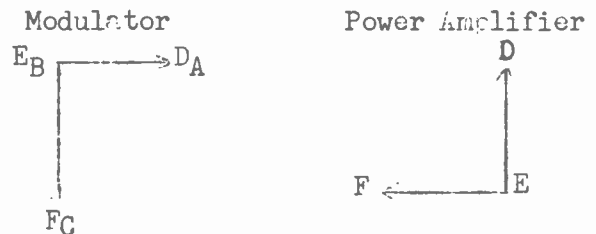

Figure 2-4 Intercabinet Connecting Panel

The filaments of the rectifiers in the high voltage supply are connected in a quadrature arrangement and care should be taken to see that the filament transformers are connected exactly as the schematic and wiring diagrams indicate. This will result in longer rec-

tifier tube life. The constant voltage transformers to which the filament transformers are connected have a 120° phase shift.

The power amplifier and modulator filaments are connected in special noise reducing circuits and must be connected correctly if advantage is to be taken of this feature. Follow the schematics and photographs implicitly and check the results with vector analysis. Viewing the tube filament terminals from the front of the cabinets, hypothetically letter the terminals from left to right A, B, C, D, E and F. Measure the voltages from A to B, A to C and so on. Then measure B to C, B to D etc. Continue in like manner until a complete set of voltage measurements have been taken. Plotting the results in vector form, the configurations should look thus:



2.1.3. EXTERNAL CONNECTIONS. (Refer to figure 2-6.)

(a) Power Connections. - The primary power connections are located in the rectifier cabinet in the front lower left hand corner of the vertical chassis. They are enclosed within a dust cover which can be removed by pulling straight up. The power input cable should be brought through the grommet hole to terminals 1, 2 and 3, on the terminal strip. The power cable should have a rating of 75 amperes max. capacity. It is necessary that a main Station switch be installed in the power line and it is recommended that its location be convenient to the transmitter so that the

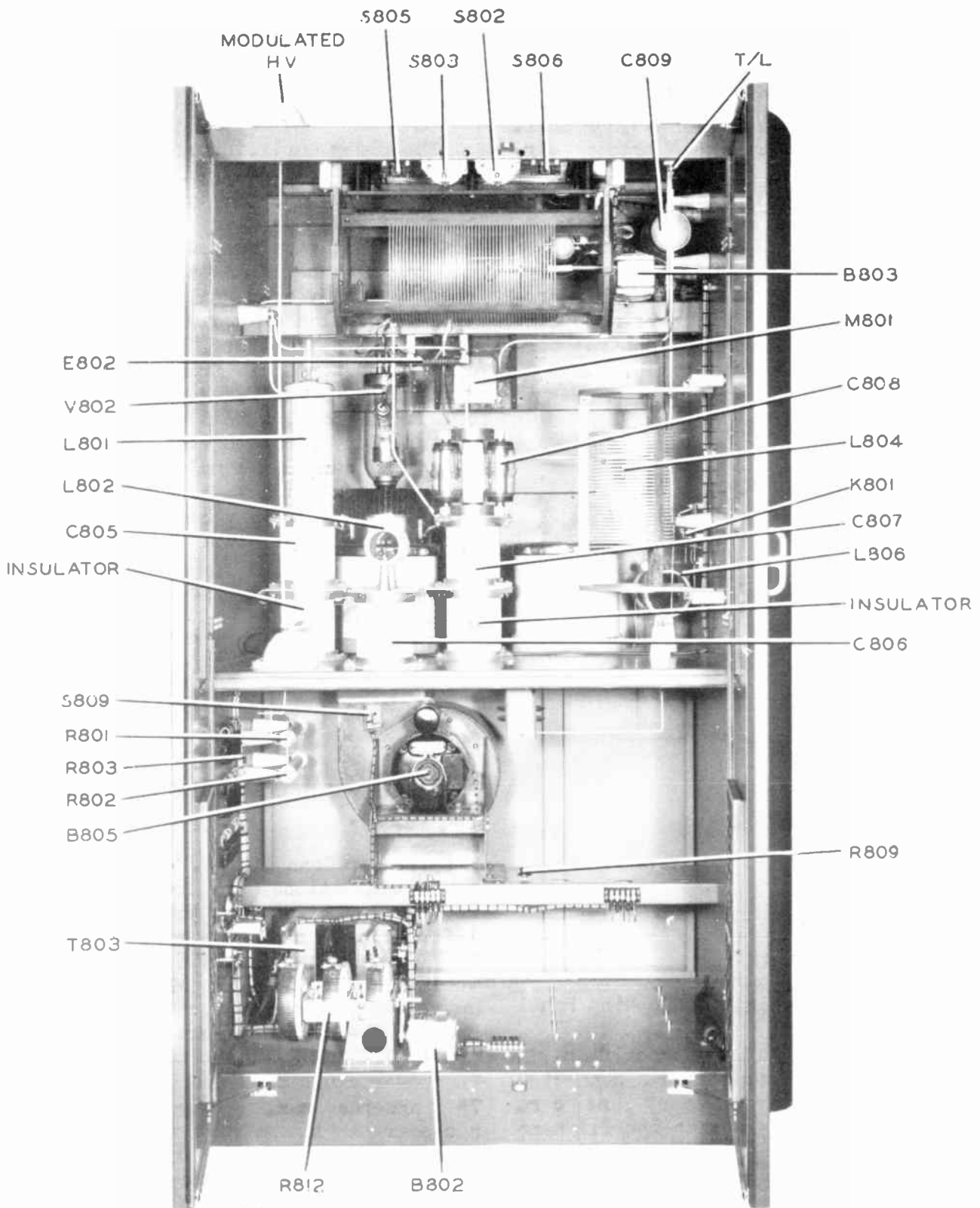
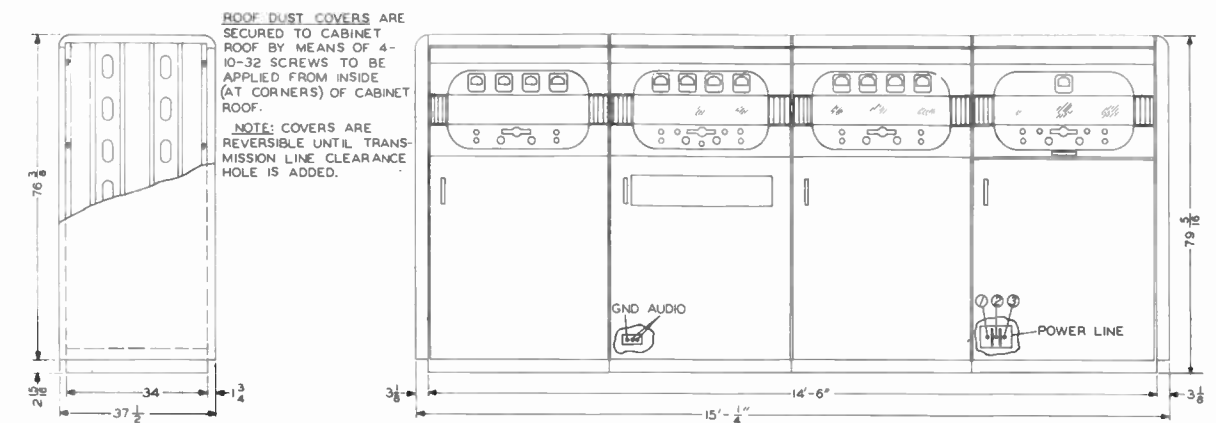
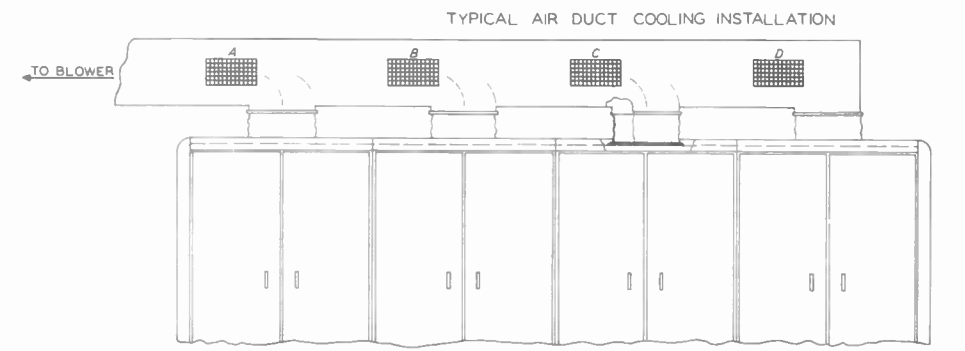
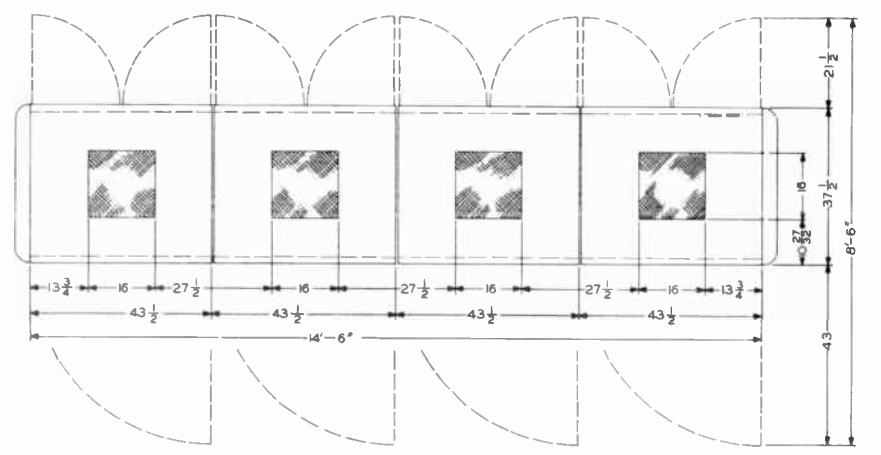

Figure 2-5 Power Amplifier Bay - Inside Rear View

~~(21L Shown, 21B has only one 892R and associated equipment.)~~



ROOF DUST COVERS: EACH IS SECURED TO CABINET SIDE CHANNEL FLANGES BY MEANS OF 8-1/4-20 SCREWS. ADJUSTMENT AND ALIGNMENT IS PROVIDED FOR BY MEANS OF VERTICAL SLOTS IN FLANGES. CLEARANCE HOLES ARE PROVIDED FOR TIGHTENING SCREWS FROM INSIDE OF CABINET.
NOTE: SIDE DUST COVERS ARE INTERCHANGEABLE UNTIL CLEARANCE HOLE FOR THE TRANSMISSION LINE IS ADDED.



SUGGESTED ALTERATIONS OF AIR DUCT FOR HEATING TRANSMITTER ROOM
A,B,C,D - RADIATORS - WITH AIR CHECKS FOR SUMMER OPERATION

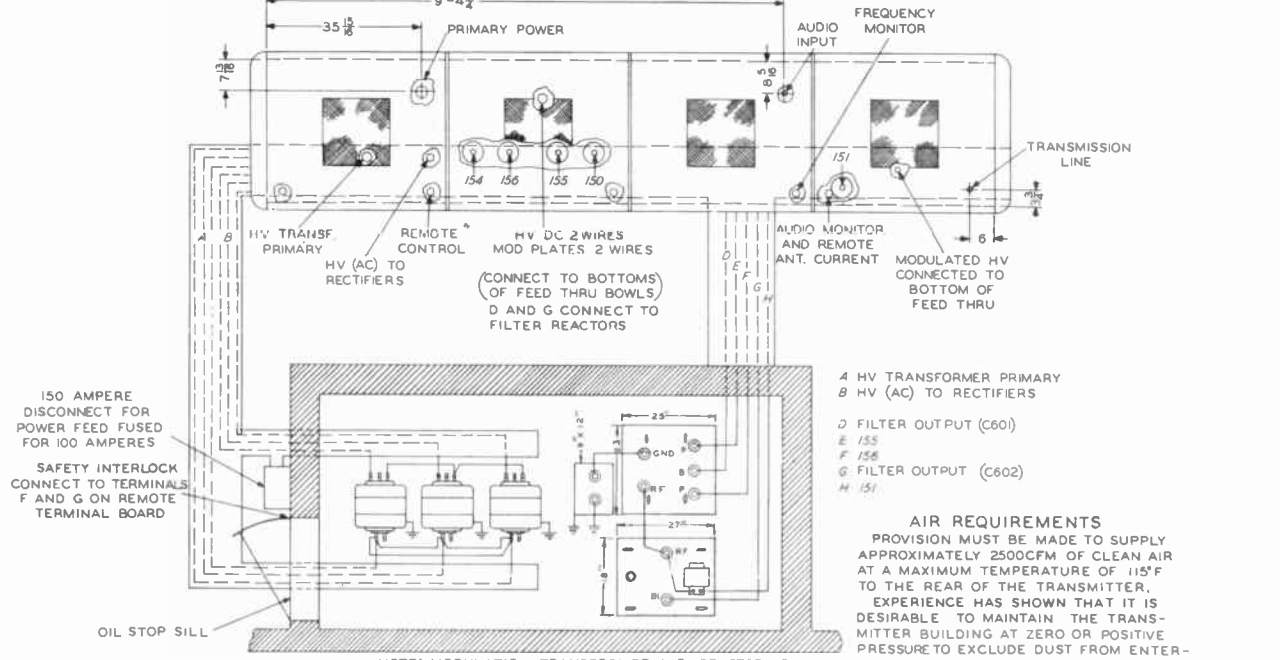
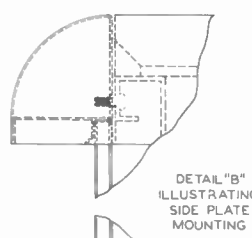
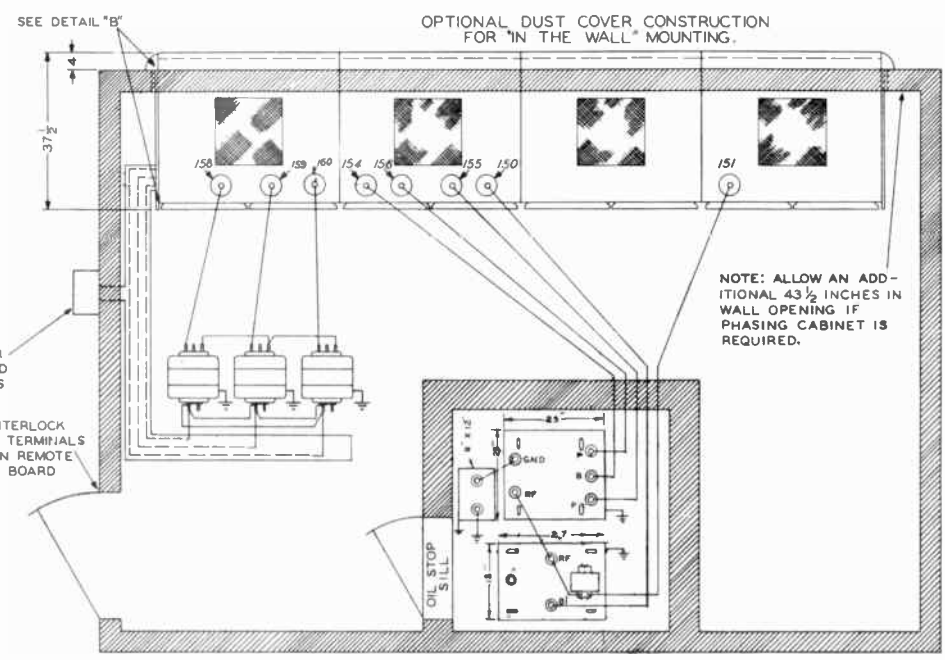
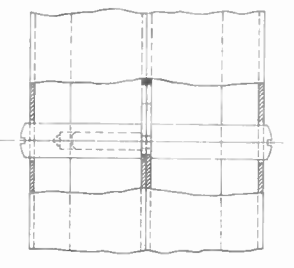
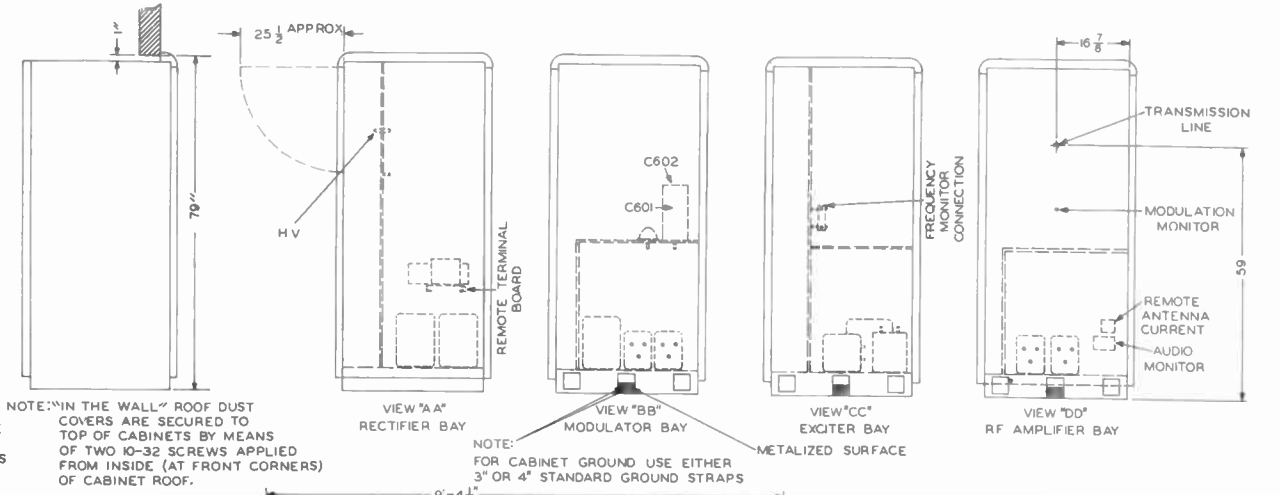
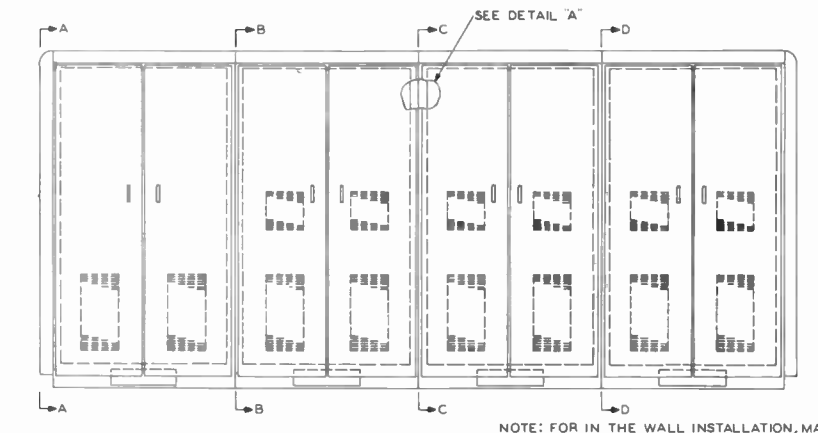

AIR REQUIREMENTS
PROVISION MUST BE MADE TO SUPPLY APPROXIMATELY 2500CFM OF CLEAN AIR AT A MAXIMUM TEMPERATURE OF 115°F TO THE REAR OF THE TRANSMITTER. EXPERIENCE HAS SHOWN THAT IT IS DESIRABLE TO MAINTAIN THE TRANSMITTER BUILDING AT ZERO OR POSITIVE PRESSURE TO EXCLUDE DUST FROM ENTERING THE BUILDING THRU CRACKS, ETC. PROVISION MUST ALSO BE MADE TO EXHAUST AN EQUIVALENT AMOUNT OF AIR FROM THE TOP OF THE TRANSMITTER.

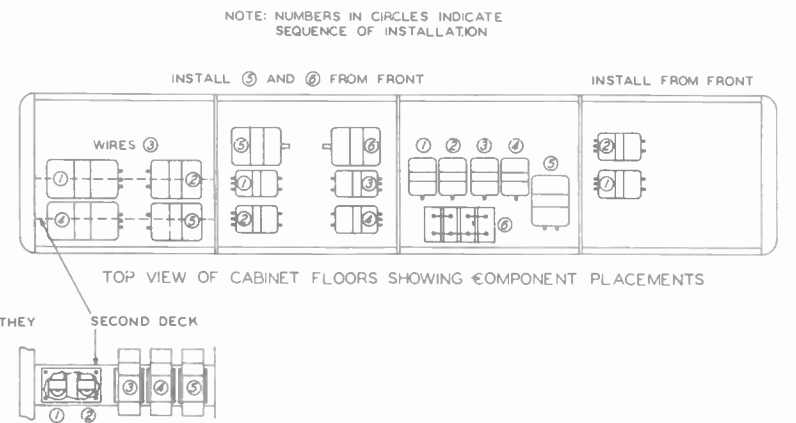
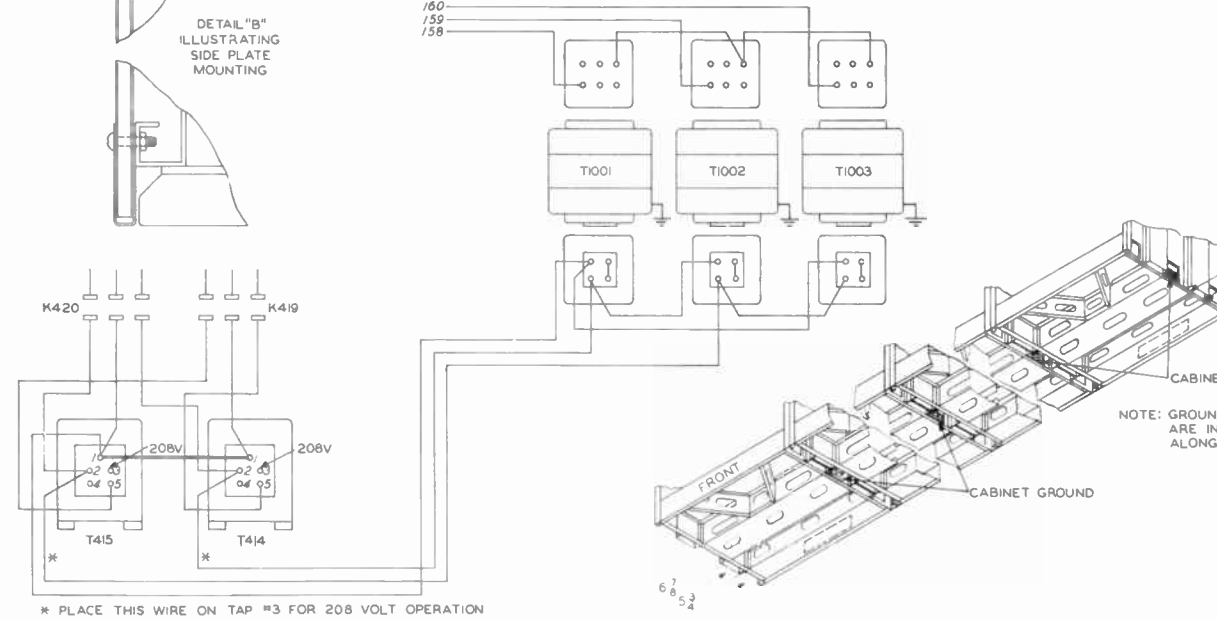

Figure 2-6 Installation Drawing

power line may be completely disconnected before attempting any major servicing of the equipment.

The crystal heat transformer T204 can be operated from either a 115 volt or 208/230 volt source. If the transformer is to be operated from a 115 volt source use terminals 1 and 2 of transformer T204. A pair of unterminated wires have been run from terminals 208 and 209 on terminal board GH to a point just above crystal heat fuses F401 and F402 to be used for 115 volt operation. To find these wires, remove the cover from the wiring channel located just above the crystal heat fuses. Disconnect the 208/230 volt source from the crystal heat fuses and solder the unterminated wires in their place, after which connect a 115 volt source to terminals 208 and 209 on terminal board GH.

(b) Speech Input Connections. - The audio input connections to the transmitter are made to the two audio terminals located on the front of the exciter vertical chassis in the lower left hand corner. See figure 2-6. Remove the shield covering these by pulling straight up. These connections should be made by means of a twisted pair shielded cable. A ground connection is also provided here for grounding the shield.

(c) Antenna Transmission Line Termination. - The transmission line may be carried up the cabinet channel or may enter through the cabinet roof and the outer conductor or ground connection fastened securely to the Transmitter ground terminal. The inner conductor of the line should be connected to the T/L terminal standoff located near the top of the transmitter. Refer to figures 2-5 and 2-6 for locations. If a phasing cabinet is used, the phasing circuit connection can be made directly through the side walls of the cabinets.

(d) Monitoring Connections. - The modulation monitoring connection should be made to the isolantite feedthru located on the outside wall of the R-F Bay. A twisted pair or small coax line should be used connecting one wire to the terminal and the other to a chassis ground. See figure 2-7.

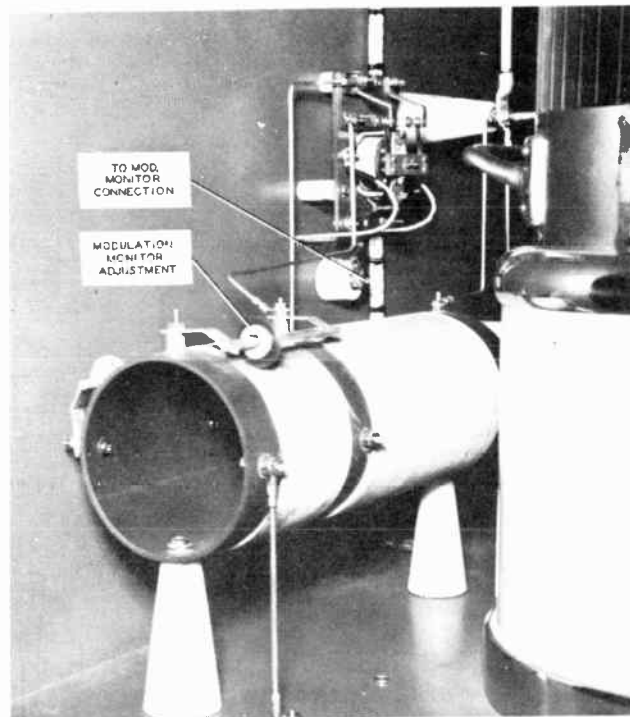

Figure 2-7 Modulation Monitor Connections

The audio monitor connections can be made to the 600 ohm - 150 ohm pad terminals located on the left wall of the Power Amplifier Bay (viewed from the rear) near the bottom of the cabinet. This connection is an unbalanced termination.

If the gain of the audio monitor requires R814 to be run near the full output position, a 6 db pad placed in the line will improve the frequency response curve to the monitor.

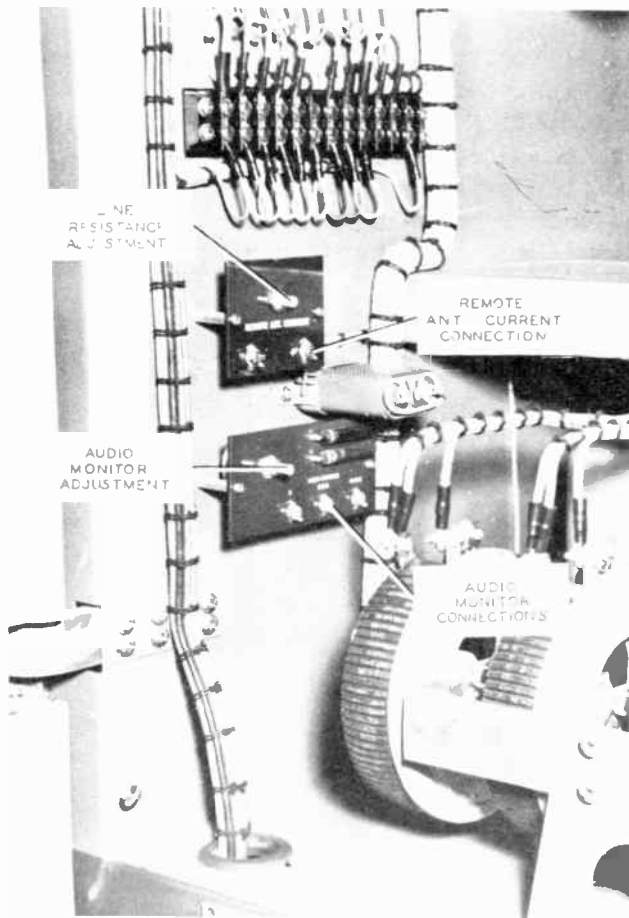

Figure 2-8 Audio Monitor and Remote Ant. Current Connections

The frequency monitoring connection is made to a binding post on L213 in the exciter cabinet. (See figure 2-9.)

(e) Remote Antenna Current Connectors. - Connections have been brought out to a terminal board located near the audio monitor connections in the Power Amplifier Bay. Connect the line from the remote thermocouple to these terminals for measuring the remote antenna current. Remote meter M901 requires 500 microamperes for operation. The total line resistance (including adjustment resistance) should not exceed 20 ohms. The line resistance adjustment is located near the connecting terminals. See figure 2-8.

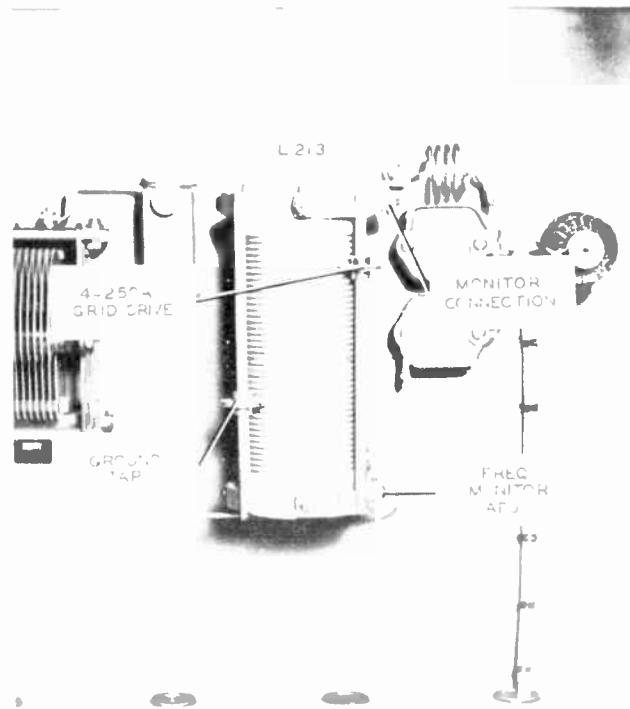

Figure 2-9 Frequency Monitor Connections

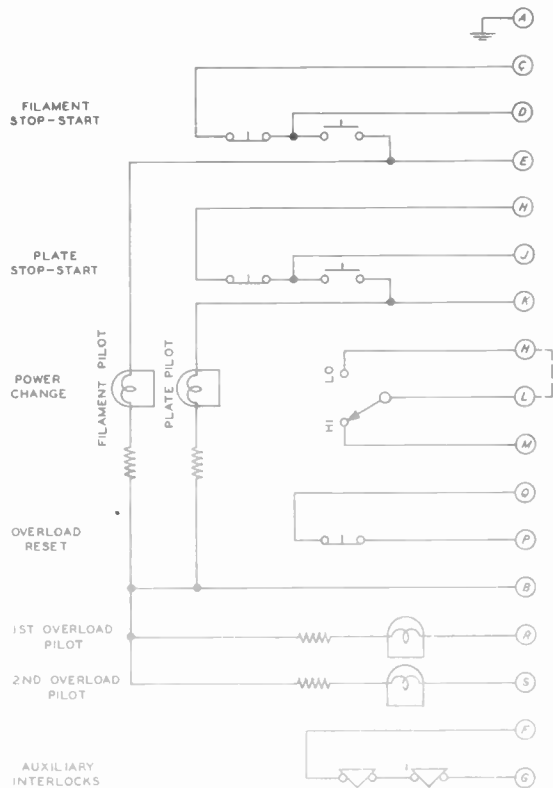

Figure 2-10 Remote Control Schematic

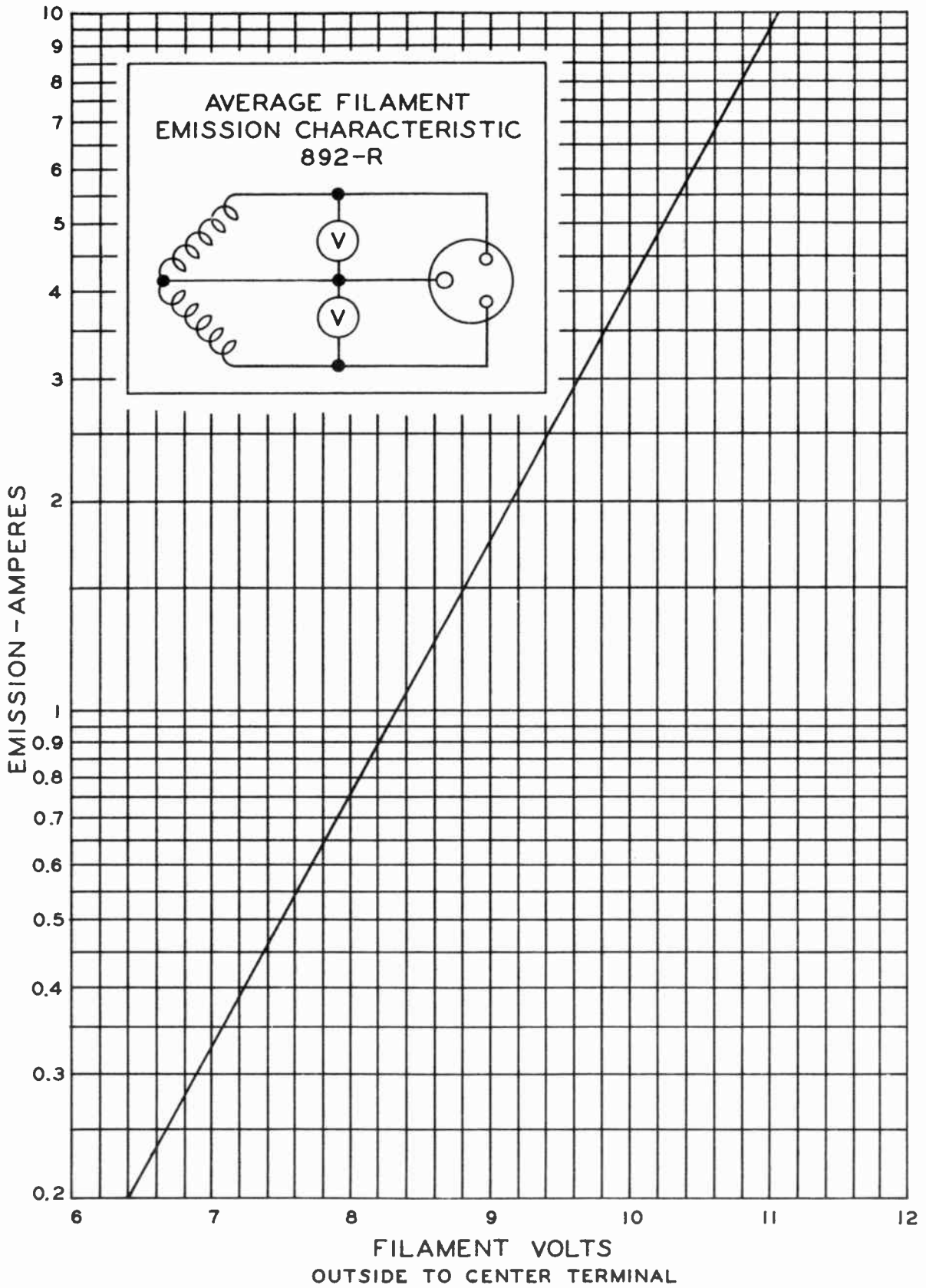

Figure 2-11 Average Filament Emission Characteristics For 892R Tube

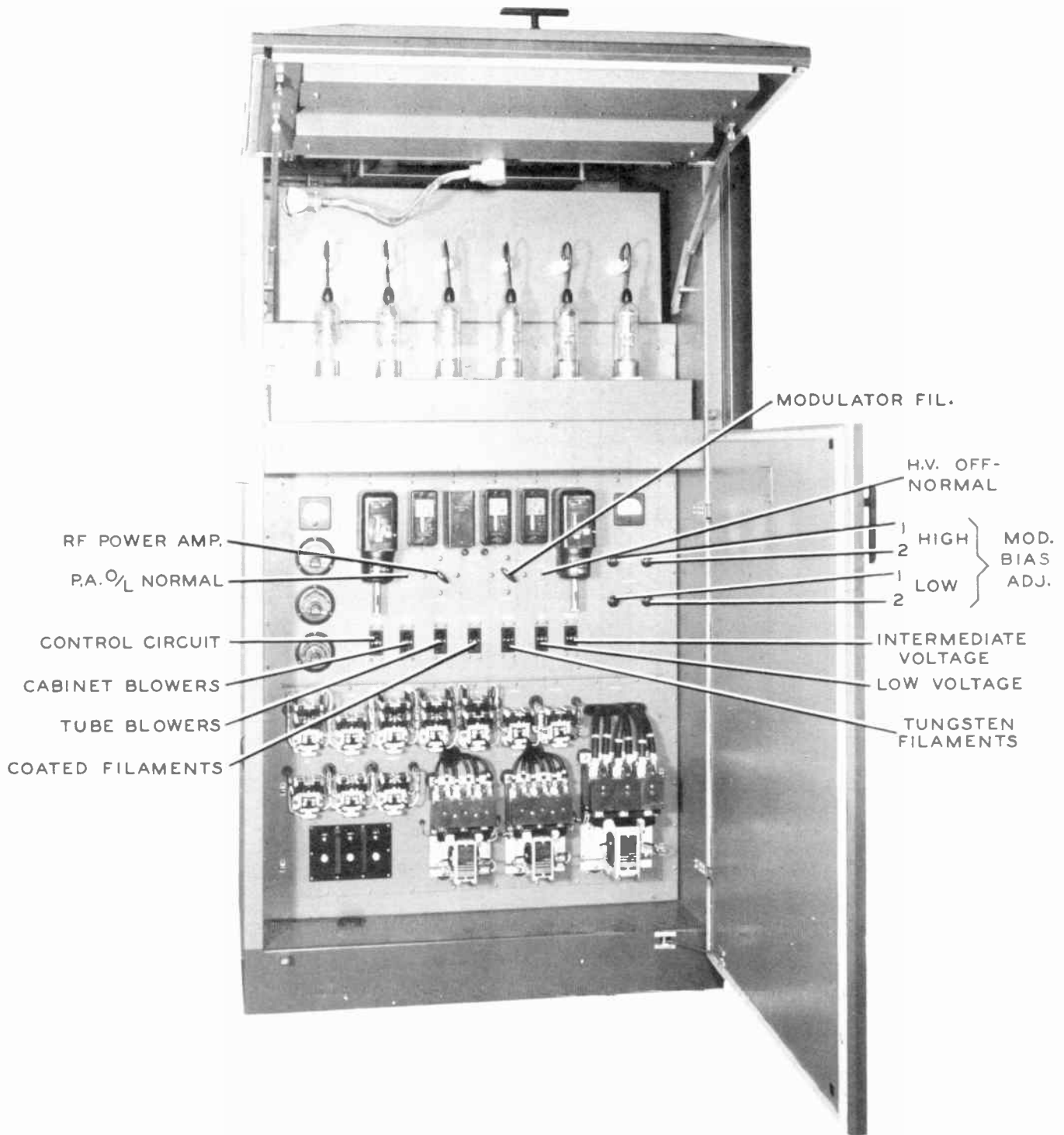

Figure 3-1a Functions of Controls

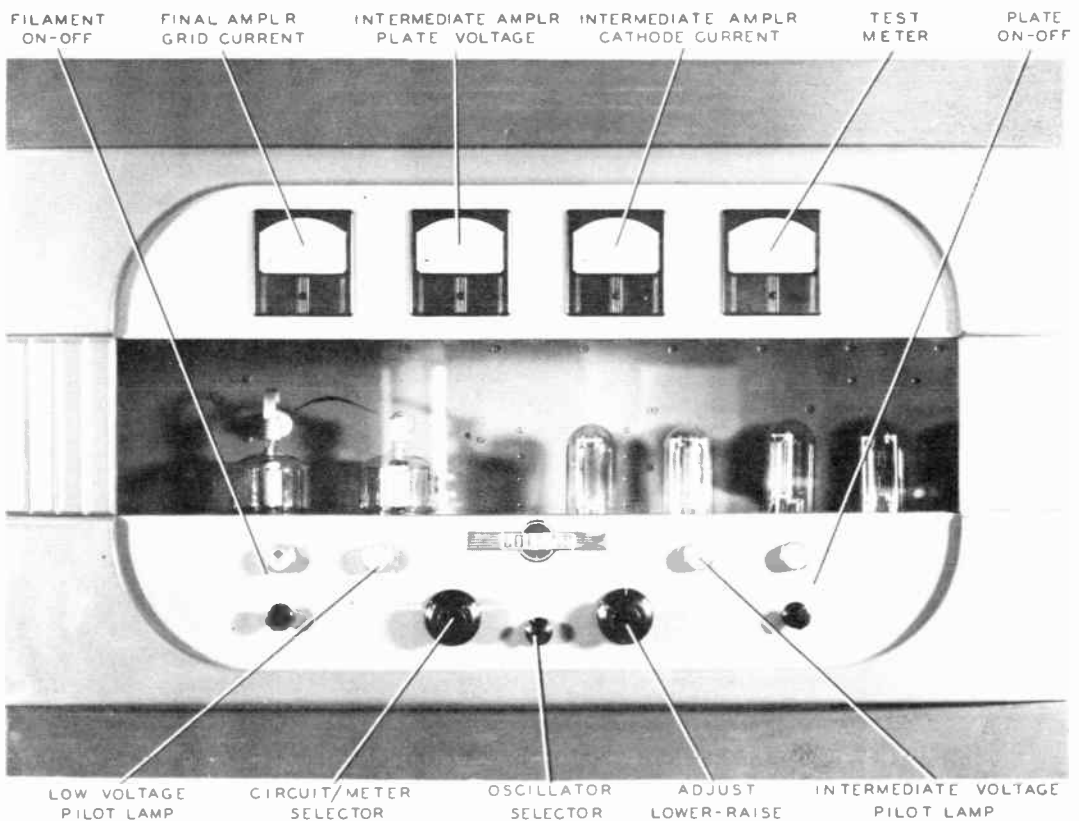
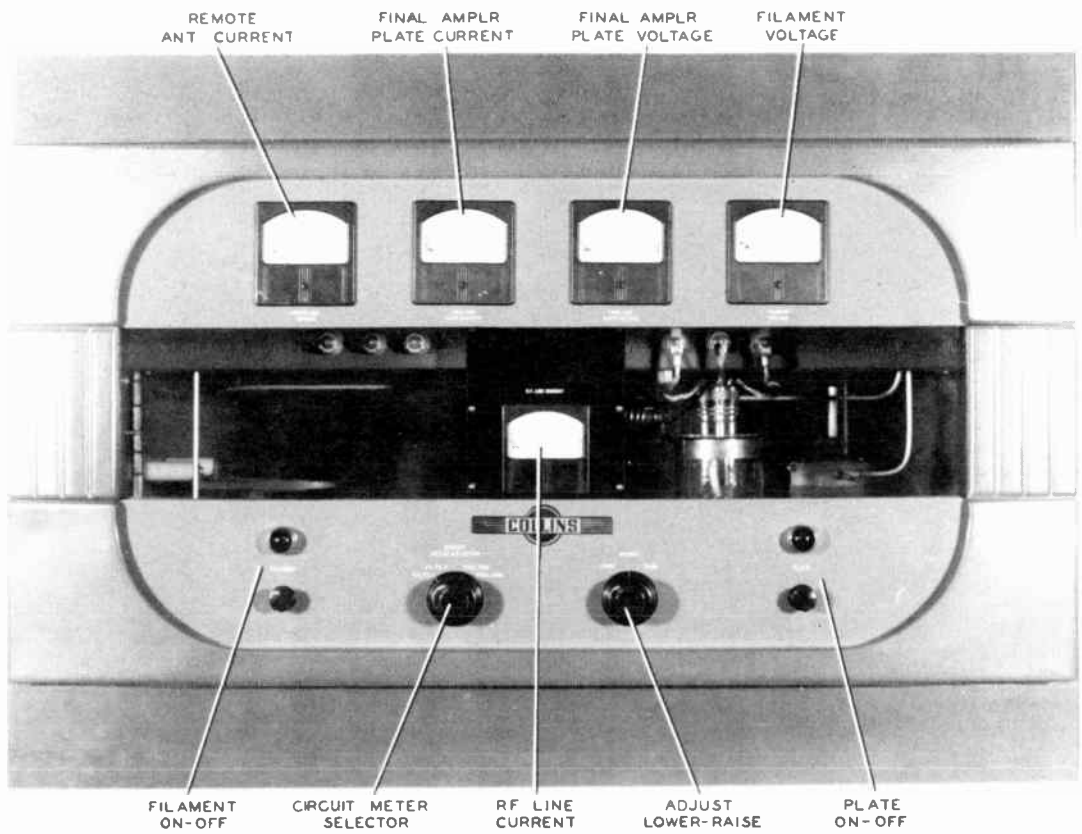

Figure 3-1b Functions of Controls (Page 1 of 2 Pages)

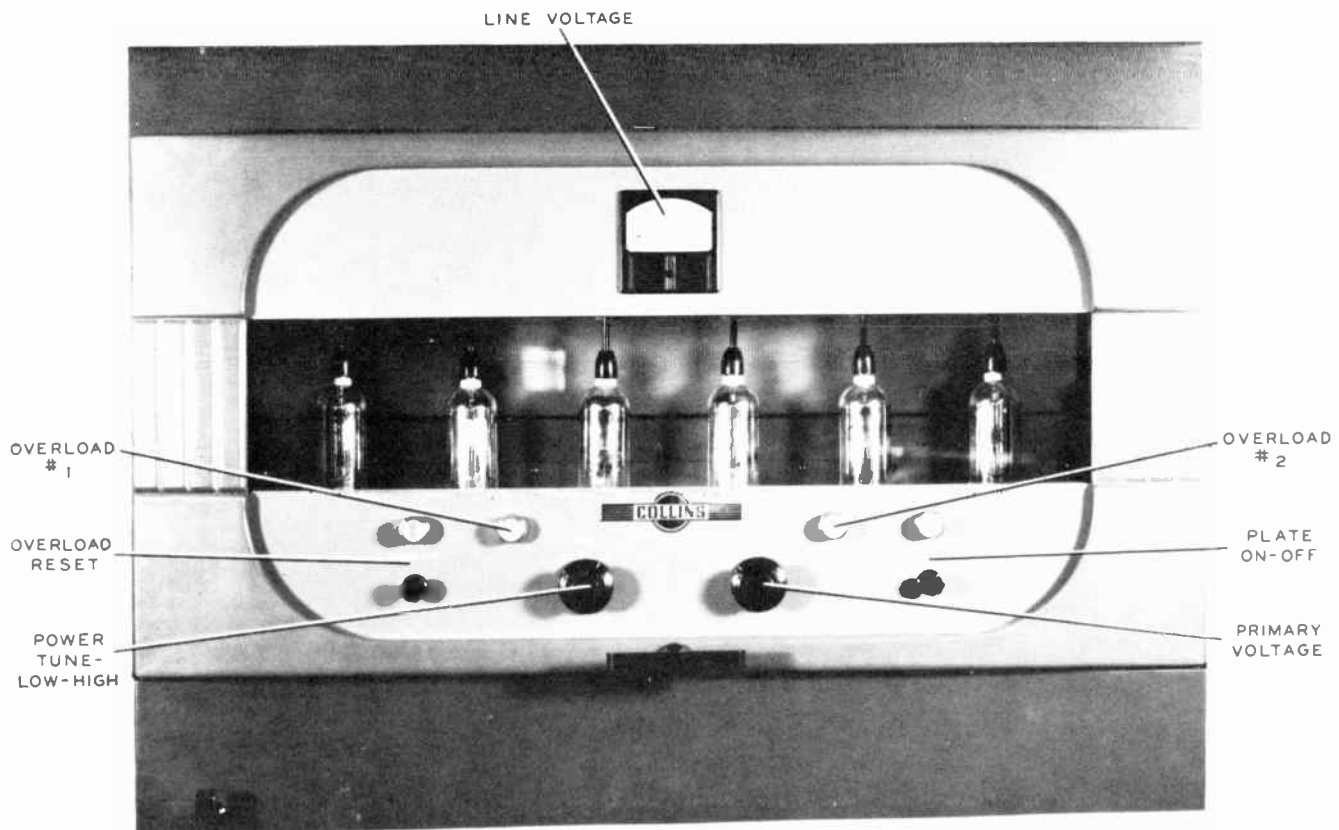
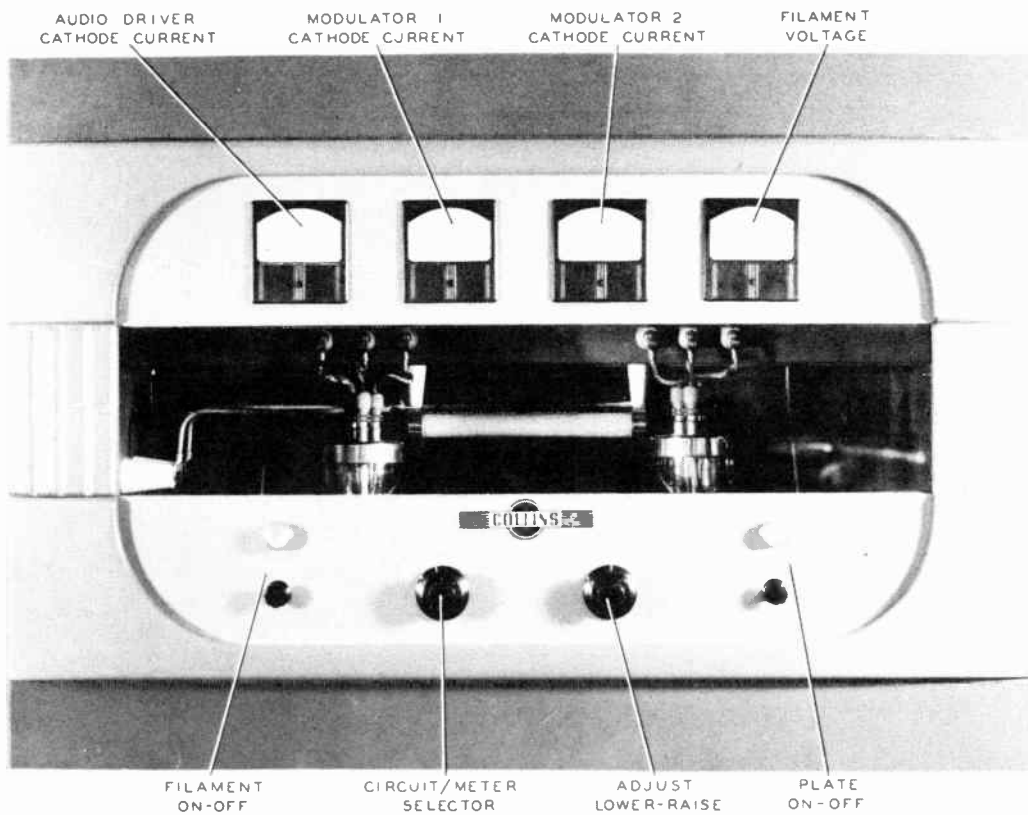

Figure 3-1b Functions of Controls (Page 2 of 2 Pages)

SECTION 3

ADJUSTMENT AND OPERATION

3.1. INITIAL ADJUSTMENTS.

3.1.1. GENERAL. - The 21B is operated from controls located conveniently on the front of the transmitter. Refer to figure 3-1. The control panels are mounted on the fronts of the doors and consist of suitable controls to turn the transmitter filament and plate power on and off, select circuits to be metered, select tuning elements to be adjusted, raise and lower the values of resistance, capacity or inductance attached to the tuning or adjusting elements, select crystal oscillators, and reset the overload circuit.

Additional switches and circuit breakers are located on the vertical chassis in the rectifier and exciter bays.

3.1.2. FUNCTION OF CONTROLS. - Refer to figure 3-4.

(a) Circuit Breakers and Switches.

(1) Crystal Heat Switch. - This control, S202, located inside the exciter front door, turns the crystal heat power on or off independent of all other power controls except the main station power switch.

(2) PA O/L NORMAL. - This control, S407, is located on the rectifier bay vertical chassis, and is used to short circuit the PA overload relay contacts to prevent the transmitter being turned off during initial tuning adjustments. Place in the NORMAL position after tuning adjustments.

(3) HV OFF-NORMAL. - This switch, S408, is used to prevent the HV being applied to the PA tubes, and is used primarily for removing the HV during

neutralizing adjustments and tuning intermediate amplifier.

(4) RF POWER AMF FIL AND MODULATOR FIL. - These two rotary type switches, S409 and S410 respectively, are used to vary the filament voltage in 7-1/2 percent steps to the above named stages. Variable resistors controlled with the CIRCUIT METER SELECTOR switches furnish finer adjustment over a 10 percent range.

(5) CONTROL CKT. - The following circuit breakers are all located side by side in the rectifier bay. The power to all of the control circuits (including tuning motors) flows through the control circuit breaker (S411).

(6) CABINET BLOWERS. - This circuit breaker, S412, is placed in the power leads supplying power to the cabinet blower motors. Power is not applied to the blowers, however, until the coated filament relay K401 is operated.

(7) TUBE BLOWERS. - The tube blowers circuit breaker, S413, is placed in the power leads to blowers for the modulator and PA air cooled tubes. These also will not operate until the coated filament relay K401 has operated.

(8) COATED FILAMENT. - This circuit breaker, S414, is in the primary circuit of the constant voltage transformers which supply power to the various coated filament tube filament transformers. The constant voltage transformers are not excited, however, until relay K401 is energized through operation of the FILAMENT ON start station.

(9) TUNGSTEN FILAMENT. - The PA and modulator filaments are energized through this circuit breaker, S415, which is in the primary circuit of auto-transformers

T411 and T412. These auto-transformers are energized only after relay K418 is energized through operation of the FILAMENT START button.

(10) LOW VOLTAGE. - The LOW VOLTAGE circuit breaker is located in the primary circuit of the low voltage supply. The low voltage supply turns on automatically after the filament time delay relay K422 operates.

(11) INTERMEDIATE VOLTAGE. - This circuit breaker, S417 is in the primary circuit of the intermediate voltage supply. This supply is turned on by operation of relay K404 which is energized by operation of the HV start stations only after the various interlock circuits are closed.

(b) Rectifier Cabinet Controls. - See figure 3-1

(1) OVERLOAD RESET. - This control, S501, is used to reset the "three shot" overload circuit in the event two overloads are experienced, (the system resets automatically in a predetermined time after just one overload) thus allowing the circuit to function in full "three shot" fashion upon the next overload. It also allows return to high power immediately if only two overloads are experienced.

(2) POWER (TUNE-LOW-HIGH). - This selector switch, S503, is used as the power level switch.

In the TUNE position, this control grounds the screen grid of the 4-125A driver tubes to reduce the plate and screen currents to a safe value while tuning the grid and plate circuits of these tubes.

In the LOW position, a reduced screen voltage is applied to the driver tubes

and the power amplifier and modulator tubes operate at reduced plate voltage. A nominal 1 kw output is obtainable operating thus. In this position, relays changing the modulator bias, audio input pad and monitor output are energized.

In the HIGH position, the plate voltage to the PA and modulator tubes is increased to full value for a nominal transmitter output of 5 kw. All auxiliary relays are de-energized to give full power operation.

(3) PRI VOLTAGE. - This control, a rotary tap switch, selects any one of the three phases of the power line for metering. It also selects the output of any one of the three constant voltage transformers for metering. The voltages thus obtained are read on the LINE VOLTAGE meter.

(4) PLATE START-STOP. - Located at the right hand edge of the control panel, this button is of the pull - to - start push-to-stop type. Pulling this button energizes plate power relays K419 or K420 to apply high voltage to the r-f driver stage, the power amplifier stage, the a-f driver stage and the modulator stage. Pressing the button releases the relays in the control circuit which, in turn, releases plate power relays K419 or K420 to remove the high voltage from the above stages. This button is wired in conjunction with the PLATE START-STOP buttons on the other three bays so that the plate power can be turned on or off from any of the four cabinets. The control circuit is arranged so that the filaments can be turned on, also, by pulling this control. When operated thus, the plate circuit will automatically turn on as soon as the filament time delay relay has operated. This can be nullified by pulling the plate control button then pressing it which will cause the filaments only to be energized.

(c) Modulator Cabinet Controls.

(1) FILAMENT START-STOP. - This is a pull-to-start, push-to-stop button similar to the plate power start-stop button. When the button is pulled, filament relay K401 (coated filaments) is energized followed by relay K418 (tungsten filaments) and the blower motors. As soon as the filament time delay relay K422 has operated, the low voltage plate relay K403 operates to apply plate voltage to the oscillator, buffer and audio stages. This filament button is connected in tandem with the filament buttons in the Power Amplifier and exciter bays. Pushing these buttons will turn the plate supply off as well as the filament supply since they are interlocked.

(2) CIRCUIT-METER SEL. - This control is a rotary tap switch, S702, which selects various circuits to be metered and, also, connects the ADJUST control to the proper motors to adjust the value of filament voltage to the modulator tubes. In positions 1 and 2, the FILAMENT VOLTAGE meter is connected to the separate filament source of each of the modulator tubes. Position 1 being Mod. 1 or the left hand tube viewed from the front of the cabinet. At the same time the proper adjusting motor is connected to the ADJUST Control and by proper manipulation of this control, the filament voltage to the modulator tubes can be adjusted.

When the CIRCUIT-METER SEL. Control is rotated to DRIVER CATHODE 1 and DRIVER CATHODE 2, the cathode current of the audio driver tubes V212, V213 and V214, V215 is metered on M701.

(3) ADJUST Control. - This Control is a single pole, double throw, center position open switch which controls the rotation of the motors used to adjust

the rheostats in the filament transformer primary circuits.

(4) PLATE START-STOP. - This control performs the same function as the PLATE START-STOP button on the rectifier bay front panel. See paragraph 3.1.2. (b) (4).

(d) Exciter Cabinet Controls.

(1) FILAMENT ON-OFF. - This control performs the same function as the FILAMENT START-STOP button on the modulator bay front panel, see paragraph 3.1.2. (c) (1).

(2) CIRCUIT-METER SEL. - The CIRCUIT-METER SELECTOR switch on the exciter control panel selects the proper circuit to be metered by M304 and at the same time connects the proper tuning motor for circuit adjustment. M304 reads the following currents as the switch is rotated clockwise from the counterclockwise stop; isolation amplifier cathode, buffer grid, buffer cathode, intermediate amplifier grid, first audio frequency amplifier cathode, and second audio frequency amplifier cathode. Simultaneously while the switch is in the BUFFER CATHODE AND TUNE position, the buffer plate circuit can be tuned by manipulation of the ADJUST control, likewise the intermediate amplifier plate circuit can be tuned while the switch is in the INT AMP GRID and TUNE position.

(3) OSCILLATOR. - This control, a small knob on the exciter control panel, selects one of the two crystal oscillator units for operation by means of relay K203. Relay K203 switches the plate and screen voltage from one oscillator tube to the other and changes the isolation amplifier grid connection from one oscillator to the other. In the counterclockwise position, the left hand oscillator is in use while in the clockwise

position the right hand oscillator is in use. The filament and crystal heater power is connected to both units at all times.

(4) ADJUST.-This control functions similar to the ADJUST control in the modulator cabinet, see paragraph 3.1.2. (c) (3).

(5) PLATE START-STOP. - This control functions identical to the PLATE START-STOP control in the rectifier cabinet. See paragraph 3.1.2. (b) (4).

(e) Power Amplifier Cabinet.

(1) FILAMENT START-STOP. - This pull-to-start, push-to-stop button functions identical to the FILAMENT START-STOP button on the modulator and exciter cabinets, see paragraph, 3.1.2. (c) (1).

(2) CIRCUIT-METER SEL. - The CIRCUIT-METER SEL control selects the proper circuit to be metered by M904 in the first two positions of the control and in the last two, selects the proper tuning motor for adjustment of the final tuning and the final loading respectively.

(3) PLATE START-STOP. - This control functions identical to the PLATE START-STOP control in the rectifier cabinet. See paragraph 3.1.2. (b) (4).

3.1.3. ENERGIZING THE EQUIPMENT FOR THE FIRST TIME.

(a) Precautions. - Before energizing the equipment, a thorough inspection of all connections and terminals should be made to assure freedom from faulty operation. Do Not insert the tubes in the transmitter. Tube plate leads and caps should be checked for clearance to any metal object and tied to some convenient support to prevent accidental short circuits when checking operation of the

plate voltage control circuit.

Inspect all door interlocks making certain that the male member is free by pressing on the contact block until the spring is completely compressed and then releasing the pressure. If the contact block does not spring out to its initial position, check the two wires comprising the arm for parallelism, adjusting the wire arms until they are free of the stop pin located between the two wires. Before applying power to the transmitter input, be certain that all circuit breakers are in the off position. These precautions having been taken, the circuit to the transmitter can be energized.

(b) Power Circuit Check.

(1) Energize the circuit to the transmitter.

(2) Close the circuit breaker marked CONTROL CIRCUIT.

(3) Close the circuit breaker marked COATED FILAMENTS.

(4) Close the circuit breakers marked CABINET BLOWERS AND TUBE BLOWERS.

(5) Close the cabinet doors.

(6) Close the circuit breaker marked TUNGSTEN FILAMENTS.

(7) Pull the FILAMENT start - stop button.

The filament relay, K401, should now be energized and held operated through, its own holding contacts. The closing of the filament relay should light the filament pilot lamps, start the ventilating blowers, energize the fields of the PA fil 1, PA fil. 2, Mod. fil. 1, and mod. fil. 2 tuning motors, energize the time delay relay, K422, energize the

constant voltage transformers and apply power to the filament transformer primaries of all tubes in the transmitters. When approximately 30 seconds have elapsed, the time delay relay should operate. If the time necessary for the operation of this relay is not within 10% of the 30 second limit, the time of operation should be adjusted. The field coil of the 807's tuning motor and the low voltage transformer will be energized immediately following the closing of the low voltage relay. Operation of the time delay relay completes the circuit necessary for the operation of the low voltage relay.

(6) Rotate the PRI VOLTAGE control on the rectifier cabinet control to \emptyset 1-2, \emptyset 2-3 and \emptyset 3-1 in succession and read the voltage on the LINE VOLTAGE meter.

(7) Continue rotation of the PRI VOLTAGE control to the FIL. 1, FIL. 2, FIL. 3 positions and note the reading on the LINE VOLTAGE meter. These readings should be approximately 230 volts.

The output of the constant voltage transformer depends somewhat on the power factor of the load. Since the power factors of the various loads on the different constant voltage transformers are not the same, the actual voltage readings will differ somewhat from each other but will be within the 5% tolerance and will always remain in this relation.

(8) Rotate the CIRCUIT - METER Sel switch on the PA cabinet control panel to the PA FIL. 1 position and manipulate the ADJUST control clockwise and counter clockwise while watching the FILAMENT VOLTAGE meter to see if the voltage changes properly. Snap the RF POWER AMP. FIL. switch on the rectifier bay vertical chassis to #1 position while observing the FILAMENT VOLTAGE meter in the PA bay.

(9) Repeat step (8) with the CIRCUIT-METER SEL switch in the PA FIL. 2 position.

(10) Repeat step (8) with the CIRCUIT-METER SEL switch on the modulator bay set in MOD FIL. 1 and MOD FIL. 2 positions while operating the MODULATOR FIL. switch in the rectifier bay.

NOTE

When the tubes are not in the sockets, the voltage readings will be only approximately correct because no power is being drawn from the transformer secondaries. If voltage readings are obtained in the correct positions of the CIRCUIT-METER SEL switches and the readings are reasonably correct for the circuit being metered, the power circuit check may be continued.

(11) Open the rectifier bay front door and place the circuit breakers marked LOW VOLTAGE and INTERMEDIATE VOLTAGE in the ON position.

(12) Place the PA O/L switch in the NORMAL position and the HV switch in the NORMAL position.

(13) Close the rectifier bay front door.

(14) Place the POWER control in the LOW position.

(15) Pull a FILAMENT START button. Allow time for the time delay relay to operate. The green pilot lamps should all light.

(16) Pull a PLATE START button. The intermediate voltage relay K404 and the low power relay K419 should operate, all red pilot lamps except the two overload lamps; should light the fields of all remaining tuning meters; should

be excited; and the filament and plate HOUR meters should start to register.

(17) Rotate the POWER switch to the HIGH position. The high power relay K412 should operate and the low power relay release.

(c) Overload Circuit Check. - With all the control circuits described in operation, take a lead pencil and open the contacts of one of the overload relays. This should cause the overload reset system to operate. Go through the three types of operation and check the results. See paragraph 4.2.2. for explanation of the "3" shot system.

When the above preliminary tests have been completed, shut off the transmitter by pressing the FILAMENT START-STOP button. If conditions seem normal and no circuit breakers have blown during the above procedure, the tubes may be inserted in their sockets.

3.1.4. FILAMENT CIRCUIT ADJUSTMENT. - To permit the proper conditioning of the mercury vapor rectifier tubes, the filaments should be excited for a period of thirty minutes before the application of any plate power. This can be accomplished by allowing one of the cabinet doors to remain open with the filaments of the tubes excited, thus preventing the operation of the low voltage relay during the conditioning process. This aging procedure is required only in the case of new tubes. In subsequent operating procedure, the time delay relay will automatically provide the proper time interval. The filament volt meters are used in conjunction with the CIRCUIT-METER SEL switches for measuring the filament voltage applied to the PA and MOD tubes.

3.1.5. TUNING ADJUSTMENT. - OPERATION OF THIS EQUIPMENT INVOLVES THE USE OF HIGH VOLTAGES WHICH ARE DANGEROUS TO LIFE.

OPERATING PERSONNEL SHOULD AT ALL TIMES OBSERVE ALL SAFETY PRECAUTIONS. DO NOT CHANGE TUBES OR MAKE ADJUSTMENTS INSIDE THE EQUIPMENT WITH THE HIGH VOLTAGE SUPPLY ON. DO NOT DEPEND UPON DCCR SWITCHES OR INTERLOCKS FOR PROTECTION. ALWAYS SHUT DOWN POWER EQUIPMENT WHEN MAKING ADJUSTMENTS.

(a) Oscillator Adjustment. - The oscillator is of the untuned type and no adjustment is available except a trimmer capacitor in the grid circuit. The frequency may be varied over a range of ± 10 to 20 cps by adjusting this trimmer capacitor. See figure 3-1B.

Should it be found necessary, the frequency may be adjusted over a range of two to three hundred cycles by means of the airgap in the crystal holder. Refer to figure 4-6. This adjustment is made by removing the name plate from the top of the holder and using a special type 280A wrench. Loosen the locknut and rotate the airgap regulator very slightly. Clockwise rotation lowers the frequency, counterclockwise rotation increases the frequency. When the adjustment has been completed, tighten the locknut and replace the name plate.

Either Oscillator Unit may be selected by the Oscillator selector Switch, S303.

(1) Rotate the CRYSTAL HEAT switch, S202, to the ON position.

(2) Close the circuit breakers to the CONTROL CIRCUIT, the CABINET BLOWERS, the TUBE BLOWERS, the COATED and TUNGSTEN FILAMENTS and the LOW VOLTAGE.

(3) Place the HV switch in the OFF position and the PA O/L in the OFF position.

(4) Rotate the POWER level control to the TUNE position.

(5) Pull the FILAMENT start-stop control. As soon as the time delay relay operates, the plate and screen voltage will be applied to the oscillator.

The normal operating current of the 6F6 oscillator tube is between 10 and 27 ma. The value of this current depends on the frequency of operation. The higher the frequency used, the higher will be the operating current.

(6) Place the CIRCUIT-METER SEL Control in the ISO AMP CATHODE position and check the cathode current of this stage. It should be approximately ma.

(b) AMPLIFIER GRID ADJUSTMENT. - When proper operation of the oscillator has been secured:

(1) Rotate the CIRCUIT-METER SEL switch to the BUFFER GRID position.

(2) Adjust the isolation amplifier grid coupling capacitor, C220, until the test meter indicates 5 to 6 ma, of grid current.

(c) Buffer Amplifier Plate Tuning.

(1) Rotate the CIRCUIT-METER SEL switch to the BUFFER CATHODE and TUNE position.

(2) Operate the ADJUST control. The cathode current will dip sharply when the point of resonance is reached. If the point of resonance cannot be found, it will be necessary to change the tap on inductor, L213. Refer to figure 2-9 for the location of the inductor.

(3) Change the tap in steps of not more than two turns at a time until resonance is established with the tuning capacitor at approximately one-half capacity.

(d) Intermediate Amplifier Grid Adjustment. - The tank inductor, L213, is provided with a sliding connector to vary the degree of loading of the buffer amplifier plate circuit and the coupling to the grid of the intermediate amplifier tube. Refer to figure 2-9.

(1) Rotate the CIRCUIT-METER SEL switch to the INT. AMP GRID and TUNE position.

(2) Read the intermediate amplifier grid current as indicated on the TEST METER. If the grid current is not within the range of 35 ma to 40 ma, adjust the rider on L213 until this value has been obtained. (When plate and screen voltage is applied to the int. amp tube, the grid current should be about 23 ma.)

(3) Adjust the rider in steps of not more than 2 turns at a time. To increase the drive, move the tap toward the plate end of the coil.

(4) Retune the buffer amplifier plate circuit to establish resonance after each tap change.

(e) Intermediate Amplifier Plate Tuning. - Before attempting to tune the intermediate amplifier plate circuit:

(1) Be sure switch S408, figure 3-1, located in the control circuit of the power amplifier is in the OFF position.

(2) Remove the power amplifier grid tap from L214. (By removing this tap a better indication of resonance may be obtained.)

(3) The intermediate amplifier plate circuit may now be tuned.

(4) Close the INTERMEDIATE VOLTAGE circuit breaker.

(5) Rotate the CIRCUIT-METER SEL switch to the INT. AMP GRID and TUNE position. The POWER switch should remain in the TUNE position.

(6) Pull the PLATE start-stop control.

(7) Operate the ADJUST control. Tune for minimum cathode current of the intermediate amplifier as indicated by a slight dip on meter M303. If the point of resonance cannot be found, it will be necessary to adjust the tap on inductor L214. Refer to figure 3-2. Change the tap in steps of not more than 2 turns at a time until resonance has been established.

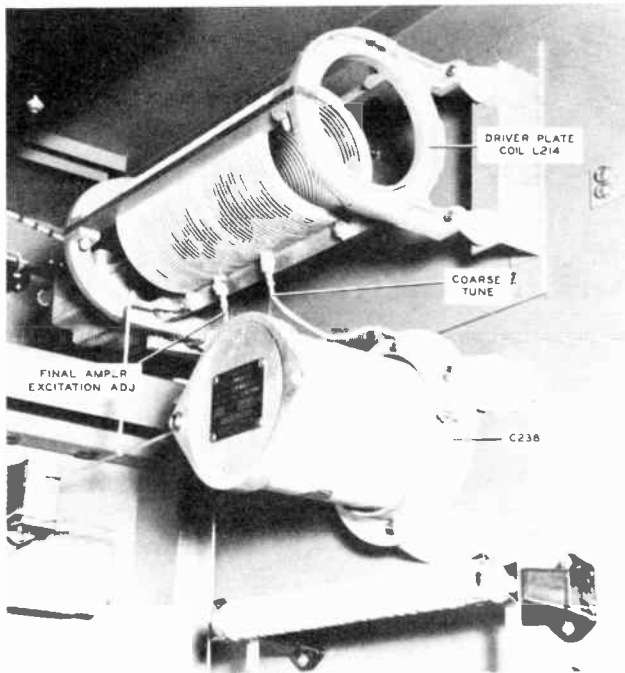

Figure 3-2 Driver Amplifier Plate Tank Inductor

(8) Rotate the POWER switch to the LOW position to complete the tuning.

(f) Final Amplifier Grid Adjustment.- When resonance has been established in the plate circuit of the intermediate amplifier, the final amplifier grid tap can be replaced on inductor L214. This adjustable tap varies the degree of loading of the intermediate amplifier plate circuit and the coupling to the grids of the final amplifier tubes.

(1) The POWER switch remains in the LOW position.

(2) Adjust the setting of the tap on the L208 at the ground end of the inductor. Increase coupling in steps of not more than 2 turns at a time.

(3) Check the final amplifier grid current after each tap change.

(4) Retune the intermediate amp plate circuit to resonance after each tap change.

(5) The tap should be adjusted so that at resonance the final amplifier grid current is approximately 225 ma with the power lever switch in the LOW position and the high voltage off the plates of the final amplifier tubes. The plate of the 4-125A tubes should now show a slight red color.

(g) Neutralization. - The final amplifier has been neutralized and locked at the factory and no further adjustment should be required. However, due to the slight difference in the interelectrode capacity of various type 892R tubes, some adjustment of the neutralizing may be necessary. An oscilloscope may be used to indicate complete neutralization of the final amplifier circuit. The high voltage lead to the plates of the final amplifier tubes should be broken by opening switch S408. Inductively couple the oscilloscope to the final pi tank coil, L804, to obtain sufficient r-f pickup.

Pull the PLATE start-stop control to apply plate voltage to the r-f stages preceding the final amplifier. Tune the plate circuit of the final amplifier to as near resonance as can be determined without application of the plate voltage. Maximum indication of r-f feedthru on the oscilloscope should appear under this condition. Adjust the coupling to give the desired pick-up. Neutralization adjustments may now be made. The neutralizing inductor should be adjusted to give a minimum r-f indication on the oscilloscope.

(3) Rotate the TUNE METER SWITCH to the FINAL TUNE position.

(4) Rotate the POWER switch to the LCW position.

(5) Pull the PLATE start-stop control.

(6) Operate the TUNING control. Tune for minimum plate current as indicated on plate meter M902. If the point of resonance cannot be reached, adjust the tap on the plate tank inductor, L803 until resonance can be established. See figure 3-4.



Figure 3-3 Neutralizing Coil Adjustment

(h) Final Amplifier Plate Tuning.

(1) Make approximate settings of the output network by referring to the test sheets.

(2) Close the switch, S408, located in the control circuit of the final amplifier tubes.

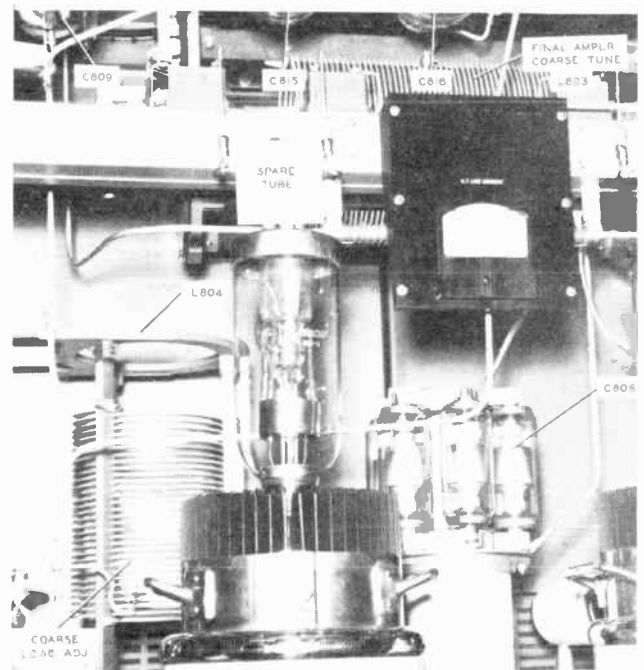

Figure 3-4 Power Amplifier Plate Tank and Output Network Inductors

(i) Loading Adjustments. - All inductor tap adjustments of the output network have been made for the frequency upon which the transmitter is to operate so that only slight adjustment of the inductor taps should be necessary.

The variable loading condenser should be set at mid range while the L section is adjusted to provide proper loading for full power operation. When operated in the HIGH power position, the normal operating power amplifier plate current is approximately 0.73 amp.

(1) Rotate the CIRCUIT-METER switch in the PA cabinet to the FINAL LOAD position.

(2) The POWER switch remains in the HIGH position.

(3) Apply voltage to the final amplifier tubes.

(4) Operate the TUNE control, and attempt to load the power amplifier to about 80% of the full load.

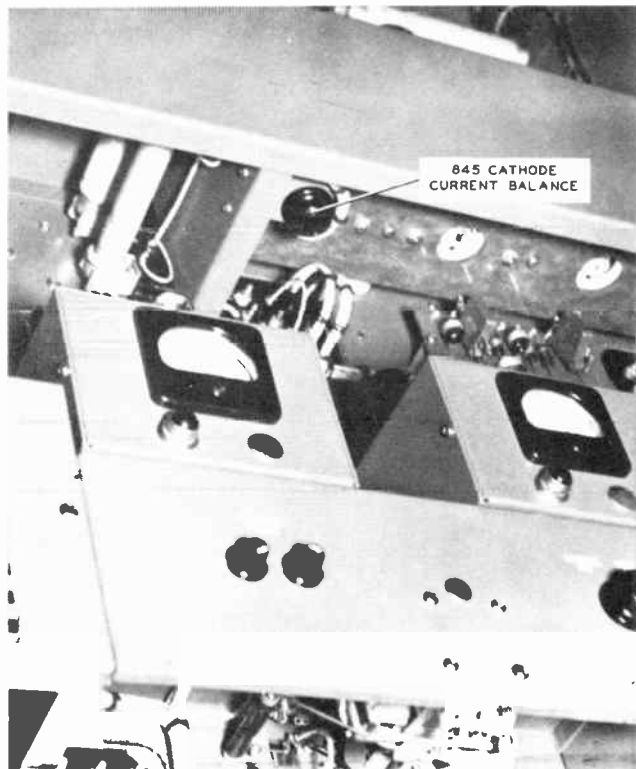

Figure 3-5' 845 Cathode Current Balancing Adjustment

(5) To decrease the loading, raise the inductance of the output coil L804 of the L section. To increase the loading, the procedure is the opposite of the above. See figure 3-4.

(6) To complete the adjustment of the L section, set the tap on the output branch to give a maximum antenna line current. When the above conditions have been obtained, a slight adjustment of power amplifier plate tank circuit is necessary. To make this adjustment, rotate the CIRCUIT-METER SEL switch to the FINAL TUNE position and operate the ADJUST control until the tank circuit is set at resonance.

(7) Now detune the plate circuit slightly to one side of this setting. The plate current and the line current will now increase as will the plate efficiency.

The loading and tuning controls should be adjusted for maximum efficiency for the desired output. The apparent amount of detuning required to obtain the proper operating point will be greater for lower frequencies.

This procedure of detuning the plate circuit slightly off resonance is necessary because the variable element in the final amplifier plate circuit is in the inductive branch, and merely tuning to minimum plate current does not tune the plate circuit to unity power factor. Strictly speaking, minimum plate current may be used as an accurate measure of unity power factor only when the capacity of the tank is the element varied. The tuning adjustment of the 21B varies the inductance of the tank coil by means of a copper disc within the tank coil, and acts as a single short circuited turn. In this case maximum impedance will not occur at unity power factor, and L803 should be adjusted to a value

slightly different than that which produces minimum plate current. This procedure will result in a higher plate efficiency in the final amplifier than would be obtained by tuning to minimum plate current.

(j) Audio Circuit Adjustments. - The only audio system adjustments necessary are the cathode current balancing adjustment on the 845's and the grid bias adjustment on the modulators. The modulator bias should be adjusted to give a static plate current of approximately 250 ma for each tube.

(1) Place the POWER switch in the HIGH position.

(2) Pull the PLATE start-stop control to apply plate voltage to the audio drivers and modulators.

(3) Rotate resistor R250 for cathode current balance of the 845 tubes. See figure 3-5.

(4) Rotate rheostat R404 in the rectifier bay until the bias is adjusted to give the recommended value of static plate current for the No. 1 modulator tube. (Rotate clockwise to increase, counterclockwise to decrease the plate current.) See figure 3-6.

(5) Rotate Rheostat R405 until the bias is adjusted to give the recommended value of static plate current for the No. 2 modulator tube.

(6) Place the POWER switch in the LOW power position and repeat steps (2), (4) and (5) with resistors R417 and R406.

3.1.6. NOISE ADJUSTMENT. - Noise on the carrier can be minimized by adjustment of hum adjusters R806 and R809 in the power amplifier cabinet and R606 and R607 in the modulator cabinet. These resistors should be adjusted for minimum

noise using a noise meter as an indicator. The adjusting can be done in steps since opening a rear door automatically turns off the high voltage.

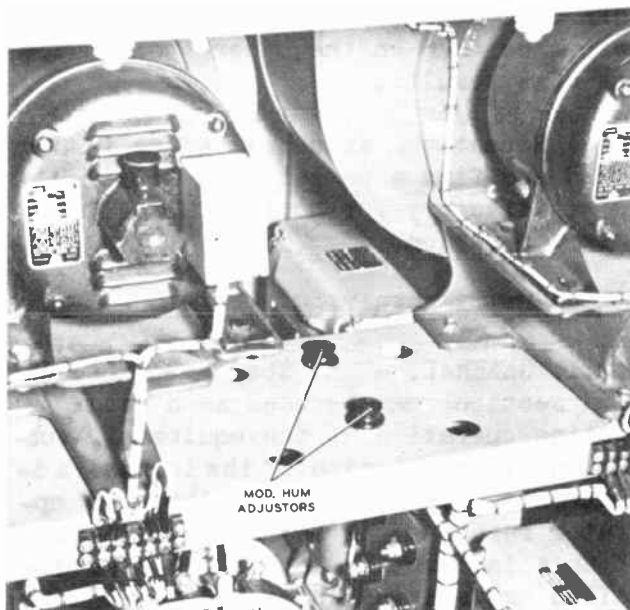
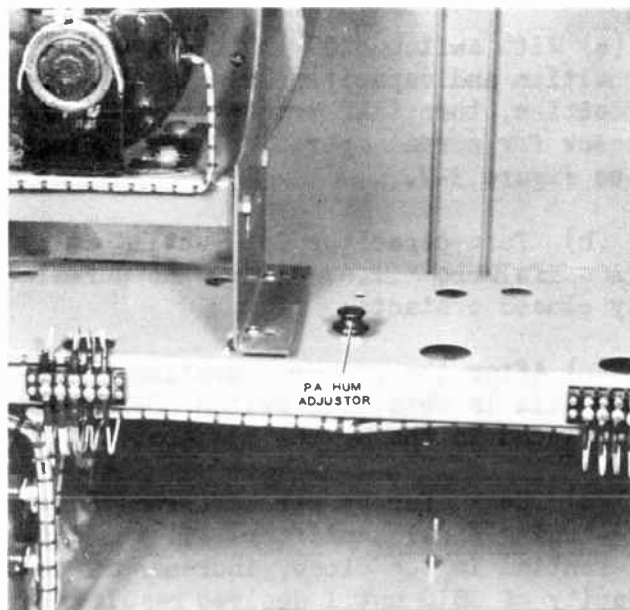

Figure 3-6 Hum Adjustments

3.1.7. ADJUSTMENT OF DIFFERENTIAL RELAY K414. - This relay should be adjusted after all tuning adjustments have been made and the transmitter is operating in normal fashion on HIGH POWER.

(a) With switch S407 in the PA O/L-OFF position and capacitor C810 in the open position, turn the transmitter on and check for normal operation and tunings. See Figure 3-7.

(b) Turn capacitor C810 until relay K404 "falls out" i.e. closes the normally closed contacts.

(c) After the proper operation of relay K414 is obtained, switch S407 can be placed in the NORMAL position.

(d) Check for proper differential by de-tuning final amplifier. If the differential is too close, increase the capacity of C810 until desired results are obtained. Note that it will normally take more detuning on one side of PA resonance than on the other to produce the same results.

(e) Repeat the above procedure in LOW POWER and find a position of C810 which is satisfactory for both HIGH and LOW power operation.

3.2. ROUTINE OPERATION.

3.2.1. GENERAL. - The steps outlined in this section may be used as a guide to routine operation of the equipment, subsequent to completion of the initial adjustments. It is suggested that the operator refer to the adjustment section of this instruction book for a more detailed explanation in regard to adjustment of the transmitter circuits. Control knobs and meter locations are shown in figure 3-1. All tuning controls are motor driven and function through raise and lower knobs on the front panel of

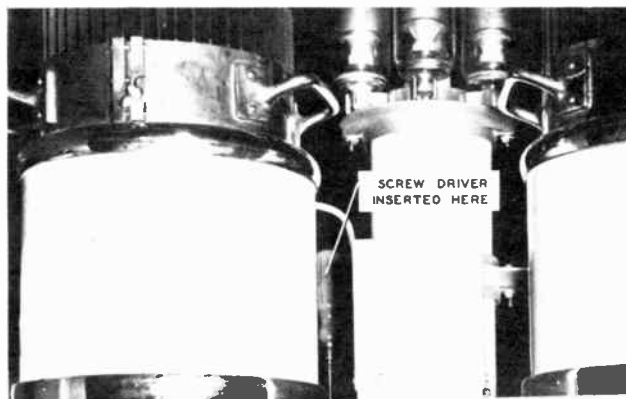

Figure 3-7 Capacitor C-810 Adjustment

the transmitter. It is assumed that the main station power switch is in the ON position and the crystal heat switch S202 (or external source) is turned on.

3.2.2. STARTING EQUIPMENT.

(a) Open the lower front door of the rectifier cabinet and place the following circuit breakers in the ON position:

- (1) CONTROL CIRCUIT
- (2) CABINET BLOWERS
- (3) TUBE BLOWERS
- (4) COATED FILAMENT
- (5) TUNGSTEN FILAMENT
- (6) LOW VOLTAGE
- (7) INTERMEDIATE VOLTAGE

(b) With the lower front door of the rectifier cabinet still open, place the PA O/L switch in the NORMAL position and the HV switch in the NORMAL position.

(c) Close the front door and all other doors that might be open and pull a FILAMENT START switch.

(d) Read filament voltages and make adjustments if needed. Check oscillator plate current, ISO AMP CATHODE, BUFFER CATHODE and BUFFER GRID current as well as 1st and 2nd AF cathode current.

(e) Place the HIGH-LOW power switch in the correct position for the power desired.

TYPICAL METER READINGS

Cabinet	Meter	Circuit	OUTPUT POWER LEVEL	
			5 KW	1 KW
Rectifier	Line voltage	Pri voltage ϕ 1		
		Pri voltage ϕ 2		
		Pri voltage ϕ 3		
		Fil 1.	230	230
		Fil 2.	230	230
		Fil 3.	230	230
Modulator	Audio driver cathode current	Driver cathode 1.	120 ma	120 ma
		Driver cathode 2.	115 ma	115 ma
	Mod 1 cathode current (STATIC)	Mod 1 cathode	260 ma	215 ma
	Mod 2 cathode current (STATIC)	Mod 2 cathode	260 ma	215 ma
	Filament voltage	Mod Fil 1.	14.2 V.	13.0 V.
		Mod Fil 2.	14.2 V.	13.0 V.
Exciter	Final amp grid current	Final amp grid	230 ma	225 ma
	Int amp plate voltage	Int amp	2900 V.	2900 V.
	Int amp cathode current	Int amp cathode	315 ma	280 ma
		Iso amp cathode	29 ma	29 ma
	Test meter	Buffer grid	5 ma	5 ma
		Buffer cathode	95 ma	95 ma
		Int amp grid*	23 ma	25 ma
		1st AF cathode	10 ma	8.5 ma
		2nd AF cathode	86 ma	86 ma
	Oscillator meter	Oscillator cathode	10-27 ma	dep. on fre.
	Power Amplifier	Remote an ⁺ . cur		
Final amp plate current		PA B - lead	730 ma	330 ma
Final amp plate voltage		Across PA plate supply	8500 V.	3800 V.
Filament voltage		PA Fil 1.	14-8 V.	13-8 V.
RF line current		Ant. lead		
	RF Tank current			

* The Int amp grid current may vary 4 or 5 ma during modulation. This is normal and will not affect the operation or quality of transmission.

(f) Pull a PLATE START switch.

(g) Check the intermediate amplifier grid and plate current, the power amplifier grid and plate current, and the driver cathode 1 and driver cathode 2 current.

(h) Check local and remote line current.

(1) Make all necessary monitoring observations.

3.2.3. STOPPING EQUIPMENT. - The transmitter may be completely shut off (with exception of the blowers) by pushing a FILAMENT start-stop control. The blowers will run for an adjustable period (recommended 2 min.) and then automatically turn off.

3.2.4. OVERLOAD RESET. - A "three shot" overload system is employed in the 21B transmitter. If one occurs, the transmitter will turn on immediately after the overload on full power and overload light #1 will turn on. If no other overload occurs immediately, the "three shot" system can be returned to full "three shot" operation by pulling the OVERLOAD RESET control, otherwise, within an adjustable period, (recommended 5 seconds) of the first overload, the system will automatically reset. If, however, a second overload occurs immediately after the first, the transmitter will turn on again at half power and the second overload light will turn on. If no other overloads are experienced, the OVERLOAD RESET control can be pulled to return the transmitter to full power operation and at the same time return the "three shot" system to full "three shot" operation. The system will not automati-

cally reset after the second overload. If three overloads occur before the OVERLOAD RESET control has been pulled, the transmitter plate supply will turn off and remain off until a PLATE POWER START button has been pulled. If the transmitter should continue to show overload and repeatedly set up on low power, until at such time when the overload condition can be eliminated, the power change switch can be placed in the LOW POWER position and the OVERLOAD RESET button pulled, thus allowing "3 shot" operation in low power.

3.2.5. POWER CHANGE. - The power output can be changed from 5 KW to 1 KW, or conversely, by merely turning the power level switch to the desired position; it is not necessary to shut the plate power off during power change.

3.2.6. OSCILLATOR CHANGE. - In event a crystal becomes erratic in operation or needs adjustment for frequency, the spare oscillator can be switched in by turning the OSCILLATOR selector switch. This can be done with no break in the program since the spare oscillator is always warmed up and ready for immediate use. With the OSCILLATOR control in the counterclockwise position, the left hand oscillator is in use; with the control in the clockwise position the right hand oscillator is in use.

3.2.7. BLOWERS. - The air blowers in the 21B will remain operating for a predetermined time after the plate and filament supplies have been turned off. This automatic turn-off feature insures the air cooled tubes reaching a safe temperature before the blowers are turned off--do not pull the main station power switch until the blowers have stopped.

SECTION 4

CIRCUIT DESCRIPTION

4.1. MECHANICAL DESCRIPTION.

4.1.1. CABINETS. - The 21B transmitter is contained within 4 cabinets, each 78" high by 37-1/2" deep by 43-1/2" wide (exclusive of dust covers). Total width is 15' 1/4" with dust covers while the height is 79-5/16". The cabinets are arranged so that in-the-wall installation may be employed; in which case, special top and side dust covers are furnished. Full access front doors are used on all cabinets except the rectifier cabinet where a special "dutch" type construction is employed to allow maximum safety to operating personnel and at the same time provide for accessibility to operating controls contained therein. The top part of the door is hinged on the top edge whereas the bottom part is hinged conventionally on the right edge. Two full length rear doors are employed on each cabinet. All doors, except the lower front on the rectifier cabinet, have primary interlocks and high voltage shorting safety switches. Front doors have glass windows where tube visibility is desirable.

4.1.2. VENTILATION. - Forced air ventilation is employed in the 21B Transmitter. Air is drawn through dust filters at the bottom of each rear door and forced by means of centrifugal blowers to the points requiring ventilation. The air is then exhausted through a large opening at the top of each cabinet which is provided with a dust trap. If an exhaust air duct is to be used, an exhaust fan capable of 3000 cu. ft./min. should be installed at the building exhaust port. Provisions can be made in the exhaust air duct for heating the transmitter room with part of the exhaust air in cold climates.

4.2. ELECTRICAL DESCRIPTION.

4.2.1. PRIMARY POWER CIRCUITS. - Refer to figure 4-1. Power for the 21B Transmitter is obtained from a 208 or 230 v 3 phase source. The entire transmitter will operate from the single set of line connections if desired. In some instances, however, it might be desirable to run the crystal heat transformer T204 from a separate 115 v source. Connections have been provided for this type of operation. The crystal heat transformer, as furnished, is connected to line terminals 1 and 3 for single phase 230 volt power through fuses F401 and F402 and switch S202.

Power for control circuit operation is obtained from line terminals 1 and 2 through circuit breaker S411.

The filament transformers for coated filament tubes are supplied from terminals 1, 2 and 3, through circuit breaker S414, relay contacts K401 and constant voltage transformers T407, T408 and T409. Line voltage for all 3 phases and regulated filament primary voltage for all three regulated primary circuits is metered in these circuits by meter M501, the different circuits being chosen by selector switch S502. Filament time delay relay K422 is connected across the secondary of constant voltage transformer T408. This relay prevents plate voltage being applied to the low voltage rectifiers (and subsequently the high voltage rectifiers) before the tube filaments have had sufficient time for heating.

Cabinet air blower motors B202 and B401 are supplied 230 v single phase power from line terminals 2 and 3 through circuit breaker S412 and the contacts of relay K402. The tube blower motors B603, B604, and B805 are supplied single or 3 phase 230 volt power from

terminals 1, 2 and 3 through circuit breaker S413 and the contacts of relay K402, the coil of which is actuated by blower time delay relay K421 which allows the blowers to operate for an adjustable time after the transmitter filaments have been turned off to insure the tubes reaching a safe temperature. The blower motors B603, B604, B805 and B806 are connected to the 3 phases as single phase loads when single phase motors are supplied.

Power for the power amplifier and modulator filament transformers is taken from line terminals 1, 2 and 3 since 3 phase 230 v operation is employed. The power goes through circuit breaker S405, relay contacts K408 to autotransformers T410 and T411 where the different taps

represent a 7-1/2% change in filament voltage. The taps on the autotransformers are connected to switches S409 and S410, S409 controlling the power amplifier filament voltage and S410 controlling the modulator filament voltages.

From switches S409 and S410 the filament primary power goes to rheostats R610, R611, R811 and R812 where full rotation of the rheostat arm represents a 10% change in filament voltage. The PA and modulator filament transformers are Scott connected high reactance transformers designed to limit the starting current surge when the cold tube filaments present a very low value of resistance. Notice that the points on modulator filament switch S410 are connected to lower voltage taps on the autotransformers

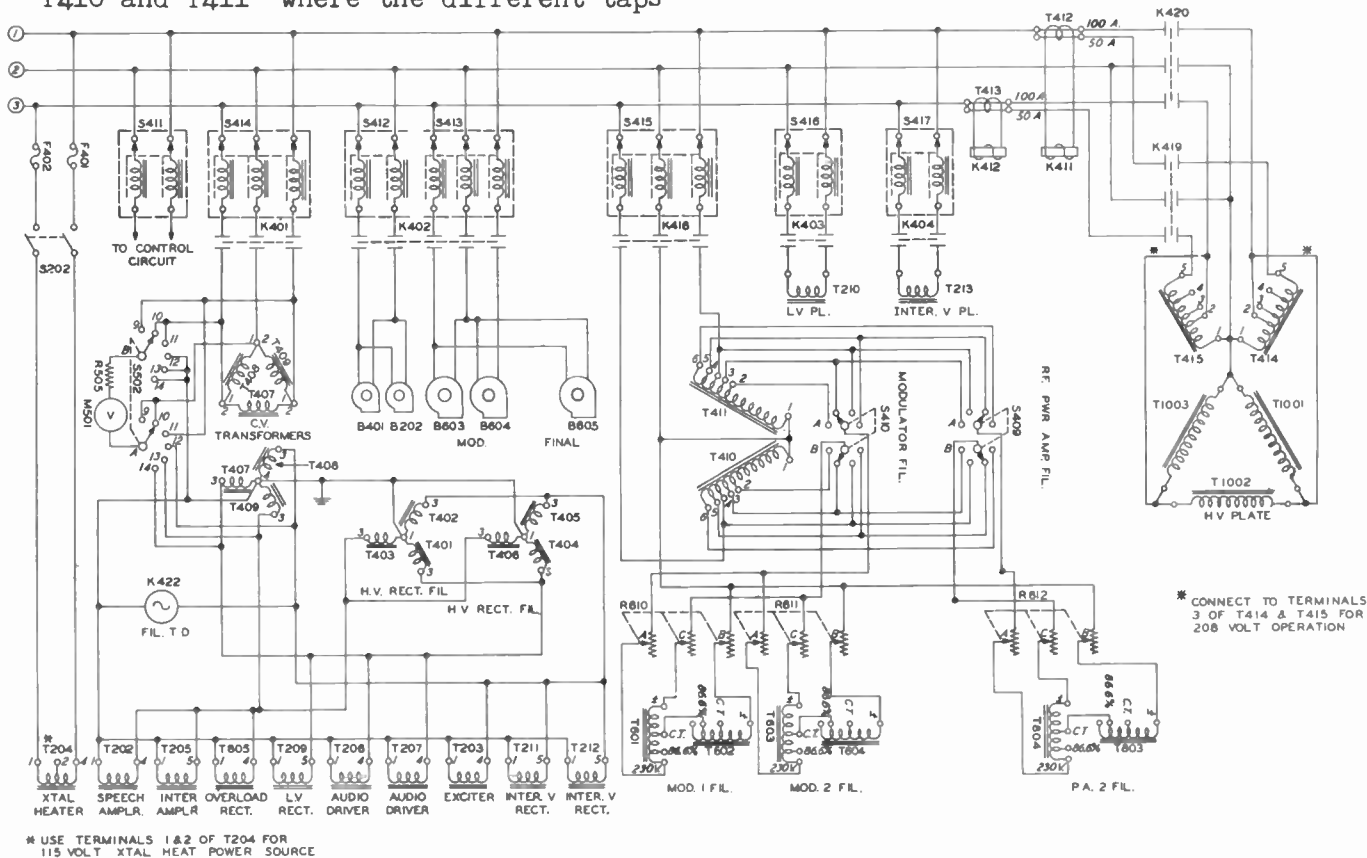

Figure 4-1 Primary Power Circuits

than corresponding points on PA filament switch S409. This is connected in such a fashion because ordinarily the modulator tubes are run at a lower filament voltage than the PA tubes since the emission requirement is somewhat less.

Single phase 230 v power is required for the low voltage plate supply. The low voltage transformer T210 is powered from line terminals 1 and 2 through circuit breaker S416 and relay contacts K403. The intermediate power supply transformer T213, also requires single phase 230 v and is powered from line terminals 1 and 3 through circuit breaker S417 and relay contacts K404.

The high voltage plate supply re-

quires 3 phase 230 v power for operation. Current transformers T412 and T413 are inserted in the power lines connected to line terminals 1 and 3 for operation of overload relays K411 and K412. 5 kw to 1 kw power change is accomplished by autotransformers T414 and T415 through operation of high power relay K420 and low power relay K419. Autotransformers T415 and T414 are tapped to compensate for a 208 v line voltage. The high voltage plate transformers T1001, T1002 and T1003 are delta connected for 3 phase 230 v operation and are tapped for line voltage adjustment. The power consumption of the entire transmitter on full power is approximately 24 kw at 85 power factor.

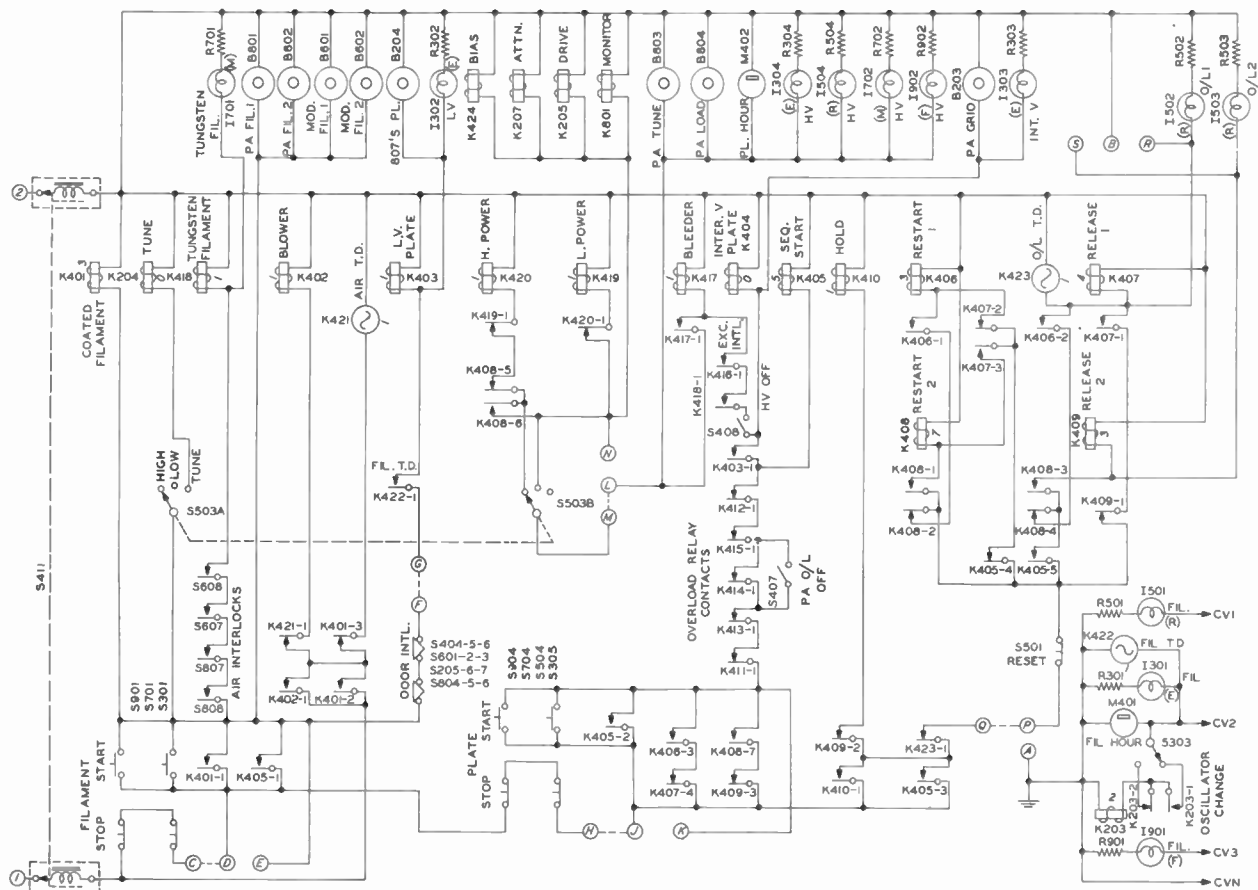

- NOTES:
1. NUMBER IN ITALICS BESIDE EACH RELAY MOTOR INDICATES NUMBER OF CONTACTS ON THAT RELAY APPEARING IN THIS SCHEMATIC.
 2. LETTER IN () BESIDE PILOT LAMP INDICATES THE CABINET ON WHICH IT IS LOCATED. (F) FINAL (M) MODULATOR (E) EXCITER (R) RECTIFIER
 3. LETTER IN ○ INDICATES REMOTE CONNECTION TERMINAL.

Figure 4-2 Control Circuits

4.2.2. CONTROL CIRCUITS.-Refer to figure 4-2. Power for operating the control circuits is drawn from line terminals 1 and 2 through circuit breaker S411. Pulling a filament start button (S301, S701 or S901) will energize coated filament relay K401 which will turn on pilot lamps I501, I301, I901 and all filaments in the transmitter except the PA and modulator filaments. Coated filament relay auxiliary contacts K401-1 close and hold the relay in the operated position. At the same time, the fields of tuning motors B801, B802, B601 and B602 are energized and filament time delay relay K422 starts to function (see lower right hand corner of figure 4-2). Upon operation of coated filament relay K401, the blower relay K402 is energized through contacts K401-2 and K421-1. After the blowers have reached operating speed, air interlock switches S608, S607, and S809 will close and the tungsten filament relay K418 will operate and energize the PA and modulator filaments and light the filament pilot light I701.

After the filaments have been on for 30 seconds, the filament time delay relay K422 will have operated closing contacts K422-1 resulting in the application of power to the coil of low voltage plate relay K403, which turns the low voltage plate power on providing the doors are closed to operate the door interlocks S404-5-6, S601-2-3, S2-5-6-7 and S804-5-6. In addition, operation of filament time delay relay K422 energizes the field of 807 tuning motor B204 and lights the low voltage pilot light I302.

Pulling a plate start button (S305, S504, S704 or S904) will energize intermediate voltage relay K404; the circuit going from line terminal #1 through one section of circuit breaker S411, through the NC contacts of the filament start buttons, the NC contacts of the plate start button, the pulled plate

start button, overload relays contacts K411-1, K412-1, K413-1, K414-1, K415-1, contacts K403-1 of low voltage plate relay K403, through the coil of intermediate voltage relay K404 and through the other section of circuit breaker S411 to line terminal #2. Operating this relay (K404) will turn on the intermediate voltage supply which powers the 4-125A and 845 tubes. In addition, the field of PA grid tuning motor B203 is energized and pilot lamp I303 is lighted and sequence start relay K405 is operated. Operation of sequence start relay locks the plate power circuit through holding contacts K405-2.

The high voltage plate relays K419 (low power) or K420 (high power) are operated by a circuit which is identical to the circuit required to operate the intermediate voltage relay except the circuit goes through high voltage switch S408, exciter interlock relay contacts K416-1, bleeder relay K417 interlock contacts K417-1, Power level switch S503B, and either through the contacts of restart #2 relay K408 and low power relay interlock contacts K419-1 to the coil of high power relay K420, or through high power relay interlock contacts K420-1 to the coil of the low power relay K419, depending upon the position of power level switch S503B. At the same time, the fields of PA tune and PA load motors B803 and B804 respectively, are energized, plate hour meter M402 starts to run and high voltage pilot lamps I304, I504, I702 and I902 are lighted. Also the bleeder relay K417 is energized to remove the bleeder from the circuit when the plate power is on. When low power is selected, bias relay K206, attenuator relay K207, drive relay K205, and monitor relay K801 are energized to condition the transmitter for low power operation. Overload switch S407 is used to short out differential overload relay contacts K414-1 during tune-up procedure. Pressing any plate

or filament stop button will release sequence start relay K505 and turn off the plate power. In addition, opening any door (except the bottom front door in the rectifier cabinet) or causing an overload in the high voltage plate circuits will turn off the plate power. Failure of the bleeder relay K417 or the excitation from the 4-125A tubes will remove the high voltage also. Likewise, should the low voltage plate supply or the blowers fail, the high voltage plate supply would be turned off through the interlock system.

The "3 shot" overload reset system which is diagramed in the upper right hand portion of figure 4-2, operates in the following manner. With the transmitter operating on full power in normal fashion, as explained above, sequence start relay K405 provides the hold circuit for the plate power by means of contacts K405-2 which parallel the start push button. Should an overload occur which would open any overload interlock contact, sequence start relay K405 would drop out and turn the plate power off. Immediately, however, restart #1 relay

OVERLOAD #1

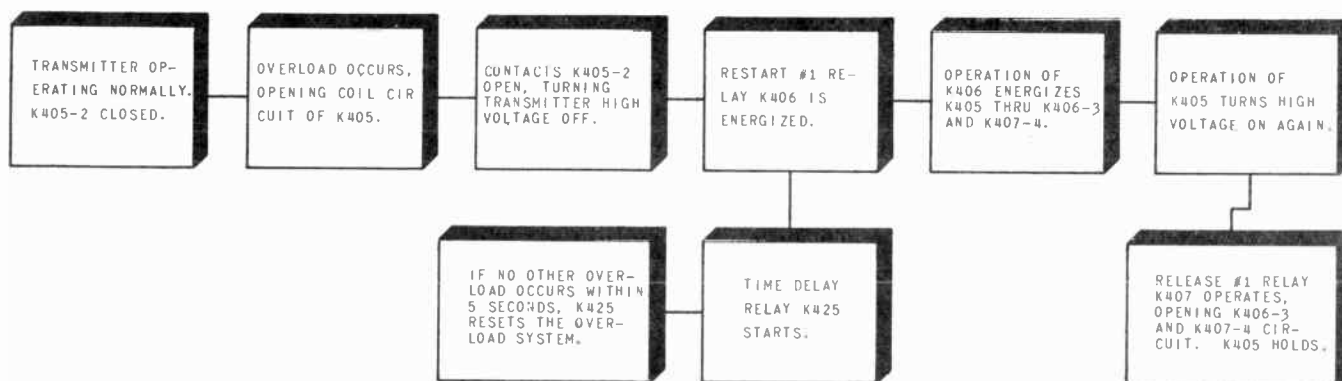

OVERLOAD #2

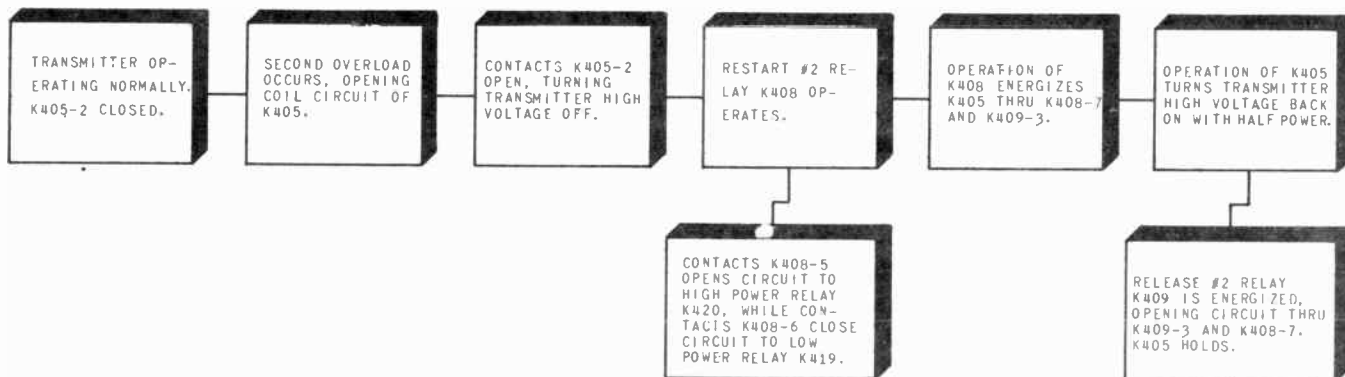

OVERLOAD #3

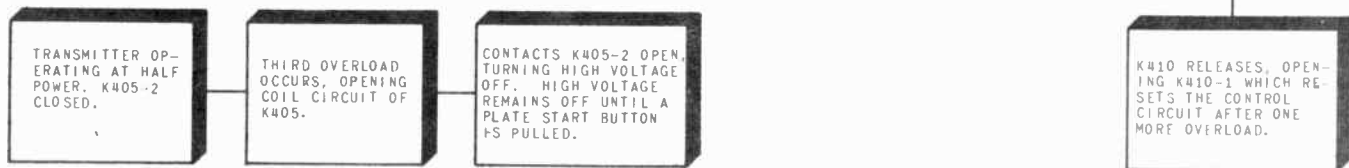

Figure 4-3 Overload System Block Diagram

K406 is energized through the circuit from terminal J through contacts K410-1, contacts K423-1, reset switch S501, contacts K405-4, and contacts K407-2. Energizing this relay closes contacts K406-3 thru contacts K407-4 and operates sequence start relay K405 again putting the transmitter back on the air. If no other overload occurs within an adjustable time, overload time delay relay K423, which is now running, opens contacts K423-1 and resets the "3 shot" system. The system can be reset manually by pulling S501. Assuming that a second overload is going to occur before the reset, notice that restart #1 relay K406 holds in the operated position by virtue of its holding contacts K406-1 and release #1 relay K407 is energized through K406-2, K408-4, K406-5, S501, K423-1 and K410-1 contacts. Energizing release #1 relay K407 opens the circuit of K406-3 and K407-4 leaving K405-2, the hold contacts of sequence start relay K405 again holding the plate power on.

When the second overload occurs, sequence start relay K405 again opens and turns the transmitter off. The transmitter is then turned on again at fifth power by restart relay K408. K408 is operated by the circuit through contacts K407-3, K405-4, S501, K423-1 and K410-1. Operation of this relay, K408, closes contacts K408-7 through K409-3 contacts which are in series across the start buttons. Therefore, the transmitter is automatically started again at fifth power since contacts K408-5 opens the high power relay K420 and contacts K408-6 closes the low power relay K419. After the plate power is applied by contacts K408-7, sequence start relay K405 again closes and release relay K409 is energized by the circuit through contacts K408-3, K405-5, S501, K423-1 and K410-1. Operation of K409 opens contacts K409-3 leaving sequence start relay contacts K405-2 again holding the plate power on.

If a third overload occurs and sequence start relay K405 is again opened, the transmitter plate supply will turn off again and remain off. When release relay K409 operates, it opens contacts K409-2 which releases hold relay K410 and opens hold contacts K410-1 thus opening the reset circuit and automatically resetting the "3 shot" system so as to be ready when the overload is cleared and the transmitter is manually turned on again.

After the second overload, the transmitter can be turned on again at full power and the "3 shot" system returned to full "3 shot" operation by pulling the overload reset control, S501. After the third overload, it will be necessary to turn the transmitter back on by pulling a plate start button. Pilot lamp I502 lights after one overload, pilot lamp I503 turns on after the second overload and I502 goes out, and on three overloads, both lamps go out along with the plate pilot lamps.

4.2.3. REMOTE CONTROL CIRCUITS. - Refer to figure 2-8 and figure 4-2. The remote control circuits for the 21B transmitter attach at the remote control terminal board in the rectifier bay. The remote controls function identical to the controls on the transmitter panel.

The filament start and the plate start buttons on the remote unit are wired in parallel with those on the transmitter while the filament stop and plate stop buttons on the remote unit are wired in series with those on the transmitter unit. The remote filament pilot light is effectively in parallel with the coated filaments and the plate pilot light is effectively in parallel with the high voltage pilot lights (plate).

The Remote power change switch is connected so that the high power con-

tacts are in series with the high power contacts on the transmitter power change switch and the low power contacts are in parallel with the low power contacts on the transmitter power change switch.

In order to change power from the remote position, it is necessary to place the transmitter power change switch in the HIGH POWER position and leave it there. Conversely, if the power change is to be made from the transmitter power change switch, the remote switch will have to remain in the HIGH POWER position. In other words, for high power operation, both switches must be in the HIGH POWER positions while for low power one or both must be in the LOW POWER position.

The overload switch for remote operation is connected in series with the transmitter overload switch while the overload pilot lamps are connected directly in parallel with the transmitter overload lamps.

Two terminals (F and G) are brought out to connect external auxiliary interlocks. These terminals are connected so that the auxiliary interlocks will be in series with the transmitter door interlocks.

4.2.4. RADIO FREQUENCY CIRCUITS.

(a) Oscillator. - The crystal oscillator employed is a modification of the Colpitts type oscillator circuit. This circuit, utilizing a type 6F6 pentode tube, has high inherent frequency stability against variations in d-c supply voltage or variation in tube characteristics. Two oscillator units are furnished with the 213 transmitter. Either unit may be selected using the oscillator selector switch, S303. The removal of one oscillator does not affect the operation of the transmitter. The oscillators are supplied with selected low temperature coefficient "A" cut quartz plate crystals with a temperature coefficient of less than three parts per

million per degree centigrade. Each crystal is mounted in a Collins type 297 crystal oven. The crystals are maintained at 50 degrees centigrade (60° C. on special order) by means of a mercury thermostat having a 0.2 degree sensitivity. A small variable capacitor, C101 is connected across the crystal so that the frequency of operation may be varied in a range ± 10 to 20 cps. If it is found necessary, the frequency may be varied over a range of 200 to 300 cps by adjusting the air gap between the connecting plate and the quartz crystal. This operation is explained in paragraph 3.1.5. (a) of this instruction book. Plate and screen voltage supply for the oscillator is made stable by a voltage regulating circuit consisting of two 6CC3/VR105 tubes and a voltage divider consisting of R207, R208 and R209. The cathode current of the oscillator is metered by M101 to indicate functioning of the oscillator.

(b) First Buffer. - The output coupling of the oscillator to the grid of the first buffer is controlled by the variable capacitor C220. The Buffer stage employs an 807 beam power amplifier operating class AB. This tube serves to isolate the oscillator from the reaction of changes in circuit tuning or operating conditions in the following stages. The cathode current of this stage is metered by the test meter M304 when the test meter switch is in the ISO AMF CATHODE position.

(c) Buffer Amplifier. - the buffer amplifier stage utilizes two 807 tubes in a parallel connected circuit operating class "C". The use of two tubes in this stage assures more than ample drive to the following stage. In case either one of the tubes should become inoperative, the remaining tube would be sufficient for satisfactory operation. The screens of this buffer amplifier stage and of the preceding isolation amplifier are tied together to create a slight automatic excitation control; thereby maintaining fairly uni-

form excitation throughout line voltage variations. The plate tank circuit of this stage is also utilized as the grid circuit of the following stage. The tank circuit capacitor is motor driven and controlled from the front panel. The tank inductor L213 is provided with a sliding connector to vary the degree of loading of the plate circuit and the coupling to the grid of the intermediate amplifier stage. An adjustable tap is also arranged on inductor L213 for the purpose of operating a frequency monitor. The cathode current of the 807 tubes is indicated on the test meter when the CIRCUIT METER SEL SWITCH is in the BUFFER CATHODE AND TUNE position. The grid current is indicated on the same meter with the SEL SWITCH in the BUFFER GRID position.

(d) Intermediate Amplifier. - The intermediate amplifier employs two type 4-125A power tetrode tubes. The amount of drive to this stage is determined by the position of the tap on inductor L213 to which the grids are capacitively coupled. A fixed bias of approximately 120 volts is applied to the grid by the low voltage supply in addition to the rectified grid voltage obtained when the tube is being driven. When the POWER change switch S502 is in the TUNE position, the screens of the 4-125A's are grounded and act as suppressors to limit the amount of plate current flow when the stage is being tuned. The plate tank circuit consists of a variable inductor L214 with adjustable taps and a fixed capacitor C238. The inductor L214 is motor driven and is controlled from the front panel. The coil of an overload relay, K413, is connected between the center tap of the 4-125A filament winding of transformer T205, and the negative side of the intermediate voltage supply. If the cathode current of

the 4-125A tubes exceeds the safe value, relay K413, will be operated, which results in the removal of the plate voltage. The grid current is metered by operating switch S302 to the INT. AMP GRID AND TUNE position. With the switch in this position, the test meter M304 is connected in series with the lead from the bias supply to the grids of the 4-125A tubes and shunts the meter across resistor R257. The cathode current is metered at all times with meter M303 inserted in series with the coil of the overload relay K413.

(e) Power Amplifier. - The power amplifier employs one type 392R triode tube. The grid of this tube is connected to an adjustable tap on the plate tank inductor of the intermediate amplifier. Bias for this stage is obtained solely from the rectified grid voltage when excitation is applied. The plate is shunt fed thru an r-f choke (L802). The plate tank and output network is a combination of "pi" and "L" matching sections. This combination reduces harmonics to a negligible value and can be matched to quite a wide range of transmission line impedances by varying the constants of the "L" section. The plate tank inductor L803 and the loading network capacitor C809 are motor driven and controlled from the front panel. The inductance of the "L" section is variable. A pick-up coil to provide means of coupling the modulation monitor to the output of the transmitter is connected from the output end of the "L" section to ground. The RF LINE CURRENT meter is connected in series with the transmission line and may be read from the front of the transmitter when the cabinet door is closed.

Coil neutralization is employed in

this stage. The inductance of L801 resonates with the grid to plate capacity of the tube at the operating frequency. When the circuit is properly adjusted the impedance from grid to plate is very high and the amplifier is neutralized for the frequency of operation.

The grid current of the two Power Amplifier tube is metered at all times by M301 which is inserted in series with the grid and the center tap of the filament windings of this tube. The cathode current is metered at all times by V902. The coil of a differential relay is connected between the center taps of the two filament windings of the tube and the negative side of the HV supply. This relay operates when the cathode current and r-f line current exceed a safe ratio and prevents damage to the tube. The line current coil of the differential relay, K414, is excited by rectified r-f from V803. The value of excitation is adjusted with capacitor C810. Should the ratio of PA cathode current to r-f line current get too large, the relay will operate and turn the transmitter off.

4.2.5. AUDIO CIRCUIT.

(a) Audio Amplifier Circuit. - The audio amplifier stage employs two type 6N7 triode tubes connected in a push pull circuit. The input circuit to this stage consists of a terminating pad across the primary of the input transformer. This pad has sufficient attenuation so that regardless of input impedance, either open or short circuited, it presents approximately the same impedance to the transmitter. This arrangement may improve the overall frequency characteristics of the station's audio system. The audio input required is of the order of +14 dbm. However, if a lower input level is required, it is only necessary to remove the input pad from the circuit. The input level required under this condition is about

+10 dbm. The secondary windings of the input transformer feed directly into the grids of the 6N7 tubes. The cathode current of this stage is metered by rotating the TEST SWITCH to the FIRST AF CATHODE position. This places the test meter across resistor R229 which is located in the cathode circuit. The output of the audio amplifier is resistance coupled to the grids of the tubes in the second audio stage.

(b) Second Audio Amplifier Circuit. - The second audio amplifier consists of a pair of 6A5G or 6B4G tubes connected in push-pull. The grids of these tubes are resistance coupled to the plates of the first audio amplifier tubes. The plate circuit is impedance coupled to the grids of the driver tubes by choke L220 and coupling capacitors C241 and C242. The cathode current of this stage is metered by the TEST METER in the 2ND AF CATHODE position.

(c) Audio Driver Circuit. - The audio driver stage utilizes four type 845 triode tubes connected in a push pull parallel circuit operating Class A. The cathode current of the tubes is metered by rotating the CIRCUIT-METER SEL switch on the modulator cabinet panel to the DRIVER CATH 1 or DRIVER CATH 2 positions. The total driver cathode current is indicated on the meter when the SEL switch is in the MOD FIL 1 and MOD Fil. 2 positions. The tubes are self biased by cathode resistors R246 and R247. The output of this stage is transformer coupled to the grids of the modulator tubes. Feedback is employed from the 845 plates to the grids of the input stage.

(d) Modulator Circuit. - Two type 892R triodes connected in a push pull circuit operating Class B are used to modulate the r-f final amplifier. These tubes operate with a fixed bias and with 8500 volts on their plates in high power operation. The bias voltage to the tubes is regulated by two rheostats, R404 and R405, which are located on the vertical

chassis of the rectifier bay. During low power operation, bias is regulated by rheostats R406 and R417 and the plate voltage is reduced in proportion to the PA tube plate voltage. A feedback circuit is connected from the plates of the modulator to the grids of the input stage. The amount of inverse feedback employed is sufficient to minimize any trouble encountered due to varying loads on the modulator. The output of the modulator is coupled to the plate circuit of the power amplifier tubes by T1004, and L1001. A low pass filter consisting of L1002 and C806, has been incorporated between the modulator and the final amplifier to attenuate the high frequency response at a fairly rapid rate above 10,000 cycles. This low pass filter is very effective in eliminating any "sing", transients, etc., that may appear on the carrier due to some part failure or other trouble in the audio amplifier. The cathode currents of the modulator tubes are metered by separate meters. DC overload protection is furnished by overload relay K415 inserted in the cathode circuit of the two tubes.

4.2.6. FILAMENT SUPPLIES.

(a) Power Amplifier. - Two filament heating transformers are employed for the 892R power amp tube, one for each half of the filament. These transformers are Scott connected in the primary and series connected in the secondary with the midpoint of the 892R filament connected to the midpoint of the transformer secondaries. The phasing of the secondaries are such that one-half of the filament for each 892R is excited 90 degrees out of phase with the second half. Therefore, theoretically, the hum appearing in the plate circuit is cancelled out. The B- and grid returns are brought to neutral points in the filament circuits established by fixed resistors

R805, R807, and variable resistor R806. The variable resistor can be adjusted from the rear of the power amplifier cabinet. Variable resistor R806 is adjusted to give minimum noise. The taps are usually near the filament center tap end of the adjustment. Filament voltage can be varied by variable resistor R811 from the front panel by operation of the ADJUST control where a 10% change in filament voltage is possible; in addition, a 7-1/2% change is possible by manipulation of switch S409 which changes the taps on the filament autotransformers T410 and T411.

(b) Modulator. - As in the case of the power amplifiers, two filament transformers are used for each 892R modulator tube. The secondaries of each set of transformers are connected 90 degrees out of phase with each other and in phase with the corresponding secondaries of the other set of transformers. The Scott connected primaries are connected in phase with each other. The result is a cancellation of hum in the push pull connected modulator plate circuits. Hum is balanced by variable resistors R606 and R607 and fixed resistors R602, R603, R604 and R605. The modulator filament voltage is adjusted by primary rheostats R610 and R611 and by tap switch S410 in 10% and 7-1/2% steps, respectively.

4.2.7. PLATE AND BIAS SUPPLIES.

(a) Low Voltage Supply. - The low voltage supply provides plate and screen voltage for the oscillator tubes, the isolation tube and the buffer tubes. In addition, it provides screen voltage for the 4-125A driver tubes and fixed bias

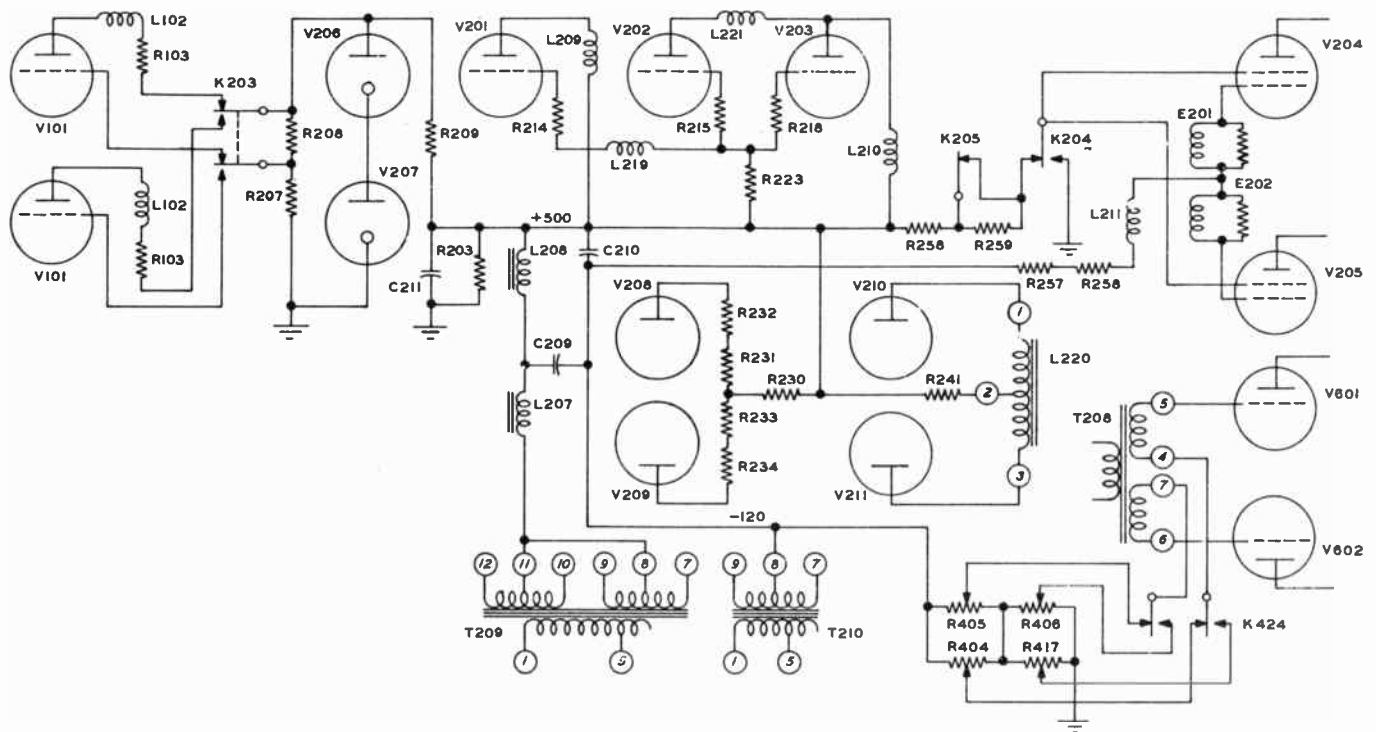

Figure 4-4 Low Voltage and Fixed Bias System

for the 4-125A grids and the 892R modulator grids. The rectifier tubes are type 8008 mercury vapor tubes. Two VR105 tubes are used in series to provide regulated plate voltage to the oscillator tubes. The center tap of the plate transformer is above ground to provide the bias voltage for the 4-125A's and the 892R's.

(b) Intermediate Power Supply. - The intermediate voltage power supply is a full wave bridge power supply employing four type 8008 mercury vapor tubes to provide approximately 2900 volts for the plates of the 4-125A tubes and approximately 1450 volts for the plates of the 845 audio driver tubes. The voltage for the plates of the 845 tubes being taken from the center tap of the plate transformer, T213, which is half that appearing across the entire power supply output terminals.

(c) High Voltage Power Supply. - The power supply employed to furnish power to the power amplifier and modulator stages is a 3 phase full wave single Y producing a ripple frequency of 6f which is comparatively easy to filter. Separate filter components are used for the power amplifier and modulator plate currents. The three plate transformers are mounted external of the transmitter cabinets. The rectifier tubes employed in the high voltage power supply are type 8008 mercury vapor rectifier. Air is blown on the base of the tubes through individual ports in the rectifier cabinet vertical chassis. Each tube has an individual filament transformer upon which the rectifier tube socket is mounted. The primaries of the filament transformers are connected in quadrature to produce longer rectifier tube life. It is important that the plate transformer connections be made exactly as speci-

fied on the schematic.

The high voltage bleeder, R406, is relay operated and is placed in the circuit when the plate voltage is turned off. Automatic shorting devices ground the positive side of the high voltage supply whenever any door (except those of the rectifier cabinet) is opened. When the rectifier cabinet doors are opened (except the lower front door) the 3 phase high voltage leads are shorted together and are grounded. Immediately prior to this shorting, however, the door interlocks function to turn off the high power and throw the bleeder into the circuits.

The plate voltage is reduced for half power operation by the use of autotransformers T414 and T415 which are tapped to give proper reduced power plate voltage.

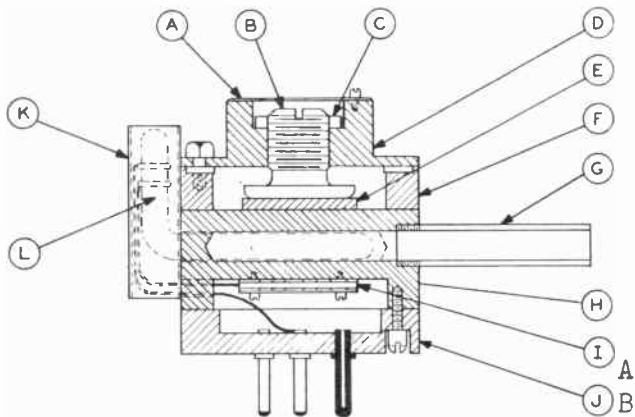

Figure 4-5 Type 297 Crystal Oven

A		Nameplate
B	500 1357 00	Air Gap Regulator
C	500 1356 00	Locking Ring
D	500 1358 00	Tap Plate
E		A-T Cut Crystal
F	190 9310 00	Isolantite Ring
G	500 1672 00	Thermometer Guide
H	500 1670 00	Anvil
I		Heater Element
J	190 7233 00	Isolantite Base
K	500 1671 00	Thermostat Cover
L	292 0013 00	Angle Thermostat

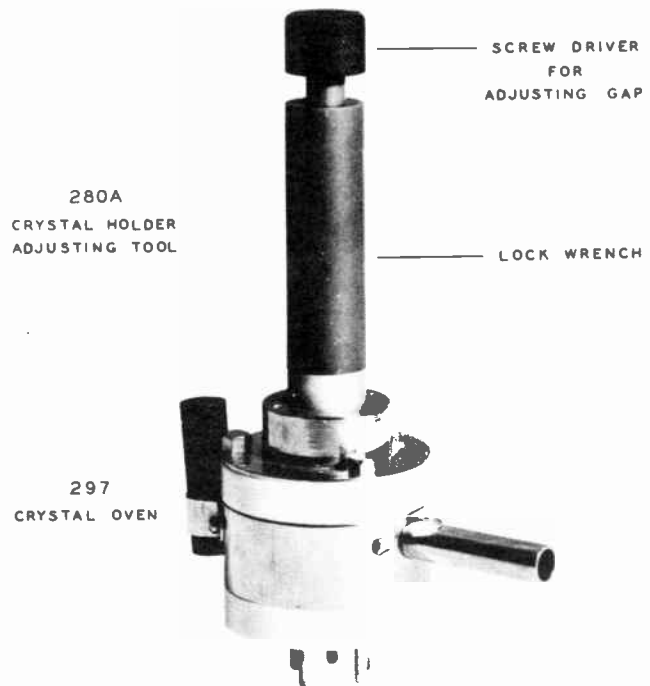

Figure 4-6 Type 280A Crystal Adjusting Tool

SECTION 5

PREVENTIVE MAINTENANCE

This radio transmitting equipment has been constructed of materials considered to be the best obtainable for the purpose, and has been carefully inspected and adjusted at the factory to reduce maintenance to a minimum. However, to insure peak performance and prevent the failure or the impairment of the operation of the equipment, a definite schedule of routine periodic checks and maintenance procedures should be adhered to.

5.1. CLEANING.

5.1.1. TRANSMITTER GENERAL.-The greatest enemy to uninterrupted service in equipment of this type is corrosion and dirt. Corrosion is accelerated by the presence of dust and moisture on the component parts in the assembly. It is impossible to keep moisture out of the equipment in certain localities, but foreign particles and dust can be periodically removed by means of a soft brush and a clean dry jet of air. Another alternative would be to use a vacuum cleaner. Although the cabinets are equipped with dust filters which will remove most of the dust particles, there is always a slight accumulation of dust in the vicinity of circuits at a high potential. Remove the dust by the above methods as often as a perceptible quantity accumulates at any place in the equipment. It is very important that rotating equipment such as variable capacitors, tap switches, etc., be kept free from dust to prevent undue wear. Corrosion resulting from a salt laden atmosphere may cause failure of the equipment for no apparent reason. In general, it will be found that contacts such as tap switches, tube prongs, and cable plug connectors are most affected by corrosion. When the equipment is operated in localities subject to such cor-

rosive atmosphere, inspection of wiping contacts, cable plugs, relays, etc., should be made more frequently in order to keep the equipment in good condition.

A cleaning schedule should be set up to include only a limited amount of cleaning and dusting to be done at one time. In this way it will require only a few minutes each night after shutdown and a more thorough job will be accomplished. Assign a different section of the transmitter to be covered each night. Arrange the schedule so that a complete coverage of the transmitter is obtained in a week's time.

5.1.2. AIR FILTER.-The spun glass filter elements at the rear of the transmitter will give more satisfactory life if the elements are cleaned about once every two weeks. A small vacuum cleaner is a satisfactory means of removing surface dirt. The elements should be replaced whenever the spun glass appears to be appreciably clogged by dust and grease.

5.2. ROUTINE CHECKS.

5.2.1. GENERAL INSPECTION.

(a) Check all connections at least once a month. Tighten all loose nuts, bolts and screws.

(b) Inspect interlock switches in the front and rear doors for proper operation.

(c) Examine all mechanical parts of motor driven assemblies for excessive wear.

(d) Check all contacts of cable receptacles and plugs to assure a clean,

firm mechanical connection between one another.

(e) Check all manually operated switches for excessive wear.

(f) Check all relays for proper operation and inspect relay contacts to make certain they are clean and free from pits.

(g) Examine electrical system for excessive heating of transformers, resistors, chokes, etc.

5.2.2. TUBE CHECK

(a) A check on the emission of all vacuum tubes should be made at least every 1000 hours of service.

(b) Keep a record of the length of time the tubes are in use.

(c) Replace tubes that have been in service an excessive length of time.

(d) Visually inspect the elements inside of the tubes. Elements may have become warped, increasing the possibility of short circuiting.

(e) Maintain the filament voltage of the coated filament tubes within $\pm 5\%$ of the recommended values for the type of tube used. Too high or too low a filament voltage affects the tube operation and reduces tube life. In the case of the 892R tubes, which have tungsten filaments, maintain the filament voltage at the minimum value which gives satisfactory operation. The filament life of these tubes can be greatly extended in this manner.

(f) Examine the prongs on all tubes to make certain that they are free from corrosion. When replacing tubes, make sure that they are seated correctly and fully

in the socket and that they make a good electrical contact. If it has a plate or grid cap lead, be sure this is properly in place and in good electrical and mechanical condition.

5.2.3. VOLTAGE AND CURRENT CHECKS. - During actual operation, meter indications should be under frequent observation to verify the proper operating currents and voltages. A table showing the approximate meter indications under typical operating conditions is shown in Section 4. Some variations in the current and voltage may occur but most satisfactory results are obtained from operation at rated values.

5.2.4. PERFORMANCE CHECKS. - Electrical performance tests should be made periodically and should include measuring the distortion at a number of modulation levels and noise measurements.

5.3. LUBRICATION.

5.3.1. MODULATOR AND PA BLOWERS. - Blower motors equipped with grease cups are lubricated by turning the grease cup $1/4$ turn every 100 hours of operation. Refill when empty with bearing grease.

Motors not equipped with grease cups have wool packed bearings which required 30 to 70 drops of SAE 20 oil after the first 3000 hours of operation and every 1000 hours thereafter.

5.3.2. RECTIFIER BLOWER MOTOR. - Lubricate the bearings of this blower motor with spindle oil of a viscosity of 190-220 Saybolt Universal Seconds at 100°F, such as Cities Service Pacemaker #2 or equal. Lubricate every 1000 hours or when the need is apparent with only a small amount of lubricant since too much will shorten the brush life.

5.3.3. EXCITER CABINET VENTILATING BLOW-

ERS. - The bearings of the ventilating blower motors should be lubricated with Cities Service North Star 000 every 3000 hours of operation. It is necessary to remove the end bells from the motors to gain access to the bearings.

5.3.4. TUNING MOTORS AND ASSEMBLIES. -- Lubricate with the same type of oil as prescribed in the EXCITER blower motors. Lubricate every 1000 hours using a small amount at one time.

NOTE

The total life expectancy of the above motors is in excess of 4500 hours.

5.4. MAINTENANCE TOOLS.

The proper use and care of maintenance tools and equipment is very important. Tools and maintenance equipment should be handled carefully while being used and kept in good condition at all times. Arrange the maintenance equipment in a well laid out manner on a work bench or cart so that the proper tools are available in case of emergencies. Always use the tool that was intended for the job being performed. When wrong tools are used while working on a unit, unnecessary damage to the equipment may result. Keep a good

supply of maintenance equipment on hand at all times. Check supplies of lubricants, cleaning agents, crocus cloth, etc., and replenish the supply when necessary.

5.5. RELAY MAINTENANCE.

Included in the schedule of preventive maintenance is relay maintenance. Dependable operation of this equipment requires proper operation of all relays. Although each relay in this equipment has been chosen because of satisfactory performance in similar service, some of these relays have rather critical adjustments and should not be tampered with. In case of failure of the telephone type relays, it is best to replace the entire relay. The only maintenance recommended is the periodic use of a burnishing tool to clean the contact surfaces.

In general, the contact adjustment of the a-c type of power relay is not critical. Contact assemblies and coils can be replaced in case of failure. Never use sandpaper or emery cloth on the contact surfaces. Relays which have excessive hum are not seating properly. Dirt on the pole faces is most likely the cause of this, and can be remedied by washing with carbon tetrachloride.

SECTION 6

CORRECTIVE MAINTENANCE

If routine Maintenance checks and inspection schedules, as outlined in Section 5, are performed regularly, very little trouble is likely to occur with this equipment. However, it is realized that at times, certain parts will fail, not because of improper selection of components but rather a defective part which may show up one or two out of every hundred. It is impossible to foresee every case of trouble that may develop, but very little should occur, without being evident by abnormal readings of the meters in the transmitter. An experienced operator should have little difficulty in locating and correcting the faults. A systematic procedure of testing should be followed to quickly isolate the circuit at fault.

6.1. TROUBLE SHOOTING.

6.1.1. TUBE FAILURE. - The most frequent cause of trouble in equipment of this type is tube failure. If a fault occurs in the equipment, isolation of the circuit at fault is helpful in determining the location of the defective tube. Defective tubes causing an overload in power circuits may usually be located by inspection. It will be found that excessive heating or sputtering within vacuum tubes is a good indication of fault in the tube circuit. Low emission tubes may be the cause of erratic or poor performance of the equipment. If there is any doubt concerning the emission of any tube, it should be checked immediately and replaced if defective. A burned out filament, obviously, would give no light with voltage applied. Tubes with electrical noises cause excessive distortion or hum. This fault may be more difficult to isolate to a particular tube; however, a tube suspected of faulty operation may be checked by replacing with a like tube

known to be in good condition.

6.1.2. LOCATION OF TROUBLE. - The transmitter may fail to function either at the time of attempting to start it, or it may fail during operation. In either case, the procedure for making a test is to check the circuits in the order of succession they are made operative in the process of starting the transmitter. Refer to paragraph 4.2.2. for the sequence of operation that takes place during normal starting sequence.

This procedure should aid in isolating the trouble to one or two units. A check of all circuit breakers should be made to ascertain the power circuit affected by the trouble.

The following tables of operating voltages and current measurements is supplied to assist the operator in trouble shooting. Open and short circuits will usually be accompanied by a change in the voltage applied to one or more of the tubes. A check of the various tube voltages and current measurements against the values shown in the tables will assist in locating the source of trouble.

6.1.3. CABLE TROUBLE. - To provide localized control and metering on the front doors it is necessary to run approximately 60 wires between the cabinet chassis and the control doors. This is done through two cables fitted with Cannon connectors. The circuits are so arranged so that only one cable is necessary to provide the essential transmitter functions such as tuning, metering, etc.. The other cable carries all the circuits which are convenient to have but are not absolutely essential to the transmitter operation, such as, filament metering, pilot lights, etc.. Therefore, should one cable give

trouble it is only necessary to put the good cable in the key position and repair the other cable while the equipment is in operation.

6.1.4. SERVICING THE EQUIPMENT. - The major portion of components are constructed on vertical chassis or side walls within the cabinets. This adds considerable accessibility to all components, as access to all components is readily attained from either front or the rear of the transmitter. Each tube SPAR has

been arranged with a cover that is easily removed and all the parts thereunder are readily accessible. The air baffles in the rear cabinet can be removed promptly if deemed necessary to gain access to components that need servicing. The wiring on the rear of the vertical chassis is exposed by removing the channel covers. The meter and control door wiring is accessible upon removal of two covers. One-man replacement of all components has been designed into this equipment wherever practical.

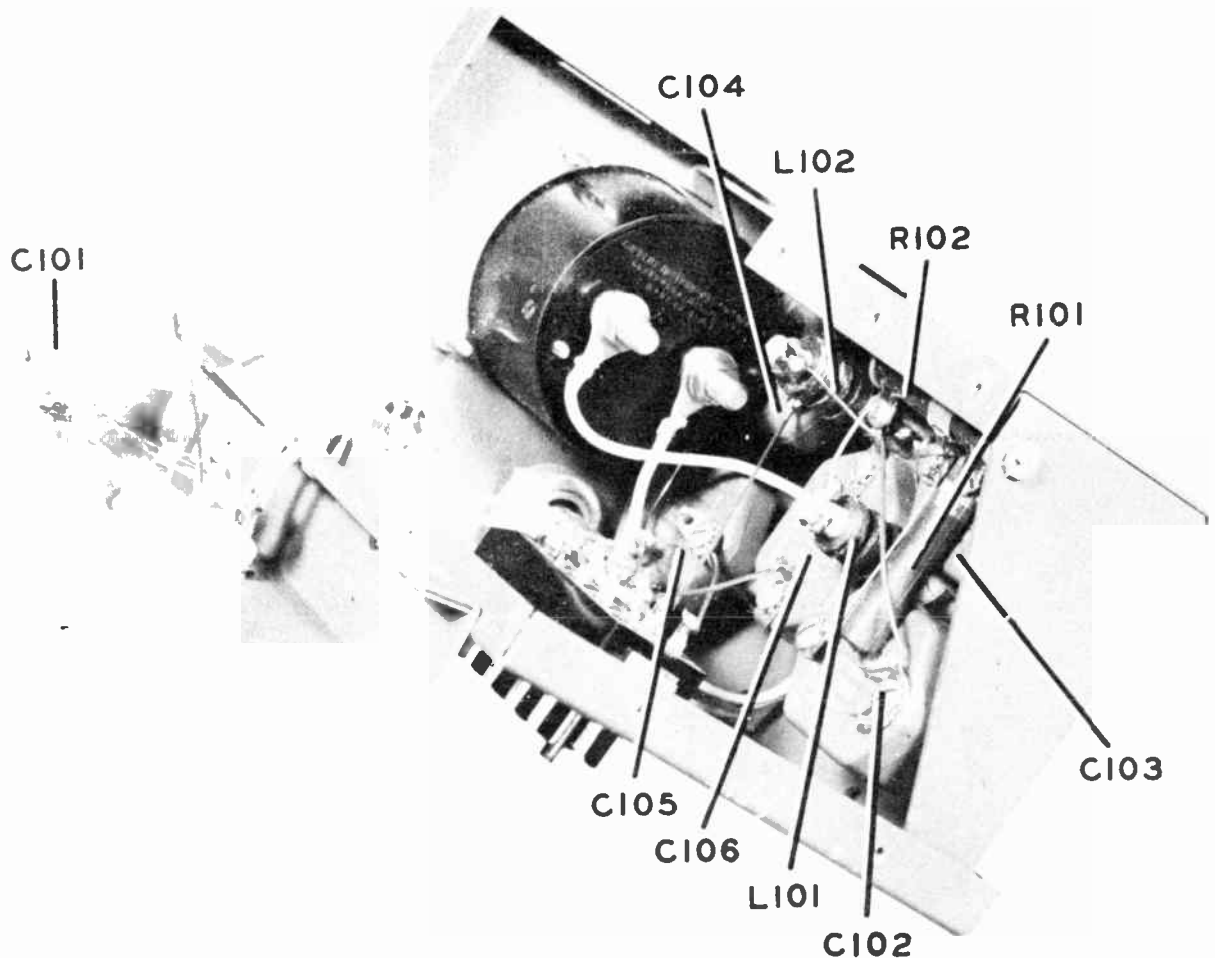

Figure 6-1 40F Frequency Control Unit Parts Arrangement

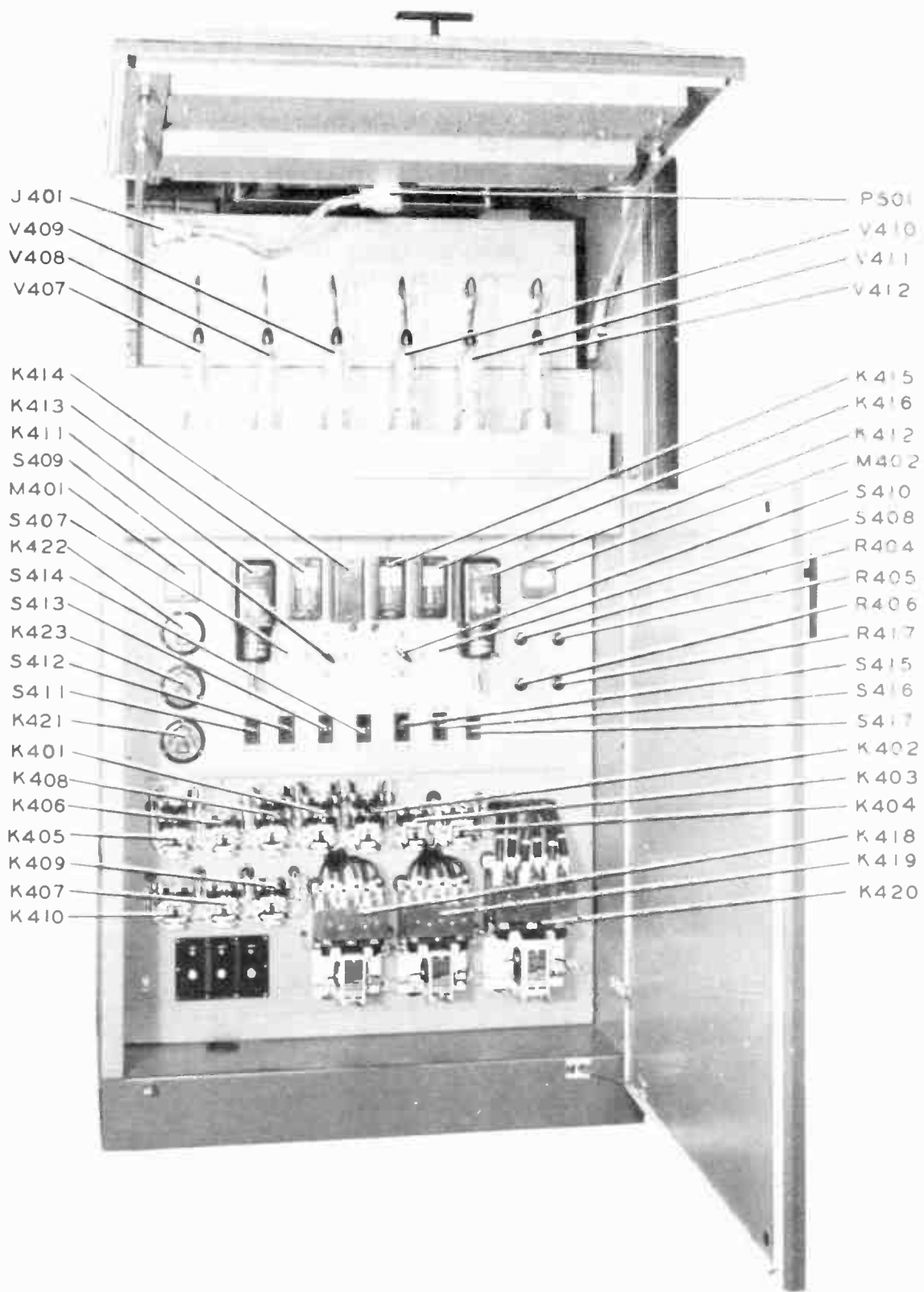

Figure 6-2 Rectifier Bay, Front Open

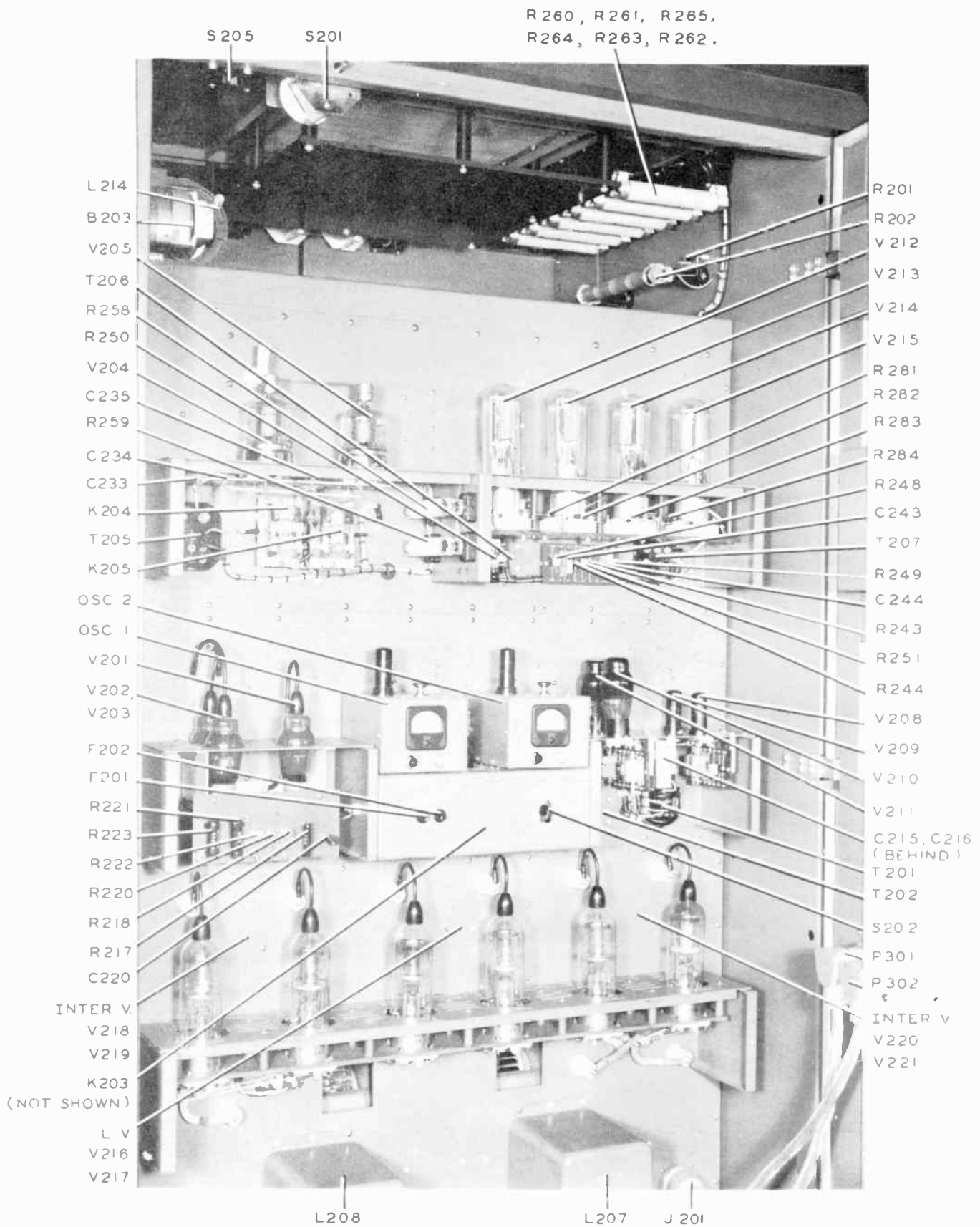

Figure 6-4 Exciter Bay, Front Open

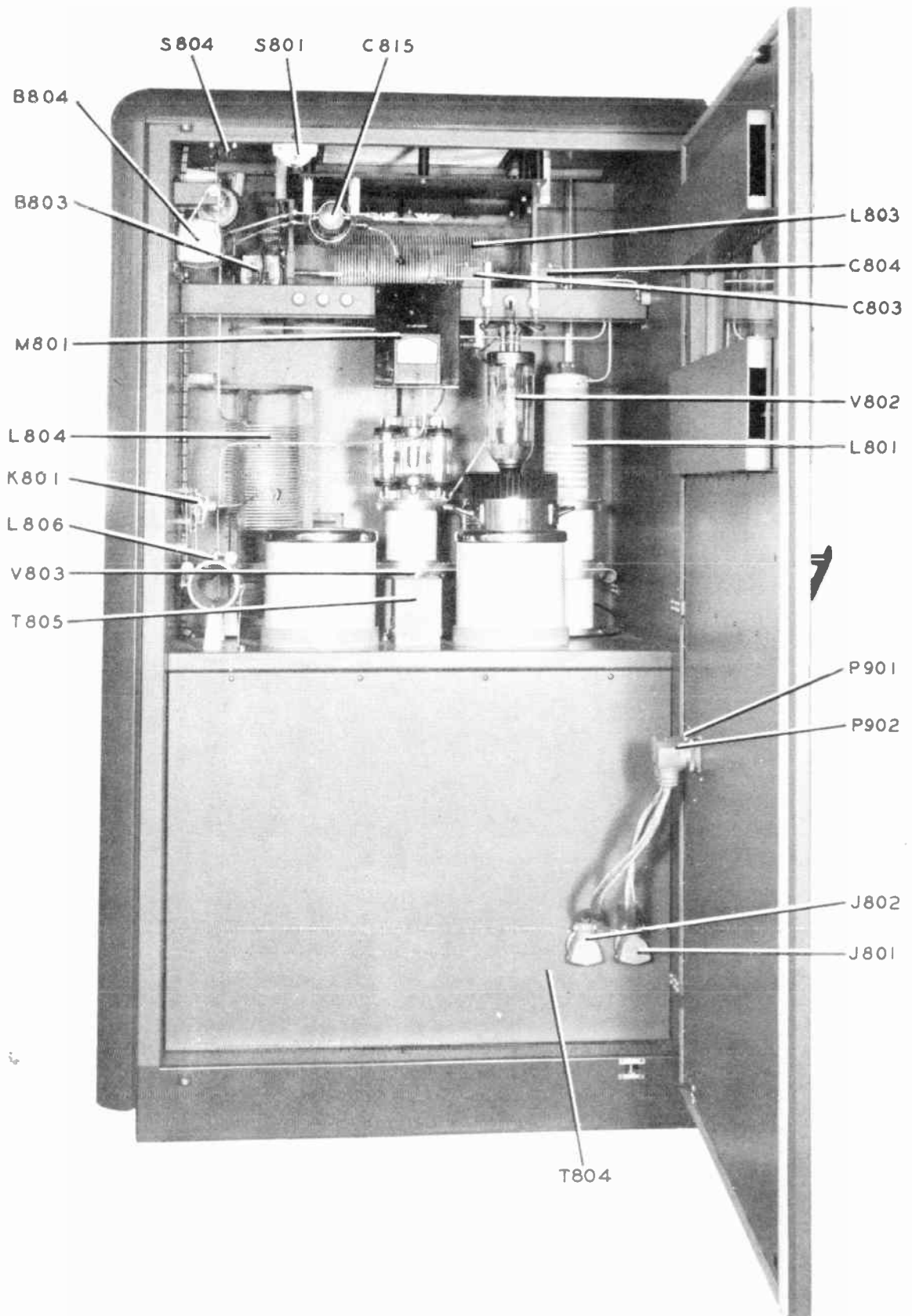

Figure 6-5 Power Amplifier Bay, Front Open

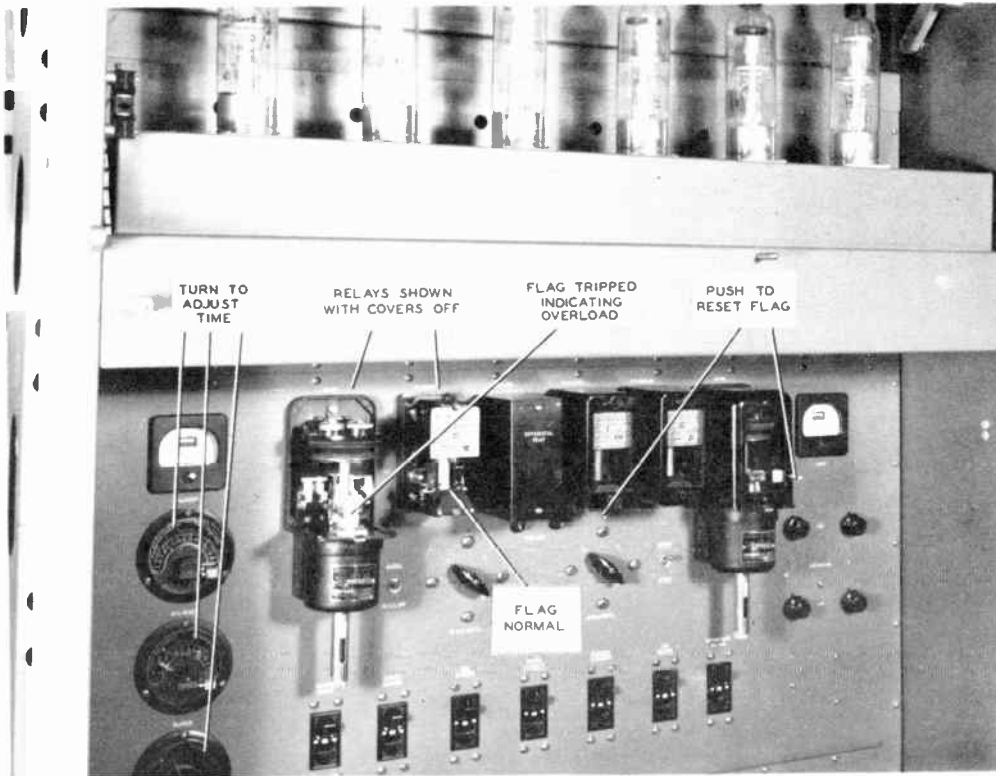

Figure 6-6 Overload Relay Adjustments

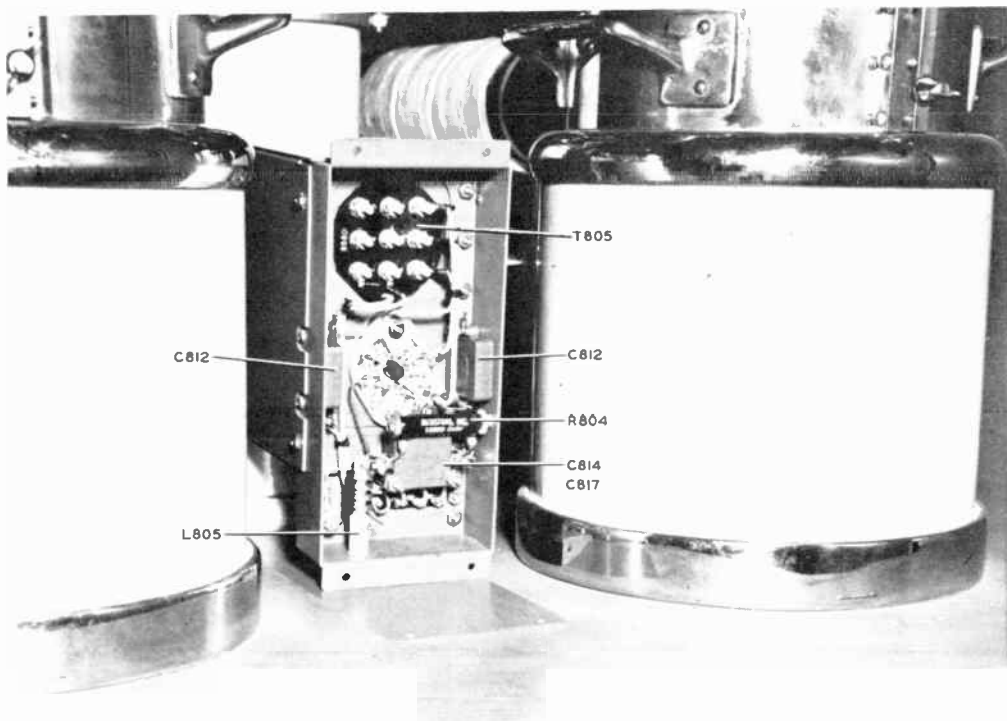

Figure 6-7 R-F Rectifier Parts Arrangement

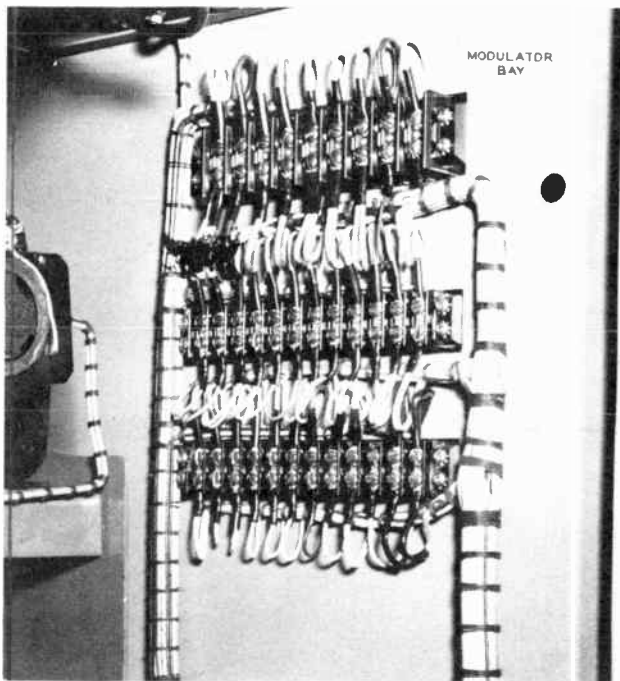
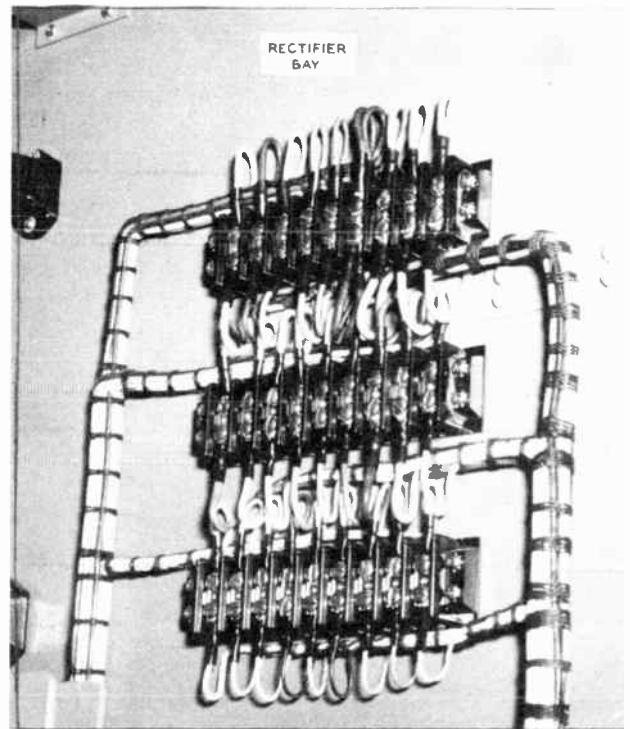
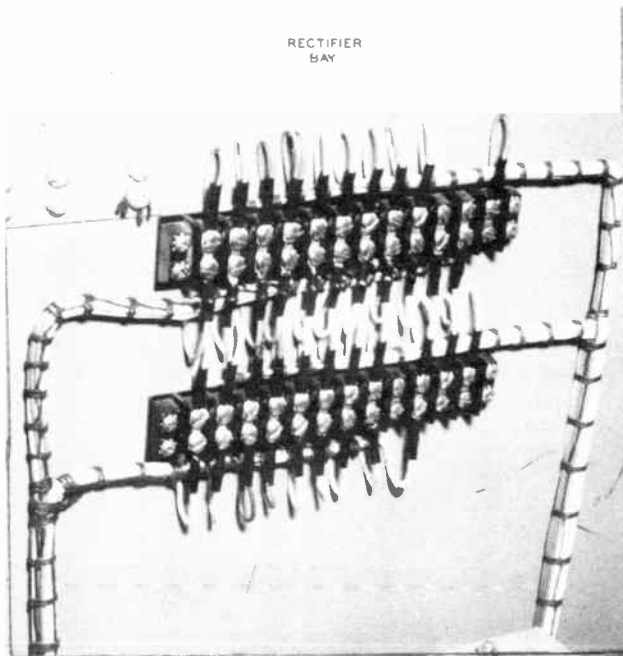

Figure 6-8a Inter-Cabinet Connecting Panels

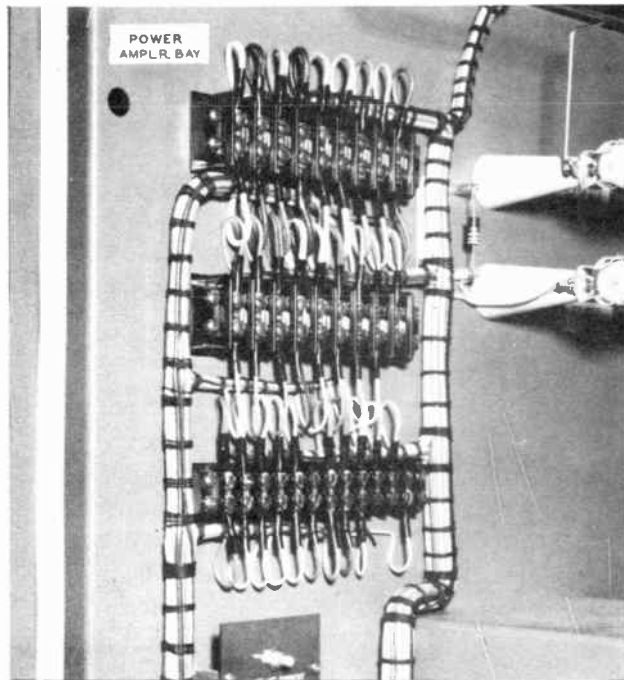
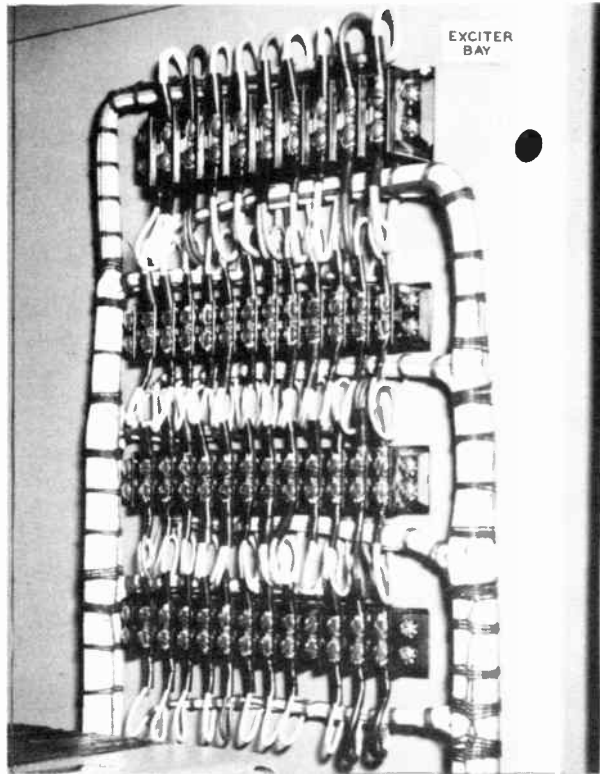

Figure 6-8b Inter-Cabinet Connecting Panels

SECTION 7
PARTS LIST

21B Transmitter			COLLINS PART NUMBER
ITEM	CIRCUIT FUNCTION	DESCRIPTION	
B202	Exciter cabinet ventilation blower	MOTOR: Split phase induction; 230 v AC, 50/60 cps, single phase	230 0013 00
B203	Driver plate tuning	MOTOR: AC; 230 v, 60 cps, single phase, 4 rpm	230 0012 00
B204	Buffer plate tuning	MOTOR: AC; 230 v, 60 cps, single phase, 4 rpm	230 0012 00
B401	Rectifier tube ventilation	BLOWER and MOTOR ASSEM: 230 v AC, 60 cps, 3400 rpm motor	503 6210 003
B601	Mod. filament adjust	MOTOR: AC; 230 v, 60 cps, single phase, 4 rpm	230 0012 00
B602	Mod. filament adjust	MOTOR: AC; 230 v, 60 cps, single phase, 4 rpm	230 0012 00
B603	Modulator tube ventilation	BLOWER and MOTOR ASSEM: includes: BLOWER and MOTOR: 230 v AC, 60 cps, 1/7 hp SWITCH ASSEM: Micro, SPDT 5 amp 250 v AC, see S607	503 6103 004 503 6162 002 503 5975 002 (260 0700 00)
B604	Modulator tube ventilation	BLOWER and MOTOR ASSEM: includes: BLOWER and MOTOR: 230 v AC, 60 cps, 1/7 hp SWITCH ASSEM: Micro, SPDT 5 amp 250 v AC, see S608	503 6103 004 503 6162 002 503 5975 002 (260 0700 00)
B802	Power amplifier filament adjust	MOTOR: AC; 230 v, 60 cps, single phase, 4 rpm	230 0012 00
B803	PA plate tuning	MOTOR: AC; 230 v, 60 cps, single phase, 4 rpm	230 0012 00
B804	PA plate loading	MOTOR: AC; 230 v, 60 cps, single phase, 4 rpm	230 0012 00
B805	PA tube ventilation	BLOWER and MOTOR ASSEM: includes: BLOWER and MOTOR: 230 v AC, 60 cps, 1/7 hp SWITCH ASSEM: Micro, SPDT 5 amp 250 v AC, see S809	503 6103 004 503 6162 002 503 5975 002 (260 0700 00)

PARTS LIST

ITEM	CIRCUIT FUNCTION	DESCRIPTION	COLLINS PART NUMBER
C101	Freq. adjust	CAPACITOR: Var, 12 mmf max, 1 mmf min, single sect	922 3100 00
C102	Osc. feedback	CAPACITOR: Mica, 51 mmf $\pm 2\%$, 2500 WV	937 0018 00
C103	Osc. cathode	CAPACITOR: Mica, 270 mmf $\pm 2\%$, 2500 WV	937 0064 00
C104	Osc. screen bypass	CAPACITOR: Mica, 10,000 mmf $\pm 10\%$, 1200 WV	937 0170 00
C105	Osc. plate bypass	CAPACITOR: Mica, 10,000 mmf $\pm 10\%$, 1200 WV	937 0170 00
C106	Iso. amp grid coupling	CAPACITOR: Mica, 1,000 mmf $\pm 10\%$, 2500 WV	937 0104 00
C201	Intermediate voltage filter	CAPACITOR: 4 mf $\pm 10\%$, 2500 WV	930 0033 00
C202	Intermediate voltage filter	CAPACITOR: 4 mf $\pm 10\%$, 2500 WV	930 0033 00
C203	Intermediate voltage filter	CAPACITOR: 4 mf $\pm 10\%$, 2500 WV	930 0033 00
C204	Intermediate voltage filter	CAPACITOR: 4 mf $\pm 10\%$, 2500 WV	930 0033 00
C205	Intermediate voltage filter	CAPACITOR: Paper, 4 mf $\pm 20\%$, 5000 WV	930 0053 00
C206	Intermediate voltage filter	CAPACITOR: Paper, 4 mf $\pm 20\%$, 5000 WV	930 0053 00
C207	Intermediate voltage filter	CAPACITOR: Paper, 4 mf $\pm 20\%$, 5000 WV	930 0053 00
C208	Intermediate voltage filter	CAPACITOR: Paper, 4 mf $\pm 20\%$, 5000 WV	930 0053 00
C209	Low voltage filter	CAPACITOR: Paper, 15 mf $\pm 10\%$, 1000 WV	930 0050 00
C210	Low voltage filter	CAPACITOR: Paper, 15 mf $\pm 10\%$, 1000 WV	930 0050 00
C211	Low voltage filter	CAPACITOR: Paper, 10 mf $\pm 10\%$, 1000 WV	930 0038 00

PARTS LIST

ITEM	CIRCUIT FUNCTION	DESCRIPTION	COLLINS PART NUMBER
C212	Feedback	CAPACITOR: Mica, 8200 mmf $\pm 5\%$, 1200 WV	936 1120 00
C213	Feedback	CAPACITOR: Mica, 8200 mmf $\pm 5\%$, 1200 WV	936 1120 00
C214	Audio amp plate de-coupling	CAPACITOR: Paper, 10 mf $\pm 10\%$, 1000 WV	930 0038 00
C215	Audio coupling	CAPACITOR: Paper, 2 mf $\pm 10\%$, 600 WV	930 7820 00
C216	Audio coupling	CAPACITOR: Paper, 2 mf $\pm 10\%$, 600 WV	930 7800 00
C217	Audio connection	CAPACITOR: Mica, 2000 mmf $\pm 5\%$, 1200 WV	936 0268 00
C218	Audio connection	CAPACITOR: Mica 2000 mmf $\pm 5\%$, 1200 WV	936 0268 00
C219	2nd audio plate de-coupling	CAPACITOR: Paper, 10 mf $\pm 10\%$, 1000 WV	930 0038 00
C220	Excitation control	CAPACITOR: Var, 100 mmf max, 5.6 mmf min, single sect.	922 0005 00
C221	V201 cathode bypass	CAPACITOR: 27,000 mmf $\pm 10\%$, 1200 WV	937 2053 00
C222	V201 screen bypass	CAPACITOR: Mica 10,000 mmf $\pm 10\%$, 1200 WV	937 0170 00
C223	V202 grid coupling	CAPACITOR: 100 mmf $\pm 10\%$, 2500 WV	937 0038 00
C224	Grid meter shunt bypass	CAPACITOR: Mica, 10,000 mmf $\pm 10\%$, 1200 WV	937 0170 00
C225	Buffer cathode bypass	CAPACITOR: 27,000 mmf $\pm 10\%$, 1200 WV	937 2053 00
C226	Buffer screen bypass	CAPACITOR: Mica, 10,000 mmf $\pm 10\%$, 1200 WV	937 0170 00
C227	Buffer plate bypass	CAPACITOR: Mica, 10,000 mmf $\pm 10\%$, 1200 WV	937 0170 00
C228	Buffer plate blocking	CAPACITOR: Mica, 5600 mmf $\pm 10\%$, 1200 WV	937 0154 00
*C229	540-700 kc	CAPACITOR: 2400 mmf $\pm 5\%$, 3000 WV	938 0084 00
*C229	700-900 kc	CAPACITOR: 2000 mmf $\pm 5\%$, 3000 WV	938 0080 00
*C229	900-1200 kc	CAPACITOR: 1500 mmf $\pm 5\%$, 3000 WV	938 0074 00
*C229	1200-1600 kc	CAPACITOR: 1000 mmf $\pm 5\%$, 3000 WV	938 0066 00
C230	Buffer plate tuning	CAPACITOR: Var. 475 mmf max, 18 mmf min, single sect.	921 1300 00

* Components used in a particular transmitter will depend on the operating frequency.

PARTS LIST

ITEM	CIRCUIT FUNCTION	DESCRIPTION	COLLINS PART NUMBER
C231	Driver grid coupling	CAPACITOR: Mica, .01 mf $\pm 10\%$, 2000 WV	950 1101 20
C232	Meter shunt bypass	CAPACITOR: Mica, 10,000 mmf $\pm 10\%$, 1200 WV	937 0170 00
C233	Driver filament bypass	CAPACITOR: Mica, 10,000 mmf $\pm 10\%$, 1200 WV	937 0170 00
C234	Driver filament bypass	CAPACITOR: Mica, 10,000 mmf $\pm 10\%$, 1200 WV	937 0170 00
C235	Driver screen bypass	CAPACITOR: Mica, 10,000 mmf $\pm 10\%$, 1200 WV	937 0170 00
C236	Driver plate bypass	CAPACITOR: Mica, 2000 mmf $\pm 5\%$, 5000 WV	938 2080 00
C237	PA grid coupling	CAPACITOR: Mica, 2000 mmf $\pm 5\%$, 5000 WV	938 2080 00
*C238	540-700 kc	CAPACITOR: 1300 mmf $\pm 5\%$, 25,000 WV	939 3028 00
*C238	700-900 kc	CAPACITOR: 1000 mmf $\pm 5\%$, 30,000 WV	939 3025 00
*C238	900-1200 kc	CAPACITOR: 620 mmf $\pm 5\%$, 30,000 WV	939 3020 00
*C238	1200-1600 kc	CAPACITOR: 470 mmf $\pm 5\%$, 30,000 WV	939 3017 00
C239	Bias bypass	CAPACITOR: Mica, 51000 mmf $\pm 5\%$, 1500 WV	938 2148 00
C240	Grid return bypass	CAPACITOR: Mica, 10,000 mmf $\pm 10\%$, 1200 WV	937 0170 00
C241	Audio coupling	CAPACITOR: Paper, 2 mf $\pm 10\%$, 1000 WV	930 3120 00
C242	Audio coupling	CAPACITOR: Paper, 2 mf $\pm 10\%$, 1000 WV	930 3120 00
C243	Audio correcting	CAPACITOR: Mica, 2000 mmf $\pm 5\%$, 1200 WV	936 0268 00
C244	Audio correcting	CAPACITOR: Mica, 2000 mmf $\pm 5\%$, 1200 WV	936 0268 00
C245	Audio driver cathode blocking	CAPACITOR: Paper, 2 mf $\pm 10\%$, 600 WV	930 7820 00
C246	Negative feedback	CAPACITOR: Mica, 220 mmf $\pm 5\%$, 2500 WV	936 0204 00
C247	Negative feedback	CAPACITOR: Mica, 220 mmf $\pm 5\%$, 2500 WV	936 0204 00
C248	Negative feedback	CAPACITOR: Mica, 220 mmf $\pm 5\%$, 2500 WV	936 0204 00
C249	Negative feedback	CAPACITOR: Mica, 220 mmf $\pm 5\%$, 2500 WV	936 0204 00
C250	Negative feedback	CAPACITOR: Mica, 220 mmf $\pm 5\%$, 2500 WV	936 0204 00
C251	Negative feedback	CAPACITOR: Mica, 220 mmf $\pm 5\%$, 2500 WV	936 0204 00

PARTS LIST

ITEM	CIRCUIT FUNCTION	DESCRIPTION	COLLINS PART NUMBER
C252	Negative feedback	CAPACITOR: Mica, 220 mmf $\pm 5\%$, 2500 WV	936 0204 00
C253	Negative feedback	CAPACITOR: Mica, 220 mmf $\pm 5\%$, 2500 WV	936 0204 00
C254	Negative feedback	CAPACITOR: Mica, 220 mmf $\pm 5\%$, 2500 WV	936 0204 00
C255	Negative feedback	CAPACITOR: Mica, 220 mmf $\pm 5\%$, 2500 WV	936 0204 00
C301	M301 meter bypass	CAPACITOR: Mica, 10,000 mmf $\pm 10\%$, 600 WV	936 0315 00
C302	M302 meter bypass	CAPACITOR: Mica, 10,000 mmf $\pm 10\%$, 600 WV	936 0315 00
C303	M303 meter bypass	CAPACITOR: Mica, 10,000 mmf $\pm 10\%$, 600 WV	936 0315 00
C304	M304 meter bypass	CAPACITOR: Mica, 10,000 mmf $\pm 10\%$, 600 WV	936 0315 00
C501	M501 meter bypass	CAPACITOR: Mica, 10,000 mmf $\pm 10\%$, 600 WV	936 0315 00
C601	High voltage supply filter	CAPACITOR: Paper, 4 mf $-5 + 15\%$, 10,000 WV	930 7620 00
C602	High voltage supply filter	CAPACITOR: Paper, 4 mf $-5 + 15\%$, 10,000 WV	930 7620 00
C603	Negative feedback	CAPACITOR: Vacuum, 6 mmf ± 0.5 mmf	919 0001 00
C604	Negative feedback	CAPACITOR: Vacuum, 6 mmf ± 0.5 mmf	919 0001 00
C701	M701 meter bypass	CAPACITOR: Mica, 10,000 mmf $\pm 10\%$, 600 WV	936 0315 00
C702	M702 meter bypass	CAPACITOR: Mica, 10,000 mmf $\pm 10\%$, 600 WV	936 0315 00
C703	M703 meter bypass	CAPACITOR: Mica, 10,000 mmf $\pm 10\%$, 600 WV	936 0315 00
C704	M704 meter bypass	CAPACITOR: Mica, 10,000 mmf $\pm 10\%$, 600 WV	936 0315 00
C803	PA filament bypass	CAPACITOR: Mica, 51,000 mmf $\pm 5\%$, 1500 WV	938 2148 00
C804	PA filament bypass	CAPACITOR: Mica, 51,000 mmf $\pm 5\%$, 1500 WV	938 2148 00
C805	Neut. blocking	CAPACITOR: Mica, 620 mmf $\pm 5\%$, 30,000 WV	939 3020 00
C806	PA tank tuning	CAPACITOR: Mica, 100 mmf $\pm 5\%$, 30,000 WV	939 3001 00
C807	PA plate blocking	CAPACITOR: Mica, 510 mmf $\pm 5\%$, 30,000 TV	939 3018 00
*C808	540-700 kc	CAPACITOR: 100 mmf ± 1.5 mmf 20,000 v max (qty 3)	919 0005 00
*C808	700-900 kc	CAPACITOR: 100 mmf ± 1.5 mmf 20,000 v max (qty 3)	919 0005 00

*Components used in a particular transmitter will depend on the operating frequency.

PARTS LIST

ITEM	CIRCUIT FUNCTION	DESCRIPTION	COLLINS PART NUMBER
*C808	900-1200 kc	CAPACITOR: 100 mmf \pm 1.5 mmf 20,000 v max (qty 2)	919 0005 00
*C808	900-1200 kc	CAPACITOR: 50 mmf \pm 1 mmf, 20,000 v max (1)	919 0004 00
*C808	1200-1600 kc	CAPACITOR: 100 mmf \pm 1.5 mmf 20,000 v max (qty 2)	919 0005 00
C809	PA plate loading	CAPACITOR: Vacuum, 500 mmf max, 25 mmf min	919 0006 00
C810	RF rect. coupling	CAPACITOR: Var, 14 mmf max, 3.8 mmf min, single section	923 1200 00
C811	RF rect. load	CAPACITOR: 47 mmf \pm 10%, 2500 WV	936 0161 00
C812	RF rect. fil. bypass	CAPACITOR: Mica, 10,000 mmf \pm 20%, 1200 WV	936 1127 00
C813	RF rect. fil. bypass	CAPACITOR: Mica 10,000 mmf \pm 20%, 1200 WV	936 1127 00
C814	RF rect plate bypass	CAPACITOR: Mica, 10,000 mmf \pm 20%, 1200 WV	936 1127 00
*C816	540-700 kc	CAPACITOR: 1000 mmf \pm 10% 15,000 v max	919 0013 00
*C816	700-900 kc	CAPACITOR: 1000 mmf \pm 10%, 15,000 v max	919 0013 00
*C816	900-1200 kc	CAPACITOR: 750 mmf \pm 10%, 15,000 v max	919 0012 00
*C816	1200-1600 kc	CAPACITOR: 500 mmf \pm 10%, 15,000 v max	919 0011 00
C817	RF rect. audio block- ing	CAPACITOR: Paper, 2 mf \pm 10%, 600 WV	930 7820 00
C901	M901 meter bypass	CAPACITOR: Mica, 10,000 ohm \pm 10%, 600 WV	936 0315 00
C902	M902 meter bypass	CAPACITOR: Mica, 10,000 ohm \pm 10%, 600 WV	936 0315 00
C903	M903 meter bypass	CAPACITOR: Mica, 10,000 ohm \pm 10%, 600 WV	936 0315 00
C904	M904 meter bypass	CAPACITOR: Mica, 10,000 ohm \pm 10%, 600 WV	936 0315 00
C1001		CAPACITOR: Paper, 2 mf + 15% - 5%, 15,000 WV	930 0147 00
CR201	Relay Supply	RECTIFIER: Dry disc, instrument	353 3000 00
CR202	Relay supply	RECTIFIER: Dry disc, instrument	353 3000 00
E201	RF driver grid	SUPPRESSOR: Parasitic, 7 watt	503 6179 00
E202	RF driver grid	SUPPRESSOR: Parasitic, 7 watt	503 6179 00
E802	PA grid	SUPPRESSOR: Parasitic, 20 watt	503 0545 002

* Components used in a particular transmitter will depend on the operating frequency

PARTS LIST

ITEM	CIRCUIT FUNCTION	DESCRIPTION	COLLINS PART NUMBER
F201	Crystal heater	FUSE: Cartridge, 2 amp 250 v	264 4070 00
F202	Crystal heater	FUSE: Cartridge, 2 amp 250 v	264 4070 00
F401	Crystal heat primary	FUSE: Cartridge, 1/2 amp 250 v	264 4030 00
F402	Crystal heat primary	FUSE: Cartridge, 1/2 amp 250 v	264 4030 00
I101	Crystal heat pilot	LAMP: Bayonet base, 6.3 v, 0.15 amp	262 3240 00
I301	Filament (Exciter bay)	LAMP: Pilot, DC bayonet base, 120 v	262 0041 00
I302,	Low voltage	6 w	
I303	Int. V (Exciter bay)		
I304,	High voltage (Exciter bay)		
I501,	Filament (Rect. bay)		
I502,	Overload 1		
I503,	Overload 2		
I504,	High voltage (Rect. bay)		
I701,	Tungsten filament		
I702,	High voltage (Mod. bay)		
I901,	Filament (Final bay)		
I902,	High voltage (Final bay)		
I305	For meters M301, M302,	LAMP: Meter, DC bayonet base, 120 v 6 w	262 0041 00
I306	M303, M304, M501, M701,		
I307	M702, M703, M704, M901,		
I308	M902, M903, M904		
I505,			
I703,			
I704,			
I705,			
I706,			
I903,			
I904,			
I905,			
I906			
J201	Door power	CONNECTOR: 30 term wall mtg receptacle, socket insert	370 2025 00
J202	Door power	CONNECTOR: 30 term wall mtg receptacle, socket insert	370 2025 00
J203	Crystal unit	CONNECTOR: 10 contact socket	364 2100 00
J204	Crystal unit	CONNECTOR: 10 contact socket.	364 2100 00
J301	Door power	CONNECTOR: 30 term right angle socket	370 2023 00
J302	Door power	CONNECTOR: 30 term right angle socket	370 2023 00
J401	Door power	CONNECTOR: 30 term wall mtg receptacle, socket insert	370 2025 00

PARTS LIST

ITEM	CIRCUIT FUNCTION	DESCRIPTION	COLLINS PART NUMBER
J501	Door power	CONNECTOR: 30 term right angle socket	370 2023 00
J601	Door power	CONNECTOR: 30 term wall mtg receptacle, socket insert	370 2025 00
J602	Door power	CONNECTOR: 30 term wall mtg receptacle, socket insert	370 2025 00
J701	Door power	CONNECTOR: 30 term right angle socket	370 2023 00
J702	Door power	CONNECTOR: 30 term right angle socket	370 2023 00
J801	Door power	CONNECTOR: 30 term wall mtg receptacle, socket insert	370 2025 00
J802	Door power	CONNECTOR: 30 term wall mtg receptacle, socket insert	370 2025 00
J901	Door power	CONNECTOR: 30 term right angle socket	370 2023 00
J902	Door power	CONNECTOR: 30 term right angle socket	370 2023 00
K201	Crystal heat	RELAY: Telephone, 6-12 v DC, 2500 ohm	970 1002 00
K202	Crystal heat	RELAY: Telephone, 6-12 v DC, 2500 ohm	970 1002 00
K203	Oscillator sele- tor	RELAY: Impulse latching, 3 SPDT, 1 SPST, 1 SPST (aux) 10 amp cont	410 0058 00
K204	TUNE relay	RELAY: Circ control, 230 v AC 50/60 cps coil	405 0119 00
K205	High-Low power driver screen control	RELAY: Circ control, 230 v AC 50/60 cps coil	405 0119 00
K207	High-Low power audio input selector	RELAY: Circ control, 230 v AC $\pm 10\%$ 3900 ohm coil	407 1007 00
K401	Coated filament	RELAY: Power contactor, 220 v AC 60 cps coil	405 0085 00
K402	Blower	RELAY: Power contactor, 220 v AC 60 cps coil	405 0059 00
K403	LV plate	RELAY: Power contactor, 220 v AC 60 cps coil	405 0041 00

PARTS LIST

ITEM	CIRCUIT FUNCTION	DESCRIPTION	COLLINS PART NUMBER
K404	Intermediate V plate	RELAY: Power contactor, 220 v AC 60 cps coil	405 0041 00
K405	Sequence start	RELAY: Power contactor; 220 v AC 60 cps coil	405 0085 00
K406	Restart #1	RELAY: Power Contactor, 220 v AC 60 cps coil	405 0041 00
K407	Release #1	RELAY: Power contactor, 220 v AC 60 cps coil	405 0045 00
K408	Restart #2	RELAY: Power contactor, 220 v AC 60 cps coil	405 0085 00
K409	Release #2	RELAY: Power contactor, 220 v AC 60 cps coil	405 0047 00
K410	Hold	RELAY: Power contactor, 220 v AC 60 cps coil	405 0041 00
K411	HV overload	RELAY: Time delay, 1 NO, 1 NC cont, 25 - 60 cps	405 0523 00
K412	HV overload	RELAY: Time delay, 1 NO, 1 NC cont, 25 - 60 cps	405 0523 00
K413	Driver overload	RELAY: Current overload, AC or DC, enclosed 1 NO, 1 NC cont.	405 0102 00
K414	Differential over- load	RELAY: Telephone, 3 amp, 150 w AC	970 9800 00
K415	Mod. overload	RELAY: Current overload, AC or DC, enclosed, 1 NO, 1 NC cont.	405 0103 00
K416	PA grid overload	RELAY: Current overload, AC or DC self reset, 100 ohm coil	405 0184 00
K417	Bleeder relay	SOLENOID: 220 v, 60 cps CONTACT: Switch, shorting	405 0513 00 503 1673 001
K418	Tune	RELAY: Power contactor, 200 v AC 60 cps coil	405 0287 00
K419	Low power	RELAY: Power contactor, 220 v AC 60 cps coil	405 0287 00

PARTS LIST

ITEM	CIRCUIT FUNCTION	DESCRIPTION	COLLINS PART NUMBER
K420	High power	RELAY: Power contactor, 220 v AC 50 cps	405 0229 00
K421	Air time delay	RELAY: Time delay, 230 v AC 60 cps coil	402 0029 00
K422	Filament time delay	RELAY: Time delay, 230 v AC 60 cps	402 0012 00
K423	Overload time delay	RELAY: Time delay, 230 v AC 60 cps	402 0013 00
K424	Bias	RELAY: Circ control, 230 v AC 50/60 cps coil	405 0119 00
K801	High power/low power monitor	RELAY: Circ control, 230 v AC 50/60 cps coil	405 0119 00
L101	Oscillator cathode	COIL: RF choke, 2.5 mh, 4 sect	240 5300 00
L102	Oscillator plate	COIL: RF choke, 2.5 mh, 4 sect	240 5300 00
L207	Low voltage supply input	REACTOR: Filter, 6 hy at .5 amp, 120 cps, 3500 v rms	678 0096 00
L208	Low voltage supply input	REACTOR: Filter, 6 hy at .5 amp, 120 cps, 3500 v rms	678 0096 00
L209	Iso. amp. plate choke	COIL: RF choke, 2.5 mh, 4 sect	240 5300 00
L210	Buffer amp. plate choke	COIL: RF choke, HF, 2.5 mh, 6 sect	240 2500 00
L211	RF driver grid choke	COIL: RF choke, HF, 2.5 mh, 6 sect	240 2500 00
L212	RF driver plate choke	COIL: ASSEM: RF choke, 3 mh	503 1038 002
*L213	540-700 kc	COIL ASSEM: Exciter tank	503 0627 003
*L213	700-900 kc	COIL ASSEM: Exciter tank	503 0627 003
*L213	900-1200 kc	COIL ASSEM: Exciter tank	503 0628 003
*L213	1200-1600 kc	COIL ASSEM: Exciter tank	503 0628 003
*L214	540-700 kc	COIL ASSEM: T section	503 6127 004
*L214	700-900 kc	COIL ASSEM: T section	503 6127 004
*L214	900-1200 kc	COIL ASSEM: T section	503 6128 004
*L214	1200-1600 kc	COIL ASSEM: T section	503 6128 004

* Components used in a particular transmitter will depend on the operating frequency.

PARTS LIST

ITEM	CIRCUIT FUNCTION	DESCRIPTION	COLLINS PART NUMBER
L215	Intermediate voltage input	REACTOR: Input filter, 10 hy, .5 amp 120 cps, 7500 TV	678 0196 00
L216	Intermediate voltage output	REACTOR: Input filter, 10 hy, .5 amp 120 cps, 7500 TV	678 0196 00
L217	Intermediate voltage input	REACTOR: Input filter, 10 hy, .5 amp 120 cps, 7500 TV	678 0196 00
L218	Intermediate voltage output	REACTOR: Input filter, 10 hy, .5 amp 120 cps, 7500 TV	678 0196 00
L219	Iso. amp. screen choke	COIL: RF choke, HF, 1 mh, 2 sect	240 2300 00
L220	Audio amp. plate	REACTOR: Audio, 80 hy CT, 50 ma 2500 v rms	678 0216 00
L221	Buffer plate	COIL: Parasitic	503 0535 001
L601	High voltage supply filter	REACTOR: HV filter, 4 hy 1.75 amp 180 cps 15 KV	678 0174 00
L602	High voltage supply filter	REACTOR: HV filter, 4 hy 1.75 amp 180 cps 15 KV	678 0174 00
*L801	PA neutralizing	COIL ASSEM: Neutral	503 6121 004
*L801	PA neutralizing	COIL ASSEM: Neutral	503 6122 004
*L801	PA neutralizing	COIL ASSEM: Neutral	503 6123 004
*L801	PA neutralizing	COIL ASSEM: Neutral	503 6124 004
L802	PA plate choke	COIL ASSEM: RF plate choke	503 6192 003
*L803	PA tank	COIL ASSEM: Pi section	503 6111 004
*L803	PA tank	COIL ASSEM: Pi section	503 6112 004
*L803	PA tank	COIL ASSEM: Pi section	503 6113 004
*L803	PA tank	COIL ASSEM: Pi section	503 6114 004
*L804	Ant. loading	COIL ASSEM: L section	503 6118 004
*L804	Ant. loading	COIL ASSEM: L section	503 6118 004
*L804	Ant. loading	COIL ASSEM: L section	503 6119 004

* Components used in a particular transmitter will depend on the operating frequency.

PARTS LIST

ITEM	CIRCUIT FUNCTION	DESCRIPTION	COLLINS PART NUMBER
*L804	Ant. loading	COIL ASSEM: L section	503 6119 004
L805	RF rect. plate	COIL: RF choke, 2.5 mh, 4 sect	240 5300 00
L806	Mod. mcnitor pick-up	COIL: ASSEM: Monitor	503 6217 004
L1001	Modulation reactor	REACTOR: Modulation, 30 hy 1.736 amp 35 KV	678 0217 00
L1002	High frequency filter	COIL: Air core, 100 mh 2500 v at 10 kc	669 2000 00
M101	Oscillator cathode current	MILLIAMMETER: DC, 0-50 ma DC	450 0013 00
M301	PA grid current	MILLIAMMETER: DC, 0-250 ma DC, 0-250 ma DC	450 0072 00
M302	Driver plate voltage	VOLTMETER: DC, 0-1 ma movement, 0-4.0 kv scale	458 1427 00
M303	Driver plate current	MILLIAMMETER: DC, 0-250 ma DC	450 0072 00
M304	Test	METER: DC, 0-5 v DC range, 0-40, 0-200 scale	458 0149 00
M401	Filament elapsed time	INDICATOR: Elapsed time, 0-9999.9 hours	458 0933 50
M402	Plate elapsed time	INDICATOR: Elapsed time, 0-9999.9 hours	458 0933 50
M501	Line voltage	VOLTMETER: AC, 300 v range	452 0029 00
M701	Audio driver cathode current	METER: DC, 0-1 v range, 0-250, 0-500 ma scale	458 0135 00
M702	Modulator current	METER: DC, 0-1 v range, 0-1000 ma scale	458 0137 00
M703	Modulator current	METER: DC, 0-1 v range, 0-1000 ma scale	458 0137 00
M704	Modulator filament	VOLTMETER: AC, 20 v range	452 0021 00
M801	Output RF meter	THERMO-AMMETER: RF, 12 amp range	451 0041 00
M901	Remote line RF meter	THERMO-AMMETER: RF, 15 amp range	459 0041 00
M902	PA plate current	METER: DC, 1.5 amp range	458 0114 00
M903	High voltage meter	VOLTMETER: DC, 0-1 ma movement, 0-10 kv scale	458 1430 00

* Components used in a particular transmitter will depend on the operating frequency.

PARTS LIST

ITEM	CIRCUIT FUNCTION	DESCRIPTION	COLLINS PART NUMBER
M904	PA filament	VOLTMETER: AC, 20 v range	452 0021 00
P101	Crystal unit	CONNECTOR: 10 contact plug	363 2100 00
P201 P202	Door power	CONNECTOR: 30 term straight plug	370 2024 00
P301	Door power	CONNECTOR: 30 term wall mtg receptacle, pin insert	370 2026 00
P302	Door power	CONNECTOR: 30 term wall mtg receptacle, pin insert	370 2026 00
P401	Door power	CONNECTOR: 30 term right angle plug	370 2036 00
P501	Door power	CONNECTOR: 30 term wall mtg receptacle, pin insert	370 2026 00
P601	Door power	CONNECTOR: 30 term right angle plug	370 2036 00
P602	Door power	CONNECTOR: 30 term right angle plug	370 2036 00
P701	Door power	CONNECTOR: 30 term wall mtg. receptacle, pin insert	370 2026 00
P702	Door power	CONNECTOR: 30 term wall mtg receptacle, pin insert	370 2026 00
P801	Door power	CONNECTOR: 30 term right angle plug	370 2036 00
P802	Door power	CONNECTOR: 30 term right angle plug	370 2036 00
P901	Door power	CONNECTOR: 30 term wall mtg receptacle, pin insert	370 2026 00
P902	Door power	CONNECTOR: 30 term wall mtg receptacle, pin insert	370 2026 00
R101	Osc. grid	RESISTOR: 51,000 ohm $\pm 5\%$, 2 w	745 5158 00
R102	Osc. cathode	RESISTOR: 100. ohm $\pm 10\%$, 10 w	710 1100 20
R103	Osc. plate drop- ping	RESISTOR: 1000 ohm $\pm 10\%$, 2 w	745 5086 00
R201	M302 meter shunt- ing	RESISTOR: 43,000 ohm $\pm 5\%$, 2 w	745 5154 00
R202	M302 meter multi- plier	RESISTOR: 4 megohm $\pm 5\%$, 4 kv	732 0008 00

PARTS LIST

ITEM	CIRCUIT FUNCTION	DESCRIPTION	COLLINS PART NUMBER
R203	LV supply bleeder	RESISTOR: 12,500 ohm $\pm 5\%$, 50 w	733 1027 00
R204	K413 coil shunt	RESISTOR: 47 ohm $\pm 5\%$, 10 w	710 0183 00
R207	Voltage divider	RESISTOR: 10,000 ohm $\pm 5\%$, 10 w	710 1104 10
R208	Voltage divider	RESISTOR: 2400 ohm $\pm 5\%$, 10 w	710 0230 00
R209	VR tube dropping	RESISTOR: 4500 ohm $\pm 10\%$, 50 w	733 1001 00
R210	Iso. amp grid	RESISTOR: 3900 ohm $\pm 10\%$, 2 w	745 5111 00
R211	Iso. amp suppressor	RESISTOR: 47 ohm $\pm 10\%$, 1 w	745 3030 00
R212	Buffer amp grid suppressor	RESISTOR: 47 ohm $\pm 10\%$, 1 w	745 3030 00
R213	Buffer amp grid suppressor	RESISTOR: 47 ohm $\pm 10\%$, 1 w	745 3030 00
R214	Iso. amp screen suppressor	RESISTOR: 47 ohm $\pm 10\%$, 1 w	745 3030 00
R215	Buffer screen suppressor	RESISTOR: 47 ohm $\pm 10\%$, 1 w	745 3030 00
R216	Buffer screen suppressor	RESISTOR: 47 ohm $\pm 10\%$, 1 w	745 3030 00
R217	Iso. amp cathode	RESISTOR: 560 ohm $\pm 10\%$, 10 w	710 0214 00
R218	Iso. amp cathode current shunt	RESISTOR: 128.2 ohm $\pm 1\%$, 1 w	721 0054 00
R219	Buffer amp grid	RESISTOR: 4700 ohm $\pm 10\%$, 2 w	745 5114 00
R220	Buffer grid current meter shunt	RESISTOR: 128.2 ohm $\pm 1\%$, 1 w	721 0054 00
R221	Buffer cathode	RESISTOR: 330 ohm $\pm 10\%$, 25 w	710 0318 00
R222	Buffer cathode meter shunt	RESISTOR: 25.10 ohm $\pm 1\%$, 1 w	721 0032 00

PARTS LIST

ITEM	CIRCUIT FUNCTION	DESCRIPTION	COLLINS PART NUMBER
R223	Screen dropping	RESISTOR: 22,000 ohm $\pm 10\%$, 25 w	710 0373 00
R224	T201 sec. load	RESISTOR: 7500 ohm $\pm 5\%$, 2 w	745 5123 00
R225	T201 sec. load	RESISTOR: 7500 ohm $\pm 5\%$, 2 w	745 5123 00
R226	Feedback divider	RESISTOR: 4300 ohm $\pm 5\%$, 2 w	745 5112 00
R227	Feedback divider	RESISTOR: 4300 ohm $\pm 5\%$, 2 w	745 5112 00
R228	1st audio cathode	RESISTOR: 2000 ohm $\pm 5\%$, 2 w	745 5098 00
R229	1st audio cathode meter shunt	RESISTOR: 128.2 ohm $\pm 1\%$, 1 w	721 0054 00
R230	1st audio plate de- coupling	RESISTOR: 4700 ohm $\pm 10\%$, 2 w	745 5114 00
R231	1st audio plate load	RESISTOR: 24,000 ohm $\pm 5\%$, 2 w	745 5144 00
R232	1st audio plate load	RESISTOR: 24,000 ohm $\pm 5\%$, 2 w	745 5144 00
R233	1st audio plate load	RESISTOR: 24,000 ohm $\pm 5\%$, 2 w	745 5144 00
R234	1st audio plate load	RESISTOR: 24,000 ohm $\pm 5\%$, 2 w	745 5144 00
R235	Audio correcting	RESISTOR: 20,000 ohm $\pm 5\%$, 2 w	745 5140 00
R236	Audio correcting	RESISTOR: 20,000 ohm $\pm 5\%$, 2 w	745 5140 00
R237	Second audio grid	RESISTOR: .24 megohm $\pm 5\%$, 2 w	745 5186 00
R238	Second audio grid	RESISTOR: .24 megohm $\pm 5\%$, 2 w	745 5186 00
R239	Second audio cathode	RESISTOR: 630 ohm $\pm 5\%$, 15 w	733 1940 00
R240	Second audio cath- ode	RESISTOR: 25.10 ohm $\pm 1\%$, 1 w	721 0032 00
R241	Second audio plate decoupling	RESISTOR: 2240 ohm $\pm 5\%$, 50 w	733 0982 00
R244	Audio driver grid	RESISTOR: .12 megohm $\pm 5\%$, 2 w	745 5173 00

PARTS LIST

ITEM	CIRCUIT FUNCTION	DESCRIPTION	COLLINS PART NUMBER
R245	Audio driver grid	RESISTOR: .12 megohm $\pm 5\%$, 2 w	745 5173 00
R246	Audio driver cathode	RESISTOR: 1600 ohm $\pm 5\%$, 50 w	733 0973 00
R247	Audio driver cathode	RESISTOR: 1600 ohm $\pm 5\%$, 50 w	733 0973 00
R248	Audio driver cathode meter shunt	RESISTOR: 4.08 ohm $\pm 1\%$, 1 w	721 0026 00
R249	Audio driver cathode meter shunt	RESISTOR: 4.08 ohm $\pm 1\%$, 1 w	721 0026 00
R250	Audio driver balancing control	RESISTOR: 350 ohm $\pm 10\%$, 25 w	735 0020 00
R251	Audio driver cathode meter shunt	RESISTOR: 2.02 ohm $\pm 1\%$, 1 w	721 0024 00
R252	PA grid leak	RESISTOR: 2500 ohm $\pm 5\%$, 140 w	746 0032 00
R254	PA grid leak	RESISTOR: 2500 ohm $\pm 5\%$, 140 w	746 0032 00
R256	RF driver grid	RESISTOR: 7500 ohm $\pm 10\%$, 10 w	710 0033 00
R257	RF driver grid current meter shunt	RESISTOR: 128.2 ohm $\pm 1\%$, 1 w	721 0054 00
R258	RF driver screen dropping	RESISTOR: 6300 ohm $\pm 5\%$, 50 w	733 1009 00
R259	RF driver screen dropping	RESISTOR: 6300 ohm $\pm 5\%$, 50 w	733 1009 00
R260	Intermediate voltage bleeder	RESISTOR: 16,000 ohm $\pm 10\%$, 86 w	733 0674 00
R261	Intermediate supply bleeder	RESISTOR: 16,000 ohm $\pm 10\%$, 86 w	733 0674 00
R262	Intermediate supply bleeder	RESISTOR: 16,000 ohm $\pm 10\%$, 86 w	733 0674 00
R263	Intermediate supply bleeder	RESISTOR: 16,000 ohm $\pm 10\%$, 86 w	733 0674 00

PARTS LIST

ITEM	CIRCUIT FUNCTION	DESCRIPTION	COLLINS PART NUMBER
R264	Intermediate supply bleeder	RESISTOR: 16,000 ohm $\pm 10\%$, 86 w	733 0674 00
R265	Intermediate supply bleeder	RESISTOR: 16,000 ohm $\pm 10\%$, 86 w	733 0674 00
R266	Audio pad	RESISTOR: 150 ohm $\pm 10\%$, 1 w	745 3051 00
R267	Audio pad	RESISTOR: 150 ohm $\pm 10\%$, 1 w	745 3051 00
R268	Audio pad	RESISTOR: 150 ohm $\pm 10\%$, 1 w	745 3051 00
R269	Audio pad	RESISTOR: 150 ohm $\pm 10\%$, 1 w	745 3051 00
R270	Audio pad	RESISTOR: 220 ohm $\pm 10\%$, 1 w	745 3058 00
R271	Audio pad	RESISTOR: 220 ohm $\pm 10\%$, 1 w	745 3058 00
R272	Audio pad	RESISTOR: 150 ohm $\pm 10\%$, 1 w	745 3051 00
R273	Audio pad	RESISTOR: 150 ohm $\pm 10\%$, 1 w	745 3051 00
R274	Audio pad	RESISTOR: 150 ohm $\pm 10\%$, 1 w	745 3051 00
R275	Audio pad	RESISTOR: 150 ohm $\pm 10\%$, 1 w	745 3051 00
R276	Audio pad	RESISTOR: 220 ohm $\pm 10\%$, 1 w	745 3058 00
R277	Audio pad	RESISTOR: 220 ohm $\pm 10\%$, 1 w	745 3058 00
R281	Audio driver grid suppressor	RESISTOR: 100 ohm $\pm 10\%$, 2 w	745 5044 00
R282	Audio driver grid suppressor	RESISTOR: 100 ohm $\pm 10\%$, 2 w	745 5044 00
R283	Audio driver grid suppressor	RESISTOR: 100 ohm $\pm 10\%$, 2 w	745 5044 00
R284	Audio driver grid suppressor	RESISTOR: 100 ohm $\pm 10\%$, 2 w	745 5044 00
R285	negative feedback	RESISTOR: .15 megohm $\pm 5\%$, 2 w	745 5176 00
R286	"	"	"
R287	"	"	"
R288	"	"	"
R289	"	"	"
R290	"	"	"
R291	"	"	"
R292	"	"	"
R293	"	"	"
R294	"	"	"
R301	I301 series	RESISTOR: 3900 ohm $\pm 10\%$, 25 w	710 0350 00
R302	I302 series	RESISTOR: 3900 ohm $\pm 10\%$, 25 w	710 0350 00
R303	I303 series	RESISTOR: 3900 ohm $\pm 10\%$, 25 w	710 0350 00

PARTS LIST

ITEM	CIRCUIT FUNCTION	DESCRIPTION	COLLINS PART NUMBER
R304	I304 series	RESISTOR: 3900 ohm $\pm 10\%$, 25 w	710 0350 00
R305	M302 meter shunt	RESISTOR: 43,000 ohm $\pm 5\%$, 2 w	745 5154 00
R401	K415 coil shunt	RESISTOR: 0.5 ohm $\pm 10\%$, 10 w	710 0275 00
R402	K414 coil shunt	RESISTOR: 13 ohm $\pm 5\%$, 25 w	710 0278 00
R403	Relay K416 coil shunt	RESISTOR: 110 ohm $\pm 5\%$, 10 w	710 0193 00
R404	Mod. bias adj.	RHEOSTAT: 1 ohm $\pm 10\%$, 50 w	736 0067 00
R405	Mod. bias adj.	RHEOSTAT: 1 ohm $\pm 10\%$, 50 w	736 0067 00
R406	Mod. bias adj.	RHEOSTAT: 1 ohm $\pm 10\%$, 50 w	736 0067 00
R407	HV bleeder	RESISTOR: 10,000 ohm $\pm 5\%$, 140 w	746 0038 00
R417	Mod. bias adj.	RHEOSTAT: 1 ohm $\pm 10\%$, 50 w	736 0067 00
R501	I501 series	RESISTOR: 3900 ohm $\pm 10\%$, 25 w	710 0350 00
R502	I502 series	RESISTOR: 3900 ohm $\pm 10\%$, 25 w	710 0350 00
R503	I503 series	RESISTOR: 3900 ohm $\pm 10\%$, 25 w	710 0350 00
R504	I504 series	RESISTOR: 3900 ohm $\pm 10\%$, 25 w	710 0350 00
R505	M50 meter mult.	RESISTOR: 2700 ohm $\pm 10\%$, 25 w	710 0345 00
R601	Mod. grid load	RESISTOR: 10,000 ohm $\pm 5\%$, 140 w	746 0038 00
R602	Noise adj. fixed	RESISTOR: 25 ohm $\pm 5\%$, 20 w	746 2524 00
R603	Noise adj. fixed	RESISTOR: 25 ohm $\pm 5\%$, 20 w	746 2524 00
R604	Noise adj. fixed	RESISTOR: 25 ohm $\pm 5\%$, 20 w	746 2524 00
R605	Noise adj. fixed	RESISTOR: 25 ohm $\pm 5\%$, 20 w	746 2524 00
R606	Mod. noise adj.	RHEOSTAT: 16 ohm, 50 w	736 1620 00
R607	Mod. noise adj.	RHEOSTAT: 16 ohm, 50 w	736 1620 00
R608	M702 meter shunt	RESISTOR: 1.005 ohm $\pm 1\%$, 1 w	721 0021 00
R609	M703 meter shunt	RESISTOR: 1.005 ohm $\pm 1\%$, 1 w	721 0021 00

PARTS LIST

ITEM	CIRCUIT FUNCTION	DESCRIPTION	COLLINS PART NUMBER
R610	Mod. fil. adj.	RHEOSTAT: 4 ohm $\pm 10\%$, 300 w each sect.	741 0001 00
R610A		Section of R610	
R610B		Section of R610	
R610C		Section of R610	
R611	Mod. fil. adj.	RHEOSTAT: 4 ohm $\pm 10\%$, 300 w each sect.	741 0001 00
R611A		Section of R611	
R611B		Section of R611	
R611C		Section of R611	
R612	Negative feedback series	RESISTOR: 2,700,000 ohm $\pm 5\%$, 22 w	731 0002 00
R613	Negative feedback series	RESISTOR: 2,700,000 ohm $\pm 5\%$, 22 w	731 0002 00
R614	Negative feedback series	RESISTOR: 2,700,000 ohm $\pm 5\%$, 22 w	731 0002 00
R615	Negative feedback series	RESISTOR: 2,700,000 ohm $\pm 5\%$, 22 w	731 0002 00
R701	I701 series	RESISTOR: 3900 ohm $\pm 10\%$, 25 w	710 0350 00
R702	I702 series	RESISTOR: 3900 ohm $\pm 10\%$, 25 w	710 0350 00
R801	HV meter mult.	RESISTOR: 5 megohm $\pm .5\%$, 5 kv	732 0009 00
R802	HV meter mult.	RESISTOR: 5 megohm $\pm .5\%$, 5 kv	732 0009 00
R803	M903 meter shunt	RESISTOR: 43,000 ohm $\pm 5\%$, 2 w	745 5154 00
R804	K414 coil series	RESISTOR: 10,000 ohm $\pm 10\%$, 10 w	710 1104 20
R808	Noise adj. fixed	RESISTOR: 25 ohm $\pm 5\%$, 20 w	746 2524 00

PARTS LIST

ITEM	CIRCUIT FUNCTION	DESCRIPTION	COLLINS PART NUMBER
R809	Noise adj. control	RHEOSTAT: 16 ohm, 50 w	736 1620 00
R810	Noise adj. fixed	RESISTOR: 25 ohm $\pm 5\%$, 20 w	746 2524 00
R812	PA fil. adjust	RHEOSTAT: 4 ohm $\pm 10\%$, 300 w each sect.	741 0001 00
R812A		Section of R812	
R812B		Section of R812	
R812C		Section of R812	
R813	Remote meter adj.	RESISTOR: Var, 25 ohm	377 0003 00
R814	Audio monitor control	RESISTOR: Var, 10,000 ohm	377 0010 00
R815	Audio monitor series	RESISTOR: 560 ohm $\pm 10\%$, 2 w	745 5076 00
R816	Audio monitor series	RESISTOR: 150 ohm $\pm 10\%$, 2 w	745 5051 00
R901	I901 series	RESISTOR: 3900 ohm $\pm 10\%$, 25 w	710 0350 00
R902	I902 series	RESISTOR: 3900 ohm $\pm 10\%$, 25 w	710 0350 00
R903	M903 meter shunt	RESISTOR: 43,000 ohm $\pm 5\%$, 2 w	745 5154 00
S201	HV grounding	SWITCH ASSEM: shorting	503 1938 003
S202	Crystal heat	SWITCH: Tap, 2 pole 2 pos, non-shorting	259 1100 00
S203	HV grounding	SWITCH ASSEM: shorting	503 1938 003
S204	HV grounding	SWITCH ASSEM: shorting	503 1938 003
S205	Door interlock	CONTACT ASSEM: male section of door interlock switch	260 4040 00
		CONTACT ASSEM: female section of door interlock switch	260 4050 00
		7-20	15746

PARTS LIST

ITEM	CIRCUIT FUNCTION	DESCRIPTION	COLLINS PART NUMBER
S206	Door interlock	CONTACT ASSEM: male section of door interlock switch	260 4040 00
		CONTACT ASSEM: female section of door interlock switch	260 4050 00
S207	Door interlock	CONTACT ASSEM: male section of door interlock switch	260 4040 00
		CONTACT ASSEM: female section of door interlock switch	260 4050 00
S301	Fil. start-stop	SWITCH: Start-stop, black button	260 0521 00
S302	Test meter circuit selector	SWITCH: Band change, 4 circ, non-shorting, 6 pos	259 0249 00
S303	Oscillator selecting	SWITCH: Tap, 2 pole, 2 pos, 1 sect, non-shorting	259 1030 00
S304	Exciter bay raise/low-er	SWITCH: Jack, DPDT with off normal	260 3080 00
S305	Plate start-stop	SWITCH: Start-stop, black button	260 0521 00
S401	High voltage shorting	SWITCH ASSEM: HV shorting	503 6213 003
S402	High voltage shorting	SWITCH ASSEM: shorting	503 1938 003
S403	High voltage shorting	SWITCH ASSEM: shorting	503 1938 003
S404	Door interlock	CONTACT ASSEM: male section of door interlock switch	260 4040 00
		CONTACT ASSEM: female section of door interlock switch	260 4050 00
S405	Door interlock	CONTACT ASSEM: male section of door interlock switch	260 4040 00
		CONTACT ASSEM: female section of door interlock switch	260 4050 00
S406	Door interlock	CONTACT ASSEM: male section of door interlock switch	260 4040 00
		CONTACT ASSEM: female section of door interlock switch	260 4050 00
S407	PA overload off	SWITCH: Toggle, DPST	260 1010 00
S408	HV off sw	SWITCH: Toggle, DPST	260 1010 00
S409	PA fil. adjust	SWITCH: Rotary, 2 pole, 4 elec pos	260 0638 00

PARTS LIST

ITEM	CIRCUIT FUNCTION	DESCRIPTION	COLLINS PART NUMBER
S410	Mod. fil adjusting	SWITCH: Rotary, 2 pole, 4 elec pos.	260 0638 00
S411	Control circuit breaker	CIRCUIT BREAKER: Magnetic, 230 v AC/250 v DC	260 0218 00
S412	Blower motors breaker	CIRCUIT BREAKER: Magnetic, 230 v AC/ 250 v DC	260 0216 00
S413	Blower motors breaker	CIRCUIT BREAKER: Magnetic, 230 v AC/ 250 v DC	260 0384 00
S414	Coated filament breaker	CIRCUIT BREAKER: Magnetic, 230 v AC/ 250 v DC	260 0424 00
S415	Tungsten filament breaker	CIRCUIT BREAKER: Magnetic, 230 v AC/ 250 v DC	260 0392 00
S416	LV plate primary breaker	CIRCUIT BREAKER: Magnetic, 230 v AC/ 250 v DC	260 0254 00
S417	Intermediate plate primary breaker	CIRCUIT BREAKER: Magnetic, 230 v AC/ 250 v DC	260 0264 00
S501	Overload reset	SWITCH: Normally closed, 600 v AC 5.0 amp (ind), 600 v AC 15.0 amp (non-ind) 600 v DC 0.1 amp	260 0707 00
S502	M502 circuit selector	SWITCH: Band change, DP, double deck, non-shorting	259 0155 00
S503	Hi, Lo, Tune selector	SWITCH: Tap, 3 pos, 2 circ, 2 gang, non- shorting	259 1300 00
S504	Plate start stop	SWITCH: Start-stop, black button	260 0521 00
S601	Door interlock	CONTACT ASSEM: male section of door interlock switch	260 4040 00
		CONTACT ASSEM: female section of door interlock switch	260 4050 00
S602	Door interlock	CONTACT ASSEM: male section of door interlock switch	260 4040 00
		CONTACT ASSEM: female section of door interlock switch	260 4050 00
S603	Door interlock	CONTACT ASSEM: male section of door interlock switch	260 4040 00
		CONTACT ASSEM: female section of door interlock switch	260 4050 00

PARTS LIST

ITEM	CIRCUIT FUNCTION	DESCRIPTION	COLLINS PART NUMBER
S604	High voltage shorting	SWITCH ASSEM: shorting	503 1938 003
S605	High voltage shorting	SWITCH ASSEM: shorting	503 1938 003
S606	High voltage shorting	SWITCH ASSEM: shorting	503 1938 003
S607	Air interlock	SWITCH: Micro, SPDT, 5 amp 250 v AC, part of B603	260 0700 00
S608	Air interlock	SWITCH: Micro, SPDT, 5 amp 250 v AC, part of B604	260 0700 00
S701	Fil. start-stop	SWITCH: Start-stop, black button	260 0521 00
S702	Mod. bay circuit/ meter selector	SWITCH: Band change, 6 circ, non-shorting, 4 pos, 3 deck	259 0244 00
S703	Mod. bay raise/ lower	SWITCH: Jack, DPDT with off normal	260 3080 00
S704	Plate start-stop	SWITCH: Start-stop, black button	260 0521 00
S801	High voltage shorting	SWITCH ASSEM: shorting	503 1938 003
S802	High voltage shorting	SWITCH ASSEM: shorting	503 1938 003
S803	High voltage shorting	SWITCH ASSEM: shorting	503 1938 003
S804	Door interlock	CONTACT ASSEM: male section of door interlock switch	260 4040 00
		CONTACT ASSEM: female section of door inter- lock switch	260 4050 00
S805	Door interlock	CONTACT ASSEM: male section of door inter- lock switch	260 4040 00
		CONTACT ASSEM: female section of door inter- lock switch	260 4050 00
S806	Door interlock	CONTACT ASSEM: male sect. of door interlock switch	260 4040 00
		CONTACT ASSEM: female sect. of door inter- lock switch	260 4050 00
S807	Air interlock	SWITCH: Snap, 2 circ, 1 NO, 1 NC	260 0003 00
S808	Air interlock	SWITCH: Snap, 2 circ, 1 NO, 1 NC	260 0003 00
S809	Air interlock	SWITCH: Micro, SPDT, 5 amp 250 v AC, part of B805	260 0700 00

PARTS LIST

ITEM	CIRCUIT FUNCTION	DESCRIPTION	COLLINS PART NUMBER
S901	Fil. start-stop	SWITCH: Start-stop, black button	260 0521 00
S902	PA bay circuit/meter selector	SWITCH: Band change, 6 circ, non-shorting, 4 pos, 3 deck	259 0244 00
S903	PA bay raise/lower switch	SWITCH: Jack, DPDT with off normal	260 3080 00
S904	Plate start-stop	SWITCH: Start-stop, black button	260 0521 00
T201	Audio input	TRANSFORMER: HF input audio, Pri: 500 ohm CT, Sec: 15,000 ohm CT	677 0092 00
T202	Audio amp fil.	TRANSFORMER: Amp fil, Pri: 210, 220, 230, 240, 250 v, 31.5 VA, Sec: 6.3 v CT, 31.5 VA	672 1121 00
T203	RF Osc. and amp fil.	TRANSFORMER: Amp fil, Pri: 210, 220, 230, 240, 250 v, 31.5 VA, Sec: 6.3 v CT, 31.5 VA	672 1121 00
T204	Crystal heat and relay	TRANSFORMER: Fil or heater, Pri: 115, 210, 220, 230, 240 v, 32 VA, Sec: 12.6 v CT	672 0086 00
T205	RF driver fil	TRANSFORMER: Fil, Pri: 230, 208, 210, 220, 240 v, Sec: 5 v CT, 32 amp	672 0169 00
T206	Audio driver fil	TRANSFORMER: Amp fil, Pri: 210, 220, 230, 240, 250 v, 65 VA, Sec: 10 v CT, 65 VA	672 1101 00
T207	Audio driver fil	TRANSFORMER: Amp fil, Pri: 210, 220, 230, 240, 250 v, 65 VA, Sec: 10 v CT, 65 VA	672 1101 00
T208	Audio driver	TRANSFORMER: Driver, Pri: 9000 ohm CT, Sec #1: 1000 ohm, Sec #2: 1000 ohm	677 0215 00
T209	LV rect. fil	TRANSFORMER: Fil, Pri: 230, 208, 210, 220, 240 v, Sec #1: 5 v CT, Sec #2: 5 v CT	672 0167 00
T210	LV plate	TRANSFORMER: Plate, Pri: 210, 220, 230, 240, 250 v, Sec: 1456 v CT	503 0521 002
T211	Intermediate voltage filament	TRANSFORMER: Fil, Pri: 230, 208, 210, 220, 240 v, Sec #1: 5 v CT, Sec #2: 5 v CT	672 0167 00

PARTS LIST

ITEM	CIRCUIT FUNCTION	DESCRIPTION	COLLINS PART NUMBER
T212	Intermediate voltage filament	TRANSFORMER: Fil, Pri: 230, 208, 210, 220, 240 v, Sec #1: 5 v CT, Sec #2: 5 v CT	672 0167 00
T213	Intermediate voltage plate	TRANSFORMER: Plate, Pri: 230, 208, 210, 220, 240 v Sec: 3310 v CT, .86 amp	672 0172 00
T401	HV rect. filament	TRANSFORMER: Filament, with socket, Pri: 220, 230, 240 v, Sec: CT, Socket: 5 v, 10 amp for V407	672 0166 00
T402	HV rect. filament	TRANSFORMER: Filament, with socket, Pri: 220, 230, 240 v, Sec: CT, Socket: 5 v, 10 amp, for V408	672 0166 00
T403	HV rect. filament	TRANSFORMER: Filament, with socket, Pri: 220, 230, 240 v, Sec: CT, Socket: 5 v, 10 amp, for V409	672 0166 00
T404	HV rect. filament	TRANSFORMER: Filament, with socket, Pri: 220, 230, 240 v, Sec: CT, Socket: 5 v, 10 amp, for V410	672 0166 00
T405	HV rect. filament	TRANSFORMER: Filament, with socket, Pri: 220, 230, 240 v, Sec: CT, Socket: 5 v, 10 amp, for V411	672 0166 00
T406	HV rect. filament	TRANSFORMER: Filament, with socket, Pri: 220, 230, 240 v, Sec: CT, Socket: 5 v, 10 amp, for V412	672 0166 00
T407	Voltage regulator	TRANSFORMER: Pri: 190 to 250 v 60 cyc, single phase, Output: 230 v @ 93% pf	664 0026 00
T408	Voltage regulator transformer	TRANSFORMER: Pri: 190 to 250 v 60 cyc, single phase, Output: 230 v @ 93% pf	664 0026 00
T409	Voltage regulator transformer	TRANSFORMER: Pri: 190 to 250 v 60 cyc, single phase, Output: 230 v @ 93% pf	664 0026 00
T410	Autotransformer	TRANSFORMER: Auto, 195, 213, 230, 247, 265 v, 25.2 amp	674 0187 00

PARTS LIST

ITEM	CIRCUIT FUNCTION	DESCRIPTION	COLLINS PART NUMBER
T411	Autotransformer	TRANSFORMER: Auto, 195, 213, 230, 247, 265 v, 25.2 amp	674 0187 00
T412	Overload current	TRANSFORMER: Current, double pri, single sec, ratio: 10/20:1, 5000 v	664 0046 00
T413	Overload current	TRANSFORMER: Current, double pri, single sec, ratio: 10/20:1, 5000 v	664 0046 00
T414	HP - LP autotransformer	TRANSFORMER: Auto, 50/60 cps, .90 to 1.0 pf, 2500 TV rms	674 0188 00
T415	HP - LP autotransformer	TRANSFORMER: Auto, 50/60 cps, .90 to 1.0 pf, 2500 TV rms	674 0188 00
T601	Mod. filament	TRANSFORMER: Power, Pri: 230, 199, 115 v, 2200 VA, 2 phase	664 6740 00
T602	Mod. filament	TRANSFORMER: Power, Pri: 230, 199, 115 v, 2200 VA, 3 phase, Sec: 11.0 v CT, 2200 VA, 2 phase	664 6740 00
T603	Mod. filament	TRANSFORMER: Power, Pri: 230, 199, 115 v, 2200 VA, 3 phase, Sec: 11.0 v CT, 2200 VA, 2 phase	664 6740 00
T604	Mod. filament	TRANSFORMER: Power, Pri: 230, 199, 115 v, 2200 VA, 3 phase, Sec: 11.0 v CT, 2200 VA, 2 phase	664 6740 00
T803	PA filament	TRANSFORMER: Power, Pri: 230, 199, 115 v, 2200 VA, 3 phase, Sec: 11.0 v CT, 2200 VA, 2 phase	664 6740 00
T804	PA filament	TRANSFORMER: Power, Pri: 230, 199, 115 v, 2200 VA, 3 phase, Sec: 11.0 v CT, 2200 VA, 2 phase	664 6740 00
T805	RF rectifier filament	TRANSFORMER: RF rect fil, Pri: 210, 220, 230, 240, 250 v, 15 VA, Sec: 5 v CT, 15 VA	672 1131 00
T1001	HV plate	TRANSFORMER: Plate, Pri: 240 v nom single phase 50/60 cps, Sec: 4160, 4056, 3952, 3888, 3744 v	664 0044 00

PARTS LIST

ITEM	CIRCUIT FUNCTION	DESCRIPTION	COLLINS PART NUMBER
T1002	HV plate	TRANSFORMER: Plate, Pri: 240 v nom single phase 50/60 cps, Sec: 4160, 4056, 3952, 3888, 3744 v	664 0044 00
T1003	HV plate	TRANSFORMER: Plate, Pri: 240 v nom single phase 50/60 cps, Sec: 4160, 4056, 3952, 3888, 3744 v	664 0044 00
T1004	Modulation	TRANSFORMER: Modulation, #1: Pri: 20,000 ohm CT, Sec: 9800 ohm, #2: Pri: 10,000 ohm CT, Sec: 4900 ohm	677 0218 00
V101	Oscillator	TUBE: Type 6F6, power amplifier pentode	255 0080 00
V201	Isolation amplifier	TUBE: Type 807, transmitting beam power amplifier	256 0033 00
V202	Buffer amplifier	TUBE: Type 807, transmitting beam power amplifier	256 0033 00
V203	Buffer amplifier	TUBE: Type 807, transmitting beam power amplifier	256 0033 00
V204	Driver amplifier	TUBE: Type 4-125A	256 0068 00
V205	Driver amplifier	TUBE: Type 4-125A	256 0068 00
V206	Voltage regulator	TUBE: Type 0C3/VR105, voltage regulator	257 0002 00
V207	Voltage regulator	TUBE: Type 0C3/VR105, voltage regulator	257 0002 00
V208	Audio input	TUBE: Type 6N7, class B twin amplifier	255 0134 00
V209	Audio input	TUBE: Type 6N7, class B twin amplifier	255 0134 00
V210	Audio amplifier	TUBE: Type 12SJ7GT, power amplifier triode	255 0124 00
V211	Audio amplifier	TUBE: Type 12SJ7GT, power amplifier	255 0124 00
V212	Audio driver	TUBE: Type 845, modulator, AF power amplifier	256 0034 00
V213	Audio driver	TUBE: Type 845, modulator, AF power amplifier	256 0034 00
V214	Audio driver	TUBE: Type 845, modulator, AF power amplifier	256 0034 00

PARTS LIST

ITFM	CIRCUIT FUNCTION	DESCRIPTION	COLLINS PART NUMBER
V215	Audio driver	TUBE: Type 845, modulator, AF power amplifier	256 0034 00
V216	LV rectifier	TUBE: Type 8008, half-wave mercury-vapor rectifier	256 0073 00
V217	LV rectifier	TUBE: Type 8008, half-wave mercury-vapor rectifier	256 0073 00
V218	Intermediate voltage rectifier	TUBE: Type 8008, half-wave mercury-vapor rectifier	256 0073 00
V219	Intermediate voltage rectifier	TUBE: Type 8008, half-wave mercury-vapor rectifier	256 0073 00
V220	Intermediate voltage rectifier	TUBE: Type 8008, half-wave mercury-vapor rectifier	256 0073 00
V221	Intermediate voltage rectifier	TUBE: Type 8008, half-wave mercury-vapor rectifier	256 0073 00
V407	HV rectifier	TUBE: Type 8008, half-wave mercury-vapor rectifier	256 0073 00
V408	HV rectifier	TUBE: Type 8008, half-wave mercury-vapor rectifier	256 0073 00
V409	HV rectifier	TUBE: Type 8008, half-wave mercury-vapor rectifier	256 0073 00
V410	HV rectifier	TUBE: Type 8008, half-wave mercury-vapor rectifier	256 0073 00
V411	HV rectifier	TUBE: Type 8008, half-wave mercury-vapor rectifier	256 0073 00
V412	HV rectifier	TUBE: Type 8008, half-wave mercury-vapor rectifier	256 0073 00
V601	Modulator	TUBE: Type 892R, RF power amp, class B modulator	256 0041 00
V602	Modulator	TUBE: Type 892R, RF power amp, class B modulator	256 0041 00

PARTS LIST

ITEM	CIRCUIT FUNCTION	DESCRIPTION	COLLINS PART NUMBER
V802	Final amplifier	TUBE: Type 892R, RF power amp, class B modulator	256 0041 00
V303	RF rectifier	TUBE: Type 5U4G, full-wave, high vacuum rectifier	255 0032 00
XF201, XF202 XF401 XF402	Holder for F201, F202, F401 and F402	HOLDER: Fuse	265 2030 00
XI101	Mounting for I101	MTG: Pilot light, miniature JEWEL CAP: Red	262 2160 00
XI301	Mounting for I301	MTG: Pilot light JEWEL CAP: green	262 0103 00 262 0105 00
XI302, XI303	Mountings for I302, I303	MTG: Pilot light JEWEL CAP: Amber	262 0103 00 262 0106 00
XI304	Mounting for I304	MTG: Pilot light JEWEL CAP: Red	262 0103 00 262 0104 00
XI305, XI306 XI307 XI308	Mountings for I305, I306, I307, I308	SOCKET: Pilot light, dc candelabra bayonet base	262 0042 00
XI501	Mounting for I501	MTG: Pilot light JEWEL CAP: Green	262 0103 00 262 0105 00
XI502, XI503	Mountings for I502, I503	MTG: Pilot light, JEWEL CAP: Amber	262 0103 00 262 0106 00
XI504	Mounting for I504	MTG: Pilot light, JEWEL CAP: Red	262 0103 00 262 0104 00
XI505	Mounting for I505	SOCKET: Pilot light, dc candelabra bayonet base	262 0042 00
XI701	Mounting for I701	MTG: Pilot light, JEWEL CAP: Green	262 0103 00 262 0105 00

PARTS LIST

ITEM	CIRCUIT FUNCTION	DESCRIPTION	COLLINS PART NUMBER
XI702	Mounting for I702	MTG: Pilot light, JEWEL CAP: Red	262 0103 00 262 0104 00
XI703 XI704 XI705 XI706	Mountings for I703, I704, I705, I706	SOCKET: Pilot light, dc candelabra bayonet base	262 0042 00
XI901	Mounting for I901	MTG: Pilot light, JEWEL CAP: Green	262 0103 00 262 0105 00
XI902	Mounting for I902	MTG: Pilot light, JEWEL CAP: Red	262 0103 00 262 0104 00
XI903, XI904 XI905 XI906	Mountings for I903, I904, I905, I906	SOCKET: Pilot light, dc candelabra bayonet base	262 0042 00
XV101	Socket for V101	SOCKET: Tube, 8 prong	220 1830 00
XV201, XV202 XV203	Sockets for V201, V202 V203	SOCKET: Tube, 5 contact	220 5520 00
XV204, XV205	Sockets for V204, V205	SOCKET: Tube, 5 prong	220 1016 00
XV206 XV207 XV208 XV209 XV210 XV211	Sockets for V206, V207, V208, V209, V210, V211	SOCKET: Tube, 8 contact	220 5810 00
XV212, XV213 XV214 XV215	Sockets for V212, V213, V214, V215	SOCKET: Tube, 4 prong	220 5420 00
XV216 XV217 XV218 XV219 XV220 XV221	Sockets for V216, V217, V218, V219, V220, V221	SOCKET: Tube, super jumbo 4 contact	220 1028 00

PARTS LIST

ITEM	CIRCUIT FUNCTION	DESCRIPTION	COLLINS PART NUMBER
XV601 XV602	Sockets for V601, V602	SOCKET: Tube, special, for air-cooled tube	220 8110 00
XV801 XV802	Sockets for V801, V802	SOCKET: Tube, special, for air-cooled tube	220 8110 00
XV803	Socket for V803	SOCKET: Tube, 8 contact	220 5810 00
XY101	Crystal socket	SOCKET: Crystal, 5 prong	220 1530 00
Y1C1	Crystal	CRYSTAL:	

Figure 8-2 Rectifier Bay Cabling Schematic

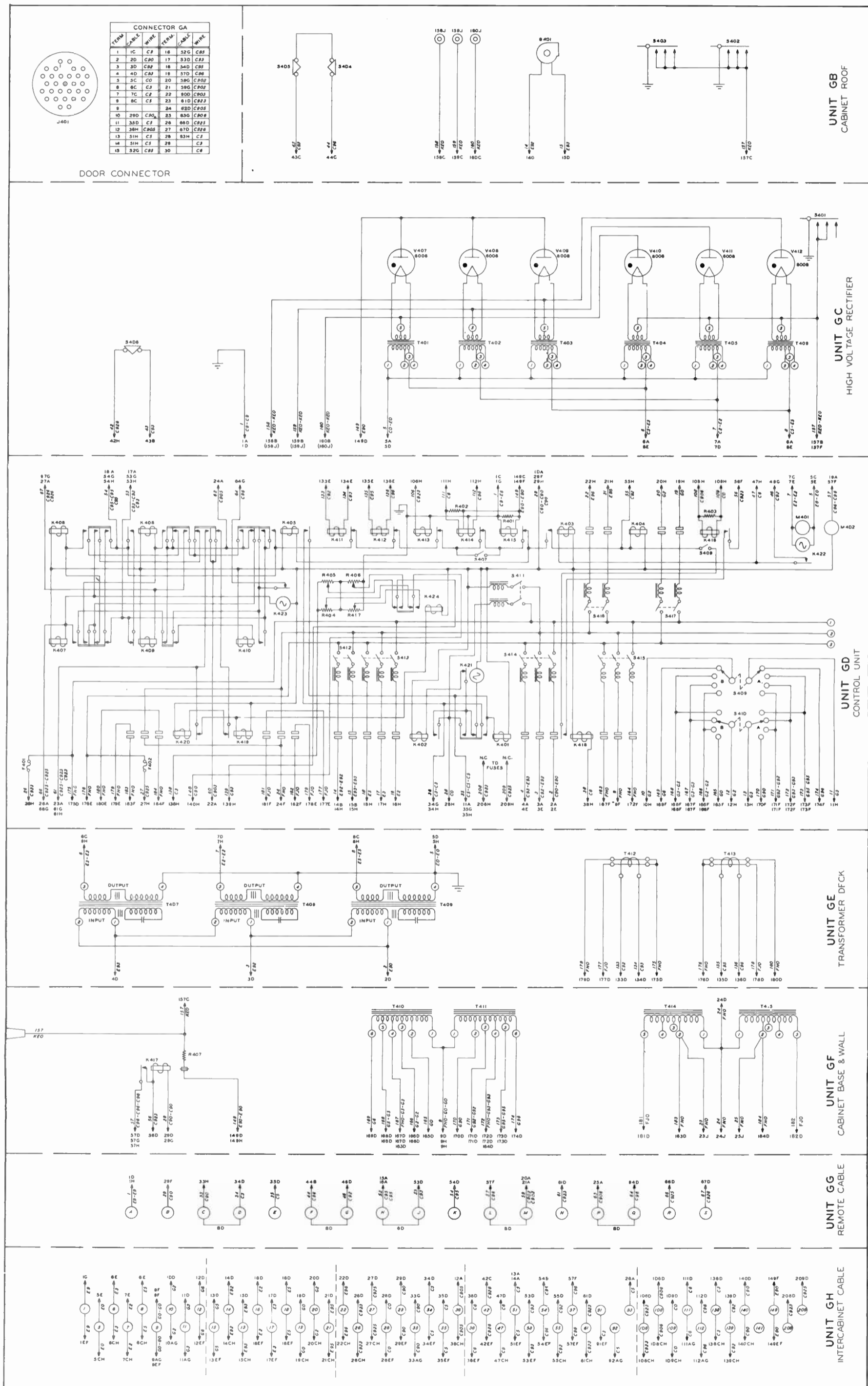
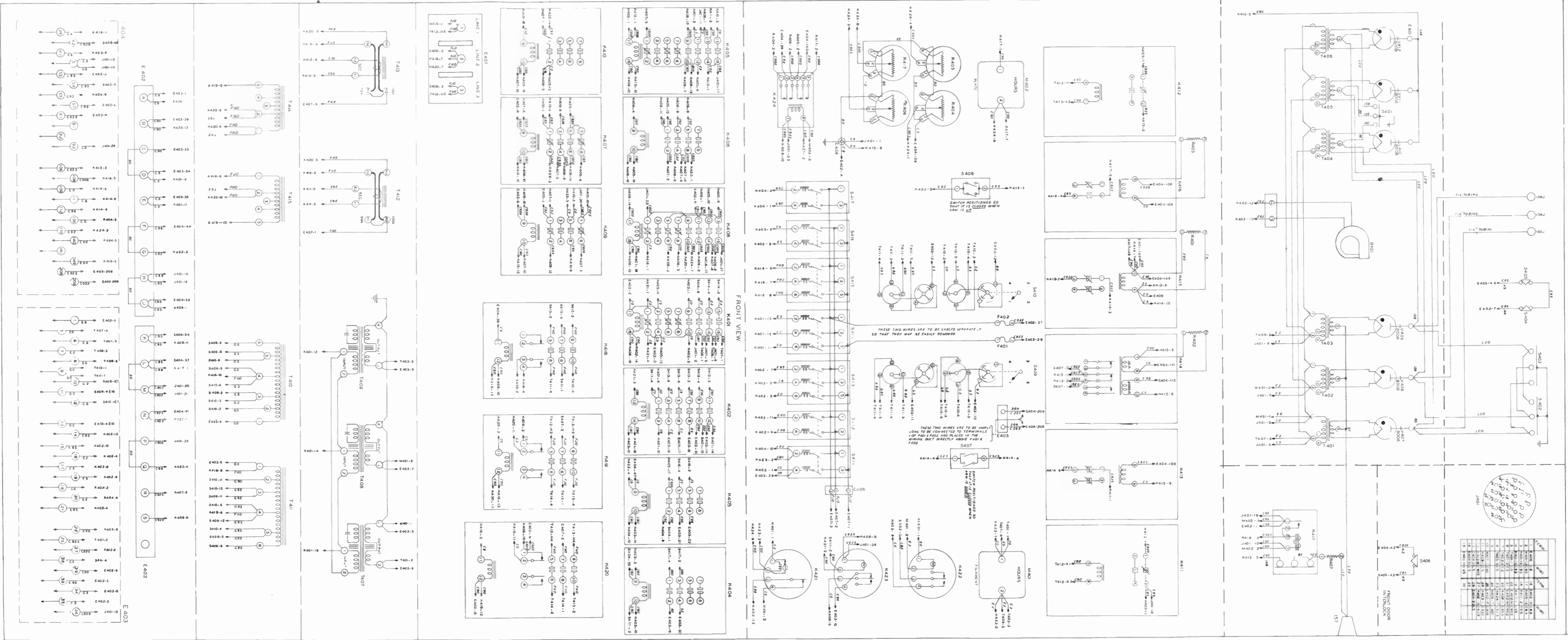
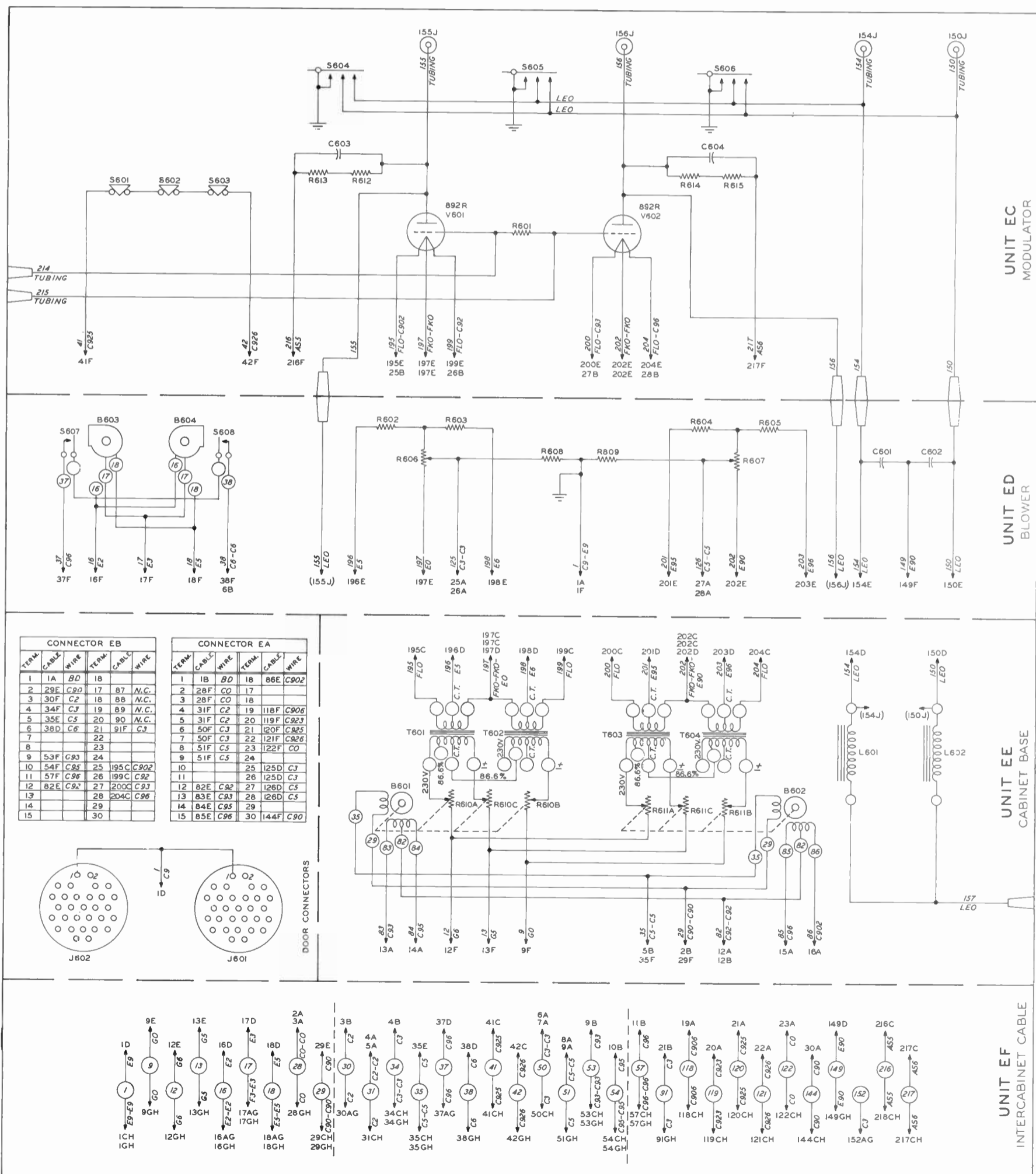

Figure 8-3 Rectifier Bay Cabling Diagram





CONNECTOR EB				CONNECTOR EA			
TERM.	CABLE	WIRE	TERM.	CABLE	WIRE	TERM.	CABLE
1	1A	BD	18			1	1B
2	29E	C90	17	87	N.C.	2	28F
3	30F	C2	18	88	N.C.	3	28F
4	34F	C3	19	89	N.C.	4	31F
5	35E	C5	20	90	N.C.	5	31F
6	38D	C6	21	91F	C3	6	50F
7			22			7	50F
8			23			8	51F
9	53F	C93	24			9	51F
10	54F	C95	25	195C	C902	10	
11	57F	C96	26	199C	C92	11	
12	82E	C92	27	200C	C93	12	82E
13			28	204C	C96	13	83E
14			29			14	84E
15			30			15	85E

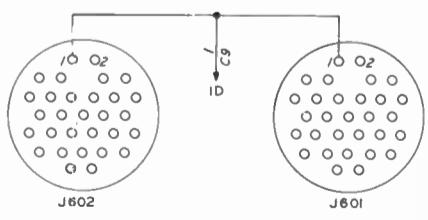

Figure 8-4. Modulator Bay Schematic

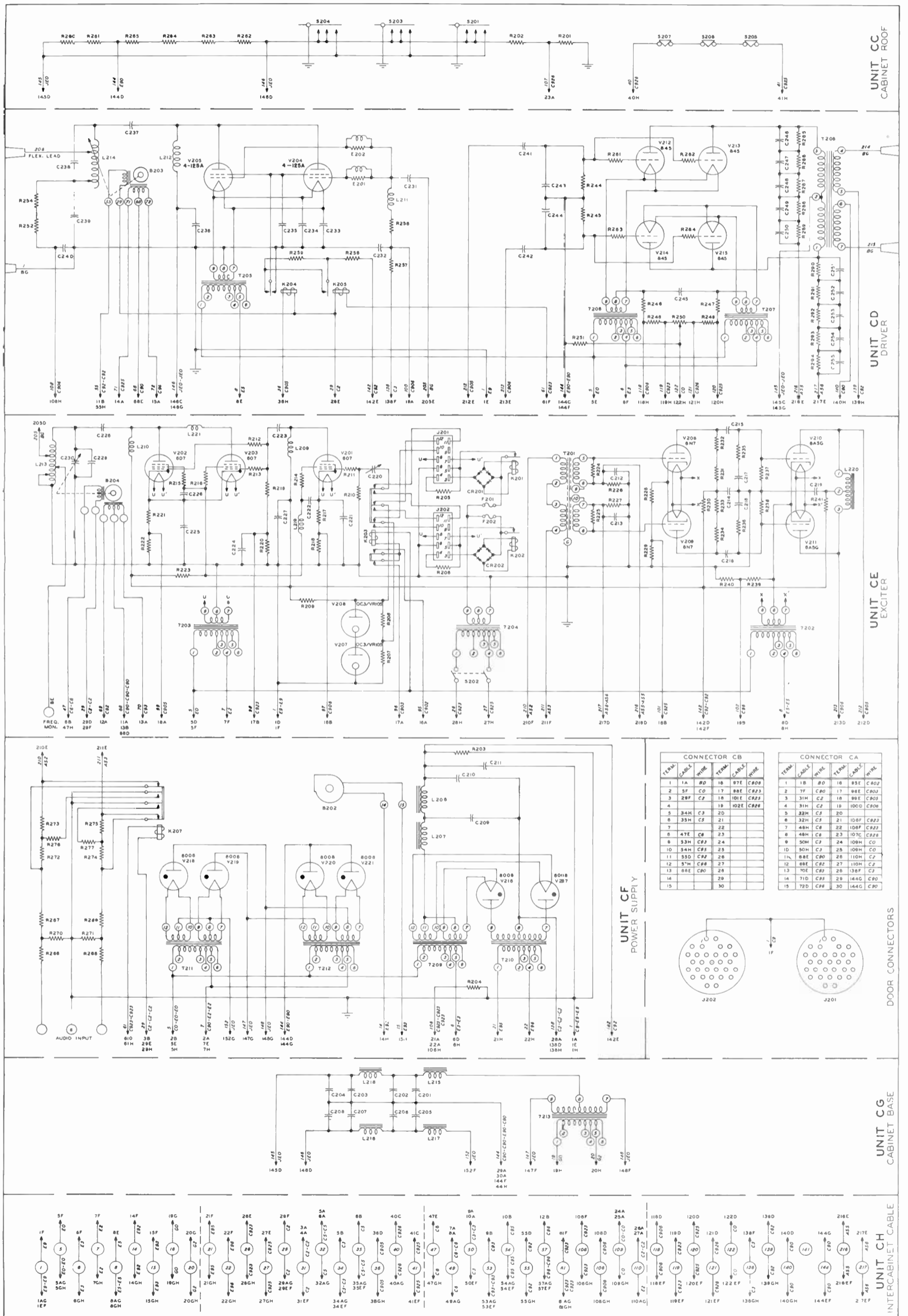
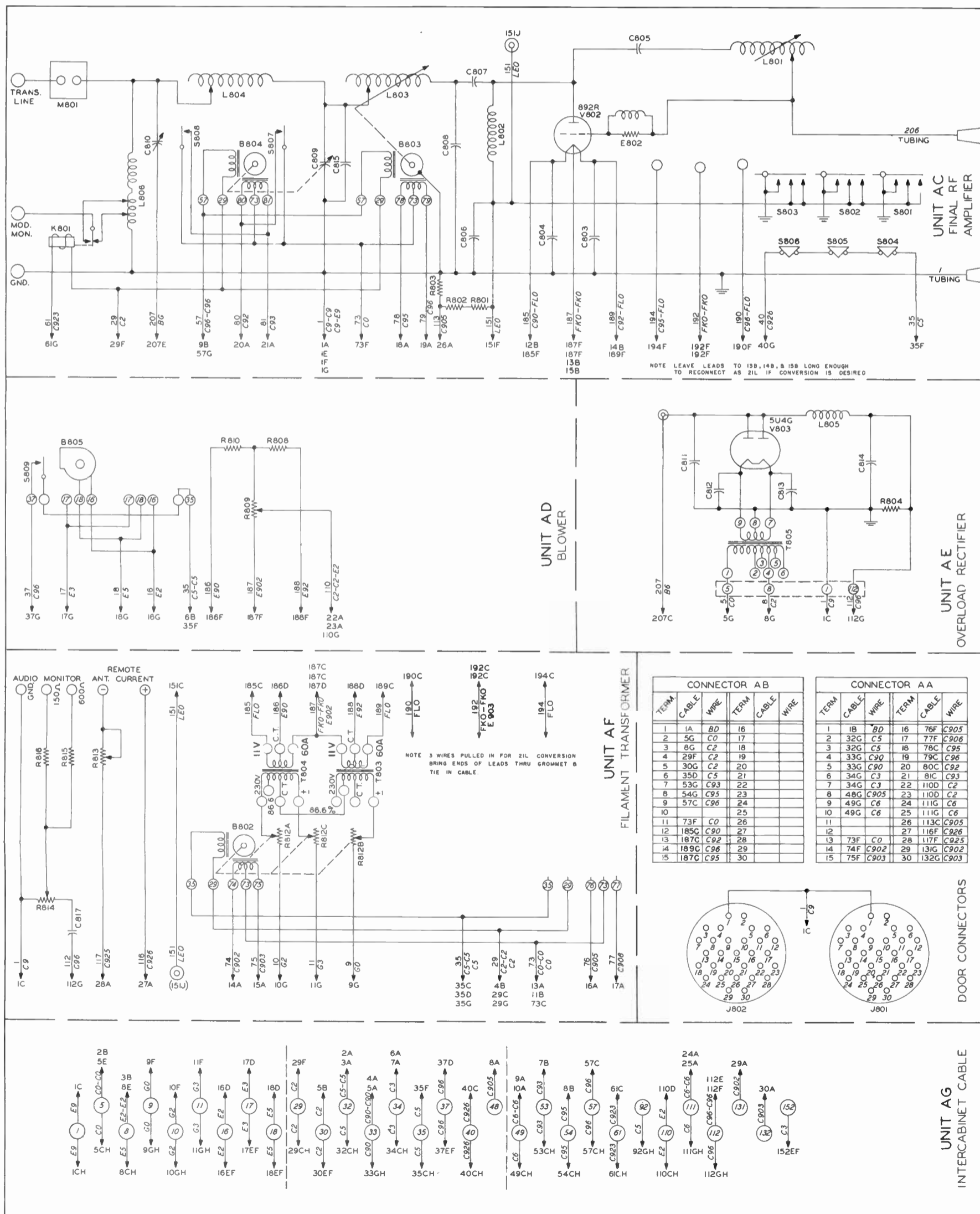

Figure 8-5 Exciter Bay Schematic

Figure 8-6 Power Amplifier Bay Schematic



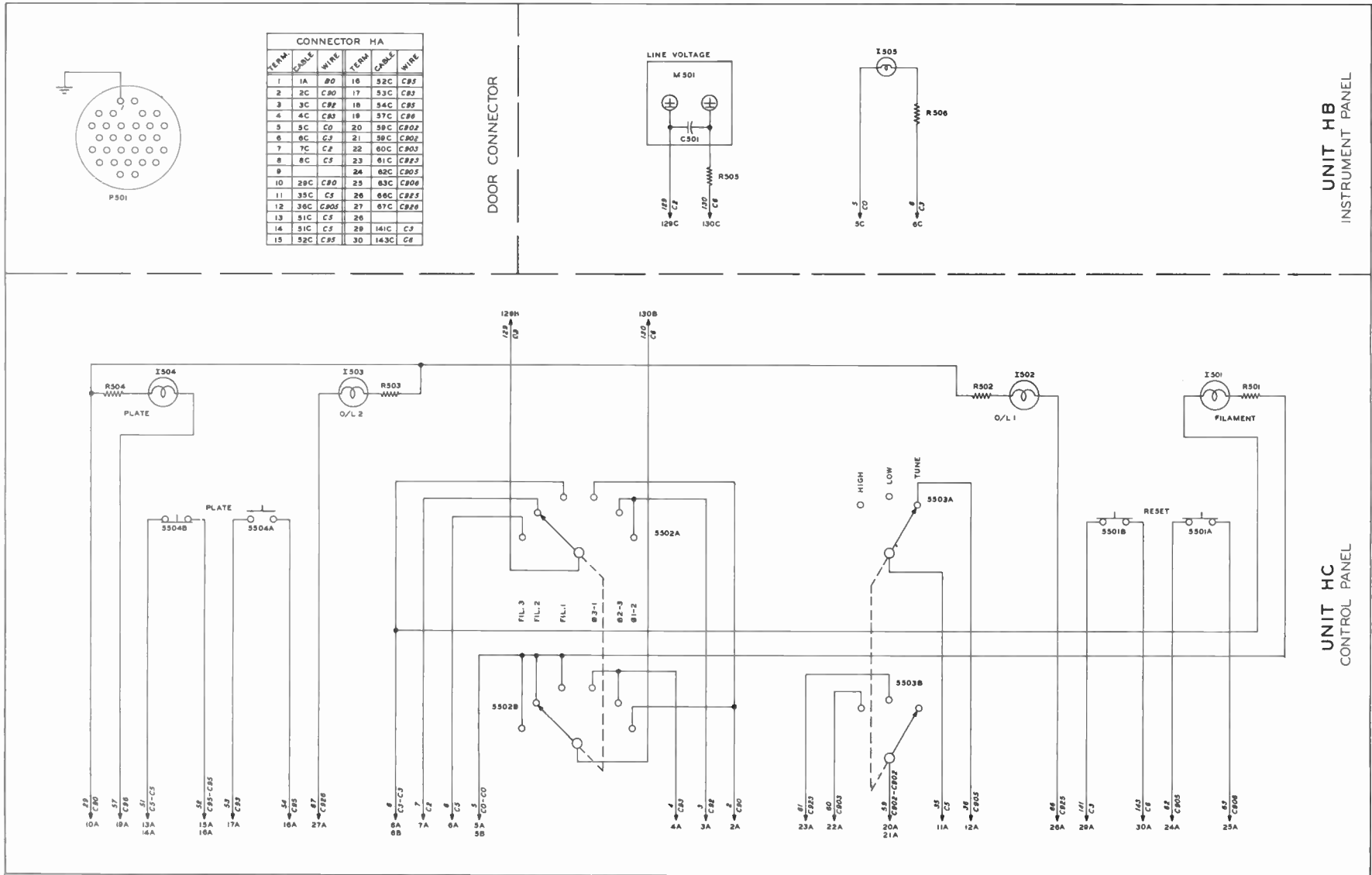
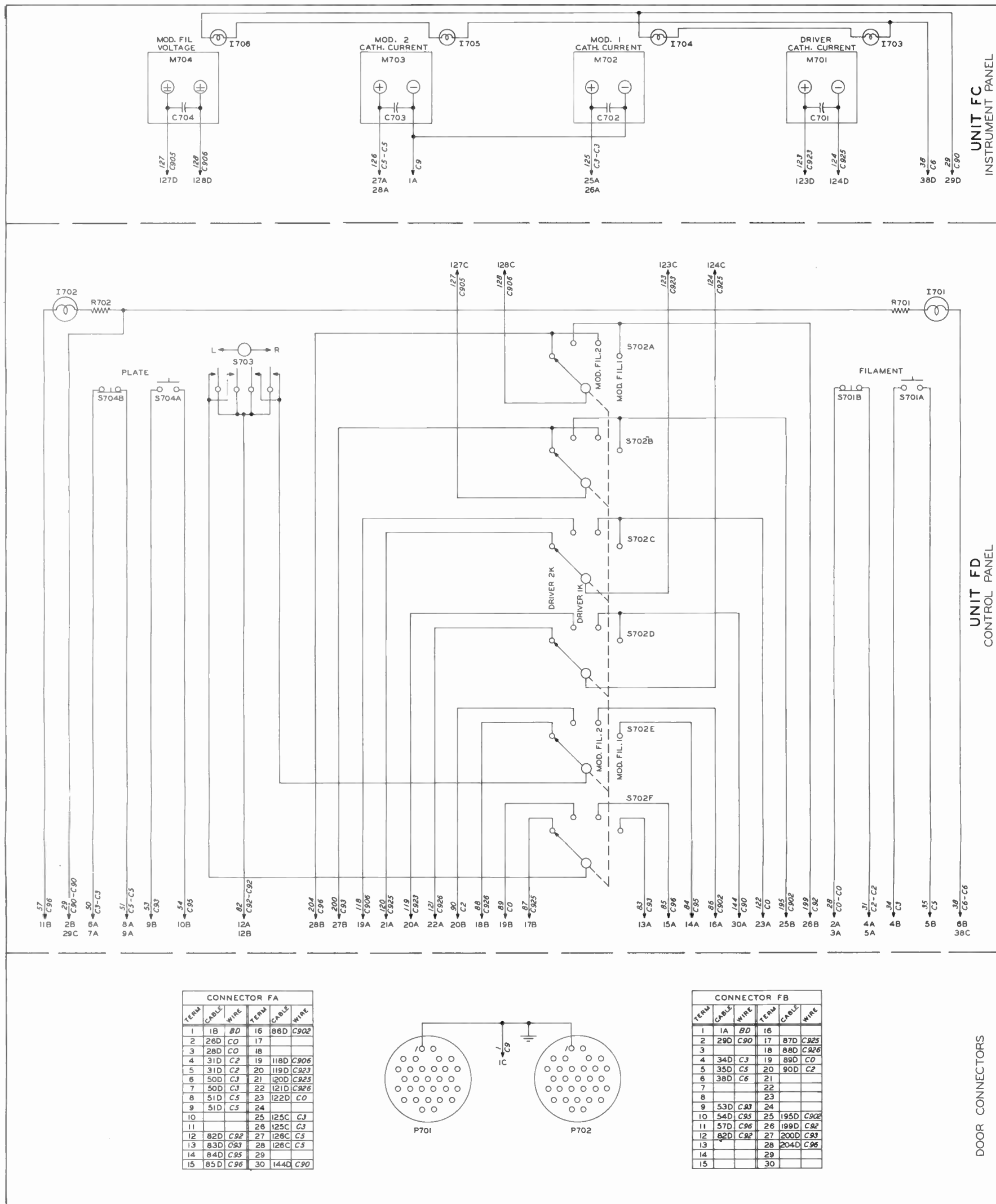

Figure 8-7 Rectifier Front Door Schematic

Figure 8-8 Modulator Front Door Schematic



CONNECTOR FA					
TERM.	CABLE	WIRE	TERM.	CABLE	WIRE
1	1B	8D	16	86D	C902
2	28D	C0	17		
3	28D	C0	18		
4	31D	C2	19	118D	C906
5	31D	C2	20	118D	C923
6	50D	C3	21	120D	C925
7	50D	C3	22	121D	C926
8	51D	C5	23	122D	C0
9	51D	C5	24		
10			25	125C	C3
11			26	125C	C3
12	82D	C92	27	126C	C5
13	83D	C93	28	126C	C5
14	84D	C95	29		
15	85D	C96	30	144D	C90

CONNECTOR FB					
TERM.	CABLE	WIRE	TERM.	CABLE	WIRE
1	1A	8D	16	87D	C925
2	29D	C90	17	88D	C926
3			18	88D	C926
4	34D	C3	19	89D	C0
5	35D	C5	20	90D	C2
6	38D	C6	21		
7			22		
8			23		
9	53D	C93	24		
10	54D	C95	25	195D	C902
11	57D	C96	26	199D	C92
12	62D	C92	27	200D	C93
13			28	204D	C96
14			29		
15			30		

Figure 8-10 Power Amplifier Front Door Schematic

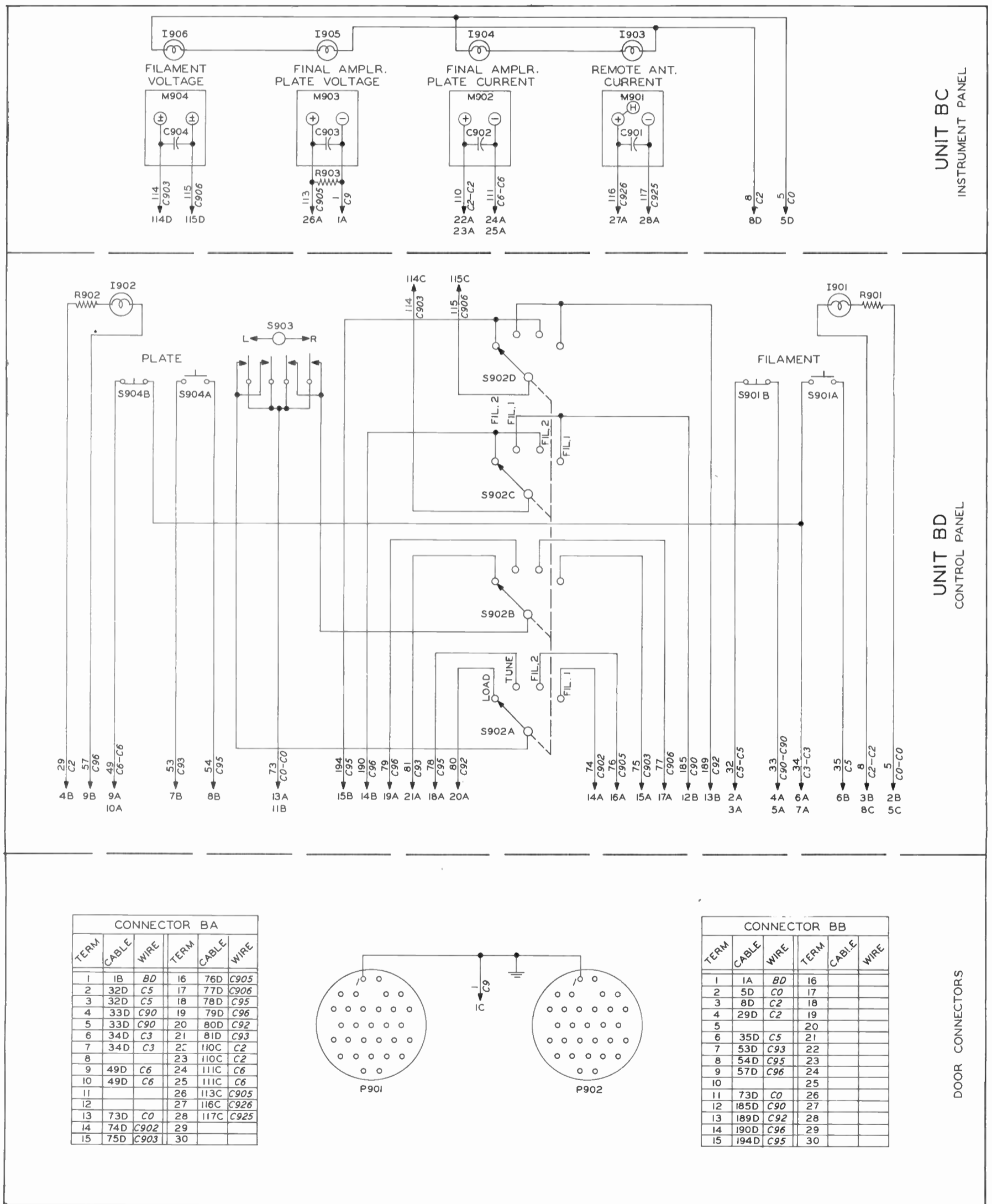

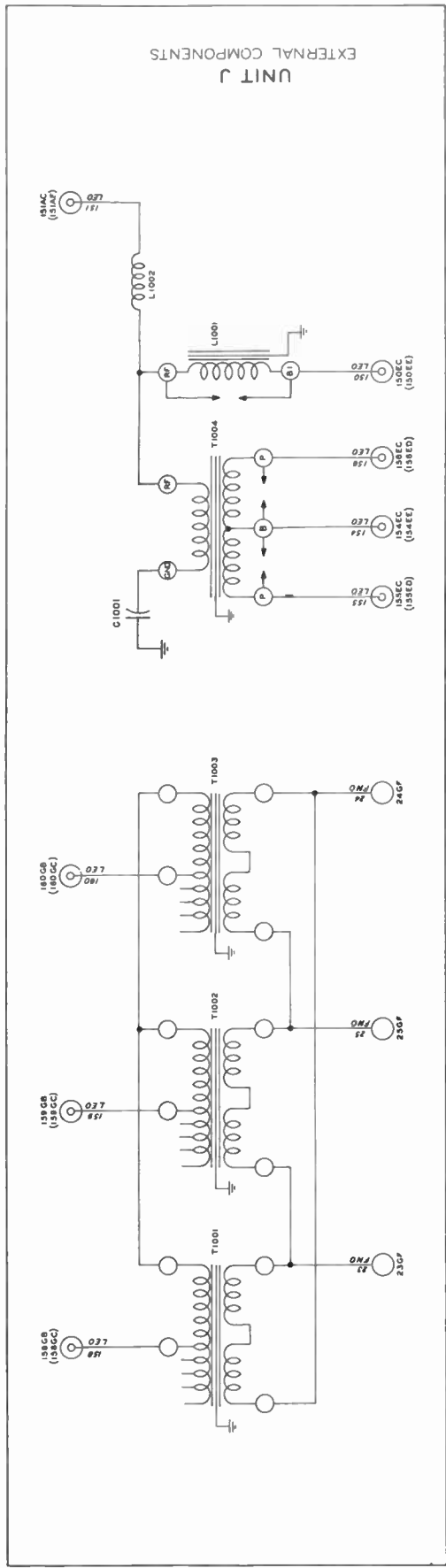

Figure 8-11 External Components Schematic

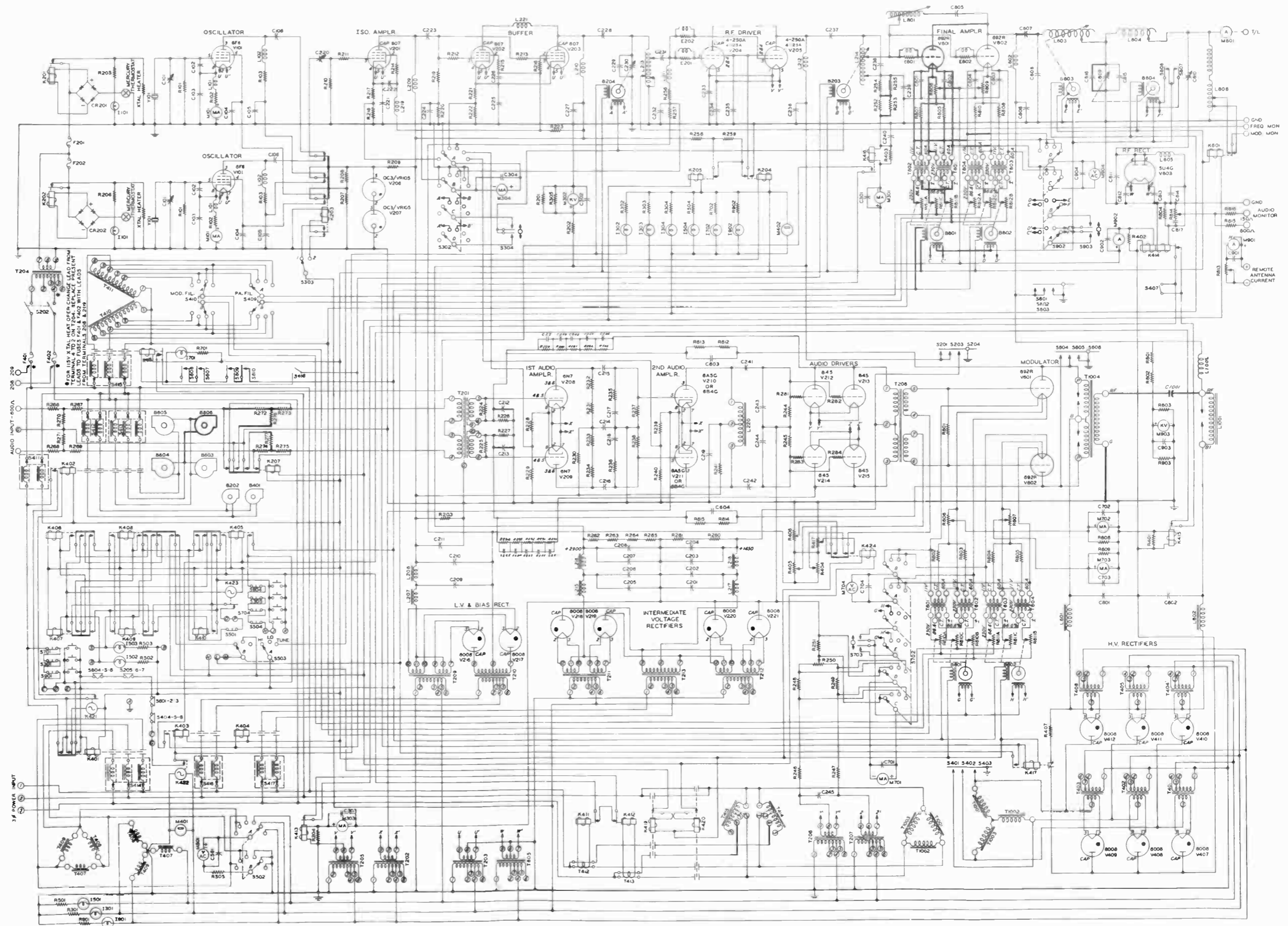

Figure 8-13 21B to 21L Conversion Schematic

