

# Broadcast Equipment

*Paul W.*

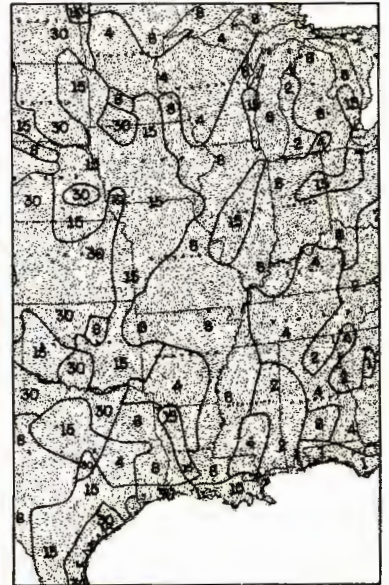

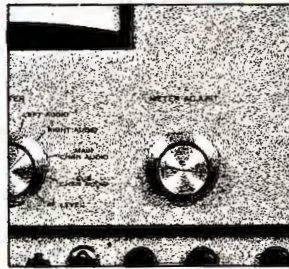
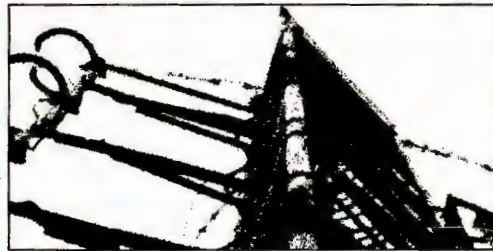
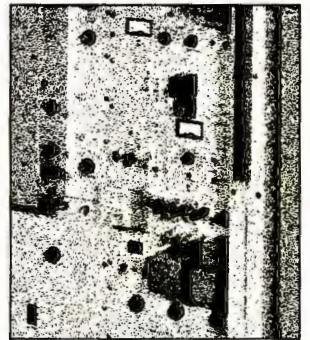
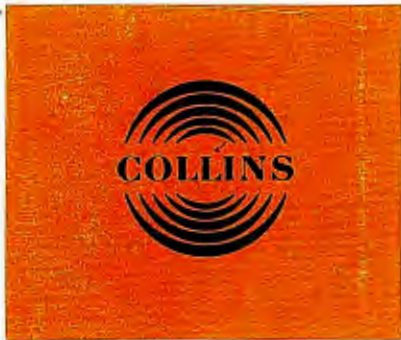

# Collins Broadcast Equipment

## TABLE OF CONTENTS

AM Transmitters .....	2	Tape Equipment .....	91
Phasing .....	12	Microphones .....	102
FM Transmitters .....	17	Studio Accessories .....	106
Antennas .....	32	Measuring, Monitoring .....	117
Towers .....	35	Remote Control .....	124
Transmission Lines & Accessories .....	38	STL Microwave .....	125
Audio Facilities .....	70	Tables, Charts, Graphs .....	128
Disc Equipment .....	84	Indices .....	148

Collins Sales Policy is found at the back of this catalog.

Equipment descriptions in this catalog were condensed so that the complete line of broadcast units supplied by Collins Radio Company could be shown. For more information on any of these units, you are invited to contact your Collins Broadcast Sales Engineer or Collins Radio Company, Broadcast Communication Division, Dallas, Texas.

*Customers in countries other than the United States are invited to contact the nearest International Sales Office or Collins International, World Headquarters, Dallas, Texas.*



The reputation of Collins Radio Company has been built on more than a quarter of a century of research, development and manufacture of distinctive electronic equipment. To assure broadcasters of the very finest equipment, Collins engineers and technicians follow without exception this company-wide philosophy:

*Design and build equipment based on technical ingenuity, unique function and quality of craftsmanship, rather than solely on the grounds of price and sales effort.*

Whatever the field—broadcast, amateur radio, aviation electronics, military or industrial communication, or space communication—Collins adheres strictly to its basic code that there is no substitute for quality.

Collins research and development, its staff of highly competent field technicians and the Company's never ending stress on quality control assure each Collins broadcast equipment owner that he has the most advanced, thoroughly tested equipment available, and that it will retain its value through the years.

In this catalog is the latest equipment of the complete broadcast line that has earned Collins its unparalleled reputation in the field. Collins famous quality and reliability are integral parts of all these units.



# AM Transmitters and Phasing

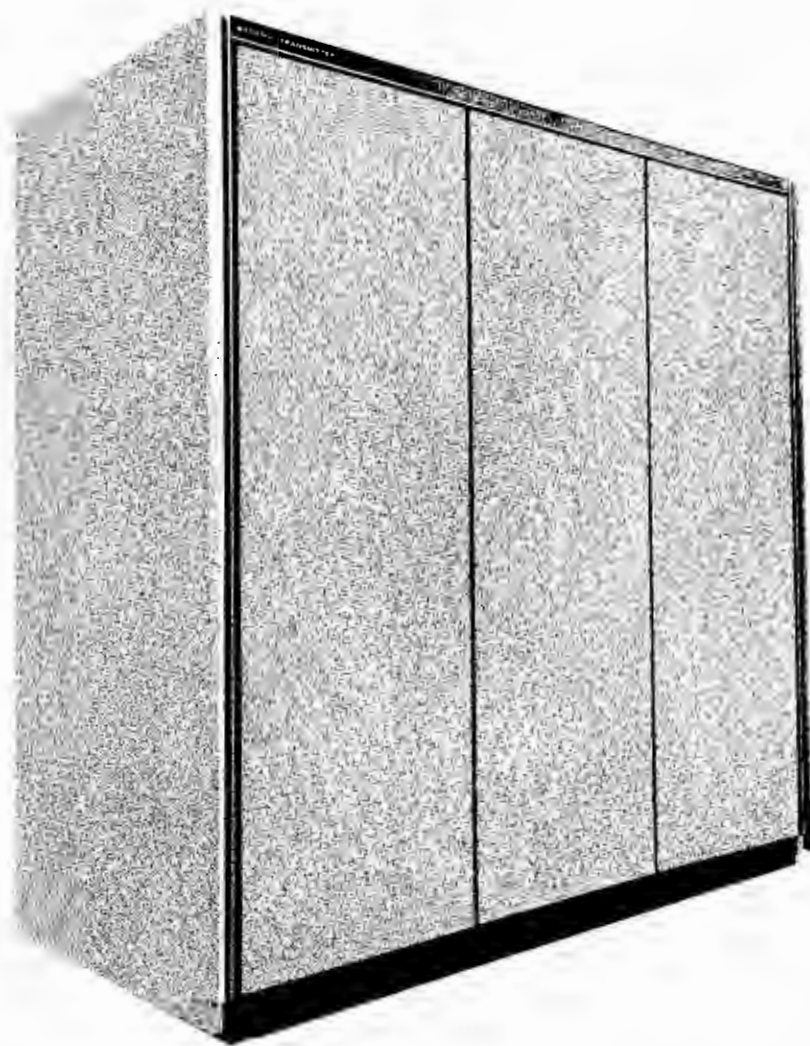

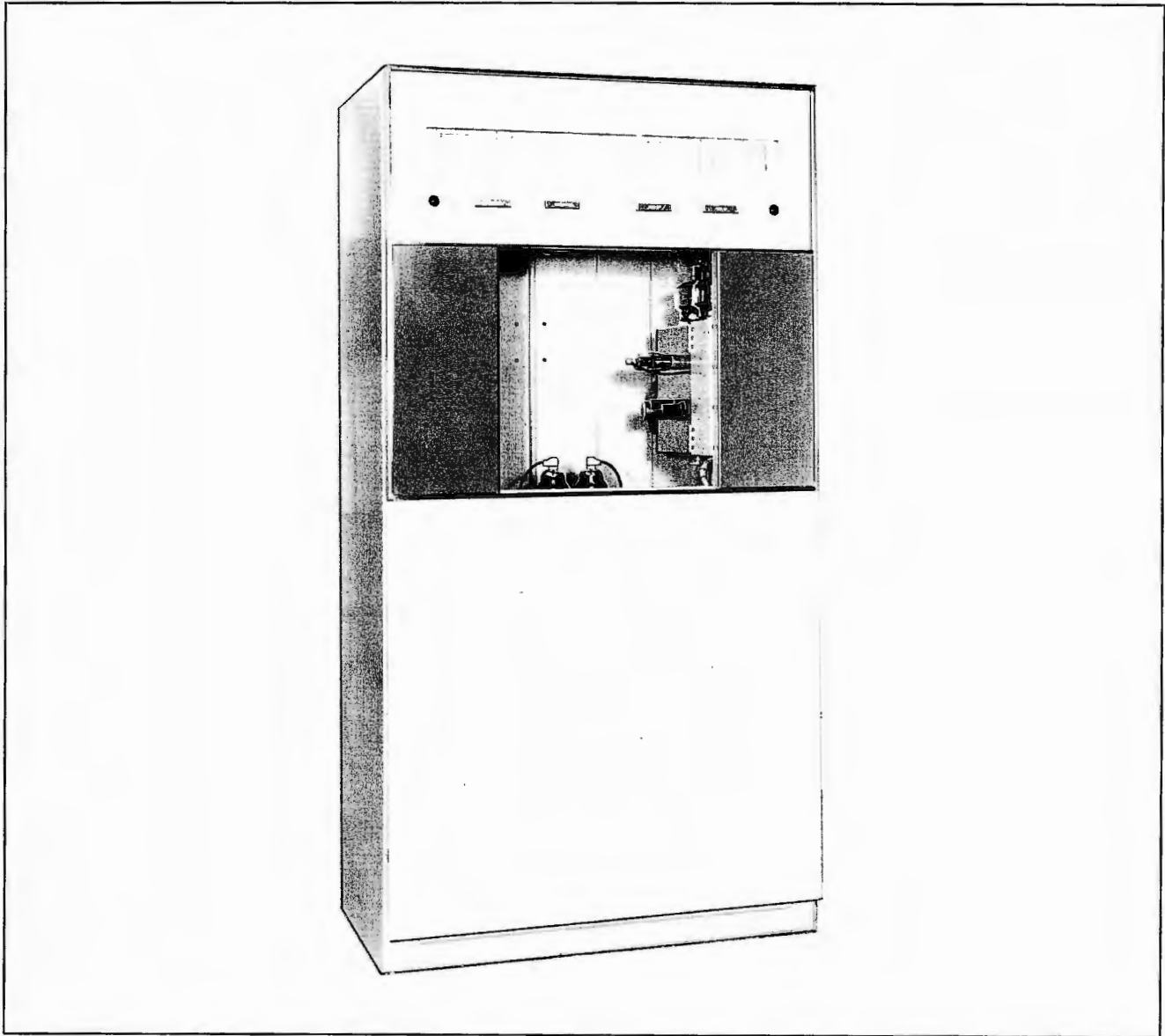

### **COLLINS 20V-3 1,000/500/250-WATT AM TRANSMITTER**

The Collins 20V-3 1,000/500/250-watt AM transmitter, designed for reliable, high fidelity broadcasting at any specified frequency from 510 to 1600 kc or in any of the high frequency broadcast bands up to 12 mc, has many features that make it one of the most advanced transmitters on the market.

The bold, clean-cut styling of the cabinet is in keeping with the modern design of the transmitter circuitry. Streamlined, brushed chrome trim and white meters add to the attractive appearance of the cabinet, which is finished in a high gloss gray, blue-gray and off-white baked enamel. The cabinet and circuitry provide unparalleled accessibility for operation, maintenance and inspection.

The RF and audio chassis swing out and the power supply tilts up so that all components are exposed. Mounted on the RF and audio chassis are quiet, high capacity

blowers which force air directly on the tubes to give an extra assurance of long tube life.

Pushbutton control of filament and plate power is provided and may be extended to a remote position. Automatic sequencing of the power control circuits is incorporated. Filament voltage control and power circuit controls may be adjusted while the transmitter is operating.

A typical stability of  $\pm 2$  cps is attained by using a highly perfected oscillator design in conjunction with very stable, low temperature coefficient crystals — a concept pioneered by Collins to eliminate the troublesome crystal oven.

Thermal time delay circuitry selects the optimum time interval before the transmitter can be returned to the air after a power line failure. After an instantaneous power interruption the carrier can be returned to the air

immediately, cutting off-the-air time to a minimum. Overload relays are adjustable and are provided for the RF driver, audio driver, power amplifier and modulator stages. These relays are connected so that an overload removes plate power and the equipment must be re-energized manually.

The 20V-3 power supplies are heavy duty and conservative. One high voltage power supply is used for the modulator and final amplifier. A separate low voltage supply feeds the modulator screen grids, as well as the plates and screen grids of the other RF and audio tubes. Bias supply provides voltages for the modulator, power amplifier and other biasing throughout the transmitter.

The Collins 20V-3 uses four, Type 4-400A tetrodes in the modulator and final amplifier. The use of the 4-400A tetrodes is another concept pioneered by Collins and now widely accepted as the best in transmitter design.

*Frequency Range:* 540-1600 kc standard. Frequencies to 12 mc available.

*Power Output:* 1,000/500/250 watts.

*Frequency Stability:* Better than  $\pm 5$  cps. (Typical—Better than  $\pm 2$  cps.)

*Audio Frequency Response:* Within  $\pm 2$  db, 50-10,000 cps.

*Audio Frequency Distortion:* Less than 3%, 50-7,500 cps up to 95% modulation level. (Typical—Less than 3%, 30-15,000 cps.)

*Residual Noise Level:* 60 db or better below 100% modulation.

*Carrier Shift:* Less than 3%, 0-100% modulation. (Typical—Less than 2%.)

*RF Output Impedance:* 50-70 ohms unbalanced. Others, including balanced, available on order.

*Audio Input Impedance:* 150/600 ohms balanced.

*Audio Input Level:* +10 dbm,  $\pm 2$  db.

*Power Source:* 208-240 v ac, single phase 50/60 cps.

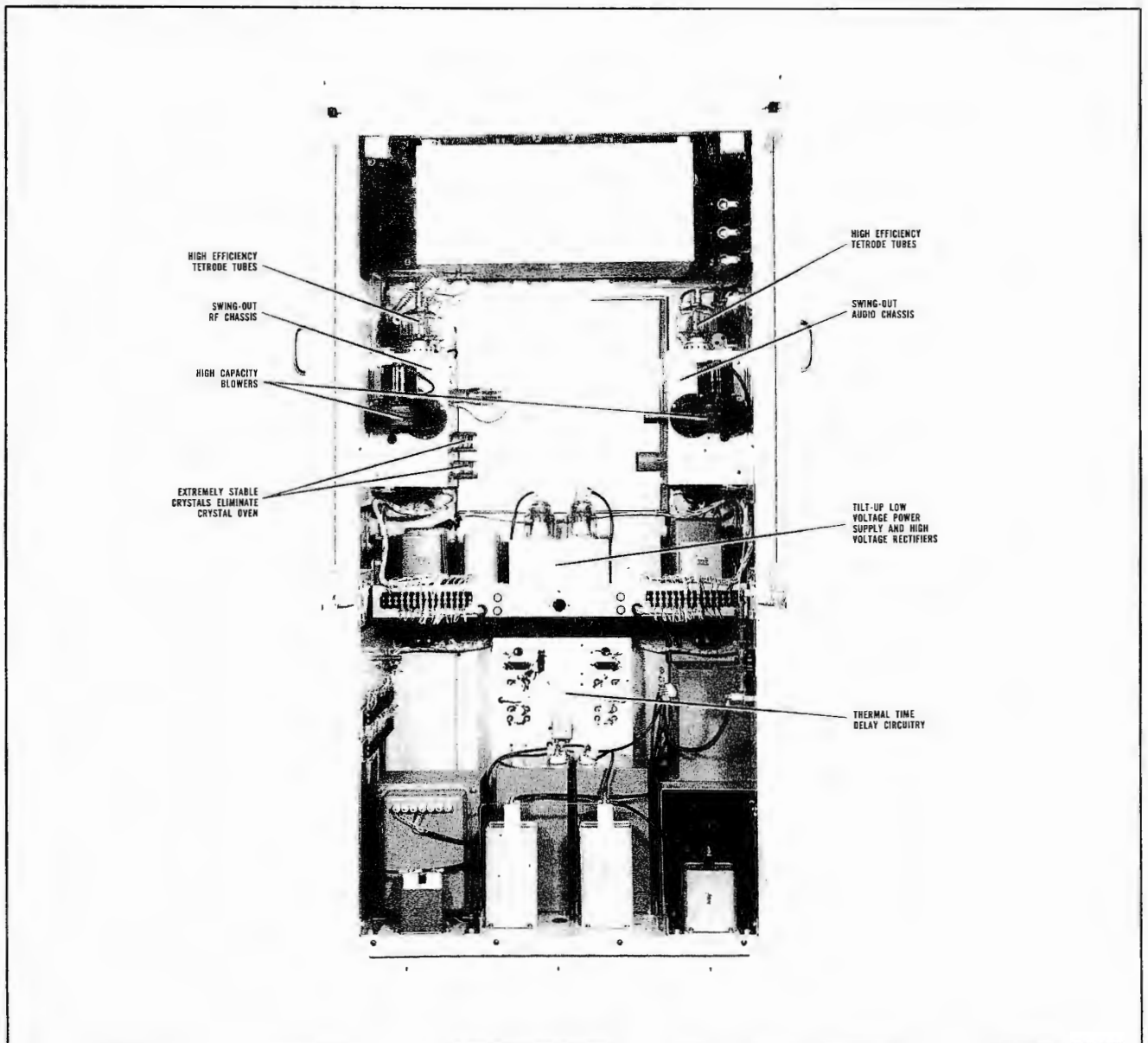

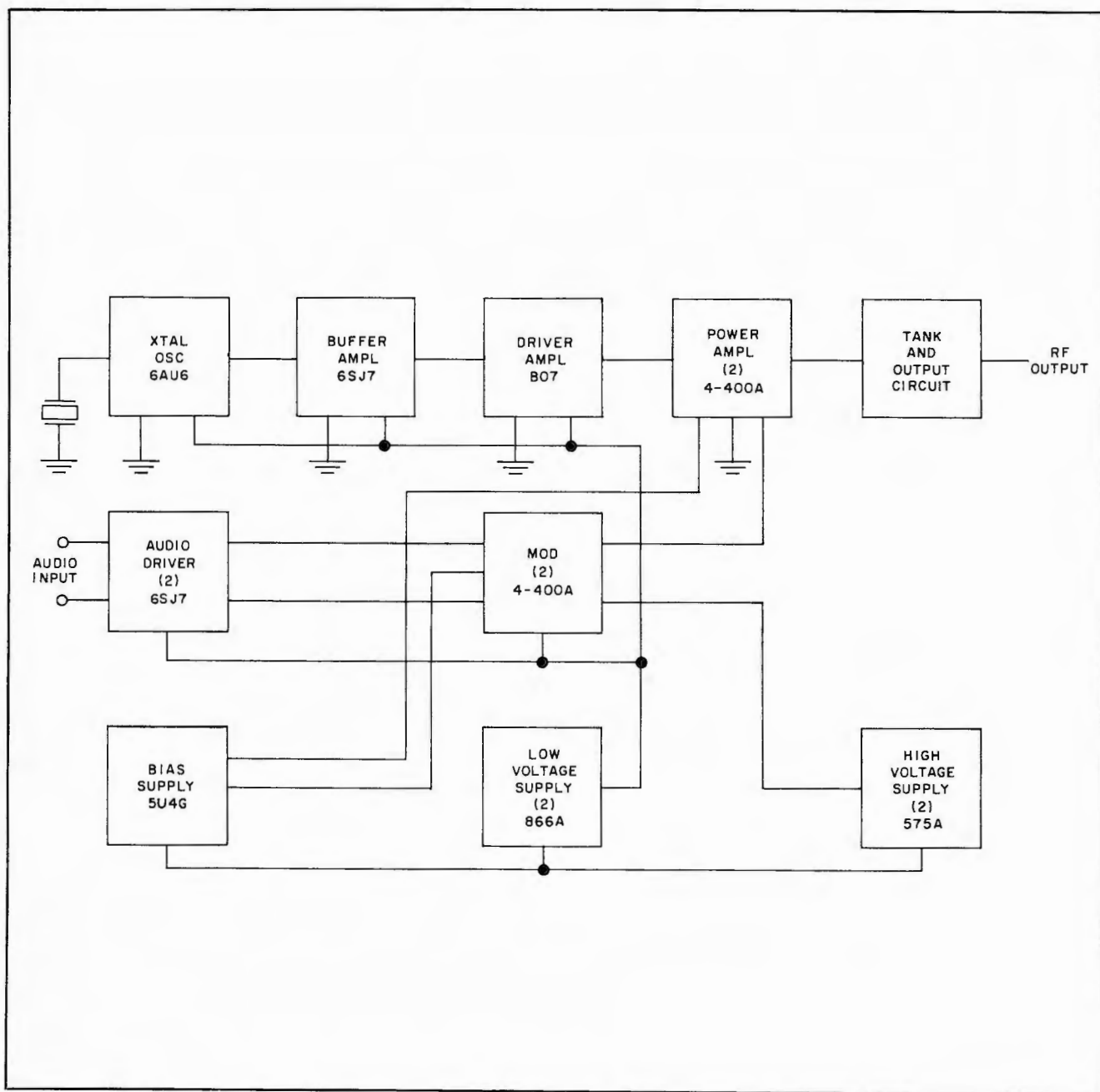

BLOCK DIAGRAM 20V-3

Power Demand (at 1,000 watts output):

Filaments	660 watts	85% pf
0% modulation	2,950 watts	80% pf
30% modulation	3,250 watts	83% pf
100% modulation	4,150 watts	83% pf

Tube Complement:

4	4-400A	2 — Final Amplifier
1	807	2 — Modulator
3	6SJ7	Driver Amplifier
1	6AU6	1 — Buffer Amplifier
2	575A	2 — Audio Amplifier
2	866A	Crystal Oscillator
1	5U4G	High Voltage Rectifier
		Low Voltage Rectifier
		Bias Rectifier

Ambient Temperature Range: +15°C to +45°C.

Size: 38" W, 76" H, 27" D (96.52 cm W, 103.04 cm H, 68.58 cm D).

Weight: Approx. 1,295 lbs (587.41 kg).

Part No. 522 2480

Includes one set of tubes, one crystal and one instruction book.

No Part Number

Complete set of spare tubes.

No Part Number

FCC set of spare tubes.

No Part Number

Factory short wave conversion, 1.6 mc-12 mc.

No Part Number

Spare crystal for 20V and 550A transmitters.



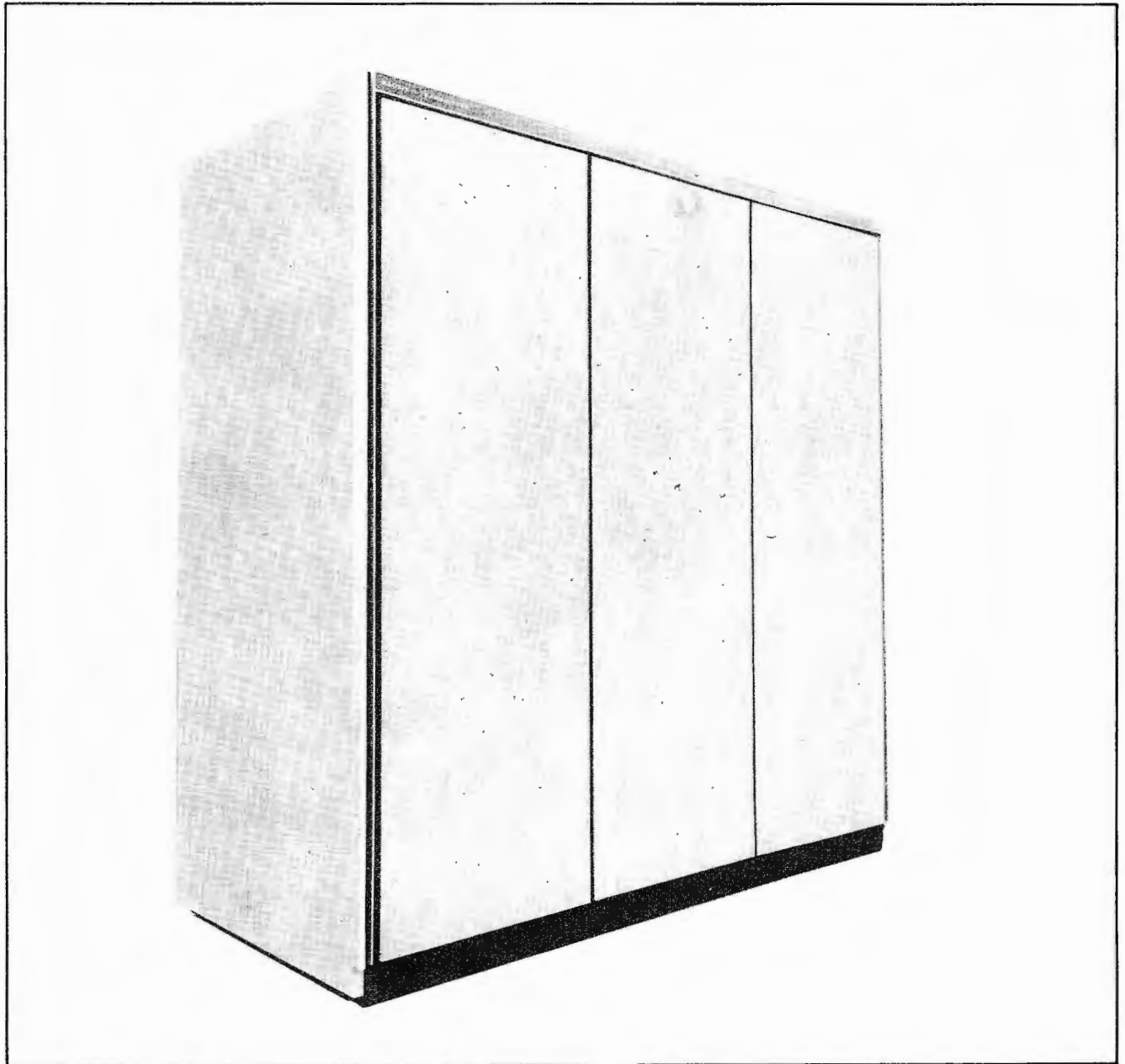

### **COLLINS 820E/F-1 5/10 KW AM TRANSMITTER**

It's the most extensively transistorized transmitter in the 5-10 kw power range. It features solid state devices in the low-level audio and driver, the power supply circuits and the r-f exciter.

This new exciter has a highly stable ovenless crystal operating in the 2.1 to 4.3 mc range, with division to standard broadcast frequency by thin-film components.

The 10 kw model, shown above, uses six tetrode vacuum tubes in the r-f driver, power amplifier and modulator circuits, but requires only two tube types. The 5 kw model uses one less tube in final r-f amplifier.

Tuning of Collins' new 820E/F-1 is automatic. A phase-comparator circuit in the power amplifier stage automatically controls the PA tuning as loading is adjusted. Since the tuning capacitor is at a higher network impedance point and since it requires less padding capacitance than the loading capacitor, tuning correction is fast enough to take place well within the time required for loading changes.

Collins designed this new transmitter for easy, space-saving installation, as well as extended reliability. It measures just 69" high x 67-7/16" wide and 32" deep. All power supply components are completely self-contained.

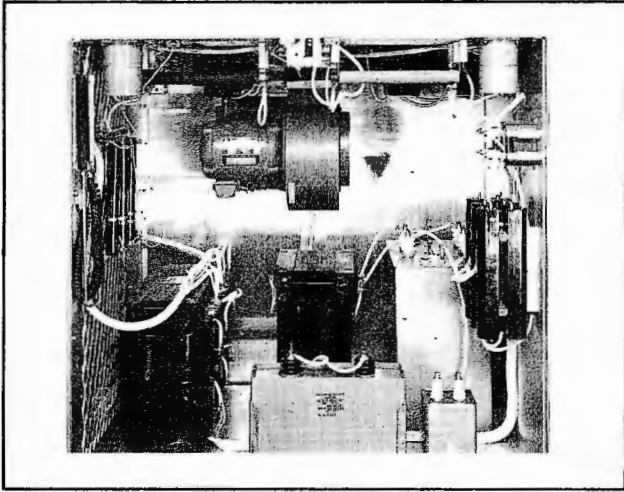

HIGH VOLTAGE POWER SUPPLY AND MAIN BLOWER

For attended operation such as a combination station, all metering and control of the transmitter is accomplished from a separate extended control panel, which requires no remote control authorization. All meters, controls and status indicators necessary for monitoring performance of the transmitter are housed at the extended control panel. When operating rules permit completely unattended operation without transmitter log, the 820E/F-1 will be immediately adaptable to that concept without rebuilding or modification. It is truly the transmitter for both the present and the future.

#### EXTENDED CONTROL PANEL:

The transmitter is suitable for installation at an unattended site, and may be remotely controlled from a distant studio location in the conventional manner. As a convenience for attended operation and maintenance, all meters, operating controls, and status indications are grouped on a 12 $\frac{1}{4}$ " x 19" extended control panel supplied with 50 feet of multiconductor shielded cable for connection to the transmitter. All controls necessary for normal operation of the transmitter can be made from the extended control panel.

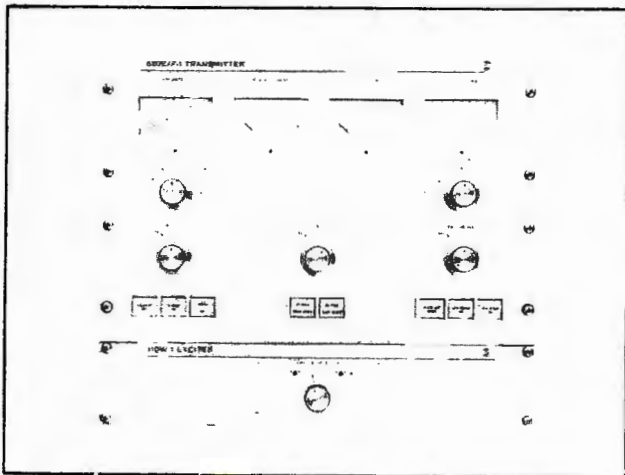

EXTENDED CONTROL PANEL AND CRYSTAL OSCILLATOR EXCITER

#### R-F EXCITER

An all-solid state unit, the type 310W-1 exciter offers increased frequency stability through operation of the oscillator at two or four times the output frequency. Division to standard broadcast frequencies is obtained by digital circuitry employing thin-film components. The exciter is normally located externally to the transmitter and supplies drive through a coaxial cable. Fifty feet of interconnecting cable is furnished with the exciter, but the unit may be located up to 250 feet from the transmitter if desired.

#### R-F DRIVER

The r-f driver uses two 6146B tubes in parallel, operating Class C. Tuned-grid, tuned-plate circuits are used, with the frequency monitor sample derived from the plate tank coil. Driver modulation is not employed except for the partial modulation which occurs due to changes in the PA grid impedance over the audio cycle.

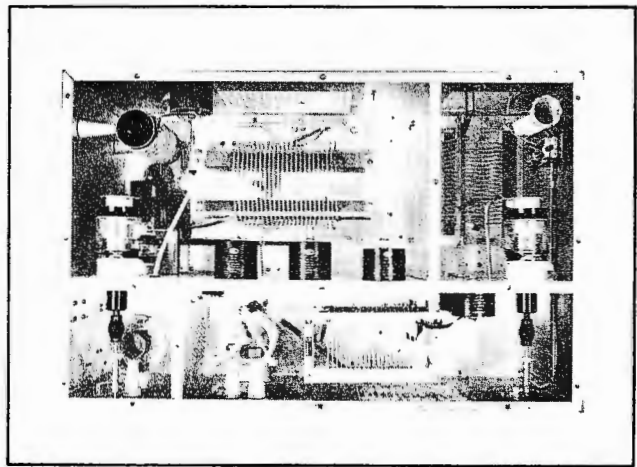

OUTPUT NETWORK COMPARTMENT

#### OUTPUT NETWORK

Conventional low-pass L-sections transform the 50 ohm nominal output impedance to 1,000 ohms plate impedance for the 10 kw transmitter, and to 2,000 ohms for the 5 kw version.

The combined network consists of three series inductances and three shunt capacitances, plus a second harmonic shunt trap to ground. Over-all phase shift through the networks is  $-360^\circ$ , giving a favorable plate impedance characteristic when operating into loads within the EIA limit for "normal" loads.

Motor-driven variable vacuum capacitors are provided in the PA tuning and loading positions—controllable from switches on the extended control panel. PA loading is used to adjust transmitter power output and is normally extended to the remote point in remotely controlled installations.

A phase-comparator circuit is used in the PA stage to automatically control the PA tuning motor as loading is adjusted. Since the tuning capacitor is at a higher network impedance point and requires less padding capacitance than does the loading capacitor, tuning correction will

occur at a more rapid rate, and within the time required for loading changes. The tuning function is not normally extended to the remote control point, and to assure fail-safe operation, the automatic tuning adjustment is disabled until loading changes take place. A Manual/Automatic Tuning switch is provided on the extended control panel to disable the automatic mode during maintenance checks.

SPECIFICATIONS

*Frequency Range:* 540-1600 kc

*Power Source:* 208/240 volts,  $\pm 5\%$ , 50/60 cycles, three phase.

*Power Output:* 820E-1: 5.5 kw max with built-in reduction to 1 kw. 820F-1: 10.6 kw max with built-in reduction to 5 kw.

*Frequency Stability:* Trimmer capacitors provided on the r-f exciter for adjusting crystals to exact center frequency. Stability as follows:

$\pm 5$  cps, 0°C to +35°C (32°F to 95°F)

$\pm 10$  cps, -10°C to +45°C (14°F to 113°F)

*Output Impedance:* Designed for feeding standard 50 ohm coaxial transmission lines. Matching to other impedance options can be supplied on special order.

*Harmonic and Spurious Radiation:* Complies with or exceeds FCC regulations regarding harmonic and spurious radiation.

*Modulation Characteristics:* Equipment incorporates high-level modulation with most desirable response characteristics for broadcast use.

*Audio Input Impedance:* 150/600 ohm, balanced.

*Audio Input Level:* +10 dbm  $\pm 2$  db.

*Audio Frequency Response:* Typically  $\pm 1.5$  db from 50 cps to 10,000 cps.

*Audio Frequency Distortion:* Less than 3% from 50 to 7,500 cps, for 95% modulation.

*Noise:* 60 db below 100% modulation.

*Carrier Shift:* Less than 3% from zero to 100% modulation.

*Ambient Temperature Range:* -25°C to +45°C (-13°F to 113°F).

*Altitude:* Up to 7,000 feet; higher altitudes on special order.

*Size:* 69 inches high by 67-7/16 inches wide by 32 inches deep (175 cm.  $\times$  171 cm.  $\times$  81 cm.).

*Total Weight Including Transformers:* 820E-1, 2,000 lbs. (910 Kg.); 820F-1, 2,450 lbs. (1115 Kg.).

- Part No. 522 3291 000 (Type 820E-1)**  
Includes one set of tubes, one crystal and one instruction book.
- No Part Number**  
Complete set of spare tubes for 820E-1.
- No Part Number**  
FCC set of spare tubes for 820E-1.
- Part No. 522 3292 000 (Type 820F-1)**  
Includes one set of tubes, one crystal and one instruction book.
- No Part Number**  
Complete set of spare tubes for 820F-1.
- No Part Number**  
FCC set of spare tubes for 820F-1.
- No Part Number**  
Spare crystal for 820E / F-1.

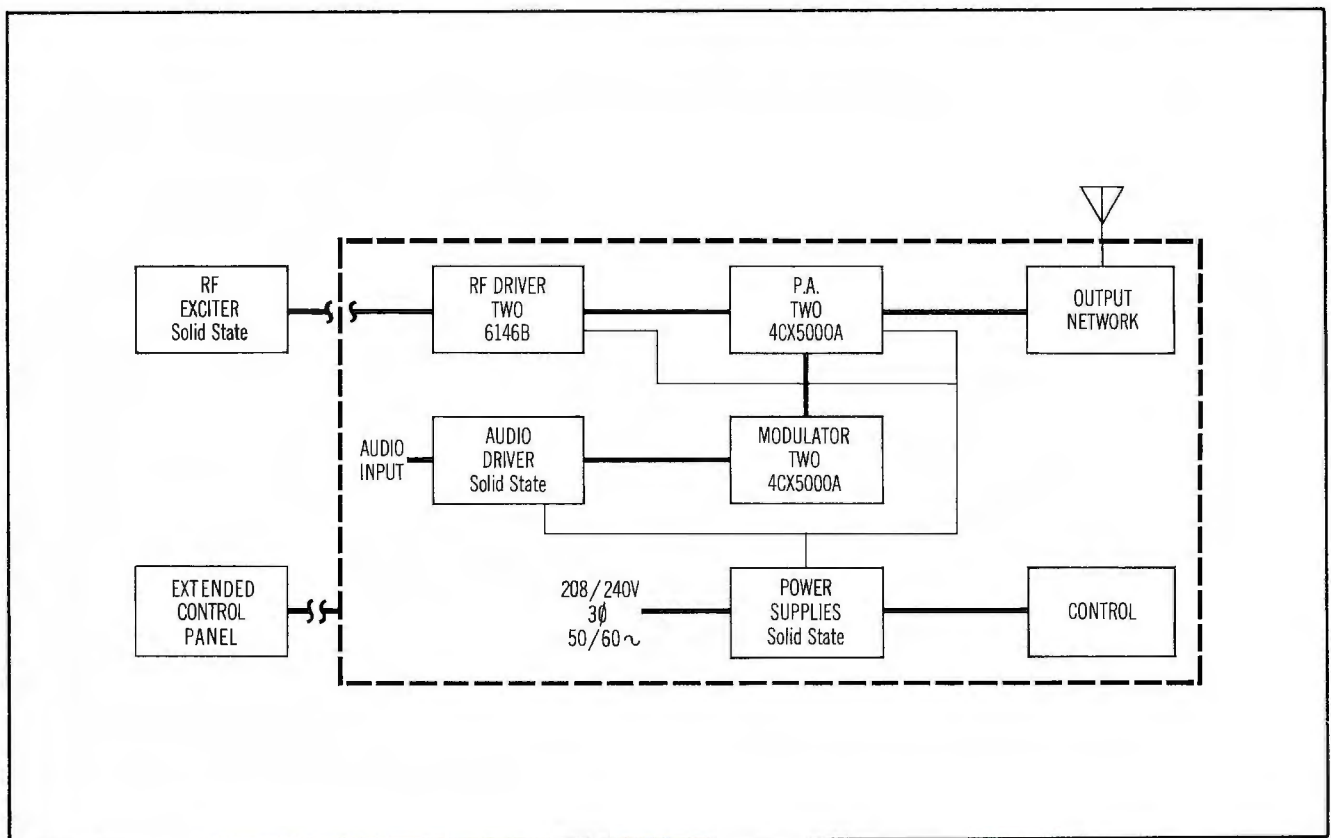

BLOCK DIAGRAM 820F-1

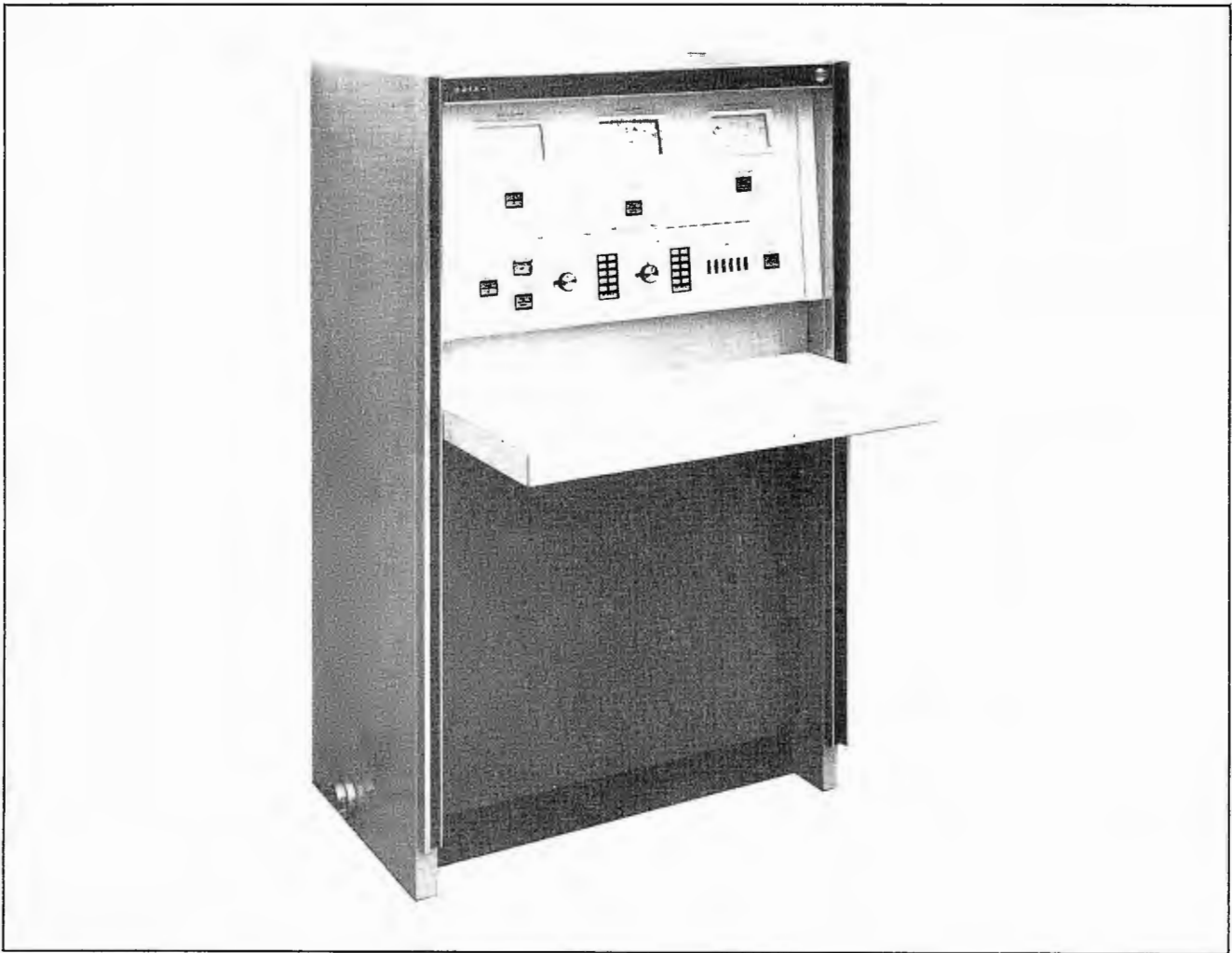

821A-1 CONSOLE

## COLLINS 821A-1 HF TRANSMITTER

Collins type 821A-1 is a high-frequency broadcast transmitter having a minimum carrier output of 250 kilowatts. The 821A-1 represents advanced state-of-the-art techniques which have been adapted to serve the needs of the international broadcaster. The trouble-free tuning and control techniques used in thousands of transmitters built by Collins Radio Company in the past few years were applied during the design of the 821A-1, resulting in a transmitter of extraordinary operating simplicity.

The 821A-1 transmitter has two features never before offered in a transmitter of this power level:

- (1) The ability to tune to any frequency in the 3.95- to 26.5-mc band in 20 seconds or less
- (2) An r-f power amplifier low-loss output tank circuit having no rolling, sliding, or switching contacts.

In broadcasting, on-the-air time is of utmost importance. The Collins 821A-1 transmitter can perform a complete tuning sequence in 20 seconds or less. This feature not only provides a considerable savings in off-the-air time, but it permits a frequency change to be

performed in the time normally allocated for a station break. For example, assume the use of a conventional transmitter operating on an r-f circuit requiring an average of four frequency changes daily. Further, assume that the time required to change frequencies on the conventional transmitter to be 5 minutes and that the station programs in 15-minute increments. A comparison of the conventional transmitter and the 821A-1 transmitter tuning times reveals the great advantage the 821A-1 has over any conventional transmitter.

One 821A-1 transmitter, with the ability to change frequency during station break, can provide 1 hour more on-the-air time daily than the conventional transmitter.

A further advantage offered by the 821A-1 is a pre-set feature to permit programming the automatic tuning circuits of the transmitter in advance of the next frequency change while the transmitter is in operation. This is accomplished by pre-setting the transmitter controls, which provide direct digital readout of the operating frequency, and the exciter crystal selector control for the correct crystal frequency. At the time for frequency



change, depressing the TUNE START pushbutton starts the tuning sequence, which is accomplished in 20 seconds or less. Automatic dissipation protection circuitry protects the r-f driver and power amplifier tubes against over-dissipation during any condition of tune-up. It is evident from the above description that a frequency change can easily be accomplished on the 821A-1 transmitter by one operator with a minimum of training.

The pi-line low-loss r-f power amplifier tank circuit and harmonic filter represents a major engineering breakthrough, which is exclusive to the 821A-1 transmitter. It not only obviates the requirement for any rolling, sliding, or switching contacts in this high-power circuit, but it provides a reduction in power loss of more than 50 percent over the equivalent circuit offered by any other transmitter of this power level.

ELECTRICAL SPECIFICATIONS.

*Emission:* High-level amplitude modulation (A3), Frequency Shift Keying (F1).

*Frequency Range:* 3.95 to 26.5 mc. continuous coverage.

*Frequency Control:* By oven controlled crystal oscillator (two each furnished), or by either of two customer-furnished external signal sources.

*Frequency Stability with Type CR-27/U Crystals:* From +5° to +50°C and primary voltage variation ±10%, less than 5 parts per million frequency change per 24-hour period. Greater stabilities obtainable with higher quality crystals.

*Tuning Time:* Frequency change accomplished in 20 seconds, maximum.

*Tuning Mode:* Automatic.

*Power Output:* At least 250-kw unmodulated carrier power.

*Carrier Shift:* Less than 5%, exclusive of that caused by primary power.

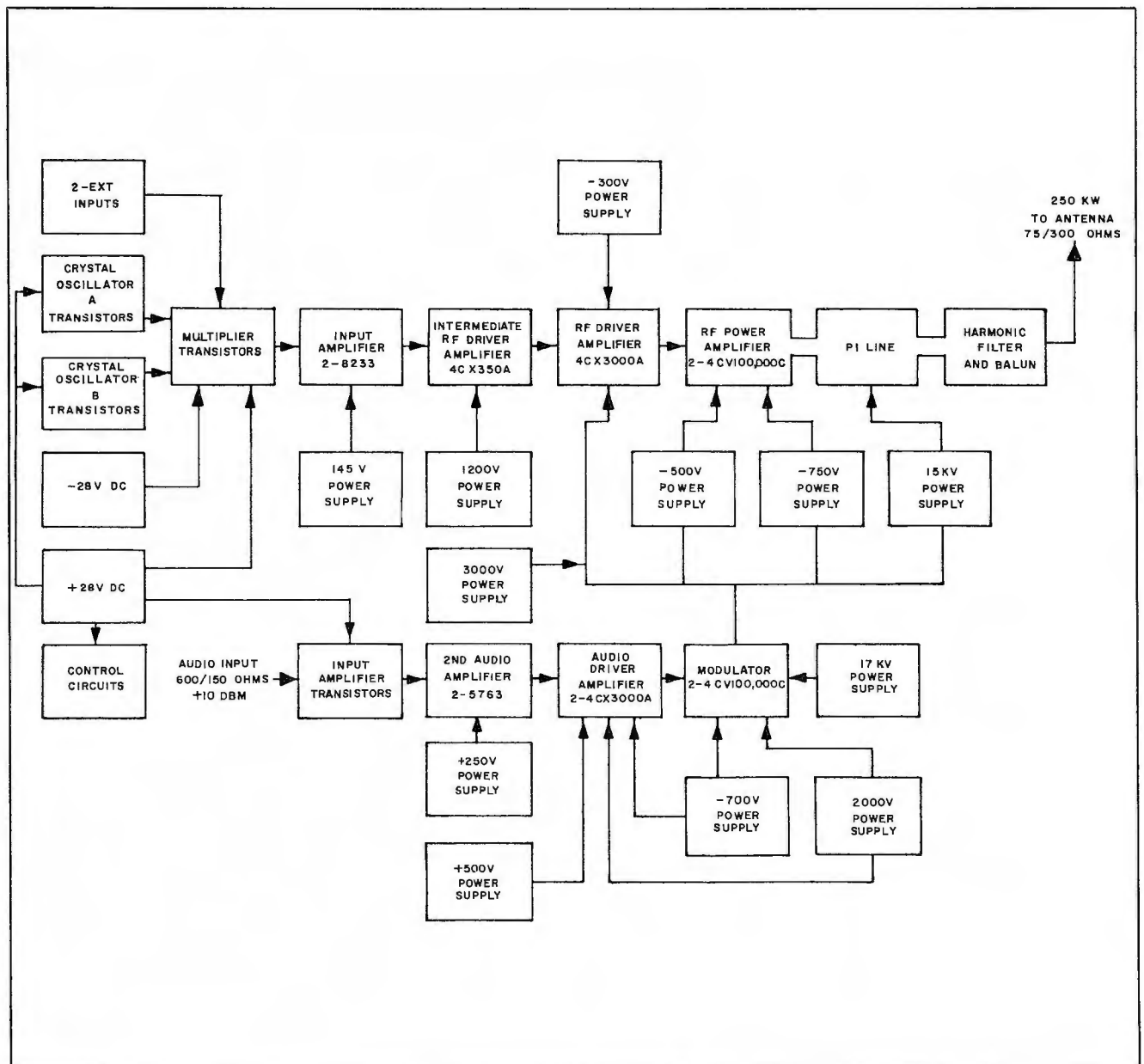

SIMPLIFIED BLOCK DIAGRAM

*Output Impedance:* 300 ohms, balanced; 75 ohms. unbalanced.

*VSWR:* 1.5:1, maximum.

*Type of Modulation:* High-level AM. FSK.

*Modulation Capability:* Capable of 100% sine wave or clipped sine wave. Less than 5% tilt or overshoot for trapezoidal waveform from 100 to 3000 cps.

*Modulation Duty Factor:* Continuous at 100% sine wave; 5 minutes at 100%, clipped sine wave.

*Audio Input for 100% Modulation:* +10 dbm,  $\pm 2$  db.

*Audio Input Impedance:* 600/150 ohms, balanced or unbalanced.

*Audio Response:* Within 1 db from that at 1000 cps between 100 and 7500 cps and within 2 db between 50 to 10,000 cps, at all modulation levels up to 95%.

*Audio Distortion:* Not more than 4% distortion when modulated 100% over the frequency range of 100 to 5000 cps; and not more than 5% from 50 to 100 cps and from 5000 to 7500 cps.

*Noise Level:* Carrier hum and extraneous noise is at least 50 db (unweighted) below 100% modulation.

*Harmonic and Spurious:* All harmonics and harmonically related spurious emissions are at least 80 db below carrier level. Incidental phase modulation products that occur close to the carrier and are a result of (1) random crystal variations, (2) power supply ripple, (3) power supply regulation during modulation, (4) mechanical vibration of the crystal, and which appear in the output of the transmitter are at least 43 db below 1 radian.

*Power Input:*

At Rated Carrier Output: 455 kw at 85% pf

At 100% Sine Wave: 682 kw at 85% pf

*Power Source:* 4160 volts,  $\pm 3\%$ ; 60 cps.  $\pm 5\%$ , 3-phase, 3-wire (50 cps optional).

*Altitude:* 0 to 6000 feet.

*Temperature:* +5° to +50°C at sea level; +5° to +38°C at 6000 feet.

*Humidity:* 0 to 95% relative humidity.

*Storage:* -35° to +60°C.

*Power Source:* 4160 volts  $\pm 3\%$  (steady state)  $\pm 33\%$  (instantaneous); 60 cps  $\pm 5\%$  (steady state);  $\pm 3\%$  (instantaneous) (50 cps optional)

**No Part Number**

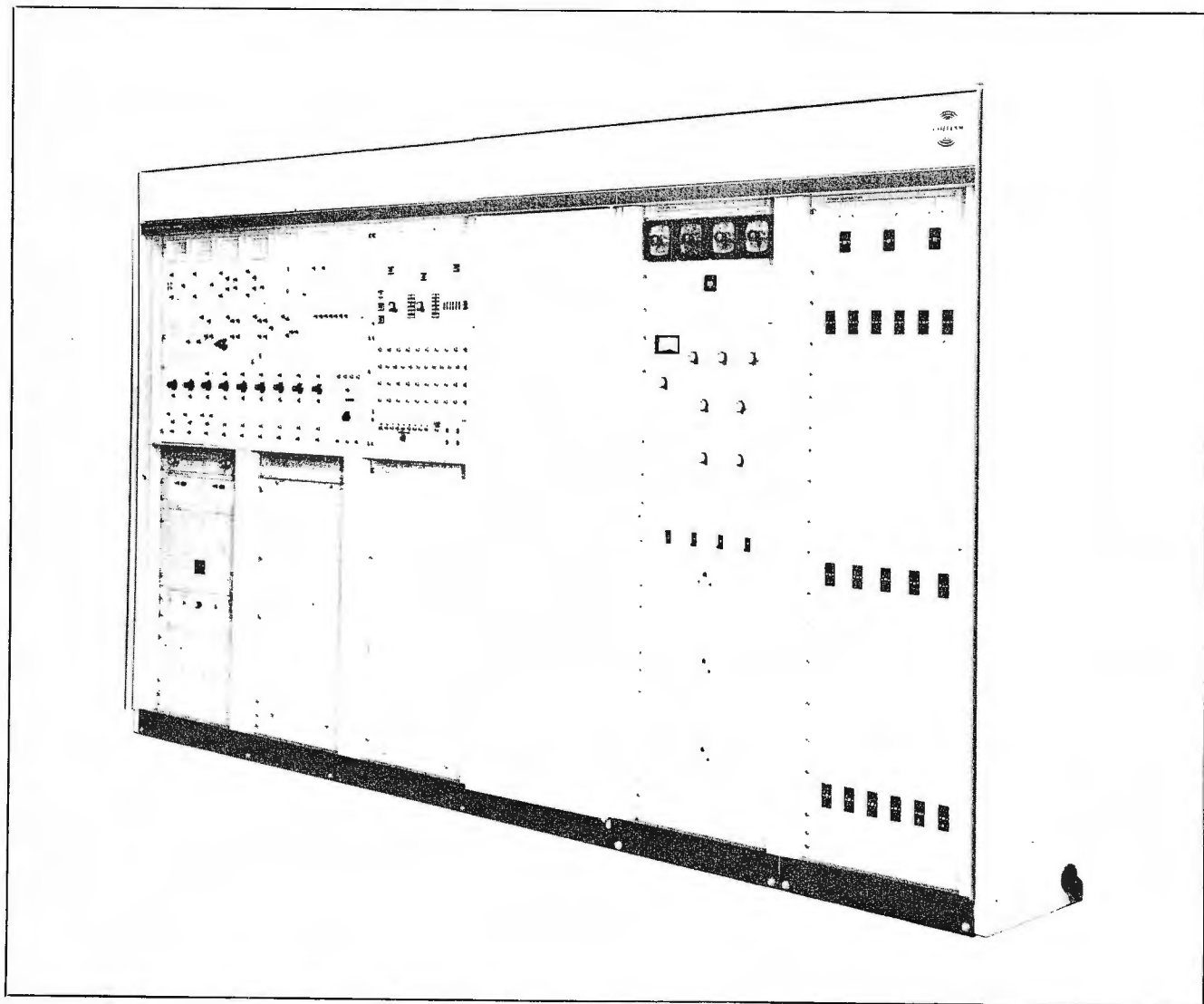

## JOHNSON FEED-THROUGH BOWL INSULATORS

Designed to carry RF transmission line through a wall. Assembly includes glass bowls, cork gasket, steel mounting with six 3/16" mounting holes. Bowl is 6 15/16" max. diameter and 4 3/8" high. Mounting flange: 7 3/4" diameter. Fittings include spun aluminum corona shield, 1/2"-13 threaded stud except 135-15-4 which has 5/18"-18 threaded stud (hollow), washers, and nuts.

Part No. 097 1501 000 (Type 135-15-1)  
One bowl and fittings, 10 1/4" stud.  
Part No. 097 6673 000 (Type 135-15-3)  
Two bowls and fittings, 16" stud for walls up to 4" thick.  
Part No. 099 1170 000 (Type 135-15-4)  
Two bowls and fittings, 24" hallow stud I.D. 7/16" for walls up to 12" thick.  
Part No. 097 5646 000 (Type 135-15-7)  
Two bowls and fittings, 24" stud for walls up to 12" thick.

## COLLINS 172G DUMMY ANTENNA

This air-cooled unit provides a load to dissipate transmitter output for off-the-air testing. Consisting of 8 ferrule type, non-inductive resistors, with insulated end brackets and clips, it may be mounted on the transmitter or adjacent wall. The 172G-1 has an impedance of 52 ohms; the 172G-2, 73 ohms.

*Power Rating:* 1 kw.

*Size:* Approx. 6" W, 9" H, 12 1/2" D (15.24 cm W, 22.86 cm H, 31.75 cm D).

*Weight:* 5 lbs. (2.27 kg).

Part No. 522 1410 014 (Type 172G-1)  
Part No. 522 1411 014 (Type 172G-2)

## STATES WG-52 DUMMY ANTENNA

An air-cooled dummy load to dissipate output of the Collins 21E AM Transmitter. The WG-52 has an impedance of 52 ohms and a peak of 7.5 kw.

Part No. 097 8138 00

## COLLINS TOWER LIGHTING FILTER CHOKES

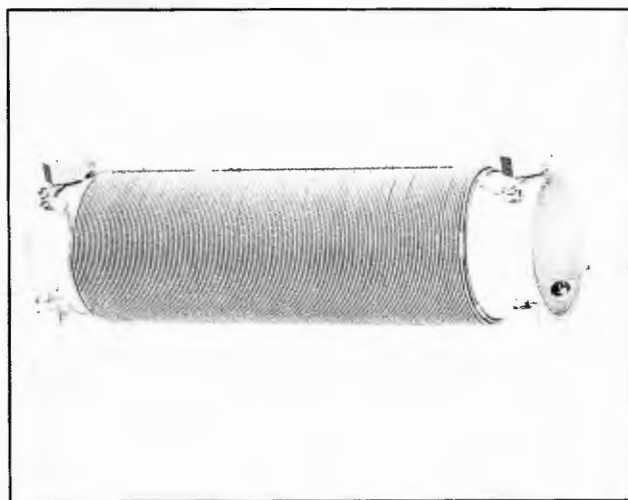

These solenoid wound 2- and 3-wire chokes provide high impedance throughout the broadcast band for isolation of the ac power lines from the antenna. Coils are wound of #10 wire and are rated at 2,000 watts, 120

v ac, single phase. Provided with mounting brackets and standoff insulators for mounting in 42E-7/8 antenna coupling units.

Part No. 543 3927  
Unhoused, 2-wire, 2,000 watts.  
Part No. 543 3926  
Unhoused, 3-wire, 2,000 watts.

## COLLINS 42E ANTENNA COUPLING UNITS

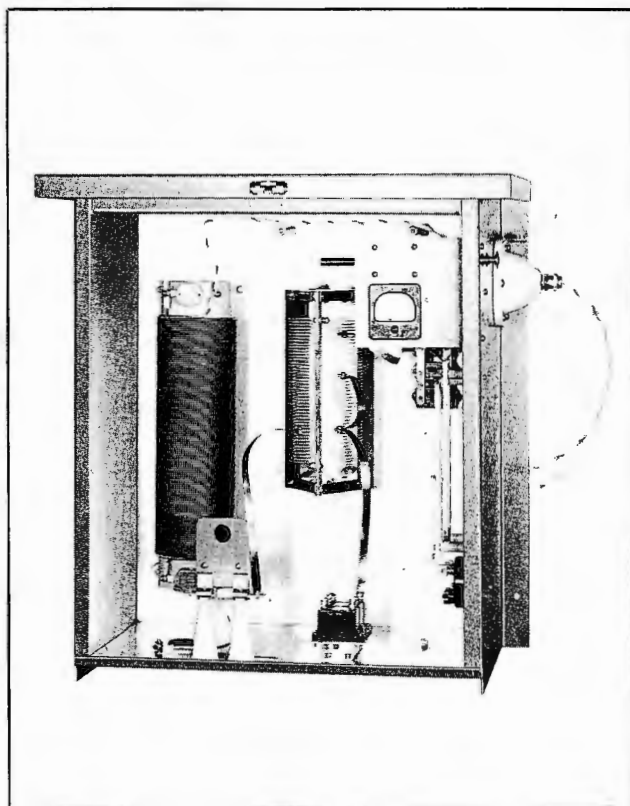

These specially constructed units match a series-fed vertical radiator to an unbalanced transmission line. Intended for continuous, unattended duty in conjunction with transmitters having emission type A0, A1, A2 or A3, the 42E-7 operates with transmitters of carrier power output of 250-1,000 watts. The 42E-8A operates with transmitters of 5,000 watts and the 42E-8B operates with transmitters of 10,000 watts.

The electrical circuit of the 42E Antenna Coupling Units is a low-pass "T" network with good harmonic attenuating properties. A three-wire or two-wire tower lighting filter choke and remote antenna current sampling transformer may be mounted in the cabinet, and an antenna current meter and line current meter jack are provided.

A horn gap furnishes lightning protection. The antenna connection is made by an insulated feed-through bushing on the side of the cabinet and the bushing has a hollow stud for the lighting circuit. The transmission line comes through the base of the cabinet. Gray weatherproof aluminum housing. Remote antenna current metering kit and antenna current transformer

for remote reading of antenna current up to 25 amps available for all Collins AM Transmitters.

Size: 42E-7—29" W, 28" H, 18" D (73.66 cm W, 71.12 cm H, 45.72 cm D).

Weight: 64 lbs. (29.03 kg).

Size: 42E-8A/B—36" W, 28" H, 22" D (91.41 cm W, 71.12 cm H, 55.88 cm D).

Weight: 124 lbs. (56.25 kg).

Part No. 522 1028 (Type 42E-7)  
Part No. 522 1029 (Type 42E-8A)  
Part No. 522 1029 (Type 42E-8B)

## COLLINS REMOTE ANTENNA METERING KIT

The Collins remote antenna current metering kit is designed for the Collins series of AM transmitters. The kit for the 20V-3 includes RF transformer, thermocouple, remote meter and meter mounting bracket. Specify type of tuner, base current of tower, base resistance or complete description of antenna system.

The kit for the 21E and 21M transmitters includes RF transformer and thermocouple. (Remote meter is included in transmitter.) Specify type of tuner, base current of tower, base resistance or complete description of antenna system.

No Part Number  
For 20V-3 Transmitters.  
No Part Number  
For 20V-3 Transmitters. Same as above but with expanded scale and matching thermocouple.  
No Part Number  
For 21E/M Transmitters.

## COLLINS ANTENNA CURRENT TRANSFORMER

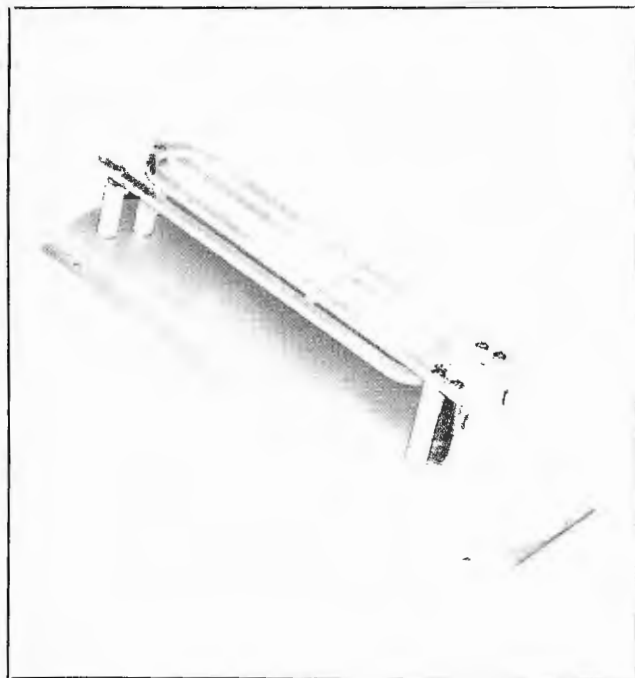

Used with remote thermocouple and meter for remote monitoring of antenna current. For currents up to 25 amps. Thermocouple not included.

Part No. 543 3917

## PHASING

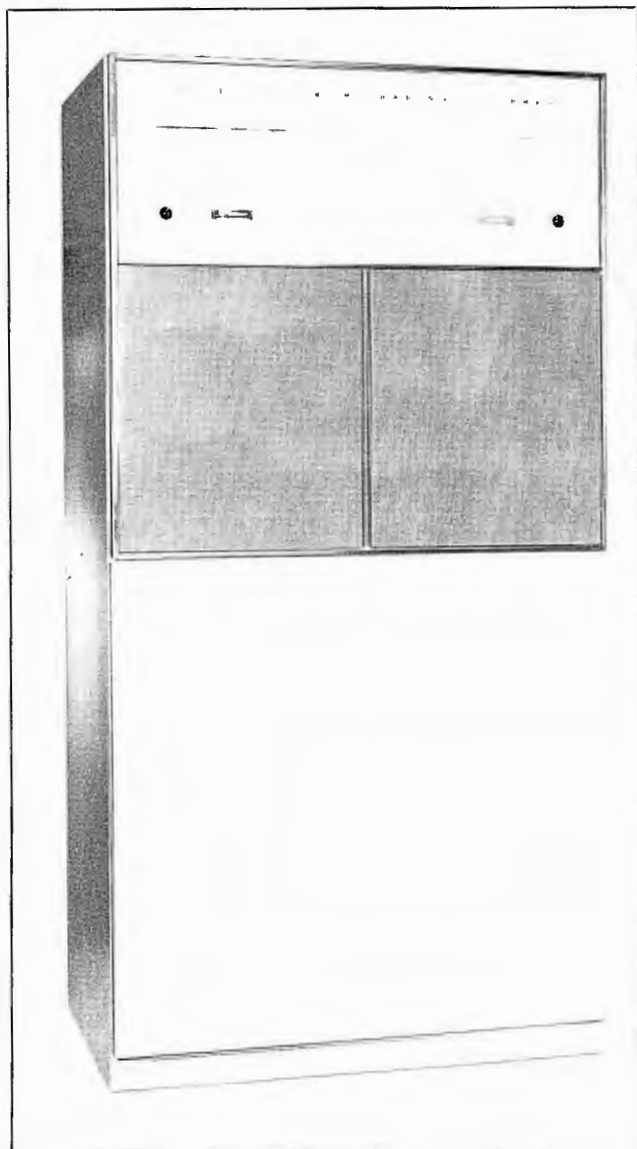

### COLLINS 81M PHASOR

Collins Radio Company maintains a research and development staff which devotes its full efforts to custom design and manufacture of phasing and tuning equipment that will meet critical operating parameters with a minimum of maintenance and adjustment. By instituting its own design and construction, Collins can offer fastest possible delivery, maintain its famous standard of quality and sell at the lowest possible cost.

Engineered into each installation are easily-adjusted networks, highest stability, adequate voltage and current safety factors and maximum economy. A customer's requirements, as specified by his consulting engineer, are strictly adhered to and designs are submitted for approval before construction is started.

After the consulting engineer has made channel studies for an available frequency, he will design an array to fit the location, frequency and other requirements. He will



determine the pattern shape and size in both the vertical and horizontal planes, the maximum expected operating values of fields in both the nulls (minimum signal areas) and the lobes (maximum signal areas), the proper size, shape, height, spacing, and orientation of the antenna towers, and the phase relationships and amplitude ratios of the radiation fields of the individual antennas. This information is then submitted to the FCC with the application for a construction permit.

A Collins 81M directional antenna phasing and branching system consists of: a branching circuit in which the

power is divided in precisely the amounts of power necessary to give the proper ratio of fields from the individual antennas; an impedance matching circuit to match the power divider input impedance to the common point impedance at which the power input is measured; phase shifting networks in series with each of the transmission lines going to the individual antenna towers; the transmission lines themselves; and the impedance matching network between each of the transmission lines and its associated antenna tower.

The power divider in Collins 81M equipment is usually

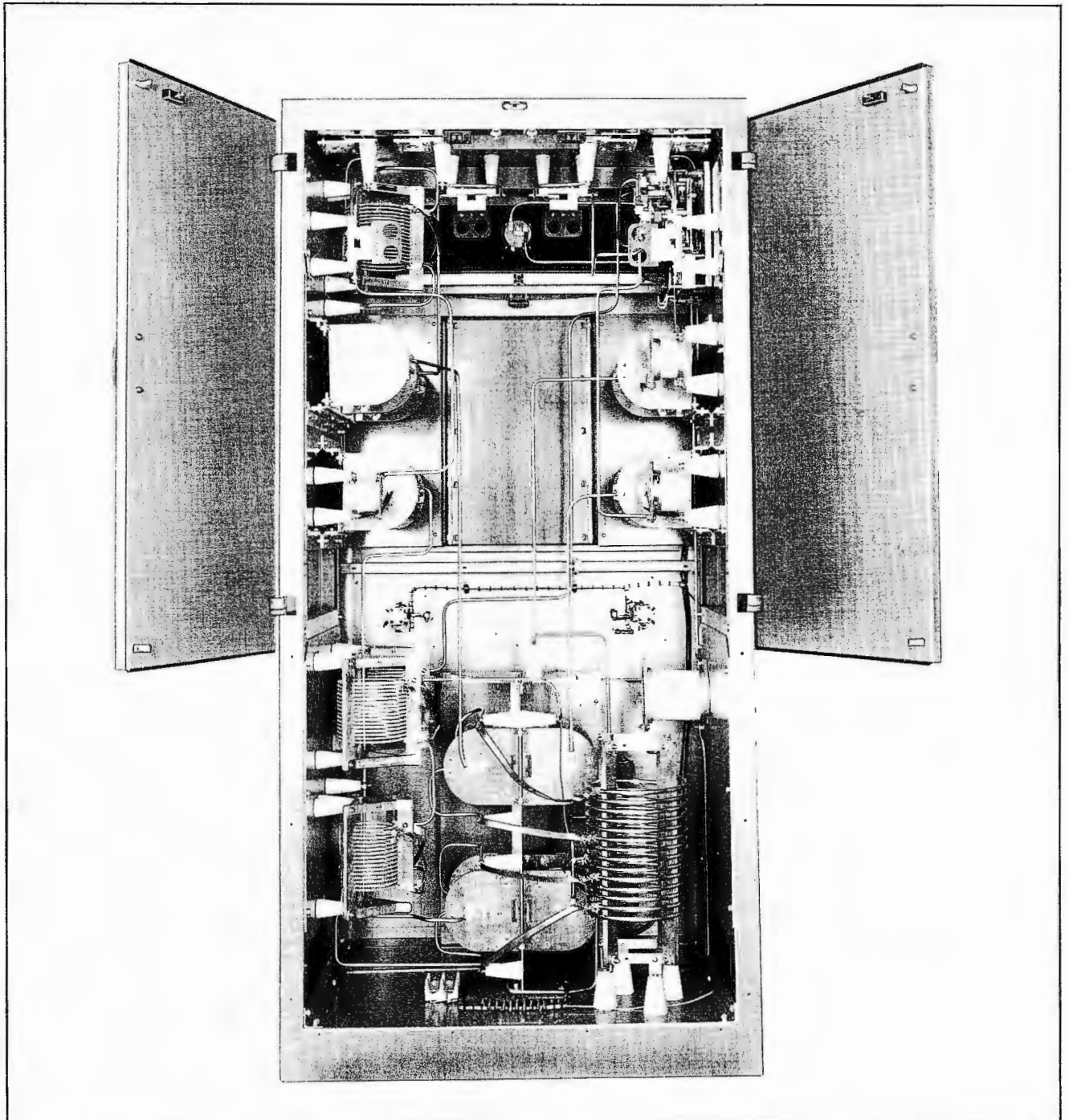

a resonant tank circuit consisting of a large fixed coil tapped with smaller variable coils for power adjustment. An alternate design uses a group of variable coils, each one feeding a tower; this group then becomes the tank coil of the circuit.

For 1 kw or lower, the capacitive arm of the tank circuit is a capacitor and variable coil connected in series. The variable coil provides tuning adjustment by varying the over-all negative reactance in this branch of the tank. In higher powers, the tank capacitance is usually a variable vacuum capacitor in parallel with one or more fixed capacitors.

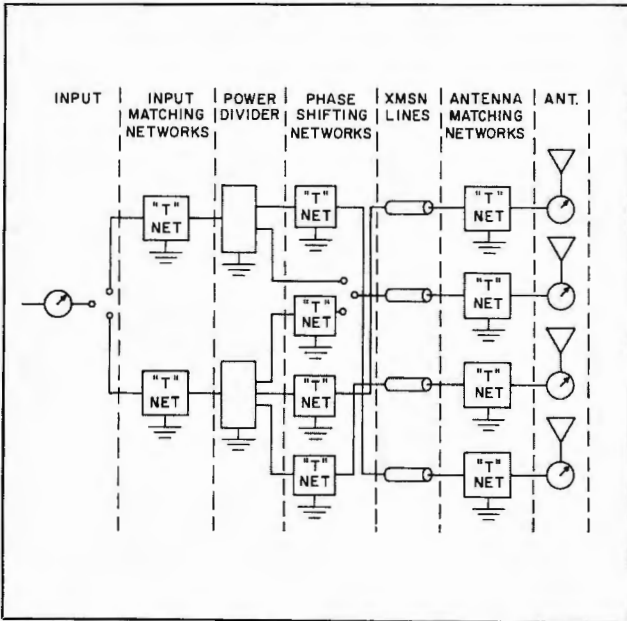

TYPICAL PHASING SYSTEM

Phase shifting networks are "T" designed, with variable coils mechanically connected in tandem for the series arms and a coil and capacitor in series for a shunt arm. Wherever possible, 90° networks — capable of being adjusted  $\pm 30^\circ$  from the design value — are supplied.

Wherever a phase shift network is not required, a series variable coil and capacitor are used to supply variation of  $\pm 20^\circ$  around a 0° setting. They are used for trimming phase shift of current in the towers in which they are used.

"T" networks are also used for impedance matching at the tower base. The network has sufficient latitude of adjustment to match the transmission line impedance to any expected base operating impedance and still permit adjustment of phase shift.

Switching of circuits for day and night operation or directional and non-directional operation is accomplished by impulse-type, toggle-operated RF relays, energized by pushbutton switches on the front panel. The pushbutton automatically removes the plate voltage of the transmitter before pattern switching and restores it when switching is completed. Interlocks on the cabinet doors also remove the plate voltage when doors are opened.

Amplitude and phase controls have counters to assure accurate resetability. In complex arrays requiring additional controls, the controls and counters are behind the tilt-out panel in the lower half of the cabinet.

Power dividing circuits and phase shift networks utilize heavy edge-wound copper ribbon inductors and ceramic cased mica capacitors. Vacuum capacitors are used where made necessary by high circulating currents.

Plated 5/16" copper tubing is used for all RF busses and insulation is steatite or Mycalex.

Input and output connections are provided at the top of the phasing cabinet unless otherwise specified. Special terminations are provided for solid dielectric cables in both the phasing cabinet and antenna coupling units.

An input common point RF ammeter is supplied along with line current meter jacks. Antenna current meters have make-before-break switches, which can be operated without opening the cabinet door on the weatherproof coupling units.

Extensive descriptions of typical systems are available upon request of CDS-377.

*Power:* 1, 5 and 10 kw in 2-, 3-, 4-, 5-, and 6-tower arrays.

*Patterns:* Directional day and night, same pattern; directional nighttime only; or different pattern day and night.

*Size:* 38" W, 76" H, 27" D (96.52 cm W, 193.04 cm H, 68.58 cm D). (Complex Collins 81M phasing systems may require two cabinets totaling 76" W.)

No Part Number

## COLLINS 564A-1 PHASE SAMPLING LOOP

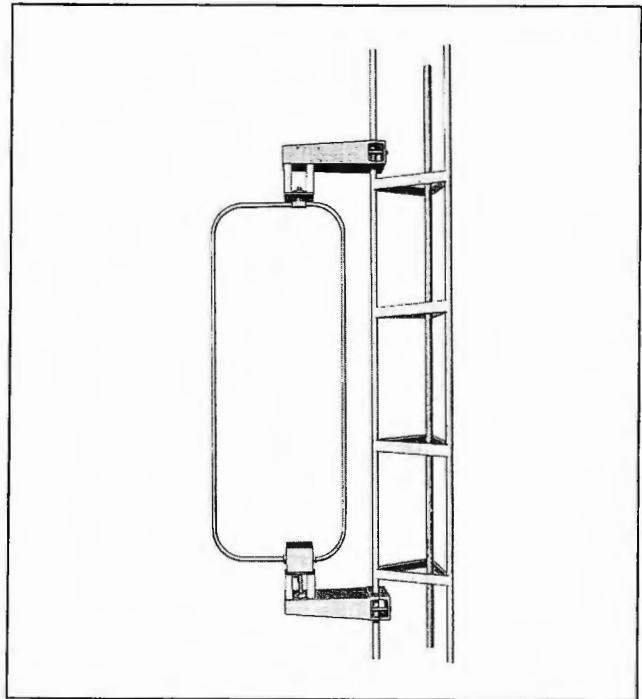

Designed to sample the relative phase relationship of radio frequency energy from 550-1600 kc antenna towers

in directional antenna arrays, the Collins 564A-1 is made of two loops of #10 copper wire which may be connected either in series or in parallel. The wires are contained within a loop of 7/8" painted, copper tubing which serves as an electrostatic shield.

A universal coupling permits the loop to be connected to any type of pressurized or unpressurized air or solid dielectric transmission line. The loop offers a good match to lines of 50-75 ohms impedance. A universal mounting bracket allows the loops to be mounted on any part of the antenna structure.

*Size:* Approx. 30" W, 7' 6" H (76.2 cm W, 228.6 cm H).  
*Weight:* 50 lbs. (22.68 kg).

Part No. 522 1518 004

### COLLINS 564A-2 PHASE SAMPLING LOOP

An unshielded loop of galvanized iron pipe.

*Size:* Approx. 42" W, 7' 2" H (106.68 cm W, 218.44 cm H).

*Weight:* 35 lbs. (15.88 kg).

Part No. 522 1519 004

### COLLINS 144A-1 ISOLATION COIL

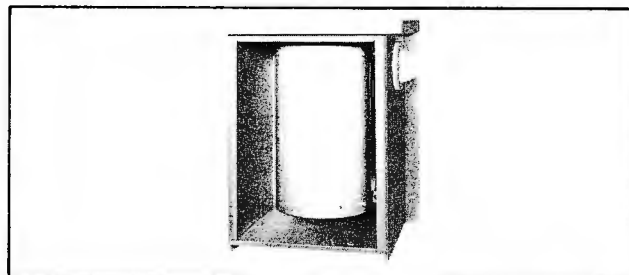

Coil provides isolation for the sampling line in directional arrays, presenting a high impedance for the line across the base insulator. Unit consists of a phenolic coil form which will accommodate 37 turns (approx. 100 ft.) of RG8/U or similar solid dielectric sampling line. May be mounted on wall of tuning shack or in housing (pictured).

*Inductance:* Approx. 180 microhenrys.

*Size:* 10" diameter, 18" L (25.4 cm diameter, 45.72 cm L).

*Weight:* 6 lbs. (2.72 kg).

Part No. 522 1520 (Type 144A-1)  
 Part No. 522 1521 (Type 49U-1) weatherproof housing.

### JOHNSON RF CONTACTORS

The 145-100 and 145-200 contactors are especially designed for high voltage radio frequency switching and dc voltage switching in high voltage rectifier circuits. They require no "holding" power and will operate with a momentary application of voltage.

Standard contactors are supplied with four auxiliary switches: two "normally closed" for control of solenoid voltage and two "normally open" for operation of signal lamps or other related functions. Solenoids are wired for 220 v, 50-60 cps or 110 v, 50-60 cps on special order.

Part No. 410 0209 00 (Type 145-101-13)  
 Part No. 410 0210 00 (Type 145-102-13)  
 Part No. 410 0211 00 (Type 145-201-13)  
 Part No. 410 0212 00 (Type 145-202-13)

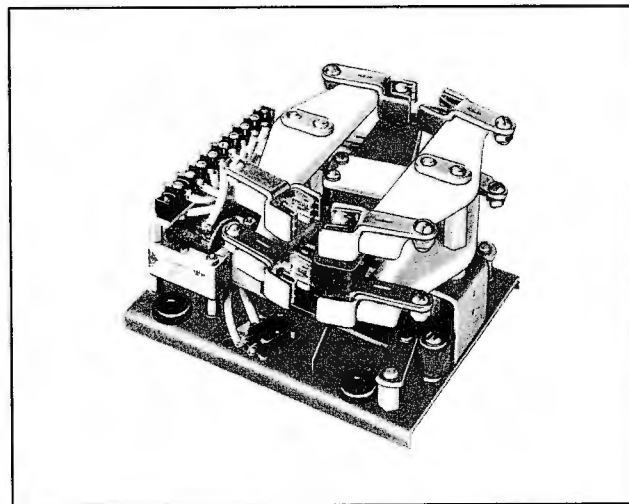

Type No.	Maximum Current	Contacts	Maximum Contact Rating (at 2 mc)	Size
145-101-13	4 amps	SPDT	17 kv, 25 amps	(20.0 cm W, 13.97 cm H, 16.51 cm D)
145-102-13	4 amps	DPDT	17 kv, 25 amps	(20.0 cm W, 13.97 cm H, 16.51 cm D)
145-201-13	8 amps	SPDT	22 kv, 25 amps	(26.67 cm W, 15.88 cm H, 20.96 cm D)
145-202-13	8 amps	DPDT	22 kv, 25 amps	(26.67 cm W, 15.88 cm H, 20.96 cm D)

# FM Transmitters

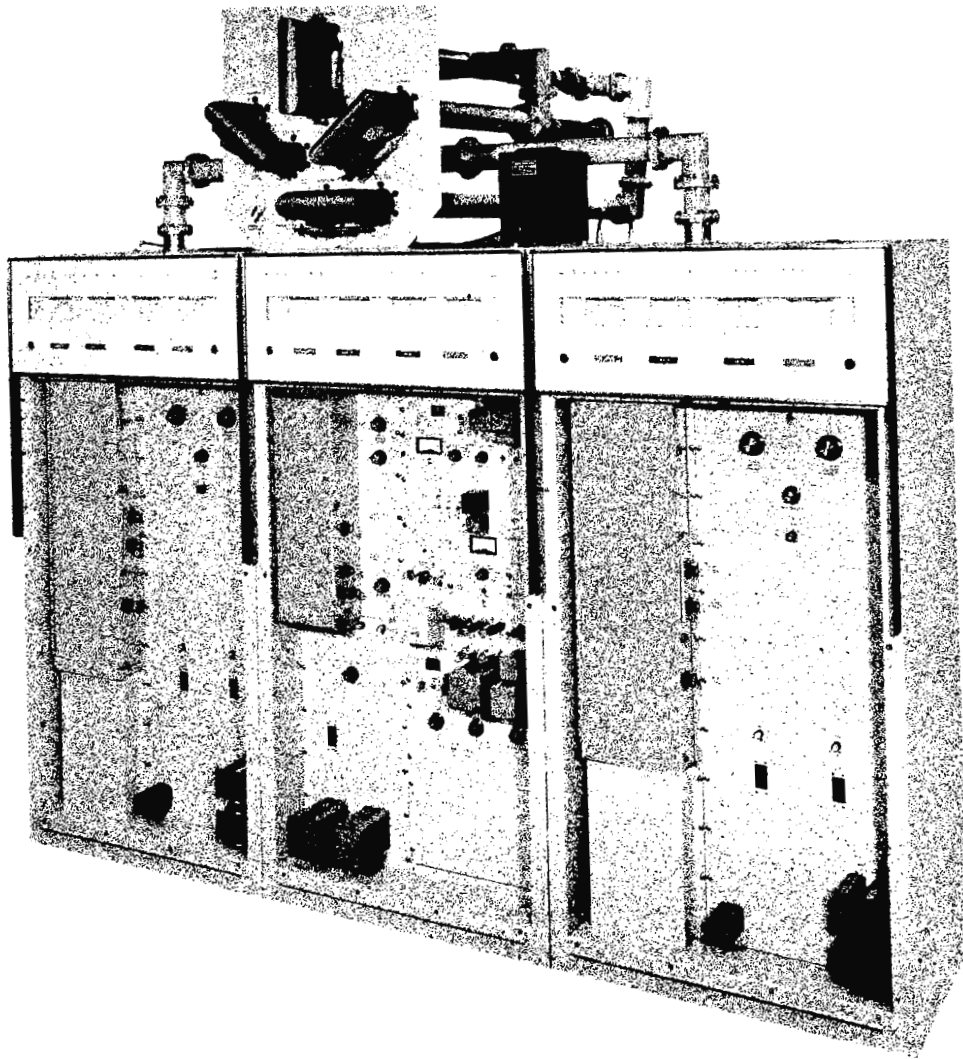



## WHAT'S THE MYSTERY ABOUT STEREO?

The mystery of stereophonic FM broadcasting is wiped away with the straightforward Collins approach. Not only does Collins equipment faithfully reproduce "live" sound in both direction and dimension, it also assures the stereo broadcaster a stable system of transmission. The Collins method of composite signal generation does away with the costly and unstable equipment needed in conventional double-injection system of stereo broadcasting.

Amplitude differences result from the directional characteristics of the human ear and the baffle effect produced by the head. The time differences result from the difference in path length to each ear from a sound source which is off to one side.

To provide a realistic stereo effect, the time delay and amplitude differences between the signal received by the left and right ears must be maintained from the original sound source to the ear of the listener. The problem becomes one of maintaining amplitude and phase differences to provide adequate channel separation.

Left and right channels must have proper *balance* to give the listener faithful reproduction of a live presentation. If the source of sound moves to the left on the program stage, the left channel's volume must increase and the right channel's volume decrease proportionately to convey accurately the change of direction of the sound source.

Adequate channel separation — at least 30 db — must be maintained. Lack of adequate *separation* would permit "bleeding" of one channel's sound into the other, thus moving the sound source to an apparent center from the listener's point of view.

Finally, *compatibility* is required. The transmitted stereo signal must be capable of being received not only by the stereo FM receiver, but by existing monaural receivers as well.

To comply with FCC requirements, a signal which can be received by monaural receivers must be transmitted. This signal is the combination of the left and right channels, or L+R. To achieve stereo broadcasting, a subcarrier FM signal provides the vehicle for the third dimensional sound. This is the L-R channel.

The Collins 786M-1 FM Stereo Multiplex Generator achieves this L-R signal by a mathematical system of

time division. More of this later. Basically, then, the stereo FM receiver gets two signals, an L+R and an L-R. To feed the left channel and the receiver's left speaker, the receiver adds the L+R and L-R signals and derives 2L. The same process by subtraction yields 2R in the right speaker. Since the figure 2 represents a volume control setting, the receiver in effect recovers the L and R sound originally produced at the left and right microphones on the program stage.

Returning to the time division principle, it is this factor which makes the Collins Stereo Generator a standout unit in operation and maintenance. In the conventional stereo generation system, two channels are required to feed L+R and L-R to the exciter. This technique, known as matrixing, requires gain and phase shift between the two channels be maintained within close tolerances to maintain adequate channel separation throughout the system.

Collins' new approach eliminates the need for continual surveillance of time delay shifting between the two channels by eliminating the double-injection system entirely.

Instead, the direct FM wide band exciter is fed a *single, composite signal on one wire*. Any shift in gain or phase will affect both channels equally, thus maintaining the 35 db channel separation. Not only does this assure the broadcaster an inherently stable method of stereo transmission, but greatly simplifies both operation and maintenance.

The rather expensive matrix networks needed in the dual channel system are eliminated as are the time delay switches needed to match the channels when a shift in gain or phase occurs.

The Collins time division system of stereo signal generation is nothing more than a sampling at a 38 kc rate of left and right audio inputs. The output from the switch is equivalent to L+R plus the L-R double sideband components centered on the switching frequency (38 kc) and its odd harmonics.

The composite wide band spectrum accepted by the exciter would include the L+R signal, a 10% 19 kc pilot carrier inserted for phasing reference, the L-R DSB components centered on the 38 kc subcarrier, and the 67 kc SCA channel when an auxiliary SCA generator is installed.

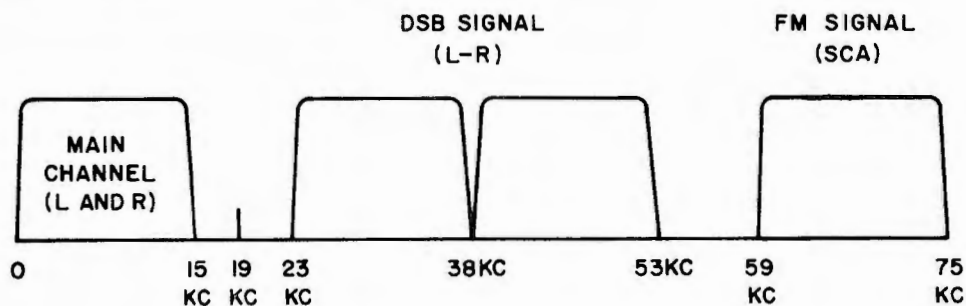

STEREO MULTIPLEX SPECTRUM

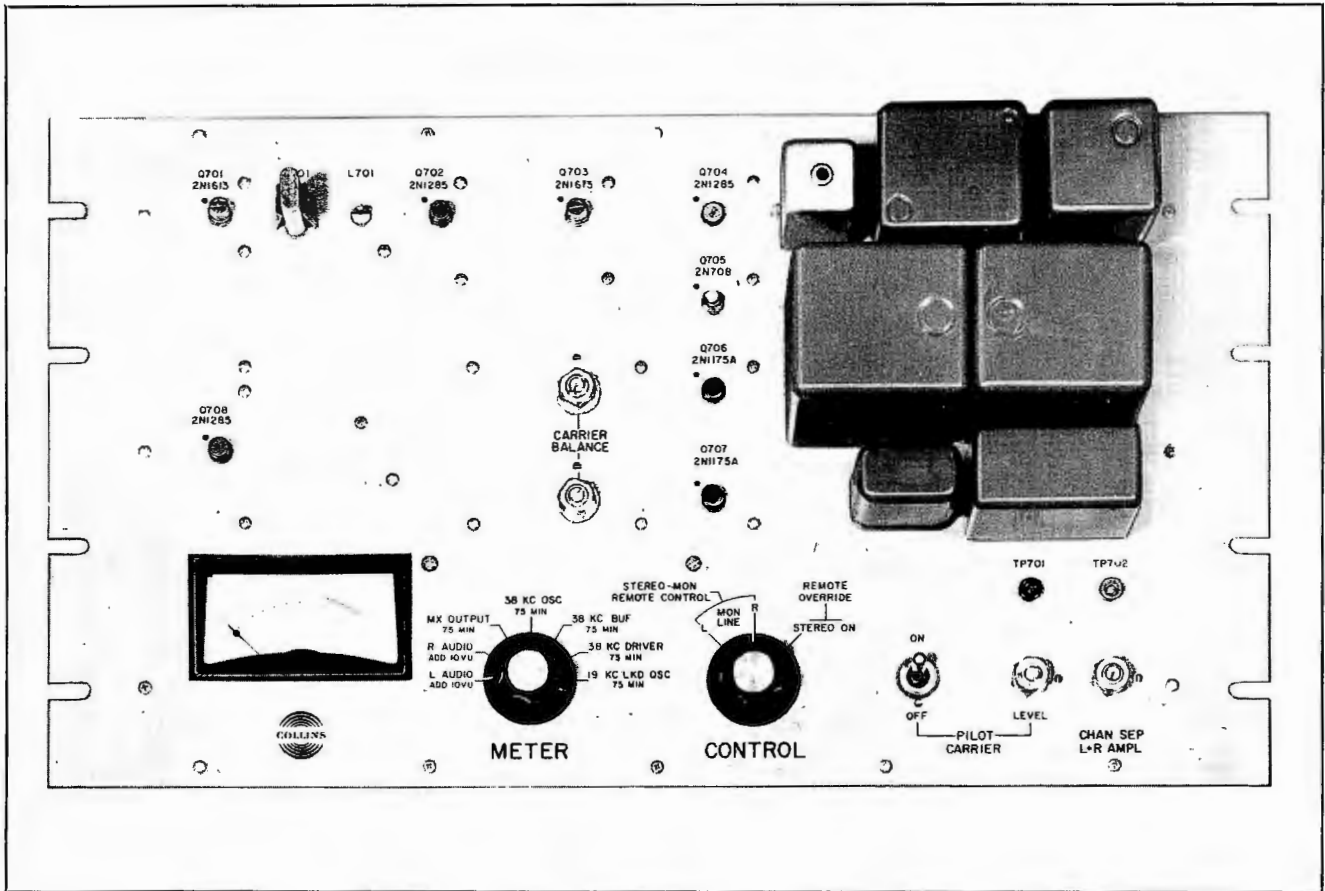

## 786M-1 FM STEREO MULTIPLEX GENERATOR

A stable and reliable method of stereophonic FM broadcasting is now available through the new time division system where both stereo channels are integrated into a composite signal which is fed to a wide band exciter (Collins A830-2) on a single line.

The Collins 786M-1 FM Stereo Multiplex Generator does away with the inherent instability of the conventional dual channel method of stereo injection.

Instead, the Collins 786M-1 feeds monaural audio and the subchannel, required for stereo operation, to the exciter on a single, composite signal. The time division system eliminates the costly and unstable dual channels which require matrix networks. L + R and L - R outputs of the matrix networks must be compensated to make up time differences in the two channels. Also, accurate amplitude balance between the two channels must be maintained. In the Collins system, this problem is eliminated by using a wide band direct FM exciter. With a system of this type, any gain changes or time delays will affect the main and sub-channels equally.

The Collins time division system is nothing more than a sampling at a 38 kc rate of the left and right audio inputs. After transmission, a corresponding component in the FM receiver demodulates the composite signal in

synchronism with the sampling, converting it to left and right audio through the respective speakers.

The composite stereo signal (L + R and L - R) is achieved by filtering out unwanted harmonics created in the function of the four-diode time division switching circuit. The resulting spectrum shows only the main channel (L + R) which is the monaural signal; a 10% 19 kc pilot carrier; the subchannel (L - R) which is the stereo signal on a 38 kc carrier. An SCA channel may be placed on a 67 kc carrier by addition of an auxiliary SCA generator.

Features of the 786M-1 are:

**SIMPLE CIRCUITS** — The single line, time division system eliminates matrixing components, greatly simplifying circuitry.

**STABLE** — All components are temperature-compensated to provide long-term stability. The unit is completely transistorized.

**SELF-METERED** — An audio VU meter monitors both audio inputs and interior circuit points for rapid maintenance.

**EASILY INSTALLED** — The Collins 786M-1 may be installed in the 830B-1A, 830D-1A or 830E-1A FM. 830F-1A. 830F-2A. 830H-1A, 830N-1A.

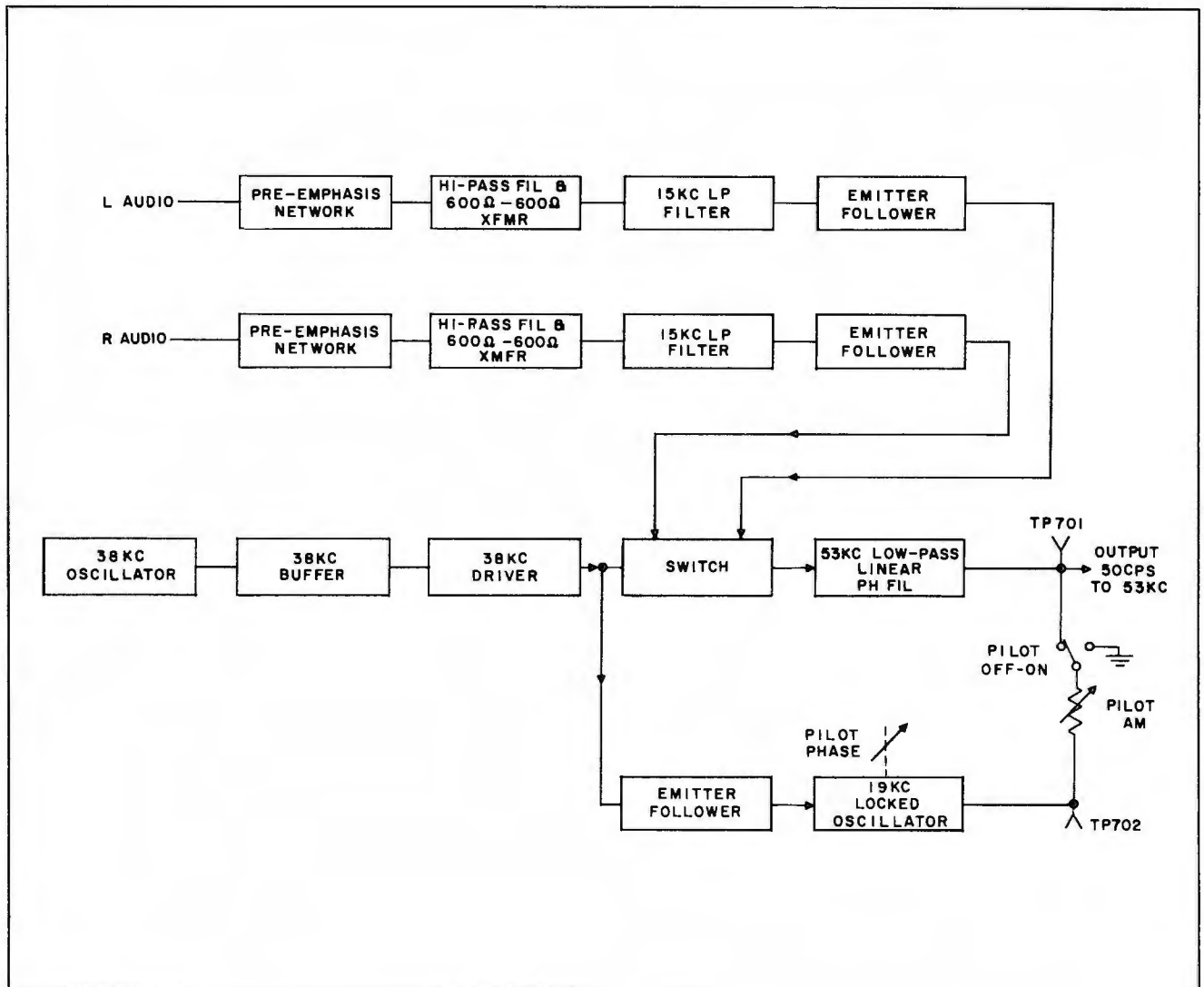

BLOCK DIAGRAM 786M-1

*Pre-emphasis networks* are plug-in type; can be replaced with 20 db flat pad for testing. *Hi-pass filter and 600 ohm-600 ohm transformers* prevent interference with exciter AFC circuits by any 5 cps components in input. Transformers convert from balanced to unbalanced inputs. *15 kc low pass filters* limit bandwidth to 15 kc to prevent cross-talk between main and sub-channels. Filters provide over 60 db attenuation for frequencies above 19 kc. *Emitter followers* provide isolation between left and right audio inputs and stereo switch. *38 kc oscillator, buffer and driver* provide 38 kc drive signal to the stereo switch. When 38 kc carrier goes positive, upper pair of diodes in *switch* conduct and connect left channel to output; when carrier goes negative, lower pair of diodes connect right channel to output. L+R correction is obtained by feeding left and right signals around switch through two resistors. *The 53 kc low pass linear phase filter* removes high frequency switching components which would fall outside the assigned bandwidth. The

filter meets the requirement of constant time delay for all frequencies up to 53 kc. Main channel audio and sub-channel DSB crossings thus occur simultaneously. The filter also has flat frequency response to 53 kc. These two factors are held to tolerances which provide over 35 db channel separation for 50-15,000 cps audio input frequencies rising to 38 db at 5 kc. *The emitter follower and 19 kc locked oscillator* provide a 19 kc pilot carrier in phase with the 38 kc subcarrier at the output of the linear phase filter.

*Distortion (either channel):* Less than 1%, 50-15,000 cps.  
*Channel Separation:* 35 db or greater, rising to 38 db at approx. 5 kc.

*Pilot Carrier Stability:*  $\pm 2$  cps at 19,000 cps.

*Output Impedance:* 600 ohms unbalanced.

*Size:* 19" W, 8 $\frac{3}{4}$ " H, 3 $\frac{1}{8}$ " D.

*Weight:* 14 lbs.

Part No. 522 2914 00

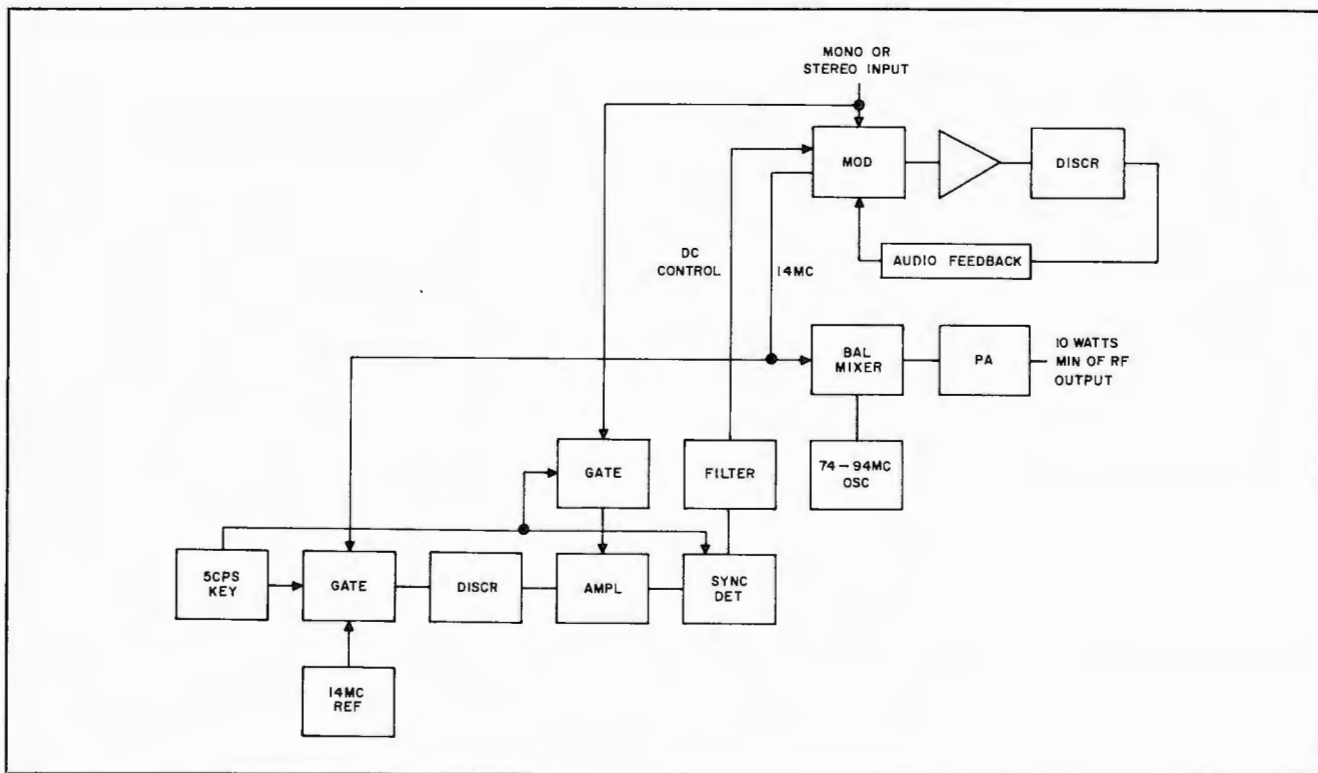

BLOCK DIAGRAM A830-2

## COLLINS A830-2 10-WATT DIRECT FM EXCITER

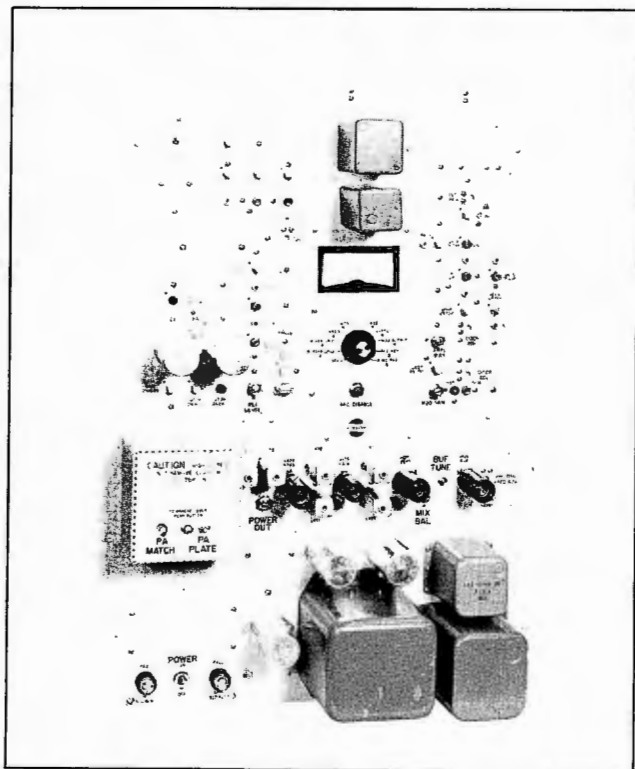

An ideal, independent unit that may be used in educational stations or for other similar low power applica-

tions, the Collins A830-2 is a 10-watt direct FM exciter that accepts audio inputs from a monophonic, stereo (see Collins FM Stereo Multiplex Generator description, or SCA source by telephone lines or direct connection and modulates an existing carrier to provide an RF drive signal for direct transmission or further amplification. The unit serves as the exciter portion of the Collins 830B-1A and 830E-1A FM Transmitters (see descriptions) and may be rack mounted in 10-watt installations.

**Power Source:** 117 v ac  $\pm 5\%$ , 50-60 cps, single phase.

**Power Supply Voltages:**

+20 v dc  $\pm 0.1$  v, regulation  $\pm 0.1$  v; ripple 0.5%.

-10 v dc  $\pm 0.1$  v, regulation  $\pm 0.1$  v; ripple 0.5%.

+300 v dc  $\pm 5.0$  v, regulation  $\pm 10$  v; ripple 1%.

**Carrier Frequency Stability:** Not more than  $\pm 2,000$  cps.

**FM Noise Level:** 65 db below 100% modulation ( $\pm 75$  kc).

**AM Noise Level (RMS):** 55 db below 100% AM level.

**Tube Complement (one each):**

6U8 6AU6

12AT7 5763

2E26

**Size:** 19" W, 26 $\frac{1}{4}$ " H, 3 $\frac{3}{8}$ " D (48.26 cm W, 66.68 cm H, 8.57 cm D).

**Weight:** 42 lbs. (19.05 kg).

**Part No. 522 2714**

Consists of 10-watt exciter, set of tubes, transistors, power rectifiers, crystal and instruction book. Rack mounted unit.

**No Part Number**

Complete set of spare tubes, plug-in transistors plus power rectifiers for 830A-2.

**No Part Number**

FCC set of spare tubes, plug-in transistors plus power rectifiers for 830A-2.

**No Part Number**

Spare crystal operating frequency for A830-2 10-watt exciter.

**Part No. 289 2743 00**

Spare 14 mc crystal.

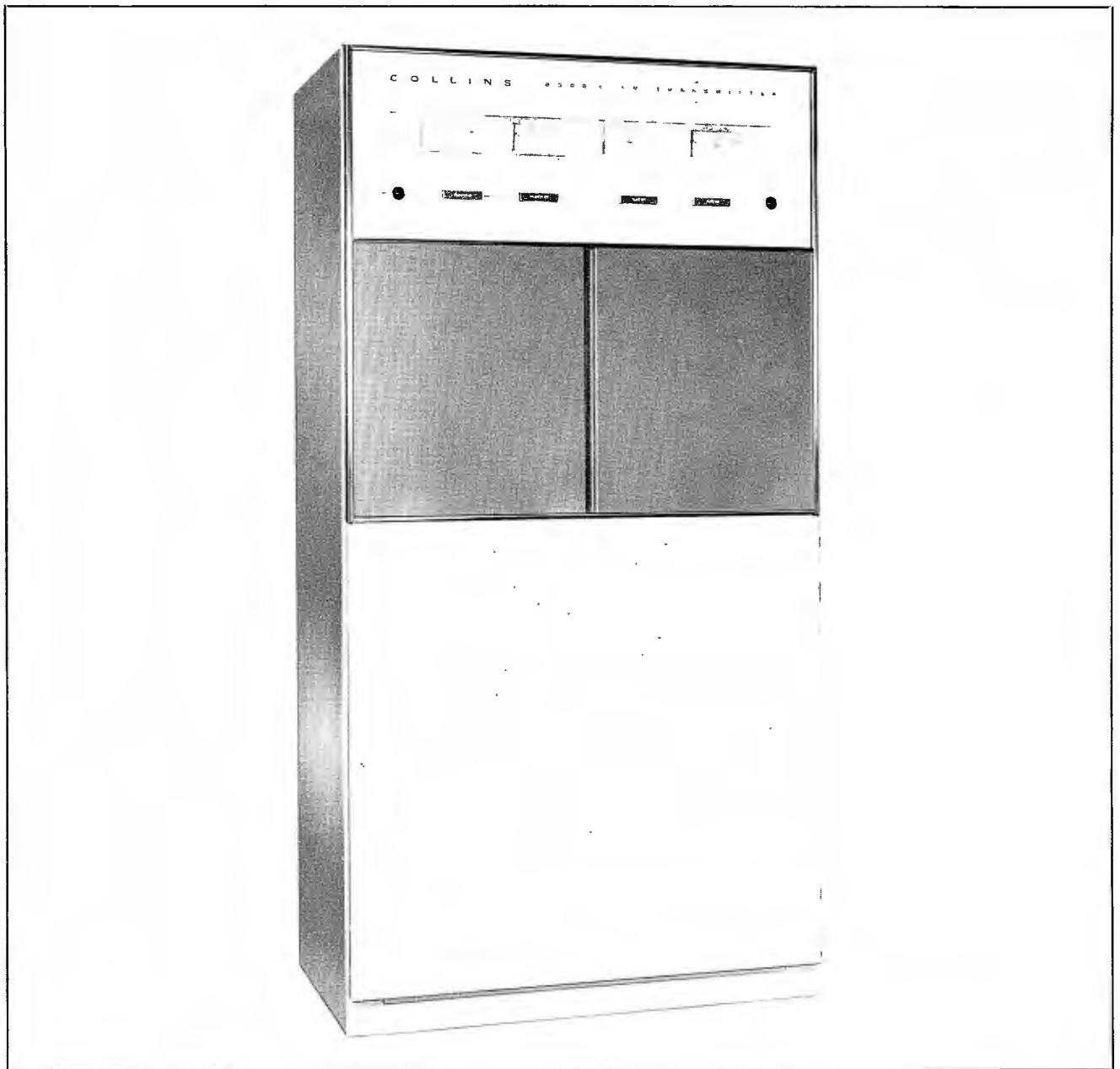

### **COLLINS 830B-1A FM TRANSMITTER**

Designed for top reliability and superior quality sound, the Collins 830B-1A 250 Watt FM Transmitter not only affords the broadcaster an economical, self-contained unit, but also is readily adaptable to a variety of uses, including stereophonic FM and increased station power.

Clean, sharp lines plus "humanized" engineering for both operation and maintenance make the Collins 830B-1A an attractive, integrated unit in the most modern broadcast station.

Other quality features of the Collins 830B-1A which underscore its superior performance include:

**SELF-CONTAINED** — Transformers for the all solid state power supply as well as the harmonic filter are housed

inside the cabinet. Self-contained multiplexing equipment, including the Collins 786M-1 Stereo Generator, also may be installed inside. Space is provided for power transformers when the unit is used as a driver for the 830E-1A 5,000 Watt Transmitter.

**SIMPLE OPERATION** — The 830B-1A is pushbutton operated, featuring a "step-start" system in which starting sequences are fully automatic. All RF circuits are tuned from the front panel. Adequate metering is provided for rapid operation analysis. All adjustments can be made while the transmitter is on the air.

**DEPENDABLE** — The compact transmitter uses space-saving silicon rectifiers which generate a minimum of



heat. Spurious radiation is minimized and the unit has a high degree of stability.

**MAINTENANCE EASE** — Vertical panel construction eliminates hidden components and allows rapid inspection and maintenance. Cabinet interlocks minimize danger during circuitry inspection and maintenance. A grounded shorting stick is readily accessible to discharge capacitors before transmitter servicing.

**RIGID TESTING** — In accordance with rigid Collins standards, the 830B-1A is tested on the broadcaster's channel under proper load conditions prior to shipment.

The 830B-1A can meet a variety of power situations. Only the blower motor need be changed to convert from the nominal 60 cycle to 50 cycle operation.

**Frequency Range:** 88-108 mc.

**Power Output:** 250 watts.

**Carrier Frequency Stability:**  $\pm 1000$  cps.

**Audio Frequency Response:**  $\pm 1$  db, 50-15,000 cps.

**Distortion:** Less than 1%, 50-15,000 cps.

**FM Noise Level:** 65 db below  $\pm 75$  kc.

**AM Noise Level:** -55 db rms.

**Harmonic Attenuation:** At least -67 db.

**Modulation Capability:**  $\pm 100$  kc.

**RF Output Impedance:** 50 ohms; SWR not to exceed 2:1.

**Audio Input Level:** +10 dbm,  $\pm 2$  db.

**Power Source:** 230 v ac nominal, 60 cps, 1 phase (tapped for 200-250 v in 10 v steps).

**Input Power Requirement:** 860 watts, 90% power factor.

**Power Line Regulation:** 3%.

**Variations:** Slow line,  $\pm 5\%$ ; rapid line,  $\pm 3\%$ .

**Tube Complement:**

2 OD3	1 5763
1 6U8	1 2E26
1 12AT7	1 4CX250B
1 6AU6	

**Temperature Range:** 15° - 45°C.

**Humidity:** 0% - 95%.

**Altitude:** 6000 ft. (1828.8 m).

**Size:** 38" W, 76" H, 27" D (96.52 cm W, 193.04 cm H, 68.58 cm D).

**Weight:** 638 lbs. (289.4 kg).

**Part No. 522 2871**

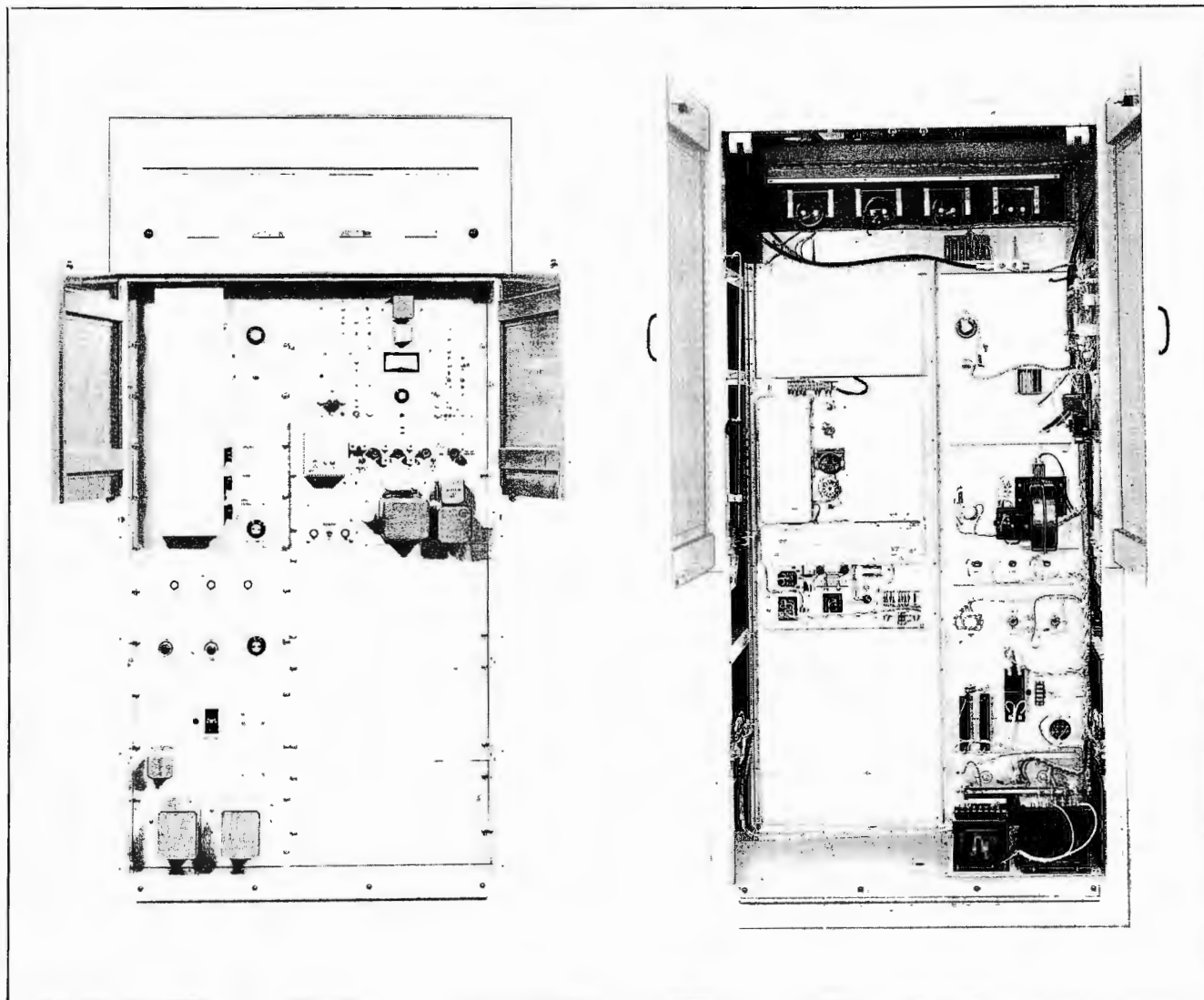

830B-1A FM TRANSMITTER

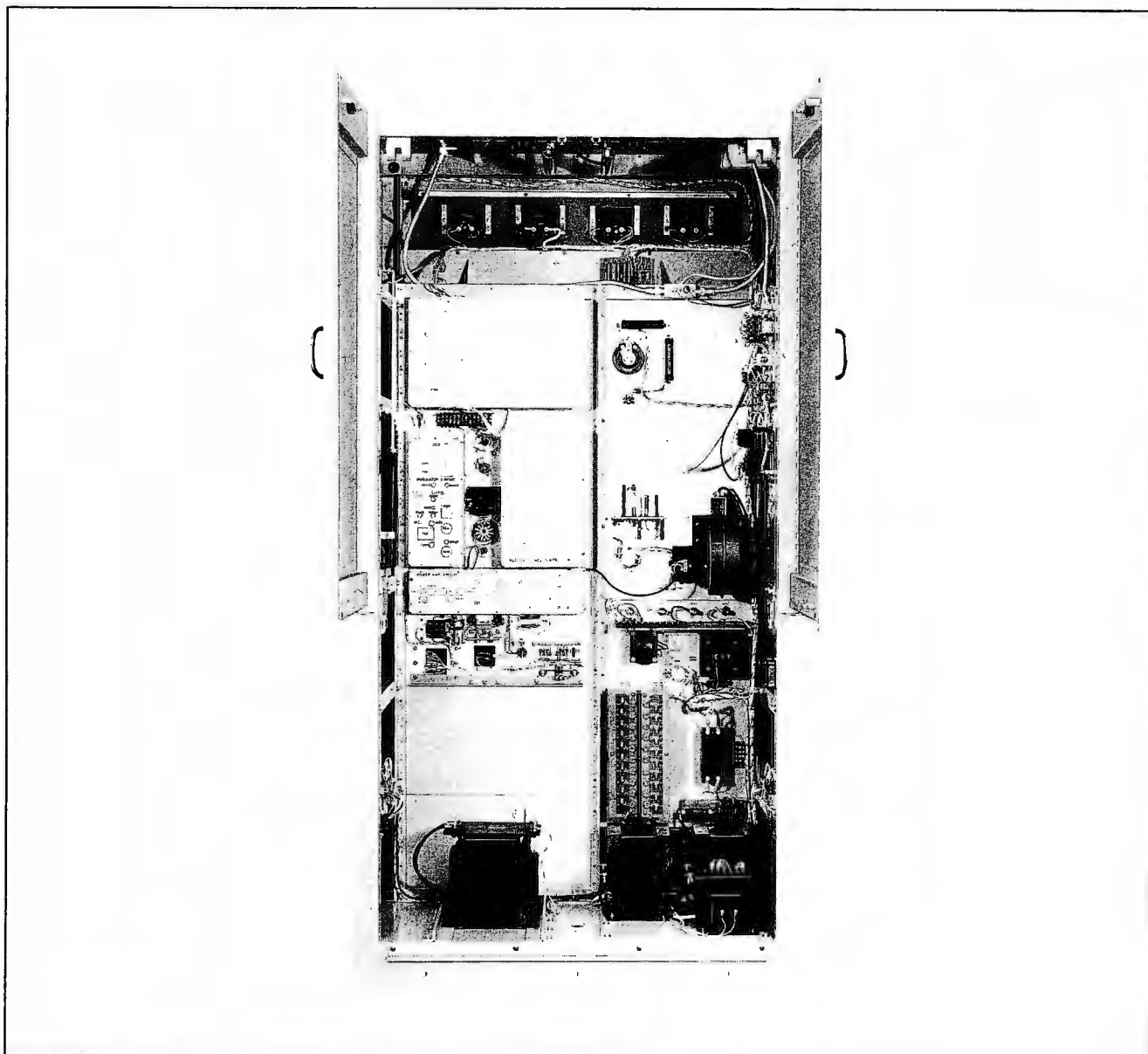

### **COLLINS 830D-1A FM TRANSMITTER**

Carefully-engineered design, straight-forward circuitry, clean-line cabinetry all make the Collins 830D-1A FM Transmitter a powerful and versatile installation in the most modern station.

The self-contained 1,000 watt unit achieves a new degree of reliability and operational ease never before obtainable by the FM broadcaster.

The new approach A830-2 10 Watt Exciter is the heart of the 830D-1A. This wide band direct FM unit accepts a composite stereo signal directly without using auxiliary modulators for either the stereo or SCA channels.

Operation and maintenance of the Collins 830D-1A is simplicity itself. Fewer components and fewer tuned circuits enhance the dependability and operational ease of the transmitter.

Some of its features are:

**SELF-CONTAINED** — Transformers for the all solid state power supply as well as the harmonic filter are enclosed in the cabinet. Self-contained multiplexing equipment, including the Collins 786M-1 Stereo Generator, also may be mounted inside.

**SIMPLE OPERATION** — The 830D-1A is pushbutton operated, featuring a "step-start" system in which starting sequences are fully automatic. All RF circuits are tuned from the front panel. Adequate metering is provided for rapid operational analysis. All adjustments can be made while the transmitter is on the air.

**DEPENDABLE** — Space-saving silicon rectifiers which generate a minimum of heat are employed. A regulated

filament transformer prolongs tube life. Stability is enhanced through the neutralized final power amplifier. Spurious radiation is held to a minimum; the entire unit has a high degree of stability.

**MAINTENANCE EASE** — Vertical panel construction eliminates hidden components and allows rapid inspection and maintenance. Cabinet interlocks minimize danger during circuitry inspection and maintenance. A grounded shorting stick is readily accessible to discharge capacitors before transmitter servicing.

**RIGID TESTING** — In accordance with rigid Collins standards, the 830D-1A is tested on the broadcaster's channel under proper load conditions *before* shipment is made.

The 830D-1A can meet a variety of power situations. Not a single component need be changed to convert from nominal 60 cycle operation to 50 cycle.

*Frequency Range:* 88-108 mc.

*Power Output:* 1000 watts.

*Carrier Frequency Stability:*  $\pm 1000$  cps.

*Audio Frequency Response:*  $\pm 1$  db, 50-15,000 cps.

*Distortion:* Less than 1%, 50-15,000 cps.

*FM Noise Level:* 65 db below  $\pm 75$  kc.

*AM Noise Level:* -55 db rms.

*Harmonic Attenuation:* -73 db.

*Modulation Capability:*  $\pm 100$  kc.

*RF Output Impedance:* 50 ohms; SWR not to exceed 2:1.

*Audio Input Level:* +10 dbm,  $\pm 2$  db.

*Power Source:* 230 v ac nominal, 50-60 cps, 1 phase (tapped for 200-250 v in 10 v steps).

*Input Power Requirement:* 2300 watts, 90% power factor.

*Power Line Regulation:* 3%.

*Variations:* Slow line,  $\pm 5\%$ ; rapid line,  $\pm 3\%$ .

*Tube Complement:*

1 6U8	1 5763
1 12AT7	1 2E26
1 6AU6	1 4CX1000A

*Temperature Range:* 15° - 45°C.

*Humidity:* 0% - 95%.

*Altitude:* 6000 ft. (1828.8 m).

*Size:* 38" W, 76" H, 27" D (96.52 cm W, 193.04 cm H, 68.58 cm D).

*Weight:* 776 lbs. (351.99 kg).

**Part No. 522 2969**

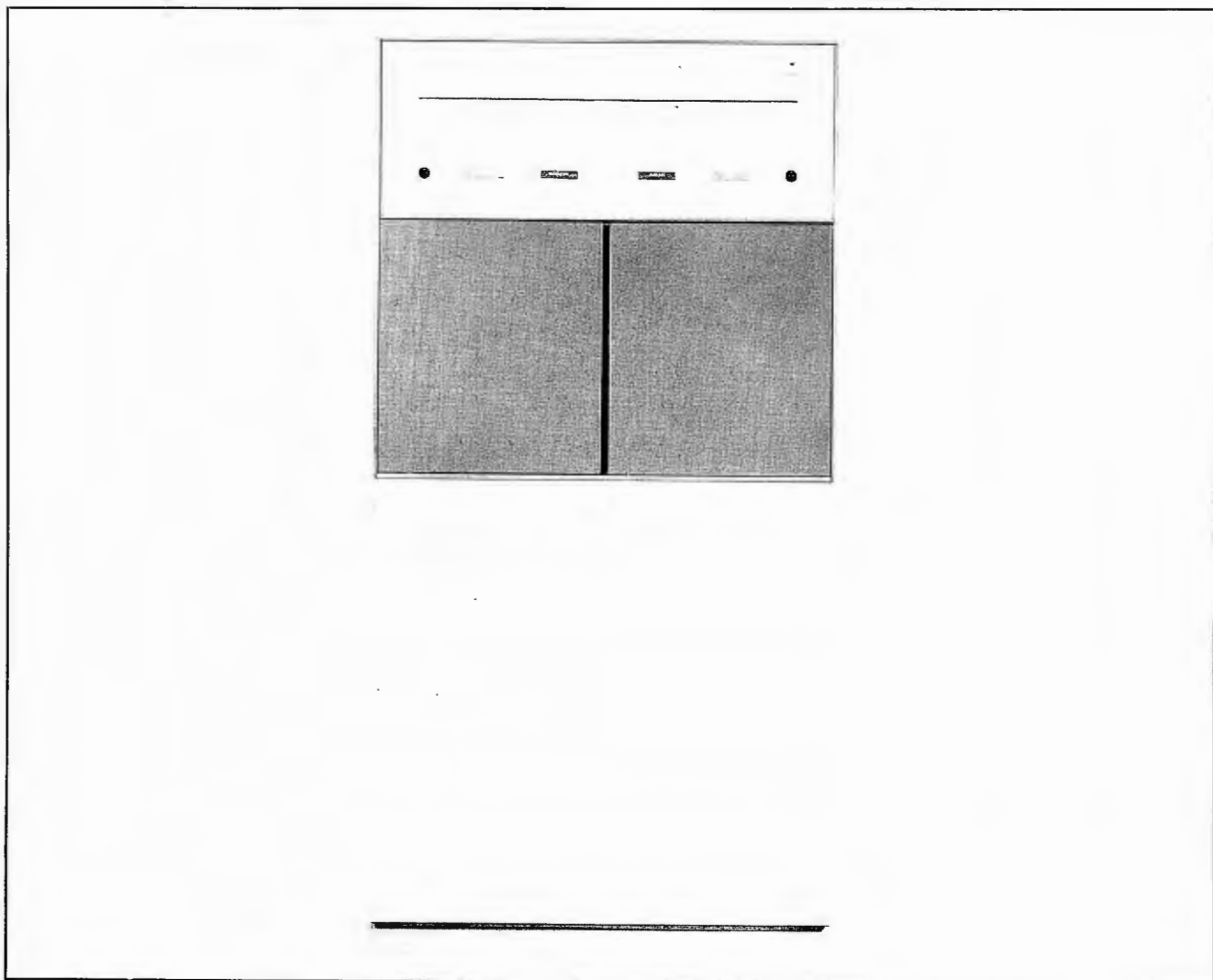

830D-1A FM TRANSMITTER

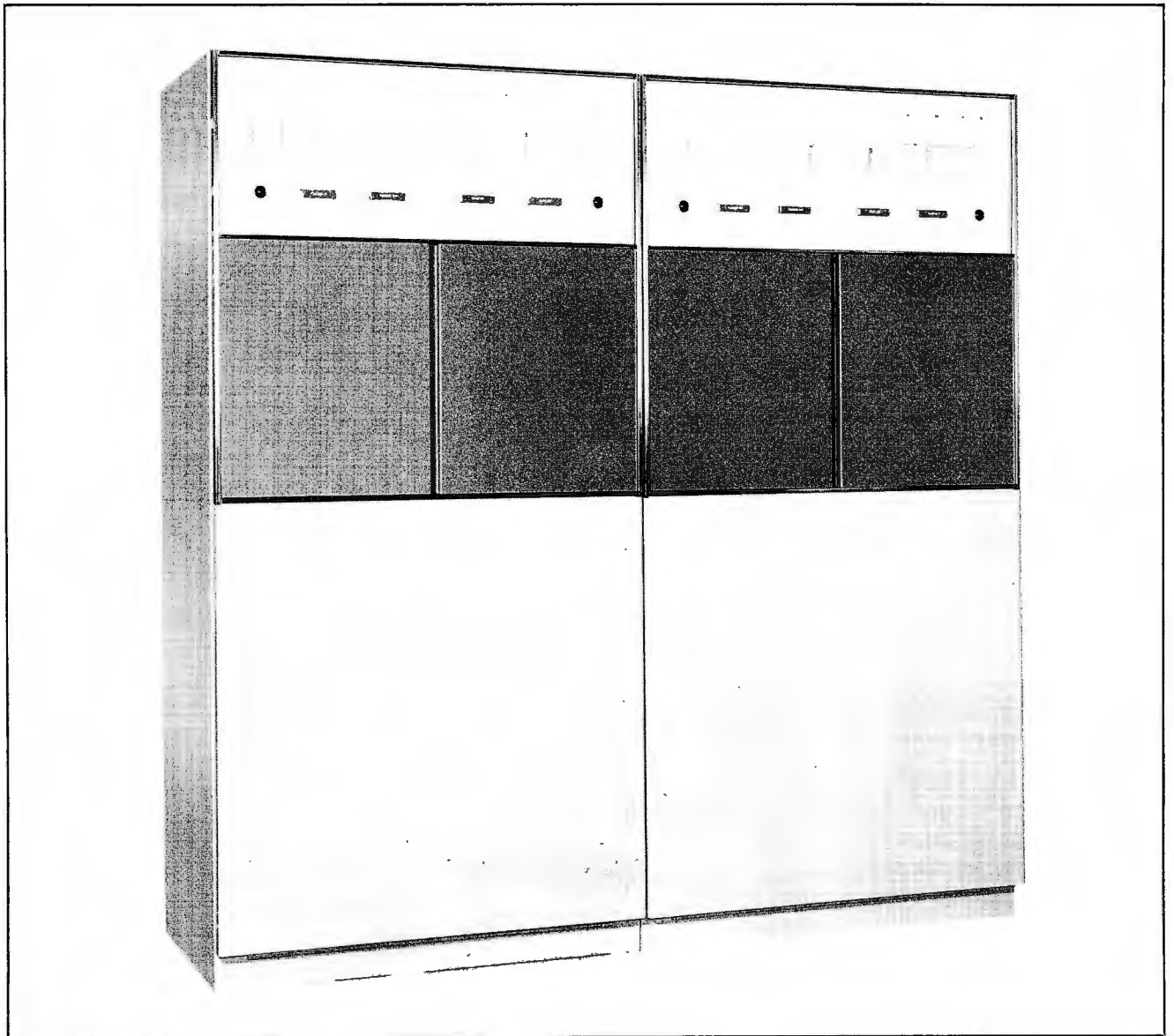

### COLLINS 830E-1A 5,000 WATT FM TRANSMITTER

Award-winning design and “humanized” engineering, hallmarks of Collins quality, are reflected in the Collins 830E-1A 5,000 Watt FM Transmitter.

One cabinet houses the A830-2 Direct FM Exciter and the 250 watt B830-1 Driver Unit; the other houses the 5,000 watt, single stage transmitter.

Features of the Collins 830E-1A are:

**SELF-CONTAINED** — Every component is housed inside the two cabinets, including power transformers, harmonic filter and directional coupler. An optional accessory is the Collins 786M-1 Stereo Generator which fits inside the driver unit cabinet. Installation of the 786M-1 is a matter of minutes.

**SIMPLE OPERATION** — The transmitter is pushbutton operated, featuring a “step-start” system in which starting sequences are fully automatic. Highly stable RF circuits

are tuned and metered from the front panel, and all adjustments can be made while the transmitter is on the air. No tuning or trimming of the harmonic filter is required. The PA stage is easily neutralized and is not critical in adjustment.

**DEPENDABLE**—Grounded screen, eliminating the screen bypass capacitor, does away with a common source of failure. Driver power supply uses silicon rectifiers which take little space and generate a minimum of heat. Efficient blowers force air directly on the 4CX250B and 4CX5000A power amplifier tubes. Power supply is all solid state with the exception of the final amplifier plate voltage supply which uses mercury vapor rectifiers.

**MAINTENANCE EASE**—Vertical panel construction eliminates hidden components and allows rapid inspection and maintenance. Cabinet interlocks minimize danger during



circuitry inspection and maintenance. A grounded shorting stick is readily accessible to discharge capacitors before transmitter servicing.

**RIGID TESTING**— In keeping with rigid Collins standards, the 830E-1A is tested on the broadcaster's channel under proper load conditions *before* the unit is shipped.

While the transmitter nominally operates on 60 cycle power, only the two blower motors need be changed to convert to 50 cycle operation.

**Frequency Range:** 88-108 mc.

**Power Output:** 5000 watts.

**Carrier Frequency Stability:**  $\pm 1000$  cps.

**Audio Frequency Response:**  $\pm 1$  db, 50-15,000 cps.

**Distortion:** Less than 1%, 50-15,000 cps.

**FM Noise Level:** 65 db below  $\pm 75$  kc.

**AM Noise Level:** -55 db rms.

**Harmonic Attenuation:** -80 db.

**Modulation Capability:**  $\pm 100$  kc.

**RF Output Impedance:** 50 ohms; SWR not to exceed 2:1.

**Audio Input Level:** +10 dbm,  $\pm 2$  db.

**Power Source:** 230 v ac, 60 cps, 3 phase (tapped for 200-250 v in 10 v steps).

**Input Power Requirement:** 11 kw, 90% power factor.

**Power Line Regulation:** 3%.

**Variations:** Slow line,  $\pm 5\%$ ; rapid line,  $\pm 3\%$ .

**Tube Complement:**

2 OD3	1 2E26
1 6U8	1 4CX250B
1 12AT7	6 872A*
1 6AU6	1 4CX5000A
1 5763	

**Temperature Range:** 15° - 45°C.

**Humidity:** 0% - 95%.

**Altitude:** 6000 ft. (1828.8 m).

**Size:** 76" W, 76" H, 27" D (193.04 cm W, 193.04 cm H, 68.58 cm D).

**Weight:** 1800 lbs. (816.48 kg).

\*Not used if silicon diode rectifiers are employed.

Part No. 522 2872

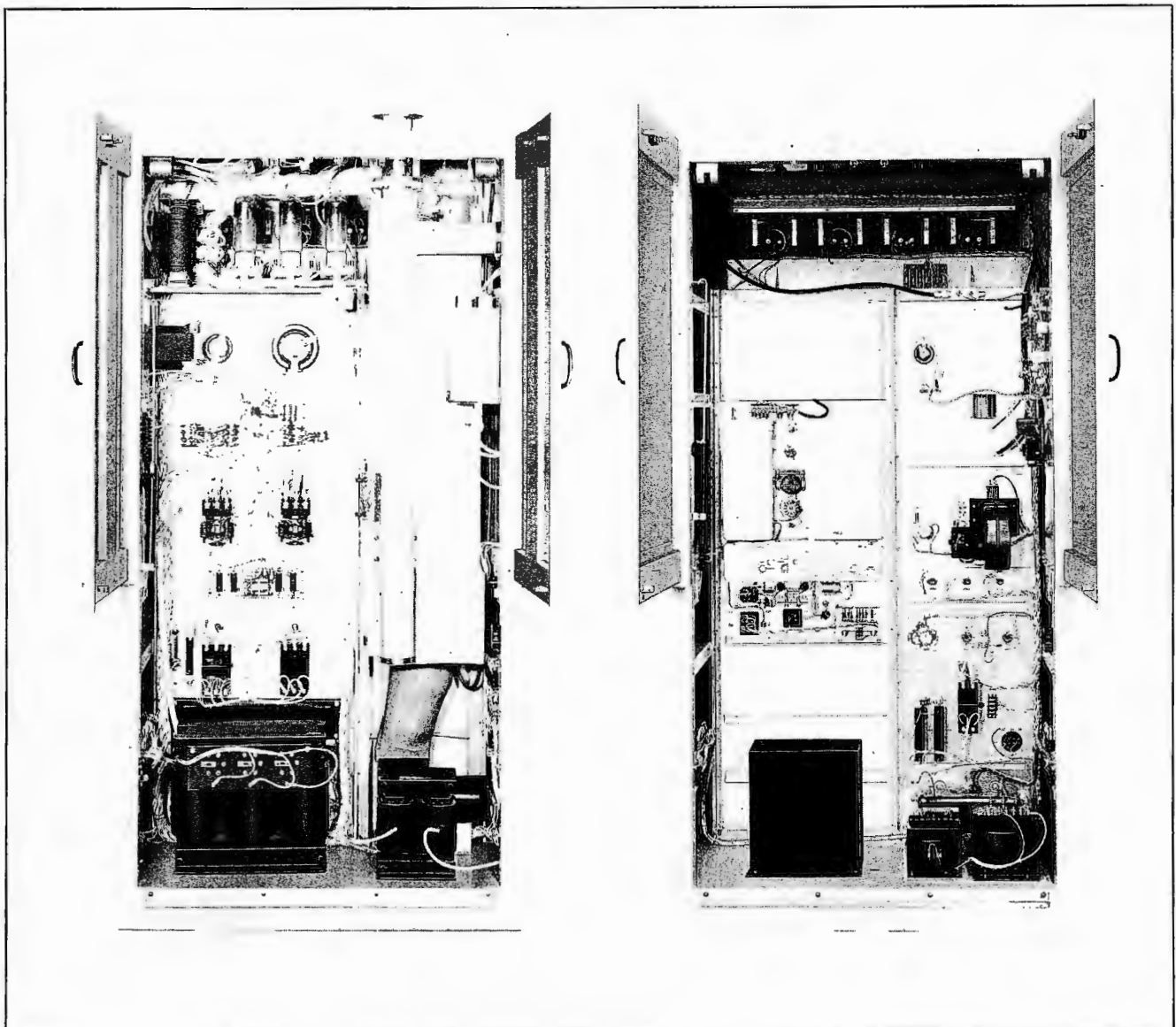

POWER AMPLIFIER REAR VIEW

DRIVER REAR VIEW



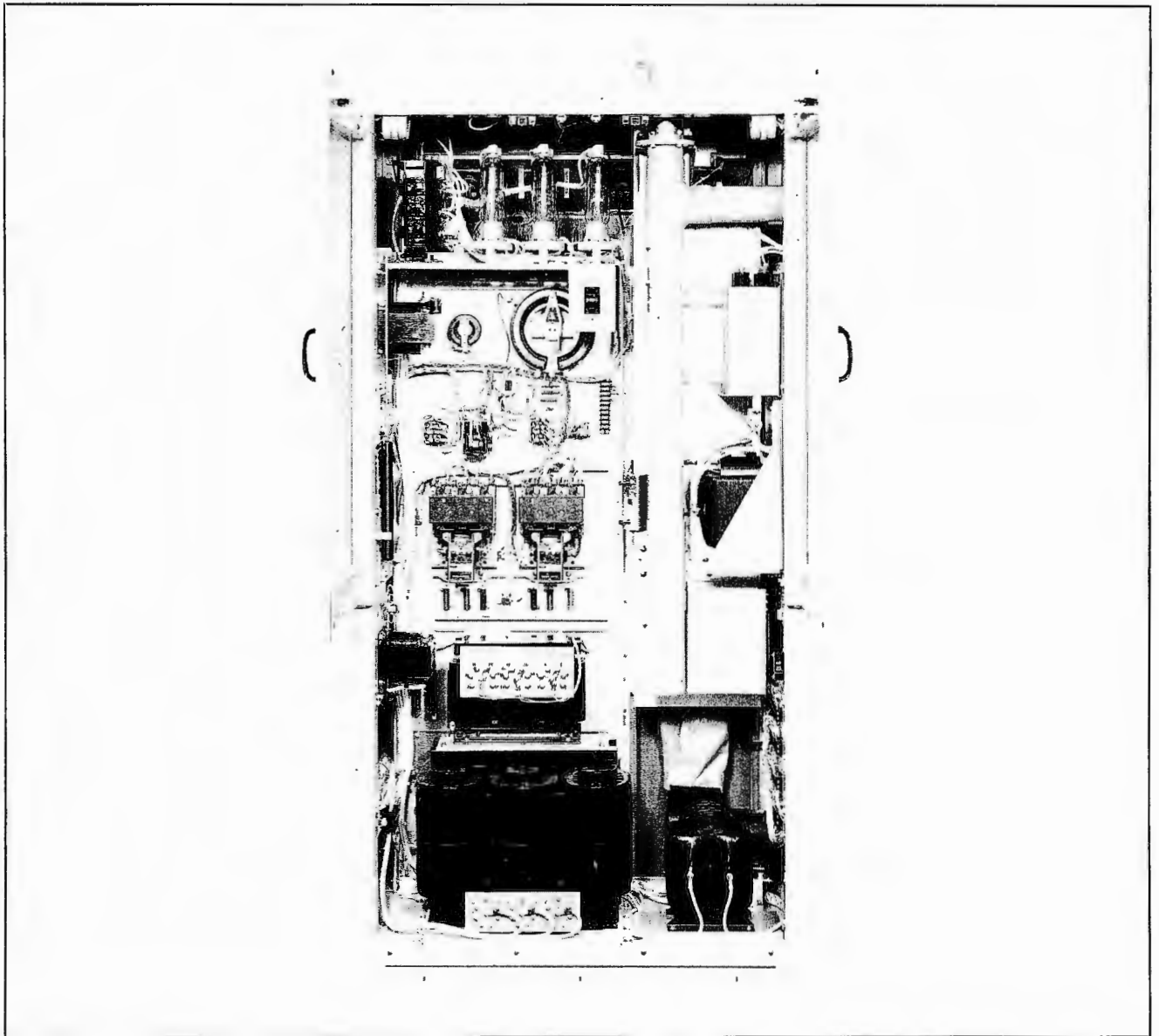

POWER AMPLIFIER REAR VIEW

### **COLLINS 830F-1A/10 KW FM TRANSMITTER**

The Collins 830F-1A 10 KW FM Transmitter assures the broadcaster the clean, strong signal he needs to make his programming outstanding in a highly competitive market area and the extended coverage required to build and maintain an audience.

Like all Collins FM transmitters, the two-cabinet 10,000 watt model is carefully engineered and manufactured to a quality level that is a hallmark at Collins.

**SELF-CONTAINED** — Every component is housed within the two cabinets, including power transformers, harmonic filters and directional coupler. An optional feature is the Collins 786M-1 Stereo Generator which mounts in minutes in the 250 watt driver cabinet.

**EASE OF OPERATION** — Pushbutton operated, the transmitter starting sequences are fully automatic by the "step-

start" system. RF circuits are tuned and metered at the front panel. All adjustments can be made while the transmitter is on the air. No tuning or trimming of the harmonic filter is required. The PA stage is easily neutralized and is noncritical in adjustment.

**DEPENDABLE** — Grounded screen eliminates the bypass capacitors, doing away with a common source of failure. The driver power supply uses solid state silicon rectifiers which generate little heat and require a minimum of space. The final amplifier plate voltage supply uses mercury vapor tubes or optional silicon diode rectifiers. Efficient blowers force cooling air directly on the power tubes.

**MAINTENANCE EASE** — All components are easily accessible and may be rapidly inspected through the use of

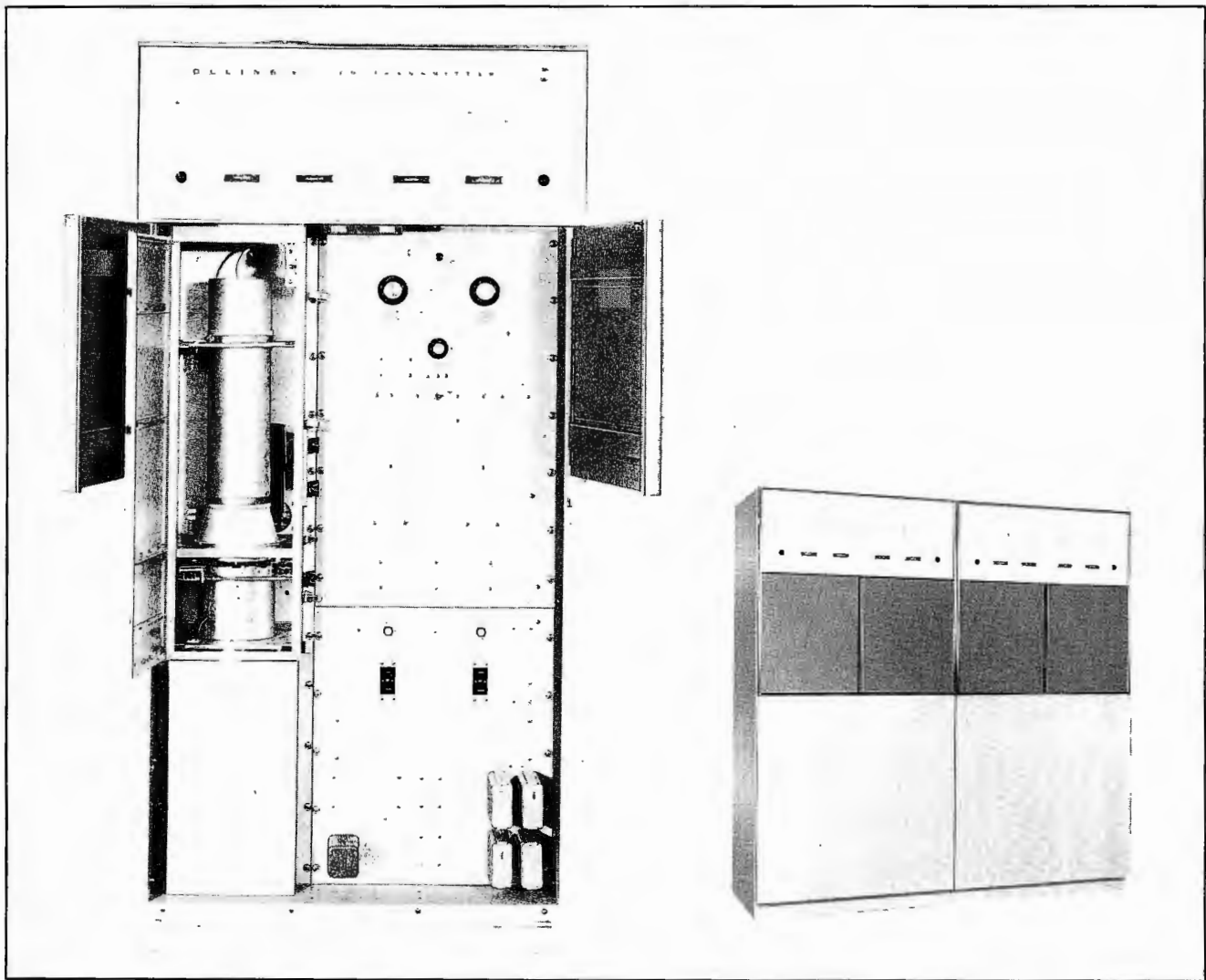

POWER AMPLIFIER FRONT VIEW

vertical panels. All panels are interlocked for safety; a grounded shorting stick is provided.

**RIGID TESTING** — In keeping with rigid Collins standards, the transmitter is tested under actual load conditions on the broadcaster's channel before the unit is shipped.

While the transmitter is designed for 60 cycle operation, only the blower motors and plate contactors need be changed for 50 cycle use.

Collins also manufactures the 830F-2A transmitter. This unit uses an 830D-1A 1,000 watt driver, required when the additional PA is installed for 20,000 watt operation. If an eventual increase to 20KW is planned, the 830F-2A should be installed initially.

- Frequency Range:* 88-108 mc.
- Power Output:* 3,000-10,000 watts nominal.
- Carrier Frequency Stability:*  $\pm 1,000$  cps.
- Audio Frequency Response:*  $\pm 1$  db, 50-15,000 cps.
- Distortion:* Less than 1%, 50-15,000 cps.
- FM Noise Level:* 65 db below  $\pm 75$  kc.
- AM Noise Level:* -55 db rms.
- Harmonic Attenuation:* -80 db.

- Modulation Capability:*  $\pm 100$  kc.
- RF Output Impedance:* 50 ohms; SWR not to exceed 2:1.
- Audio Input Level:* +10 dbm,  $\pm 2$  db.
- Power Source:* 230 v ac, cps (50 cps optional), 3 phase (tapped for 200-250 v in 10 v steps).
- Input Power Requirement:* 20 kw, 90% power factor.
- Power Line Regulation:* 3%.
- Variations:* Slow line,  $\pm 5\%$ ; rapid line,  $\pm 3\%$ .

*Tube Complement:*

2 OD3	1 6AU6	1 4CX250B
1 6U8	1 5763	6 872A*
1 12AT7	1 2E26	1 4CX5000A

*Temperature Range:* 20°-45°C with mercury vapor rectifiers. 10°-45°C with silicon diode rectifiers.

*Humidity:* 0%-95%.

*Altitude:* 6,000 ft. (1828.8 m).

*Size:* 76" W, 76" H, 27" D (193 cm W, 193 cm H, 68.6 cm D).

*Weight:* 1,900 lbs. (861.8 kg).

\*Not used if silicon rectifiers are employed.

Part No. 522 3054 (Type 830F-1A)  
Part No. 522 3139 (Type 830F-2A)

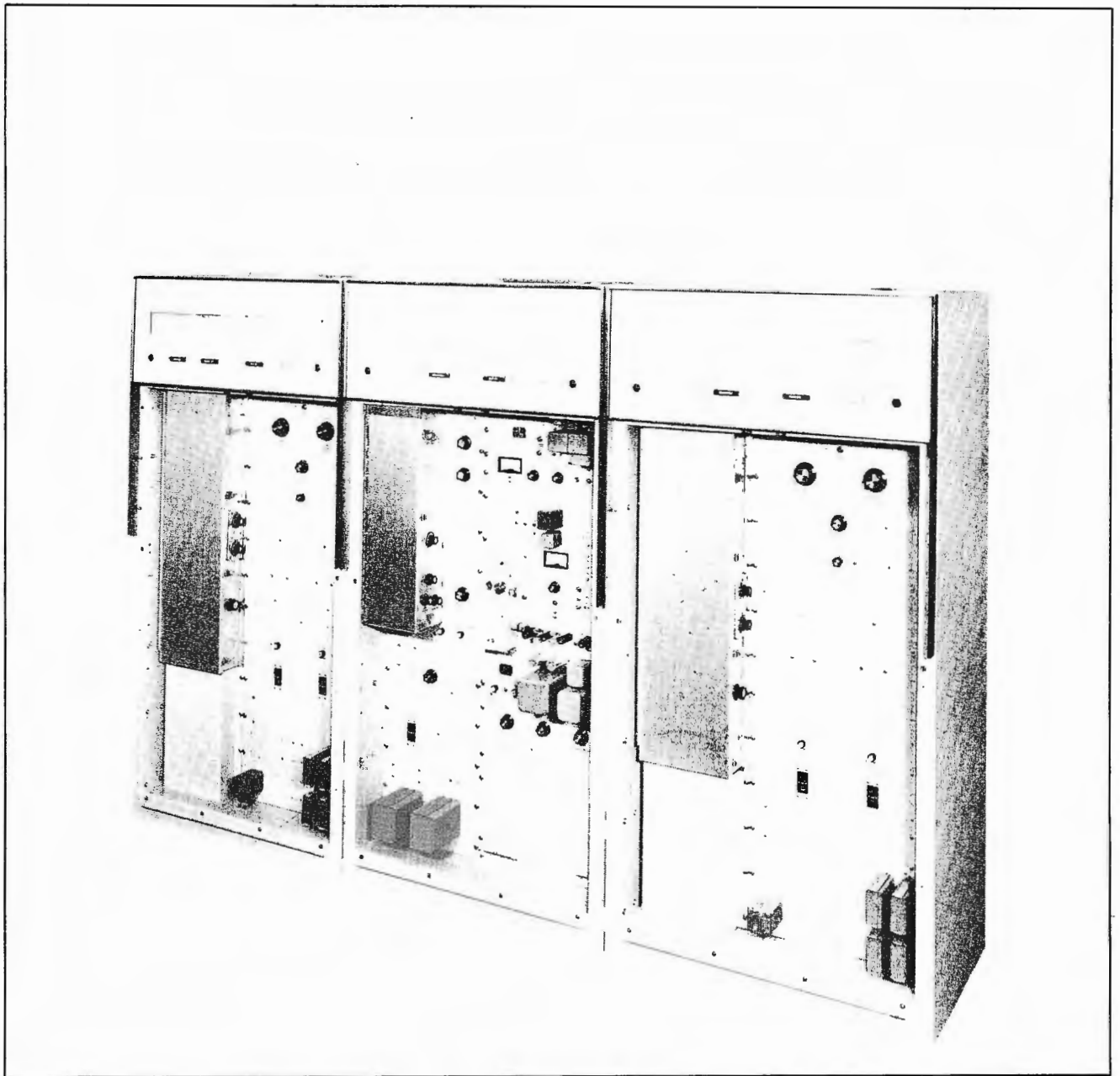

### **COLLINS 830H-1A/20 KW FM TRANSMITTER**

For the broadcaster requiring extended coverage in major markets, Collins offers the 830H-1A, a 20,000 watt FM transmitter contained in only three cabinets. Use of a diplexing system assures continuous duty even though one of the two power amplifiers is removed from service for routine maintenance or repair.

Careful engineering, use of conservatively-rated components and precision manufacturing techniques assure the broadcaster of quality upon which he can depend.

Outstanding benefits of the 830H-1A are:

**SELF-CONTAINED** — Every component, including power transformers, harmonic filters and directional couplers, are housed within the three cabinets. Only the diplexer

assembly is mounted on the exterior. While the photograph shows a top mounted diplexer, this assembly may be located anywhere convenient to the broadcaster. An optional accessory is the 786M-1 Stereo Generator, which mounts in minutes inside the driver cabinet.

**SIMPLE OPERATION** — A pushbutton-operated “step-start” system assures automatic starting sequencing. RF circuits, tuned and metered at the front panel, may be adjusted while the transmitter is on the air. The harmonic filter requires no tuning or trimming. The PA stage is neutralized easily and is noncritical in adjustment.

**DEPENDABLE** — In event of a PA outage, the transmitter remains on the air at 6 db lower output until the an-

tenna is patched to one amplifier to permit half-power (-3 db) operation while the disabled PA is being restored to service. The transmitter is not off the air during this operation. A grounded screen eliminates the bypass capacitors, common trouble points. Independent driver power supply is solid state, requiring little space and generating little heat. The PA power supply consists of mercury vapor tubes, with a solid state supply an optional feature. Efficient, quiet blowers force air directly on the 4CX1000A and two 4CX5000A power amplifier tubes.

**MAINTENANCE EASE** — All components are easily accessible for inspection and maintenance through vertical panel construction. All cabinet panels are interlocked for safety; a grounded shorting stick is installed in each cabinet to discharge capacitors before servicing.

**RIGID TESTING** — The 830H-1A, like all Collins transmitters, is tested on the broadcaster's channel under actual load conditions *before* shipment.

While the transmitter nominally operates on 60 cycles, only the blower motors and plate contactors need be changed for 50 cycle operation.

**Frequency Range:** 88-108 mc.

**Power Output:** 6,000-20,000 watts nominal.

**Carrier Frequency Stability:** ±1,000 cps.

**Audio Frequency Response:** ±1 db, 50-15,000 cps.

**Distortion:** Less than 1%, 50-15,000 cps.

**FM Noise Level:** 65 db below ± 75 kc.

**AM Noise Level:** -55 db rms.

**Harmonic Attenuation:** -80 db.

**Modulation Capability:** ±100 kc.

**RF Output Impedance:** 50 ohms; SWR not to exceed 2:1.

**Audio Input Level:** +10 dbm, ±2 db.

**Power Source:** 230 v ac, 60 cps (50 cps optional), 3 phase (tapped for 200-250 v in 10 v steps).

**Input Power Requirement:** 40 kw, 90% power factor.

**Power Line Regulation:** 3%.

**Variations:** Slow line, ±5%; rapid line, ±3%.

**Tube Complement:**

1 6U8	1 2E26
1 12AT7	1 4CX1000A
1 6AU6	12 872A*
1 5763	2 4CX5000A

**Temperature Range:** 20° - 15°C with mercury vapor rectifiers; 10° - 15°C with silicon diode rectifiers.

**Humidity:** 0% - 95%.

**Altitude:** 6,000 ft. (1828.8 m).

**Size:** 114" W. 76" H. 27" D (289.6 cm W. 193 cm H. 68.6 cm D).

**Weight:** 2,900 lbs. (1315 kg).

\*Not used if silicon diode rectifiers are employed.

**Part No. 522 3555**

## 830N-1A FM TRANSMITTER

For the broadcaster whose market includes extensive mobile reception, Collins sells the 830N-1A, a dual 10,000 watt transmitter. This unit transmits 10,000 watts through vertically polarized antennas for automobile receivers and 10,000 watts to the horizontally-polarized antennas for home receivers.

**Part No. 522 3592**

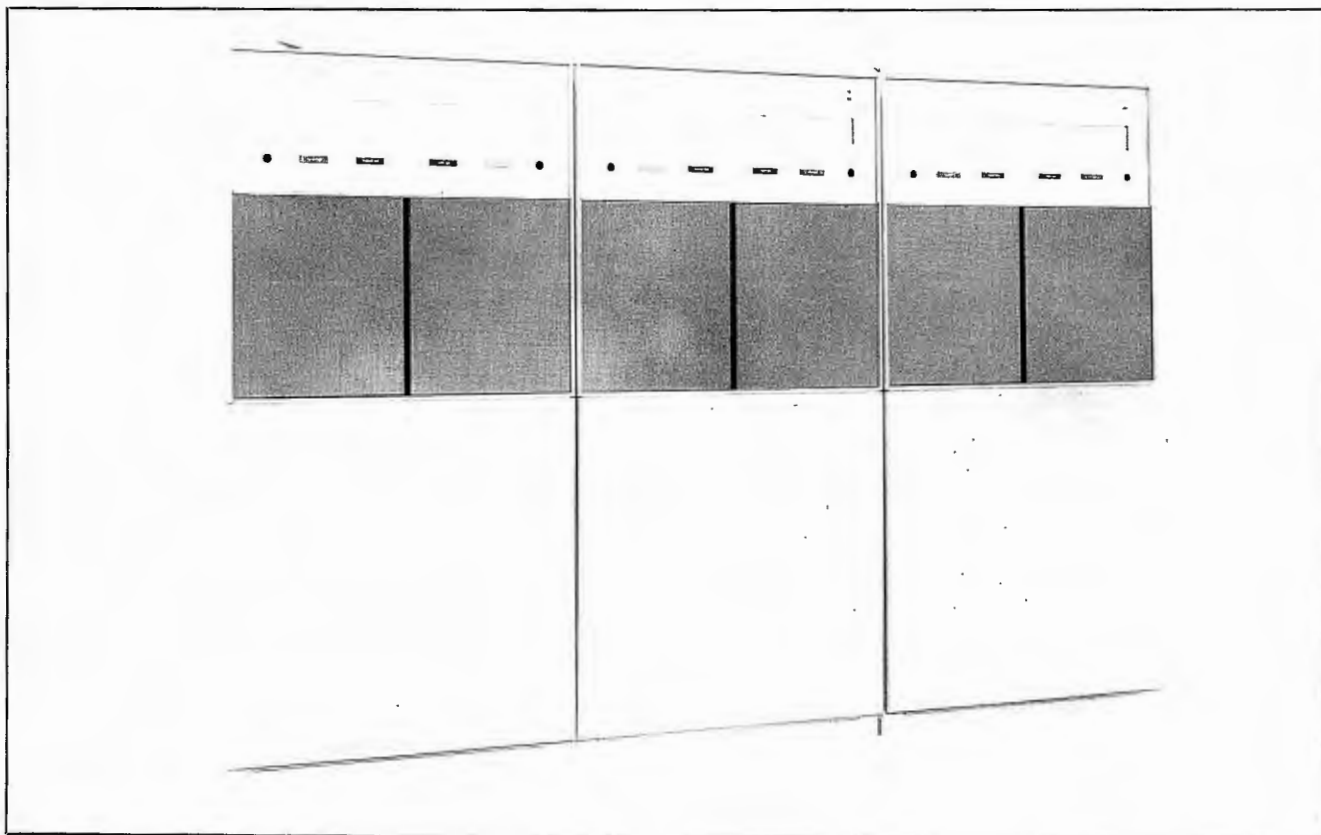

830H-1A FM TRANSMITTER

# Antennas, Towers, Transmission Lines

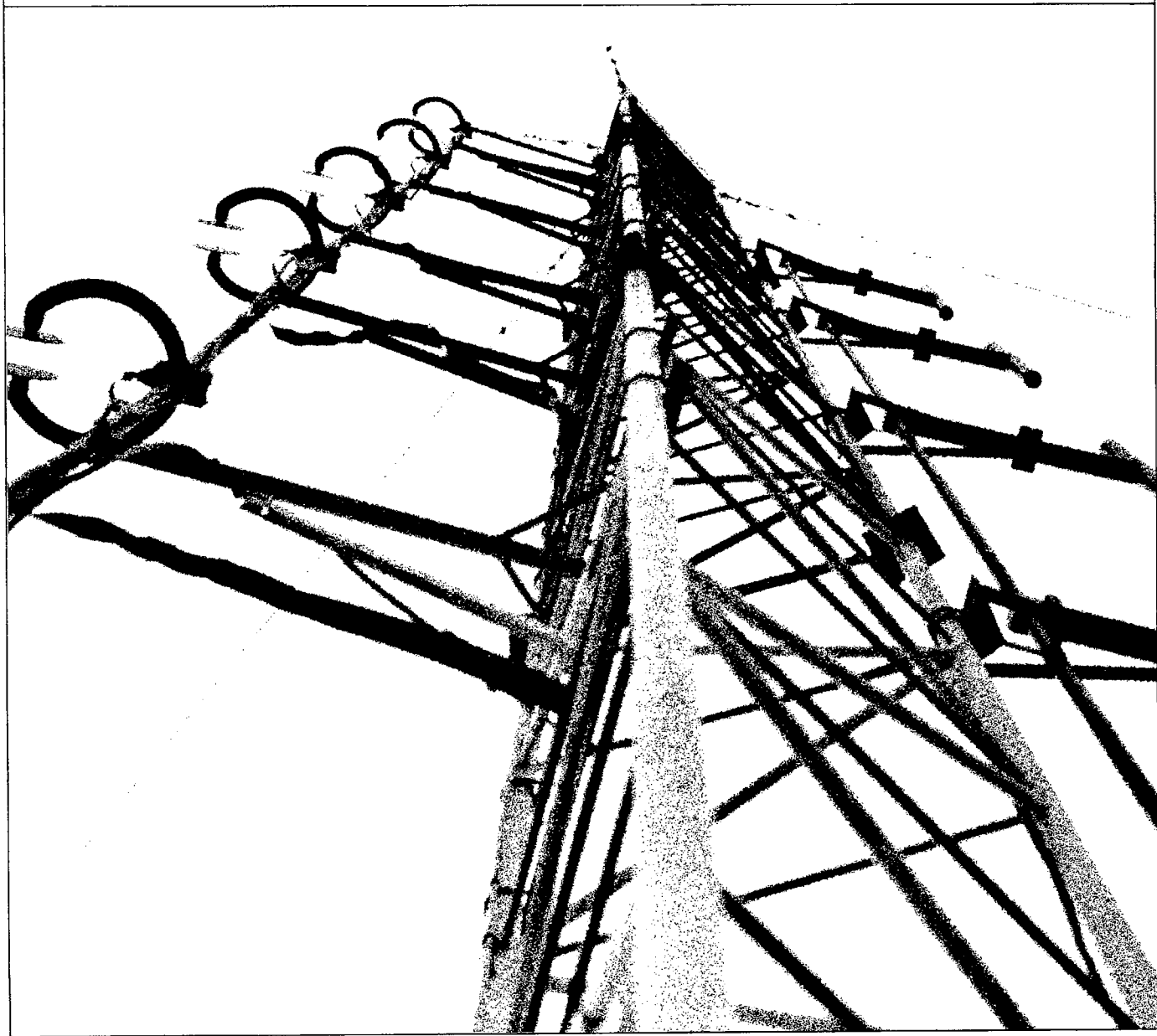



## COLLINS 37M FM ANTENNA

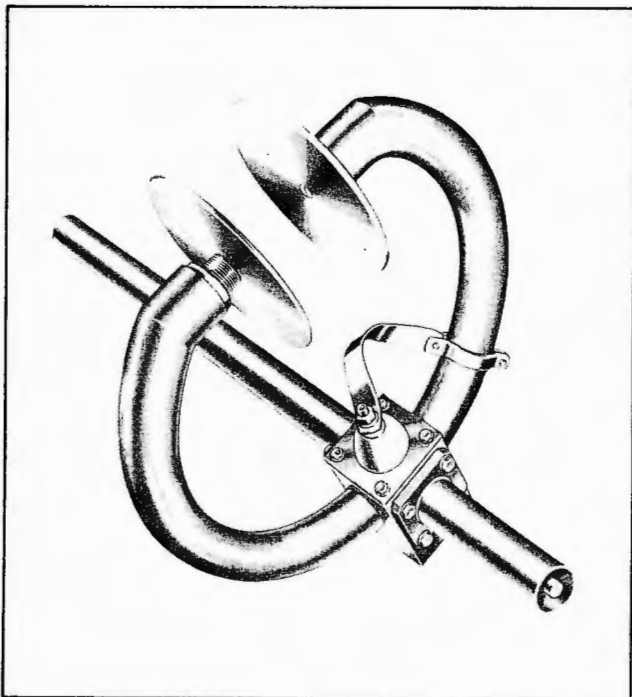

A proven design that has been imitated but never duplicated in efficiency during the past decade, the Collins 37M Antenna still maintains its position of leadership in FM broadcasting.

The advanced design features of the unit make it an ideal antenna for stereo and multiplex operations. The aerodynamic simplicity and low weight of the 37M provide greater efficiencies and savings in new tower costs, erection time and maintenance expense. These features also eliminate undue oscillating and weaving of the tower and antenna.

The Collins 37M Ring Antenna consists of only two basic parts: the radiating ring and the connecting inter-ring transmission line. Any number of rings, either odd or even, may be used to provide maximum flexibility in high power gain.

Antenna arrays mounted on  $1\frac{5}{8}$ " or  $3\frac{1}{8}$ " line are available for handling transmitter powers up to 20 kw. Antenna assemblies on  $1\frac{5}{8}$ " line are rated for power inputs at base of antenna up to 2.5 kw for a single ring array; 10 kw for four or more rings. Antenna assemblies on  $3\frac{1}{8}$ " line are rated for power inputs up to 2.5 kw per ring at base of antenna with maximum of 20 kw for eight or more rings.

Only one inter-element transmission line is required to feed all rings in a multiple element array. The individual radiating rings are identical mechanically and electrically. They are both shunt fed and supported by a single interconnecting feed line, which consists of modified lengths of standard EIA rigid coaxial line insulated with Teflon. The Collins 37M FM Antenna feed system has a stub at the top of the array which is capacitive and ade-

quately removes the inductive reactance created by the shunt feed on the ring. The 37M terminates in a standard EIA 50 ohm flange connection on the bottom element of the array for coupling directly to  $1\frac{5}{8}$ " or  $3\frac{1}{8}$ " transmission line.

The horizontal radiation pattern of the Collins 37M FM Antenna is essentially circular for both top mounting and side mounting arrays. The extent of deviation from a circular pattern in the side mounted antenna is dependent on the type and size of tower on which the antenna is mounted. In cases of very large supporting structures and in all cases where guy wires are used, expert recommendations should be requested on spacing of insulators and guy wires and mounting of the antenna. Insulators should be placed where the guys attach to the tower and guys should also be broken with insulators approximately every three feet for 15 feet in the immediate area of the antennas.

The voltage standing wave ratio of the Collins 37M Antenna can be maintained at better than 1:15:1 when field tuned due to the inherently high stability of the tuning system. The capacitor plates of the 37M are adjustable for optimum performance and equal power distribution through all rings. These features allow an accurate prediction of the gain from the given number of loops in the array. Adequate bandwidth virtually eliminates detuning effects caused by changes in atmospheric conditions. The bandwidth and linearity of the antenna are more than adequate for multiplexing service.

The compactness and simplicity of the 37M allow maximum efficiency in ice removal. Each ring may be equipped with an internally mounted, 200-watt heating unit which consists of a cartridge type element inside each of the tuning capacitor plates and an additional flexible heating element extending the full circumference of the inside of the ring. The simplicity of the heating arrangement makes it possible to replace the elements in the field if necessary. The absence of large masses of metal assures efficient and practical deicing of the antenna and capacitor, which is the most critical part of the antenna when icing occurs.

The 37M Antenna is easy and quick to erect. There are no heavy hoisting problems so that many hours of erection time can be saved. Support brackets are specially fabricated for each installation to match the tower and mounting arrangement, thus minimizing erection problems at the site.

Either guyed or self-supporting towers will in nearly all cases support the side mounting 37M. Towers which support top mounting television antenna arrays increase their usefulness with the addition of a side mounting 37M Antenna.

Top or pole mounting design is available on special order for installation on towers where no TV antenna is present or planned. This type of mounting provides the maximum in height and coverage. The light weight and windloading of the top mounting series allows erection on

most guyed and self-supporting towers without extensive tower modification.

Further information and quotations on the 37M FM Directional Antenna will be supplied upon request.

Part No.	Type and Number of Rings	Part No.	Type and Number of Rings
013 0020	37M-1	013 0070	37M-6
013 0030	37M-2	013 0080	37M-7
013 0040	37M-3	013 0090	37M-8
013 0050	37M-4	097 1693	37M-10
013 0060	37M-5	097 1528	37M-12

For top mounted, with mast rings mounted on 1 1/8" Line or 3 1/8" Line, Part Number remains the same for the specified number of rings.

No Part Number

37M FM Antennas for power inputs over 20 kw.

Part No. 013 0099

Deicer per bay installed at the factory

Part No. 099 0005 00

Replacement heating element. Two required per ring.

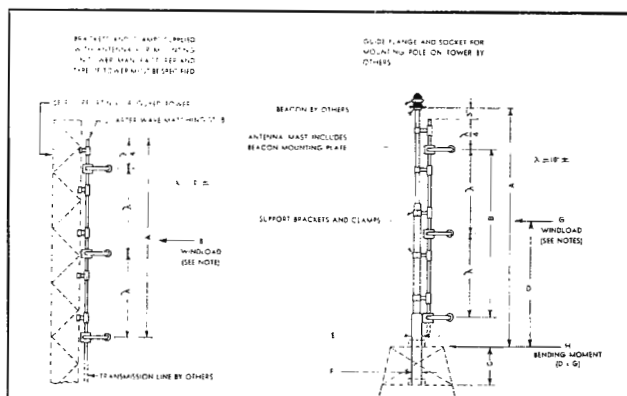

### COLLINS 37-M ANTENNA — SIDE MOUNTED

Collins Type	No. of Rings	Power Gain	Field Gain	db Gain	A** Feet & Inches	On 1 1/8" Line		On 3 1/8" Line	
						B***	Weight (lbs.)	B***	Weight (lbs.)
37M-1	1	0.9	.95	- 0.45	2' 5"	43	42	81	69
37M-2	2	2.0	1.41	3.01	12 3	125	91	234	155
37M-3	3	3.0	1.73	4.77	22 1	206	140	386	241
37M-4	4	4.1	2.02	6.13	31 10	288	189	538	327
37M-5	5	5.2	2.28	7.16	41 8	370	238	691	413
37M-6	6	6.3	2.51	7.99	51 5	451	287	843	499
37M-7	7	7.3	2.70	8.63	61 3	533	336	996	585
37M-8	8	8.4	2.90	9.24	71 0	614	385	1148	671
37M-9*	9	9.4	3.07	9.73	80 10	696	434	1300	757
37M-10*	10	10.5	3.24	10.21	90 7	778	483	1453	843
37M-12*	12	12.5	3.54	10.97	110 3	941	581	1758	1015
37M-14*	14	14.5	3.81	11.61	129 10	1104	679	2062	1187
37M-16*	16	16.5	4.06	12.17	149 5	1267	777	2367	1359

\* Antennas of over 8 bays are center fed with even numbers of bays or at 1/2 bay separation below center with odd numbers of bays.

\*\* Computed for 100 Mc. For other frequencies multiply by 100 divided by frequency in Mc/s.

\*\*\* Wind loads based on 60 pounds on flat surfaces, 40 pounds per square foot on projected areas of cylindrical surfaces with all sections considered round.

### COLLINS 37-M ANTENNA — TOP MOUNTED

Collins Type	No. of Rgs.	Pwr. Gn.	On 1 1/8" Line										On 3 1/8" Line				
			A Fr.	B Fr.	C Fr.	D Fr.	E Dia.	F Dia.	G Lbs.	H Fr.-Lbs.	Dead Wt.	D Fr.	E Dia.	F Dia.	G Lbs.	H Fr.-Lbs.	Dead Wt.
37M-1	1	.9	6			4-7	3 1/8"	3 1/8"	50	230	223	4-7	3 1/8"	3 1/8"	68	312	250
37M-2	2	2.0	16	10±	4	10	4 1/2"	4 1/2"	239	2,390	305	12-3	4 1/2"	4 1/2"	291	3,565	360
37M-3	3	3.0	26	20±	7	14-5	6 3/8"	6 3/8"	403	5,803	736	14-4	6 3/8"	6 3/8"	486	6,950	825
37M-4	4	4.1	36	30±	10	19	7 3/8"	7 3/8"	564	10,716	1169	18-9	7 3/8"	7 3/8"	678	12,713	1290
37M-5	5	5.2	46	40±	12	23	8 5/8"	7 7/8"	747	17,181	1652	22-8	9 5/8"	9 5/8"	919	20,769	2128
37M-6	6	6.3	56	50±	14	27-2	9 3/8"	8 3/8"	951	25,867	2285	26-7	10 3/8"	9 3/8"	1173	31,260	2770
37M-7	7	7.3	66	60±	15	31	10 3/4"	8 3/4"	1175	36,425	3218	31-3	10 3/4"	8 3/4"	1388	43,375	3485
37M-8*	8	8.4	76	70±	16-6	34-9	11 3/4"	9 3/4"	1417	49,241	4051	34-8	12 3/4"	11 3/4"	1696	58,682	4650

\*up to 12 bays on application

### ANDREW FITTINGS FOR COLLINS 37M-FM ANTENNA

The following end terminals and fittings are required for connection of various types of transmission line to Collins 37M FM Antenna. The 37M is supplied with 1 5/8" or 3 1/8" line. The following lists only Andrew fittings for antenna end of transmission line to antenna line. Be sure to specify correct fitting for transmitter end.

ANDREW H5-50, 7/8" Heliax to 1 5/8" 37M: 75AR EIA

Flange and 1860 Reducer (inner connectors supplied with 75AR and 1860).

ANDREW H7-50A, 1 5/8" Heliax to 1 5/8" 37M: 87R EIA

Flange (with inner connector).

ANDREW H7-50A, 1 5/8" Heliax to 3 1/8" 37M: 87R EIA

Flange (with inner connector) and 1861 Reducer.

ANDREW H8-50A, 3" Heliax to 3 1/8" 37M: 78R EIA.

AMPHENOL RG 17U, 7/8" Solid to 1 5/8" 37M: 12418-1 Plug, 15069 Inner Connector and 2361 Adapter.

ANDREW 560, 7/8" Rigid to 1 5/8" 37M: 1860 Reducer (with inner connector).

ANDREW 561, 1 5/8" Rigid to 1 5/8" 37M: 15069 Inner Connector.

ANDREW 562A, 3 1/8" Rigid to 1 5/8" 37M: 1861 Reducer (with inner connector).

ANDREW 562A, 3 1/8" Rigid to 3 1/8" 37M: 15093 Inner Connector.

## COLLINS 300C VERTICALLY POLARIZED FM ANTENNA

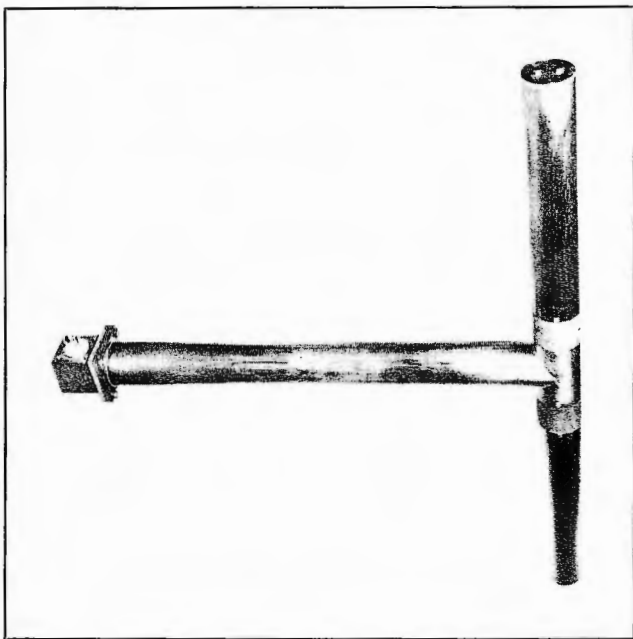

Collins 300C vertically polarized FM antenna can significantly improve your FM coverage. Here's how:

FCC regulations permit simultaneous FM radiation in both horizontal and vertical planes. For example, if your

station is authorized for 5 kw ERP (horizontal), vertical radiation can be added up to the same power. Stations now operating with greater ERP than specified in new FCC rules for their classification may radiate vertically up to the maximum ERP specified in the rules.

Two methods are commonly used:

(1) A single power amplifier and transmission line to provide power for each antenna.

(2) Two power amplifiers fed from a common exciter-driver and two transmission lines. The antennas are fed separately.

The preferred method will be dictated by your power situation. If minimum initial investment is your primary concern, the first method is preferred. If redundancy is important, the second method permits either amplifier to be operated individually or both simultaneously. The recommended ratio of vertical to horizontal ERP is unity.

Collins Type 300C costs no more than your present horizontal bays, can be installed on your present tower and is compatible with your FM transmitter.

Vertical polarization with Collins 300C:

- \* fills in shadow areas
- \* reduces null effects
- \* improves fringe area reception
- \* vastly improves car FM radio reception
- \* maintains FM stereo quality
- \* improves SCA operation

### TYPE 300C ANTENNA — SIDE MOUNTED

Type	No. of Dipoles	Power Gain	Field Gain	DB Gain	Power Rating		Length	
					On 1 5/8" Line	On 3 1/8" Line	Feet	Inches
300-1	1	.950	.975	-.002	3	3	3	9
300-2	2	1.969	1.400	2.942	6	6	13	7
300-3	3	3.120	1.767	4.942	9	9	23	4
300-4	4	4.198	2.045	6.230	10	12	33	2
300-5	5	5.310	2.305	7.251	10	15	42	11
300-6	6	6.393	2.528	8.057	10	18	57	9
300-7	7	7.500	2.738	8.751	10	21	62	7
300-8*	8	8.571	2.926	9.330	20	24	72	4
300-9*	9	9.755	3.124	9.892	20	27	82	2
300-10*	10	10.960	3.311	10.398	20	30	91	11
300-12*	12	13.195	3.633	11.204	20	36	111	7
300-14*	14	15.290	3.910	11.844	20	42	131	2
300-16*	16	17.483	4.181	12.426	20	48	150	9

Type	Weight		Wind Load**		Over Turning Moment***	
	On 1 5/8" Line	On 3 1/8" Line	On 1 5/8" Line	On 3 1/8" Line	On 1 5/8" Line	On 3 1/8" Line
300-1	50	55	104	104	0	0
300-2	111	135	259	307	1,190	1,430
300-3	171	215	414	510	3,900	4,840
300-4	232	295	569	713	8,350	10,200
300-5	292	375	724	916	14,300	17,600
300-6	353	455	879	1119	21,100	27,000
300-7	413	535	1034	1322	29,900	38,400
300-8*	474	615	1189	1525	40,200	51,700
300-9*	534	695	1344	1728	52,100	67,100
300-10*	595	775	1499	1931	65,400	84,400
300-12*	716	935	1809	2337	96,600	125,000
300-14*	837	1095	2119	2743	133,965	173,000
300-16*	958	1255	2429	3149	177,000	230,000

\* Antennas of eight bays and over are center fed with even numbers of bays or at a point 1/2 bay below center with odd numbers of bays.

\*\* Wind load in the direction through the mounting toward the tower computed for 60 lbs. on flat surfaces and 40 lbs. on projected areas of cylindrical surfaces.

\*\*\* For 60 lbs. wind loading direction through the mounting toward the tower and referred to the center line of the bottom bay.

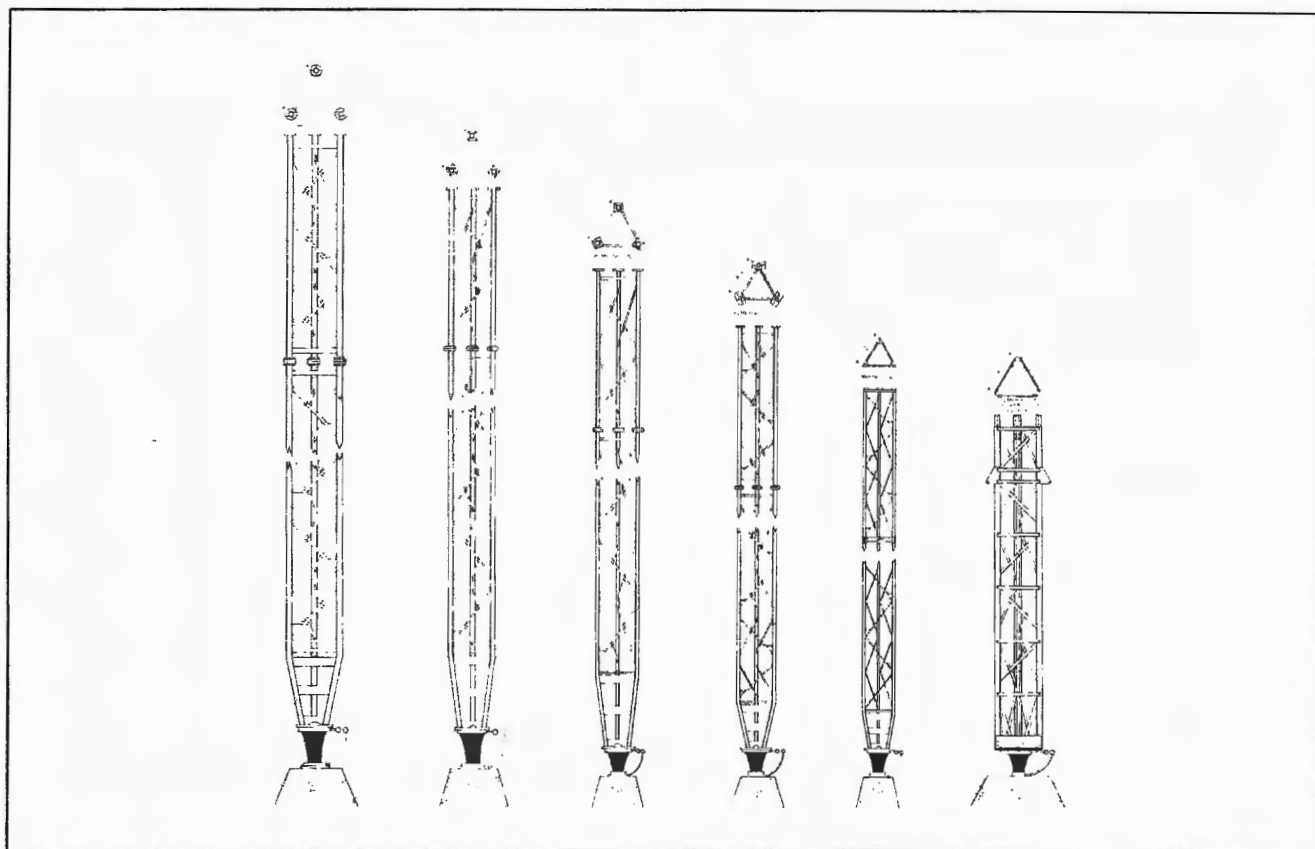

## AM AND FM TOWERS

Collins furnishes a wide selection of both self-supporting and guyed antenna towers to meet the requirements of any AM or FM installation.

Towers are normally supplied with a protective coating of rust inhibitive paint prior to shipment, although they can be supplied with a galvanized finish at a slightly higher price. Galvanized is recommended in locations where the tower will be subjected to salt water spray, extreme humidity or other corrosive conditions. The finish coat is normally supplied by the tower erector and is in keeping with FAA requirement.

All hardware, fittings, guy insulators, anchor steel and base insulator (where required) are supplied with each tower. The applicable FCC (FAA) lighting kit and wiring are also provided.

## UTILITY TOWERS

Available in the six basic designs shown, Utility towers meet or exceed EIA specifications. In the five standard models, steel pipe members are welded together in 20-foot sections, except for the top section length which is according to individual specification. The Type 170 KD tower is of bolted angle-iron construction in 10-foot sections.

Anchors are individually designed to meet the requirements of each tower installation. The I-beam used is imbedded in a concrete slab re-inforced with steel rods and with an earth fill on top.

Each section receives one coat of rust inhibitive, primer paint. Guy lines are galvanized and have a minimum breaking strength of at least twice the maximum calculated loads.

No Part Number

Tower Type	Maximum Recommended Height	Tower Width	Weight Per Foot*	Type of Base Insulation
480	480 ft. (146.3 m)	33 in. (83.82 cm)	28 lbs. (12.7 kg)	Locke or Lappe
340	350 ft. (106.68 m)	19 7/8 in. (50.48 cm)	17 lbs. (7.71 kg)	Utility 340I
220	250 ft. (76.2 m)	19 1/8 in. (49.37 cm)	12 1/2 lbs. (5.67 kg)	Utility 340I
180	200 ft. (60.96 m)	16 7/8 in. (41.12 cm)	10 lbs. (4.54 kg)	Utility 220I
120	200 ft. (60.96 m)	13 1/4 in. (33.34 cm)	8 lbs. (3.63 kg)	Utility 220I
170KD	320 ft. (97.54 m)	18 in. (45.72 cm)	17 lbs. (7.71 kg)	Utility 340I

\*Tower steel only. Weight of guys, insulators, etc., not included.



# FOOTAGE TABLE FOR BROADCAST TOWER HEIGHTS

550 KC TO 1070 KC					1080 KC TO 1600 KC				
KC	METERS	1 WAVE	1/2 WAVE	1/4 WAVE	KC	METERS	1-WAVE	1/2 WAVE	1/4 WAVE
550	545	1787.6	893.8	446.8	1080	277.8	911.1	455.5	227.7
560	536	1758.0	879.0	439.5	1090	275.2	902.6	451.3	225.6
570	526	1725.3	862.6	431.3	1100	272.7	894.4	447.2	223.6
580	517	1695.7	847.8	423.9	1110	270.3	886.5	443.2	221.6
590	509	1669.5	834.7	417.3	1120	267.9	879.0	439.5	219.7
600	500	1640.0	820.0	410.0	1130	265.5	870.8	435.4	217.7
610	492	1612.7	806.3	403.1	1140	263.2	862.6	431.3	215.6
620	484	1587.5	799.7	396.8	1150	260.9	855.7	427.8	213.9
630	476	1561.2	780.6	390.3	1160	258.6	847.8	423.9	211.9
640	469	1546.3	773.1	386.5	1170	256.4	840.9	420.4	210.2
650	462	1515.3	757.6	378.8	1180	254.2	834.7	417.3	208.6
660	455	1492.4	746.2	373.1	1190	252.1	826.8	413.4	206.7
670	448	1469.4	734.7	367.3	1200	250.0	820.0	410.0	205.0
680	441	1446.4	723.2	361.1	1210	247.9	813.1	406.5	203.2
690	435	1426.8	713.4	356.2	1220	245.9	806.3	403.1	201.5
700	429	1407.1	703.5	351.2	1230	243.9	799.1	399.5	199.7
710	423	1387.4	693.7	346.8	1240	241.9	793.7	396.8	198.4
720	417	1367.7	683.8	341.9	1250	240.0	787.2	393.6	196.8
730	411	1348.0	674.0	337.0	1260	238.1	780.9	390.4	195.2
740	405	1328.4	664.2	332.1	1270	236.2	774.7	387.3	193.6
750	400	1312.0	656.0	328.0	1280	234.4	768.8	384.4	192.2
760	395	1295.6	647.8	323.4	1290	232.6	762.9	381.4	190.7
770	390	1279.2	639.6	319.8	1300	230.8	757.0	378.5	189.2
780	385	1262.8	631.4	315.7	1310	229.0	751.1	375.5	187.7
790	380	1246.4	623.2	311.6	1320	227.3	746.2	373.1	186.5
800	375	1230.0	615.0	307.5	1330	225.6	739.9	369.9	184.9
810	370	1213.6	606.8	303.4	1340	223.9	734.7	367.3	183.6
820	366	1200.4	600.2	300.1	1350	222.2	728.8	364.4	182.2
830	361	1184.0	592.0	296.0	1360	220.6	723.2	361.1	180.5
840	357	1170.9	585.4	292.7	1370	219.0	718.3	359.1	179.5
850	353	1157.8	578.9	289.4	1380	217.4	713.4	356.2	178.1
860	349	1144.7	572.3	286.1	1390	215.8	707.8	353.1	176.5
870	345	1131.6	565.8	282.9	1400	214.3	703.5	351.2	175.6
880	341	1118.4	559.2	279.6	1410	212.8	696.9	348.4	174.2
890	337	1105.3	552.6	276.3	1420	211.3	693.7	346.8	173.4
900	333	1092.2	546.1	273.0	1430	209.8	688.1	344.0	172.0
910	330	1082.4	541.2	270.6	1440	208.3	683.8	341.9	170.9
920	326	1069.2	534.6	267.3	1450	206.9	678.6	339.3	169.6
930	323	1059.4	529.7	264.8	1460	205.5	674.0	337.0	168.5
940	319	1046.3	523.1	261.5	1470	204.1	669.4	334.7	167.3
950	316	1036.4	518.2	259.1	1480	202.7	664.2	332.1	166.5
960	313	1026.6	513.3	256.6	1490	201.3	660.2	330.1	165.0
970	309	1013.5	506.7	253.3	1500	200.0	656.0	328.0	164.0
980	306	1003.6	501.8	250.9	1510	198.7	651.7	325.8	162.9
990	303	993.8	496.9	248.4	1520	197.4	647.8	323.4	161.7
1000	300	984.0	492.0	246.0	1530	196.1	643.2	321.6	160.8
1010	297	974.1	487.5	243.7	1540	194.8	639.6	319.8	159.9
1020	294.1	964.6	482.3	241.1	1550	193.5	634.6	317.3	158.6
1030	291.3	955.3	477.6	238.8	1560	192.3	631.4	315.7	157.8
1040	288.5	946.2	473.1	236.5	1570	191.1	626.8	313.4	156.7
1050	285.7	937.1	468.5	234.2	1580	189.9	623.2	311.6	155.8
1060	283.0	928.2	464.1	232.0	1590	188.7	618.9	309.4	154.7
1070	280.4	919.7	459.8	229.9	1600	187.5	615.0	307.5	153.7



### WIND VELOCITIES AND CORRESPONDING PRESSURES

TRUE "EXTREME" VELOCITY MILES PER HOUR $V_s$	CYLINDRICAL SURFACES Pressure in Lbs./Sq. Ft. of Projected Area $P = 0.0025V_s^2$	FLAT SURFACES Pressure in Lbs./Sq. Ft. of Projected Area $P = 0.0042V_s^2$
10	.25	.42
15	.56	.95
20	1.00	1.7
25	1.6	2.6
30	2.3	3.8
35	3.1	5.2
40	4.0	6.7
45	5.1	8.5
50	6.3	10.5
55	7.6	12.7
60	9.0	15.1
65	10.6	17.8
70	12.3	20.6
75	14.1	23.6
80	16.0	26.9
85	18.1	30.4
90	20.3	34.0
95	22.6	37.9
100	25.0	42.0
105	27.6	46.3
110	30.3	50.8
115	33.1	55.5
120	36.0	60.5
125	39.1	65.6
130	42.3	70.9
135	45.6	76.5
140	49.0	82.3
145	52.6	88.3
150	56.3	94.5
155	60.1	100.9
160	64.0	107.5
165	68.1	114.3
170	72.3	121.4
175	76.6	128.6
180	81.0	136.1
185	85.6	143.7
190	90.3	151.6
195	95.1	159.7
200	100.0	168.0
205	105.1	176.5
210	110.3	185.2
215	115.6	194.1
220	121.0	203.3
225	126.0	212.6

### COPPER GROUND WIRE

Bare #10 copper ground wire is used for ground radials. Wire attaches to mesh ground screen.

Weight: 31.8' per lb.

Part No. 421 1010 001

### COPPER GROUND STRAP

This fine quality copper ground strap is available in two sizes: 2" x .032" (4.02' per lb.), and 4" x .032" (2.01' per lb.).

Part No. 097 1445 00 (2" strap)  
Part No. 097 0811 00 (4" strap)

### TRUSCON MESH GROUND SCREEN

Expanded copper mesh ground screen is for use beneath base of antenna tower to increase soil conductivity. Available in 8' x 21' sheets.

Part No. 013 0107 00

### HUGHEY & PHILLIPS RING TRANSFORMER

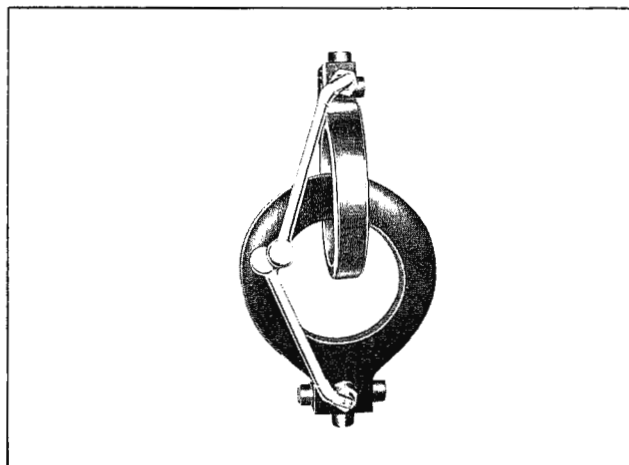

For use wherever 60 cps energy must be transferred across two points with very low capacitance or at very high voltages. Provides a highly reliable, low capacity means of supplying power across base insulator or insulated radio towers employed as radiators. Their relatively large spacing and low capacity between windings make these isolation transformers desirable for use in directional arrays, and especially with radiators which develop very high voltages across the base insulators. No tuning or RF adjustments are necessary. Available in load capacities of 1750 watts (Model TI 2017) and 3500 watts (Model TI 2035) 115/230 volts.

Part No. 097 6920 00 (Type TI 2017)  
Part No. 097 0365 00 (Type TI 2035)

### FISHER-PIERCE 63305-DB BEACON LIGHT CONTROL

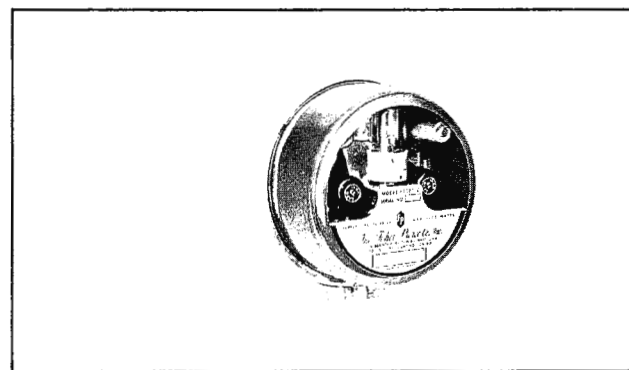

Designed to mount in a standard commercial meter socket. The 63305DB will automatically control broadcast tower lights directly or with auxiliary contactors. Adjustable potentiometer allows adjustment for operation from 0 to 50 f.c.

Power Requirements: 105-130 volts, 50/60 cycles.

Built-in Load Contactors: Single Pole, Single Throw, Double Break.

Load Rating: 3,000 watts.

Part No. 63305DB

## SOLID DIELECTRIC CABLES

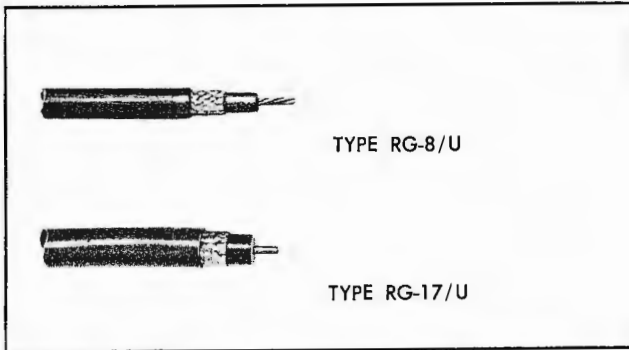

Andrew 1079-1, Type RG-8/U—Used for jumper connections between equipment and to HELIAX. Use types N and UHF connectors below.

Part No. 099 0146 000

Andrew 10791-7, Type RG-17/U—Used for longer jumper connections. Use type LC connectors below.

Part No. 099 0137 000

## CABLE FITTINGS

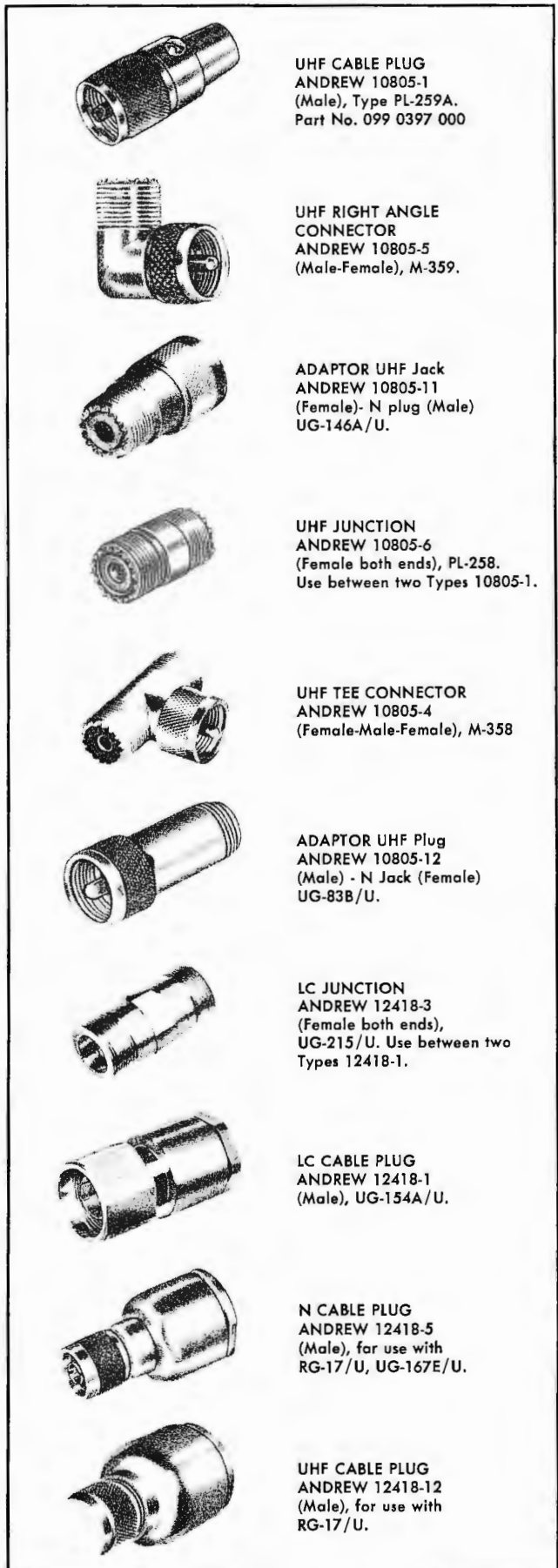

**AIR DIELECTRIC HELIAX®**

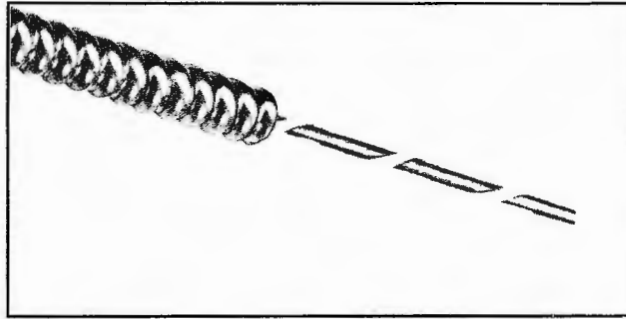

These small diameter air dielectric HeliAx cables are ideal for use as sampling lines and in phased arrays where stability of electrical characteristics is important. For all uses, the copper inner and outer conductors assure optimum performance.

Types H1 and H2 are phase stable cables having coefficients of phase velocity change with temperature on the order of one part per million per degree Fahrenheit.

Teflon insulated cables, with 35% higher power ratings are available in the 1/2" size; Types HT4-50 (unjacketed) and HTJ4-50 (polyethylene jacketed). Type 74 series connectors are suitable for use with these cables.

**CHARACTERISTICS**

Nominal Size	1/4"	3/8"	1/2"
Type	H1-50	H2-50	H4-50
Type (Jacketed)	HJ1-50	HJ2-50	HJ4-50

*Electrical*

Nominal Size	1/4"	3/8"	1/2"
Impedance, Ohms	50	50	50
Maximum Frequency, Gc	23	15.5	10.9
Velocity, Percent	85	85	91.4
Peak Power Rating, Kw	2	5	9.8

*Mechanical*

Nominal Size	1/4"	3/8"	1/2"
Insulation	Polyethylene*		
Outer Conductor			
Major Diameter, Inches	.250	.375	.500
Diameter over Jacket, Inches	.290	.435	.580
Recommended Minimum			
Bending Radius, Inches	2.5	4	5
Cable Weight,			
Unjacketed, Pounds per Foot	.07	.14	.20
Jacketed, Pounds per Foot	.08	.16	.25

**ACCESSORIES**

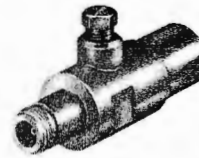

**TYPE N JACK**  
(Female) mates with UG-21.  
1/4" Cable—TYPE 71N.  
3/8" Cable—TYPE 72N.  
1/2" Cable—TYPE 74N.



**TYPE N PLUG**  
(Male) mates with UG-23.  
1/4" Cable—TYPE 71W.  
3/8" Cable—TYPE 72W.  
1/2" Cable—TYPE 74W.

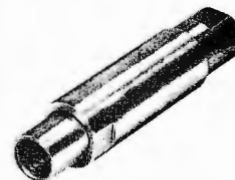

**SPLICE**  
1/4" Cable—TYPE 71Z.  
3/8" Cable—TYPE 72Z.  
1/2" Cable—TYPE 74Z.



**END TERMINAL**  
For strap connection to center conductor.  
1/4" Cable—TYPE 71T.  
3/8" Cable—TYPE 72T.  
1/2" Cable—TYPE 74T.

**INSULATED RIGID HANGER**  
ANDREW 11662-3  
Use at 5 foot intervals—for 1/2" cable shim for smaller sizes. (NPN).

**GROUNDING KIT**—Designed for 1/2" cable, may be shimmed for smaller sizes.  
Unjacketed—TYPE 26892-1 (NPN).  
Jacketed—TYPE 26892-2 (NPN).

**COPPERWELD TIE WIRES**  
ANDREW 27290  
20 for 100 ft. of cable.  
Part No. 124 0032 278

**STAINLESS STEEL WRAPLOCK**  
ANDREW 12395-1  
Use at 5 foot intervals.  
Part No. 097 5010 000

## 7/8" AIR DIELECTRIC HELIAX

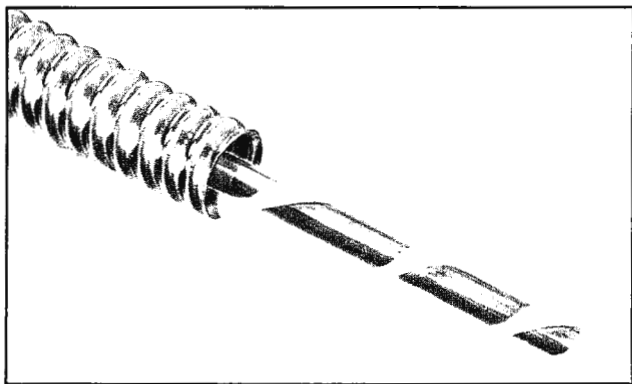

Type H5 HeliAx is the preferred coaxial cable for low power RF systems. Its low attenuation makes it desirable for long runs in receiving antenna systems.

The cable types indicated in the opposite column feature copper conductors for optimum performance.

This cable is also available with a corrugated aluminum outer conductor, Type LJ5-50 (jacketed only). Retaining much of the strength and flexibility of the copper cable, the aluminum HELIAX is lighter in weight and lower in cost with a degradation of only 12% in attenuation and 10% in average power ratings. The basic electrical and mechanical data shown below apply to both copper and aluminum versions.

Teflon insulated cables with 35% higher power ratings are available in the 50 ohm version; Types HT5-50 (unjacketed) and HTJ5-50 (polyethylene jacketed). Type 75 series connectors are suitable for use with these cables.

### CHARACTERISTICS

Impedance	50 Ohms	75 Ohms
Andrew Type	H5-50	H5-75
Military Number	RG-269A/U	RG-284/U
Andrew Type (Jacketed)	HJ5-50	HJ5-75
Military Number	RG-318/U	-----

#### Electrical

	50	75
Impedance, Ohms	50	75
Maximum Frequency, Gc	5.200	5.600
Velocity, Percent	91.6	90.0
Peak Power Rating, Kw	44	29

#### Mechanical

	50	75
Impedance, Ohms	50	75
Insulation	Polyethylene*	
Outer Conductor,		
Major Diameter, Inches	1.005	1.005
Diameter over Jacket, Inches	1.115	1.115
Recommended Minimum Bending		
Radius, Inches	10	10

\*Teflon available in 50 ohm version

## TYPICAL CONNECTOR CONSTRUCTION

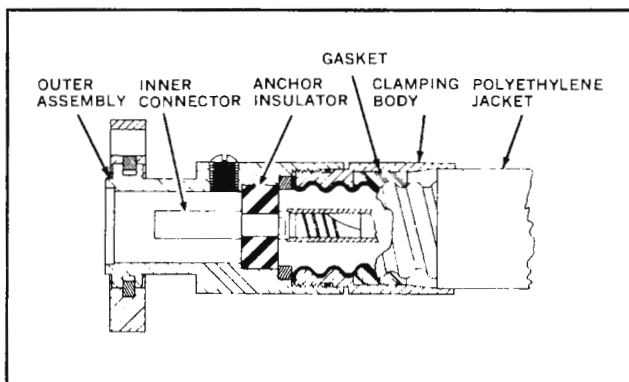

## ACCESSORIES FOR 7/8" HELIAX

All flanged items include inner connector, "O" ring, silicone grease and hardware kit.

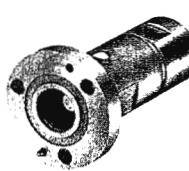

**7/8" EIA FLANGE**

For use with copper cable.  
50 ohm—TYPE 75AR.  
75 ohm—TYPE 75AR-75.

---

For use with aluminum cable.  
50 ohm—TYPE 75AR-3.  
Part No. 099 0283 000-75AR

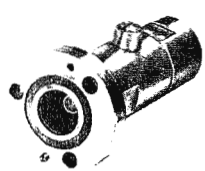

**7/8" EIA FLANGE**  
(includes gas barrier).

For use with copper cable.  
50 ohm—TYPE 75AG.

---

For use with aluminum cable.  
50 ohm—TYPE 75AG-3.

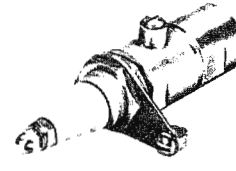

**END TERMINAL**, for strap connection to center conductor.

For use with copper cable.  
50 ohm—TYPE 75AT.  
75 ohm—TYPE 75AT-75.

---

For use with aluminum cable.  
50 ohm—TYPE 75AT-3.  
Part No. 099 0281 000-75AT

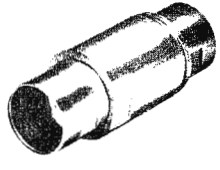

**SPLICE.**

For use with copper cable.  
50 ohm—TYPE 75AZ.

---

For use with aluminum cable.  
50 ohm—TYPE 75AZ-3.





**TYPE N JACK (Female)** mates with UG-21.  
 For use with copper cable.  
 50 ohm—TYPE 75AN.  
 75 ohm—TYPE 75AN-75.  
 For use with aluminum cable.  
 50 ohm—TYPE 75AN-3.  
 Part No. 099 0400 000-75AN

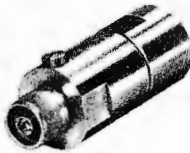

**TYPE N PLUG (Male)** mates with UG-23.  
 For use with copper cable.  
 50 ohm—TYPE 75AW.



**TYPE LC JACK (Female)** mates with UG-154.  
 For use with copper cable.  
 50 ohm—TYPE 75AL.



**TYPE LC PLUG (Male)** mates with UG-352.  
 For use with copper cable.  
 50 ohm—TYPE 75 AM.  
 75 ohm—TYPE 75AM-75.



**UHF JACK (Female)** mates with PL 259A.  
 For use with copper cable.  
 50 ohm—75AU  
 75 ohm—75AU-75.  
 For use with aluminum cable.  
 50 ohm—TYPE 75AU-3.



**90° EIA MITER ELBOW**  
 50 ohm—TYPE 1060.  
 75 ohm—TYPE 1070.  
 May be used with either copper or aluminum cable.  
 Part No. 099 0404 000-1060  
 Part No. 099 0405 000-1070



**EIA GAS BARRIER**  
 50 ohm—TYPE 1260.  
 May be used with either copper or aluminum cable.  
 Part No. 099 0203 000

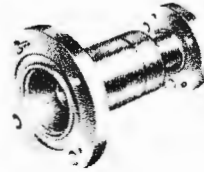

**REDUCER, 1 1/2" EIA to 7/8" EIA.**  
 50 ohm—TYPE 1860.  
 May be used with either copper or aluminum cable.  
 Part No. 097 5405 000

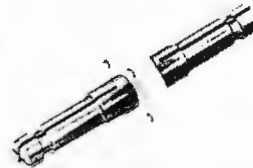

**EIA INNER CONNECTOR**  
 50 ohm—TYPE 18275.  
 75 ohm—TYPE 25385.  
 May be used with either copper or aluminum cable.  
 Part No. 099 0406 000-18275  
 Part No. 099 0407 000-25385

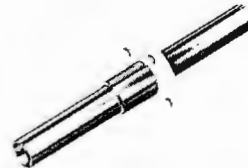

**ADAPTOR INNER CONNECTOR**  
 50-51.5 ohm—TYPE 4850.  
 50-75 ohm—TYPE 25388.  
 May be used with either copper or aluminum cable.  
 Part No. 097 5958 000-4850

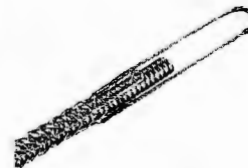

**CABLE GRIP.**  
 Unjacketed cable—Type 29958.  
 Use at 575 foot intervals.  
 Jacketed cable—TYPE 19256A.  
 Use at 500 foot intervals.  
 May be used with either copper or aluminum cable.



**INSULATED HANGER**  
 ANDREW 11662-2  
 Use on insulated tower at five foot intervals.  
 May be used with either copper or aluminum cable.



**STAINLESS STEEL WRAPLOCK**  
 ANDREW 12395-1  
 Use at 5 foot intervals.  
 May be used with either copper or aluminum cable.  
 Part No. 097 5010 000

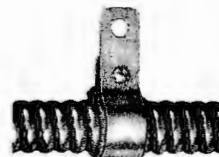

**GROUNDING KIT.**  
 For use with copper cable.  
 Unjacketed—TYPE 24810-1.  
 Jacketed—TYPE 24810-2.  
 For use with aluminum cable.  
 Jacketed—TYPE 24810-4.  
 Part No. 099 0409 000-24810-1  
 Part No. 124 0032 267-24810-2



## 1 5/8" AIR DIELECTRIC HELIAX

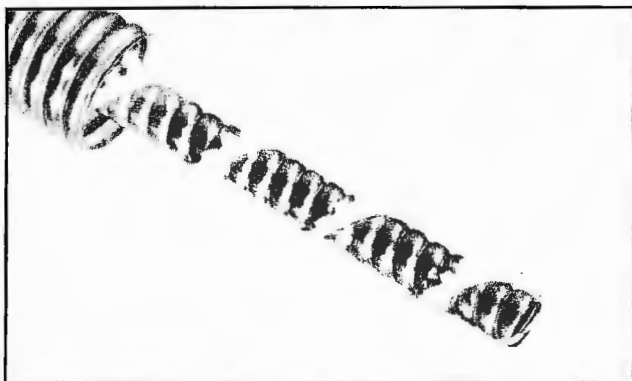

Type H7 HeliAx is widely used for medium power HF, AM and FM antenna installations. Its low attenuation also makes it popular at microwave frequencies.

Connectors include anchor insulator and feature positive clamping of both conductors, eliminating any possibility of uncertain contact with movement, vibration or time. They are compensated electrically and are suitable for field attachment with ordinary hand tools.

The cable types indicated in the opposite column feature copper conductors for optimum performance.

This cable is also available with a corrugated aluminum outer conductor, Type LJ7-50 (jacketed only). Retaining much of the strength and flexibility of the copper cable, the aluminum HeliAx is lighter in weight and lower in cost with a degradation of only 12% in attenuation and 10% in average power ratings. The basic electrical and mechanical data shown below apply to both copper and aluminum versions.

The connectors on the opposite page indicated for use with the aluminum cable are the same as those for copper cable, except plated.

### CHARACTERISTICS

Impedance	50 Ohms	75 Ohms
Andrew Type	H7-50A	H7-75
Military Number	RG-270B/U	RG-286/U
Andrew Type (Jacketed)	HJ7-50A	HJ7-75
Military Number	RG-319A/U	RG-292/U

#### Electrical

	50	75
Impedance, Ohms	50	75
Maximum Frequency, Gc	2.63	3.0
Velocity, Percent	92.1	92.4
Peak Power Rating, Kw	145	98

#### Mechanical

	50	75
Impedance, Ohms	50	75
Insulation	Polyethylene	
Outer Conductor,		
Major Diameter, Inches	1.830	1.830
Diameter over Jacket, Inches	2.00	2.00
Recommended Minimum Bending		
Radius, Inches	20	20

## TYPICAL CONNECTOR CONSTRUCTION

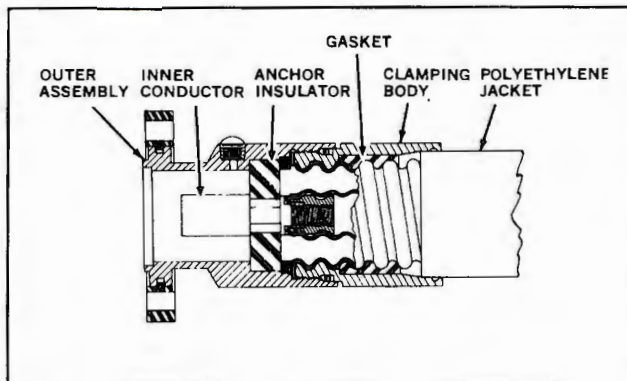

## ACCESSORIES FOR 1 5/8" HELIAX

All flanged items include inner connector, "O" ring, silicone grease and hardware kit.



#### 1" EIA FLANGE

For use with copper cable.  
50 ohm—TYPE 87R.  
75 ohm—TYPE 77AR-75.

For use with aluminum cable.  
50 ohm—TYPE 87R-3.  
Part No. 097 3002 000-87R

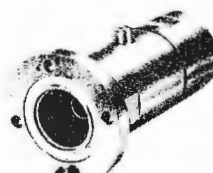

#### 1" EIA FLANGE (includes gas barrier).

For use with copper cable.  
50 ohm—TYPE 87G.

For use with aluminum cable.  
50 ohm—TYPE 87G-3.  
Part No. 124 0032 194-87G

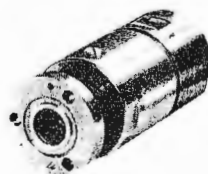

#### REDUCER CONNECTOR (to 3/8" EIA flange).

For use with copper cable.  
50 ohm—TYPE 87S.  
Part No. 099 3006 000



#### SPLICE.

For use with copper cable.  
50 ohm—TYPE 87Z.  
75 ohm—TYPE 77AZ-75.

For use with aluminum cable.  
50 ohm—TYPE 87Z-3.

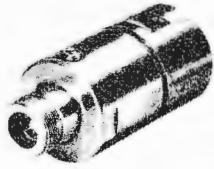

**TYPE LC JACK (Female)** mates with UG-154.  
For use with copper cable.  
50 ohm—TYPE 87L.  
75 ohm—TYPE 77AL-75.

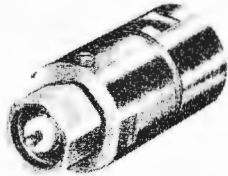

**TYPE LC PLUG (Male)** mates with UG-352.  
For use with copper cable.  
50 ohm—TYPE 87M.  
75 ohm—TYPE 77AM-75.



**TYPE N JACK (Female)** mates with UG-21.  
For use with copper cable.  
50 ohm—TYPE 87N.  
For use with aluminum cable.  
50 ohm—TYPE 87N-3.

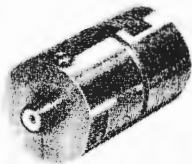

**TYPE UHF JACK (Female)** mates with PL259A.  
For use with copper cable.  
50 ohm—TYPE 87U.  
Part No. 099 3004 000



**END TERMINAL** for strap connection to center conductor.  
For use with copper cable.  
50 ohm—TYPE 87T.  
75 ohm—TYPE 77AT-75.  
Part No. 099 3005 000-87T

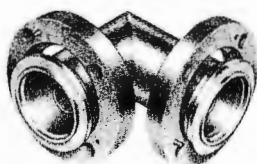

**90° EIA MITER ELBOW.**  
50 ohm—TYPE 1061.  
75 ohm—TYPE 1071.  
May be used with either copper or aluminum cable.  
Part No. 097 5620 000-1061  
Part No. 099 0415 000-1071

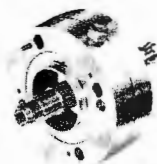

**EIA GAS BARRIER.**  
50 ohm—TYPE 1261.  
75 ohm—TPE 1271.  
May be used with either copper or aluminum cable.  
Part No. 099 0238 000-1261  
Part No. 099 0416 000-1271



**EIA END TERMINAL.**  
50 ohm—TYPE 2061.  
75 ohm—TYPE 2071.  
May be used with either copper or aluminum cable.  
Part No. 097 7042 000-2061  
Part No. 099 0417 000-2071



**EIA INNER CONNECTOR.**  
50 ohm—TYPE 15069.  
75 ohm—TYPE 24254.  
May be used with either copper or aluminum cable.  
Part No. 126 0658 030-15069



**ADAPTOR INNER CONNECTOR**  
50-51.5 ohm—TYPE 4851.  
50-75 ohm—TYPE 25572.  
May be used with either copper or aluminum cable.  
Part No. 097 5406 000-4851



**CABLE GRIP**  
ANDREW 24312  
Use one per 430 feet of unjacketed cable, or 325 feet of jacketed cable.  
May be used with either copper or aluminum cable.  
Part No. 099 0420 000



**INSULATED RIGID HANGER**  
ANDREW 24622  
Use on insulated tower at five foot intervals.  
May be used with either copper or aluminum cable.  
Part No. 099 0124 000



**STAINLESS STEEL WRAPLOCK**  
ANDREW 12395-1  
Use at five foot intervals.  
May be used with either copper or aluminum cable.  
Part No. 097 5010 000

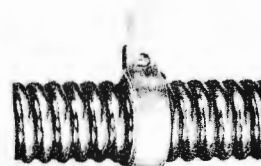

**GROUNDING KIT.**  
For use with copper cable.  
Unjacketed—TYPE 24811-1.  
Jacketed—TYPE 24811-2.  
For use with aluminum cable.  
Jacketed—TYPE 24811-4.  
Part No. 099 0419 000-24811-1

### 3" AIR DIELECTRIC HELIAX

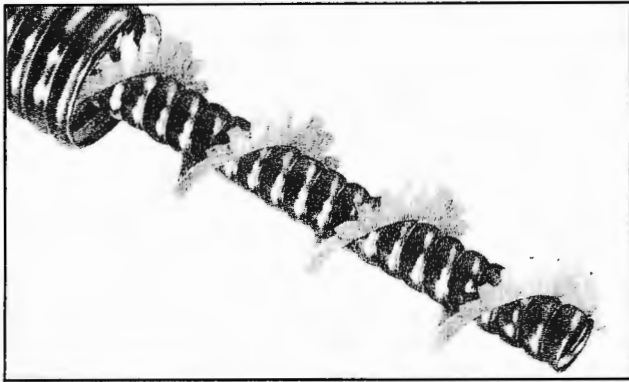

Type H8 HeliAx is ideally suited for all high power RF services and for long runs at lower power where attenuation and efficiency are important.

Flexible and easy to install, it is available in long splice-free lengths for one piece connection from transmitter to antenna.

Type H8 is lighter than comparable semiflexible aluminum cables, has greater crushing strength and is more highly resistant to impact damage. In addition, the corrugated copper conductors provide a degree of corrosion resistance and electrical efficiency not available in other cable types.

Connectors include anchor insulators and feature positive clamping of both conductors, eliminating any possibility of uncertain contact with movement, vibration or time. They are compensated electrically and are suitable for field attachment with ordinary hand tools.

#### CHARACTERISTICS

Impedance	50 ohms	75 ohms
Andrew Type	H8-50A	H8-75A
Military Number	RG-321/U	-----
Andrew Type (Jacketed)	HJ8-50A	HJ8-75A
Military Number (Jacketed)	RG-322/U	-----

#### Electrical

Impedance, Ohms	50	75
Maximum Frequency, Gc	1.64	1.90
Velocity, Percent	93.3	93.6
Peak Power Rating, Kw	320	210

#### Mechanical

Impedance, Ohms	50	75
Insulation	Polyethylene	
Outer Conductor,		
Major Diameter, Inches	2.850	2.850
Diameter over Jacket, Inches	3.020	3.020
Recommended Minimum Bending		
Radius, Inches	30	30

### TYPICAL CONNECTOR CONSTRUCTION

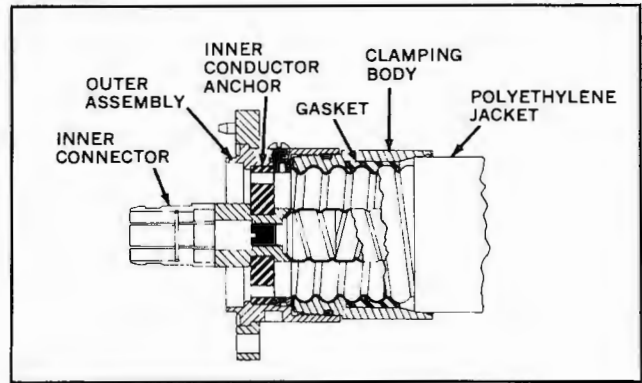

### 3" COMPONENTS

All flanged items include inner connector, "O" ring, silicone grease and hardware kit.

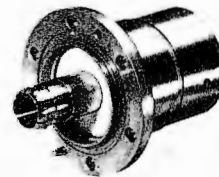

3/4" EIA FLANGE (Male).  
50 ohm—TYPE 78R.  
75 ohm—TYPE 78R-75.  
Part No. 099 2314 000-78R

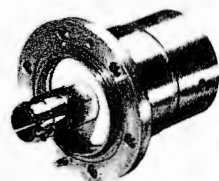

3/4" EIA FLANGE (Male)  
includes gas barrier.  
50 ohm—TYPE 78G.  
75 ohm—TYPE 78G-75.



REDUCER CONNECTOR  
(to 1 1/8" EIA flange).  
50 ohm—TYPE 78S  
75 ohm—TYPE 78S-75.

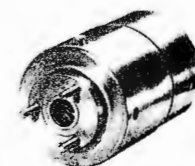

REDUCER CONNECTOR  
(to 3/8" EIA flange).  
50 ohm—TYPE 26666.





SPLICE.  
50 ohm—TYPE 78Z.  
75 ohm—TYPE 78Z-75.



TYPE LC JACK (Female) mates with UG-154.  
50 ohm—TYPE 78L.



90° EIA MITER ELBOW.  
50 ohm—TYPE 1062.  
75 ohm—TYPE 1072.  
Part No. 097 5621 000-1062  
Part No. 099 0391 000-1072



EIA GAS BARRIER  
50 ohm—TYPE 1262.  
75 ohm—TYPE 1272.  
Part No. 097 5754 000-1262  
Part No. 099 0394 000-1272

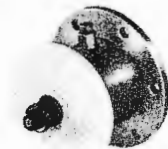

EIA END TERMINAL  
50 ohm—TYPE 2062.  
75 ohm—TYPE 2072.  
Part No. 099 0392 000-2062  
Part No. 099 0393 000-2072



REDUCER.  
3/8" EIA to 1/8" EIA.  
50 ohm—TYPE 1861.  
75 ohm—TYPE 1871.  
Part No. 097 6050 000-1861



EIA INNER CONNECTOR.  
50 ohm—TYPE 15093.  
75 ohm—TYPE 24444.  
50-75 ohm ADAPTOR—  
TYPE 25570.



ADAPTOR, male to male (3/8" EIA), use between fittings with fixed male inner connectors.  
50 ohm—TYPE 23187.  
75 ohm—TYPE 24530.  
Part No. 097 7262 000-23187



RIGID HANGER.  
ANDREW 13927  
Use at five foot intervals.  
Part No. 097 7018 000



INSULATED HANGER  
ANDREW 22418.  
Use on insulated towers at five foot intervals.  
Part No. 099 0515 000



HANGER ADAPTOR  
ANDREW 13555.  
Use with rigid or insulated hangers on angular member tower.  
Part No. 097 6124 000



HANGER ADAPTOR  
ANDREW 13550.  
Use with rigid or insulated hangers on round member towers up to 3" diameter.  
Part No. 097 6745 000



GROUNDING KIT.  
Unjacketed cable—TYPE 28708-1.  
Jacketed cable—TYPE 28708-2.



CABLE GRIP.  
ANDREW 26985A.  
Use one per 425 feet of unjacketed cable or 300 feet of jacketed cable.

## 5" AIR DIELECTRIC HELIAX

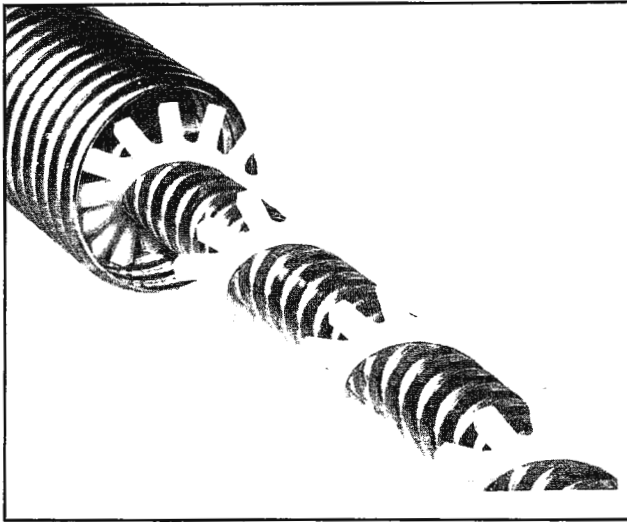

Type H9 Heliax is designed for very high power, low attenuation service and is the largest available flexible coaxial cable. From VLF, LF and HF up through UHF-TV it is being used to replace many 6 1/8" rigid transmission line installations.

The corrugated copper conductors provide a combination of strength, flexibility, corrosion resistance and electrical efficiency not found in any other type of coaxial transmission line.

Installation of cable and connectors requires no special tools or bending fixtures.

### CHARACTERISTICS

Type (Unjacketed)	H9-50
Type (Jacketed)	HJ9-50
Military Number (Jacketed)	RG-367/U

### Electrical

Impedance, Ohms	50
Maximum Frequency, Mc	960
Velocity, Percent	93.0
Peak Power Rating, Kw	830

### Mechanical

Insulation	Polyethylene
Outer Conductor, Major Diameter, Inches	5.00
Outer Diameter, (Jacketed) Inches	5.20
Recommended Minimum Bending Radius, Inches	50

### ACCESSORIES FOR 5" HELIAX

All flanged items include inner connector, "O" ring, silicone grease and hardware kit.



6 1/8" EIA FLANGE (Male).  
50 ohm—TYPE 79R.

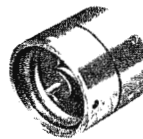

6 1/8" EIA FLANGE (Male)  
includes gas barrier.  
50 ohm—TYPE 79G.



SPLICE.  
50 ohm—TYPE 79Z.

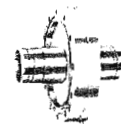

90° EIA MITER ELBOW.  
50 ohm—TYPE 1073.



EIA GAS BARRIER.  
50 ohm—TYPE 1273.

REDUCER.  
6 1/8" EIA to 3 1/8" EIA.  
50 ohm—TYPE 1872.

GROUNDING KIT.  
Unjacketed cable—TYPE 30417-1.  
Jacketed cable—TYPE 30417-2.

CABLE GRIP.  
ANDREW 31031.  
Use one per 195 feet of unjacketed or 130 feet  
of jacketed cable.



1/4" AND 3/8" FOAM DIELECTRIC

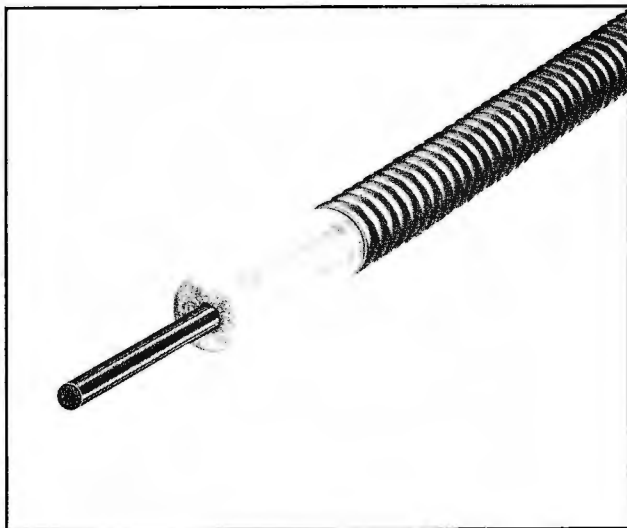

Types FH1 and FH2 Foam Heliax are ideal for all low power coaxial cable application, particularly where space is at a premium.

The corrugated copper outer conductors and foamed polyethylene dielectrics result in cables with combinations of strength, corrosion resistance, flexibility and electrical efficiency not found in smooth wall aluminum or solid dielectric cables.

The "solid" outer conductors assure noise-free characteristics which will not deteriorate with time.

The connectors are compensated electrically and are easily attached with ordinary hand tools.

CHARACTERISTICS

Nominal Size	1/4"	3/8"
Type	FH1-50	FH2-50
Type (Jacketed)	FHJ1-50	FHJ2-50

Electrical

Nominal Size	1/4"	3/8"
Impedance, Ohms	50	50
Maximum Frequency, Gc	20	13
Velocity, Percent	79	79
Peak Power Rating, Kw	5	8

Mechanical

Nominal Size	1/4"	3/8"
Insulation	Foamed Polyethylene	
Outer Conductor		
Major Diameter, Inches	.250	.375
Diameter over Jacket, Inches	.290	.435
Recommended Minimum Bending		
Radius, Inches	2.5	4

ACCESSORIES FOR 1/4" AND 3/8" HELIAX



TYPE UHF JACK (Female) mates with PL-259A.  
1/4" Cable—TYPE 41U.  
3/8" Cable—TYPE 42U.  
Part No. 124 0032 380-42U

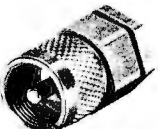

TYPE UHF PLUG (Male) Mates with SO-239A.  
1/4" Cable—TYPE 41P.  
3/8" Cable—TYPE 42P.



TYPE N JACK (Female) mates with UG-21.  
1/4" Cable—TYPE 41N.  
3/8" Cable—TYPE 42N.

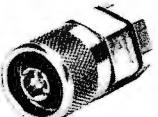

TYPE N PLUG (Male) mates with UG-23.  
1/4" Cable—TYPE 41W.  
3/8" Cable—TYPE 42W.

STAINLESS STEEL WRAPLOCK.  
ANDREW 12395-1.  
Use at five foot intervals.  
Part No. 097 5010 000

COPPERWELD TIE WIRES.  
ANDREW 27290.  
20 for 100 feet of cable.  
Part No. 124 0032 278

## 1/2" FOAM DIELECTRIC HELIAX

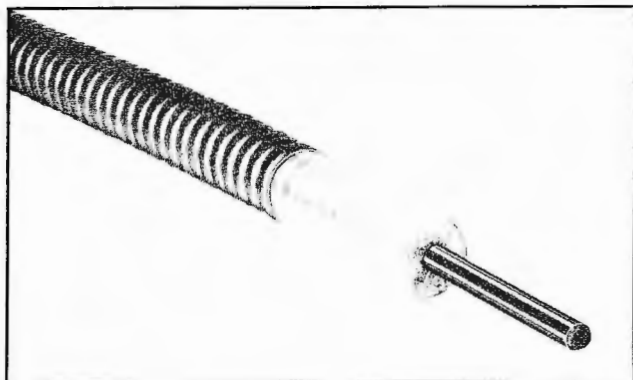

Type FH4 Foam Heliax is designed for fixed station antenna use and other low power applications.

The corrugated outer conductor and foam dielectric provide a combination of strength, flexibility, efficiency and permanence not available in semiflexible smooth wall or solid dielectric cables.

The cable types listed in the opposite column feature copper conductors for optimum performance.

This cable is also available with a corrugated aluminum outer conductor, Type FLJ4-50 (jacketed only). Retaining much of the strength and flexibility of the copper cable, the aluminum Heliax is lighter in weight and lower in cost with a degradation of only 12% in attenuation and 10% in average power ratings. The basic electrical and mechanical data shown below apply to both copper and aluminum versions.

The connectors on the opposite page indicated for use with the aluminum cable are the same as those for copper cable, except plated.

### CHARACTERISTICS

Impedance	50 ohms	75 ohms
Type	FH4-50A	FH4-75
Type (Jacketed)	FHJ4-50A	FHJ4-75
Military Number (Jacketed)	RG-366/U	—

#### Electrical

Impedance, Ohms	50	75
Maximum Frequency, Gc	8.1	9.1
Velocity, Percent	79	79
Peak Power Rating, Kw	19	12.7

#### Mechanical

Impedance, Ohms	50	70
Insulation	Foamed Polyethylene	
Outer Conductor,		
Major Diameter, Inches	.540	.540
Diameter over Jacket, Inches	.620	.101
Recommended Minimum Bending		
Radius, Inches	5	5

## TYPICAL CONNECTOR CONSTRUCTION

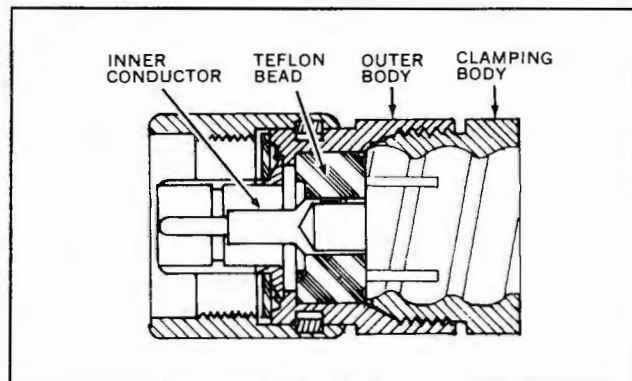

## ACCESSORIES FOR 1/2" HELIAX

All flanged items include inner connector "O" ring, silicone grease and hardware kit.



**7/8" EIA FLANGE**, includes inner connector, "O" ring and hardware.

---

For use with copper cable.  
50 ohm—TYPE 44AR.

---

For use with aluminum cable.  
50 ohm—TYPE 44AR-3.

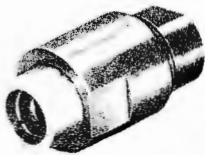

**SPLICE**.

For use with copper cable.  
50 ohm—TYPE 44AZ.  
Part No. 124 0032



**TYPE LC PLUG (Male)** mates with UG-352.

For use with copper cable.  
50 ohm—TYPE 44AM.



**TYPE LC JACK (Female)** mates with UG-154.

For use with copper cable.  
50 ohm—TYPE 44AL.

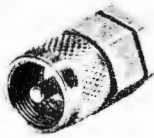

**TYPE UHF PLUG (Male)** mates with SO-239A.  
 For use with copper cable.  
 50 ohm—TYPE 44AP.  
 For use with aluminum cable.  
 50 ohm—TYPE 44AP-3.  
 Part No. 099 2557 000-44AP



**TYPE UHF JACK (Female)** mates with PL-259A.  
 For use with copper cable.  
 50 ohm—TYPE 44AU.  
 For use with aluminum cable.  
 50 ohm—TYPE 44AU-3.  
 Part No. 099 2455 000-44AU

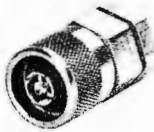

**TYPE N PLUG (Male)** mates with UG-23.  
 For use with copper cable.  
 50 ohm—TYPE 44AW.  
 75 ohm—TYPE 44AW-75.  
 For use with aluminum cable.  
 50 ohm—TYPE 44AW-3.



**TYPE N JACK (Female)** mates with UG-21.  
 For use with copper cable.  
 50 ohm—TYPE 44AN.  
 For use with aluminum cable.  
 50 ohm—TYPE 44AN-3.



**END TERMINAL** for strap connection to center conductor.  
 For use with copper cable.  
 50 ohm—TYPE 44AT.  
 For use with aluminum cable.  
 50 ohm—TYPE 44AT-3.  
 Part No. 099 2517 000-44AT



**TYPE HN PLUG (Male)** mates with UG-60.  
 For use with copper cable.  
 50 ohm—TYPE 44AJ.

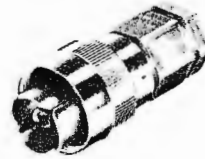

**GENERAL RADIO ADAPTOR.**  
 Mates with GR874BL.  
 For use with copper cable.  
 50 ohm—TYPE 44AGR.



**SOLID DIELECTRIC JUMPER CABLE.**  
 ANDREW 16253-21.  
 (RG8A/U), for connection to antennas or equipment, four feet long with Type "N" plugs on each end.



**INSULATED MOUNTING CLAMP.**  
 ANDREW 11662-3.  
 Use on insulated towers at five foot intervals.  
 May be used on either copper or aluminum cable.



**COPPERWELD TIE WIRES.**  
 ANDREW 27290.  
 20 for 100 feet of cable.  
 May be used with either copper or aluminum cable.  
 Part No. 124 0032 278



**STAINLESS STEEL WRAPLOCK.**  
 ANDREW 12395-1.  
 Use at five foot intervals.  
 May be used with either copper or aluminum cable.  
 Part No. 097 5010 000



**GROUNDING KIT.**  
 For use with copper cable.  
 Unjacketed—TYPE 26892-1.  
 Jacketed—TYPE 26892-2.  
 For use with aluminum cable.  
 Jacketed—TYPE 26892-4.

## 7/8" FOAM DIELECTRIC HELIAX

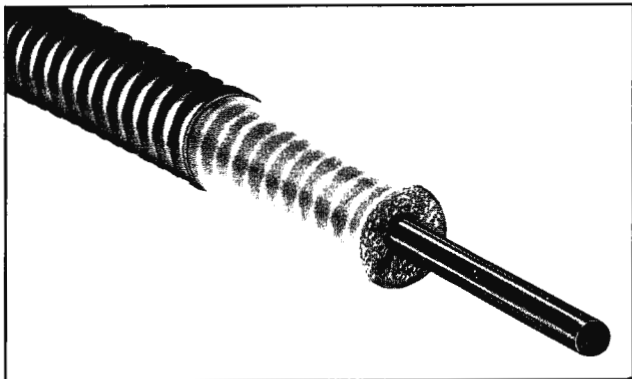

Type FH5 Foam Heliax is used extensively for long run fixed station antenna installations and HF receiving systems.

This cable outperforms comparable semiflexible smooth wall cables and all solid dielectric cables.

The cable types listed in the opposite column feature copper conductors for optimum performance.

This cable is also available with a corrugated aluminum outer conductor, Type FLJ5-50 (jacketed only). Retaining much of the strength and flexibility of the copper cable, the aluminum Heliax is lighter in weight and lower in cost with a degradation of only 12% in attenuation and 10% in average power ratings. The basic electrical and mechanical data shown below apply to both copper and aluminum versions.

The connectors on the opposite page indicated for use with the aluminum cable are the same as those for copper cable, except plated.

### CHARACTERISTICS

Impedance	50 ohms	75 ohms
Andrew Type	FH5-50	FH5-75
Military Number	RG-324/U	-----
Andrew Type (Jacketed)	FHJ5-50	FHJ5-75
Military Number	RG-323/U	-----

#### Electrical

Impedance, Ohms	50	75
Maximum Frequency, Gc	4.4	4.9
Velocity, Percent	79	79
Peak Power Rating, Kw	44	29

#### Mechanical

Impedance, Ohms	50	75
Insulation	Foamed Polyethylene	
Outer Conductor,		
Major Diameter, Inch	.980	.980
Outer Diameter,		
(Jacketed), Inches	1.090	1.090
Recommended Minimum Bending		
Radius, Inches	10	10

## TYPICAL CONNECTOR CONSTRUCTION

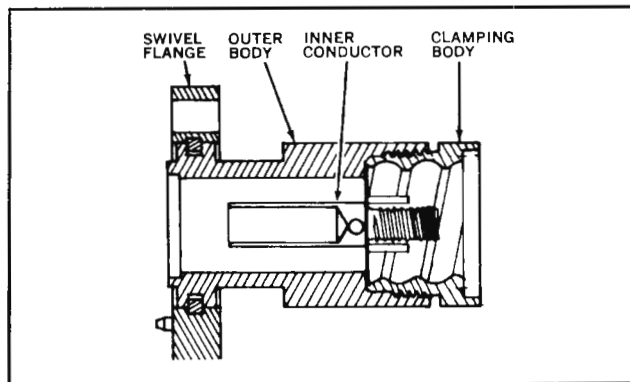

## ACCESSORIES FOR 7/8" HELIAX

All flanged items include inner connector, "O" ring, silicone grease and hardware kit.

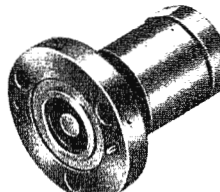

**7/8" EIA FLANGE.**

---

For use with copper cable.  
50 ohm—TYPE 45AR.

---

For use with aluminum cable.  
50 ohm—TYPE 45AR-3.  
Part No. 124 0032 419-45AR

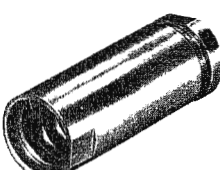

**SPLICE.**

---

For use with copper cable.  
50 ohm—TYPE 45AZ.

---

For use with aluminum cable.  
50 ohm—TYPE 45AZ-3.  
Part No. 124 0032 152-45AZ

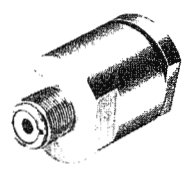

**TYPE UHF JACK (Female)**  
mates with PL-259A.

---

For use with copper cable.  
50 ohm—TYPE 45AU.

---

For use with aluminum cable.  
50 ohm—TYPE 45AU-3.  
Part No. 099 2553 000-45AU

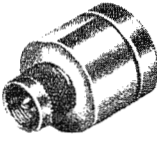

**TYPE UHF PLUG (Male)**  
mates with SO-239A.

---

For use with copper cable.  
50 ohm—TYPE 45AP.

---

For use with aluminum cable.  
50 ohm—TYPE 45AP-3.





**TYPE N JACK (Female)** mates with UG-21.  
 For use with copper cable.  
 50 ohm—TYPE 44AN.  
 75 ohm—TYPE 44AN-75.  
 For use with aluminum cable.  
 50 ohm—TYPE 45AN-3.

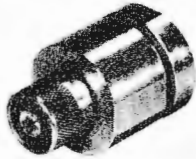

**TYPE N PLUG (Male)** mates with UG-23.  
 For use with copper cable.  
 50 ohm—TYPE 45AW.  
 For use with aluminum cable.  
 50 ohm—TYPE 45AW-3.



**END TERMINAL** for strap connection to center conductor.  
 For use with copper cable.  
 50 ohm—TYPE 45AT.  
 For use with aluminum cable.  
 50 ohm—TYPE 45AT-3.  
 Part No. 099 2519 000-45AT



**TYPE LC JACK (Female)** mates with UG-154.  
 For use with copper cable.  
 50 ohm—TYPE 45AL.

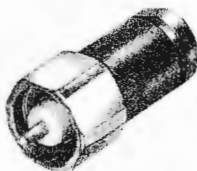

**TYPE LC PLUG (Male)** mates with UG-352.  
 For use with copper cable.  
 50 ohm—TYPE 45AM.

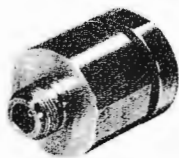

**TYPE HN JACK (Female)** mates with UG-59.  
 For use with copper cable.  
 50 ohm—TYPE 45AH.



**TYPE HN PLUG (Male)** mates with UG-61.  
 For use with copper cable.  
 50 ohm—TYPE 45AJ.



**90° EIA MITER ELBOW.**  
 50 ohm—TYPE 1060.  
 May be used with either copper or aluminum cable.  
 Part No. 099 0404 000



**EIA INNER CONNECTOR.**  
 ANDREW 18275.  
 50 ohm. Part No. 099 0406 000  
**ADAPTOR INNER CONNECTOR.**  
 ANDREW 4850.  
 50 ohm to 51.5 ohm.  
 May be used with either copper or aluminum cable.  
 Part No. 097 5958 000



**INSULATED MOUNTING CLAMP.**  
 ANDREW 11662-2.  
 Use on insulated towers at five foot intervals.  
 May be used with either copper or aluminum cable.  
 Part No. 099 0410 000



**CABLE GRIP.**  
 Unjacketed cable—TYPE 29958.  
 Use at 1400 foot intervals.  
 Jacketed cable—TYPE 19256A.  
 Use at 1200 foot intervals.  
 May be used with either copper or aluminum cable.  
 Part No. 099 0408 000-19256A



**COPPERWELD TIE WIRES.**  
 ANDREW 27290.  
 20 for 100 feet of cable.  
 May be used with either copper or aluminum cable.  
 Part No. 124 0032 278



**STAINLESS STEEL WRAPLOCK.**  
 ANDREW 12395-1.  
 Use at five foot intervals.  
 May be used with either copper or aluminum cable.  
 Part No. 097 5010 000



**GROUNDING KIT.**  
 For use with copper cable.  
 Unjacketed—TYPE 24810-1.  
 Jacketed—TYPE 24810-2.  
 For use with aluminum cable.  
 Jacketed—TYPE 24810-3.  
 Part No. 099 0409 000-24810-1



## 1 5/8" FOAM DIELECTRIC HELIAX

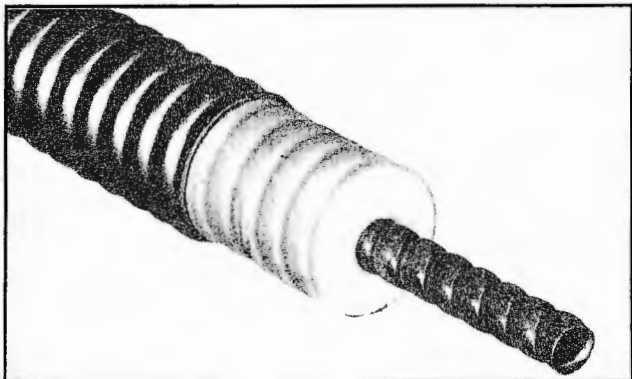

Type FH7 Foam HeliAx provides high efficiency and power handling capabilities without the need for pressurization.

As with all HeliAx sizes, connectors for FH7 are compensated electrically and are suitable for either factory or field installation with ordinary hand tools.

The cable types listed in the opposite column feature copper conductors for optimum performance.

This cable is also available with a corrugated aluminum outer conductor, Type FLJ7-50 (jacketed only). Retaining much of the strength and flexibility of the copper cable, the aluminum HeliAx is lighter in weight and lower in cost with a degradation of only 12% in attenuation and 10% in average power ratings. The basic electrical and mechanical data shown below apply to both copper and aluminum versions.

### CHARACTERISTICS

Impedance	50 ohms
Type	FH7-50
Type (Jacketed)	FHJ7-50

#### Electrical

Impedance, Ohms	50
Maximum Frequency, Gc	2.3
Velocity, Percent	79
Peak Power Rating, Kw	145

#### Mechanical

Insulation	Foamed Polyethylene
Outer Conductor, Major Diameter, Inches	1.830
Diameter over Jacket, Inches	2.000
Recommended Minimum Bending Radius, Inches	20

## TYPICAL CONNECTOR CONSTRUCTION

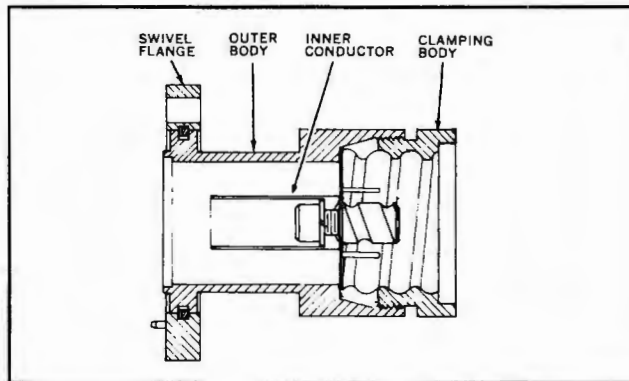

## ACCESSORIES FOR 1 5/8" HELIAX

All flanged items include inner connector, "O" ring, silicone grease and hardware kit.

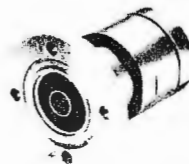

#### 1 1/2" EIA FLANGE.

For use with copper cable.  
50 ohm—TYPE 47R.

For use with aluminum cable.  
50 ohm—TYPE 47R-3.  
Part No. 124 0032 150-47R



#### SPLICE.

For use with copper cable.  
50 ohm—TYPE 47Z.

For use with aluminum cable.  
50 ohm—TYPE 47Z-3.



#### TYPE LC JACK (Female) mates with UG-154.

For use with copper cable.  
50 ohm—TYPE 47L.

For use with aluminum cable.  
50 ohm—TYPE 47L-3.



#### TYPE N JACK (Female) mates with UG-21.

For use with copper cable.  
50 ohm—TYPE 47N.

For use with aluminum cable.  
50 ohm—TYPE 47N-3.



TYPE N PLUG (Male) mates with UG-23.

For use with copper cable. 50 ohm—TYPE 47W.

For use with aluminum cable. 50 ohm—TYPE 47W-3.



90° EIA MITER ELBOW. 50 ohm—TYPE 1061.

May be used with either copper or aluminum cable. Part No. 097 5620 000



EIA GAS BARRIER. 50 ohm—TYPE 1261B.

May be used with either copper or aluminum cable. Part No. 099 0238 000-1261B



EIA END TERMINAL for strap connection to center conductor. 50 ohm—TYPE 2061.

May be used with either copper or aluminum cable. Part No. 097 7042 000

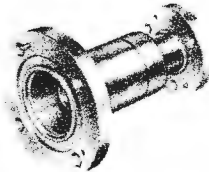

REDUCER. 1 1/2" EIA to 7/8" EIA. 50 ohm—TYPE 1860.

May be used with either copper or aluminum cable. Part No. 097 5405 000



REDUCER. 3 1/2" EIA to 1 1/2" EIA. 50 ohm—TYPE 1861.

May be used with either copper or aluminum cable. Part No. 097 6050 000

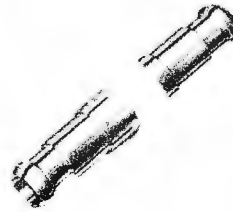

EIA INNER CONNECTOR. 50 ohm—TYPE 15069.

May be used with either copper or aluminum cable. Part No. 126 0658 030

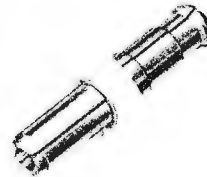

ADAPTOR INNER CONNECTOR. 50-51.5 ohm—TYPE 4851.

50-75 ohm—TYPE 25572. May be used with either copper or aluminum cable. Part No. 097 5406 000-4851

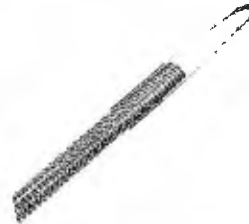

CABLE GRIP. ANDREW 24312.

Use one per 430 feet of unjacketed cable, or 325 feet of jacketed cable. May be used with either copper or aluminum cable. Part No. 099 0420 000



INSULATED RIGID HANGER. ANDREW 24622.

Use on insulated tower at five foot intervals. May be used with either copper or aluminum cable. Part No. 099 0124 000



STAINLESS STEEL WRAPLOCK. ANDREW 12395-1.

Use at five foot intervals. May be used with either copper or aluminum cable. Part No. 097 5010 000

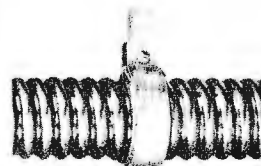

GROUNDING KIT.

For use with copper cable.

Unjacketed—TYPE 24811-1.

Jacketed—TYPE 24811-2.

For use with aluminum cable.

Jacketed—TYPE 24811-3.

Part No. 099 0419 000-24811-1

### 3" FOAM DIELECTRIC HELIAX

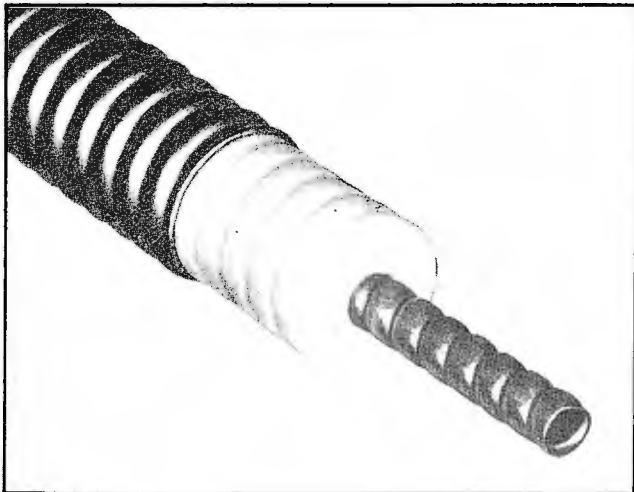

Type FH8 is the largest size foam dielectric Heli-ax available. The use of corrugated copper inner and outer conductors guarantees a flexible cable with extremely low attenuation for long runs or high efficiency systems.

As with all Heli-ax sizes, no special tools or bending fixtures are required to install this cable or its connectors.

#### CHARACTERISTICS

Type	FH8-50
Type (Jacketed)	FHJ8-50

#### *Electrical*

Impedance, Ohms	50
Maximum Frequency, Gc	1.5
Velocity, Percent	92
Peak Power Rating, Kw	320

#### *Mechanical*

Insulation	ANDREW P-205
Outer Conductor, Major Diameter, Inches	2.850
Diameter over Jacket, Inches	3.020
Recommended Minimum Bending Radius, Inches	50

### ACCESSORIES

For elbows, reducers, hangers, see Page 45.

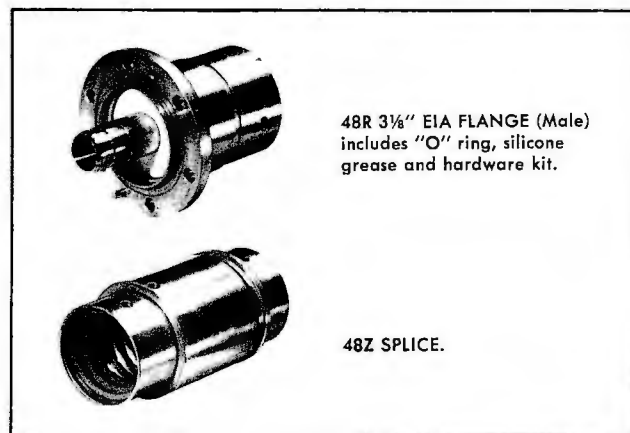

48R 3/8" EIA FLANGE (Male)  
includes "O" ring, silicone  
grease and hardware kit.

48Z SPLICE.

All flanged items include inner connector, "O" ring, silicone grease and hardware kit.

### SPECIAL HELIAX CABLES, FITTINGS AND ASSEMBLIES

On the preceding pages we have described the standard line of Heli-ax cables and fittings, the popular sizes, impedances and types which are stocked for quick delivery. Many other types have been or can be designed and made to special order.

#### IMPEDANCE

75 ohm and 100 ohm cables are available or can be designed for all sizes of Heli-ax.

#### SPECIAL FITTINGS

In addition to the large variety shown, Heli-ax fittings are available to connect to almost all types of connectors. Adaptors to the HN series and the General Radio Type 874BL connector, for instance, are available for most cables.

#### PHASE STABLE

Heli-ax is available in several sizes with a negligible coefficient of phase velocity change with temperature for use in phased or sampling arrays.

#### PHASE MEASURED

Heli-ax assemblies can be produced and phase tested with fittings attached to assure stability of arrays. Phase adjustable fittings are available for field tuning cable lengths.

#### HIGH TEMPERATURE OR POWER

Teflon insulated cables are available in a number of sizes and impedances. Other higher temperature materials have been used, in conjunction with plated conductors.



7/8" RIGID TRANSMISSION LINES

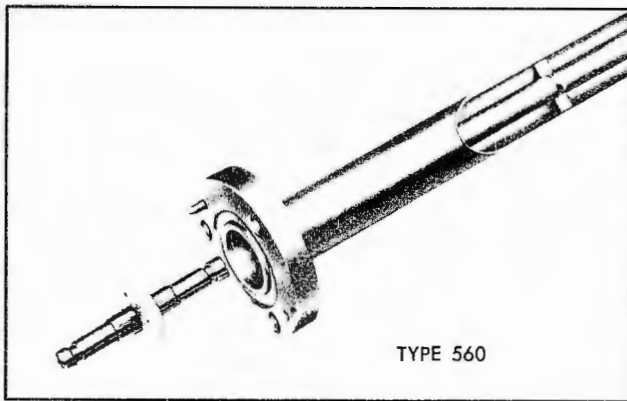

Type 560, Rigid Copper Coaxial Transmission Line is supplied in standard 20 ft. sections with EIA flanges on both ends. All flanged sections include EIA inner connector, "O" ring gasket and hardware. Specify operating frequency when ordering lines.

Type 560-3, 20 ft. section flanged on one end.

Type 560-2, 20 ft. section without flanges.

Type 2760, special length flanged, specify length in inches.

Type 2760-21, special length without flanges, specify length in inches.

CHARACTERISTICS

Electrical

Characteristic Impedance, Ohms	50
Frequency Range, Gc	0-3.0
Velocity, Percent	99.8
Peak Power Rating, Kw*	43

Mechanical

Outer Conductor, Inches	0.875 O.D. x 0.785 I.D.
Inner Conductor, Inches	0.341 O.D. x 0.291 I.D.
Net Weight, Per Section, Pounds	13
Number of Sections in Crate	12
Shipping Weight, 12 Sections, Pounds	400
Shipping Dimensions, 12 Sections, Inches	14 x 13 x 245

ACCESSORIES

All flanged items are EIA standard and include inner connector, "O" ring, silicone grease and hardware kit.

**ELBOW.**  
ANDREW 1060.  
90° miter, brass construction with swivel flanges on both ends.  
Part No. 099 0202 000

**ADAPTOR.**  
ANDREW 2360.  
Type LC (Female) mates with UG-154. Gas tight with vent plug.  
Part No. 097 5959 000

**SOFT SOLDER FIELD FLANGE KIT.**  
ANDREW 1560A.  
Part No. 099 0433 000

**GAS BARRIER.**  
ANDREW 1260A.  
With fixed male connectors on both ends.  
Part No. 099 0203 000

**ADAPTOR.**  
ANDREW 2260A.  
Type N (Female), mates with UG-21. Gas tight with vent plug.  
Part No. 099 0037 000

**INNER CONNECTOR.**  
ANDREW 18275.  
50 ohm with Teflon anchor bead.  
Part No. 099 0406 000

**RIGID HANGER.**  
ANDREW 14328.  
Use at top of tower. Mounts through 1/16" diameter hole or adaptors. Part No. 124 0032 316

**SPRING HANGER.**  
ANDREW 13889.  
Use at 100 ft. intervals. Mounts through 3/16" diameter hole or adaptors. Part No. 099 0512 000

**ANGLE ADAPTOR.**  
ANDREW 13555.  
A galvanized clamp for attaching hangers to angle tower members up to 3/8" thick.  
Part No. 097 6124 000

**FIXED FLANGE KIT.**  
ANDREW 18630.  
Includes solder and flux.

**SWIVEL FLANGE KIT.**  
ANDREW 18096.  
Includes fixed and sliding rings, flux and solder.

**INNER CONNECTOR ADAPTOR.**  
ANDREW 4850.  
50 ohm—51.5 ohm. Part No. 097 5958 000

**SLIDING HANGER.**  
ANDREW 14327.  
Use at 6 ft. intervals. Mounts through 1/16" diameter hole or adaptors. Part No. 099 0511 000

**HORIZONTAL ANCHOR.**  
ANDREW 3900.  
Attaches line to entry wall at angles up to 45°. Includes weatherproof cover.  
Part No. 099 0513 000

**ROUND MEMBER CLAMP.**  
ANDREW 13550.  
Attaches hangers to tower members up to 3" diameter.  
Part No. 097 6745 000

## 1 5/8" RIGID TRANSMISSION LINES

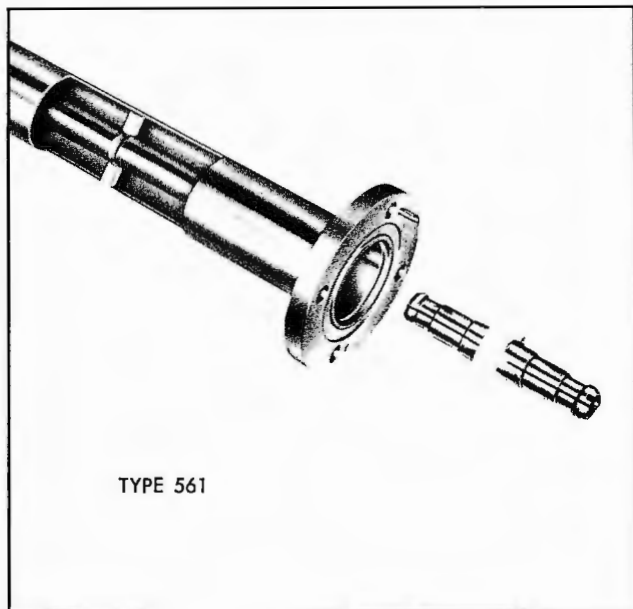

Type 561, Rigid Copper Transmission Line is supplied in standard 20 ft. sections with EIA flanges on both ends. All flanged sections include EIA inner connector, "O" ring gasket and hardware. Specify operating frequency when ordering lines.

Type 561-11, 20 ft. section flanged on one end.

Type 561-21, 20 ft. section without flanges.

Type 2671, special length flanged, specify length in inches.

Type 2761-11, special length with one flange, specify length in inches.

Type 2761-21, special length without flanges, specify length in inches.

### CHARACTERISTICS

#### Electrical

Characteristic Impedance, Ohms	50
Frequency Range, Gc	0.2-7
Velocity, Percent	99.8
Peak Power Rating, Kw	140

#### Mechanical

Outer Connector, Inches	1.625 O.D. x 1.527 I.D.
Inner Conductor, Inches	0.664 O.D. x 0.588 I.D.
Net Weight, per Section, Pounds	25
Number of Sections in Crate	6
Shipping Weight, 6 Sections, Pounds	290
Shipping Dimensions, 6 Sections, Inches	12 x 8 x 24.5

## ACCESSORIES

All flanged items are EIA standard and include inner connector, "O" ring, silicone grease and hardware kit.





HANGERS

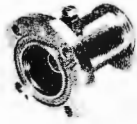

**END TERMINAL.**  
ANDREW 2061.  
For strap connection. Gas tight with vent plug.  
Part No. 097 7042 000



**FLEXIBLE SECTION.**  
ANDREW 20695.  
Accommodates vibration and angles up to 30 degrees. Maximum offset is 1/4". Length 10".  
Part No. 099 0434 000



**MALE TO MALE ADAPTOR.**  
ANDREW 30452.  
For joining 1 3/8" components with captivated inner connectors. Length 6".



**SOFT SOLDER FIELD FLANGE.**  
ANDREW 1561A.  
Consists of solder sleeve with fixed ring and sliding ring.  
Part No. 097 6351 000



**UNPRESSURIZED STRAIGHT COUPLING.**  
ANDREW 4861A.  
Connects unflanged lines and fittings. Includes inner connector and clamps.  
Part No. 099 0437 000

**FIXED FLANGE KIT.**  
ANDREW 18631.  
Consists of flange, alignment pin, silver solder ring and flux.

**SWIVEL FLANGE KIT.**  
ANDREW 18041.  
Consists of fixed ring, sliding ring, silver solder ring, alignment pin and flux. Part No. 124 0032 172

**HARDWARE KIT.**  
ANDREW 11381-2.  
Consists of four hex head bolts, nuts and lockwashers, for one connection.

**"O" RING GASKET.**  
ANDREW 10683-2.  
For 1 3/8" EIA flange.  
Part No. 124 0032 173



**RIGID HANGER.**  
ANDREW 13924.  
Use one for every 300 ft. of line. Mounts through 3/8" diameter hole or adaptors.  
Part No. 097 5969 000



**SLIDING HANGER.**  
ANDREW 14378.  
Use at 10 ft. intervals. Mounts through 3/8" hole or adaptors.  
Part No. 097 5972 000



**INSULATED SLIDING HANGER.**  
ANDREW 14442.  
Similar to 14378 except includes insulator 14063 and hardware.



**SPRING HANGER.**  
ANDREW 14379.  
Use at 50 ft. intervals. Accommodates line expansion. Mounts through 3/8" diameter hole or adaptors.  
Part No. 124 0032 189



**INSULATED SPRING HANGER.**  
ANDREW 14441.  
Similar to 14379 except includes insulator 14063 and hardware.  
Part No. 124 0032 190

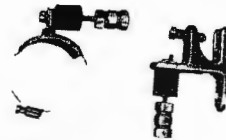

**LATERAL BRACE.**  
ANDREW 3921.  
For bottom of vertical run. Prevents lateral motion. Includes rubber cushion and end fittings for 1/2" conduit.  
Part No. 124 0032 187



**ROUND MEMBER CLAMP.**  
ANDREW 13550.  
Attaches hanger to tower members up to 3" diameter.  
Part No. 097 6745 000

**ANGLE ADAPTOR.**  
ANDREW 13555.  
Attaches hangers to angle tower members up to 7/8" thick.  
Part No. 097 6124 000

**EXTENSION SPACER.**  
ANDREW 13552.  
Is used to space noninsulated line hangers the same distance from tower as insulated hangers.  
Part No. 097 6744 000

**HORIZONTAL HANGER.**  
ANDREW 3911.  
Permits axial movement caused by expansion. Includes clamps and hardware. Part No. 097 7535 000

**HORIZONTAL ANCHOR.**  
ANDREW 3901.  
Attaches line to entry wall at angles up to 45°. Includes weatherproof cover. Part No. 097 5968 000

**GROUND CLAMP.**  
ANDREW 12430-1.  
For grounding insulated line to tower.  
Part No. 099 0509 000

**SPARE INSULATOR.**  
ANDREW 14063.  
No hardware included. Shown as part of Type 14441 above.

## 3 1/8" RIGID TRANSMISSION LINES

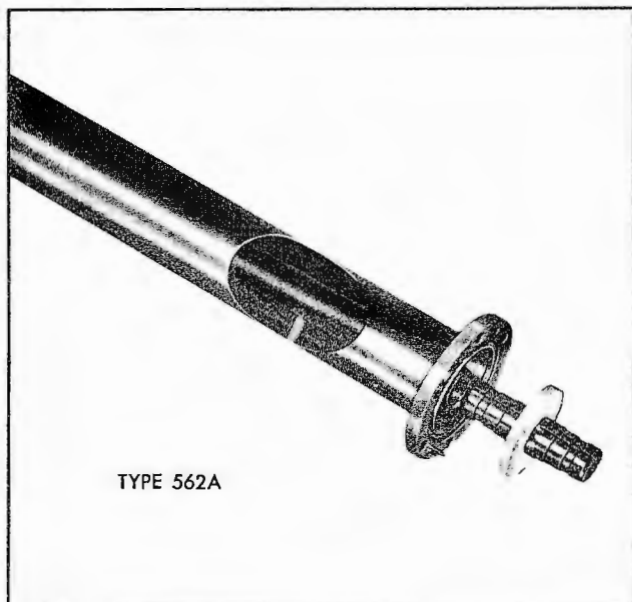

TYPE 562A

Type 562A Rigid Copper Transmission Line is supplied in standard 20 ft. sections with EIA flanges on both ends. All flanged sections include EIA inner connector, "O" ring gasket and hardware. Standard 19' 8" lengths are available for special frequency applications. Specify frequency or channel when ordering lines.

Connectors included with straight sections are the coated type as described below.

Type 562A-11, 20 ft. section flanged on one end.

Type 562A-21, 20 ft. section without flanges.

Type 2762A-1, special length flanged, specify length in inches.

Type 2762A-11, special length with one flange, specify length in inches.

Type 2762A-21, special length without flanges, specify length in inches.

### CHARACTERISTICS

#### Electrical

Characteristic Impedance, Ohms	50
Frequency Range, Gc	0-1.6
Velocity, Percent	99.8
Peak Power Rating, Kw	400

#### Mechanical

Outer Connector, Inches	3.125 O.D. x 3.027 I.D.
Inner Conductor, Inches	1.315 O.D. x 1.231 I.D.
Net Weight, per Section, Pounds	55
Number of Sections in Crate	4
Shipping Weight, 4 Sections, Pounds	425
Shipping Dimensions, 4 Sections, Inches	13 x 14 x 245

## ACCESSORIES

All flanged items are EIA standard and include inner connector, "O" ring, silicone grease and hardware kit.



ELBOW.  
ANDREW 1062.  
90° miter, brass construction,  
flanged on both ends.  
Part No. 097 5621 000

ELBOW.  
ANDREW 1062-3.  
90° miter, no flanges.  
Requires 4862A couplings.

COATED CONNECTOR.  
ANDREW 30079.  
Silver plated with dry baked  
molybdenum compound.  
Designed to minimize effects of  
expansion and contraction.

ADAPTOR INNER CONNECTOR  
ANDREW 4852.  
Connects 50 ohm to 51.5 ohm  
line.

INNER CONNECTOR.  
ANDREW 15093.  
With teflon anchor bead.

GAS BARRIER.  
ANDREW 1262.  
With fixed male connectors  
on both ends.  
Part No. 097 5754 000

ADAPTOR.  
ANDREW 2262.  
Type N (Female) mates  
with UG-21.  
Part No. 099 0445 000

REDUCER.  
ANDREW 1861.  
3 1/8" EIA to 1 3/8" EIA.  
Has captivated 3 1/8" connector.  
No. 097 6050 000

REDUCER.  
ANDREW 1872.  
6 1/8" EIA to 3 1/8" EIA.



**END TERMINAL.**  
ANDREW 2062.  
For strap connection. Gas tight with vent plug.  
Part No. 099 0444 000



**BREAKAWAY SECTION.**  
ANDREW 2962.  
Permits easy opening of transmission line run. Pressure tight when closed. Length, 19 7/16".  
Part No. 099 0442 000



**FLEXIBLE SECTION.**  
ANDREW 19209B.  
Accommodates vibration and angles up to 30 degrees. Maximum offset is 1/2".  
Length, 18".  
Part No. 099 0441 000

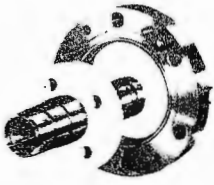

**GAS INLET COUPLING.**  
ANDREW 1362.  
Has 1/8" inlet with pipe plug.  
Part No. 099 0446 000



**MALE TO MALE ADAPTOR.**  
ANDREW 23187.  
Joins two components having captivated inner connectors.  
Length 6".  
Part No. 097 7262 000

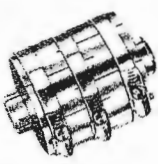

**UNGASSED COUPLING.**  
ANDREW 4862.  
Connect sections of unflanged line. Includes special connector and clamps.  
Part No. 099 0443 000

**SOFT SOLDER FIELD FLANGE KIT.**  
ANDREW 1562A.  
Includes swivel flange with soft solder sleeve.

**"O" RING GASKET.**  
ANDREW 10683-3.  
For 3 1/8" EIA flange.

**SWIVEL FLANGE KIT.**  
ANDREW 18200.  
Includes fixed, sliding and silver solder rings. Alignment pin and flux.

**FIXED FLANGE KIT.**  
ANDREW 15840.  
Consists of flange solder ring alignment pin and flux.

**HARDWARE KIT.**  
ANDREW 11381-3.  
Consists of 6 bolts, nuts and lockwashers, for one connection.

HANGERS



**RIGID HANGER.**  
ANDREW 13927.  
Use one for every 300 feet of line. Mounts through 3/16" diameter hole or adaptors.  
Part No. 097 7018 000



**SPRING HANGER.**  
ANDREW 13925.  
Use at 10 ft. intervals. Accommodates line expansion. Mounts through 3/16" diameter hole or adaptors.  
Part No. 097 6122 000



**INSULATED SPRING HANGER.**  
ANDREW 13926.  
Similar to 13925 except includes insulator 14063 and hardware.  
Part No. 097 6768 000



**GROUND CLAMP.**  
ANDREW 12431.  
For grounding insulated line to tower.  
Part No. 099 0503 000



**LATERAL BRACE.**  
ANDREW 3922.  
For bottom of vertical run. Includes rubber cushion and end fittings for 1/2" conduit.  
Part No. 099 0504 000



**HORIZONTAL HANGER.**  
ANDREW 3912.  
Permits axial movement caused by expansion. Includes clamps and hardware.  
Part No. 099 0505 000



**HORIZONTAL ANCHOR.**  
ANDREW 3902.  
Attaches line to entry wall at angles up to 45°. Includes weatherproof cover.  
Part No. 099 9506 000



**ANGLE ADAPTOR.**  
ANDREW 13555.  
Attaches hangers to angle tower members up to 7/8" thickness.  
Part No. 097 6124 000



**ROUND MEMBER CLAMP.**  
ANDREW 13550.  
Attaches hanger to tower members up to 3" diameter.  
Part No. 097 6745 000

**SPARE INSULATOR.**  
ANDREW 14063.  
No hardware included. Shown as part of Type 13926 above. Part No. 097 6746 000

**EXTENSION SPACER.**  
ANDREW 13552.  
Used to space non-insulated line hangers the same distance from tower as insulated hangers.  
Part No. 097 6744 000

## HEATLESS AUTOMATIC DEHYDRATOR

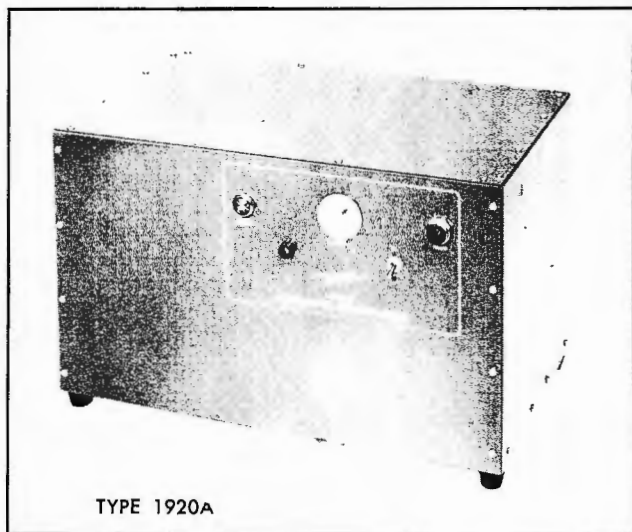

TYPE 1920A

### CHARACTERISTICS

#### Electrical

Power Consumption	600 watts
Fuse	20 amps
Power Cord	7 ft., 3 conductors
Safety	Grounded Chassis

#### Mechanical

Line Termination	1/8" M.P.T.
Internal Operating Pressure	60 psig
Output	1 CFM @ 8 psig.
Air Line	20 feet, 3/8" O.D. polytubing
Ambient Inlet Temp.	0° — 120° F
Ambient Humidity	95%
Outlet Dew Point	Below — 37° F
Net Weight, Pounds.	80
Dimensions	Height — 15 3/8" Width — 24" Depth — 14 1/4"

Part No. 124 0032 273

## REGULATING TANK

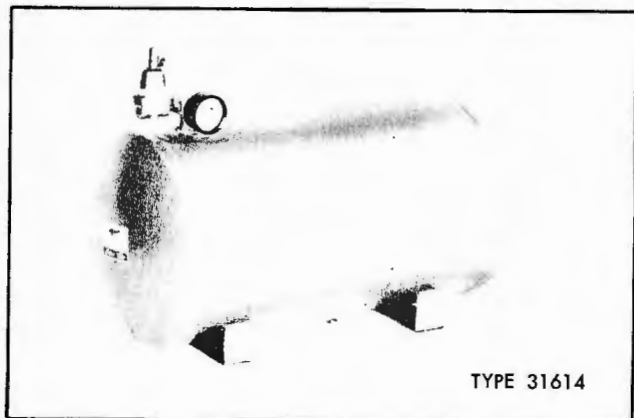

TYPE 31614

Type 31614 Regulating Tank Assembly is used with the 1920 series dehydrators for pressurization of the smaller sizes of Heliac (1/2" and below) and microwave waveguide.

The assembly consists of a 10 gal. (approximately 1.5 cu. ft.) tank and regulator which may be adjusted down to 1.5 psig output pressure along with all necessary fittings and tubing to allow connection of the unit between the dehydrator and transmission line or waveguide.

The regulator tank assembly prevents excessive cycling when pressurizing small diameter cables. It also provides a convenient means of reducing the output pressure to the 3 psig recommended for waveguide use.

## HUMIDITY SENSOR

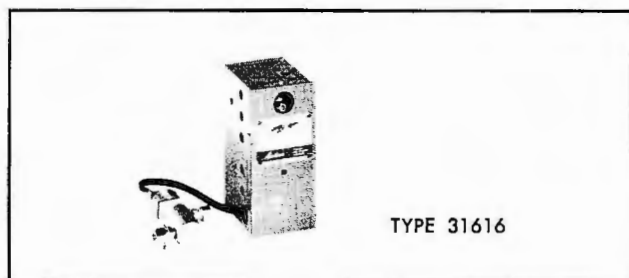

TYPE 31616

Type 31615 Humidity Sensor is designed to activate remote indicators on alarms at the presence of moisture in the output of dehydrators. The unit is factory installed in any of the 1920 series dehydrators and is set for specific values of humidity. The leads are brought to a terminal block installed in the dehydrator for the external connection.

Type 31616 is the basic unit only for field installation in existing units or systems.

## PRESSURE SENSOR

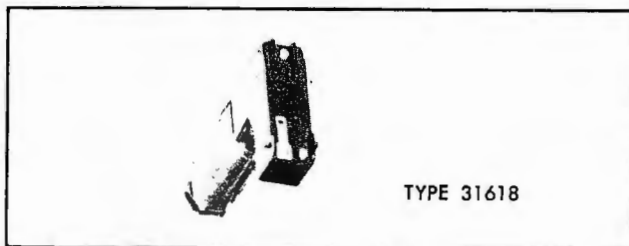

TYPE 31618

Type 31617 Pressure Sensor is used as either a high or low pressure indicator. SPDT contacts switch at any pre-set pressure in the 0 to 30 psig range to activate remote indicators or alarms. Singly the units provide either low or high pressure indications; in pairs both can be indicated. The sensors are factory installed in any of the 1920 series dehydrators, pre-set for specific pres-



sure levels and wired to terminal blocks for external connections.

Type 31618 is the basic sensor unit only for field installation in existing units or systems.

**GAS DISTRIBUTION MANIFOLD**

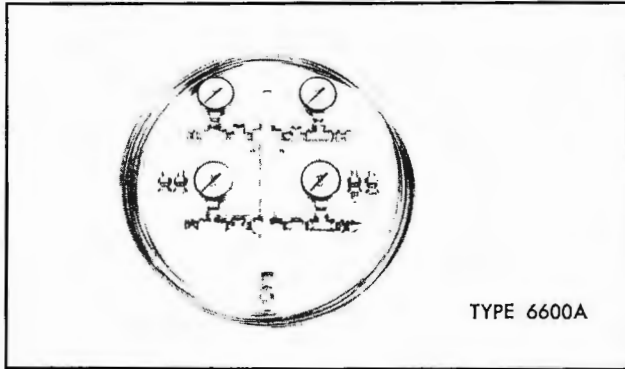

TYPE 6600A

Type 6600A Gas Distribution Manifold includes pressure gauges, needle valves, all necessary fittings and 15 feet of 3/8" polyethylene tubing for each outlet. Specify number of outlets required.

**LOW PRESSURE DEHYDRATOR**

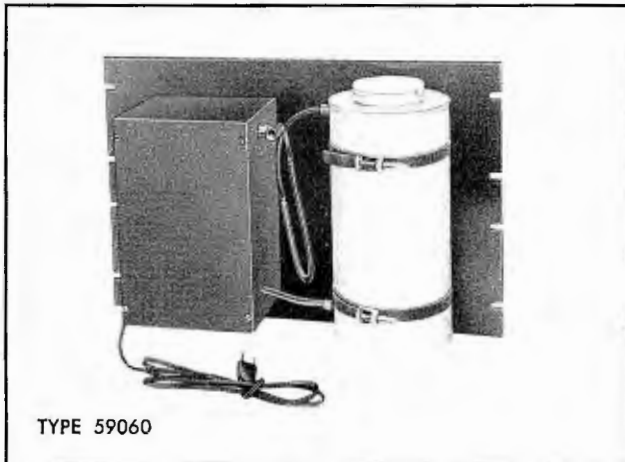

TYPE 59060

Type 59060, Low Pressure Dehydrator is ideal for pressurizing microwave waveguide systems or small air dielectric cables. This dehydrator maintains a constant pressure of dry air inside the waveguide or coaxial cable.

High reliability is insured by minimizing the number of component parts. The entire unit is assembled on a panel, for easy mounting in a standard rack.

Type 59060 will maintain dry air pressure inside a nominally pressure tight waveguide or coaxial cable system for several months before reactivation or replacement of the desiccant is required. The desiccant condition is shown by the color indicator on the front panel.

**CHARACTERISTICS**

Output	2.0 psi maximum pressure
Drying Agent	sova beads, 5 pounds
Output Connection	1/8" female pipe thread
Power Input	115 volts, 60 cycles, 5 watts
Electrical Connection	Terminal board
Weight	10 pounds
Mounting	standard 19" rack
Height	12 1/4" inches
Capacity	3/8" Heliacx 50 feet WR-137 Waveguide 50 feet

**DRY AIR HAND PUMP**

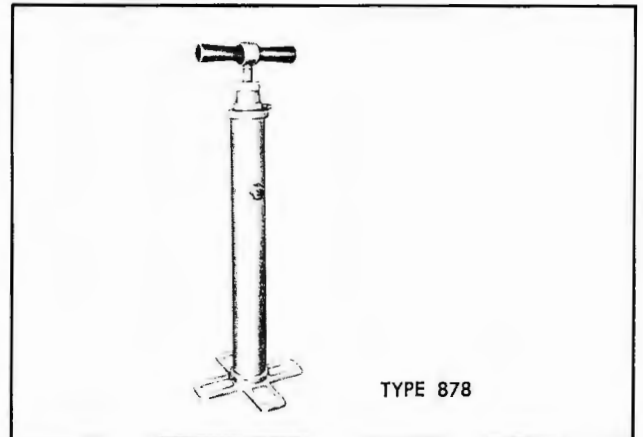

TYPE 878

Type 878 Dry Aid Hand Pump pressurizes up to 1,000 ft. of 7/8" cable and up to 250 ft. of 1 5/8" line. Supplied with 1 lb. of silica gel and 8 feet of hose. Weight: Net 10.5 lbs., Gross 12 lbs.

Part No. 097 5960 000

**NITROGEN TANK FITTINGS**

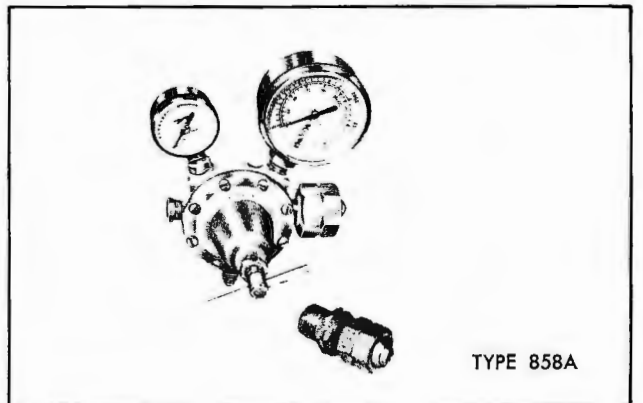

TYPE 858A

Type 858A Nitrogen Tank Fittings includes a pressure regulator, high and low pressure gauges and 10 feet of 3/8" O.D. polyethylene tubing with fittings to fit 1/8" pipe threads and adaptors to nitrogen tanks.

Part No. 124 0032 159



## PRESSURIZATION FITTINGS AND ACCESSORIES



**GAS INLET VALVE**  
**ANDREW 3017**  
 Has 1/8" male pipe thread.  
 Part No. 013 0365 000



**PRESSURE GAUGE**  
**ANDREW 3500**  
 Reads 0-20 psi and has 1/8" male pipe thread. Indoor use only.  
 Part No. 013 0366 000



**RELEASE VALVE**  
**ANDREW 3027**  
 Has 1/8" male pipe thread on one end.  
 Part No. 013 0368 000



**RELEASE VALVE**  
**ANDREW 4944**  
 Has 1/8" male pipe threads on both ends.  
 Part No. 013 0728 000



**RELEASE VALVE**  
**ANDREW 4949**  
 Has 1/8" pipe threads, male one end, female, other end.  
 Part No. 013 0730 000



**MALE CONNECTOR**  
**ANDREW 31680-1**  
 For 3/8" poly tubing, has 1/8" male pipe threads one end.



**MALE CONNECTOR**  
**ANDREW 31680-2**  
 For 3/8" poly tubing, has 1/4" male pipe threads one end.



**MALE BRANCH TEE**  
**ANDREW 31680-3**  
 For 3/8" poly tubing, has 1/4" male pipe threads on one outlet.



**MALE RUN TEE**  
**ANDREW 31680-5**  
 For 3/8" poly tubing, has 1/4" male pipe threads on one outlet.



**ELBOW**  
**ANDREW 25436-4**  
 For 3/8" poly tubing, has 1/8" male pipe threads one end.

### PIPE TEES

**ANDREW 3016** Part No. 013 0364 000  
 Has 1/8" female pipe threads each outlet.

**ANDREW 3022** Part No. 013 0701 000  
 Has one male and 2 female 1/8" pipe thread outlets.

### PIPE PLUG

**ANDREW 3018** Part No. 013 0367 000  
 Has 1/8" male pipe thread.

### PIPE NIPPLES

Threaded entire length.

**ANDREW 3026** Part No. 013 0703 000  
 1/8" male pipe threads.

**ANDREW 25436-12**  
 1/4" male pipe threads.

### THREAD LUBRICANT

**ANDREW 3012** Part No. 013 0272 000  
 4 cc. tube.

### VINYL TAPE

**ANDREW 9905-18**  
 20 ft. by 3/4" wide.

### SPARE HOSE ASSEMBLY

**ANDREW 10195**  
 Is 7 ft. long for Type 878 pump.

### SILICA GEL REFILL

**ANDREW 210** Part No. 013 0439 000  
 One pound package.

### POLYETHYLENE TUBING

**ANDREW 25435**  
 3/8" diameter.

### MOUNTING STRAP

**ANDREW 31712**  
 For 3/8" poly tubing.

### COPPER TUBING

**ANDREW 10741-2**  
 1/4" diameter, soft temper.

### COUPLING

**ANDREW 10994-4**  
 For 1/4" tubing, has flared fitting on one end and 1/8" male pipe thread on the other end.

### FLARE COUPLING

**ANDREW 10994-2**  
 For 1/4" tubing.

### SPlicing SLEEVE

**ANDREW 12129**  
 Solders to 1/4" tubing.

### COUPLING

**ANDREW 4947** Part No. 013 0729 000  
 Solders to 1/4" tubing, has 1/8" male pipe thread.

ATTENUATION — HELIAX/AIR DIELECTRIC CABLES

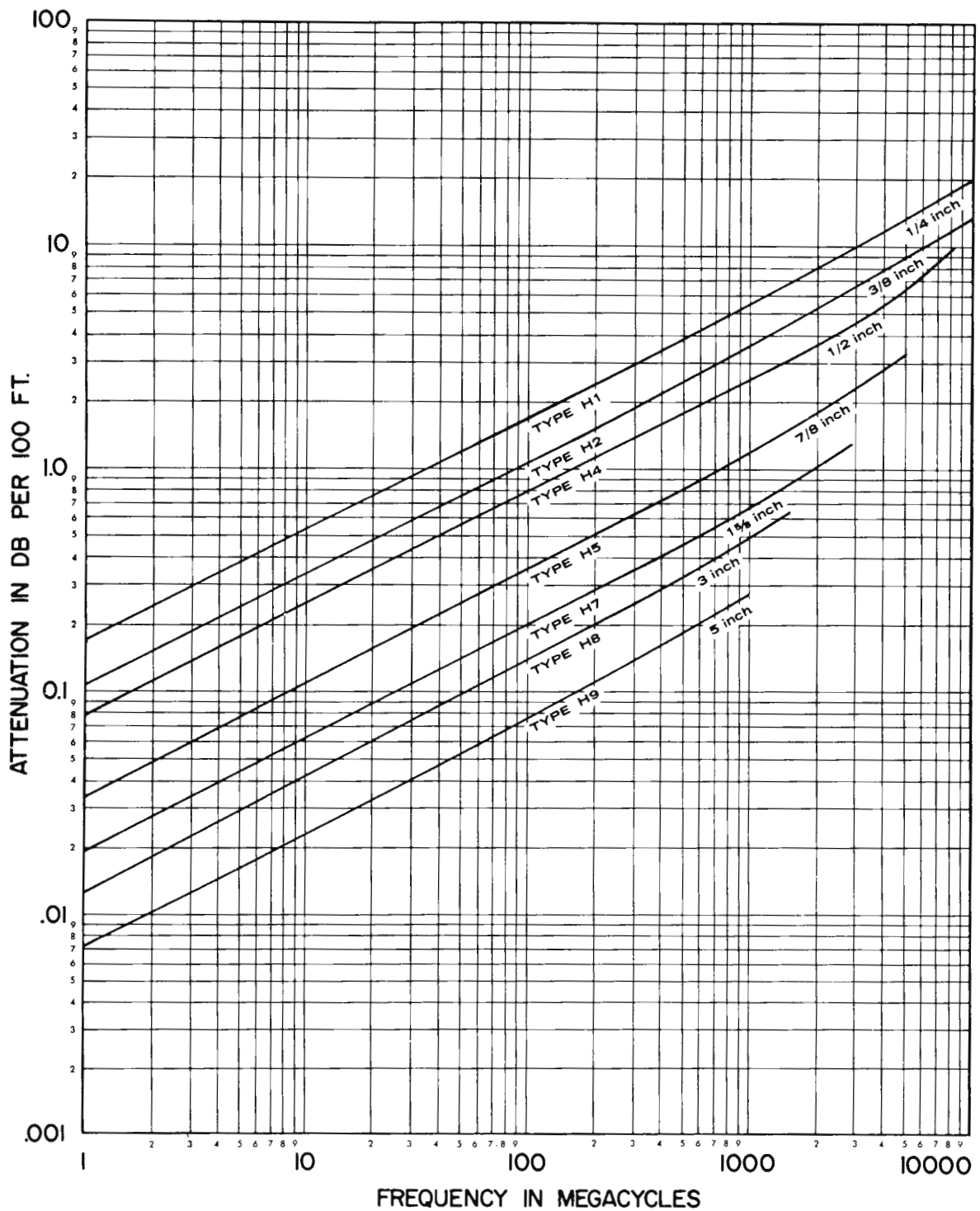

The attenuation curves above are for 50 ohm copper Heliax at unity VSWR. For 75 ohm copper cables the values shown should be reduced 5%. For 50 ohm aluminum (outer conductor) cables the values should be increased 12%.

# POWER RATING — HELIAX/AIR DIELECTRIC CABLES

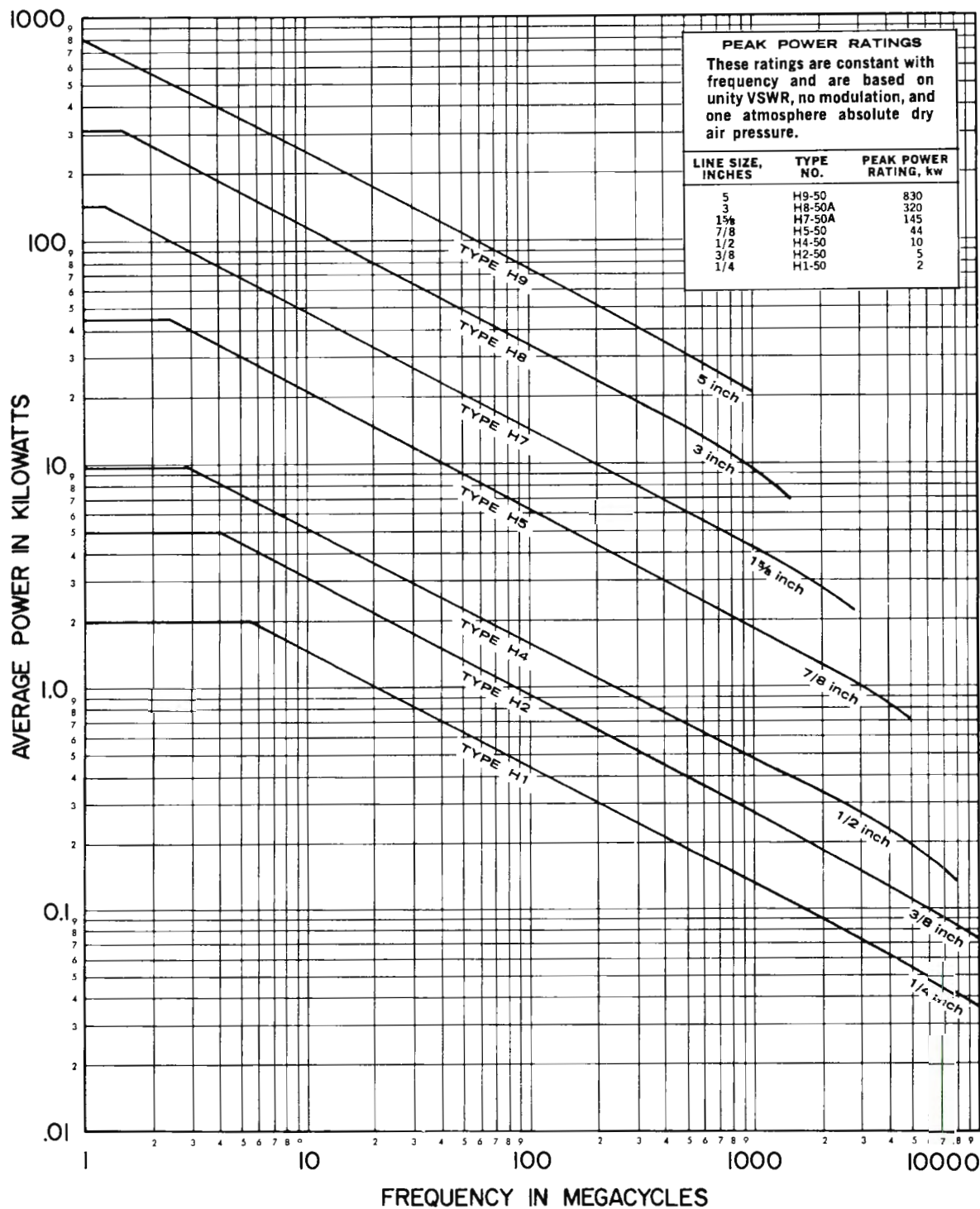

The average power ratings shown above are for 50 ohm copper Heliax and are based on unity VSWR and a maximum inner conductor temperature of 212°F at an ambient temperature of 104°F. For 75 ohm copper cables the values shown should be reduced 30%. For 50 ohm aluminum (outer conductor) cables the values should be reduced 10%. For Teflon insulated cables, average power ratings should be increased by 35%.

ATTENUATION— HELIAX/FOAM DIELECTRIC CABLES

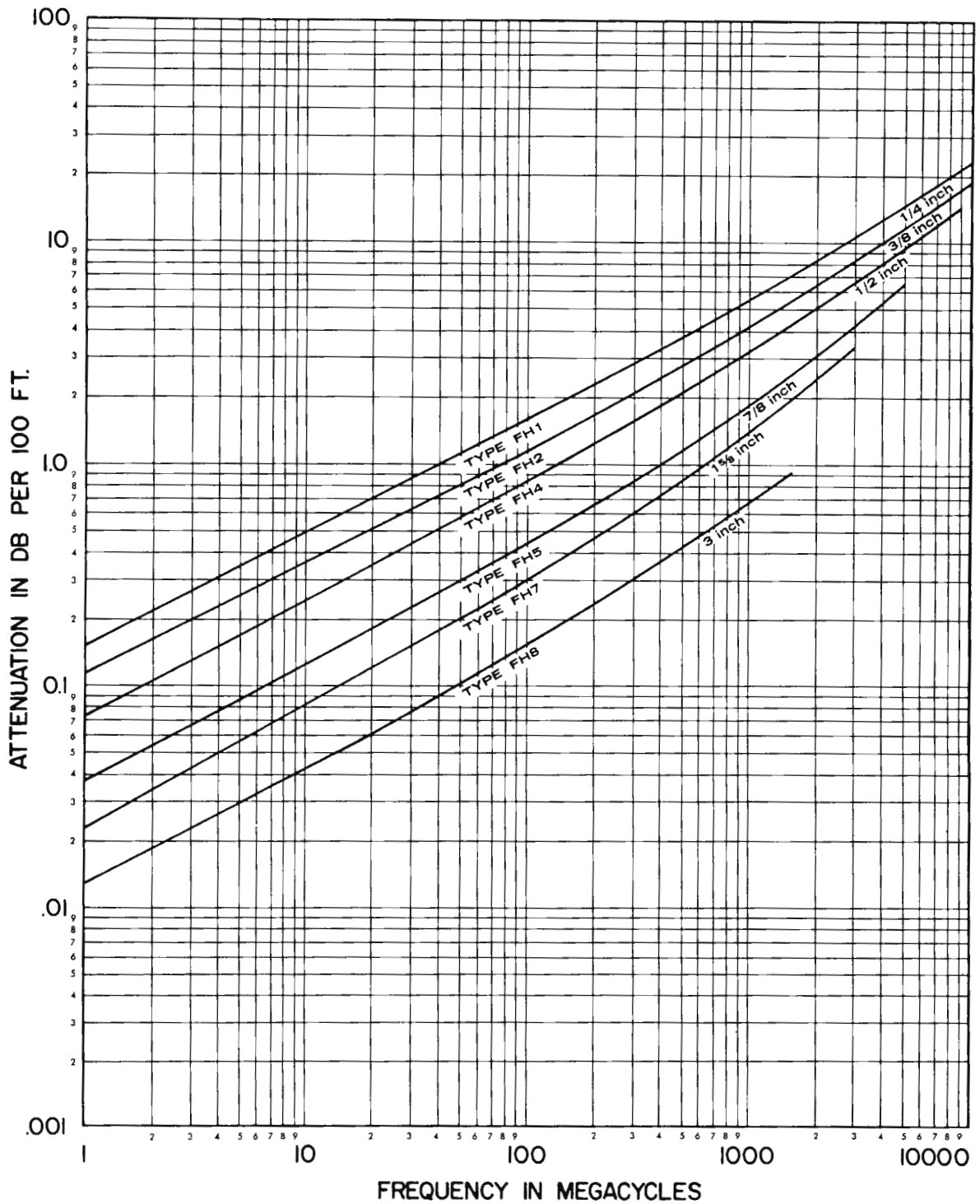

The attenuation curves above are for 50 ohm copper Heliax at unity VSWR. For 75 ohm copper cables the values shown should be reduced 5%. For 50 ohm aluminum (outer conductor) cables the values should be increased 12%.



# POWER RATING — HELIAX/FOAM DIELECTRIC CABLES

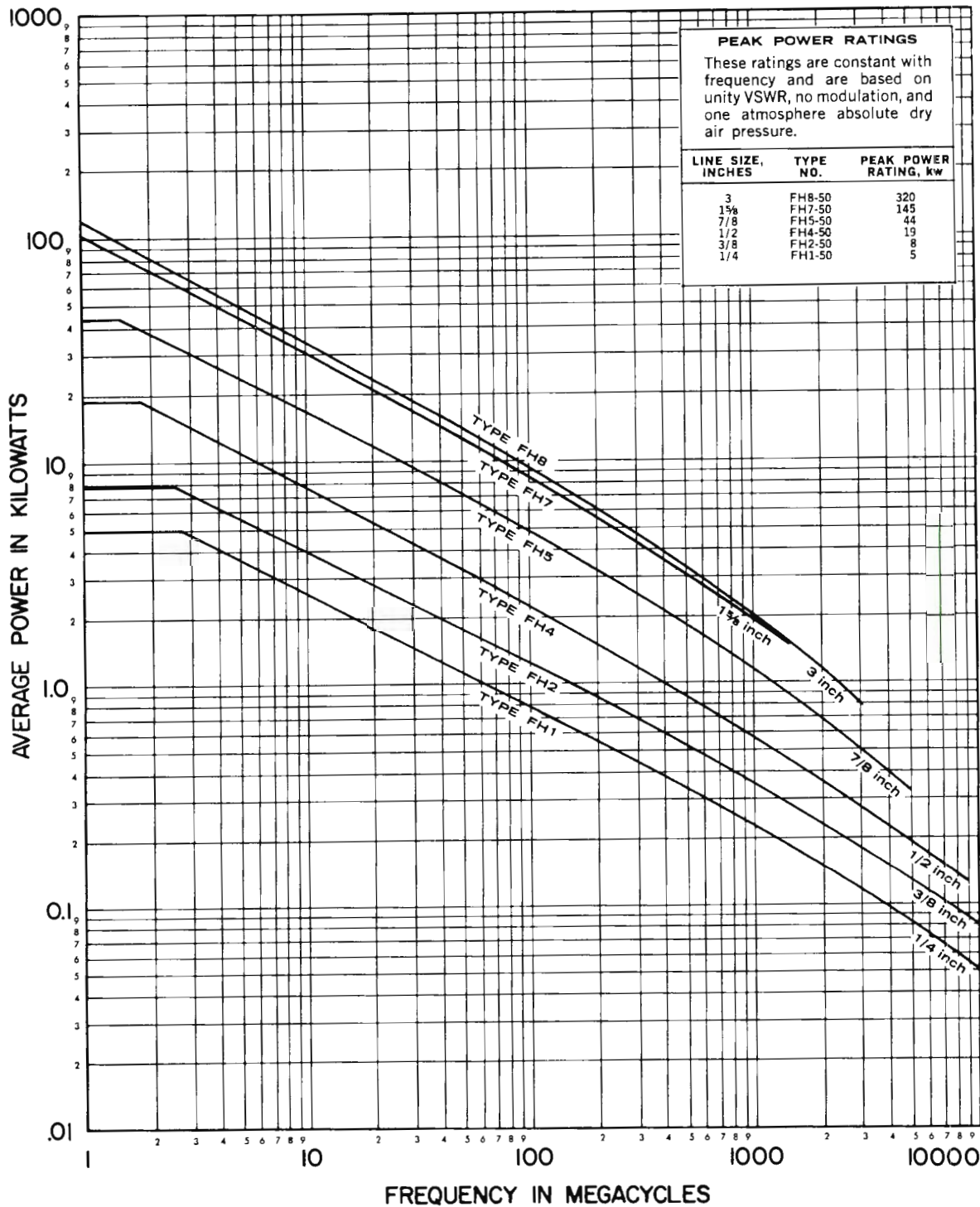

The average power ratings shown above are for 50 ohm copper Heliax and are based on unity VSWR and a maximum inner conductor temperature of 175°F at an ambient temperature of 104°F. For 75 ohm copper cables the values shown should be reduced 30%. For 50 ohm aluminum (outer conductor) cables the values should be reduced 10%.

ATTENUATION — RIGID TRANSMISSION LINES

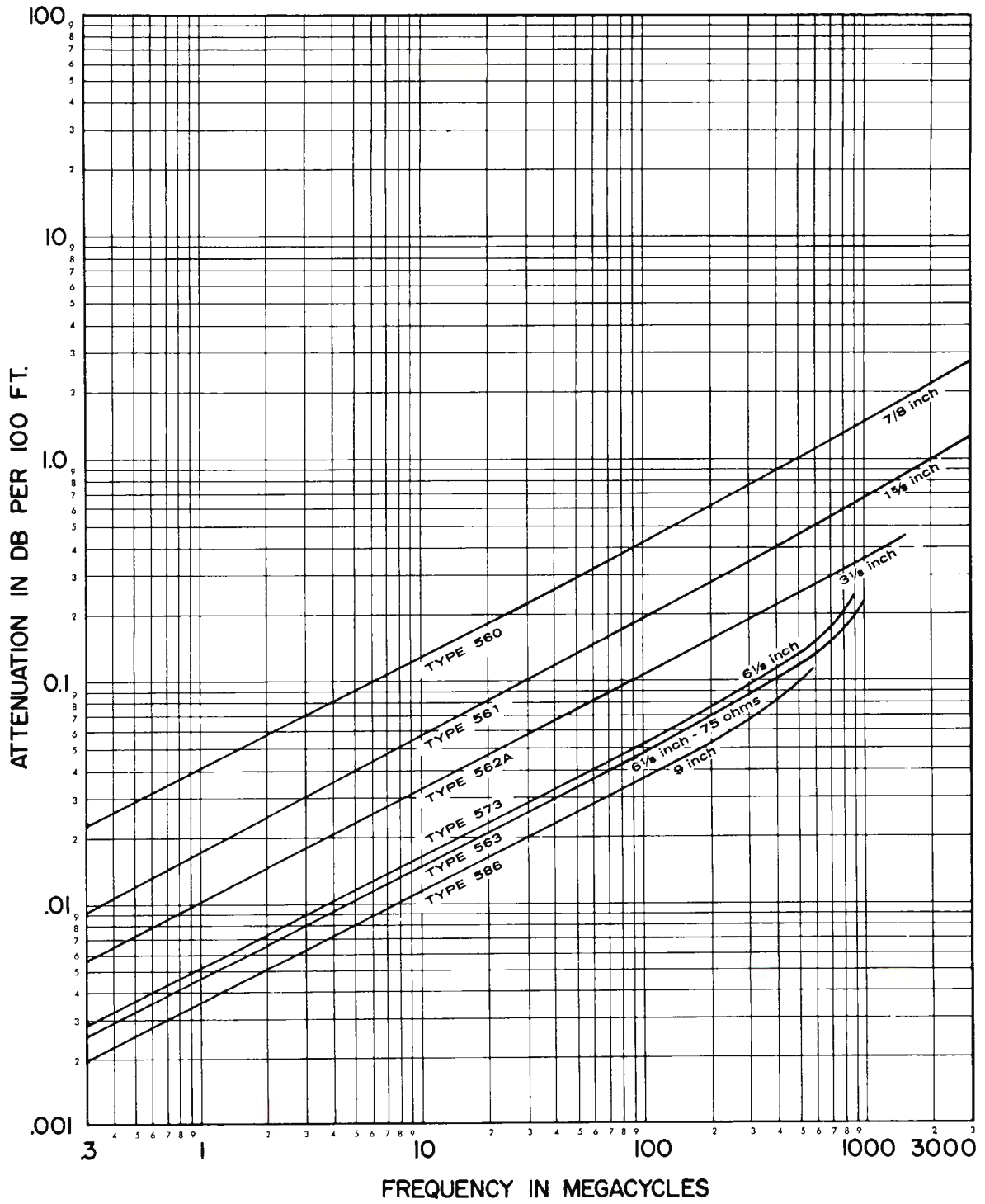

The attenuation curves above are based on unity VSWR.

# POWER RATING — RIGID TRANSMISSION LINES

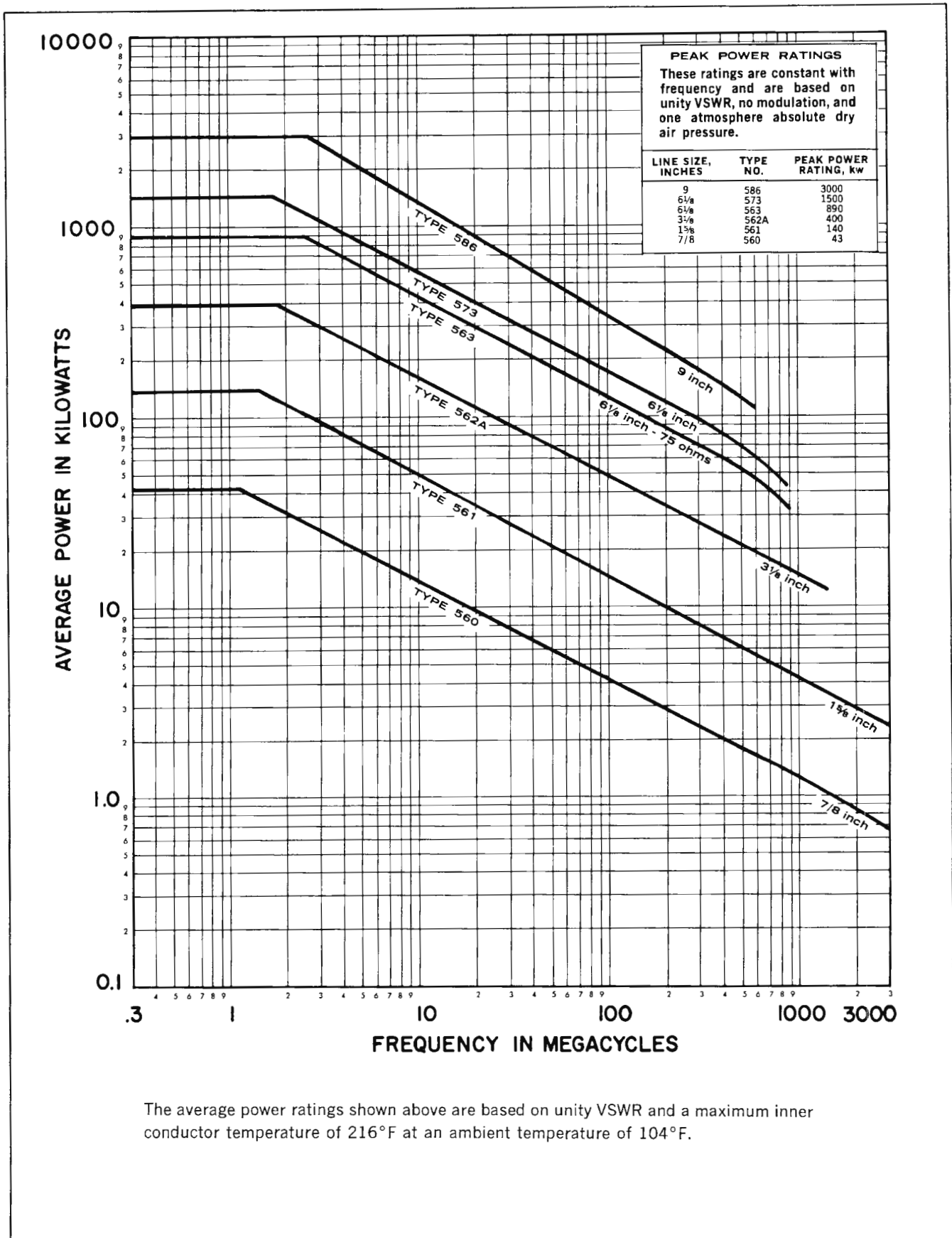

# Audio Facilities

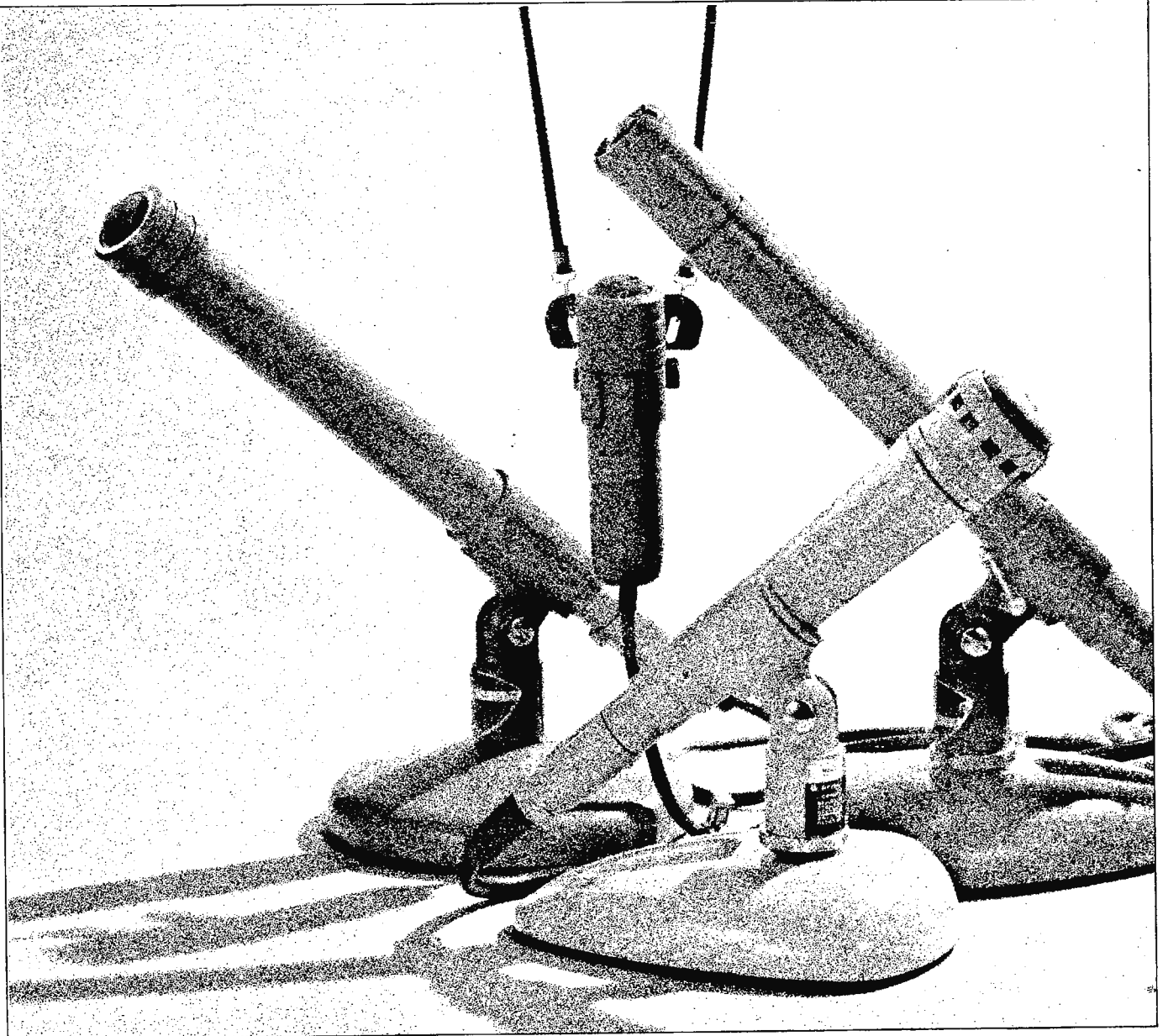



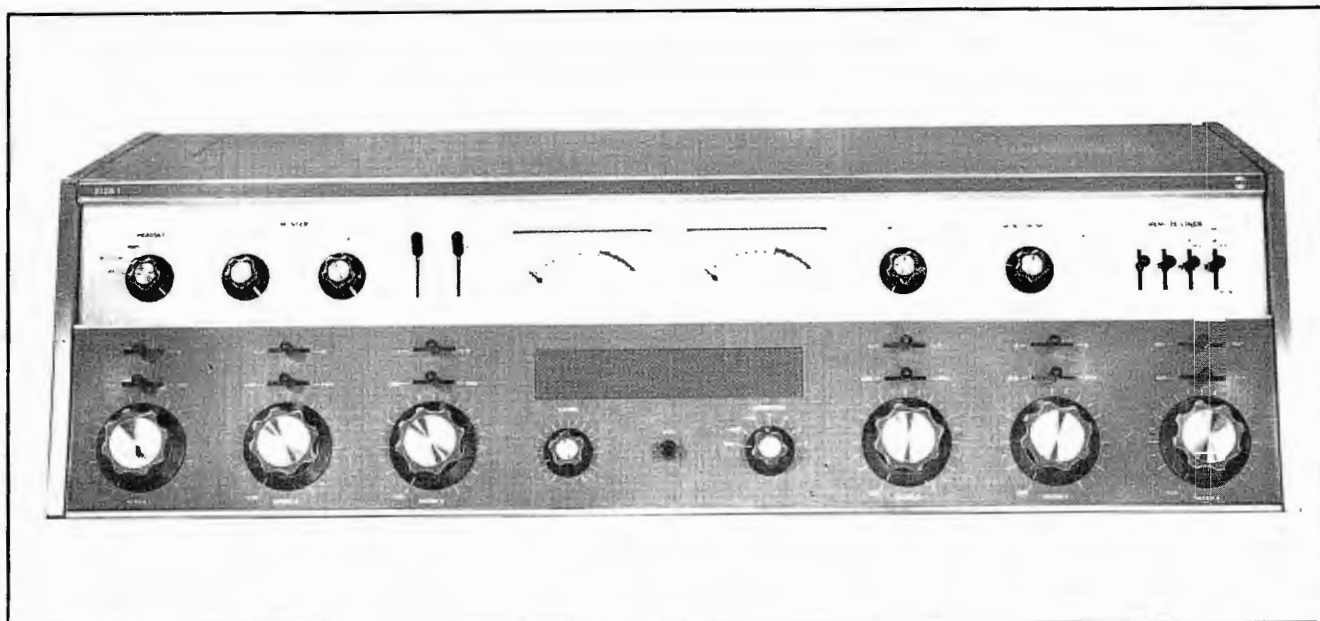

## COLLINS 212S-1 STEREO SPEECH INPUT CONSOLE

The Collins 212S-1 Speech Input Console features new concepts and techniques to offer broadcasters, recording studios and television studios quality performance with versatility and adaptability.

It's the newest switching technique in speech input consoles. It's noiseless. The switch is made of a photoconductive cell and a lamp in a sealed container. The cell shows a very low resistance when the lamp is on. This makes a switch with no contacts to wear, bounce or become contaminated.

A similar device for level control of the program material is also used. The photoconductive cell responds to variable voltages from a potentiometer to control attenuation in the signal path. This control eliminates maintenance time normally required for cleaning and relubrication of mixer controls.

Collins' new 212S-1 was designed primarily for stereo, but it can be used for monaural, too. It provides monaural output simultaneously on both program channels from a single input, or you can handle completely separate monaural material from inputs through two program outputs. One switch controls this function.

The fact that these photoconductive devices can be remotely controlled by dc voltages makes it possible to mount the switching and attenuating components where they are needed rather than on the front panel. This allows complete physical and electrical separation of the two program channels and elimination of all program audio wiring and components from the front panel.

Like all other Collins broadcast equipment, the 212S-1 is easy to install and maintain. Simple removal of a protective cover exposes the input/output terminals on the deck. Cable access ports through this deck permit an installation that's free of the "haywire look"! Removal

of another protective cover exposes the wiring to the card box receptacles. And inspection of the cards can be made simply by lifting the hinged card box to the vertical position. An extender card is furnished for troubleshooting at the component level with the cards connected to the rest of the console.

The solid-state amplifiers and the control elements are mounted on the plug-in cards which fit in two card boxes, one box for each program channel. The card box provides space and receptacles for six high-level or low-level pre-amplifiers, one program amplifier, one monitor amplifier and one switch matrix for remote line input switching. Each high-level and low-level card has two balanced inputs selectable from the front panel. Stable, high-quality components and circuits are used throughout the amplifiers to assure reliability and fidelity.

The VU meters may be switched to the channels or to external lines. Switching and terminals are also provided for the connection of the Collins type 900C-1 FM Stereo Modulation Monitor outputs to the inputs of monitor amplifiers.

The 212S-1 also includes an intercom amplifier that can be switched to one of four stations or to a selected remote line. The speaker is also used for the intercom microphone. The intercom amplifier can be used as the amplifier for the signals on the cue bus by setting the intercom switch at the cue position. A reverse cue amplifier is also provided so that program material may be sent back to a remote site preceding the start of a remote program.

Switching for warning light and speaker muting is provided by a relay unit with a self-contained 12-volt dc power supply. The power supply is used to power the

lamps which illuminate the VU meters. Four relays are included in the unit.

**CUSTOM INSTALLATION**

The same modules used in the 212S-1 lend themselves to custom radio and television studio installations. In custom installations, the modular flexibility of the 212S-1 allows the basic amplifiers to be arranged in many configurations depending upon your requirements. The modules containing the low-level input amplifiers, high-level input amplifiers, program amplifiers and monitor amplifiers can be rack-mounted while the control knobs and switches can be centralized for accessibility, or placed where needed. A control panel can be designed to special requirements or incorporated into your present system. If you're interested in custom studio operation, send a block diagram of your requirements for a quotation.

**260S-1 MIXER ADD-ON UNITS**

You can add input capability to the 212S-1 Speech Input Console with the addition of one or more Collins 260S-1 Mixer Add-on Units. You can add two complete stereo input channels for microphones, turntables or tape recorders. Each input amplifier has two selectable inputs. Level and switching control on the 260S-1 units are performed the same as on the 212S-1. The add-on units accommodate either four pre-amplifiers or four high-level input cards, or two pre-amplifiers and two high-level cards — depending upon your needs or sources.

**SPECIFICATIONS**

**Maximum Number of Channels:** Five stereo inputs from local sources plus one of four remote stereo inputs or one network stereo input. Each local stereo input may have two selectable sources. With each Add-On Unit 260S-1, two additional local stereo inputs may be used, each having two selectable sources.

**Power Source:** 115 v or 230 v AC  $\pm 10\%$ , 50-60 cps, single phase.

**Input Impedance:** Lower level — 30/150/250/600 ohms, balanced or unbalanced. Net/Remote — 600 ohms balanced. Medium level — 600 ohms balanced or unbalanced.

**Output Impedance:** Line — 600 ohms. 150 ohms on special order. Monitor — 8 ohms.

**Input Level:** Low — -55 dbm nominal. Medium — -10 dbm. Net/Remote — +8 dbm.

**Gain:** Low level to program output at least 100 db.

**Output Level:** Program — +8 dbm. Monitor — 10 watts.

**Frequency Response:**  $\pm 1$  db, 30-15,000 cps (ref. 1 kc) on both program and monitor outputs.

**Harmonic Distortion:** Less than 1% at max. program level or max. monitor level.

**Noise:** -120 dbm or less equivalent input noise.

**Size:** 10-1/8" (25.7 cm.) High  $\times$  37-3/16" (94.5 cm.)

Wide  $\times$  18-3/8" (46.7 cm.) Deep.

**Weight:** 65 lbs. approx. (29.5 Kg.).

**Color:** White and dark gray front panel; terra cotta accent strip. Light gray cabinet.

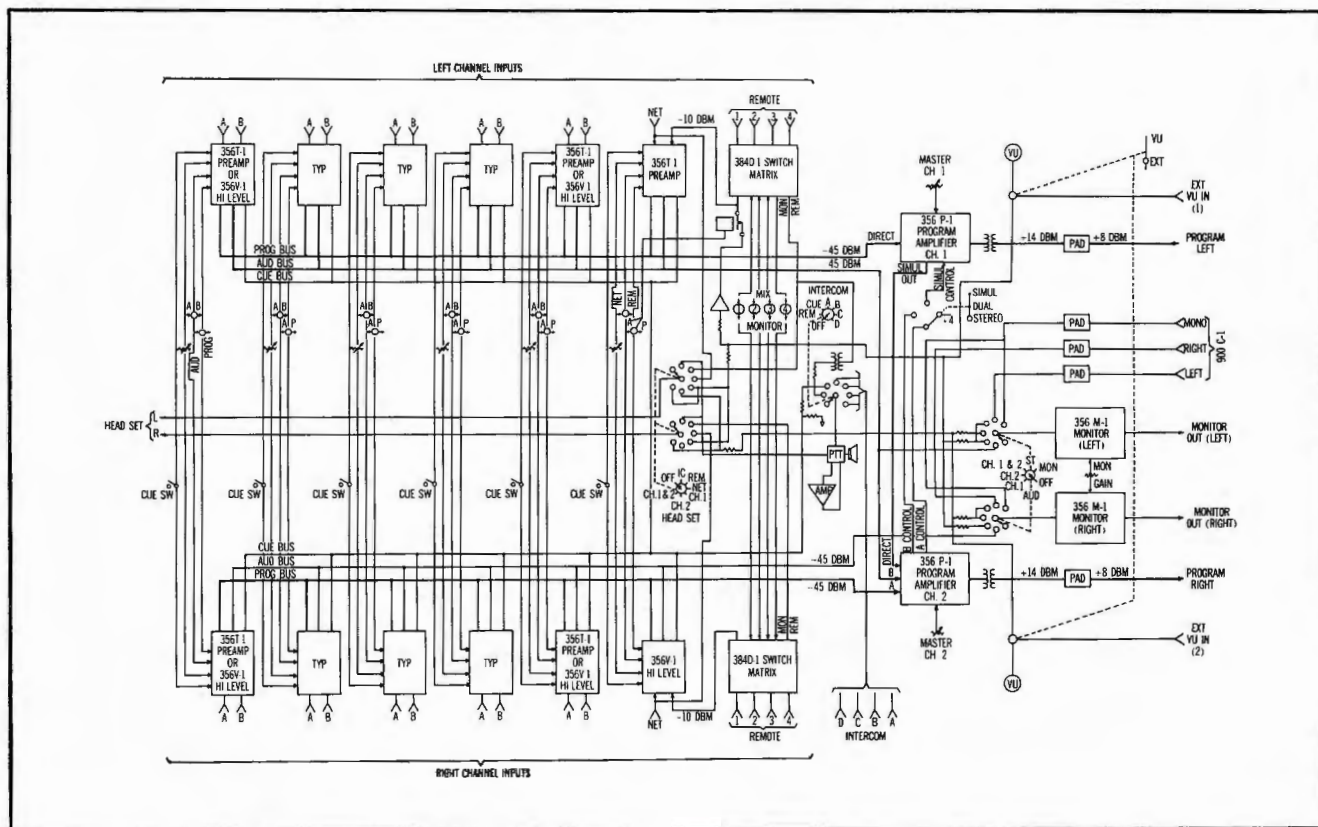

BLOCK DIAGRAM 212S-1



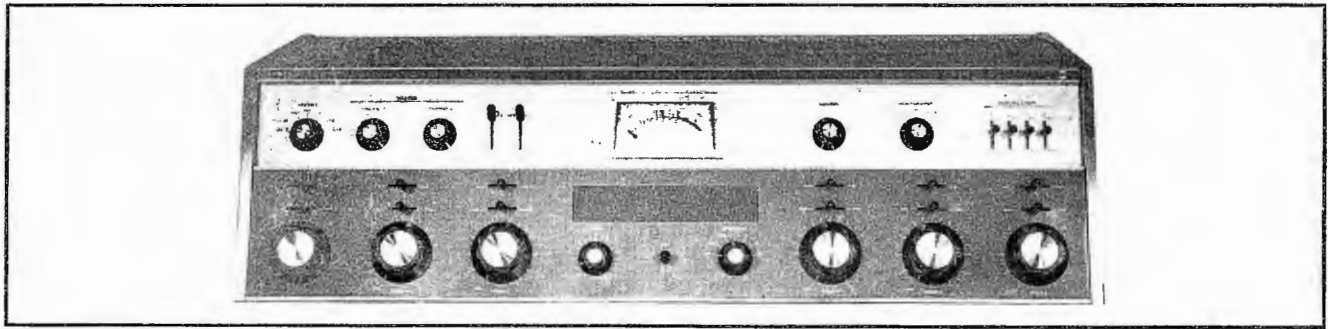

## COLLINS 212M-1 SPEECH INPUT CONSOLE

The 212M-1 is the monaural equivalent of the 212S-1 Stereo Console. Utilizing the source modules in a lesser quantity, the broadcaster can realize the same reliability, fidelity and operational features as described above by the 212S-1.

### SPECIFICATIONS

**Maximum Number of Channels:** Five mono inputs from local sources plus one of four remote inputs or one network input. Each local input may have two selectable sources. With each Add-On Unit 260A-1, two additional local inputs may be used, each having two selectable sources.

**Power Source:** 115 v or 230 v AC  $\pm 10\%$ , 50-60 cps. single phase.

**Input Impedance:** Low level — 30/150/250/600 ohms, balanced or unbalanced. Net/Remote — 600 ohms balanced. Medium level — 600 ohms balanced or unbalanced.

**Output Impedance:** Line — 600 ohms. 150 ohms on special order. Monitor — 8 ohms.

**Input Level:** Low — -55 dbm nominal. Medium — -10 dbm. Net/Remote — +8 dbm.

**Gain:** Low level to program output at least 100 db.

**Output Level:** Program — +8 dbm. Monitor — 10 watts.

**Frequency Response:**  $\pm 1$  db, 30-15,000 cps (ref. 1 kc) on both program and monitor outputs.

**Harmonic Distortion:** Less than 1% at max. program level or max. monitor level.

**Noise:** -120 dbm or less equivalent input noise.

**Size:** 10 $\frac{1}{8}$ " (25.7 cm.) High x 37- $\frac{3}{16}$ " (94.5 cm.) Wide x 18 $\frac{3}{8}$ " (46.7 cm.) Deep.

**Color:** White and dark gray front panel; terra cotta accent strip. Light gray cabinet.

**Weight:** 75 lbs.

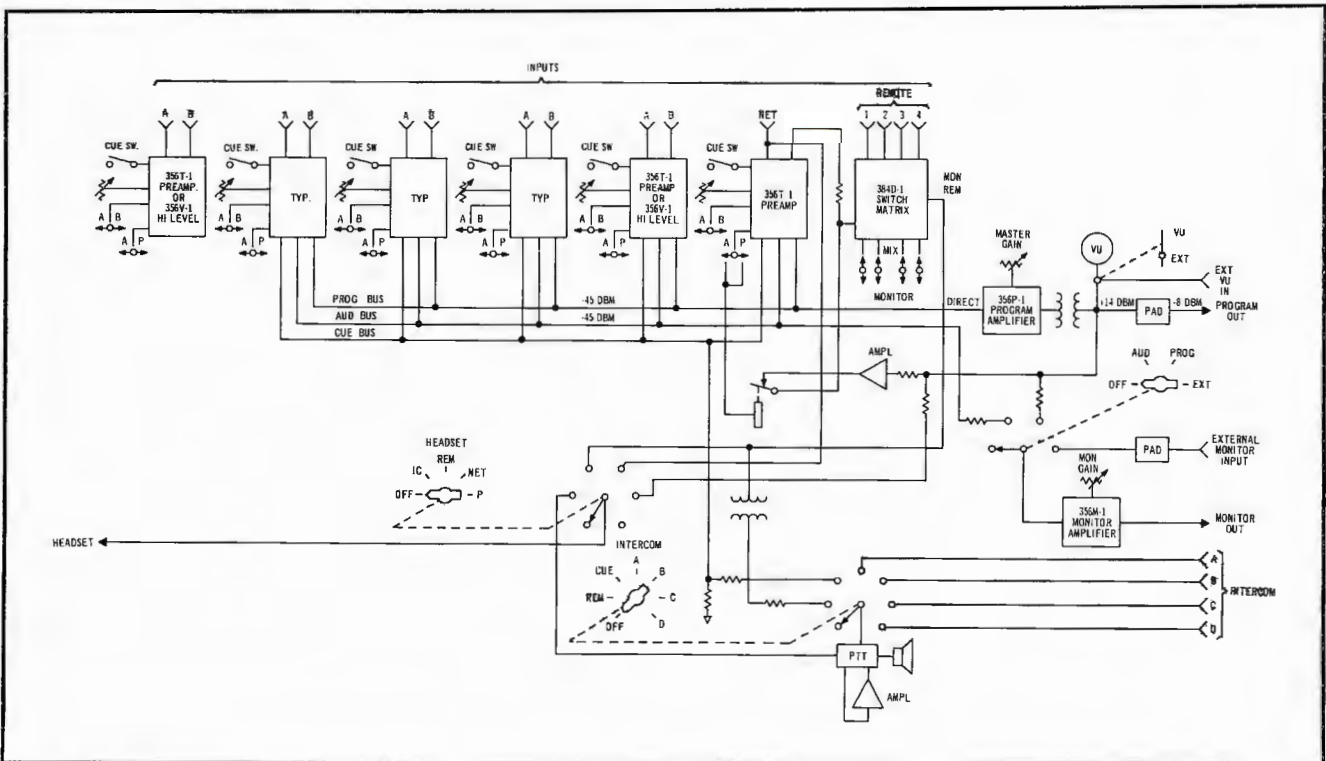

BLOCK DIAGRAM 212M-1

**COLLINS 356T-1 PREAMPLIFIER**

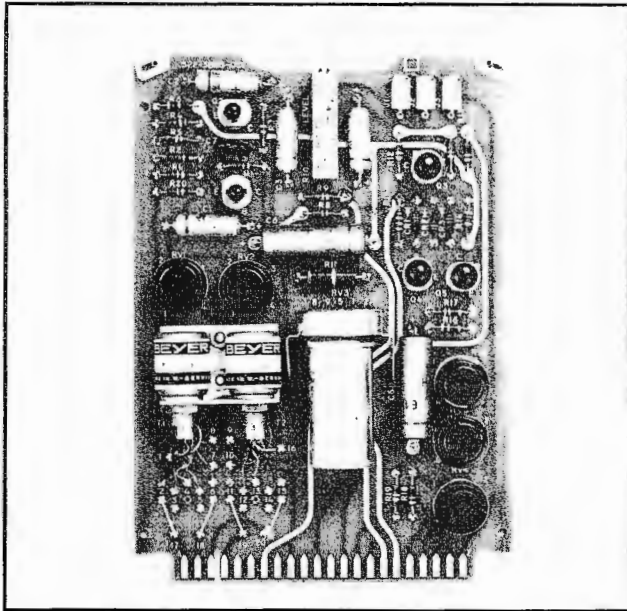

The 356T-1 is used with the 212S-1 and 212M-1 consoles in input channels where microphones are to be utilized.

**SPECIFICATIONS**

*Input Impedance:* 600, 250, 150, 30 choice, factory wired for 150. Balanced.

*Gain:* Total 50 DB voltage gain, -65 DBM from mic. will deliver -45 DBM to input to program amplifier. (Includes mixer loss.)

*Noise:* E. I. N. 120 DBM.

*Output Impedance:* Direct  $\approx$  150 ohms. Program >10K ohms - 25 DB mixing loss.

*Outputs:* 1. Direct                      3. Audition  
                  2. Program                    4. Cue

*Inputs:* MIC 1                      Max. IN = -30DBM  
                  MIC 2                      Max. IN = -30DBM

*Power Requirements:* +30 VDC Regulated at 5 MA

Attenuator & Switch Lamps       $\left\{ \begin{array}{l} +6 \text{ VDC Regulated at } 60 \text{ MA} \\ \text{(1 lamp)} \\ +4 \text{ VDC Regulated at } 120 \text{ MA} \\ \text{(3 lamps)} \end{array} \right.$

*Frequency Response:*  $\pm .5$  DB from 30 cps to 15 KC. (ref. to 1 KC)

*Harmonic Distortion:* 0.5% max. at rated output.

*Temperature Limits:* 0° to 50° C.

*Size:* 4" x 6" plug-in card; 1" max. component height.

*Adjustments:* Trim Pot for tracking attenuators.

*Attenuator:* Photo-cell lamp unit built into circuit board. 0 VDC to 6 VDC (controlled by external series variable resistor\*) attenuates signal over a 55 DB range.

*Switches:* Photo-cell lamp unit used for all audio circuit switching.

\*One variable resistor may be used to control attenuation of two Preamps. Preamps track within  $\pm$  DB.

**356V-1 HIGH LEVEL INPUT PREAMPLIFIER**

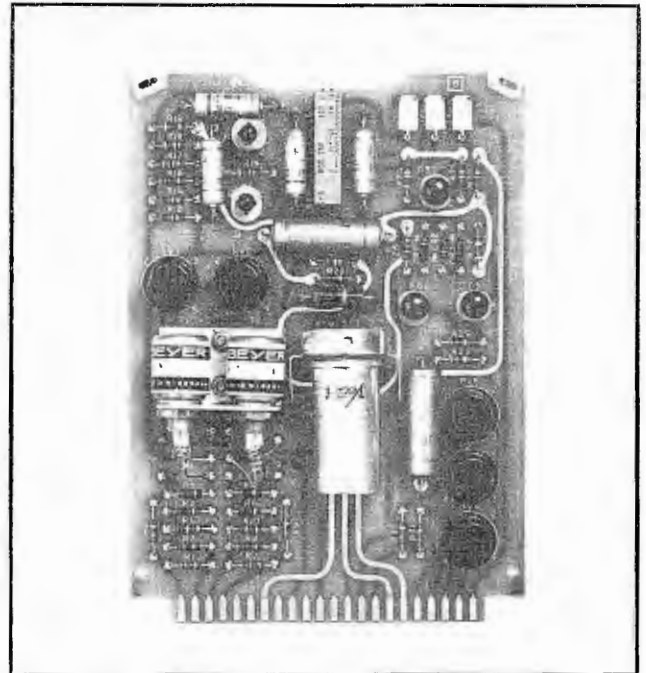

The 356V-1 is required for input channels for the 212S-1 and 212M-1 consoles where outputs of the turntable preamplifier, tape recorders, and other equipments with audio outputs between -10 DBM and +10 DBM are fed into the console.

**SPECIFICATIONS**

*Input Impedance:* 600 ohms, balanced.

*Gain:* -10 DBM input will deliver -45 DBM to input of program amplifier. (Includes mixer loss) 30 DB pad on input.

*Output Impedance:* Direct  $\approx$  15 ohms.

Program: >10K ohms - 25 db mixing loss

*Outputs:* 1. Direct                      3. Audition  
                  2. Program                    4. Cue

*Inputs:* IN 1: Maximum input = +10 DBM

*Inputs:* IN 2: Maximum input = +10 DBM

*Power Requirements:* +30 VDC at 5 MA

Attenuator & Switch Lamps       $\left\{ \begin{array}{l} +6 \text{ VDC at } 60 \text{ MA Regulated} \\ \text{(1 lamp)} \\ +4 \text{ VDC at } 120 \text{ MA Regulated} \\ \text{(3 lamp)} \end{array} \right.$

*Frequency Response:*  $\pm .5$  DB from 30 cps to 15 keps (Ref. to 1 KC)

*Harmonic Distortion:* 0.5% maximum at rated output.

*Temperature Limits:* 0° to +50° C.

*Size:* 4" x 6" plug-in card; 1" maximum component height.

*Adjustments:* Trim-pot for Tracking Attenuators.

*Attenuator:* Photo-cell lamp unit built into circuit board. 0 VDC to 6 VDC (controlled by external series variable resistor\*) attenuates signal over a 55 DB range.

*Switches:* Photo-cell lamp unit used for all audio circuit switching.

\*One variable resistor may be used to control attenuation of two hi-level inputs. Tracking is within  $\pm 1$  db.



## 356P-1 PROGRAM AMPLIFIER

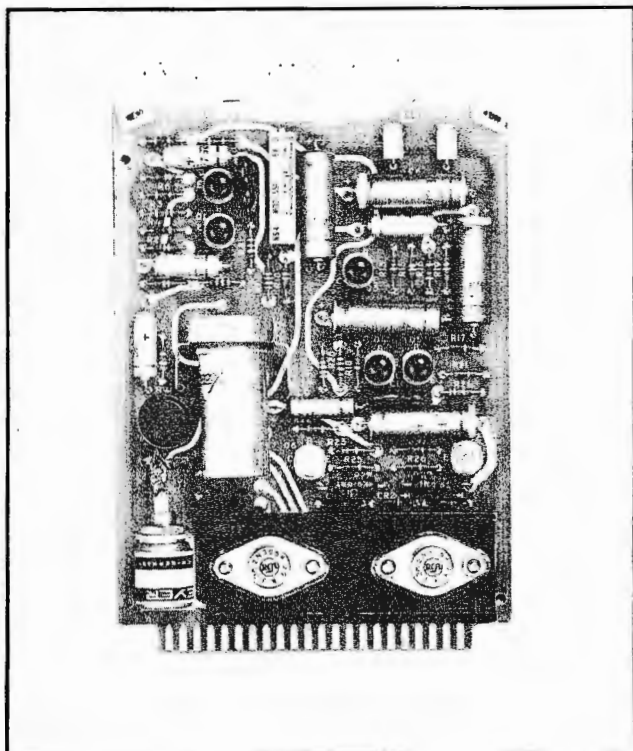

The 356P-1 is supplied for use in 212S-1 and 212M-1 consoles as program output amplifiers.

### SPECIFICATIONS

*Input Impedance:* 600 ohms, balanced or unbalanced.

*Gain:* -45 DBM input will deliver +18 DBM at maximum gain setting. 63 DB GAIN.

*Output Impedance:* 600 ohms (external transformer and capacitor required, not supplied) (direct output impedance less than 30 ohms)

*Outputs:* 1. Program  
2. Simulcast

*Inputs:* 1. Switched 1  
2. Switched 2  
3. Direct

*Power Requirements:* +48 VDC at 100 MA (full output)

Attenuator & Switch Lamps  $\left\{ \begin{array}{l} +6 \text{ VDC at } 60 \text{ MA regulated} \\ +4 \text{ VDC at } 40 \text{ MA regulated} \end{array} \right.$

*Frequency Response:*  $\pm 0.5$  DB from 30 cps to 15k cps (Ref. to 1 KC)

*Harmonic Distortion:* 0.5% maximum at rated output.

*Temperature Limits:* 0° to +50° C.

*Size:* 4" x 6" plug-in circuit card; 1" maximum component height.

*Adjustments:* Trim-pot for Simulcast gain set.

*Attenuator:* Photo-cell lamp unit built into circuit board. 0 VDC to 6 VDC (controlled by external series variable resistor) attenuates signal over a 50 DB range.

*Simulcast:* Simulcast output and photo-cell switched inputs allow switching for dual, stereo or simulcast without level adjustments.

## 356M-1 MONITOR AMPLIFIER

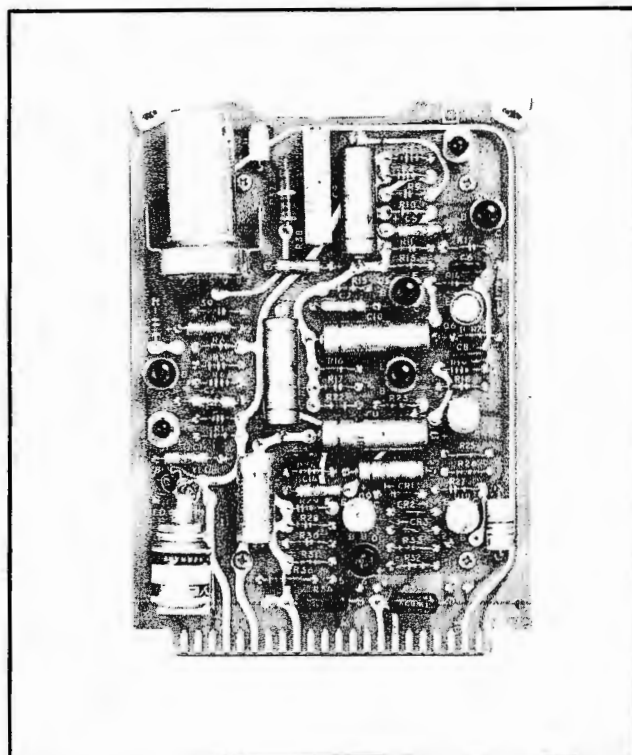

The 356M-1 is used in 212S-1 and 212M-1 consoles as the monitor amplifier.

### SPECIFICATIONS

*Input Impedance:* 600 ohms balanced.

*Gain:* 90 DB — -50 DBM input will deliver 10 watts to speaker load.

*Output Impedance:* 4, 8 or 16 ohm speakers may be used; 8 ohms optimum. (External coupling capacitor required.)

*Outputs:* One to speaker

*Inputs:* One

*Power Requirements:* +48 VDC at 750 MA (full output)

Attenuator: +6 VDC at 60 ma regulated.

*Frequency Response:*  $\pm 1$  DB from 30 cps to 15k cps. (Ref. to 1 KC)

*Harmonic Distortion:* Less than 1% at rated output. (10 watts RMS)

*Temperature Limits:* 0° to +50° C.

*Size:* 4" x 6" plug-in circuit card; 3 $\frac{3}{8}$ " thick (heatsink attached)

*Adjustments:* Trim-pot for tracking attenuator.

*Attenuator:* Photo-cell lamp unit built into circuit board. 0 VDC to 6 VDC (controlled by external series variable resistor\*) attenuates signal over a 50 DB range.

\*One variable resistor may be used to control attenuation of two monitor amplifiers, tracking is within  $\pm 1$  DB.

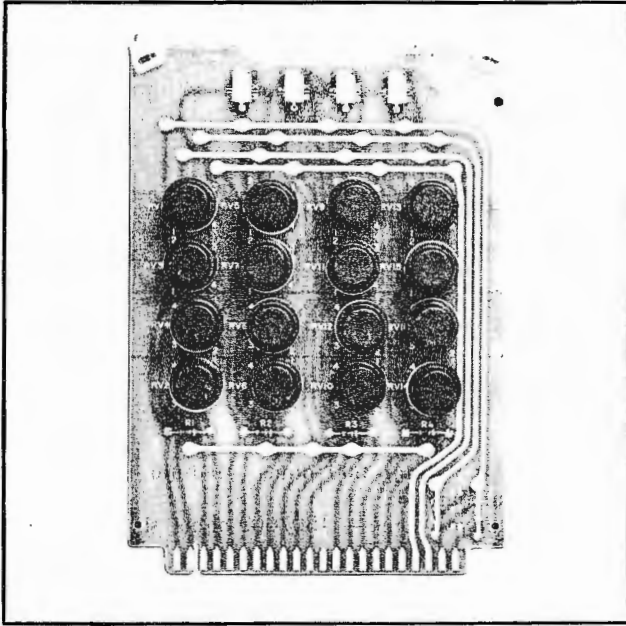
**384D-1 SWITCH MATRIX**

The 384D-1 is used in the 212S-1 and 212M-1 consoles to switch remote lines coming into the consoles.

**SPECIFICATIONS**

*Function:* A 4 x 2 matrix switch using photo-cell lamp combinations.

*Inputs:* 4 (balanced lines)

*Input Impedance:* 820 ohms.

*Outputs:* 2 (balanced lines)

*Output Impedance:* Designed to work into 10K ohms.

*Power:* 4VDC at 40 MA times number of cells turned on.  
Maximum requirement  $16 \times .04 = .64$  amps.

*Temperature Limits:* 0 to +50° C.

*Size:* 4" x 6" plug-in circuit card, 3/4" maximum component height.

*Switching Control:* Eight switching functions.

**COLLINS 212G-1 SPEECH INPUT CONSOLE**

The 212G-1 is a flexible, self-contained unit that provides complete control over simultaneous broadcasting and auditioning from any combination of 9 to 13 inputs.

The Collins 212G-1 Console is designed for medium-size radio stations and recording studios which demand a versatile console at production line prices. Main features of the 212G-1 are its quality, reliability, ease of servicing plug-in modules and wide variety of controls.

The long, low design of the 212G-1 assures easy operation on an uncrowded control panel. Finger-fitted knobs with big skirts are easily grasped for exact level control.

The VU meter is centered on the panel directly in front of the operator. The lights are external to the meter and may be replaced without removing the meter face. The

**409Z-1 POWER SUPPLY**

The 409Z-1 supplies the necessary voltage for the modules of the 212S-1 and 212M-1 consoles.

**SPECIFICATIONS**

*Input Voltage:* 115/220 VAC at 4/2 amps 50/60 cps.

*Output Voltage:*

- Outputs*
1. 48 volts DC at 1 amp series regulated, zener reference. Less than 5 MV ripple.
  2. 48 volts DC at 1 amp series regulated, zener reference. Less than 5 MV ripple.
  3. 30 VDC at 50 MA zener regulated. Less than 1 MV ripple.
  4. 30 VDC at 50 MA zener regulated. Less than 1 MV ripple.
  5. +6 VDC at 1.5 amps, less than 5 MV ripple. Adjustable series regulator, temperature compensated.
  6. +4 VDC at 2.5 amps, less than 5 MV ripple. Adjustable series regulator, temperature compensated.

*Size:* Chassis construction. 13" x 8" x 8 1/2" height.

*Weight:* 30 lbs.

meter lights operate from the relay supply voltage giving visual indication of proper operation. A switch allows the VU meter to measure program or external audio levels and gain reduction when a 356E-1 Limiting Amplifier is substituted for a Collins 356B-1 Program Amplifier.

The 356B-1 Monitor Amplifier input may be switched to program, audition or external inputs. Six cueing-type attenuators, a plug-in cueing amplifier and a cueing speaker free the 212G-1 monitor circuits from cueing service.

The hinged top of the Collins 212G-1 Console provides adequate room to service components while the panel remains in position and the unit is operating. No high voltage points are exposed when the cabinet is opened. A



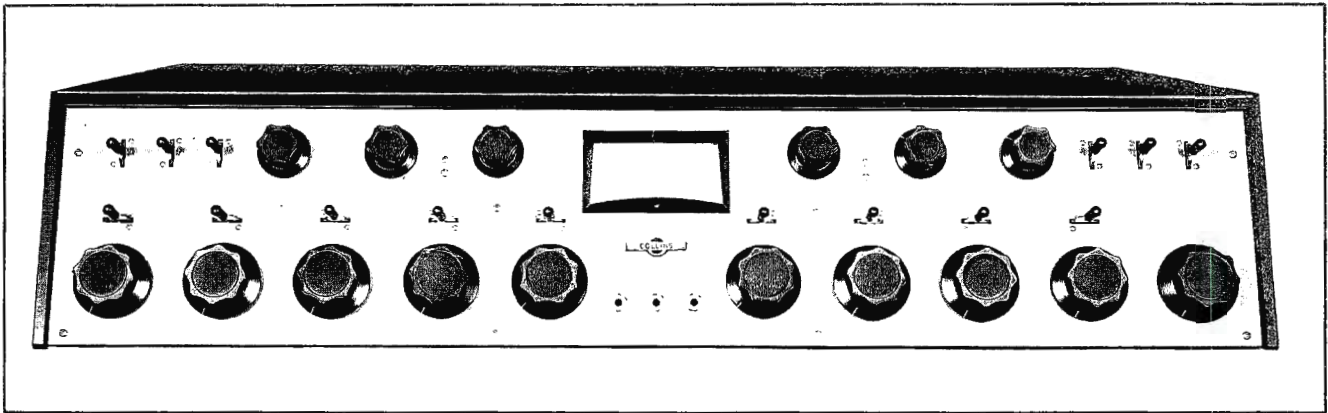

COLLINS 212G-1 SPEECH INPUT CONSOLE

cover protects the terminal wiring strip and connector wiring.

Any of eight circuits may be selected on a terminal strip for control of speakers and warning lights. Extra wiring terminals and two spare lever-switches are provided.

Only two tube types are used in the 212G-1. Slots in the bottom, back and top of the Console provide adequate ventilation for low operating temperatures insuring longer component life.

**Maximum Number of Channels:** Six low level channels, two medium level channels, one net/remote channel, one program channel, one monitor channel and one cueing channel when provided with: eight 356A-1 Preamplifiers, one 356B-1 or 356E-1 Amplifier, one 356B-1 Program/Monitor Amplifier, one 274K-2 Relay Unit, one 356Q-1 Cueing Amplifier and one 409X-2 Power Supply.

**Power Source:** 115 v or 230 v ac  $\pm 10\%$ , 50-60 cps, single phase.

**Input Impedance:** Low level — 30/150/250/600 ohms balanced or unbalanced, shipped wired for 150 ohms. Net/remote lines — 50/150/250/600 ohms.

shipped wired for 600 ohms. Medium level — 600 ohms unbalanced.

**Output Impedance:** Line — 150/600 ohms, shipped wired for 600 ohms. Monitor — 600 ohms.

**Input Level:** Low — -50 dbm nominal (100 db gain). Net/remote — 0 dbm. Medium — -10 dbm nominal (60 db gain).

**Gain:** Low level to program line 100 db. Remote line to program line 53 db. Medium level to program line 62 db.

**Output Level:** Program — +18 dbm (65 mw). Monitor — +39 dbm (8 watts).

**Response:**  $\pm 1.5$  db. 50-15,000 cps at program line.

**Distortion:** Less than 1% at +18 dbm at program line.

Less than 3% at 8 watts out of Monitor Amplifier.

**Noise:** At least 68 db below +18 dbm output with -50 dbm low level input. (Equivalent input noise level -118 dbm or less.)

**Size:** 41 1/2" W, 8 1/4" H, 21 1/8" D (104.3 cm W, 20.96 cm H, 53.66 cm D).

**Weight:** 75 lbs. (34.02 kg), less modules.

**Part No. 522 1605**

Includes basic cabinet, three 356A-1 Preamplifiers, two 356A-1 boosters, two 356B-1 Program/monitor Amplifiers, one 409X-2 Power Supply, one 274K-2 Relay Unit, one set of tubes and instruction book.

**No Part Number**

FCC set of spare tubes for 212G-1 as listed above.

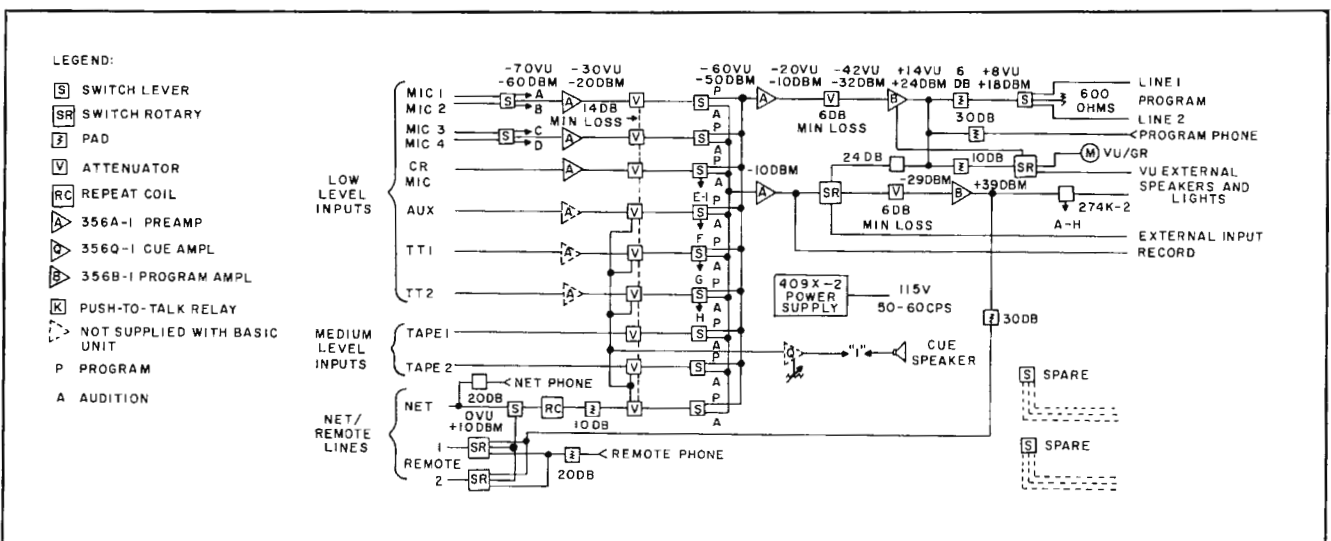

BLOCK DIAGRAM 212G-1

**COLLINS 356A-1 PREAMPLIFIER**

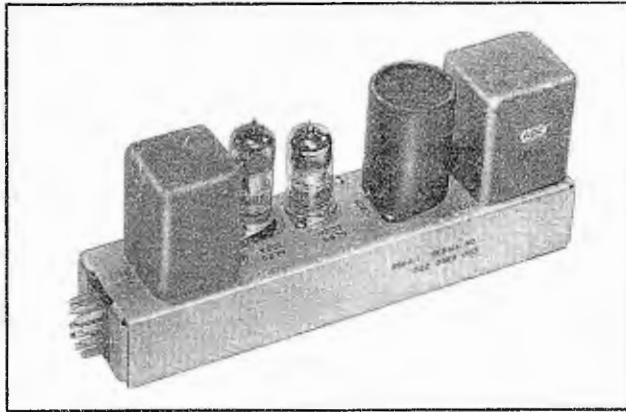

Usually used to feed a line amplifier in the Collins Consoles, the 356A-1 operates from a low level microphone or similar source and has sufficient output to drive a program amplifier or audition facilities.

*Input Impedance:* Unloaded transformer, source impedance 30/150/250/600 ohms balanced or unbalanced, shipped wired for 150 ohms.

*Input Level:* -60 db nominal.

*Output Impedance:* 150/600 ohms balanced or unbalanced, shipped wired for 600 ohms.

*Output Level:* +18 dbm maximum.

*Gain:* 40 db.

*Frequency Response:* ±1 db, 50-15,000 cps.

*Distortion:* 0.5% maximum.

*Noise:* -118 dbm at input, or 96 db below full output.

*Tubes:* Two 5879.

*Power Requirements:* 6.3 v ac or dc at 0.3 amp. 250 v dc at 6.5 ma or 300 v dc at 7.5 ma.

*Size:* 2 1/8" W, 4 3/8" H, 9 1/2" D (5.40 cm W, 11.75 cm H, 24.13 cm D).

*Weight:* 2 1/4 lbs. (1.02 kg).

Part No. 522 0389 005  
No Part Number  
100% spare tube kit.

**COLLINS 356B-1 PROGRAM/MONITOR AMPLIFIER**

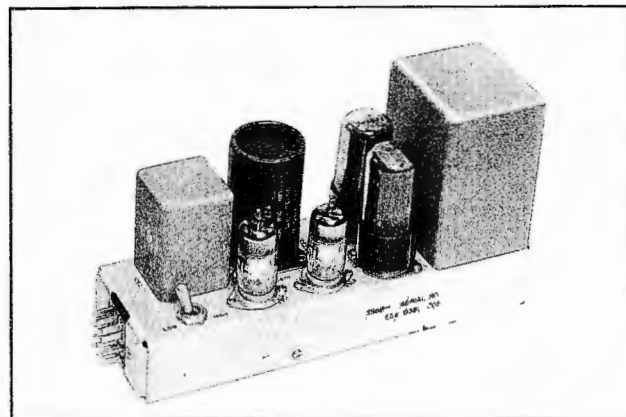

Used as the program line amplifier and monitor amplifier in Collins Consoles, the 356B-1 is a three stage amplifier with push-pull output and has a switch for high or low gain.

*Input Impedance:* Unloaded transformer, source impedance 150/600 ohms balanced or unbalanced, shipped wired for 600 ohms.

*Input Level:* -32 dbm.

*Output Impedance:* 150/600 ohms balanced or unbalanced, shipped wired for 600 ohms.

*Output Level:* +39 dbm (8 watts) maximum.

*Gain:* 56 db or 68 db, selected by toggle switch.

*Frequency Response:* ±1 db, 50-15,000 cps.

*Distortion:* 0.5% maximum at +30 dbm, 3% maximum at +39 dbm (8 watts).

*Noise:* -116 dbm at input, or 90 db below full output of 1 watt.

*Tubes:* Two 5879 and two 6V6.

*Power Requirements:* 6.3 v ac at 1.2 amps. 63 ma at 250 v dc at 1 watt output. 75 ma at 300 v dc at 1 watt output. 88 ma at 300 v dc at 8 watts output.

*Size:* 2 7/8" W, 5 3/4" H, 9 1/2" D (7.3 cm W, 14.61 cm H, 24.13 cm D).

*Weight:* 6 lbs. (2.72 kg).

Part No. 522 0390 005  
No Part Number  
100% spare tube kit.

**COLLINS 356E-1 LIMITING AMPLIFIER**

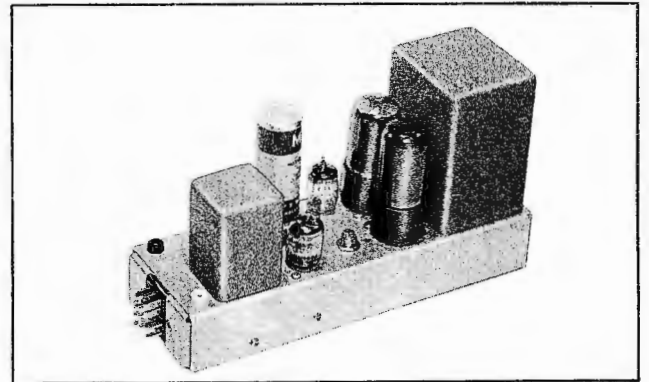

Designed for Collins Speech Input Consoles to permit unattended remote audio operation, the 356E-1 can be used to control level differences between two or more sources, as a program line compressor, in an expander-compressor operation or as a program amplifier.

The module consists of a push-pull variable gain input stage driving a push-pull output stage. A bias rectifier provides bias to regulate gain of the input stage. A decal to convert a VU meter to a gain reduction meter is furnished with the unit.

*Input Impedance:* Unloaded transformer, source impedance 150/600 ohms balanced or unbalanced, shipped wired for 600 ohms.

*Input Level:* -54 dbm to -24 dbm, with threshold control set at 0 dbm output. -34 dbm to -4 dbm, with threshold control set at +20 dbm output. -24 dbm to +6 dbm, with threshold control set at +30 dbm output. (0 dbm equals 1 mw across 600 ohms.)

*Output Impedance:* 150/600 ohms balanced or unbalanced, shipped wired for 600 ohms.

*Output Level:* 0 dbm to +18 dbm, with threshold control set at 0 dbm output. +20 dbm to +30 dbm, with threshold control set at +20 dbm output. +30 to +36 dbm, with threshold control set at +30 dbm output.

*Response:*  $\pm 1$  db, 50-15,000 cps.

*Distortion:* 1.5% maximum, 50-15,000 cps, with no compression. 2% maximum, 50-15,000 cps, at any level up to 30 db gain reduction, with threshold control set at +20 dbm output.

*Output Noise:* -50 dbm or less, threshold control set for +20 dbm output.

*Compression Ratio:* Adjustable 1.6:1 to 5:1, with 3:1 optimum performance over a 30 db range at input.

*Attack Time:* 11 milliseconds, with switch set for dual operation. 62 milliseconds, with switch set for average operation.

*Release Time:* 0.9 seconds for 63% recovery, with switch set for dual operation. 5.2 seconds for 63% recovery, with switch at average operation.

*Gain:* 54 db.

*Controls:* Dual/Average toggle switch at top near front of chassis.

*Tubes:* One GL-6386 Variable Gain Input Amplifier, two 6V6GT Output Amplifiers and one 6AL5 Bias Rectifier.

*Power Source:* 6.3 v ac at 1.55 amps, 300 v dc at 77 ma.

*Size:* 3" W, 5 $\frac{3}{8}$ " H, 9" D (7.63 cm W, 13.65 cm H, 22.86 cm D).

*Weight:* 5 lbs. (2.27 kg).

Part No. 522 0394 005

No Part Number

100% spare tube kit.

## COLLINS 356Q-1 CUE AMPLIFIER

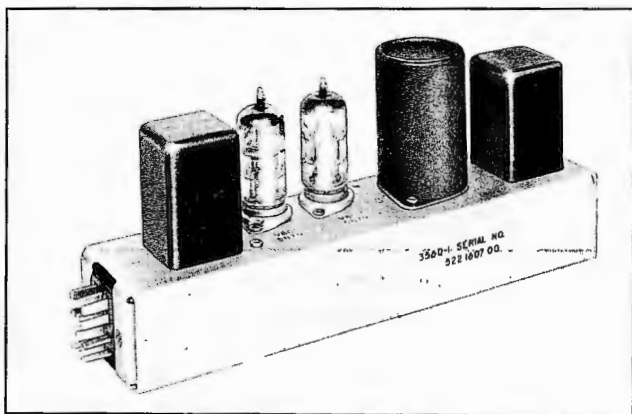

Designed for use in the Collins Consoles, the 356Q-1 is a two stage amplifier used to amplify signals from the cueing line. The 212G-1 has provisions for controlling the gain of the amplifier and includes a speaker for the output.

*Gain:* 55 db.

*Range:* 300-10,000 cps.

*Input Level:* -30 dbm nominal.

*Output Level:* +20 dbm (100 mw) nominal.

*Input Impedance:* 600 ohms nominal.

*Output Impedance:* 4 ohms.

*Tubes:* Two 5879.

*Power Requirements:* 6.3 v ac or dc at 0.3 amp, 300 v dc at 7.5 ma.

*Size:* 2 $\frac{1}{8}$ " W, 4 $\frac{5}{8}$ " H, 9 $\frac{1}{2}$ " D (5.4 cm W, 11.75 cm H, 24.13 cm D).

*Weight:* 2 $\frac{1}{4}$  lbs. (1.02 kg).

Part No. 522 1607 00

No Part Number

100% spare tube kit.

## COLLINS 409X-2 POWER SUPPLY

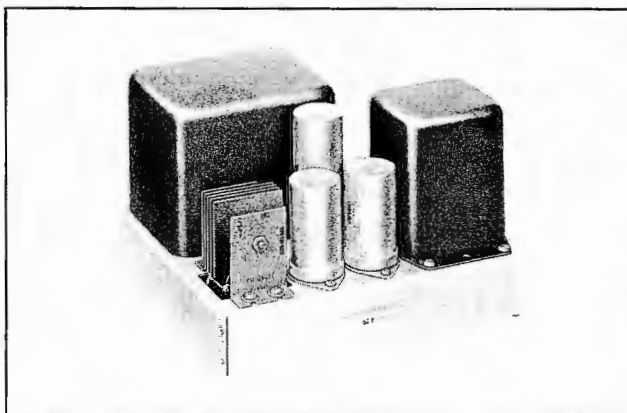

A plug-in module for Collins Consoles, this unit uses silicon rectifiers in the high voltage circuit for long life and to eliminate heat associated with vacuum tube rectifiers.

*Output Voltages:* Up to 250 ma at 300 v dc adjustable. 6.0 amps at 6.3 v ac, 1.0 amp at 12 v dc.

*Power Requirements:* 115/230 v ac  $\pm 10\%$ , 50-60 cps, single phase.

*Power Input:* 225 watts maximum.

*Size:* 8" W, 6" H, 9 $\frac{1}{2}$ " D (20.32 cm W, 15.24 cm H, 24.13 cm D).

*Weight:* 25 lbs. (11.34 kg).

Part No. 522 1691 00

Part No. 542 3042 004

Power Supply Cable.

## COLLINS 274K-1 RELAY UNIT

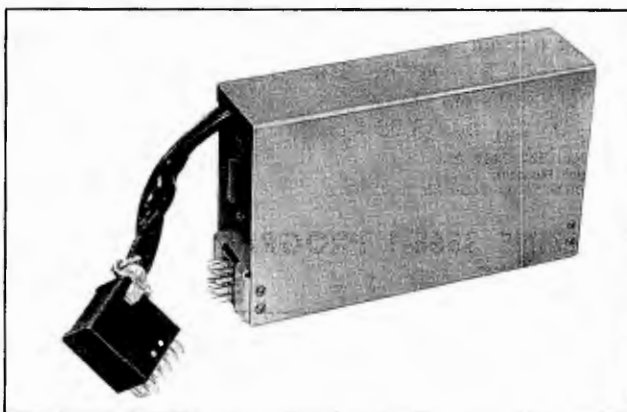

Used in Collins 212E-1 Console, this unit has four relays to control studio speakers and warning lights. Each relay is provided with a series shunt circuit to minimize switching transients and arcing. Noise is held to a minimum by mounting the relays on rubber. The 409X-2 Power Supply provides 12 v dc at 1 amp and studio wiring provides power for the warning lights.

*Connectors:* Howard Jones P-312-AB connector mounted on the front surface and P-315-CCE connector on a 5 $\frac{1}{2}$ " pendent cable.

*Size:* 21 $\frac{1}{2}$ " W, 5 $\frac{1}{2}$ " H, 9" D (6.35 cm W, 13.97 cm H, 22.86 cm D).

*Weight:* 2 $\frac{1}{2}$  lbs. (1.13 kg).

Part No. 522 0391 005



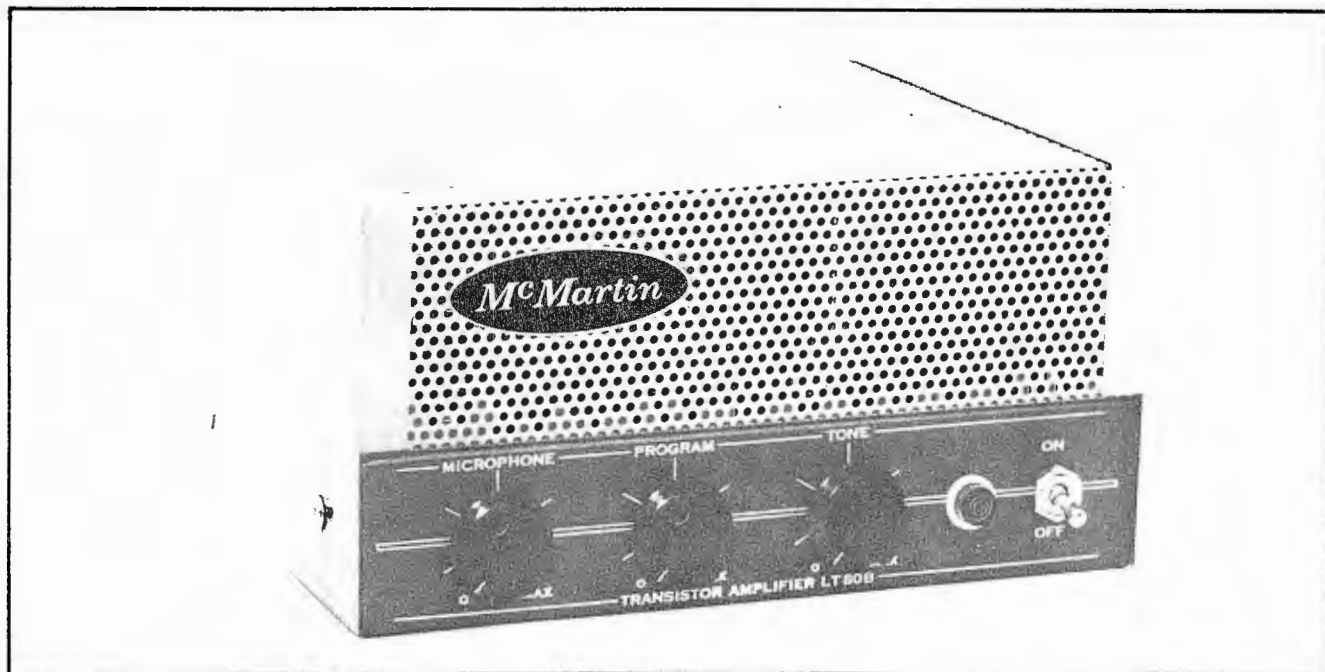

## McMARTIN MODEL LT-80B AUDIO AMPLIFIER

The LT-80B is a transistorized light weight audio amplifier which delivers a full 8 watt rms with less than 1% distortion from 50 to 15,000 cps at 1 watt. Hand wired circuitry provides a compact unit weighing less than 6 pounds. The unit is provided with complete overload protection and operates at full performance in high ambient temperatures to 150° F.

### SPECIFICATIONS

**Power Output:** 8 watts RMS @ 1,000 cps  
12 watts music power  
16 watts peak power

**Frequency Response:** 30 to 15,000 cps  $\pm 2$  db.  
20 to 20,000 cps  $\pm 3$  db.

**Distortion:** Less than 1% 50 to 15,000 cps @ 1 watt  
Less than 1% @ 1,000 cps @ 8 watts.

### Hum and Noise:

Microphone — Unbalanced Hi Z or balanced Low Z with MT-4

Program — Unbalanced 15,000 ohms

Phone (with PH-6A) — Magnetic, ceramic, or crystal

Tuner (with PH-7) — Hi Z (270K ohms); 5 db gain increase

Tape Head (with PH-8) — Equalized for 3 $\frac{3}{4}$  or 7 $\frac{1}{2}$  IPS

Line (with MT-4) — Balanced 10,000 ohms bridging  
Balanced 600 ohms matching

**Outputs:** Balanced 70.7 v and 25 v  
Unbalanced 8 ohm

**Controls:** Microphone Gain  
Program Gain  
Tone (cut to -20 db @ 10,000 cps)  
Power ON-OFF Switch

**Semi-conductors:** Q1, Q2, Q3 MC40232; Q4, Q5, SE 4001; Q6 SFT-325; Q7, Q8 MC110; SR-1, -2 -3 — IN1693

**Power Supply:** 120v AC, 50/60 cps, fused, 18 watts max.

**Ambient Temperature:** Full performance to 150° F.

**Dimensions & Finish:** 9" w x 7" d x 4 $\frac{1}{2}$ " h, black and natural gray.

**Shipping Weight:** 6 lbs.

**Part No.** 124 0032 556

## PLUG-IN ACCESSORIES

MT-4 — Shielded 600 ohm input transformer. Frequency response 20 to 20,000 cps.

PH-6A — Phonograph preamplifier. Equalized for magnetic, ceramic, or crystal cartridges.

PH-7 — Program preamplifier. Converts the bridging input to 270 K ohms and provides extra gain of 5 db.

## RP-80

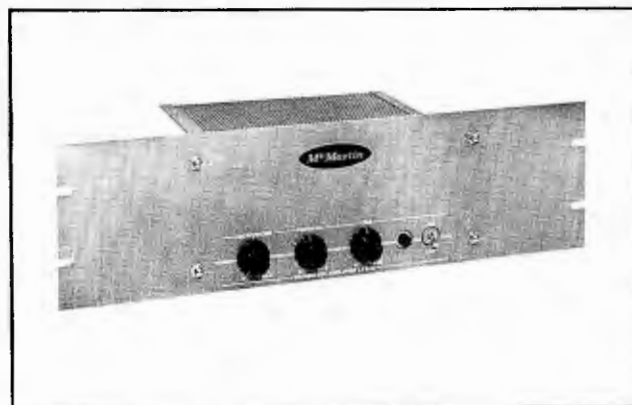

The RP-80 is a rack mounting adapter for the Model LT-80B.

**Part No.** 124 0032 254

## COLLINS 274K-2 RELAY UNIT

Used with the Collins 212G-1 Console, the 274K-2 is similar to the 274K-1 in all specifications except that relays are unenergized in standby.

Part No. 522 1606 000

## COLLINS CONSOLE TEST CABLE

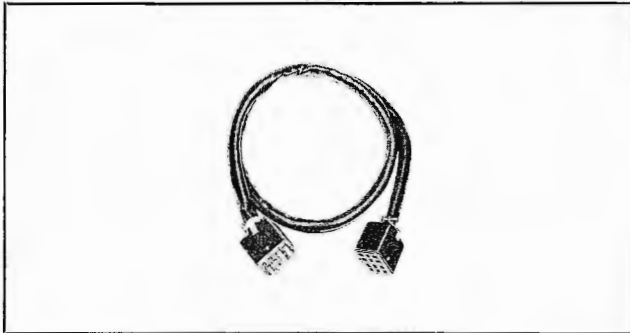

Permits operation and service of any module while removed from the console cabinet.

Part No. 541 6473 003

## COLLINS CONSOLE JUMPER PLUG

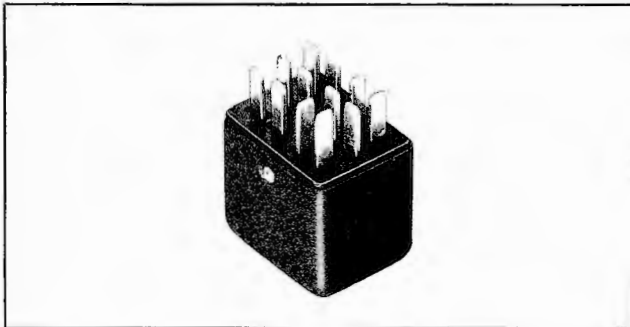

For use where high level signal inputs eliminate the need for 356A-1 Preamplifiers.

Part No. 541 6459 002

## 26J-1 AUTO-LEVEL LIMITING AMPLIFIER

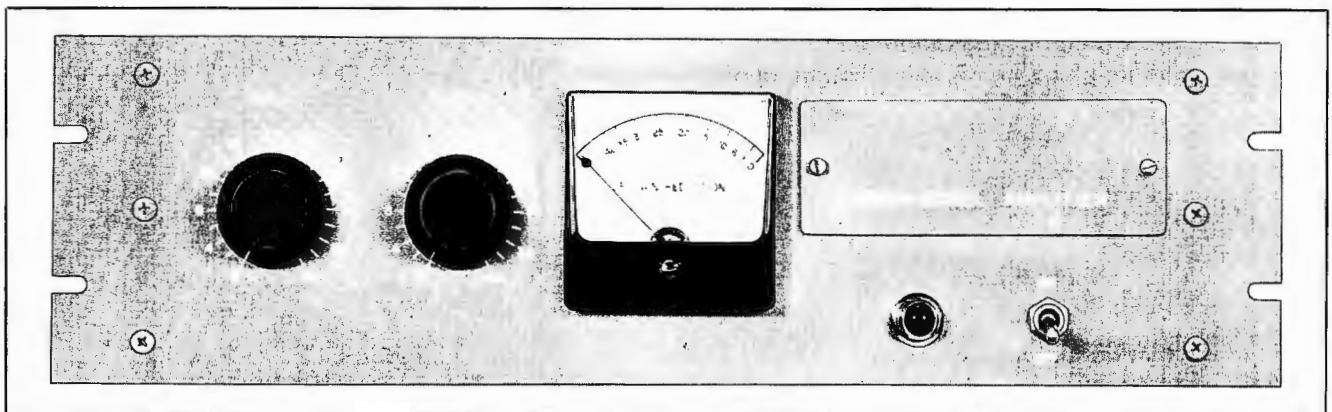

The average program level of the radio broadcast station can be automatically and effectively raised with the 26J-1 Auto-Level Limiting Amplifier. The resulting effect

## COLLINS 499G-1 SHELF

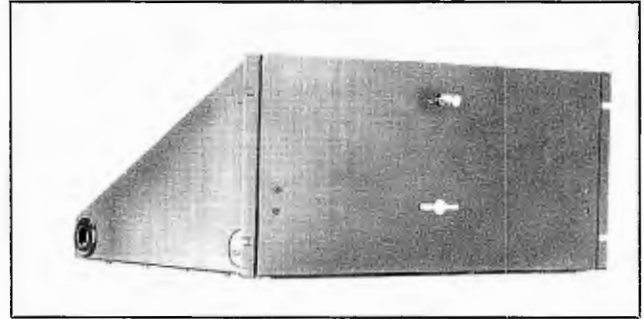

The 499G-1 is a rack mounting shelf used to mount amplifiers, relay units and power supplies associated with the Collins 212E-1 Speech Input Console. The unit is a fixed type rack mounting shelf with a hinged, front panel 8½" H by 17¾" W. The floor of the shelf is of cadmium plated, perforated sheet metal.

A Howard Jones barrier strip is mounted at the front or back of the unit. Holes on both sides at front and back allow wiring to individual style. The perforated bottom plate allows mounting components without drilling additional holes.

Size: 19" W, 8¾" H, 14" D (48.26 cm W, 22.23 cm H, 35.56 cm D).

Weight: 11 lbs. (4.99 kg).

Part No. 522 0774 00

## COLLINS PLUG-IN BRACKET ASSEMBLIES

Plug-in bracket assemblies in 12-pin models without cable are available to facilitate mounting of 356A/B/E-1 Amplifiers in the 499G-1 Rack Mounting Shelf. Also available are 12- and 15-pin plug-in bracket assemblies with cable for use with 274K-1 or 274K-2 Relay Units.

Part No. 542 3038 002

12-pin assembly without cable.

Part No. 542 3040 003

12-pin assembly with cable.

Part No. 542 3039 002

15-pin assembly without cable.

Part No. 542 3041 004

15-pin assembly with cable.

Automatic fades between microphone and recorded music are also accomplished with the 26J-1. By setting the microphone level at a higher level than the turntable, the automatic fade occurs when the microphone is activated. The higher microphone level automatically fades the music into the background and allows the speech to come through clearly. When the voice portion is absent, the 26J-1 restores the music level to normal. Since these fades are done automatically and electronically, they are far smoother and superior to manual fades.

The 26J-1 does not act as a peak limiting amplifier but functions on a low compression ratio which allows limiting action without noticeable effect on program material. With the slow action and compression ratio of the 26J-1, it is possible to limit up to 30 db without a noticeable effect other than bringing up the average listening level of the program material.

Working in conjunction with the Collins 26U-1 Peak Limiting Amplifier, the two units provide excellent peak limiting as well as average program limiting. The wide dynamic ranges used in most classical and popular music require considerable compression to allow low and high passages to be broadcast equally well.

The Collins 26U-1 Peak Limiting Amplifier, ideally located at the transmitter, protects over-modulation of the transmitter, and the 26J-1 Auto-Level Limiting Amplifier, located at the studio, boosts the average and low level program portions. Thus, these two units allow even the low-priced home and car receivers, which are not capable of reproducing wide dynamic ranges, to receive the entire broadcast as transmitted.

In those instances where there is not a good signal-to-noise ratio, such as old phonograph records and sports events with background noises, the 26J-1 can be operated as a straight amplifier. The limiting action may be disabled by turning off the gain reduction switch.

*Frequency Response:*  $\pm 1$  db, 50-15,000 cps.

*Gain:* 25 db maximum as shipped.  $\pm 1$  db maximum, with input pad changed from 22 db to 6 db.

*Input Impedance:* 600 ohms unbalanced.

*Input Level:* Adjustable,  $-26$  dbm to  $+30$  dbm. Easily changed 22 db "T" pad in input circuit available. (0 dbm equals 1 mw across 600 ohms.)

*Output Impedance:* 600 ohms unbalanced.

*Output Level:* Adjustable,  $-24$  dbm to  $+30$  dbm;  $+14$  dbm nominal.

*Distortion:* 1.5% maximum, 50-15,000 cps, with no compression. 2% maximum distortion, 50-15,000 cps, at any level up to 30 db gain reduction, with threshold set for 3:1 compression ratio.

*Output Noise:*  $-50$  dbm or less. (Threshold set for 3:1 ratio.)

*Compression Ratio:* 3:1 optimum; adjustable 1.6:1 to 5:1.

*Attack Time:* 11 milliseconds, with switch set for dual operation. 62 milliseconds, with switch set for average operation.

*Release Time:* 0.9 seconds for 63% recovery, with switch set for dual operation. 5.2 seconds for 63% recovery, with switch set for average operation.

*Power Source:* 115 v or 230 v ac, 50-60 cps, single phase. Shipped wired for 115 v.

*Size:* 19" W, 5 1/2" H, 9" D (48.26 cm W, 13.97 cm H, 22.86 cm D).

*Weight:* 16 lbs. (7.26 kg).

Part No. 099 2814 00

No Part Number

FCC set of spare tubes (includes two silicon rectifiers).

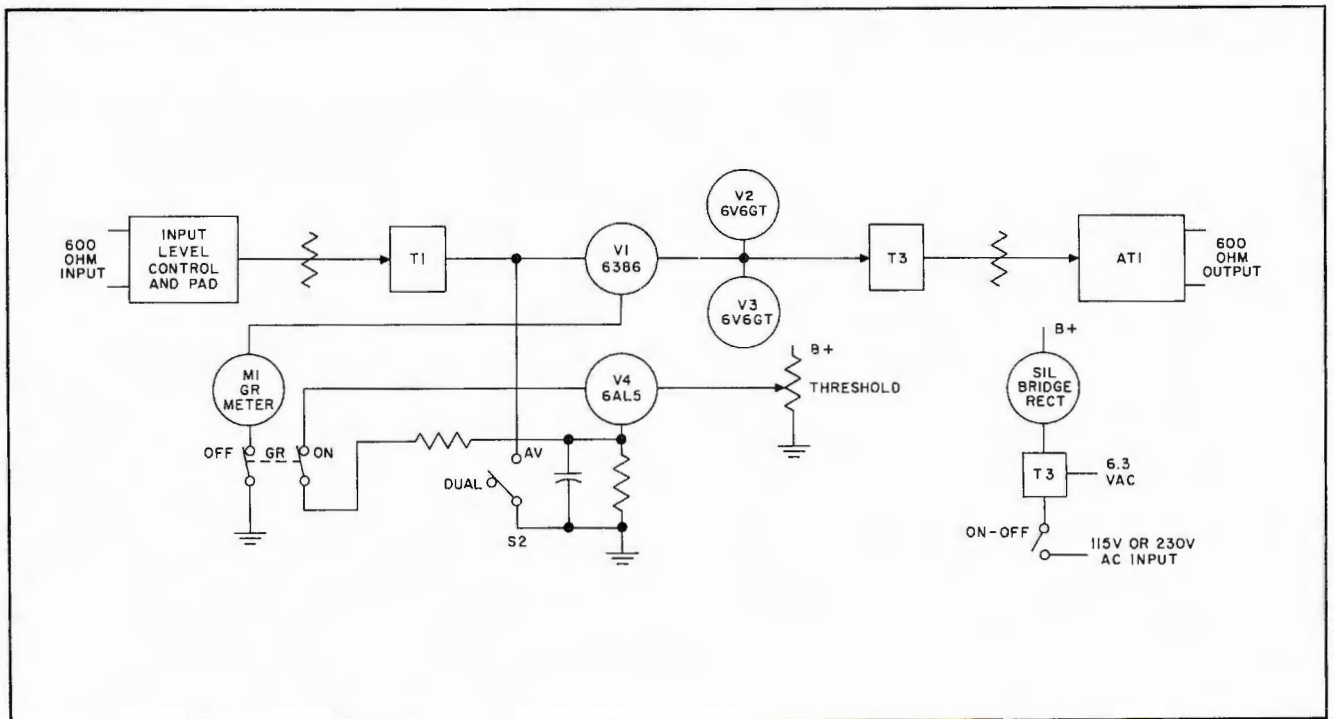

BLOCK DIAGRAM 26J-1



## COLLINS 26U-1 LIMITING AMPLIFIER

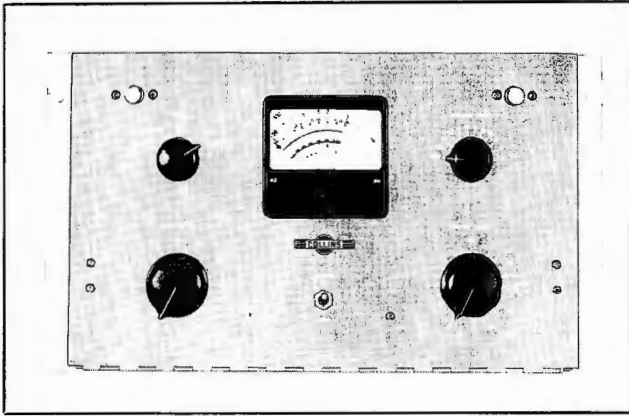

Designed to achieve maximum modulation with minimum distortion, the Collins 26U-1 Limiting Amplifier provides full tonal range broadcasting with thump-free performance.

The Collins Limiting Amplifier limits loud audio passages to prevent overmodulation, distortion and adjacent channel interference, while allowing low level passages to be broadcast in their true range.

The transmission range of the station's signal and the over-all efficiency of the transmitter are increased through the limiting action which permits a higher average modulation level.

When used with recording equipment or with a public address system, the 26U-1 prevents overloading, and by allowing a higher average audio level, the limiting amplifier improves the signal-to-noise ratio.

A self-balancing circuit eliminates the need of tube selection or delicate balancing procedures usually associated with peak limiters. The Collins Limiting Amplifier is capable of greater than 30 db compression.

Conventional circuitry, negative feedback, full wave rectification for control voltage and silicon rectifiers in the power supply are incorporated into this unit.

An illuminated VU meter with a special scale calibrated in VU and db of compression, which measures five functions, is provided in the Collins Limiting Amplifier.

The VU meter attenuator and a rotary switch allow measurement of external gain reduction, db of compression and levels of input, output and external audio circuits. This external meter circuit measures audio levels on other program lines, eliminating the need for an additional VU meter panel.

Silicon diodes and extended life electrolytic capacitors provide an efficient, low heat power supply with a minimum of maintenance. A voltage regulator provides stabilized reference voltages. Input, output and VU meter level controls are Daven step-type.

The 26U-1 consists of a push-pull variable gain input stage, a push-pull interstage voltage amplifier, and a push-pull output stage. A bias rectifier supplies dc bias from the signal output to regulate the gain of the input stage. A self-contained power supply provides the plate and filament voltages.

Designed for rack mounting, the Collins Limiting Amplifier has a minimum number of controls, tubes and tube types. It has a hinged front panel for access to internal wiring and components.

The panel is finished with blue-gray enamel, and the chassis is cadmium plated and chromate dipped.

*Frequency Response:*  $\pm 1.5$  db, 50-15,000 cps.

*Gain:* 32 db minimum.

*Input Impedance:* 600 ohms unbalanced.

*Input Level:* -20 dbm to +20 dbm. Note: 0 dbm equals 1 mw across 600 ohms.

*Output Impedance:* 600 ohms unbalanced adjustable. or 600 ohms balanced fixed level.

*Output Level:* -20 dbm to +20 dbm.

*Distortion:* 1.5% maximum.

*Output Noise:* -50 dbm or less.

*Compression Ratio:* 12:1 first 10 db above threshold.

*Attack Time:* Adjustable, 0.5-3.0 milliseconds.

*Release Time:* Adjustable, .5-3.0 seconds for 63% recovery.

*Power Source:* 115 v or 230 v ac, 50-60 cps, single phase. Shipped wired for 115 v.

*Size:* 19" W, 10 $\frac{1}{2}$ " H, 9" D (48.26 cm W, 26.67 cm H, 22.86 cm D).

*Weight:* 32 $\frac{1}{2}$  lbs. (14.75 kg).

**Part No. 522 0966 00**  
**No Part Number**  
 100% set of spare tubes.

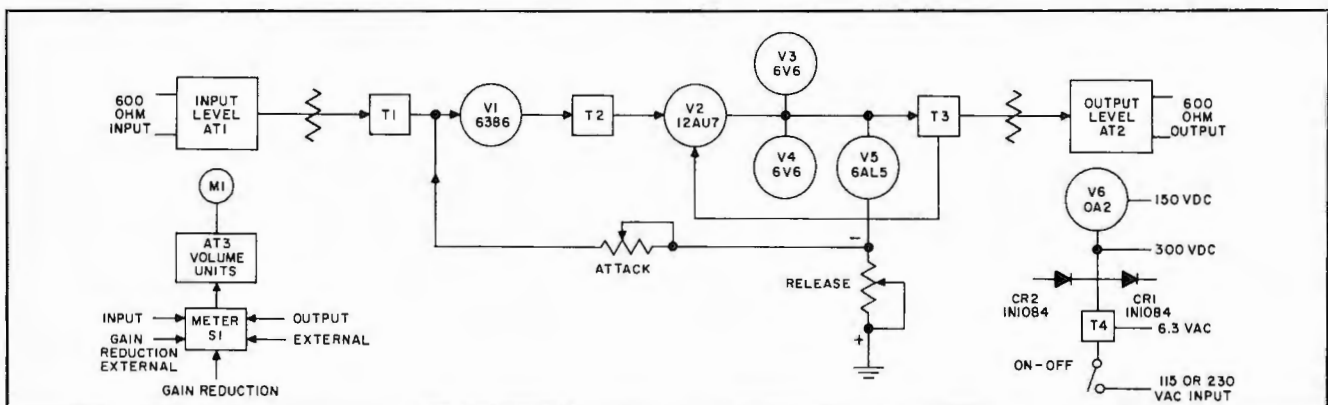

BLOCK DIAGRAM 26U-1

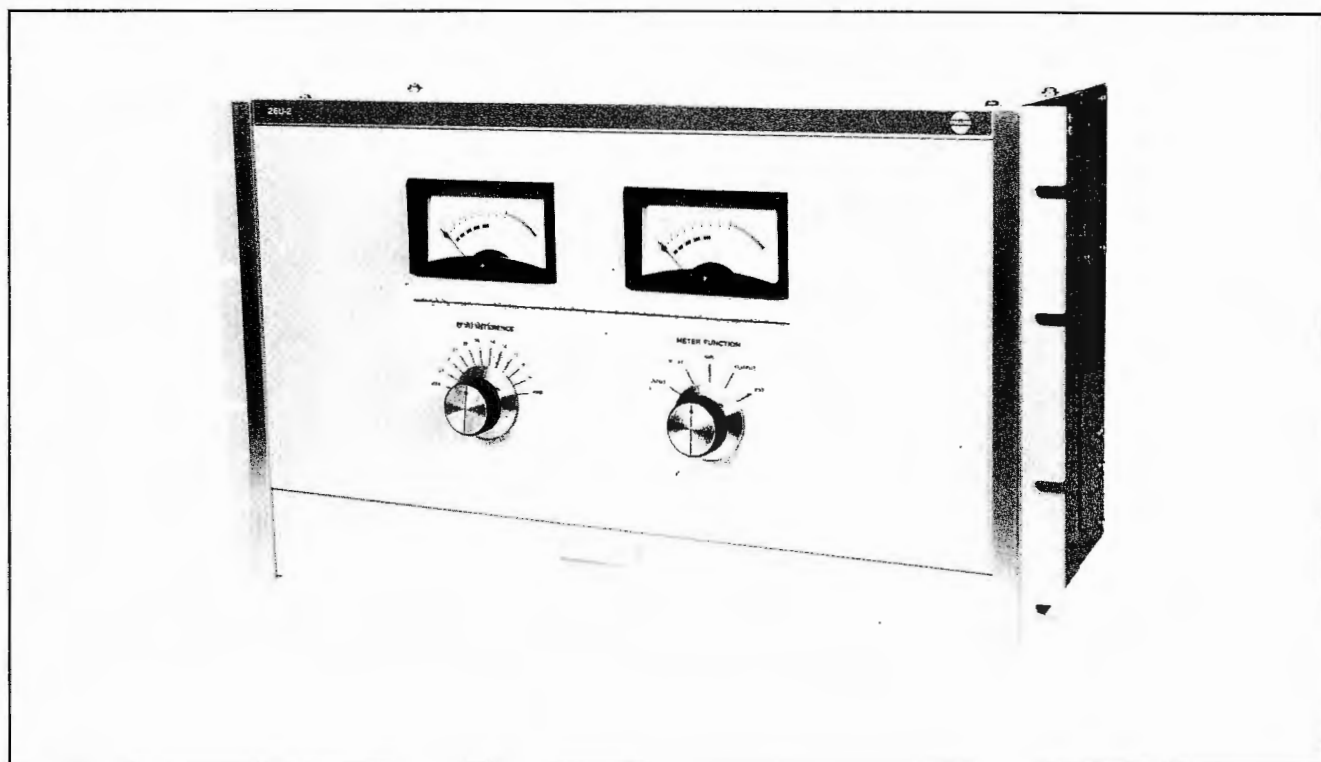

## COLLINS 26U-2 STEREO LIMITING AMPLIFIER

Easy to operate and maintain and affording maximum flexibility, the Collins 26U-2 Stereo Limiting Amplifier is designed to permit maximum modulation with minimum distortion. It provides full tonal range broadcasting with thump-free performance.

The 26U-2 limits loud audio passage to prevent over-modulation, distortion and adjacent channel interference, while raising low level passages to be broadcast in their true value.

When used with stereo recording equipment, the Collins Stereo Limiting Amplifier prevents overloading and improves signal-to-noise ratio by allowing a higher average audio level.

Based on the time-proven circuitry of the Collins 26U-1, the stereo limiter has conservatively-rated components and long life. Typical mean time between failures: four years of continuous service.

The 26U-2 is designed to meet any requirement of the broadcaster. It may be used as a single channel limiter, two monaural channels or for stereo broadcasting. A switch in the subpanel selects either stereo or monaural operation.

The self-balanced circuit eliminates the need for tube selection or delicate balancing procedures usually associated with peak limiters. The Collins 26U-2 is capable of greater than 30 db compression.

Two illuminated VU meters, calibrated in VU and db of compression, which measure five functions, are incorporated. The meters' attenuator and function switch allow

measurement of external and internal gain reduction (db of compression), and levels of input, output and external audio circuits. The external circuit measures audio levels of other program lines, eliminating the need for an additional VU meter panel.

Silicon diodes provide an efficient, low heat power supply with a minimum of maintenance. A voltage regulator provides stabilized reference voltages. Input and output level controls are continuously variable bridge-T attenuators.

Occupying only 10.5 inches of rack space, the Collins 26U-2 has a minimum number of controls, tubes and tube types. A hinged front panel with magnetic latches provides access to the subpanel controls.

**Size:** 19" W, 10½" H, 10¼" total D — 9¼" behind panel (48.26 cm W, 26.67 cm H, 26.04 cm total D — 23.5 cm behind panel).

**Weight:** 35 lbs. (15.88 kg).

**Power Source:** 115 v or 230 v ac, 50-60 cps, single phase (150 watts at 115 v ac).

**Frequency Range:** 50-15,000 cps  $\pm 1.5$  db.

**Input:** 600 ohm bridged T (ungrounded), -20 dbm to +20 dbm.

**Output:** 600 ohm bridged T (ungrounded), -20 dbm to +20 dbm.

**Distortion:** 1% maximum.

**Output Noise:** -50 dbm or less.

**Cross-Talk:** 60 db minimum.

**Compression Ratio:** 12:1 first 10 db above threshold.

**Gain:** 40 db.

**Attack Time:** Adjustable, 0.5-3.0 milliseconds.

**Release Time:** Adjustable, 0.5-3.0 seconds.



**Controls:**

- Panel Mounted
  - Meter Selector Switch
  - Meter Multiplier Selector
- Subpanel Controls
  - Input Level (2)
  - Output Level (2)
  - Gain Reduction Meter Zero (2)
  - Gain Reduction Balance (2)
  - Stereo-Mono
  - Power ON-OFF
- Rear Chassis Controls
  - Attack Time (2)
  - Release Time (2)

**Protection:** Overload fuse in primary circuit.

**Metering:** Two 3 1/2" voltmeters which can be switched to measure Input Level, External Gain Reduction, Gain Reduction, Output Level and External Level.

**Tube and Rectifier Complement:**

- 2 GL-6386 Variable gain input stages
- 2 12AU7 Interstage voltage amplifiers
- 4 6V6GTA Output amplifiers
- 2 6AL5 Limiter bias rectifiers
- 2 OA2 Voltage regulators
- 1 1N3256 Power rectifiers (silicon commercial)

**Part No. 522 3237 00**

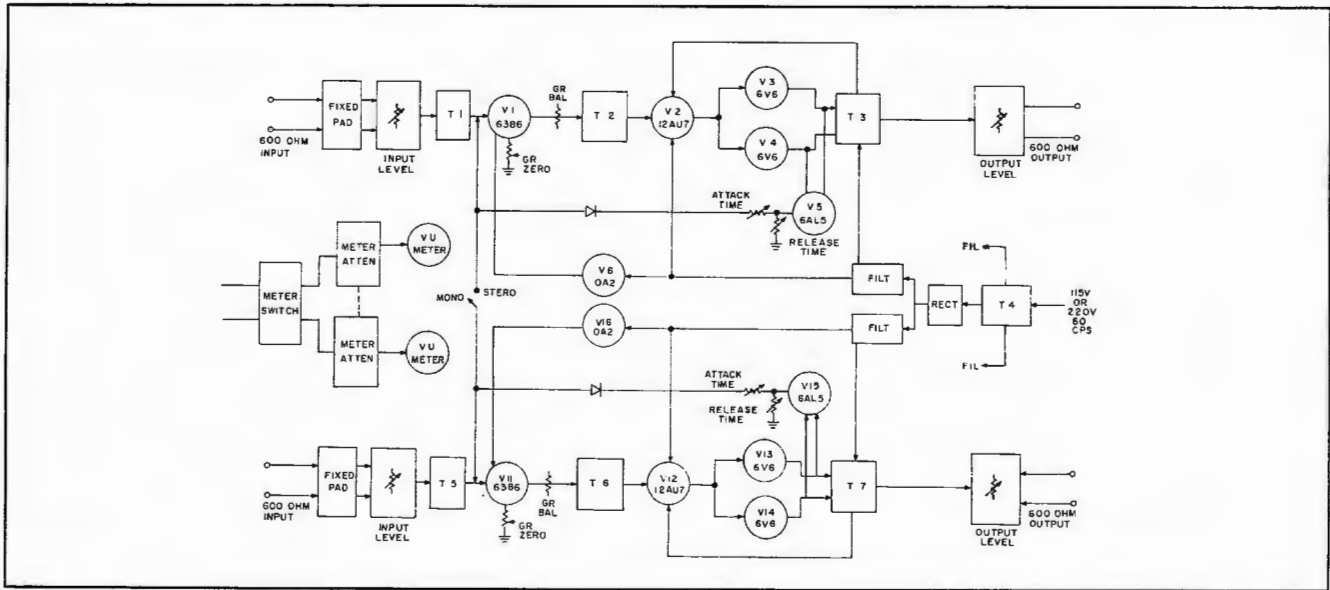

BLOCK DIAGRAM 26U-2

**COLLINS TT-900 TURNTABLE**

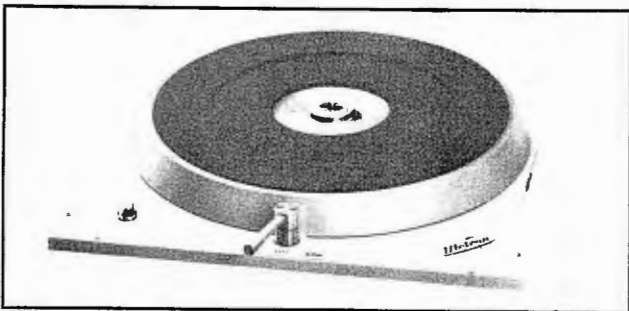

- Acceleration:** Less than 1/12 rpm for full speed.
- Wow Limit:** .2%
- Flutter Limit:** .2%
- Wow and Flutter Limit:** .2%
- Vertical Rumble:** -36 db
- Lateral Rumble:** -40 db
- Mono Rumble:** -36 db
- Size:** 14.5" wide by 15.34" deep
- Cut Out Size:** 13.5" wide by 14.34" deep
- Weight:** 53 lbs. (24.04 kg)

**Part No. 124 0032 011**

**COLLINS TT-400/200 TURNTABLES**



The TT-900 is a turntable designed specially for stereo operation and meets NAB specifications for stereo operation. The chassis is of heavy cast aluminum. A simple speed shift lever is located in the center of the chassis for choice of 2 speeds, 33 1/3 and 45 rpm. In the off position the drive puck is removed from the rim to prevent flattening. An indentation in the platter eliminates the need for a spindle adapter for 7" 45 rpm records.

- Motor:** Synchronous
- Speeds:** 33 1/3 & 45 rpm
- Speed Regulation:** .05%

Collins Turntables feature a simplicity of design which requires only three moving parts in the drive mechanism. There is no complicated linkage system to break down or to add to wow or rumble.

The turntables, constructed of heavy cast aluminum with a blue-gray wrinkle finish, are non-magnetic. A gear speed shift offers selection of 33, 45 and 78 rpm, with neutral between slots. An indentation in the turntable eliminates the need for a spindle adaptor for 7" 45 rpm records.

The tables are rim-driven by a single molded neoprene idler wheel. The idler wheel serves only to transfer power to the rim. It does not determine the speed of the table. Normal wear and reduction of the idler wheel have no effect on the precision of the platter speed.

	Speed	Noise level*	Speed Acceleration
16" TT-400	33 $\frac{1}{3}$	-48 db	1/10 rev.
	45	-47 db	1/8 rev.
	78	-42 db	1/2 rev.
12" TT-400	33 $\frac{1}{3}$	-49 db	1/16 rev.
	45	-49 db	1/12 rev.
	78	-46 db	1/3 rev.

\*Based on reference level of 7 cm/sec., at 1,000 cps

**Models:**

- TT-400 — 16", 4-pole motor
- TT-400S — 16", synchronous motor
- TT-450S — 16", synchronous motor, 50 cps
- TT-200 — 12", 4-pole motor
- TT-200S — 12", synchronous motor
- TT-250S — 12", synchronous motor, 50 cps

**Size:** TT-400 and TT-400S — 2" (5.08 cm) above base plate, 6" (15.24 cm) below base plate, overall base 19 $\frac{5}{8}$ " square (49.85 cm).

**Size:** TT-200 — 1 $\frac{1}{2}$ " (3.81 cm) above table, 4 $\frac{1}{4}$ " (10.8 cm) below table, base 15 $\frac{3}{8}$ " W, 14 $\frac{1}{2}$ " D (39.05 cm W, 36.83 cm D).  
 TT-200S — Same as TT-200, except 6" (15.24 cm) below table.

**Weight:** TT-400 — 53 lbs. (24.04 kg). TT-200 — 22 lbs. (10.23 kg).

- Part No. 097 3736 00 (Type TT-400)
- Part No. 097 3737 00 (Type TT-400S)
- Part No. 097 6286 00 (Type TT-450S)
- Part No. 097 8123 00
- Part No. 097 3971 00 (Type TT-200)
- Part No. 097 3811 00 (Type TT-200S)
- Part No. 097 6285 00 (Type TT-250S)
- Rubber pad to fill turntable indentation for TT-400/200 series. Allows playing small hole 33 $\frac{1}{3}$  rpm records.
- Part No. 097 7523 00
- 220 v to 115 v step-down transformer. 150 watts, for use with TT-400/200 turntables.

**COLLINS TURNTABLE CABINET**

Has front door for accessibility to turntable components. Cutout on top for one Collins TT-900, TT-400 or TT-200 Series Turntable. Cabinet finished in Regency walnut Formica. Other coverings available on special order. Specify turntable model number.

**Size:** 24" W, 30" H, 24" D (60.96 cm W, 76.2 cm H).

- Part No. 124 0032 228 (Type TCW-9Q)  
For use with TT-900 series turntables.
- Part No. 124 0032 230 (Type TCW-2Q)  
For use with TT-200 series turntables.
- Part No. 124 0032 229 (Type TCW-4Q)  
For use with TT-400 series turntables.

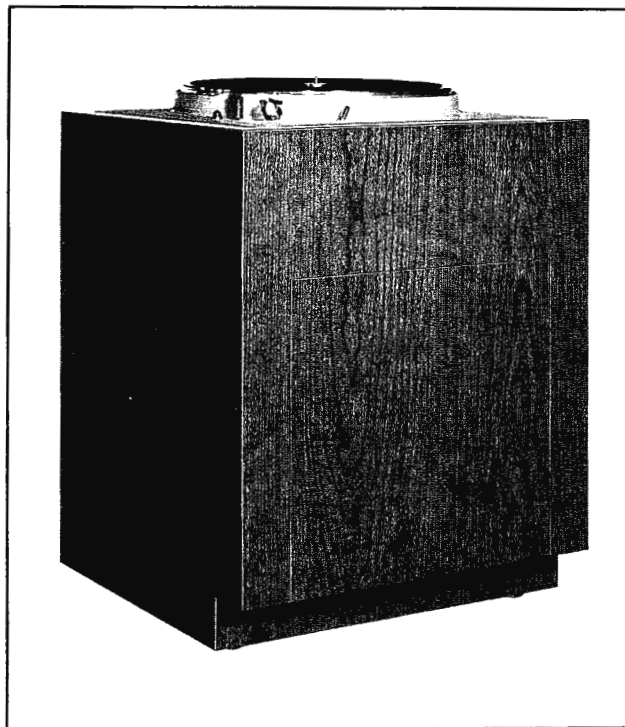

**COLLINS 356H-1 PHONO EQUALIZER PREAMP**

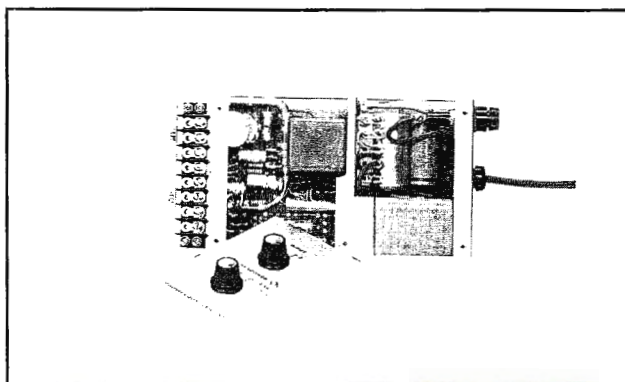

An economical unit to equalize and amplify the output signal of a magnetic phono cartridge, this small transistorized unit is used to replace passive equalizers and console or turntable preamplifiers. The housing of the unit is constructed of steel for magnetic shielding.

Control shafts are 3" long and may be cut to proper length after mounting the unit in the cabinet. The 356H-1 provides choices between two inputs and between four response curves: (1) Flat, for test purposes, and mike preamp use; (2) Hi-Boost, which has a 4 db rise above normal at 15,000 cps; (3) Normal, which is the RIAA equalizing curve, and (4) Hi-Cut, which has a 4 db drop below the Normal curve at 15,000 cps.

**Frequency Range:** 30-15,000 cps, (Typical — "Flat" position  $\pm 1.5$  db. 20-20,000 cps).

**Frequency Response:**  $\pm 1.5$  db from RIAA playback equalization response curve.

*Output Level:* -10 dbm,  $\pm 3$  db with -50 dbm input at 1,000 cps.

*Output Impedance:* 150/600 ohms, balanced or unbalanced.

*Input Impedance:* High impedance bridging, unbalanced.

*Distortion:* 1.0% maximum, 30-15,000 cps at -10 dbm output.

*Output Noise:* Signal-to-noise ratio 60 db.

*Gain:* 40 db at 1000 cps minimum.

*Power Source:* 120/240 v ac,  $\pm 5\%$ , 50/60 cps.

*Size:* 4" W, 2" H, 7 $\frac{3}{4}$ " D (10.16 cm W, 5.08 cm H, 19.60 cm D).

*Weight:* 5 lb. (2.27 kg).

Part No. 522 2468 00

## SHURE MODEL SE-1 STEREO TRANSCRIPTION PREAMPLIFIER

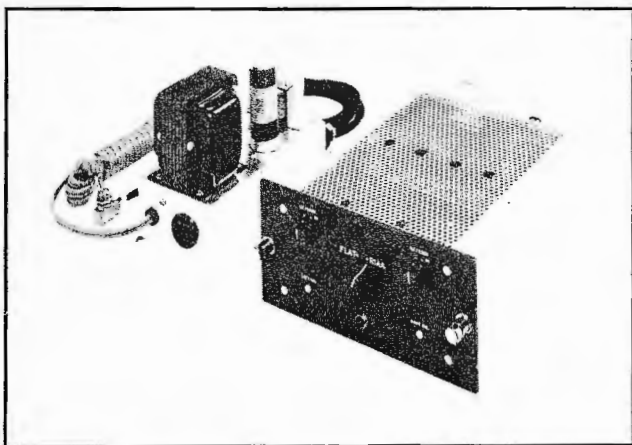

The SE-1 two channel transcription preamplifier is designed for use with magnetic reproducers in professional application of recording, film studios, television and broadcast stations. It is a high gain, low noise level preamplifier designed to operate into a 600 ohm bus at +4 or +8 dbm and equalized for magnetic reproducers. The power capabilities are such that when operating at a +4 dbm level, there is more than a 12 db power reserve for instantaneous peaks. (The harmonic distortion at 1000 cps is less than 1% at +18 dbm.) Clipping starts at approximately +20 dbm.

*Gain:* .0012 volt input produces a minimum output of +4 dbm.

*Response:* +1 db from 30 to 15,000 cps within specified characteristic, i.e., RIAA, or flat.

*Output:* 600 ohms (150 ohms by re-wiring transformer output connections).

*Input Impedance:* 47,000 ohms.

*Distortion:* Less than 1% at +15 dbm from 50 to 10,000 cps.

*Hum and Noise:* 64 db below +4 dbm output with gain adjusted for an input level of 4.5 millivolts.

*Channel Separation:* Better than 37 db at 10,000 cps in RIAA position.

*Size:* Requires opening 7" x 3 $\frac{3}{8}$ ", 11" deep. Power supply 3 $\frac{1}{2}$ " wide, 6" high, 11" long supplied with 2 $\frac{1}{2}$  ft. cable.

Part No. 099 3020 000

## GRAY 602C EQUALIZER

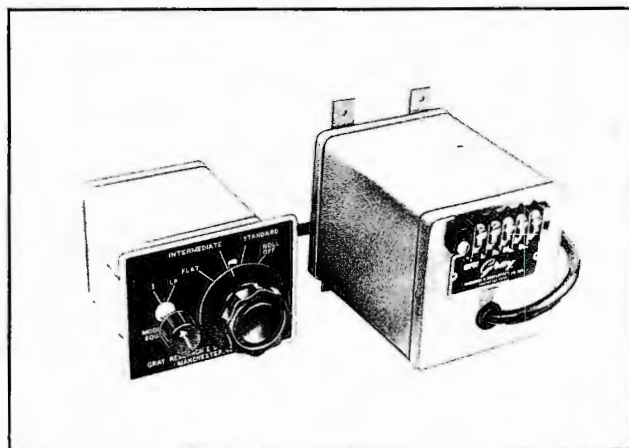

Normally used with standard microphone preamplifiers, making it unnecessary to purchase special audio input equipment when using magnetic cartridges. A convenient control permits instantaneous input switching from conventional records to microgroove.

*Output Impedance:* 250 ohms balanced (150 or 50 ohms available).

*Insertion Loss:* 20 db.

*Output Level:* -67 VU at 4.7 cm/second.

*Cable Length:* 18" (45.72 kg).

Part No. 272 1438 00

## GRAY 212-TN PLAYBACK ARM

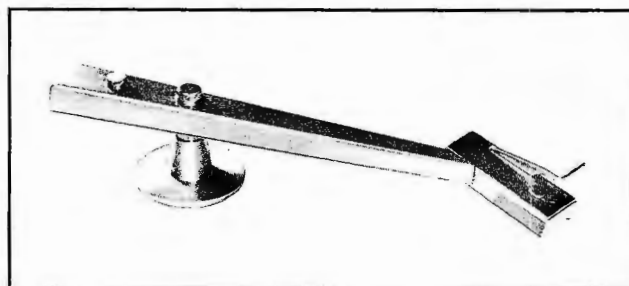

A slide-in cartridge is used to allow instant change from standard groove to microgroove. The arm will accommodate all popular magnetic pickup cartridges, including Pickering, G. E., and Fairchild. Available for 12" (212-TN) recordings.

Part No. 099 0386 00

(Type 212-TN)

## GRAY 208 SERIES PLAYBACK ARMS

The Gray professional stereo tone arm is available in two models that are identical in performance. Model 208-S comes with a slide and modular weights for mounting single play stereo or monophonic cartridges. Model 208-SG has a special slot cut into the front of the tone arm to clear the stem of a G. E. turnaround cartridge allowing plug-in operation and comes with specific hardware for this application.

Accessory slide kits are available for multiple cartridge operation.



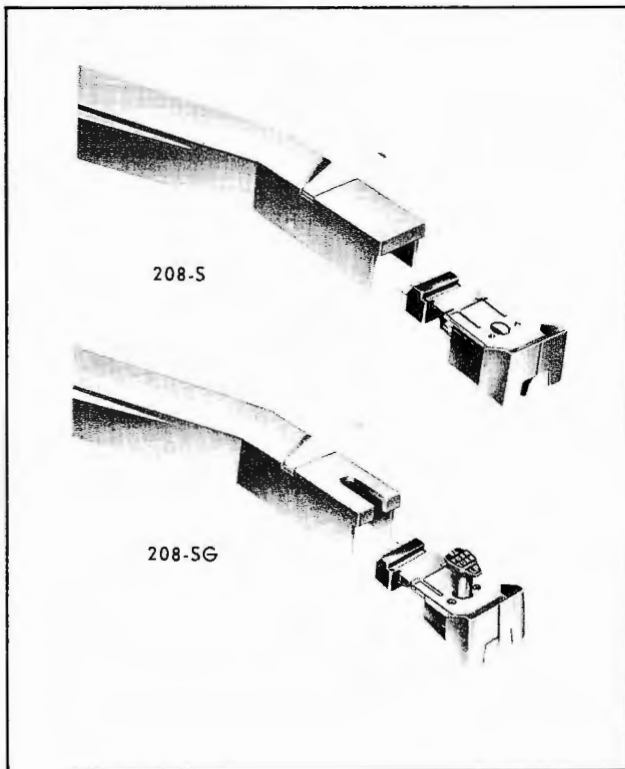

The 8-S accessory slide assembly includes the cartridge slide, modular weights, mounting hardware and impressive spacers for the installation of stereo or monophonic single play cartridges. The 8-S slide assembly with cartridge mounted is usable in either the 208-S or 208-SG interchangeably.

The 8-SG accessory slide assembly is specifically designed to mount the G. E. turnaround cartridge. With this cartridge installed, it will only fit the 208-SC arm; however, cartridges are interchangeable between arms in this model.

*Response:*  $\pm 1$  db from 5 cps to top end limit imposed by cartridge used.

*Size:*  $2\frac{1}{8}$ " W,  $2\frac{5}{8}$ " H, 15" L (7.46 cm W, 6.67 cm H, 38.1 cm D).

*Weight:* 2 lbs. (0.91 kg).

Part No. 099 0387 000 (Type 208-S)  
 Part No. 099 0164 000 (Type 208-SG)  
 Part No. 099 0837 000 (Type 8-SG) Slidemount for 208-SG.

## SHURE SERIES 2 PRECISION PICK-UP ARMS MODELS 3009 AND 3012

The realism and clarity of a stereo record reflect the skill and technical perfection underlying its manufacture. Only when this is maintained in the reproducing equipment can justice be done to the art of the recording engineers. In playing a phonograph record the stylus must follow a path of extraordinary complexity and be highly compliant if the minute detail of the groove is to be traced without damage. Even the best cartridge cannot achieve this unless it is poised free from extraneous influences. The design of a carrying arm capable of realizing the full potential of pick-up and record is highly specialized

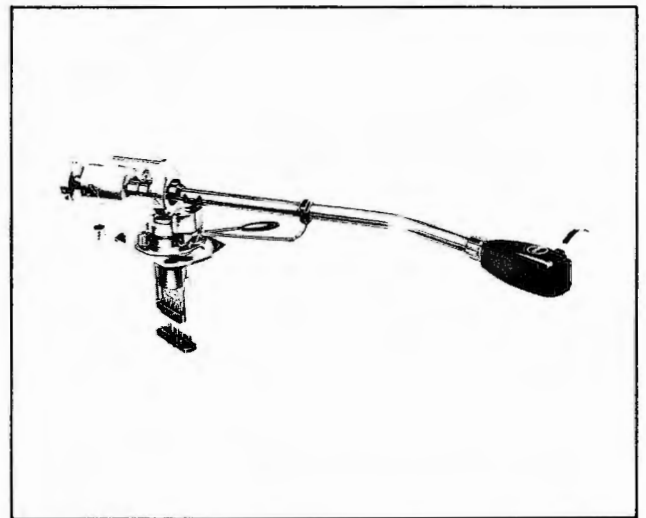

involving many problems. These have been successfully resolved in the S.M.E., an instrument of unrivalled quality presented with confidence that the user will endorse the claim 'The best pick-up arm in the world'.

### DESIGN FEATURES

Compensation is provided for the force which tries to move a pick-up arm towards the center of a record. The arm is given an opposing bias, adjustable for various tracking pressures, which balances the stylus centrally in the groove so that it does not favor one wall.

Precision ball races and knife-edge bearings reduce pivot friction to approximately .020 gram measured at the stylus. Cartridges can be used at optimum stylus pressure without the excess weight otherwise required to overcome friction in the pivots.

A carefully chosen offset minimizes distortion due to tracking error.

The tubular tone arm has a wood lining and the balance system is decoupled by a compliant joint. Resonances are placed where they can have no effect on the recorded range.

The balance system permits accurate longitudinal and lateral balance of cartridges from 5-20 grams weight and tracking pressures from  $\frac{1}{4}$  to 5 grams applied precisely without the need for a stylus pressure gauge.

Versatile and quickly aligned for optimum tracking by sliding the base on its graduated bed plate using the protractor included with each arm. Full advantage can be taken of the best present and future cartridges, impracticable with arms of integrated design.

Lever operated raising and lowering control gives automatic slow descent. Fascinating to use — safeguards valuable records.

Choice of tone arm length to suit space available. If the motor board is big enough the 3012 is better, tracking error is even smaller and for studio use 16" records can be played. Otherwise the 3009 can be used with every confidence and indeed is the one most frequently employed.

## SHURE PHONOGRAPH CARTRIDGE MODEL M44-7

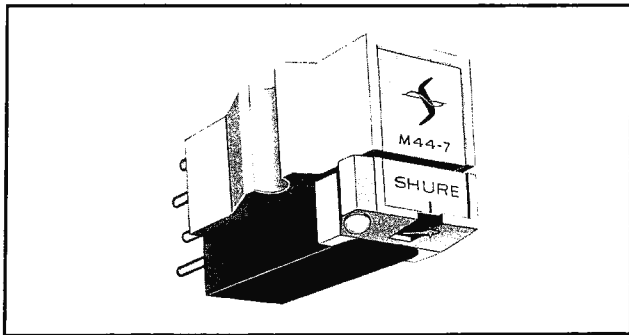

The Model M44-7 Dynetic Phonograph Cartridge has been developed for use in all high fidelity applications. It has been designed to connect into magnetic and constant velocity inputs.

Recently, highly technical papers have been published in the leading audio journals to the effect that a hitherto "hidden" source of distortion has finally been identified. It was stated that the difference in the effective angles between the record cutting mechanism's chisel point and the angle of the ball point playback stylus led to an annoying, discernible and measurable distortion. A matching of the vertical tracking angle of the playback stylus to the effective angle at which the record has been cut will eliminate this distortion.

Major recording companies have now begun to use a 15° effective cutting angle and it is the proposed E.I.A. standard (similar in practice and effect to the adoption of the RIAA equalization curve).

The M44 Series of Stereo Dynetic Phono Cartridges has been specifically designed to complement the 15° effective cutting angle now being used on the newest recordings. It also serves to significantly improve the sound obtained from older discs.

The M44-7 is completely compatible. It will play Stereo Discs Stereophonically, Monaural Discs Monaurally, and Stereo Discs Monaurally without excessive wear and distortion.

The Model M44-7 utilizes the Moving Magnet principle and features:

- High needle compliance.
- Low needle talk.
- Low tracking force.
- Wide range frequency response.
- Improved shielding for maximum reduction of hum pickup.
- Exceptional ease in changing stylus assembly.
- No magnetic attraction to steel turntables.

### SPECIFICATIONS

*Frequency Response:* From 20 to 20,000 cps.  
*Output Voltage:* 9 millivolts per channel at 1,000 cps.  
*Channel Separation:* More than 25 db at 1,000 cps.

*Recommended Load Impedance:* 47,000 ohms (per channel).

*Stylus Replacement:* Model Number N44-7; Radius: .0007" (.018 mm) diamond; stylus grip color: White;  
 \*See note — Stylus Model Number N44-3: Radius .0025" (.064 mm) diamond; stylus grip color: Green.

*Compliance:* Vertical-Horizontal, 20.0 x 10<sup>6</sup> cm/ dyne.

*Tracking:* 1.5 to 3.0 grams.

*Stylus:* "No Scratch" Retractable Feature.

*Inductance:* 680 millihenries.

*D. C. Resistance:* 650 ohms.

*Terminals:* 4 terminals (See Figures 2).

*Mounting:* Standard 1/2" (12.7 mm) mounting center.

*Weight:* Net Weight: 7 grams. Packaged weight: 5 1/2 ounces (156 grams).

\*The N44-3 Stylus may be used in the M44 Dynetic Cartridge to reproduce the standard 78 rpm records. In this case the amplifier should be set to "Monaural" or "A + B." The M44-3 is designed for tracking forces of 1.5 to 3.0 grams.

Part No. 099 0318 000 (Type M44-7)  
 Part No. 124 0032 301 (Type M44-7)  
 Special J.O. 198 with .001 needle.  
 Part No. 124 0032 302 (Type M44-7)  
 .0007" needle assembly.  
 Part No. 124 0032 303 (Type N44-1)  
 .001" needle assembly.

## SHURE PHONOGRAPH CARTRIDGE MODEL M44-5

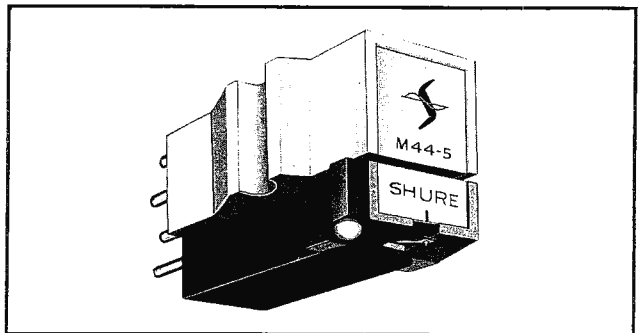

### SPECIFICATIONS:

*Frequency Response:* From 20 to 20,000 cps.

*Output Voltage:* 6 millivolts per channel at 1,000 cps.

*Channel Separation:* More than 25 db at 1,000 cps.

*Recommended Load Impedance:* 47,000 ohms (per channel).

*Stylus Replacement:* Model Number N44-5; Radius: .0005" (.013 mm) diamond; Stylus grip color: Red;  
 \*See Note — Stylus Model number N44-3; Radius .0025" (.064 mm) diamond; Stylus grip color: Green.

*Compliance:* Vertical-Horizontal, 25.0 x 10<sup>6</sup> cm per dyne.

*Tracking:* 3/4 gram to 1 1/2 grams.

*Stylus:* "No Scratch" Retractable Feature.

*Inductance:* 680 millihenries.

*D. C. Resistance:* 650 ohms.

*Terminals:* 4 terminals (See Figure 2).

*Mounting:* Standard 1/2" (12.7 mm) mounting center.



*Weight:* Net Weight: 7 grams. Packaged weight: 5½ ounces (156 grams).

\*The N44-3 Stylus may be used in the M44 Dynetic Cartridge to reproduce the standard 78 rpm records. In this case, the amplifier should be set to "Monaural" or "A + B." The N44-3 is designed for tracking forces of 1.5 to 3.0 grams.

**SHURE PHONOGRAPH CARTRIDGE MODELS M5D AND M6S**

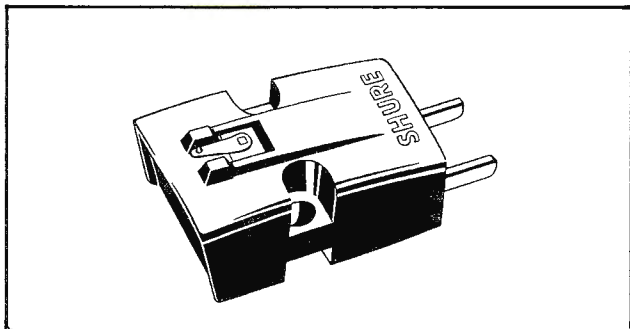

The M5 and M6 Professional Dynetic Cartridges have been developed specifically for use in custom high fidelity sets, record changers, and transcription arms. These cartridges have been designed to connect into magnetic and constant velocity inputs.

This new electromagnetic transducer utilizes the same Dynetic principle employed in the Studio Dynetic Cartridge and tone arm assembly. This new electro-mechanical principle uses a moving magnet which provides extreme linearity and freedom from distortion. Since the magnet turns on its vertical axis, it is possible to place the needle tip at the end of a light metallic beam, providing very low needle point mass. The stylus assembly is held in a durable elastomer composition which provides high needle compliance. Vertical compliance at the needle tip is excellent. Because of these factors, needle talk is practically nonexistent. Other important features are:

1. Needle replacement is exceptionally simple and fast. No tools are required.
2. Magnetic induction from external hum fields is reduced to a minimum.
3. No magnetic attraction to steel turntables.

**SPECIFICATIONS — MODEL M5D**

*Use:* Microgroove, 33⅓ — 45 R.P.M.  
*Stylus Radius:* 1 Mil (0.025 mm) Diamond.  
*Stylus No.:* N5D.  
*Stylus Color Coding:* Black Dot.

**SPECIFICATIONS — MODEL M6S**

*Use:* Standard 78 R.P.M.  
*Stylus Radius:* 2.7 Mil (0.069 mm) Synthesized Sapphire.  
*Stylus No.:* N6S.  
*Stylus Color Coding:* Yellow Dot.  
*Response Frequency Characteristic:* From 20 to 20,000 cps (See Fig. 1) designed to ideally meet the exacting requirements of typical high fidelity reproduction.

*Output Voltage:* Output at 1000 cycles 21 millivolts for 10 centimeters per second.

*Recommended Load Impedance:* 27,000 ohms. Higher values will produce a slight increase in high frequency response.

*Compliance:* 3.0 x 10<sup>6</sup> centimeters per dyne.

*Tracking Force:* 3 to 6 grams.

*Inductance:* 350 millihenries.

*D. C. Resistance:* 440 ohms.

*Weight:* .44 ounces (12.4 g.).

*Packaged Weight:* 3.3 ounces (95 g.).

**SHURE PLAYBACK ARMS**

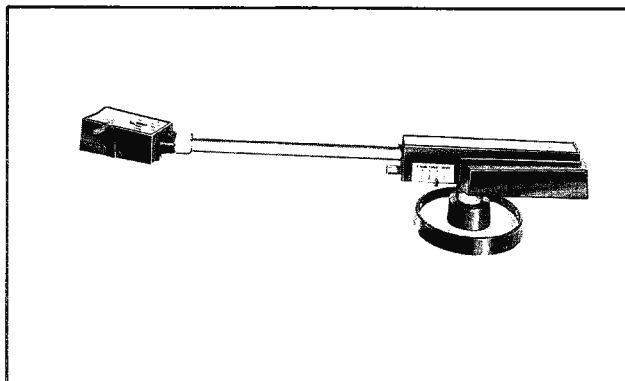

Accepts stereo and monophonic cartridges. Arm features precision ball bearings at all pivot points, plug-in head with positive alignment lock and variable adjustment. Supplied with arm rest, mounting template, mounting hardware and 4-foot cable assembly.

*Size and Weight:* 12" arm (M232), 12<sup>11</sup>/<sub>16</sub>" L, 1 lb. (0.45 kg); 16" arm (M236), 14<sup>1</sup>/<sub>2</sub>" L, 1<sup>1</sup>/<sub>8</sub> lbs. (0.48 kg).

Part No. 097 8118 00 (Type M232)  
 Part No. 097 8122 00 (Type M236)

**REK-O-KUT PLAYBACK ARMS**

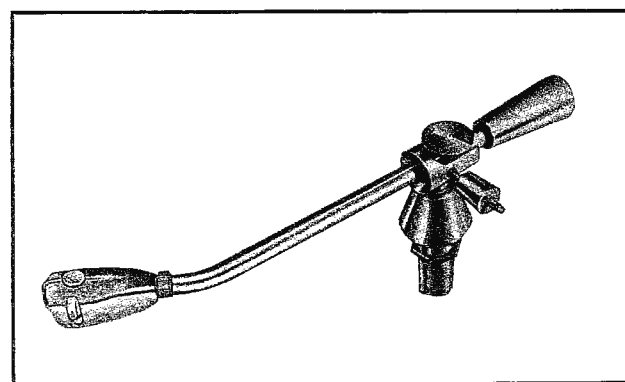

Tubular arm body with die cast aluminum cartridge shell. Four-conductor lead accommodates all 3- and 4-wire stereo cartridges. Does not include but uses all standard cartridges. Available for either 16" (S-260) or 12" (S-320) recordings.

Part No. 099 0242 000 (Type S-260) less balance weight.  
 Part No. 099 0241 000 (Type S-320) with balance weight.  
 Part No. 124 0032 094 Balance weight for S-260

## GENERAL ELECTRIC CARTRIDGES AND STYLI

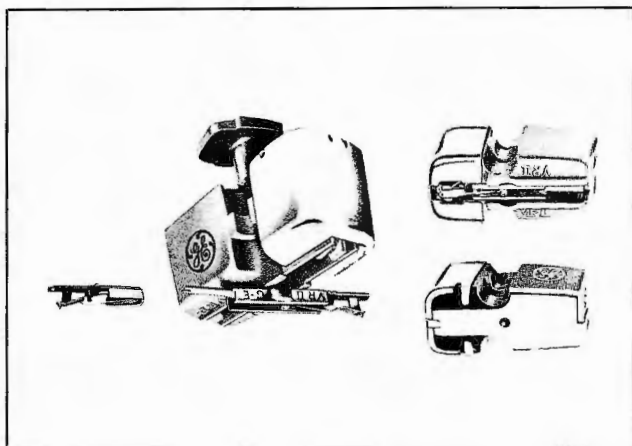

- 4GS-01D — Cartridge with 1 mil diamond stylus.
- 4GS-02D — Cartridge with 2.5 mil diamond stylus.
- 4GS-01S — Cartridge with 1 mil sapphire stylus.
- 4GS-02S — Cartridge with 2.5 mil sapphire stylus.
- 4GD-01D-02S — Cartridge with 1 mil diamond and 2.5 mil sapphire styli.
- 4GD-01D-02D — Cartridge with 1 and 2.5 mil diamond styli.
- 4GD-01S-02S — Cartridge with 1 and 2.5 mil sapphire styli.
- 4G-01D — 1 mil Diamond Stylus (above cartridges only).
- 4G-02D — 2.5 mil Diamond Stylus (above cartridges only).
- 4G-01S — 1 mil Sapphire Stylus (above cartridges only).
- 4G-02S — 2.5 mil Sapphire Stylus (above cartridges only).

Part No. 097 3844 00	(Type 4GS-01D)
Part No. 097 3845 00	(Type 4GS-02D)
Part No. 097 3846 00	(Type 4GS-01S)
Part No. 097 3847 00	(Type 4GS-02S)
Part No. 097 3848 00	(Type 4GD-01D-02S)
Part No. 097 3849 00	(Type 4GD-01D-02D)
Part No. 097 3850 00	(Type 4GD-01S-02S)
Part No. 097 3853 00	(Type 4G-01D)
Part No. 097 3854 00	(Type 4G-02D)
Part No. 097 3851 00	(Type 4G-01S)
Part No. 097 3852 00	(Type 4G-02S)

## COLLINS 642A-2 AND 216C-2 TAPE CARTRIDGE SYSTEM

Tape cartridge programming with Collins equipment means perfection in recording and playback. Stored in 40-second to 31-minute endless tape cartridges, programs are conveniently and safely stored until air time. Then the cartridge is inserted into the playback deck, one button pressed, and the program is on the air, on cue.

The ease of programming is only a feature of convenience to the broadcaster. The degree of perfection in cueing spot announcements and the resulting tight production are features the listening audience can observe as a mark of the truly professional broadcaster.

Cueing the tape with Collins equipment is an automatic process not dependent upon human skills. A fraction of a second before the start of the recording process

on the upper half of the tape, a tone burst is recorded on the bottom half of the tape. This tone burst automatically stops the endless tape during the playback operation so that there is less than a 0.1-second start time for the next play.

The tone burst recorded on the tape automatically cues the tape for the next play. The playback units contain the necessary relay switching to automatically switch audio feed from an unlimited number of units into a single input of the speech input console. When any unit is started, all others are automatically disconnected from the line. Any unit that is running when another unit is started will continue to run until it is cued to the start position or is manually stopped. A second cue tone can be inserted anywhere on the tape. This is used to trigger the next playback unit or to operate remote equipment.

The cartridge is inserted along a guide and under a sturdy retaining spring which keep the entire cartridge firmly in place. Pressure pads within the cartridge hold the tape flat and firmly against the record/playback head and cue head. A precision gap of 0.00020 of an inch in the record/playback head provides resolution of the complete audio range at the 7½-inch tape speed. The heads are built on laminated cores, which permit high recording levels without danger of core saturation. The laminated cores and the balanced double coil winding result in a signal-to-noise ratio of 55 db or better as measured by the proposed NAB standard of 400 cps at 3% THD.

The capstan pressure roller, pivoting 90° from below the deck surface, snaps into position to hold the tape securely against the driving capstan. The tension of this roller is easily adjustable. The pressure roller resists wear and is accurately ground so that the tape is not fluted or stretched as it passes between the capstan and the pressure roller.

Pulling the pressure roller into position is a heavy duty solenoid guaranteed to last. This solenoid was activated over 2-million times in the Collins Quality Control laboratories and showed no appreciable wear. Activation of the solenoid and pressure roller is a fast, tight operation. Shimmy and vibration are not present.

Mounted on a strong and accurately machined aluminum deck, the mechanical portions of the Collins playback and recorder units are guaranteed to stay in perfect alignment. The precision of the playback and record heads in relation to the capstan, solenoid-activated linkage system and flywheel requires more than a pressed mounting plate. The Collins deck has a cast structural reinforcement so that alignment of all moving parts is always perfect.

Driving the unit is a heavy duty-Bodine synchronous motor with vertical ball thrust bearing. The motor is energized by inserting a tape cartridge. The life and low wear of the motor are features second only to the steady speed. The tape is moved through the unit at 7½ inches per second with 99.6% accuracy.

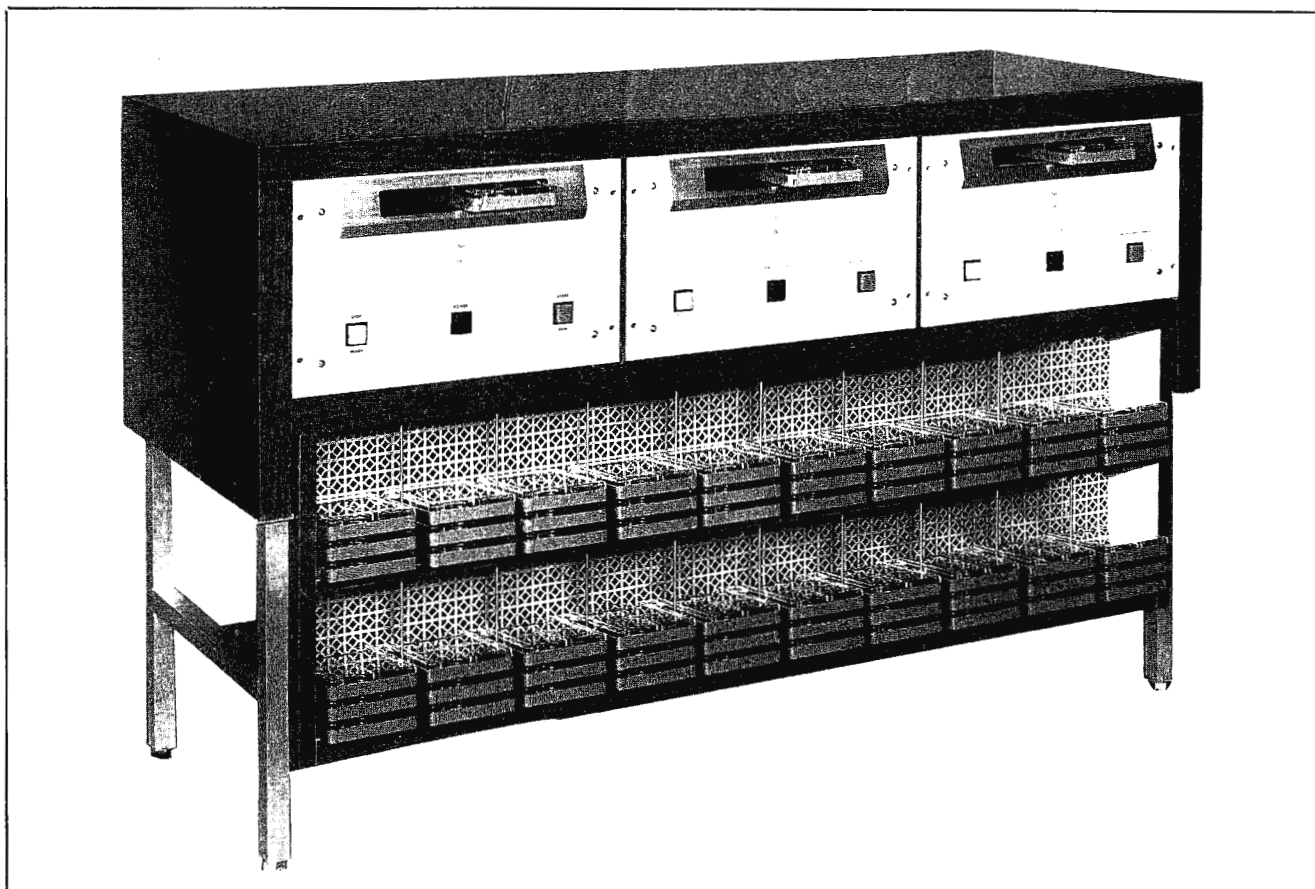

642A-2 TAPE CARTRIDGE SYSTEM

The motor is coupled to the flywheel with three resilient drive belts. This indirect drive, found in premium grade tape equipment, features much greater driving torque than in direct drive capstan systems. This torque is a must for syllable-splitting cueing required by present day broadcasting standards.

The machined and highly polished solid brass flywheel is typical of Collins precision. The flywheel and capstan, with two Oilite lateral bearings and a ball thrust vertical bearing, are virtually wearproof and maintain their equal balance. The result is very important: the playback unit holds flutter and wow to less than 0.2 of 1% RMS.

The units are finished in a blue-gray baked enamel, and extenders are furnished for rack mounting or other 19" width mounting requirements. The following specifications apply to both the 216C-2 Record and 642A-2 Playback Units:

*Power Source:* 105-125 v ac, 60 cps (50 cps model available on order), single phase.

*Frequency Response:* ±2 db 50-12,000 cps, ±4 db 50-15,000 cps, with 1,000 cps reference frequency.

*Harmonic Distortion:* 2% or less at 0 VU record level.

*Signal-to-Noise Ratio:* 45 db or better at 400 cps.

**642A-2 PLAYBACK SPECIFICATIONS**

*Power Consumption:* 100 watts during operation, 25 watts standby.

*Gain:* 55 db at 1,000 cps.

*Size:* 15" or 19" W, 8¾" H, 13¾" D (38.1 cm or 48.26 cm W, 22.23 cm H, 31.93 cm D).

*Weight:* 40 lbs. (18.15 kg).

**Part No. 522 3497 00 (Type 642A-2 Playback)**

**216C-2 RECORD SPECIFICATIONS**

*Power Consumption:* 125 watts.

*Audio Inputs:* Microphone and line, both variable gain and capable of being mixed. Microphone input 250 ohm impedance (50/600 ohms optional.) Will accommodate input levels from -65 dbm to -35 dbm. Line input 600 ohm impedance (50/250 ohms optional). Will accommodate levels from -15 dbm to +10 dbm.

*Cueing:* Primary tune, 1000 cps. Secondary tune, 350 cps.

*Size:* 15" or 19" W, 7" H, 13¾" D (38.1 cm or 48.26 cm W, 17.78 cm H, 34.93 cm D).

*Weight:* 15 lbs. (6.8 kg).

**Part No. 522 3496 00 (Type 216C-2 Record)**

**COLLINS DESK WING CONSOLE**

Functional and economical unit for housing three 15" Collins automatic programming playback units (or two playback units and one record unit) and 120 of the Series 300 tape cartridges. Sturdy construction and wear resistant Formica finish in walnut (DWW-3). Other finishes available on request.

*Size:* 51" W, 30" H, 18" D, (129.5 cm W., 76.2 cm H., 45.72 cm D).

*Weight:* 150 lbs. (68.04 kg).

**Part No. 097 5350 00**

## COLLINS PRODUCTION CONSOLE CABINET

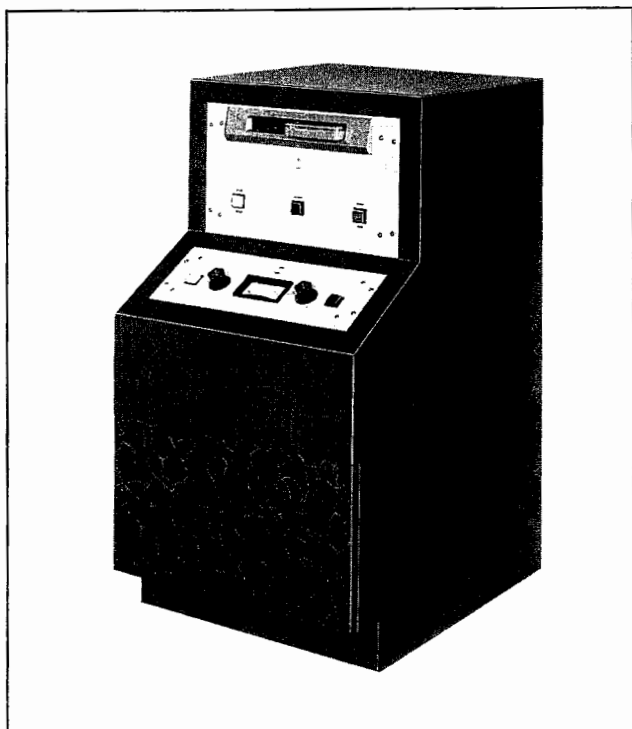

Complete Collins automatic programming recording and playback facilities may be mounted in this cabinet. Houses one 15" playback and one 15" recording amplifier. Has cutout for one 8" speaker (not included). Walnut Formica finish. Other finishes available on request. Size: 18" W, 34" H, 21" D (45.72 cm W, 86.36 cm H, 60.96 cm D).

Weight: 85 lbs. (38.36 kg).

Part No. 097 7522 00

## COLLINS TAPE CARTRIDGE RACK

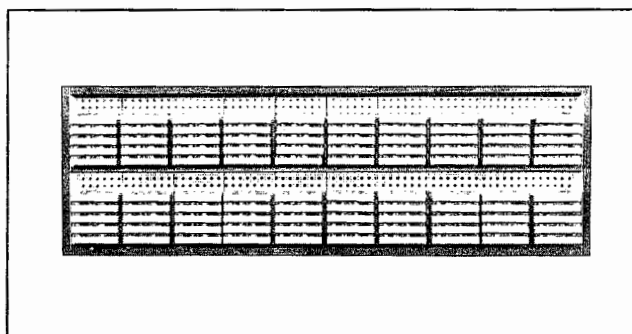

Formica covered wood rack holds 120 of the Series 300 cartridges used with Collins automatic programming equipment. Four rubber cushions allow rack to be set on top of programming wing. It also may be hung on wall. Walnut Formica. Other finishes available on request. Size: 45 $\frac{3}{4}$ " W, 14 $\frac{3}{8}$ " H, 4" D (116.21 cm W, 36.51 cm H, 10.16 cm D).

Weight: 25 lbs. (11.34 kg).

Part No. 124 0032 300

## ABCO LAZY SUSAN CARTRIDGE RACK

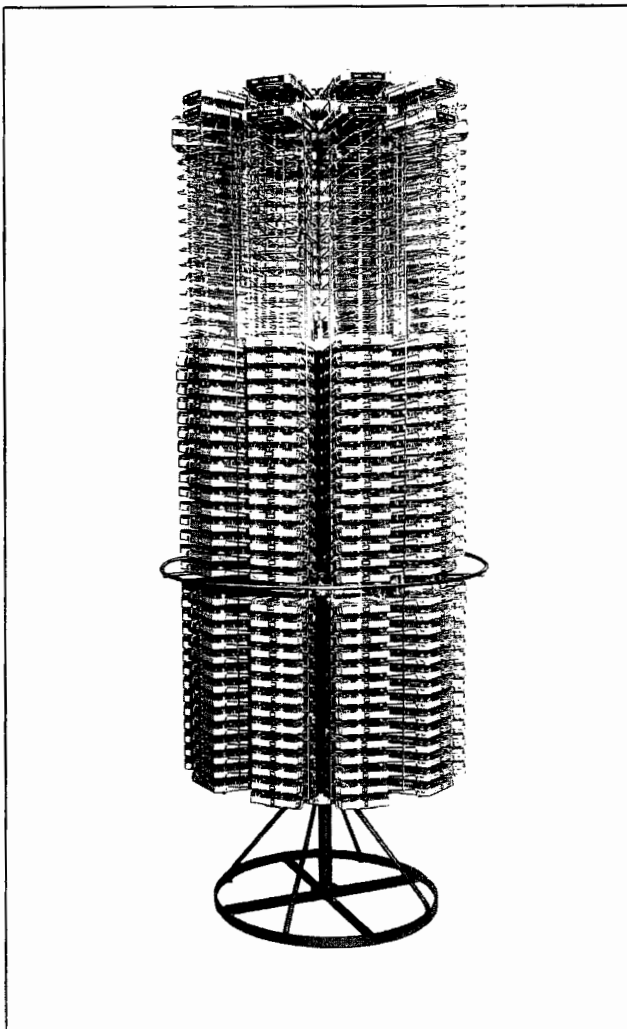

This sturdy, heavy Lazy Susan rack holds 500 of the Series 300 Collins automatic programming equipment tape cartridges. Ten chrome-plated racks with 50 slots each make storage and selection of cartridges fast and simple. Revolves easily on roller bearing hub and will not tip regardless of arrangement of cartridges. Cartridges held in wire holders at an angle to prevent slipping out while the rack is being revolved. Shipped knocked down.

Size: Approx. 72" H, 36" diameter (182.88 cm H, 91.44 cm diameter).

Weight: Approx. 50 lbs. (22.68 kg).

Part No. 097 7559 00

## ABCO WIRE CARTRIDGE RACK

Individual wire rack holding 50 Collins automatic programming equipment cartridges. Identical rack to those used in the Lazy Susan. Includes tapped mounting brackets welded to wire rack.

Size: Approx. 5" W, 1 $\frac{1}{2}$ " H, 7" D (12.7 cm W, 3.81 cm H, 17.78 cm D).

Weight: Approx. 2 lbs. (0.91 kg).

Part No. 097 7560 00



### COLLINS 313T-4 REMOTE CONTROL PANEL

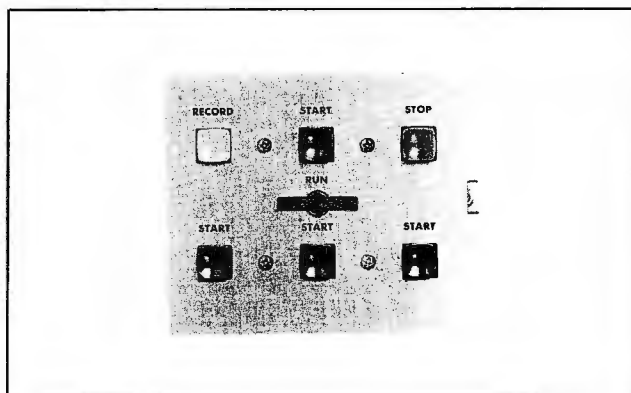

Three Collins automatic programming playback units, in addition to a record/playback system, may be operated with this control panel from a remote point in the broadcast studio. Buttons illuminate when in operation.  
 Size: 5 1/8" W, 2 3/4" H, 4 1/2" D (13.02 cm W, 6.99 cm H, 11.43 cm D).

Part No. 522 2552 00

### COLLINS 313T-3 REMOTE CONTROL PANEL

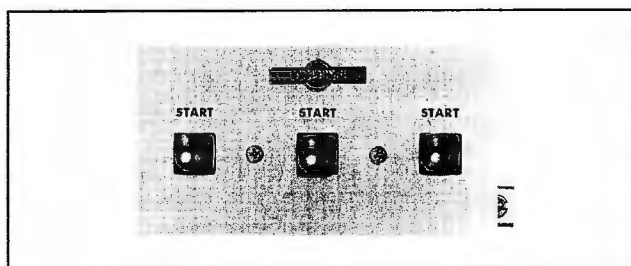

Has three illuminated "start" buttons for control of three or less playback units from a remote point.  
 Size: 5 1/8" W, 4 1/2" H, 4 1/2" D (13.02 cm W, 11.43 cm H, 11.43 cm D).

Part No. 522 2551 00

### COLLINS 313T-1 REMOTE CONTROL PANEL

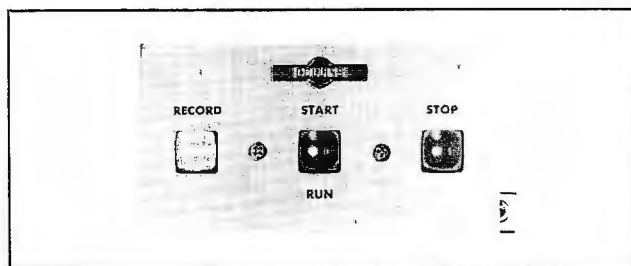

Has illuminated "start," "record" and "stop" buttons for control of one record/playback system from a remote point.  
 Size: 5 1/8" W, 2 3/8" H, 4 1/2" D (13.02 cm W, 6.99 cm H, 11.43 cm D).

Part No. 522 2550 00

### COLLINS AUTOMATIC PROGRAMMING LOADED CARTRIDGES

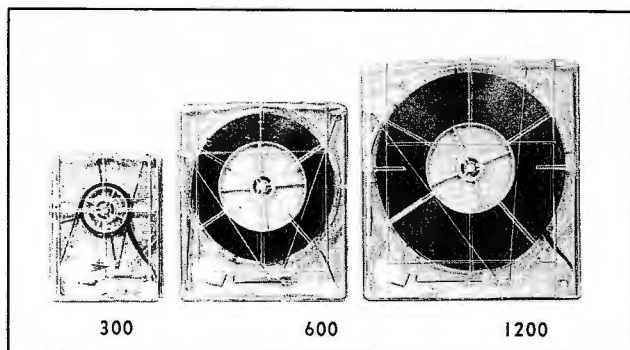

Manufactured for Collins automatic programming equipment, these cartridges are loaded with fine quality, specially lubricated tape.

**300 Series:** Loaded cartridges packed six per box (minimum one box) in following lengths: 40, 70, 90, 100 seconds; 2 1/2, 3, 3 1/2, 5, 5 1/2, 7, 7 1/2, 10, 10 1/2 minutes. Specify length.

Type No.	Part Number	Length
300 Series	124 0032 057	40 Second Tape Cartridges
300 Series	124 0032 058	70 Second
300 Series	124 0032 059	90 Second
300 Series	124 0032 060	100 Second
300 Series	124 0032 061	2 1/2 Minute
300 Series	124 0032 062	3 Minute
300 Series	124 0032 063	3 1/2 Minute
300 Series	124 0032 064	5 Minute
300 Series	124 0032 090	5 1/2 Minute
300 Series	124 0032 065	7 1/2 Minute
300 Series	124 0032 066	10 Minute
300 Series	124 0032 067	10 1/2 Minute

**600 Series:** Loaded cartridges packed two per box (minimum one box) in following lengths: 11, 12 1/2, 15, 16 minutes. Specify length.

600 Series	124 0032 067	11 Minute
600 Series	124 0032 069	13 1/2 Minute
600 Series	124 0032 070	15 Minute
600 Series	124 0032 071	16 Minute

**1200 Series:** Loaded cartridges packed two per box (minimum one box) in 31 minute lengths.

1200 Series	124 0032 072	31 Minute
-------------	--------------	-----------

### COLLINS AUTOMATIC PROGRAMMING BLANK CARTRIDGES

Identical to above cartridges for custom loading.

**300 Series:** Blank cartridges packed six per box (minimum one box). Up to 10 1/2 minutes playing time.

Part No. 124 0032 073

**600 Series:** Blank cartridges packed two per box (minimum one box). From 11 to 16 minutes playing time.

Part No. 124 0032 074

**1200 Series:** Blank cartridges packed two per box (minimum one box). From 16 1/2 to 31 minutes playing time.

Part No. 124 0032 075

### COLLINS AUTOMATIC PROGRAMMING MM-151 BULK RECORDING TAPE

A fine quality, specially lubricated, Minnesota Mining tape in bulk lengths of 1,700' on 7" reels for use with Collins Automatic Programming blank cartridges.

Part No. 099 2629 000

## AUDIOTAPE AND MM RECORDING TAPES

The following tapes are designed for conventional recorders (see description under Collins Automatic Programming MM-151 Bulk Recording Tape for specially lubricated bulk tape):

111A-12: Minnesota Mining tape, 1200 ft., 7" reel.

150-18: Minnesota Mining tape, Mylar, 1800 ft., 7" reel.

190-18: Minnesota Mining tape, plastic base, 1800 ft., 7" reel.

Part No. 272 1407 00 (Type 111A-12)  
Part No. 097 7112 00 (Type 150-18)  
Part No. 099 0040 00 (Type 190-181)

## ROBBINS ST-500 BULK SPLICING TAPE

Robbins splicing tape for use with automatic programming equipment and reel to reel recording tape. 1/2" x 100" mylar tape.

Part No. 124 0032 544.

## ROBINS TS-8D SPLICER-CUTTER

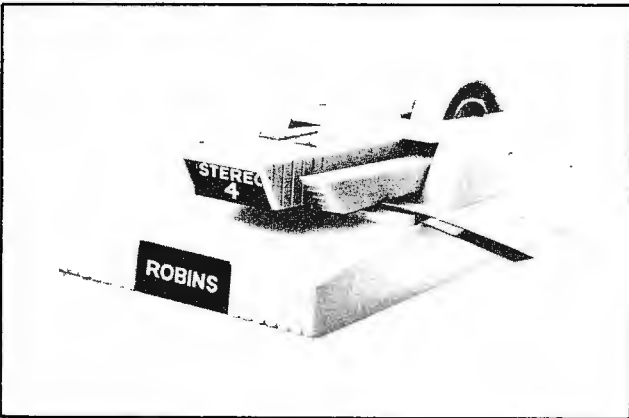

Used for magnetic recording tape, this unit cuts two rounded indentations in the tape splice, giving the splice a "Gibson Girl" shape and leaving the edges of the tape free of adhesive. The unit can be removed from its base and mounted directly on any tape recorder. It comes complete with a roll of splicing tape and tape feed.

Part No. 124 0032 178

## COLLINS AUTOMATIC PROGRAMMING TEST TAPE

Azimuth head alignment test tape for Collins automatic programming playback in 70-second length with 5,000 cps tone on cue track and 10,000 cps tone on program track.

Part No. 097 6076 00

## REPLACEMENT PRESSURE PADS

Long lived Polyurethane pad interchangeable with pads in original cartridge in boxes of 50.

Part No. 094 2546 00

## TAPE CARTRIDGE REPAIR KIT

Collins Automatic Programming cartridges may be repaired easily with this repair kit which includes 12 Teflon washers, 12 pressure pads and 12 center screws.

Part No. 099 0066 00  
Minimum order of three kits as described above.

## MAGNERASER 200C TAPE ERASER

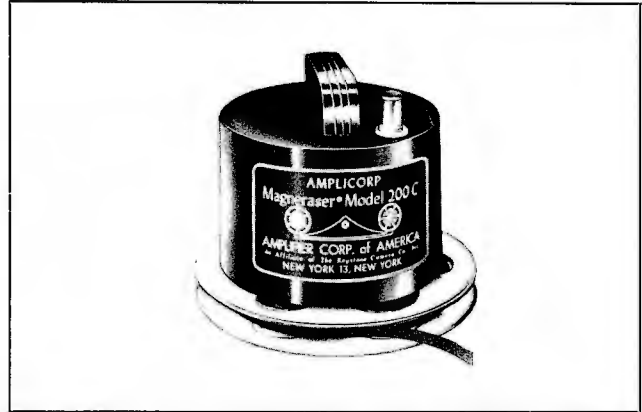

A compact and convenient bulk tape eraser that removes recorded signals from tape up to 35 mm in size and lowers background noise level up to 6 db below that of unused tape. A pushbutton safety switch prevents current from being applied when not in use.

Operating Voltage: 100-130 v. 50-60 cps.

Size: 2" H. 4" diameter (5.08 cm H. 10.16 cm diameter).

Weight: 2 1/2 lbs. (1.13 kg).

Part No. 097 5172 00

## MICROTRAN HD-11M TAPE ERASER

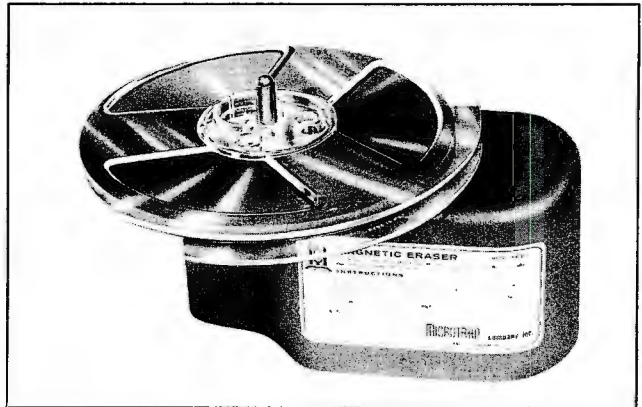

A bulk tape demagnetizer that develops a high intensity magnetic field to erase signals and noise without rewinding. Spindle mounting of reel permits rapid and thorough coverage.

Reel Size Range: 5", 7", 10 1/2" (spindle removable for use with other size reels).

Adapter Hub: Available for use with 10 1/2" reels.

Rating: 117 v ac. 5 amps.

Size: 5" W. 3" H. 8" D (12.7 cm W. 7.62 cm H. 20.32 cm D).

Part No. 099 0371 00

## AMPEX 602 SERIES RECORDER

The 602 is a field recorder that will go where you go—and give you the reliability and professional studio-quality you need when you get there! The 602 series units have hysteresis synchronous drive motors and three separate heads: erase, record, and playback. For rack mounting in the studio, it uses minimal rack space.

### SPECIFICATIONS/602 SERIES

Measured by professional standard methods. These are the guaranteed minimum specifications the user can expect in long-term operation.

*Frequency Response:* 40 to 15,000 cps; down no more than 4 db at 15,000;  $\pm 2$  db from 40 to 10,000 cps at 7½ ips. 3¾ ips model +2 -4 db from 40 to 8,000 cps.

*Signal-to-Noise Ratio:* Model 602-1: with full track head, over 57 db; with half-track head, over 55 db. Model 602-2: over 55 db. All at 7½ ips.

*Flutter and Wow:* Less than 0.17% at 7½ ips; less than 0.25% at 3¾ ips (measured at ASA standard).

*Timing Accuracy:*  $\pm 0.2\%$  at 7½ ips ( $\pm 3.6$  seconds in a 30 minute recording).

*Fast Forward or Fast Rewind Time:* 90 seconds for full 1200-foot reel.

*Heads:* Three separate heads: erase, record, playback.

Model 602-1: Full-track or half-track

Model 602-2: Two-track heads

*Speeds:* 7½ ips model or 3¾ ips model.

*Reel Size:* 7" and 5".

*Inputs (each channel):* Two inputs, individual gain controls on each.

a. low impedance mike input, 150 microvolts required for program record level (for use with mikes of 30 to 250 ohms nominal impedance).

b. Line input (100K unbalanced), —10 dbm required for program record level.

All inputs are Cannon XL connectors. Provision for use of plug-in balanced line or bridging input transformers.

Line input can be used as input for second microphone by accessory plug-in preamplifier (allowing 2 microphones to be mixed on one channel).

*Outputs (each channel):* a. +4 dbm into 600 ohm. Balanced or unbalanced load.

b. Head phone jack (on front panel).

Monitor selector knob permits monitoring from either the input source or the tape playback, while recording.

*Equalization:* For 117 volt, 50 and 60 cps models: 7½ ips, NAB; 3¾ ips, 120 microsecond.

For 115/230 volt, 50 cps models: 7½ ips (19 cm/s), CCIR; 3¾ ips (9.5 cm/s) 200 microsecond.

*Power Requirements:* Models for 117 v., 60 cps; 117 v., 50 cps; 115/230 v., 50 cps. Model 602-1, 70 volt-amperes; Model 602-2, 105 volt-amperes.

*Weight (in case):* Model 602-1: 28 lbs. Model 602-2: 42 lbs.

U. L. Approved

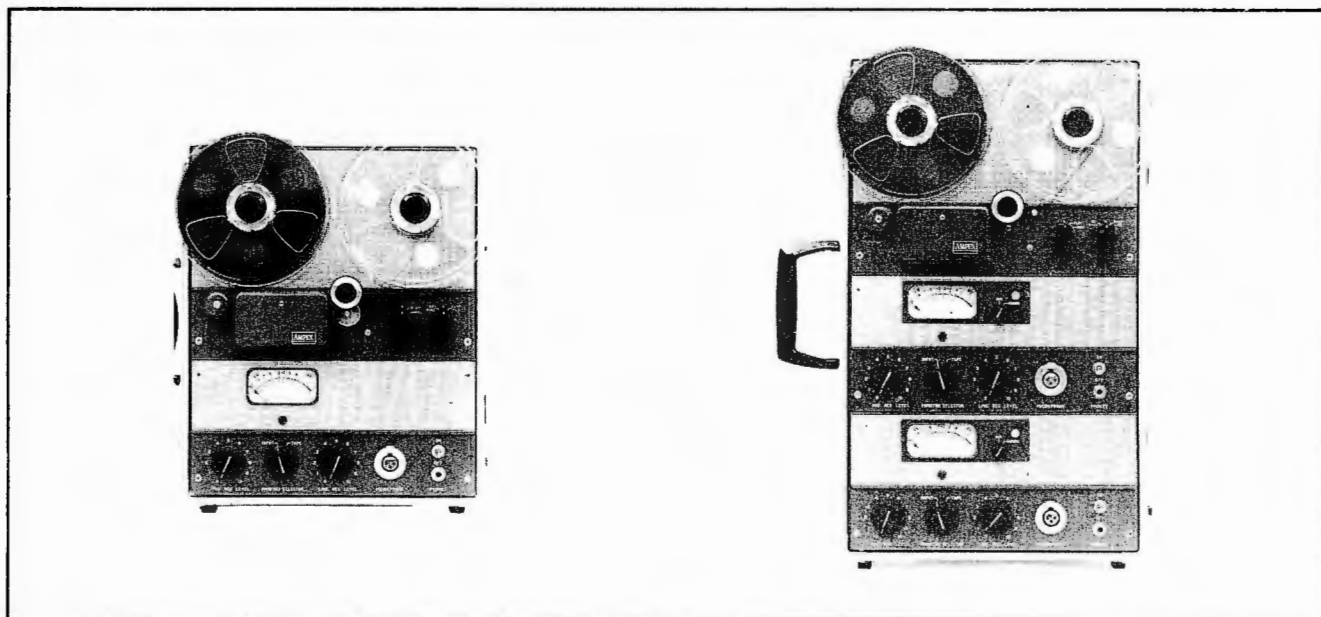

### AMPEX 602-1 ONE CHANNEL RECORDER

You may choose full or half-track heads. A rugged, dependable recorder that will meet your performance requirements for a professional mono input.

*Portable:* 7½ ips, half-track head, 4016021-04; 7½ ips, full-track head, 4016021-02. 3¾ ips, half-track head, 4016021-08.

*Uncased:* 7½ ips, half-track head, 4016021-03. 7½ ips, full-track head, 4016021-01.

### AMPEX 602-2 TWO CHANNEL RECORDER

The 602-2 provides two-track heads with selective-track erase head; two electronic channels, give you the versatility of two-track stereo and half-track mono in one unit.

*Portable:* 7½ ips, two-track head, 4016023-02. 3¾ ips, two-track head, 4016023-04.

*Uncased:* 7½ ips, two-track head, 4016023-01.

## AMPEX 622 SPEAKER/AMPLIFIER

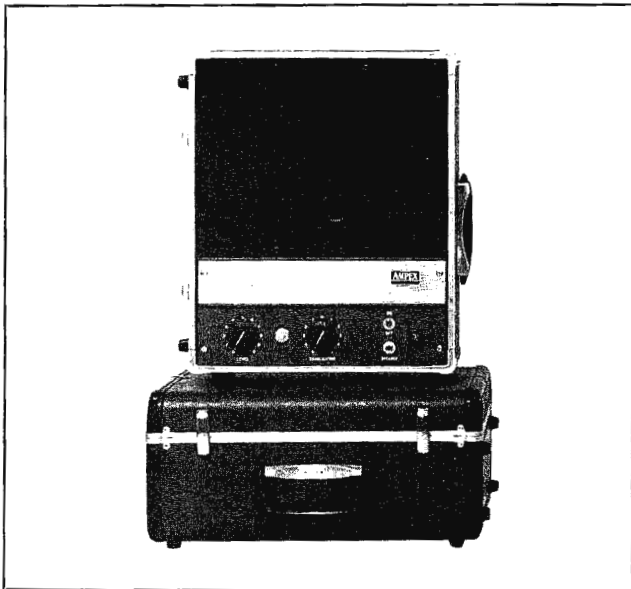

The 622 unit gives you "on-the-spot" studio-quality playback for demonstration or monitoring. Its 10 watt amplifier provides ample volume for a medium size auditorium.

### SPECIFICATIONS/622 SPEAKER-AMPLIFIER

*Overall Frequency Response (in air):* Essentially flat acoustically, range better than 65-10,000 cps.

*Speaker Size:* Special design 8" full-range speaker.

*Power Output:* 10 watts amplifier power with no audible harmonic distortion. Speaker can handle full power.

*Signal-to-Noise:* Amplifier noise (including hum), 70 db below rated output.

*Controls & Connections:* Volume control, bass-treble control, power switch and on-off indicator light. Built-in AC convenience outlet. Audio input connector is concentric pin type. External speaker connection is head-phone type jack.

*Equalization:* Single control on front panel provides adjustment, boosting bass and attenuating treble or vice versa. Maximum bass boost 6 db relative to treble. Maximum treble boost 6 db relative to bass.

*External Speaker Feed:* Use of "SPEAKER" jack automatically cuts out the 622's internal speaker and reciprocal network. Flat amplifier output is fed to the external speaker.

*Impedance:* Inputs, 100,000 ohms. Output, 12 ohms to external speaker.

*Power Requirement:* 117 volts, 50 or 60 cycles, 0.5 amps. 55 watts.

*Weight:* 25 pounds.

*U. L. Approved*

### DIMENSIONS/602-1 602-2 622

*Transport top area:* 9 5/8" x 12 1/2".

*Electronic top area:* 6 1/8" x 12 1/2".

(two electronic sections in Model 602-2).

*Depth below top plate:* 5".

*Overall size, include carrying case:*

Model 602-1; 8" x 13 3/4" x 16 1/2"

Model 602-2; 8" x 13 3/4" x 23"

*Rack Space:* will mount in standard 19" width rack, with appropriate Ampex adapter panel.

Model 602-1 with #864 Adapter Panel, takes only 17 1/2" of vertical rack space.

Model 602-2 with #865 Adapter Panel, takes only 23 3/4" of vertical rack space.

*Model 622 speaker/amplifier, overall size in carrying case:* 13" x 16" x 8". Catalog No. 01-0622.

Part No. 099 2484 000

## ACCESSORIES FOR AMPEX 602 SERIES

	Order By Type Number
Minor Hardware Kit	01-0897
Portable case —	
for 602-1 one-channel model	01-0854
for 602-2 two-channel model	01-0855
Rack Mount Adapter — for 602-1	01-0864
for 602-2	01-0865
Operation & Maintenance Manual (602 series)	89-0080
Operator's Guide for 622 Amplifier/Speaker	89-0099
Professional Accessory Kit (includes head cleaner, demagnetizer, motor oil, Q-tips)	01-0894
Head Demagnetizer	820
Head Cleaner, 4-oz. Can	823
Lubricating Oil, approved, in plastic oiler bottle	825
Alignment Tapes (see separate Alignment Tape Price Schedule and descriptions). Speed and power frequency conversion kits available on request from Ampex Service Engineering Department.	

## AMPEX TYPE AG-350

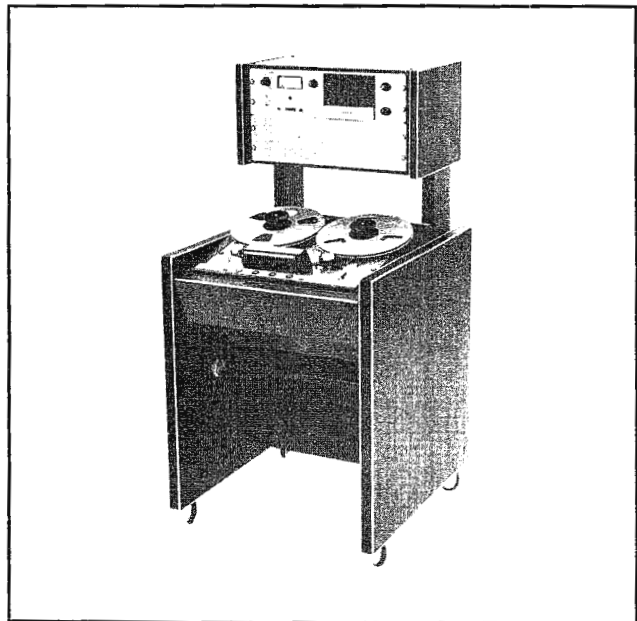

The ampex AG-350 series transport retains the time proven 350 series transport features. Outstanding features include automatic equalization, rigid top plate, direct drive capstan, accurate traction pressure through positive solenoid control of capstan idler which disengages automatically when power is shut off, take up arm to eliminate tape bounce, push button control panel, 10 1/2 inch reels, tape speed switch automatically switches equalization,



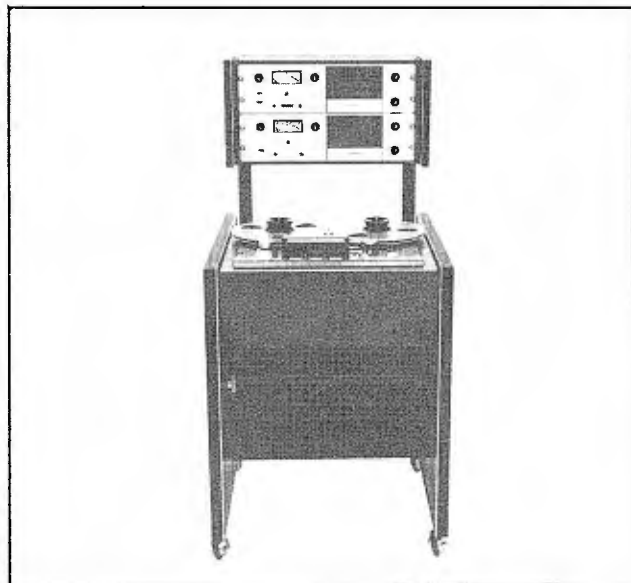

and self-limiting design brakes. The amplifier incorporates 100% solid state design, front panel adjustments, plug in equalizers, low frequency adjustment, large VU meter, single record button for one or two channels, record/safe switch with ready light, locking-level knob, and accessory socket.

AG-350-1 Mono record/reproducer available in console, portable, and unmounted.

AG-350-2 Stereo record/reproducer available in console, portable, and unmounted.

AG-355-1 Mono reproducer available in console, and unmounted.

AG-355-2 Stereo reproducer available in console, and unmounted.

**SPECIFICATIONS**

*Tape Speeds:* 7½-15 ips or 3¾-7½ ips  
*Frequency Response Overall:* 15 ips ±2 db 30-18,000 cps.

7½ ips ±2 db 40-10,000 cps.

+2-4 db 30-15,000 cps

3¾ ips ±2 db 50-7,500 cps.

*Frequency Response Playback:* 15 ips ±1 db 50-10,000 cps.

±1½ db @ 15,000 cps.

7½ ips ±1 db 50-10,000 cps.

±2 db @ 7,500 cps.

+2-3 db @ 15,000 cps.

3¾ ips ±1 db 50-5,000 cps.

±2 db @ 7,500 cps.

<i>Signal-To-Noise Ratio:</i>	Speed	Full Track	2 Track
	15 ips	60 db	55 db
	7½ ips	55 db	55 db
	3¾ ips	55 db	50 db

<i>Flutter:</i>	Speed	Percentage
	15 ips	below 1.11% rms
	7½ ips	below 1.14% rms
	3¾ ips	below 0.18% rms

*Playback Output:* +8 dbm into 600 ohms — restrappable for +4 dbm output, balanced or unbalanced. Maximum of +28 dbm before clipping.

*Record Input:* 100K bridging — 20 dbm to produce recommended operating level.

*Start/Stop:* Start: Tape at full speed in less than 1/10 second. Stop: At 15 ips, tape moves less than 2 inches after pressing button.

*Playback Timing Accuracy:* ±0.2% (± 3.6 seconds in 30 minutes recording time).

*Tape Width:* Standard ¼" tape.

*Reel Size:* Up to 10½ inch reels.

*Equalization:* All standard models supplied with NAB equalization. CCIR curves available on special order.

*Rewind Time:* Approximately 1 minute for 2400 feet NAB reel; 30 seconds for 1200 ft. EIA reel (Thin base types proportionately longer).

*Power Requirements:* 117 volts AC, single channel, 2.0 amperes, two channel 2.5 amperes. Specify 60 or 50 cps. (Universal series 90 to 130 volts dc and 200 to 240 volts dc on special order).

*Dimension/Weight:* Standard 19" wide panels with commercial notching for rack mounting. Tape transport uses 15½ inches of rack space, weight 19 lbs. (Two electronics required for stereo). Console: 52" high (to top of electronics) 24¾" wide, 27¼" deep. Weight approximately 180 lbs.

**MAGNECORD 1028 RECORDER-REPRODUCER**

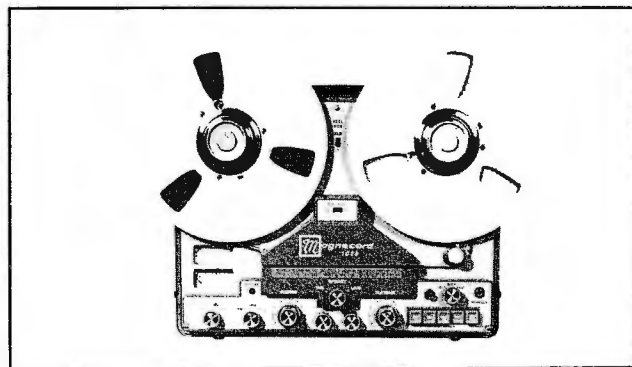

The MagneCORD 1028 has advanced circuit design, utilizing latest types, and printed wiring to insure uniform high performance from recorder to recorder.

**SPECIFICATIONS:**

*Tape Speeds:* 7.5 and 15 inches per second.

*Flutter and Wow:* 0.15% at 7.5 ips; 0.1% at 15 ips.

*Timing Accuracy:* ±0.2%.

*Reel Size:* 5-, 7- and 10½-inch.

*Rewind Time:* 2400 feet, less than 100 seconds.

*Frequency Response:* ±2 db — 40 to 16,000 cps at 7.5 ips; 40 to 22,000 cps at 15 ips.

*Signal-to-Noise Ratio:* 56 db per channel.

*Inputs:* Hi-Z microphone and Hi-Z unbalanced bridge; Lo-Z microphone and Hi-Z balanced bridge. With input transformer.

*Input Sensivity:* -90 dbm to -30 dbm.

*Outputs:* Cathode follower, 2.0 volts; 150/600-ohm balanced, +4 dbm. With output transformer.

*Heads:* Selectable Erase, 2-channel Record and 2-channel Play.

*Weight:* 50 pounds (60 pounds encased).

*Dimensions:* 17⅝" wide, 12⅞" high, 12" deep. (17⅝" wide, 14⅛" high, 12" deep encased.)

50 cps model at extra cost.

Part No. 099 3013 000

## MAGNECORD 1022 RECORDER-REPRODUCER

**FEATURES:** Solid state electronics with regulated power supply and built-in input and output transformers.

### SPECIFICATIONS

*Tape Speeds:* 7.5 and 15 inches per second.

*Flutter and Wow:* 0.17% at 7.5 ips; 0.15% at 15 ips.

*Timing Accuracy:*  $\pm 0.2\%$ .

*Reel Size:* 5-, 7- and 8-inch E.I.A. hubs.

*Rewind Time:* 1200 feet in 80 seconds.

*Frequency Response:*  $\pm 2$  db — 25 to 18,000 cps at 7.5 ips; 35 to 22,000 cps at 15 ips.

*Signal-to-Noise Ratio:* 53 db, both speeds.

*Inputs Per Channel:* Lo-Z microphone, balanced bridge, unbalanced bridge, auxiliary bridge.

*Outputs Per Channel:* 150/600-ohm balanced, auxiliary A and auxiliary B unbalanced (+8 dbm).

*Heads:* Selectable 2-channel Erase, 2-channel Record, 2-channel Play and  $\frac{1}{4}$ -track Play.

*Weight:* 47 pounds.

*Dimensions:* 19" wide, 15 $\frac{3}{4}$ " high, 12" deep.

50 cps model at no extra cost.

Part No. 124 0032 375

## MAGNECORD 1021 RECORDER-REPRODUCER

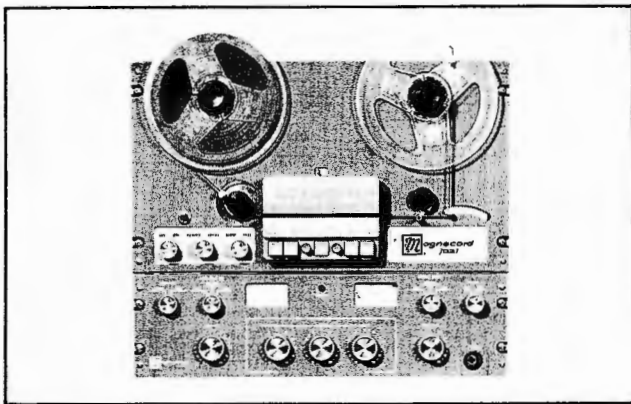

**FEATURES:** Fully transistorized with regulated power supply. Switchable equalization (N.A.B. standard).

### SPECIFICATIONS

*Tape Speeds:* 3.75 and 7.5 inches per second.

*Flutter and Wow:* 0.25% at 3.75 ips; 0.2% at 7.5 ips.

*Timing Accuracy:*  $\pm 0.2\%$ .

*Reel Size:* 5-, 7- and 8-inch E.I.A. hubs.

*Rewind Time:* 1200 feet in 80 seconds.

*Frequency Response:*  $\pm 2$  db — 30 to 8,000 cps at 3.75 ips. 20 to 15,000 cps at 7.5 ips.

*Signal-to-Noise Ratio:* 53 db, both speeds.

*Inputs:* Lo-Z microphone, balanced bridge, unbalanced bridge, mixing bridge and auxiliary bridge.

*Outputs:* 150/600-ohm balanced; unbalanced, auxiliary A and auxiliary B (+8 dbm).

*Heads:* Full-track Erase, Record and half-track Play.

*Weight:* 47 pounds (uncased).

*Dimensions:* 19" wide, 15 $\frac{3}{4}$ " high, 12" deep.

50 cps model at no extra cost.

Part No. 124 0032 183 (Type 1021RX)  
With remote control less case  
Part No. 124 0032 184 (Type 1021R)  
With remote control and case  
Part No. 124 0032 185 (Type 1021X)  
Less case

## MAGNECORD PT6-6A/J

The PT6-6A Recorder and PT6-6J Amplifier are designed for either rack mounting or portable use. Powered by two-speed hysteresis synchronous motor for 7 $\frac{1}{2}$  and 15 ips, selectable by switch. Low impedance and high impedance inputs are provided as well as 4, 8, 16 and 50 ohm outputs. The unit includes full-track erase and record/playback heads (half-track heads may be specified at no additional cost).

*Power Input:* 60 cps. 50 cps at extra cost.

*Frequency Response:*  $\pm 2$  db 50-15,000 cps at 15 ips;  $\pm 2$  db 50-7,500 cps at 7 $\frac{1}{2}$  ips.

*Signal-to-Noise Ratio:* 50 db.

*Distortion:* Less than 2% at 10 watts output.

*Flutter:* 0.3% at 15 ips; 0.5% at 7 $\frac{1}{2}$  ips.

*Size:* Amplifier — 19" W, 7" H, 8" D (48.26 cm W, 17.78 cm H, 20.32 cm D). Recorder — 19" W, 7" H, 11" D (48.26 cm W, 17.78 cm H, 27.94 cm D).

*Weight:* Amplifier — 21 lbs. (9.53 kg) in case. Recorder — 26 lbs (11.79 kg) in case.

Part No. 097 3806 00 (Type PT6-6A)  
With case.  
Part No. 097 4491 00 (Type PT6-6AX)  
Without case.  
Part No. 097 3807 00 (Type PT6-6J)  
With case.  
Part No. 097 4492 00 (Type PT6-6JX)  
Without case.

## CROWN 800 TAPE RECORDERS



Available in either monaural or stereo models, the Crown 800 series recorder has many advanced features to make it a professional unit for broadcast stations. Each unit is guaranteed to give top quality performance and is thoroughly tested to assure complete satisfaction.

Among its features: 3 heads for 15, 7 $\frac{1}{2}$  and 3 $\frac{3}{4}$  ips operation, AM adjustment control, transistorized photo electric automatic stop for all functions, photo electric program cueing, all-electric relay and solenoid operation, 3-speed electronic reverberation for echo, automatic shift from front panel for 3 $\frac{3}{4}$  and 7 $\frac{1}{2}$  ips, automatic torque compensator, accepts 10 $\frac{1}{2}$ " reels, lowest record-playback

intermodulation distortion in industry and over-size life-time bearings. The stereo version (Type 822) is similar to the monaural unit shown except for the addition of an identical amplifier unit for the second channel.

**Power Input:** 60 cps, 50 cps at extra cost.

**Size:** Monaural — 19" W, 15" H, 10½" D (48.26 cm W, 38.1 cm H, 26.67 cm D). Stereo — 19" W, 18½" H, 10½" D (48.26 cm W, 46.99 cm H, 26.67 cm D).

**Weight:** Monaural — 48 lbs. (21.77 kg). Stereo — 56 lbs. (25.40 kg).

Speed	Frequency Response	Flutter and Wow	Noise Ratio
15	±2 db, 30-30,000 cps	.06%	57 db
7½	±2 db, 30-20,000 cps	.09%	55 db
3¾	±3 db, 30-13,000 cps	.18%	51 db

- Part No. 099 0479 000 (Type BX801)  
Less case.
- Part No. 099 0731 000 (Type BX822)  
Less case.
- Part No. 099 0481 000  
Case for Type B801 monaural recorder.
- Part No. 099 0482 000  
Case for Type B22 stereo recorder.

### CROWN RC8 REMOTE CONTROL

This unit, with indicator light, is a duplicate of the rewind, play, forward and stop functions mounted on the recorder cabinet. The RC8 includes 25' cable.

Part No. 099 0158 00 — Remote control unit.

### CONCERTONE TAPE RECORDERS



Designed for rugged reliability under continuous performance conditions, the Series 90 meets exacting broadcast requirements. The Concertone Edit-O-Matic® feature

enables quick cueing, and a flutter filtering system virtually eliminates spurious vibrations and tape flutter.

The unit accommodates up to four heads for stereo. A multichannel erase head provides separate erase for each track to assure easy monophonic and sound-on-sound recording. Separate gain controls for each input signal permit recording from two different sources simultaneously, mixing sounds for proper balance. Handles all reel sizes from 5" to 10½". Available in monophonic full-or half-track and stereo 2- or 4-track versions in studio consoles, portable case or rack mounting.

**Tape Speeds:** 15 and 7½ ips; or 7½ and 3¾ ips.

**Frequency Response:** ±2 db, 40-15,000 cps at 15 ips; ±2 db, 40-12,000 cps at 7½ ips; ±2 db, 50-7,500 cps at 3¾ ips.

**Signal-to-Noise Ratio:** Full track — 55 db at 7½ and 15 ips; 50 db at 3¾ ips. Stereo — 50 db at 7½ and 15 ips; 45 db at 3¾ ips (based on 2% distortion).

**Timing Accuracy:** 99.8% or better.

**Flutter and Wow:** Less than 0.1% rms at 7½ and 15 ips; less than 0.3% rms at 3¾ ips.

**Rewind and Fast Forward:** 90 seconds for 2,400 ft.

**Input Impedance:** High impedance unbalanced; 50, 250, 600 ohms balanced or unbalanced with plug-in transformers.

**Output Impedance:** 600 ohms balanced with terminating switch to allow connections to high impedance input.

**Output Level:** 0 VU.

**Power Requirements:** Monophonic — Approx. 280 watts, 115 v, 60 cps (50 cps on special order). Stereo — Approx. 320 watts, 115 v, 60 cps.

**Size:** Transport — 19" W, 15¾" H, 8" D (48.26 cm W, 15¾ cm H, 20.32 cm D). Amplifier — 19" W, 5¼" H, 8¼" D (48.26 cm W, 13.34 cm H, 20.96 cm D).

**Weight:** Transport — 48 lbs (21.77 kg). Amplifier — 12 lbs. (5.44 kg).

- Part No. 099 0373 00 (Type 91)  
Full track, 15 and 7½ ips, rack mounted.
- Part No. 099 0374 00 (Type 92)  
Half track, 15 and 7½ ips, rack mounted.
- Part No. 099 0375 00 (Type 93)  
Two track stereo, rack mounted.
- Part No. 099 0376 00 (Type 93-4)  
Four track stereo, rack mounted.
- No Part Number  
Factory installed conversion kit to 3¾ and 7½ ips. Specify "A" following model number.
- No Part Number  
Factory installed conversion kit for 50 cps operation. Specify "50 cps" following model number.
- Part No. 099 0377 00  
Extra playback head, two track or four track stereo head, factory installed.
- Part No. 099 0378 00  
Complete stereo head assembly. Four heads (erase, record, play, play) two or four track stereo. Factory installed.
- Part No. 099 0379 00 (Type 700105)  
Transformer, 50-ohm microphone, input.
- Part No. 099 0380 00 (Type 700106)  
Transformer, 250-ohm microphone, input.
- Part No. 099 0381 00 (Type 700107)  
Transformer, 10,000-ohm line-level, input.
- Part No. 099 0382 00 (Type 700108)  
Transformer, 600-ohm line-level, input).
- Part No. 099 0383 00 (Type 700122)  
Portable case (for transport or two preamplifiers).
- Part No. 099 0384 00 (Type 700133)  
Portable case (for one preamplifier).
- Part No. 099 0385 00 (Type 700120)  
Remote control with 25 ft. cord.

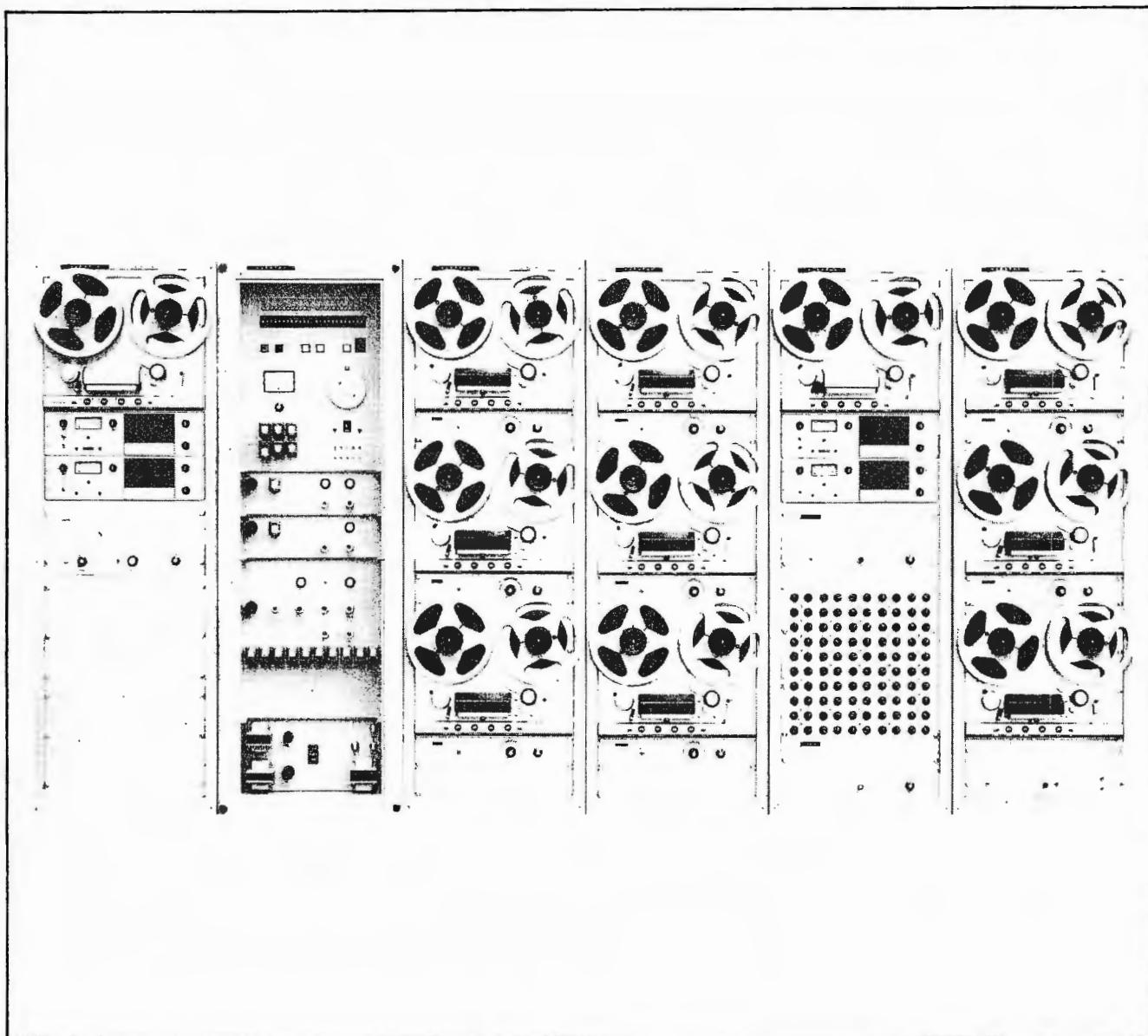

## SCHAFFER MODEL 800 PROGRAM CONTROL SYSTEM

The Model 800 Program Control is a completely new broadcast Program Control system designed for the station that wants to prepare a full day of programming in just a few hours and still maintain the flexibility necessary for today's requirements. Smooth, tight programming becomes extremely simple. Up to ten or more program sources may be controlled by the control unit, allowing a multitude of program combinations. Program categories are assembled automatically at the desired pace with a reliability factor difficult, if not impossible, to achieve with a manual operation. A 25-cycle tone allows overlap, extremely tight segue, or any timing desired. Automatic tape cueing is accomplished in a number of ways, including the latest photocell method.

The format may be interrupted or changed at any time, even when the program is playing on the air. If a chan-

nel should fail, the auto-step circuit sustains on-the-air operation and that channel is by-passed until it is repaired.

The remote control for the Program Record Unit provides all controls necessary for recording tapes for use on the Program Control System. Remote control is also provided.

A built-in clock can be used to control the program format, or be used to make insertions at predetermined times.

New digital switches and new miniature indicator lights give a new uncluttered appearance to the Program Control System. The lighted digital readout indicates which channel is playing. A monitor is built in for cueing purposes.

The system is available with any configuration of recorders or other accessories and can incorporate recorders or accessories now owned by the station.



**SCHAFER MODEL SA-100  
SPOT LOCATOR**

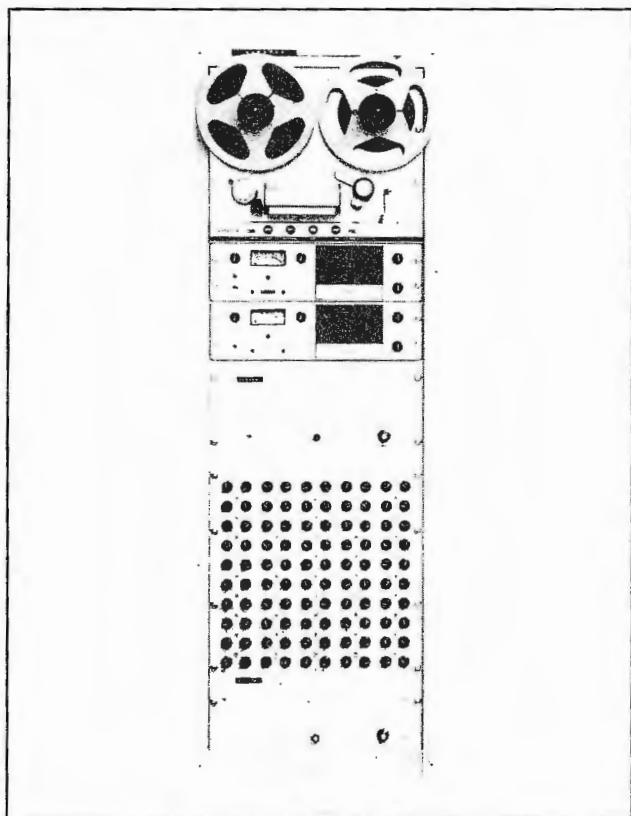

The SA-100 Spot Locator was developed to fill a need for high fidelity record-playback facilities to be used in the AM and FM broadcasting industry. This is a device that eliminates storage problems associated with acetate discs, tape cartridges, rolls of tape, etc. Recording and playback is accomplished with the absolute minimum of effort and time.

Connect the SA-100 Spot Locator to an Ampex Recorder and select any one of the 100 spots stored on the tape by merely setting the switches.

**SA-100 REMOTE CONTROL**

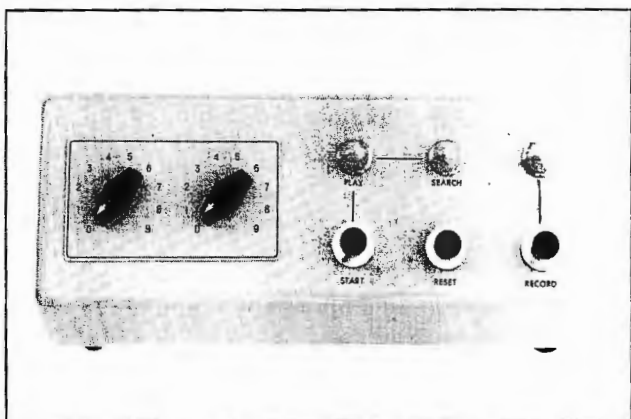

Remote Control Box permits operation of the Spot Locator from any remote location.

Memory allows pre-setting of sequence of spots for hours in advance for automatic or full automation operation.

**SCHAFER MODEL TM-8 AUDIO CLOCK**

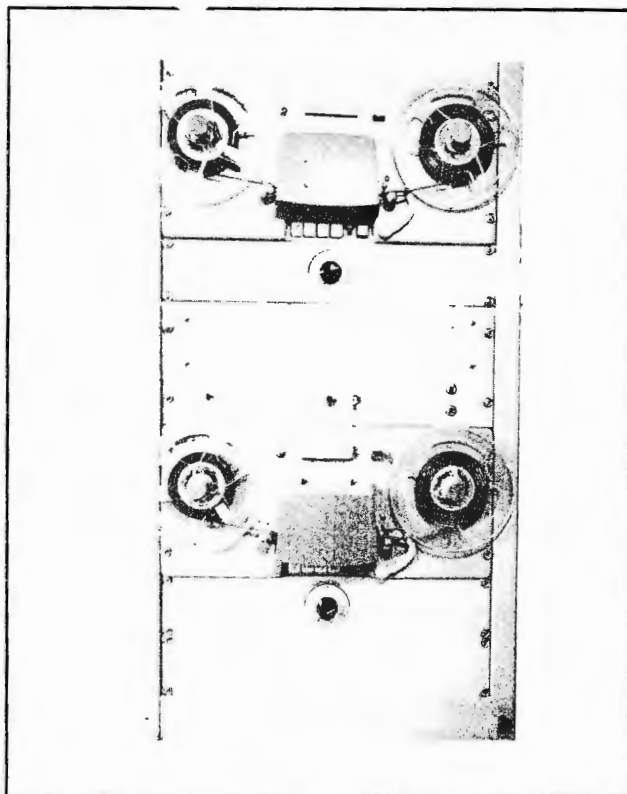

When time signals are desired in program format it can be easily accomplished with singing jingles or verbal announcements on the Audio Clock. Each tape deck holds 320 time signals. The control unit advances each deck every minute to keep the time signals synchronized with the clock whether each time signal is aired or not. The TM-8 is usually furnished with 2 Ampex PB-355's.

**SCHAFER MODEL APL-1 AUTOMATIC  
PROGRAM LOGGER**

Meeting FCC requirements the Schafer Automatic Program Logger eliminates the necessity to keep a written program log. It records 24 hours on a 7-inch reel of 1200 feet of ordinary 1/2 inch tape. The Monitor Alarm provides a monitor, as well as an alarm, should the program or the logger fail.

**SCHAFER MODEL ANP-1 AUTOMATIC  
NETWORK PROGRAMMER**

Operates in conjunction with the Model 800 Program Control to automatically coordinate Program Control system and a network.

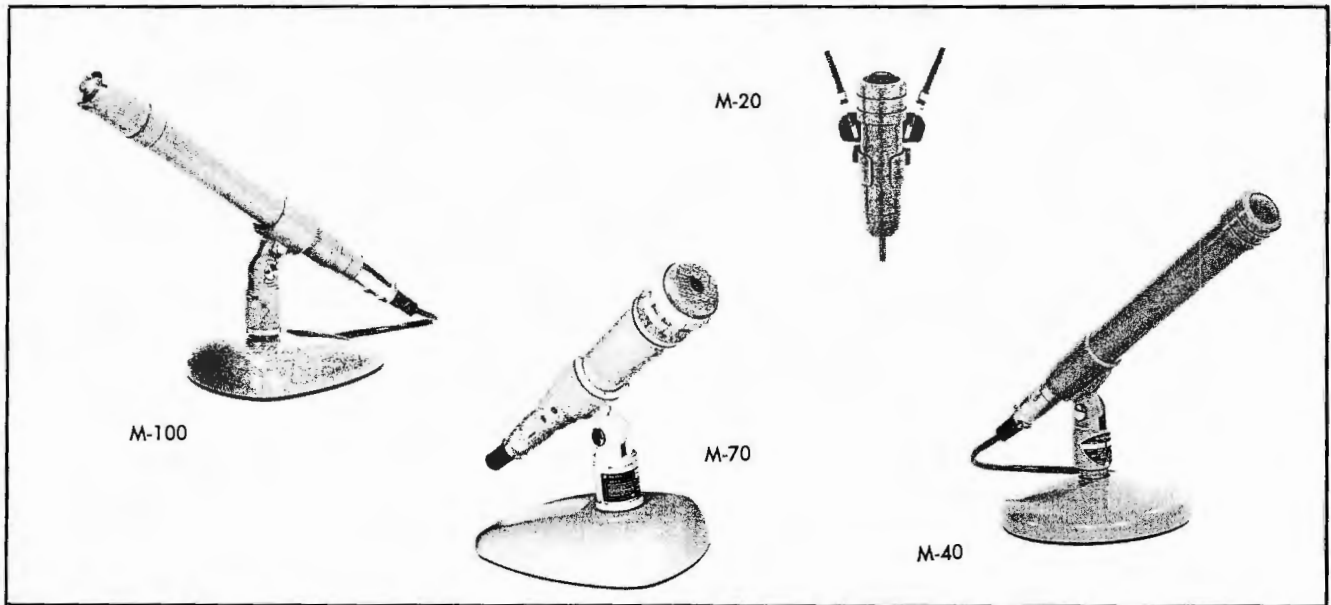

## COLLINS M-100 MICROPHONE

Gives a flexibility unequaled by any other microphone in its price range. Its response is smooth and uniform from 40 to 20,000 cps, but it may be adjusted for varying audio conditions when used by the soprano or the low-voiced sportscaster, or on exceptionally difficult remote broadcasts. Simple screwdriver adjustments allow a low frequency cutoff at 40, 80 or 160 cps, and a high frequency cutoff at 10,000 or 20,000 cps.

The Collins M-100 is a dynamic, omnidirectional microphone that may be used with any amplifiers having a 35-80 ohm or 150-250 ohm input. Includes 20 ft. of cable and desk stand with grip cam-lock to allow easy removal from the stand without disconnecting.

*Impedance:* 50 ohms or 200 ohms, selectable.

*Frequency Response:* 40-20,000 cps.

*Output Level:* -62 db, with reference to 1 mv/10 dynes/cm<sup>2</sup>.

*Size:* 10½" long, 1" diameter (26.67 cm L, 2.54 cm diameter).

*Weight:* 9½ oz. (0.269 kg).

*Color:* Non-reflecting blue-gray.

Part No. 099 0078 00

## COLLINS M-20 MICROPHONE

This small and rugged lavalier microphone frees hands in one-man speaking situations such as weather shows and demonstrations. It is small enough to be hidden behind a necktie or lapel. Supplied with lavalier clip and 25 ft. of 3-conductor cable. Essentially omnidirectional polar pattern. Desk stand available on order.

*Impedance:* 50 ohms or 200 ohms, selectable.

*Frequency Response:* 60-18,000 cps.

*Output Level:* -57 db, with reference to 1 mv/10 dynes/cm<sup>2</sup>.

*Size:* 4" long, 1" diameter (10.16 cm L, 2.54 cm diameter).

*Weight:* 3½ oz. (0.099 kg).

*Color:* Non-reflecting blue-gray.

Part No. 097 5464 00

M-20.

Part No. 097 6627 00

Replacement lavalier clip for M-20.

Part No. 097 5826 00

Desk stand for M-20.

Part No. 099 0870 00

Replacement cord and clip.

## COLLINS M-40 MICROPHONE

Ideal for panel discussions, dinner meetings and interviews. Equipped with desk stand and 20 ft. of three-conductor, plastic jacketed cable. Essentially omnidirectional polar pattern.

*Impedance:* 50 ohms or 200 ohms, selectable.

*Frequency Response:* 40-20,000 cps.

*Output Level:* -59 db, with reference to 1 mv/10 dynes/cm<sup>2</sup>.

*Size:* 9⅝" long, 1" diameter (24.45 cm long, 2.54 cm diameter).

*Weight:* 11 oz. (0.31 kg).

*Color:* Non-reflecting blue-gray.

Part No. 097 5463 00

## COLLINS M-70 MICROPHONE

Provides highly directional sound selectivity to double the conventional working distance and to cut out unwanted background sounds. It is especially useful in small booths where reflecting surfaces could be a problem. Comes equipped with desk stand and a 20-foot, three-conductor shielded cable.

*Impedance:* 50 ohms or 200 ohms, selectable.

*Frequency Response:* 40-15,000 cps.

*Output Level:* -55 db below 1 mm/10 dynes/cm<sup>2</sup>.

*Size:* 6¼" long, 1⅓" diameter (17.30 cm long, 3.89 cm diameter).

*Weight:* 12 ounces, (0.34 kg) (without cable).

*Color:* Non-reflecting blue-gray.

Part No. 099 2402 000

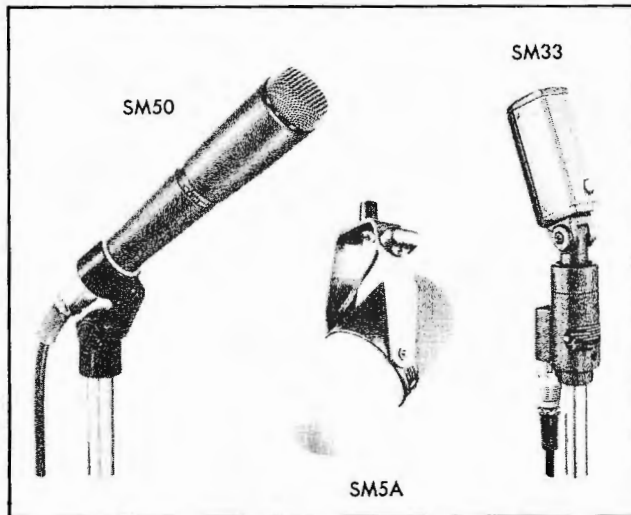

## SHURE SM5A AND SM5B MICROPHONE

The Shure SM5 Dynamic cardioid provides directivity, minimizes sound coloration due to off axis pickup, wide range frequency response, integral windscreen, absence of transformers or response correcting inductors prevents pickup of electrical noise, especially suited for Boom application.

*Frequency Response:* 50 to 15,000 cps.

*Polar Pattern:* Unidirectional.

*Impedance:* SM5A — 50 ohms, SM5B — 150 ohms.

*Output Level:* 1,000 cps response.

SM5A (50 ohm) — open circuit voltage:  $-84.0$  db\*  
(.063 mv).

Power level into 50 ohms:  $-57.0$  db\*\*

EIA microphone rating:  $-150.0$  db\*\*\*

Gm (sensitivity).

SM5B (150 ohm) — open circuit voltage:  $-79.5$  db\*  
(.103 mv).

Power level into 150 ohms:  $-57.0$  db\*\*

EIA microphone rating:  $-150.0$  db\*\*\*

Gm (sensitivity).

*Connector:* Cannon XLR-3-42 receptacle mounted on microphone.

*Finish:* Textured dark gray enamel. Light and dark gray plastic foam wind screens.

*Mounting:* 5/8-27 adaptor is supplied. Desk mount available as accessory.

*Weight:* 1 lb., 15 oz. (879 grams).

*Hum Level:*  $-120$  dbm with field of  $1 \times 10^{-3}$  gauss at 60 cps.

## SHURE SM33 MICROPHONE

The model SM33 is a compact and rugged unidirectional ribbon microphone combining wide range response and a super-cardioid directional pattern. This polar pattern is somewhat more directional than the conventional cardioid, providing excellent control of unwanted surrounding noise and reverberation. The performance characteristics are ideal for studio use in broadcasting, recording, and

for critical sound reinforcement applications. The SM33 features super-cardioid pickup, wide frequency response, low frequency response adjustable by means of a response selector switch, built in shock mount and rugged mechanical design.

*Type:* Ribbon.

*Frequency Response:* 40 to 15,000 cps.

*Polar Pattern:* Super-cardioid.

*Impedance:* Dual. Choice of 30-50 ohms or 150-250 ohms.  
(Connected for 150-250 ohms when shipped).

*Output Level:* 1,000 cps response.

SM33 30-50 ohms — open circuit voltage  $-87.0$  db\*  
(0.049 mv).

Power Level  $-60.0$  db\*\*

EIA microphone rating  $-152.5$  db\*\*\*

Gm (sensitivity)

SM33 150-250 ohms — open circuit voltage  $-81.0$  db\*  
(0.089 mv).

Power Level  $-58.5$  db\*\*

EIA microphone rating  $-152.5$  db\*\*\*

Gm (sensitivity)

*Connector:* Equipped with cannon XL-3-12 type connector in microphone.

*Cable:* 20 ft., 2 conductor shielded with cannon XLR-3-11-C connector attached (one end).

*Finish:* Textured light and dark gray enamel.

*Swivel:* Self adjusting lifetime swivel permits tilting the head  $45^\circ$  forward and  $70^\circ$  backward.

*Shock Mount:* Special live rubber vibration isolation unit.

*Stand Thread:*  $5/8$ "-27 thread.

*Weight:* 1 lb. 10 oz. (736 grams).

*Shipping Weight:*  $3\frac{1}{4}$  lbs. (1474 grams).

## SHURE SM50 MICROPHONE

The model SM50 is a rugged, omnidirectional microphone built to withstand the severest field use. It provides very natural and intelligible voice reproduction and unusual freedom from annoying wind and breath noises. Very comfortable hand-held, or mounted in the slip-in stand adaptor, the SM50 is ideally suited to remote interviews, news and sports pickups, and a variety of field and studio applications. The SM50 features natural response from 40 to 15,000 cps, highly effective built-in wind and breath filter, comfortable size, lightweight, and rugged construction.

*Type:* Dynamic.

*Frequency Response:* 40 to 15,000 cps.

*Polar Pattern:* Omnidirectional.

*Impedance:* Dual. 30-50 ohms and 150-250 ohms. (connected for 150-250 ohms when shipped).

*Output Level:* 1,000 cps response.

SM50 30-50 ohms — open circuit voltage  $-85.0$  db\*  
(.053 mv).

Power level  $-58.0$  db\*\*

EIA microphone rating.

Gm (sensitivity)  $-150$  db\*\*\*

SM50 150-250 ohms — open circuit voltage  $-79.0$  db\*  
(.111 mv).

Power level  $-58.0$  db\*\*

EIA microphone rating -150 db\*\*\*  
Gm (sensitivity).

*Connector:* Cannon XL-3-12 type in microphone.

*Cable:* 20 ft two conductor shielded with Cannon XLR-3-11C connector (one end).

*Finish:* Textured dark gray enamel.

*Swivel Adapter:* Positive action 90° swivel to mount microphone to stand on fixture with 5/8"-27 threads.

*Weight:* 8 oz. (227 grams).

*Shipping Weight:* 2 lbs., 5 oz. (1049 grams).

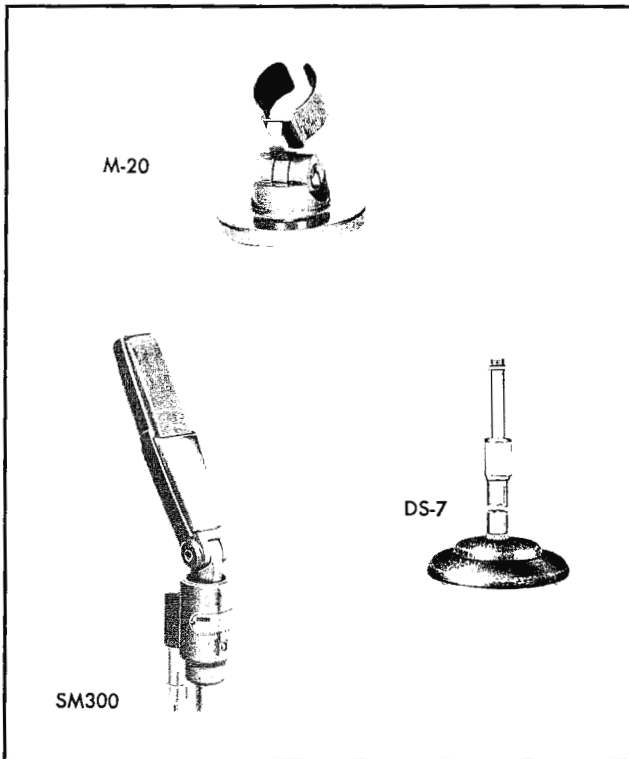

*Impedance:* Choice of three by switch. "L" 30 to 50 ohms, "M" 150 to 250 ohms, "H" high.

*Output Level:* 1,000 cps response.

Model 300 — 30 to 50 ohms "L" position.

Open circuit voltage -87.5 db\* (.043 mv).

Power level into 50 ohms -60.5 db\*\*

EIA microphone rating -153.0 db\*\*\*

Gm (sensitivity).

Model 300 — 150 to 250 ohms "M" position.

Open circuit voltage -79.5 db\* (.105 mv).

Power level into 250 ohms -59.0 db\*\*

EIA microphone rating

Gm (sensitivity) -151.0 db\*\*\*

Model 300 High Impedance "H" position

Open circuit voltage -57.5 db\* (1.32 mv).

Loaded with 100,000 ohms -60.0 db\*\*

Gm (sensitivity) -154.0 db\*\*\*

*Finish:* Textured dark gray enamel.

*Swivel:* Self-adjusting lifetime swivel permits tilting the head 45° forward and 90° backward so that the microphone can be aimed at the source of sound.

*Shock Mount:* Live-rubber vibration-isolation unit.

*Connector:* Cannon type XLR-3-12 in microphone.

*Cable:* 20 ft., 2 conductor shielded with cannon XLR-3-11C (one end).

*Stand Thread:* 5/8"-27 thread.

*Response Selector:* Two position switch to adjust low frequency characteristic.

\* 0db = 1 volt per microbar.

\*\* 0db = 1 milliwatt with 10 microbars.

\*\*\* 0db = EIA Standard SE-105, August 1949.

## ELECTRO-VOICE AND ALTEC-LANSING MICROPHONES

A complete line of Electro-Voice and Altec-Lansing general purpose and specialized microphones, stands, call letter plates and accessories is sold by your Collins Broadcast Equipment Sales Engineer.

### COLLINS M-20 MICROPHONE DESK STAND

A small, non-reflecting blue-gray stand that holds the Collins M-20 Microphone. The M-20 is held with a felt padded clamp that allows the microphone to be slipped in and out of the stand easily.

Part No. 097 5826 00

### ATLAS DS-7 MICROPHONE DESK STAND

A general purpose, chrome plated adjustable desk stand with a base of cast iron and finished in gun metal shrivel finish. Stable base is equipped with pads to prevent damage to desk. Equipped with standard "velvet action" clutch adjustment. Thread size at microphone end is 5/8"-27. Adjustable from 8" to 12" (20.32 cm to 30.48 cm).

*Weight:* 3 lbs. (1.36 kg).

Part No. 097 1119 00

## SHURE 300 MICROPHONE

The model 300 is an unusually compact ribbon microphone. The "300" is an excellent choice for broadcast or recording studio and for critical sound reinforcement applications in which its symmetrical front and rear pickup with greatly reduced side pickup is useful. Ideal for applications such as "across the table" interviews or dialogue. The bidirectional pattern provides the same control of overall surrounding noise and reverberation as an equivalent microphone. The model 300 features warm, smooth sound from wide range front and rear response, low frequency characteristic adjustable by means of a response selector switch, bidirectional polar pattern, built-in shock mount, impedance selection, and rugged mechanical design.

*Type:* Ribbon.

*Frequency Response:* 40 to 15,000 cps.

*Polar Pattern:* Bidirectional. Equally sensitive at front and rear. Response at sides down 15 to 20 db from front and rear response.



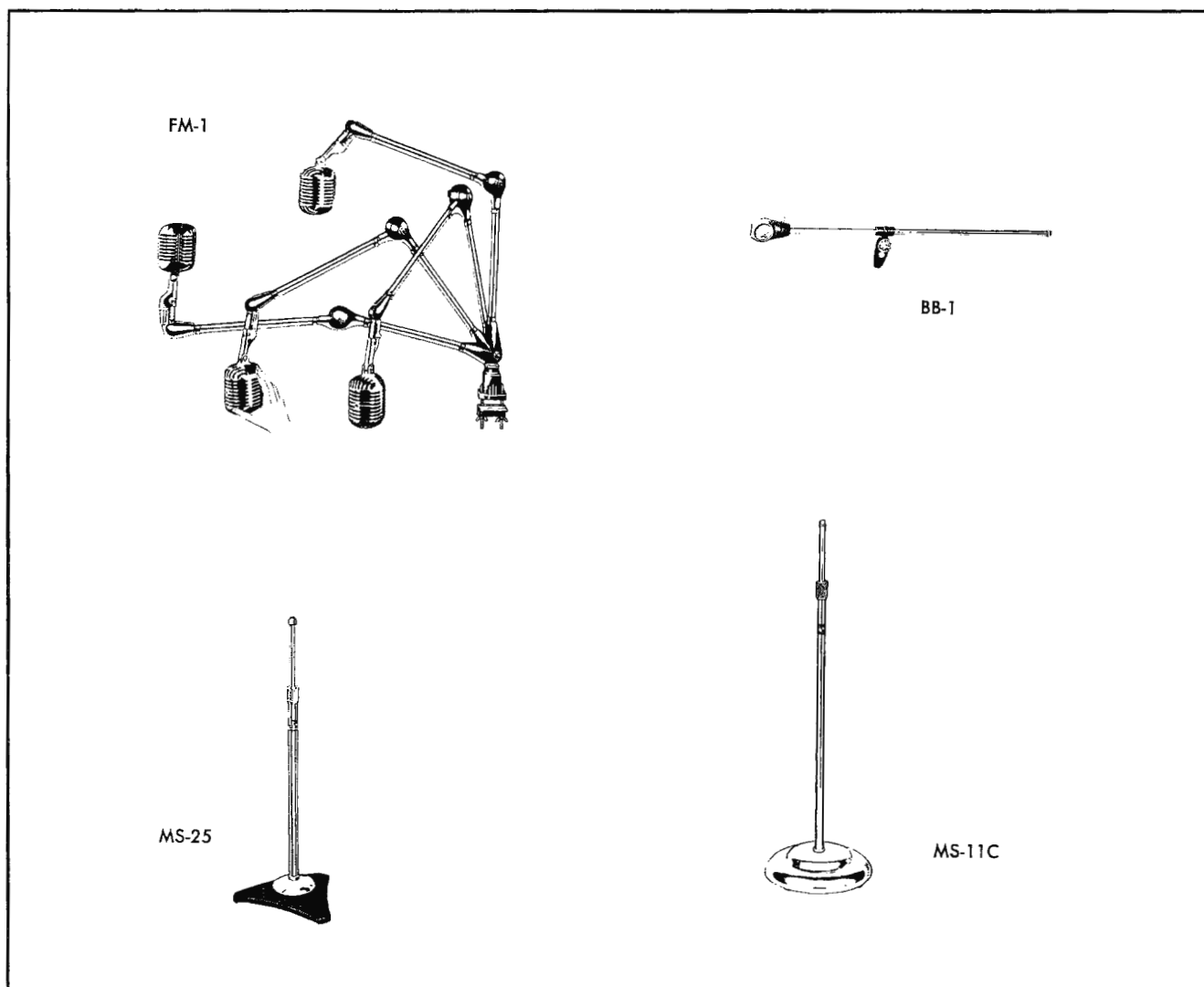

### FLEXO MIKESTER FM-1

This arm will handle any mike up to 4 lbs. It can be instantly positioned, incorporates a patented enclosed spring-controlled swiveling device, swings out 36" in any direction when fully extended. Clips or screws to any position. Clips hold cable in place.

*Weight:* 4 $\frac{3}{4}$  lbs. (2.15 kg).

*Part No.* 097 1499 00

### ATLAS MS-25 FLOOR STAND

Features "safety air-lock cushion" to prevent slippage of telescoping section. Uses a large diameter, oversize telescoping tube ( $\frac{7}{8}$ " telescoping tube,  $1\frac{1}{8}$ " base tube). Terminated in  $\frac{5}{8}$ "-27 thread.

*Finish:* Chrome and gray wrinkle.

*Height Adjust:* 37" to 66" (93.98 cm to 167.18 cm).

*Base Diameter:* 17" (43.18 cm).

*Weight:* 24 lbs. (10.89 kg).

*Part No.* 097 1510 00

### ATLAS BB-1 MICROPHONE BOOM

This 31" microphone boom may be attached to any type of floor stand. All swivel parts are precision die castings resulting in smooth operation and secure positioning. Boom is chrome plated and has  $\frac{5}{8}$ "-27 thread.

*Weight:* 3 $\frac{1}{2}$  lbs. (1.59 kg).

*Part No.* 097 0984 00

### ATLAS MS-11C FLOOR STAND

Features an extended length clutch body, inner lined with a wear-proof locking collet which grips without jamming, slipping or sudden dropping. Includes self-leveling, shock absorbing base pads, plus three additional "anti-tip" points located between the base pads. Terminates in a  $\frac{5}{8}$ "-27 thread.

*Finish:* Chrome or gray wrinkle (Model MS-10C).

*Height Adjust:* 35" to 65" (88.90 cm to 165.10 cm).

*Base Diameter:* 10" (25.4 cm).

*Weight:* 12 lbs. (5.44 kg).

*Part No.* 097 1511 00  
*Part No.* 097 5729 00

(Type MS-11C)  
(Type MS-10C)

## COLLINS CUSTOM CONTROL DESKS

Attractiveness is combined with operational efficiency and economy in Collins control desks, custom designed to each broadcaster's requirements. These desks are sturdily constructed of wood covered with any of a wide range of patterns of long lasting Formica.

Among the features that may be incorporated without sacrificing attractiveness are adjustable feet, built-in rec-

ord compartments, hidden console cables and provisions for rack mounting.

A Collins tape cartridge system desk wing console may be placed on left wing to give complete studio facilities in one compact unit. Collins will provide free estimates upon submission of the physical layout of the studio and an outline of functions desired for inclusion in the desk.

No Part Number

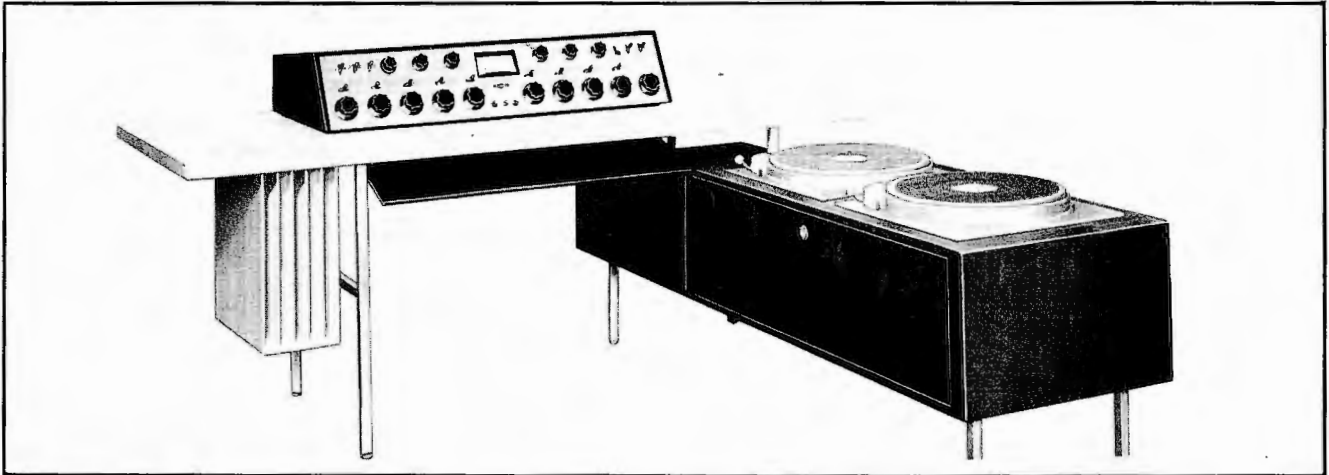

## COLLINS CS-12 LOUDSPEAKERS

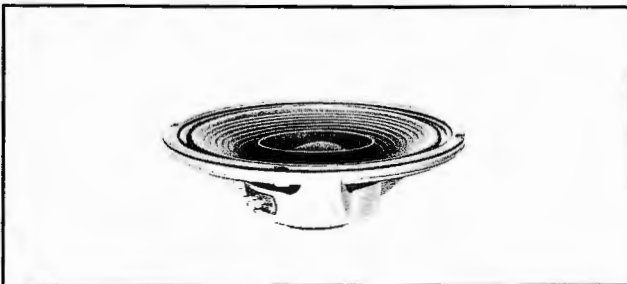

Producing the very finest in high fidelity sound, the Collins CS-12 loudspeaker produces a consistently stable and precise definition. The speaker is designed to operate equally well at full range or as woofers in multiway systems. The CS-12 features Radax construction, which divides the sound between the two cones. A mechanical crossover, when the smaller cone responds to the higher frequencies, occurs at 1,800 cps.

A slug-type magnet is used for concentrating flux density into the air gap. This type magnet has the lowest possible leakage and greatest structural strength. The high frequency long throw voice coil remains in the air gap even on the longest of excursions to prevent non-linear operation.

An edge-wound voice coil, which gains an equivalent of five extra watts from most amplifiers over round-wire coils, is wound with precision, flattened ribbon conductor.

Each speaker is carefully tested and inspected before leaving the factory. An individual frequency response

curve check is run on each speaker so that it matches the performance of the laboratory standard.

*Frequency Response:* 30-13,000 cps.

*EIA Sensitivity Rating:* 43 db.

*Free-Space Cone Resonance:* 40 cps.

*Power Handling Capacity:*

*Program Material:* 20 watt.

*Peak:* 40 watt.

*Critical Damping Factor:* 15.

*Impedance:* 8 ohm.

*Mechanical Crossover:* 1800 cps.

*Voice Coil Diameter:* 2".

*Total Flux:* 70,700 maxwells.

*Power Required for 100 db level:* 12 watt.

*Mounting:* Four  $\frac{1}{4}$ " holes equally spaced on 11 $\frac{1}{2}$ " circle.

*Baffle Opening:* 11".

*Size:* 12 $\frac{1}{4}$ " diameter, 3 $\frac{1}{2}$ " deep (31.12 cm diameter, 8.89 cm deep).

*Weight:* 5 $\frac{1}{2}$  lbs. (2.49 kg).

Part No. 124 0032 017

(Type CS-12)

Part No. 099 2686 000 Stancor A-3818 Speaker Transformer

## FRAZIER MANHATTAN

Now a famous loudspeaker, made especially for built-in systems, is available as a handsomely finished cabinet model. Its unique reproduction qualities for bringing to life the whole musical spectrum of the symphonic orchestra, vividly and brilliantly are well known.

In actuality, the "Manhattan" enclosure is the well-known Frazier "Black Box I" that long has been the leading unit used in the finest built-in systems. The enclosure is a modified Helmholtz type using two slit-type tuning tubes, one on each side with a system consisting of

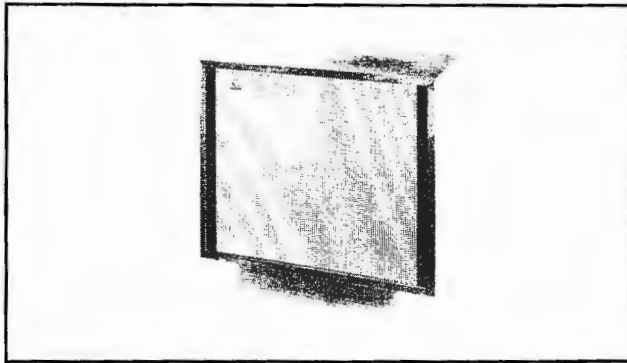

a special full range 8-inch loudspeaker unit, one 3½-inch high frequency unit, and one high pass filter mounted in a special enclosure. The base stand is a separate unit. The "Manhattan" mounts horizontally, vertically or can be used book shelf style.

**SPECIFICATIONS**

*Useable Frequency Response:* 40 cycles to beyond 15,000 cycles.

*Efficiency:* According to an independent testing laboratory, 1/10 of one watt provides sufficient power for living room listening level.

*Impedance:* 8 ohms.

*Dimensions:* 23 7/8 inches wide, 19 inches high, and 11 7/8 inches deep.

*Finish:* Oil walnut with cane fibre type grille.

**THE FRAZIER MODEL XII**

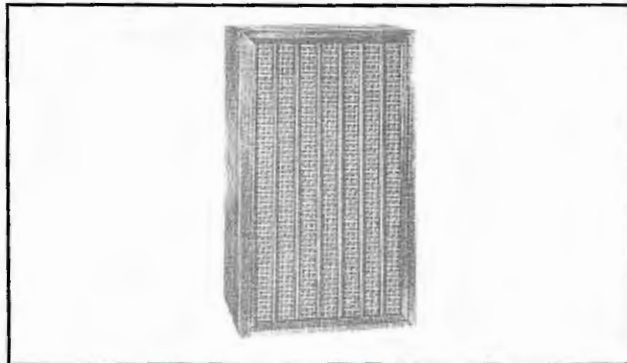

The new Model XII loudspeaker sets a new standard of excellence both in performance and appearance.

The marriage of the new twelve inch diameter low frequency driver, to the two special cone-type high frequency drivers through the media of a special network and unique fixed acoustical tuning arrangement provides unusual smoothness from low organ pipes to silky overtones of violins and flutes.

With this arrangement complete balance is obtained over the entire musical spectrum. Heavy bass is present, but all solo instruments also speak with authority. This loudspeaker's performance approximates live renditions to the extent many people have never heard.

*Dimensions are:* Fourteen inches wide; Twenty-four inches high; and Twelve inches deep.

*Impedance:* 8 ohms.

*Shipping Weight:* 54 pounds.

**JENSEN P12-T SPEAKER**

This economy speaker is ideal for a high fidelity system to which additional units may be added.

*Impedance:* 3.2 ohms.

*Power Rating:* 12 watts.

*Baffle Opening:* 10½". Jensen transformer (Stancor A-3818 speaker transformer) for P12-T speaker matches to 600 ohms.

Part No. 097 2119 00 (Type P12-T)

Part No. 099 2686 00 Stancor A-3818 speaker transformer.

**JENSEN P8-T3 SPEAKER**

Similar to the P12-T.

*Impedance:* 3.2 ohms.

*Power Rating:* 7 watts.

*Baffle Opening:* 6¾". Jensen transformer (Stancor A-3818 speaker transformer) for P8-TS speaker matches to 600 ohms.

Part No. 099 2644 00 P8-T3

Part No. 099 2686 Stancor A-3818 speaker transformer.

**JENSEN LEVEL CONTROLS**

Designed for use in voice coil or line circuits of similar nominal impedance, Jensen level controls are of the two-section L-pad type. They provide continuously adjustable level without disturbance of other circuit levels or total impedance. Single hole panel mounting. Complete with lock nut, pointer knob and flat metal escutcheon plate. Model ST-760 for 4 ohms impedance, 15 watts. Model ST-276, 8 ohm, 15 watts, L pad.

Part No. 097 2190 00 (Type ST-760)

Part No. 124 0032 123 (Type ST-276)

**STANCOR A-3818 TRANSFORMER**

Transformer for Collins CS-12, Jensen P12-T and P8-TS speakers.

*Primary Impedance:* 500/1000/150 ohms.

*Secondary Impedance:* 15/8/4 ohms.

*Power Rating:* 25 watts.

Part No. 099 2686 00

**MIRITEL AIR ALERT**

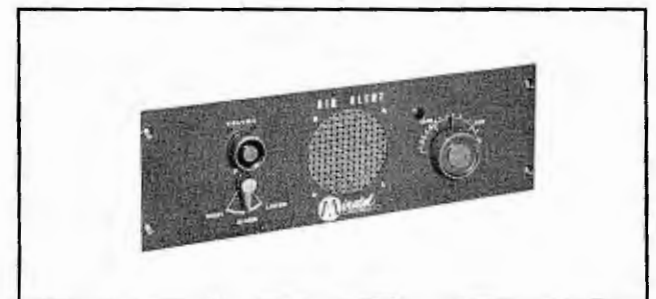

Designed to control visible and/or audible alarm circuits on EBS signal from local or sky wave stations. Frequently tunable from 550 to 1600 kc. Built-in speaker operates upon alarm. Relay circuit is voltage regulated. External bell or light control terminals and antenna terminals on rear terminal board. Available for rack mounting only.

Part No. 097 3192 000

## ARGOS BAFFLES

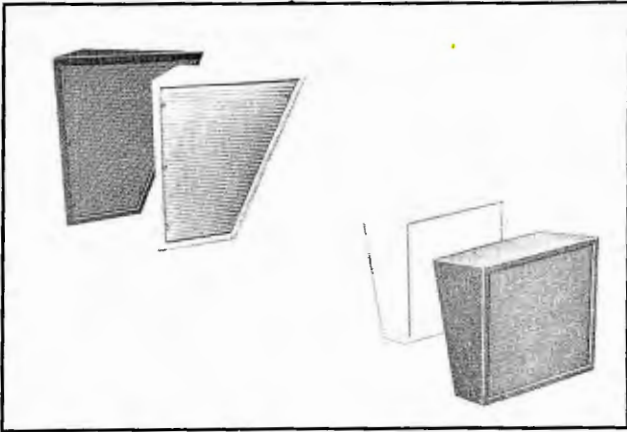

Entire front is inset with plastic grille and cloth covered panel. Constructed of plywood and hardboard for good resonant tone. Extra reinforcing blocks and four bolts installed for mounting speakers. Covering is plastic coated leatherette. Available in blonde or walnut. Slanting corner baffle for 8" speaker (SCB-8D) or 12" speaker (SCB-12D).

*Weight:* 6 lbs. or 8 lbs. (2.72 kg or 3.63 kg). Wall baffle for 8" speaker (WB-8D) or 12" speaker (WB-12D).

*Weight:* 2½ lbs or 4¼ lbs. (1.13 kg or 1.93 kg).

Part No. 099 2374 00	(Type SCB-8D)
Walnut finish.	
Part No. 099 2375 00	(Type SCB-8D)
Blonde finish.	
Part No. 099 2376 00	(Type SCB-12D)
Walnut finish.	
Part No. 099 2377 00	(Type SCB-12D)
Blonde finish.	
Part No. 124 0032 295	(Type WB-8D)
Walnut finish.	
Part No. 124 0032 296	(Type WB-8D)
Blonde finish.	
Part No. 124 0032 297	(Type WB-12D)
Walnut finish.	
Part No. 124 0032 298	(Type WB-12D)
Blonde finish.	

## TRIMM HEADPHONES

Lightweight, rugged headphones with black Bakelite shell and cap. Rubber covered headband.

*Impedance:* 600 ohms (Model 156) or 17,000 ohms (Model 157).

*Weight:* 5 oz. (0.14 kg).

Part No. 273 0003 00	(Type 156)
Part No. 273 0004 00	(Type 157)

## BRUSH BA-206 HEADPHONES



The Brush BA-206 headphones have an exceptionally flat response out to 10,000 cps and create outstanding

fidelity of reception. Their high impedance and negligible power requirements allow monitoring without any effects on associated equipment. The special "Metalseal" crystal elements provide maximum protection against excessive humidity.

Part No. 099 0495 00

## BRUSH BA-200 HEADPHONES

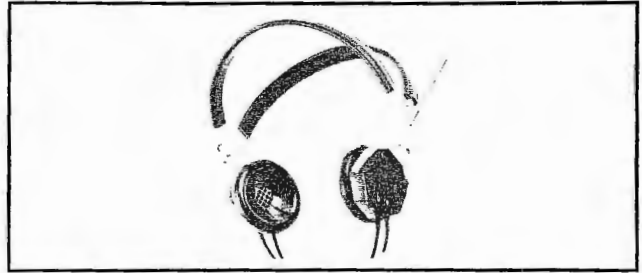

Ideal for general purpose service, the Brush BA-200 headphones have a frequency range from 100 to 5,000 cps. They are especially suitable for general laboratory and studio work as well as for the skilled amateur.

*Impedance:* 45,000 ohms at 1,000 cps.

*Weight:* 6 oz. (0.17 kg).

Part No. 099 2488 000	(Type BA-200-1)
4500 ohm with plug.	
Part No. 099 2489 000	(Type BA-200-2)
4500 ohm with eyelet terminals.	

## PATCH CORDS

The plugs are of the shielded type, with the sleeves tied together and grounded. The circuit is maintained through connections to the plug tips. The following lengths are available: 6"; 12"; 24"; 36"; 48"; 60" and 120". Other patch plugs, phone jacks and single circuit jacks available.

Part No. 361 0010 00	(6")
Part No. 361 0011 00	(12")
Part No. 361 0012 00	(24")
Part No. 361 0013 00	(36")
Part No. 361 0014 00	(48")
Part No. 361 0015 00	(60")
Part No. 361 0016 00	(120")

## TRIMM JACK PANELS

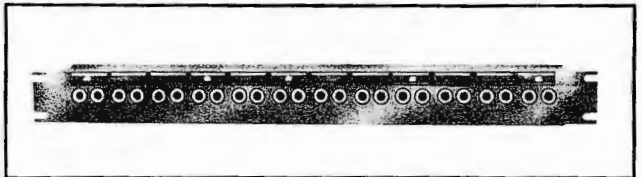

These panels are available in 12 pair, single row and 24 pair, double row models to fit any standard 19" rack and include such features as: solid 5/8" thick Bakelite panel with steel reinforcing; heavy gauge, special spring temper nickel/silver alloy leaves; ground lugs aligned to allow single ground bus to be run full length of strip; large palladium silver contacts; connection lugs fanned out for ease of soldering.

Part No. 097 3561 00	12-pair, single row.
Part No. 097 4200 00	24-pair, double row.



**TELECHRON 1H1612 STUDIO CLOCK**

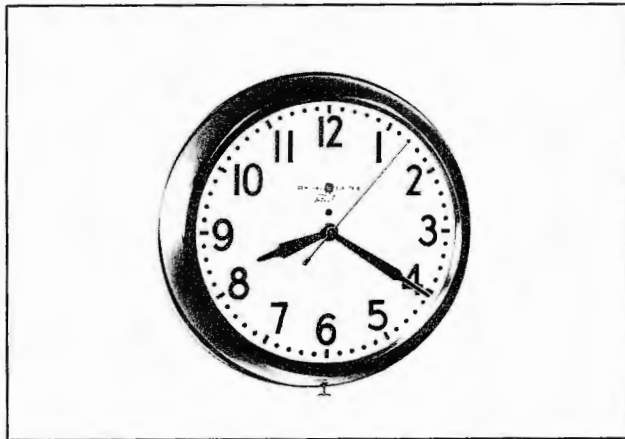

The Telechron "Commerce" clock has a 12" dial, rich brown case.

Part No. 097 1735 00

**SHIELDED WIRE AND MICROPHONE CABLE**

8758 — Belden 2-conductor #20, twisted, shielded pair, stranded copper conductors, vinyl insulated.

8738 — Belden 2-conductor #22, twisted, shielded pair, solid copper conductors, vinyl insulated.

439-5900-00 — Two-conductor #22 stranded, 7 No. 30 conductors, one red and one black conductor with one #22 groundwire. Shield is single right-hand wrap, #30 AWG maximum diameter of stranding. Nylon jacket, maximum outside diameter is .140".

8422 — Belden, shielded microphone cable, 2-conductor #22.

8412 — Belden, shielded microphone cable, 2-conductor #20.

423-0219-00 — High voltage wire, 15 kv breakdown insulation.

125-0061-00 — Shielded pair, #16 stranded cotton insulated, 15 amps.

425-0151-00 — Shielded pair, #12 stranded cotton insulated, 20 amps.

- Part No. 097 6030 00 (Type 8758)
- Part No. 097 6029 00 (Type 8738)
- Part No. 439 5900 00 (Type 439 5900 00)
- Part No. 097 1142 00 (Type 8422)  
In lengths of less than 100 ft. More than 100 ft., see below.
- Part No. 097 1142 00 (Type 8422)  
In lengths of 100 ft. or more. Less than 100 ft., see above.
- Part No. 425 0250 00 (Type 8412)  
In lengths of less than 100 ft. More than 100 ft., see below.
- Part No. 425 0250 00 (Type 8412)  
In lengths of 100 ft. or more. Less than 100 ft., see above.
- Part No. 423 0219 00 (Type 423 0219 00)
- Part No. 425 0061 00 (Type 425 0061 00)
- Part No. 425 0151 00 (Type 425 0151 00)

**TRIMM 427-6 TERMINAL BOARD**

Contains two groups of terminals, each 13 terminals long and 6 terminals high.

Part No. 097 6282 00

**BUD CR-1773-B RACK CABINET**

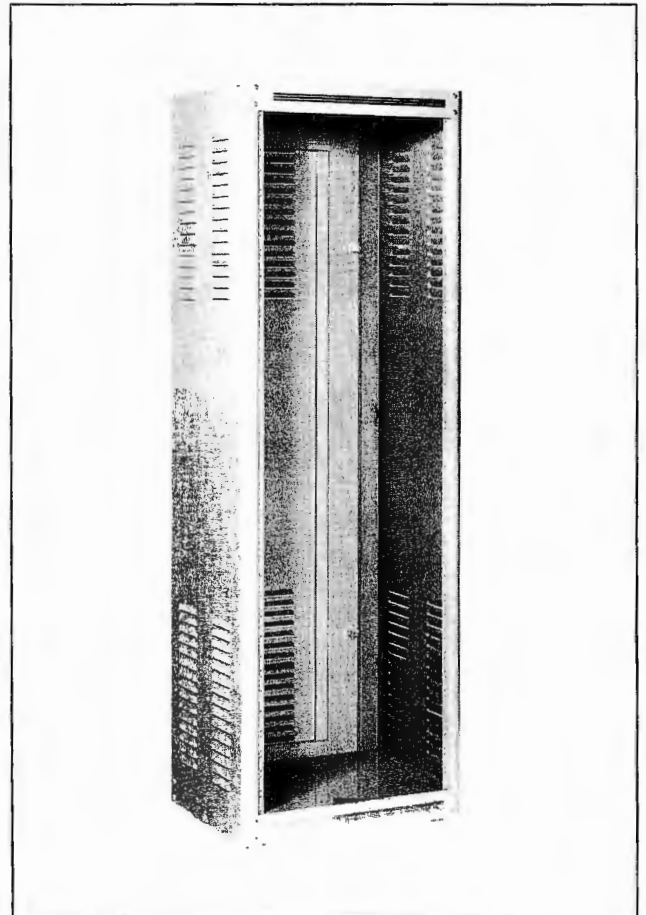

A heavy duty rack cabinet that is custom-made for Collins Radio Company. Finished in light gray, this cabinet is made of sturdy steel with a door on the back and provision at the top for mounting a blower fan. Provides 70" of panel space. Shipped knocked down.

Size: 19" W, 76" H, 17 1/8" D (48.26 cm W, 193.04 cm H, 43.5 cm D).

Part No. 099 2474 00

**RACK CABINET BLANK PANELS**

These blank panels of 3/16" aluminum are finished in light gray to match the BUD CR-1773-A Rack Cabinet. Size: 19" W (48.26 cm W) and in heights as listed below.

	Inches	Cm.
Part No. 502 8389 123	(1 3/4")	(4.45)
Part No. 502 8393 113	(3 1/2")	(8.89)
Part No. 502 8397 123	(5 1/4")	(13.34)
Part No. 502 8401 113	(7")	(17.78)
Part No. 502 8405 113	(8 3/4")	(22.23)
Part No. 502 8409 123	(10 1/2")	(26.67)
Part No. 502 8413 113	(12 1/4")	(31.12)
Part No. 502 8417 113	(14")	(35.56)

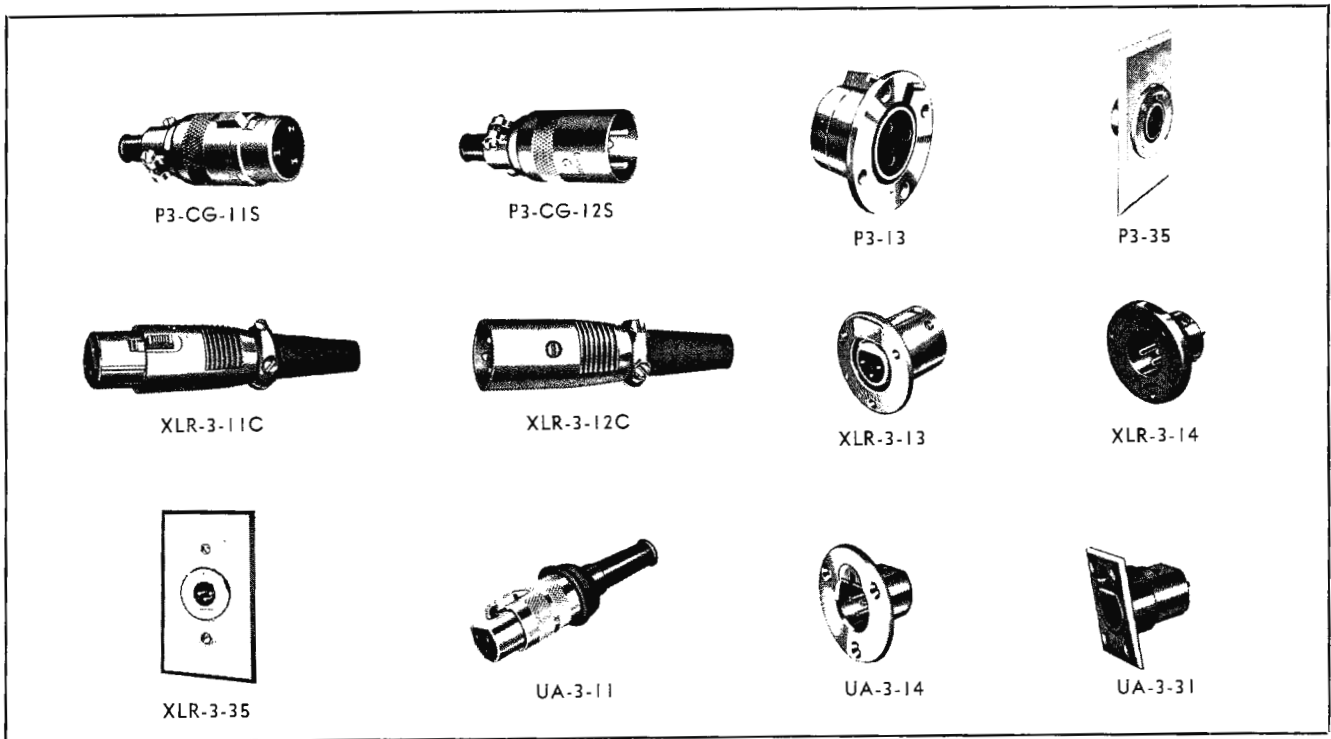

## CANNON CONNECTORS

Collins Radio Company is an authorized distributor of the full line of Cannon Connectors. The following is a listing of those connectors most often required in audio applications. All are three-contact plugs unless otherwise indicated.

- P3-CG-11S — Cannon female cable plug.  
P3-CG-12S — Cannon male cable plug.  
P3-13 — Cannon female panel receptacle.  
P3-14 — Cannon male panel receptacle.  
P3-35 — Cannon single gang female wall receptacle.  
P3-35-2G — Cannon 2 gang female wall receptacle.  
XLR-3-11C — Cannon female cable plug.  
XLR-3-11SC — Cannon female cable plug with latch-lock cable clamp.  
XLR-3-12C — Cannon male cable plug.  
XLR-3-12SC — Cannon male cable plug with latch-lock cable clamp.  
XLR-3-13 — Cannon female panel receptacle, flush mount.  
XLR-3-13N — Cannon female panel receptacle with lock nut.  
XLR-3-14 — Cannon male panel receptacle, flush mount.  
XLR-3-14N — Cannon male panel receptacle with lock nut.  
XLR-3-35 — Cannon single gang female wall receptacle.  
XLR-3-35-2G — Cannon 2-gang female wall receptacle.  
XLR-3-36 — Cannon single gang male wall receptacle.  
XLR-3-36-2G — Cannon 2-gang male wall receptacle.  
UA-3-11 — Cannon female cable plug.  
UA-3-12 — Cannon male cable plug.  
PA-3-13 — Cannon female panel receptacle, flush mount.  
UA-3-14 — Cannon male panel receptacle, flush mount.  
UA-3-31 — Cannon female wall mount receptacle.  
UA-3-32 — Cannon male wall mount receptacle.

Part No. 370 2180 00	(Type P3-CG-11S)
Part No. 370 2190 00	(Type P3-CG-12S)
Part No. 370 2060 00	(Type P3-13)
Part No. 370 2090 00	(Type P3-14)
Part No. 370 2150 00	(Type P3-35)
Part No. 370 2170 00	(Type P3-35-2G)
Part No. 097 5372 00	(Type XLR-3-11C)
Part No. 097 5371 00	(Type XLR-3-11SC)
Part No. 097 5370 00	(Type XLR-3-12C)
Part No. 097 5369 00	(Type XLR-3-12SC)
Part No. 097 5368 00	(Type XLR-3-13)
Part No. 097 5367 00	(Type XLR-3-13N)
Part No. 097 5366 00	(Type XLR-3-14)
Part No. 097 5365 00	(Type XLR-3-14N)
Part No. 097 5364 00	(Type XLR-3-35)
Part No. 097 5363 00	(Type XLR-3-35-2G)
Part No. 097 5362 00	(Type XLR-3-36)
Part No. 097 5361 00	(Type XLR-3-36-2G)
Part No. 370 2082 00	(Type UA-3-11)
Part No. 370 2081 00	(Type UA-3-12)
Part No. 370 2079 00	(Type UA-3-13)
Part No. 370 2083 00	(Type UA-3-14)
Part No. 099 0463 00	(Type UA-3-31)
Part No. 099 0464 00	(Type UA-3-32)



### **COLLINS 808A-1 REMOTE TURNTABLE-CONSOLE**

A compact, completely transistorized portable unit, the three-channel 808A-1 is designed for quick, easy, high fidelity program origination in remote broadcasting. Ideal for promotion-type shows, the turntable-console offers complete facilities to feed program material into a telephone line to the broadcast station. The unit also will allow independent control of public address facilities and can be used to drive a remote amplifier such as the Collins 212H-1.

The 808A-1 is especially suited for combination work in a small announce booth; for schools where an economical unit but complete facilities are needed; for use in conjunction with sound systems; and for standby studio facilities at the transmitter site in case of breakdown between the studio and transmitter.

The 808A-1 eliminates the need for multiple equipments. Once on location, the unit can be plugged in, connected to a remote line and it is ready for use. It can simultaneously combine the two self-contained turntable outputs with any one of three remote inputs. Built-in phono equalization meets RIAA standards. A VU meter indicates program level, and a headphone jack is provided for program monitoring. Line terminals and microphone jacks are located on the back of the unit.

A bottom dust cover, easily removed, protects the lower portions of the turntables, cabling and amplifiers. The preamplifiers attach to the control panel, which is remov-

able as a unit for servicing. Legs are detachable and self-storing beneath the unit. The sturdy, modern-looking cabinet is made of steel with a white and gray baked enamel finish. The panel and trim strips are brushed aluminum.

Controls on the panel include the following: and external input selector switch, which will select one of the external outputs of Mike 1, Mike 2 or NEMO; motor power switches which energize the turntable motors; three cue switches which are gauged to the fader control; three separate fader controls for the three inputs; master gain, which controls the over-all output signal; ac power switch, which is gauged to the public address gain; public address gain, which allows independent adjustment of the public address or other remote systems; headphone gain; and turntable shift levers for selection of proper turntable speed of 33, 45 or 78 rpm.

The remote amplifier, made up of six low level modules and one line amplifier module, uses eight General Electric 1175A low noise transistors and two Motorola 651 push-pull Class A-B transistors. Bias is stabilized over a wide temperature range by the use of a germanium diode. The turntable preamplifiers conform to NAB and RIAA specifications and feature a feedback design which offers a consistently stable performance.

Two Collins TT-200 Turntables with Rek-O-Kut S-320 pickup arms and General Electric sapphire cartridges are furnished with the 808A-1. Specially designed for radio

broadcast use, Collins Turntables maintain 99.95% accurate speed and have negligible wow and flutter. They are mounted on a strong cast aluminum base, and precision machining is used throughout.

**Frequency Response:**  $\pm 2$  db, 50-15,000 cps with 1,000 cps reference.

**Gain:** 100 db minimum on mike input.

**Balanced Inputs:** Mikes 1 and 2, 50 ohms,  $-55$  dbm nominal. NEMO input 600 ohms, 0 dbm nominal.

**Noise:** Signal-to-noise ratio, 55 db.

**Distortion:** 2% maximum, 50-15,000 cps at  $+18$  dbm.

**Power Output:**  $+18$  dbm ( $+8$  VU) into 60 ohm program line. Adjustable, high impedance public address output.

**Power Source:** 120 v ac,  $\pm 10\%$ , 60 cps, 1 phase.

**Size:**  $33\frac{1}{2}$ " W, 33" H (with legs),  $20\frac{1}{2}$ " D (85.09 cm W, 83.82 cm H, 52.07 cm D).

**Weight:** 78 lbs. (35.38 kg).

Part No. 522 2609 00

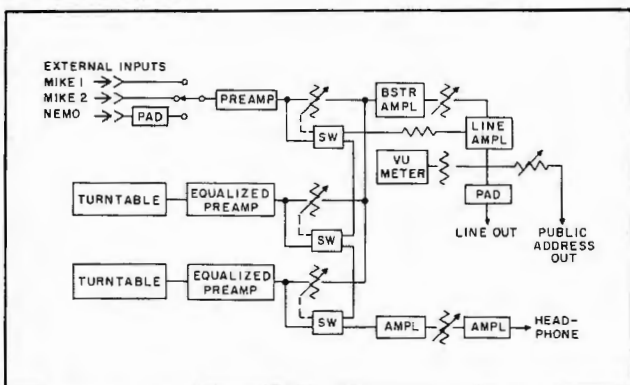

BLOCK DIAGRAM 808A-1

## COLLINS 212H-1 REMOTE AMPLIFIER

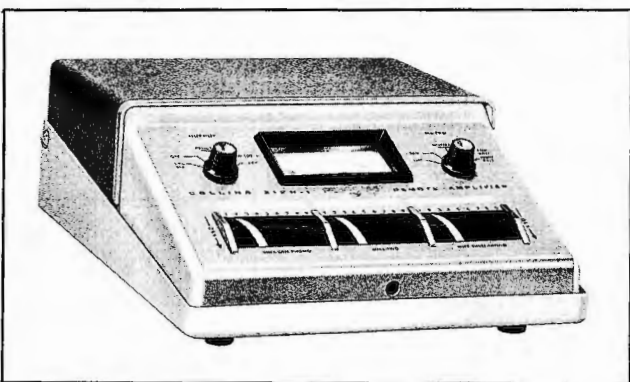

The only one of its kind on the market with so many advanced and deluxe features, the Collins 212H-1 is a three channel remote amplifier that provides adequate facilities for most remote applications.

The 212H-1 is transistorized throughout and is built into a highly punishable thermoplastic and vinyl-clad aluminum case. A handle is mounted on the rear chassis to allow quick and easy handling between remote locations. A snap-on cover of durable thermoplastic protects the panel, controls and VU meter.

The unit is completely self-contained and operates from

fourteen 1.5 volt flashlight batteries. These batteries supply power to the amplifier for about 200 hours. The supply is interlocked with the headphone jack so that the unit requires headphones to be plugged in before it becomes operational. The VU meter indicates remaining battery voltage.

A built-in phono equalizer on two of three channels provides instantaneous switching between two phonos and a microphone, or between three microphones. A built-in multiple tone generator allows a quick response check of the remote line or provides a standby tone of 100, 1000 or 5000 cps. Sure-grip thumb wheels  $2\frac{1}{4}$ " wide indicate volume input control by a diagonally moving white stripe.

**Frequency Response:**  $\pm 3$  db 50-15,000 cps (1000 cps reference at  $+8$  dbm output).

**Gain:** 90 db nominal on mike input.

**Output:** Line — Normal,  $+8$  VU ( $+18$  dbm) into 600 ohms; Low, 0 VU ( $+10$  dbm) into 600 ohms; Bridge —  $-40$  dbm into 250 ohms.

**Power Source:** Self-contained batteries — twelve 1.5 v flashlight batteries for amplifier and two 1.5 v batteries for meter light.

**Distortion:** 2% maximum 50-15,000 cps  $+18$  dbm output.

**Noise:**  $-115$  dbm equivalent input noise or less ( $-55$  dbm input,  $-60$  db noise).

**Inputs:**

- |        |   |
|--------|---|
| One:   | a. Unbalanced mike.                         |
|        | b. Phono, equalized for magnetic cartridge. |
| Two:   | a. Low impedance balanced mike.             |
|        | b. Self-contained tone generator.           |
| Three: | a. Unbalanced mike.                         |
|        | b. Phono, equalized for magnetic cartridge. |

**Output Connectors:**

- Program line, binding terminal posts.
- Bridge feed, male Cannon connector.
- Program monitor, headphone jack.

**Ambient Temperature Range:**  $-20^{\circ}\text{C}$  to  $+50^{\circ}\text{C}$  ( $-4^{\circ}\text{F}$  to  $+122^{\circ}\text{F}$ ).

**Ambient Humidity Range:** Up to 95%.

**Size:** 10" W,  $4\frac{1}{2}$ " H, 12" D (25.4 cm W, 11.43 cm H, 30.48 cm D).

**Weight:** 11 lbs. (4.99 kg).

**Color:** Green, white and gray.

Part No. 522 2419 00  
Includes batteries.

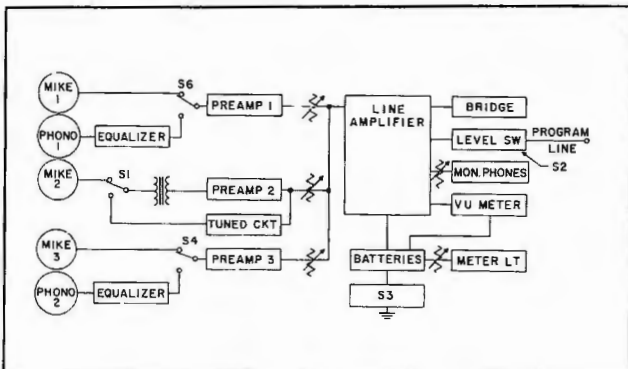

BLOCK DIAGRAM 212H-1



**COLLINS 212Z-1 REMOTE AMPLIFIER**

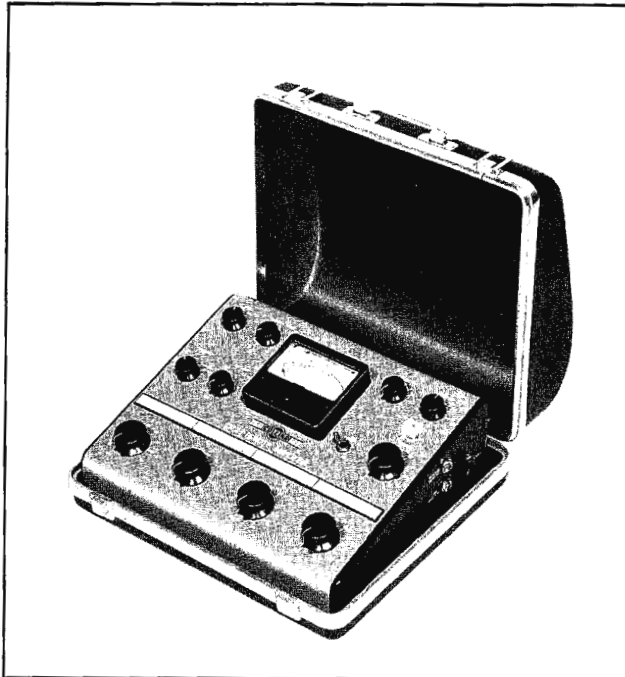

Weighing a total of 22 pounds including batteries and carrying case, the 212Z-1 offers full functions for remote broadcasts. This transistorized remote amplifier mixes inputs from up to four microphones, with program line and communication line outputs as well as an auxiliary output for PA feed.

A power source of both 115 v ac and batteries assures uninterrupted service. Should the ac power fail, an automatic changeover switches the 212Z-1 to battery power and reverts when ac power is restored. A light on the panel indicates when the 212Z-1 operates on ac power. The self-contained batteries have a long life of about 75 hours.

The Collins 212Z-1 is attractively style — yet rugged and convenient to use. Housed in a Royalite carrying case, the 212Z-1 securely fastens to the bottom of the case. The 212Z-1 has a black and metallic blue-gray abrasion-resistant finish.

The four channel mixing circuit incorporated in the amplifier is designed to work with all microphones having a 30 to 600 ohm impedance. The output circuit matches a 600 ohm line. Provisions are made for two program lines and a telephone through the output switch.

Although simultaneous program feed and communication cannot take place over a single line at the same time, the output switch allows rapid interchange between communication and the amplifier output on the same line.

The power supply is a shielded, full-wave unit with germanium diodes and multi-section filtering. A power interlock switch insures no battery drain when the unit is in its closed carrying case.

The Collins 212Z-1 Remote Amplifier is completely transistorized throughout. The tone oscillator, preampli-

fiers and interstage amplifiers use 2N422 hermetically-sealed low noise transistors. The driver employs a 2N465 transistor. The output amplifier, with transformer coupling on the input and output sides, has push-pull 2N41 transistors.

Since line levels are most easily set up by means of a steady audio tone, the 212Z-1 includes a built-in audio tone oscillator as a standard feature.

One or two headphones may be plugged into the monitor jacks. Where loudspeaker monitoring or feed for local public address is desired, the PA terminals are used. An isolated PA feed and an individual gain control allow the operator to handle the program and simultaneously ride gain on the PA system. A multiple jack on the side permits two units to be used simultaneously and controlled by one master gain control.

*Frequency Response:* ±1.5 db 50-15,000 cps.

*Input:* 4 channels selected by Daven step-type attenuators numbered to correspond with input plugs.

*Input Impedance:* 30-600 ohms.

*Gain:* 90 db maximum.

*Noise Level:* 55 db below normal output level.

*Distortion:* Less than 1½% at +5 dbm.

*Power Output:* Normal +11 dbm; emergency +16 dbm.

*Output Impedance:* 600 ohms (150 ohms available).

*Power Source:* 115 v or 230 v ac 50/60 cps or self-contained batteries, such as one 4.5 v Burgess D-3 or Eveready 726, and two 22.5 v Eveready 763. Life of 22.5 v battery is approximately 75 hours; 4.5 v approximately 90 hours. (Batteries not supplied with unit.)

*Microphone Connections:* 4 Cannon XL-3-13N.

*Ambient Temperature Range:* 0°-45°C.

*Ambient Humidity Range:* Up to 95%.

*Size:* 15½" W, 6½" H, 14½" D (39.37 cm W, 16.51 cm H, 36.83 cm D).

*Weight:* 22 lbs. (9.98 kg) (with batteries).

**Part No. 522 0330 003**

212Z-1 without batteries.

**Part No. 015 0520 000** (Type 726)

Two batteries required in addition to one Type 726 battery (below).

**Part No. 015 0519 000** (Type 726)

One battery required in addition to two Type 763 batteries (above).

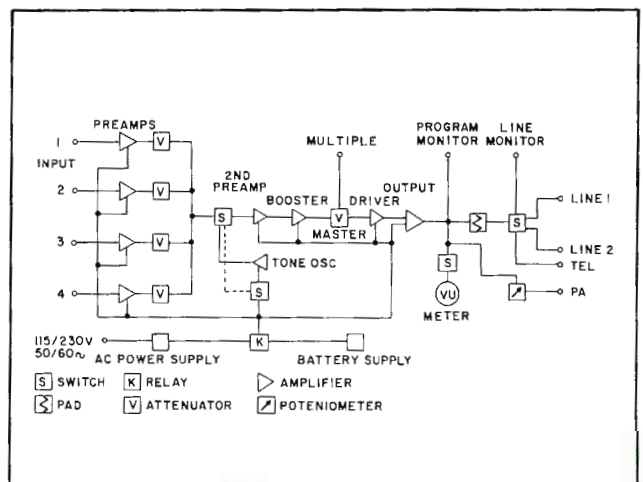

BLOCK DIAGRAM 212Z-1

## MARTI REMOTE PICK-UP EQUIPMENT

Marti Remote Transmitter and Receiver provide quality transmission of sports, spot news reports and interviews on frequencies assigned for exclusive use by broadcasters. The unit is compact and light enough to be carried into stadiums and press boxes as easily as a multi-channel remote amplifier.

The audio quality of the Marti for music or voice transmission is guaranteed to be equal to or better than lines with coverage up to 40 miles radius depending upon the type and location of the transmitting and receiving antennas. The Marti Receiver is equipped with an automatic relay that operates an alarm system in the station to indicate a forthcoming broadcast.

The unit may legally be used instead of lines even where lines are available. Many stations, after installing the Marti system, have standing sponsorship of all their remote programs and have actually paid for the equipment in savings on line charges alone. The equipment also opens new program possibilities that are overlooked because of inconvenience in using other, cumbersome and less reliable means.

The Marti Transmitter is operated either by ac or batteries. Designed for continuous duty, the equipment meets the most stringent FCC requirements regarding bandwidth.

It is easily portable and lightweight and does not require frequent tuning. The transmitter and transistorized power supply and associated equipment are easily installed in a car for permanent and immediate use.

## M-30B/TPS MOBILE TRANSMITTER

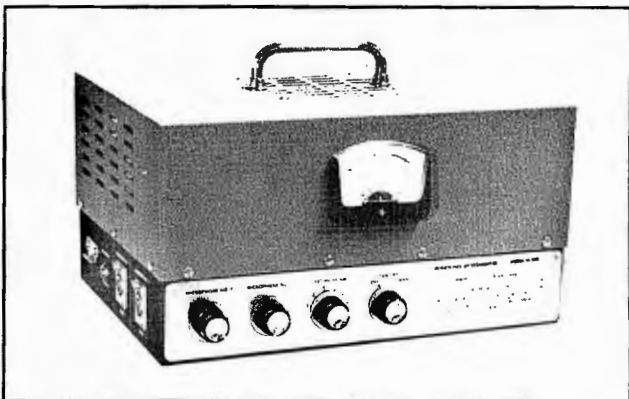

The M-30B/TPS is a 30 watt base station transmitter for communication with mobile units operating in the 152 to 172 megacycle range. The unit provides frequency stability of  $\pm .0005\%$  within a temperature range of minus 30 degrees C to plus 60 degrees C. The modulation characteristic is adjusted at the factory for  $\pm 7.5$  kc for 100% modulation at 1000 cycles.

*R. F. Output:* 30 Watts, continuous

*Frequency:* 152-172 megacycles

*Crystal Multiplication:* 36

*Spurious Emission:* Spurious Radiation attenuated at least 70 DB below carrier level. Harmonics suppressed at least 60 DB.

*Frequency Stability:* Plus, or minus 0.0005%

*Temperature Range:* Minus 30 degrees C to Plus 60 degrees C.

*Modulation:* 30 F3 Maximum (Normally adjusted for Plus or Minus 10 Kcs. swing.)

*Audio Inputs:* Two (2). Can be adjusted for either 150 ohms or 600 ohm input. Use of a 50, 150, or 250 microphone will work satisfactorily into the 150 ohm input.

*Audio Input Level:* Minus 70 DB.

*Audio Connectors:* Cannon XLR-3-31.

*Power Requirements:* 120 Volts AC or 12.6 Volts DC.

*Modulation Control:* Push-pull Limiter.

*Noise Level of Transmitter:* Better than Minus 45 DB.

*Overall Response With Matched Receiver:* Plus or Minus 2 DB from 75 to 7500 cycles.

*Distortion in Transmitter:* Less than 3%.

*Net Weight:* 16 pounds.

*Dimensions:* 14" wide, 10" long, and 7" high.

Part No. 099 1572 000

## MARTI MR-30/150 = 170 RECEIVER

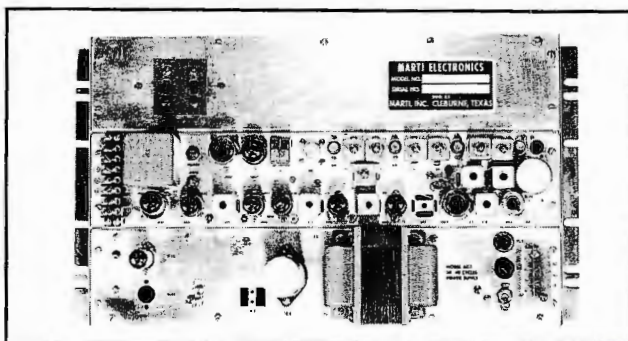

The MR-30/150-170 receiver is used for pickup from a mobile station operating in the 150 to 174 megacycle range. The receiver is sensitive to 0.6 micro-volts or less for 20 db quieting, and is selective to -100 db at  $\pm 32$  kc; -6 db or less at  $\pm 15$  kc.

*Application:* Remote Pickup.

*Frequency Range:* 150 to 174 megacycles.

*Spurious Response:* All spurious and image responses attenuated at least 100 db.

*Overall Response:*  $\pm 2$  db, 60 to 7500 cps with matching transmitter.

*Frequency Stability:*  $\pm 0.0005\%$  with crystal oven.

*Temperature Range:*  $-40^{\circ}\text{C}$  to  $+70^{\circ}\text{C}$ .

*Audio Output:* +8 VU at 600 ohms.

*Metering:* Signal strength and VU brought out to test Jacks. Visual metering optional.

*Tube Complement:* 15 required. 8 tube types.

6DS4 — 1st RF Amp. (Nuvistor)

6DS4 — 2nd RF Amp. (Nuvistor)

6DS4 — 1st Mixer (Nuvistor)

- 6DS4 — HF Osc. Trip. (Nuvistor)
- 6HS6 — 1st IF Amp.
- 12AT7 — 2nd Mixer & LF Osc.
- 6HS6 — 2nd IF Amp.
- 6HS6 — 3rd IF Amp.
- 6BH6 — 1st Limiter
- 6BH6 — 2nd Limiter
- 6AL5 — Discriminator
- 12AX7 — Noise Amp.
- 12AT7 — Noise Rect. & Relay Amp.
- 6CG7 — Audio Amp.
- OB2 — Voltage Reg.

Dimensions: 10½" H, 19" W, 9" D. Panel finish — WE  
 hammertone grey.

Weight (net): 20 lbs.

### MARTI REMOTE EQUIPMENT ACCESSORIES

**MOBILE ASSEMBLAGE** — Consists of control unit, all battery and control cables and mounting rack for the M-30B/TPS transmitter (Type TPS-TC).

**REMOTE CONTROL CONSOLETTTE** — For use with M-30B or M-30B/11RS-2R (Type RMC-1). Constructed of wood cabinet and aluminum anodized front panel, complete with VU meter.

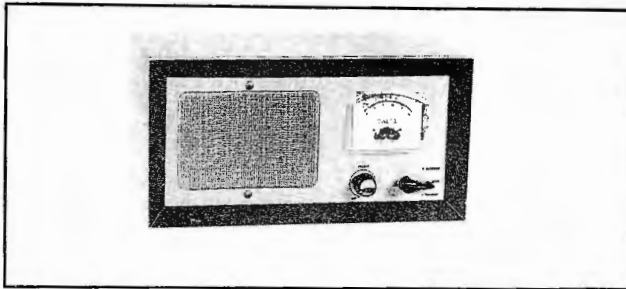

Size: 14" W, 9" H, 10" D (35.56 cm W, 22.86 cm H, 25.4 cm D).

Part No. 099 0542 00

The following antennas are tuned or cut to frequency with a standing wave ratio of less than 1.5:1 and are designed for 50-52 ohm transmission lines.

**SINGLE RING ANTENNA** — Essentially non-directional, horizontally polarized and unity gain.

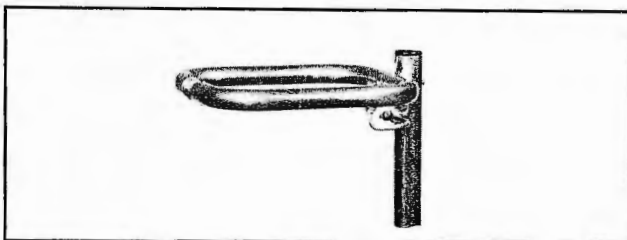

Specify whether for portable (PA-1) or mobile (MA-1)

use.

Part No. 097 6952

(Type PA-1)

Part No. 097 6953

(Type MA-1)

**TWO RING ANTENNA** — Essentially non-directional, horizontally polarized. Has a gain of 3 db (Type RA-2).

Part No. 099 0543

**ANTENNA BUMPER MOUNT** — Chain link bumper mount (Type ASP-143) for use with mobile antenna.

Part No. 097 6880 00

**FOUR RING ANTENNA (TYPE RA-4)** — Essentially non-directional, horizontally polarized. Has a gain of 6 db and power gain of 4.

Impedance: 52 ohms.

Weight: 11 lbs.

Part No. 097 6950

**FIVE ELEMENT YAGI ANTENNA (TYPE YC)** — Unidirectional antenna.

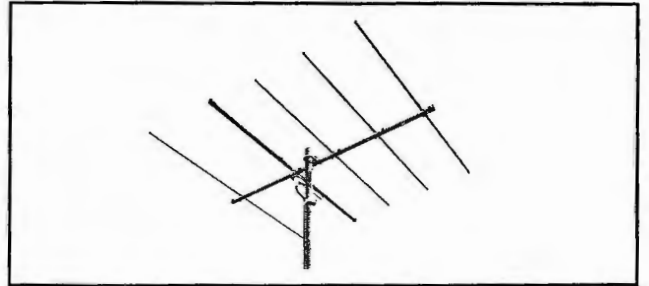

Nominal Impedance: 50 ohms.

Average Gain: 9 db.

Typical VSWR: Under 1.5.

Typical Rear Signal Rejection: 25 db.

Power Handling Capacity: 60 watts.

Input Connector: Type AN-SO-239 (Amphenol Type 83-1R).

Polarization: Horizontal or vertical.

Part No. 099 0177

**COAXIAL STACKING HARNESS** — Required for stacking two, five element Yagi antennas. It is made up of two sections of RG-11/U 75 ohm coaxial cable joined at the center by a coaxial "T" fitting. Each "half" of the phasing harness is an odd multiple of a quarter wave length and by virtue of its characteristic impedance and length, steps the 50 ohm antenna impedance to 100 ohms. When the two cables are joined at the "T" connector, the impedance again becomes 50 ohms (Type 2YC).

Part No. 099 0190

**KREKO VERTICALLY POLARIZED ANTENNA** — This vertically polarized base antenna has a gain of 6 db (Type SC-155-B).

Part No. 099 0544

**VEHICLE ROOFTOP ANTENNA** — Designed especially for mounting on a vehicle, this antenna has a 3 db gain (Type ASP-177).

Part No. 099 0545

**COAXIAL CABLE AND CONNECTORS** — The following coaxial cables and connectors may be used with the Marti Remote Pick-Up Equipment:

Part No. 099 0146

RG 8/U coaxial cable, 100'.

Part No. 099 0137

RG 17/U coaxial cable, 100'

Part No. 099 0546 00

RG 8/U connector PL-259 (Type 83-ISP).

Part No. 099 0547 00

RG 8/U straight adapter PL-258 (Type 83-IJ).

Part No. 099 0548 00

RG 17/U to RG 8/U connector (Type GR-6355).

Part No. 097 7023

RG 253/U Spir-O-line cable, ½", polyethylene jacketed

Part No. 099 0549 00

Spir-O-line RG 253/U to PL-258 connector (Type 87-500).



# Measuring, Monitoring, Remote Control

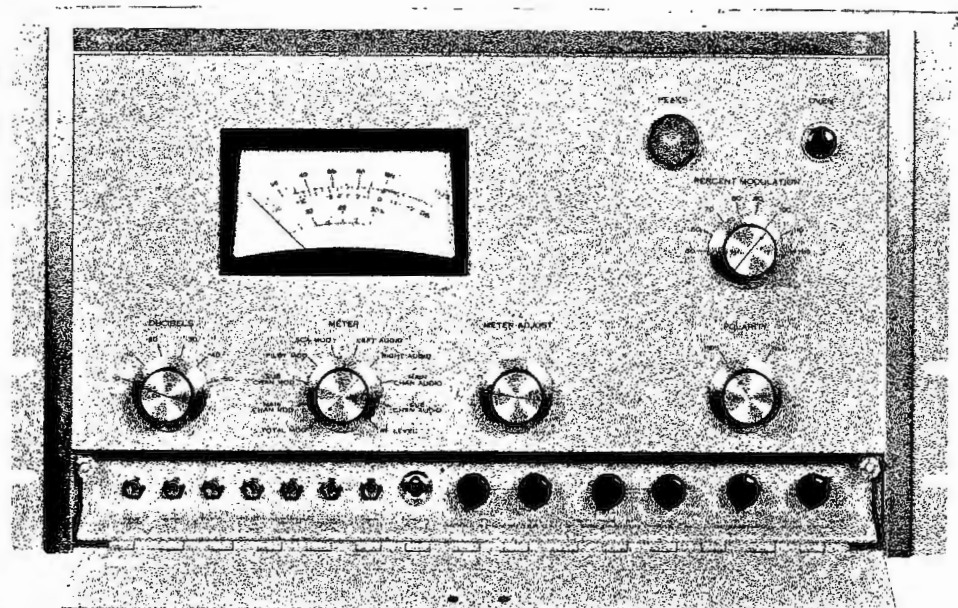



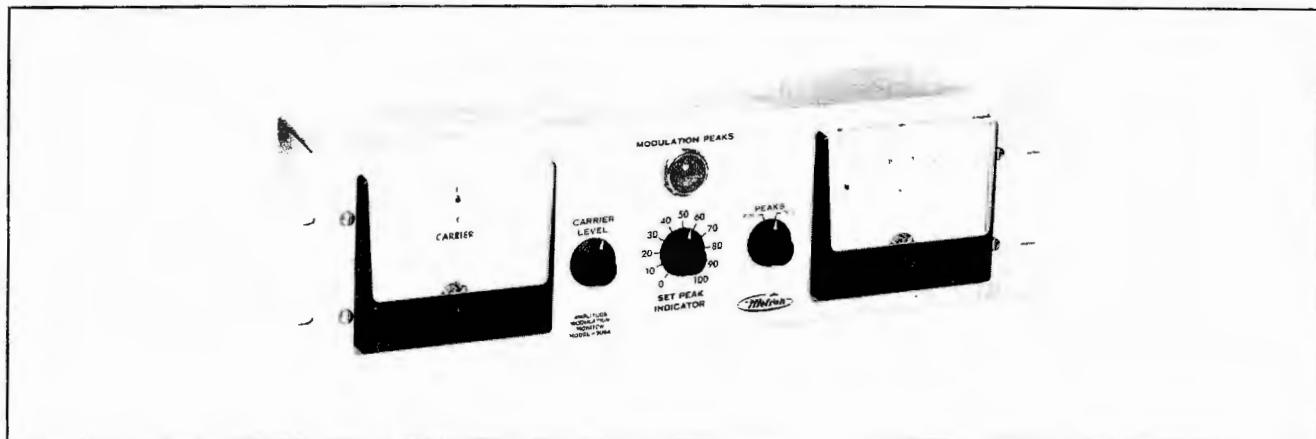

### METRON 506B AMPLITUDE MODULATION MONITOR

Occupying only  $5\frac{1}{4}$  inches of rack space, the fully transistorized Metron 506B Amplitude Modulation Monitor continuously measures modulation of the AM r-f carrier.

Meeting or exceeding FCC requirements, the 506B mounts in any standard 19-inch rack or cabinet. Frequently used controls are conveniently located on the front panel together with two easy-to-read illuminated meters for monitoring carrier level and percentage modulation.

Modulation peaks are indicated by a flashing lamp. Flashing level is adjustable from 0 percent to 100 percent modulation. Lamps operate at 60 percent of rated voltage to assure long life.

All external connections are made at the back of the unit. The r-f input may be made to either a coaxial receptacle or barrier type terminal strip. A remotely controlled modulation meter and/or remote flasher may be connected to terminals provided and may be switched in or out at will without affecting circuit calibration.

Two auxiliary audio outputs are provided. One of these is a high impedance, high level output for fidelity measurement; the other feeds a 600-ohm audio monitoring circuit.

*Input impedance:* 75 ohms

*Frequency range:* 0.5 to 1.6 mc

*R-f power required:* 0.5 watts (6 to 20 v rms)

*Power requirement:* 105 to 125 v a-c, 50 to 60 cycles.  
10 watts

*Dimensions:* W 19". H  $5\frac{1}{4}$ ". D 5" (W 48.26 cm, H 13.34 cm, 12.7 cm)

*Weight:* 10 lbs. (4.54 kg)

#### MODULATION PERCENTAGE METER

*Accuracy:*  $\pm 2\%$  of full scale, modulating frequency 1000 cps

*Response:*  $\pm 0.3$  db, 30 cps to 100 kc

$\pm 0.1$  db, 100 cps to 30 kc

#### MODULATION PEAKS FLASHER

*Range:* Continuously adjustable, 0% to 100%

*Flash point:* Flashes when negative modulation exceeds dial set point by more than 2%

*Accuracy:*  $\pm 2\%$  of full scale, 30 to 15,000 cps

#### AUDIO MONITORING OUTPUT

*Response:*  $\pm 0.5$  db, 30 cps to 100 kc

*Distortion:* Less than 0.2%, 600-ohm load

*Output voltage:* 0.5 v rms, 100% modulation with 600-ohm load

#### FIDELITY MEASURING OUTPUT

*Response:*  $\pm 0.5$  db, 30 cps to 100 kc

*Distortion:* Less than 0.1%, 600-ohm load

*Hum and noise level:* At least 80 db below 1.5-v rms signal level

*Output voltage:* 3.5 v rms at 100% modulation with load resistance exceeding 100,000 ohms shunted by capacitance of less than 500 mmf.

Part No. 099 300 000

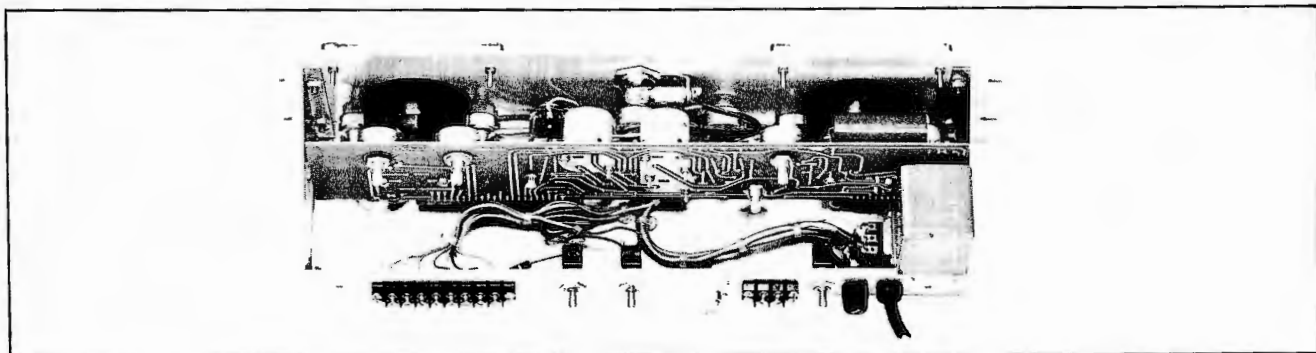

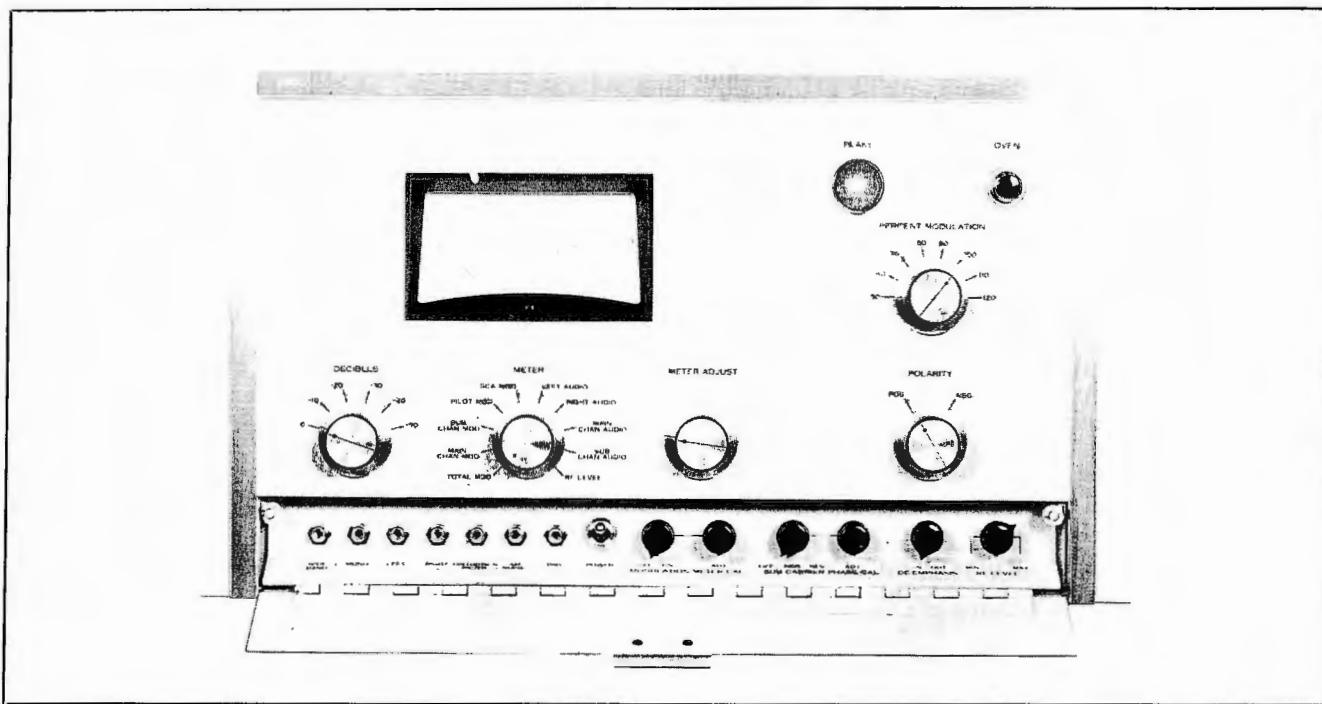

## COLLINS 900C-1 FM STEREO MODULATION MONITOR

The versatility of the 900C-1 is highlighted by these capabilities:

- Total peak frequency deviation measurement.
- Individual modulation component deviation measurement.
- Stereo signal demodulation for channel separation measurement.
- Channel cross-talk measurement.
- Both monaural and stereo outputs for monitoring and proof-of-performance as required.
- Wideband output for visual proof of separation with oscilloscope.
- AM noise level output for VTVM measurement.
- Test points for pilot carrier frequency measurements.

Versatile and dependable, the Collins 900C-1 FM Stereo Modulation Monitor assures the broadcaster accurate measurement and monitoring of FM stereo multiplex programming in accordance with FCC standards.

Fully transistorized, the unit uses a minimum of primary power, has low heat dissipation and is carefully engineered and manufactured to assure long life through the use of conservatively-rated components.

Plug-in wired circuit cards not only enhance the unit's flexibility and versatility but also speed up fault isolation and maintenance, keeping down-time to a bare minimum.

The 900C-1 has proper phase and frequency response, reads peak values of complex audio signals and has the necessary demodulation circuits. These requirements are not met by monaural monitors, even with modification.

The 900C-1 provides the demodulating circuitry required not only to measure total peak frequency deviation

of the carrier in the 50 cycle to 75 kilocycle range but also to measure deviation caused by the different bands of modulating frequencies: main channel, stereo subchannel, pilot carrier and SCA subchannel.

Total modulation is measured with the peak light and meter; individual modulation components are checked by the meter alone. A self-contained voltmeter is used for direct measurements of channel separation, cross-talk and signal-to-noise ratio.

Careful attention to engineering design and excellence in manufacturing, traditional at Collins, make the 900C-1 an invaluable tool for the current needs of FM and stereo broadcasters.

Referring to the block diagram, the signal flow is as follows:

The input RF is attenuated and mixed with the output of an oscillator-tripler which has an output frequency 500 kc above the input signal carrier frequency.

The 500 kc intermediate frequency is coupled through an isolation stage to a limiter and pulse counter which delivers constant area pulses to a phase linear low pass filter. The filter's output is the wideband audio containing all frequencies between 50 cps and 75,000 cps which are modulating the transmitted carrier. At this point the audio is fed to the modulation metering and stereo demodulator circuits.

In the modulation metering circuit, the wideband audio is fed to a phase splitter which delivers two outputs of opposite phase. One of these, selected by the front panel modulation polarity switch, is fed to the peak light circuit and the true peak reading voltmeter circuit.

Switched filters in the audio path break up the total modulation into the four different bands: main channel, stereo subchannel, pilot carrier and SCA subchannel.

In the stereo demodulator circuit, the audio signal from the phase linear low pass filter has the 19 kc pilot carrier separated, doubled to 38 kc and amplified to a level capable of driving the switching diodes. The switch breaks the composite signal into left and right output signals and amplitude correction is made by cross-coupling left and right outputs. The two outputs are filtered to remove all frequencies above 15 kc and then are identically amplified to provide left and right signals.

A built-in calibration circuit assures proper phasing of the regenerated 38 kc subcarrier as required for accurate stereo demodulation.

**MODULATION METER SECTION**

*Meter Positions:* Total modulation, main channel modulation, stereo subchannel injection, pilot carrier modulation, SCA subchannel injection.

*Meter Range:* 0%-133% for total, main and stereo subchannel modulation. 0%-30% for pilot carrier and SCA subchannel injection.

*Accuracy:* 5% over entire scale.

*Meter Characteristics:* Rise time, decay time and damping factor as prescribed by FCC for FM monaural monitors (all meter positions).

*Frequency Response:* ±0.5 db from 50-75,000 cps.

*Calibration:* Self-contained calibrating signal source.

*External Meters:* Provisions for adding series meter in short line (100 foot maximum) or remote meter in telephone line (5000 ohm maximum loop resistance).

**PEAK LIMIT INDICATOR LIGHT**

*Range:* Threshold adjustable from 50%-120% modulation.

*Response:* Will flash on modulation peaks of 20 milliseconds duration or greater.

*External Indicators:* Provision included for external peak limit indicator light.

**MONAURAL AUDIO SECTION**

*Outputs:* 0 dbm unbalanced (600 ohm flat or de-emphasized). 10 v rms across 10,000 ohms (flat or de-emphasized).

*Frequency Response:* ±0.5 db from 50-15,000 cps or within 1.0 db of standard 75 microsecond de-emphasis curve.

*Distortion:* 0.25% max. 50 cycles per second to 15 kc at 100% modulation.

*Signal-to-Noise Ratio:* 75 db.

**STEREOPHONIC AUDIO SECTION**

*Outputs:* 0 dbm unbalanced (600 ohms flat or de-emphasized). Distortion meter output: 10 v rms across 10,000 ohms unbalanced.

*Frequency Response:* ±1 db from 50-15,000 cps or within 1.0 db of standard 75 microsecond de-emphasis curve.

*Distortion:* .5% max. from 50-15,000 cps at 90% modulation.

*Signal-to-Noise Ratio:* 55 db on self-contained voltmeter.

*Channel Separation:* 40 db from 50-15,000 cps. Read on self-contained audio voltmeter.

*Channel Cross-Talk:* 45 db. Read on self-contained audio voltmeter.

*Stereophonic Subcarrier Suppression:* 60 db. Read on self-contained audio voltmeter.

*Pilot Carrier Phasing:* Transmitter pilot carrier phasing adjusted for proper 0 crossing after calibration of stereophonic subcarrier regeneration in monitor.

**GENERAL**

*RF Input:* 4-10 v rms at 50 ohms. Input on rear of unit.

*Outputs:*

Rear Chassis—Left Channel, Right Channel, Monaural, Remote Meter, Remote Peak Indicator, Wideband Output, IF (500 kc) Output for Frequency Meter, and 19 kc Output (for frequency measurement).

Front Panel—Wideband Output, Monaural Audio Output, Left Audio Output, Right Audio Output, Distortion—Measurement Output, 38 kc, 19 kc, and AM Noise Measurement Output.

*Controls:*

Front Panel—Function Selector, Voltmeter Reference Adjust, Voltmeter Range Adjust, Peak Indicator Threshold Adjust, Modulation Polarity Select.

Subpanel—Modulation Meter Calibrate Switch, Modulation Meter Calibrate Adjust, Subcarrier Phase Calibrate Switch, Subcarrier Phase Calibrate Adjust, De-emphasis Switch, RF Input Level Adjust, and Power On-Off.

*Size:* 19" W, 10 1/2" H, 13-25/32" D (48.26 cm W, 26.67 cm H, 33.02 cm D).

*Weight:* 35 lbs. (15.88 kg).

*Primary Power:* 120 v or 240 v ±10%, 50-60 cps. 50 watts.

Part No. 522 3275 000

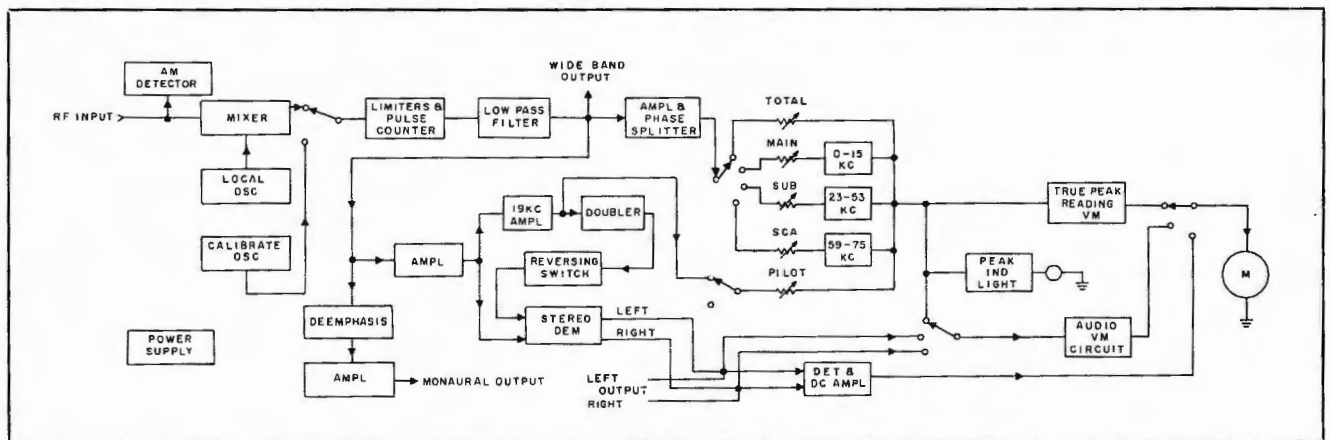

BLOCK DIAGRAM 900C-1

## McMARTIN FM FREQUENCY AND MODULATION MONITORS

The McMARTIN TBM-3000 and TBM-3500 are another first . . . a completely self contained frequency monitor and separate self contained modulation monitor, each independent of the other. These are the first and only monitors to comply with present FCC requirements.

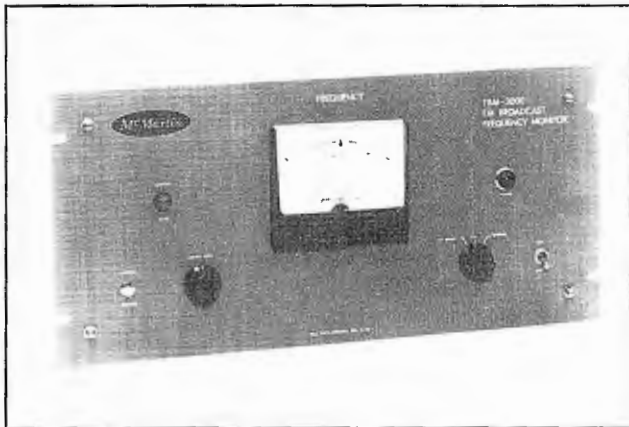

### McMARTIN TBM-3000 FM FREQUENCY MONITOR FEATURES:

- Type Approval Number 3-113
- Single purpose frequency monitor
- Completely self contained
- Accuracy .001%
- Unaffected by modulation
- External metering available
- Reliable double regulated silicon rectifier power supply
- Special meter for good visibility

*Frequency Range:* 88 to 108 mc — fixed

*Deviation Range:* +4 kc to -4 kc of specified frequency

*Accuracy:* Better than .001% or better than 1000 cps @ any frequency

*Stability:* 75 to 150 cps within 24 hours

*RF Input:* 1 to 5 volts @ 50 ohms — 1/2 watt maximum

*Front Panel Indicators:* Modulation meter. AC power—neon. Crystal oven—6 v. incandescent

*Front Panel Controls:* Selector switch: RF input, calibrate, operate, meter zero, crystal tuning, power on-off

*Chassis Controls:* RF level

*Outputs:* Provisions for external remote meter (optionally available)

*Tubes & Diodes:* 3—6201; 2—6265; 1—5814A; 1—OB2; 1—OA2; 4—1N56

*Rectifiers:* 4 silicon 750 ma/600 v.

*Power Supply:* 100-130VAC; 55 watts; 50-60 cps; C.C.S.; double; regulation; fused

*Dimensions:* Standard rack 19" width x 8 3/4" height x 7 1/2" depth (behind panel)

*Shipping weight:* 18 lbs.

Part No. 099 2309 000

Type No. TBM 3000



### McMARTIN TBM-3500 FM MODULATION MONITOR FEATURES:

- Self contained single purpose modulation monitor
- Accuracy 1/2 db, 50-75,000 cycles
- External metering available
- High speed indicator reads 10 millisecond peaks
- Measures all modulation carried by FM transmitter, including subchannels
- Measures separately main channel audio modulation without subchannels
- Output provisions for stereo and SCA monitors and proof-of-performance tests

*Operating Range:* Main Channel 88 to 108 mc

*Modulation Range:* Full scale meter deflection indicates deviation of ±100 kc or 133% modulation. Scale calibration indicates 100% modulation @ ±75 kc.

*Metering Accuracy:* Within 5% over entire scale (FCC standard for FM)

*Meter Characteristics:* Well within FCC requirements. Pointer reaches 90% value of a modulation peak, with a duration of only 70 milliseconds. Overshoot is less than 3%. Meter decays from full reading to 10% of value in 720 milliseconds.

*Peak Flash Indicator:* Responds to modulation peaks with a duration of 10 milliseconds or less.

*Frequency Response (Meter & Flasher):* ±1/2 db; 50 cps to 75 kc @ 100% modulation

*Stability:* Maintained by special inverse feedback.

*Audio Frequency Range:* Follows FCC de-emphasis curve. ±1.0 db 50 to 15,000 cps.

*Audio Distortion:* Main Channel—0.5% 50 to 15,000 cps

*Audio Hum and Noise:* Main Channel—65 db below 100% modulation @ low audio frequencies

*RF Input:* 1 to 5 volts @ 50 ohms (1/2 watt max.) coaxial input

*Front Panel Indicators:* 1) Main channel modulation peak flasher (neon)

2) AC power (neon)

*Front Panel Meters:* 1) Main channel modulation (RF input—total modulation—main channel modulation)

*Front Panel Controls:* 1) AC power on-off

2) Main channel modulation meter function switch

3) Main channel ±modulation polarity switch

4) Main channel peak modulation flasher control

*Rear Chassis Controls:* RF attenuator

*Outputs (front panel):* 1) Main Hi-Z phone jack



*Outputs (rear chassis):* 1) External main channel modulation meter  
2) Multiplex  
3) Main channel audio Hi-Z  
4) Main channel audio 600 ohms

*Tubes:* 12—Types: 2—12AT7; 1—6BH6; 2—6AK5; 1—12AX7; 1—6BE6; 1—6EM7; 1—2D21; 1—0B2; 1—6AB4; 1—7581

*Diodes:* 3 (1N51)

*Fuse:* 1—1 Amp SB-3AG

*Rectifiers:* 4 type 1N2095 Silicon

*Power Supply:* 100-130VAC; 55 watts; 50-60 cps; C.C.S.; double; regulation; fused

*Dimension:* Standard rack 19" width x 8 $\frac{3}{4}$ " height x 7 $\frac{1}{2}$ " depth (behind panel)

*Shipping weight:* 18 lbs.

Part No. 099 2308 000

Type No. TBM 3500

## McMARTIN FM MODULATION — SCA MULTIPLEX MONITOR

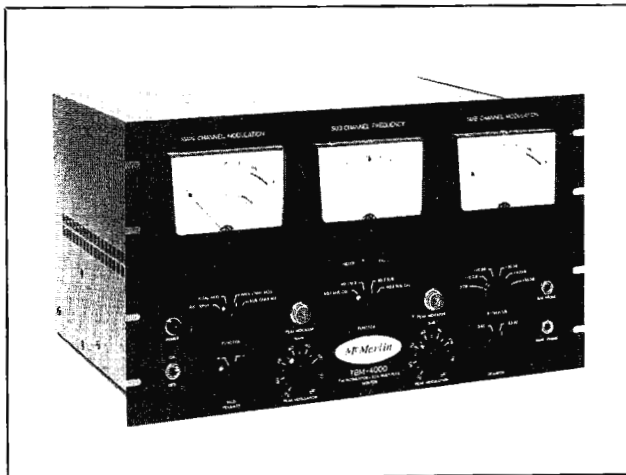

Drawing on their experience as the nation's leading manufacturer of multiplex receivers, McMARTIN engineers have developed an exceptional instrument which can measure all main channel modulation characteristics as well as all SCA-multiplex operating characteristics.

### FEATURES:

- Self contained independent Modulation Monitor, measures all modulation carried by the FM transmitter.
- Separate metering for direct reading of main channel modulation.
- Provisions for measuring all characteristics of one or two subchannels separately.
- Instantaneous direct reading of either subchannel injection at any time.
- Continuous metering of either subchannel frequency.
- Continuous metering of either subchannel modulation. Referred to either 5 or 7.5 kc deviation.
- Subchannel metering characteristics identical to main channel requirements as outlined by FCC.
- Direct reading of noise or crosstalk on either subchannel from any source without auxiliary equipment.

- Audio output of both main channel and either sub-channel available for aural monitoring and proof of performance checks.
- Separate high speed main and sub peak modulation lamps respond to 10 millisecond peaks.
- Automatic subchannel muting.
- Output terminals for external subchannel failure alarm.
- Output terminals for main channel and subchannel modulation extension meters.
- Reliable double regulated silicon rectifier power supply.
- Total modulation output jack to feed either McMARTIN TBM-2000 (separate SCA-multiplex monitor) or TBM-4500 (stereo monitor).

### SPECIFICATIONS

*Operating Range:* Main Channel 88 to 108 mc. SCA Multiplex 25 to 75 kc.

#### MAIN CHANNEL MODULATION

*Modulation Range:* Full scale meter deflection indicates deviation of  $\pm 100$  kc or 133% modulation. Scale calibration indicates 100% modulation @  $\pm 75$  kc.

*Metering Accuracy:* Within 5% over entire scale (FCC standard for FM).

*Meter Characteristics:* Well within FCC requirements. Pointer reaches 90% value of a modulation peak with a duration of only 70 milliseconds. Overshoot is less than 3%. Meter decays from full reading to 10% of value in 720 milliseconds.

*Peak Flash Indicator:* Responds to modulation peaks with a duration of 10 milliseconds or less.

*Frequency Response (Meter & Flasher):*  $\pm 1/2$ db; 50 cps to 75 kc @ 100% modulation.

*Stability:* Maintained by special inverse feedback.

#### SCA MULTIPLEX MODULATION

*Modulation Range:* 100% modulation on the meter scale may correspond to deviation of  $\pm 5$  kc or  $\pm 7.5$  kc as desired. Selection is made by a front panel switch. 133% modulation (full scale) corresponds to deviation of  $\pm 6.67$  kc or  $\pm 10$  kc.

*Metering Accuracy:* Same as main channel specifications above.

*Meter Characteristics:* Same as main channel specifications above.

*Peak Flash Indicator:* Responds to modulation peaks with a duration of 10 milliseconds or less.

*Frequency Response (Meter & Flasher):*  $\pm 1/2$  db; 50 to 7500 cps @ 100% modulation.

*Stability:* Maintained by special inverse feedback.

#### SCA MULTIPLEX FREQUENCY

*Operating Range:* Any two SCA multiplex subcarriers between 25 kc and 75 kc by front panel selector switch.

*Deviation Range:* Zero center scale is calibrated to  $\pm 4000$  cps ( $\pm .004\%$  of 67 kc).

*Accuracy:* Better than 100 cps at 67 kc.

*Stability:* Maintained by crystal with .005% tolerance.

#### SCA MULTIPLEX INJECTION

*Injection Percentage:* A separate circuit and meter scale indicates the maximum allowed (FCC) modulation percentage of the main carrier by SCA subcarriers. 30% injection corresponds to about 2/3 of full scale reading.

*Accuracy:* Within 5% over entire scale.

## CROSSTALK & SIGNAL-TO-NOISE RATIO

*Metering:* Reads crosstalk and S/N ratio of SCA multiplex channel to -65 db with calibrated scale and step attenuator. Measures crosstalk of main into SCA. SCA and/or stereo into SCA.

## AUDIO

*Frequency Range:* Main Channel— Follows FCC de-emphasis curve.  $\pm 1.0$  db 50 to 15,000 cps.

SCA Channel— 75 microsecond de-emphasis  $\pm 1.0$  db 50 to 7500 cps.

*Distortion:* Main Channel— 0.5% 50 to 15,000 cps.

SCA Channel— 1.0% 50 to 7500 cps.

*Hum and Noise:* Main Channel— -65 db below 100% modulation @ low audio frequencies.

SCA Channel— -65 db below  $\pm 7.5$  kc deviation @ low audio frequencies.

## GENERAL

*RF Input:* 1 to 5 volts @ 50 ohms ( $\frac{1}{2}$  watt max.) coaxial input.

*Front Panel Indicators:* 1) Main Channel modulation peak flasher (neon).

2) SCA modulation peak flasher (neon).

3) AC power (neon).

*Front Panel Meters:* 1) Main channel modulation (RF input— total modulation— main channel modulation— sub-channel injection).

2) Subchannel frequency (reads selected subchannel).

3) Subchannel modulation, crosstalk, S/N.

*Front Panel Controls:* 1) AC power on-off.

2) Main channel modulation meter function switch.

3) Main channel  $\pm$  modulation polarity switch.

4) Main channel peak modulation flasher control.

5) Subchannel frequency meter function switch.

6) Subchannel frequency meter calibrate control.

7) Subchannel peak modulation flasher control.

8) Crosstalk, S/N step attenuator.

9) SCA deviation selector 5 or 7.5 kc.

*Rear Chassis Controls:* RF attenuator.

*Outputs (front panel):* 1) Main Hi-Z phone jack.

2) SCA Hi-Z phone jack.

*Outputs (rear chassis):* 1) External main channel modulation meter.

2) External SCA channel modulation meter.

3) Multiplex.

4) Main channel audio Hi-Z.

5) Main channel audio 600 ohms.

6) Subchannel audio Hi-Z.

7) Subchannel audio 600 ohms.

8) Subchannel failure relay (for alarm).

*Tubes:* 24.

Types: 4—12AT7                    1—6SN7

4—6BH6                        1—6U8

2—6AK5                        2—2D21

3—12AU7                       2—OA2

1—6BE6                         1—OB2

2—6AB4

*Diodes:* 14 (1N51).

*Fuse:* 1— 1 Amp SB-3AG.

*Rectifiers:* 4 type 1N2095 Silicon.

*Power:* Constant regulated voltage transformer 105-125 volts, 60 cycle AC 65 watts Gaseous regulator type tubes.

*Dimensions:* Panel— standard rack  $10\frac{3}{4}$ " x 19".

Chassis—  $13\frac{1}{2}$ " behind panel.

*Weight:* 34 lbs.

Part No. 099 0824 —

(Type No. TBM-4000)

## McMARTIN RF AMPLIFIER

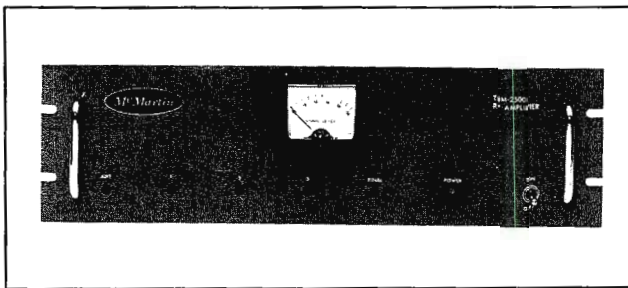

The McMARTIN TBM-2500 RF Amplifier is used in conjunction with any McMARTIN TBM series FM station monitor when remote operation is necessary. It will also operate with other brands of monitors which require a higher input power level. It will feed a combination of high and low input level monitors.

### FEATURES:

- Complete alignment from front panel
- Relative signal level meter
- Carrier failure relay for alarm circuit
- Complete circuit shielding
- Antenna (cut-to-frequency, 4 elements) & 50' coaxial cable supplied
- Stable, non-critical design
- Exceptionally long tube life

### SPECIFICATIONS:

*Operating range:* 88-108 mc.

*RF Sensitivity:* 300 uv input for  $\frac{1}{2}$  watt output. 1000 uv input for 2 watt output.

*Input:* 50 ohms coaxial.

*Outputs:* (2) 50 ohms coaxial.

*Dimensions:* 19" wide,  $5\frac{1}{4}$ " high, 7" deep.

*Finish:* Natural gray panel.

*Power:* 120 VAC, 50-60 cps, 45 watts.

Part No. 099 2502 —

(Type TBM-2500)

## BARKER & WILLIAMSON 210 AUDIO OSCILLATOR

Resistance capacitance type for making frequency response, distortion and other audio measurements.

*Ranges:* 30-300, 300-3,000, 3,000-30,000 cps.

*Output:* 10 v into 500 ohm load. Less than 1% rms harmonics 30-15,000 cps with 500 ohm load.

*Response:* Better than  $\pm 1$  db 30-15,000 cps.

*Calibration Accuracy:* 3% of scale reading.

*Size:*  $13\frac{3}{4}$ " W,  $9\frac{1}{2}$ " H,  $7\frac{1}{4}$ " D (34.93 cm W, 24.13 cm H, 18.42 cm D).

*Shipping Weight:* 17 lbs. (7.71 kg).

Part No. 099 0827 00

## NEMS-CLARK 120-E FIELD INTENSITY METER

A lightweight instrument for the measurement of a wide range of radio signal intensities.

*Frequency Range:* 540-1600 kc.

*Field Intensity Range:* 10 mv/meter to 10 v/meter.

*Accuracy of Attenuators:* 2%.

*Output Indicator:* Direct reading panel meter.

*Antenna:* Shielded, unbalanced loop.  
*Power Requirements:* Batteries, five 1½ v, two 67½ v (provisions for external supply).  
*Size:* 13" W, 9" H, 5¾" D (33.02 cm W, 22.86 cm H, 14.61 cm D).  
*Weight:* 12½ lbs. (5.67 kg) with batteries.  
**Part No. 097 5516 000**

**NEMS-CLARK 121 ACCESSORY UNIT**

Designed as a companion unit to the 120-E (also 120-D, WX-2A, WX-2B, WX-2C and WX-2D). Its principal function is to operate 1 ma recorders of the Esterline Angus type to give a permanent record of field strength. It can also be used as a general purpose recording and monitoring amplifier when a high input impedance is desired and 5 v dc is available.  
*Input Required:* Approximately 5 v dc.  
*Output:* 1 ma into loads up to 2,000 ohms.  
*Speaker:* 4" panel mounted.  
*Power Source:* 117 v, 50-60 cps, or 6 v dc.  
*Power Input:* 15 watts ac or 2.5 amps dc.  
*Size:* 12½" W, 6½" H, 4½" D (31.75 cm W, 16.51 cm H, 11.43 cm D).  
*Weight:* 10 lbs. (4.54 kg).  
**Part No. 099 0370 000**

**NEMS-CLARK 108-E PHASE MONITOR**

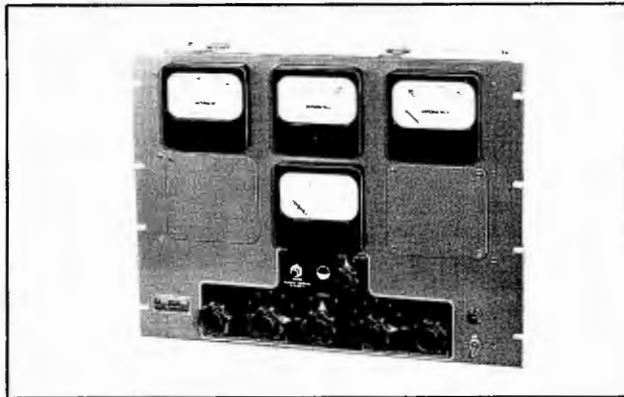

Provides an indication of the phase relations in directional antenna systems, and is tailored for the particular installation. It usually incorporates provision for indicating the relative amplitudes of the currents in the various antennas, as well as the phase relation. Specify requirement for monitoring 2, 3, 4, or over 4 elements.  
*Frequency Range:* 100 kc to 2 mc.  
*Phase Angle Range:* 0° to 360°.  
*Monitoring Accuracy:* 1°.  
*Resolution:* ½°.  
*RF Input Impedance:* 50 or 70 ohms nominal.  
*RF Voltage Range:* 1-7 v.  
*Tubes:* Two 6AU6, two OB3, one 5Y3 and three 6AL5.  
*Power Requirements:* 105-125 v, 80 watts.  
*Size:* 19" W, 14" H, 7" D (48.26 cm W, 35.56 cm H, 17.78 cm D).  
*Weight:* 20 lbs. (9.07 kg).  
**Part No. 099 0366 000 (2 element)**  
**Part No. 099 0367 000 (3 element)**  
**Part No. 099 0368 000 (4 element)**  
**Part No. 099 0369 000 (over 4 element)**

**BARKER & WILLIAMSON 410 DISTORTION METER**

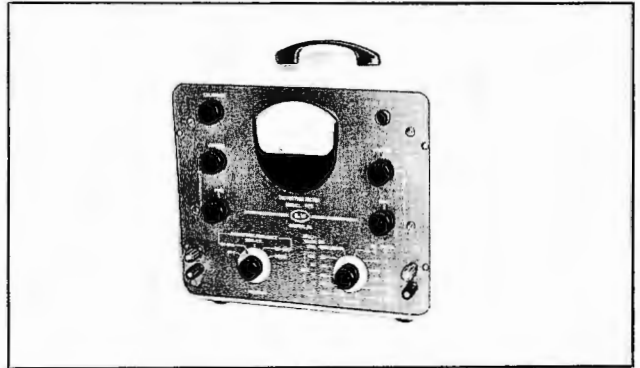

Ideal for FCC proof of performance tests and general laboratory use in measuring audio distortion, noise level and ac voltage level, the B & W 410 operates over a wider frequency range and provides increased sensitivity than earlier models.

The distortion meter measures distortion on fundamental frequencies from 20-20,000 cps and indicates harmonics up to 100,000 cps. Distortion levels as low as 0.1% can be indicated and measurements may be made on signal levels of 0.1-30 v rms. Distortion ranges provided are 1% full scale, 3%, 10%, 30% and 100% (full scale). The unit is designed for optimum accuracy on 600 ohms but is satisfactory on sources up to 100,000 ohms.

The 410 voltmeter input impedance is 1 megohm, and it has an accuracy of ±5% on measurements from 0.0005-300 v. Residual noise is less than 0.02 mv. For noise and db measurements, the unit is calibrated in 1 db steps from 0 db to -15 db. The attenuator provides additional ranges from -60 db to +50 db in 10 db steps.

The chassis, panel and case are of aluminum and attractively styled and finished in two tone gray.  
*Size:* 11¼" W, 9" H, 8" D (28.58 cm W, 22.86 cm H, 20.32 cm D).  
*Weight:* 11 lbs. (4.99 kg).  
**Part No. 099 0569 000**

**GENERAL RADIO 1181-B FREQUENCY DEVIATION MONITOR**

Gives direct indications of magnitude and direction of frequency deviation of AM transmitter. Positive indication is provided for failure of either transmitter carrier or monitor crystal oscillator.  
*Frequency Range:* 0.5-1.6 mc (specify crystal frequency).  
*Deviation Range:* ±30 cps.  
*Primary Power:* 105-125 or 210-250 v, 50/60 cps, 125 watts.  
*Size:* 19" W, 15¾" H, 13" D (48.26 cm W, 40.01 cm H, 33.02 cm D).  
*Weight:* 51 lbs. (23.4 kg).  
**Part No. 097 5948 —**  
**No Part Number** Spare set of tubes. **No Part Number** FCC set of spare tubes.

# SCHAFFER TRANSMITTER REMOTE CONTROL

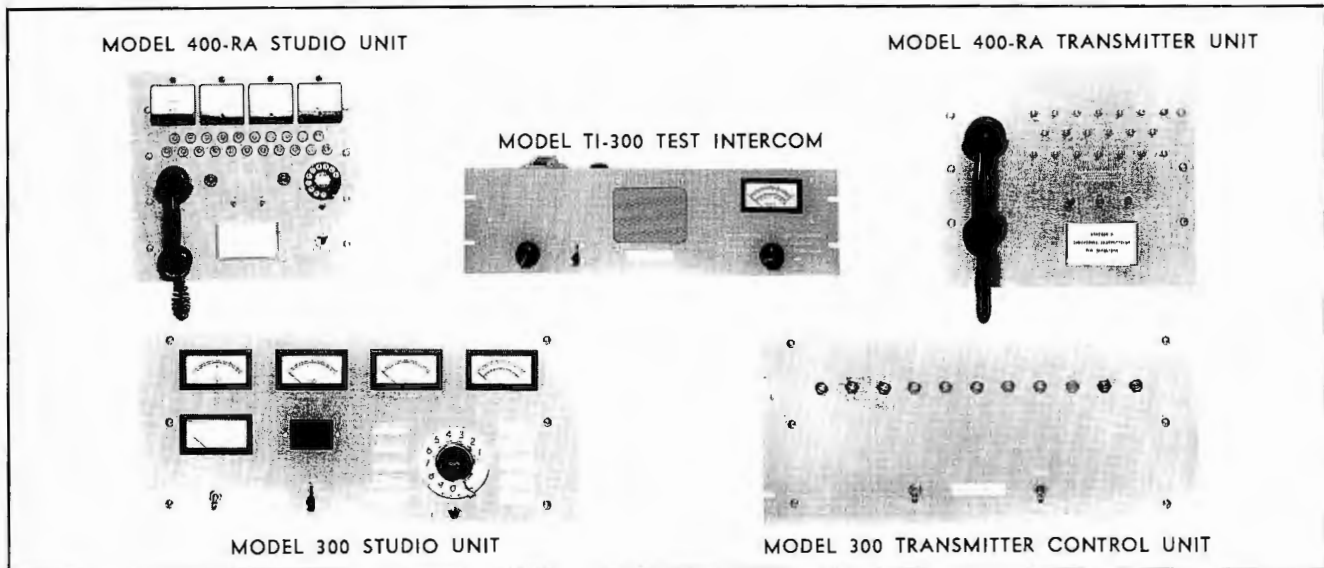

## MODEL 400-RA STUDIO UNIT

An all DC Remote Control that operates on any two metallic lines (lowest tariff). Controls forty (40) different functions and meters twenty (20) different circuits and allows 2-way telephone conversations at all times. Four meters included.

Part No. 099 1518 000

## MODEL 400-RA TRANSMITTER UNIT

Designed for location near the transmitter. Provides all calibration controls for the Studio Unit, as well as 110V AC to operate all accessory relays.

Part No. 099 1519 000

## MODEL TI-300 TEST INTERCOM

This is a test intercom unit used with the Model 300 Remote Control System for 2-way communication, as well as being a test unit for checking the remote control operation. Two units are necessary for communication between studio and transmitter without additional telephone lines.

NPN

## MODEL 300 STUDIO UNIT

A new all DC Remote Control system that operates on any two metallic lines with a resistance of up to 6000 ohms or more. Controls up to twenty (20) different functions and meters up to eleven (11) different circuits, including modulation and frequency. Five meters included. With a TI-300, two-way communication is available, as well as having a test unit at each end.

Part No. 597 0409 000

## MODEL 300 TRANSMITTER CONTROL UNIT

Provides all calibration controls for the studio unit, as well as 48 V DC to operate all accessory relays.

Part No. 597 0410 000

## REMOTE CONTROL ACCESSORIES

### POR-1 PRIMARY OVERLOAD RELAY

Parallels present manual primary overload circuit breaker used in some transmitters, so that overload may be reset by Remote Control.

NPN

### TOWER LIGHT CURRENT METERING UNIT TC-25

The TC-25 provides DC output to represent tower light current.

Part No. 099 1521 000

### LATCHING RELAY UNIT LR-1-C

The LR-1-C is used to control circuits locally controlled by switches, such as filaments on-off and plates on-off.

Part No. 099 1520 000

### MOTORIZED PLATE RHEOSTAT

For adjustment of plate power without affecting tuning.

MPR-2 For 250 or 500 watt transmitter. Part No. 099 1544 000  
MPR-3 For 1000 watt transmitter. Part No. 099 1545 000  
MPR-4 For over 1 Kilowatt transmitter. Part No. NPN

### MOMENTARY RELAY UNIT MR-2-C

The MR-2-C is used to control circuits locally controlled by push-buttons, such as filaments on-off and plates on-off.

Part No. 097 6781 000

### ANTENNA CURRENT METERING UNIT AC-100

The AC-100 provides DC output to represent antenna current.

Part No. 097 7581 000

### PLATE CURRENT METERING UNIT PCK-10

The PCK-10 provides remote metering voltage to indicate plate current.

300 MA Part No. 099 1538 000  
600 MA Part No. 099 1539 000  
1200 MA Part No. 099 1540 000  
2400 MA Part No. 097 6663 000

### PLATE VOLTAGE METERING UNIT PV-10

The PV-10 provides remote metering voltage to indicate plate voltage for connection to any one mil metering circuit.

Part No. 097 6664 000



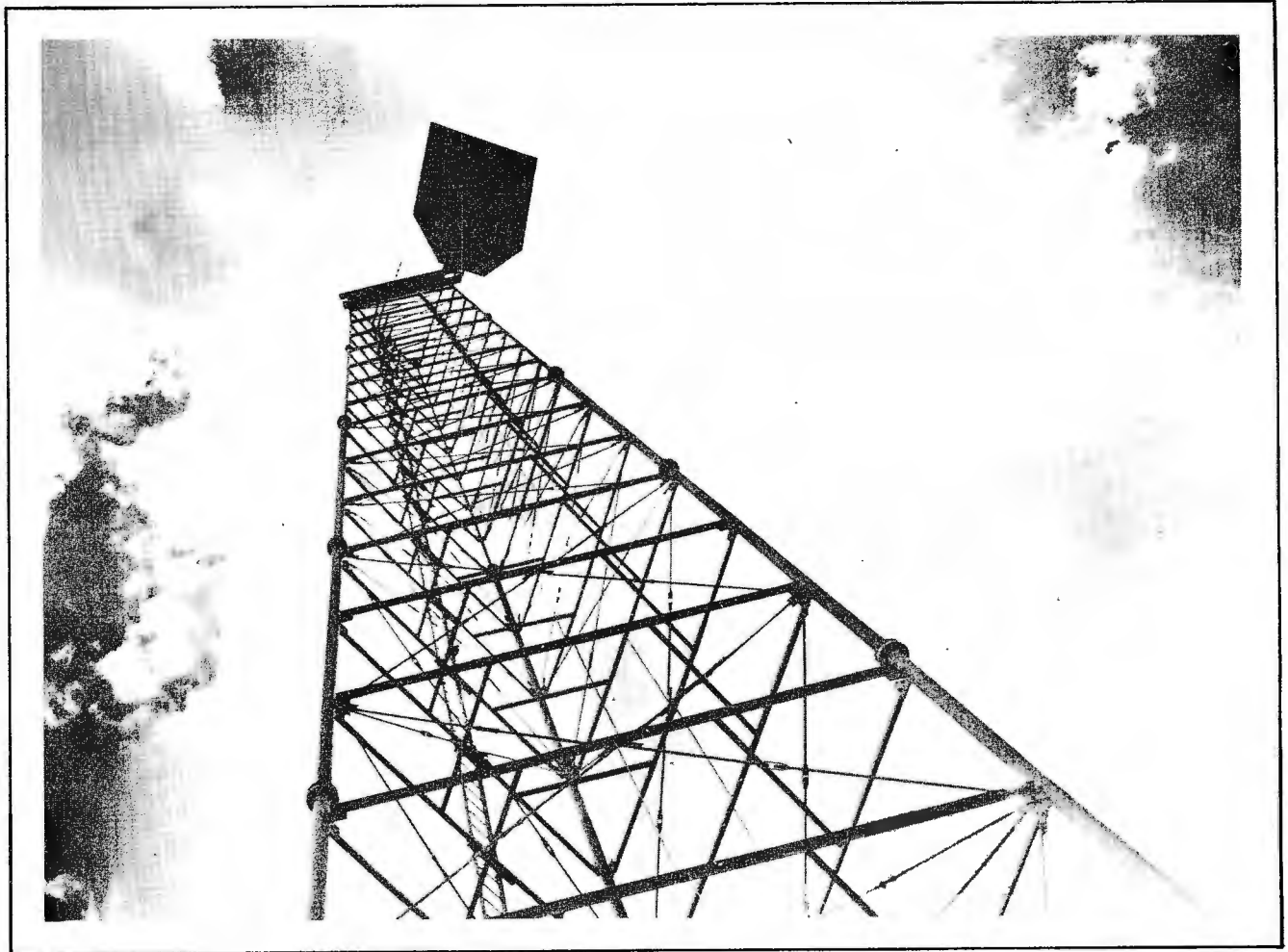

## COLLINS STL MICROWAVE SYSTEMS

As a part of its Universal Microwave Group, Collins offers STL systems for the broadcast industry. These systems are part of a broad, flexible, transistorized product line.

Collins Universal Microwave Group (U/M/G) equipment provides high performance on short-, medium-, and long-haul video relay applications for operation in the 6875- to 7125-mc STL band. The U/M/G offers a choice of 1-watt or 5-watt output power and remodulating or heterodyne repeaters in a compatible integrated family of fully transistorized\* microwave radio products. Most basic and accessory modules are identical to minimize training and spares provisioning in a system of mixed power requirements. Short- to medium-length system performance requirements are met with 1-watt remodulating equipment. Extra long paths are possible using 5-watt remodulating equipment, while 5-watt i-f heterodyne repeaters are available for long-haul systems. IF heterodyne repeaters eliminate the waveform distortion generated by the extra modulation step in remodulating type repeaters. Simplex (one-way) or duplex operation is available in non-standby or hot-standby configurations.

*MW-408A*: 1-watt (+30 dbm) power output, Terminal or Remodulating Repeater Application.

*MW-409A*: 5-watt (+37 dbm) power output, Terminal or Remodulating Repeater Application.

*MW-409B*: 5-watt (+37 dbm) power output, IF Heterodyne Repeater Application.

### FEATURES

Full transistorization\* for maximum reliability / IF heterodyne or remodulating repeaters / High frequency service channel and fault alarm available / U/M/G module interchangeability reduces spares program and training / Long-life TWT's with low-cost replacement envelope on 5-watt transmitters / Nonstandby or hot-standby transmitter operation / Economical 24-vdc basic powering with 48-vdc or a-c options available / Simplex (one-way) or duplex operation / Ample built-in metering facilities / Standby systems use power splitters and optional combiners on receivers for maximum reliability / Temperature stabilization of all klystrons.

\*Except for Klystrons and TWT's

## MARTI STL EQUIPMENT

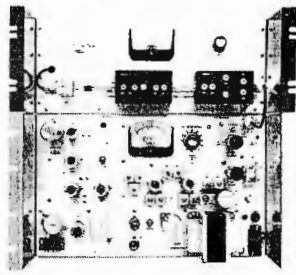

M-3/STL TRANSMITTER

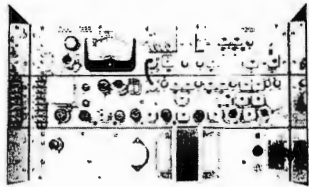

MR-200/942-952 RECEIVER

## MOSELEY STL EQUIPMENT

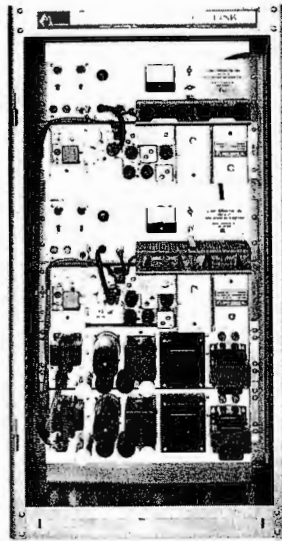

MODEL PCL-2B STUDIO TRANSMITTER LINK



MODEL SCG-4 CARRIER GENERATOR

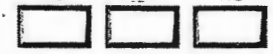

MODEL PBR-21 METER PANEL



MODEL PBR-21 STUDIO CONTROL UNIT



MODEL PBR-21 TRANSMITTER CONTROL UNIT

## MARTI STUDIO-TRANSMITTER LINK

The MARTI M-3/STL Transmitter and MR-200/942-952 Receiver with antennas and transmission line, combine to form a microwave link to feed program material from studio to transmitter or network material from city to city.

A system, including transmitter, receiver, two (2) parabolic antennas, each with 17.0 db. gain and 200' of  $\frac{7}{8}$ " transmission line, is designed to cover up to 18 miles, allowing a full 30 db. fade factor for 99.99% reliability. For greater distances, antennas and transmission lines are selected as necessary to obtain the desired gain. To be assured of a path, a minimum of 75' above line-of-sight is necessary to accommodate fresnel zone clearance.

### SPECIFICATIONS FOR TRANSMITTER

*Application:* Studio-Transmitter Link & Inter City Relay.

*Frequency Range:* 942.5-952.5 Mcs.

*Power Output:* Maximum 3 watts; Normal 2.5 watts as set at factory.

*Output Impedance:* Nominal 50 ohms.

*R. F. Connector:* UG-997A/U (mates with UG-21D/U).

*Frequency Stability:* .001% or better.

*Type of Modulation:* Phase.

*Modulation Capabilities:*  $\pm 100$  Kcs. (75 Kcs. considered as 100% mod.)

*Type of Oscillators:* Temperature controlled crystals.

*Audio Input Impedance:* 600 ohms.

*Audio Input Level:* 10DBM  $\pm 2$ DB.

*Auxiliary Input:* 41 or 67 KC. SCA.

*Frequency Response:* + or - 1 DB. 40 to 15,000 CPS.

*Distortion @ 100% Modulation:* 1.25% Max., 40 to 100 CPS. 0.08% Max., 100 to 7500 CPS. 1.25% Max., 7500 to 15,000 CPS.

*FM Noise Level:* Referenced signal 400 CPS modulated 100%. (+ & - 75 Kcs.) Exceeds -65 DB as measured with 75 micro-second pre-emphasis, & 15 Kcs. low-pass filter.

*AM Noise Level:* Exceeds -50 DB referred to carrier amplitude.

*Power Line Requirements:* 120 VAC, 50/60 cycle, 150 Watts.

*Dimensions:* 17 $\frac{1}{2}$ " high, 19" wide, 9" deep (Std. relay rack type mounting).

*Tube Complement:* Four 6U8A; one 6CG7; two 12AT7; two 6360-A; one 6DS4 Nuvistor; one OA2; one Motorola IN4387 Varactor; & one Motorola IN4388 Varactor.

### SPECIFICATIONS FOR RECEIVER

*Frequency Range:* 942.5 to 952.5 Mcs.

*Bandwidth:* 200 Kcs. - 3 DB points.

*Sensitivity:* 2.0 microvolts for 30 DB signal to noise ratio.

3.2 microvolts for 40 DB signal to noise ratio. 10.0

microvolts for 50 DB signal to noise ratio. 32.0

microvolts for 60 DB signal to noise ratio.

*Overall Response:* 40 to 15,000 cycles + or - 1 DB (75 microsecond curve).

*Oscillators:* Two; both temperature controlled.

*Input:* Nominally 50 ohms (Type "N").

*Output:* 600 ohms at plus 10 dbm.

*Metering:* Audio, Discriminator, Limiter, Last IF, Osc. No. 1 output, Osc. No. 2 Output and CR-1 drive. Meter w/selector switch.

*Power Requirements:* 120 VAC, 50/60 cycles, 60 watts.

*Tube Complement:* Eight 6DS4; three 6HS6; two 6HB6; one 7059; one 6AL5; three 12AX7; one 6CG7; and one OB2. (20 required; 8 types).

*Dimensions:* 10 $\frac{1}{2}$ " high, 19" wide, 9" deep. Panel finish, WE grey hammertone.

*Net Weight:* 20 pounds.

## MOSELEY STUDIO-TRANSMITTER LINK

The Model PCL-2B STUDIO-TRANSMITTER LINK provides a high quality audio channel between a broadcast studio and a remote transmitting site. It can be used in conjunction with available Remote Control Systems to relay main channel program and control signals to a remote FM broadcast transmitter. Designed for continuous service, the Model PCL-2B operates in accordance with Subpart E, Part 74 of the FCC Rules and Regulations.

Meters are provided on both the STL transmitter and receiver to measure important circuit parameters. An RF filter is employed at the transmitter output to attenuate spurious signals to at least 60 db below rated output. A sampling probe to monitor the relative output power delivered to the antenna transmission line is an integral part of the filter. Two silent running muffin type axial blower fans keep the tube seals of the final tubes at a safe operating temperature for longer tube life. A pre-wired socket mounted on the rear of the control panel provides a convenient means for remote controlling the STL transmitter.

Two Model PCL-2B Studio-Transmitter Links can be operated in one 500 kc/s channel assignment to provide dual program channels for FM stereo. Because two separate STL systems are used, there is no measurable amount of cross talk between channels. The redundancy of the system also offers protection against loss of air time. In addition to carrying the stereo program channels, remote control tones and an SCA multiplex sub-carrier can be transmitted over a dual system.

### SPECIFICATIONS

*Audio Response:*  $\pm 1/2$  db, 50 cps to 15,000 cps.

*Distortion:* Less than 0.5%, 100 cps to 10,000 cps. 1.0%, 50 cps to 15,000 cps.

*Signal to Noise Ratio:* Greater than 65 db below 100% modulation.

*Multiplex Input:* Two type BNC connectors provided for SCA multiplex channels. Requires approximately 1 volt rms for optimum operation.

*Primary Power Source:* 120/240 VAC, 50-60 cps.

#### *Mounting:*

Transmitter — Complete transmitter requires  $15\frac{3}{4}$ " of standard 19" rack space. Single or dual STL transmitter supplied in 42" enclosed cabinet.

Receiver — Complete receiver requires  $10\frac{1}{2}$ " of standard 19" rack space.

## MOSELEY FM SUBCARRIER GENERATOR MODEL SCG-4

Designed to comply with F.C.C. Rules and Regulations for SCA operations, the Model SCG-4 Subcarrier Generator offers the FM broadcaster a reliable subcarrier generator for the transmission of a high fidelity SCA multiplex signal. This unit is compatible with FM stereophonic broadcasting. Precision components are utilized in the oscillator timing circuits to enhance the center

frequency stability and to minimize effects of tube aging or replacement on the operating frequency.

### SPECIFICATIONS

*Type of Circuit:* Positive grid, free running multivibrator.

*Type of Modulation:* Frequency.

*Center Frequency:* Between 20 kcs and 75 kcs (factory set to within 5% of desired frequency).

*Stability:*  $\pm 0.2\%$

*Deviation:* Adjustable to  $\pm 10\%$  of center frequency.

*Modulation Response:* 50 cps to 12,000 cps.

*Distortion:* Less than 1% — 50 cps to 12,000 cps.

*FM Noise:* Greater than -65 db.

*Input Impedance:* 600 ohms balanced.

*Output Voltage:* 4.0 volts rms, 10 K ohms; 1.5 volts rms, 600 ohms.

*Physical Size:*  $8\frac{3}{4}$ " x 19" standard rack panel, 3" deep.

*Power Line:* 120/240 VAC  $\pm 10\%$ ; 50-60 cps.

## MOSELEY TRANSMITTER REMOTE CONTROL SYSTEM

The PBR-21 represents a new concept in the design of broadcast and television transmitter remote control systems. The path between studio and transmitter is no longer restricted to DC line requirements. A single low cost, voice quality line or STL circuit is all that is necessary. Line attenuation up to 20 db will not adversely affect system operation.

Simple, versatile and reliable, the PBR-21 features push-button selection of 42 control and 21 metering circuits. The binary logic scheme employs only one silicon transistor type throughout all circuits. Panel lights display CYCLE and READ modes. This feature also serves to indicate a malfunction of the return telemetering circuits. A RECYCLE button allows fast confirmation of each channel selection. The CALIBRATE position verifies system accuracy at a touch. The binary logic output momentarily interrupts the fail-safe signal to reposition the channel selector switch. The LOWER and RAISE command tones are 2000 cps and 2500 cps. Metering is returned to the studio by a temperature stable oscillator operating between 400 cps and 750 cps. Additional control and sub-carrier modules adapt the PBR-21 for radio remote control systems.

A complete line of accessories is available to adapt the PBR-21 to any remote control requirement. Various kits will translate voltage, current, and tower light (etc.) indications into appropriate sample voltages for telemetering.

### SPECIFICATIONS

*Control Functions:* 21 raise, 21 lower commands.

*Metering:* 21 telemetering channels.

*Fail-Safe:* Protected from system failure exceeding 25 sec.

*Line Requirements:* 20 db allowable loss from 400-3000 cps.

*Calibration Reference:* Zener diode.

*Power Requirements:* 120/240 VAC, 50-60 cps.

*Finish:* Anodized and etched aluminum panels.

# Tables, Charts, Graphs





FINDING POWER AND VOLTAGE/CURRENT WHEN DECIBELS ARE KNOWN

Voltage Ratio	Power Ratio	-db+	Voltage Ratio	Power Ratio	Voltage Ratio	Power Ratio	-db+	Voltage Ratio	Power Ratio
1.0000	1.0000	0	1.000	1.000	.5623	.3162	5.0	1.778	3.162
.9886	.9772	.1	1.012	1.023	.5559	.3090	5.1	1.799	3.236
.9772	.9550	.2	1.023	1.047	.5495	.3020	5.2	1.820	3.311
.9661	.9333	.3	1.035	1.072	.5433	.2951	5.3	1.841	3.388
.9550	.9120	.4	1.047	1.096	.5370	.2884	5.4	1.862	3.467
.9441	.8913	.5	1.059	1.122	.5309	.2818	5.5	1.884	3.548
.9333	.8710	.6	1.072	1.148	.5248	.2754	5.6	1.905	3.631
.9226	.8511	.7	1.084	1.175	.5188	.2692	5.7	1.928	3.715
.9120	.8318	.8	1.096	1.202	.5129	.2630	5.8	1.950	3.802
.9016	.8128	.9	1.109	1.230	.5070	.2570	5.9	1.972	3.890
.8913	.7943	1.0	1.122	1.259	.5012	.2512	6.0	1.995	3.981
.8810	.7762	1.1	1.135	1.288	.4955	.2455	6.1	2.018	4.074
.8710	.7586	1.2	1.148	1.318	.4898	.2399	6.2	2.042	4.169
.8610	.7413	1.3	1.161	1.349	.4842	.2344	6.3	2.065	4.266
.8511	.7244	1.4	1.175	1.380	.4786	.2291	6.4	2.089	4.365
.8414	.7079	1.5	1.189	1.413	.4732	.2239	6.5	2.113	4.467
.8318	.6918	1.6	1.202	1.445	.4677	.2188	6.6	2.138	4.571
.8222	.6761	1.7	1.216	1.479	.4624	.2138	6.7	2.163	4.677
.8128	.6607	1.8	1.230	1.514	.4571	.2089	6.8	2.188	4.786
.8035	.6457	1.9	1.245	1.549	.4519	.2042	6.9	2.213	4.898
.7943	.6310	2.0	1.259	1.585	.4467	.1995	7.0	2.239	5.012
.7852	.6166	2.1	1.274	1.622	.4416	.1950	7.1	2.265	5.129
.7762	.6026	2.2	1.288	1.660	.4365	.1905	7.2	2.291	5.248
.7674	.5888	2.3	1.303	1.698	.4315	.1862	7.3	2.317	5.370
.7586	.5754	2.4	1.318	1.738	.4266	.1820	7.4	2.344	5.495
.7499	.5623	2.5	1.334	1.778	.4217	.1778	7.5	2.371	5.623
.7413	.5495	2.6	1.349	1.820	.4169	.1738	7.6	2.399	5.754
.7328	.5370	2.7	1.365	1.862	.4121	.1698	7.7	2.427	5.888
.7244	.5248	2.8	1.380	1.905	.4074	.1660	7.8	2.455	6.026
.7161	.5129	2.9	1.396	1.950	.4027	.1622	7.9	2.483	6.166
.7079	.5012	3.0	1.413	1.995	.3981	.1585	8.0	2.512	6.310
.6998	.4898	3.1	1.429	2.042	.3936	.1549	8.1	2.541	6.457
.6918	.4786	3.2	1.445	2.089	.3890	.1514	8.2	2.570	6.607
.6839	.4677	3.3	1.462	2.138	.3846	.1479	8.3	2.600	6.761
.6761	.4571	3.4	1.479	2.188	.3802	.1445	8.4	2.630	6.918
.6683	.4467	3.5	1.496	2.239	.3758	.1413	8.5	2.661	7.079
.6607	.4365	3.6	1.514	2.291	.3715	.1380	8.6	2.692	7.244
.6531	.4266	3.7	1.531	2.344	.3673	.1349	8.7	2.723	7.413
.6457	.4169	3.8	1.549	2.399	.3631	.1318	8.8	2.754	7.586
.6383	.4074	3.9	1.567	2.455	.3589	.1288	8.9	2.786	7.762
.6310	.3981	4.0	1.585	2.512	.3548	.1259	9.0	2.818	7.943
.6237	.3890	4.1	1.603	2.570	.3508	.1230	9.1	2.851	8.128
.6166	.3802	4.2	1.622	2.630	.3467	.1202	9.2	2.884	8.318
.6095	.3715	4.3	1.641	2.692	.3428	.1175	9.3	2.917	8.511
.6026	.3631	4.4	1.660	2.754	.3388	.1148	9.4	2.951	8.710
.5957	.3548	4.5	1.679	2.818	.3350	.1122	9.5	2.985	8.913
.5888	.3467	4.6	1.698	2.884	.3311	.1096	9.6	3.020	9.120
.5821	.3388	4.7	1.718	2.951	.3273	.1072	9.7	3.055	9.333
.5754	.3311	4.8	1.738	3.020	.3236	.1047	9.8	3.090	9.550
.5689	.3236	4.9	1.758	3.090	.3199	.1023	9.9	3.126	9.772

## FINDING POWER AND VOLTAGE/CURRENT WHEN DECIBELS ARE KNOWN (Continued)

Voltage Ratio	Power Ratio	-db+	Voltage Ratio	Power Ratio	Voltage Ratio	Power Ratio	-db+	Voltage Ratio	Power Ratio
.3612	.1000	10.0	3.162	10.000	.1778	.03162	15.0	5.623	31.62
.3126	.09772	10.1	3.199	10.23	.1758	.03090	15.1	5.689	32.36
.3090	.09550	10.2	3.236	10.47	.1738	.03020	15.2	5.754	33.11
.3055	.09333	10.3	3.273	10.72	.1718	.02951	15.3	5.821	33.88
.3020	.09120	10.4	3.311	10.96	.1698	.02884	15.4	5.888	34.67
.2985	.08913	10.5	3.350	11.22	.1679	.02818	15.5	5.957	35.48
.2951	.08710	10.6	3.388	11.48	.1660	.02754	15.6	6.026	36.31
.2917	.08511	10.7	3.428	11.75	.1641	.02692	15.7	6.095	37.15
.2884	.08318	10.8	3.467	12.02	.1622	.02630	15.8	6.166	38.02
.2851	.08128	10.9	3.508	12.30	.1603	.02570	15.9	6.237	38.90
.2818	.07943	11.0	3.548	12.59	.1585	.02512	16.0	6.310	39.81
.2786	.07762	11.1	3.589	12.88	.1567	.02455	16.1	6.383	40.74
.2754	.07586	11.2	3.631	13.18	.1549	.02399	16.2	6.457	41.69
.2723	.07413	11.3	3.673	13.49	.1531	.02344	16.3	6.531	42.66
.2692	.07244	11.4	3.715	13.80	.1514	.02291	16.4	6.607	43.65
.2661	.07079	11.5	3.758	14.13	.1496	.02239	16.5	6.683	44.67
.2630	.06918	11.6	3.802	14.45	.1479	.02188	16.6	6.761	45.71
.2600	.06761	11.7	3.846	14.79	.1462	.02138	16.7	6.839	46.77
.2570	.06607	11.8	3.890	15.14	.1445	.02089	16.8	6.918	47.86
.2541	.06457	11.9	3.936	15.49	.1429	.02042	16.9	6.998	48.98
.2512	.06310	12.0	3.981	15.85	.1413	.01995	17.0	7.079	50.12
.2483	.06166	12.1	4.027	16.22	.1396	.01950	17.1	7.161	51.29
.2455	.06026	12.2	4.074	16.60	.1380	.01905	17.2	7.244	52.48
.2427	.05888	12.3	4.121	16.98	.1365	.01862	17.3	7.328	53.70
.2399	.05754	12.4	4.169	17.38	.1349	.01820	17.4	7.413	54.95
.2371	.05623	12.5	4.217	17.78	.1334	.01778	17.5	7.499	56.23
.2344	.05495	12.6	4.266	18.20	.1318	.01738	17.6	7.586	57.54
.2317	.05370	12.7	4.315	18.62	.1303	.01698	17.7	7.674	58.88
.2291	.05248	12.8	4.365	19.05	.1288	.01660	17.8	7.762	60.26
.2265	.05129	12.9	4.416	19.50	.1274	.01622	17.9	7.852	61.66
.2239	.05012	13.0	4.467	19.95	.1259	.01585	18.0	7.943	63.10
.2213	.04898	13.1	4.519	20.42	.1245	.01549	18.1	8.035	64.57
.2188	.04786	13.2	4.571	20.89	.1230	.01514	18.2	8.128	66.07
.2163	.04677	13.3	4.624	21.38	.1216	.01479	18.3	8.222	67.61
.2138	.04571	13.4	4.677	21.88	.1202	.01445	18.4	8.318	69.18
.2113	.04467	13.5	4.732	22.39	.1189	.01413	18.5	8.414	70.79
.2089	.04365	13.6	4.786	22.91	.1175	.01380	18.6	8.511	72.44
.2065	.04266	13.7	4.842	23.44	.1161	.01349	18.7	8.610	74.13
.2042	.04169	13.8	4.898	23.99	.1148	.01318	18.8	8.710	75.86
.2018	.04074	13.9	4.955	24.55	.1135	.01288	18.9	8.811	77.62
.1995	.03981	14.0	5.012	25.12	.1122	.01259	19.0	8.913	79.43
.1972	.03890	14.1	5.070	25.70	.1109	.01230	19.1	9.016	81.28
.1950	.03802	14.2	5.129	26.30	.1096	.01202	19.2	9.120	83.18
.1928	.03715	14.3	5.188	26.92	.1084	.01175	19.3	9.226	85.11
.1905	.03631	14.4	5.248	27.54	.1072	.01148	19.4	9.333	87.10
.1884	.03548	14.5	5.309	28.18	.1059	.01122	19.5	9.441	89.13
.1862	.03467	14.6	5.370	28.84	.1047	.01096	19.6	9.550	91.20
.1841	.03388	14.7	5.433	29.51	.1035	.01072	19.7	9.661	93.33
.1820	.03311	14.8	5.495	30.20	.1023	.01047	19.8	9.772	95.50
.1799	.03236	14.9	5.559	30.90	.1012	.01023	19.9	9.886	97.72
					.1000	.01000	20.0	10.000	100.00

FINDING DECIBELS WHEN VOLTAGE/CURRENT RATIO IS KNOWN

Voltage Ratio	.00	.01	.02	.03	.04	.05	.06	.07	.08	.09
1.0	.000	.086	.172	.257	.341	.424	.506	.588	.668	.749
1.1	.828	.906	.984	1.062	1.138	1.214	1.289	1.364	1.438	1.511
1.2	1.584	1.656	1.727	1.798	1.868	1.938	2.007	2.076	2.144	2.212
1.3	2.279	2.345	2.411	2.477	2.542	2.607	2.671	2.734	2.798	2.860
1.4	2.923	2.984	3.046	3.107	3.167	3.227	3.287	3.346	3.405	3.464
1.5	3.522	3.580	3.637	3.694	3.750	3.807	3.862	3.918	3.973	4.028
1.6	4.082	4.137	4.190	4.244	4.297	4.350	4.402	4.454	4.506	4.558
1.7	4.609	4.660	4.711	4.761	4.811	4.861	4.910	4.959	5.008	5.057
1.8	5.105	5.154	5.201	5.249	5.296	5.343	5.390	5.437	5.483	5.529
1.9	5.575	5.621	5.666	5.711	5.756	5.801	5.845	5.889	5.933	5.977
2.0	6.021	6.064	6.107	6.150	6.193	6.235	6.277	6.319	6.361	6.403
2.1	6.444	6.486	6.527	6.568	6.608	6.649	6.689	6.729	6.769	6.809
2.2	6.848	6.888	6.927	6.966	7.008	7.044	7.082	7.121	7.159	7.197
2.3	7.235	7.272	7.310	7.347	7.384	7.421	7.458	7.495	7.532	7.568
2.4	7.604	7.640	7.676	7.712	7.748	7.783	7.819	7.854	7.889	7.924
2.5	7.959	7.993	8.028	8.062	8.097	8.131	8.165	8.199	8.232	8.266
2.6	8.299	8.333	8.366	8.399	8.432	8.465	8.498	8.530	8.563	8.595
2.7	8.627	8.659	8.691	8.723	8.755	8.787	8.818	8.850	8.881	8.912
2.8	8.943	8.974	9.005	9.036	9.066	9.097	9.127	9.158	9.188	9.218
2.9	9.248	9.278	9.308	9.337	9.367	9.396	9.426	9.455	9.484	9.513
3.0	9.542	9.571	9.600	9.629	9.657	9.686	9.714	9.743	9.771	9.799
3.1	9.827	9.855	9.883	9.911	9.939	9.966	9.994	10.021	10.049	10.076
3.2	10.103	10.130	10.157	10.184	10.211	10.238	10.264	10.291	10.317	10.344
3.3	10.370	10.397	10.423	10.449	10.475	10.501	10.527	10.553	10.578	10.604
3.4	10.630	10.655	10.681	10.706	10.731	10.756	10.782	10.807	10.832	10.857
3.5	10.881	10.906	10.931	10.955	10.980	11.005	11.029	11.053	11.078	11.102
3.6	11.126	11.150	11.174	11.198	11.222	11.246	11.270	11.293	11.317	11.341
3.7	11.364	11.387	11.411	11.434	11.457	11.481	11.504	11.527	11.550	11.573
3.8	11.596	11.618	11.641	11.664	11.687	11.709	11.732	11.754	11.777	11.799
3.9	11.821	11.844	11.866	11.888	11.910	11.932	11.954	11.976	11.998	12.019
4.0	12.041	12.063	12.085	12.106	12.128	12.149	12.171	12.192	12.213	12.234
4.1	12.256	12.277	12.298	12.319	12.340	12.361	12.382	12.403	12.424	12.444
4.2	12.465	12.486	12.506	12.527	12.547	12.568	12.588	12.609	12.629	12.649
4.3	12.669	12.690	12.710	12.730	12.750	12.770	12.790	12.810	12.829	12.849
4.4	12.869	12.889	12.908	12.928	12.948	12.967	12.987	13.006	13.026	13.045
4.5	13.064	13.084	13.103	13.122	13.141	13.160	13.179	13.198	13.217	13.236
4.6	13.255	13.274	13.293	13.312	13.330	13.349	13.368	13.386	13.405	13.423
4.7	13.442	13.460	13.479	13.497	13.516	13.534	13.552	13.570	13.589	13.607
4.8	13.625	13.643	13.661	13.679	13.697	13.715	13.733	13.751	13.768	13.786
4.9	13.804	13.822	13.839	13.857	13.875	13.892	13.910	13.927	13.945	13.962
5.0	13.979	13.997	14.014	14.031	14.049	14.066	14.083	14.100	14.117	14.134
5.1	14.151	14.168	14.185	14.202	14.219	14.236	14.253	14.270	14.287	14.303
5.2	14.320	14.337	14.353	14.370	14.387	14.403	14.420	14.436	14.453	14.469
5.3	14.486	14.502	14.518	14.535	14.551	14.567	14.583	14.599	14.616	14.632
5.4	14.648	14.664	14.680	14.696	14.712	14.728	14.744	14.760	14.776	14.791
5.5	14.807	14.823	14.839	14.855	14.870	14.886	14.902	14.917	14.933	14.948
5.6	14.964	14.979	14.995	15.010	15.026	15.041	15.056	15.072	15.087	15.102
5.7	15.117	15.133	15.148	15.163	15.178	15.193	15.208	15.224	15.239	15.254
5.8	15.269	15.284	15.298	15.313	15.328	15.343	15.358	15.373	15.388	15.402
5.9	15.417	15.432	15.446	15.461	15.476	15.490	15.505	15.519	15.534	15.549
6.0	15.563	15.577	15.592	15.606	15.621	15.635	15.649	15.664	15.678	15.692
6.1	15.707	15.721	15.735	15.749	15.763	15.778	15.792	15.806	15.820	15.834
6.2	15.848	15.862	15.876	15.890	15.904	15.918	15.931	15.945	15.959	15.973
6.3	15.987	16.001	16.014	16.028	16.042	16.055	16.069	16.083	16.096	16.110
6.4	16.124	16.137	16.151	16.164	16.178	16.191	16.205	16.218	16.232	16.245

## FINDING DECIBELS WHEN VOLTAGE/CURRENT RATIO IS KNOWN (Continued)

Voltage Ratio	.00	.01	.02	.03	.04	.05	.06	.07	.08	.09
6.5	16.258	16.272	16.285	16.298	16.312	16.325	16.338	16.351	16.365	16.378
6.6	16.391	16.404	16.417	16.430	16.443	16.456	16.469	16.483	16.496	16.509
6.7	16.521	16.534	16.547	16.560	16.573	16.586	16.599	16.612	16.625	16.637
6.8	16.650	16.663	16.676	16.688	16.701	16.714	16.726	16.739	16.752	16.764
6.9	16.777	16.790	16.802	16.815	16.827	16.840	16.852	16.865	16.877	16.890
7.0	16.902	16.914	16.927	16.939	16.951	16.964	16.976	16.988	17.001	17.013
7.1	17.025	17.037	17.050	17.062	17.074	17.086	17.098	17.110	17.122	17.135
7.2	17.147	17.159	17.171	17.183	17.195	17.207	17.219	17.231	17.243	17.255
7.3	17.266	17.278	17.290	17.302	17.314	17.326	17.338	17.349	17.361	17.373
7.4	17.385	17.396	17.408	17.420	17.431	17.443	17.455	17.466	17.478	17.490
7.5	17.501	17.513	17.524	17.536	17.547	17.559	17.570	17.582	17.593	17.605
7.6	17.616	17.628	17.639	17.650	17.662	17.673	17.685	17.696	17.707	17.719
7.7	17.730	17.741	17.752	17.764	17.775	17.786	17.797	17.808	17.820	17.831
7.8	17.842	17.853	17.864	17.875	17.886	17.897	17.908	17.919	17.931	17.942
7.9	17.953	17.964	17.975	17.985	17.996	18.007	18.018	18.029	18.040	18.051
8.0	18.062	18.073	18.083	18.094	18.105	18.116	18.127	18.137	18.148	18.159
8.1	18.170	18.180	18.191	18.202	18.212	18.223	18.234	18.244	18.255	18.266
8.2	18.276	18.287	18.297	18.308	18.319	18.329	18.340	18.350	18.361	18.371
8.3	18.382	18.392	18.402	18.413	18.423	18.434	18.444	18.455	18.465	18.475
8.4	18.486	18.496	18.506	18.517	18.527	18.537	18.547	18.558	18.568	18.578
8.5	18.588	18.599	18.609	18.619	18.629	18.639	18.649	18.660	18.670	18.680
8.6	18.690	18.700	18.710	18.720	18.730	18.740	18.750	18.760	18.770	18.780
8.7	18.790	18.800	18.810	18.820	18.830	18.840	18.850	18.860	18.870	18.880
8.8	18.890	18.900	18.909	18.919	18.929	18.939	18.949	18.958	18.968	18.978
8.9	18.988	18.998	19.007	19.017	19.027	19.036	19.046	19.056	19.066	19.075
9.0	19.085	19.094	19.104	19.114	19.123	19.133	19.143	19.152	19.162	19.171
9.1	19.181	19.190	19.200	19.209	19.219	19.228	19.238	19.247	19.257	19.266
9.2	19.276	19.285	19.295	19.304	19.313	19.323	19.332	19.342	19.351	19.360
9.3	19.370	19.379	19.388	19.398	19.407	19.416	19.426	19.435	19.444	19.453
9.4	19.463	19.472	19.481	19.490	19.499	19.509	19.518	19.527	19.536	19.545
9.5	19.554	19.564	19.573	19.582	19.591	19.600	19.609	19.618	19.627	19.636
9.6	19.645	19.654	19.664	19.673	19.682	19.691	19.700	19.709	19.718	19.726
9.7	19.735	19.744	19.753	19.762	19.771	19.780	19.789	19.798	19.807	19.816
9.8	19.825	19.833	19.842	19.851	19.860	19.869	19.878	19.886	19.895	19.904
9.9	19.913	19.921	19.930	19.939	19.948	19.956	19.965	19.974	19.983	19.991

Voltage Ratio	0	1	2	3	4	5	6	7	8	9
10	20.000	20.828	21.584	22.279	22.923	23.522	24.082	24.609	25.105	25.575
20	26.021	26.444	26.848	27.235	27.604	27.959	28.299	28.627	28.943	29.248
30	29.542	29.827	30.103	30.370	30.630	30.881	31.126	31.364	31.596	31.821
40	32.041	32.256	32.465	32.669	32.869	33.064	33.255	33.442	33.625	33.804
50	33.979	34.151	34.320	34.486	34.648	34.807	34.964	35.117	35.269	35.417
60	35.563	35.707	35.848	35.987	36.124	36.258	36.391	36.521	36.650	36.777
70	36.902	37.025	37.147	37.266	37.385	37.501	37.616	37.730	37.842	37.953
80	38.062	38.170	38.276	38.382	38.486	38.588	38.690	38.790	38.890	38.988
90	39.085	39.181	39.276	39.370	39.463	39.554	39.645	39.735	39.825	39.913
100	40.000	—	—	—	—	—	—	—	—	—



**Distance in Miles From an FM Transmitter to  
Its 54 dbu (0.5 mv/m) Contour For Various Heights and Powers**

AHAAT in Ft.	Power in dbk																				
	-20	-18	-16	-14	-12	-10	-8	-6	-4	-2	0	2	4	6	8	10	12	14	16	18	20
3400	20	23	26.5	30	34	38	42	47.5	51.5	55	60	65	69.5	73	78	82	87	91.5	95	100	113.5
3200	19	22	25	29	32.5	37	40.5	45	50	53.5	58.5	63	67	71	75	80	85	90	93	97	100.5
3000	18.5	21.5	24.5	28	31.5	35	40	43	48	52	56.5	60.5	65	69.5	73	77.5	82	86.5	91.5	95	98.5
2800	18	20.5	23	27	30	33.5	38	42	45.5	50	54.5	58.5	63	67	71	75	80	84	89	93	96
2600	17.5	20	22	25.5	29	32	36	40	44.5	48.5	52	56	60	65	69	73	77	81.5	85.5	90	94
2400	17	19	21.5	24.5	28	31	35	38.5	42	46	50.5	54.5	58.5	62	67	70.5	75	78.7	83	88	92
2200	16	18.2	20	23	26.5	29	32.5	36.5	40	44.5	48	52	55.5	60	65	68	72	76.5	80	85	90
2000	15	17.4	19	22	25	28	31	35	38	42	45.5	50	53	57	61.5	65	69.5	73.7	78	82	86
1900	15	17	18.5	21.5	24.5	27	30	33.5	37.5	40.5	45	48.5	52	55.5	60	64	68	72	76	80	85
1800	14	16	18	20.5	23	26.5	29	32.5	36	40	43	47.5	51	55	58.5	62.5	66	70	75	79	83
1700	13.5	15.5	17.5	20	22.5	25	28	31.5	35	38	42	45.5	50	53	57	60.5	65	69	71.5	77	81
1600	13	15	17	19	21.5	24.5	27	30	33	36.5	40.5	44	48	52	55.5	60	63	67	71	75	80
1500	12.5	14.6	16.5	18.5	21	23.5	26.5	28.5	32	35.5	39.5	43	46.5	50	54.5	58	61.5	65	69.5	73	78
1400	12	14	16	18	20	22	25	28	30.5	34.5	38	41.5	45	48.5	52.5	56	60	63	67	71.5	75
1300	11.5	13.4	15.5	17	19	21.5	23.5	27	30	32.5	36	40	43	47	50.5	55	58	61.5	65	70	73.5
1200	11	13	14.5	16.5	18.5	20.5	23	25.5	28	31	35	38	41.7	45	48.5	52.5	56	60	63	67	71.5
1100	10	12	13.5	15.5	17.5	19.5	21.5	24.5	26.5	30	33	36.5	40	43	47	50.5	54.5	58	61.5	65	70
1000	9.1	11.5	13	15	17	18.5	20.5	23	25.5	28	31.2	34.5	38	41	45	48	52	56	58.5	63	68
900	8.7	10.5	12	14	16	18	19.5	21.5	24.5	27	29.6	32.5	35.5	38.5	42.5	46	50	54	57	60.5	65
800	8.2	9.2	11.5	13	15	16.5	18	20	22	25	28	30.5	33.5	37	40	43	47.5	52	55	58.5	63.5
700	7.7	8.7	10.5	12	13.5	15.5	17	18.5	21	23	26	28.5	32	35	38	41	45	49	53	56.5	63
600	7.2	8	9	11	12	14	15.5	17.5	19	21.5	24	26.5	28.7	32	35	38	42	45.5	50	55	60
500	6.5	7.3	8.2	9	11	12.5	14	16	17.5	19	22	24	27	29	32.5	35.5	38.5	43	47	52	57
400	5.8	6.6	7.3	8.3	8.5	11	12.5	14	16	17.5	19	22	24.5	27	29.5	32	35.5	40	43.5	49.5	55
300	5	5.7	6.5	7.2	8	8.7	10.5	12	13.5	15	17	18.5	21	23.5	26.5	28.5	32	35.5	40	45.4	52
200	4	4.6	5.2	5.7	6.5	7.3	8.2	9	11	12	13.7	15.5	17.5	19	22	24.5	28	31.5	35	42	48
100	2.8	3.2	3.7	4.1	4.6	5.2	5.8	6.6	7.4	8.2	9	10.7	12.5	14	16	18.2	21.5	25	30	35.5	45

# Distance in Miles From an FM Transmitter to Its 60 dbu (1 Mv/m) Contour For Various Heights and Powers

AHAAT in Ft.	Power in dbk																				
	-20	-18	-16	-14	-12	-10	-8	-6	-4	-2	0	2	4	6	8	10	12	14	16	18	20
3400	11	13	15	17.5	20	22.5	27	30	34	37	40.5	45	49	52	57	60	64	65	65	65	65
3200	11	12.2	14.5	16.5	19.5	22	25	28.5	32	35	39	42.5	47	50.5	55	59	62	64	65	65	65
3000	10.5	12	14	16	19	21.5	24.5	28	31	34	38	41	45	49.5	53	57	60	64	65	65	65
2800	10	11.8	13.5	15.7	18	20.5	24	26.5	30	33	36	40	44	48	51	55	59	62	64	65	65
2600	9.7	11.5	13	15	17	20	22.5	25.5	29	32	35	39	42	46	49.5	53	58	60	63	64	65
2400	9.4	11	12.8	14	16	19	21.5	24.5	28	30.5	34	37	40	44	47.5	51	55	59	61	64	65
2200	9.2	10.8	12	13.5	15.5	18	20.5	23.5	26	29	32	35	39	42	45.5	49	52	56.5	59.5	62	65
2000	9	10.2	11.7	13.1	15	17	20	22	25	28	30	33.5	37	40	44	46.5	50.5	54	57.5	60.5	64
1900	8.7	10	11.2	12.7	14.5	16.5	19	21.5	24.5	27	29.5	33	35.5	39	43.5	45.5	49.5	52.5	55.5	59.5	62
1800	8.5	9.7	11	12.6	14	16	18	20.5	23.5	25.5	29	31.5	35	38.5	43	44.5	48.5	51.5	55	59	61
1700	8.3	9.2	10.5	11.6	13.8	15.5	17.3	20	22.5	25	28	30	33	37	40	43	46.5	50	53	57.5	60
1600	8.1	9	10.3	11.5	13.2	15	17.1	19.2	21.5	24	26.5	29.5	32.5	35.5	39	42	45	49	51.5	55	58
1500	8	9	10	11.4	13	14.9	16.9	18.6	21	23	26	28.5	31.5	35	38	40.5	44	47	50.1	54	57
1400	7.5	8.6	9.7	11.2	12.5	14	16.2	18	20	22	25	27.5	30	33	36	40	43	46	48.5	52	55
1300	7.3	8.2	9.3	10.5	12	13.8	15.5	17.5	19	21.5	24	26.5	29	32.5	35	39	41.5	45	47.5	51	54
1200	7	7.8	9	10	11.5	13	15	17	18	21	23	25.5	28	31	34	37.5	40	44	46	49	52
1100	6.8	7.6	8.5	9.5	11	12.5	14.5	16	17.1	20	22	24.5	26.5	29.5	32	35	38	41	44.5	47	50
1000	6.4	7.2	8	9	10.2	12	14	15.6	17	19	21	23	25.5	28	31	34	36.5	40	43	45.5	49
900	6.2	6.8	7.8	8.8	9.7	11.2	13	14.5	16.4	18	20	21	24.5	26	29	32	35	38	40.5	44	47
800	5.8	6.6	7.3	8.2	9.2	10.3	12	13.5	15.2	17	18.5	20.5	23	25	27.5	30	33	36	39	41.5	45
700	5.4	6.2	7	7.8	8.6	9.7	10.5	13	14	16	17	19.2	21	24	26	28.5	31	33	36	39	42
600	5	5.7	6.5	7.1	8	9	9.8	11.8	12.3	14.5	16	18	19.7	21.5	24	26	29	32	35	36.5	40
500	4.6	5	5.8	6.6	7.3	8.2	9	10	12	13.2	14.5	16.1	17.9	20	22	24.5	27	29.5	31.5	35	37
450	4.2	4.8	5.5	6.2	7.0	7.8	8.6	9.6	10.5	12.5	14.0	15.2	17.0	19.0	20.5	23.0	25.4	28	30	33	36
400	4	4.6	5.1	5.9	6.6	7.4	8.2	9	10	11.8	12.5	14.5	16	17.8	19.8	21.5	24.5	26.5	29	31.5	35
350	3.8	4.2	4.8	5.3	6.1	7.0	7.8	8.6	9.5	10.3	11.0	14.0	15	16.8	18.5	20.2	23	25	27.5	30	33
300	3.6	4	4.5	5	5.7	6.3	7.2	8	8.8	10	10.5	12.6	14	15.6	17	19	21	23	25.5	28	30
250	3.2	3.7	4.0	4.6	5.1	5.9	6.7	7.3	8.0	8.9	9.9	10.6	12.5	14.0	15.8	17.8	19	21.5	24	26	28
200	2.9	3.3	3.7	4.1	4.7	5.1	5.9	6.6	7.4	8.1	9	10	11.3	12.5	14	15.5	17.5	19.5	21.5	24	26
150	2.5	2.8	3.2	3.6	4.0	4.5	5.0	5.7	6.4	7.1	7.9	8.8	9.7	10.8	12	14.0	15.2	17.0	19	21	24
100	2	2.3	2.7	2.9	3.2	3.8	4.1	4.7	5.2	5.9	6.5	7.4	8.3	9	10	11.3	12.9	14.5	16.2	18.1	20

**Distance in Miles From an FM Transmitter to  
Its 80 dbu (10 mv/m) Contour For Various Heights and Powers**

AHAAT in Ft.	Power in dbk																				
	-20	-18	-16	-14	-12	-10	-8	-6	-4	-2	0	2	4	6	8	10	12	14	16	18	20
3400	1.3	1.8	2.1	2.6	3.2	4.0	4.8	6.0	7.3	9	12.5	15	18	20	23	26.5	30	34	38	42	46.5
3200	1.3	1.8	2.1	2.6	3.2	4.0	4.8	6.0	7.3	8.8	12	15	17	19	22	25	29	32.5	36.5	40.5	45
3000	1.3	1.8	2.1	2.6	3.2	4.0	4.8	6.0	7.1	8.5	11.5	14.5	17	18.5	21.5	24.5	28	31.5	35	40	43
2800	1.3	1.8	2.1	2.5	3.2	4.0	4.8	5.9	7.1	8.4	11.3	14	16	18	20	23	26.5	30	34	38	41.5
2600	1.3	1.8	2.1	2.5	3.2	4.0	4.7	5.8	7.0	8.1	11	13	15.5	17.5	19.6	22	25.5	29	32	35.5	40
2400	1.3	1.8	2.1	2.5	3.2	3.9	4.7	5.7	7.0	8.1	10.5	12.5	15	17	19	21.5	24.5	27.5	30.5	35	38.5
2200	1.3	1.8	2.1	2.5	3.2	3.8	4.7	5.6	6.8	8	10	12	14.5	16.5	18	20	23	26.5	29.5	32.5	36.5
2000	1.3	1.8	2.0	2.5	3.1	3.8	4.6	5.4	6.7	7.8	9	11.5	13.5	15	17.5	19.5	21.5	25	28	31	35
1900	1.3	1.8	2.0	2.5	3.0	3.7	4.6	5.3	6.6	7.7	9	11	13	14.8	17	19	21	24.5	27	30	34
1800	1.3	1.8	2.0	2.5	3.0	3.7	4.5	5.3	6.3	7.6	8.7	10.5	12.5	14.5	16.5	18.5	20.5	23	26	29	32.5
1700	1.3	1.8	2.0	2.4	2.9	3.6	4.4	5.2	6.1	7.3	8.4	10	12	14	15.5	18	20	22	25	28	31
1600	1.2	1.7	2.0	2.3	2.9	3.6	4.3	5.1	6	7.0	8.1	9.2	11.8	13.5	15	17.5	19	21.5	24.5	27	30
1500	1.2	1.7	2.0	2.3	2.8	3.6	4.2	5.0	5.9	7.0	8.0	9.0	11	13	14.5	17	18.5	20.5	23	26	29
1400	1.2	1.7	1.9	2.3	2.8	3.5	4.2	5.0	5.7	6.7	7.7	8.7	10.5	12	14	16	18	20	22	25	28
1300	1.2	1.7	1.9	2.2	2.7	3.4	4.1	4.8	5.6	6.4	7.4	8.3	10	11.5	13	15	17	19	21.5	24	26.5
1200	1.2	1.7	1.8	2.2	2.7	3.3	4.0	4.7	5.4	6.2	7.1	8	9.2	11	12.5	14.5	16.5	18	20.5	23	25.5
1100	1.2	1.7	1.8	2.2	2.7	3.2	3.9	4.6	5.2	6	6.8	7.8	8.7	10.2	11.5	14	15.5	17.5	19.5	22	24.5
1000	1.2	1.6	1.8	2.2	2.6	3.1	3.8	4.4	5	5.8	6.4	7.2	8.2	9.2	11	13	15	17	18.5	20.5	23
900	1.2	1.6	1.7	2.1	2.6	3	3.7	4.2	4.8	5.6	6.2	7.0	7.8	8.8	10.5	12	14	16	18	19	22
800	1.2	1.5	1.7	2.1	2.5	2.9	3.4	3.9	4.6	5.1	6.0	6.7	7.4	8.3	9.3	11.5	13	15	16.5	18	20
700	1.2	1.5	1.7	2.0	2.4	2.8	3.2	3.7	4.2	4.8	5.5	6.3	7.0	7.8	8.8	10	12	13.5	15.5	17	18.5
600	1.2	1.4	1.7	1.9	2.3	2.7	3.0	3.4	3.8	4.5	5.0	5.8	6.5	7.2	8	9.0	10.5	12.5	14	15.5	17.5
500	1.1	1.4	1.6	1.8	2.1	2.5	2.8	3.2	3.6	4	4.6	5.2	6	6.7	7.5	8.2	9.2	11	12.5	14.5	15.5
400	1.0	1.3	1.5	1.7	2.0	2.2	2.6	2.8	3.2	3.7	4.1	4.7	5.2	6.0	6.7	7.5	8.2	9.1	11	12.5	14.5
300	0.9	1.2	1.3	1.5	1.8	1.9	2.2	2.6	2.8	3.2	3.6	4	4.5	5.0	5.8	6.2	7.2	7.8	8.9	10.5	12
200	0.8	1.0	1.2	1.3	1.5	1.7	1.8	2	2.3	2.6	3.0	3.3	3.8	4.2	4.7	5.2	6.0	6.7	7.5	8.2	9.0
100	0.5	0.6	0.8	0.9	1.0	1.2	1.3	1.5	1.7	1.9	2.0	2.3	2.7	3.0	3.3	3.7	4.2	4.7	5.2	6.0	6.8

# CONVERSION TABLE FOR UNITS OF LENGTH

	ANGSTROMS	MICRONS	MILS	INCHES	FEET	MILES	MILLIMETERS	CENTIMETERS	KILOMETERS
MULTIPLY NUMBER OF BY TO OBTAIN NUMBER OF	1	$10^4$	$2.540 \times 10^5$	$2.540 \times 10^8$	$3.048 \times 10^9$	$1.609 \times 10^{13}$	$10^7$	$10^8$	$10^{13}$
ANGSTROMS									
	$10^{-4}$	1	$2.540 \times 10$	$2.540 \times 10^4$	$3.048 \times 10^5$	$1.609 \times 10^9$	$10^3$	$10^4$	$10^9$
MICRONS									
	$3.937 \times 10^{-6}$	$3.937 \times 10^{-2}$	1	$10^3$	$1.2 \times 10^4$	$6.336 \times 10^7$	$3.937 \times 10$	$3.937 \times 10^2$	$3.937 \times 10^7$
MILS									
	$3.937 \times 10^{-9}$	$3.937 \times 10^{-5}$	$10^{-3}$	1	12	$6.336 \times 10^4$	$3.937 \times 10^{-2}$	$3.937 \times 10^{-1}$	$3.937 \times 10^4$
INCHES									
	$3.281 \times 10^{-10}$	$3.281 \times 10^{-6}$	$8.333 \times 10^{-5}$	$8.333 \times 10^{-2}$	1	$5.280 \times 10^3$	$3.281 \times 10^{-3}$	$3.281 \times 10^{-2}$	$3.281 \times 10^3$
FEET									
	$6.214 \times 10^{-14}$	$6.214 \times 10^{-10}$	$1.578 \times 10^{-8}$	$1.578 \times 10^{-5}$	$1.894 \times 10^{-4}$	1	$6.214 \times 10^{-7}$	$6.214 \times 10^{-6}$	$6.214 \times 10^{-1}$
MILES									
	$10^{-7}$	$10^{-3}$	$2.540 \times 10^{-2}$	$2.540 \times 10$	$3.048 \times 10^2$	$1.609 \times 10^6$	1	10	$10^6$
MILLIMETERS									
	$10^{-8}$	$10^{-4}$	$2.540 \times 10^{-3}$	$2.540 \times 10$	$3.048 \times 10$	$1.609 \times 10^5$	0.1	1	$10^5$
CENTIMETERS									
	$10^{-13}$	$10^{-9}$	$2.540 \times 10^{-8}$	$2.540 \times 10^{-5}$	$3.048 \times 10^{-4}$	$1.609 \times 10^{-6}$	$10^{-6}$	$10^{-5}$	1
KILOMETERS									



**SYMBOLS AND PREFIXES**

ac	alternating current	ISO	International Standards Organization	uhf	ultra-high frequency
af	audio frequency	$j$	$\sqrt{-1}$	$v$	velocity
AFC	automatic frequency control	k	kilo ( $10^3$ )	va	voltampere
a-m	amplitude modulation	kg	kilogram	vhf	very high frequency
amp	ampere	kva	kilovolt ampere	vlf	very low frequency
ASA	American Standards Association	kw	kilowatt	vol	volume
ASTM	American Society for Testing Materials	$L$	inductance	vs	versus
AVC	automatic volume control	lab	laboratory	w	watt
ave	average	lb	pound	$X$	reactance
$B$	susceptance	LC	inductance-capacitance	$Y$	admittance
BCD	binary-coded decimal	lf	low frequency	$Z$	impedance
$C$	capacitance	log	logarithm	$\alpha$	short-circuit forward current-transfer ratio (common base)
C	Centigrade, degrees Centigrade	$m$	mass	$\beta$	short-circuit forward current-transfer ratio (common emitter)
cm	centimeter	m	meter; milli ( $10^{-3}$ )	L	reflection coefficient
COD	cash on delivery	ma	milliampere	$\Delta$	increment
cps	cycles per second	max	maximum	$\delta$	loss angle
cw	continuous wave	mbar	millibar	$\theta$	phase angle
$D$	dissipation factor	Mc	megacycles per second	$\lambda$	wavelength
db	decibel	mh	millihenry	$\mu$	micro- ( $10^{-6}$ )
dbm	decibel referred to one milliwatt	mil	0.001 inch	$\mu a$	microampere
dc	direct current	min	minimum; minute	$\mu bar$	microbar
$E$	voltage	mm	millimeter	$\mu f$	microfarad
EIA	Electronics Industries Association	mmho	millimho	$\mu h$	microhenry
emf	electromotive force	m $\Omega$	milliohm	$\mu sec$	microsecond
F	Fahrenheit, degrees Fahrenheit	M $\Omega$	megohm	$\mu v$	microvolt
f	farad	MM $\Omega$	megamegohm	$\Omega$	ohm
$f$	frequency	mv	millivolt	$\bar{O}$	mho
f <sub>m</sub>	frequency modulation	mw	milliwatt	$w$	angular velocity ( $2\pi f$ )
f.o.b.	free on board	n	nano ( $10^{-9}$ ); any number		
$G$	conductance	nsec	nanosecond		
$g$	gravitation constant	n $\bar{O}$	nanomho		
Gc	gigacycles per second	oz	ounce		
$g_m$	transconductance	p	parallel, as $L_p$		
h	henry	PF	power factor		
$h_f$	forward current-transfer ratio	pf	picofarad		
$h_i$	short-circuit input impedance	PH	hydrogen in concentration		
$h_o$	open-circuit output admittance	pp	push-pull; pages		
$h_r$	reverse voltage-transfer ratio	ppm	parts per million		
$I$	current	p-to-p	peak-to-peak		
IEC	International Electrotechnical Commission	prf	pulse repetition frequency		
IEEE	Institute of Electrical and Electronics Engineers	$Q$	quality factor		
i-f	intermediate frequency	$R$	resistance		
in.	inch	$\bar{r}$	registered trademark		
IRE	Institute of Radio Engineers	RC	resistance-capacitance referred to		
		rf	radio frequency		
		RH	relative humidity		
		rms	root-mean-square		
		rpm	revolutions per minute		
		s	series, as $L_s$		
		sec	second		
		sync	synchronous, synchronizing		
		$T$	period		
		t	temperature		
		$t$	time		

**PREFIXES**

Orders of magnitude from  $10^{12}$  to  $10^{-18}$  are designated by the following prefixes:

Order	Prefix	Symbol
$10^{12}$	tera	T
$10^9$	giga	G
$10^6$	mega	M
$10^3$	kilo	k
$10^2$	hecto	h
10	deka	da
$10^{-1}$	deci	d
$10^{-2}$	centi	c
$10^{-3}$	milli	m
$10^{-6}$	micro	$\mu$
$10^{-9}$	nano	n
$10^{-12}$	pico	p
$10^{-15}$	femto	f
$10^{-18}$	atto	a

## FREQUENCY DESIGNATION OF FM BROADCAST CHANNELS

Freq. (Mc):	Channel No.	Freq. (Mc):	Channel No.	Freq. (Mc):	Channel No.
88.1	201	94.9	235	101.5	268
88.3	202	95.1	236	101.7	269
88.5	203	95.3	237	101.9	270
88.7	204	95.5	238	102.1	271
88.9	205	95.7	239	102.3	272
89.1	206	95.9	240	102.5	273
89.3	207	96.1	241	102.7	274
89.5	208	96.3	242	102.9	275
89.7	209	96.5	243	103.1	276
89.9	210	96.7	244	103.3	277
90.1	211	96.9	245	103.5	278
90.3	212	97.1	246	103.7	279
90.5	213	97.3	247	103.9	280
90.7	214	97.5	248	104.1	281
90.9	215	97.7	249	104.3	282
91.1	216	97.9	250	104.5	283
91.3	217	98.1	251	104.7	284
91.5	218	98.3	252	104.9	285
91.7	219	98.5	253	105.1	286
91.9	220	98.7	254	105.3	287
92.1	221	98.9	255	105.5	288
92.3	222	99.1	256	105.7	289
92.5	223	99.3	257	105.9	290
92.7	224	99.5	258	106.1	291
92.9	225	99.7	259	106.3	292
93.1	226	99.9	260	106.5	293
93.3	227	100.1	261	106.7	294
93.5	228	100.3	262	106.9	295
93.7	229	100.5	263	107.1	296
93.9	230	100.7	264	107.3	297
94.1	231	100.9	265	107.5	298
94.3	232	101.1	266	107.7	299
94.5	233	101.3	267	107.9	300
94.7	234				

## CHANNELS AVAILABLE FOR ASSIGNMENT TO NONCOMMERCIAL EDUCATIONAL FM STATIONS

Freq. (Mc):	Channel No.	Freq. (Mc):	Channel No.	Freq. (Mc):	Channel No.
88.1	201	89.5	208	90.9	215
88.3	202	89.7	209	91.1	216
88.5	203	89.9	210	91.3	217
88.7	204	90.1	211	91.5	218
88.9	205	90.3	212	91.7	219
89.1 <sup>1</sup>	206	90.5	213	91.9	220
89.3	207	90.7	214		

<sup>1</sup> The frequency 89.1 Mc in the New York City metropolitan area is reserved for the use of the United Nations.

## CONVERT ELECTRICAL DEGREES TO FEET, OR VICE VERSA WHEN FREQUENCY AND EITHER FEET OR DEGREES IS KNOWN

From the expression

$$\text{Feet} = \frac{\text{degrees}}{360^\circ} \times \frac{300}{f(\text{Mc})} \times 3.281 = \text{degrees} \times \frac{2.734}{f(\text{Mc})}$$

The following ratio may be set up on the slide rule using C and D scales:

$$\frac{2.734}{f(\text{Mc})} = \frac{\text{feet}}{\text{degrees}}$$

Set 2.734 on scale C over frequency in megacycles on scale D; read feet and degrees on scales C and D, respectively. In some instances it may be convenient to use the folded scales CF and DF.

## METRIC CONVERSION

To convert pounds to kilograms,  
multiply by .4536  
To convert inches to centimeters,  
multiply by 2.54

## TELEPHONE CABLE COLOR CODE

Pair No.	Color	Mate
1	Blue	White
2	Orange	White
3	Green	White
4	Brown	White
5	Slate	White
6	Blue White	White
7	Blue Orange	White
8	Blue Green	White
9	Blue Brown	White
10	Blue Slate	White
11	Orange White	White
12	Orange Green	White
13	Orange Brown	White
14	Orange Slate	White
15	Green White	White
16	Green Brown	White
17	Green Slate	White
18	Brown White	White
19	Brown Slate	White
20	Slate White	White
21	Blue	Red
22	Orange	Red
23	Green	Red
24	Brown	Red
25	Slate	Red
26	Blue White	Red
27	Blue Orange	Red
28	Blue Green	Red
29	Blue Brown	Red
30	Blue Slate	Red
31	Orange White	Red
32	Orange Green	Red
33	Orange Brown	Red
34	Orange Slate	Red
35	Green White	Red
36	Green Brown	Red
37	Green Slate	Red
38	Brown White	Red
39	Brown Slate	Red
40	Slate White	Red
41	Blue	Black
42	Orange	Black
43	Green	Black
44	Brown	Black
45	Slate	Black
46	Blue White	Black
47	Blue Orange	Black
48	Blue Green	Black
49	Blue Brown	Black
50	Blue Slate	Black

NOTE—The last pair in all cables is a Red with White mate, viz.

6-pair cable	6th pair	Red	White
11-pair cable	11th pair	Red	White
16-pair cable	16th pair	Red	White
26-pair cable	26th pair	Red	White
51-pair cable	51st pair	Red	White

FORWARD VS. REFLECTED POWER

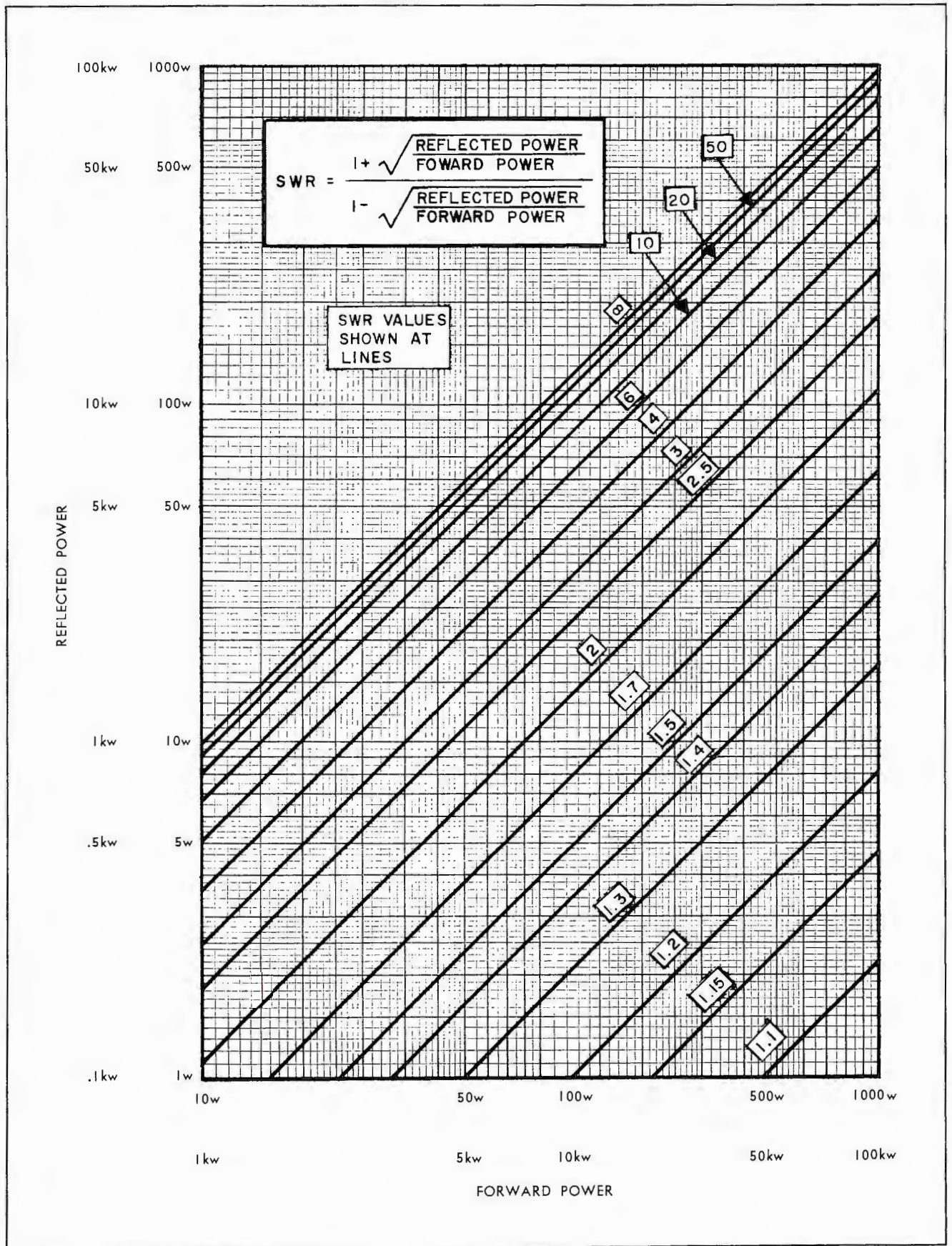

# ATTENUATOR NETWORK

Input and Output  $Z_0 = 600$  ohms

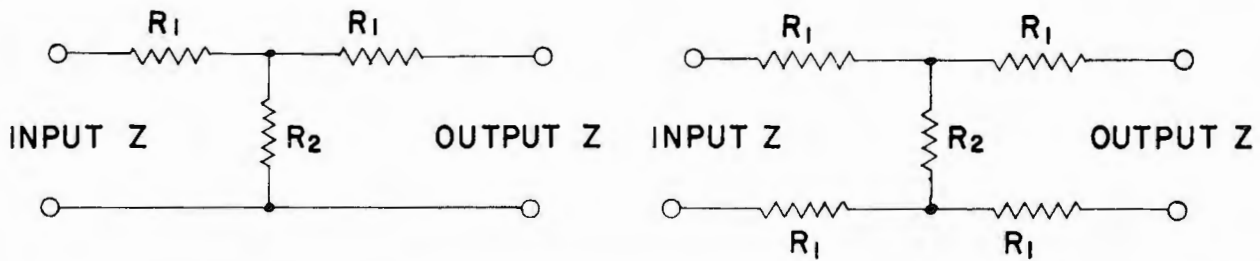

DB LOSS	$R_1$	$R_2$	DB LOSS	$R_1$	$R_2$	DB LOSS	$R_1$	$R_2$	DB LOSS	$R_1$	$R_2$
0.5	17.2	10464	16	435.8	195.1	0.5	8.6	10464	16	217.9	195.1
1	34.5	5208	17	451.5	172.9	1	17.25	5208	17	225.7	172.9
2	68.8	2582	18	465.8	152.5	2	34.4	2582	18	232.9	152.5
3	102.7	1703	19	479.0	136.4	3	51.3	1703	19	239.5	136.4
4	135.8	1249	20	490.4	121.2	4	67.9	1249	20	245.2	121.2
5	168.1	987.6	22	511.7	95.9	5	84.1	987.6	22	255.9	95.9
6	199.3	803.4	24	528.8	76.0	6	99.7	803.4	24	264.4	76.0
7	229.7	685.2	26	542.7	60.3	7	114.8	685.2	26	271.4	60.3
8	258.4	567.6	28	541.1	47.8	8	129.2	567.6	28	277.0	47.8
9	285.8	487.2	30	563.0	38.0	9	142.9	487.2	30	281.6	38.0
10	312.0	421.6	32	570.6	30.2	10	156.0	421.6	32	285.3	30.2
11	336.1	367.4	34	576.5	24.0	11	168.1	367.4	34	288.3	24.0
12	359.1	321.7	36	581.1	19.0	12	179.5	321.7	36	290.6	19.0
13	380.5	282.8	38	585.1	15.1	13	190.3	282.8	38	292.5	15.1
14	400.4	249.4	40	588.1	12.0	14	200.2	249.4	40	294.1	12.0
15	418.8	220.4				15	209.4	220.4			

# ESTIMATED GROUND CONDUCTIVITY

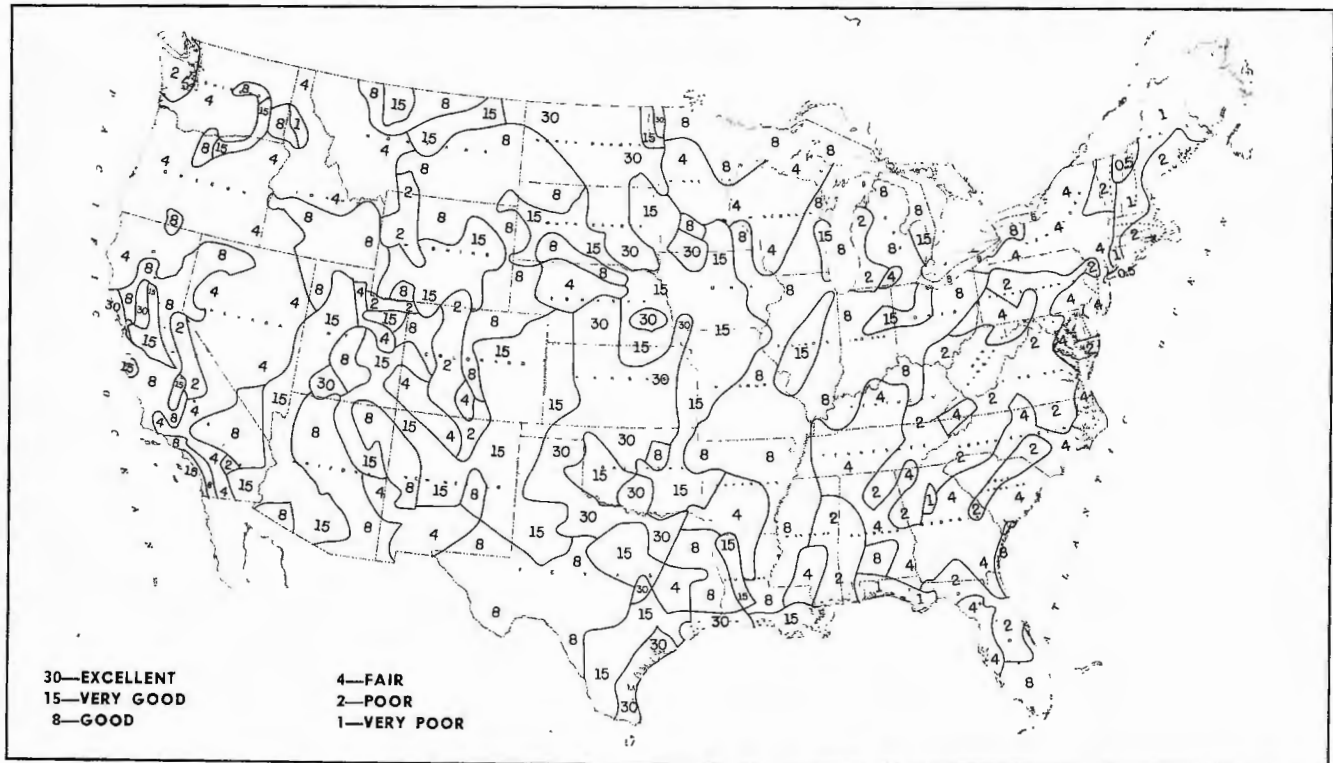



REACTANCE CHART

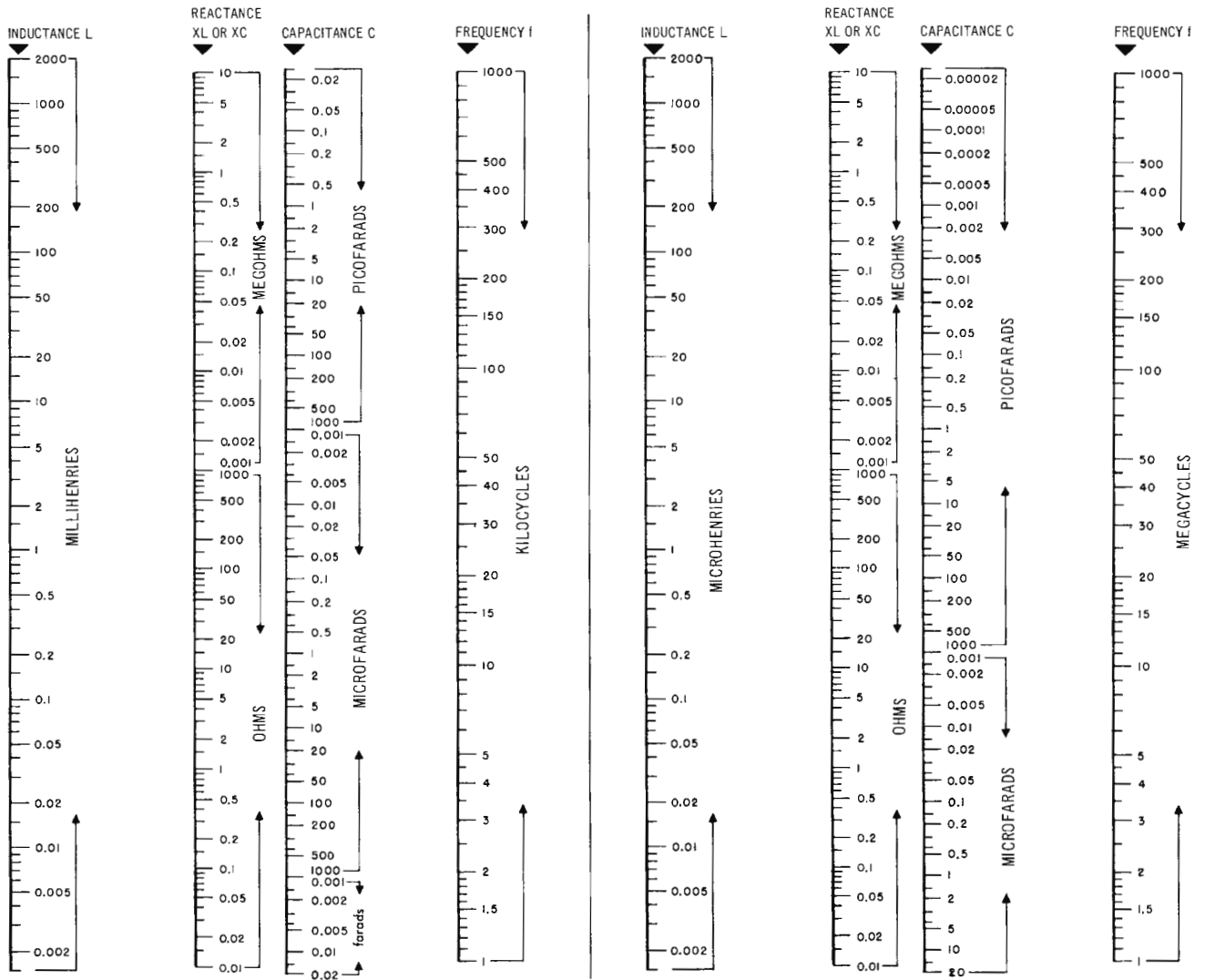

DECIMAL EQUIVALENTS OF FRACTIONS

1/32	.03125	9/32	.28125	17/32	.53125	25/32	.78125
1/16	.0625	5/16	.3125	9/16	.5625	13/16	.8125
3/32	.09375	11/32	.34375	19/32	.59375	27/32	.84375
1/8	.125	3/8	.375	5/8	.625	7/8	.875
5/32	.15625	13/32	.40625	21/32	.65625	29/32	.90625
3/16	.1875	7/16	.4375	11/16	.6875	15/16	.9375
7/32	.21875	15/32	.46875	23/32	.71875	31/32	.96875
1/4	.25	1/2	.5	3/4	.75	1	1.0

## ATTENUATION EXPRESSED AS EFFICIENCY

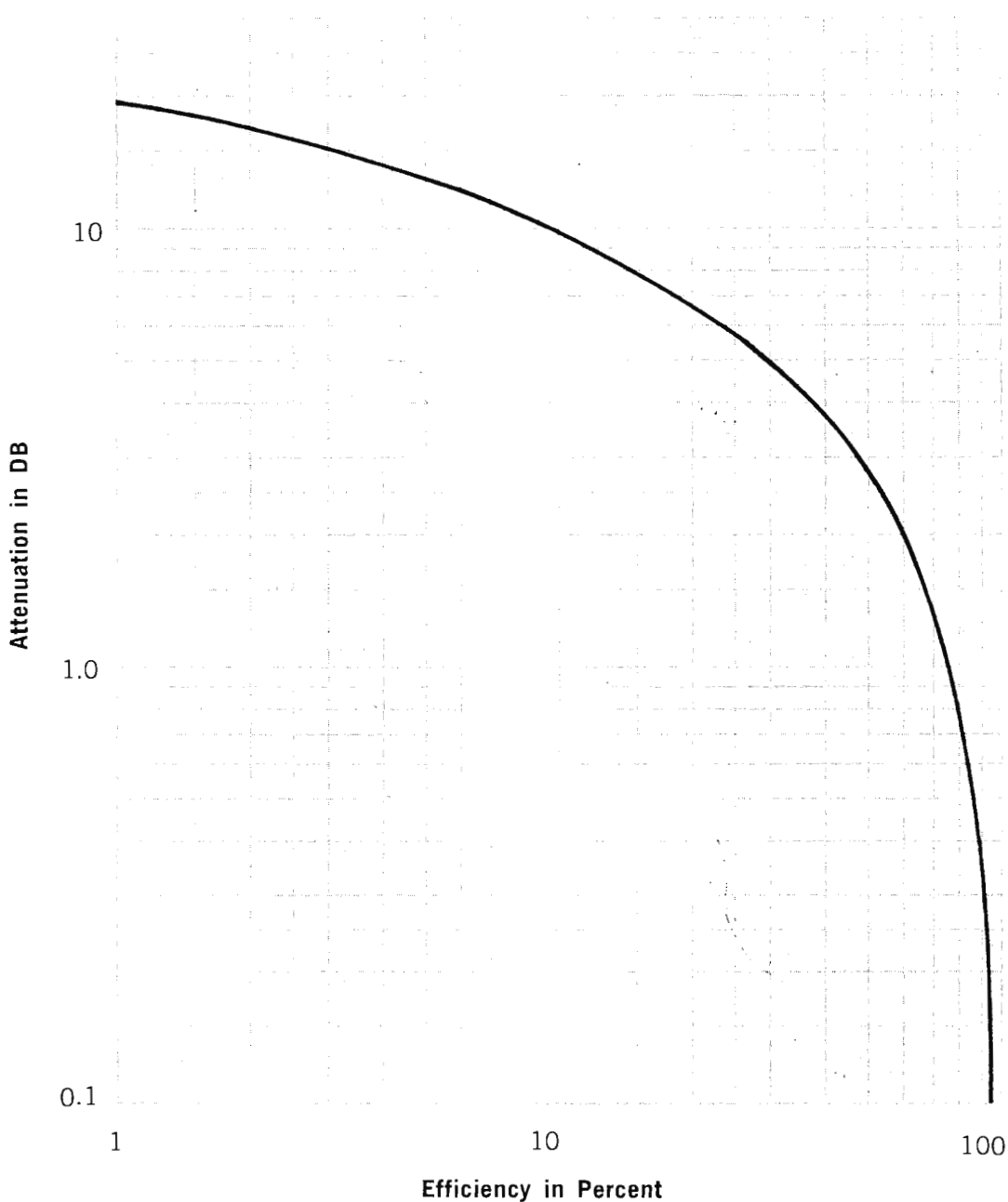

### DETERMINATION OF OVERALL TRANSMISSION LINE EFFICIENCY

To obtain total loss in a given transmission line, multiply the attenuation in db per 100 ft. by the number of 100 foot lengths of line to be used. By referring to the curve on this page, the overall transmission efficiency may be determined.

# STATION LAYOUTS

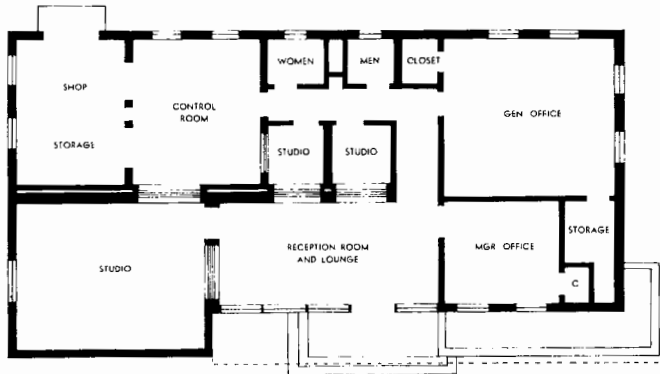
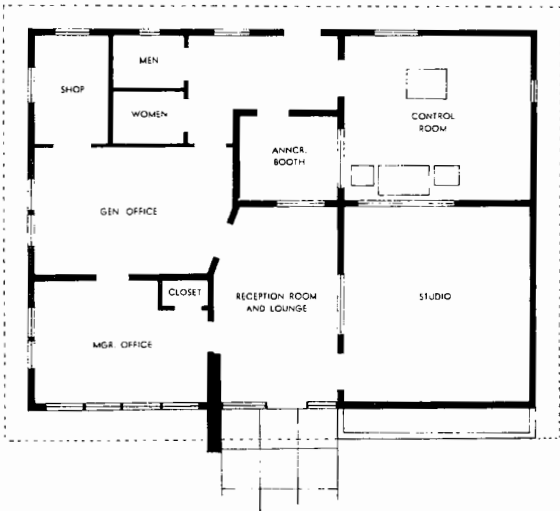
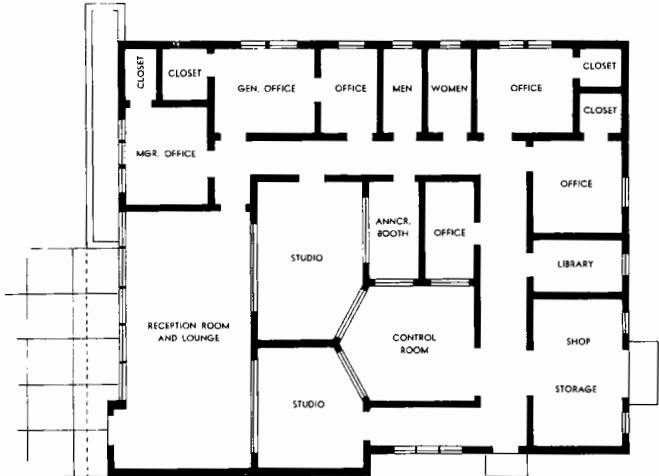
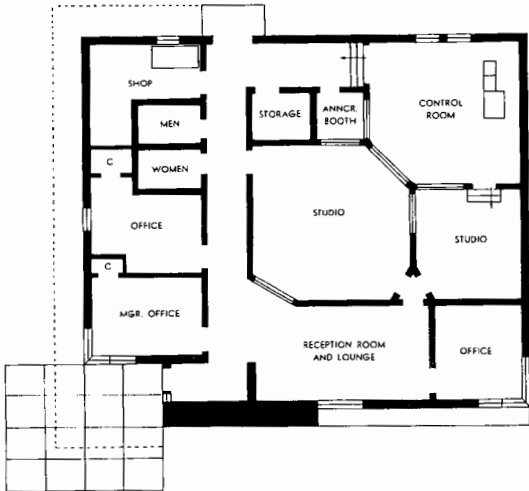

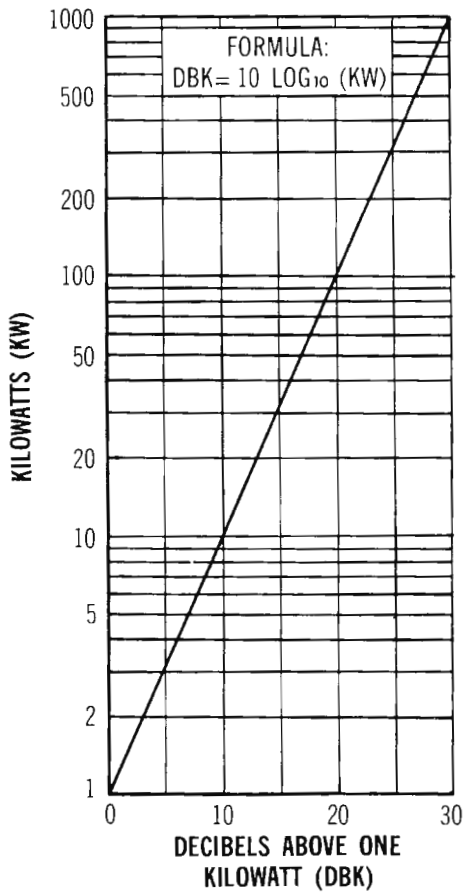

Transformation of kilowatts to decibels above 1 kw.

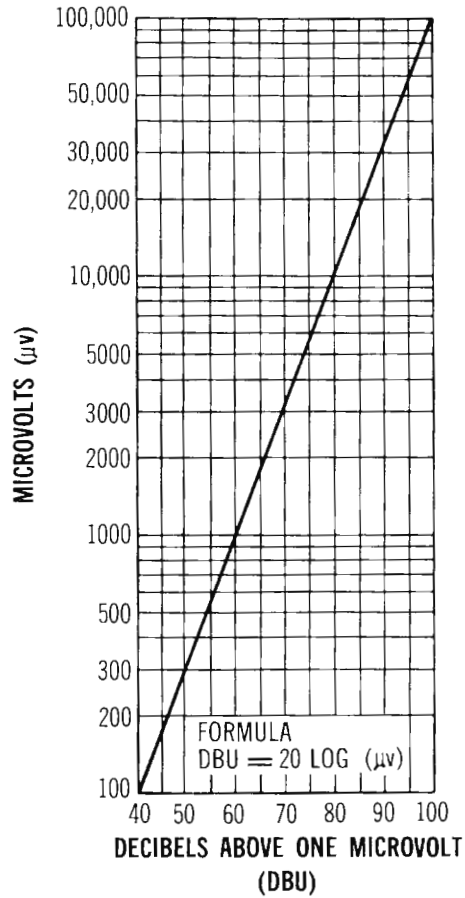

Transformation of microvolts to decibels above 1 μv.

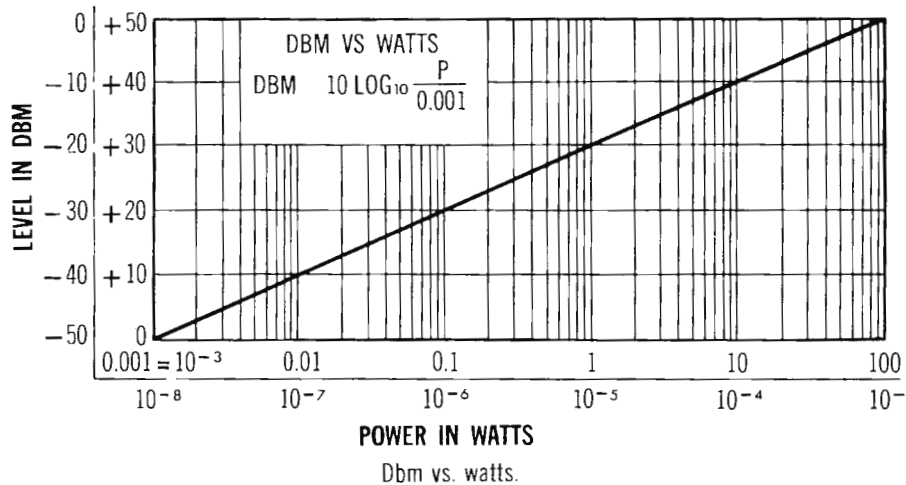

Dbm vs. watts.



Volume Level to Power and Voltage Conversion		
Reference Level		
0 dbm = 1 mw, 600 ohms		
Milliwatts	Volts	Dbm
0.000001	0.0007746	- 60
0.000010	0.002449	- 50
0.000100	0.007746	- 40
0.001	0.02449	- 30
0.010	0.07746	- 20
0.100	0.2449	- 10
1.000	0.7746	0
Watts	Volts	Dbm
0.001000	0.7746	0
0.002512	1.228	+ 4
0.006310	1.946	+ 8
0.01000	2.449	+ 10
0.1000	7.746	+ 20
1.000	24.49	+ 30
10.00	77.46	+ 40

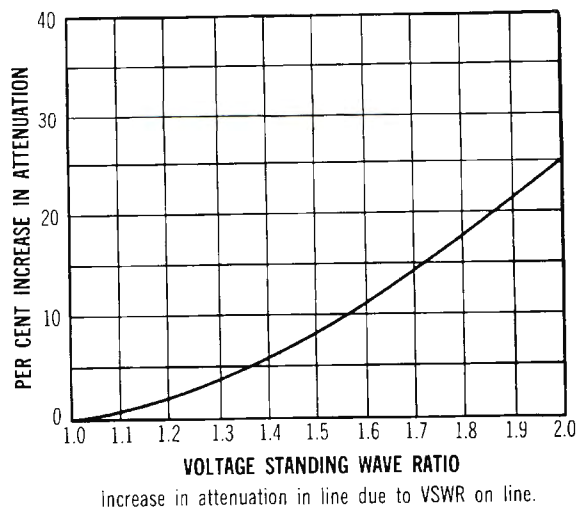
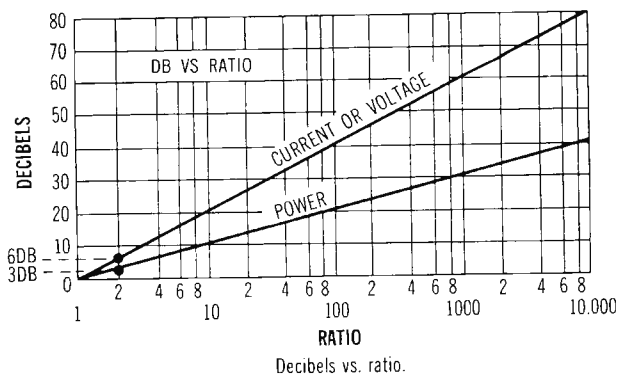

**STANDARD COLOR CODE—MOLDED MICA TYPE CAPACITORS**

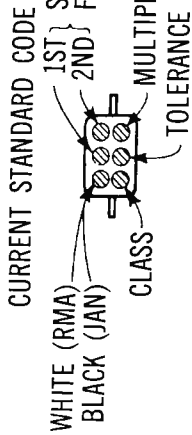

JAN 8,  
1948  
RMA  
CODE

RMA 3-DOT (OBSOLETE)  
RATED 500 W.V.D.C.  $\pm$  20% TOL.

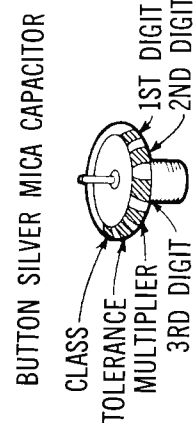
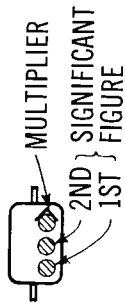

**RMA (5-DOT OBSOLETE CODE)**

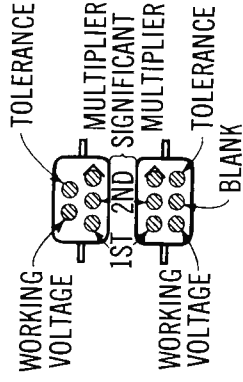
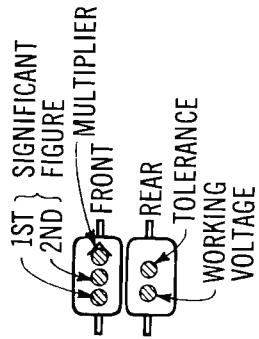

**RMA 4-DOT (OBSOLETE)**

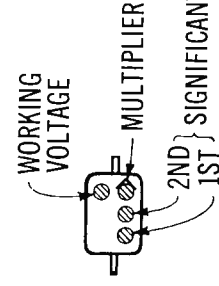

**RMA 6-DOT (OBSOLETE)**

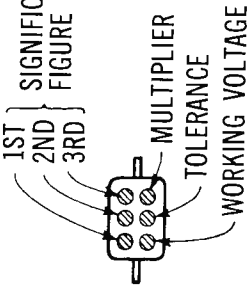

**STANDARD COLOR CODE—MOLDED PAPER TYPE CAPACITORS**

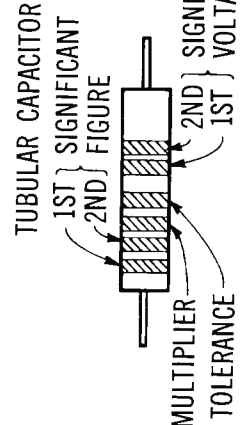

MOLDED FLAT CAPACITOR  
COMMERCIAL CODE

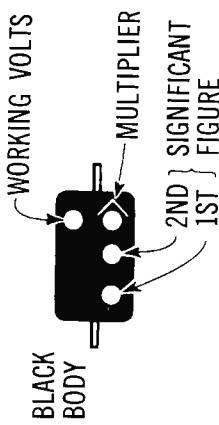

**JAN. CODE CAPACITOR**

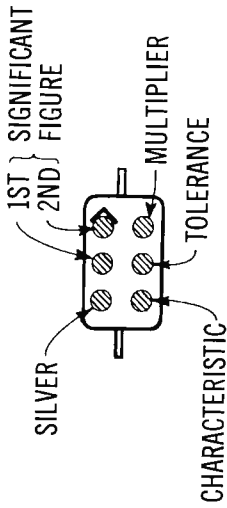

**STANDARD COLOR CODE—RESISTORS AND CAPACITORS**

INSULATED UNINSULATED COLOR	FIRST RING BODY COLOR FIRST FIGURE	SECOND RING END COLOR SECOND FIGURE	THIRD RING DOT COLOR MULTIPLIER
BLACK	0	0	NONE
BROWN	1	00	0
RED	2	,000	
ORANGE	3	0,000	
YELLOW	4	00,000	
GREEN	5	,000,000	
BLUE	6	0,000,000	
VIOLET	7	00,000,000	
GRAY	8	000,000,000	
WHITE	9		

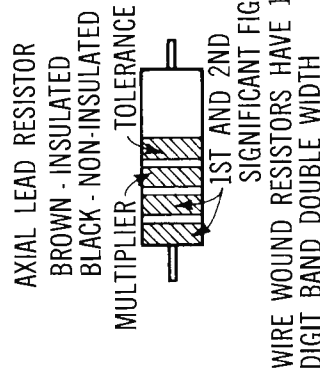
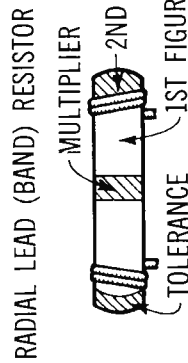
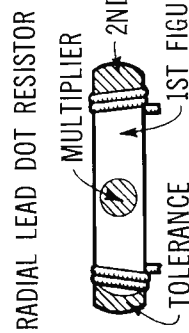

**BY-PASS COUPLING  
CERAMIC CAPACITOR**

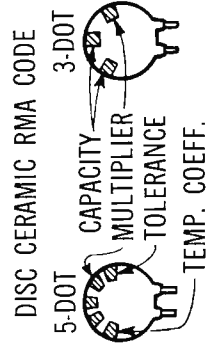
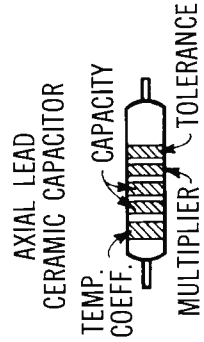
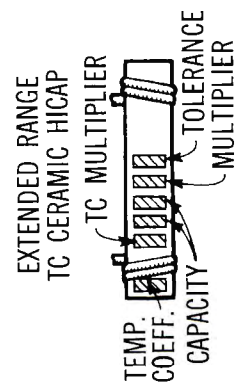
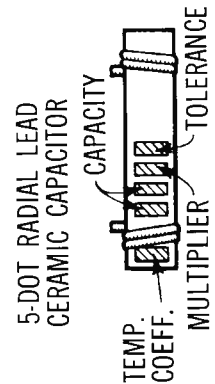
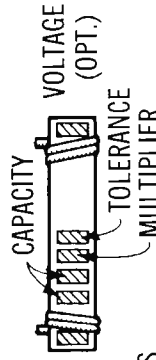

## INDEX BY DESCRIPTION

Air Alert .....	107	Equalizer .....	85
AM Towers .....	35	Exciter, FM .....	20
AM Transmitters .....	2, 5, 8	Flexo Mikester FM-1 .....	105
Amplifier, Audio .....	79	FM Antenna .....	32-34
Amplifier, Auto-Level Limiting .....	80	FM Towers .....	35
Amplifier, Cue .....	78	FM Transmitters .....	21, 23, 25, 29
Amplifier, Limiting .....	77	Frequency Deviation Monitor .....	123
Amplifier, Program/Monitor .....	77	Generator, Stereo Multiplex .....	18
Amplifier, Stereo Limiting .....	83	Ground Screen .....	37
Antenna Coupling Unit .....	11	Ground Strap .....	37
Antenna Current Metering Unit .....	124	Ground Wire .....	37
Antenna Current Transformer .....	12	Headphones .....	108
Audio Amplifier .....	79	Heating Element, FM Antenna .....	33
Audio Clock .....	101	Insulator, Feed-Through .....	11
Audio Oscillator .....	122	Intercom, Test .....	124
Auto-Level Limiting Amplifier .....	80	Isolation Coil .....	15
Automatic Network Programmer .....	101	Jack Panels .....	108
Automatic Program Logger .....	101	Jumper Plug, Console .....	80
Automation System .....	100	Latching Relay .....	124
Baffles .....	108	Lavalier Microphone Clip .....	102
Batteries, Remote Amplifier .....	113	Level Controls .....	107
Beacon Light Control .....	37	Loudspeakers .....	106-107
Bracket Assemblies, Console .....	80	Meter Accessory Unit .....	123
Cable, Power Supply .....	78	Meter, Distortion .....	123
Cabinet, Turntable .....	85	Meter, Intensity .....	122
Cannon Connectors .....	110	Metering Unit, Plate Current .....	124
Cartridges, Automatic Programming .....	93	Metering Unit, Plate Voltage .....	124
Cartridges & Styli .....	88, 89, 90	Microphones .....	102, 103, 104
Choke, Tower Lighting .....	11	Microphone Boom .....	105
Clock, Audio .....	101	Microphone Boom Stand .....	104-105
Clock, Studio .....	109	Microphone Cable .....	109
Coaxial Cable, Helix, Air Dielectric .....	39-46	Microphone Cord & Clip .....	102
Coaxial Cable, Helix Foam Dielectric .....	47-54	Microphone Desk Stands .....	104
Coaxial Cable, Rigid .....	55-59	Microphone Floor Stands .....	105
Coaxial Cable, Solid Dielectric .....	38	Microwave Systems, STL .....	125-127
Connectors, Cannon .....	110	Mobile Receiver .....	114
Console, Desk Wing .....	91	Mobile Transmitter .....	114
Console, Production Cabinet .....	92	Momentary Relay .....	124
Console, Speech Input .....	70, 72, 75	Monitor, Frequency Deviation .....	123
Contactors .....	15	Monitor, Modulation .....	117, 118, 120, 121
Control Panels, Remote .....	93	Oscillator, Audio .....	122
Conversion Kits, Tape Recorder .....	99	Pads, Replacement Pressure .....	94
Conversion Kit, Transmitter .....	11	Pads, Turntable Indentation .....	85
Crystal, Transmitter .....	4, 7, 20	Patch Cords .....	108
Custom Control Desk .....	106	Phase Monitor .....	123
Deicer, Antenna .....	33		
Dummy Antenna .....	11		



Phasing	12	Shelf, Console	80
Phasor	12	Short Wave Conversion	4
Phono Equalizer Preamp	85	Speaker	106, 107
Phonograph Cartridge	88, 89, 90	Speaker/Amplifier	96
Pick-up Arms	87	Splicing Tape	94
Plate Current Metering Unit	124	Spot Locator	101
Plate Voltage Metering Unit	124	Stereo Head Assembly	118
Playback Arms	86, 89	Stereo Multiplex Generator	18
Playback Head, Tape Recorder	100	STL Microwave Systems	125-127
Power Supply, Console	75, 78	Studio Clock	109
Power Supply, Remote	115	Styli	90
Preamplifier	73, 77	Tape, Automatic Programming Test	94
Pressurization Fittings and Accessories	62	Tape Cartridge Racks	92
Primary Overload Relay	124	Tape Cartridge Repair Kit	94
Programmer, Automatic Network	101	Tape Cartridge System	90, 91
Rack Cabinet Panels	109	Tape Erasers	94
Recorders	95, 96, 97, 98, 99	Tape Recorders	95-99
Recorder Accessories	96	Tape Recorder Case	95-99
Recorder/Reproducer	97, 98	Tape Splicer, Cutter	94
Recording Tapes	93	Terminal Board	109
Rectifiers	20	Test Cable, Console	80
Relay Unit, Console	78	Towers, AM	35
Remote Amplifier	112, 113	Towers, FM	35
Remote Control	101	Tower Light Current Metering	124
Remote Control Accessories	124	Tower Lighting Choke	11
Remote Control Panels	93	Transformer, Speaker	106
Remote Control Recorder	117	Transformers, Tape Recorder	99
Remote Control Tape Recorder	99	Transformer, Turntable	85
Remote Equipment	114	Transistors	20
Remote Equipment Accessories	133	Transmission Lines and Accessories	38-68
Remote Turntable, Console	111	Transmitter Control Unit	124
Replacement Pressure Pads	94	Transmitter, Remote Control Studio Unit	124
Reproducer	97, 98	Tubes	4, 7, 20, 76, 77, 78, 80, 82, 123
RF Amplifier	122	Turntables	84-85
Rheostat, Motorized Plate	124	Turntable Cabinet	85
Ring Transformer	37	Utility Towers	35
Sampling Loop	14	Wire, Shielded	109

## INDEX BY TYPE NUMBER

1H1612 Studio Clock	109	4GD-01S-02S Cartridge & Styli	90
2YC Stacking Harness	115	4GS-01D Cartridge & Styli	90
4G-01D Cartridge & Styli	90	4GS-02D Cartridge & Styli	90
4G-02D Cartridge & Styli	90	4GS-01S Cartridge & Styli	90
4G-01S Cartridge & Styli	90	4GS-02S Cartridge & Styli	90
4G-02S Cartridge & Styli	90	20V3 Transmitter	2
4GD-01D-02D Cartridge & Styli	90	26J-1 Auto-Level Limiting Amplifier	80
4GD-01D-02S Cartridge & Styli	90	26U-1 Amplifier, Limiting Console	82

26U-2 Amplifier, Stereo Limiting	83
37M FM Antennas	32
42E-7 Antenna Coupling Unit	11
42E-8A Antenna Coupling	11
42E-8B Antenna Coupling	11
44AGR Adapter	49
44AN N Jack	51
44AN-75 N Jack	51
44AR Flange	48
44AR-3 Flange	48
44AZ Helix Splice	48
45AH HN Jack	51
45AJ HN Plug	51
45AL LC Jack	51
45AM LC Plug	51
45AN-3 N Jack	51
45AP UHF Plug	50
45AP-3 UHF Plug	50
45AR Flange	50
45AR-3 Flange	50
45AT End Terminal	51
45AT-3 End Terminal	51
45AU UHF Jack	50
45AU-3 UHF Jack	50
45AW N Plug	51
45AW-3 N Plug	51
45AZ Helix Splice	50
45AZ-3 Helix Splice	50
47L LC Jack	52
47L-3 LC Jack	52
47N N Jack	52
47N-3 N Jack	52
47R Flange	52
47R-3 Flange	52
47W N Plug	53
47W-3 N Plug	53
47Z Helix Splice	52
47Z-3 Helix Splice	52
48R Flange	54
48Z Helix Splice	54
71N N Jack	39
71T End Terminal	39
71W N Plug	39
71Z Helix Splice	39
72N N Jack	39
72T End Terminal	39
72W N Plug	39
72Z Helix Splice	39
74N N Jack	39
74T End Terminal	39
74W N Plug	39
74Z Helix Splice	39
75AG Flange & Gas Barrier	40
75AG-3 Flange & Gas Barrier	40
75AL LC Jack	41
75AM LC Plug	41
75AM-75 LC Plug	41
75AN N Jack	41
75AN-3 N Jack	41
75AN-75 N Jack	41
75AR Flange	40
75AR-3 Flange	40
75AR-75 Flange	40
75AT End Terminal	40
75AT-3 End Terminal	40
75AT-75 End Terminal	40
75AU UHF Jack	41

75AU-3 UHF Jack	41
75AU-75 UHF Jack	41
75AW N Plug	41
75AZ Helix Splice	40
75AZ-3 Helix Splice	40
77AL-75 LC Jack	43
77AM-75 LC Plug	43
77AR-75 Helix Flange	42
77AT-75 End Terminal	43
77AZ-75 Helix Splice	42
78G Flange & Gas Barrier	44
78G-75 Flange & Gas Barrier	44
78L LC Jack	45
78R Flange	44
78R-75 Flange	44
78S Connector	44
78S-75 Reducer Connector	44
78Z Helix Splice	45
78Z-75 Helix Splice	45
79G Flange & Gas Barrier	46
79R Flange	46
79Z Helix Splice	46
81M Phasor	12
87G Flange & Gas Barrier	42
87G-3 Flange & Gas Barrier	42
87L LC Jack	43
87M LC Plug	43
87N N Jack	43
87R Flange	42
87R-3 Flange	42
87S Connector	42
87T End Terminal	43
87U UHF Jack	43
87Z Helix Splice	42
87Z-3 Helix Splice	42
91 Tape Recorder	99
92 Tape Recorder	99
93 Tape Recorder	99
93-4 Tape Recorder	99
108-E Phase Monitors	123
111A-12 Recording Tape	94
120 Tower	35
120-E Intensity Meter	123
121 Meter Accessory Unit	123
135-15 Feed-Thorough Insulator	11
144A-1 Isolation Coil	15
145-101-13 Contactor	15
145-102-13 Contactor	15
145-201-13 Contactor	15
145-202-13 Contactor	15
150-18 Recording Tape	94
156 Headphones	108
157 Headphones	108
170KD Tower	35
172G-1 Dummy Antenna	11
172G-2 Dummy Antenna	11
180 Tower	35
190-18 Recording Tape	94
200C Tape Eraser	94
208-S Playback Arm	87
208-SG Playback Arm	87
210 Audio Oscillator	122
212G-1 Console	75
212H-1 Remote Amplifier	112
212M-1 Console	72

## INDEX BY TYPE NUMBER (Continued)

212S-1 Console	70	1021 Recorder/Reproducer	98
212TN Playback Arm	86	1022 Recorder/Reproducer	98
212Z-1 Remote Amplifier	113	1028 Recorder/Reproducer	97
216C-2 Tape Recorder	90	1060 Elbow	41, 51, 55
220 Tower	35	1061 Elbow	43, 53, 56
260S-1 Mixer Add-On Unit	71	1062 Elbow	45, 58
274K-1 Relay Unit, Console	78	1070 Elbow	41
274K-2 Relay Unit, Console	80	1071 Elbow	43
300 Cartridges	93	1072 Elbow	45
300 Studio Unit	124	1073 Elbow	46
300 Transmitter Control	124	1181-B Frequency Deviation Monitor	123
300C Antenna	34	1200 Cartridge	93
313T Remote Control Panels	93	1200MA Plate Current Metering Unit	124
340 Tower	35	1260 Gas Barrier	41, 43
350AG Recorder	96	1260A Gas Barrier	55
356A-1 Preamplifier	77	1261B Gas Barrier	53, 56
356B-1 Program/Monitor Amplifier	77	1262 Gas Barrier	45, 58
356E-1 Limiting Amplifier	77	1271 Gas Barrier	43
356H-1 Phonograph Equalizer Preamplifier	85	1272 Gas Barrier	45
356M-1 Monitor Amplifier	74	1273 Gas Barrier	46
356P-1 Program Amplifier	74	1362 Gas Inlet Coupling	59
356Q-1 Cue Amplifier	78	1560A Flange Kit	55
356T-1 Preamplifier	73	1561A Flange Kit	57
356V-1 Hi Level Amplifier	73	1562A Flange Kit	59
384D-1 Switch Matrix	75	1860 Reducer	41, 53, 56
400-RA Studio Unit	124	1861 Reducer	45, 53, 56, 58
400-RA Transmitter Unit	124	1871 Reducer	45
409X-2 Power Supply	78	1872 Reducer	46, 58
409Z-1 Power Supply	75	1920A Dehydrator	60
410 Distortion Meter	123	2061 End Terminal	43, 53, 57
423-0219-00 Microphone Cable	109	2062 End Terminal	45, 59
425-0061-00 Microphone Cable	109	2071 End Terminal	43
425-0151-00 Microphone Cable	109	2072 End Terminal	45
427-6 Terminal Board	109	2260 Adapter	55
439-5900-00 Microphone Cable	109	2261 Adapter	56
480 Tower	35	2262 Adapter	58
499G-1 Console Shelf	80	2360 Adapter	55
506B Modulation Monitor	117	2361 Adapter	56
560 Rigid Transmission Line	55	2400MA Plate Current Metering Unit	124
561 Rigid Transmission Line	56	2962 Breakaway Section	59
562A Rigid Transmission Line	58	3009 Horizontal Anchor	55
564A-1 Sampling Loop	14	3009 Pick-Up Arms	87
564A-2 Sampling Loop	15	3012 Pick-Up Arms	87
600 Cartridge	93	3012 Thread Lubricant	62
600MA Plate Current Metering Unit	124	3016 Pipe Tee	62
602 Recorders	95	3017 Inlet Valve	62
602 Recorder Accessories	96	3018 Pipe Plug	62
602C Equalizer	86	3022 Pipe Tee	62
622 Speaker/Amplifier	96	3026 Pipe Nipple	62
642A-2 Tape Playback	91	3027 Release Valve	62
726 Amplifier Batteries	113	3500 Pressure Gauge	62
763 Amplifier Batteries	113	3901 Anchor	57
786M-1 Generator	18	3902 Anchor	59
800 Automation System	100	3911 Hanger	57
808A-1 Remote Turntable, Console	111	3912 Hanger	59
820E/F-1 5/10 KW AM Transmitter	5	3921 Brace	57
821A-1 HF Transmitter	8	3922 Brace	59
830B-1 FM Transmitter	21	4850 Adapter Interconnector	41, 51, 55
830D-1A FM Transmitter	23	4851 Adapter Interconnector	43, 53, 56
830E-1A FM Transmitter	25	4852 Adapter	58
830F-1A FM Transmitter	27	4861 Coupling	57
830F-2A FM Transmitter	27	4862 Coupling	59
830H-1A FM Transmitter	29	4944 Release Valve	62
830N-1A FM Transmitter	30	4947 Coupling	62
858A Tank Fittings	61	4949 Release Valve	62
878 Dry Air Pump	61	5960 Dehydrator	61
900C-1 Modulation Monitor	118	6600A Gas Manifold	61

8412 Microphone Cable	109	24444 Interconnector	45
8422 Microphone Cable	109	24530 Adapter	45
8738 Microphone Cable	109	24622 Hanger	43, 53
8758 Microphone Cable	109	24810-1/2/3 Ground Kit	41, 51
9905-18 Vinyl Tape	62	24811-1/2/3/4 Ground Kit	43, 53
10195 Hose Assembly	62	25385 Interconnector	41
10683-2 O-Ring Gasket	57	25388 Interconnector	41
10683-3 O-Ring Gasket	59	25435 Tubing	62
10741-2 Copper Tubing	62	25436-4 Elbow	62
10804-4 N Panel Receptacle	38	25436-12 Pipe Nipple	62
10804-9 N Junction	38	25572 Adapter	43
10804-10 N Right Angle Connector	38	26666 Reducer Connector	44
10804-11 N Junction	38	26892-1/2/4 Grounding Kit	49
10804-34 N Cable Jack	38	26985 Hoisting Kit	45
10804-36 N Cable Plug	38	27290 Copper Weld Tie Wire	39, 47, 49, 51
10805-1 UHF Cable Plug	38	28708-1 Grounding Kit	45
10805-4 UHF Tee Connector	38	28708-2 Grounding Kit	45
10805-5 UHF Right Angle Connector	38	29958 Cable Grip	41, 51
10805-6 UHF Junction	38	30079 Connectors	58
10805-11 Adapter, UHF Jack	38	30417-1 Grounding Kit	46
10805-12 Adapter, UHF Plug	38	30417-2 Grounding Kit	46
10994-2 Coupling	62	30452 Adapter	57
10994-4 Coupling	62	31031 Cable Grip	46
11381-2 Hardware Kit	57	31614 Regulating Tank	60
11381-3 Hardware Kit	59	31616 Humidity Sensor	60
11662-2 Insulated Mounting Clamp	41, 51	31618 Pressure Sensor	60
11662-3 Insulated Mounting Clamp	39, 49	31680-1/2 Connector	62
12129 Sleeve	62	31680-3/5 Tee Connector	62
12395-1 Wraplock	33, 39, 41, 47, 49, 53	31712 Strap	62
12418-1 LC Cable Plug	38	63305-DB Beacon Light Control	37
12418-3 LC Junction	38	700105 Transformer	99
12418-5 N Cable Plug	38	700106 Transformer	99
12418-12 UHF Cable Plug	38	700107 Transformer	99
12430-1 Ground Clamp	57	700108 Transformer	99
12431 Ground Clamp	59	700120 Remote Control, Tape Recorder	99
13550 Hanger Adapter	45, 59	700122 Tape Recorder Case	99
13552 Spacer	57	700133 Tape Recorder Case	99
13555 Hanger Adapter	45, 55, 59	A830-2 FM Exciter	20
13889 Spring Hanger	55	A-3818 Speaker Transformer	107
13924 Rigid Hanger	57	AC-100 Antenna Current Metering Unit	124
13925 Spring Hanger	59	AG-350-1 Mono Record/Reproducer	97
13926 Spring Hanger	59	AG-350-2 Stereo Record/Reproducer	97
13927 Rigid Hanger	45, 59	AG-355-1 Mono Reproducer	97
14063 Insulator	57, 59	AG-355-2 Stereo Reproducer	97
14327 Sliding Hanger	55	ANP-1 Automatic Network Programmer	101
14328 Rigid Hanger	55	APL-1 Automatic Program Logger	101
14379 Sliding Hanger	57	ASP-143 Bumper Mount	115
14387 Sliding Hanger	57	ASP-177 Antenna	115
14441 Sliding Hanger	57	BA-200 Headphones	108
14442 Sliding Hanger	57	BA-206 Headphones	108
15069 Connector	43, 53, 56	BB-1 Microphone Boom	105
15093 Connector	45, 59	BX801 Tape Recorder	99
15840 Flange Kit	59	BX822 Tape Recorder	99
16253 Jumper Cable	49	CR-1773-B Rack Cabinet	109
18041 Flange Kit	57	CS-12 Loudspeaker	106
18096 Flange Kit	55	DS-7 Microphone Desk Stand	104
18200 Flange Kit	59	DWW-3 Desk Wing Console	91
18275 Connector	41, 51, 55	FM-1 Flexo Mikester	105
18630 Flange Kit	55	GR-6355 Connector	115
18631 Flange Kit	57	HI-50 Heliac Cable	39
19209B Flexible Section	59	H2-50 Heliac Cable	39
19256A Hoisting Kit	41, 51	H4-50 Heliac Cable	39
20695 Flexible Section	57	H5-50 Heliac Cable	40
22418 Hanger	45	H5-75 Heliac Cable	40
23187 Adapter	45	H7-50A Heliac Cable	42
24254 Interconnector	43	H7-75 Heliac Cable	42
24312 Hoisting Kit	43, 53		

## INDEX BY TYPE NUMBER (Continued)

H8-50A Heliac Cable	44	RP-80 Rack Mounting Adapter	79
H8-75A Heliac Cable	44	S-260 Playback Arm	89
H9-50 Heliac Cable	46	S-320 Playback Arm	89
HD-11M Tape Eraser	94	SA-100 Remote Control	101
HJ1-50 Heliac Cable	39	SA-100 Spot Locator	101
HJ2-50 Heliac Cable	39	SC-155-B Antenna	115
HJ4-50 Heliac Cable	39	SCB-8D Baffle	108
HJ5-50 Heliac Cable	40	SCB-12D Baffle	108
HJ5-75 Heliac Cable	40	SCG-4 Carrier Generator	127
HJ7-50A Heliac Cable	42	SE-1 Stereo Transcription Preamplifier	86
HJ7-75 Heliac Cable	42	SM5A Microphone	103
HJ8-50A Heliac Cable	44	SM33 Microphone	103
HJ8-75A Heliac Cable	44	SM50 Microphone	103
HJ9-50 Heliac Cable	46	SM300 Microphone	104
LC Jack	48	ST-276 Level Control	107
LC Plug	48	ST500 Splicing Tape	94
LR-1-C Latching Relay	124	ST-760 Level Control	107
LT-80B Amplifier	79	TBM-2500 RF Amplifier	122
M-3/STL Transmitter	126	TBM-3000 Frequency Monitor	120
M5D Phonograph Cartridge	89	TBM-3500 Modulation Monitor	120
M6S Phonograph Cartridge	89	TBM-4000 Modulation Monitor	121
M-20 Microphone	102	TC-25 Tower Light Current Metering Unit	124
M-20 Microphone Desk Stand	104	TCW-2Q Turntable Cabinet	85
M-30B/TPS Mobile Transmitter	114	TCW-4Q Turntable Cabinet	85
M-40 Microphone	102	TCW-9Q Turntable Cabinet	85
M44-5 Phonograph Cartridge	88	TI-300 Test Intercom	124
M44-7 Phonograph Cartridge	88	TI-2017 Ring Transformer	37
M-70 Microphone	102	TI-2035 Ring Transformer	37
M-100 Microphone	102	TM-8 Audio Clock	101
M232 Playback Arm	89	TPS-1 Remote Power Supply	115
M236 Playback Arm	89	TPS-TC Mobile Assemblage	115
MA-1 Antenna	115	TS-8D Tape Splicer, Cutter	94
MM-151 Recording Tape	93	TT-200 Turntable	85
MPR-2 Motorized Plate Rheostat	124	TT-200S Turntable	85
MPR-3 Motorized Plate Rheostat	124	TT-250S Turntable	85
MPR-4 Motorized Plate Rheostat	124	TT-400 Turntable	85
MR-2C Momentary Relay Unit	124	TT-400S Turntable	85
MR-30/150-170 Remote Receiver	114	TT-450S Turntable	85
MR-200/942-952 Receiver	126	TT-900 Turntable	84
MS-10C Microphone Floor Stand	105	Type UHF Jack	47
MS-11C Microphone Floor Stand	105	Type UHF Plug	47
MS-25 Microphone Floor Stand	105	Type UHF N Jack	47
MT-6 Input Transformer	79	Type UHF N Plug	47
P3-13 Connector	110	Type UHF Jack	49
P3-14 Connector	110	Type UHF Plug	49
P3-35 Connector	110	UA-3-11 Connector	110
P3-35-2G Connector	110	UA-3-12 Connector	110
P3-CG-11S Connector	110	UA-3-13 Connector	110
P3-CG-12S Connector	110	UA-3-14 Connector	110
P8-T3 Speaker	107	UA-3-31 Connector	110
P12-T Speaker	107	UA-3-32 Connector	110
PA-1 Antenna	115	WB-8D Baffle	108
PBR-21 Meter Panel	127	WB-12D Baffle	108
PBR-21 Studio Control Unit	127	WG-52 Dummy Antenna	11
PBR-21 Transmitter Control Unit	127	XLR-11C Connector	110
PCL-2B Studio Transmitter Link	127	XLR-11SC Connector	110
PH-6A Phonograph Preamplifier	79	XLR-3-12C Connector	110
PH-7 Program Preamplifier	79	XLR-3-12SC Connector	110
PT6-6A Recorder	98	XLR-3-13 Connector	110
PT6-6AX Recorder	98	XLR-3-13N Connector	110
PT6-6J Recorder	98	XLR-3-14 Connector	110
PT6-6JX Recorder	98	XLR-3-14N Connector	110
PV-10 Plate Voltage Metering Unit	124	XLR-3-35 Connector	110
RA-2 Antenna	115	XLR-3-35G Connector	110
RA-4 Antenna	115	XLR-3-36 Connector	110
RC 8 Remote Control	99	XLR-3-36-2G Connector	110
RMC-1 Remote Control	115	YC Antenna	115



***COLLINS BROADCAST  
COMMUNICATION  
SALES POLICY***

**HOW TO ORDER**

This catalog has been prepared to make it possible for you to order directly from the Collins Broadcast Communication Division or your Collins Broadcast Sales Engineer with a minimum of effort and maximum assurance that you will receive the best equipment available. Collins type numbers and part numbers are listed so that you may order by mail, if you wish, and receive the same fast, personal service that is available from your Collins Broadcast Sales Engineer.

**PRICES**

Prices in the price book inside the back cover replace all previous prices and are subject to change without notice. Orders are filled at prices in effect at the time of shipment. If prices are reduced, you receive the advantage of the lower price. Collins customers outside the 50 United States should contact Collins Radio Company, International Division, Dallas, Texas, or Collins Radio Company of Canada, Ltd., Toronto 16, Ontario.

**SIGNED ORDERS**

All orders must be signed by an officer of the purchasing corporation, partnership or company. All orders, down payment agreements and terms are subject to final acceptance at the Collins Broadcast Sales Division office in Dallas, Texas.

**SUBSTITUTION AND MODIFICATION**

Collins reserves the right to modify, without notice, the design and specifications of equipment designed by Collins.

**TERMS OF SALE**

Terms of payment for all Collins Radio Company broadcast equipment sales fall into the following categories:

1. Cash in advance or C.O.D.
2. Net 30 days.
3. 30-60-90 days (no interest or carrying charge).
4. Conditional Sales Contract.

## **DOWN PAYMENT**

On all firm orders applicable to Conditional Sales Contracts, a minimum down payment of 25% is required, with the balance spread equally. In the case of contingent orders, a minimum of 3% down is required.

## **SHIPMENT**

In the absence of specific instructions Collins will select the carrier to whom delivery will be made for shipment to the purchaser.

## **DAMAGES IN SHIPPING**

Usually, shipments from Collins Radio Company or one of its vendors on a drop ship basis are made "Shipping Charges Collect." As such, the equipment automatically becomes the property of the purchaser when picked up by the carrier. Should damage occur during shipment, the request for inspection and claims for damage must be made by the purchaser with reimbursement paid directly to him. Collins will gladly assist the purchaser with any necessary information he may require to successfully negotiate a claim.

## **DELIVERY**

Unless otherwise specified, delivery will be made f.o.b. from one of Collins' various shipping points or from the shipping point of a supplier of Collins. Although Collins makes every effort to expedite shipments, the Company cannot guarantee nor be held responsible for delays in shipments caused by a supplier of Collins or by the carrier.

## **FIELD SERVICE**

Fast field service is assured owners of Collins broadcast equipment by the Collins Service Division. A staff of selected specialists is maintained to provide Collins customers a level of service consistent with high performance equipment. For service on Collins equipment which is essential to continued on-the-air operations of the station, contact your Collins Broadcast Sales Engineer. For emergency, after-hours service, call Dallas, Texas, 214 AD 5-9511. Collins field service engineers are stationed at key points throughout the world. Overseas customers contact your nearest International office.

## **RETURNING GOODS**

All returned goods, whether for repair, replacement or credit, must be authorized by Collins Radio Company. A

return material tag and service report will be enclosed with your authorization for the return of the goods. An accurately completed report will assure prompt handling of repairs, necessary parts, replacements and adjustments of accounts where required. Address material as follows:

Collins Radio Company

Dallas, Texas 75207

Attention: CRC/Re (Sales Order Number)

Contingent on Collins' agreement to accept such returned goods, a restocking charge of 15% will be made on all items returned due to customer requested changes or deletions from original orders after shipment is made. All returns must be sent prepaid and properly insured by the customer. If warranted, Collins will adjust and/or issue credit for these shipping expenses.

## **GUARANTEE**

Collins' faith in its equipment — as well as its record of quality and reliability — allows the Company to maintain a formal guarantee that Collins will repair or replace, without charge, any equipment, parts or accessories which are defective as to design, workmanship or material, and which are returned to Collins with transportation prepaid. To be eligible for the Collins guarantee, several conditions must be met:

1. Notice of the claimed defect in equipment manufactured by Collins is given Collins within two years from date of delivery and goods are returned in accordance with Collins' instructions to you.

2. Equipment, accessories, tubes and batteries not manufactured by Collins or from a Collins design are subject to only such warranties and adjustments as Collins may obtain from the supplier.

3. Equipment or accessories will not be considered defective if the equipment has been exposed to improper treatment, excessive moisture or if it has been altered or repaired by persons other than Collins authorized representatives.

In no event does Collins have any liability for consequential damages or for the loss, damage or expense directly or indirectly arising from the use of the products or any inability to use them either separately or in combination with other equipment or materials or from any other cause. Collins further guarantees that any Collins radio transmitter will deliver full radio frequency power output at the antenna terminal when connected to a suitable load, but Collins does not guarantee any definite coverage or range.

## UNITED STATES BROADCAST OFFICES

**Collins Radio Company**  
**Broadcast Communication Division**  
**Dallas 7, Texas**  
**Telephone: Area Code 214 ADams 5-9511**

K. A. Blake  
Collins Radio Company  
P. O. Box 57087  
Los Angeles, California 90057  
Telephone: DUmkirk 5-6421

California, Nevada, Arizona, Utah, Hawaii

R. C. Evans  
P. O. Box 8026  
Jackson, Mississippi 39204  
Telephone: 939-4220

Arkansas, Western Half of Kentucky, Louisiana, Mississippi, Western Half of Tennessee

R. J. Henry  
Route 2  
Roanoke, Indiana  
Telephone: 672-2906

Indiana, Michigan (East of Lake Michigan), Ohio

L. H. Leggett  
Collins Radio Company  
1271 Avenue of the Americas  
New York, New York 10020  
Telephone: JUdson 6-5678

Connecticut, Delaware, District of Columbia, Maine, Maryland, Massachusetts, New Hampshire, New Jersey, New York, Pennsylvania, Rhode Island, Vermont

J. L. Littlejohn  
12708 Myrtle Circle  
Hopkins, Minnesota 55343  
Telephone: 935-7011

Michigan (West of Lake Michigan), Minnesota, Nebraska, North Dakota, South Dakota, Wisconsin

R. O. Looper  
P. O. Box 207  
Clinton, Illinois 61727  
Telephone: 935-5502

Illinois, Iowa, Kansas, Missouri

J. H. Speck  
Collins Radio Company  
Dallas, Texas 75207  
Telephone: ADams 5-9511

New Mexico, Oklahoma, Texas, Colorado

J. F. Stanbery  
P. O. Box 748  
Gatlinburg, Tennessee 37738  
Telephone: 436-5497

Eastern Half of Kentucky, North Carolina, South Carolina, Eastern Half of Tennessee, Virginia, West Virginia

C. W. Walters  
3658 Colebrook Drive  
Jacksonville, Florida 32210  
Telephone: SPring 1-2978

Alabama, Florida, Georgia

W. J. Monroe  
Collins Radio Company  
2826 Empire Way South  
Seattle, Washington 98144  
Telephone: 725-3385

Alaska, Idaho, Montana, Oregon, Washington, Wyoming

**Special Consultant**  
A. P. Walker  
Collins Radio Company  
Universal Building  
Washington, D. C.



## Why is this trademark important to you?

For 30 years one principle has guided us in meeting our responsibility to provide you with equipment of the highest performance standards. That principle is *integrity*.

<i>integrity in design</i>	25% of our people are in Research and Development.
<i>integrity in manufacturing</i>	The best facilities, the best materials, the industry's finest craftsmen.
<i>integrity in sales</i>	Honest claims, backed up by a seldom-used but always dependable guarantee.
<i>integrity in service</i>	Around the world, around the clock to <i>insure</i> Collins performance.

*Our trademark is a symbol of Collins integrity. You can depend on it.*



1 214 235 9511  
COLLINS RADIO COMPANY • Broadcast Communication Division, Dallas • International Division, Dallas







