

# SECRET

# CB<sup>®</sup>



CONFIDENTIAL  
**FACTUAL  
REPORT**  
SCHEMATICS ETC.  
UPDATED QUARTERLY

# TABLE OF CONTENTS

## EXCITING NEW PRODUCTS

Micromonitor.....	1- 5
Echo Box.....	6
Secret CB's Dummy Load.....	7
Built-In Power Mike.....	8- 9

## TEST EQUIPMENT YOU CAN MAKE

5 Mile Simulator.....	10
Pre Amp You Can Build.....	11

## INFORMATION

Glen Digital Controller for use as counter and to determine unknown frequency.....	12-13
Technician Notes.....	14
Antenna Secrets.....	15-17
"Oops We Goofed" Corrections on previous volumes.....	17-18

## EXCITING NEW MODIFICATIONS

Robyn SB-540D.....	19
Cobra 2000.....	20
Dak IX.....	21-23
New Grant, Sears Roadtalker 40 and more.....	24-60

## SPECIAL CHAPTER ON REDCO UFO

Programing Special Tuning Modifications, etc.....	61-69
---	-------

<b>HINTS AND KINKS.....</b>	<b>70</b>
-----------------------------	-----------

## SLIDE INCREASE

Application on all Sideband Radios.....	71
8KHZ - 12KHZ - 20KHZ	

<b>RADAR COMMUNICATOR.....</b>	<b>72-73</b>
--------------------------------	--------------

## EXCITING NEW PRODUCT!

### 10 METER CONVERSION MICROCOMPUTER COMES TO HAM RADIO

Until recently, many CB to 10 meter conversions have been performed using heterodyne crystal oscillator changes and simply taking what frequencies that came without question. Now however, a new development, the MICROMONITOR, has come available which is designed to remotely program the radio and give frequency ranges that includes the entire 10 Meter band. Step sizes of 5KHz are possible and are indicated in the built in display.

The MICROMONITOR consists of two pieces. First is the computer controlled hand held unit. Enclosed within the unit is a microcomputer, a display and a keyboard. The user simply keys in the frequency he desires to use and the computer does the rest. First, the computer updates the display to the desired frequency. It then calculates the command code that corresponds to the desired frequency. Once the code is calculated, it transmits the code command to the second part of the system.

The second unit is called the interface board. This piece is designed to mount inside the radio. The board contains the necessary interface logic that interprets the computer's commands and translates those codes into the desired frequency. This is accomplished by substituting the radio's own phase locked loop synthesizer circuitry with a dedicated chip of its own. The chips that normally come with the CB radios are usually of limited range and therefore do not readily lend themselves to 10 meter conversion techniques. The chip supplied with the interface assembly can supply up to 1024 different frequencies at 5KHz spacing. Given that the average CB radio only requires up to 88 of these frequencies, it is frequently possible to program a much higher division ratio, allowing sufficiently higher output frequencies. Simple retuning of the filter and VCO for operation in the ten meter spectrum of the band completes the conversion.

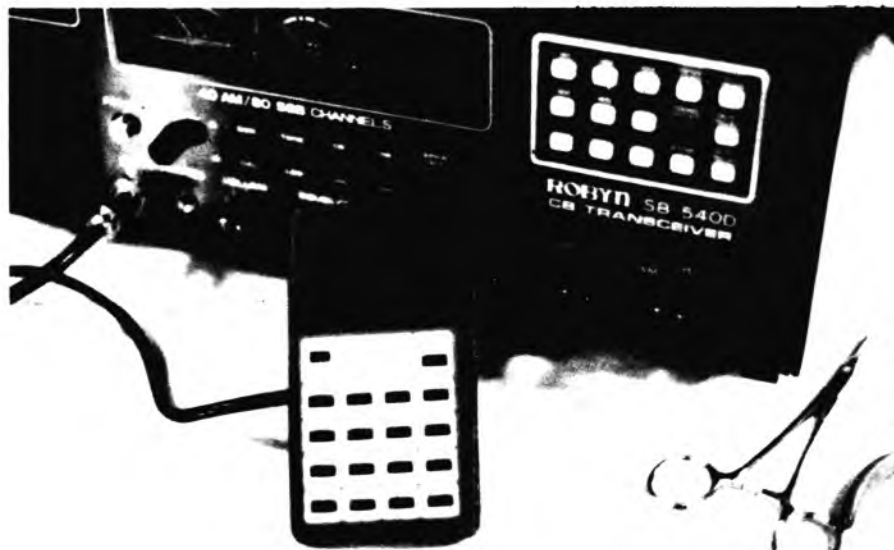

Once the system is installed, the user simply keys in the four least significant digits of the frequency desired and the combination of the computer and interface synthesizer do the rest. Programmed limits of operation are computer controlled and range between 28.0 and 29.7MHz. As long as the user keys in any number between these limits, that frequency is automatically commanded by the micromputer and synthesizer by the interface board. One limitation exists, however; on most converted CB radios, their initial design is for a total operational range of 440KHz. The 10 Meter modification calls for 1.7MHz total range which is about 4 times the original design range. As a result, the practical maximum frequency range is usually reduced. This phenomenon is entirely dependent upon the radio being converted and by the actual components within the radio. Techniques exist, however, to expand the range of the VCO.

The MICROMONITOR system uses much of the radio's circuitry to perform the synthesis. The synthesizer chip supplied includes the reference oscillator, programmable divider and phase comparator. Neither the filter nor the VCO is included. Instead, the filter and VCO provided with the radio are pressed into dual service, both stock and for use with the MICROMONITOR.

An interesting design feature includes the capability of conventional CB operation whenever the MICROMONITOR is turned off. In this case, electronic switching automatically restores the radio to stock configuration and normal CB operation is resumed. Keep in mind however, that once the unit has been retuned for 10 Meter operation, this last feature is not really practical. Should this be a desirable feature, then perhaps a mid-range tuning technique can be employed to allow limited operation on either hand.

With the MICROMONITOR installed, many additional user features are now possible. The system allows for automatic frequency scanning. And, when used in conjunction with the radio's squelch circuitry, automatically stops any scan function when the squelch circuit is activated; making it very easy to scan the band in search of active frequencies. Momentarily activating the push-to-talk switch will stop the scan. Alternatively, provision is also provided to allow the unit to scan for unused frequencies, again determined by the squelch circuit.

The computer has provisions for up to five separate memories for use in storing any commonly used user frequencies subject to instant recall by the user. All he must do is depress the appropriate memory key and the frequency stored in memory is instantly recalled for immediate use.

The MICROMONITOR has built in provision for splitting the transmit and receive frequencies. In this case, the user can independently program both transmit and receive frequencies. Whenever the user transmits, the computer automatically retrieves the desired transmit frequency. When receive mode is returned, the computer exchanges the transmit code with the receive frequency code and the receiver now operates on the desired receive frequency. This feature allows for operation frequently used by DX stations which listen on one frequency and transmit on another.

Installation is a snap. The interface board is simply wired in place using the supplied instructions. Only one resistor is necessary to be removed. Once the radio has been interfaced, the user plugs in the MICROMONITOR, keys in the frequency he chooses and viola! He is on the air.

Summarizing, it is now possible to bring computer control to your own radio. In the process, user features only found on the big rigs (and some that are not) are now available at your fingertips. Simple readjustment of the rig completes the process.

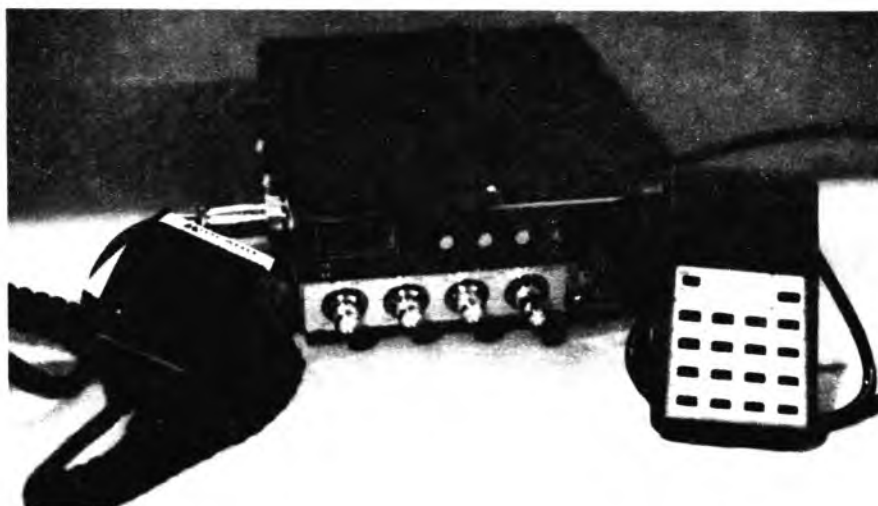
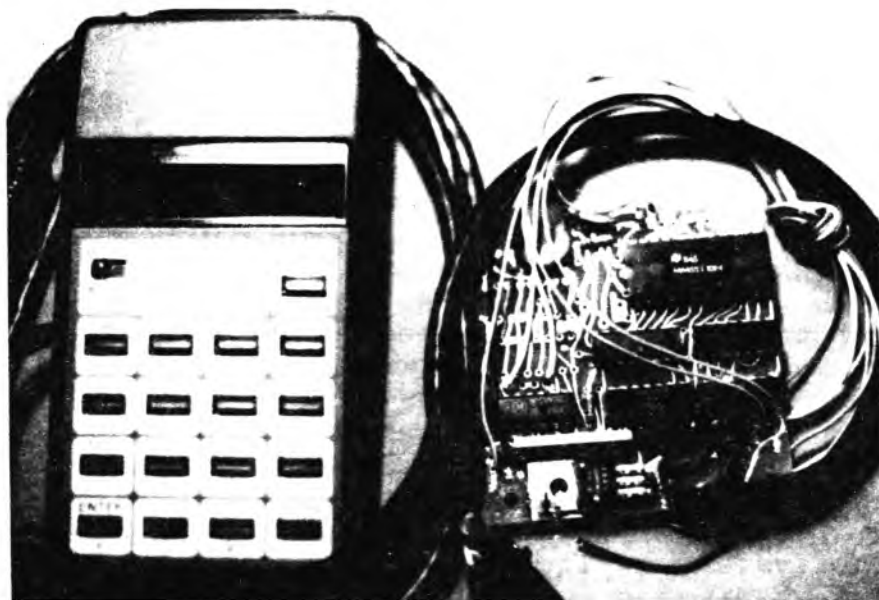



	MM1	UP-800	RM-2	RM-76	Yaesu
Step Size	5KHz	5KHz	.1, 1, 15KHz	5KHz	5KHz
Memory Channels	5	4	4	6	4
Band Scan	up/down	up/down	up/down	up/only	up/down
Memory Scan	yes	yes	no	yes	?
Open or Busy Scan	yes	yes	no	yes	?
Tone Pad Option	yes 16 buttons	no	yes	no	yes
Programmable Splits	yes	yes	yes	yes*	yes
Upper & Lower Scan Limits Adjustable	no	no	no	yes	no
Single Step Scan up/down	yes	yes	yes	yes	yes
Scan Stop	PTT/fcn	Hold/PTT	PTT/Hold	HOLD	HOLD
Reverse Pair	yes	no	no	no	no
Automatic Duplexing	yes	no	no	no	no
Direction/Amount					
HELP Frequency Recall	yes	no	no	no,	no
# Channels	1024	800	800	800	800
MARS & CAP Use	yes	Radio Dependent	no	SPX only	no
Memories Retained When off	no	yes	no	no	no
Display Type	LED	LED*	Flourescent	LED	LED
Keyboard Entry	yes	no	yes	yes	yes
Installation	Removable	Permanent	Removable	Removable	Permanent
Separate Regulated Voltage Power Supply	yes	no	no	no	no
Size	small	Medium	Medium-Large	Medium-Large	small
Price	190	100	220	179	190

\* Uses Radio Functions

MEMORY, SCAN, DUPLEX, SELECT HELP  
IT DOES IT ALL



UNPLUG MICROMONITOR AND RADIO  
GOES BACK TO STOCK CONDITION



SMALL AS A CALCULATOR

## NEW PRODUCT RELEASE

### ECHO BOX

At first look this may seem to be a toy, but it is not. It is a form of voice processing. Ask every old timer like ALDO RAE, the father of the electronic guitar, and an old time Ham Radio Operator. The old time Amateurs' will tell you that in heavy Q.R.M., insert a little ECHO and you will punch through the Q.R.M. This unit works good on SSB also.





SECRET CB'S 250 WATT DUMMY LOAD  
(COLLECTORS ITEM)



APPLICATION: Ideal for CB Amateur or insustrial use.

SIZE: Quart Can

SPECIFICATIONS: 250 watts intermittent 2 minutes  
150 watts long durations 10-15 minutes  
100 watts continuous

FREQUENCY RANGE: to 500 MHZ

INSTRUCTIONS: Fill the unit with transformer oil or mineral oil to within 3/4 inches from the top of the can. Transformer oil is the first choice. The mineral oil may be obtained from your local Pharmacist or Drugstore.

# BUILT-IN POWER MIC

## NEW PRODUCT RELEASE

The PM-1 Built-In Power Mic is a variable-gain 40dB amplifier especially designed to eliminate squeal and muffled sound normally associated with conventional power mics. Since the PM-1 runs off of the radios internal power supply, NO BATTERIES ARE NEEDED, ever! The PM-1 is also well suited for radios with CONTROLS IN THEIR MICROPHONES that cannot otherwise accept conventional external power mics.

The performance of the PM-1 greatly surpasses the performance of the first mic amp in most CB transceivers. Thus, using the PM-1, this stage can be eliminated, which many times results in cleaner modulation and reduced "muffled" transmission. NOTE: the PM-1 must never be installed as to defeat the transceivers modulation limiter which would result in direct violation of the Federal Communications Commission.

Once installed and properly adjusted, the PM-1 gives the user clean, optimum modulation without the need for adjusting external "mic gain" controls.

### INSTALLATION

The PM-1 is relatively easy to install. If the first mic amp is left as is, only the audio lead from the microphone need be broken. The microphone side of the audio lead goes to the AUDIO INPUT (A). The radio side of the audio lead goes to the AUDIO OUTPUT (B). A wire should then be connected from the transmit wire on the mic connector to point (C). NOTE: When point (C) is grounded, the amplifier is ON; when point (C) has 12 volts on it, the amplifier is OFF. A short ground wire should then be run from point (D) to some point close to the audio input stage. Remember, this is also a DC return wire, so this cannot be connected to the case of the radio!! 12 volts should then be fed to point (E). The best place to obtain this voltage is on the power switch so power will be off when the radio is off, yet the input filters in the radio will keep ignition noises out of the power mic.

If the first mic amp in the transceiver is to be eliminated, connect the audio lead from the microphone to the AUDIO INPUT (A) Disconnect one side of the interstage coupling capacitor and connect this side to the AUDIO OUTPUT (B) to keep the DC in the PM-1 out of the radio.

In the rare event that squealing does occur, connect a .01uf ceramic capacitor between points x,x on the power mic board.

# BUILT-IN POWER MIC (CONTINUED)



BUILT IN  
POWER MIC.  
MODULE

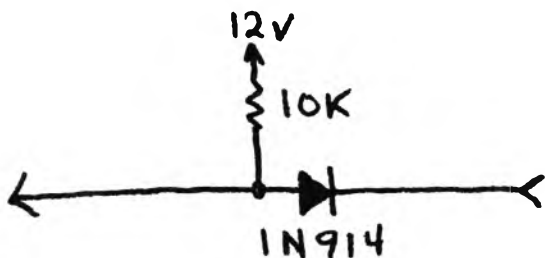
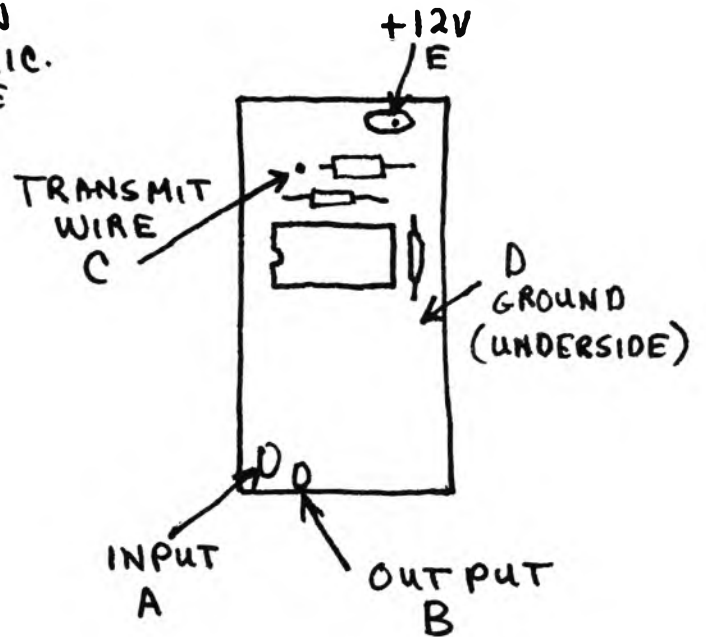
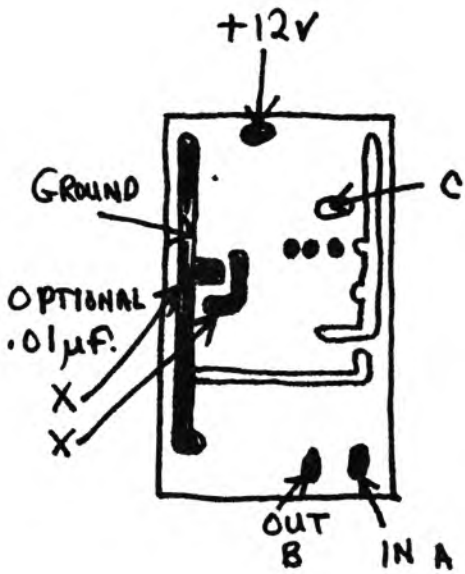

FROM POINT  
13 ON CYBERNET  
MIDLAND, RCA ETC. PCB.

When using the PM-1 on 23 channel CYBERNET radios, the additional diode and capacitor are necessary. The ground wire should be connected to point G1, located next to the TC7205 audio IC. This is most important.

ADVANCED COMMUNICATIONS

## TEST EQUIPMENT YOU CAN MAKE

### The 5 Mile Simulator

Your customer comes in the shop and says that his radio is not getting out, or that his radio squels or one of the many other complaints like mike problems. Well, this is the answer. All you need is another working radio. Connect the unit to each radio and talk to the other one. Use the external speaker jack with ear phones or turn down the radio and stand close. With this unit you will hear just what the radio will sound like at a distance of 5 miles.

The Parts You Will Need Are As Follows:

- (1) One small metal mini Box Bud or Radio Shack
- (2) Two chassis mount coax connectors
- (3) Eight 220 ohms 2 watt 5% resistors
- (4) One 1.5M ohms  $\frac{1}{4}$  watt
- (5) Two 6 Foot Jumpers
- (6) Two terminal lugs

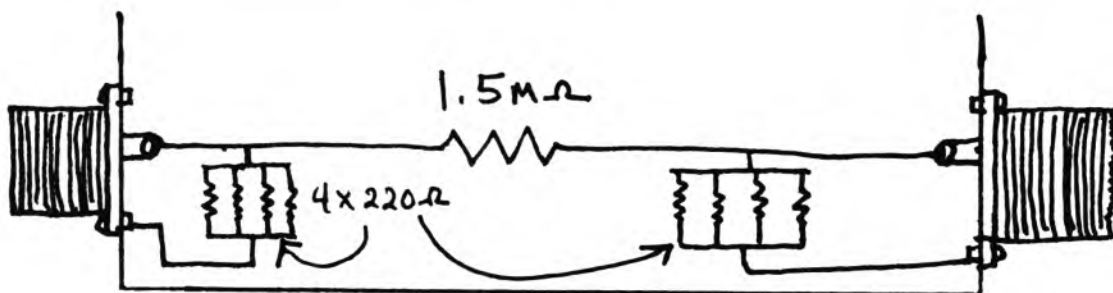
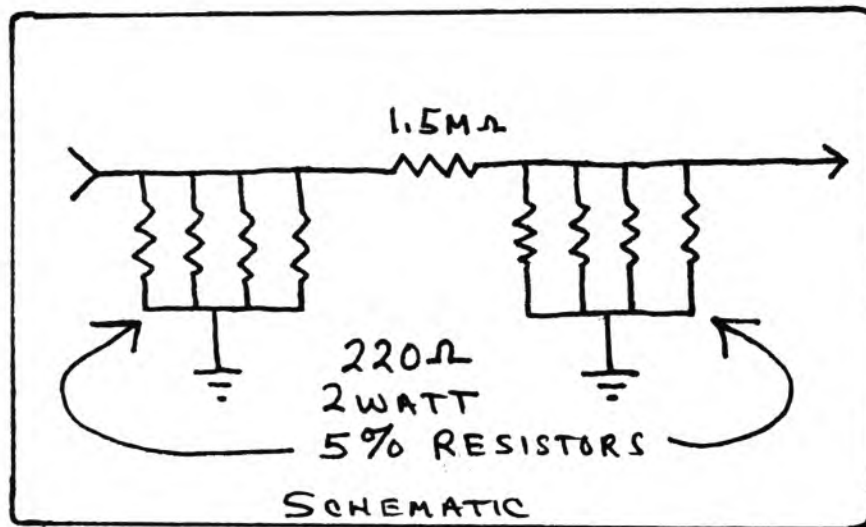

"THE 5 MILE SIMULATOR"

HERE IS A RECEIVER PREAMP YOU CAN BUILD

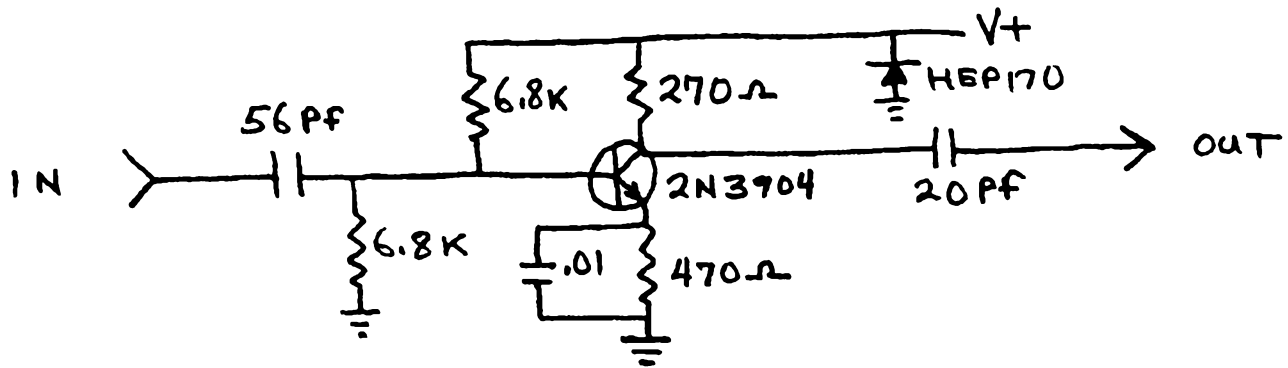

THIS UNIT MAY BE INSTALLED IN A RADIO. IT MAY BE USED AS A COUNTER PREAMP OR SCOPE AMP.

\*\*\*\*\*



On the 14T302 RCA AM/SSB radio you can use a SPDT center off switch to ground pins 9 & 10. If you make a small plate like the above drawing, you can replace the noise blanker switch with the SPDT center off switch. Then with a minor adjustment of the VCO, you will get 27.415-27.595 on channels 11-27. In the other position you will get 27.605 thru 28.045. In the center off position you will be in the normal mode.

GLEN DIGITAL CONTROLLER USED TO DETERMINE "UNKNOWN" FREQUENCY.  
(SIGNAL GENERATOR APPLICATION)

APPLICATION: THE "GLEN" WILL READ OUT "UNKNOWN" FREQ. DESIRED IN ANY RADIO. ALMOST A MUST FOR ANY SHOP!

EXPLODED VIEW OF PILLBOX

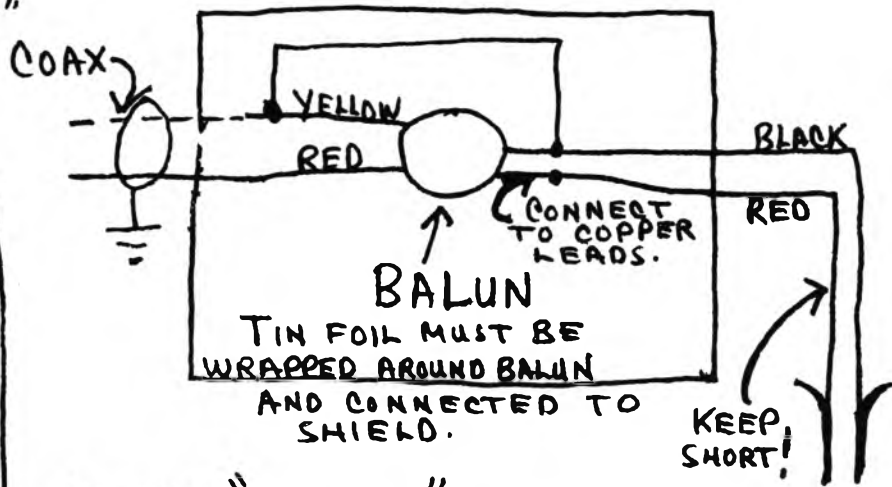

ATTACH "PILL BOX" LEADS WHERE XTAL WAS REMOVED.

ALLIGATOR CHIPS (MINI)

ALLIGATOR CHIPS

PILL BOX BALUN

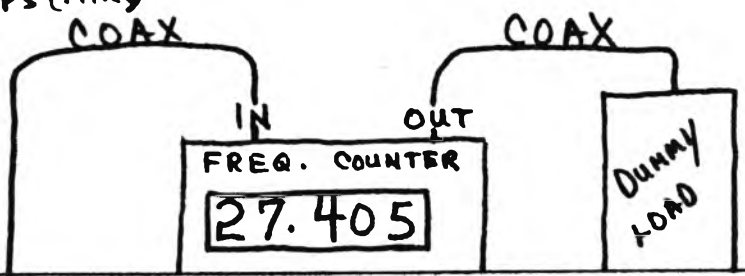

REMOVE XTAL THAT YOU ARE HAVING PROBLEMS WITH. DIAL IN GLEN FREQ. DESIRED. KEY RADIO AND READ OUT ON COUNTER.



NOTE: THIS PROCEDURE MAY BE USED TO DETERMINE EXTRA CHANNELS FOR 10 METER AMATEUR USE.

BENCH



326-G GLEN DIGITAL CONTROLLER  
 MODIFICATION TO USE AS LOW LEVEL COUNTER

APPLICATION: CONVERT 326-G TO LOW LEVEL COUNTER.  
 ALLOWS FREQ. TO BE READ DIRECTLY OFF  
 XTAL OR AT THE MIXER. NOTE: GLEN  
 PRE-AMP MAY BE USED AS SCOPE OR RECEIVER  
 PRE-AMP!

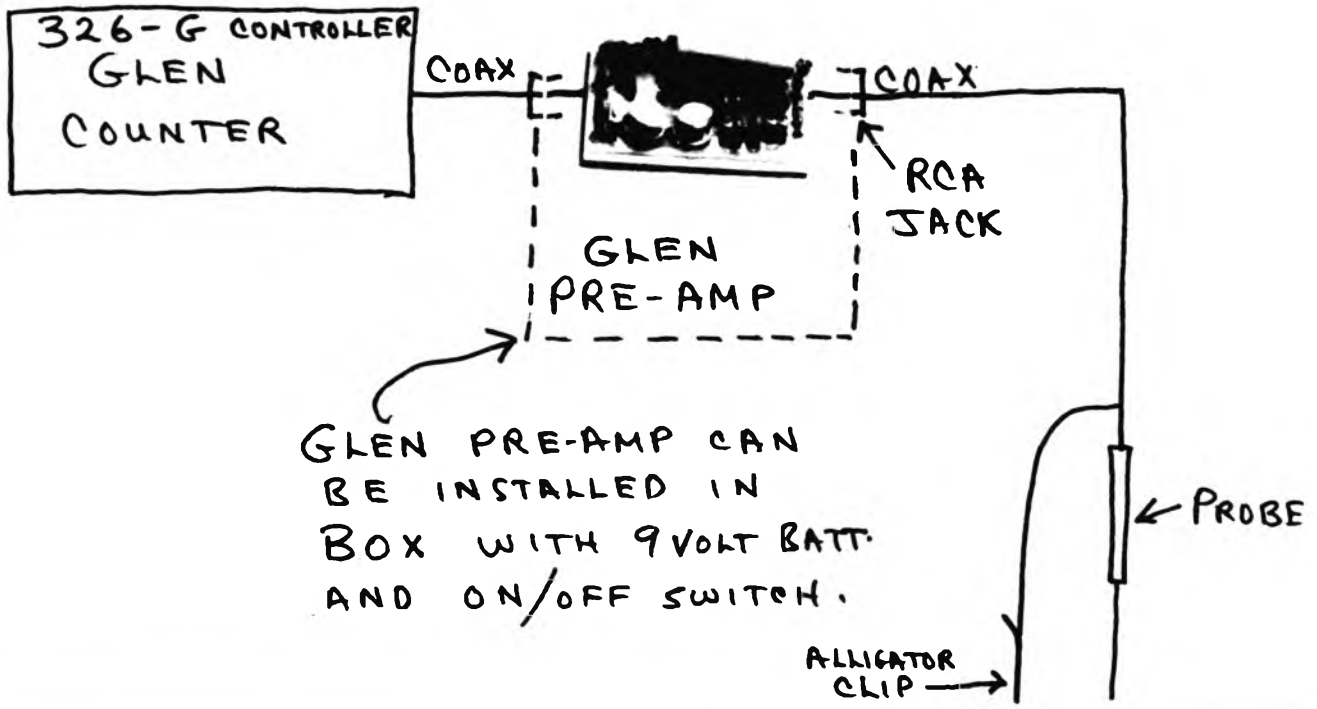

By ADDING  
 THIS NEW SWITCH.  
 THE GLEN CAN  
 BE USED AS  
 A FREQUENCY  
 COUNTER OR  
 SIGNAL GEN.  
 PRESETS (DIP SWITCHES)  
 MUST SET FOR  
 ZERO IN ORDER  
 TO USE GLEN  
 AS FREQ. COUNTER.

ADD MINATURE 3-30PF TRIMMER CAP  
 ACROSS TWO HOLES NEXT TO XTAL TO  
 INCREASE ACCURACY OF COUNTER.

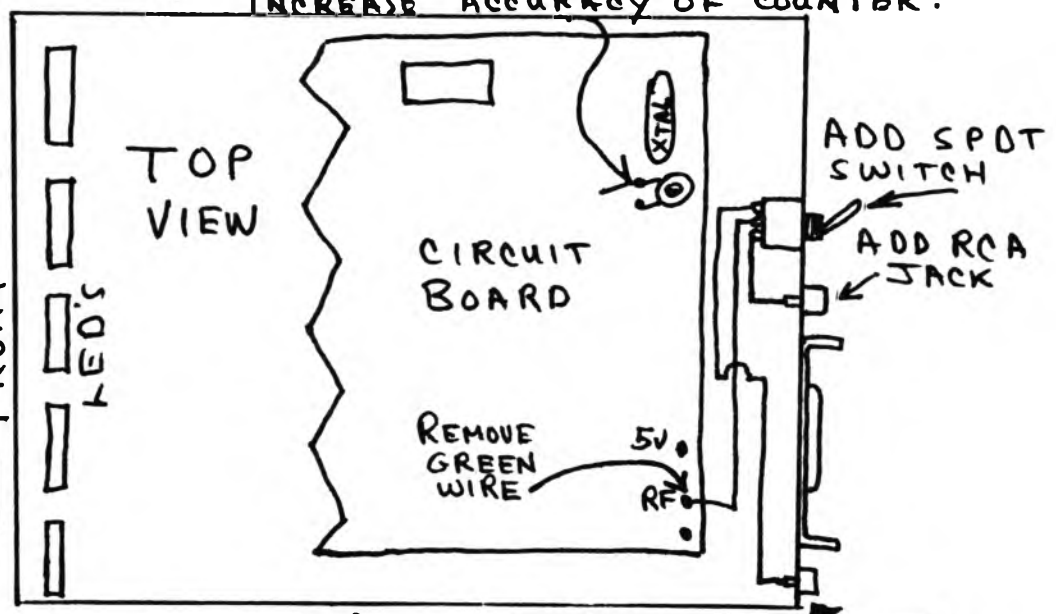

NOTE: DO NOT REMOVE ANY  
 WIRES FROM THIS JACK!

## TECHNICIAN NOTE

Here is a helpful hint to eliminate HF Audio noise from your speaker. Install two 47MF 25WVDC filters across the speaker. A SPST toggle switch may be used to switch CAP in and out.

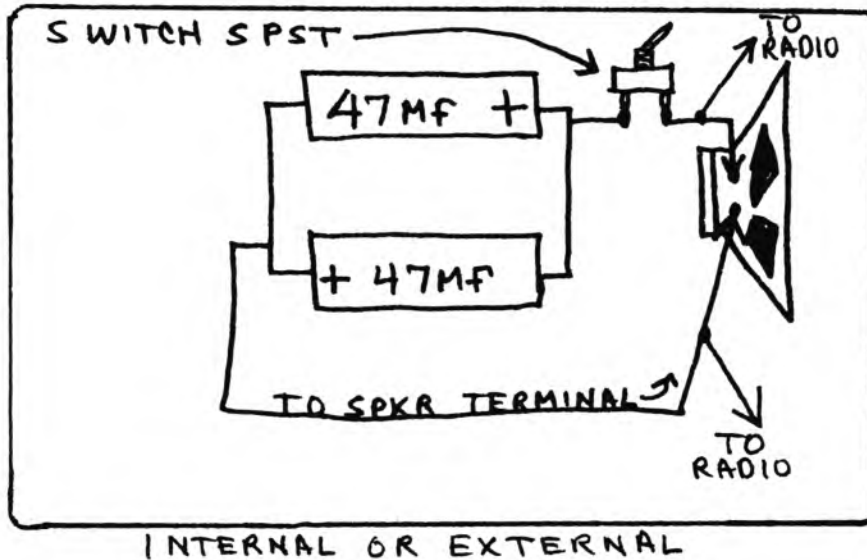

### ROYCE 1-632 CLARIFIER MODIFICATION

- 1-Cut R-48.
- 2-Cut white wire from clarifier. Replace white wire with a jumper to a 9 volt source. Clarifier is now unlocked.

### TELSTAT 1240 LAFAYETTE

POWER: Eliminate D-5 in power supply.

MODULATION: Cut D-311.

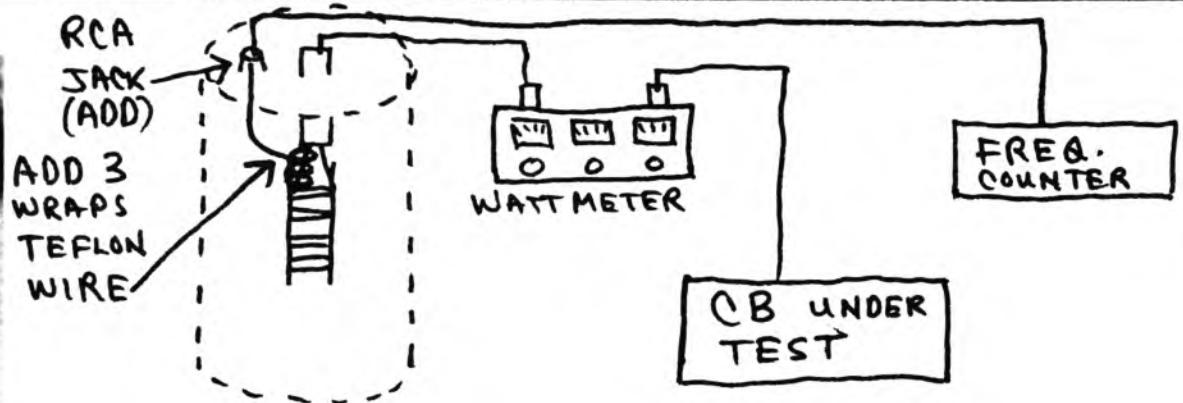

## CAN'T GET THE STANDING WAVE DOWN ON BASE ANTENNAS?

Many times problems with standing wave on base station antennas lie not in the antenna but in the coax. That extra 5 or 10 feet of coax, that was not needed coiled up or that band around a corner has caused many people to turn against the best antennas. Use only the length you need. Cut off all excess.

First let's start with the antenna. Put it together according to manufactures instructions, clear of all wires and metal objects. Make sure you have a ground rod installed and connected. Next, let's adjust the standing wave at the antenna. Once the standing wave has been set at the antenna remove the SWR meter and connect the coax to the antenna.

Now let's put the SWR meter on the radio. If the standing wave is higher than the antenna setting, move the coax around until the lowest reading is obtained.

This method will show you if the antenna or the coax is the problem.

This method will also work with some mobile antennas.

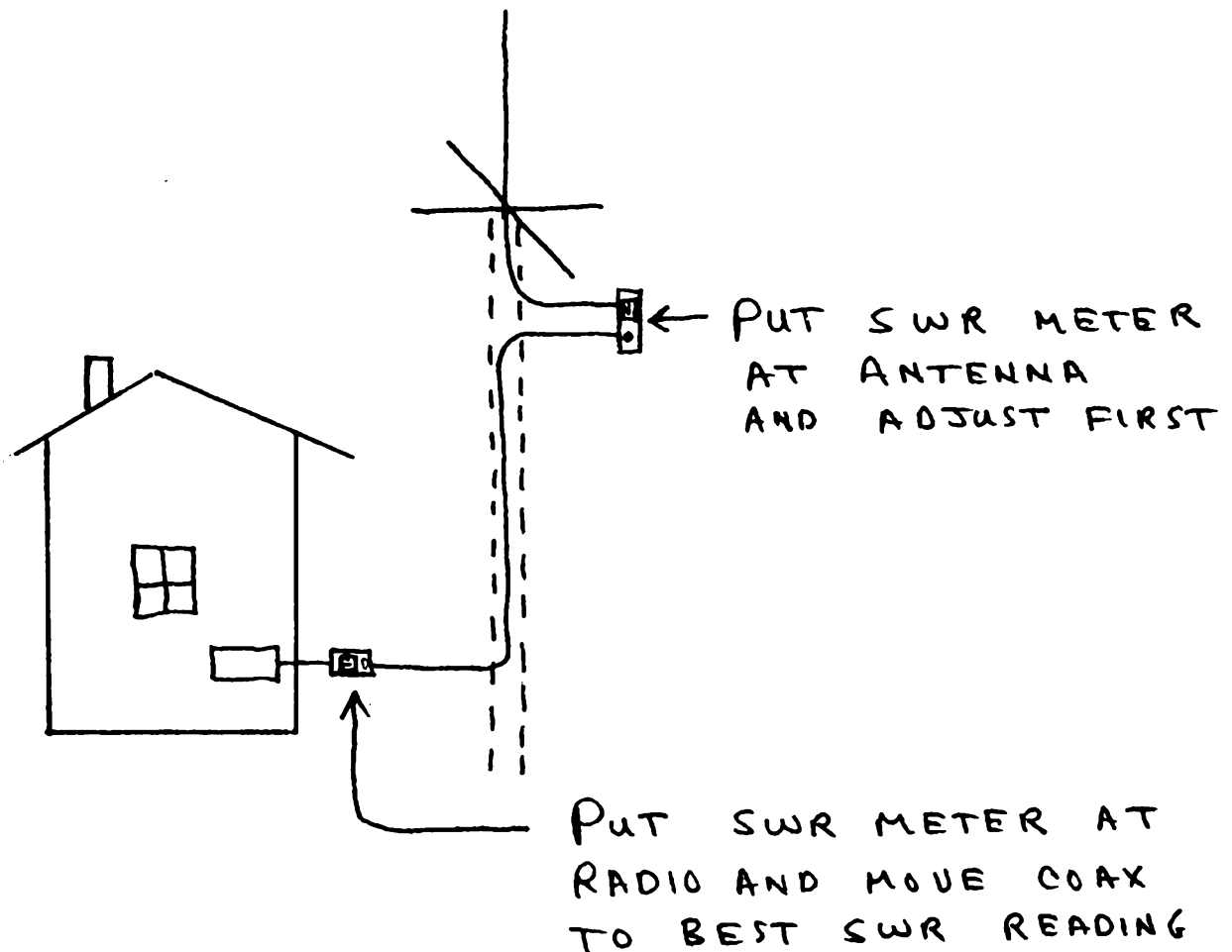

## APARTMENT ANTENNA IDEA THAT WORKS

There are many people living in apartments who would like to use a base station, but due to the restrictions on attaching antennas to apartments, some people have all but given up the idea. Also, some so called apartment antennas' that were on the market did or do not perform with any satisfaction.

Here is an antenna that performs quite well in apartments. Purchase a Shakespeare 388 Marine antenna from your local CB store. Place the antenna on a board and you will be able to shove the antenna out the window and bring it in when you have finished talking. This antenna can be used inside also.

IMPORTANT: You may add coax by an adapter, sometimes called a barrel connector, or "double male". Be sure not to splice the coax from the 388 antenna. If the antenna wire is cut you will not be able to use the antenna. (NOTE WE FOUND THIS OUT THE HARD WAY).

If the SWR's are high on the upper channels, you may adjust the SWR's by trimming back the shorted stub. NOTE that the center conductor is shorted to the shield. Unsolder the center conductor and trim slightly. Re-check SWR. If all OK, tape shorted stub back to coax.

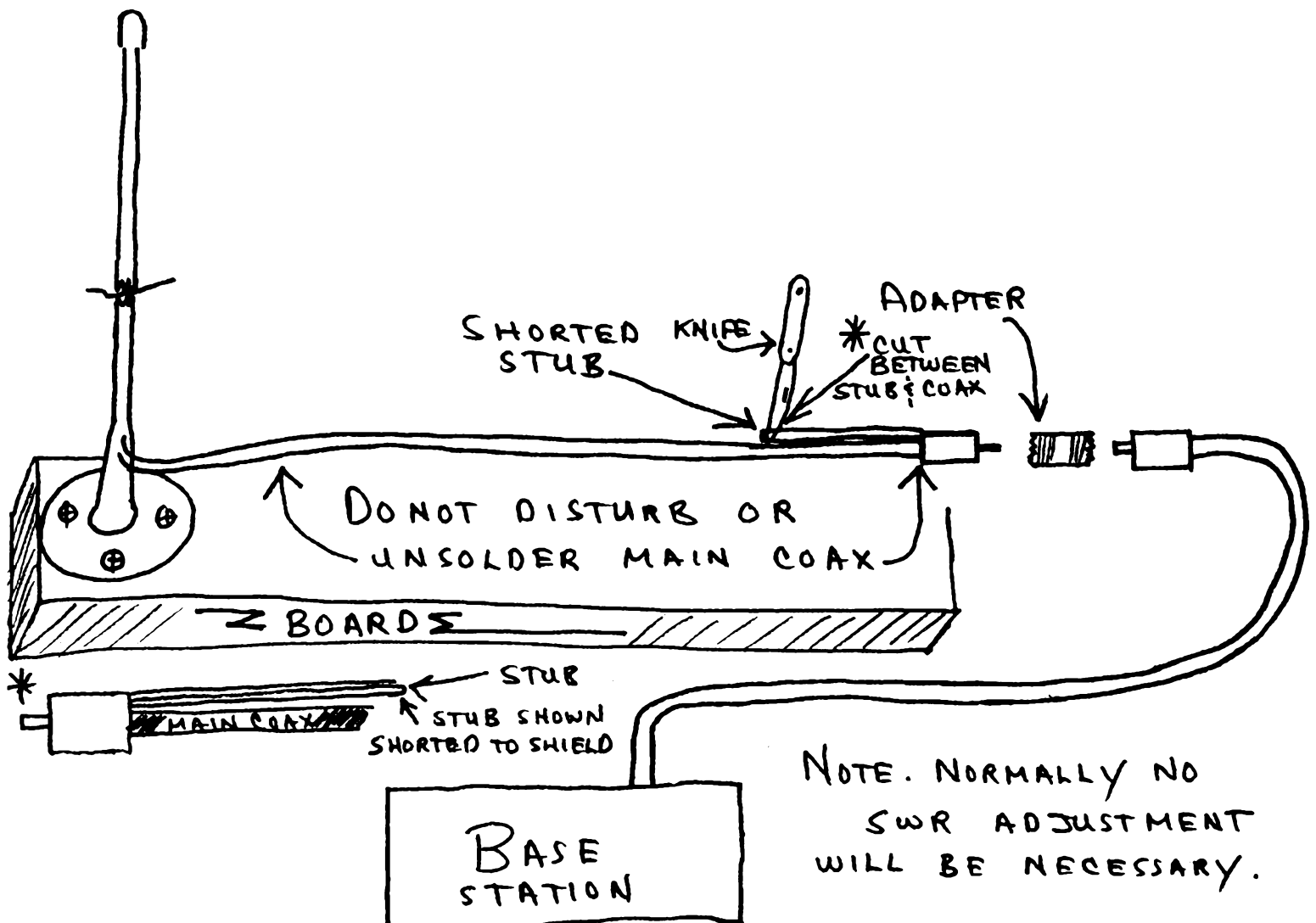

## GROUNDING MOBILE

- 1-Your power cord is not sufficient for RF ground. A separate cable must be used, (Belden 8663 or you may strip the shielding from 6 pieces of old coax). A length of hookup wire will not work for RF ground. The thing you must remember about RF is that it travels on the surface of the conductor and you must have a large surface to conduct RF.
- 2-Rust and oxidization will not pass RF because it is on the surface of the material. All connections must be rust free and clean. Remember rust and oxides disrupt RF path's and ground connections.
- 3-The antenna must have a ground plane of 108 inches to work properly.
- 4-You can not measure RF ground with a ohmmeter. A special RF Bridge must be used.
- 5-The rule of thumb is,if it is clean, bright, and shiny it is a good RF ground.
- 6-All insulated joints such as hood, trunk, and side mirror's must have a ground strap to the car body.
- 7-Silicon or zinc ointment will help oxidization from causing you trouble at your antenna by keeping it down.  
(I prefer zinc ointment).

\*\*\*\*\*COPS! WE COOFED!\*\*\*\*\*

### CORRECTIONS FOR VOLUME 4

Page 50-should be Clarifier Modification R187 (Cut)

Page 45-Under item 4,R301 should be R310

Page 5--Item 7, the drawing is found on page 35.

\*\*\*\*\*

SPACE BELOW FOR YOUR PERSONAL NOTES

OOPS WE GOOFED!

Volume 1, page 23 - Under (1) add step (d) Cut D32 & cut R117.

Volume 2, page 20 - Cross out the entire Transmit Clarifier Modification and use this modification:  
(1) Short R132, cut D24, Cut R60, cut brown wire from clarifier and move it to the brown/white wire on the PA Switch. For 8KHZ + Slide - remove D1, D2, D3, C22, C28, C33, CT2, CT3, & CT4, and install three (3) Super Diodes in place of D1, D2, & D3.

Volume 2, page 21 - On the drawing Pin 20 is shown as Pin 21, Pin 21 is the next Pin to the left.

Volume 3, page 4 - under Parts Needed #1 - Replace 1k with 3k.  
under Steps #4 - Replace 1k with 3k.

Volume 3, page 7 - Top drawing Pin #9 & #10 are backwards.

Volume 3, page 11 - Step 5 - Clip R23 & R24, remove C17 & install 34 PF Cap. in it's place, yields + 6KHZ down 2.5 KHZ.

Volume 3, page 25 - Cross out 2500. ✓

Volume 4, page 5 - Figure 1 for step 7 is found on Page 35 (middle of page). Wonder who made that goof??????????

---

---

~~CORRECTIONS VOLUME III pg 33~~

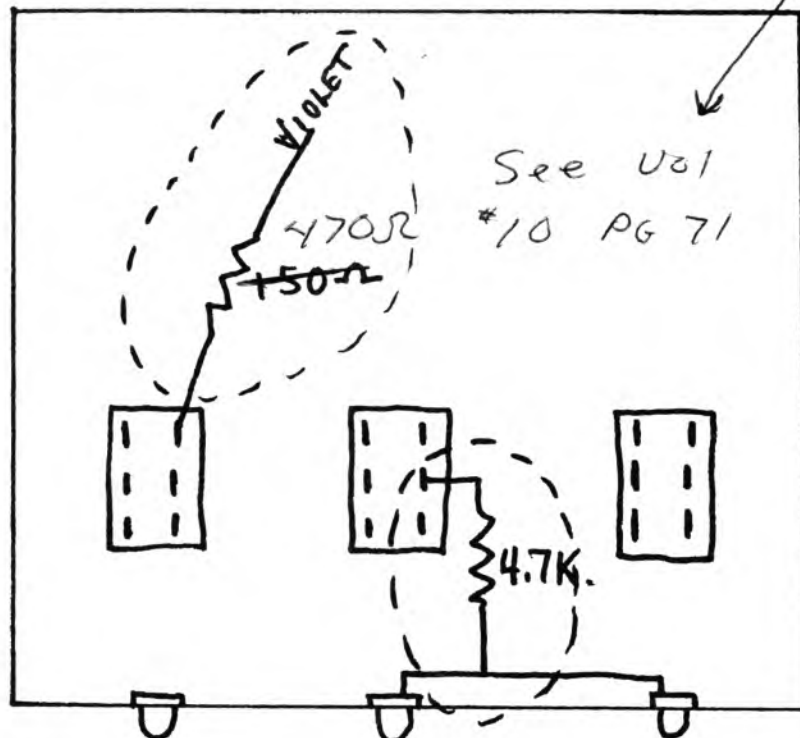

--- → DENOTES AREA TO BE CORRECTED



# ROBYN SB-540D

## CHANNEL EXPANSION & SLIDE

### CLARIFIER MODIFICATION

- 1-Cut B 652.
- 2-Cut R 655
- 3-On J2 pin #5 remove end of L991 that is now connected to the plug and connect it to pin #2 of J2 mike plug.
- 4-Locate the clarifier and find the wire that runs to switch #S5. This wire is one of the end wires. On the clarifier leave this wire intact and remove the wire from the other end of the POT and tape back. Connect the now free end of POT to PC ground. The wire that runs to switch (S.F.) is left intact, but the common wire on S5 must be left and taped back and a new wire soldered to the common terminal. The free end of this wire goes to the 9V regulator. This completes the clarifier mod.
- 5-NEW CHANNEL EXPANSION: Cut the PC trace on pin #8 and pin #7. Isolate the pins. Install a SPST toggle switch across each pin to the PC trace. Open both switches and the set goes down one switch at a time and the set goes up.

### SEARS SSB BASE MODEL #934,38310701

CLARIFIER: Cut R-702. Cut etches on clarifier pot as described below.

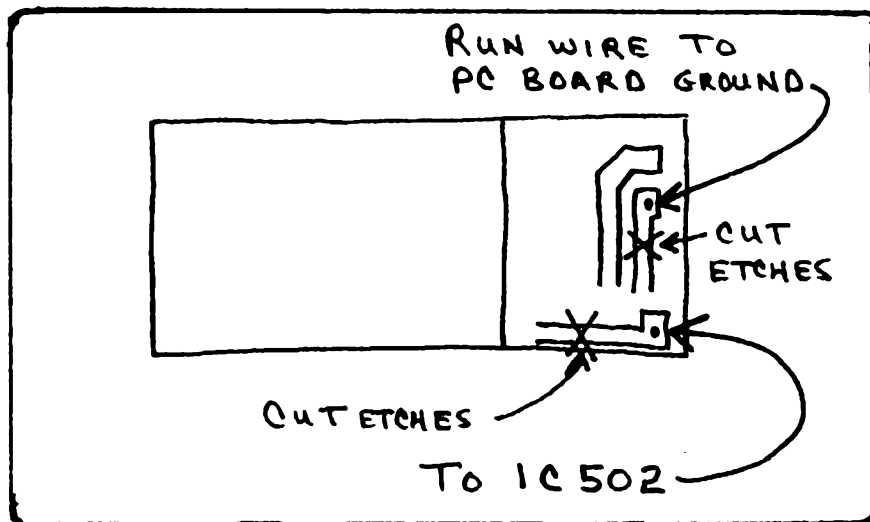

Replace D-702 with super diodes or equivalent for 6-8Kc slide. If more slide is necessary add a super slider diode in series with the newly installed maxi-tune. Be sure to lift anode end of maxi-tune and place in series from that side. The radio will now slide approximatley 11-15Kc.

# COBRA 2000 GTL

## CHANNEL MODIFICATION & FREQUENCY EXPANSION

- 1-Clarifier control MOD allows the frequency counter to follow the clarifier control on transmit and receive.
- 2-Remove the BROWN wire from R407, the fine voice lock and tape back.
- 3-Remove the YELLOW wire from VR402, the coarse voice lock at the PC board and connect it to PC ground.
- 4-Cut D52 and R44. Connect end of FVL to pin 1 of IC4, 8 V source. This completes the slide conversion.
- 5-Remove the MB8734 PLL & install replacement MB8719 PLL Chip.
- 6-Install a kit available from your favorite dealer or two SPST toggle switches or use NB ANL switches. In the radio, run a wire from the common of both switches to pin #18 and the blank terminal of each switch. Run a wire to pin #10 & pin #11. This completes the modification.

### PIN 10

1	27.605	11	27.725	21	27.855	31	27.955
2	27.615	12	27.745	22	27.865	32	27.965
3	27.625	13	27.755	23	27.895	33	27.975
4	27.645	14	27.765	24	27.875	34	27.985
5	27.655	15	27.775	25	27.885	35	27.995
6	27.665	16	27.795	26	27.905	36	28.005
7	27.675	17	27.805	27	27.915	37	28.015
8	27.695	18	27.815	28	27.925	38	28.025
9	27.705	19	27.825	29	27.935	39	28.035
10	27.715	20	27.845	30	27.945	40	28.045

### PIN 10 & 11

15	27.455	22	27.545	29	27.615	36	27.685
16	27.475	23	27.575	30	27.625	37	27.695
17	27.485	24	27.555	31	27.635	38	27.705
18	27.495	25	27.565	32	27.645	39	27.715
19	27.505	26	27.585	33	27.655	40	27.725
20	27.525	27	27.595	34	27.665		
21	27.535	28	27.605	35	27.675		

### PIN 11

15	26.815	20	26.885	25	26.925	30	26.985
16	26.835	21	26.895	26	26.945	31	26.995
17	26.845	22	26.905	27	26.955	32	27.005
18	26.855	23	26.935	28	26.965		
19	26.865	24	26.915	29	26.975		

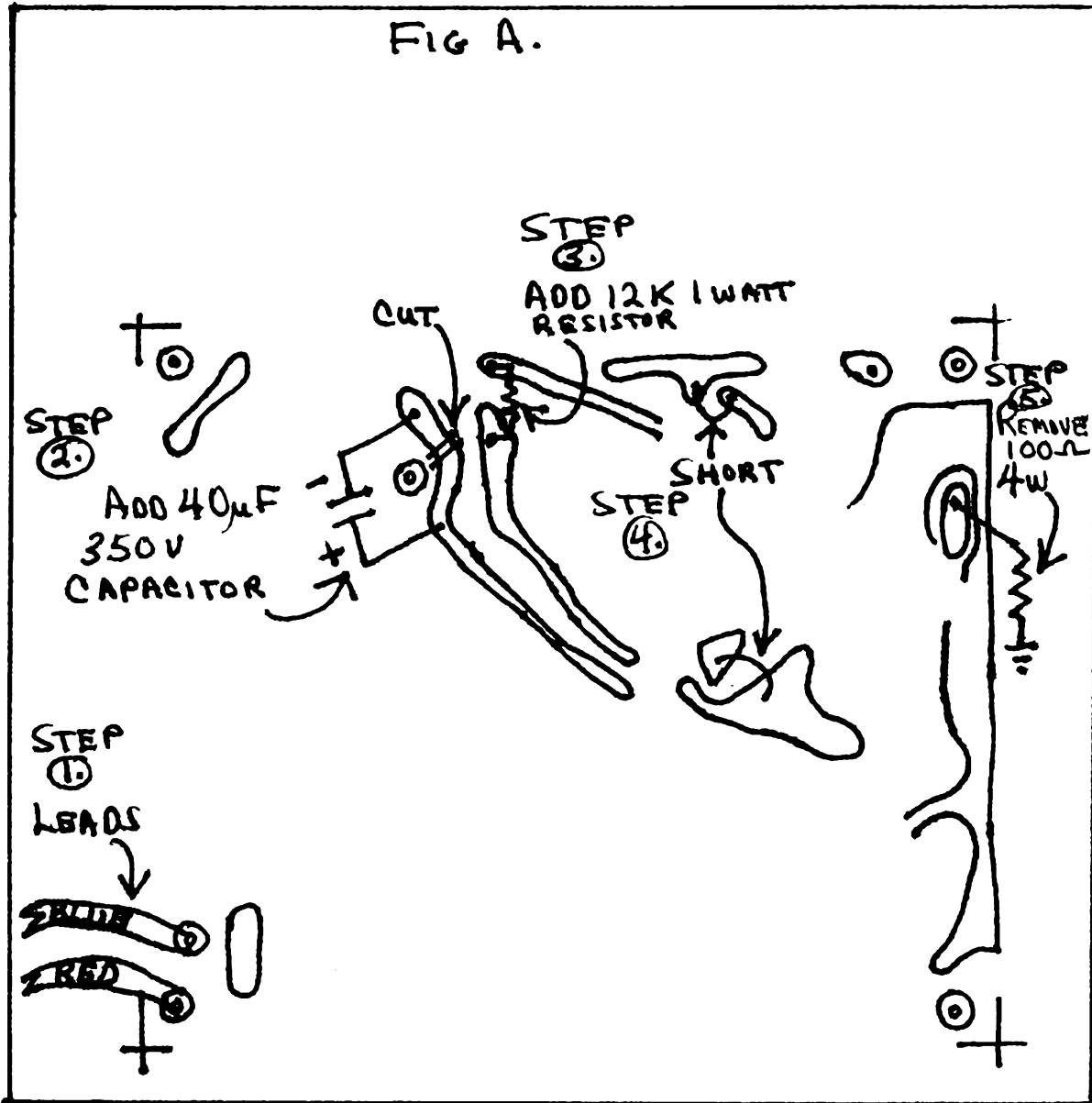

INSTRUCTIONS

- STEPS: 1-Change red and blue lead. Red must be on P702.  
 2-40uf/350V Cap must be installed or voltage will be too high for old CAP and it will blow.  
 3-Install 12K 1 watt resistor as shown.  
 4-Install jumpers (R711 and R712).  
 5-Remove 100 ohm 4 w resistor.

# DAK MARK IX

(CONTINUED)

- STEPS: 6-Remove 6BQ5 tube and socket.  
7-Install new 6L6 tube socket in place of old tube socket as follow:
- (a) Solder a 2" piece of #14 tinned solid copper buss wire to pins, 2, 3, 4, 5, 7, and 8.
  - (b) 6L6 must be cross-wired to fit the printed circuit board taking care wires are spaced and insulated with tubing as needed.
  - (c) Bend wires and install as follows:

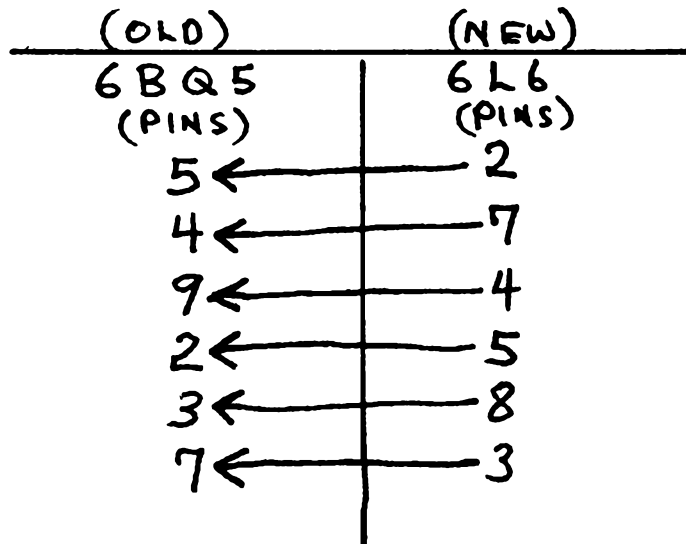

- 8-Install new 6L6 in socket.
- 9-Double check above steps.
- 10-Plug set into wall, install dummy load. Place standby switch in standby mode. Turn on power and observe 6L6 filaments to see that they are "lit". If by now there is no smoke and fuses are not blown this portion of modification is complete and done correctly.

# DAK MARK IX (CONTINUED)

- STEPS:
- 11-Turn standby switch on. Momentarily depress mike button and observe wattmeter you should see upward deflection in power. If not, check all above for wiring errors.
  - 12-Cut D202 found on main radio printed circuit board between RV101 and T201 near center of board.
  - 13-IMPORTANT: MAKE NO ADJUSTMENTS ON MAIN CIRCUIT BOARD. If you do, just put it in the box and send to factory  
NOTE: This mistake was made in attempt to broad band and increase power. Factory adjustments are just fine.
  - 14-Adjust only C-714 and C-715 for power. Nominal power out 18 watts, Dead carrier 27 watts peak.
- ADDITIONAL NOTES:
- (a) Do not short R715.
- 15-Adjust RV603 so that power meter reads correctly.

---

## DAK MARK IX CHANNEL CONVERSION

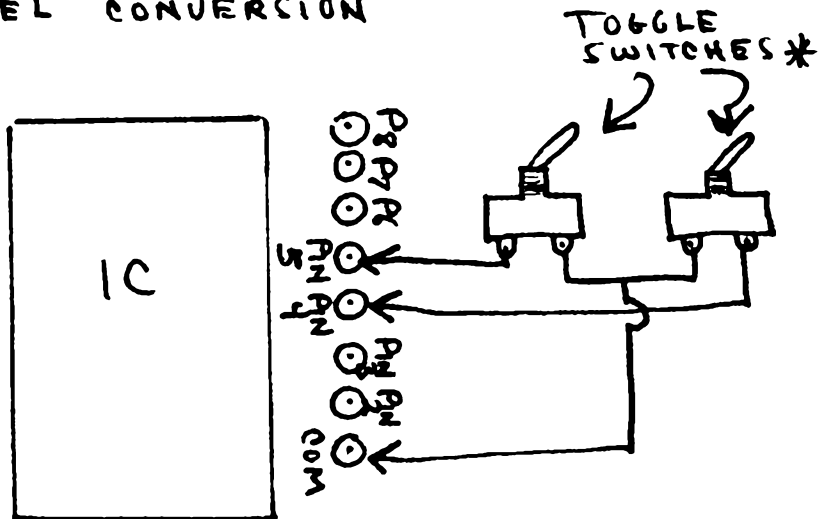

NOTE:

PUSH SWITCHES ALSO MAKE EXCELLENT SWITCHES.

## NEW GRANT WITH 8719 CHIP

1. For Modification #1 ground pin 10 of IC1  
For Modification #2 ground pin 10 and 11 of IC1  
For Modification #3 pin 11 to ground of IC1
2. For clarifier modification, remove the red and orange wires from the clarifier control. Ground one side of the clarifier (red wire) pot and connect the (orange wire) other side to pin 3 of IC 4. Cut R174. Remove C121 10 pf. Remove ctl 20 pf trimmer. Cut D52. Do not cut ~~R149~~. Cut R418.  
*R148*
3. ALC SSB power: VR11 *VA11 will BE DISABLED IF YOU DO STEP #4*
4. AM modification cut collector of TR24 *→ ALSO WILL DISABLE ALC SSB*  
*TO LEAVE ALC AS IS BUT OPEN AM MODULATION cut D54*
5. AM power: VR10
6. Transmitter alignment: L47-L48, L46-L45-L48
7. TR 36 2SC1969B may replaced with 2SC1307

Do not adjust L36, this is the TVI Trap.

Before adjusting wax filled slugs, you must heat to melt wax or you will damage the Ferite Slug.

Locate the SW Board PC-414AA and cut the red and white wire behind the Channel 9 Scan SW. Tape the white wire and connect the red wire to ground. Locate the shielded cable that connects to the PC Board. (behind the NB SW) Cut the shield and the small red and white wire from the board and tape. Connect the 3 wires to the P11 chip. (one to pin 18, one to pin 10 and one to pin 11) Then the wire from 18 goes to the common of the 2 SW's. Pin 10 to the NB SW and pin 11 to the Dimmer SW.



NEW PRESIDENT GRANT WITH 8719 PLL

Modification #1

1	27.605	21	27.855
2	27.615	22	27.865
3	27.625	23	27.895
4	27.645	24	27.875
5	27.655	25	27.885
6	27.665	26	27.905
7	27.675	27	27.915
8	27.695	28	27.925
9	27.705	29	27.935
10	27.715	30	27.945
11	27.725	31	27.955
12	27.745	32	27.965
13	27.755	33	27.975
14	27.765	34	27.985
15	27.775	35	27.995
16	27.795	36	28.005
17	27.805	37	28.015
18	27.815	38	28.025
19	27.825	39	28.035
20	27.845	40	28.045

Modification #2

15	27.455	28	27.605
16	27.475	29	27.615
17	27.485	30	27.625
18	27.495	31	27.635
19	27.505	32	27.645
20	27.525	33	27.655
21	27.535	34	27.665
22	27.545	35	27.675
23	27.575	36	27.685
24	27.555	37	27.695
25	27.565	38	27.705
26	27.585	39	27.715
27	27.595	40	27.725

Modification #3

15	26.815	24	26.915
16	26.835	25	26.925
17	26.845	26	26.945
18	26.855	27	26.955
19	26.865	28	26.965
20	26.855	29	26.975
21	26.895	30	26.985
22	26.905	31	26.995
23	26.935	32	27.005

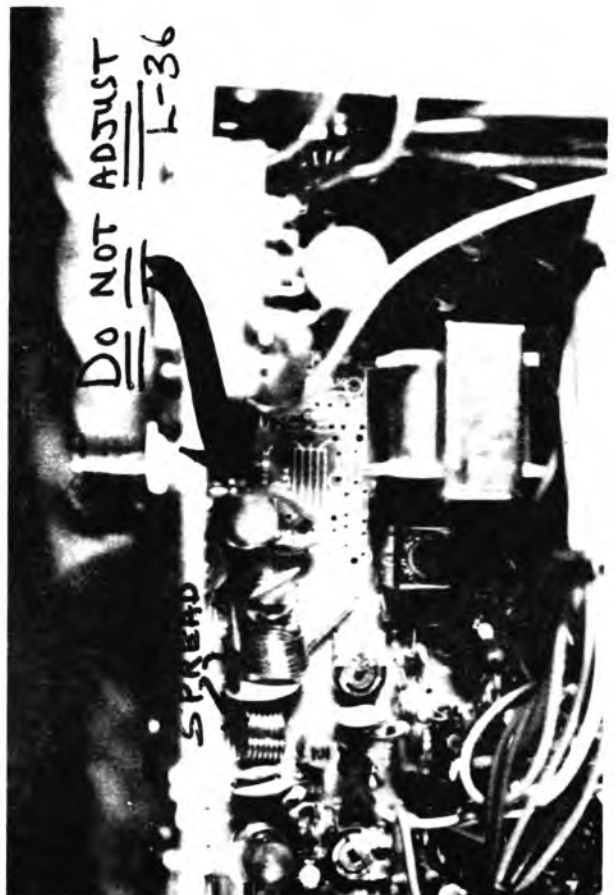
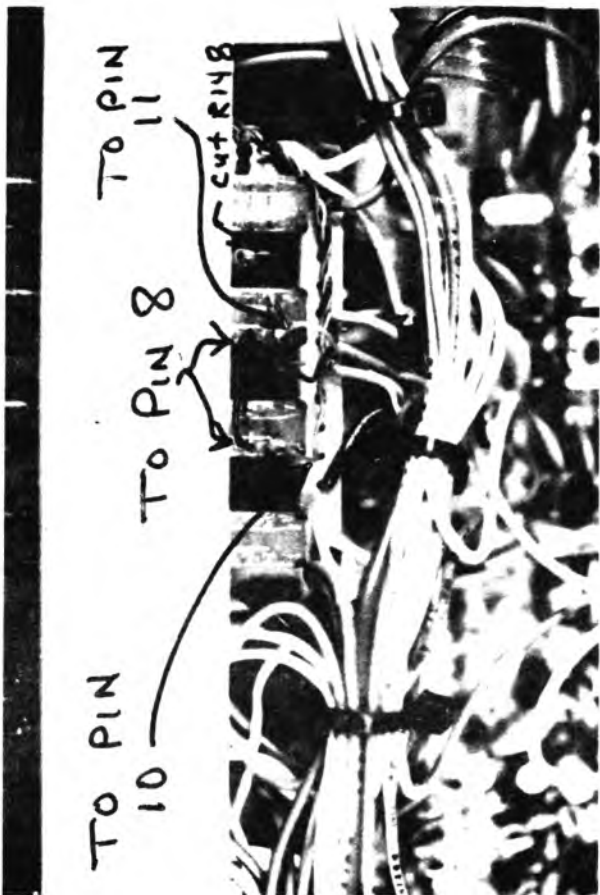
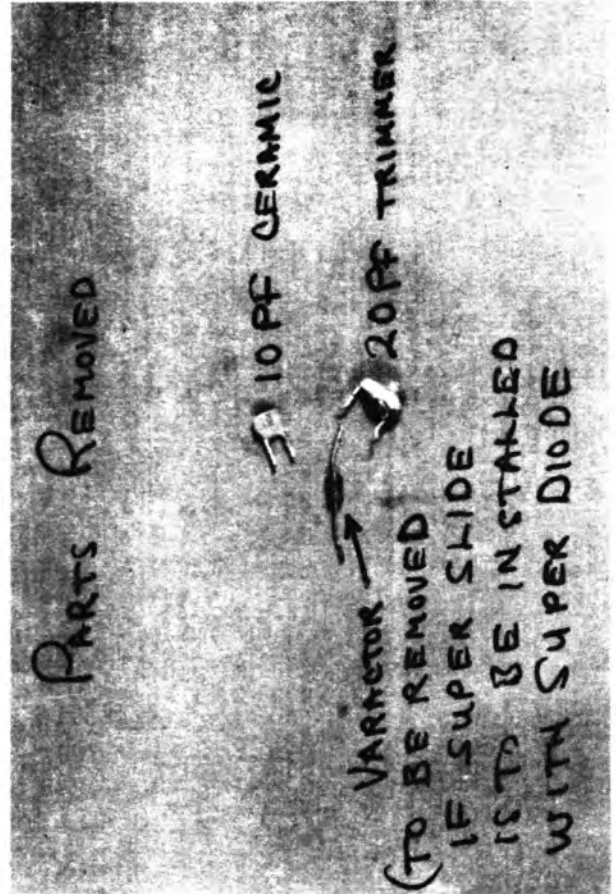
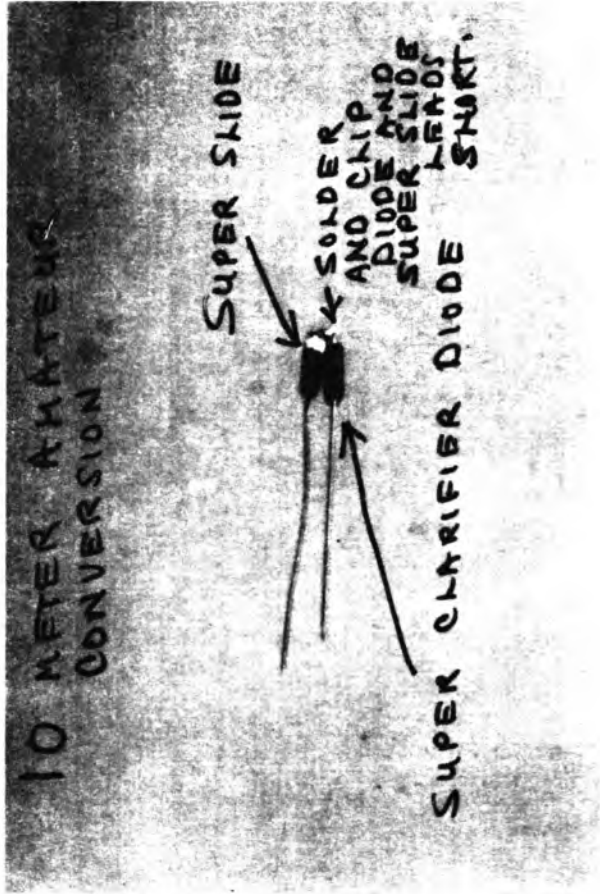

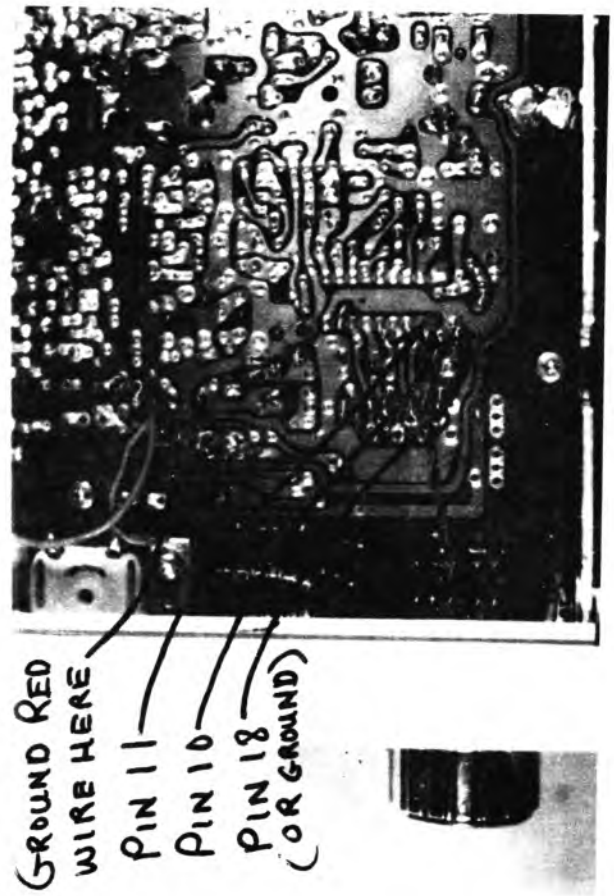
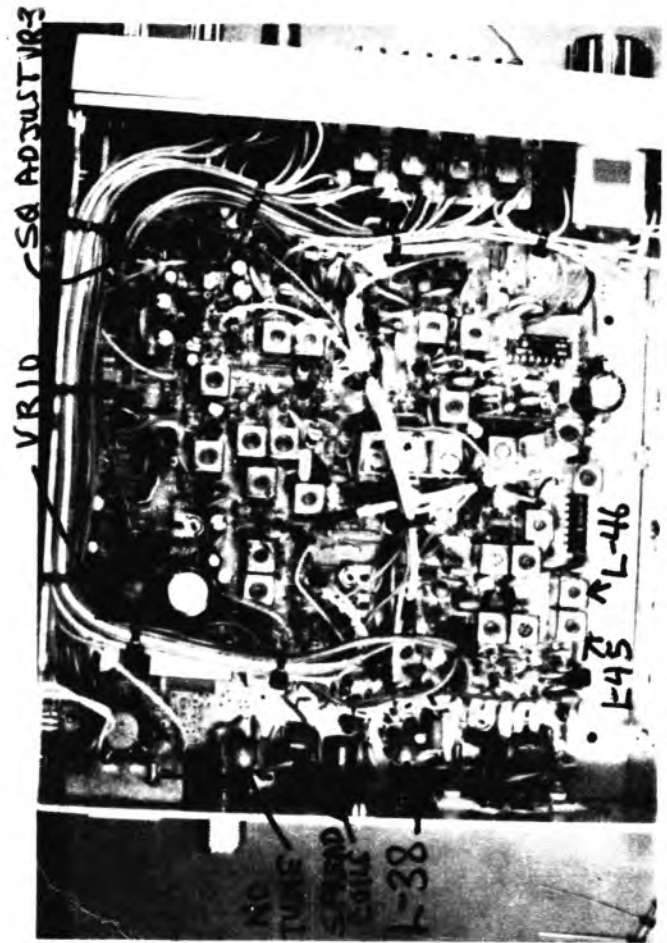
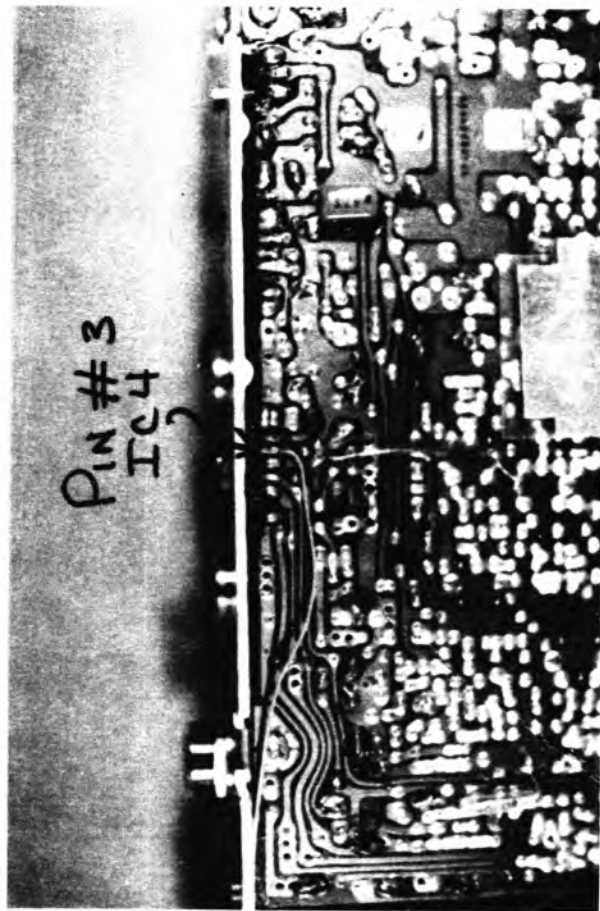
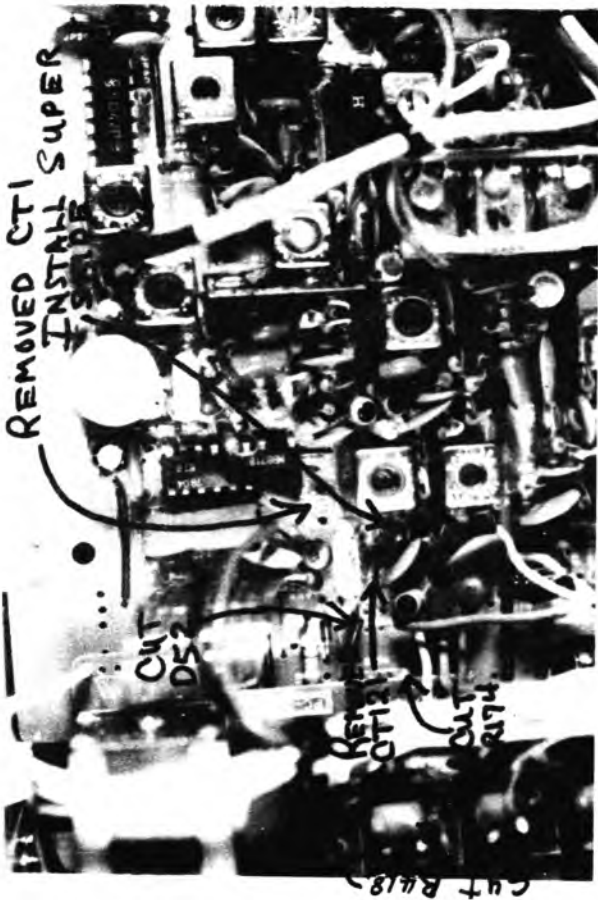

SEARS ROAD-TALKER 40  
MODEL #934-3827-0700  
CHANNEL EXPANSION AND SLIDE

- 1-Remove R303. Unsolder the green wire from the clarifier control at the printed circuit board and connect to 8 volts regulated, this is found at point BB. There is a red wire solder there. Solder the green wire to the red wire. Follow the black wire from the clarifier, connect to the printed circuit board and unsolder it and move it to ground and solder. The unit will slide +2 and -2 KHZ. For +5 and -5 KHZ, remove ct 302 and ct 301, remove D304 and D 306 and install super diodes.
- 2-For maximum AM modulation, connect the anode of a 1N914 to the base of Q405 and ground the cathode.
- 3-AM power adjust RT602. ALC adjust RT701. Adjust L702 and L708 with 1000 HZ tone for peak AM. Note: RT602 is 13.8 regulator.
- 4-Cut the printed circuit trace at pin #9 and isolate the pin. Connect 6 inch piece of wire to pin #9, 10, and 11. Connect a 6 inch piece of wire to pin #1. You must have 2 switches, a single-pole, single-throw toggle and a double throw center off toggle. Connect pin #1 to the common of both switches, pin #9 to the blank pin of the single-pole, single-throw and pin #10 and #11 to the blank pins of the center off switch. Adjust the VCO for full coverage.

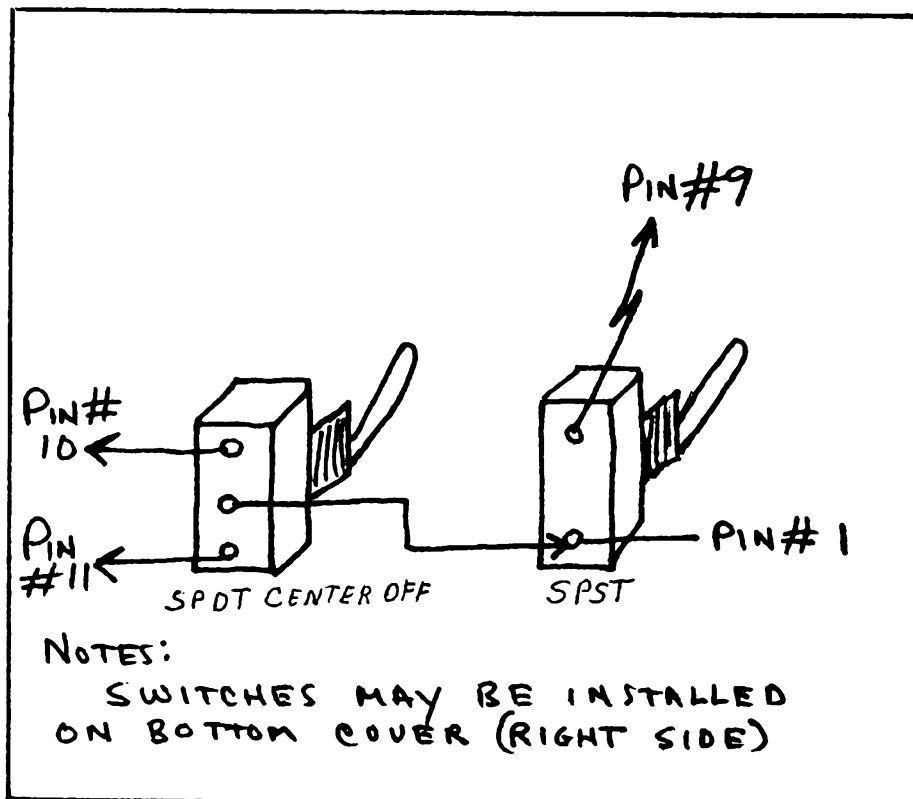

SEARS ROADTALKER

A--Switch on Front  
B--Switch center

1	27.605	11	27.725	21	27.855	31	27.955
2	27.615	12	27.745	22	27.865	32	27.965
3	27.625	13	27.755	23	27.895	33	27.975
4	27.645	14	27.765	24	27.875	34	27.985
5	27.655	15	27.775	25	27.885	35	27.995
6	27.665	16	27.795	26	27.905	36	28.005
7	27.675	17	27.805	27	27.915	37	28.015
8	27.695	18	27.815	28	27.925	38	28.025
9	27.705	19	27.825	29	27.935	39	28.035
10	27.715	20	27.845	30	27.945	40	28.045

A--Switch off  
B--Switch back

1	27.285	11	27.405	21	27.535	31	27.315
2	27.295	12	27.425	22	27.545	32	27.325
3	27.305	13	27.435	23	27.545	33	27.335
4	27.325	14	27.445	24	27.555	34	27.345
5	27.335	15	27.455	25	27.565	35	27.355
6	27.345	16	27.475	26	27.585	36	27.365
7	27.355	17	27.485	27	27.595	37	27.375
8	27.375	18	27.495	28	27.285	38	27.385
9	27.385	19	27.505	29	27.295	39	27.395
10	27.395	20	27.525	30	27.305	40	27.405

A--Switch off  
B--Switch Front

1	27.125	11	27.245	21	27.215	31	27.475
2	27.135	12	27.265	22	27.225	32	27.485
3	27.145	13	27.275	23	27.255	33	27.495
4	27.165	14	27.125	24	27.235	34	27.505
5	27.175	15	27.135	25	27.245	35	27.515
6	27.185	16	27.155	26	27.265	36	27.525
7	27.195	17	27.165	27	27.275	37	27.535
8	27.215	18	27.175	28	27.445	38	27.545
9	27.225	19	27.185	29	27.455	39	27.555
10	27.235	20	27.205	30	27.465	40	27.565

B--Switch center  
A--Switch off back

NORMAL 1-40

Switch-A-Forward

Switch-B-Back

1	27.765	11	27.885	21	27.855	31	28.115
2	27.775	12	27.905	22	27.865	32	28.125
3	27.785	13	27.915	23	27.895	33	28.135
4	27.805	14	27.765	24	27.875	34	28.145
5	27.815	15	27.775	25	27.885	35	28.155
6	27.825	16	27.795	26	27.905	36	28.165
7	27.835	17	27.805	27	27.915	37	28.175
8	27.855	18	27.815	28	28.085	38	28.185
9	27.865	19	27.825	29	28.095	39	28.195
10	27.875	20	27.845	30	28.105	40	28.205

CIVIL AIR PATROL MODIFICATION

SPARTAN PLL, TEABERRY,  
MIDLAND, AND OTHER RADIOS  
USING 858 CHIP

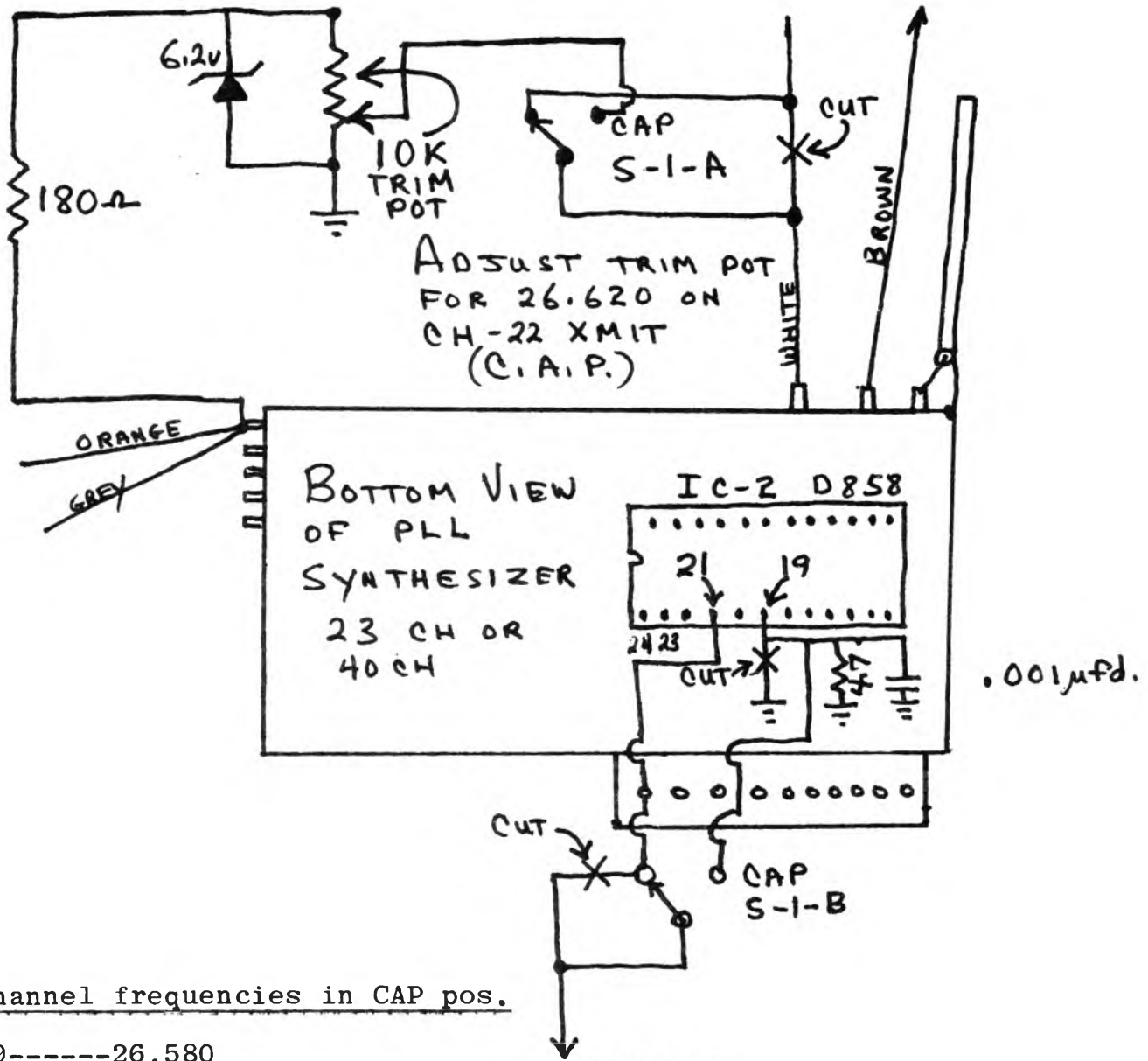

Channel frequencies in CAP pos.

- 19-----26.580
- 20-----26.600
- 21-----26.610
- 22-----26.620 CAP
- 23-----26.650

TO CHANNEL  
SELECT SWITCH

Note: Use DPDT Toggle Switch for S-1, clarifier is disabled in CAP position

Alignment on CB channel 4

Receive

- T-7
- T-6
- L-6 in PLL

Transmit

- T-10 most effective
- L-10
- L-7



SONAR MODEL FS-2340  
Channel Change + Mod + Power

1. Remove the four screw's on osc. board to gain access to bottom of board. Find the back row of contact's on channel selector switch with radio top side up, find the first two terminals running left to right and solder a wire to each of them, the second one is ground, run the wire's through the chassis to the ANL switch - you will use them later. Unsolder the wire from the bottom of the ANL switch marked #38 and tape. Then remove the three wire's from the center post and the one wire from the top contact and solder the wire's together and tape. Then solder the wire's from the PLL to the top contact and to the center contact of the ANL switch.
2. Adjust R105 for maximum modification.
3. Adjust C62 and C63 and L4 and T6 for maximum peak power with 1000 HZ tone.

ANL on

17	26.845
18	26.855
19	26.865
20	26.885
21	26.895
22	26.905
23	26.935
24	26.915
25	26.925
26	26.945
27	26.955

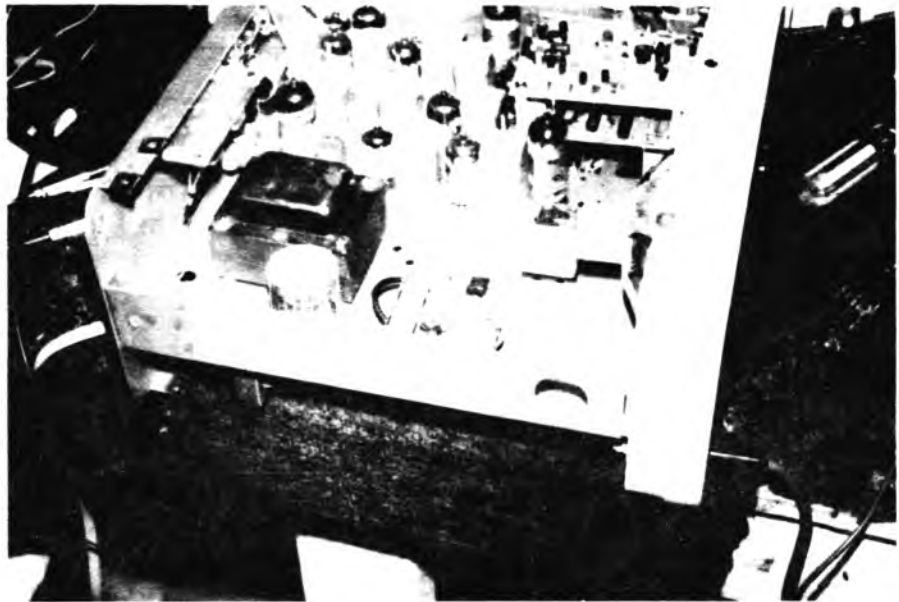

# PALOMAR SSB500 UPDATE

The drawing is  
located in Vol. 8 Pg. 41

## SLIDER 5KC UP & 4.5KC DOWN

- 1-Cut D30
- 2-Jumper D29
- 3-Cut R119. NOTE: R119 must be cut at the end shown in drawing.
- 4-Add a wire from the cut end of R119 to the stripe end of D44.
- 5-Ground the lug on the clarifier as shown in drawing.

High frequencies 27.415 thru 27.965. This requires three SPST switches.

- 1-Add switches 1, 2, 3, & 4 as shown in drawing. Switch 1 to pin 14, switch 2 to pin 13, switch 3 to pin 12, switch 4 to pin 11 of the PLL CKT MC145106.
- 2-See the back of this sheet for operation and frequencies.

Low frequencies 26.325 thru 26.955. This requires 2 SPST switches.

- 1-Cut brown wire between pin 11 of the PLL CKT (MC145106) and the channel selector. Add a switch, this is switch 6.
- 2-Cut the red wire between pin 10 of the PLL CKT (MC145106) and the channel selector. Add a switch, this is switch 5.
- 3-See frequency listing and operation on the back of this sheet.

AM power up NOTE: If low frequencies are added, use channel 20.  
If high frequencies are added use channel 40.

- 1-Adjust VR8 to maximum AM power.
- 2-Adjust L32, L30, L37, & L38 for maximum AM power.

## SSB POWER

Adjust CT7 for maximum SSB power.

## MODULATION

- 1-Adjust VR7 for 100% modulation on AM.
- 2-Adjust VR408 for maximum output on SSB. A scope should be used.

RF GAIN CONTROL 20K POT REQUIRED OR USE SQUELCH POT. (disconnect yellow and green leads)

- 1-Disconnect the RED & ORANGE wires from the RF GAIN SWITCH.
- 2-Turn VR2 fully counter clockwise. (Not necessary if squelch is used).
- 3-Connect the ORANGE wire to the center lug on the 20K POT.
- 4-Connect the RED lead to one of the outside lugs.
- 5-Ground the outer side of the POT. (NOTE: the shield around the PLL CKT may be used as a ground).

DRAWING FOR PALOMAR SSB 500  
IS IN VOL. 8 PG. 41

# HIGH FREQUENCY CONVERSION

FOR  
PALOMAR SSB-500

THE HIGH FREQUENCIES ON THE SSB-500 WILL BE ON CHANNELS 33-40

## SWITCH 1 ON

33	27.415
34	27.425
35	27.435
36	27.445
37	27.455
38	27.465
39	27.475
40	27.485

## SWITCH 3 ON

33	27.655
34	27.665
35	27.675
36	27.685
37	27.695
38	27.705
39	27.715
40	27.725

## SWITCH 1,2&3 ON

33	27.895
34	27.905
35	27.915
36	27.925
37	27.935
38	27.945
39	27.955
40	27.965

## SWITCH 2 ON

33	27.495
34	27.505
35	27.515
36	27.525
37	27.535
38	27.545
39	27.555
40	27.565

## SWITCH 1&3 ON

33	27.735
34	27.745
35	27.755
36	27.765
37	27.775
38	27.785
39	27.795
40	27.805

## SWITCH 4 ON

33	27.975	
34	27.985	
35	27.995	
36	28.005	10 Meter Ham Band
37	28.015	10 Meter Ham Band
38	28.025	10 Meter Ham Band
39	28.035	10 Meter Ham Band
40	28.045	10 Meter Ham Band

## SWITCH 1&2 ON

33	27.575
34	27.585
35	27.595
36	27.605
37	27.615
38	27.625
39	27.635
40	27.645

## SWITCH 2&3 ON

33	27.815
34	27.825
35	27.835
36	27.845
37	27.855
38	27.865
39	27.875
40	27.885

## SWITCH 1&4 ON

33	28.055	10 Meter Ham Band
34	28.065	10 Meter Ham Band
35	28.075	10 Meter Ham Band
36	28.085	10 Meter Ham Band
37	28.095	10 Meter Ham Band
38	28.105	10 Meter Ham Band
39	28.115	10 Meter Ham Band
40	28.125	10 Meter Ham Band

## SWITCH 2&4 ON

33	28.135	10 Meter Ham Band
34	28.145	10 Meter Ham Band
35	28.155	10 Meter Ham Band
36	28.165	10 Meter Ham Band
37	28.175	10 Meter Ham Band
38	28.185	10 Meter Ham Band
39	28.195	10 Meter Ham Band
40	28.205	10 Meter Ham Band

SWITCH #1-ANL SWITCH (ON is UP)  
SWITCH #2-RF GAIN SWITCH (ON is UP)  
SWITCH #3-LED BRITE/DIM SWITCH (ON is UP)  
SWITCH #4-SWITCH on rear of radio (ON is UP) -Remove PA outlet and install SPST switch. SWITCH IN DOWN POSITION is normal operation except as indicated in above switching sequences.

Squelch control has been converted to a variable RF GAIN CONTROL. The radio at present has no squelch, (If modification included).

ANL is now on same switch as noise blanker (NB). When NB SWITCH is in the ON position, so is the ANL.

THE LOW FREQUENCIES FOR SW5 WILL BE ON CHANNELS 5 THRU 28.

SW 5 ON

5	26.695	13	26.795	21	26.895
6	26.705	14	26.805	22	26.905
7	26.715	15	26.815	23	26.935
8	26.735	16	26.835	24	26.915
9	26.745	17	26.845	25	26.925
10	26.755	18	26.855	26	26.945
11	26.765	19	26.865	27	26.955
12	26.785	20	26.885	28	26.965 (Channel ONE)

LOW FREQUENCIES FOR SW6 WILL BE ON CHANNELS 1 THRU 32

SW 6 ON

1	26.325	11	26.445	21	26.575	31	26.675
2	26.335	12	26.465	22	26.585	32	26.685
3	26.345	13	26.475	23	26.615		
4	26.365	14	26.485	24	26.595		
5	26.375	15	26.495	25	26.605		
6	26.385	16	26.515	26	26.625		
7	26.395	17	26.525	27	26.635		
8	26.415	18	26.535	28	26.645		
9	26.425	19	26.545	29	26.655		
10	26.435	20	26.565	30	26.665		

NOTE: To add low frequencies, use the following

SW1 - NB

SW2 - ANL

SW3 & 4 - DPDT CENTER OFF SWITCH mounted in PA outlet in rear of radio.

SW5 - RF GAIN SWITCH (UP position is ON - Break contact).

SW6 - Led Bright/Dim switch (UP position is ON - Break contact).

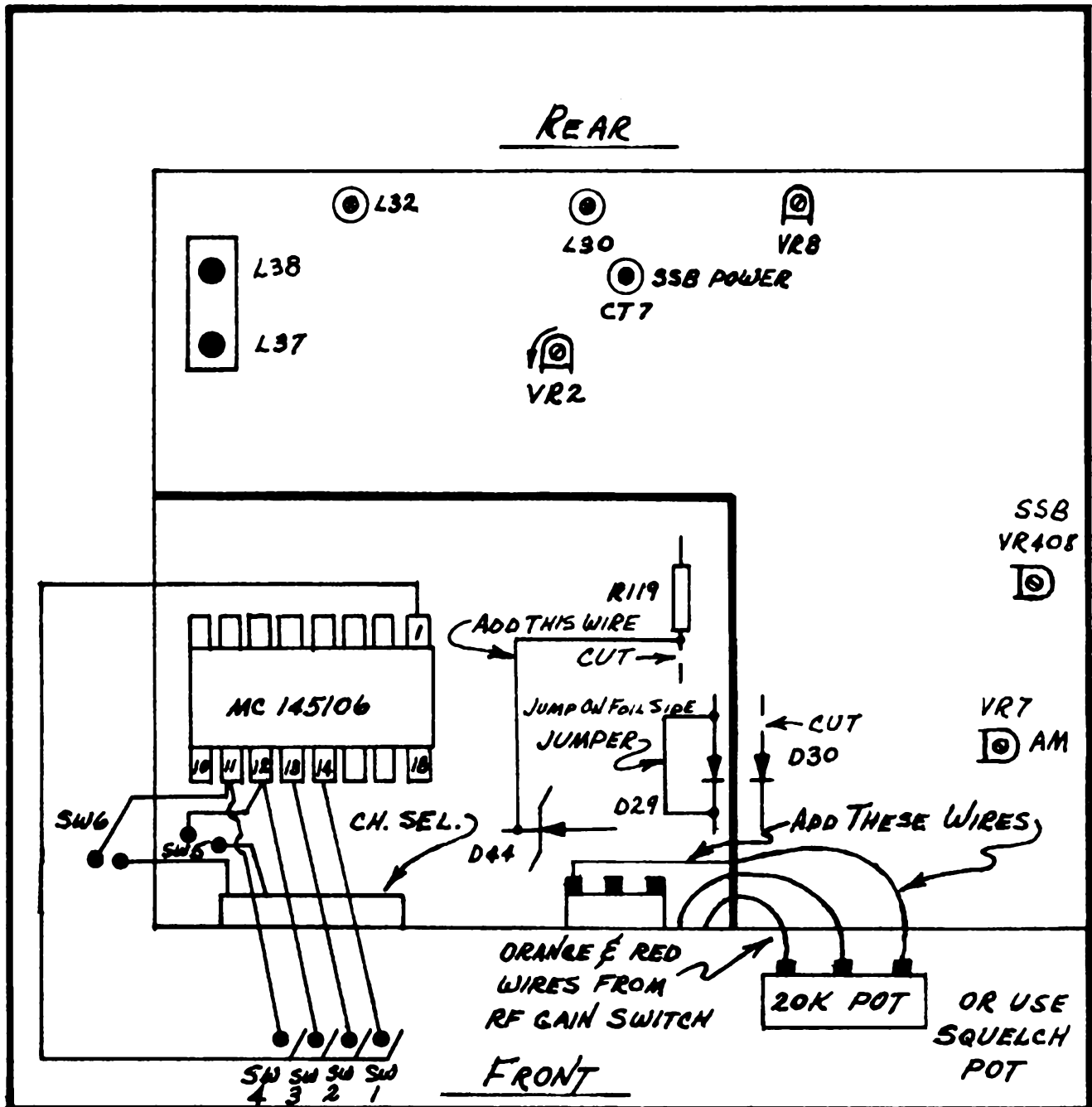

# NEW PALOMAR SSB 500

## Using LC7120 Chip

### CHANNEL EXPANSION

1. Disconnect pins #7 and #8 of IC #7 from the printed circuit board. Reconnect each pin through a single-pole single throw toggle switch.
2. NORMAL CHANNELS - Both switches ON. 27.860 - 27.420 - #7 and #8 OFF. 27.875 - 28.315 - #7 off and #8 on. Below channel 1 coverage, both switches are off.

### CLARIFIER EXPANSION

3. On clarifier control VR401, remove black wire from printed circuit board at junction with 1K ohm resistor and connect to PC board ground.
4. Remove brown wire at printed circuit board from junction of R119 and D32 and connect to cathode of D44.
5. Remove R119.
6. Remove pink wire from D29 anode.
7. Remove D29 and D30.
8. Install pink wire at D29 cathode.

### CONVERSION CHART

#### PIN 7:

1	27.420	11	27.540	21	27.670	31	27.770
2	27.430	12	27.560	22	27.680	32	27.780
3	27.440	13	27.570	23	27.710	33	27.790
4	27.460	14	27.580	24	27.690	34	27.800
5	27.470	15	27.590	25	27.700	35	27.810
6	27.480	16	27.610	26	27.720	36	27.820
7	27.490	17	27.620	27	27.730	37	27.830
8	27.510	18	27.630	28	27.740	38	27.840
9	27.520	19	27.640	29	27.750	39	27.850
10	27.530	20	27.660	30	27.760	40	27.860

#### PIN 8:

1	27.875	11	27.995	21	28.125	31	28.225
2	27.885	12	28.015	22	28.135	32	28.235
3	27.895	13	28.025	23	28.165	33	28.245
4	27.915	14	28.035	24	28.145	34	28.255
5	27.925	15	28.045	25	28.155	35	28.265
6	27.935	16	28.065	26	28.175	36	28.275
7	27.945	17	28.075	27	28.185	37	28.285
8	27.965	18	28.085	28	28.195	38	28.295
9	27.975	19	28.095	29	28.205	39	28.305
10	27.985	20	28.115	30	28.215	40	28.315

# CPI 2500 CONVERSION

- 1-For 5KHZ Drop, in control head, run a jumper to single-pole, single-throw switch to one side. To the other side connect a jumper to pin #16 of ICF.
- 2-Pin #11 in control cable is not used.
- 3-In the trunk run a jumper from pin #11 to pin #3 of ICG.

## CLARIFIER SLIDE

In the trunk cut the collector of Q15. Then short the emitter to the collector of Q18, on 7H060 board.

In the control head of 75078 board, cut D403 by meter lamp.

## CHANNEL SWITCH

Mount a double-pole, single-pole throw switch in the control head.

Connect a wire to one switch section to ground. Run the other side of contact to pin #5 of ICE on 7H037 board. Connect the other section of the switch to the fourth pin of the channel selector switch as per drawing. The other side of the switch to back terminal of 22K ohm resistor, next to IC-E.

In the trunk ground pin #8 on ICK SMO board all the time.

Retune L 603 for 1.8 volts at TP3 on 7H015 board.

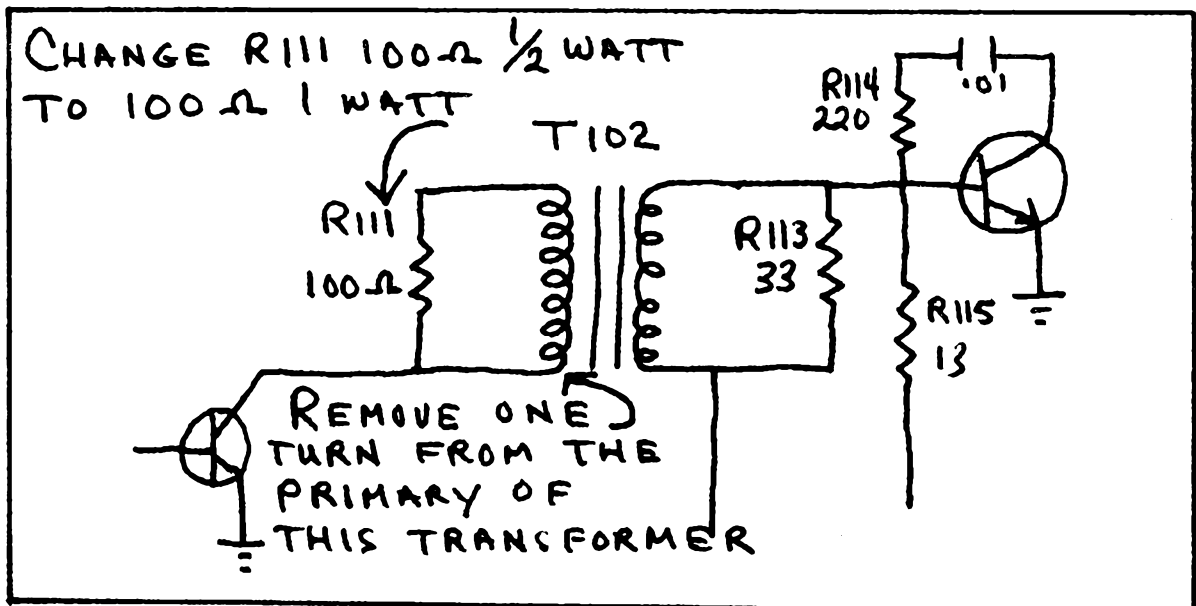

POWER INCREASE APPLIES TO ALL CPI

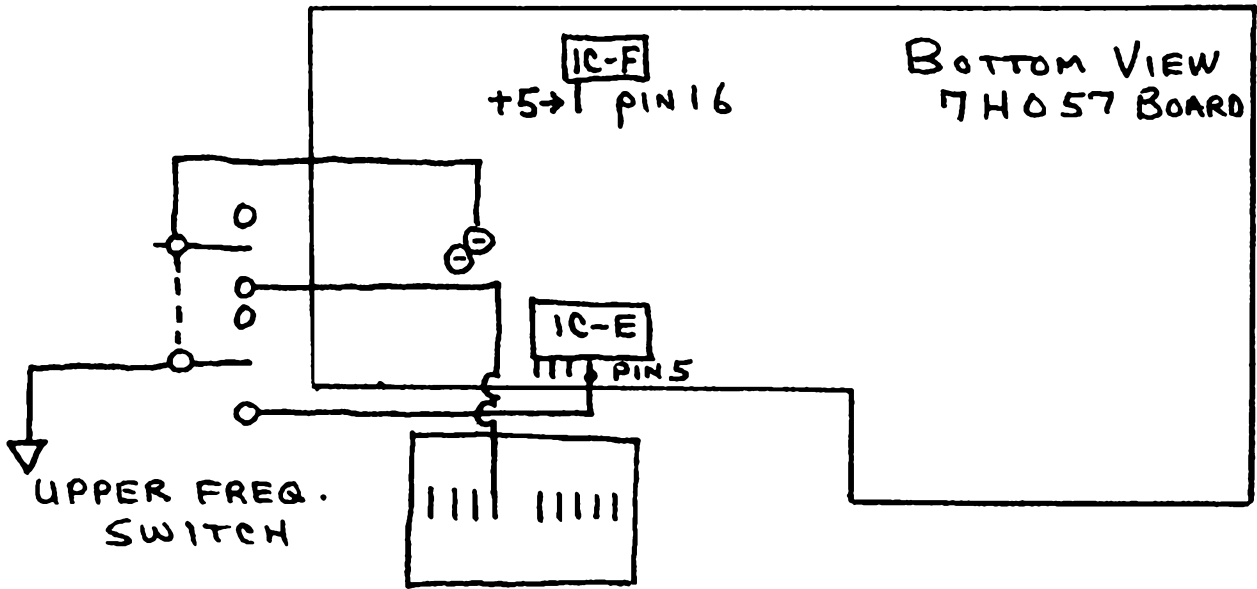

---

CB-640  
AIR COMMAND  
MODULATION ADJUSTMENT

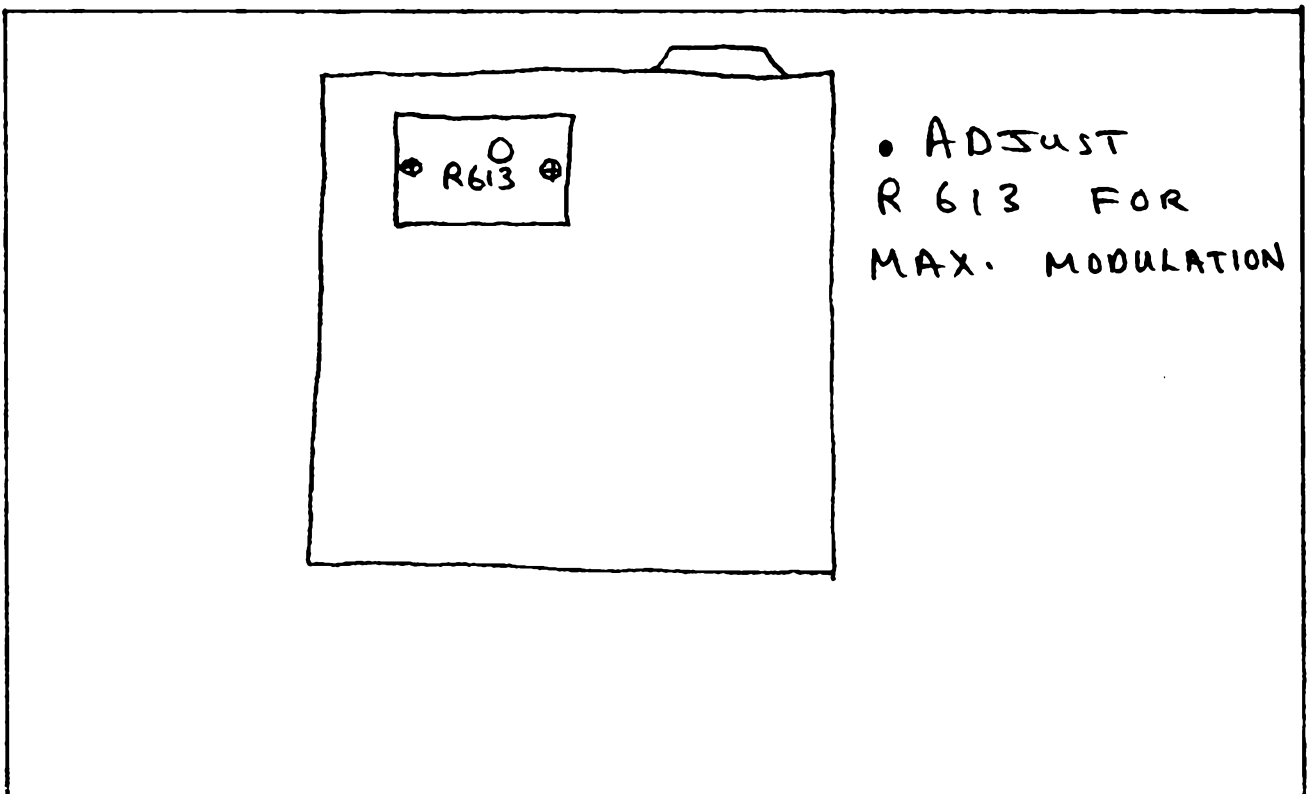



# CHANNEL EXPANSION

BOWMAN 950 / COLT 480 / GEMTRONICS GTX 77 / RCA 14+302

1-Remove the case from the radio. Turn the unit upside down. Front towards you. Cut pins 9-10-11 next to IC and bridge the gap with a 3K 1/8 or 1/4 W resistor. Install a IN914 diode on pin 10 & 11 anode - towards the IC PL 202A or IC 1. Connect the cathodes together and run a wire to the ANL switch. This switch should ground in the on position. This allows 480 KHz. Run a wire from pin 9 of the IC to the NB switch. It should ground in the on position. This will allow 640 KHz up.

2-The VCO OSC. may need to be adjusted--Just a touch!

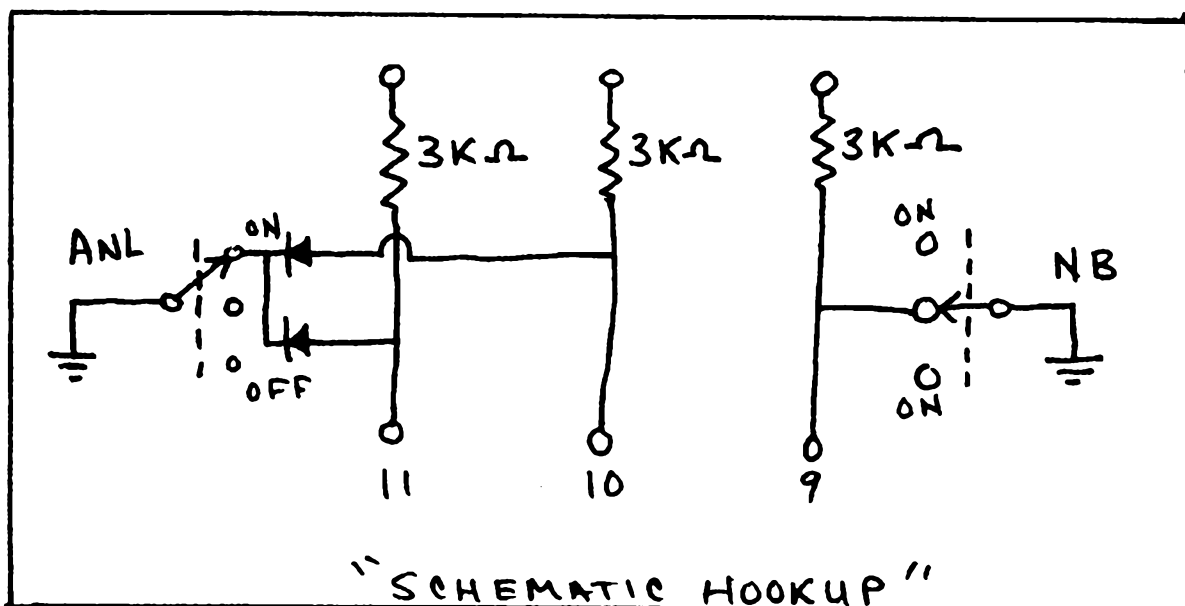
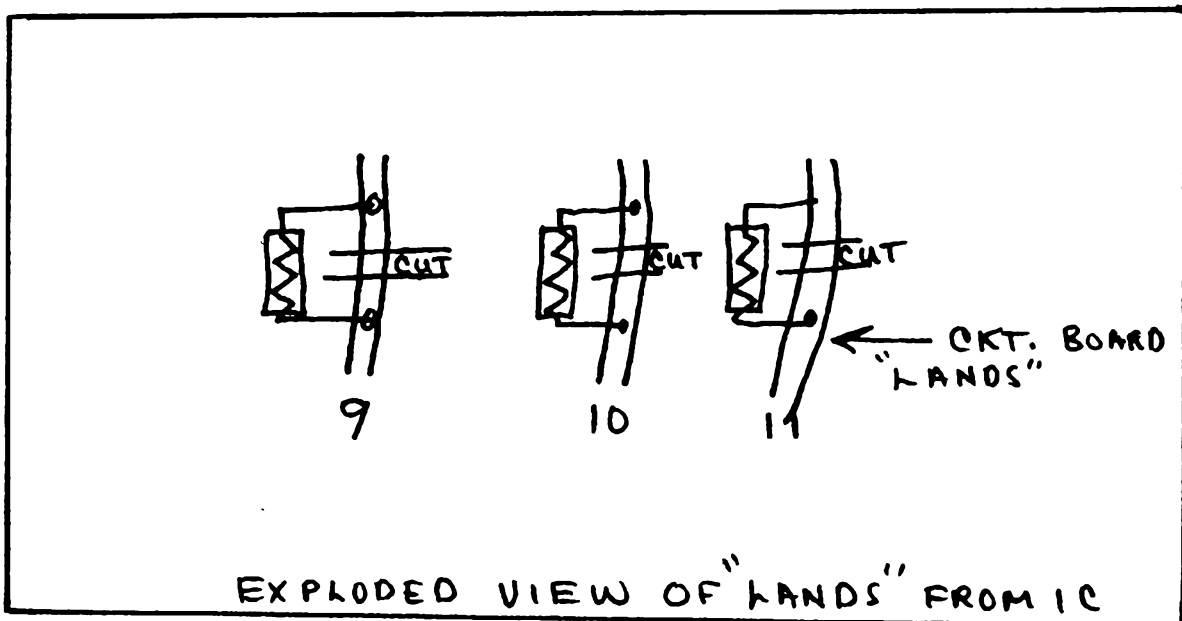

# TRAM 42 CONVERSION

- 1-Cut the PC trace on pin #8 of IC10 and isolate pin #8.
- 2-Move the GREEN wire from pin #8 to the other side of the cut and solder.
- 3-Install a 100K ohm  $\frac{1}{4}$  watt resistor from pin #8 to ground.
- 4-Solder a wire to pin #8 and one to the other side of the PC cut and let hang loose. The lag will be used later.
- 5-Solder a wire to pin #7 and one to pin #16 and let them hang loose. (they will be used later)
- 6-Install two miniature SPST toggle switches in a convenient place and connect one to the wires from pin #8 and the other side of the PC cut. This is the switch #1.
- 7-Connect the other switch to the wires from pin #7 & 16. This is switch #2. This completes the modification.  
SWITCH #1 & 2 WILL GIVE YOU THE LOWER CHANNELS.

DOWN -SW 1&2	DOWN -SW 1&2	DOWN -SW 1&2	UP -SW 2	UP -SW 2
26 - 26.945	18 - 26.855	10 - 26.755	11 - 27.405	19 - 27.505
25 - 26.925	17 - 26.845	9 - 26.745	12 - 27.425	20 - 27.525
24 - 26.915	16 - 26.835	8 - 26.735	13 - 27.435	21 - 27.535
23 - 26.935	15 - 26.815	7 - 26.715	14 - 27.445	22 - 27.545
22 - 26.905	14 - 26.805	6 - 26.705	15 - 27.455	23 - 27.575
21 - 26.895	13 - 26.795	5 - 26.695	16 - 27.475	24 - 27.555
20 - 26.885	12 - 26.785	4 - 26.685	17 - 27.485	25 - 27.565
19 - 26.865	11 - 26.765	3 - 26.665	18 - 27.495	26 - 27.585



SIDE VIEW

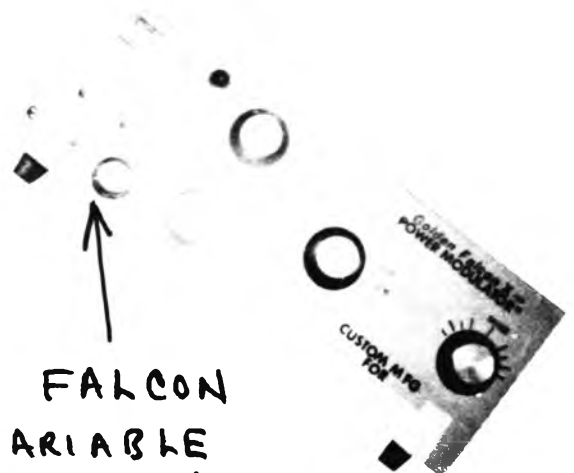

GOLDEN FALCON  
WITH VARIABLE  
POWER CONTROL  
AND POWER MODULATOR.

ROBIN SB-505  
MOBILE SIDEBAND

26.965 MHZ to 27.925 MHZ

Additional 40 channels using II.2858 MHZ crystal

- 1-Use dimmer switch as crystal change switch.
- 2-Remove the orange wire and the black wire from the dimmer switch and solder them together and tape.
- 3-Remove the 100ohm  $\frac{1}{2}$  watt resistor R421.
- 4-Remove the 680 ohm resistor R420.
- 5-Remove the gray wire in front of R420. This wire may be cut out as it will not be used. These parts are all located on the dimmer switch.
- 6-Remove the II.II25 MHZ crystal in back of the channel switch.
- 7-Solder a short heavy bare wire in the crystal lead hole next to CT3. This lead must come through the board far enough to solder one lead of the II.II25 MHZ crystal and one lead of the II.2858 MHZ crystal to this wire. Keep this lead as short as possible to prevent unstable operation.
- 8-Solder one end of a  $2\frac{1}{2}$  inch piece of hook up wire in the other crystal lead hole. The other end is soldered to the center lug of the dimmer switch.
- 9-Solder one end of a  $2\frac{1}{2}$  inch piece of hook up wire to the unused crystal pin on the II.II25 crystal. The other end is soldered to the rear lug of the dimmer switch.
- 10-Solder one end of a  $2\frac{1}{2}$  inch piece of hook up wire to the unused crystal pin on the II.2858 MHZ crystal. The other end is soldered to the front lug on the dimmer switch.

CLARIFIER RANGE

- 1-Open microphone and short out the 3.3 K resistor. This will increase the range of your clarifier.

CLARIFIER ON TRANSMIT

- 1-Remove DI36. (Located by the channel switch).
- 2-Open the microphone and remove the black wire going from the push to talk switch to the upper side of the clarifier control.
- 3-Solder a 2.2K resistor from the supply line for pin 9 on MB8719 IC to pin 6 of the microphone socket.
- 4-The 3.3K resistor in the microphone must be shorted for this to work.

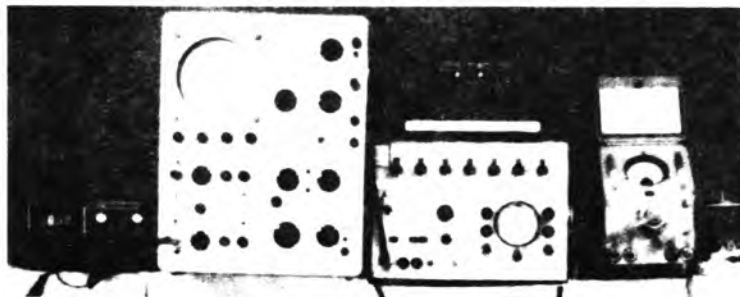

ROBIN SB-505  
MOBILE SIDEBAND

THE FOLLOWING ALIGNMENT MAY BE NEEDED:

- 1-Channel 40 standard A-M receive mode clarifier in center of range. Correct probe of RF VTVM or oscilloscope to test point TP-10 and adjust L-18 for maximum out put.
- 2-Same mode as step one except DC VTVM probe to TP-9. Adjust L-13 to obtain 3.5 to 3.7 volts on VTVM.
- 3-Channel 40 USB receive mode R-F VTVM probe to TP-I. Adjust L-I4 for maximum out put.
- 4-Channel 40 USB receive mode frequency counter to TP-I. Adjust CT3 to 35.2075 MHZ.
- 5-Channel 40 A-M receive mode frequency counter to TP-I. Adjust L20 to 35.2050.
- 6-Channel 40 LSB receive mode frequency counter to TP-I. Adjust LI9 to 35.2025 MHZ.
- 7-Channel 40 LSB transmit mode frequency counter to TP-I. Adjust VR3 to 35.2025 MHZ.
- 8-Channel 40 USB receive mode frequency counter to TP-3. Adjust CTI to 7.8025.
- 9-Channel 40 LSB receive mode frequency counter to TP-3. Adjust CT2 to 7.7975.
- 10-Channel 40 A-M transmit mode frequency counter to TP-3. Adjust LI7 to 7.8000MHZ.

If the 11.2858 MHZ crystal is high in frequency it may be lowered by soldering a 2 to 5PF capacitor in parallel with the crystal. Keep lead wires short.

Use 50ohm dummy load during transmitter adjustments. To balance transmitter out put adjust L36 on highest, then lowest channel for same wattage out. To balance receiver adjust L10 for maximum S meter reading and L9 and L8 alternately on highest and lowest channels.



# BOMAN BASE CBH-990

## SUPER POWER MODULATION MODIFICATION

**THEORY:** This modification causes the radio to idle at approximately  $\frac{1}{2}$  watt with the mike keyed and modulate to full power when mike is spoken into. This results in very loud audio when heard on the other end. Power Mod circuit may be applied to other circuits. This helpful hint courtesy of my good friend, R. Boyer.

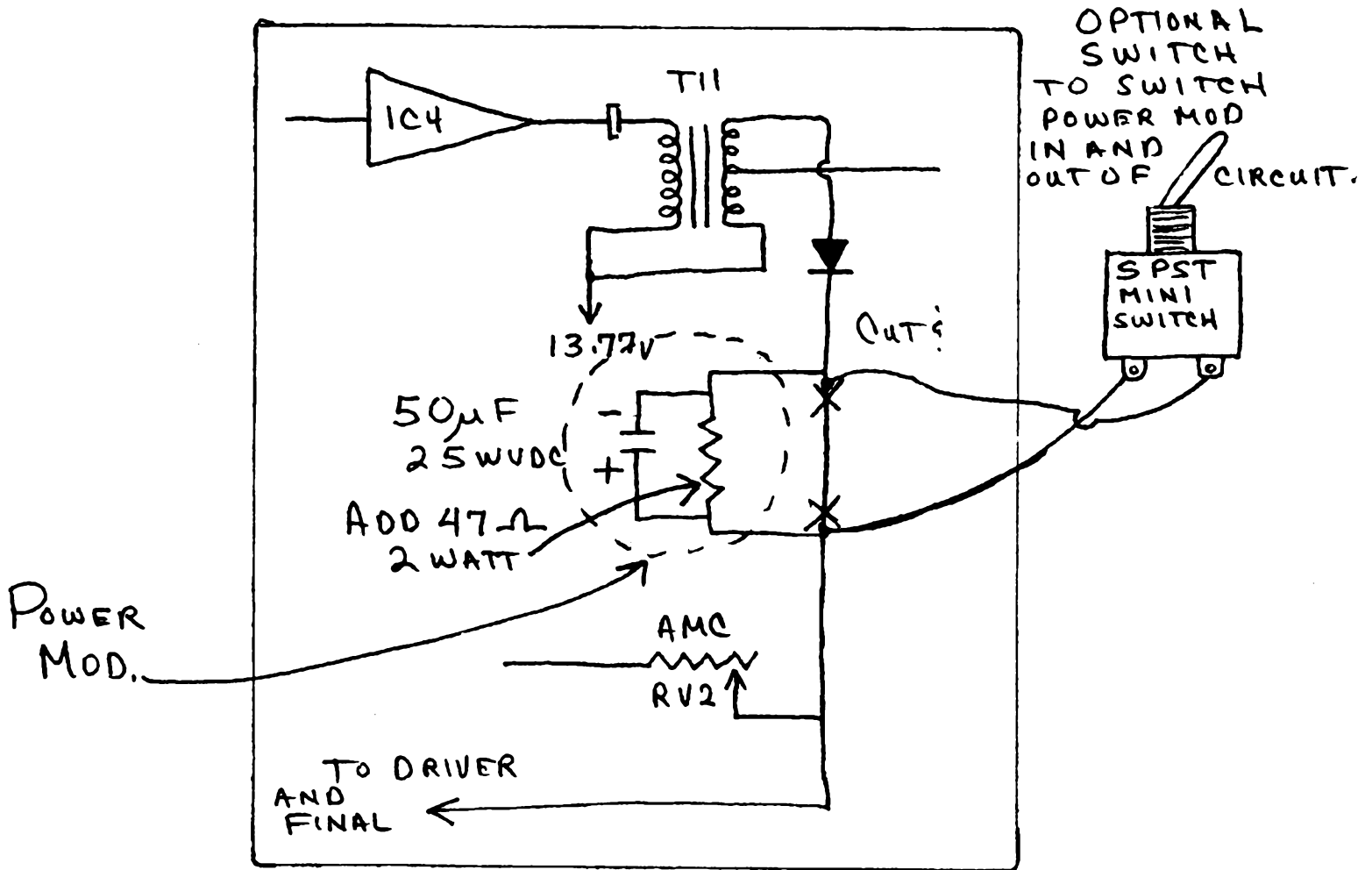

**NOTE:** THIS MOD. WORKS IN AM MODE ONLY.

# THE "ART OF WIDEBANDING"

AS APPLIED TO 858 UNIDEN CHASSIS  
CURES PROBLEM OF POWER DROP  
FROM 26 to 28 MHZ

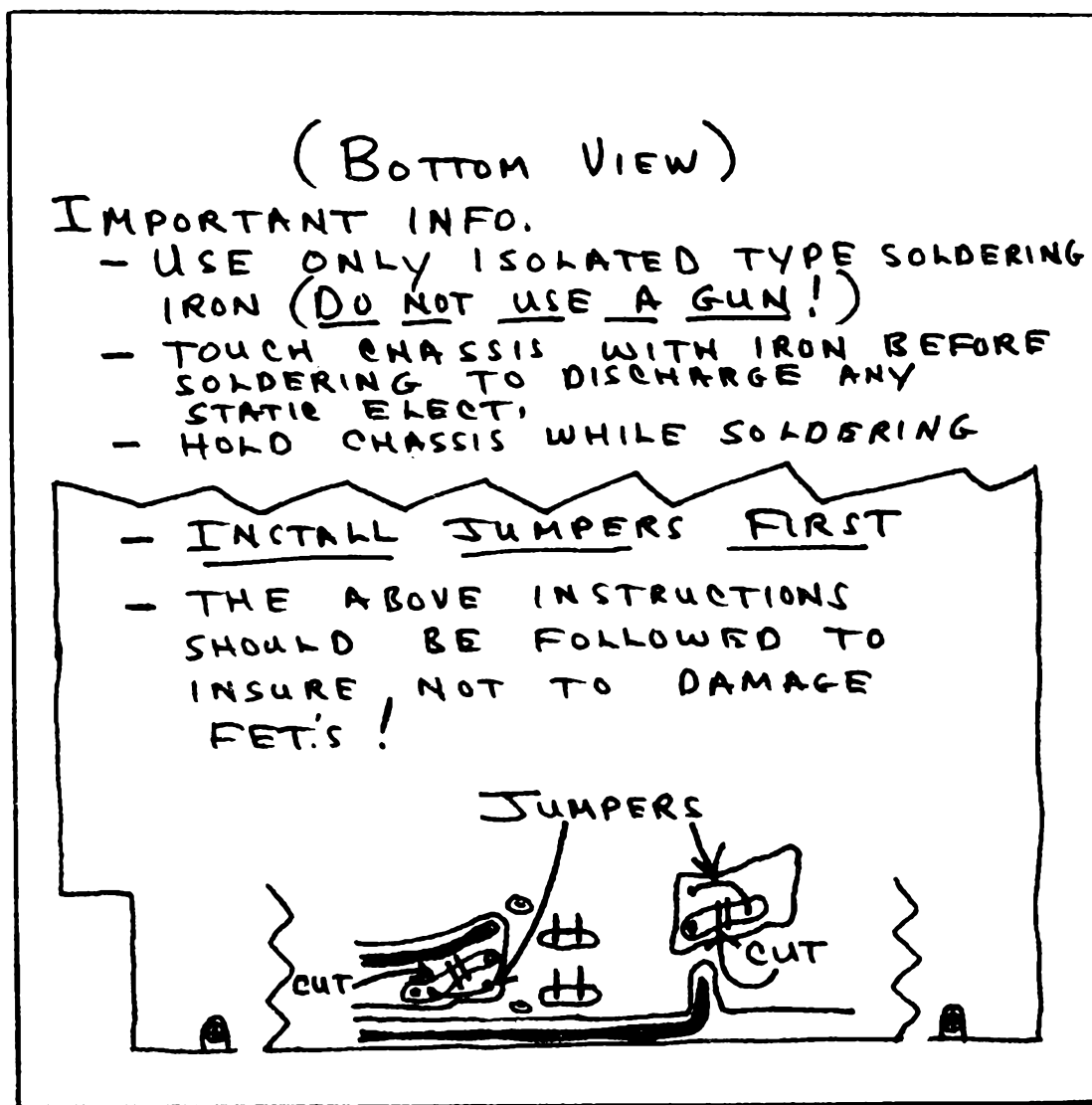

## INSTRUCTIONS

1. Locate L-37.
2. Looking at bottom of circuit board, locate areas to be modified (should be near bottom of L37). Cut traces first.
3. Make two cuts as shown by "11". Make two jumpers and place in location as shown.
4. Retune rear slug on "hi freqs.", and front slug on Ch. 1 or "low freq.".

## ROYCE MODEL 612 MODIFICATION

At the channel selector switch, there is six leads which go to the PLL circuit. The leads are designated 2-0 thru 2-5. By placing the terminals at 1.5 volts or at ground, the channels are selected. Removing a lead is the same as placing the terminal at 1.5v.

By removing certain leads or placing them at ground, the Royce 612 can be modified to go up or down in frequency. Attached is a chart that shows which frequencies can be obtained by removals or grounds. This can best be accomplished thru a switch.

By taking the orange wire from the Loc-Distance switch and soldering it to ground on the circuit board (this places radio in distance permantely) and removing black lead entirely will allow you to now use the switch in whatever way needed.

Also removing both leads from the ANL switch and taping them so that they do not make contact with each other or any other part of the radio (this will leave the ANL in the ON position all the time). Ths ANL switch can now be used for whatever need be.

Normal Channel	Removal of			Grounding Terminal		Remove & Ground
	5	4	3	5	3	
	2 Red wire	2 Orange	2 Yellow	2 Red	2 Yellow	2
1	27.285				26.885	27.205
2	27.295				26.895	27.215
3	27.305				26.905	27.225
4	27.325				26.925	27.245
5	27.335				26.935	27.255
6	27.345				26.945	27.265
7	27.335				26.955	27.275
8		27.215				
9		27.225				
10		27.235				
11		27.245				
12		27.265				
13		27.275				
14		27.285				
15		27.295				
16		27.315				
17		27.325				
18		27.335				
19		27.345				
20			27.285	26.885		
21			27.295	26.895		
22			27.305	26.905		
23			27.335	26.935		

-Continued-

EXAMPLE: To have frequencies of Column 1, remove leads from Loc-Distance switch as per previous paragraph. Take RED wire (2<sup>5</sup>) from PLL terminal and wire it to the center terminal on switch. Add lead from local position on switch to PLL terminal 2<sup>5</sup>. In local position channels 1-23 are normal. In the distance position channels 1-7 are the ones in column 1.

\*\*\*\*\*

RELAY-LESS LINEAR SWITCHING FOR AM & SSB

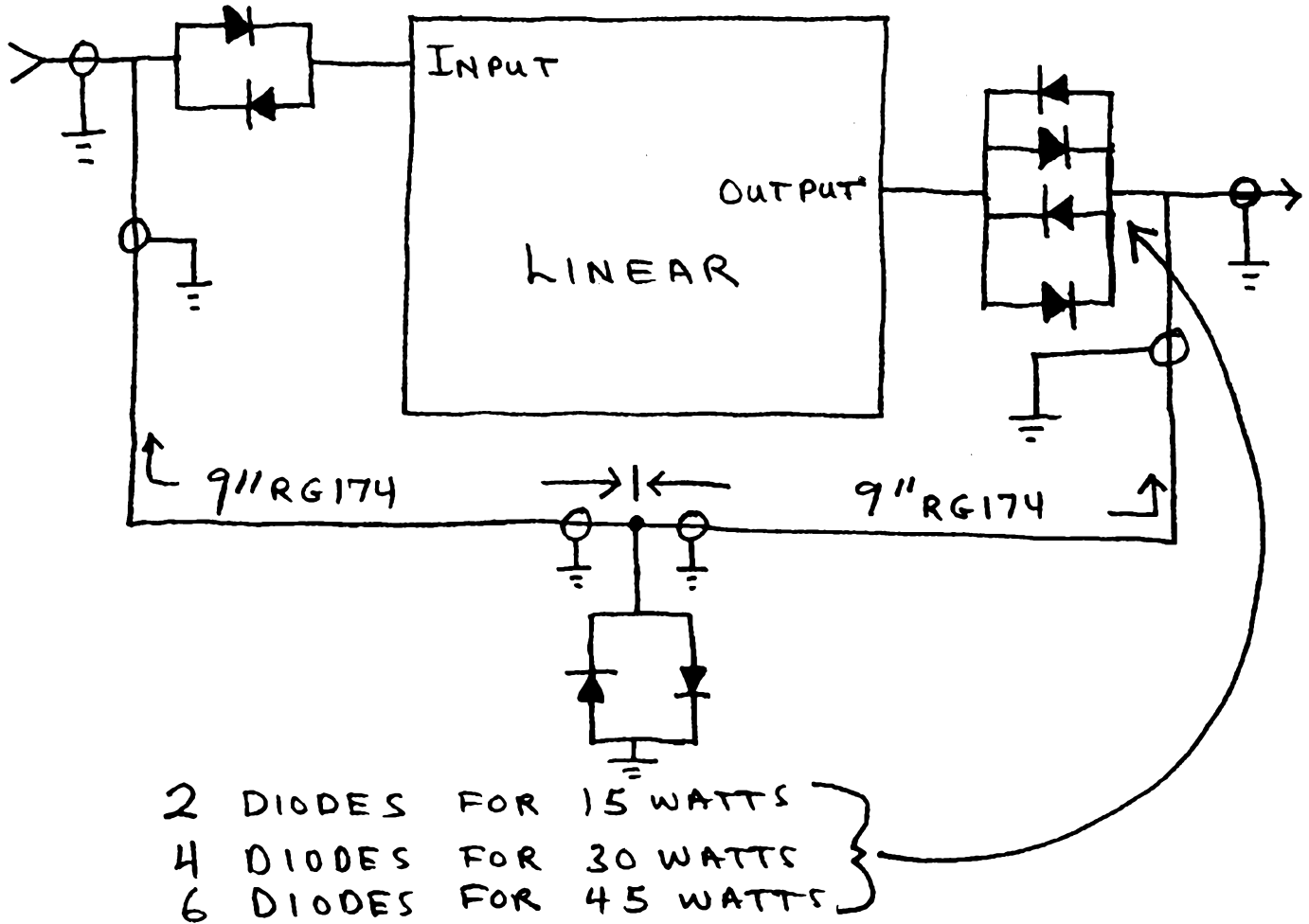

ALL DIODES  
 IN 914



# MIDLAND 79-900

## SLIDE & CHANNEL EXPANSION

*CORRECTION FOR THIS STEP IS IN VOL. 18 PG. 62*

~~1-Lift <sup>CLIP</sup> gray wire <sup>AT</sup> from bottom of clarifier control and tape back. Run a wire from bottom of clarifier control to pin 1 of IC6 MB3756. Remove the blue wire from the center of the clarifier control and tape back. Remove the blue wire from the P/C board (P/C-343AA) and connect to the center of the clarifier control clip D39 (found near VR5) this will allow + 2 & 3 KHz. For + 1 and -10 KHz lift the cathode of D40 (IS26870) and install a super slide, then remove CT3 (20 PF). For -20 KHz + install a super diode in place of D40 with super slide in the positive leg. This will give a coarse tune on the radio and a fine tune on the mike.~~

2-Remove X4 11.1125 and install a 11.3258 crystal in its place. Isolate pin #10 of the PLL from ground by cutting the pin from the P/C board with an exacto knife, solder a wire from pin #10 and pin #11 approximately 6 inches long (they will be used later). Remove the green wire from the bright dim switch and tape. Ground the center contact to the front contact and solder the wire from pin #10 to the back contact. On the hi-low tone switch connect the 3 contacts on the right together. Connect the center contact of the left switch to ground. The back contact goes to pin #11.

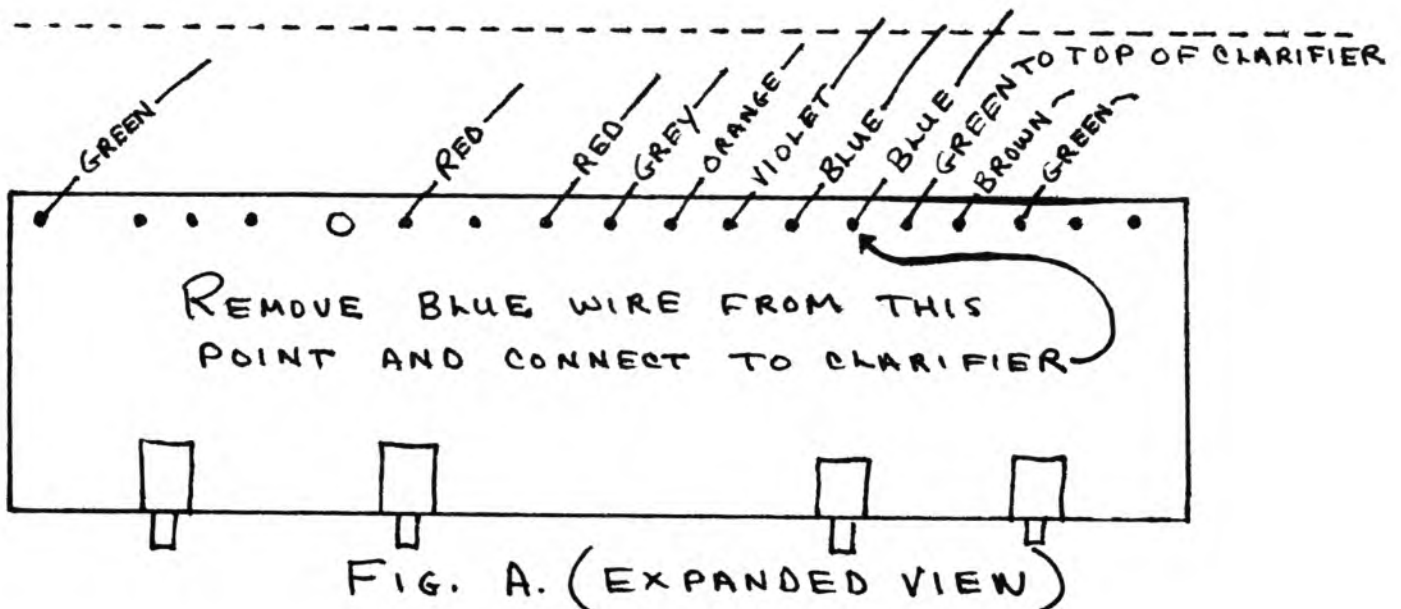
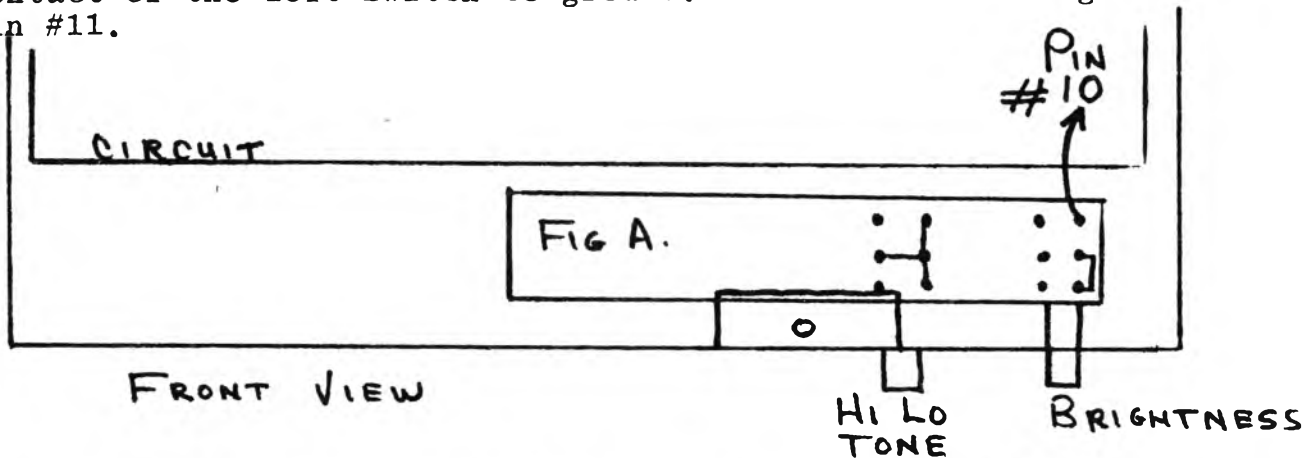

EXCITING NEW AMATEUR CONVERSION KIT PLUS  
M.A.R.S. AND CAP FOR SSB RADIOS

This unit is the fast channel changer available from amateur supplier's. This unit will inexpensively give the licensed amateur a way to get on 10 meter. Let's save the 10 meter band!

Now you can convert the new PLL transceivers, as well as most of the older models, for up to 136 additional frequencies with no skip, without extra crystals, rewiring of the channel control wiring, or removal of the PLL chip.

Even better, every transceiver conversion comes out the same regardless of the crystals or PLL used. The need for figuring out what channels go with which wire is thus eliminated.

The frequencies coming out are also exact since the existing PLL system is essentially untouched.

Only 6 connections are made to the PLL. Remaining wires are only needed for power and control.

Only one model covers most radio's (all radios except CYBERNET radios or radios with a 5KHz loop system).

The fast channel changer module (Models FCC-1 and FCC-1A) give the user a relatively easy means of converting existing 40 channel PLL transceivers to cover up to 136 additional receive frequencies. Although the module is primarily designed to work with the newer PLL chips having only 6 frequency control lines, it works equally well on most of the older PLL chips.

NOTE: Models FCC-1 and FCC-1A will not work on single crystal AM transceivers. (A "B" version will be available for these radios soon).

No crystals are needed. Complex tuning and matching are eliminated as is the need for stocking types for each radio.

The FCC-1 module is very easy to install. The module essentially connects in series with the divider input of the PLL chip. The only other necessary connections (besides power, ground, and control lines) are to the 10.240MHz input pin and phase detector output pin. The PLL IC does not need to be removed. The channel selector wiring does not need to be touched. (except in 23 channel radios). Just hook it up and GO!!!!

FCC-1 MODULE  
IS NO LONGER AVAILABLE

## SPECIFICATIONS

Frequency Range: Lo 26.515MHz-26.955MHz

Off 26.965MHz-27.405MHz

HI-I 27.415MHz-27.855MHz

HI-2 27.875MHz-28.315MHz

Same for all PLL  
systems regardless  
of crystals used.

All skips are covered in these areas without modifying the channel selector.

POWER CONSUMPTION: 175ma 13.6VDC

SIZE: 2-3/8" X 6-1/8" X 3/4"

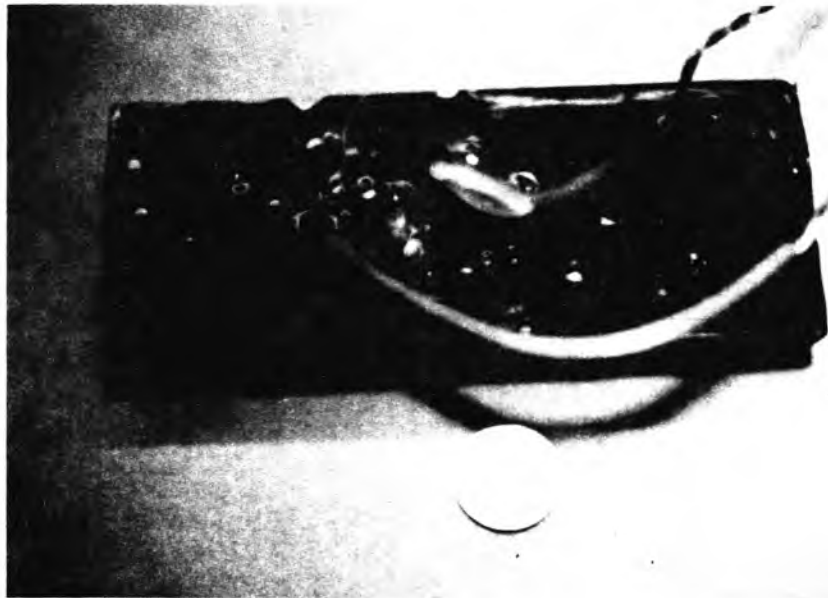

# FREQUENCY MOD FOR

HALLICAFTERS MODEL HCM271

NOTE: This mode requires 2 SPTS switches.

- 1-Remove top and bottom cover from unit.
- 2-Remove cover from the PLL circuit.
- 3-Remove PLL circuit.
- 4-Cut foil paths as shown in drawing.
- 5-Add wire and hook to switches #1 & #2 as shown.

TUNE UP: Set selector to channel 20 normal operation.  
Adjust L104, L105, L108, & L109 for Maximum output.  
Adjust VR105 for 100% modulation.

NORMAL OPERATION SWITCH #1 ON SWITCH #2 OFF

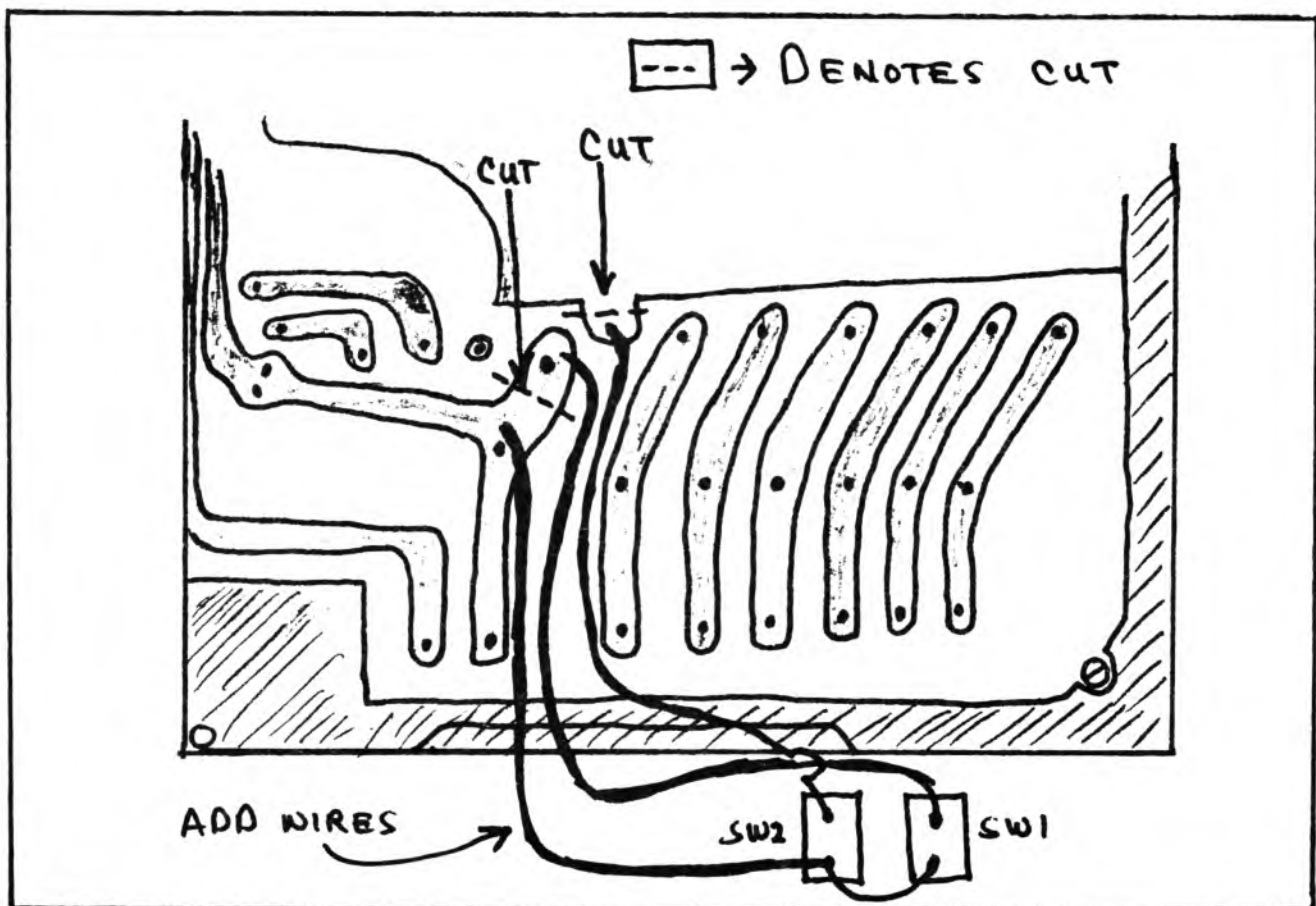

# FREQUENCY MOD FOR HALLICAFTERS MODEL HCM271

LOW FREQUENCY OPERATION SW1 OFF SW2 ON			
CHANNEL	FREQUENCY	CHANNEL	FREQUENCY
1	26.325	21	26.575
2	26.335	22	26.585
3	26.345	23	26.615
4	26.365	24	26.595
5	26.375	25	26.605
6	26.385	26	26.625
7	26.395	27	26.635
8	26.415	28	26.645
9	26.425	29	26.655
10	26.435	30	26.665
11	26.445	31	26.675
12	26.465	32	26.685
13	26.475	33	26.695
14	26.485	34	26.705
15	26.495	35	26.715
16	26.515	36	26.725
17	26.525	37	26.735
18	26.535	38	26.745
19	26.545	39	26.755
20	26.565	40	26.765

HIGH FREQUENCY OPERATION SW1 ON SW2 ON			
CHANNEL	FREQUENCY	CHANNEL	FREQUENCY
1	27.605	21	27.855
2	27.615	22	27.865
3	27.625	23	27.895
4	27.645	24	27.875
5	27.655	25	27.885
6	27.665	26	27.905
7	27.675	27	27.915
8	27.685	28	27.925
9	27.695	29	27.935
10	27.705	30	27.945
11	27.715	31	27.955
12	27.725	32	27.965
13	27.745	33	27.975
14	27.755	34	27.985
15	27.765	35	27.995
16	27.775	36	28.005
17	27.805	37	28.015
18	27.815	38	28.025
19	27.825	39	28.035
20	27.845	40	28.045

## ATTENTION HAMS:

Here is an inexpensive way to get on 10 meter amateur radio. These inexpensive modification may be performed by licensed amateurs only.

### CONVERSION OF AM/ SSB UNITS TO 10 METER AMATEUR RADIO SERVICE

#### CENTURION PLL, PLL 40 & 40D, GLADIATOR PLL, PLL 40

The mixing crystal, X3 (11.2855 MHz), in the PLL section must be changed to a crystal on the operating frequency one third of the frequency increment over what the original frequency was for channel 1.

#### FORMULA:

1. Desired Channel 1 Frequency minus Present Channel 1 frequency = Frequency increment
2.  $\frac{\text{Frequency increment}}{3}$  plus Present Mixer Crystal frequency =  
New Mixer Crystal frequency

For example: Channel 1 is now on 26.965 MHz. If we want Channel 1 to operate on 28.50 MHz, we subtract 26.965 from 28.50. This will give us 1.535 MHz, and since the oscillator frequency is triple, we have to divide this number by 3. In this case, 0.511666 MHz. Adding this last figure to the present mixer crystal frequency brings the new mixer crystal frequency to 11.7971 MHz. This is the Upper Side Band.

For AM and lower Side Band, the same formula is used with crystal X2 (11.2845 MHz). Since the mixer crystal is 11.2845 MHz and since one third of the frequency difference is 0.511666, the new mixer crystal for operation on 28.50 MHz for AM and LSB will be 11.7961 MHz.

The PLL section, the transmitter section and receiver front end must be tuned to the new frequencies following the indications found in the service manual with the only difference being that we must change the receiver input frequency and transmitter output from the CB frequencies that appear in the service manual.

In order to broad band the transmitter, change the connection on the transformer between the mixer FET6 and the buffer from a center tap configuration to full winding. This can be done by cutting the pc board copper pattern with a sharp knife and putting an extra jumper. This is L24 primary.

## SPARTAN PLL, PLL 40

The theory behind this conversion is exactly the same as the Centurion and Gladiator conversion. The only difference is that this particular circuit uses only one mixer crystal, in this case 11.285 MHz. For conversion of the unit to start at 28.50 MHz on channel 1, follow the formula used for the Gladiator and Centurion conversion. The answer to the first step of the formula will be the same (1.535 MHz). One third of the frequency increment will again be 0.511666 MHz. Complete step 2 adding the frequency of the original mixer crystal (11.285 MHz), which will give you 11.7067 MHz as the desired mixer crystal frequency.

Again, the complete unit must be tuned according to our service manual indications.

## GALAXY

The theory behind this conversion is exactly as above. This particular circuit uses only one crystal, in this case 11.3258 MHz. For conversion of the unit to start channel 1 at 28.50 MHz, follow the formula, but the original mixer crystal frequency will be 11.3285 MHz and the desired mixer crystal frequency will be 11.840 MHz.

If we want to increase the number of channels over 40 channels, we can do so by using a single pole, single throw switch and connecting the switch to pin 10 of the PLL chip (MB8719). If the unit has a MB8734 chip installed, it must be replaced with a MB8719. The other side of the switch is connected to ground. Also, we will have to connect a 0.005 mfd capacitor from pin 10 to ground for RF bypass. When pin 10 is off ground, the frequency output of the synthesizer will jump 640 kHz higher. This means that it is possible to cover from 28.50 to 29.58 MHz.

After the crystal change, the transmitter should be peaked to maximum output and the receiver tuned to maximum sensitivity. The PLL VCO coil must be realigned to obtain 3.5 volts at the test point.(TP9) when the channel selector is set to channel 40.

Clarifier Modifications: *Better Mod on pg 19 Vol 7.*

In order to increase the clarifier range:

1. Jump R188 at clarifier range.
  2. Disconnect wire connected to the hot side of the clarifier control.
  3. Jump hot side of clarifier control to pin 1 of IC5 voltage regulator.
  4. Omit diode D36 connected to VR3 transmitter frequency adjust.
- With this modification, the clarifier control operates on transmit and receive, which is a good feature for 10 meter operation.

Power Adjustment for 10 Meter Operation:

AM:

1. Adjust VR6 to proper power.
2. Adjust VR11 for proper modulation level.
3. Remove C119 if necessary.

SSB:

1. Adjust VR7 (ALC) for proper PEP output.
  2. Readjust L36 (PA tuning).
- 

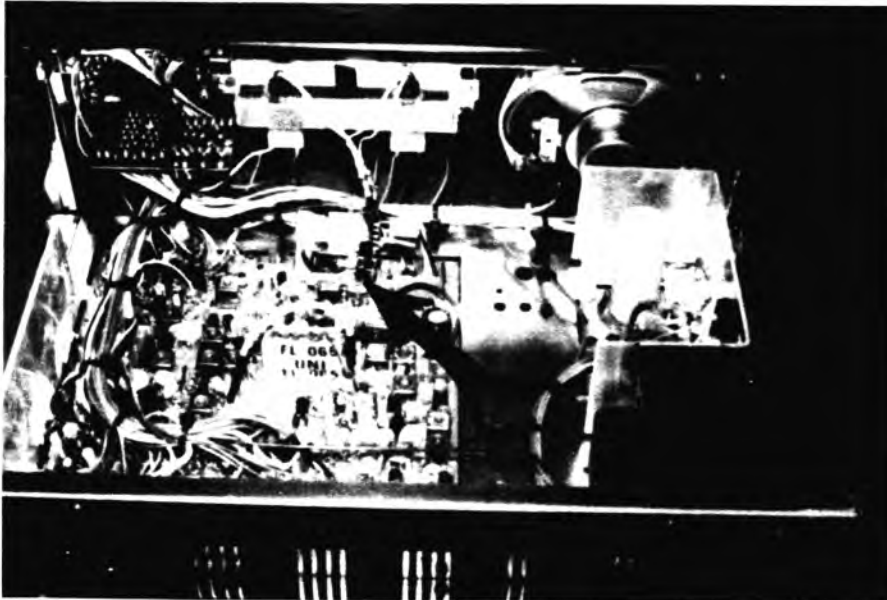

SHOWS XTAL SWITCHING  
WITH RELAY MOUNTED IN RADIO.



## CENTURION PLL

1. HOW TO SHIFT THE CHANNEL FREQUENCY ON THE CLARIFIER CONTROL ON TRANSMITTER MODE.
  - A. The channel frequency will be shifted each side (plus & minus) 1.5KHz by the clarifier control.
    - (1) Eliminate D39 (1S2473).
    - (2) Remove R119 (220 OHM) from the P.C.B., and connect a 100 OHM  $\frac{1}{2}$ watt resistor between the cathode side of D36 (WZ061) and the junction of D48, C103, and C104.
  - B. In addition to the above mentioned, the channel frequency will be shifted for minus 4.5KHz by the clarifier control. In other words, frequency will be shifted plus 1.5KHz, minus 4.5KHz.

## GLADIATOR PLL

1. HOW TO SHIFT THE CHANNEL FREQUENCY BY THE CLARIFIER CONTROL ON TRANSMITTER MODE.
  - A. The channel frequency will be shifted each side (plus & minus) 1.5KHz by the clarifier control.
    1. Eliminate D30 (1S2473).
    2. Remove R116 (220 OHM) from the P.C.B., and connect a 100 OHM  $\frac{1}{2}$ watt resistor between the cathode side of D36 (WZ061) and the junction of D48, C103, and C104.
  - B. In addition to the above mentioned, the channel frequency will be shifted for minus 4.5KHz by the clarifier control. In other words, frequency will be shifted plus 1.5KHz, minus 4.5KHz.
    1. Short circuit RT16 and RT18, and omit RT17.

## FANFARE 350/SPARTAN PLL

1. HOW TO SHIFT THE CHANNEL FREQUENCY BY THE CLARIFIER CONTROL ON TRANSMITTER MODE
  - A. The channel frequency will be shifted each side (plus & minus) 1.5KHz by the clarifier control.
    1. Eliminate D24 (1S2473).
    2. Remove 61 (100 OHM) from the P.C.B., and put it on between the cathode side of D26 (WZ071) and the conjunct position of D32 & R106 at bottom side of P.C.B.
  - B. In addition to the above mentioned, the channel frequency will be shifted for minus 4.5KHz by the clarifier control. In other words, frequency will be shifted plus 1.5KHz, minus 4.5KHz.
    1. Short circuit R132 and omit R60.

FREQUENCY  
of OPERATION  
USING 11.1125  
CRYSTAL (MHz)

CHANNEL  
READOUT  
INDICATION

FREQUENCY  
of OPERATION  
USING 11.2858  
CRYSTAL (MHz)

---

26.965	1	27.485
26.975	2	27.495
26.985	3	27.505
27.005	4	27.525
27.015	5	27.535
27.025	6	27.545
27.035	7	27.555
27.055	8	27.575
27.065	9	27.585
27.075	10	27.595
27.085	11	27.605
27.105	12	27.625
27.115	13	27.635
27.125	14	27.645
27.135	15	27.655
27.155	16	27.675
27.165	17	27.685
27.175	18	27.695
27.185	19	27.705
27.205	20	27.725
27.215	21	27.735
27.225	22	27.745
27.255	23	27.775
27.235	24	27.755
27.245	25	27.765
27.265	26	27.785
27.275	27	27.795
27.285	28	27.805
27.295	29	27.815
27.305	30	27.825
27.315	31	27.835
27.325	32	27.845
27.335	33	27.855
27.345	34	27.865
27.355	35	27.875
27.365	36	27.885
27.375	37	27.895
27.385	38	27.905
27.395	39	27.915
27.405	40	27.925

CENTURION PLL/FANFARE 350/SPARTAN PLL/GLADIATOR PLL/  
AND OTHER RADIOS

1. HOW TO MAKE 32 EXTRA CHANNELS.

- A. Put the extra switch (one transfer circuit) on.
- B. Put the diode (1N60) on between the extra switch and pin #21 IC7 (UPD858C). The cathode side of the diode should face toward the switch.
- C. Cut the island of pin #19 of IC7 (UPD858C), and put the resistor 4.7 OHM on between the two islands which were separated.
- D. Connect the lead wire between the empty position of the switch and the separated island from the pin #19.
- E. Realign on transmitter to make the minimum difference of RF output power between channel #1 and #40.
- F. Realign on transmitter to make the minimum difference of receiver sensitivity between channel #1 and #40.
- G. Check the P.L.L. circuit as well.

Turning the extra switch on, you can enjoy additional 32 channels on your unit. The center frequency of the extra channels are as follows:

<u>Channel</u>	<u>Freq.</u> <u>(MHz)</u>	<u>Channel</u>	<u>Freq.</u> <u>(MHz)</u>	<u>Channel</u>	<u>Freq.</u> <u>(MHz)</u>
8	27.455	19	27.585	30	27.705
9	27.465	20	27.605	31	27.715
10	27.475	21	27.615	32	27.725
11	27.485	22	27.625	33	27.735
12	27.505	23	27.655	34	27.745
13	27.515	24	27.635	35	27.755
14	27.525	25	27.645	36	27.765
15	27.535	26	27.665	37	27.775
16	27.555	27	27.675	38	27.785
17	27.565	28	27.685	39	27.795
18	27.575	29	27.695	40	27.805

YASEAU 101  
CRYSTAL CONVERSION INFORMATION

REPLACE THE 10 METER CRYSTALS WITH

A--32.02 covers 26.0 to 26.5

B--32.52 covers 26.5 to 27.0

C--33.02 covers 27.0 to 27.5

D--33.52 covers 27.5 to 28.0

THIS WILL ALLOW OUT OF BAND COVERAGE FOR THE ABOVE RADIO.

SWAN SYGNET  
MODEL 270  
11 M CONVERSION

To use this radio on 27.000MHZ to 28.000MHZ the modification is an easy one.

- (1) Remove the case and locate the VFO in the front right cover.
- (2) Remove the cover and locate C.1601 #5PF and remove this cap.
- (3) Install a 10PF in its place and reinstall the cover.
- (4) Then calibrate C160Z with a non metallic (plastic) screw driver. (28.MHZ=27.000)
- (5) The modification is now complete. Reinstall the top cover.

\*\*\*\*\*GOOD LUCK\*\*\*\*\*

## STANDARD HORIZON 29A

For channel expansion below Channel 1:

- (1) Lift pin 19 from PLL and isolate.
- (2) Run a wire from pin 19 to one side of a single pole, single throw switch.
- (3) Run a wire from where pin 19 was connected to the other side of the switch.
- (4) This will yield 14 extra channels below Channel 1.

For channel expansion above Channel 40.

- (1) Cut and isolate pin #18 of PLL on radio.
- (2) Run a wire from pin #18 to the center pole of a double throw, single pole switch.
- (3) Run a wire from one of the outside contacts to the place where pin 18 was.
- (4) Then run a wire from VCC 5V to the other outside contact of the switch in one position. You will now have normal channels in the other position.
- (5) You will have the channel up to 27.805. The VCO may have to be adjusted for full coverage.

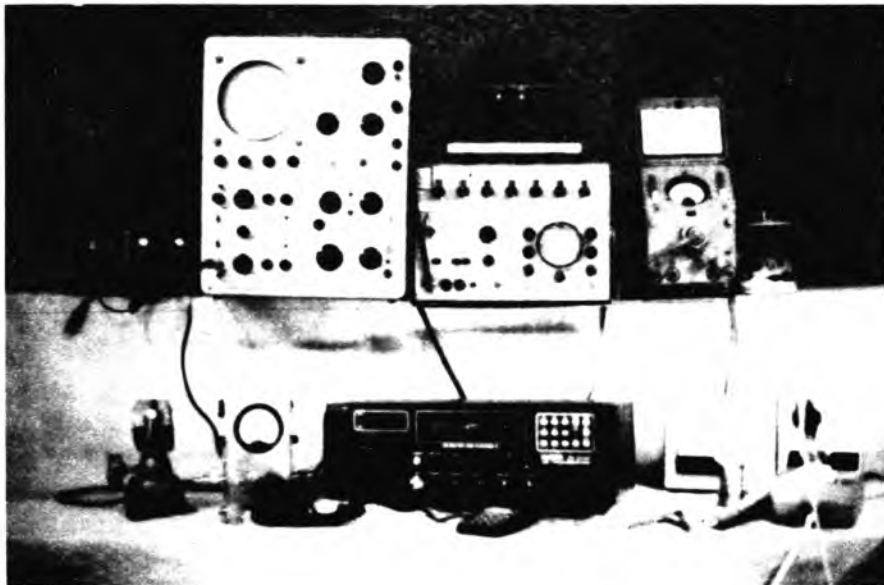

# MODIFICATION OF DEMCO STAR II AND SUPER SATELLITE II

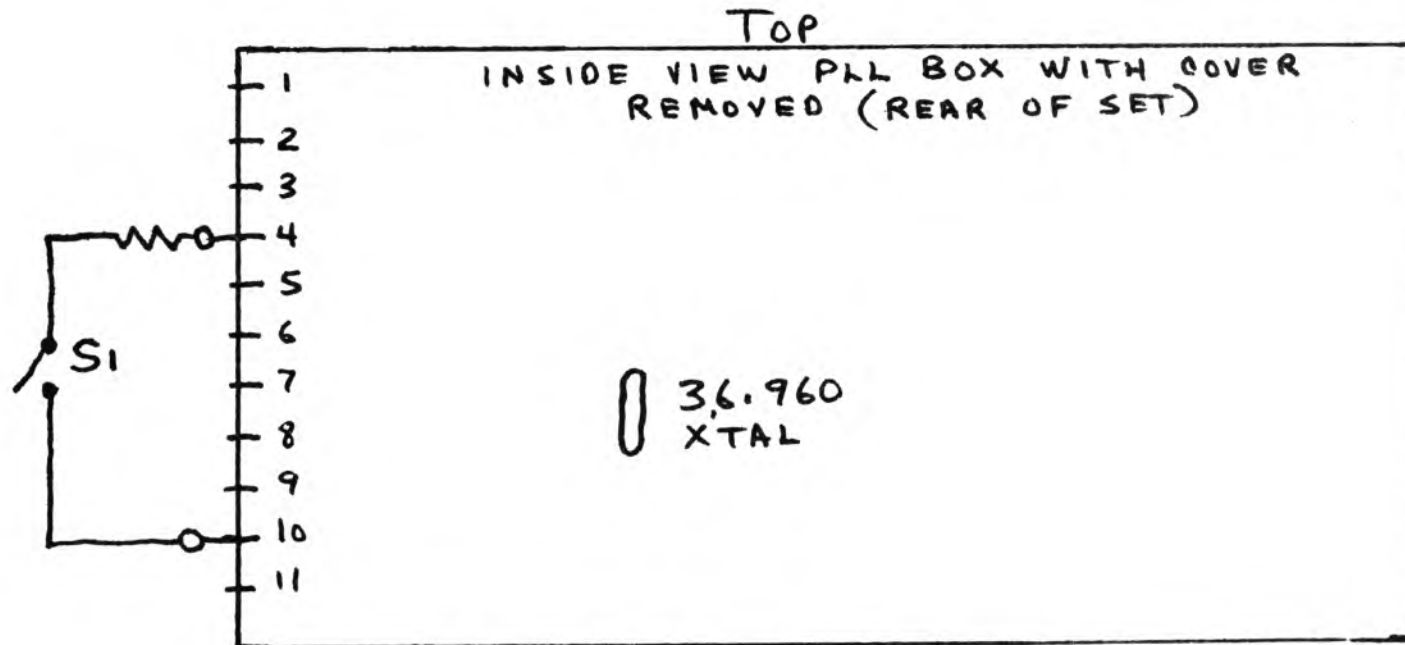

To get channels 44 to 56 on channel 28 to 40 positions, add 100K resistor and switch as shown.

To get 200KC down from normal 40 channels, replace 36.960 crystal with crystal "DD". (36.760)

This is a tube type transceiver and may require realignment when shifting more than 200KC from original design. Capable of 248 channel spread.

UFO INSTALLATION TO  
 SBE-39 CB Sidebander 5  
 SBE-40 CB Console 5  
 SBE-27 CB/A Sidebander 4

INSTALLATION:

- 1-Remove 3 capacitors in UFO as in 858 installation.
- 2-Remove D-901.
- 3-Replace X1 (10,000) with 26.965 MHZ.
- 4-De-solder Pin #13 of IC-901.
- 5-Hook center of coax 2 to trace that was connected to Pin #13 of IC-901.
- 6-Hook Coax 1 to Pin #6 of IC-902.
- 7-Remove D-904.
- 8-For transmit inhibit remove Q501.
- 9-Apply power to radio and UFO.
- 10-Align T-901 for maximum signal output on Coax 1.
- 11-Align VCO such that the VCO will lock between 25.995 and 28.000.  
 This can be tested by monitoring frequency on Coax 1 or DC voltage on Coax 2.
- 12-Align L-904 and L-905 for correct frequency on AM and lower sideband.

PROGRAM CODE: BBWB BWBB WWWW WW

NOTE: USB will be 5 KC lower than frequency display.

HOW TO PROGRAM YOUR UFO

THIS DIAGRAM INDICATES THE AMOUNT  
 OF FREQUENCY CHANGE CONTROLLED  
 BY EACH PIN.

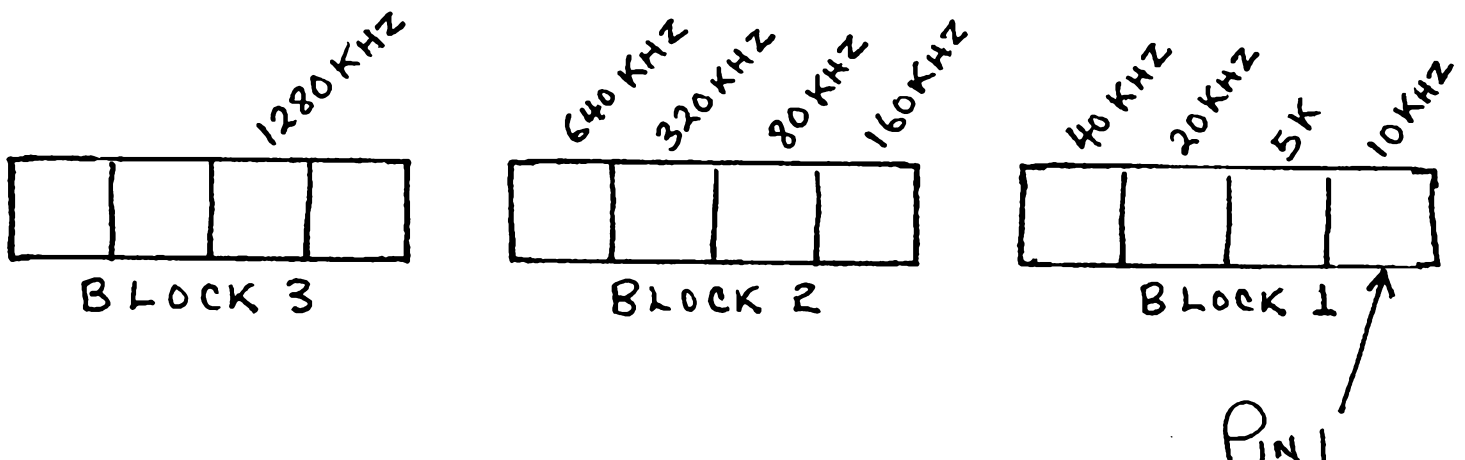

REDCO  
SPECIAL INSTRUCTIONS FOR INSTALLATION  
OF 10 METER CONVERSION

- 1-Install ribbon cable exactly as shown in Figure 5 of the Instruction Book.
- 2-Locate pin 22 of the D858 PLL Chip and isolate from all connections.
- 3-Install 22 gauge jumper wire from pin 22 of the D858 PLL Chip to pin 12 (5.1 volts).
- 4-Follow the alignment procedure below.

SYNTHESIZER ALIGNMENT

TEST EQUIPMENT	DIGI SCAN	ADJUST	REMARKS
Input of RF VTVM to TP6	28.965 AM Clarifier-Midrange AM	L24	Adjust for maximum
Input of DC meter to TP7	28.205	L17	Adjust for 2.0 volts
Input of RF VTVM to TP8	29.005	L16	Adjust for maximum
Input of frequency counter to TP8	29.005 AM	CT6	Adjust for 36.7050MHz +20Hz
Input of frequency counter to TP8	29.005 USB	CT4	Adjust for 36.7075 MHz +20Hz
Input of frequency counter to TP8	29.005 LSB	CT5	Adjust for 36.7025MHz +20Hz
Input of frequency counter to TP8	29.005 LSB Transmit	VR9	Adjust for 36.7025MHz +20Hz
Input of frequency counter to TP9	29.005 USB Transmit	CT2	Adjust for 7.8025MHz +5Hz-0Hz
Input of frequency counter to TP9	29.005 LSB Transmit	CT3	Adjust for 7.7975 +0Hz -5Hz

SAMS MISPRINT ON COBRA  
140 and 142 GTL

It has come to our attention that the SAMS schematic on Cobra 140 and 142 CTL has labled R-72 as R-7. Please be advised R-72 is a 2.7 K resistor which must be removed for proper UFC operation; R-7 is an emitter resistor on TR-3 which is used in the noise blanker circuit. We will try to keep you advised of any other problems of this nature.



UFO INSTALLATION TO  
SM-5104 PLL CHIP

APPLICATIONS: SEARS ROADTALKER/J.C. PENNEY 6241

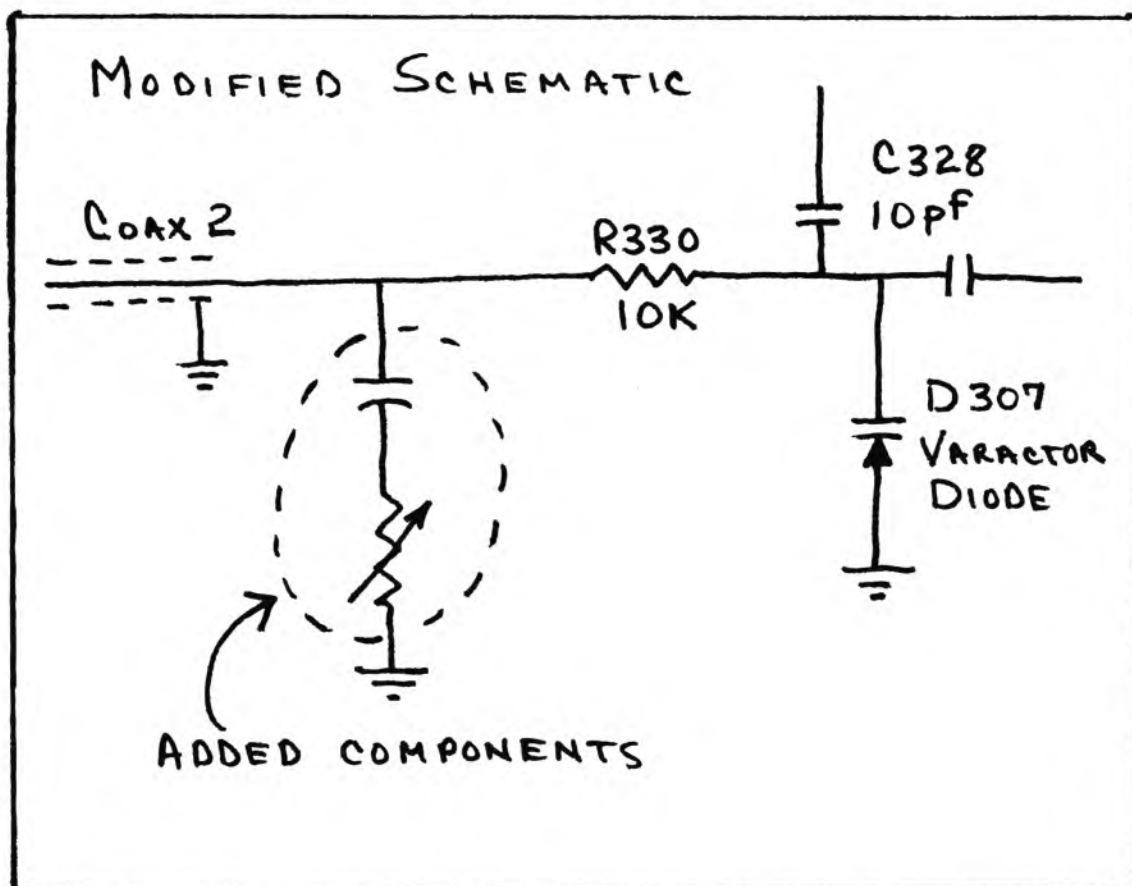

PROGRAM CODE: WBWB WBBB WWWW WW

NOTE: All part designation numbers refer to the Sears Roadtalker.

## RECEIVER ALIGNMENT

Connect an AC VTVM or AF wattmeter across speaker voice coil.  
Adjust volume control to obtain a suitable indication.

### SSB

TEST EQUIPMENT	DIGI SCAN	ADJUST	REMARKS
Out put of signal generator thru .01uF to antenna jack. 29.006MHz, no modulation. Output .25uV.	29.005 USB  RF Gain-Maximum Clarifier-Midrange Volume-Maximum	L8,L7 L6,L5 L4,L3	Adjust for maximum output.
Output of signal generator thru .01uF to antenna jack. 29.006MHz, no modulation. Output .25UV.	29.005	CT1	Adjust for .5watts audio.

### RECEIVER ADJUSTMENTS

Connect an AC VTVM or AF wattmeter across speaker voice coil.  
Adjust volume control to obtain a suitable indication.

TEST EQUIPMENT	DIGI SCAN	ADJUST	REMARKS
Output of signal generator thru .01uF to antenna jack. 29.006MHz, no modulation. Output 250uV.	29.005 USB  RF Gain-Maximum Volume-Maximum	VR2	SSB AGC Adjust VR2 for .5volts audio.
Output of signal generator thru .01uF to antenna jack. 29.006MHz, no modulation Output 100uV.		VR1	S Meter Adjust for 9 on S scale of meter.
Output of signal generator thru .01uF to antenna jack. 29.006MHz, no modulation Output 500uV.		VR3	SQUELCH RANGE Set squelch control VR404 fully clockwise. Adjust VR3 so that squelch just breaks.
Output of signal generator thru .01uF to antenna jack. 29.005MHz, 1000Hz @ 30% mod- ulation. Output .5uV.	29.005 AM	VR5	AM AGC Adjust VR5 for .5watts audio.

UFO INSTALLATION PROCEDURE  
FOR PALOMAR 500

INSTALLATION:

- 1-Locate and remove MC 145106 chip.
- 2-Remove C-125.
- 3-Connect Coax #1 to junction of C-125 & R-137.
- 4-Connect Coax #2 to junction of R-151 & R-153.
- 5-Solder shields to various ground points on the circuit board.
- 6-For transmission inhibit, remove Fet 7.
- 7-Solder black wire to ground on circuit board.
- 8-Hook up red wire to switched side of power switch.

PROGRAM CODE: BBWW BWWW BBWW WW

UFO INSTALLATION TO COURIER  
RADIOS USING 858 CHIP  
SPARTAN/GLADIATOR/CENTOURIAN/FANFARE 350

INSTALLATION:

- 1-Hook center of coax #1 to pin 11 of 858 chip.
  - 2-Disconnect the lead of R154 (15 K) going to pin #2 of the 858 chip.
  - 3-Solder center of coax #2 to disconnected lead of R154.
  - 4-Short C-508.
  - 5-For transmit inhibit remove TR-22.
  - 6-Remove two blue 1.5 uf tantalum capacitors located in left rear corner of UFO.
  - 7-Remove green .01 mylar capacitor  $\frac{1}{2}$ " forward and right from tantalums.
- DO NOT USE MODULE PROVIDED FOR 858 RADIOS.

PROGRAM CODE: BBWW BWWW BBBB WW

UFO INSTALLATION TO O2A CHASSIS  
DAK 9/DAK 10/LAFFAYETTE/ALL COLT & MIDLAND

When the UFO is installed on an O2A chassis, the lowest obtainable is 26.965. In order to go below this frequency the 10.0525 crystal in the radio must be changed to a lower frequency. A 10.000 Mhz crystal available from REDCO will produce a low of 26.755. Changing to a 9.82 Mhz crystal will allow operation to 26.300 Mhz without sacrificing top end.

PROGRAMMING: 9.82 crystal----BWBB WBBB WWWW BB  
10.000 crystal---WWW WBBW WWBB BB

## TRANSMITTER ADJUSTMENTS

Connect an RF wattmeter and 50-ohm, 25-watt dummy load to antenna connector.  
 NOTE: Be sure to check transmit frequency and power on all active channels after adjustment of transmitter.

TEST EQUIPMENT	DIGI SCAN	ADJUST	REMARKS
DC current meter to TP3 and TP4 No Modulation.	29.005 USB	VR15	Bias Adjust VR15 for 40mA +10mA.
DC current meter of TP1 and TP2. No modulation.	29.005 USB	VR16	Bias Adjust VR16 for 70mA +10mA.
No modulation.	29.005 USB	VR4	BALANCE Adjust for MINIMUM RF.
No modulation.	29.005 AM	VR8	AM REG Adjust VR8 for 3.8watts.
No modulation.	29.005 AM	VR12	RF PANEL METER Adjust VR12 for 3.8watts on RF scale of meter.
Inject a 1000Hz signal at MIC input.	29.005 AM AMC-Max	VR7	AM AMC Adjust signal for 50% modulation. Increase VR7 for 95% modulation.

## TRANSMITTER ALIGNMENT

Connect an RF wattmeter and 50-ohm, 25-watt dummy load to antenna connector.  
 NOTE: Be sure to check transmit frequency and power on all active channels after alignment of transmitter.

### SSB

TEST EQUIPMENT	DIGI SCAN	ADJUST	REMARKS
Output of 2 tone generator to mike input. 500 Hz and 2400Hz at .5 volts.	29.005 USB MIKE Gain-Maximum	L39,L37 L32,L30	Adjust for Max- imum.
Output of 2 tone generator to mike input. 500Hz and 240Hz at .5volts.	29.005 LSB	CT7	Adjust CT7 for 11.5 watts.

REDCO UFO INSTALLATION TO 858 AM RADIOS  
USING 36.570 CRYSTAL  
PRESIDENT: ZACHARY T/JOHN Q/THOMAS J/  
COBRAS: 21 XLR/77 X/29 XLR/

INSTALLATION PROCEDURE:

- 1-Hook center coax # 1 to TP-4 or pin 11 of 858.
  - 2-Lift the side of R104 (4.5 K) going to pin #2 of 858.
  - 3-Solder center of coax 2 to open leg of R104.
  - 4-Remove two blue 1.5uf tantalum capacitors from UFO located in rear left corner of PCB.
  - 5-Remove green .01uf mylar cap  $\frac{1}{2}$ " forward right from tantalums.
  - 6-Short C-140.
  - 7-For transmit points and component designations refer to Zachary T.
- \*ALL TEST POINTS AND COMPONENT DESIGNATIONS REFER TO ZACHARY T\*

PROGRAM CODE: BBBB BBBB WWWW WW

On AM 858 installations the chip must be left in circuit as the 10.240 oscillator is used to receive.

LOOP FILTERING:

On some UFO installations additional loop filtering may be required because of the close channel spacing and large bandwidth. By adding the modifications below, low end stability will improve.

- 1-Add a 1K resistor in series with R103.
- 2-Series a 1-uf electrolytic capacitor and a 10K pot from TP-5 to ground. Adjust 1-K pot for best VCO stability.

NOTE: The UFO will not install on AM radios using the TC9106P chip as there is a 455KC shift built in chip.

EXAMPLES: 21 GTL, 25GTL, 29GTL, VEEP, Andrew J.

UFO INSTALLATION TO  
MOTOROLA CB-555

INSTALLATION: (do not remove TC-9105 PLL chip)

- 1-Hook center of coax 1 to pin 17 of the PLL chip.
- 2-Remove R-604 (PLL-stop).
- 3-Lift the side of R-603 connecting to pin 7 of the PLL chip (TC-9105).
- 4-Connect center of coax 2 to the disconnected side of R-603.
- 5-Remove two blue 1.5 uf capacitors in rear left corner of PCB and green .01 mylar  $\frac{1}{2}$ " forward and right. (Capacitors are located in UFO).
- 6-Align VCO for maximum bandwidth.
- 7-Remove TR-301 for transmit inhibit.

PROGRAM CODE: WWBB BWBW WWWW WW

NOTE: The UFO will install to the Motorola CB-555 chassis but the highest frequency obtainable is 27.695 and lower sideband will be 5 KHz above frequency display.

DOWN MIXER TUNING OF 8719 RADIOS  
USING MB8719 SYNTHESIZER CHIP  
(COBRA 140 GTL (L-18)/142 GTL (L-18)  
(COBRA 148 GTL (L-21)/2000 GTL (L-21)  
PRESIDENT GRANT (late) (L-21)/McKinley (L-18)

It has come to our attention that the down mixer coil in 8719 radios can cause problems if improperly aligned. If the coil is tuned for maximum, the signal going to the UFO on coax 1 will double peak and cause an unlocked condition on some frequencies. This is cured by slightly detuning L-18, 3/4 turn clockwise works well. For best results use oscilloscope during alignment.

ALIGNMENT OF L-18 WITH OSCILLOSCOPE

- 1-Connect scope probe to pin 2 of the PLL chip in UFO. (PLL chip in UFO is an 18-pin dip located in rear left corner of PCB).
- 2-Adjust oscilloscope for stable trace and align L-18 for maximum output without double peaking (see diagram). Check for correct alignment throughout the band.

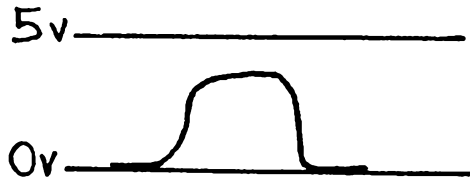

CORRECT

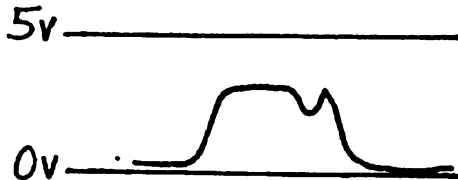

INCORRECT

# REDCO UFO APPLICATIONS

## I. APPLICATIONS

A. SEARS ROADTALKER

B. J. C. PENNEY 6241

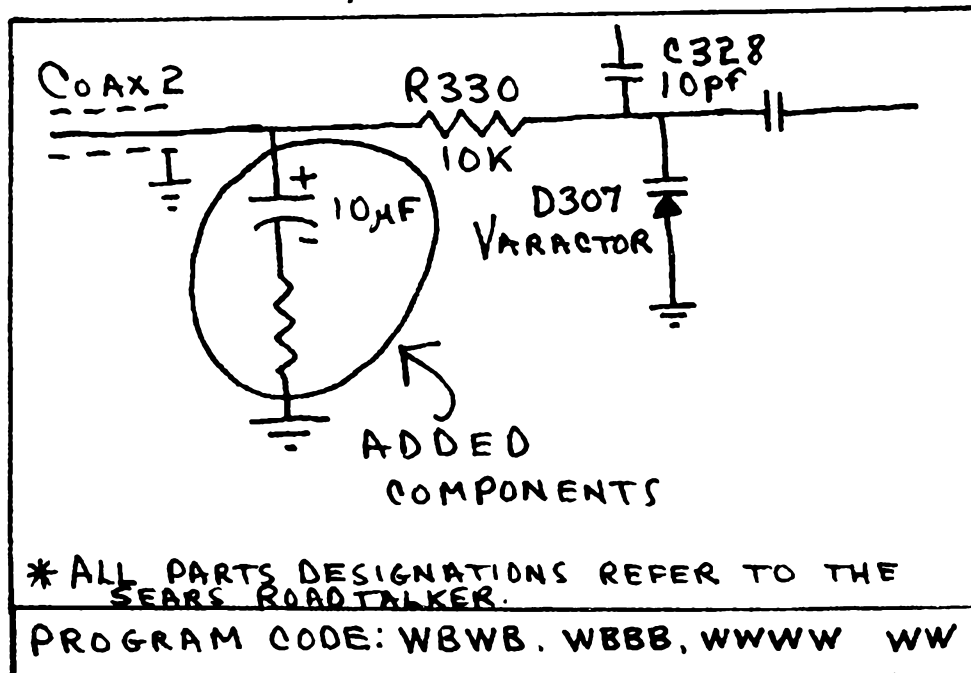

### UFO INSTALLATION TO SM-5104 PLL CHIP

1. Remove the SM5104 chip.
2. Connect center of Coax 1 to the point where Pin 2 of the PLL was connected.
3. Jumper points where pins 7 & 8 of PLL chip were connected.
4. Remove varactor diode D-307.
5. Reinstall cathode (banded end) of varactor diode to point where anode was connected.
6. Solder the anode of D-307 to ground.
7. Disconnect the side of R-330 going to Q306.
8. Connect center of Coax 2 to disconnected lead of R-330 (10K).
9. Install a 10uf electrolytic capacitor and a 10K pot in series from center of Coax 2 to ground.
10. Remove two blue 1.5 uf tantalum capacitors in left rear corner of PCB in UFO. Remove green .01 mylar cap  $\frac{1}{2}$ " foreword and right from tantalums.

HINT'S AND KINK'S

COBRA 140GTL/142GTL/148GTL

SUBJECT: Regulator IC shorting out in the 140GTL, 142GTL and 148GTL. IC-5 (140 & 142GTL), IC-4 (148GTL).

SYMPTOM: High AM power output (10 watts) and low modulation weak of no receive.

SOLUTION: Replace IC-5 (IC-4 for 148GTL) and change D-60 (D-44 for 148GTL) to a 18.2 volt zener diode. Add a SR1k2 diode from pin 1 to pin 2 of IC-5 (IC-4 for 148GTL). (Use Diode) Remove from D-60/44.

ADJUSTMENTS: NONE REQUIRED

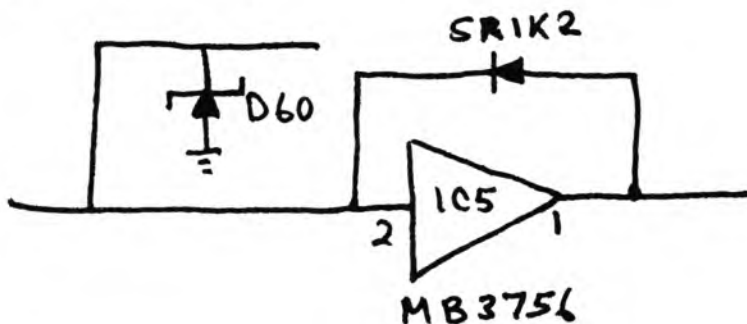

Dynascan Part numbers SR1k2 151-045-9-001  
Sub 16.2 Volt Zener 152-057-9-001. 18.2 Volt Zener (P/N N.A. as yet) to be used when in stock.

NOTE: This modification should be done on all radios In-Warranty repair. If IC-5 (IC-4) checks good, only make diode changes.

CUSTOM MODIFIED  
D AND A TO VARIABLE  
POWER





# SLIDE INCREASE APPLICATION ON ALL SIDEBAND RADIOS

## 8KHZ - 12KHZ - 20KHZ+

### PARTS NEEDED:

1. Super Clarifier Diode
2. Super Slider

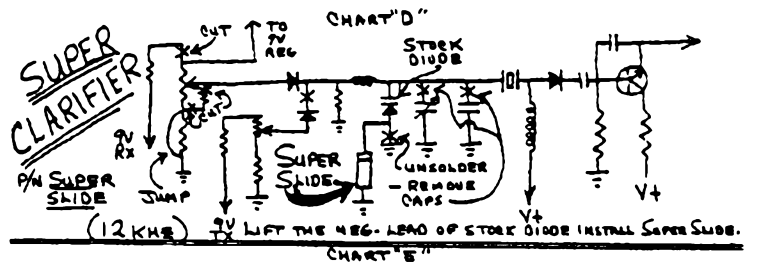
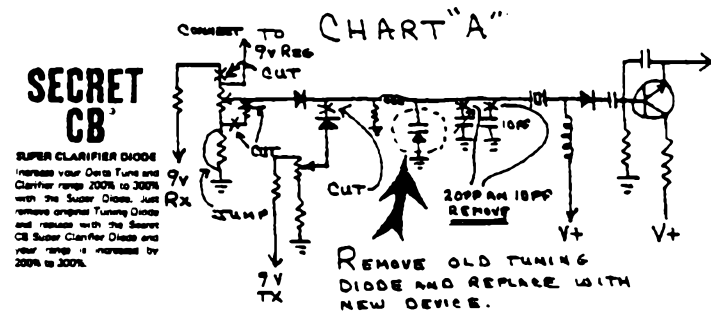

85% UNIDEN CHASSIS WILL USE 3 DIODES LOCATED NEAR VITALS. IN MOST APPLICATIONS PRODUCES 8KHZ DOWN

100 TO 300% INCREASE IN CLARIFIER RANGE

CHART "B"

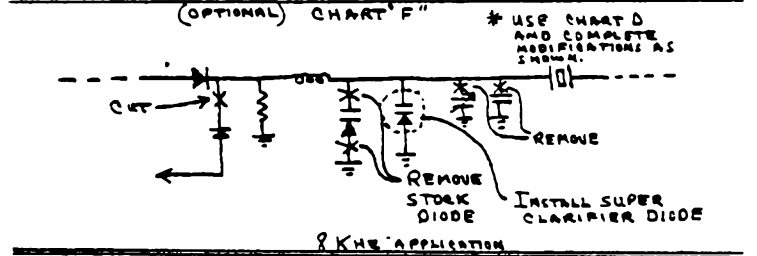
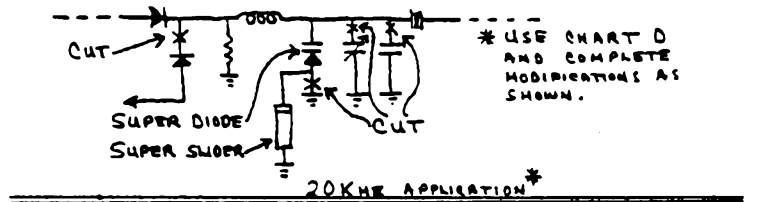
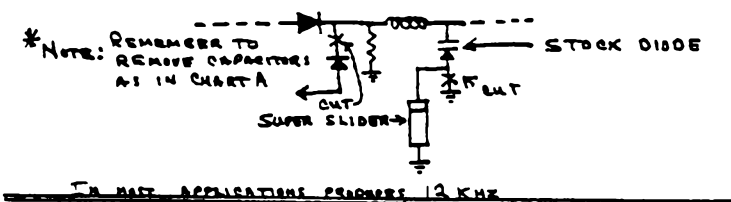
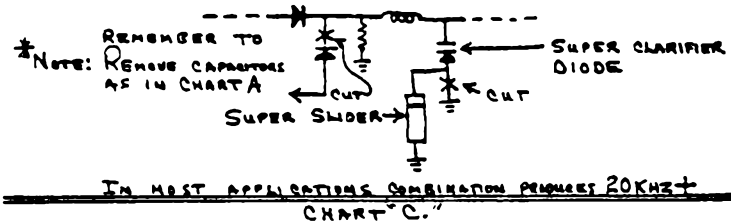

**HELPFUL HINTS**

Most UNIDEN CHASSIS WILL USE "THREE DIODES" OR THREE "SUPER SLIDES" OR A COMBINATION OF BOTH. FOR USING THE SUPER CLARIFIER DIODE USE CHARTS A, B, AND C. ALSO F. FOR USING THE SUPER CLARIFIER USE CHARTS D AND E. DO NOT BE ALARMED IF THE SUPER CLARIFIER READS SHORT ON YOUR METER. OBSERVE POLARITY AND INSTALL PER DIRECTIONS.

# RADAR COMMUNICATOR

© Microwave Specialists, Incorporated 1978

NOTICE: A valid Technicians, or above, Amateur operators license must be secured before using this device. If no such license is possessed before use, this will result in illegal operation, and the owner will be open to penalties as perscribed by the FEDERAL COMMUNICATIONS COMMISSION.

The MS-1 is a sophisticated microwave (RADAR) transmitter designed for the Amateur radio service between the frequencies of 10.400 to 10.500 GHZ ("X" band).

The transmitter has a power output of over 100 milliwatts, and may be used for C.W., A.M., or PULSED transmissions. A highly efficient GUNN oscillator is used in a mechanically tuned enclosure to insure for dependable, long life. The attached cast metal horn antenna is rectangularly polarized with a gain factor of 17 db, and an extremely narrow beam width, for high efficiency with compact size.

The control head contains circuitry for modulating the transmitter, and a six position rotary switch to allow for a wide selection of encoding tones. A.M. and C.W. signals may be easily sent, providing the control head is properly modified for such activity. (SEE "MODIFICATIONS" SECTION)

## tone encoder use:

The six tone positions are as follows- 643 hz (20mph), 957 hz (30 mph), 1271 hz (40mph), 1742 hz (55mph), 1899 hz (60mph), and 2527 hz (noise test - 80mph). The MPH designations are on the control head to remind operators to be alert when using the MS-1 on or around public highways.

## TECHNICAL NOTICE:

BECAUSE OF THE DEFECTS IN DESIGN OF LAW ENFORCEMENT RADAR, THE MS-1 WILL LOCK UP POLICE RADAR COMPUTORS, WHEN AIMED IN THEIR GENERAL DIRECTION.

This is not the fault of the MS-1, but rather the blundering oversight of speed radar manufacturers. The speed radar units on the market today are built with broad-banded diode receive which receive the surrounding Amateur frequencies, as well as their own designated 10.525 GHZ.

WHILE THE QUESTION OF MORALITY IN PURPOSELY DOING SUCH A THING ARISES, THIS ACION WOULD CERTAINLY NOT BE ILLEGAL, FROM THE TECHNICAL STANDPOINT. (Assuming the MS-1s operating frequency was between 10.400 to 10.500 GHZ, and the owner owns a valid Amateur license.)

## NOTICE TO OWNER/OPERATORS WITHIN THE STATE OF VIRGINIA:

The Virginia state law against radar receivers EXCLUDES the MS-1 because it is an Amateur radio transmitter. The VIRGINIA statute is aimed against radar detectors, and is quite specific. However, there is absolutely no mention of radar transmitters in the state law.

If there is any conflict over the unit, simply remind the official that your unit is a duly licensed Amateur transmitter, and the FEDERAL COMMUNICATIONS COMMISSION removed all rights from the states to regulate radio transmitters in the COMMUNICATIONS ACT OF 1934. ANY attempt to regulate, or confiscate, the MS-1 from a properly licensed Amateur operator by a state, or local, authority, will be a direct violation of FEDERAL LAW!!!

# RADAR COMMUNICATOR

© Microwave Specialists, Incorporated 1978

## What is the "Radar Communicator?"

The MS-1 is an Amateur Band radio (microwave) transmitter designed for communication to RADAR-frequency receiving devices. The microwave section is nearly identical to common speed radar units, utilizing the same sophisticated and expensive electronics. The transmitter is controlled by the "control head" which modulates or encodes the signal for positive communication to radar-frequency receivers. Transmission is directional and line-of-sight, with a range of up to two miles depending largely on receiver sensitivity. Unlike radar which determines information from a reflected signal, MS-1 is a one-way communicator, more like a microwave relay station. Because it continually transmits the signal to the receiver, coded reception is **DIRECT AND INSTANTANEOUS.**

## SPECIFICATIONS

Frequency Range: .... 10.450 GHz  $\pm$  50 MHz  
Generated R. F. Power: ... 100 Milliwatts min.  
Generated Waveform: ..... Sawtooth  
Transmission Modes: ..... AM; continuous  
Beam Width: ... 28° half-power (double axis)  
Antenna Gain: ..... 17 db; rect. polarized  
Tone Encoding: vco with integrated circuitry  
Operating Voltage: ... 12-18 vdc, floating gnd.  
Operating Temperature: ... -20° F to + 150° F

## What can receive the MS-1?

The "radar communicator" is an experimental device which allows ham operators many new avenues of amateur communication. Because all common radar-frequency detection or reception equipment uses broad-banded diode receiving techniques, effective communication to a wide variety of such gear is possible. Since absolute frequency isolation does not exist, operators are urged to guard against interfering with other X-band users. The receiver sections of police radar units are very broad-banded, and are extraordinary receivers for MS-1 communication. Older speed radars are sometimes available at reasonable cost from county and municipal agencies. The recent explosion of inexpensive police radar detectors also provides amateurs with access to good, basic receivers for the MS-1.



Use discretion in mobile configuration.

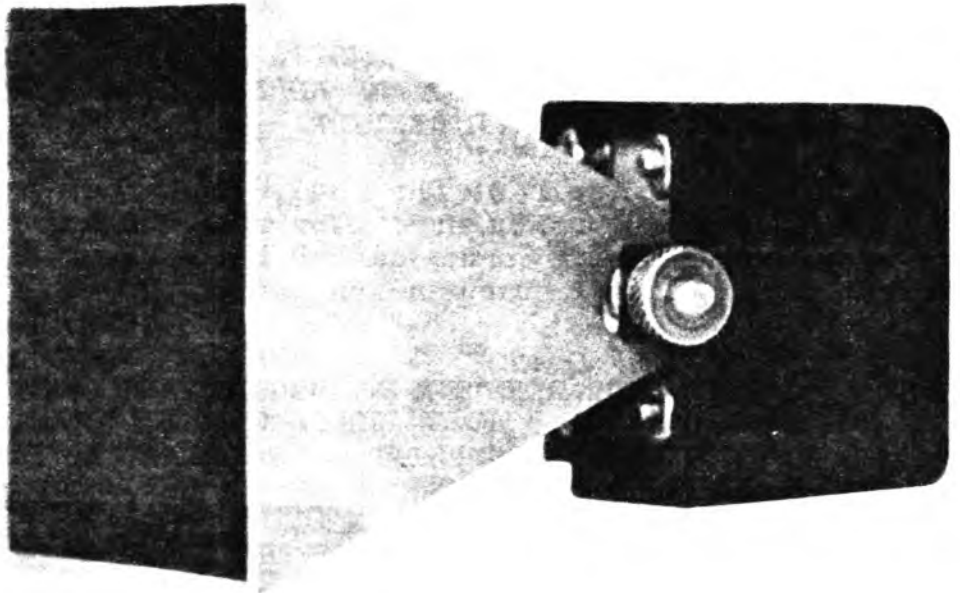

**3-1/2" W x 3" H x 4-1/2" D**

**ACTUAL SIZE**

**4" W x 2" H x 3-3/8" D**

**Suggested**  
**\$589**  
**List Price**