

# SECRET CB

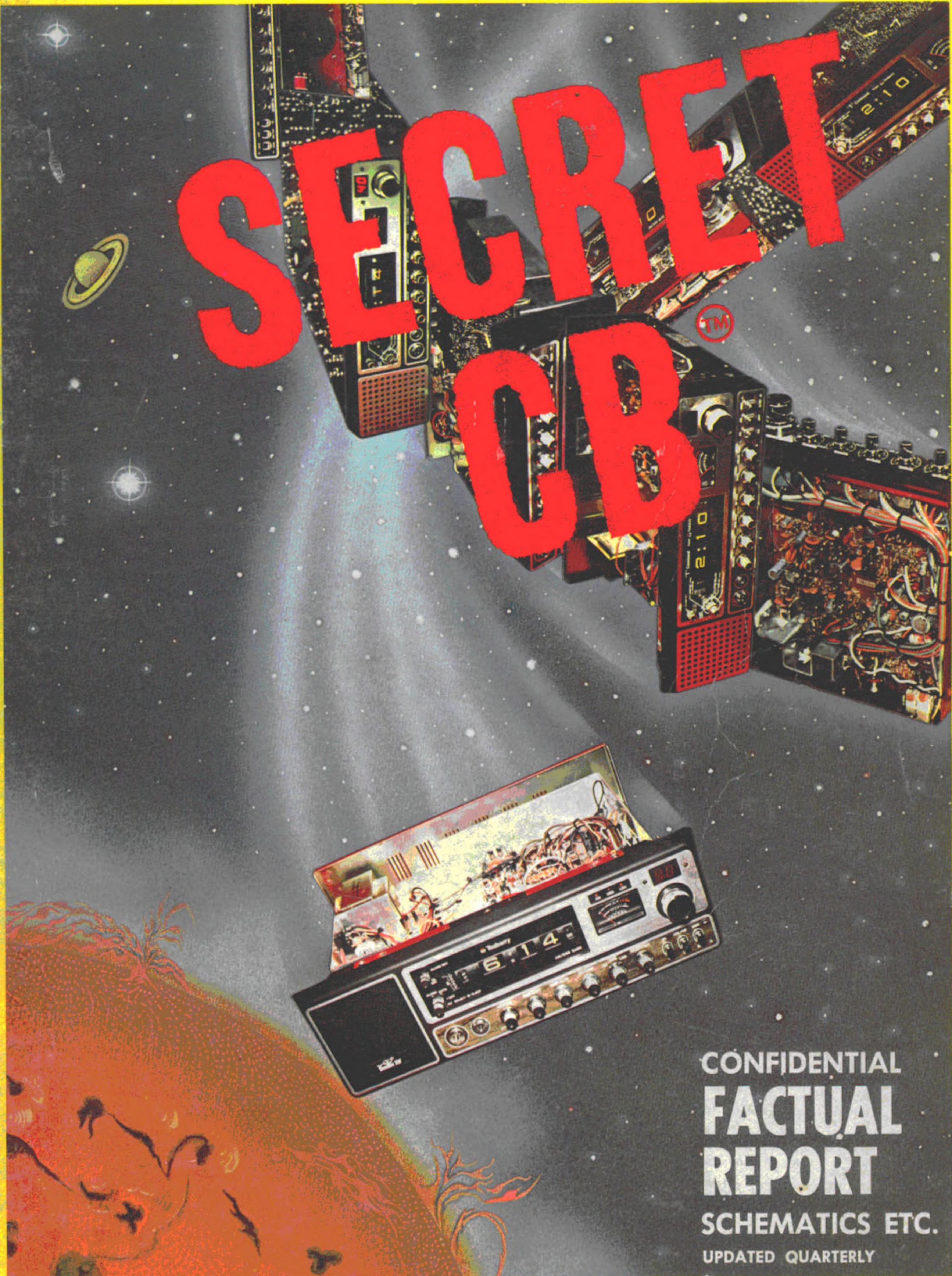

CONFIDENTIAL  
**FACTUAL  
 REPORT**  
 SCHEMATICS ETC.  
 UPDATED QUARTERLY

BY ROD JOHNSON

©COPYRIGHT 1979

PRICE \$15.95

# NEW PRODUCT RELEASE



STALKER XV

T COMMAND



STALKER 101  
(May be difficult to find)

STALKER V



AND MORE AT YOUR LOCAL  
CB DEALER / DISTRIBUTOR



# Teaberry®



IMPORTANT: READ THIS FIRST

The information in this book is not to be used to exceed F. C. C. specifications, in any case, as applied to power, modulation, frequency spectrum, etc. It is illegal to do this to any CLASS D RADIO.

This book is a factual report of gathered information, and as such is intended for use on radios for EXPORT ONLY.

If you are not familiar with electronics, it is better to check for advise with your local electronics or CB center, as to restrictions, etc., concerning your radio.

More information, on other units will be forthcoming in future issues, to be published on a quarterly basis.

This book will not be found at a book store, but can be obtained through your local CB Dealer or Distributor, or by sending \$12.95 to:

Secret CB

P. O. Box 8189

Corpus Christi, Texas 78412

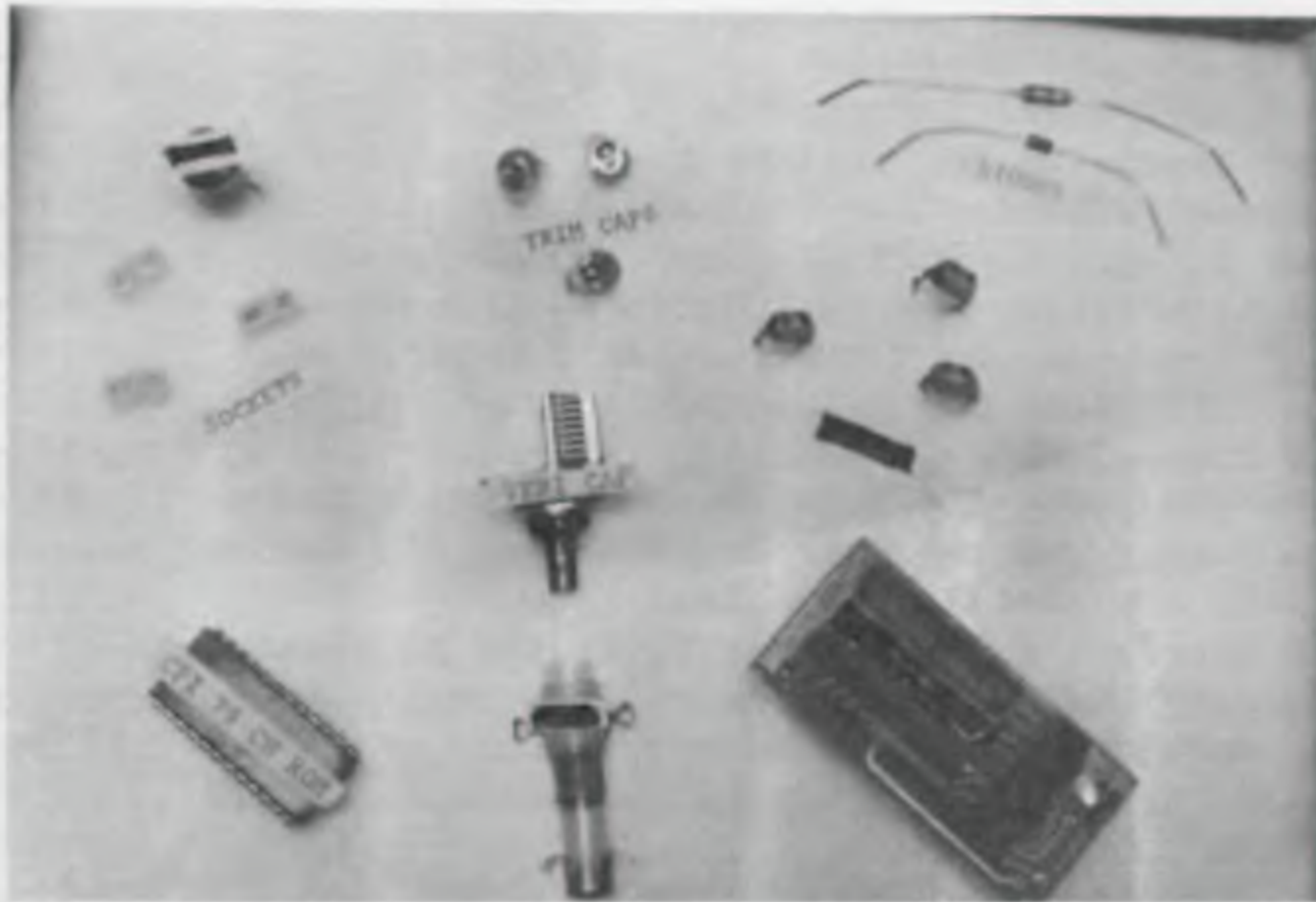

MODIFICATION SECTION - A

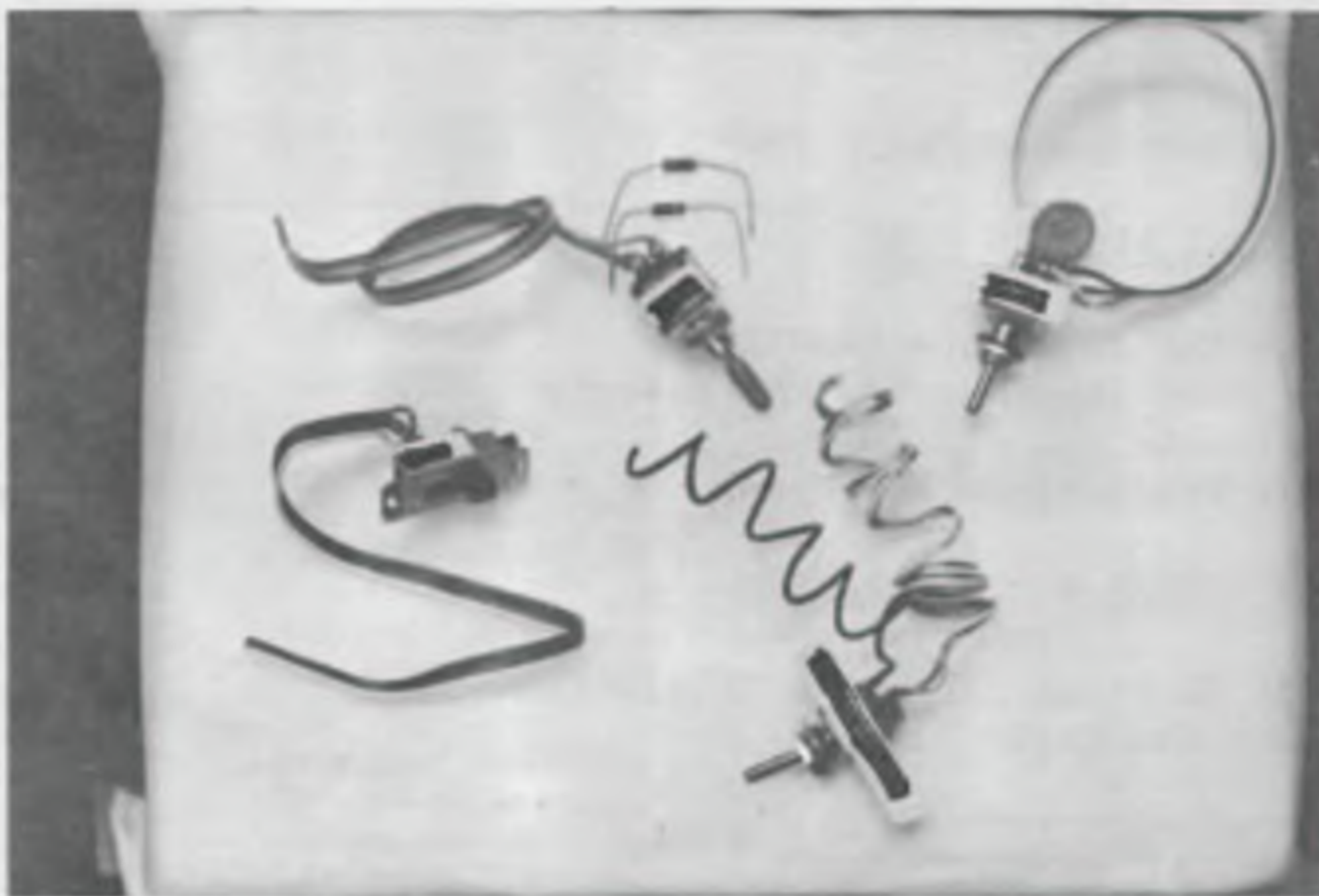

RANGER T CHANNEL EXPANSION

CHANNEL	P15	P16
1	27.605	27.285
2	27.615	27.295
3	27.625	27.305
4	27.645	27.325
5	27.655	27.335
6	27.665	27.345
7	27.675	27.355
8	27.695	27.375
9	27.705	27.385
10	27.715	27.395
11	27.725	27.405
12	27.745	27.425
13	27.755	27.435
14	27.765	27.445
15	27.775	27.455
16	27.795	27.475
17	27.805	27.485
18	27.815	27.495
19	27.825	27.505
20	27.845	27.525
21	27.855	27.535
22	27.865	27.545
23	27.895	27.575
24	27.875	27.555
25	27.885	27.565
26	27.905	27.585
27	27.915	27.595
28	27.925	
29	27.935	
30	27.945	
31	27.955	
32	27.965	
33	27.975	
34	27.985	
35	27.995	
36	28.005	
37	28.015	

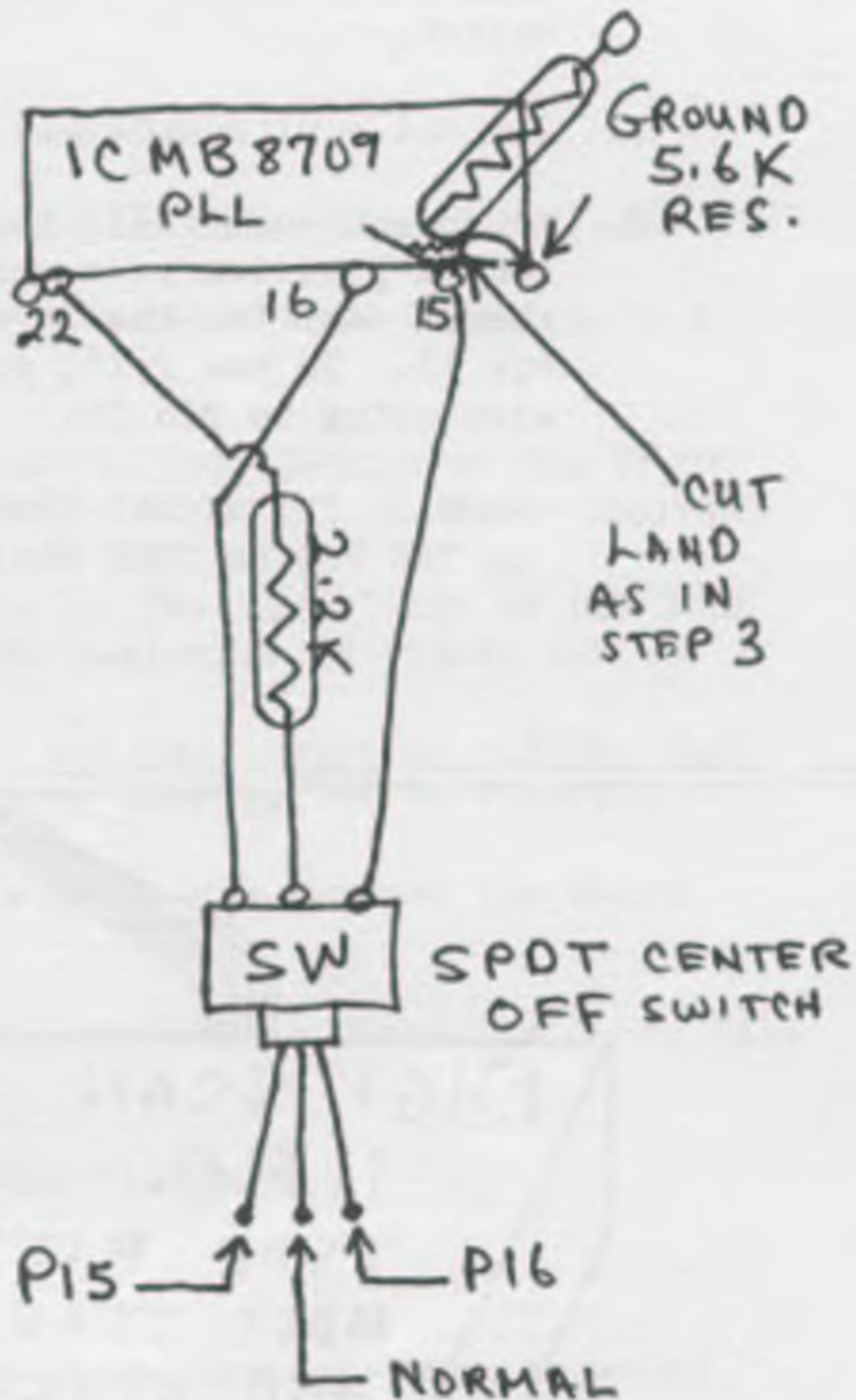

- STEP 1. Remove Top and Bottom Covers.
2. Locate IC (MB 8709).
3. Cut land to Pin #15. Refer to Figure 1.
4. Select a location free from other components and drill a 1/4 inch hole on the rear of chassis.
5. Mount a miniature SPDT center off switch using the 1/4 inch hole.
6. Connect 2200 Ohm resistor from Pin 22 to center terminal of switch. You will have to connect a piece of hook up wire between the switch and resistor.

RANGER T CHANNEL EXPANSION - Continued

- STEP 7. Connect a 5600 Ohm resistor from Pin 14 to ground as indicated in Fig. 1.
8. Also connect a wire from Pin 15 to one of the outer terminals of the switch.
  9. Connect a wire from Pin 16 to the other outer terminal.
  10. Now check your radio for proper operation. When the switch is in the center position your unit will operate normal. To use P-15 of your chart, position the lever of the switch away from the wire going to Pin 15. To use P-16, position the lever of the switch away from the wire going to Pin 16.

CAUTION: SOME OF THE HIGHER CHANNELS ON P-15 MAY NOT OPERATE DUE TO THE RANGE OF THE VCO ON SOME RADIOS.

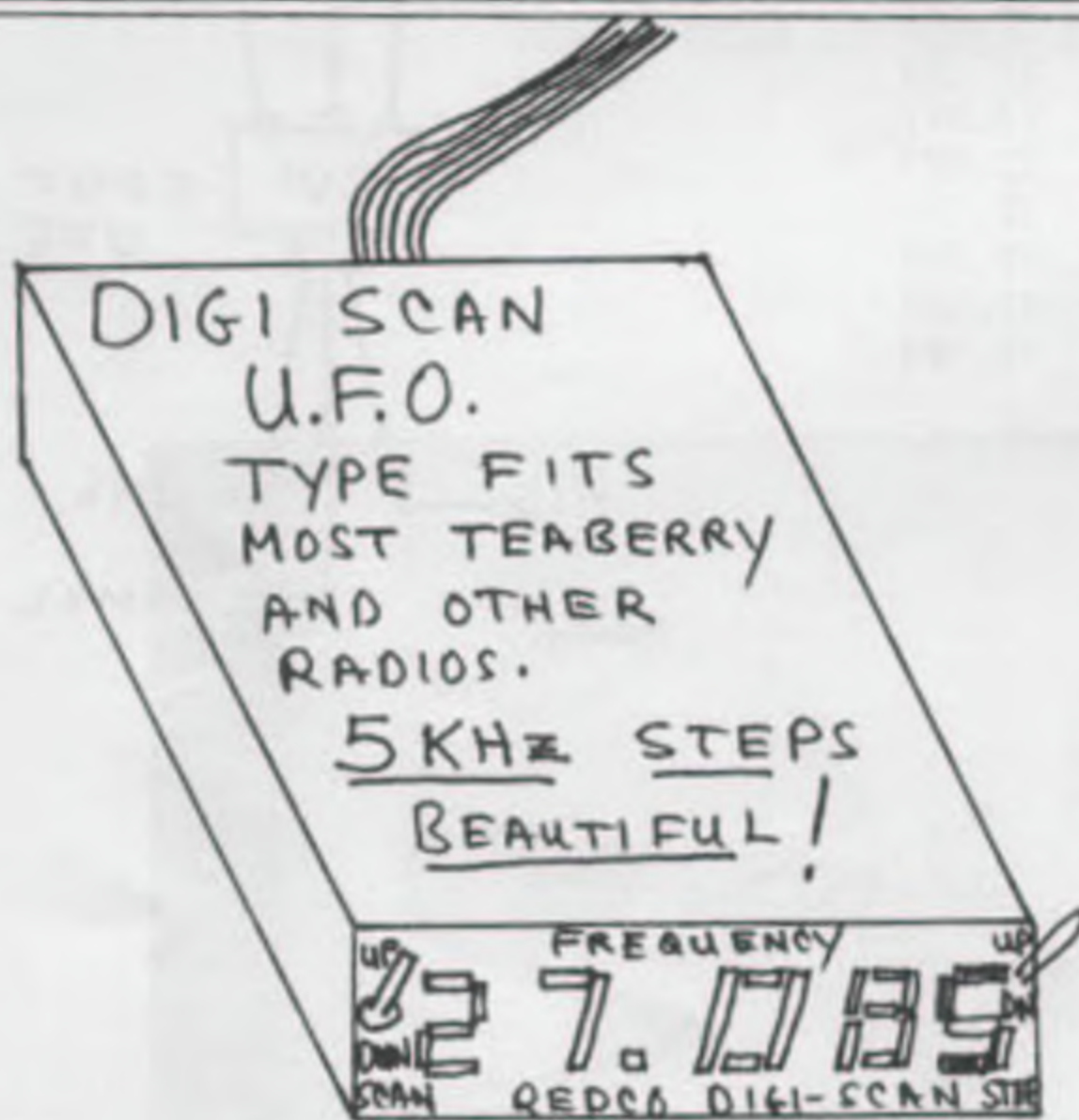

NEW  
PRODUCT!

THIS UNIT MAY BE USED TO EXTEND  
RECEIVE CAPABILITIES OF YOUR RADIO.  
CHECK WITH YOUR LOCAL LIC. TECH.  
FOR REGULATIONS CONCERNING THIS UNIT.

## MODEL-T 4011 CHANNEL EXPANSION

- STEP
1. Remove Top and Bottom Covers.
  2. Locate Channel Selector and PLL PC Board on Top of Chassis.
  3. Locate IC Q13 MSM 5907.
  4. Solder A Wire to Pin #3 About 8 Inches Long.
  5. Locate D-192 On Power Supply PC Board on Underside of Chassis.
  6. Solder A Lead To The Positive End of D-192 5 Volt Zener About 8 Inches Long.
  7. Remove The Green & White Wires From The S-RF Switch on The Front Panel.
  8. Remove One End of The 100K Resistor on The Lower Side of The S-RF Switch & Move it up One Terminal as Indicated in Figure 1.
  9. Connect the White & Green Wires to the Same Point as the One End of the 100K Resistor you Moved up one Terminal as in Figure 1.
  10. Connect the Wire From the D-192 to Where you Removed the White Wire on the S-RF Switch.
  11. Connect the Wire From Pin #3 of the MSM5907 to Where the Green Wire was Connected on the S-RF Switch.
  12. To Operate Normally, Switch to S For Standard.
  13. To Operate Expanded, Switch to RF.

**CAUTION:** Some Power Loss May Be Observed At The Upper Channels When Expanded, DO NOT ATTEMPT TO READJUST As This May Cause Some Trouble On The Normal Channels.

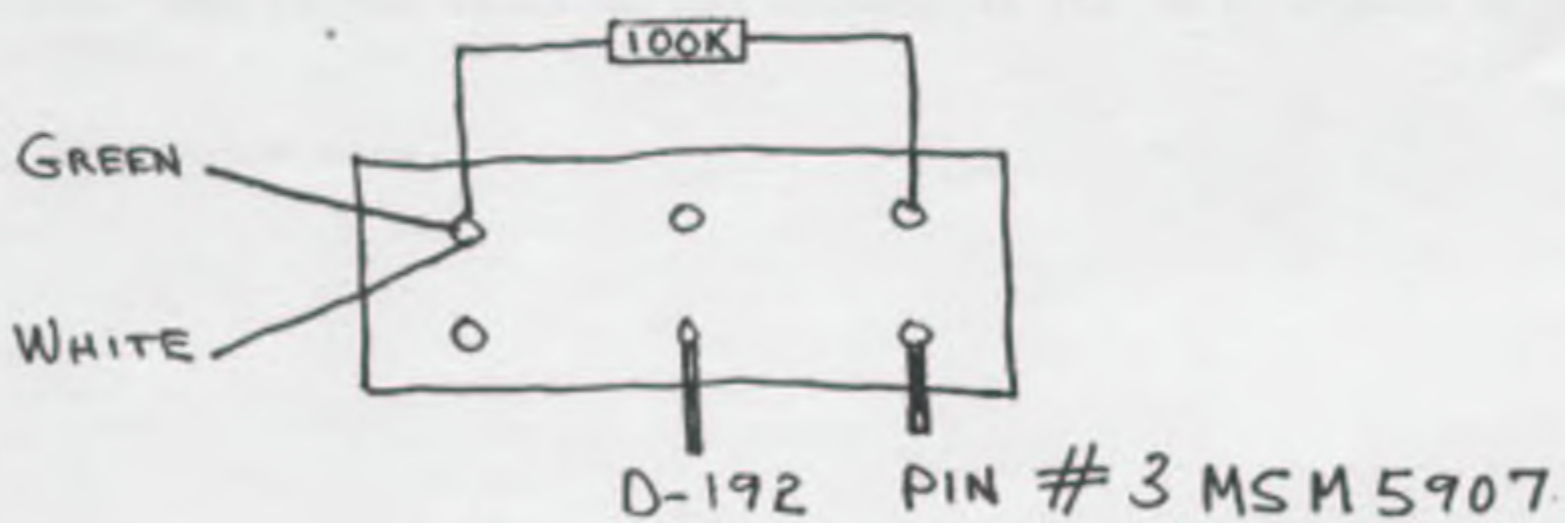

FIG 1

MODEL-T 4011 CHANNEL EXPANSION - CONTINUED

<u>CHANNEL</u>	<u>FREQUENCY</u>	
1	27.285	
2	27.295	
3	27.305	
4	27.325	
5	27.335	
6	27.345	
7	27.355	
8	27.375	
9	27.385	
10	27.395	
11	27.405	
12	27.425	New Channel
13	27.435	"
14	27.445	"
15	27.455	"
16	27.475	"
17	27.485	"
18	27.495	"
19	27.505	"
20	27.525	"
21	27.535	"
22	27.545	"
23	27.575	"
24	27.555	"
25	27.565	"
26	27.585	"
27	27.595	"
28-40	Normal	



## CHANNEL EXPANSION FOR STALKER I

### 23 Channel

1. Remove all 8 screws holding case to chassis. Remove case top and bottom.
2. Remove 4 screws holding digital block to P. C. Board.
3. Unsolder orange and yellow wires on digital block. (Remember where they were connected). Carefully lift digital block up to expose bottom of P. C. Board.
4. Unsolder IC 11 (SN7490) remove IC 11. Replace the SN7490 with a SN7493. Resolder.
5. Solder a wire to pin 9 of IC 11.
6. Replace digital block, reconnect yellow and orange wires.
7. Jumper terminals 1 and 2 on digital block. (See Fig. 1)



FIG. 1

8. Remove orange wire from rear wafer of channel selector switch. Connect two IN 60 diode to the switch terminal left empty, (anode end toward SW) connect orange wire to one diode.
9. Connect one IN 60 diode to channel selector switch where brown wire is connected to rear washer. (anode end toward SW)
10. Remove the two blue, one gray, one green wires from DX / local switch. Connect the two blue wires and the one gray wire together. Solder and tape. Tape off the green wire.
11. Connect wire from pin 9 of IC 11 to the center terminal of DX / local switch. Connect two wires to the top terminal of DX / local switch. Connect the other end of the wires to the cathode of the IN 60 diodes on the selector switch.
12. Reassemble case.

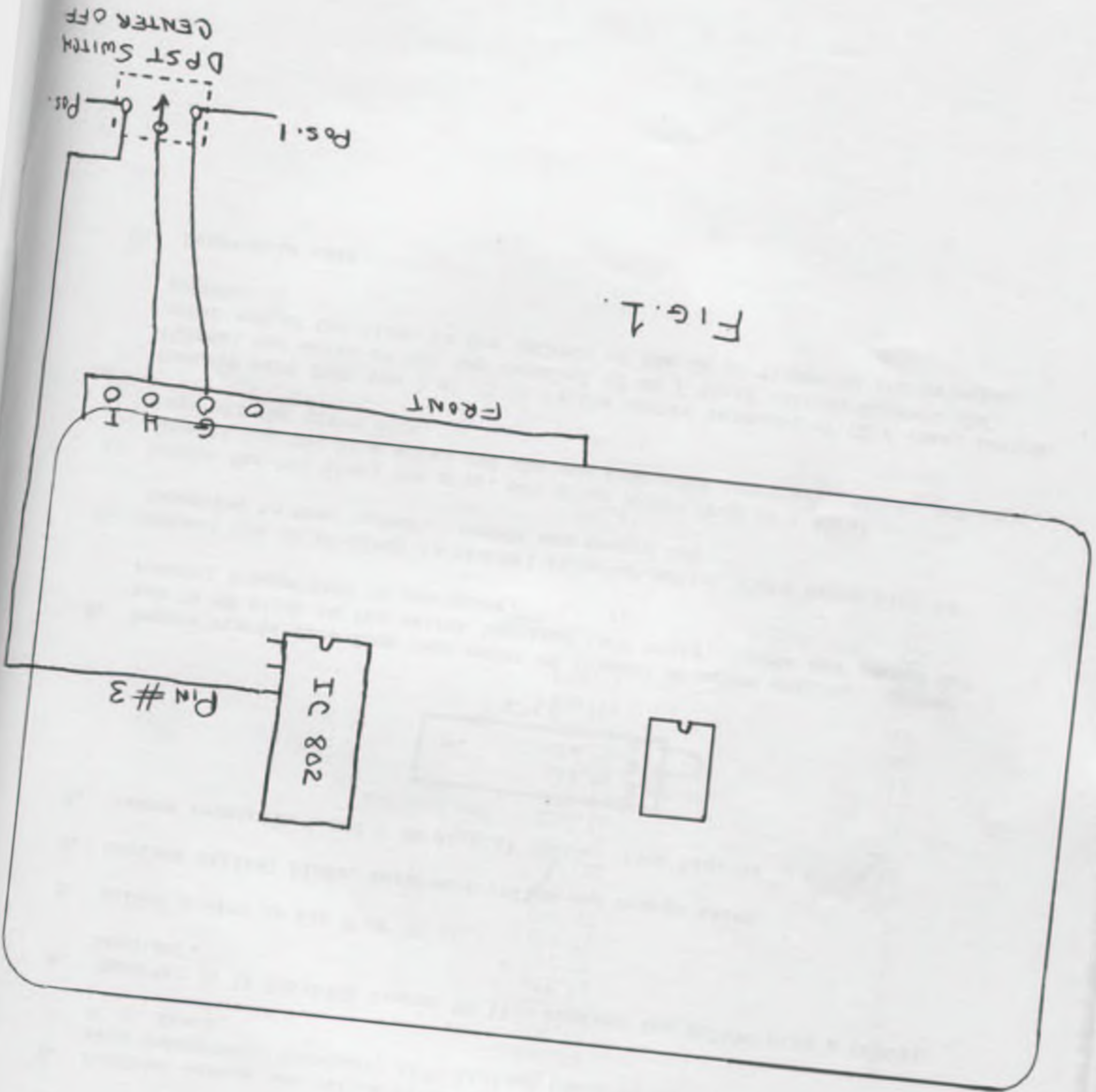

FIG. 1.

TOP VIEW OF PLL  
STALKER I 23 CHANNEL

120 CHANNEL EXPANDER  
FOR STALKER IX AND XV

CAUTION: ILLEGAL FOR USE IN CLASS D CITIZEN'S BAND. FOR AMATEUR OR EXPORT USE ONLY.

Installation instructions

- Step 1. Remove covers from unit.
- Step 2. Choose an area for mounting your switch which is free from obstructions. (A .250" hole is required.)
- Step 3. Locate X-4 crystal which is 11.1125 mhz and remove by desoldering.
- Step 4. Install X-4 into the S-15 next to the existing crystals. (See figure 1.)
- Step 5. Now position the S-15 IC towards the rear of the cabinet and plug the two bare leads in the two holes left by the removal of X4 and solder. Caution should be exercised to keep these leads as short as possible to eliminate off frequency operation. (See figure 1.)
- Step 6. Connect the red lead to pin 9 of IC2 MB8719. (See figure 1.)
- Step 7. Solder the ground strap to top of L-18. (See figure 1.)
- Step 8. Install covers, installation is complete.

Alignment: If alignment becomes necessary, adjust CT-3 in each switch position to insure proper on frequency operation.

MODIFICATION FOR SLIDING STALKER IX AND XV

1. Cut D36.
2. Cut R187.
3. Remove orange wire from 8 volt supply to clarifier control. (Stalker IX)
4. Connect a wire from pin 1 of IC5 to clarifier.
5. Jumper R415 (Stalker XV) or R188 (Stalker IX) to ground.
6. Set radio in USB.
7. Run probe from counter to TP1.
8. Center clarifier control.
9. Radio to be on channel 20.
10. Adjust CT3 for frequency counter to read 35.0075 Mhz.
11. Set radio on LSB.

12. Adjust L19 for frequency counter to read 35.0025 Mhz.
13. Set radio on AM.
14. Adjust L20 to read 35.0050 Mhz.
15. Your radio should now slide approximately 2.5k low + 1.5K high.

FREQUENCY COROLATION FOR EXPANDED STALKER IX AND XV

<u>CHANNEL</u>	<u>LOW</u>	<u>NORMAL</u>	<u>HIGH</u>
1	26.515	26.965	27.415
2	26.525	26.975	27.425
3	26.535	26.985	27.435
4	26.555	27.005	27.455
5	26.565	27.015	27.465
6	26.575	27.025	27.475
7	26.585	27.035	27.485
8	26.605	27.055	27.505
9	26.915	27.065	27.515
10	26.625	27.075	27.525
11	26.635	27.085	27.535
12	26.655	27.105	27.555
13	26.665	27.115	27.565
14	26.675	27.125	27.575
15	26.685	27.135	27.585
16	26.705	27.155	27.605
17	26.715	27.165	27.615
18	26.725	27.175	27.625
19	26.735	27.185	27.635
20	26.755	27.205	27.655
21	26.765	27.215	27.665
22	26.775	27.225	27.675
23	26.805	27.255	27.705
24	26.785	27.735	27.685
25	26.795	27.245	27.695
26	26.815	27.265	27.715
27	26.825	27.275	27.725
28	26.835	27.285	27.735
29	26.845	27.295	27.745
30	26.855	27.305	27.755
31	26.865	27.315	27.765
32	26.875	27.325	27.775
33	26.885	27.335	27.785
34	26.895	27.345	27.795
35	26.905	27.355	27.805
36	26.915	27.365	27.815
37	26.925	27.375	27.825
38	26.935	27.385	27.835
39	26.945	27.395	27.845
40	26.955	27.405	27.855

REAR

120 CHANNEL EXPANDER  
FOR STALKER IX AND XV

COMPONENT SIDE

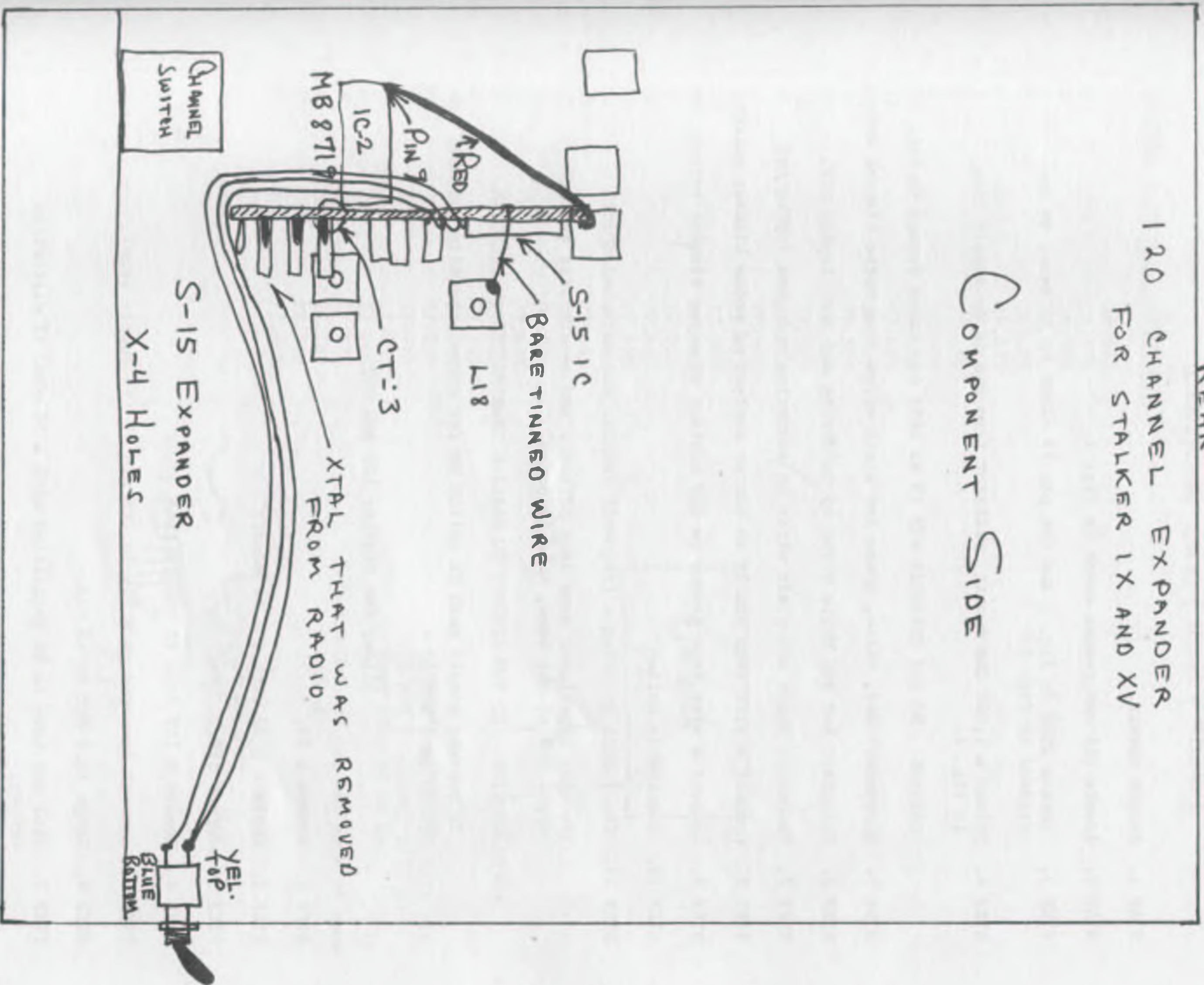

FIGURE 1

STALKER ONE (4001 & 4002) 80 CHANNEL CONVERSION

- STEP 1. Remove covers.
- STEP 2. Locate PLL and remove cover in Fig. 1.
- STEP 3. Locate D858 in Fig. 1 and cut pin 19 close to PC Board as indicated in Fig. 2.
- STEP 4. Solder a 1,000 Ohm  $\frac{1}{2}$  watt resistor from pin 19 to supply line in Fig. 1.

CAUTION: DO NOT OVERHEAT PIN 19 as this can cause damage to PLL.

- STEP 5. Disconnect Red, White, Green and plain wires from noise blanker switch.
- STEP 6. Reconnect Red and White wires by soldering and then taping off.
- STEP 7. Reconnect Green and plain wires by soldering and then taping off.
- STEP 8. Connect a wire from Pin 19 to center contact of noise blanker switch.
- STEP 9. Connect a wire from ground to TOP contact of noise blanker switch.
- STEP 10. Reassemble unit.
- STEP 11. Check unit by using a frequency counter and attached chart.

You may experience some loss of power and sensitivity at the upper end of the band, this is normal.

CAUTION: DO NOT ATTEMPT TO REALIGN TRANSMITTER OR RECEIVER.

To operate simply push NB switch up for normal channels and down for expanded channels.

Slider for Stalker 101 and 202

- STEP 1. Remove D 30.
- STEP 2. Replace D 32 with a 7.6V zenor.
- STEP 3. Jumper 116.
- STEP 4. Remove R 119 from RX supply line.
- STEP 5. Connect open end of R 119 to IC6 pin #1 (9v supply line)
- STEP 6. Range +1.5 Khz to -3 Khz
- STEP 7. R161 may have to be paralleled with a 56 ohm, if distortion occurs.

TEABERRY  
 STALKER ONE (4001 & 4002)

CHANNEL                      FREQUENCY

1	26.565
2	26.575
3	26.585
4	26.605
5	26.615
6	26.625
7	26.635
8	27.455
9	27.465
10	27.475
11	27.485
12	27.505
13	27.515
14	27.525
15	27.535
16	27.555
17	27.565
18	27.575
19	27.585
20	27.605
21	27.615
22	27.625
23	27.655
24	27.635
25	27.645
27	27.675
28	27.685
29	27.695
30	27.705
31	27.715
32	27.725
33	27.735
34	27.745
35	27.755
36	27.765
37	27.775
38	27.785
39	27.795
40	27.805

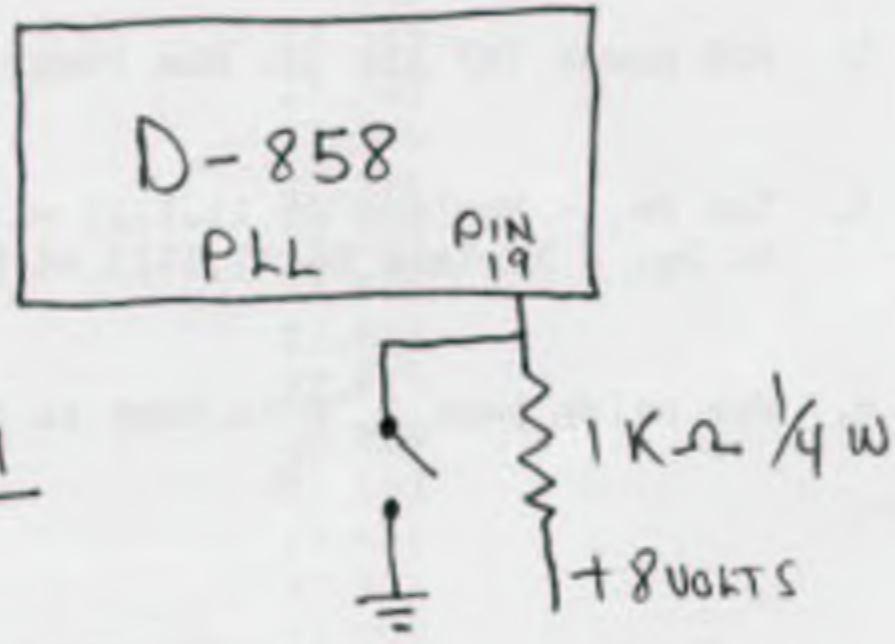

FIG 1

- \* Do the same except lift pin 23 and frequency will go down instead of up.
- \* The mod may not work on some radios.

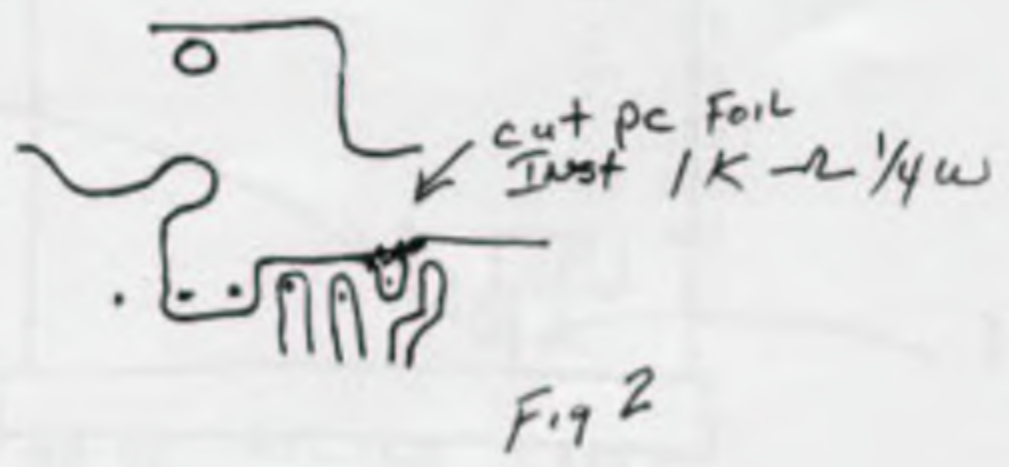
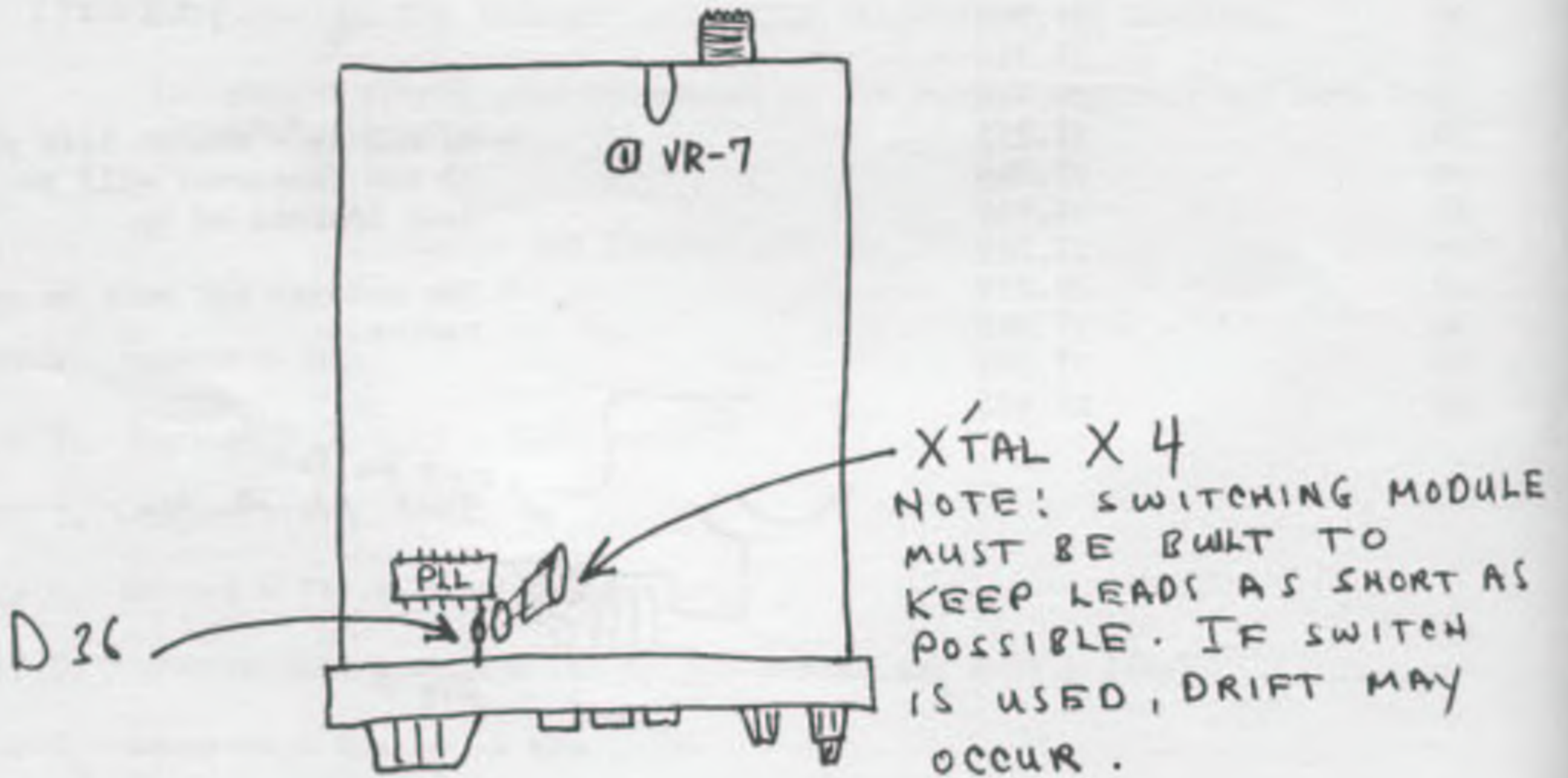

Fig 2

President McKinley

Specific Radio Modification

1. Clarifier Mod cut D36 - cut orange and red wire from clarifier pot. Connect one side to ground and one side to pin 3 of IC5. This allows +1.5 and -5KHz. (Red wire to ground).
2. SSB ALC Adjust VR7 for Max. = AM ALC cut collector of TR32.
3. AM power VR6 for Max - L-26, L-27, L29, L36 for Max peak power with 1000 Hz tone. Do not adjust L39 - Also VR8 - VR9.
4. SSB power VR7 ALC for Max Power.
5. Low Fq. - Replace X4 11.1125 with a 10.9582MHz, Xtal.  
Hi Fq. - Replace X4 11.1125 with a 11.2580 MHz, Xtal.
6. Use relay page in this book to build switching module.





## AM HI CONVERSION CHANNEL LIST

OLD CHANNEL	NEW CHANNEL
1	27.365
2	27.375
3	27.385
4	27.405
5	27.415
6	27.425
7	27.435
8	27.455
9	27.465
10	27.475
11	27.485
12	27.505
13	27.515
14	27.525
15	27.535
16	27.555
17	27.565
18	27.575
19	27.585
20	27.605
21	27.615
22	27.625
23	27.655
24	27.635
25	27.645
26	27.665
27	27.275
28	27.285
29	27.295
30	27.305
31	27.315
32	27.325
33	27.333
34	27.345
35	27.355
36	27.365
37	27.375
38	27.385
39	27.395
40	27.405

## CHANNEL EXPANSION

T BEAR, TITAN T AND T DISPATCH

<u>EXPANDED CHANNEL</u>	<u>FREQUENCY</u>
-------------------------	------------------

1	27.365
2	27.375
3	27.385
4	27.405
5	27.415
6	27.425
7	27.435
8	27.455
9	27.465
10	27.475
11	27.485
12	27.505
13	27.515
14	27.525
15	27.535
16	27.555
17	27.565
18	27.575
19	27.585
20	27.605
21	27.615
22	27.625
23	27.645
24	27.635
25	27.645
26	27.665
27	Thru 40 Normal

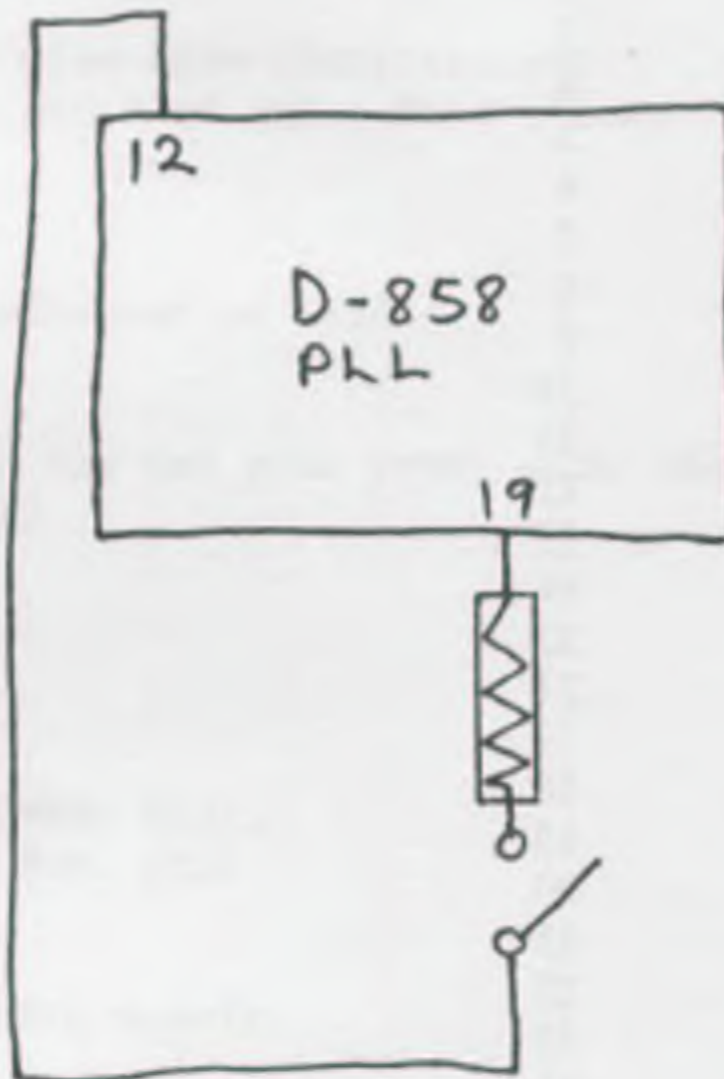

**CAUTION:** Some of the upper channels may not function due to being too far out of band on some radios.

DO NOT align the VCO coil

- STEP**
1. Remove the chassis from the cabinet, both top and bottom.
  2. Locate IC D-858 PLL.
  3. Connect a 1,000 Ohm  $\frac{1}{2}$  watt resistor to Pin 19.
  4. Locate ANL Switch and remove both wires and tape each separately. In the case of the Titan T cut the two lands going to the switch. On the T Bear remove the blue and green wires and tape separately, remove the brown and orange wires and solder together and tape off. The NB switch is used on the T Bear.
  5. Connect a wire from the 1,000 Ohm resistor to the center of the switch on the Titan T and T Dispatch. On the T Bear solder the resistor wire to the terminal you removed the orange wire from.
  6. Connect a wire from Pin #12 to the outer terminal opposite the ANL land or wire. The T Bear should have the Pin #12 wire connected to the terminal you removed the Brown wire from.

STEP 7. To operate in the expanded mode simply push the switch to on and off for normal.

CAUTION: Some units may not operate on some of the higher channels due to range of the VCO.

---

## PERSONAL NOTES:

IMPORTANT: KEEP LEADS AS SHORT AS POSSIBLE. USE ONLY SOLID WIRE AGW20 TINNED COPPER WIRE.

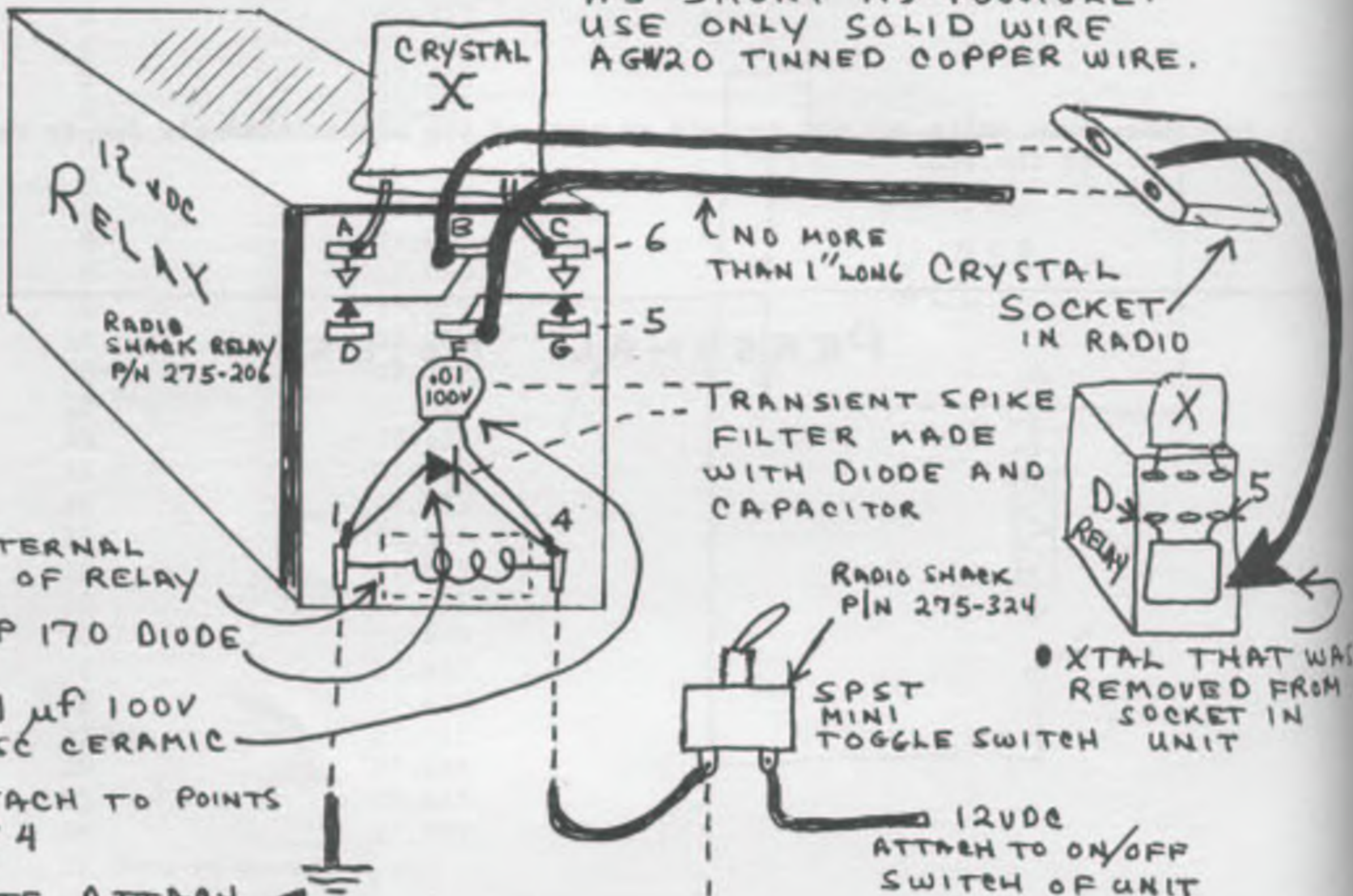

- INTERNAL COIL OF RELAY
- HEP 170 DIODE
- .01 µF 100V DISC CERAMIC
- ATTACH TO POINTS 1 & 4
- NOTE ATTACH TO PRINTED CIRCUIT GROUND

(IMPORTANT, NOTE PRINTED CIRCUIT GROUND IS NOT THE SAME AS CHASSIS GROUND!)

- DRILL HOLE FOR LED ATTACH WITH PLASTIC CEMENT IN A CONVENIENT LOCATION ON FACE PLATE.
- ATTACH XTAL MODULE THAT YOU HAVE BUILT DIRECTLY ABOVE XTAL SOCKET. SECURE WITH SILICON SEAL.

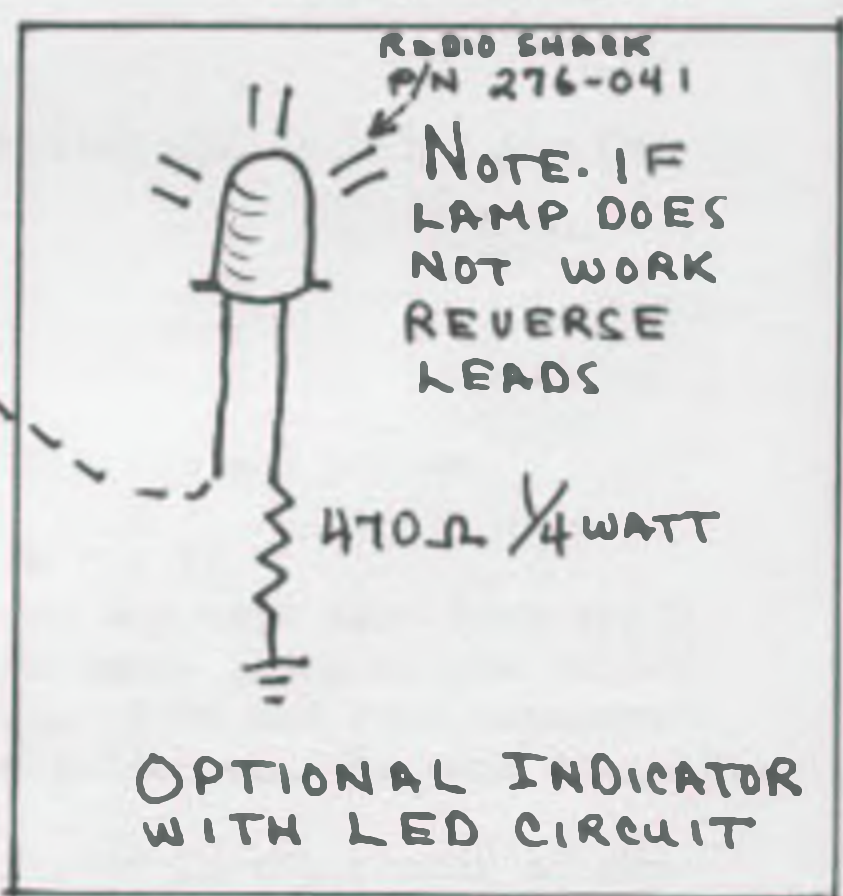

ITT 40 CHANNEL MODEL  
4400M

1. For Max Mod cut D209.
2. For power increase short R280. This gives 1 Watt power increase.
3. Tune L207 - L208 - L209 - L210 - L211 for max with 1000HZ.
4. Cut the PC - trace on pin 3 of PLL IC - connect a Single Pole Single Throw Switch Min toggle switch across the cut. This will give you upper channels.

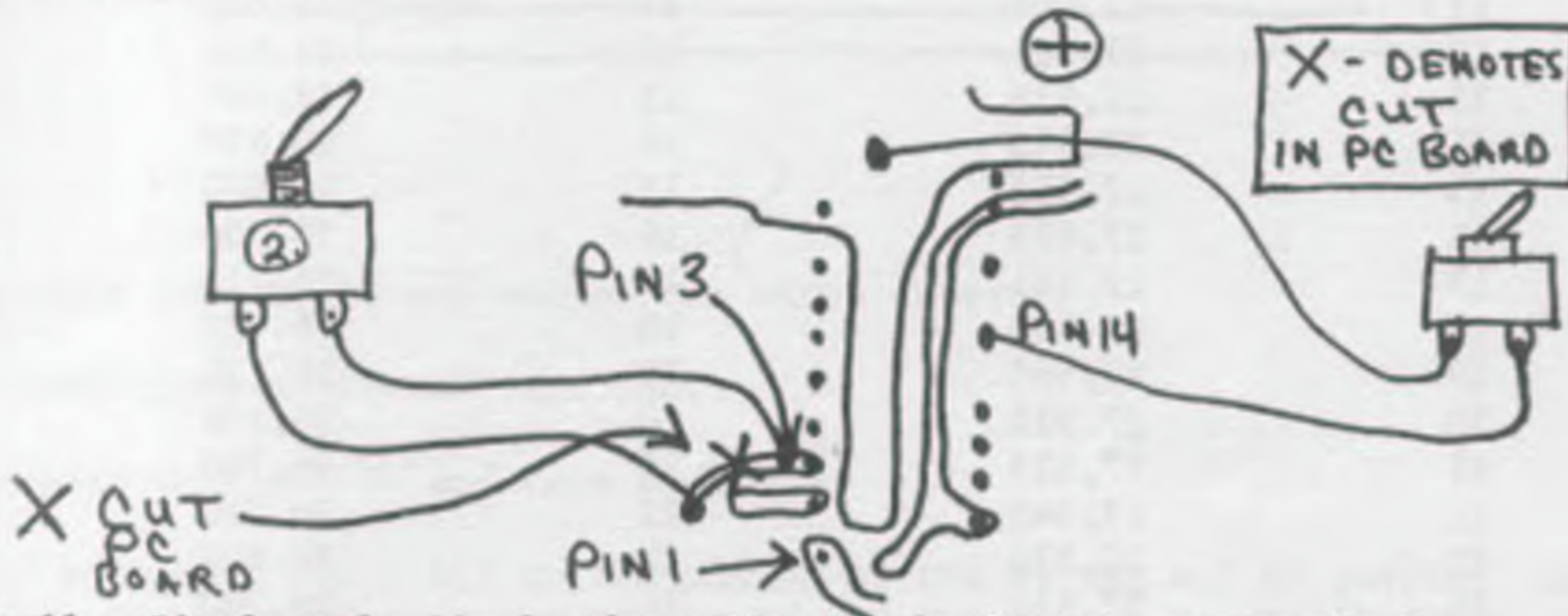

5. Install a Single Pole Single Throw Min Toggle Switch across pin 9. Ground and pin #14. This will give you the Lower Channels.

PARTS LIST

- ① DPDT CENTER OFF TOGGLE SWITCH.  
RADIO SHACK P/N 275620
- ② SPST SWITCH  
RADIO SHACK P/N 275-612  
QTY 2

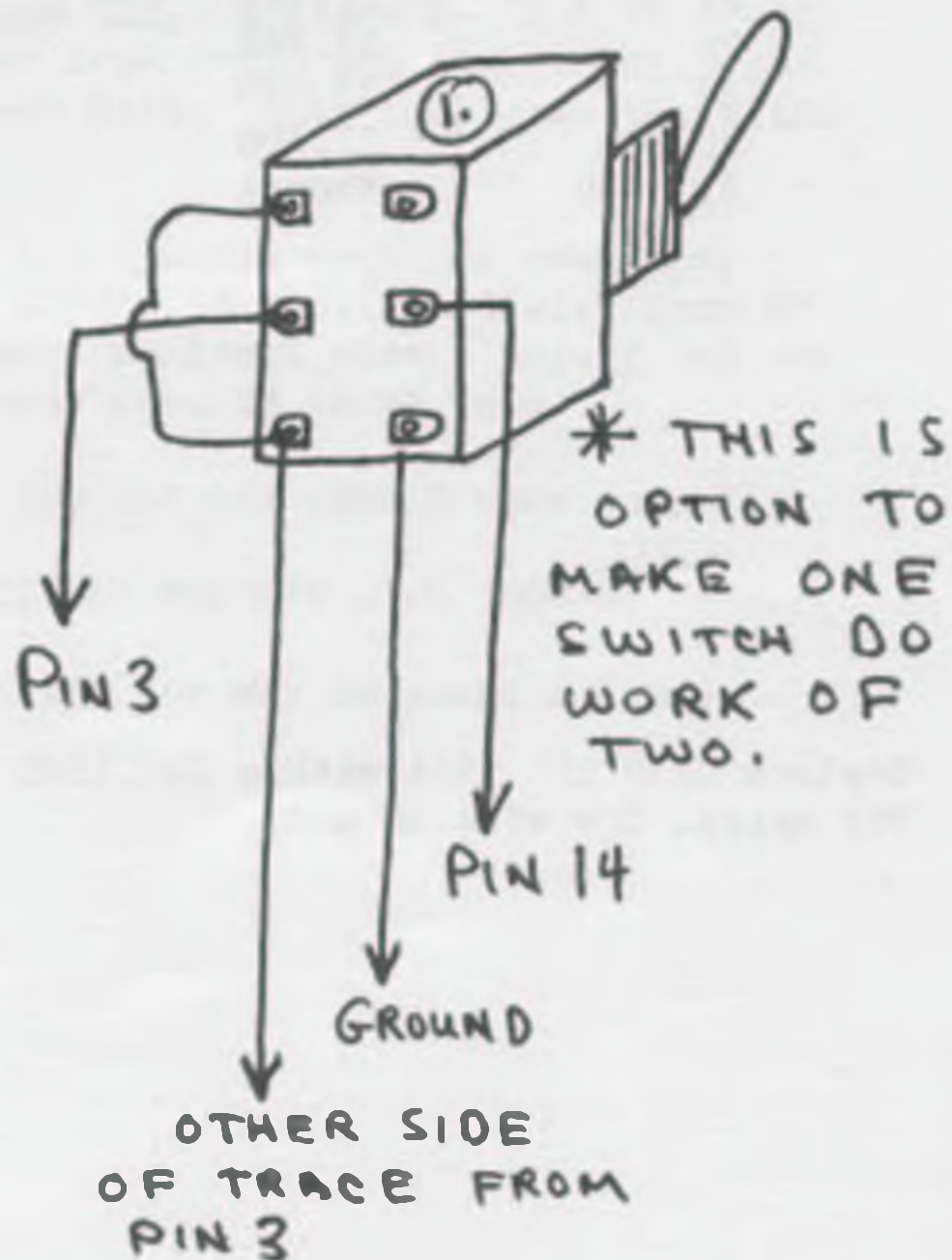

ITT 4400M

HIGH CHANNELS

LOW CHANNELS

HIGH CHANNELS		LOW CHANNELS	
1	27.285	1	26.510
2	27.295	2	26.520
3	27.305	3	26.530
4	27.325	4	26.550
5	27.335	5	26.560
6	27.345	6	26.570
7	27.355	7	26.580
8	27.375	8	26.600
9	27.385	9	26.610
10	27.395	10	26.620
11	27.405	11	26.630
12	27.425	12	26.650
13	27.435	13	26.660
14	27.445	14	26.670
15	27.555	15	26.680
16	27.475	16	26.700
17	27.485	17	26.710
18	27.495	18	26.720
19	27.505	19	26.730
20	27.525	20	26.750
21	27.535	21	26.760
22	27.545	22	26.770
23	27.575	23	26.800
24	27.555	24	26.780
25	27.565	25	26.790
26	27.585	26	26.810
27	27.595	27	26.820
28	27.285	28	26.830
29	27.295	29	26.840
30	27.305	30	26.850
31 - 40	Normal	31	26.860
		32	26.870
		33	26.880
		34	26.890
		35	27.900
		36	26.910
		37	26.920
		38	26.930
		39	26.940
		40	26.950

6. Replace Q219 2SC 1964 with a 2SC 1306 for 7 $\frac{1}{2}$ w + out put.  
PEP aprox. 20w with AM mod.

## CHANNEL EXPANSION AND SLIDE CHANGE

N.B. ANL. RF

S0 Cont to RF Gain

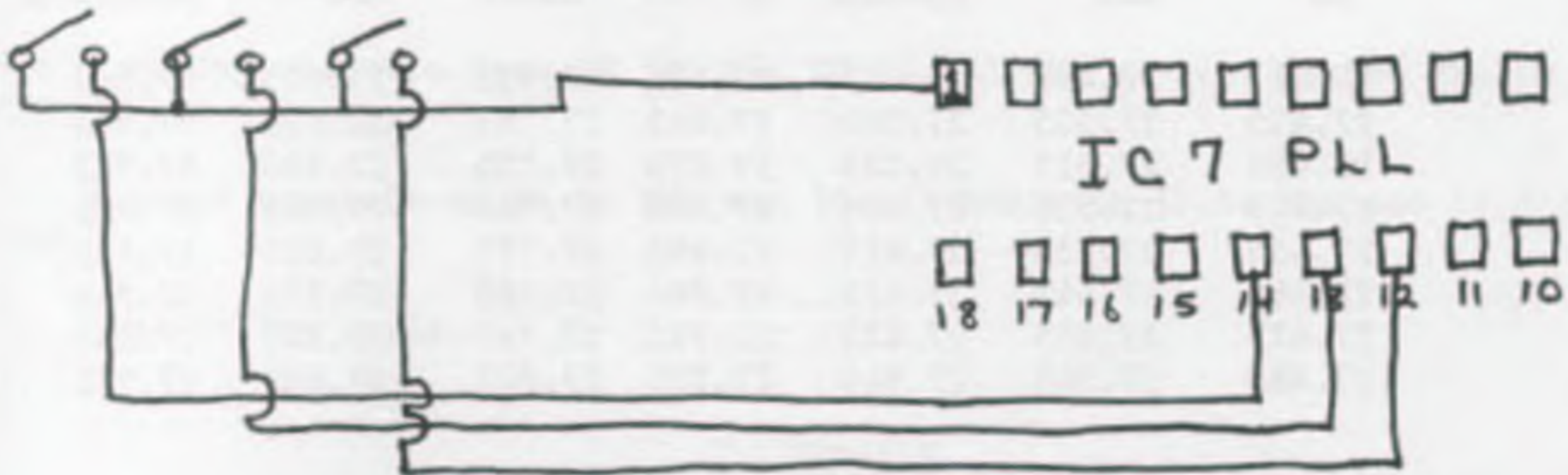

1. Cut Leads from NB SW and solder the wires together.
2. Cut Leads from RF SW and tape back.
3. Cut Leads from ANL SW and tape back.
4. Run a wire from pin 1 IC7 to the common of the NB ANL and RF switch. Run 3 wires from the NO position of the NB -RF ANL switch to pin 14-13-12. This completes the channel expansion from 27.415 to 27.965.
5. Slide Mod - Remove D30 - R119 - R162 and D32. Replace R-162 4.7K- $\Omega$  with a 1K $\Omega$ . Install R119 100 $\Omega$   $\frac{1}{2}$ w resistor from C-135 pos side to C110 pos side on the PC side of the board. Short R116. This completes the slide +2.5 -5 KHZ.
6. Cut leads from S0 cont. Solder red & brown wires together and tape. Solder orange wire from RF Gain SW to middle S0 cont. Red wire from RF SW to term closest to vol control, tape the black wire. Adjust VR2 for RF Gain range. This completes the change from S0 to RF Gain
7. SSB ALC cut C155 Adjust VR408 for max L28 for Max with 2 tone source.
8. Power AM - Adjust VR8 Max L29 L30 - L32 for Max PEP with 1000 HZ tone.
9. For Max F $\phi$  spread - adjust L37 - L38 - L39 for Max AM power and Mod over the range.

Palomar 500

OFF	NB	ANL	NB+ANL	RF	NB+RF	ANL+RF	NB+ANL+RF
33	27.415	27.495	27.575	27.655	27.735	27.815	27.895
34	27.425	27.505	27.585	27.665	27.745	27.825	27.905
35	27.435	27.515	27.595	27.675	27.755	27.835	27.915
36	27.445	27.525	27.605	27.685	27.765	27.845	27.925
37	27.455	27.535	27.615	27.695	27.775	27.855	27.935
38	27.465	27.545	27.625	27.705	27.785	27.865	27.945
39	27.475	27.555	27.635	27.715	27.795	27.875	27.955
40	27.485	27.565	27.645	27.725	27.805	27.885	27.965

NB 41-48

ANL 49-56

NB+ANL 57-64

RF 65-72

NB+RF 73-80

ANL+RF 81-88

NB+ANL+RF 89-96



HOW TO CHANGE THE TRS CHALLENGER,  
MODELS 850 AND 1400, TO AMATEUR RADIO BAND (10M)

On expanding channels from 28.505 MHz to 28.945 MHz or from 28.960 MHz to 29.400 MHz.

1. Replace crystals of 16.27 MHz and 16.273 MHz with 17.81 MHz and 17.813 MHz.
2. Tune up the coils.

DETAILS

Replace crystals of 16.27 MHz and 16.273 MHz with 17.81 MHz and 17.813 MHz.

Replace crystals presently installed on the PLL Unit, 16.27 MHz (X1) and 16.273 MHz (X2) with 17.81 MHz and 17.813 MHz. If you use USB only, replacement is only the crystal 16.273 MHz with 17.81 MHz. (See figure 1 and 2).

Tue up

After changing above crystals, the coils should then be tuned.

PLL UNIT

1. Prepare the tester and connect it between test point 2 (TP2) and any minus (-) ground (earth). Next, set to channel 1 position - the tester range should be 2 - 10 Volts (DC). "L2" should be tuned up as the tester indicates 2 Volts. As you are tuning up the coil, the channels should be checked individually 1 thru 40 so that as the coil is being tuned, the tester will show a balanced change from 2 Volts to about 4.5 Volts (DC) on each of the channels. (see figure 3).
2. Put your Model 850 or 1400 in AM and TX mode. Then while watching the power meter tune up the coils T1 and L3. This is to be done carefully so as to increase the Out Put Level on your power meter.

TRANSMITTER

Put your Model 850 or 1400 in AM mode and RX mode. Then follow the same procedures as discribed in above, matching the power meter and tuning up the following coils so as to increase the power; T1, L1, L14, T2, T3, L2, L5, L10. (See figure 5).

RECEIVER

Put your Model 850 or 1400 in AM mode and RX mode. Then by listening to the set noise, tune up the following coils so as to increase the set noise; T4, T5, T6. (figure 6)

HOW TO CHANGE THE TRS CHALLENGER ( CONTINUED )

FREQUENCY TABLE

<u>CHANNEL</u>		
1	28.505	28.960
2	28.515	28.970
3	28.525	28.980
4	28.545	29.005
5	28.555	29.010
6	28.565	29.020
7	28.575	29.030
8	28.595	29.050
9	28.605	29.060
10	28.615	29.070
11	28.625	29.080
12	28.645	29.100
13	28.655	29.110
14	28.665	29.120
15	28.675	29.130
16	28.695	29.150
17	28.705	29.160
18	28.715	29.170
19	28.725	29.180
20	28.745	29.200
21	28.755	29.210
22	28.765	29.220
23	28.795	29.250
24	28.775	29.230
25	28.785	29.240
26	28.805	29.260
27	28.815	29.270
28	28.825	29.280
29	28.835	29.290
30	28.845	29.300
31	28.855	29.310
32	28.865	29.320
33	28.875	29.330
34	28.885	29.340
35	28.895	29.350
36	28.905	29.360
37	28.915	29.370
38	28.925	29.380
39	28.935	29.390
40	28.945	29.400

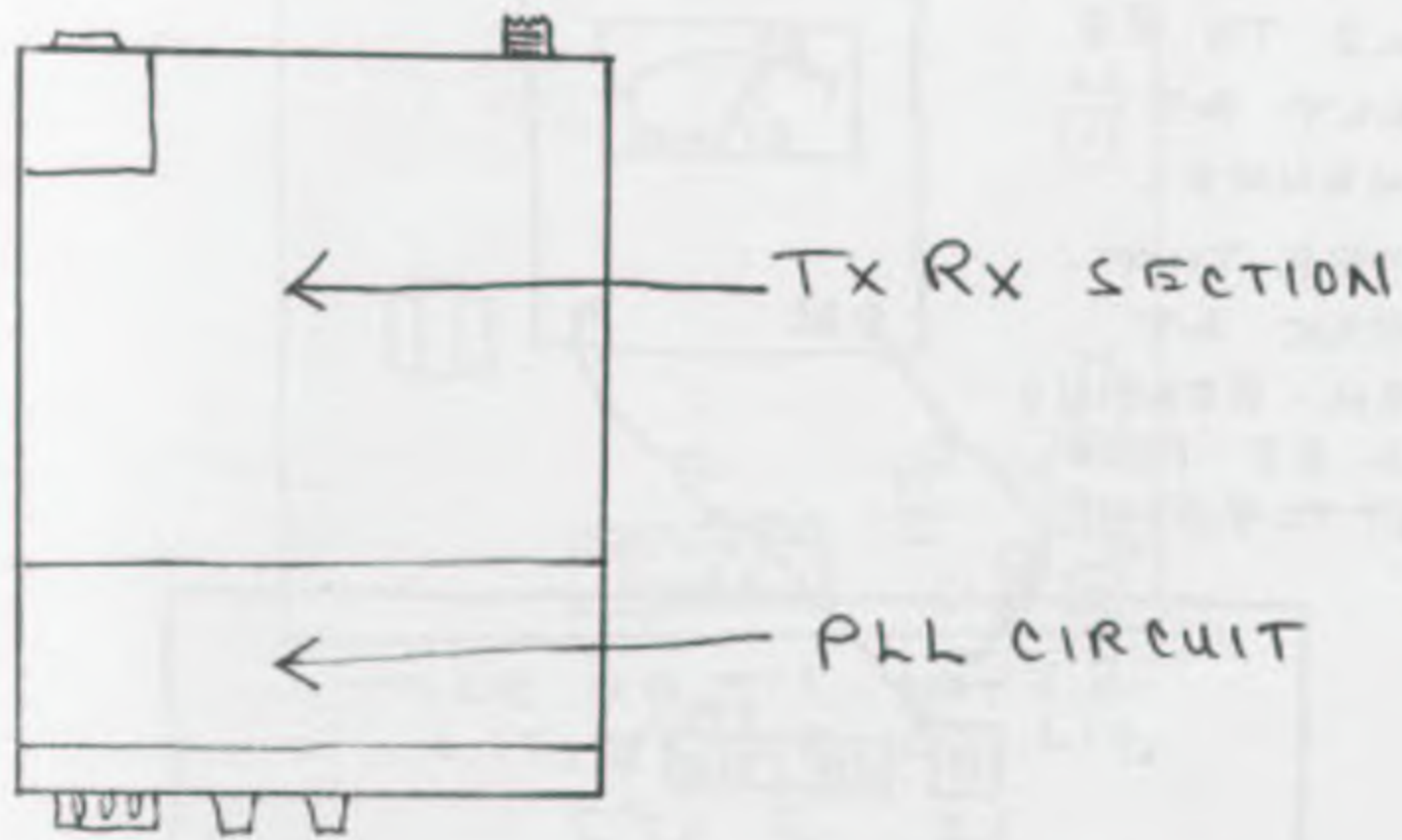

FIG 1 (INNER VIEW)

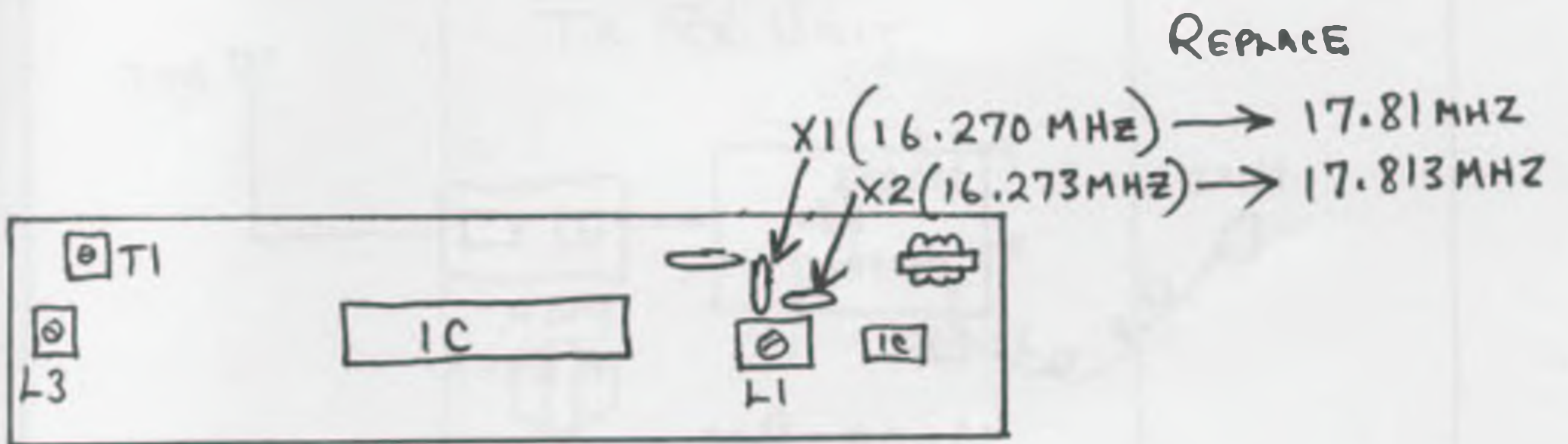

FIG 2 (PLL UNIT)

1. TUNE UP THE COIL (L2) AS BETWEEN TP2 AND CASE OF L2 TO BE 2 VOLT AT 1 CHANNEL.
2. AFTER THAT, CHECK AT 40 CH. READING WILL BE FROM 4 VOLT TO 4.5 VOLT.

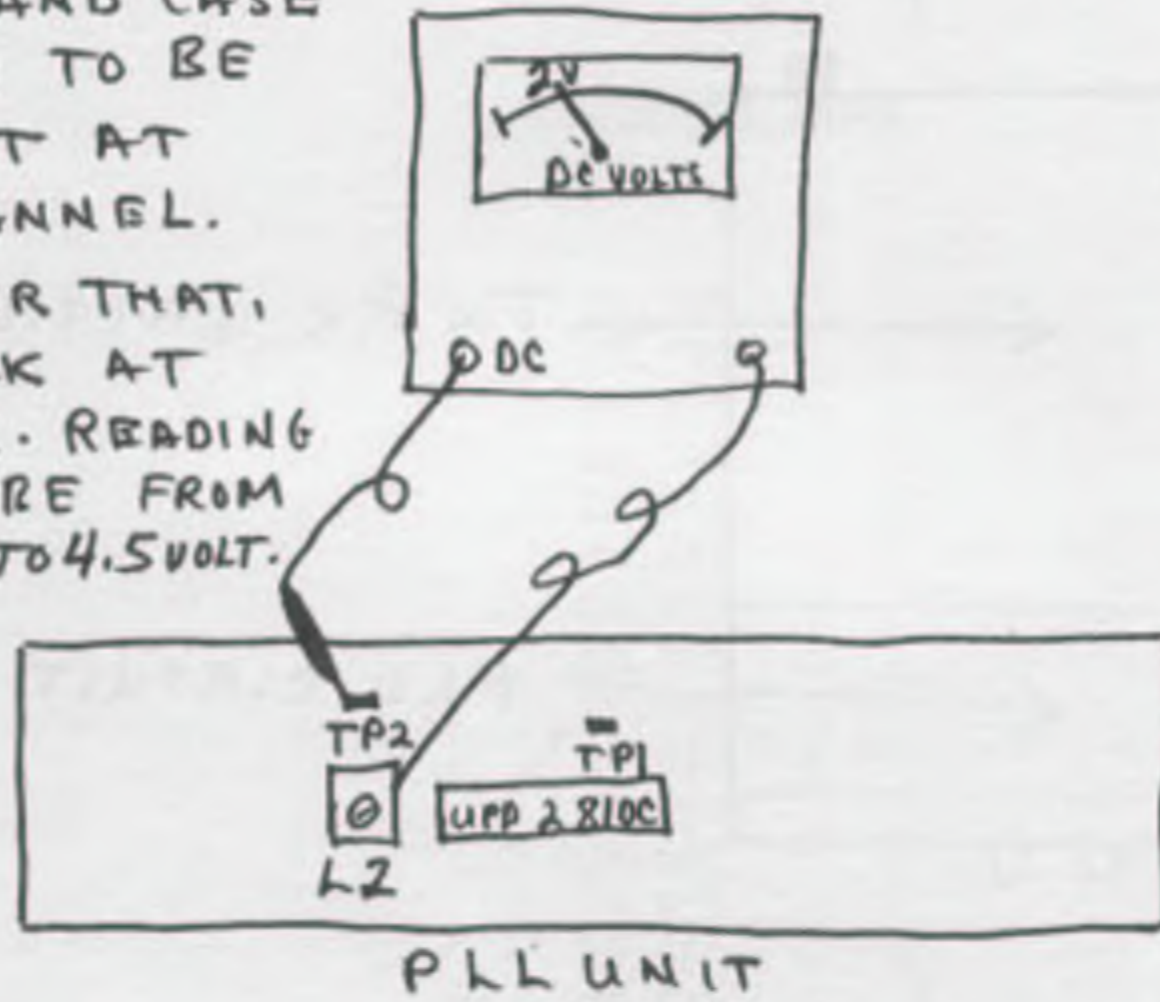

FIG 3 (TUNE UP PLL UNIT) NO1

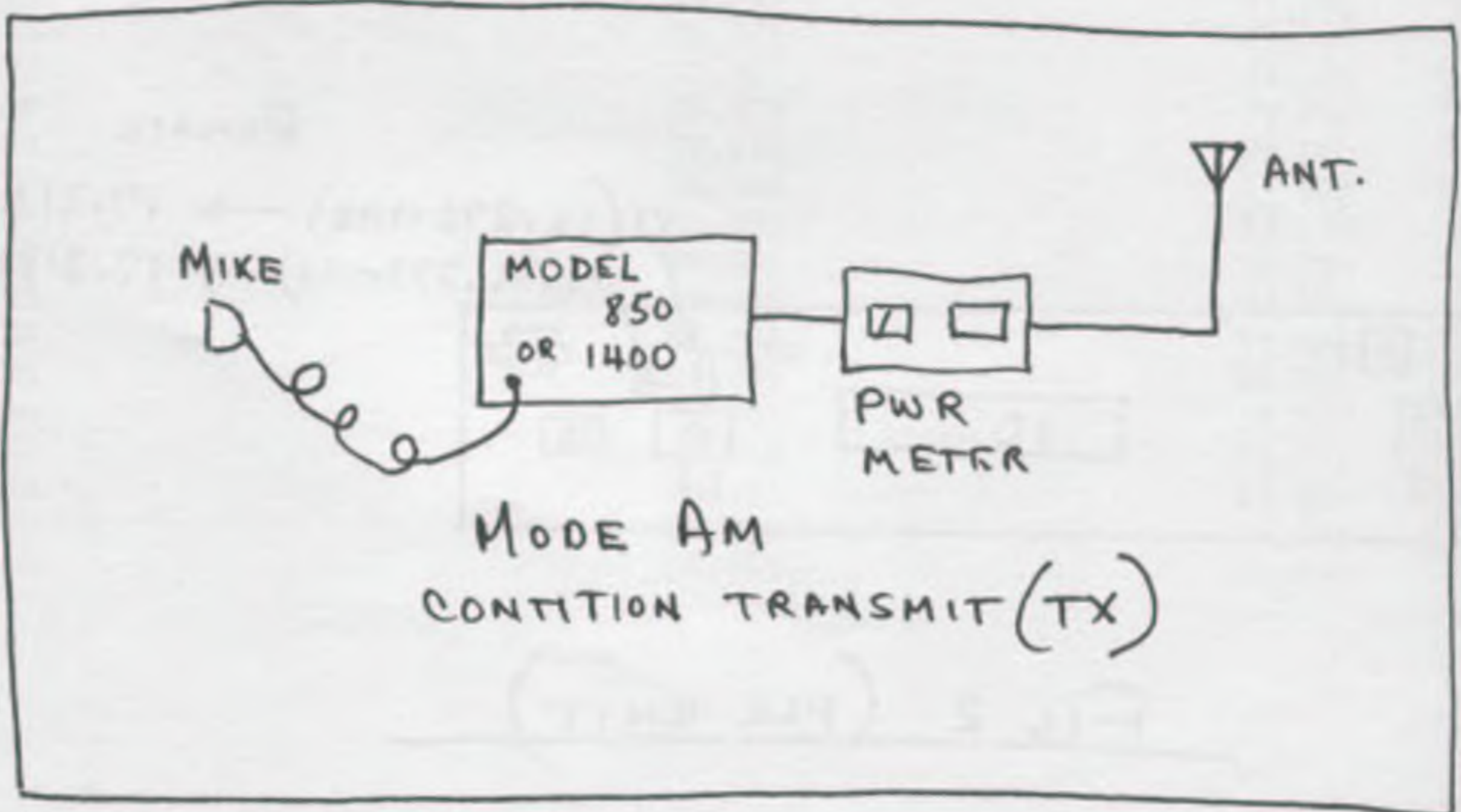
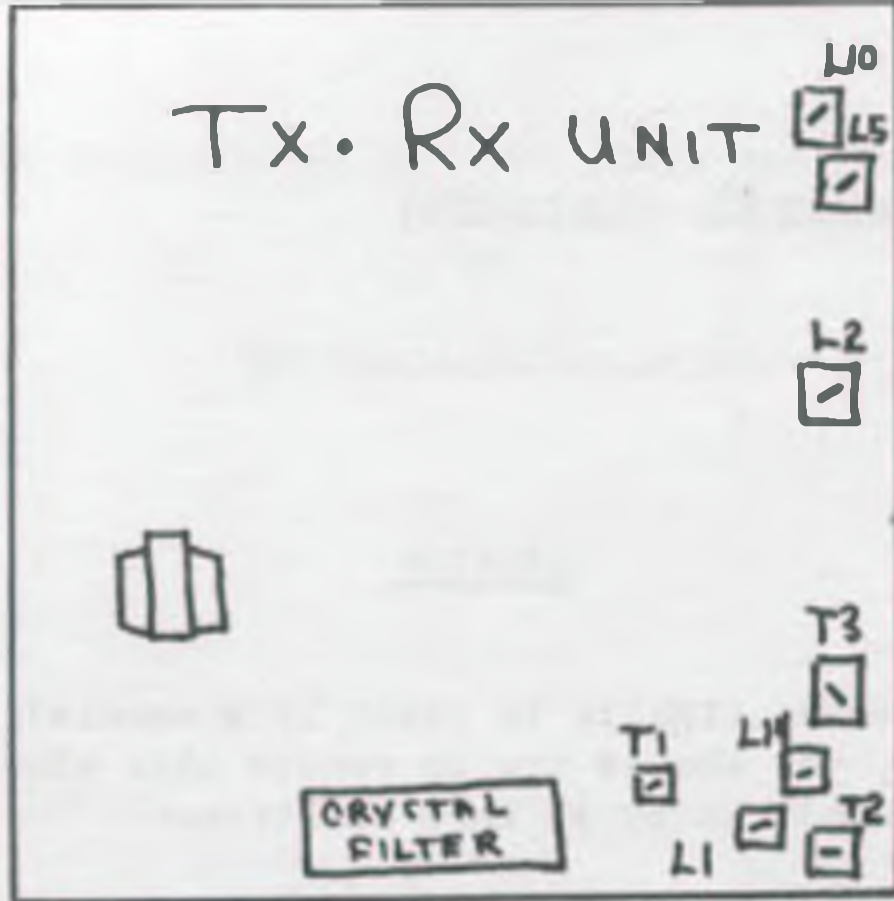

FIG 4



TUNE UP T1, L1, T2,  
L4, T3, L2, L5, L10.

FIG 5

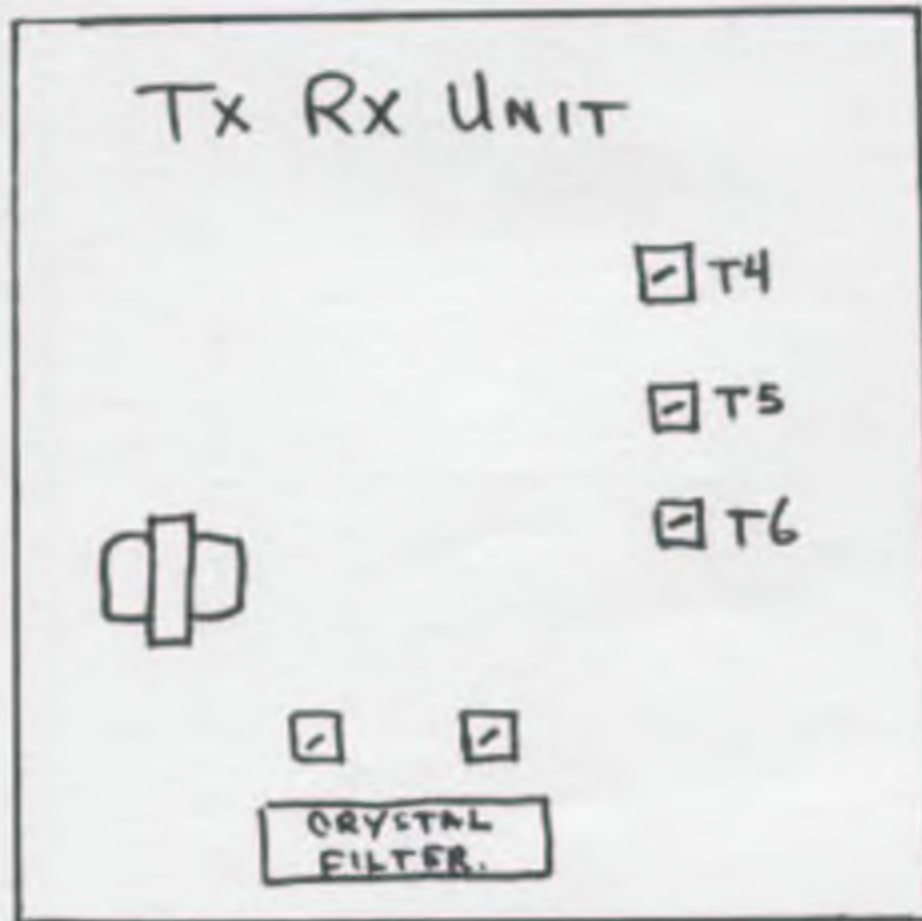

FIG 6

TUNE UP. T4, T5, T6

HOW TO CHANGE THE TRS CHALLENGER (CONTINUED)

CAUTION

\*Each of the coils are locked tightly in place by a special glue. So before you tune up these coils, you should try to remove this glue. Take care in turning the core of the coil as it is very sensitive.

\*Selecting for the Band desired, either from 28.505 to 28.945 MHz or from 28.960 MHz to 29.400 MHz is your choice and that choice is determined by connecting one lead of the IC to earth or not as shown in figure 7.

HOW TO INCREASE THE OUT-PUT POWER AND MODULATION  
OF  
TRS CHALLENGER RADIOS

GENERAL:

(All models) Set and prepare the unit as shown in the following fig. 1.



FIG 1

1. For models 460,600,730 and 1200 specifically, remove the glue locking the cores from the specific coils and then you are prepared for re-tuning.
2. Re-tune the coils per the following pages by monitoring the quality of the wave.

DETAIL

MODEL 460

1. How to increase out-put-power.

1.1 Re-tune the coils, L103, L107 and L106 to increase the indicated out-put power meter. Then you can get the high power to 6 to 7W.

1.2 After fixed item of 1.1, increase the power supply voltage to 16V if possible, then you can get the higher power 7 to 9W.

2. How to increase MOD %.

Turn VR3 shown as fig. 2.

Note: You can obtain higher output power but the power transistor may not be able to take more than 9W.

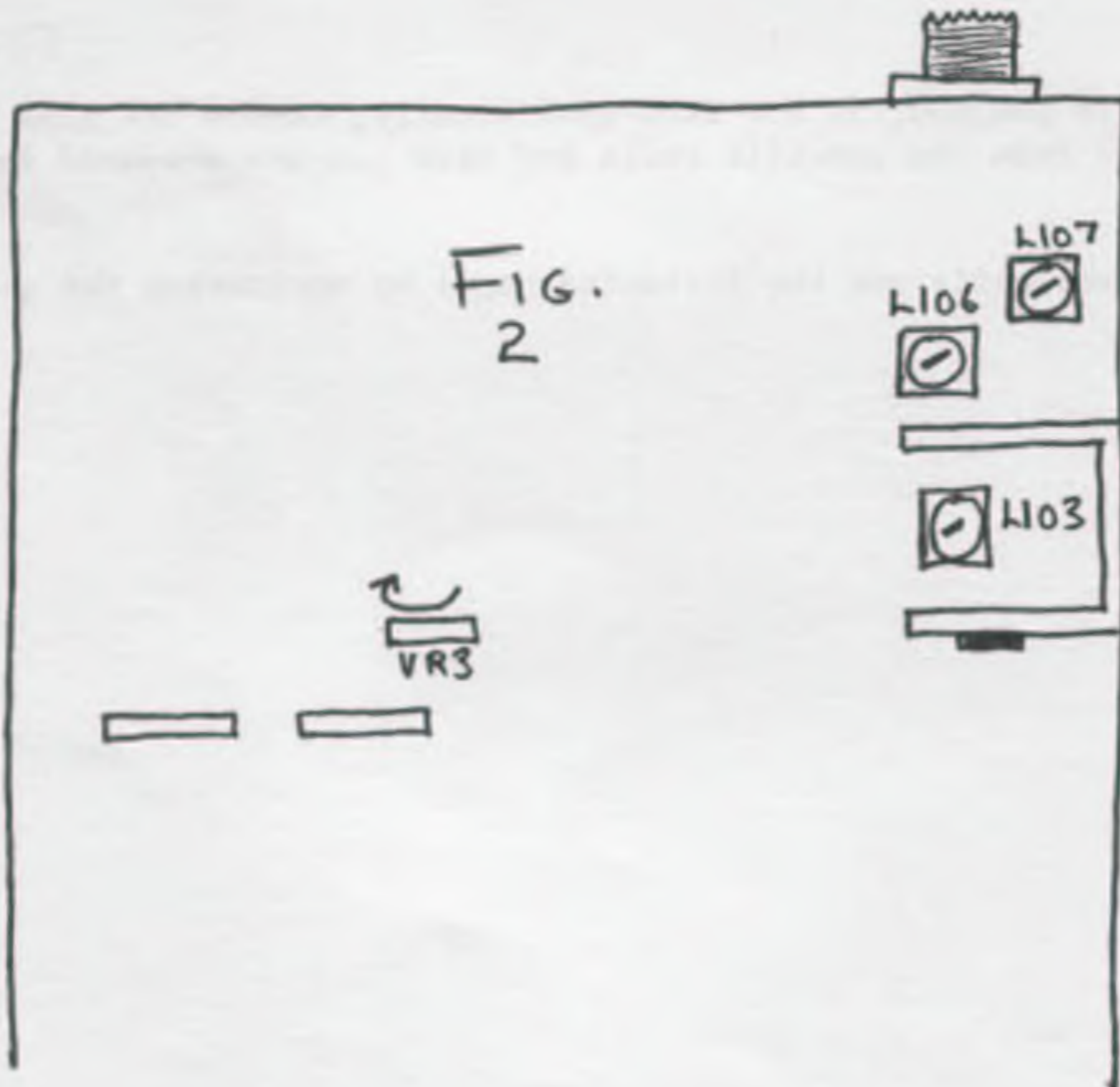



DETAIL

MODEL 600

1. How to increase output power.

1.1 Re-tune the coils, L208 and L209 and turn VR10 shown as fig. 3. Then you get 5 to 6W.

1.2 After fixed item of 1.1, increase the power supply voltage to 16V if possible. Then you can get the higher power 6 to 7W.

Note: You can increase the power output, but the power transistor may not be able to take more than 7W.

2. How to increase MOD %.

Turn VR1 shown as fig. 3.

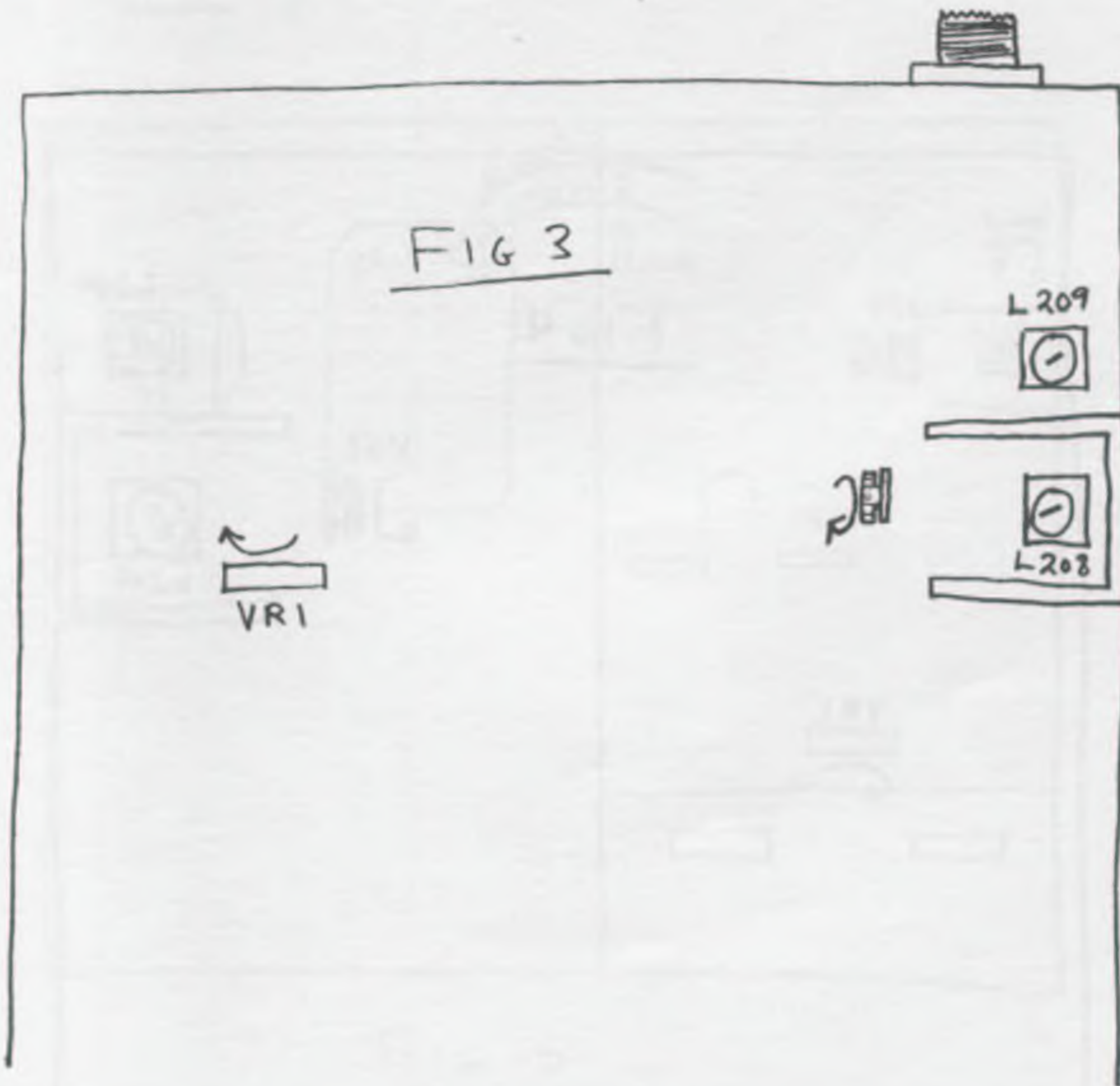

DETAIL

MODEL 730

1. How to increase output power.

- 1.1 Re-tune the coils, L204 and L205 and turn VR6 shown as fig. 4. Then you can get 5 to 6W.
- 1.2 After fixed item of 1.1, increase the power supply voltage to 16V if possible. Then you can get the higher power 6 to 7W.

Note: You can obtain a higher output but the power transistor may not be able to take more than 7W.

2. How to increase MOD %.

Turn VR1 shown as fig 4.

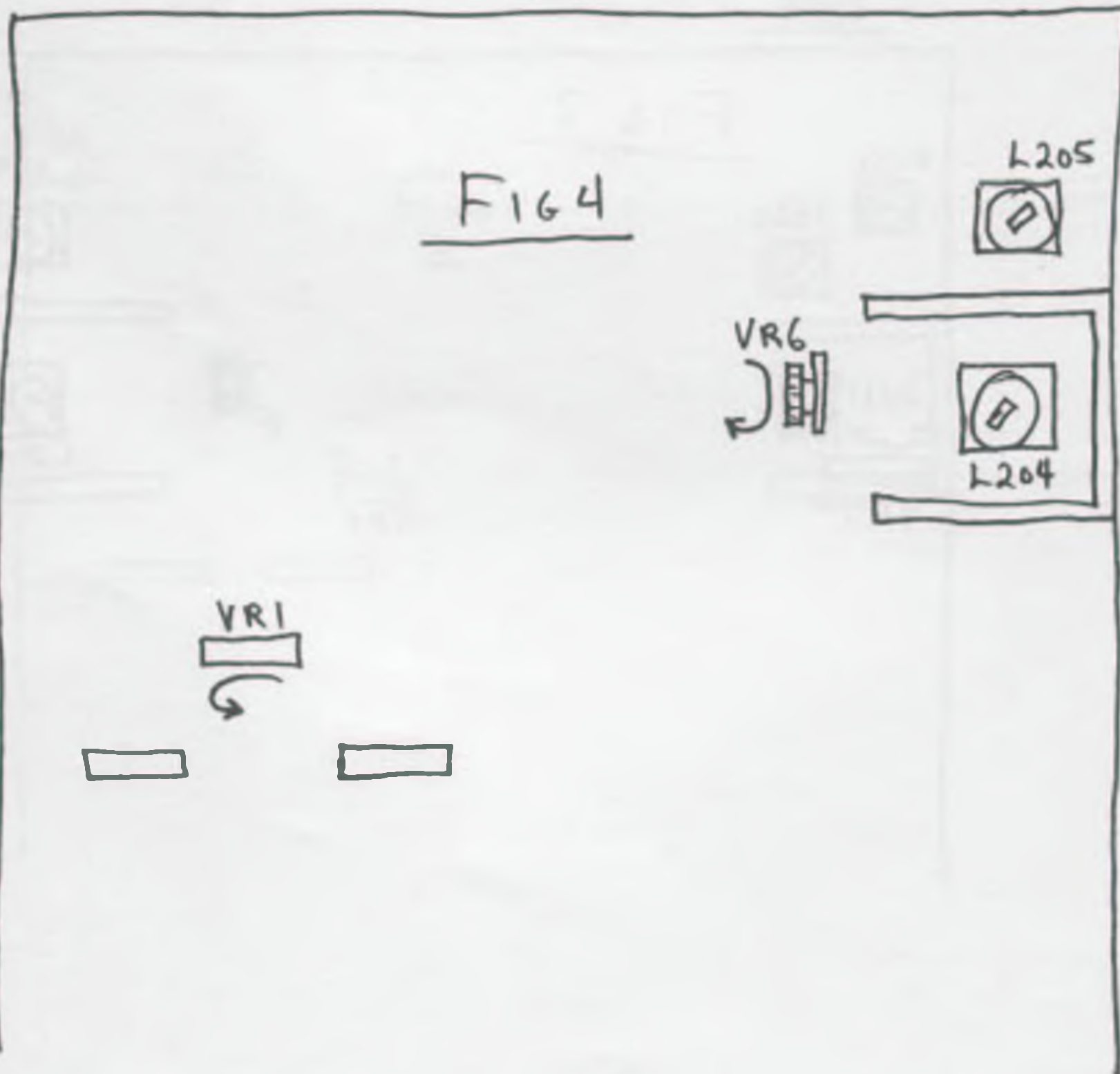

DETAIL

MODEL 1200

1. How to increase output power.

- 1.1 Re-tune the coils, L204 and L205 and turn VR6 shown as fig. 5. Then you can get 5 to 6W.
- 1.2 After fixed item 1.1, turn VR1 which controls DC power supply voltage so as to be 15-16V between black and red wires. Then you can get higher power 6 to 7W.

Note: You can obtain a higher output but the power transistor may not be able to take more than 7W.

2. How to increase MOD %.

Turn VR1 shown as fig. 5.

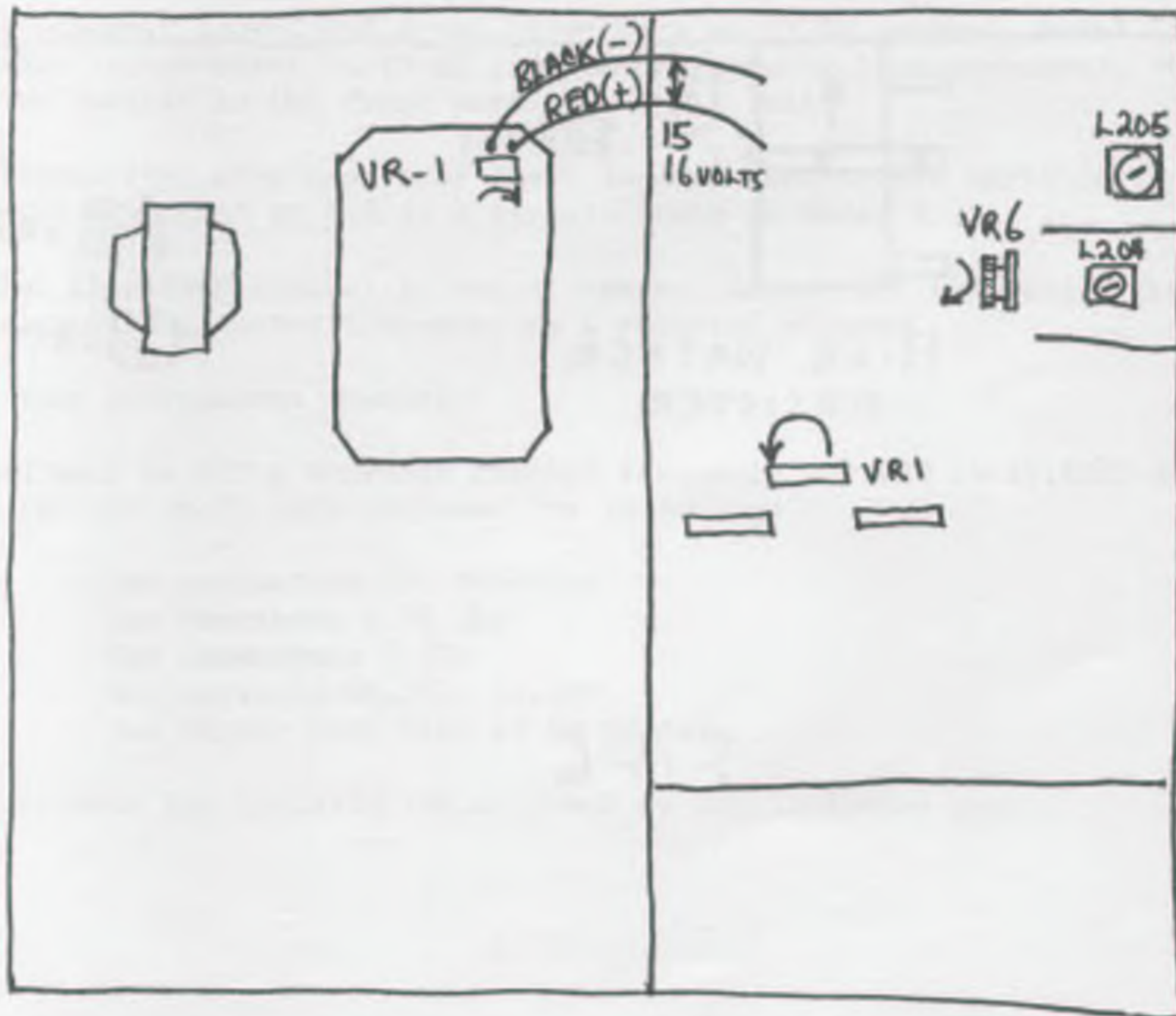

FIG. 5

DETAIL

MODEL 850 & 1400

1. How to increase output power.

1.1 AM mode.

Move the center-slide-tap of high watage resistor shown as fig. 6.  
Then you can get 5 to 6W.

1.2 SSB Mode.

Turn VR8 shown as fig. 6.

2. Increase in MOD %.

Turn VR1 shown as fig. 6.

3. Increase in Mic-Gain.

Turn VR2 shown as fig. 6.

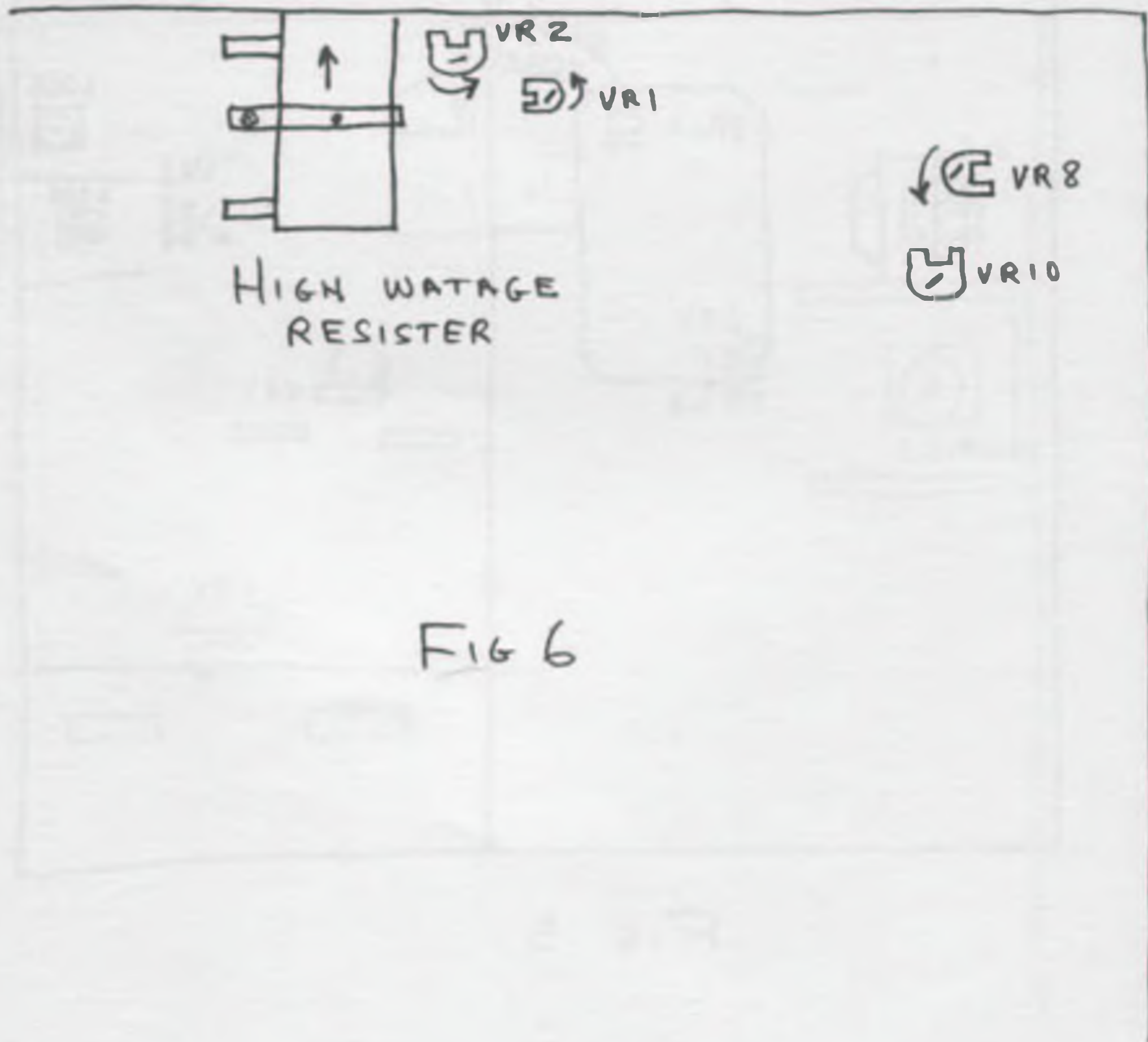
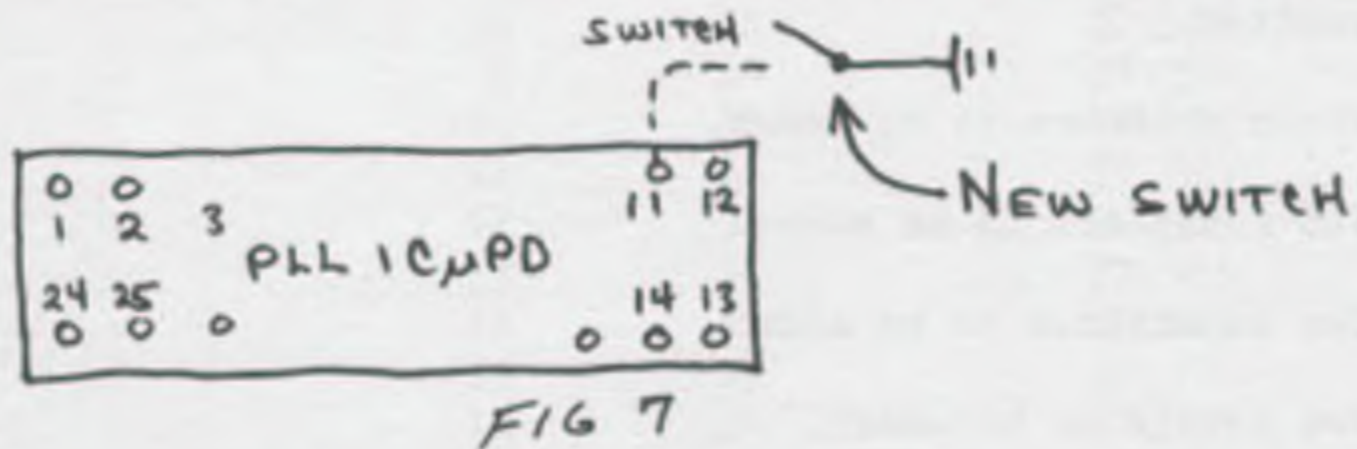

Fig 6

## HOW TO MODIFY MODEL 850 and 1400

### 1. Channel Expansion

You can get more channels 27.420 to 27.860 by modifying. This modification needs one SW.



### 2. To make the clarifier more effective both in mode TX and RX proceed as follows.

- A. Remove two wires (Model 850 - two blue wires, Model 1400 - Red and White wires) from tap of clarifier volume. Two wires must be connected together after removed and then insulated where connected.
- B. Connect a wire between +8V and the vacant tap where two wires were removed.
- C. Disconnect (Model 850 - the brown wire on TX-RX control, Model 1400 - two yellow wires on TX-RX control and connect them together), which are located in the front part of the PLL Unit.
- D. Remove 15pF disc capacitor (C-8) located next to CV1 variable capacitor. (C-8 is marked as C-9 on a circuit board on Model 850).
- E. Set clarifier control to center range. Adjust CV1 by using a frequency counter for center frequency on a selected channel.

### 3. 5KHz down of expanded channel

If you want to bring expanded channel frequency (27.420 to 27,860) down to 5KHz (27.415 to 27.855) you need the following:

- Two contact double switches
- Two resistors 3.9K Ohm
- Two capacitors 0.02u
- Two crystals 16.265, 16.268
- Two diodes (any kind of RF diode)

The instructions for installation is shown on the following page.

HOW TO MODIFY MODEL 850 and 1400

Expanding channels from 27.415 to 27.855 MHz can be done by the attached instruction.

1. Three switches to be added.
2. Two resistors to be added.
3. Two capacitors to be added.
4. Two X-tals to be added.
5. Two diodes to be added.

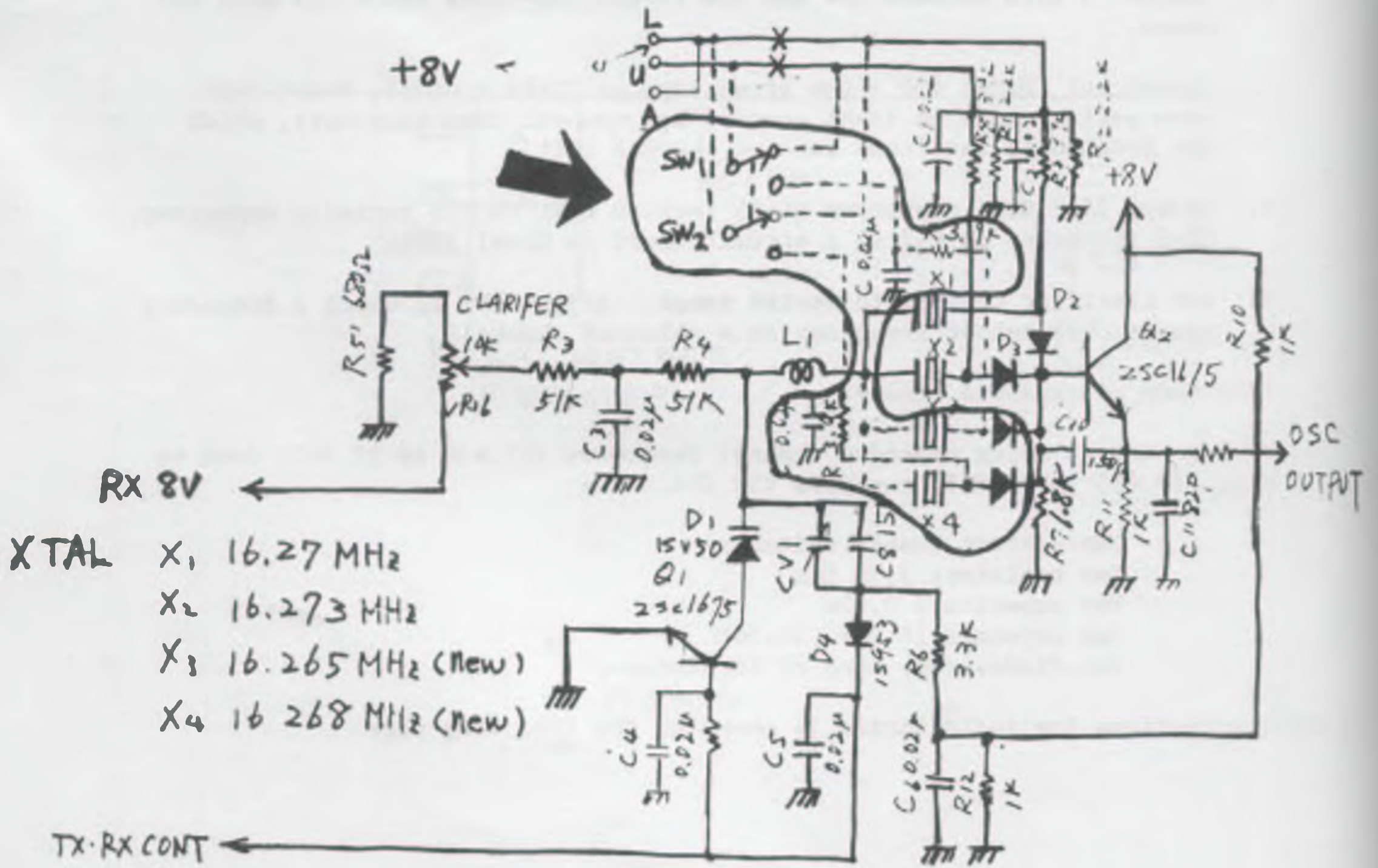

CHANNEL DIAL	FREQUENCY	CHANNEL DIAL	EXP. CHANNEL	FREQUENCY
1	26.965	21		27.215
2	26.975	22		27.225
3	26.985	22A	23	27.235
4	27.005			
5	27.015	23	25	27.255
6	27.025	9	26	27.265
7	27.035	10	27	27.275
8	27.055	11	28	27.285
9	27.065	12	30	27.305
10	27.075	13	31	27.315
11	27.085	14	32	27.325
12	27.105	15	33	27.335
13	27.115	16	35	27.355
14	27.125	17	36	27.365
15	27.135	18	37	27.375
16	27.155	19	38	27.385
17	27.165	20	40	27.405
18	27.175	21	41	27.415
19	27.185	22	42	27.425
20	27.205		43	27.435
		23	45	27.455

CHANNEL MISSING

24	27.245
29	27.295
34	27.345
39	27.395
44	27.445

PARTS

3 - IN 60 Diodes  
 1 - S/N 7493 IC  
 Approx. Conversion Time .55  
 40 min. not including un-  
 packing, opening, testing,  
 closing, and repacking.

1. Remove the unit from its cabinet and locate IC-1 foil side and cut foil paths to pins 9, 10 and 11.
2. Solder a 3300 ohm resistor to each pin next solder other end of each resistor to bottom of cut foil path where a pin is present to solder to.
3. Solder a IN34 diode (anode) side to pins 10 & 11 - next connect both banded ends (cathode) side together. Next solder a 6 in. piece of wire to both diodes. Next solder other end of wire to a SPST switch S-1 pin A, next solder a second wire to S-1 pin B and the other end to Neg. foil path. Unit will now operate from 27.445 thru 27.595 starting on channel 1.
4. Solder two 6 in. pieces of wire to a second SPST switch (S-2), solder wire from pin A to IC-1 pin 9 and other wire from pin B to Neg. foil path. Unit will now operate from 27.605 thru 28.045 starting on channel 1.

Note: Unit will operate normal with S-1 & S-2 in off position.  
Unit will not transmit with both S-1 & S-2 in on position.

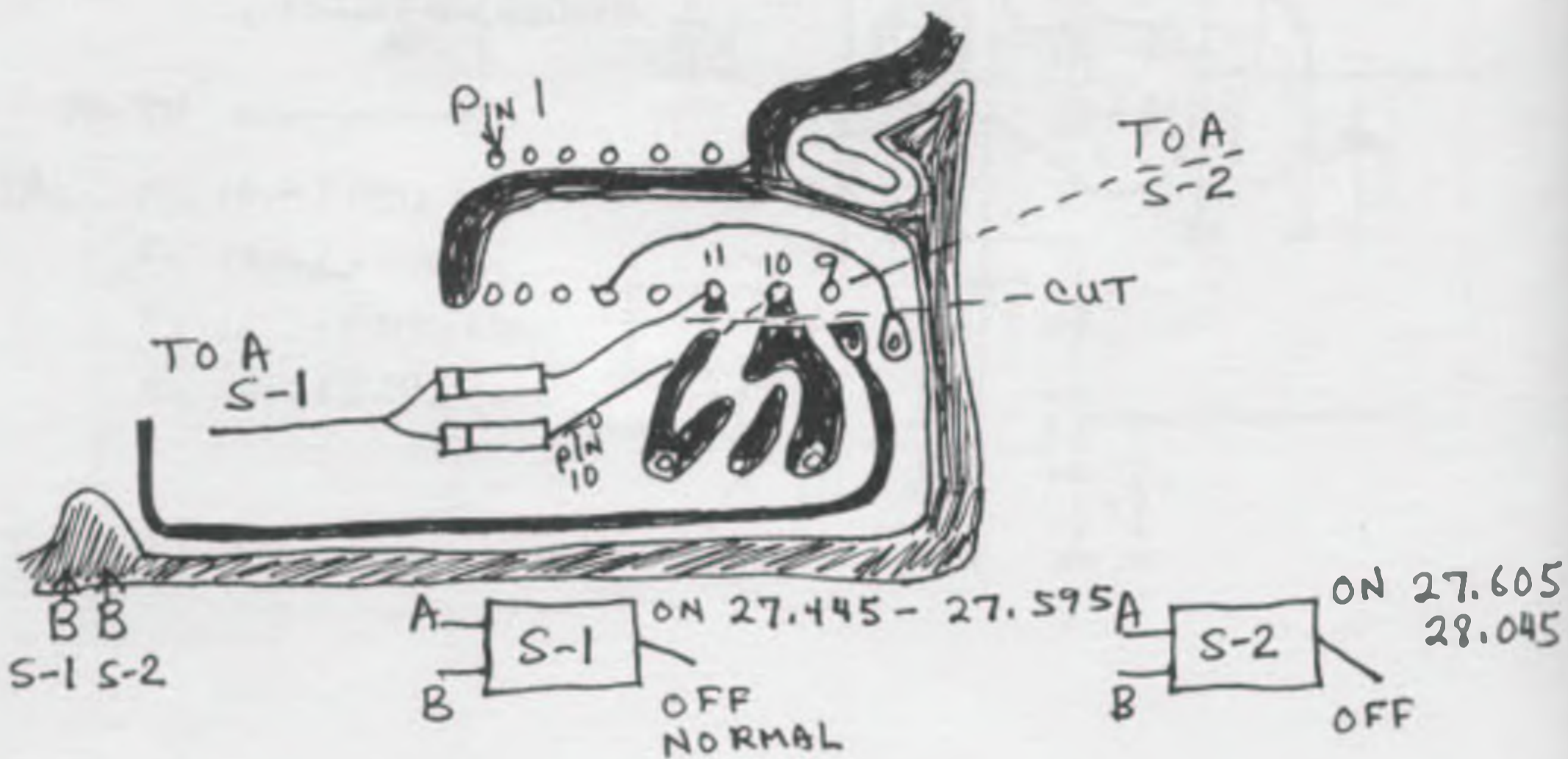



## SPECIFIC RADIO TUNE UPS

### Realistic TRC-45A

T-7, T-6, T-5; Max Power adjustment.

(L-1 using interval antenna extended, adjust for max field strength)

Following is Base or Mobiles:

### Realistic TRC-431

C-511 (3.3mfd / 50VDC Electrolytic Capac.) Remove from PC Board modulation increases to 100% Plus; Don't use power mike or will over modulate.

L-901, L902, L903, L904, T-803, L905, L907, L910, Adjust for max pwr. (Some units are capable of 9 watts).

VR-4; S Meter Adjustment.

VR-5; RF Meter Adjustment.

F-901; TVI Adjustment (Put Port. TV or Bench Next to CB - TV to Channel 2, Key - CB and adjust for minimum distribution.

### Realistic TRC-200

T-6, T-7, L-4, L-5; Adjust for max pwr in Hi Pwr mode.

VR-5; Adjust for 100% in high power mode. (Modulation)

VR-4; Adjust for 100% in low power mode. (Modulation)

(Use some caution as some units will key 7.8 watts)

### Realistic TRC-180

L-9, L-13, L-12, L-8; Adjust for max pwr. (Do not exceed 6 watts.)

R-48; Adjust for 100% Mod.

### Realistic TRC-100 / 99A

T-9, T-10, L-6, L-7; Max pwr adj. (Do not exceed 6 watts.)

T-5; Adjust for max modulation - do not turn over  $\frac{1}{2}$  turn - get a happy medium between power and modulation.

COBRA 135 XLR

1. Remove unit from cabinet. Remove speaker cover from unit. Cut the PC Board on each side of voice lock. Run a wire from one side to ground and the other side to the Gray wire on the PA/CB switch. Clip diode CD304. This allows - 10 KHZ and +5KHZ Slide.
2. For AM A.L.C. Adjust R134 for max modulation.
3. For SSB A.L.C. Adjust R130 for max power.
4. For AM power short R92A and R92B. Adjust +8 - +9 - +10 - T11 - T12 - L5 L7 - L3 +7 with 1000 HZ for max peak out put.
5. For new C.H. 27.405 to 27.925 - remove X302 and Install SPD+ Min Slide Electrocraft Cat #34-202 in the speaker grill on the R+ side with the unit up side down and the back facing you. Use super glue to install switch.

CHANNEL      FREQUENCY

1	27.405
2	27.425
3	27.435
4	27.475
5	27.485
6	27.505
7	27.525
8	27.555
9	27.575
10	27.585
11	27.605
12	27.635
13	27.655
14	27.675
15	27.685
16	27.725
17	27.735
18	27.755
19	27.775
20	27.805
21	27.825
22	27.835
23	27.885
24	27.855
25	27.875
26	27.905
27	27.915
28	27.925

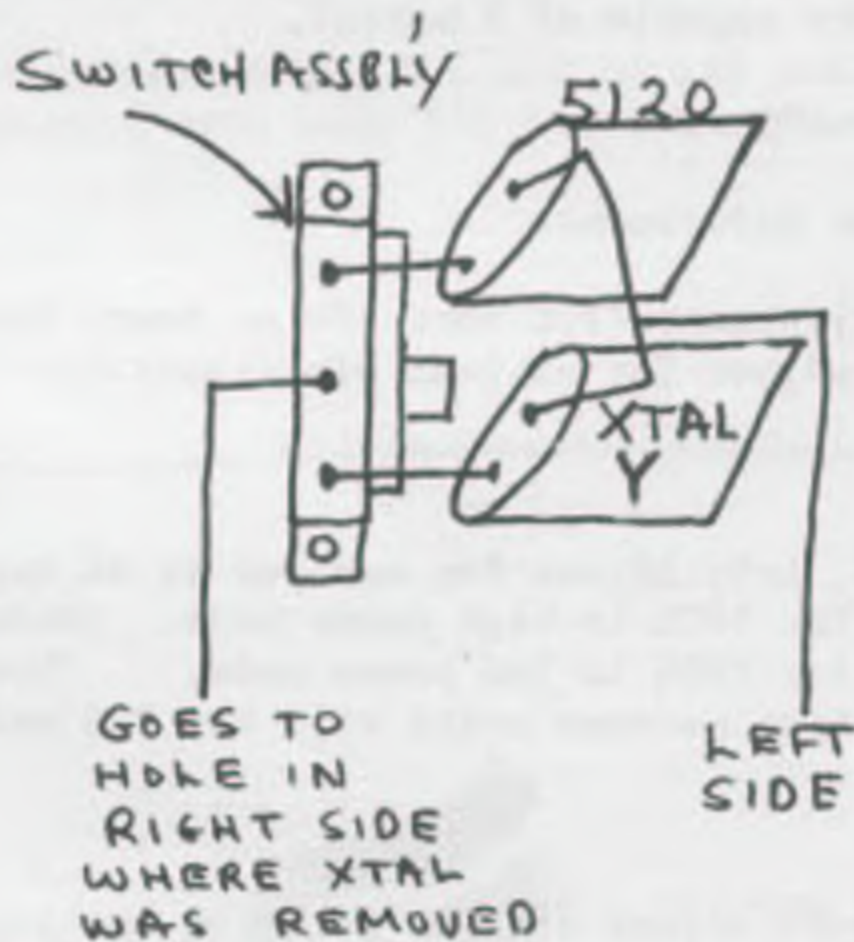

\* THE COMMON SIDE OF THE XTALS GOES TO THE HOLE ON THE LEFT SIDE.

\* THE CENTER TERM. OF THE SWITCH GOES TO THE HOLE ON THE RIGHT SIDE - KEEP LEADS SHORT USE SOLID WIRE.

PARTS NEEDED

- (1) ELECTRORAFT # 35-202
- (2) XTAL Y AVAILABLE FROM LOCAL DISTRIBUTOR.

## Power Modification

- 1) Remove cabinet cover, botton plate, and rear panel.
- 2) Remove 6DG6 tube and then hold down clamp.
- 3) Remove 12BY7A tube and shield.
- 4) Unsolder pin 3 of octal socket RF power amp VT202.
- 5) Make a parasitic suppressor by winding 6 turns of #20 Buss wire on a 47ohm 2w carbon resistor. Evenly spaced wrap the leads next to the body of the resistor and solder. Bend the leads of the parasitic suppressor so it will connect to the plate cap and lay parallel with the length of the tube. Solder to plate cap. Install 6DQ5 tube in VT202 socket, solder parasitic suppressor choke to plate cap connector and install on tube. Run a length of television HV wire from the other end of the parasitic suppressor and replace the wire that was unsoldered from pin 3. The free end of the new wire goes to the 4.7lw resistor and remove the old wires.
- 6) Remove the 3.9k 2w R211 on pin 4 and replace with a 39k ohm 2w resistor.
- 7) Remove all wires and connections and grounds from pins 1,6 and 8.
- 8) Install a .01/100v ceramic from pin 2 to pin 7 and solder.
- 9) Route the blue wire removed from pin 8 under terminal strip TB-1 to pin 3 and solder.
- 10) Install a 4.7ohm  $\frac{1}{2}$ w resistor between pin 6 and 7 . Do not solder.
- 11) Install a .01/100v ceramic disc cap between pins 6 and 7. Solder pin 6.
- 12) Connect the ground buss wire to pin 7.
- 13) Connect the yellow and purple wires removed in step 7. Fill leads tp pin 7.
- 14) Connect the free end of C209 Now on pin 4 a .001 2kv cap to pin 7. The cap now run's between pin 4 and 7.
- 15) Connect the free end of the .001mf 2kv cap #C210 to the last lug on terminal strip TB-1.
- 16) Add a 450v 1mfd across R204 47k 2w resistor. Connect the positive side to terminal 2 and the negative to terminal 3.
- 17) Remove the wire from R309 2.2k ohm 10w to terminal 4 of TB-3 and discard.
- 18) Install a piece of insulated wire from 1000ohm 10w to terminal 4 of TB-3
- 19) Locate R210 56k  $\frac{1}{2}$ w. This resistor is surrounded by a shield on the foil side of board.
- 20) Install a 33mf 6 volt cap from the collector of Q34. SQ amp to ground positive side of cap to collector.

- 20) Install a 33MF 6 volt cap from the collector of Q34 SQamp to ground positive side of cap to collector.
- 21) Install a 4.7k ~~kw~~ resistor between the mike lead and the mike plug.
- 22) Install a 12GN7 tube in VT201 and replace the tube shield.
- 23) Install a stancore part # p -8605 48v transformer as shown in drawing.
- 24) Route leads from new transformer . Throw holes in chassis with the other Transformer leads.
- 25) Connect red wire from new transformer to the fuse holder connection with the red wire.
- 26) Connect the yellow wire from the new transformer to terminal strip TB5 terminal 3.
- 27) Tape the brown and green wires separately. They are not used.
- 28) Also tape the black wire separately. It is not used.
- 29) Remove the yellow wire from TB-4, terminal 5 and connect to the light green wire from the new transformer and tape.
- 30) Connect the gray wire from the new transformer to TB-4, terminal 5.
- 31) Check all connections for shorts . Solder blob's, etc.
- 32) Set is ready to turn on. Turn standby switch to off and trun on set. Allow to warm up. CAUTION, the plate cap of the 6DQ5 has high voltage 480V dc.
- 33) Connect a 1khz tone source to the mike input, pin 2 + pin 2.
- 34) Jumper pin 3 and 4 together on the mike plug. This is for transmitter key up.
- 35) Rotate mike gain control to full counter-clockwise position.
- 36) Mode switch to USB.
- 37) Meter switch to plate current.
- 38) Channel selector to channel 20.
- 39) Connect a 50ohm 100w dummy load to the RF output.
- 40) Connect a low capaity scope probe across the dummy load.
- 41) Connect a voltmeter from pin 3 on the 6DQ5 tube socket to ground positive lead to pin 3. 3 volt range DC.
- 42) Turn transmit standby switch to transmit positive.
- 43) Adjust RV202 so voltmeter reads 0.47 volts DC at pin 3.
- 44) Adjust RV-802 so the plate meter reads 50 ma. This will allow the p.a. meter to read one half value. You must now multiply by two for correct reading.

- 45) Turn mike gain control full clockwise position, then adjust c902 and then c903 back and forth until maximum power is obtained.
- 46) Change to channel 1. Adjust the bottom slug of L203 for maximum output on scope. Change to channel 40 and adjust the top slug of L203 and alternate until even output is obtained.
- 47) Change to two-tone signal. Checkscope for flat topping. If you observe flat topping adjust RV2 to correct.
- 48) Switch to AM mode and adjust RV201 for 50ma on plate meter.  $50\text{ma} \times 2 = 100\text{ma}$
- 49) Adjust RV204 for 100% mod on scope.
- 50) Using a power meter adjust output meter. Adjust RV602 for AM and RV603 for SSB. AM should be approximately 20w, AM envelope power 35w, output SSB PeP approximately 75w output.



WARNING: BEWARE  
OF ELECTRICAL SHOCK  
HAZARD WHEN WORKING  
AROUND RADIOS AND  
OTHER ELECTRICAL  
EQUIPMENT. WHEN WORKING  
INSIDE LARGE RADIOS  
LIKE THE DAK REMOVE  
RINGS ETC.  
IF YOU ARE NOT FAMILIAR  
WITH ELECTRONICS SEEK  
ADVICE FROM A COMPETENT  
TECH.



FIG 5

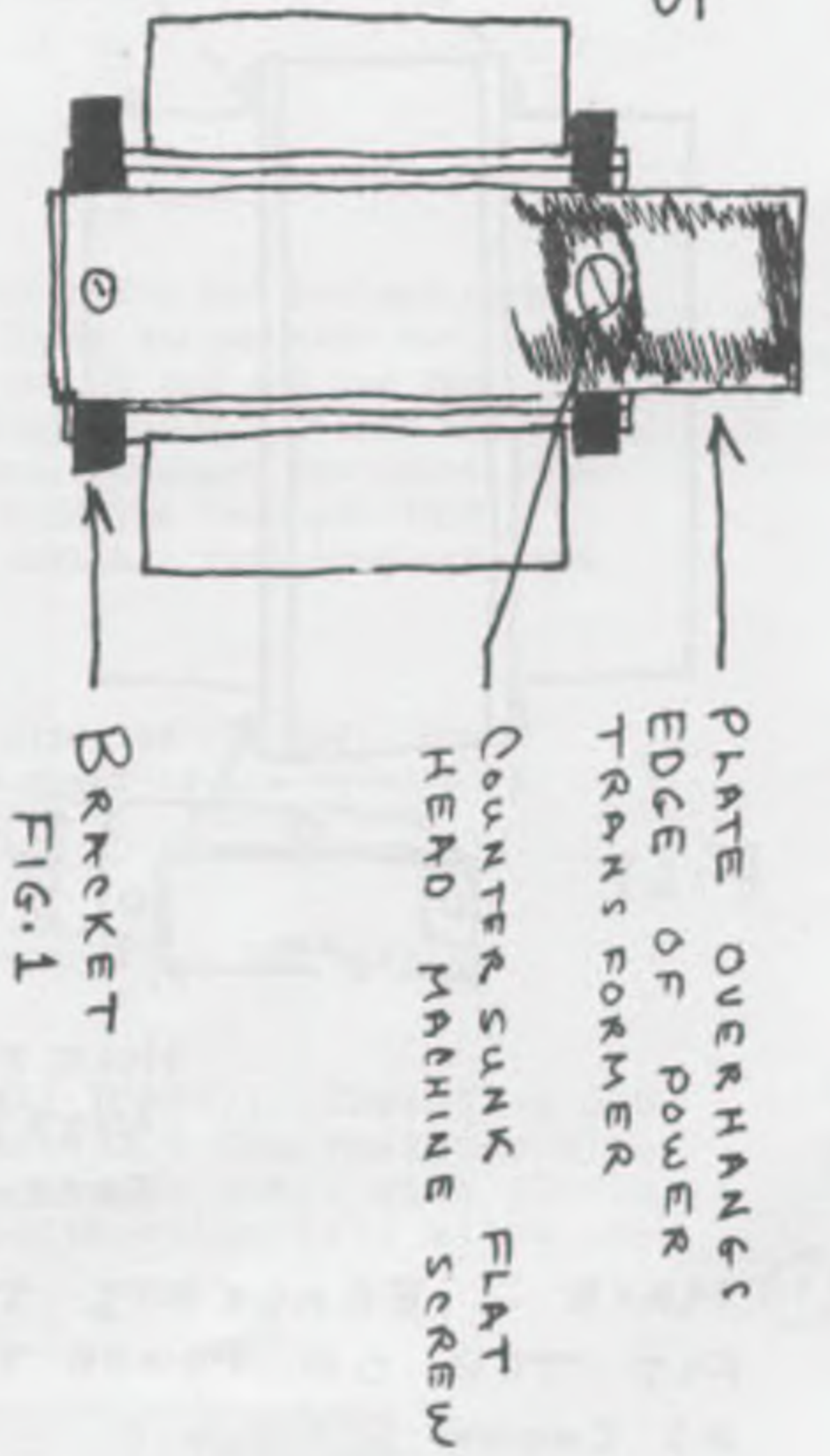

4. MOUNT PLATE ON TOP OF BRACKETS. DO NOT BOLT TO TRANSFORMER AT THIS TIME.
5. ASSEMBLE P-8605 TRANSFORMER AS SHOWN IN FIG 6.

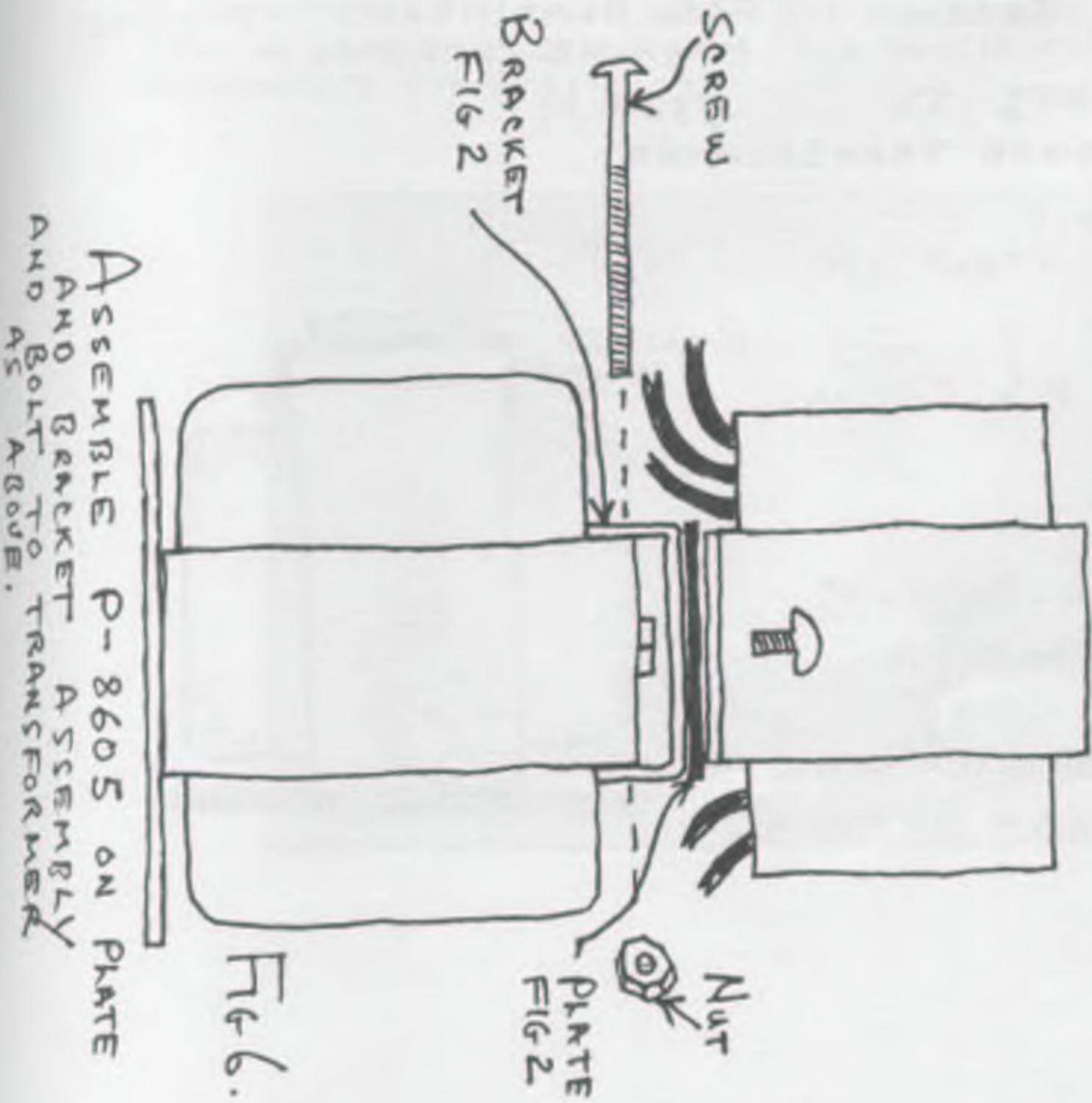

ASSEMBLE P-8605 ON PLATE AND BRACKET ASSEMBLY AND BOLT TO TRANSFORMER AS ABOVE.

FIG. 6.

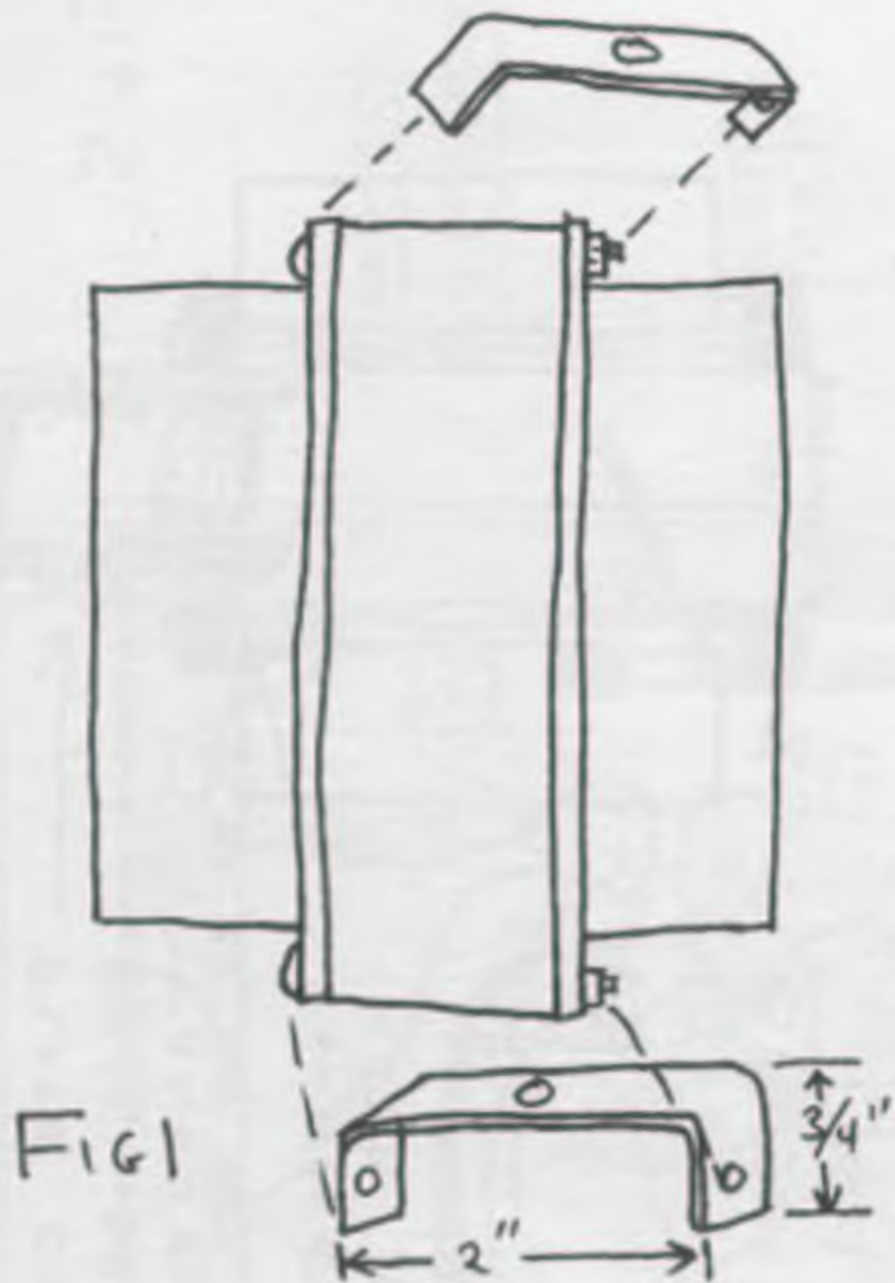

FIG 1

LOCATION OF MOUNTING BRACKET SUPPORTS

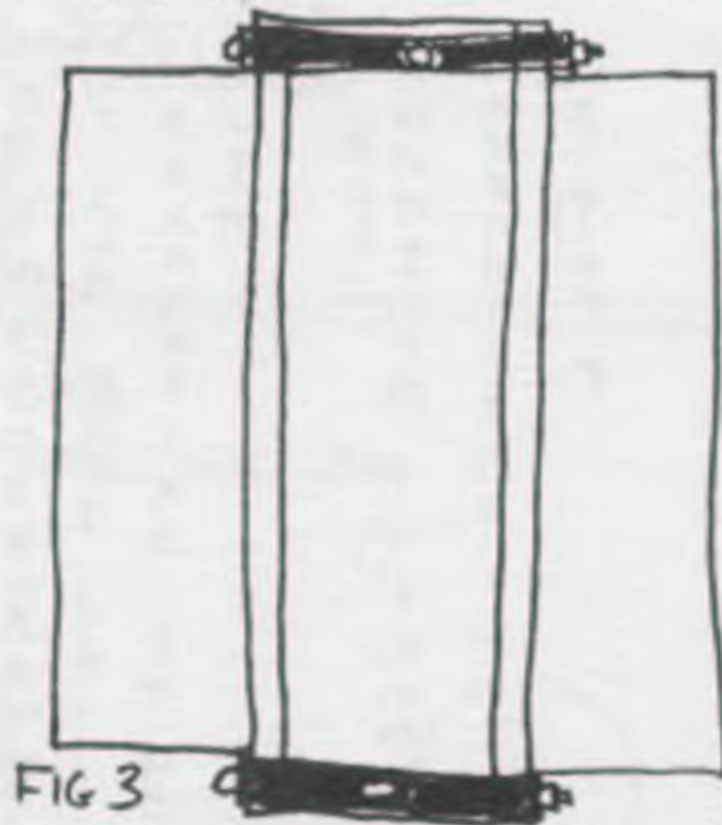

FIG 3

HOLE FOR  
 $8/32 \times 3/8$ "  
SCREW

COUNTERSINK  
FOR FLAT HEAD  
MACHINE SCREW  
 $8/32 \times 1/4$ "

HOLE FOR  
 $8/32 \times 3/8$ "  
SCREW

18 GA.  
ALLUMIN.  
OR  
STEEL

- ① MAKE 2 BRACKETS TO FIT TOP OF POWER TRANSFORMER AS SHOWN IN FIG. 1 (USE ALUMINUM STRIP .090 THICK.)
- ② MAKE PLATE AS SHOWN IN FIG 2.
- ③ REMOVE SCREWS FROM POWER TRANSFORMER. TOP SCREWS ONLY. LEAVE PLASTIC WASHER IN PLACE WHEN REMOVING SCREWS.

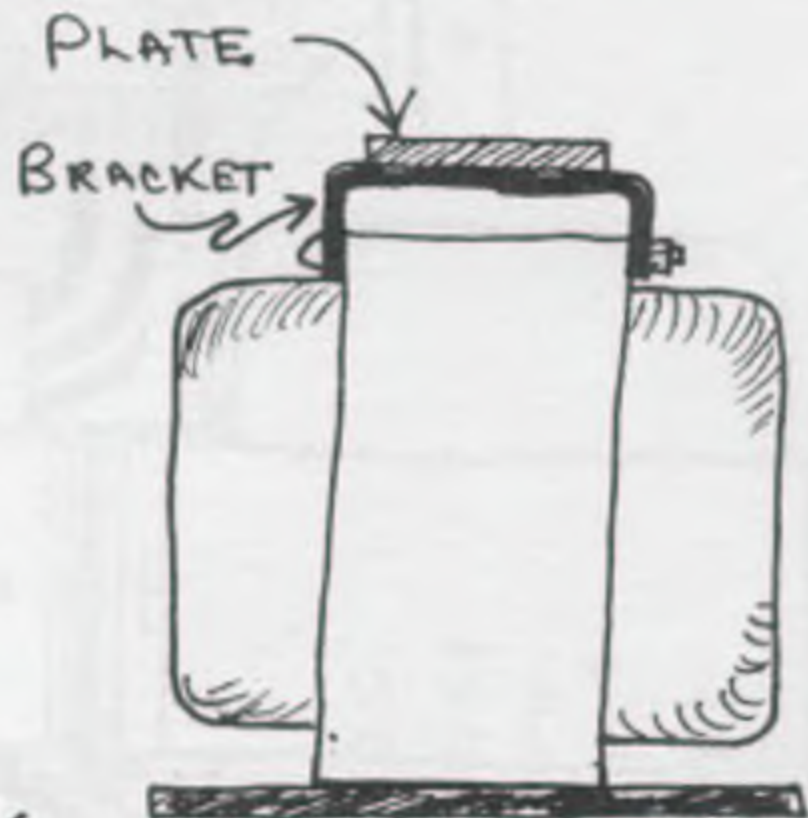



## CHANNEL EXPANSION, POWER AND SLIDE MODIFICATION

## 1. PLL IC 1 (P11 2)

Cut the PC Board on pins 9-10-11 with a xacto knife and isolate them as close to the IC as possible. Install a 3K  $\Omega$  across each cut. Install a IN914 on Pin 11 & 10 anode towards the IC pin and tie the cathodes together. Install 2 Single Pole Single Throw Switches and run a wire from one side of the switch to ground. Connect the other side of one switch to the cathode of the diodes that run from pin 10. Run wire from pin 9 of the IC to the other switch. This completes the Channel Expansion.

## 2. Slide cut D5 - Cut R24. Install a 18PF in place of C17 33PF. Run a wire from the unused terminal on VR4 to the wiper of the squelch control. This will allow -2 and +8 KHZ.

## 3. RV12 adjust for max AM Mod with 1000 HZ tone &amp; R204. RV2 &amp; RV11 adjust with two tone source for max power.

## 4. Install a 12GN7 tube in place of VT201 12BY7/. Install a 6y6 in place of VT202 6DG6 tube, short R310 1.5 KHz resistor with a jumper wire. Adjust L201-C903 for max AM power with 1000Hz tone on peak reading meter. This modification will allow approximately 35W SSB.



DAK X

CHANNEL	(SWITCH - 1) FREQUENCY	(SWITCH - 2) FREQUENCY
1	27.445	27.605
2	27.455	27.615
3	27.465	27.625
4	27.485	27.645
5	27.495	27.655
6	27.505	27.665
7	27.515	27.675
8	27.535	27.695
9	27.545	27.705
10	27.555	27.715
11	27.565	27.725
12	27.585	27.745
13	27.595	27.755
14		27.765
15		27.775
16		27.795
17		27.805
18		27.815
19		27.825
20		27.845
21		27.855
22		27.865
23		27.895
24		27.875
25		27.885
26		27.905
27		27.925
28		27.935
29		27.945
30		27.955
31		27.965
32		27.975
33		27.985
34		27.995
35		28.005
36		28.015
37		28.025
38		28.035
39		28.045
40		

Use a pencil to change F~~0~~ SW 1 at a time the SW's are push type

Tram D42 or Cobra 32XLR

Frequency Conversion

- 1) Cut the p/c trace on pin 8 of IC10 and isolate pin 8.
- 2) Move the green jumper wire from pin 8 to the other side of the cut and solder.
- 3) Install a 100k ohm  $\frac{1}{2}$ w resistor from pin 8 to ground.
- 4) Solder a wire to pin 8 and one to the other side of the p/c cut. Let this hang loose as it will be used later.
- 5) Solder a wire to pin 7 and one to pin 16 and let them hang loose. They also will be used later.
- 6) Install two miniature SPST toggle switches in a convenient place and connect one to the wires from pin 8 and the other side of the p/c cut. This is SW#1.
- 7) Connect the other switch to the wires from pin 7 and 16. This is SW#2. This completes the mod switch #2 which will give you the upper channels. Switch #1 + #2 will give you the lower channels.

Frequency Program Chart

Down - SW 1 & 2	Down - SW 1 & 2	Down - SW 1 & 2	UP - SW 2	UP - SW 2
26- 26.945	18- 26.855	10- 26.755	11- 27.405	19- 27.505
25- 26.925	17- 26.845	9- 26.745	12- 27.425	20- 27.525
24- 26.915	16- 26.835	8- 26.735	13- 27.435	21- 27.535
23- 26.935	15- 26.815	7- 26.715	14- 27.445	22- 27.545
22- 26.905	14- 26.805	6- 26.705	15- 27.455	23- 27.575
21- 26.895	13- 26.795	5- 26.695	16- 27.475	24- 27.555
20- 26.885	12- 26.785	4- 26.685	17- 27.485	25- 27.565
19- 26.865	11- 26.765	3- 26.665	18- 27.495	26- 27.585

TRAM D201

MODIFICATION

1. To use the VFO SW to manual channel selector to Channel 9 - 12 the VFO will now read normal.
  - a. To add 50 KC to dial channel selector 13 to 16
  - b. To add 100 KC to dial channel selector 17 to 20
  - c. To add 150 KC to dial channel selector 21 - 23
  - d. To subtract 50 KC from dial channel selector 5 - 8
  - e. To subtract 100 KC from dial channel selector 1 - 4
2. With knob in manual and dial on 27.305. If you put the channel selector on 13 - 16 your  $f\theta$  will be 27.355 if you put the channel selector on 5 - 7 your  $f\theta$  will be 27.255.
3. Locate your Hi Low power SW is in side the cabinet between the two large tubes at the back of set with the red cap on it. Low power is aprox. 6W and Hi power is aprox 15W. AM

MIDLAND 13-892

1. AM Power - Adjust VR 305
2. AM Mic Gain - RV7.
3. SSB Mic Gain - RV8.
4. Cut D206 For AGC (Mic).
5. TX Adjust L1 - L2 - L3 - L4 - L5 - L6 - L7 - L9. For Max Mod with a peak reading meter in to a 50  $\sim$  dummy load. Adjust on CH 13.
6. Do not adjust L301 as this is your 54 MHZ TVI Trap and missalinement will cause TVI.
7. Clarifier Slide.
  - a. Cut Brown wire from clarifier control and foldback and tape.
  - b. Cut Wh- VIO wire and connect to ground this will allow the unit to slide.
  - c. If more slide is needed replace RFC 201 with a miller part #4204 5 to 12 wh chok.

1. Remove R-22 100K  $\sim$  resistor.
2. Remove D3 and replace with 20 Pf.
3. Remove C+-1 20 Pf trimmer.
4. Remove clarifier control - replace with 2 - 30Pf variable. Cap in its place.
5. Make a choke or by a JW miller part #4204 5-12 yh Rf choke.
6. Ground one side of cap + the choke is soldered on the cap and the other side of the choke goes to the place where the C+-1. trimmer was removed. This will allow 20 + KHz slide.

COBRA 78X

10.240 Regular Channels

10.412 Up 27.415 - 27.865

10.071 Down 26.955 - 26.625

VR6 - Adjust for Max Mod.

L12 & L15 - Peak for max mod.

Do not adjust L18 this is your TVI trap and miss tuning will cause bleed over and cross mod on TV. If this slug has been tuned and you do not have a Spectrum Analyzer you may use Channel 2 on a TV and tune for minimum interference.

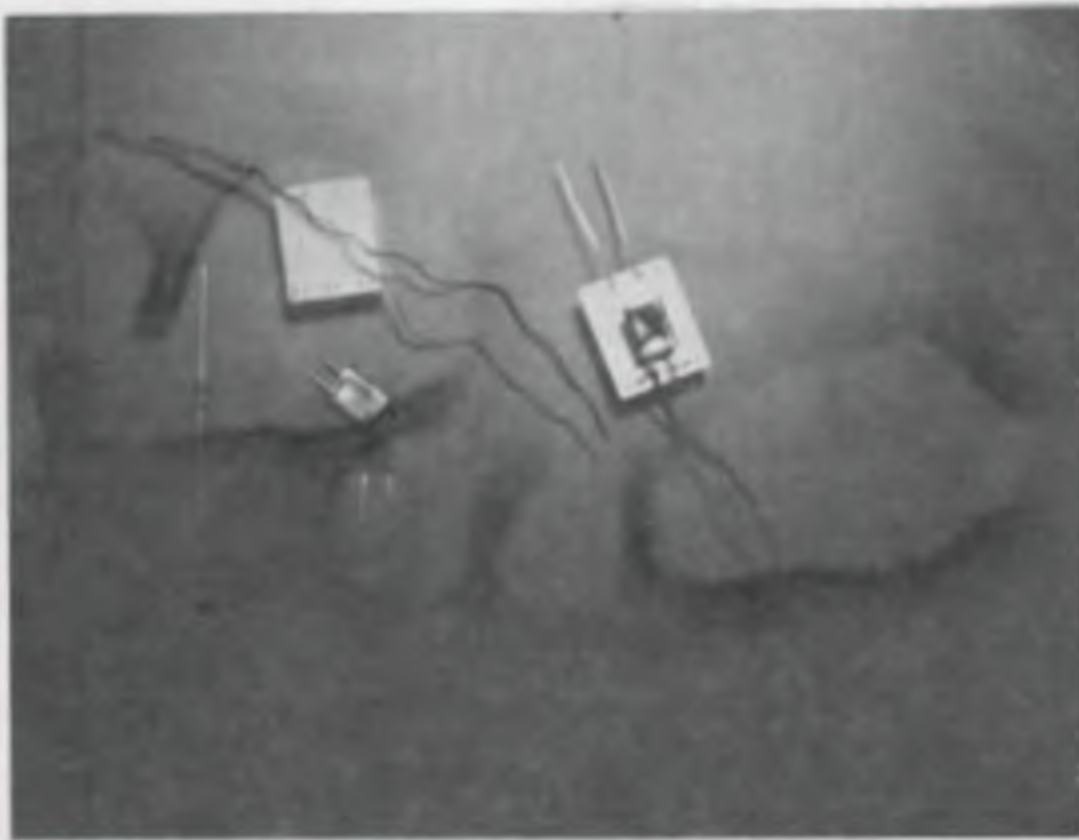

TYPICAL RELAY MODULE

COBRA 140 & 142 GTL

1. Clarifier Mod cut R187. Cut orange and red wire from clarifier pot. Connect one side to ground and one side to pin 3 of IC5. This allows +1.5 and -5 KHz. (red wire to ground.)
2. SSB ALC - adjust VR7 for max - AM ALC - cut collector of TR32.
3. AM power VR6 for max - L-26, L-27, L-29, L36 for max peak power with 1000 Hz tone. Do not adjust L39 - also VR8 - VR9.
4. SSB power VR7 ALC for max power.
5. Low F $\emptyset$  replace X4 11.1125 with a 10.9582 MHz xtal.  
Hi F $\emptyset$  replace X4 11.1125 with a 11.2580 MHz xtal.

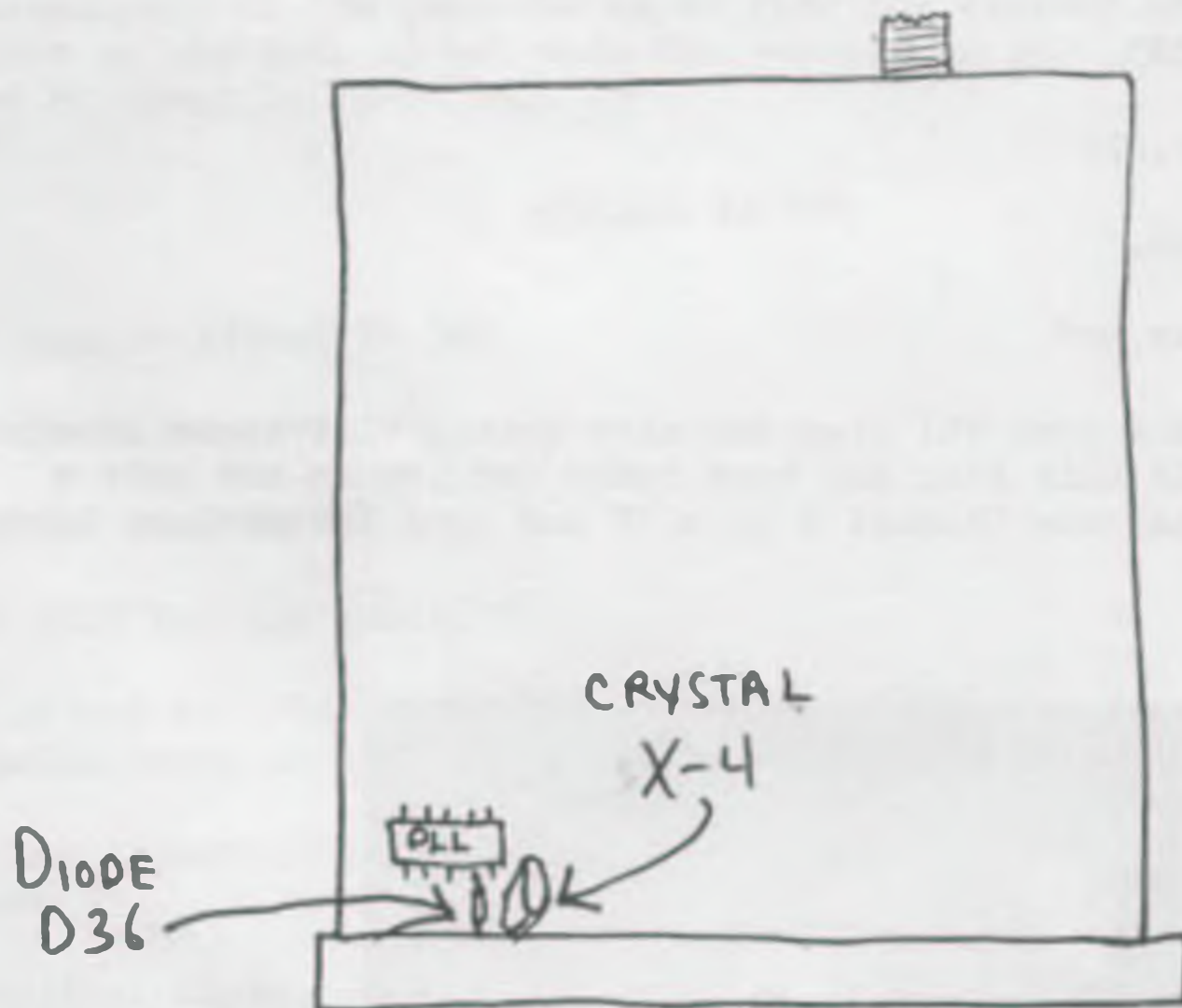

NOTE: AGAIN, SEE RELAY PAGE IN THIS BOOK WHEN SWITCHING FREAS. TO AVOID DRIFT.

MIDLAND 13-893

1. AM power parallel R148 A 5  $\sim$  5w with another 5  $\sim$  5w.
2. AMC VR12 - set for max AM mod with tone.
3. ALC VR 15 - set for Max SSB ourput tone.
4. Adjust - T22 - T21 - T20 - L10 - L8 for max on peak reading watt meter with tone in AM mode. Do Not adjust L5 401 trap.
5. Clarifier Slide
  - a. Short R68 with wire.
  - b. Adjust VR5 & VR6 for best range - this will give aprox 15KC slide.

ROYCE 1-641

1. Clarifier Mod.
  - a. Cut R 98
  - b. Remove pink wire from T.P. 13 and connect to T.P. 8.

This completes clarifier Mod - Pink wire is on clarifier cont -
2. Locate the blue and gray that go between the PLL unit and Channel Switch. Install a SPST Switch in the blue & gray leads. This will give your new channels.
3. To disable ALC cut R47 - Adjust VR7 - AMC to Max mod with 1000 Hz tone. AM Xmit - adjust +6 - +11 - +12 - +13 - +14 - +15 - +16 for max with 1000 Hz tone. SSB - adjust VR8 for max SSB power.

Note: VR9 should be 13.80 volts at xmit.

## EXPORT MODIFICATIONS FOR THE STONER PRO - 40

It may be desirable to incorporate the following modifications to the Stoner Pro-40 when the equipment is exported to foreign countries. It is not legal to make these changes in domestic equipment since it will void the FCC Type Acceptance.

HF Channels - It is possible to increase the frequency coverage of the Stoner Pro-40 up to 27.865 MHz by simply grounding pin 5 of connector P501. This connector is directly aft of the clarifier potentiometer and pin 5 is the 6th pin from the front of the radio.

A popular conversion consists of using the headphone jack for frequency changing. This can be accomplished in the following manner:

1. Disconnect the wires from the headphone jack, connect them together and insulate them.
2. Remove the 100 ohm resistor from the headphone jack.
3. Connect a wire from the "hot" connection of the headphone jack to pin 5 of connector P501. (This wire should be as short as possible to avoid picking up stray voltages that may cause the PLL to unlock in high frequency operation. A shielded cable is ideal. Connect the shield to the ground lug on the headphone jack and terminate the other end to float.)
4. Prepare a shorted headphone plug. When inserted in the headphone jack, the upper register of channels will be selected. This conversion will also place an "H" on the digital display where the hyphen is on low frequency usage.

Frequency Control System - The clarifier diode connects to the arm of the clarifier potentiometer and the arm of the transmit frequency adjust potentiometer via two gating diodes located on the front panel circuit board. On receive, plus 9 volts is applied to the "top end" of the clarifier pot. On transmit, this voltage goes to zero and plus 9 volts is applied to the "top end" of the transmit adjust pot. The "bottom end" of both potentiometers is grounded. Connected in this manner, the clarifier functions on receive only and the transmit frequency adjustment affects only the transmit frequency.

Clarifier Tune, Receive and Transmit - The clarifier control circuit can be modified to function on both receive and transmit modes in the following manner:

1. Clip the top end of the clarifier potentiometer at the point where it enters the circuit board. Note it requires a very thin cutter to clip this lug without cracking the carbon element of the pot. (Some units may have a black wire at this point or a piece of solid conductor wire instead of the potentiometer lug in the circuit board. The point to cut is the lug with plus 9 volts on it during receive.
2. Connect the top of the clarifier control to the plus 9 volt circuit. A convenient point is located on the center lug of the USB/LSB switch nearest the electrolytic capacitor.
3. Turn the transmit frequency adjustment potentiometer (R-403) full clockwise so it does not affect the frequency of operation.



These two modifications will allow operation up to 27.865 MHz without missing any channels by tuning the clarifier.

Split Frequency Operation - Some users like separate control of the receiver and transmitter frequency. This is extremely useful when someone is causing intentional interference. By operating on two split frequencies, the interference can bother one station or the other, but not both. Usually, the interfering station gives up when his efforts are not immediately successful. The split frequency modification can be accomplished as follows:

1. Do not modify the clarifier as described in the previous section. This control will continue to adjust the receive frequency.
2. Clip the top end and center (or arm) connections of the RF Gain control potentiometer. Use caution not to crack the carbon element to the potentiometer.
3. The two "stumps" sticking up from the front panel board must be soldered together or the receiver will not function.
4. Set the transmit frequency adjust potentiometer to the exact center of its mechanical range.
5. Connect a wire from the center (or arm) of the transmit frequency adjustment potentiometer to the center (or arm) of the former RF Gain control.
6. Connect a wire from the top end of the transmit frequency adjustment potentiometer to the top end of the former RF Gain control.

This completes the conversion. The former RF Gain control will now adjust the transmit frequency. The adjustment of the former RF Gain control will be critical since only 270° or rotation covers 10KHz. However, the transmit frequency can be set very accurately with the aid of the frequency counter.



# COMPLETE INFORMATION ON O2A CHIP

## 1. SSB O2A = AS FOUND IN MANY SSB RADIOS

Modulation - Remove C-175

AM Watts - turn VR-4 counter clockwise

SSB watts - adjust RV2

Slider - cut D4, D5. Move center wire from clarifier pot from anode side of D4 to cathode of D4. Run a wire from empty side of clarifier pot to 9v source (R9 is in the front of unit, and has a regulated 9v).

Frequency modification - Range 25.675 to 28.235

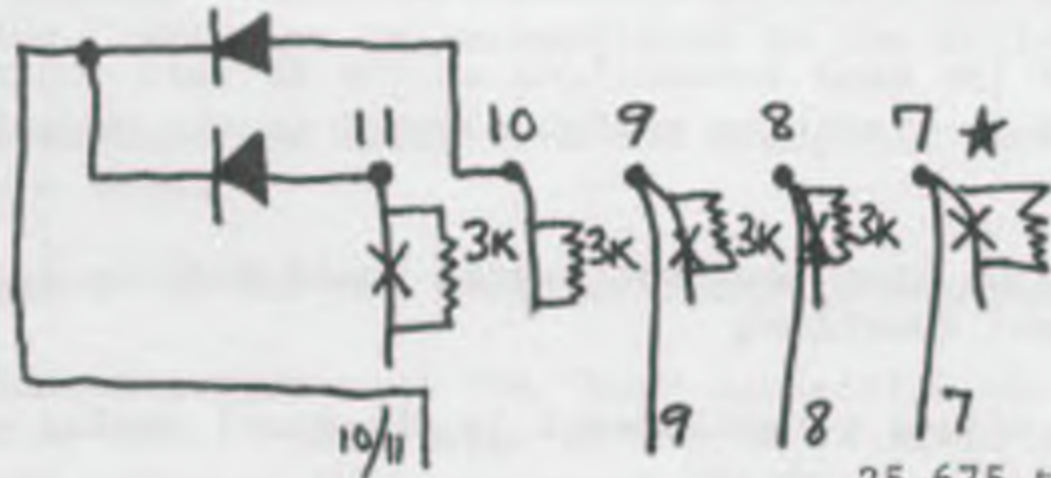

X DENOTES CUT FOIL

★ MUST CUT FOIL  
ON BOTH SIDES  
OF THIS PIN

0 = GROUND

1 = 5 VOLTS

25.675 to 26.165 -	1 to pin 7
	0 to Pin 8
	0 to Pins 10/11
26.325 to 26.765 -	1 to Pin 7
	0 to Pin 8
	0 to Pin 9
26.805 to 26.955 -	1 to Pin 7
	0 to Pin 8
	0 to Pin 10/11
	0 to Pin 9

X = Cut Foil

\* = Must Cut Foil on Both Sides of This Pin

0 = Ground

1 = 5v

2. 27.445 to 27.595 -	0 Pin 7
	1 Pin 8
	0 Pin 10/11
27.605 to 28.045 -	0 Pin 7
	1 Pin 8
	0 Pin 9
28.065 to 28.235 -	0 Pin 7
	1 Pin 8
	0 Pin 9
	0 Pin 10/11

NOTE: With Pin 7 high and Pin 8 low, unit is in down frequency range (below one) when 7 is low and 8 is high, unit is in up frequency range (above 40).

Cut foil between pins \*7,8,9,10 and 11. Add 3k resistors across breaks in foil. Place one diode (in34/in60) anode side to pin 10 and one to pin 11. Join the cathode sides together.

The cybernet units that utilize the O2A chip will not spread over the entire frequency range without broad banding. These units will spread an average of

1500kc. I have tried many experiments in broadbanding, and have only found one way, which is very costly and requires extensive modifications and additions to the unit. I will enclose this modification on a separate paper.  
\*Pin 7 is connected to ground on both sides of the pin. The foil must be cut on both sides.

### 3. Broadbanding cybernet O2A units.

This modification should not be attempted unless you are willing to spend a lot of time and money (\$25.00).

1. Remove VCO Block from unit.
2. Mount original VCO Block and second VCO \* Block on a small piece of perf-board.
3. Mount a 12 volt relay in a convenient location and wire so the relay will switch the VCO blocks back and forth.
4. At 27.595 tune one VCO for highest wattage. Check the unit at 28.235 and at 26.965 to assure, it is transmitting on frequency.
5. At 26.325 tune the 2nd VCO block for watts. Check unit again at 26.955 and 25.675.
6. Realign transmit section of unit at 26.955.

\* AVAILABILITY OF VCO \* BLOCK MAY BE DIFFICULT TO FIND.



MODEL 770 VICTOR

STEP 1

- A. Remove bottom cover on PLL circuit.
- B. Locate IC1 and cut ground foil connection to Pin 10.
- C. Attach 10K OHM resistor to ground and Pin 10 (attach red wire to Pin 10).
- D. Attach white wire to Pin 11.
- E. Attach black wire to Pin 9.
- F. Cut slot in lip of cover to allow wires to exit. Replace cover.

STEP 2

- A. Remove violet wire from PC Board at rear of response switch. Attach red wire to this point.
- B. Attach white wire to one of the two empty pins on the response switch.
- C. Cut the ground foil going to the next two switch contacts and attach the black wire here.

STEP 3

- A. The transmitter will cover only about 800 KHz.
- B. Set the switches to the highest channel to be used. Adjust L14, for 3.8 volts at TP5.
- C. Set the switches for the middle of the selected range. Adjust L18, L19, and L20 for maximum output. It is usually unnecessary to adjust any other coils in the transmitter.
- D. Tune signal generator for center channel and adjust L1, L2, L3 for maximum receiver sensitivity.
- E. Check highest and lowest channels for transmitter operation and receiver performance and adjust above coils as necessary to balance operation.

SEE PAGE TWO FOR CHANNELS SELECTIONS

MODEL 770 - CONTINUED

SET CHANNEL DIAL	ANL (SOFT)	ANL (SHARP)
1	27.605	27.285
2	27.615	27.295
3	27.625	27.305
4	27.645	27.325
5	27.655	27.335
6	27.665	27.345
7	27.675	27.355
8	27.695	27.375
9	27.705	27.385
10	27.715	27.395
11	27.725	27.405
12	27.745	27.425
13	27.755	27.435
14	27.765	27.445
15	27.775	27.455
16	27.795	27.475
17	27.805	27.485
18	27.815	27.495
19	27.825	27.505
20	27.845	27.525
21	27.855	27.535
22	27.865	27.545
23	27.895	27.575
24	27.875	27.555
25	27.885	27.565
26	27.905	27.585
27	27.915	27.595
28	27.925	27.285
29	27.935	27.295
30	27.945	27.305
31	27.955	27.315
32	27.965	27.325
33	27.975	27.335
34	27.985	27.345
35	27.995	27.355
36	28.005	27.365
37	28.015	27.375
38	28.025	27.385
39	28.035	27.395
40	28.045	27.405

MODEL 790 VICTOR

STEP 1

- A. Remove bottom cover on PLL circuit.
- B. Locate ICI and cut ground foil connection to Pin 10.
- C. Attach 10K OHM resistor to ground and Pin 10 (attach red wire to Pin 10).
- D. Attach white wire to Pin 11.
- E. Attach black wire to Pin 9.
- F. Cut in lip of cover to allow wires to exit. Replace cover.

STEP 2

- A. Attach red wire to front unused terminal of "Pull SWR" Switch.
- B. Remove blue wire from ANL Switch, remove short green wire completely, attach blue wire to terminal with long green wire.
- C. Attach black wire from PLL to center terminal of "Pull SWR" Switch and a jumper to terminal of ANL Switch where green jumper was attached.
- D. Attach white wire to previously unused terminal of ANL Switch.

STEP 3

- A. The transmitter will cover only about 800 KHz.
- B. Set the switches to the highest channel to be used. Adjust L14 for 3.8 volts at TP5.
- C. Set the switches for the middle of the selected range. Adjust L18, L19, and L20 for maximum output. It is usually unnecessary to adjust any other coils in the transmitter.
- D. Tune signal generator for center channel and adjust L1, L2, L3 for maximum receiver sensitivity.
- E. Check highest and lowest channels for transmitter operation and receiver performance, and adjust above coils as necessary to balance operation.

SEE PAGE TWO FOR CHANNEL SELECTIONS

MODEL 790 \_ CONTINUED

SET CHANNEL DIAL	SWR SWITCH PULL	ANL (on)
1	27.605	27.285
2	27.615	27.295
3	27.625	27.305
4	27.645	27.325
5	27.655	27.335
6	27.665	27.345
7	27.675	27.355
8	27.695	27.375
9	27.705	27.385
10	27.715	27.395
11	27.725	27.405
12	27.745	27.425
13	27.755	27.435
14	27.765	27.445
15	27.775	27.455
16	27.795	27.475
17	27.805	27.485
18	27.815	27.495
19	27.825	27.505
20	27.845	27.525
21	27.855	27.535
22	27.865	27.545
23	27.895	27.575
24	27.875	27.555
25	27.885	27.565
26	27.905	27.585
27	27.915	27.595
28	27.925	27.285
29	27.935	27.295
30	27.945	27.305
31	27.955	27.315
32	27.965	27.325
33	27.975	27.335
34	27.985	27.345
35	27.995	27.355
36	28.005	27.365
37	28.015	27.375
38	28.025	27.385
39	28.035	27.395
40	28.045	27.405

674A HY GAIN  
15-40 KHZ SLIDE

1. Unsolder coax on back of fine tune control. Install variable choke in lead. Install choke so you can adjust it.

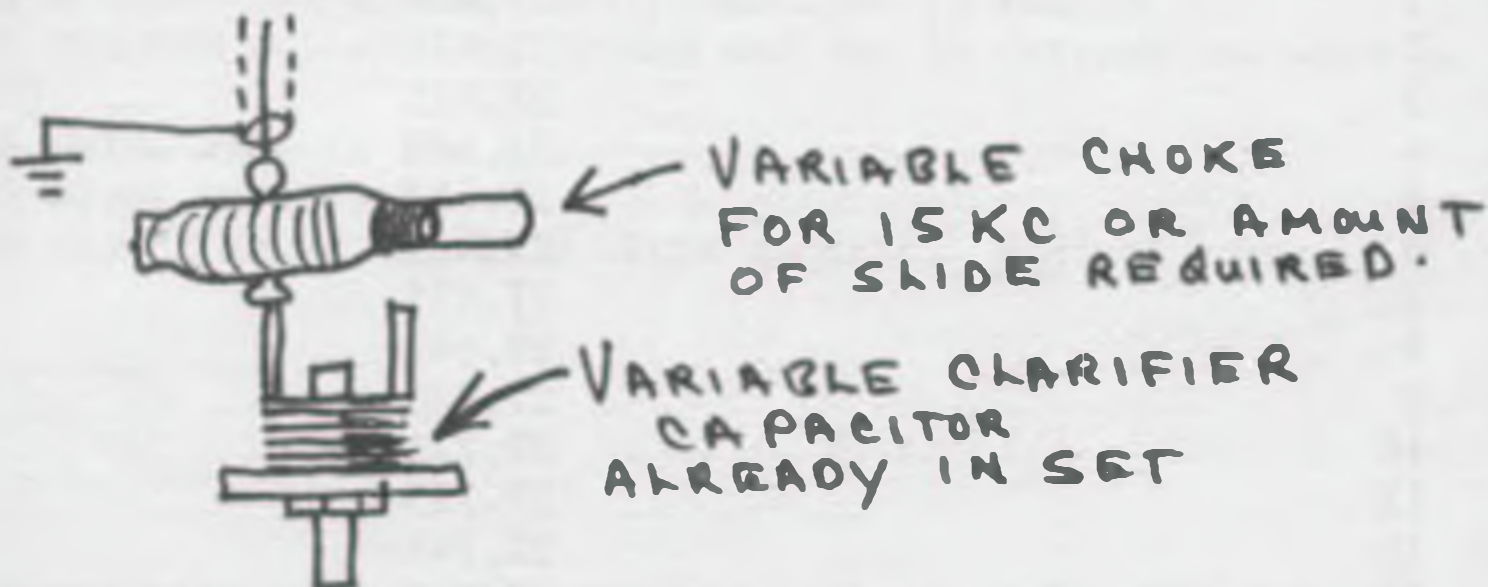

2. Locate R180. This is a long square resistor along the side of unit and install a 2.~ 10w in place of it.
3. Do not adjust L19 AM Adjust L11 - L12 - L13 - L14 - L15 - L16 - L17 - L18. Adjust for max peak with 1000 HZ tone. SSB - Do not adjust L19. Connect two tone generator (400 HZ 1000 HZ). Adjust L10 to Max.
4. Adjust RF panel meter VR6 6 - so it will not peg the meter.

Instructions For Grounding A Mobile Unit

- 1) Your power cord is not sufficient for an RF ground. A separate cable must be used. Beldon 8663 may be used or you may strip the shielding from an old piece of coax. A length of hook up wire will not work for the RF ground. The thing you must remember about RF is that it travels on the surface of the conductor and you must have a large surface to conduct RF.
- 2) Rust and oxidation will not pass RF because it is on the surface of the material. All connections must be Rust free and clean. Remember rust and oxides disrupt RF paths and ground connections.
- 3) The antenna must have a ground plain of 108 sq. in. to work properly.
- 4) You cannot measure RF ground with an ohm meter. A special RF bridge must be used.
- 5) The rule of thumb is that if it is clean and bright, it is a good RF ground.
- 6) All insulated joints such as hood, trunk and side mirrors must have a ground strip to the car body.
- 7) Silicon or zinc ointment will help oxidation from causing you trouble with your antenna by helping prevent it from getting started.



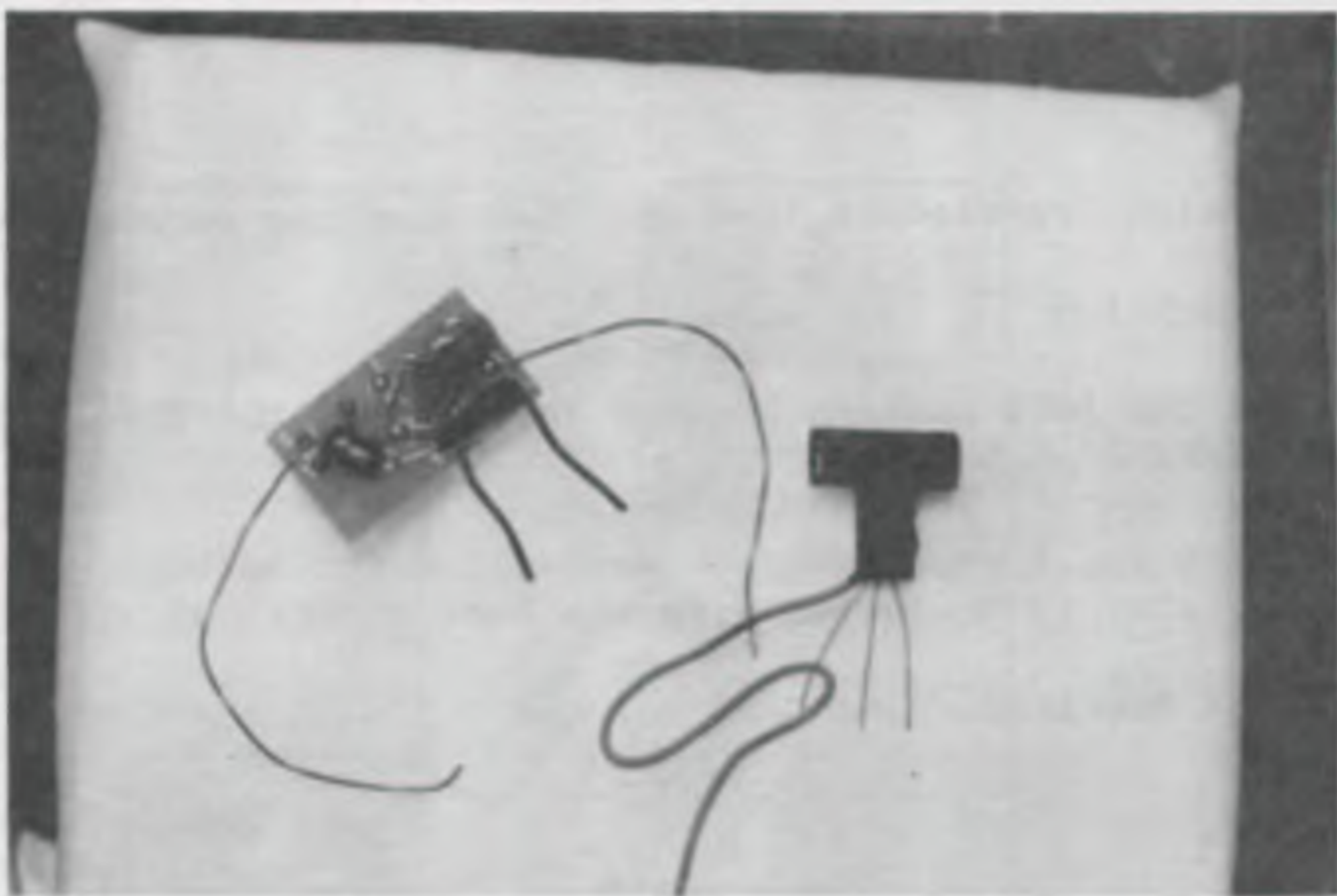

HINTS AND KINKS SECTION - B

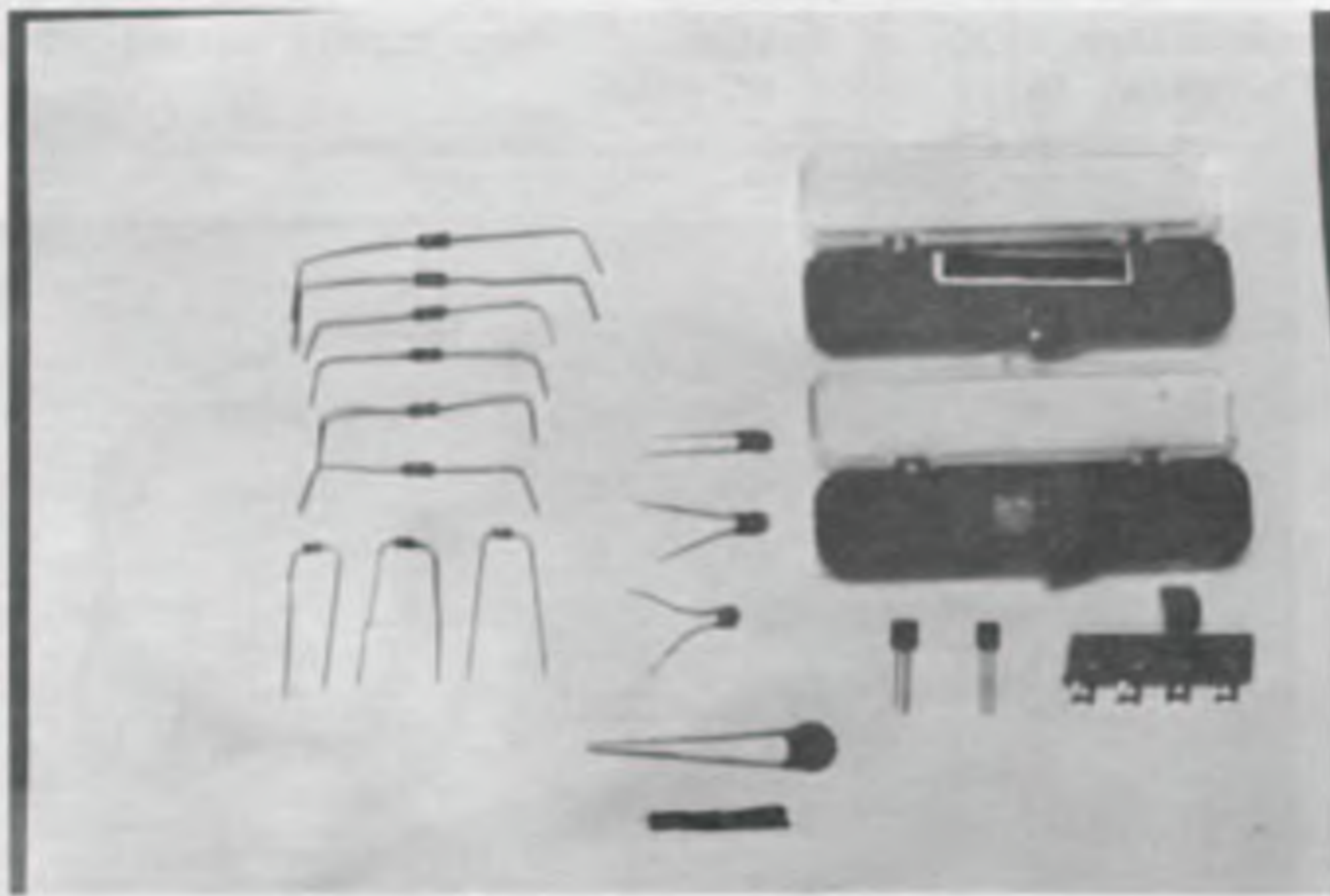

## HINT'S AND KINK'S

### COBRA 62XLR

**SUBJECT:** Squelch Transistors TR-8 and TR-9 Shorting on the 62XLR

**SYMPTON:** No Squelch

**SOLUTION:** Cut the foil pattern between the base of the TR-8 and the junction of D-12, C-17.

Add a 1k,  $\frac{1}{2}$  watt resistor across the cut pattern, so the resistor is in series with the base circuit of TR-8.

**ADJUSTMENTS:** None required

### COBRA 142GTL

**SUBJECT:** Reduction of AC hum on the 142GTL

**SYMPTOM:** AC hum in audio. Most noticeable when customer is using headphones or external speaker at low volume.

**SOLUTION:** Unsolder black ground wire (from cable harness) at power supply board. Remove small tie wrap which wraps red & Black wires together. Pass black ground lead through large chassis hold and resolder directly to negative terminal of filter capacitor C-304 on bottom of power supply board. Negative terminal faces front of unit.



TURNER MIKE EXPANDER

500 AMC DISABLE

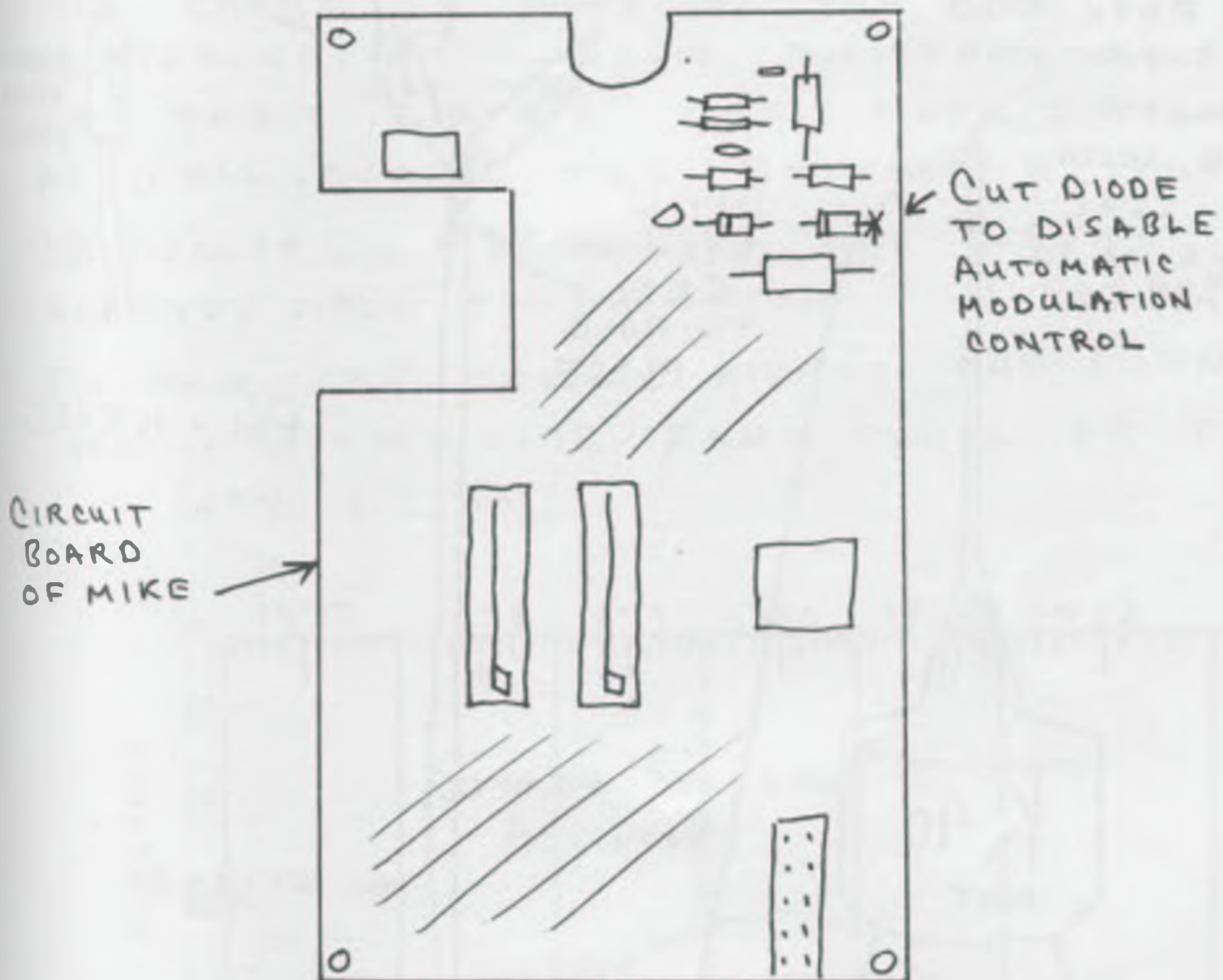

1. Remove knobs from top of Mike.
2. Remove four screws from bottom of case and remove the P/C Board.
3. Cut the diode and fold back.
4. Reinstal in case make sure the battery clips are in place.

K 40 BLINKIE

WRAP TWO NE-2's  
ONE ON EACH SIDE  
OF THE TIP OF YOUR  
K40 STINGER  
AND GLUE WITH  
SILICONE SEAL.  
ALLOW 1HR OR SO  
BEFORE MOVING.

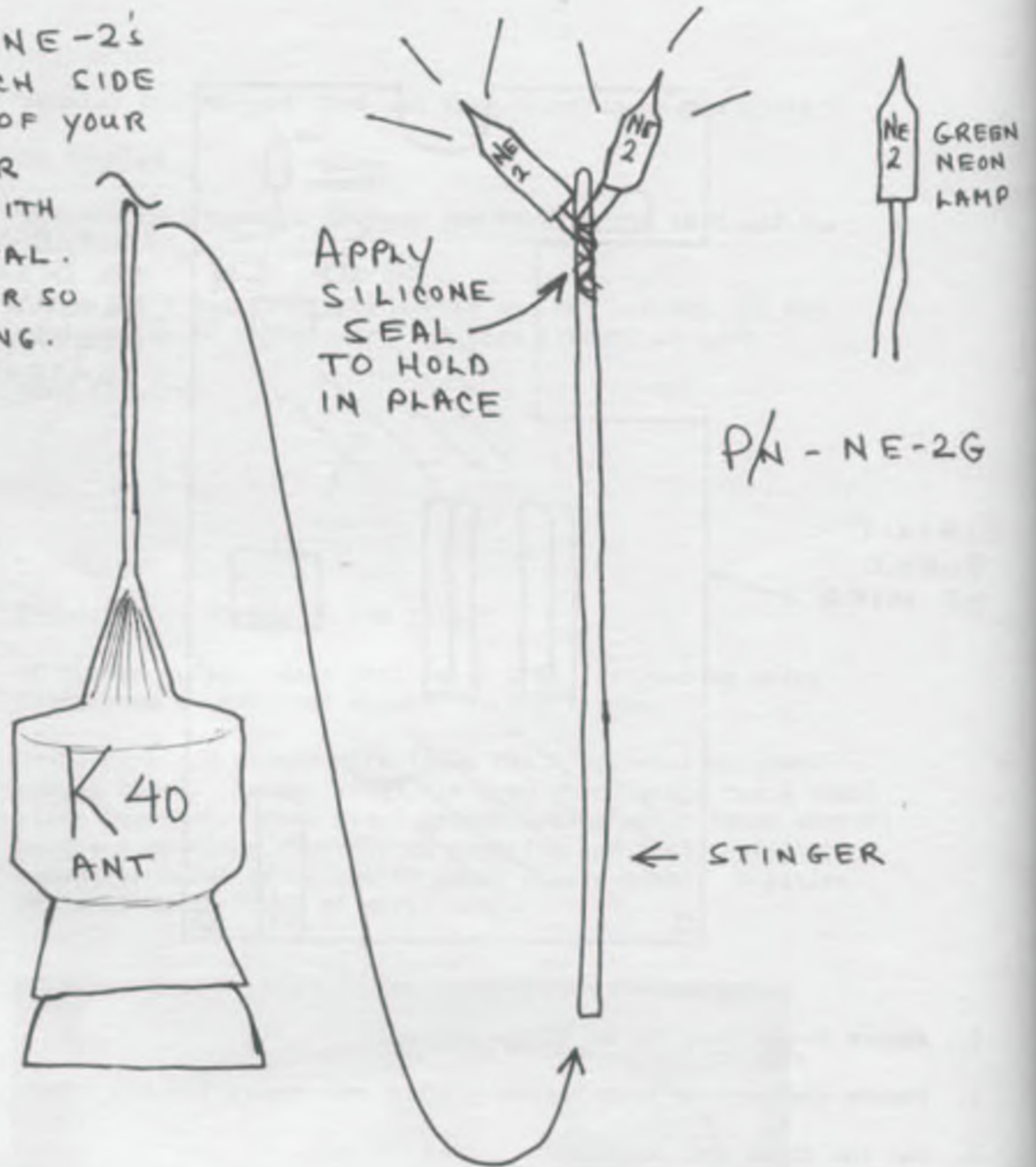

WHEN YOU KEY UP AND TALK THE LIGHT WILL GLOW GREEN AND WILL GET BRIGHTER AS YOU TALK. DO NOT USE RED NE - 2's AS SMOKEY WILL BE ON YOUR CASE!

NOTE: THIS MAY BE APPLIED TO OTHER ANTENNAS

# SUNSPOT PREDICTION CHART

THIS CHART IS PUT INTO THE BOOK FOR CB DEALERS TO SHOW THEIR CUSTOMERS WHY THEIR "AM RIG" DOES NOT "GET OUT" AS WELL, DURING THE SUNSPOT ACTIVITY. CB DEALERS, SIDEBANDERS AND OTHERS ALREADY HAVE EXPERIENCED THIS PHENOMENON. IN THE THE COMING YEARS, AND EVEN NOW - SINGLE SIDE BAND WILL BE THE WAY TO GO!

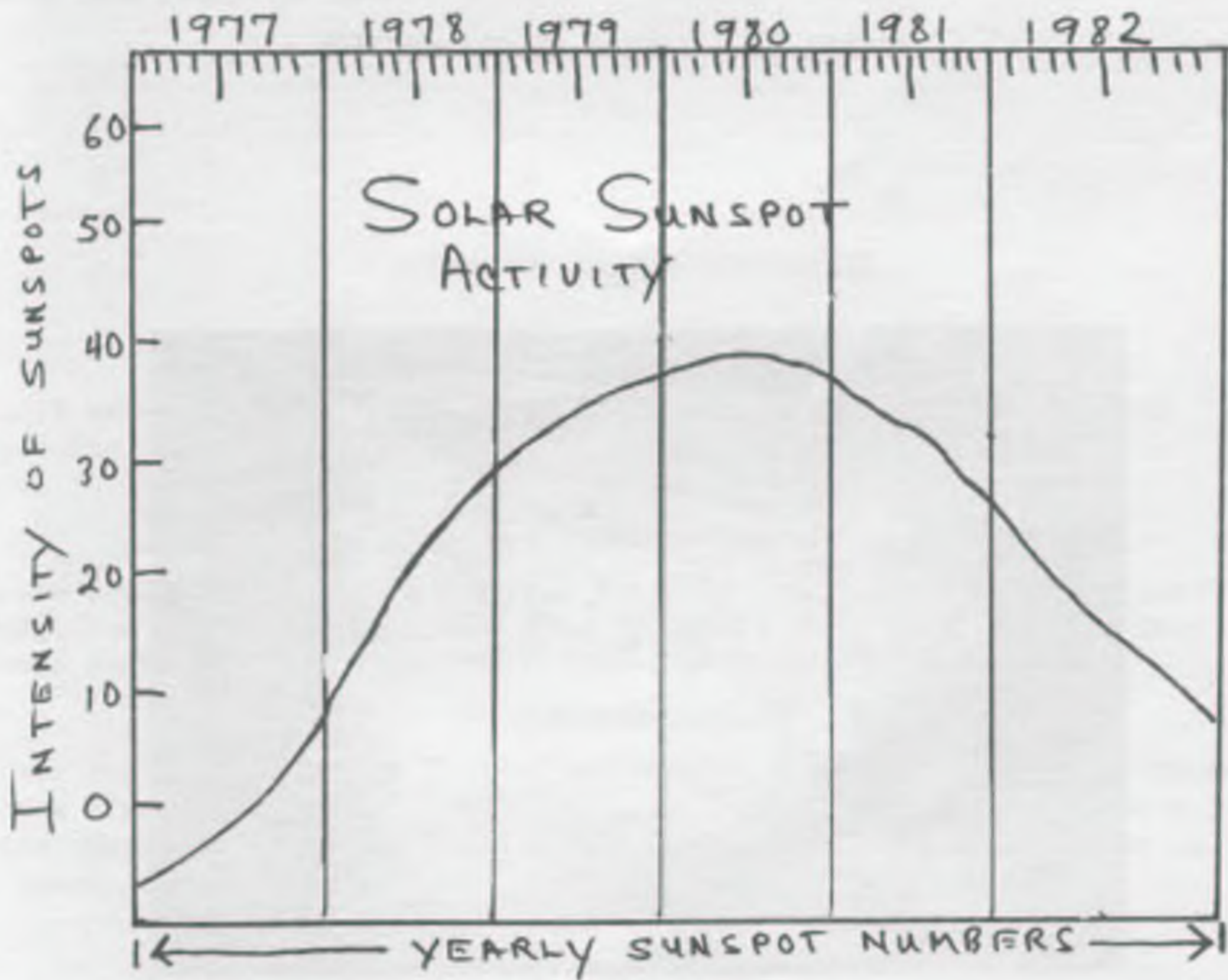

 - DENOTES PREDICTED SUNSPOT ACTIVITY.

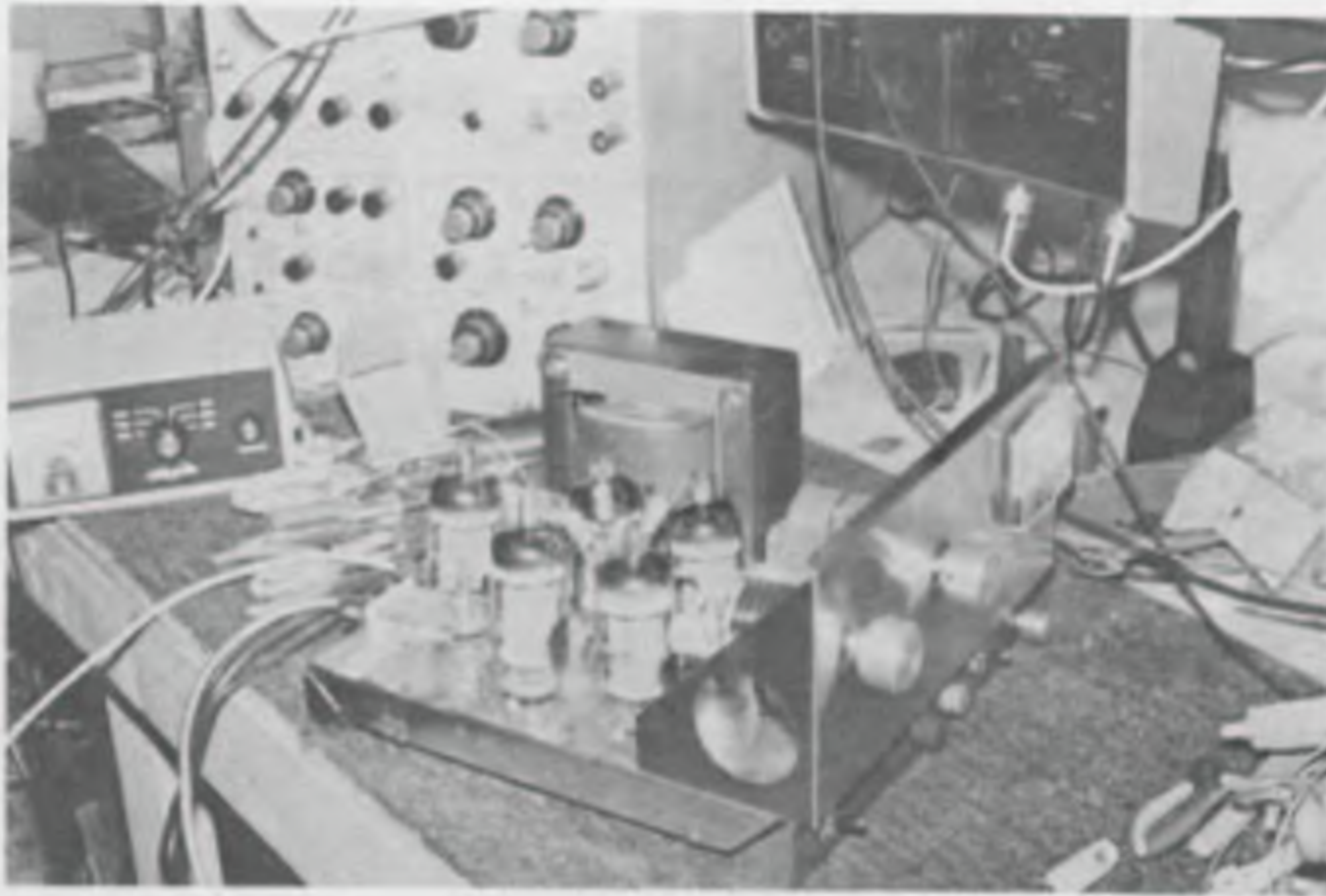

SECRET CB - LINEAR REPORT SECTION - C

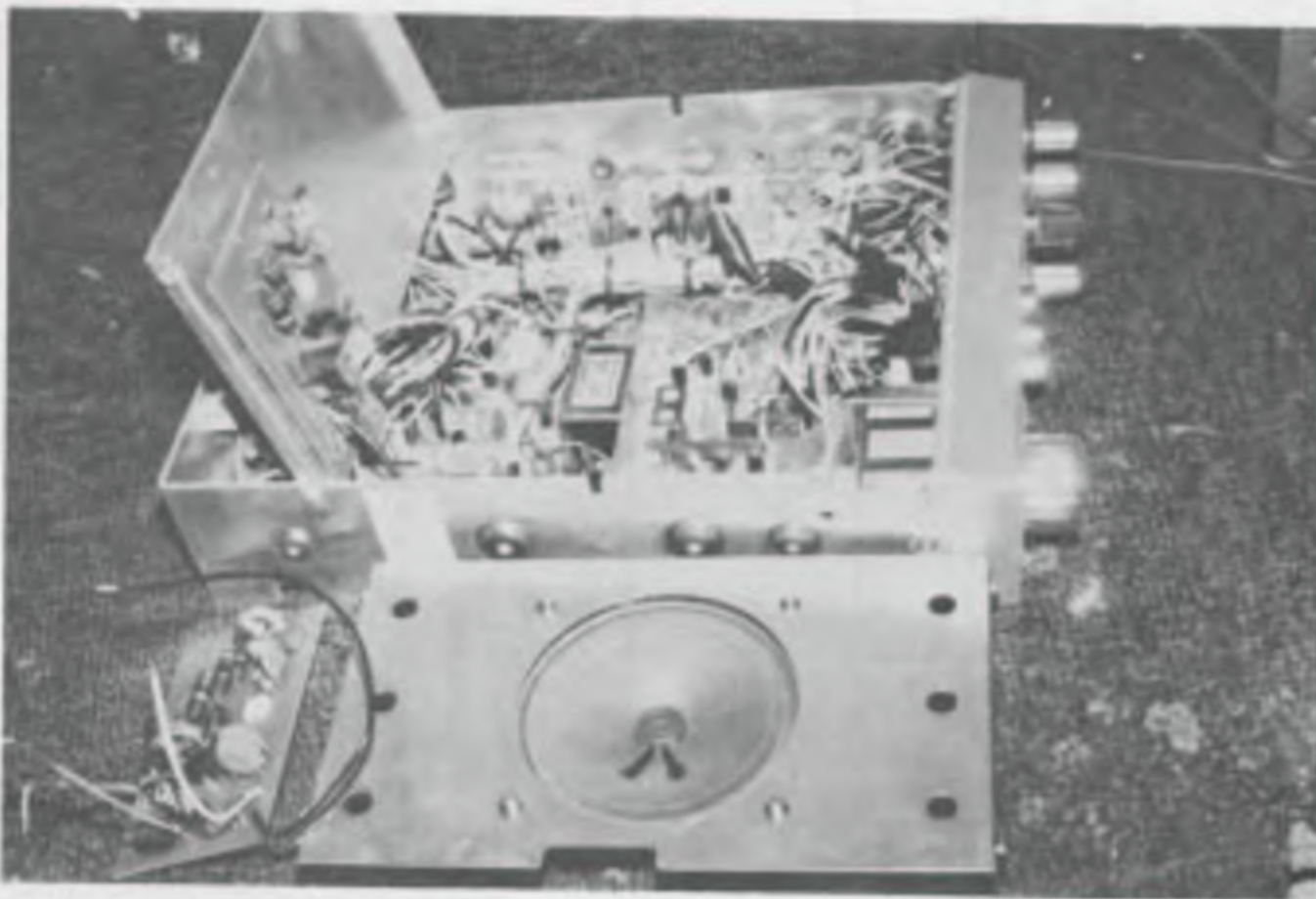

## D AND A MAVERICK

1. Turn the unit upside down with the front toward you.
2. Remove the 5pf disc capacitor that is connected between the VFO input (SO-239) and pin #2 of the oscillator tube socket.
3. Remove the 470K 2 watt resistor that is connected to pin #1 of the oscillator tube socket and the first lug of the 5 terminal strip.
4. A. Disconnect the brown wire where it is connected to pin #7 of the antenna relay and reconnect it to pin #4 of the antenna relay.  
B. Solder a piece of #18 or larger copper wire from the VFO input (SO-239) to pin #7 pin of the antenna. (wire should be as short as possible).
5. Starting at the top of the tank coil (lead control) on left hand end) brifge solder from the end of the coil across one air gap to the first full turn and then across the second air gap to the second full turn.
6. Unit is now ready to load.

## D AND A 500 TRIPLE CONVERSION

Locate coil between load and tune knob and bridge with solder across two turns starting where the coil starts (at either end). Not in the middle of a turn.

Next locate coil between drivertune and load and do the same, then locate wire going from VFO output (so239 on back of unit) to a tube socket. This wire should contain a .001 Capacitor. Completely remove this wire.

Next locate the relays between the so239 connectors on the back side. There should be a brown wire going from the relay and going to the 2nd lug on a 5 lug strip. Cut this wire at the strip. Shorten the wire and attach it to the VFO output so239.

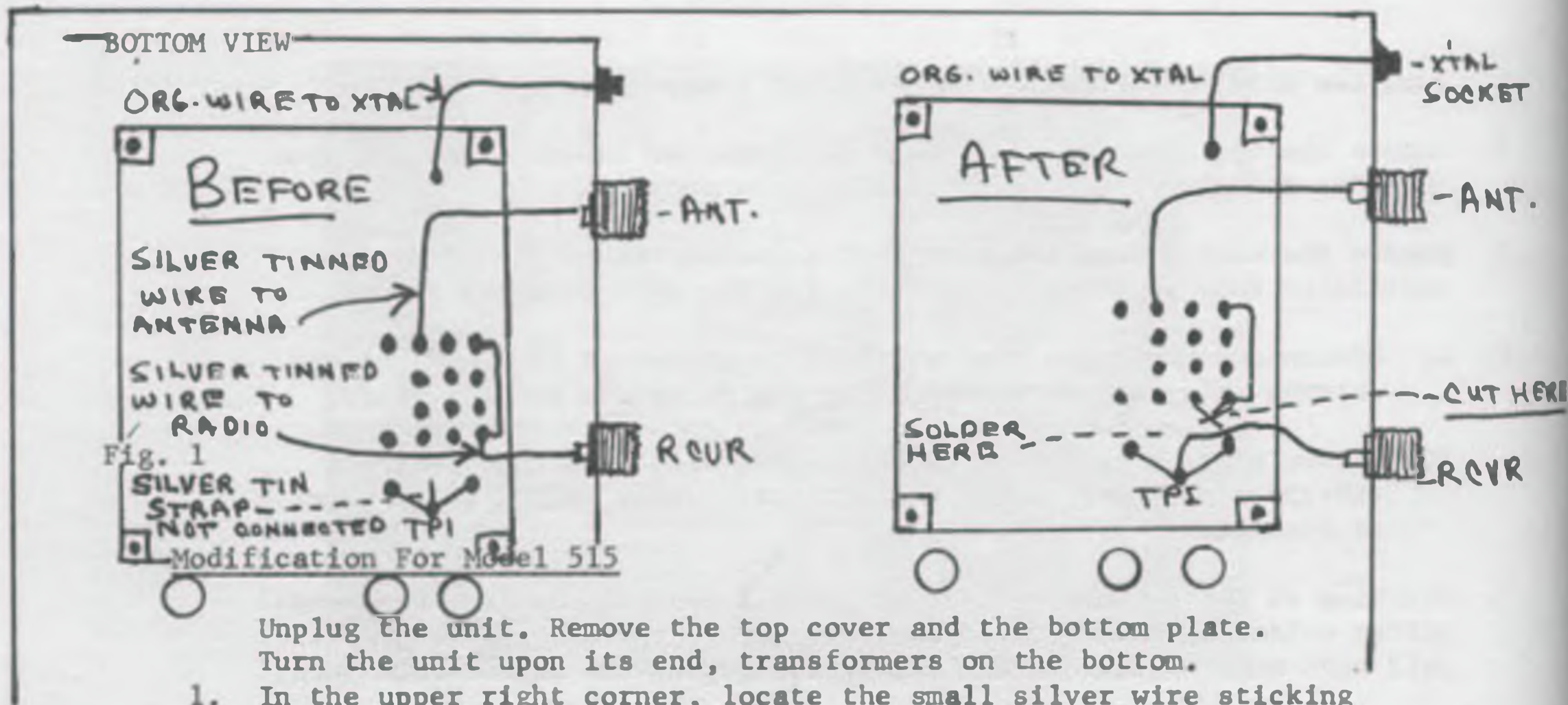

- Unplug the unit. Remove the top cover and the bottom plate. Turn the unit upon its end, transformers on the bottom.
1. In the upper right corner, locate the small silver wire sticking up out of the board with nothing soldered to it. Cut the silver wire that goes from the receiver connector, indicated by an "X" (Fig. 1) and solder it to the silver wire sticking up out of the board.

DRIVER MODIFICATION:

Fig. 2

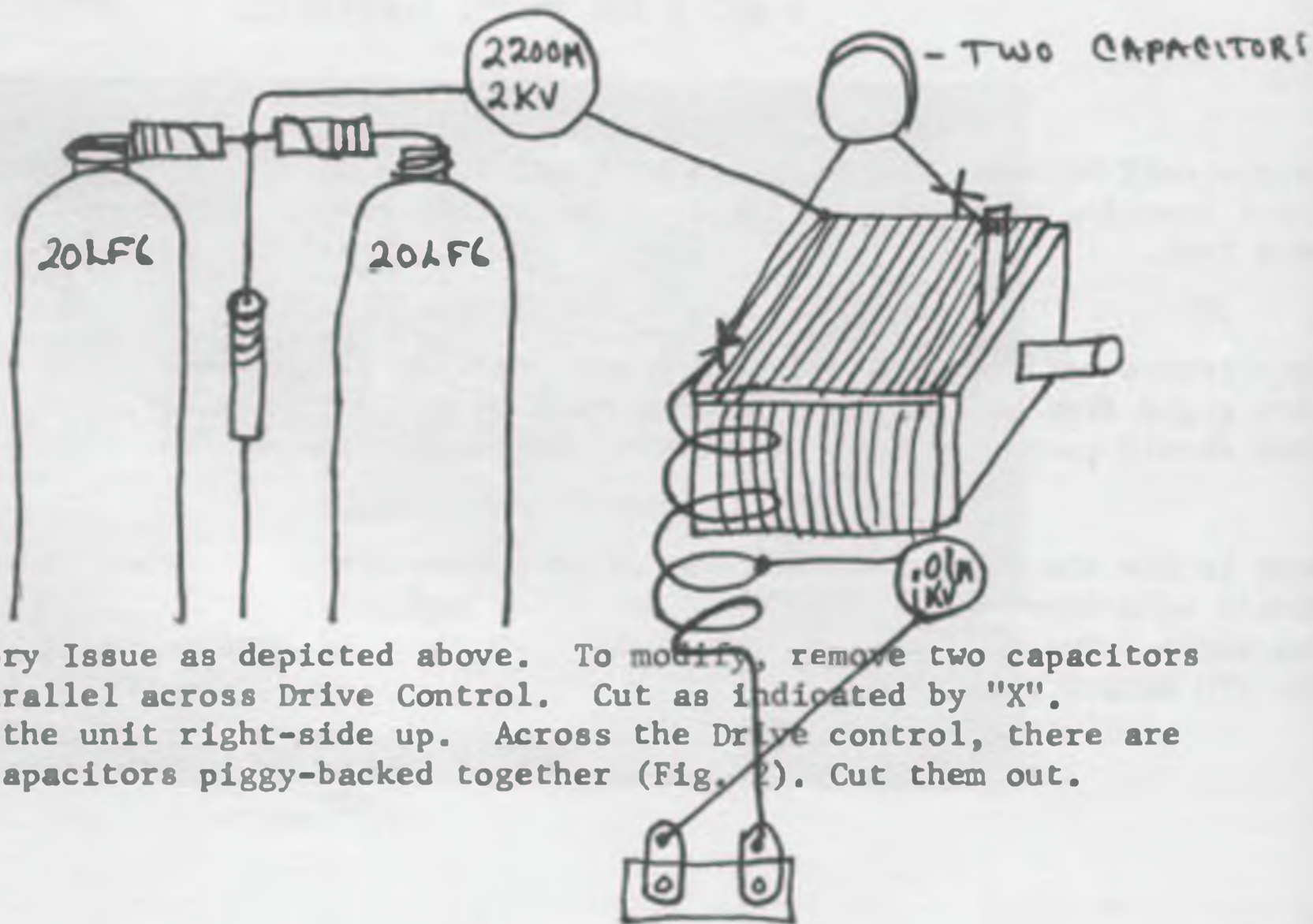

- Factory Issue as depicted above. To modify, remove two capacitors in parallel across Drive Control. Cut as indicated by "X".
2. Turn the unit right-side up. Across the Drive control, there are two capacitors piggy-backed together (Fig. 2). Cut them out.



# EAGLE 515

OUTPUT MODIFICATION:

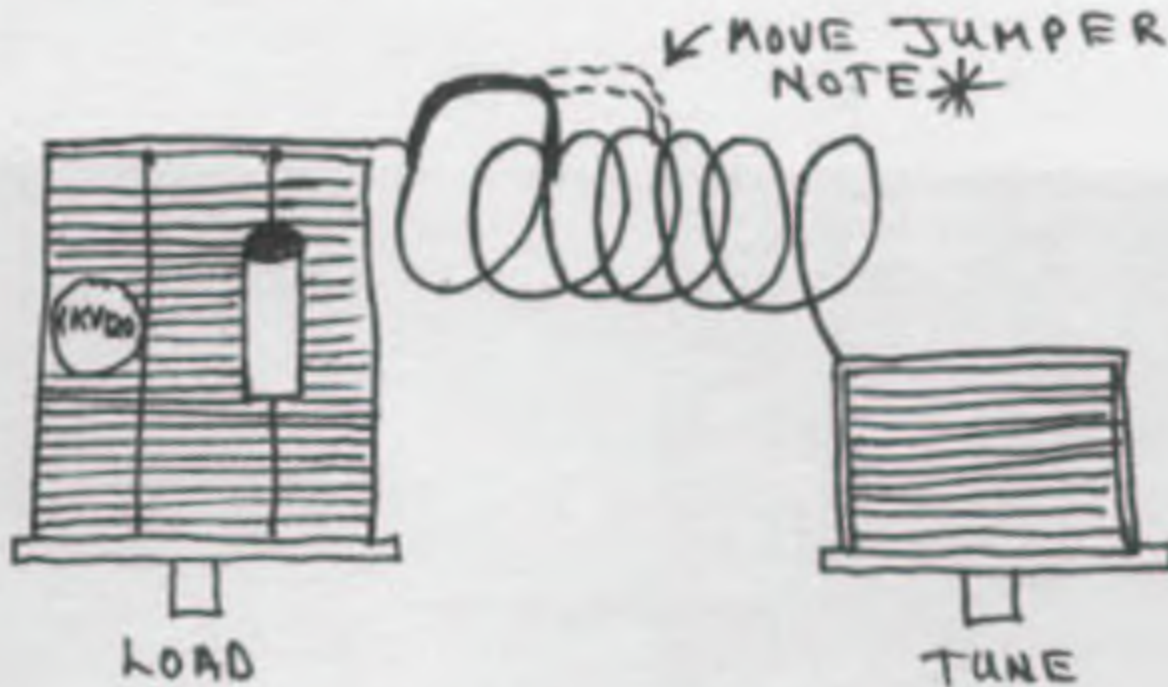

Fig. 3

Factory Issue as depicted above. To modify, move strap on coil between "Load" and "Tune" from third turn (as per factory issue) to fifth turn (as indicated above).

3. In between the Tune and Load controls is the Output Coil. If you are facing the unit, from the left end of the coil, there is a piece of silver wire soldered to the end of the coil and to the third turn (counting from left to right). Unsolder it at the third turn and re-solder it to the fifth turn (Fig. 3).

YOU MAY ---  
 \* INSTEAD OF JUMPERING,  
 CAREFULLY REMOVE FROM  
 CIRCUIT - STRAIGHTEN  
 COIL AT POINT OF  
 JUMPER THUS REMOVING  
 EXCESS COIL SHORTEN  
 WIRE TO DESIRE LENGTH,  
 REINSTALL AS BEFORE.  
 THIS INCREASE EFFICIENCY!  
 (EXCESS CHOKE JUMPERED  
 WILL ABSORB POWER)

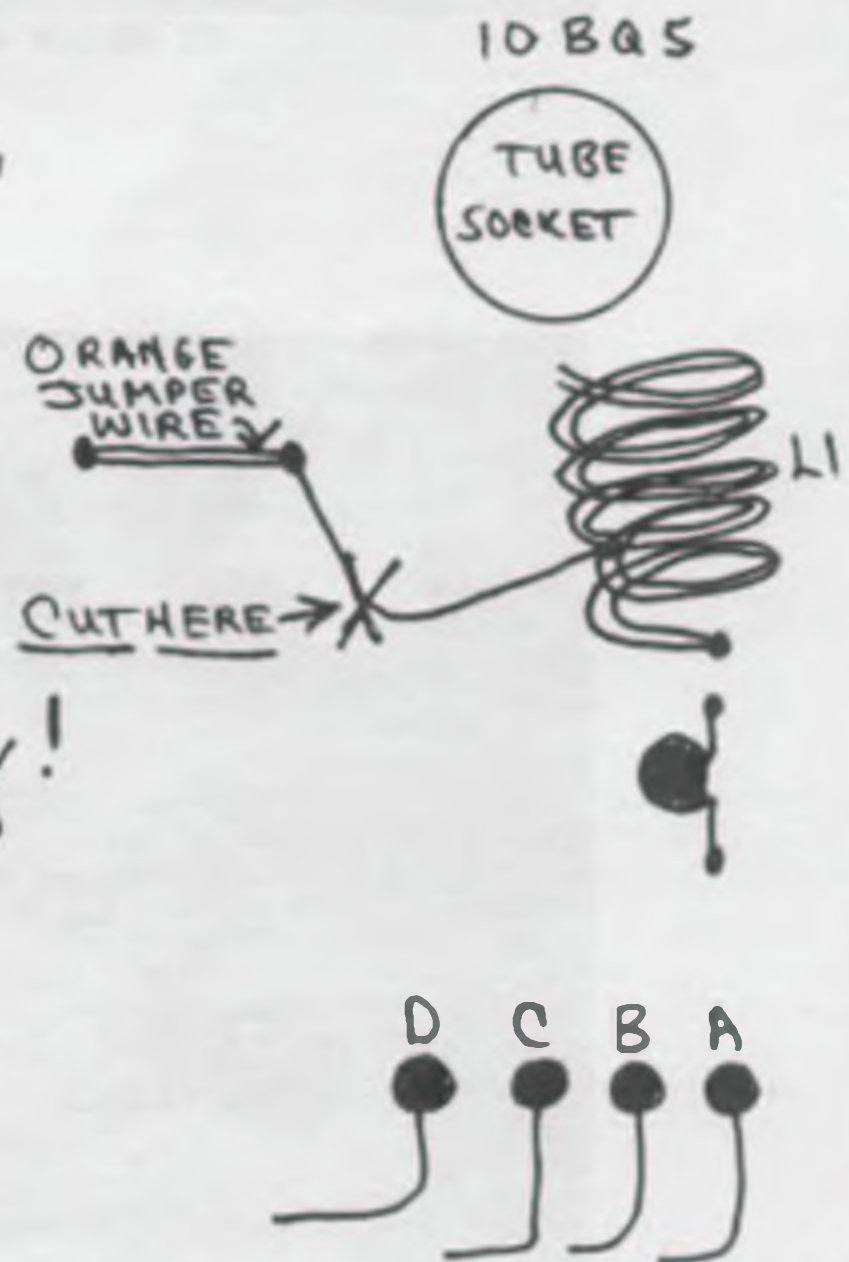
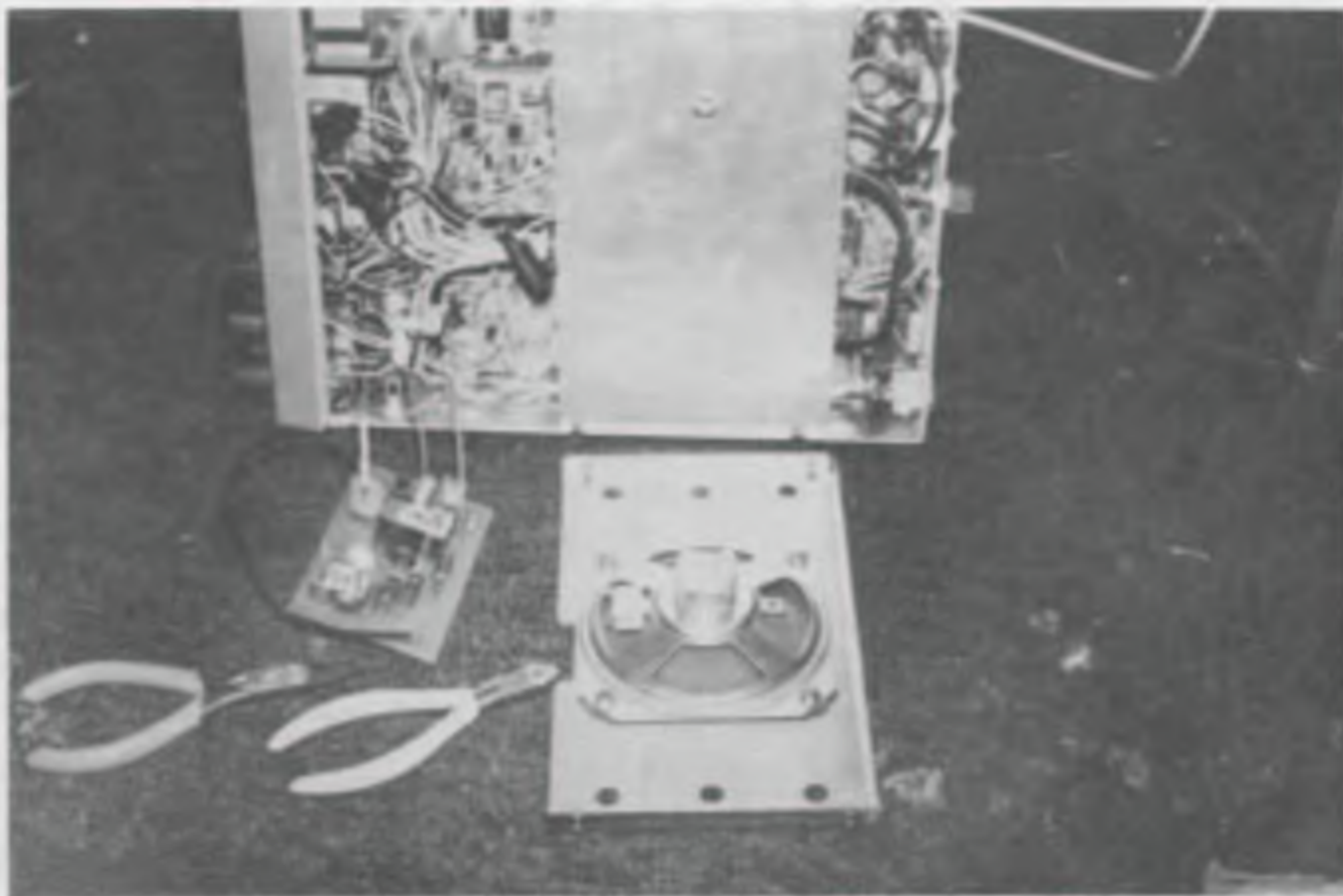
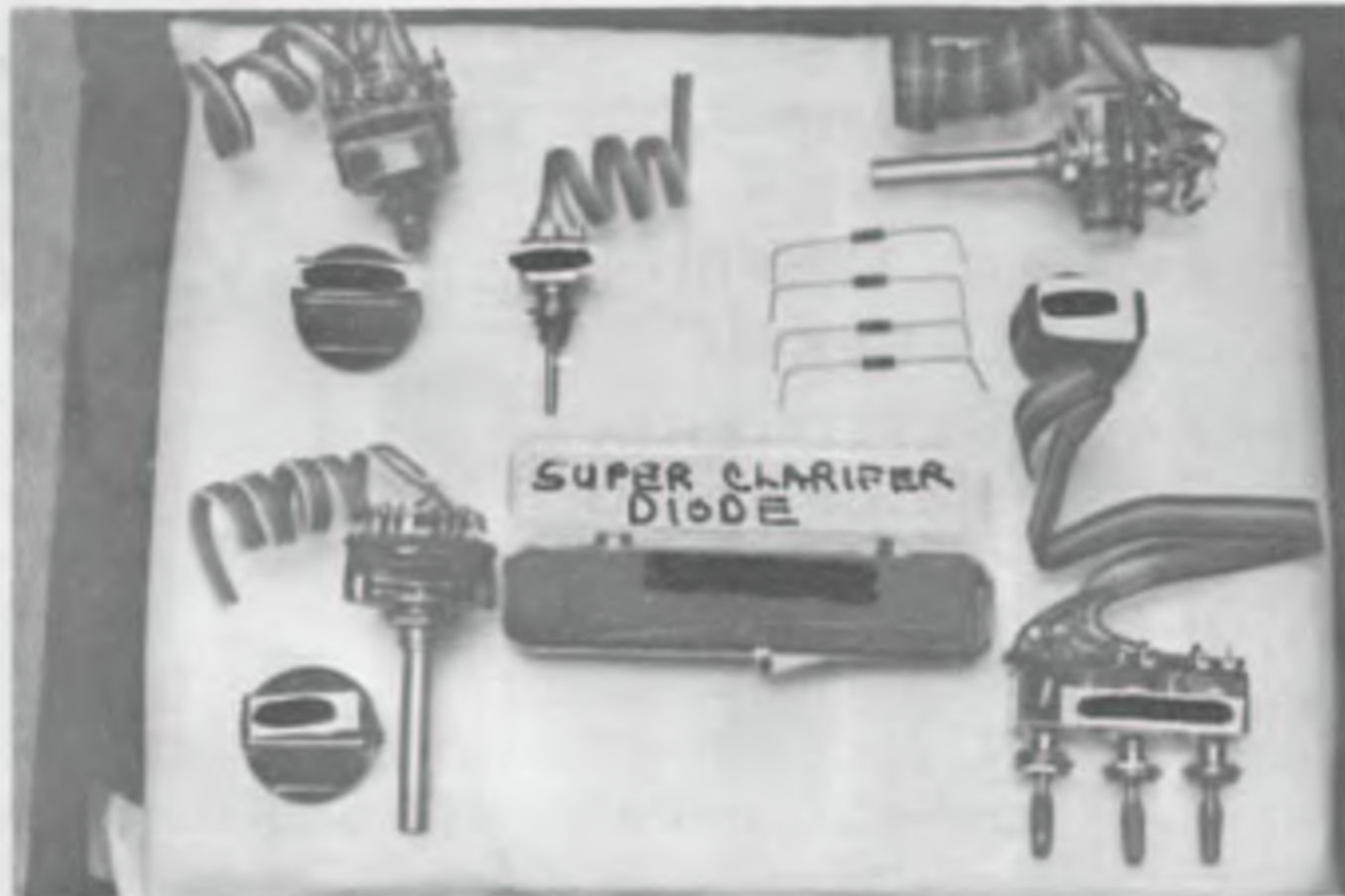

Fig. 4

4. With the unit facing you, there is a small silver coil in the back right side, by the antenna relay. There is a small silver wire soldered to the middle of the coil, which goes to the board. Cut this wire, indicated by an "X", (Fig. 4).
5. Remove the 10BQ5 Oscillator Tube located on the right rear board of the chassis. This completes the modification.



10 METER OR AMATEUR SECTION - D



10 Meter Ham Power Conversion  
Installed on Uniden SSB chassis



\*Note: Aluminum bracket (for heat sink purposes) replaces speaker bracket.  
Nominal output: AM 47 watts, SSB 60 watts

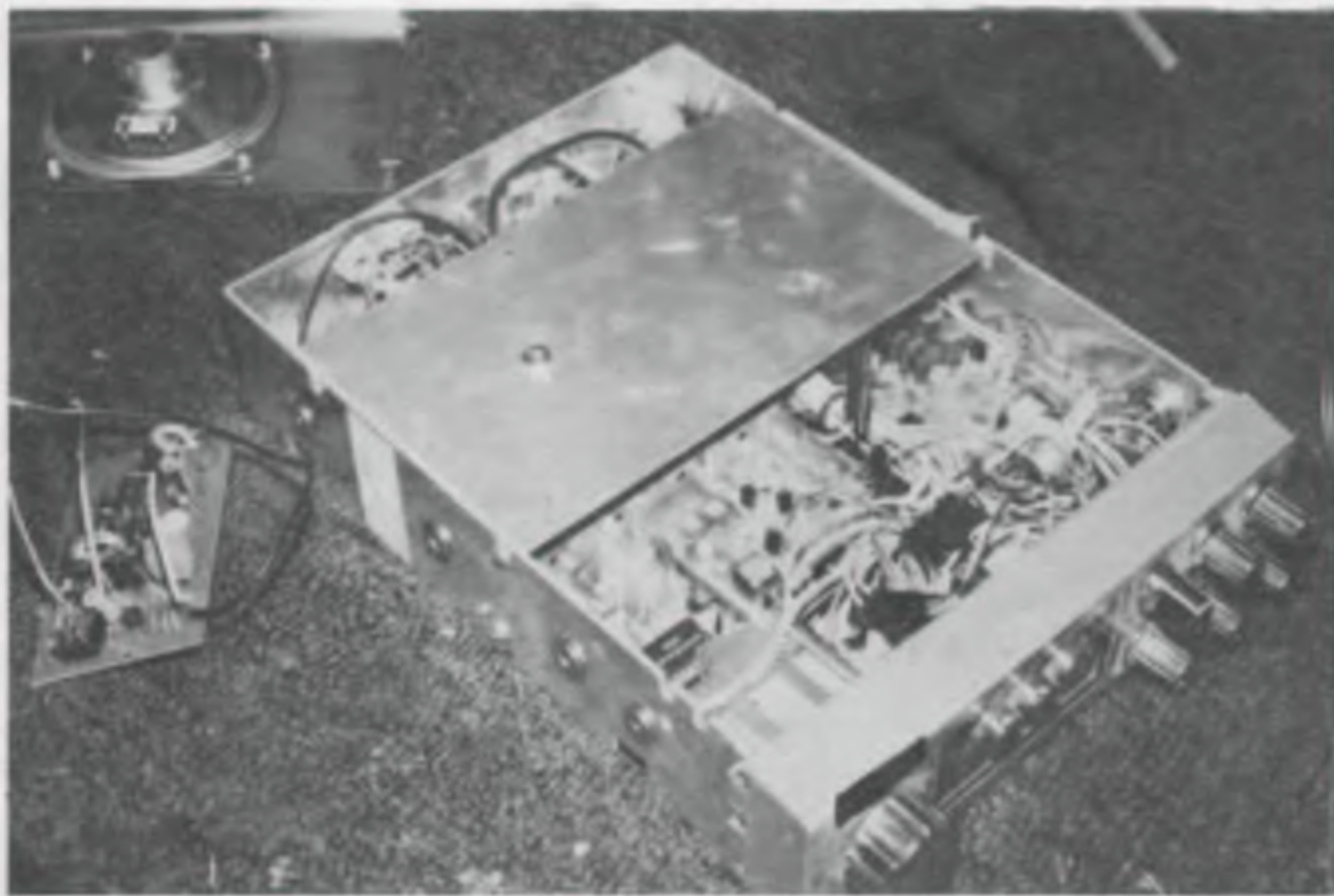

10 Meter Power Conversion

Conversion fits most AM and AM/SSB base units

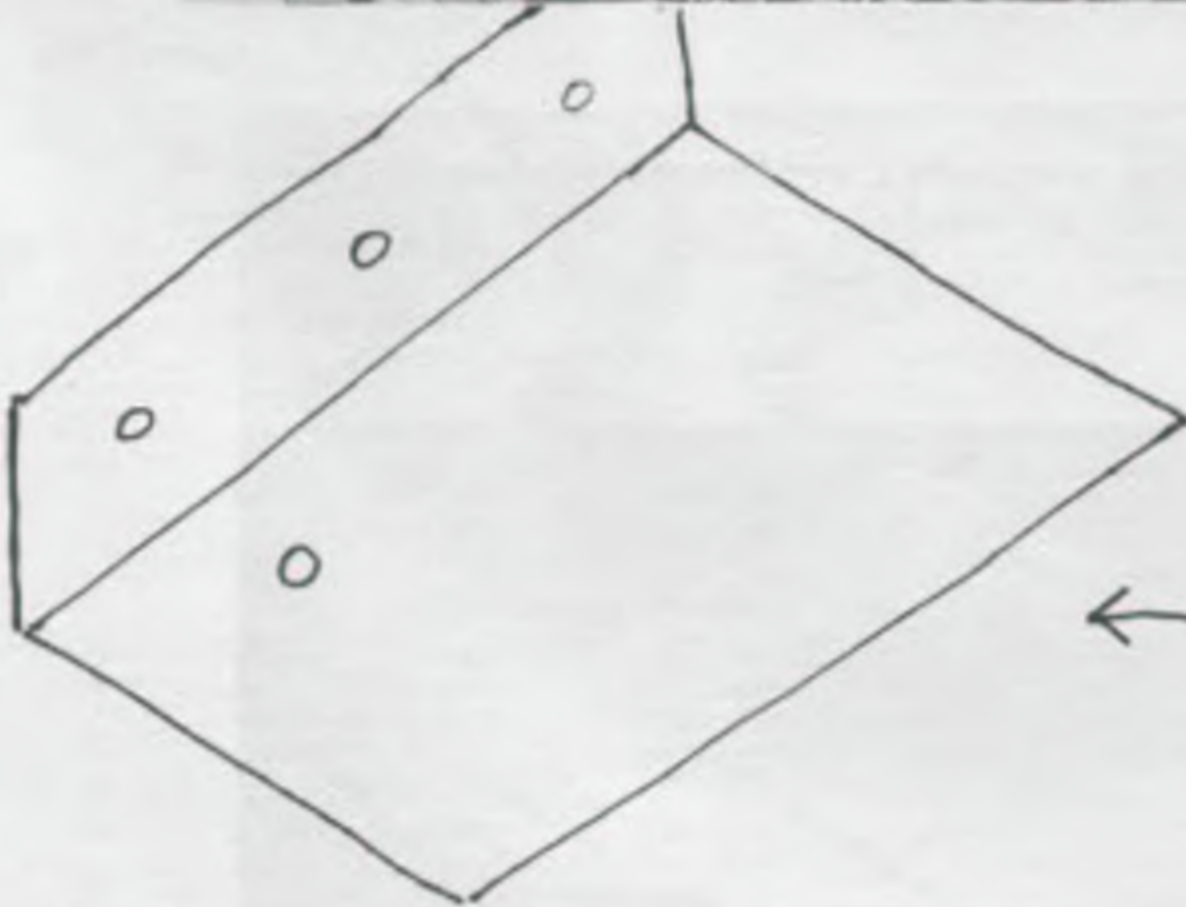

← BASE MOUNTING BRACKET

NOMINAL OUTPUT 47 WATTS - AM  
60 WATTS - SSB

AMATEURS MAY CONVERT OLD CB RADIOS TO 10 METER BAND. AVERAGE PWR OUTPUT 47 WATTS AM - 60 WATTS SSB.

FOLLOW WIRE FROM COAX CONNECTOR THAT YOU REMOVED AND INSTALL IN PRINTED CKT. BOARD AFTER REMOVING WIRE. (OBSERVE WHERE SHIELD AND CENTER CONDUCTOR WERE CONNECTED)

INSTALL THIS WIRE AFTER REMOVING COAX CONNECTION FROM CONNECTOR INSIDE RADIO

SIMPLE MODIFICATIONS MAKE THIS A FINE LOW POWER TRANSMITTER OR UPRIGHT DRIVER.

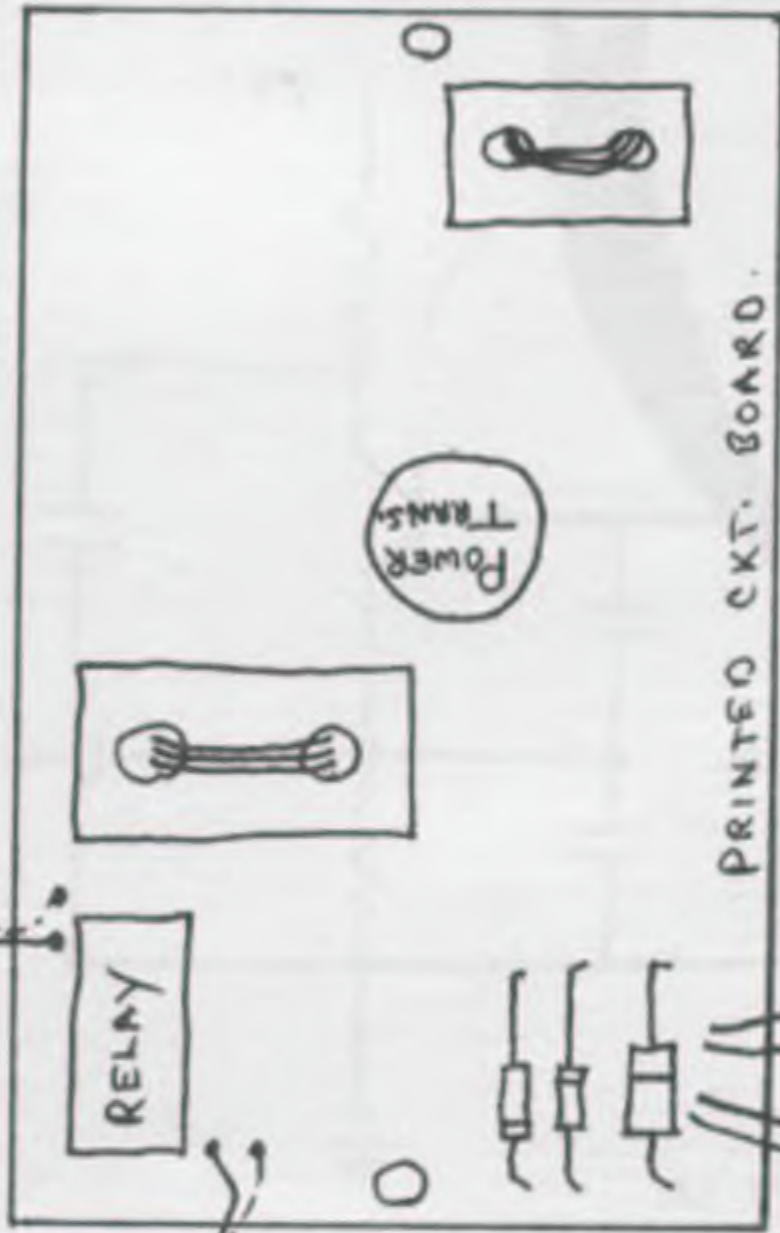

WARNING! THIS UNIT IS NOT INTENDED FOR ANY USE OTHER THAN AMATEUR APPLICATIONS. COMES WITH NO SWITCHES, RF CONNECTORS, OR MOUNTING HDWR.

AMATEUR EXPERIMENTER BOARD  
DRIVER SUB ASSEMBLY KIT

AM PWR CONSUMPTION - 3 AMPS PEAK  
SSB PWR CONSUMPTION - 1 1/2 AMPS AVERAGE

SECRET CB'S SUPER AMATEUR CLARIFIER DIODE  
INCREASE YOUR DELTA TUNE AND CLARIFIER RANGE 200% TO 300%

Introducing Secret CB's Super Amateur Diode. Increase your Delta Tune or Clarifier range 200% to 300% with the Secret CB super diode. Just remove original Tuning diode and replace with the Secret CB diode and your range is increased 200% to 300%.

\* For use on 10 meter or amateur only. Not for use on CB service. Check FCC regulations or check with your local amateur product distributor.

TYPICAL  
10 METER  
CIRCUIT  
APPLICATION

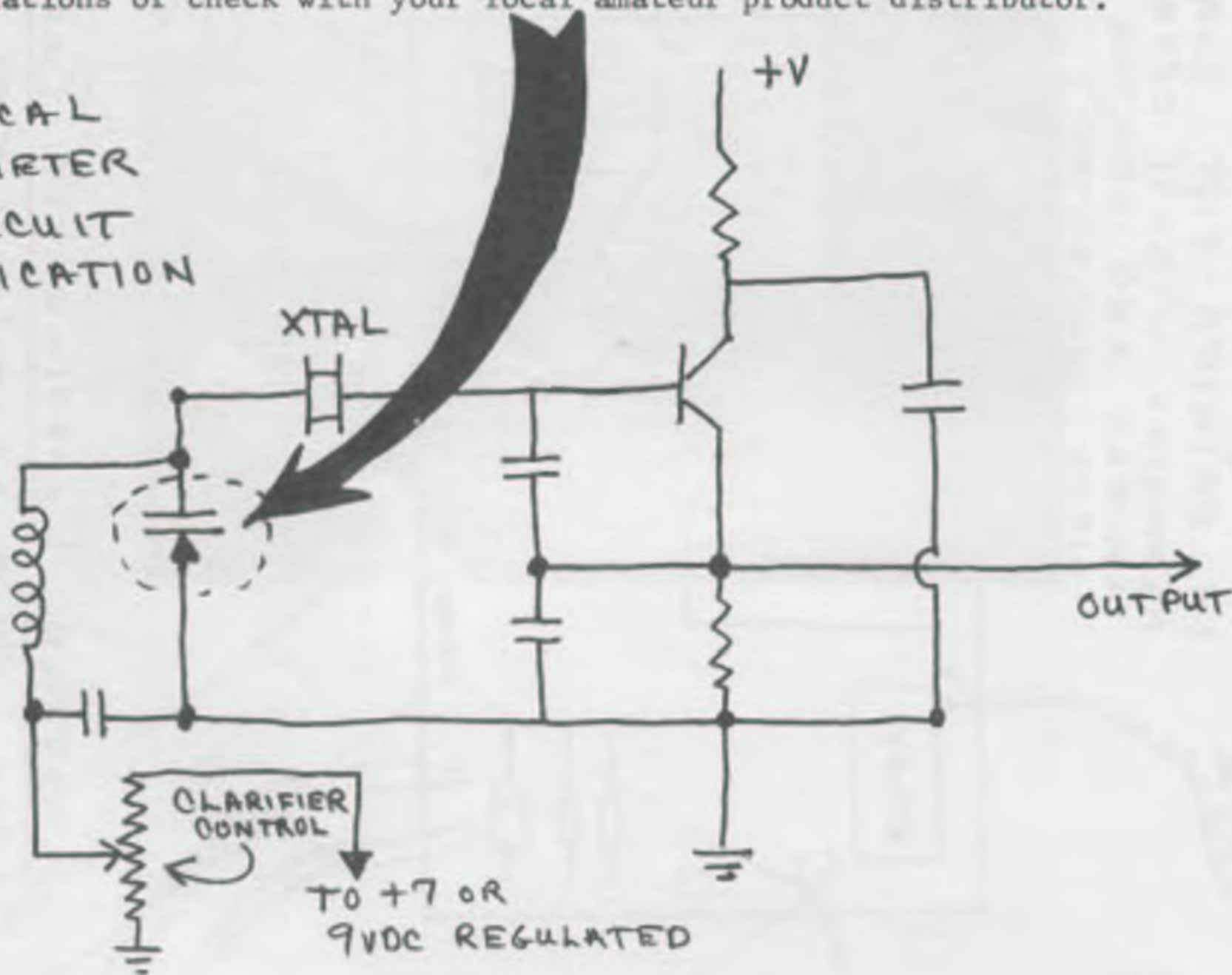

- AMATEUR'S, PICK UP AN OLD SIDEBAND CB OR NEW AND CONVERT INEXPENSIVELY TO 10 METER AMATEUR BAND. DIODE WILL ALLOW UP TO 30KC SKIDE.
- FITS ALL SIDEBANDS OR RADIO'S WITH DELTA TUNE.
- NORMAL SKIDE ON UNIDEN CHASSIS 12KC-15KC.

NOTES:





# STALKER XK

## Deluxe Radar Warning System



### CUSTOMERS AND DEALERS -

You will probably find all kinds of claims about Radar Detectors across the country - some good and some ridiculous.

After lining the dash with several units and trying them out myself, I personally chose the Stalker XK, made in Canada for Teaberry. The Stalker out performed all units on the market in both short range and long range radar. As a store dealer, I usually keep one or two other brands in stock and then sell up to the Stalker XK.

Try this hot little unit, I think you will be surprised!

Sincerely,

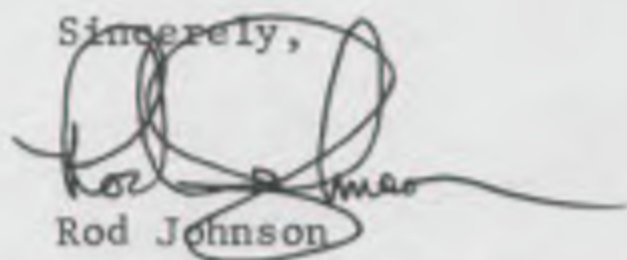

Rod Johnson







Watch for  
Volume 5