

FCC Drops All CB License Fees ...story pg. 9

CB RADIO

\$9

March 1977

A Steal at \$1.50

Since 1962 nearly 21,000,000 copies sold!

AMERICA'S OLDEST AND LARGEST CB MAGAZINE

ICD 08818

**The Sidebanders' Creed
Channel 9:
The Battle Continues!**

New 40-Channel Rigs

**Tomcat In Tinseltown—Almost
Big 136 Page Issue**

...including CB newswire

**You're Needed In
The CB Crimewatch!**



**THE
OFFICIAL
CB RADIO
Magazine**

WOW! Lots Of Brand New CB Products!

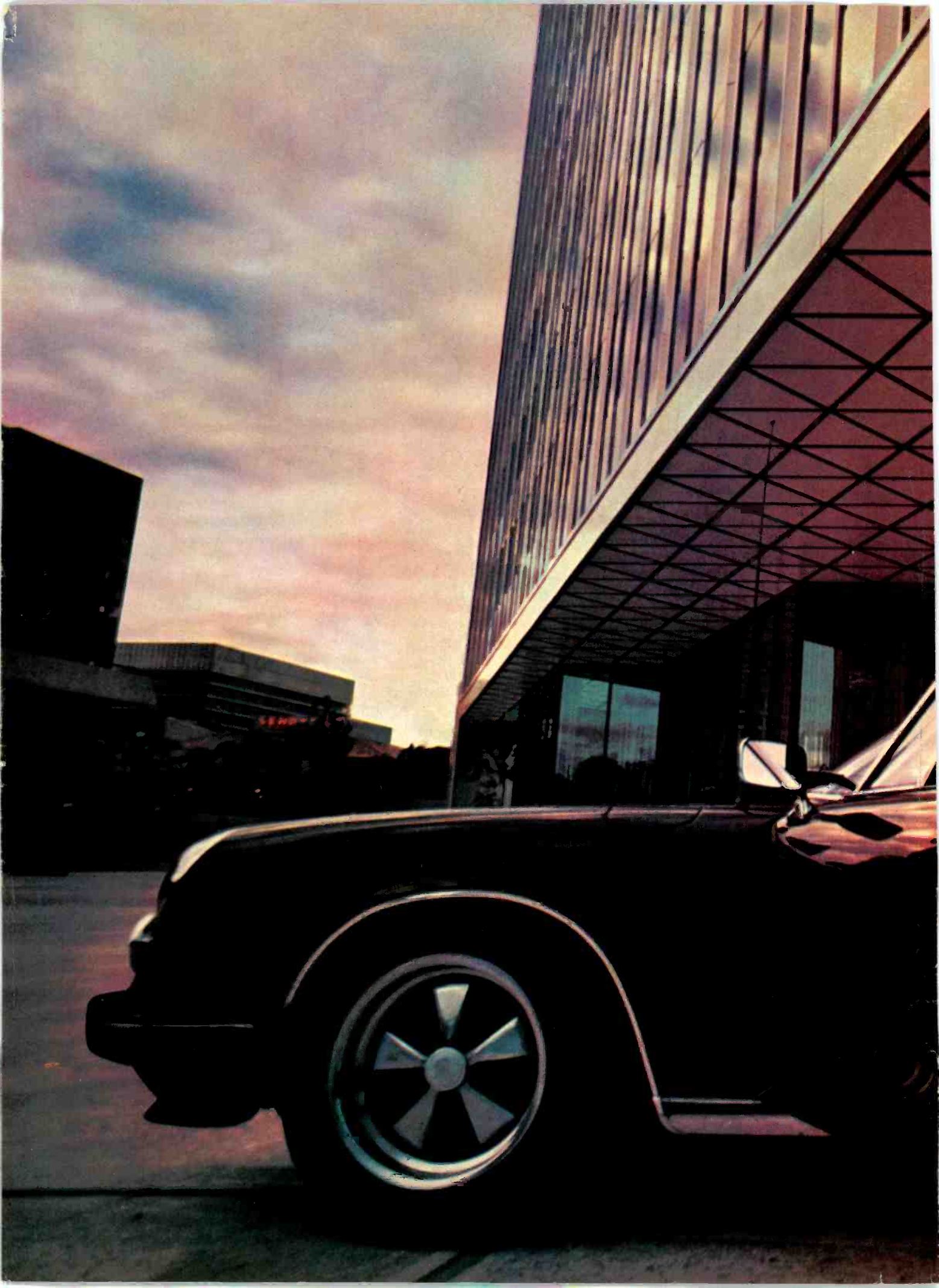

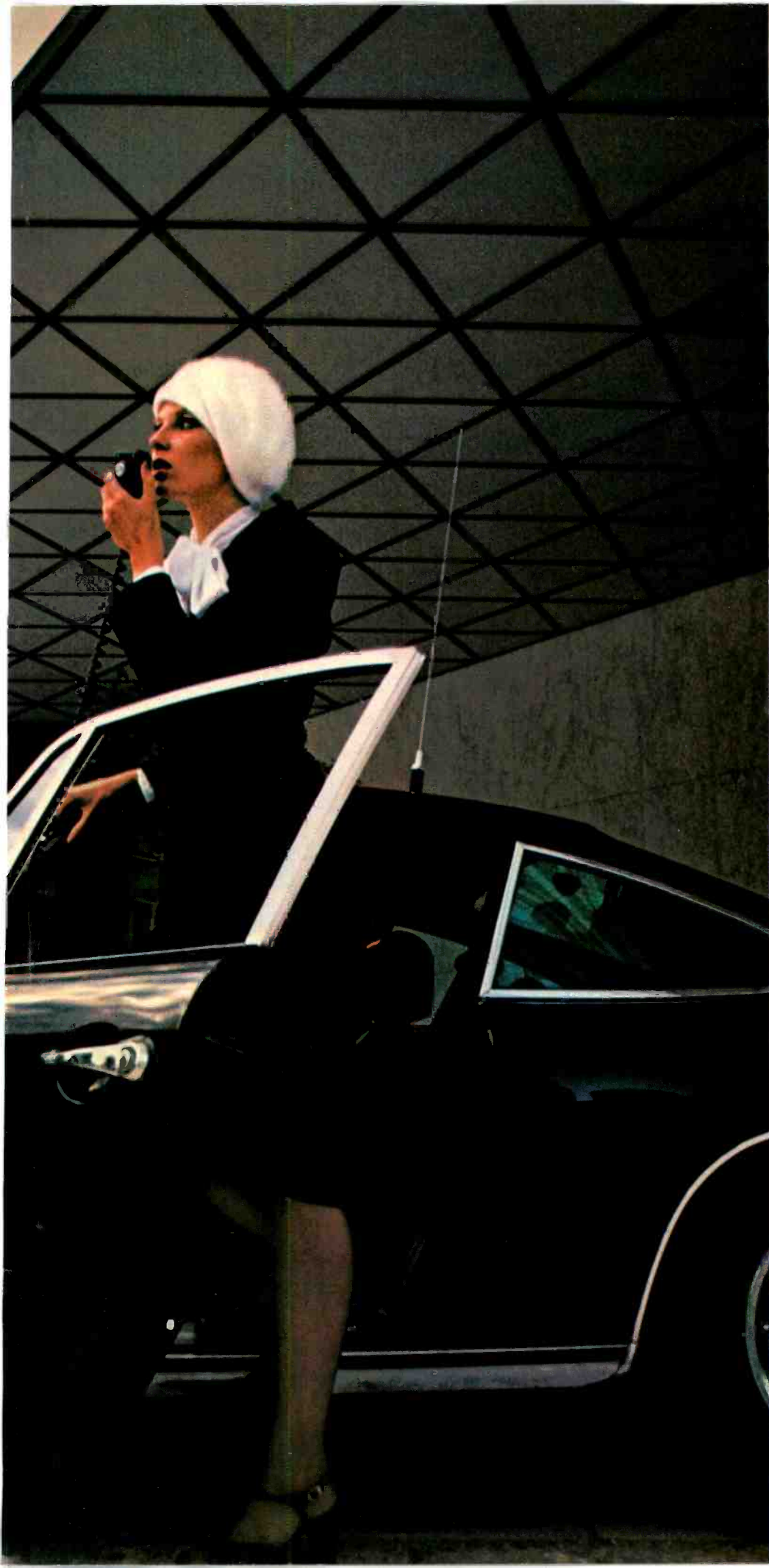

**President.
Better than CB really has to be.**

Nobody needs a 134 MPH sports car to get to work and back. And you probably don't need a CB as good as a President. But maybe...just maybe...you want one.

Because you want quality.

You want 40 channels. You want all the little extras like variable mike gain, delta tune, LED channel readout and an Automatic Noise Limiter you can override with the flick of a switch.

Every single President CB—not just one in twenty—is thoroughly tested to make sure it works perfectly before it leaves the factory.

And every single President incorporates high technology like IC chips and our exclusive compression circuit for superior talk power.

Maybe we've gone too far with the simple CB.

But maybe... just maybe...you won't settle for anything less.



PRESIDENT

Engineered to be the very best.

16691 Hale Avenue, Irvine, Calif. 92714. (714) 556-7355.

This device has not been approved by the FCC. This device is not and may not be offered for sale or lease or sold or leased until the approval of the FCC has been obtained.



With its Tradition Of Electronic Excellence
 —Cornell-Dubilier proudly introduces
 their 40-channel CB Transceivers.
 Mobiles—SSB—Base Stations

Sale or lease of Cornell-Dubilier 40-Channel CB radios is subject to
 FCC type acceptance.

QUALITY SETS STANDARDS



THE MARK OF QUALITY IS ON EVERYTHING WE MAKE

CDE CORNELL-
DUBILIER

150 Avenue L, Newark, N.J. 07101 • (201) 589-7500

The 40-channel Cobra 29XLR. From the sleek brushed chrome face to the matte black housing, it's a beauty. But its beauty is more than skin deep. Because inside, this CB has the guts to pack a powerful punch.

The illuminated 3-in-1 meter tells you exactly how much power you're pushing out. And pulling in. It also measures the system's efficiency with an SWR check. In short, this Cobra's meter lets you keep an eye on your ears.

The Digital Channel Selector shows you the channel you're on in large LED numerals that can be read clearly in any light. There's also switchable noise blanking to reject short-pulse noise other systems can't block. The built-in power of DynaMike Plus. Automatic noise limiting

and Delta Tuning for clearer reception.

And the added protection of Cobra's nationwide network of Authorized Service Centers with factory-trained technicians to help you with installation, service and advice.

The Cobra 29XLR. It has 40 channels. And it has what it takes to improve communications by punching through loud and clear on every one of them. That's the beauty of it.



Punches through loud and clear.

Cobra Communications Products
DYNASCAN CORPORATION
6460 W. Cortland St., Chicago, Illinois 60635

Write for color brochure

EXPORTERS: Empire • Plainview, N.Y. • CANADA: Atlas Electronics • Toronto

PUNCH AND BEAUTY



CB RADIO

S9

14 Vanderventer Avenue
Port Washington, N.Y. 11050

America's Oldest & Largest CB Magazine

Vol. 17 No. 3 March, 1977

COVER STORY

Cartoonist John Kane explores the possibilities of smokies in contact with goodbuddies. More than just for smokey reports, CB can be an important anti-crime tool.

Table of Contents

MESSAGE FROM THE PUBLISHER	9
CB NEWSWIRE	10
THE S9 CB CRIMEWATCH—	
Use Your CB to Aid in the Fight Against Crime	26
TOMCAT IN TINSELTOWN (ALMOST)!	32
ON THE COUNTERS	34
CB TYPES: Number 3 Of a Series	40
COMING EVENTS	44
CHANNEL 9: AFTERMATH, Readers Comment on	
Last November's Question: "Should We Dump Channel 9?" ..	50
ON THE SIDE.	58
WHICH 40 CHANNEL ANTENNA DO YOU NEED?	62
BILL ORR ON ANTENNAS, PART 13: Quad Beam Antennas	64
NUTS & BOLTS DICTIONARY	76
TOMCATTIN' WITH TOMCAT	77
ANATOMY OF A SCANNER, PART 4: Programmable Scanners . .	82
40—CHANNEL CB TRANSCEIVERS	
PASS FCC LABORATORY TECHNICAL TESTS	85
BASIC RADIO, PART 13: Alternating Current	86
CB RADIO/S9 FIX'M UP	96
THE HAMBANDER, Number 3 of a Series	97
THE PISCES CB PERSONALITY	102
WASHINGTON OUTLOOK	105
DX KORNER	120
CB USAGE TIPS FROM S9	124
THE MONITOR POST	125
CB SHOP	131

The entire contents of this publication are fully protected under the U.S. Copyright laws. No portion of this publication may be reproduced in any manner whatsoever without the express written permission of Cowan Publishing Corp. Violations of our Copyright are actively pursued by our Legal Department.

CB RADIO/S9 (Title registered U.S. Post Office) is published monthly by Cowan Publishing Corp. Executive editorial and advertising offices at 14 Vanderventer Ave., Port Washington, L.I., NY 11050. Telephone: (516) 883-6200. Subscription Rates: One Year \$12.00, Two Years, \$20.00, in the United States and Possessions, APO, FPO, Canadian and foreign rates: One Year, \$13.00, Two Years \$22.00. Printed in U.S.A. Entire contents copyright 1977 by Cowan Publishing Corp. CB RADIO/S9 does not acknowledge or return unsolicited material. We regard all material sent to us by and about CB clubs or organizations (whether in club bulletins or otherwise), and from manufacturers or distributors of commercial products, as being submitted for publication as a public relations or publicity gesture. While we pay for stories and articles specifically written for our exclusive use and accepted for publication, we do not pay for any public relations or publicity material which we publish. Stories or articles sent by Registered or Certified Mail are not accepted. All circuits, designs and construction projects in CB RADIO/S9 are strictly experimental and we do not guarantee the results which can be expected from their use or application.

Controlled Circulation Postage Paid at Glasgow, KY and Port Washington, NY

SEND FORM 3579 TO: CB RADIO/S9
14 Vanderventer Ave., Port Washington, L.I., N.Y. 11050

... Use S9 READER SERVICE.

TOP Choice

IN 40 CHANNEL ELECTRIC CB, AM/FM ANTENNAS!

CPD top loaded Electric Mobile Antennas outperform other electrics for important reasons:

100-plus-watt top mounted loading coils efficiently get your signal above your vehicle!

Only CPD's coils are *always* connected to prevent radio "burn out" damage.

CPD's drive motors are protected against moisture and debris for long, dependable operation.

- TOP LOADED FOR OUTSTANDING 40 CHANNEL PERFORMANCE!
- PREVENTS THEFT!
- REPLACES EXISTING ANTENNAS ON MOST VEHICLES!
- SWR 1:5 OR BETTER
- EXCELLENT AM/FM RECEPTION!
- AUTOMATICALLY EXTENDS & RETRACTS!



Models
• EMA-100
• EMA-100C
• EMA 11
FROM \$69.95



CPD INDUSTRIES
2100-A E. Wilshire Ave.
Santa Ana, Ca. (714) 542-7228
Manufacturers of
Blue Streak and Ramm
Antennas and Hardware



Royce CB is built to take it.

We put a Royce CB in a paint shaker and it took it.

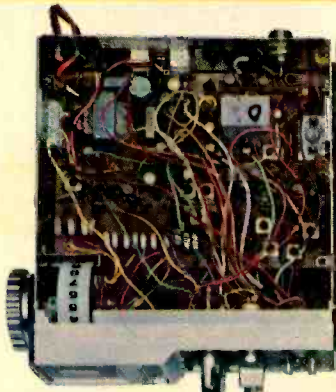

The typical CB. A mass of wires. Old-fashioned methods of soldering and assembly, tuning and testing.

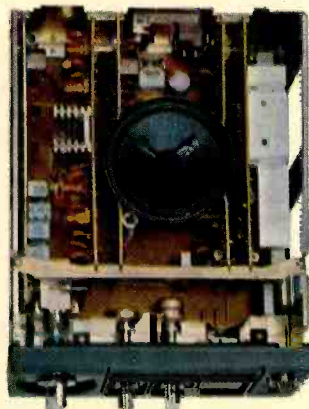

The advanced Royce CB. Exclusive modular construction. Fewer wires. And the quality of automated assembly and computer tuning.

Here's Why. Precision, simplicity, and exclusive modular design. That's the Royce difference. And that's why the Royce CB is tough enough to take the circuit-jarring torture of a paint shaker.

When you've got a 40-channel Royce CB, you've got quality in a lot of different ways. Like exclusive modular circuit design. The simplicity of fewer wires. The strength of automatic soldering. The precision of automated assembly. And the quality consistency of computer tuning.

Put it together and you've got one tough CB radio. The 40-channel Royce CB radio. It's built to take it. And that's why

Everybody's talking 'bout Royce 

© Royce Electronics Corp. 1976

Write for free brochure or send \$2.00 for full-color 1977 40-channel CB catalog to Royce Electronics Corp., 1746 Levee Rd., N. Kansas City, Mo. 64116.

EDITORIAL STAFF

editor

TOM KNEITEL, KEZ5173

contributing editors

DON JENSEN

RICK MASLAU, KNY2GL

GARY DECKELNICK, KCS0994

BUSINESS STAFF

chairman of the board

S. R. COWAN, KCV7359

president and publisher

RICHARD A. COWAN, KGB4096

associate publisher

RICHARD A. ROSS

circulation manager

GLORIA FORSYTH

circulation assistant

NANCY GOLD

controller

CARY L. COWAN, KZR4375

accounting

SARAH GREENBERG

promotional services

MARC GILMAN, KSU7373

ADVERTISING STAFF

adv. representatives

RICHARD A. COWAN

JACK N. SCHNEIDER

west coast adv. rep.

BILL SLAPIN & CO.

16200 Ventura Blvd., Suite 209
Encino, CA 91436 (213) 995-0257

PRODUCTION STAFF

production manager

LORI A. RESSA, KBH2503

production assistant

PRISCILLA REGAL

production consultant

CARY L. COWAN, KSR4375

classified advertising

EILEEN LUCEY

art director

WILLIAM H. TRAVIS

art staff

LIZ BEENER

SHERYL STERN

HAROLD PERRY

Technical Illustrations by
K & S Graphics, Island Park, N.Y.

**Two-way
improvement**



Avoid CB radio theft with magnetic mount antenna. Just lift off and lock inside vehicle. Extra-strong magnet has 90-lb. pull.



Has your CB ever let you down? Right when you needed it the most?

It could be that "good deal" antenna. Or the lightweight mike that came with the set. To get the most out of your CB, switch to Turner at both ends.

Try a Turner amplified mike. You'll find out how much talk power your set can really deliver. For full range when you need it.

Make sure your antenna is dependable. Step up to a Turner. Turner builds them tougher. There are 43 models for all kinds of base and mobile installations.

Ask anybody who has been around CB for awhile. They know us. Wherever CB is sold, Turner.

The talk of the road

TURNER
MICROPHONES
ANTENNAS

CONRAC
CORPORATION

716 Oakland Road N.E., Cedar Rapids, Iowa 52402



channels ...and more

Browning is proud to be among the first to bring you 40-channel mobiles and base stations. Beyond their 40-channel capability, these new radios embody electronic innovations specifically designed to make your CB hours more pleasurable and rewarding. In the new Sabre, you'll find phase-lock loop circuitry (PLL) and LED digital readout — in the new Golden Eagle Mark IV are Browning engineering advances such as a revolutionary "Transcan System" which **lets you turn a knob and electronically sweep all transmit frequencies!**

If you're serious about CB, discover what Browning performance and quality are all about — you'll soon understand why CBers have relied upon the name Browning since Citizens Band began almost two decades ago.

Write for illustrated literature and specifications or see Browning's entire line of products at your nearby CB specialty store.

browning[®]
bringing people together

browning laboratories, incorporated, laconia, new hampshire 03246

Message from the Publisher

FCC Announcement On License Fees Startles CB World

We have some good news and some bad news. Here's the good news first: Effective January 1, 1977 all license fees for CB radio, and other FCC regulated services were suspended. Now for the bad news: Effective January 1, 1977 all license fees for CB radio, and other FCC regulated services were suspended. Okay, by now you've probably decided that I've lost my mind.

Not quite. Last December 22nd I received a phone call from a key staff member at the FCC's Washington office. The purpose of that call was to inform me that all FCC license fees were to be suspended indefinitely. My immediate reaction was that this would be a boon to all CBers. After all, four extra bucks in your pocket and mine can't be all bad. That's twenty million extra dollars to spend on shoes for the kids, that extra loaf of bread, etc.

But then I realized the long-term ramifications of the situation. The CB radio service desperately needs another entire service. Maybe not this year, but surely within the next year or so. Picture hundreds of additional channels on a noise-free band in the UHF spectrum. Picture interference-free operation, extended range for conversations. Picture a really viable point-to-point communications service.

The entire CB industry recognizes the long-haul need for the additional CB service, and so does the FCC. The obstacle so far has been money. The Commission's been working on a budget too tight to allocate extra services. It was the hope of many industry insiders that we could persuade Congress to allocate the entire \$20 million that comes in from license fees back to the FCC. Last year the Commission's budget was \$5.1 million, and this year it'll be about \$6.8 million. Enough pressure in the right places could have brought the dollars to where they'd do the CB public the most good.

Now, unfortunately, we'll have to come up with other arguments to get the FCC off dead center on the Class E service. Sure, the need's still the same, and the staff at the Commission admit to it. But now, getting the extra dollars could be tougher than ever.

At any rate, these things somehow have a way of working themselves out. Hopefully, by this time next year, we might be able to announce FCC launches Class E CB service with two hundred channels. Hopefully. But not too likely!

Appleton, Wisc., Police Accept Memorial Gesture

In a rather touching gesture at the Appleton Police Department, an Appleton man donated a 23-channel citizens band radio to the police department recently to honor the memory of his late wife.

Jerry Graham told Police Chief Earl Wolff that he could think of no more fitting tribute to his wife "who hopes it will be used to save lives."

The radio was accompanied by a gold plaque, which read "In loving memory of Katherine "Kat" Graham, donated by her husband Jerry, daughter Sherri and Valley CB'ers."

An obviously moved Wolff told Graham in response, "I'm quite sure it will be a long-lasting memory to your wife be helpful to people who are in need of emergency assistance."

Both Graham and his late wife have been CB radio buffs for about 14 years. Graham runs a CB radio outlet. His CB handle is "Guitar Picker" while that of his wife was "Kat."

When she died last November of a cerebral hemorrhage, Graham said there was an outpouring of sympathy from CB fans all over the Valley.

It was their spontaneous contributions of money to her memory that gave him the idea of purchasing the gift for the police. The police had earlier received an antenna and coaxial cable to hook up the base station unit from local CB fans. For a long time CB operators have been urging police to monitor their transmissions.

Helen Jorgensen—"Little Rowboat"—a close friend of the Grahams, said "there are over 20,000 CB users in the Valley and they are like members of a family." Some came from as far away as Fond du Lac to attend the funeral, even though they didn't know her personally, she said.

Wolff said the CB radio will be monitored by the radio dispatchers in the police department's communications room. It will be tuned into Channel 9, the emergency channel, and the police

CB'ers Splice In Hawaii

'There were many weddings going on last November in Oahu.

Probably only one, however, verged near the brink of unreality.

It occurred in the large and pleasant backyard of a Kailua house, dominated by a banyan tree, yellow polypropylene guy wires linked to a 60-foot-high antenna and a homemade wedding arch fashioned of green-papered sticks and fuschia bougainvillea.

All was not quiet on the windward front.

"Hi, I'm Hot Lips," said a strong-looking female dressed in white.

The visitor moved on cautiously. Smiling. The visitor knew Hot Lips was not the one. Brides-to-be are not allowed to talk that way before the wedding.

"Hi, good buddy, I'm Red Rooster," said a jovial man. "Wanna see my camera?"

The visitor moved on relentlessly. Again, the stranger knew. He was not the groom-to-be. Where was the perspiration?

Suddenly, the couple was evident.

"Are you the bride?" the visitor murmured.

"Yes," she said. "My handle is Grover."

"And I'm the groom," said the man in white. "I'm the Cookie Monster. Preference is peanut butter. What's your handle?"

"I beg your pardon," said the visitor, who could move no longer.

Grover (Barbara Kahre) and Cookie Monster (James Munro), bearing their handles of Sesame Street characters,

were wed in the yard of Big Art (Art Gertsen) by Family Court Judge John T. West Jr. (no handle).

While Kahre and Munro were introduced by a mutual friend, nearly every wedding guest present had met first via CB conversation before meeting one another in person.

Munro, a Navy E6 stationed at Barbers Point, met Big Art because of CB.

"Art and I used to talk every morning," reminisced Munro. "I met nearly everyone here on the radio."

Said Gertsen, "This could be a break if it weren't a wedding."

A break is CB-ese for a get-together of CBers. It is where voices become faces.

After West pronounced Munro and Kahre husband and wife, he "backed out," or stopped transmitting.

The couple kissed. For a long time. Someone yelled, "ten-four." This means "okay, understood, received."

Then the Munros (the Cookie Monsters?) marched under the crossed CB antennae wielded just a shade short of snappy Naval Academy fashion by the Fonz, Bald Eagle, Four Roses, Lady K, Cricket and others.

Watching were the likes of Ricochet, Lucky Lady, the Bud Man, the Frito Kid, Pokey, Swinging Chick, Canuck and Soft Sailor. They were waiting to offer their "threes and eights," or best regards.

The visitor left cautiously. Stepping over valuable CB units removed from cars for the occasion, slipping through the driveway, head filled with short-speak language and the name of a handle (handle of a name?) for more CB advice.

But the scene was incomplete.

Where was the 18-wheel trailer rig, immortalized in a CB country western song waiting to take the newlyweds away?

will have the callsign KFE-2865.

Sgt. Gerald Breen, of the police department's community support division, said the officers are coming to realize just how helpful the CB operators can be.

"They've really been an asset to us and of terrific value to law enforcement with all those eyes and ears out there," he said.

In recent weeks, he said, CB'ers have helped to halt a burglary in progress and apprehend a suspect, stop a man who was waving a gun in his car and recover walkaways from the Health Center.

Graham said "If you knew my wife, you would know how helpful she was. I'm sure this is what she would have wanted."

ALL NEW FOR '77

KRIS® 40 CHANNEL CB'S **EVERYTHING YOU'VE WAITED FOR,** **AND MORE**

Kris 40 Channel CB personal communications systems are here. They have everything you've waited for, and more. KRIS XL40, dollar-for-feature the best buy for '77: switchable ANL, CB/PA, internal/external speaker switching, dual-functioning S/Rf meter and the exclusive Kris S-Meter jack for larger extension meter. KRIS XL45, with the valuable and convenient "talk back" intercom — great for RV's; and digital LED readout, 3-position noise control, CB/PA, internal/external speaker switching, delta tune and a dual-function S/Rf meter. Brighten up your dash with our top-of-the-line KRIS XL50, illuminated S-Meter, Power Meter, Modulation Meter, "Receive" and

"Transmit" lights, "talk back" intercom, delta tune, noise blanking, tone control, PA/CB, internal/external speaker switching. KRIS 40 CHANNEL CB's . . . everything you've waited for, and more. See your KRIS Dealer today for a free demonstration. FCC Type Accepted.

Performance Never Locked So Good!



Cedarburg, Wisconsin



XL50

XL45

XL40

CB Newswire

YOUR CB NEWSPAPER

MARCH, 1977

INCLUDED IN \$9

Texas Shoot-Em-Up Ends In Indictment

The Tarrant County grand jury indicted a 47-year-old Haltom City man for the Oct. 15 death of a 36-year-old Fort Worth garage owner, one of two men killed in a gun battle over CB transmissions.

Henry Sidney Tidwell was indicted for voluntary manslaughter in connection with the death of Donald Hilcher, known as "Blue Goose."

Howard C. Collins, who used the handle, "Dirty Bird," died Oct. 21 of wounds received in the gun battle.

The indictment charges that Tidwell, "under the influence of a sudden passion arising from a just cause," killed Hilcher after Hilcher had shot Collins.

Bond was set at \$2,000 by Criminal Dist. Court No. 1 Judge Byron Matthews, Sheriff's deputies said.

The grand jury opted to indict Tidwell on charges less serious than murder.

The Texas penal code defines voluntary manslaughter as the "reckless caused death of an individual" and classifies it a third degree felony.

If convicted, Tidwell faces a maximum of 10 years in the state prison and a \$5,000 fine.

According to other CB operators and witnesses who talked with Haltom City police detectives, Collins got into an argument when Hilcher accused Collins of monopolizing Channel 6.

After several hours of threats and curses over their CB radios, the two agreed to meet and settle the argument.

Collins fell mortally wounded while, witnesses said, Hilcher sped away in his pickup, followed by a yellow pickup.

After more shots were fired, Hilcher was found dying from bullet wounds in the wreckage of his truck which had plowed into a utility pole.

Investigators said they discovered a pistol with three spent rounds in the wreckage.

Because of what investigators called "very complicated" facts, the case went directly to the grand jury instead of charges being filed.

CB More Than Fun On Guam

The CB community on the Pacific island of Guam is systematically solving the communications problems of Guam schools, many of which have been without telephones since the typhoon last May.

Working during their off-duty time, Andersen AFB CBers have installed radios at George Washington High School and Leon Guerrero School in Yigo.

"We're trying to get a CB radio in each school on the island," said the "Lone Ranger," Sgt. Donald Same. The flu started it. Without any telephones, the schools had no way to notify parents when their children became ill at school."

A fund-raising campaign on the base was begun to purchase radios and antennas to install in the schools.

When the "Tall Texan," S. Sgt. Bill Davis, stepped up to the counter at the Andersen Federal Credit Union to open an account and deposit \$150 donated by the Andersen Chief's Group, Credit Union Manager Robert W. Gaskins added \$2,500 to the fund. He personally donated \$150 and took out a \$2,350 loan from the credit union and loaned it, interest free, to the organization.

Ohio CBer Credited For Killer Capture

Ohio highway patrolmen are crediting "Whipped Cream" and her CB rig for the capture of four men wanted in connection with the death of an Athens County village marshal.

Louise Kincaid, 36, of Stone Creek, Ohio, disabled by lung disease, uses her citizen band radio as sort of a clearing-house between truckers and state troopers.

The CB equipment is being donated and installed in the schools "with no strings attached," according to Lt. Col. Gene Crissey, base liaison officer. The CBers' only request is that schools, villages and Andersen residents try to hold some kind of benefit to replenish the fund.

The first such event was Nov. 13 when the Leon Guerrero faculty played the Andersen CBers in a softball fundraiser at Andersen field.

In addition to the benefit of being able to reach the local community in emergencies, George Washington High School principal Marion Wright said, "It also gives better communication on campus. We can contact the assistant principals and others around the campus by turning to Channel 7, which is the same channel our walkie-talkies are on."

So, authorities asked her to broadcast the description of a car wanted in connection with the death of Trimble Village Marshal Ted Holcomb, 29, who was killed when he was setting up a blockade.

The four suspects drove north from Athens County and were apprehended at an Interstate 77 interchange after a trucker radioed troopers he spotted the car.

CB—Where The Action Is?

CB'ers always say that our rigs put us where the action is, and they won't get any argument from Monty Rodgers.

The 32-year-old Bakersfield, Calif., man was sitting in his CB-equipped van outside his house when he and another operator got into a heated argument.

Witnesses said that shortly afterward, a man walked up to Rodgers' van and fired a shot from a large caliber handgun through the front window, striking Rodgers in the upper chest.



Buy a cheap antenna, and you may never be heard from again.



M-510 "Big Momma" Heavy Duty Antenna

When you're miles from help, you need a CB antenna that reaches for miles and miles. It could be your only link to safety. So saving a couple of dollars on a cut-rate brand could cost you.

But the price of an A/S antenna is worth the extra you might pay—just for the peace of mind. Every single A/S antenna is hand-tuned and tested for 23- and 40-channels. That's the kind of care and quality control that makes A/S the choice of police departments, truckers and safety people everywhere. And that's why A/S has been the leader in antennas for 24 years.

So look for the red and black A/S stripes. You'll be heard when you have to be heard. We'll bet our A/S on it.



© Stripes of Quality

the antenna specialists co.

12435 Euclid Avenue, Cleveland, Ohio 44106 • a member of The Allen Group, Inc.

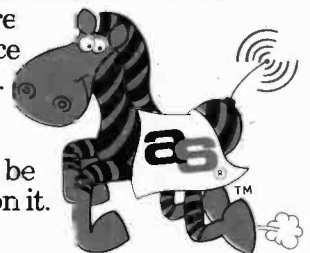

ORIGINAL HUSTLER



First and with CB

WITH HUSTLER ANTENNAS YOU BUY FOR THE FUTURE! GET TOTAL 40 CHANNEL COVERAGE PLUS MORE!

Get base station reports from your mobile with this 74" original Hustler antenna.

Model CB-111-fender or deck location
Model CB-211-bumper mount location

From the original Hustler of 1961 to the newest CB-AM/FM design, get superior 40 channel coverage plus reserve for future channel expansion.

HUSTLER ANTENNA PRODUCTS—for sixteen years—original designs—created and manufactured by American ingenuity, labor and materials—used by communicators throughout the world.

Hustler designs are patented under one or more of the following assigned to New-Tronics Corporation 3287732, 3513472, 3419869, 3873985, 3327311, 3599214, 3582951.

Graphs shown with each antenna are plotted from actual mobile installations and illustrate the ratio of forward to reflected voltage (VSWR) over a total of seventy (70) channels.

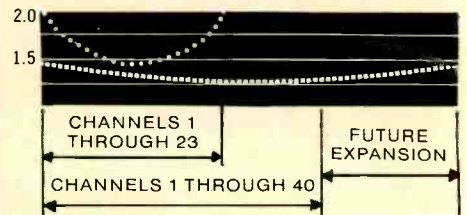

..... average antenna with limited channel use.
— antenna with total channel coverage.

TRUCK & RV's

"HI Q" Twin Huskies for rugged performance. Dual 51" antenna system attaches to all West Coast style mirrors.

Model HTM-1
Single Husky w/m mirror mount
Model HSM-1

DELUXE MOBILES

Choose from four versions of this popular 48" antenna for trunk lip or roof/deck mounting location.
Trunk lip mount
Models XBLT-3, XBLT-4
Roof/deck mount
Models XBL-3, XBL-4

CB-AM/FM

Get combined Citizens-band two way and entertainment radio performance with this deluxe 48" trunk lip mount antenna.
Model HLM-27Z

Foremost TOTAL Coverage!

"the home of originals"



Available from
all distributors
who recognize the best.

**new-tronics
corporation**

15800 Commerce Park Drive
Brookpark, Ohio 44142
(216) 267-3150

Exporter: Roburn Agencies, Inc., New York, N. Y.

ULTRA PERFORMANCE

Custom assemble your
Hustler for the ultimate in
mechanical and electrical
performance — lowest
SWR, outstanding signals,
transmitting and receiving.

Model MO-1 or MO-2
mast and **RM-115 Super**
Resonator



SUPER-FLEX STAINLESS

Cowl or trunk groove mount,
super-flex stainless steel 48"
antenna for excellent per-
formance and economy.

Model FGB-27L with cowl
mount

Model TGF-27L with trunk
groove mount



DELUXE DUALS

Get optimum all direc-
tional coverage. Easy
to install 48" anten-
nas with trunk groove
mounts.

Model SDTs



SPECIAL DESIGN

Trunk lip mount 48" white
vinyl covered stainless
steel antenna. Easy to
install, no holes to drill.

Model TLA-27L

Antenna only 3/8"-24
base **Model FG-27**



"POWER-PACKER"

Super-flex stainless steel
55" antenna and deluxe
trunk lip mount with 180°
swivel adjustment.

Model HQ-27M

Antenna only 3/8"-24
base

Model HQ-27



CB Newswire

YOUR CB NEWSPAPER

MARCH, 1977

INCLUDED IN S9

"Sweet Pea" Helps Youngster To Regain Sight

Thanks to a trucker named "Sweet Pea" and his CB radio, 12-year-old Tammy Siegrist may soon see with both eyes.

Tammy, a seventh grader at Meadville Junior High School, Crawford County, Pa., lost the sight of one eye in a freak accident when she was 5 years old.

Her right eye was damaged by a splinter of wood and until recently doctors said she would be blind in that eye for life.

But in September, she went to Michigan with her mother and grandparents to consult a specialist.

After examining Tammy, he said he could repair the damage so she would need only the aid of a contact lens.

There was just one hitch.

According to the family, the doctor wanted \$2,000 for medical expenses—before the operation.

Unable to meet costs, Tammy and

her kin packed up to return home.

In Ohio, Tammy's grandmother, whose CB handle is "Lucky Lady," hooked up with Sweet Pea over the airwaves, and planned to meet him for a coffee break. Lucky Lady had been on the horn with Sweet Pea when the Siegrists were heading west to Michigan two days before.

They told Sweet Pea about the trip, and Tammy's disappointment.

"I saw this little girl and thought we should do something for her," Sweet Pea recalled. "She looked like she just come out of a magazine."

When they parted, Sweet Pea told Tammy's mother, "Green Pop," that he'd do what he could to help.

His promise became a reality.

With the help of dozens of CBers, Sweet Pea set up a donation headquarters along Interstate 80 in Mercer County.

Sweet Pea's friends brought doughnuts to give to weary travelers.

Volunteers manned the airwaves, asking truckers to take a coffee break and give a little for Tammy.

Sweet Pea was elated at the response—more than \$1,150, two live turkeys, and CB radio paraphernalia.

"You wouldn't believe it," he said. "These guys are great."

"I didn't think we'd ever hear from Sweet Pea again," said Mrs. Patricia

Siegrist, Tammy's mother. "He's such a kind, kind man."

Mrs. Siegrist said that through Sweet Pea's concern, a Meadville resident has offered to fly Tammy to Port Huron, Mich., for the operation.

"They're all wonderful, absolutely terrific," said Lucky Lady, who is Mrs. Paul Merchbaker.

"It would have been tough for my son-in-law, Charles ("Nine Fingers") Siegrist, to pay for that operation. He's got six mouths to feed and work has been slow.

"Heaven knows, my husband and I would help if we could," she said.

Mr. Merchbaker, "Cool Hand Luke," and his wife planned to drive to Michigan.

"All the truckers are stoppin.' That Sweet Pea—he's a wonderful guy," he said.

At the midway point sandy-haired Tammy knew the operation would take place.

Sweet Pea—alias James R. Lewis, played down his role in the fund raising.

"I just called up some women who had done this sort of thing once before, and talked with some buddies at Cooper Jarrett Trucking in Sharon.

"They did all the work," he said.

Tammy didn't believe Sweet Pea.

"He's a really nice man. I'm really grateful for all he's done."

Idaho CB'er Doesn't Read The Mail—He Delivers It!

When postal patrons on Boise's Rural Route 3 hear from the "Thresher" they know important mail is coming their way.

"Thresher" is the handle of Chet Lane, who is the postman on the rural route south of Boise, Idaho.

Last spring, Lane installed a CB in his own vehicle, used to make deliveries on the route. He estimates a third of the 460 families on the route have CBs in their homes.

"When I have a C.O.D. package or registered letter for them, I call them on the CB," Lane said. "They can get the money ready for the package or, with registered mail, they can be ready at home to sign for it. It saves them running to town if they're not home

and I have to leave a notice."

Lane also said patrons on his route will call him via CB and ask him to deliver stamps or ask him to hold their mail if they are going on vacation.

"So many people on the route have CBs that it comes in pretty handy," he said. "It seems there's more and more of them (CBs) every day."

Lane said he goes by the handle "Thresher" because he runs a grain combine during his vacations. "A friend just started calling me 'Thresher.'" he said in explaining his CB monicker.

Lane said the CB in his car also comes in handy in other ways while making his deliveries.

"Once in awhile I'll see a traffic acci-

dent and use it to contact the sheriff's department," he said.

Lane said he just decided he wanted a CB in his car, and it was later that he discovered that it would be useful in his work. Lane, a postal employee for about 29 years, thinks he is the only postman using a CB on a Boise mail route.

His 48-mile route runs from Gowen Field to Cole Road south of the freeway.

When his daily mail deliveries are about completed, Lane said the CB comes in handy in another important way.

"I call the wife on her CB and tell her within a few minutes when I'll be home for dinner," he said.



Channel Master's Mag-Ne-Tenna™ won't fly off!

We put Mag-Ne-Tenna on a plane to make sure it will hang on to your car!

We wind tested Mag-Ne-Tenna on a plane going 140 mph to make sure it was the strongest magnetic CB antenna mount you could buy. Tests indicate that Mag-Ne-Tenna's 6 pole, 8 oz. magnet has more "holding power" than all other magnetic mount antennas....up to 50% stronger on vinyl surfaces! Mag-Ne-Tenna flies on but won't fly off.

ONLY MAG-NE-TENNA HAS AN "IN-LINE" RF CHOKE!

An "in-line" RF choke is a must for vinyl top cars....maintains stable SWR, aids in tuning, eliminates CB noise and enhances performance. Only Mag-Ne-Tenna has an "in-

line," ferrite bead, RF choke. You get maximum CB performance everytime....no drift, no annoying RF interference. Mag-Ne-Tenna is a full sized, base loaded CB antenna. It is fully weather protected and comes with 24 feet of coaxial cable for hassle-free mounting.

STRENGTH, PERFORMANCE and THEFT-PROOF FEATURES!

Mag-Ne-Tenna holds on strong, won't come off till you take it off! Removes completely when parking or washing car....leaves no trace of CB. Works with 23 or 40 channel transceivers, both AM and SSB.

Mag-Ne-Tenna....the BIG CB ATTRACTION
From Channel Master. See one today!

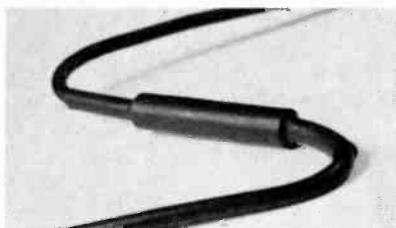

Channel Master **CB**

DIVISION OF AVNET, INC., S9377
ELLENVILLE, NEW YORK 12428

CB Newswire

YOUR CB NEWSPAPER

MARCH, 1977

INCLUDED IN S9

Pigeon Base— A Silent Mike

New Jersey CB channels were all jammed early last November with the news of the death of an Edison woman who was known from coast to coast for her CB radio assistance efforts to long-haul truckers.

Known by the CB handle "Pigeon" or "Pigeon-Base," Clara Gaskill, 45, of McArthur Drive, helped truckers passing the area in a variety of ways, according to the chatter on Channel 19.

"I guess she was known coast to coast," said Mrs. Gaskill's husband, Walter, 51, after completing funeral arrangements. "She tried to help everyone all the time. She went out of her

way for everybody."

Mrs. Gaskill got into CB three years ago, when it became necessary for her to spend a great deal of time at home with her invalid mother.

Until becoming ill a couple of weeks ago, Mrs. Gaskill manned her base station KFR-4542 on a regular basis, doing everything from giving out weather reports and traffic conditions to relaying a message to a terminal or warehouse that a trucker was disabled on the toll road.

Gaskill, a long-haul truck driver himself, said his wife took CB very seriously in the three years she was on the air.

"Everything she did for them was serious," Gaskill said. "Her aim was getting truckers to their destination and slowing them down so they wouldn't get tickets."

During an emergency situation on the turnpike not too long ago, Mrs. Gaskill was called upon by state police to relay to approaching truckers the word to slow

down and take alternate routes.

"She got into it, I guess, because I put her into it," said Gaskill, whose rig is equipped with a CB unit.

Truckers were steadily passing the word as to when the funeral was to be.

"There's going to be a lot of 18 wheelers over there," one trucker said over Channel 19 which was being used during the early evening to alert truckers in the area of Mrs. Gaskill's death.

"This radio band is not going to be the same ever again," another trucker said. "In the mornin' she got everyone to work on time and home safe 'n sound at night."

"Yeah, good buddy, I know," said yet another trucker. "She was well-known across the Eastern Seaboard."

It was just two weeks earlier that Mrs. Gaskill received a letter of commendation and well wishes from Betty Ford.

A memorial fund drive is expected to last for a week, according to one CBER.

Alaskan CB Report

You start up the 4,800-foot pass in the care of "The Heartbreaker," who turns you over to "The Pass Watcher." Once over the top you are in the hands of "The Happy Pappy."

All three of them drive road graders on the trans-Alaska pipeline haul road. And their rigs are equipped with CB radios, which are much more than a device for "hollering" at friends when you are this far north of the Arctic Circle.

They can make the difference between life and death.

The 359-mile road north of the Yukon River is kept open all year to get supplies to the pipeline construction camps. Roughly 80 per cent of the road lies north of the Arctic Circle, and winter temperatures 60 below zero are common.

"The one and only, world famous Thunderbug" drives this two-lane dirt road like there was no tomorrow as he roars "home to mamma." As he stands in front of the shiny Rolls Royce-like grill of his 18-wheeler he locks tough enough to handle most obstacles.

Paul Konig, "the Thunderbug," boasts

of going over Atigun Pass "barefoot" (without chains).

The Anchorage trucker says, "I will not go up this road without my CB."

His buddy, Marty DeWitt of Fairbanks, or "Tiny Tim," tells a story about hauling a pipeline load on the stretch of state-maintained road south of the Yukon. He was headed up a hill when his rig tumbled over a cliff.

He broke a rib but his radio still worked, and he heard a friend who was traveling ahead of him ask: "Did you make it over the hill?"

"I told him: 'Yeah, but not the right way.'"

Alyeska Pipeline Service Co., the consortium of oil companies building the pipeline, maintains the road north of the Yukon.

The truckers, like their "good buddies" down south, monitor Channel 19. But they also can use Channel 11 to talk with the 12 pipeline camps along the route.

Each camp has a radio operator handling the commercial band frequency used by Alyeska Pipeline Service Co., as well as monitoring Channel 11.

The drivers are never more than 25 miles from a camp, so most of the time they are within the transmission range of CB radios. And if a trucker can't

reach the nearest camp, there's usually another trucker closer who can relay a message.

Many Alyeska construction trucks have CB and can relay messages to camps via their more powerful company commercial-band radios.

The radio operator in Old Man camp said that hardly a day passes that he doesn't get a request for some kind of assistance, usually from a disabled vehicle.

Truckers also can call CBERs like "The Winemaker" in Dietrich Camp, to reserve a room for the night. The drivers are allowed to spend the night in the camps and eat in the cafeterias free.

The truckers occasionally get road information from the camps, more often from each other. And there are road condition signs occasionally.

One thing truckers don't need to worry about are bears of the four-wheel variety. Bears—of the four-legged variety—and wolves are seen frequently along the road.

The radios also are crucial to break the loneliness. The truckers, many riding without partners, use them to pass the time. More than once we heard a static-filled and faint plea: "Breaker 19, is there anybody on this here haul road today?"

Mura Introduces the MikeMate™ System.



**You never touch a wire.
You just plug it in.**

Until now, installing a mike was a five-pronged problem. Because the mike cord ended in five confusing wires.

But with MURA'S new MikeMate™, all the wiring is done for you.

The mike cord ends in one simple plug. Which plugs into a simple connector. Which plugs right into virtually all CB sets.

It's so simple, in fact, you can install it yourself.

MURA'S new MikeMate. The system that practically plugs itself.

MURA
CORPORATION

CB Newswire

YOUR CB NEWSPAPER

MARCH, 1977

INCLUDED IN S9

Truckers, CBs Foil Robbers

CB radios and two truck drivers were the heroes after a West Memphis, Ark., woman was assaulted by two men attempting to rob her at the rest area on Interstate 55 north of Fruitland.

But before it was all over, gunfire was exchanged at the rest area, injuring one of the assailants.

"CBs really saved us," said truck driver Gary S. Lively, who assisted the woman in recovering her car keys from the assailants and attempted to block their exit from the rest area.

Further CB contact from another truck driver who sighted the car at the Jackson-Fruitland exit after the robbers drove across the rest area grass to escape and CB contact with the Jackson Police Department led to the apprehension of the two men by Cape County sheriff's officers on Highway 61 at Route Y.

Charged with robbery and assault with intent to kill are R. V. Pride and Roscoe Pittman, both of Chicago, Ill.

Mrs. Mabel Jean Stewart of West Memphis was assaulted in the rest area women's restroom, officers said. Mr. Lively said he saw one of the men at the door on his way to the men's room. After coming out, he saw both men outside.

When Mrs. Stewart came to the

door, her face bloody, he said she stood behind him and he demanded the men return her car keys. They returned the keys and walked toward their car.

Another truck driver, Philip W. Brough of Raleigh, Tenn., came to assist. He was given a .32-caliber gun by Mrs. Stewart that she had in her car. At least nine shots were exchanged.

A Cape County sheriff's deputy, Lt. Warren Rauh, said four shell casings from a .22 rifle were found where the assailants' car was parked and five casings from Mrs. Stewart's gun were found by a picnic table that Mr. Brough sought cover behind.

One of the assailants, Roscoe Pittman, 27, of Chicago, Ill., was wounded in the head during the shooting, Lt. Rauh said.

The two drove around Mr. Lively's truck, which was blocking the entrance to the interstate, but were apprehended after exiting south on Highway 61 by Cape County sheriff's officers and taken into custody.

Mrs. Stewart was taken to St. Francis Medical Center, treated for bruises on her nose, forehead and right eye, and released.

Pittman was treated for the head wound and released to the sheriff's office.

Boston CB'ers Ticket Voided

A ticket for using a citizen's band radio while driving has been voided, but the controversy it generated among CB proponents apparently lives on.

Gary LaRoche of Salem, N.H., who received the ticket on Sept. 29, said he won't give up the petition drive to legalize CB radio use in vehicles even though his ticket has been, in effect, thrown out of court.

"We want to make it 100 per cent legal so that no one else will be bothered with a ticket like this," he said in a telephone interview from Boston.

LaRoche said about 500 signatures were gathered at a meeting of the CB Club in Salem, and he expected that to grow to about 2,000.

The petitions will be presented to the Massachusetts and New Hampshire state legislatures, he said.

LaRoche was cited by a Massachusetts state police officer in Interstate 93 in Boxboro. The ticket said he was operating while "conversing with CB mike in hand."

However, LaRoche said he received a letter from Ayer District Court saying the ticket would not be processed. The effect was to invalidate the ticket.

The law in question says drivers may not have anything in their vehicles or on their person that could interfere with proper operation of the vehicle.

TVI Advice

The United States CB Radio Association, in conjunction with the Radio Shack Corporation and the FCC, has established an inquiry center for persons experiencing television interference problems caused by citizens band radios. A television interference instructional kit has been prepared by the R. L. Drake Company and J. W. Miller Company, both manufacturers of filters used to alleviate the interference problem.

This kit details how to handle the interference problem and will be sent at no charge to those requesting it by writing to TVI, P.O. Box 21, Hartford, Conn. 06101. The United States CB Radio Association will coordinate the dissemination of these kits.

Ontario Youth Electrocuted Putting Up Antenna

A 16-year-old youth was electrocuted when the citizen's band radio antenna he was helping to install toppled onto a power line.

Burton Smith was helping with the antenna at the family home in Port Credit.

Also injured were his brother, Roy, 19, and two friends, Gary Small, 16, of Helene St. N. and Norman Brown, 28, who lives at the Smith home.

Brown, Roy Smith and Small received burns to their hands and feet and internal injuries.

Roy Smith was taken out of intensive care and hospital officials said the three are out of danger.

"Nobody knows exactly what happened, but we think the pole toppled over because of the wind, its weight and maybe being attracted by the current in the power lines near the house," said Marshall Smith, the dead youth's brother.

TUNE INTO THE TOP 40.

This device has not been approved by the Federal Communications Commission. This device is not, and may not be, offered for sale or lease, or sold or leased until the approval of the F.C.C. has been obtained.

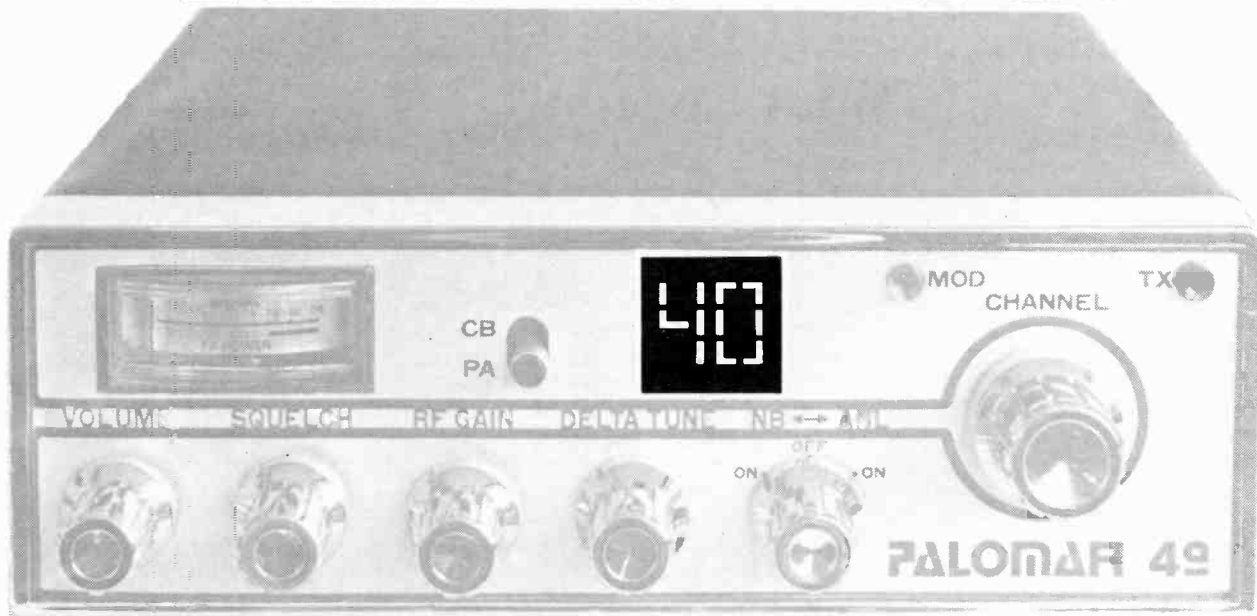

Now that 40 Channel C.B. is a reality, tune into the number one name in two-way radio . . . with the PALOMAR 41 or PALOMAR 49!

You can count on PALOMAR to establish a new standard of excellence in 40 channel personal two-way

communications systems.

The PALOMAR 41 and PALOMAR 49 will both be available at your dealer.

When it comes to C.B., there's always a PALOMAR number at the top of the charts.



PALOMAR Electronics Corporation
'We're Wired for Progress'

665 Opper Street • Escondido, Calif. 92025 • Telephone: (714) 746-2666

CB Newswire

YOUR CB NEWSPAPER

MARCH, 1977

INCLUDED IN S9

Admits Sending Bad CB Signals

A 26-year-old Chaska, Minn., man pleaded guilty to broadcasting a phony distress signal on a citizens band radio.

Bruce Edward Schaaf entered the plea before U.S. District Judge Edward J. Devitt in St. Paul. Schaaf had been indicted for making the distress call from a truck in downtown Shakopee.

Up to 75 rescuers and two helicopters were sent out to search for a nonexistent airplane that reportedly was sinking in the Minnesota River near downtown Shakopee with three injured passengers on board.

Police called off the search after six hours when no plane was found.

The maximum penalty for the offense is a year in prison and a \$10,000 fine. Under a plea negotiation between Schaaf's attorney and the U.S. attorney's office, the maximum sentence recommended to Judge Devitt was six months. The judge ordered a presentence investigation and continued the case for sentencing.

Schaaf did not say why he made the phony call, but he apologized to the judge for the hoax.

Connecticut CBers Credited In Boat Rescue

A group of citizens band radio operators helped police rescue a stranded boater and his 15-year-old son after the two had engine trouble on Long Island Sound.

Robert Salfton of Hamden, credited the CB operators with their rescue. "In a green boat, the same color as the water, they never would have found us" without the help of the CBers, he said.

Police heard the first distress call relayed from Madison resident John Chitenden. Police then called Joyce Bruno, wife of patrolman Frank Bruno who was on the docks trying to spot the missing boat with binoculars.

Meanwhile, Mrs. Bruno, "with a radio in one hand and the telephone in the other," worked for more than an hour to piece together messages heard by other CB operators regarding the Salftons' position.

Clinton police and fire boats finally rescued the two, who were not injured. Mrs. Bruno said the local CB group calls itself the "Night Owls" and often assists motorists and campers.

Crossed Wires

Training exercises are for training, but even a 'green' operator can come up with a red face.

During a recent Utah Wing Civil Air Patrol simulated emergency, a radio operator was handed a simple message. She hurried into the radio room and transmitted to a mobile unit stationed near Hill Air Force Base: "Check on a damaged Sessna report at Hill Air Force Base."

Since the messages were arranged with some "reality" intended, the mobile unit proceeded to question the security guard about a "damaged Cessna."

Receiving several funny looks, and no 'canned reply' to his question, he called back to the radio center to confirm the message.

The radio operator, inexperienced and quite red, said: "Check a damage assessment report at Hill Air Force Base."

CB'ers using unit number ID's with increasing popularity!

Many CB operators have begun switching away from their traditional *Handles* in favor of more professional sounding Unit Number type identifications or at least using Unit Numbers in addition to *Handles* at times. *Handles*, which have proven to be heavily duplicated and hard to copy under difficult communications conditions, are now giving way to ID's such as UNIT 177-X, UNIT 007, UNIT 2766, etc. The popular Unit Number ID system started up several years back, with all numbers being registered with and/or issued by one single national source; it's been growing with increasing popularity and now seems a major move-

ment within the ranks of AM CB'ers. Those wishing to register existing Unit Number ID's, or receive assignment of a set of Unit Numbers should send a self-addressed stamped envelope and \$2.95 to Z-Tech, P.O. Box 70-M, Hauppauge, N.Y. 11787. In return you will receive an official 2-color Certificate Of Registration, bearing your name, Unit Number, and the date of registration. Included is a valuable 1,400 word exclusive report on how to use Unit Number ID's for best results and maximum talk power. Don't forget the stamped self-addressed envelope! And don't forget to mention your Handle if you want it inscribed on the certificate.

Help Us Publish CB Newswire!

Be an S9 Reporter! Get your hometown CB news in the pages of S9. Send your news clippings to us and we'll try to bring your area news on to the national CB newswire—through the pages of the nation's oldest and largest CB publication. If you enclose a self-addressed, stamped envelope with your news clippings and we'll send you an S9 PRESS CARD! Address your news clippings to:

**Tomcat, CB Newswire
CB Radio/S9 Magazine
14 Vanderventer Ave.
Port Washington, NY 11050**

A ONE SOURCE SYSTEM

With Wilson Antennas, Towers, Rotors

A Star in the Sky...
To Deliver your Thunder...
8 Element Shooting Star

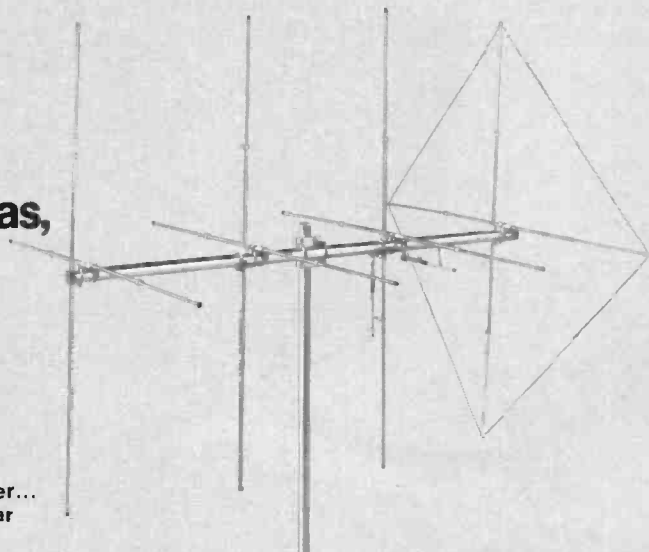

An industry first from Wilson, known for almost a decade for excellence in CB Antennas and Amateur Equipment: a complete system to put your thunder where it counts.

For the Buyer who insists on the best for less, is the Wilson Line of base and mobile antennas, crank-up towers, and directional rotors.

With Dual Parasitic Excitation, the size of your antenna is increased electrically. Wilson's unique design, using DPE, combines the best advantage of the Yagi Antenna with the best of the Quad unit. Thus you get more power out the front door...up to effective power level 60 times the power of the transceiver itself; with less interference..

40 channel capacity...All Wilson antennas provide the famous 2,000 watts handling capacity, adjustable gamma match, lowest SWR, heavy wall aircraft aluminum tubing, no holes drilled in elements, solid fiberglass reflector arms, and on and on.

Our crank up towers are unique too! Up to 64 feet high, allows access to antenna and rotor from ground or roof; available in free standing or guyed models; one man raising fixture options, you name it we've got it. Features include galvanized steel tubing, tested to handle 10 sq. ft. of antenna at 50 mph wind, and the 800 lb. winch is easy to raise and has lockable security feature; great looking for the ecology minded, and the price makes it easy to buy.

Rotors Too! They'll easily turn the biggest antennas...for pinpoint accuracy...capable of handling antennas with wind load areas up to 25 sq. ft., with a braking system four times that of other rotors on the market.

For a complete catalog of these Wilson products: C.B. Antennas, Crank-Up Towers, Rotors,



WR1000

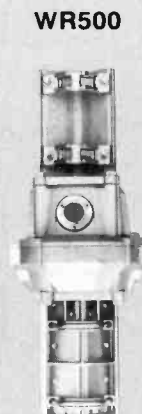

WR500

See your local dealer, or write:



Wilson Electronics Corp.

4288 S. Polaris Avenue, Las Vegas, Nevada 89103



**"FROM TWIN MAMAS
TO LUNCH BOXES, WE HAVE
HARDWARE
FOR EVERY APPLE"**

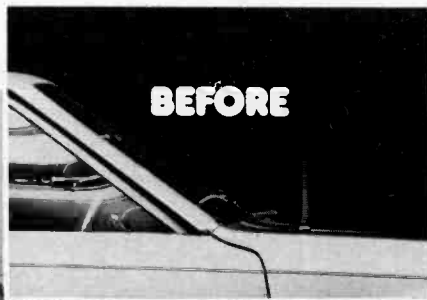

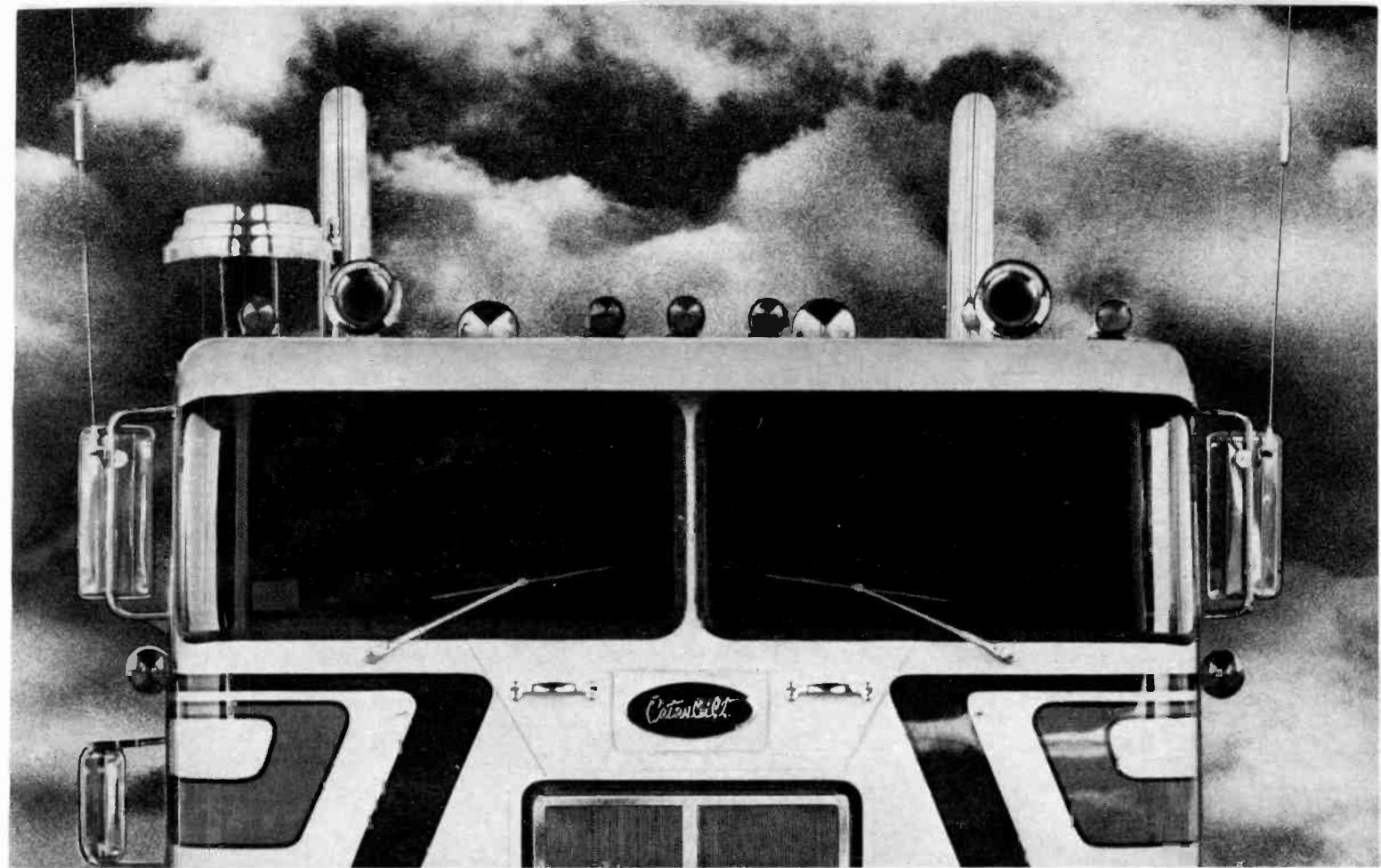

Loosely translated, that's CB talk for: "Sparkomatic has CB twin trucker antennas, CB base station antennas, CB instant mount antennas like magnet mount and clip ons, CB motorized and manually operated disappearing antennas, CB indoor and outdoor public address speakers, CB external speakers with tone purifiers, CB external speakers without tone purifiers and CB converters.

Not to mention, a complete line of 40 channel in-dash and under-dash mobile transceivers and base station units. Including 40 channel transceivers with memory control buttons, digital readouts and other up-to-the-minute innovations."

In other words, Sparkomatic has the very best CB equipment. And enough CB equipment to meet the needs of every CB'er

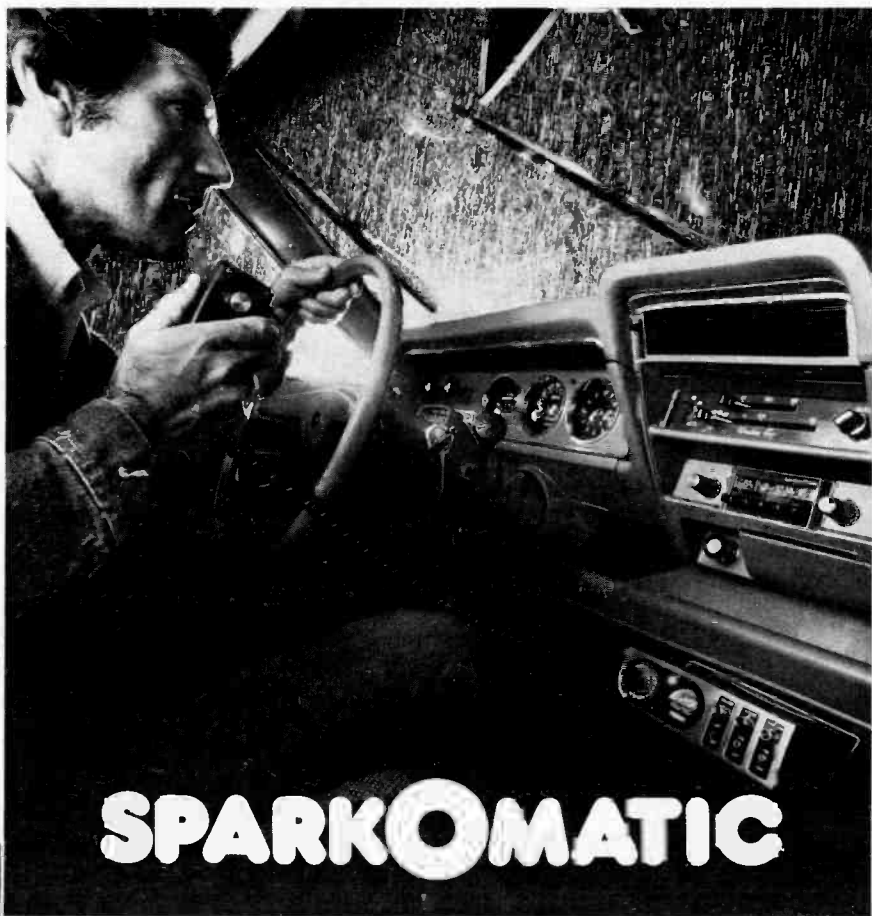

SPARKOMATIC

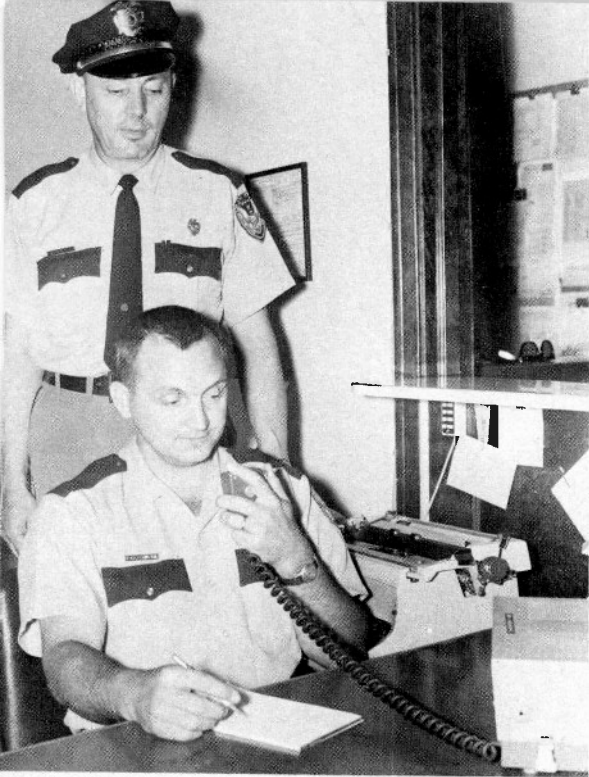

Tomcat Looks at CB CRIMEWATCH Use Your CB Rig to Fight Crime!

by Tom Kneitel, TOMCAT, Editor of CB RADIO/S9

IN case you haven't noticed, crime is on a continual upward spiral—there doesn't seem to be any easing of this trend; robberies, burglaries, muggings, vandalism, car thefts! CB'ers seem to have also become part of these statistics, since our mobile communications gear has become the newest *in* thing for the small time sharpie.

Maybe it's time for CB'ers to do more than just sit around adding more locks and alarms to our cars, maybe it's time that we put our communications equipment into service to do battle against the tide of crime!

In some areas, law enforcement agencies have made arrangements with area CB operators to participate in a communications program which can effectively add to the success of law enforcement activities. For instance, in Aspen, Colorado, the police have commenced a project called CRIME BUSTERS which is coordinated with local CB operators.

We at CB RADIO/S9 think this project (and similar ones are popping up across the country) gives additional potential to the uses of CB Radio, it's one *more* way to serve the community.

Now don't get me wrong, CB'ers in such a program are *not* vigilantes or do-it-yourself Smokeys—there is *no* crime prevention or apprehension work involved—these CB'ers are asked only to be on the look out for certain types of criminal activity, and then to use their communications gear to summon the intervention of local, county, or state law enforcement agencies. The programs are done in cooperation and conjunction with these agencies. The *wrong* type of person for this is the potential *Death Wish* character who is interested in taking the law into his own hands—that's why police departments appreciate the opportunity to manage these programs in their own local areas, so they can see exactly

who they are working with, and best judge the level of success of the program. In fact, I know of one police department (large western city) which absolutely refused to institute one of these programs because they did not feel that the bulk of their area CB'ers were serious or responsible enough to handle the task to any worthwhile ends.

There are no uniforms or badges, helmets or marked vehicles involved in this, no firearms—just CB'ers going about their business as usual, however they have been clued in on what to look for in the area of certain types of crime, and told how to radio the message to law enforcement officials.

WHY?

No police department can function effectively without the concerned assistance of responsible citizens. They depend upon citizens calling them and telling them whenever suspicious persons or actions are observed. This adds countless eyes to the marked and unmarked patrol cars already circulating in their regular patrol areas.

What happens is that some people fail to call the police simply because they are not aware of what seemingly innocent activities might be suspicious. Others may notice suspicious activity and be hesitant to call for fear of seeming a nosy *neighbor* or a *crank*. Still others take it for granted that someone else *surely* must have called!

Most law enforcement agencies say to call them immediately about any suspicious activity. Don't think that you are *bothering* them because that's what they are there for. Don't worry about your suspicions being unfounded—but think about what could happen if you *don't* act! And think about the possibility of you, your



Here is the dispatch console for a program called "Neighborhood Watch," established by the police in Gardena, Calif. Such programs, while useful, must be operated at the discretion and under the direction of police authorities so they do not take upon themselves a distasteful "vigilante" flavor.

loved ones, or your property being a *future* victim of the person who got away *this time* because you did not take action.

ENTHUSIASTIC

The Aspen, Colo., Police Department are quite enthusiastic about their project, which is run under the direction of Det. Michael S. Chandler, the Aspen PD's Crime Prevention Specialist.

Det. Chandler told me that "Activity on our CB network has been brisk, to say the least. We've used the network for stolen vehicles, fleeing felons, lost children and motorists in distress. We even alert motorists when we're running radar in speed traps; our goal, of course, being to get people to slow down. The public's reaction to Smokey himself telling CB'ers about a *Kojak* is phenomenal."

The Aspen PD, of course, has a fully coordinated and well planned-out program involving CB'ers, complete with a base station which transmits alerts for members of CRIMEBUSTERS monitoring Channel 9 (a notification to listen on Channel 9 is sent out in advance on Channel 19). Still, even in areas where law enforcement agencies do not have a formal program established, concerned CB'ers can probably be of use in calling messages in to their own base stations for 10-5 to the police via landline. Possibly in those areas the law enforcement agencies might be interested in

starting such a program if it were brought to their attention by local CB groups or clubs—maybe they would be anxious to put this into action but don't know who to contact in CB-land. You could approach them—possibly let them read this issue of CB RADIO/S9!

If you are a member of a club, your club might wish to present the PD with a program in which members would maintain a base station (either at PD Headquarters or at another selected location) for CRIME-WATCH purposes. Possibly members could even establish Midnight to 6 AM (high crime hours) to cruise certain areas designated by the police to be on the look out for certain activities. These might be two-operator vehicles which could cover hundreds of miles of local streets in a single evening.

This, of course, would be an ambitious undertaking and should be attempted only with the sanction of local law enforcement agencies, lest *your* "patrol car," cruising around in the wee hours, be reported as being suspicious! That's why law enforcement agencies should be consulted should you be considering any organized effort.

However, on a lesser level, no organization is required for individuals or club members to simply become involved in community security—at least on a more increased level than present—by reporting suspicious activities spotted during regular activities.

Based on the excellent and successful program



established in Aspen, Colo., we are presenting herewith some thoughts on how a CB CRIMEWATCH might be instituted in *your* area with the sanction and cooperation of local law enforcement agencies. The Aspen PD, by the way, recruits members by having *Meter Maids* place brochures on all parked vehicles sporting CB whips—applicants can then appear at Police HQ to fill out an application, receive information on how to function, plus a windshield sticker.

Why not see how and if you can get something like this going in your neck of the woods? Let us know how you make out—and, also let us know any specific instances in which the use of CB Radio has been used to communicate with the police or sheriff in the fight against crime. We'll probably run the most interesting ones here in our pages—address these reports to: S9 CB CRIMEWATCH, 14 Vanderverter Avenue, Pt. Washington, N.Y. 11050. *(continued)*

CB CRIMEWATCH ORGANIZED EFFORT GUIDELINES

1. To commence an alert, the police base (or authorized affiliated base) will call members on Channel 19.
2. Alerts will be aired over a predetermined channel. All subsequent CB CRIMEWATCH transmissions between mobiles and will continue over this channel.
3. All transmissions connected with CB CRIMEWATCH will be accompanied by the member's FCC callsign and any other registered Unit Number ID or Handle suitable for rapid local identification.
4. Members are instructed NOT to take any overt or aggressive action in any CB CRIMEWATCH alerts dealing with criminal matters. The law enforcement agency will dispatch authorized personnel for appropriate action.
5. Fire and other non-police emergency reports may be handled at the discretion of the agencies concerned.
6. The CB CRIMEWATCH base(s) will monitor a specified channel 24-hours a day. Any member wishing to contact the police with information on accidents, suspected criminal activity in progress, fire, etc., should report as soon as possible on the designated channel.
7. Anyone transmitting deliberately false or misleading information will face immediate dismissal from the program, possible charges filed with the FCC, and possible local charges of filing a false police report.

INFORMATION MOST OFTEN NEEDED BY THE POLICE

- What happened?
- When?
- Where?
- Is anyone injured?
- Vehicle license number
- Vehicle description
- Direction of flight
- Description of persons (including clothing)
- When describing suspects, notice age, race, sex, height and weight. Compare your weight and height with suspects. Pick out some unique characteristics which will help you identify the suspect in the future if need be.

BUT WHAT IS SUSPICIOUS?

Basically, anything that seems even slightly "out of place" for our area or during the time of day in which it occurs may mean criminal activity.

Some of the most obvious things to watch for and

report include:

- A stranger entering your neighbor's house when it is unoccupied may be a burglar.
- A scream heard anywhere may mean robbery or rape.
- Offers of merchandise at ridiculously low prices could mean stolen property.
- Anyone removing accessories, license plates or gasoline from a car should be reported.
- Anyone peering into parked cars may be looking for a car to steal or for valuables left displaced in the car.
- Persons entering or leaving a business place after hours could mean burglars.
- The sound of breaking glass or other loud explosive noises could mean an accident, housebreaking or vandalizing.
- Persons loitering around schools, parks, secluded areas or in the neighborhood could be sex offenders.
- Persons around the neighborhood who do not live there could be burglars.

FOR BIG 40 CHANNEL PERFORMANCE THE NEW HORIZON 29-A

Standard's digitally synthesized Horizon 29 CB is now available with the new 40 CB Channels. This new model, known as the **Horizon 29-A**, features the same outstanding "Astropoints" for maximum power and performance.

Get the facts about the **Horizon 29-A**, the impressive new 40 channel CB from Standard. **Horizon 29-A** Full 40 channel operation from an innovative "Phase-Lock-Loop" frequency system. **Horizon 29-A** The CB radio with "Hear Power" receiver performance. **Horizon 29-A** Speaks with maximum legal power output. **Horizon 29-A** Special 10 watts of audio power adds fantastic "kick" to outside speaker. **Horizon 29-A** Microphone in-the-mike gain control for convenient modulation adjustment. **Horizon 29-A** Remarkable "on frequency" stability even at extreme temperatures. **Horizon 29-A** Outstanding receiver selectivity/sensitivity with range extending image rejection. **Horizon 29-A** All solid state for reliable performance. **Horizon 29-A** Positive or negative ground. **Horizon 29-A** Switchable Automatic Noise Limiter and Noise Blanker. Use both simultaneously.

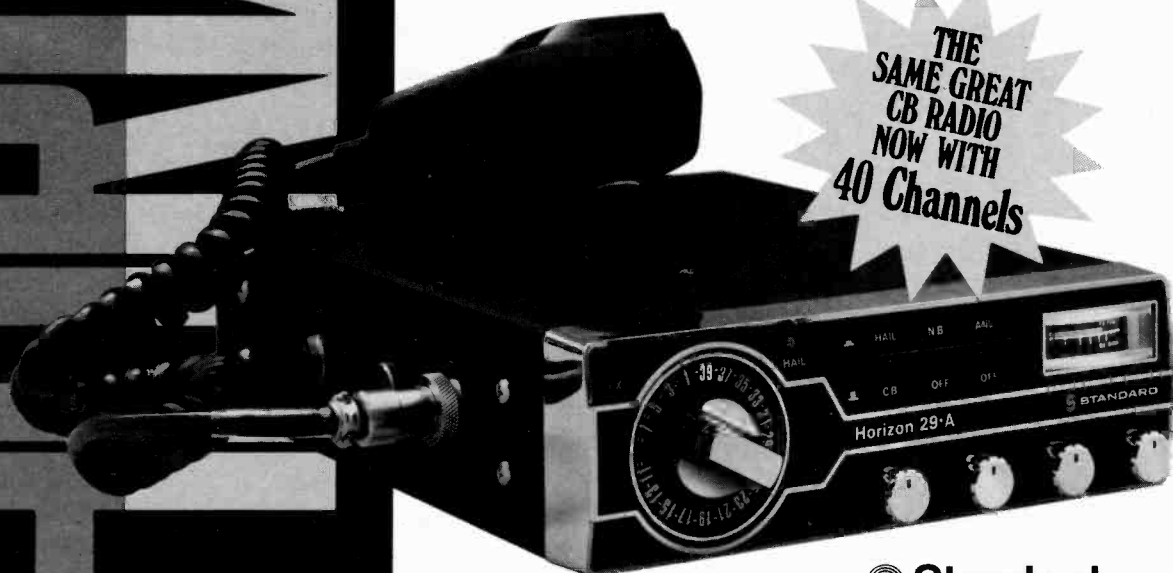

 **Standard
Communications**

Standard Communications Corp. · P.O. Box 92151 · Los Angeles · Ca · 90009

This device has not been approved by the FCC. This device is not and may not be offered for sale or lease or sold or leased until the approval of the FCC has been obtained.

SOME NOT SO OBVIOUS THINGS TO WATCH FOR

Not every stranger who comes into your neighborhood is a criminal by any means. There are many perfectly legitimate door-to-door salesmen, repairmen and servicemen moving around Aspen all the time. But criminals do take advantage of this by assuming the guise of the legitimate business representatives. After all, if a criminal looked like a criminal, no one would have any trouble spotting him.

Here are some situations involving people you might see and what their actions might mean.

- Someone is going door to door in your neighborhood. Watch for a while. If, after a few houses are visited, one or more of the persons tries a door to see if it is locked or goes into a back or side yard, could be a burglar. Such action is even more suspicious if one person remains in the front when this occurs or if there is a car following a few houses away.

- Someone waiting in front of a house or business becomes suspicious if the owners are absent, or—if it's a business—the business is closed. This might be a lookout for a burglary in progress inside.

- Anyone forcing entrance to or tampering with a residence, business or vehicle is suspicious anytime, anywhere.

- A person running, especially if carrying something of value, could be leaving the scene of a crime.

- Carrying property could be suspicious too, if it's at an unusual hour or in an unusual place, and if the property is not wrapped as if just purchased.

- A person exhibiting unusual mental or physical symptoms may be injured, under the influence of drugs or otherwise needing medical or psychiatric assistance.

- Much human traffic to and from a certain residence is not suspicious unless it occurs on a daily or very regular basis, especially during late or unusual hours. It could possibly be the scene of vice activities or a "fence" operation.

Here are some things to watch for involving vehicles.

- Any vehicle moving slowly and without lights, or

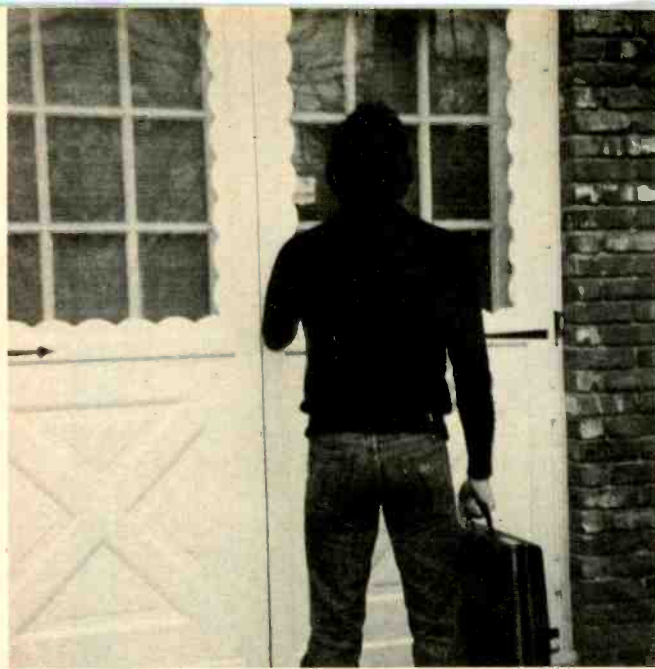

following a course that appears aimless or repetitive is suspicious in any location, but particularly so in areas of schools, parks and playgrounds. Occupants may be "casing" for places to rob or burglarize, or could possibly be a drug pusher or sex offender.

- Parked, occupied vehicles containing one or more persons are especially significant if observed at an unusual hour. They could be possible lookouts for a burglary in progress, even if the occupants appear to be lovers.

- Vehicles being loaded with valuables are suspicious if parked in front of a closed business or untended residence—even if the vehicle is legitimate-looking commercial unit. More and more professional thieves are taking the time and trouble to "customize" their vehicles with special signs in order to move more freely without suspicion.

- Apparent business transactions conducted from a vehicle, especially around schools or parks and if juveniles are involved, could mean possible drug sales.

- Persons being forced into vehicles—especially if juveniles or females—may mean a possible kidnapping.

- The abandoned vehicle parked on your block may be a stolen car.

REPORT

- Continuous "repair" operations at a non-business location could mean stolen property being stripped, repainted and otherwise altered.

- Open or broken doors or windows at a closed business or residence whose owners are absent could mean a burglary in progress or already completed.

- Unusual noises such as gunshots, screaming, sounds of combat, abnormally barking dogs—anything suggestive of foul play, danger or illegal activity should be reported.

While some, if not all, of the suspicious situations described could have innocent explanations, the Police would rather investigate a crime-prone situation than be called when it is too late.

AN Associated Press national survey of state and local police indicates that for the most part the CBers in this country have been helpful. And the police say this even though CBers are fond of reporting highway patrol cars trying to catch speeders. Police say that practice results in traffic slowing down.

But there have been grim incidents.

—A woman kidnap victim was killed by her abductors after CBers interfered with a ransom drop.

—A vigilante posse of citizens band operators chased the wrong truck for 75 miles thinking it had sideswiped another vehicle.

—A Pennsylvania man shot another CB enthusiast after an argument on the air over use of a channel.

—In California, officers monitoring the CB network found that during a civil disturbance those involved were using CB radios to protect their flanks.

Florida Highway Patrol Sgt. Paul Gracey said citizens band operators are becoming an increasing influence on law enforcement operations—both good and bad.

“Like every other part of life, some

But CBers can also be an annoyance.

“Sometimes they feel that having a CB unit makes them nearly a policeman,” said Sgt. Robert Marshall of the Little Rock, Ark., police department. “Their intentions are good, but mostly they are a nuisance, being in the way.”

An example given by Marshall was the woman who thought she heard a robbery plan being discussed on CB, called police and detectives went to a motel where they found two persons, searched them and found no evidence of wrongdoing.

“We were lucky they were understanding,” said Marshall. “We left red-faced.”

In Ohio, Richland County Sheriff's Capt. Gene Hart said that his department has had good experiences with CB operators.

“When a Mansfield policeman was killed last February, a CB spotted the getaway car,” Hart said. “We've gotten tremendous cooperation from them.”

“It's an absolute asset to law enforcement,” said Sheriff Bernard Grysen of Ottawa County, Mich. Grysen said the deputies monitor the CB channels, and

Crystal, assistant chief of the Iowa Highway Patrol. But he said troopers have to be wary of CB reports and make their own cases.

“The day we start making arrests on the basis of CB transmissions is the day we'll be in court for false arrests.”

In Idaho recently, a CB operator whose camper-truck was sideswiped by a pickup, broadcast a description. The result was a 75-mile high speed chase which ended when police intervened. The CB chasers were chagrined to find they had been pursuing the wrong truck. The pickup driver was charitable enough not to press charges, police said.

“We've had a few isolated incidents where they were playing vigilante,” said Al Brockway, assistant police chief in Helena, Mont., “One involved a person allegedly using foul language on the air, and some CBers took it on themselves to find this person. A fight ensued and it turned out it was the wrong man.”

Police generally agree that many CB operators do provide useful information to law enforcement agencies.

Michigan State Police reported that in June there were calls from CB oper-

S9 CB

Crimewatch

Casebook

people abuse CB radio,” he said. Mostly, “They report traffic congestion, disabled vehicles, accidents and extent of injuries. It can save three minutes getting to the scene. It doesn't necessarily save anyone's life, but it does get help sooner, and you don't know what might have happened.”

But he added, “There are some sick ones who make false accident reports.”

“The big problem with CBers is overreaction,” said David Arnold, a New York State trooper. “They overreact and get all excited in an emergency situation. But I don't think they are a nuisance.”

Other law enforcement agencies reported that the CB operators have helped foil burglaries and car break ins, made reports that resulted in the arrest of a man wanted for the slaying of a police officer, the capture of another sought for killing his wife, and helped gather clues in the Cowchilla, Calif., kidnaping of 26 children and their school bus driver.

One parent of a child aboard the bus said he first learned the children were safe from a citizens band operator.

there have been numerous cases where citizen band operators have helped in recovering stolen cars and catching traffic violators.

“It's been tremendously successful,” said Lt. Roderick Moore of the Michigan State Police. “I've got to believe many of those possibly intoxicated drivers would have gotten away if it had not been for the CB reports.”

In Alabama, Capt. John Henderson of the state patrol said the only interference by CBers with law enforcement are the “Smokey reports, but even the reports on the location of the patrol cars have helped to slow traffic in the area,” he said.

But in Livingston County, Ill., Sammie J. Graham was ticketed on a charge of interfering with a police officer after being stopped for speeding. The state police said Graham got back in his car after getting the speeding citation and broadcast the location of the police cruiser.

“I have a very positive feeling toward the ability of the officer to communicate with the citizen,” said Lt. Col. Alton

ators resulted in 29 drunk driving arrests, 72 speeding citations and 37 for crimes including 11 felonies.

The California Highway Patrol said that of 36 reports on drunk drivers from CB operators, there were 35 arrests.

Coatsville, Pa., police said that the CB organization “Townwatch” resulted in seven arrests for mugging, burglary and assault in July.

In Boston, police credited CB operators with assisting in keeping tension down during the turmoil resulting from busing for desegregation.

“CBers have sometime assisted when they see someone driving into an area that is tense and advised the party of the situation,” said a city police spokesman.

Boston police Capt. John Dow said that in one case a bus driver declined to drive through an area because earlier one driver had been pulled from his vehicle and others had been robbed. He said CB operators working with the Community Action Team, a civilian group, agreed to escort the bus and others until the trouble died down.

Tomcat in Tinseltown (Almost!)

CB Radio/S9 Visits a

CB Film in Production

HAVING spent several of my pre-CB years in the motion picture industry, I was especially turned on when I received an invitation from Paramount Pictures to zip out to Shakeaside to spend a few days watching the Fields Company shoot the first major company film devoted entirely to CB radio—in fact, the film is called **CITIZENS BAND** and is scheduled for release this Spring.

Filming was on-location in Marysville, California, which is north of Sacramento, an especially beautiful

area just west of the old gold mining towns in the Sierra Nevada Mountains. So I hopped a plane and made my way out to see what was going on.

The film is a comedy-drama, a \$2-million color production, directed by Johnathan Demme—a talented young filmmaker.

The first thing I did when I got there was get a hefty smack on the back and a bear hug from none other than Chuck Napier, one of the stars of the film. Chuck is a long-time CB'er, in fact he's written for this publi-

Candy Clark strikes a happy chord in the soul of CB Radio/S9's Editor.





Candy Clark did more than act the roll of a CB'er, she has a Radio Shack CB rig at her apartment—she spent quite a bit of time on the channels. Hey guys, want her Channel number?

cation a number of times in the past. Well, besides being on CB (his AM handle is *Overdrive*, on sideband he's SSB-55), Chuck is a thousand and one other things—trucker, singer, general all-around zany character, and actor! You may have seen Chuck on *Baa Baa Black Sheep*, *The Rockford Files*, *Kojak*, or other TV programs. Some of Chuck's films include *Super Vixens*, *Rolling Thunder*, and *Moonfire*.

Chuck plays a trucker in *CITIZENS BAND*, his handle in the film is *Chrome Angel*—which is a handle that relates to a really spectacular 18-wheel vehicle used in the story.

Between takes, Chuck and I rattled on about (you guessed it) CB radio—some of the recent developments and where it's all heading.

Which one is the actor? It's Chuck Napier (right), also known on the sideband channels as SSB-55. Chuck greeted me with a friendly bear hug and discussed the current status of CB radio.



Left to right: Sidebander SSB-99, who dropped by to say hello; actress Ann Wedgeworth, who had some CB tales of her own to exchange; and Tomcat.

One of the stars of *CITIZENS BAND* is Candy Clark—whose handle in the film is *Electra*. You probably know Candy since her performance in *American Graffiti* earned her a nomination for an Academy Award—Candy was also in *The Man Who Fell to Earth* (with David Bowie). One of the days I was there, Candy was outfitted for a wedding ceremony (she was the bride)—and it turned out to be a CB wedding to end all past/present/future CB weddings!

Also in *CITIZENS BAND* is Ann Wedgeworth. Ann is a Broadway actress who starred in "Thieves". Ann was a delightful person with a total fascination for CB radio—in fact, during some of the orientation drives which the cast was given (in CB-equipped mobile units), Ann said that she had a great time shouting dozens of goodbuddies on Channel 19!

One of the highpoints of my visit was meeting Ed Begley, Jr., who plays a priest in the film (handle: *Priest*). Ed should be a familiar face to all of you *Mary Hartman, Mary Hartman* TV fans, since he appeared in the series as the deaf mute poet. Yes, he can and does talk—in fact he has one of those outrageous off-beat senses of humor which had everybody cracking up!

Others starring in the film are Paul Le Mat (you saw him in *Aloha Bobby and Rose* and *American Graffiti*), Marcia Rodd, Roberts Blossom, Bruce McGill, and Alix Elias.

All in all, it was an interesting and tantalizing peek at CB on the silver screen—gives you something to look forward to. One of the scenes which I watched them shoot was when a local character gets lost in the woods and they locate him via CB—but when they find him he's—oh well, don't want to spoil the film for you. Wait until you see it!

Actor Ed Begley, Jr., who plays a priest in the film *CITIZENS BAND*, gives some words of encouragement to Tomcat.





ON THE COUNTERS

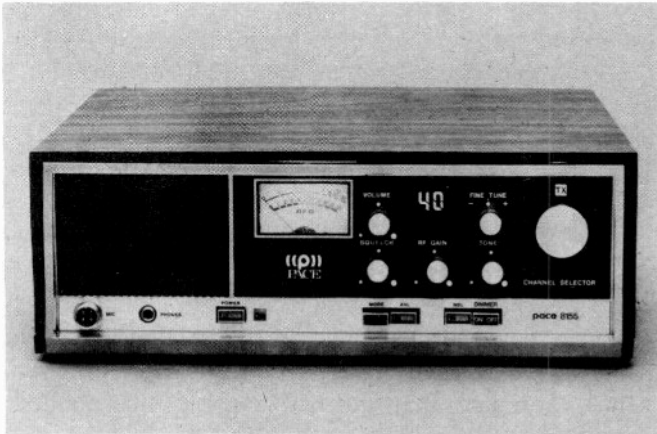

PACE 40-CHANNEL BASE

The deluxe PACE "8155," 40-channel base station brings it all home with L.E.D. channel display, S/RF meter, RF gain control knob, noise blanker switch, automatic noise limiter switch, tone and fine tune controls, dimmer button, transmit indicator light, public address capability and external speaker jack.



THE DWIGHT D 40-CHANNEL AM BASE STATION

President Electronic's new 40-channel AM base station, Dwight D. comes with an elaborate list of features, including a separate speaker and digital alarm clock.

Controls include volume, squelch, adjustable mike gain, RF gain, time set, alarm set, meter mode switch, noise blanker, delta tune and PA/CB switch. It has two

dual-functioning meters, the SWR-MOD and the SR/F calibrate, as well as a large 100mm digital L.E.D. channel indicator.

The Dwight D also features a new automatic speech compression circuit for consistent high level modulation, selectivity is rated at -65 db or better.

On the back panel are jacks for AC and DC power, antenna, PA and external speaker. Earphone and mike jacks are on the front panel.

The transceiver is 4¾"H x 15"W x 11½"L, and weighs 13.2 lbs. The separate speaker is 4¾"H x 5¾"W x 11½"L and weighs 3.5 lbs.

The Dwight D is backed by a limited one-year warranty covering both parts and labor. The suggested retail price is \$329.95. Complete details on the new Dwight D are available by writing to President Electronics Inc., 16691 Hale Ave., Irvine, CA. 92714.



40 CHANNEL BASE STATION

The Alaron B-5050 has a P.L.L. Synthesizer AC/DC circuitry, illuminated large S/RF meter, variable squelch control and a local-distant PA-CB switch.

It is also equipped with a built-in automatic noise limiter (ANL), transmit and receive indicators, and jacks for PA, extension speaker and headphones.

The four watt maximum RF output unit has both the AC and the DC power cables and a plug-in dynamic microphone with coiled cable.

Suggested retail price is \$159.95 from B & B Import-Export, 185 Park St., Troy, Mich. 48084. (continued)

CP-400... a 40 channel set from day one!



This device has not been approved by the Federal Communications Commission. This device is not, and may not, be offered for sale or lease, or sold or leased until the approval of the FCC has been obtained.

Here is no outdated design "doctored" for stretch to 40 channels . . . CP-400, two years in development, is a product of highly advanced computer technology . . . **had 40 channel capability from day one**; digital logic . . . high stability . . . digital frequency synthesis . . . comprehensive "memory" . . . state-of-the-art semiconductor technology throughout. 23 channels was child's play. 40 channels meant merely 17 more up the line. The functional, no-nonsense twin dials were already there for direct channel readout. CP-400 is designed and manufactured by CPI in the U.S. Come to think of it, who knows more about sophisticated technology than Americans?

Forget for the moment, the exceptional compactness, the very low silhouette, the handsome white cabinet and the anti-rip-off, swing away mounting bracket; consider only the following CP-400 **performance factors**:

- 40 channels. Digital frequency synthesizer has high (0.001%) stability (essential for SSB).
- SSB w/USB/LSB plus fully modulated AM.
- Super, logarithmic-speech-compressor holds AM,SSB modulation at highest levels without flat-topping. Meets new FCC modulation requirements and still has incredible talk power.
- Built-in, 7 element TVI harmonic filter.
- Excellent audio quality, transmit and receive. THD less than 3% at 2 watts output.
- Special microphone w/built-in transistor amplifier/gain control. Custom manufactured for Communications Power by Turner.
- Built-in JFET pre-selector has extremely low (1.5db) noise figure.
- Unequaled sensitivity: 0.25 μ V, SSB, 0.5 μ V, AM.
- 80db selectivity both SSB/AM. Uses crystal lattice filter. Very high rejection to adjacent channel "spillover" interference.
- High dynamic range! Has power mixer for -80db cross modulation performance. Practically impervious to overload. Also has automatic PIN diode RF gain control and AGC.
- Built-in noise BLANKER. Effective! Blanks out noise without distorting signal. Has its own noise sampling receiver. Commercial quality!
- Full power output: 4W AM, 12W p.e.p. SSB.
- Dimensions: 2.25"H, 9"W, 11.75"D. Wt. 7 lbs. MM: 57H, 228.5W, 298.5D. Wt. 3.1KG
- 13.8VDC. Positive or negative ground.

Unique, functional power supply converts CP-400 to handsome base station. 115VAC supply is voltage regulated, has 3" x 5" speaker for full quality sound.



At your CPI dealer. Write for brochure.

599⁹⁵

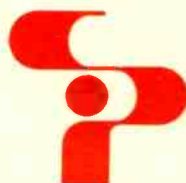

COMMUNICATIONS POWER, INC.

2407 Charleston Rd. Mountain View, CA 94043 (415) 965-2623

Canada: E. S. Gould Marketing Co., Ltd. 109 Montee de Liesse, Montreal, Quebec, Canada H4T 1S9

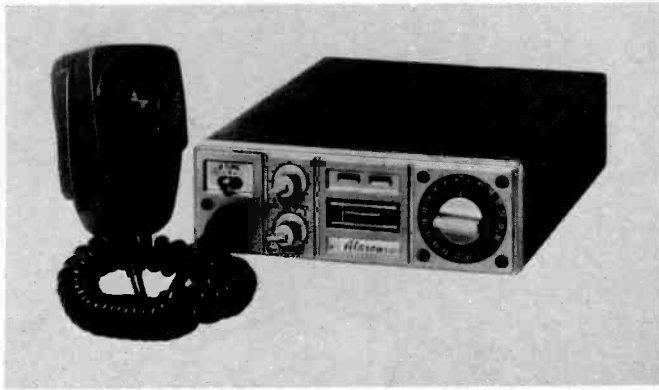

40 CHANNEL MOBILE TRANSCEIVER

The Alaron Model B-4075 has a large illuminated S/RF meter, variable squelch control (and PA switch) as well as a Delta Switch. It also features a built-in automatic noise limiter (ANL), transmit and receive indicator lights and jacks for PA and extension speaker.

It has the four watt maximum RF output and has a positive or negative ground 12V DC system.

Accessories include the plug-in dynamic microphone with coiled cable, mounting bracket and screws, mike mounting bracket and screws as well as the DC power cable with fuse holder and fuse.

Suggested retail price is \$129.95 from B & B Imports, 185 Park St., Troy, Mich. 48084.

Unit operates on positive or negative ground.

Boman Industries, located near Los Angeles, is one of the nation's leading designers and manufacturers of CB radios,—in-dash and under-dash—, antennas and accessories and in-dash and under-dash AM, AM/FM, AM/FM/MPX car radios, cassette and 8-track cartridge car stereos, speakers and accessories.



40-CHANNEL MINI-MOBILE

Small enough to fit into a glove compartment and priced for the budget conscious, the new PACE "8006," 40-channel CB Radio provides solid state reliability and features an RF gain min./max. switch, S/RF meter, noise limiter circuit, public address capability, external jack and a transmit indicator light.



40 CHANNEL TRANSCEIVER WITH DIGITAL READ-OUT

Boman Industries announced an all new under-dash 40 channel CB transceiver with large digital channel read-out.

Designated the CB-760, this unit offers all the basic features the user looks for in a quality, standard CB transceiver. The CB-760 incorporates digital syntheses and phase lock loop circuitry for optimum frequency stability.

Other features include: large S/RF meter for monitoring incoming signal strength and relative power output; transmit and receive mode indicator lights; squelch control for quiet standby; noise blanker control for reducing external noise; PA system; external speaker jack.



40-CHANNEL REMOTE TRANSCEIVER WITH THEFT PROOF DESIGN

The Hy-Gain 9 (2679A) is an advanced Phase-Lock-Loop system that transmits and receives on all 40 channels. With exceptional circuitry for a crisp far-reaching signal. And exceptional sensitivity (0.7 uV for 10 db (S+N)/N) to help pull in even distant signals. Plus 40 db adjacent channel rejection and 4 full watts RF power output, the legal maximum, on AM.

From a standpoint of design, the 2679A is even more (continued)

When you're serious about CB only the BEST will do!

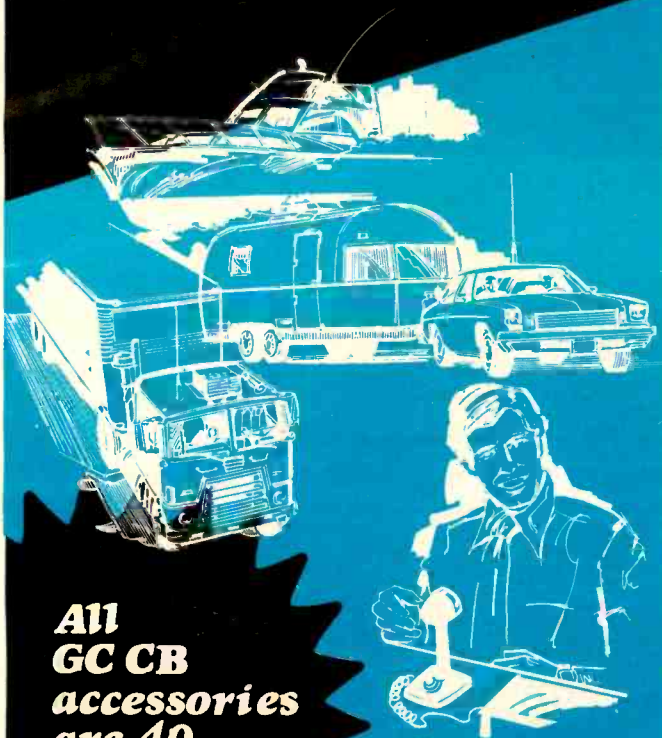

All GC CB accessories are 40 channel approved!

SEE THE COMPLETE LINE OF GC CB ACCESSORIES AT YOUR FAVORITE CB DEALER TODAY!

IMPROVE THE PERFORMANCE OF YOUR RIG! COLORFUL CATALOG ILLUSTRATES AND DESCRIBES NEARLY 150 CB ACCESSORIES--ALL 40 CHANNEL APPROVED! FOR YOUR FREE COPY, SEE YOUR FAVORITE CB DEALER TODAY!



GC ELECTRONICS
ELECTRONICS DIVISION OF HYDROMETALS, INC.
ROCKFORD, ILLINOIS 61101 U.S.A.

METERS...

CB MULTI-METER SWR/PWR & MODULATION METER

Measures R. F. Power in two scales: 0-10 watts, or 0-100 watts, as well as VSWR and relative modulation. Front panel switches.
Cat.No. 18-153



SWR/FS METER

Accurately measures SWR and FS for peak system performance. For mobile or base station application.
Cat.No. 18-155



MIKES...

POWER BASE MIKE

Built-in two stage amplifier increases range of any transceiver by boosting modulation up to 50 times. Excellent with AM and SSB also! Designed for use with modern, solidstate transceivers, but will greatly increase modulation of older tube type transceivers as well.
Cat.No. 18-000

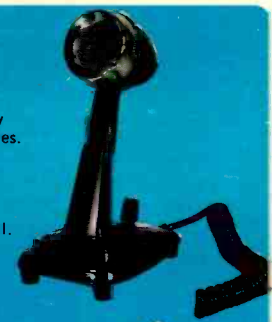

POWER HAND MIKE

Rugged, powerful, dependable! Power amplified modulation punches through "skip" and interference to increase range. Solid-state circuitry withstands temperature extremes.
Cat.No. 18-010



ANTENNA ACCESSORIES...

TWO POSITION COAX ANTENNA SWITCH

Easy switching of directional to omnidirectional antenna! No changing of connectors from ground-plane to beam antenna. Accepts PL-259 coax connectors. May be used for 52 ohm CB or switching 72 ohm Ham antennas up to 1000 watts.
Cat.No. 18-710



CB ANTENNA MATCH

Improves reception range and permits you to match your system even in adverse weather conditions! Tunes your antenna system to perfect SWR to allow all transmitted power to leave antenna. Accepts PL-259 coax connectors. Equipped with dual SWR adjustment controls.
Cat.No. 13-716



ON THE COUNTERS (continued)

exciting. Hy-Gain engineers have separated the transceiver and its controls into two separate components, allowing the transceiver to be installed in a remote location hidden from would-be thieves.

All Hy-Gain 9 controls are located on the MSR (for microphone, speaker and radio) Control Unit for easy hand-held operation. There's volume and squelch thumbwheel controls. Push-to-talk button with integrated speaker. And a 40 channel selector switch plus digital channel readout.

The MRS Control Unit is linked by coiled cord to an under-dish connector. From there an optional cable (model 1179) runs to the transceiver which may be located beneath the seat, in the trunk or any other protected area.

The Hy-Gain 9 (2679A) is \$239.95 manufacturer's suggested retail price.

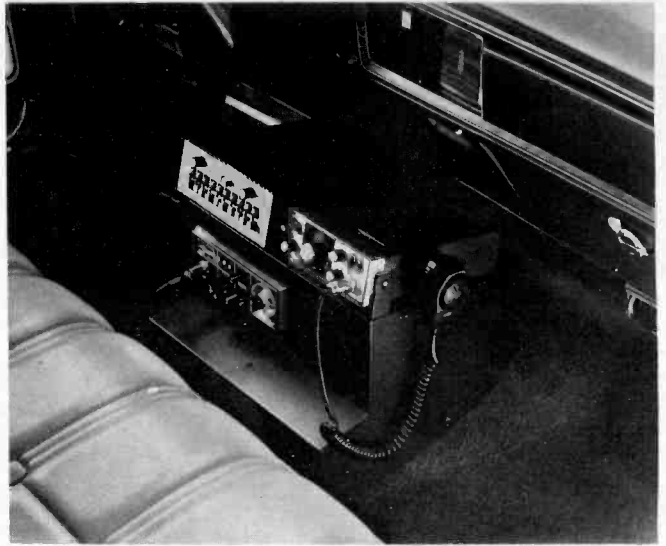

Mounting in any American-made car, this console puts all equipment at the fingertips of the operator, yet is centrally located, utilizing space normally unused. Fabricated from 20 gauge steel and heliarc welded, the console features double hems with rounded edges and two coats of baked-on, scratch-resistant epoxy paint.

Installation and mounting holes may be located according to the requirements of your equipment. Consoles, with equipment intact, can readily be changed from car to car at "Change-over time", at a fraction of normal time! Periodic in-shop servicing can be easily accomplished with all equipment processed at one time.

Typical units to be mounted on the Hartzell Console include; CB Radios VHF Control Head, Remote Speaker, Scanner, Cigar Lighter (for radar plug), Microphone clasps and map lights. Priced under thirty dollars in single units, generous quantity discounts are available.



40 CHANNEL UNIT FEATURES ANTENNA WARNING INDICATOR

General Electric's 40-channel CB Model 3-5812 features a warning light that glows to tell the user his antenna system needs adjustment. Other features include internal burn out protection, switchable noise blanker and ANL plus delta tune. The model 3-5812 has a manufacturer's suggested retail value of \$174.95.



40 CHANNEL MODEL WITH BUILT IN SWR METER

General Electric's 40-channel Model 3-5819 CB transceiver contains a three-way lighted SWR/S/RF meter which not only shows relative receive and transmit signal strength, but in conjunction with a three-way switch and calibration control, can check and adjust the SWR for maximum antenna efficiency. Other features include delta tune, tone control, and LED channel readout.

The 3-5819 has a manufacturer's suggested retail value of \$219.95.

MOBILE CONSOLE GIVES FAST, SECURE INSTALLATION

Hartzell Manufacturing Company of Dayton, Ohio, has just introduced a new mobile communications console that provides a means of installing ALL radio, communications and electronic equipment conveniently and neatly, quickly and securely! Additional benefits are realized with the console because equipment can be mounted prior to installation in the vehicle, thereby reducing time out of service. Once installed, all equipment is rigidly secured, with no threat of loose or flying units during emergency situations.

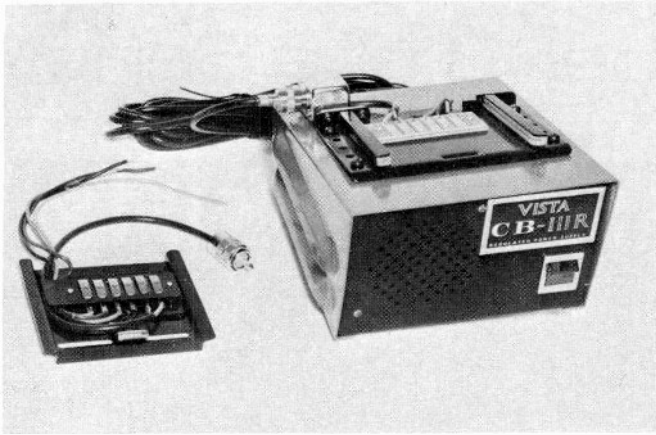

VISTA CB-IIIIR POWER SUPPLY

Clifford Industries, Inc., has added to its extensive line of power supplies the VISTA CB-IIIIR. This model provides 13.8 VDC 3 Amps continuous power.

The VISTA CB-IIIIR incorporates a built-in slide mount for ease of attachment of power and antenna connectors. The model also has a built-in speaker, thereby making it possible to create a base station with a mobile CB. This model will accommodate either 23-channel CB sets or the new 40-channel CB sets.

Contact Clifford Industries, P.O. Box 436, Camarillo, CA 93010.

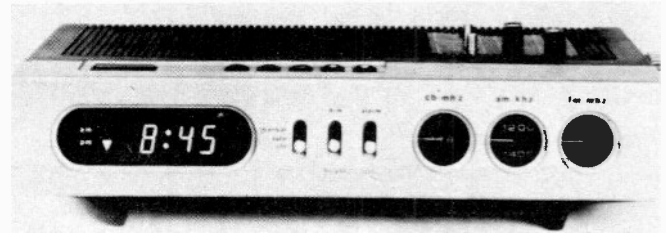

CB MONITOR/ELECTRONIC CALENDAR AM/FM CLOCK RADIO

KingsPoint's Model KP-23 can probably lay claim to being the clock radio with the mostest. This electronic AM/FM clock radio is also a perpetual calendar and it features large green digital read-out displays that are absolutely noiseless!

In addition, the unit has a full feature alarm system which can be set to awaken one to alarm alone, music alone or alarm and music. A 59 minute "snooze and/or alarm control" with automatic shut-off is also featured.

The display units are bright enough to provide a low power night light and can be adjusted to a pleasant soft glow. Automatic frequency control (AFC) assures drift-free FM reception. The KP-23 is priced to sell for under \$70. For further details, write KingsPoint Corp., 106 Harbor Drive, Jersey City, N. J. 07305.



DELUXE CB TRANSCEIVER

Automatic Radio, leading manufacturer of automotive sound products for over fifty years, announces the introduction of its latest CB transceiver. Model BCB-1130 is a deluxe 23 channel unit with all the most useful features available. Included are delta tuning, to assure best reception of even off-frequency transmissions, and Automatic Noise Limiter (ANL) for quiet, interference-free operation. An illuminated S/RF meter and channel selector/indicator allow for convenient night use. The dynamic microphone is detachable and features a front panel connector for easy use. Variable volume control, squelch control and Public Address (PA) circuit are also included. Model BCB-1130 is a top-quality unit which provides the maximum legal output power. Suggested list price is \$182.50.



PR-7 RADAR DETECTOR

Prime Electronics, Inc., 8605 Quivira Road, Lenexa, Kansas, announced the introduction of the Beartector PR-7 extended-range radar monitor. Capable of positive radar detection at an extended distance, the Beartector PR-7 provides an extra margin of early warning not presently available using other radar detectors. The very latest in state-of-the-art electronic design is incorporated throughout including several new circuit

(continued on page 114)

CB Types: Number 3 of a Series

by WOLVERTON

40 CHANNEL PHYSIOGNOMY

A recent breakthrough in surgical technology allows the addition of multiple mouths. For many, this will mean the realization of a lifelong goal: to dominate the conversation on all 40 channels at the same time. In addition to 40 mouths, of course, one would need 40 transceivers, 40 hands to operate them, 40 pairs of lungs, and a 40 track mind. However, since 40 channel single sideband rigs have a capability of 120 channels, the operation is a bit more cumbersome for sidebanders, and 3 times more hideous—so hideous that postal authorities would not allow us to distribute an illustration of it through the mails.

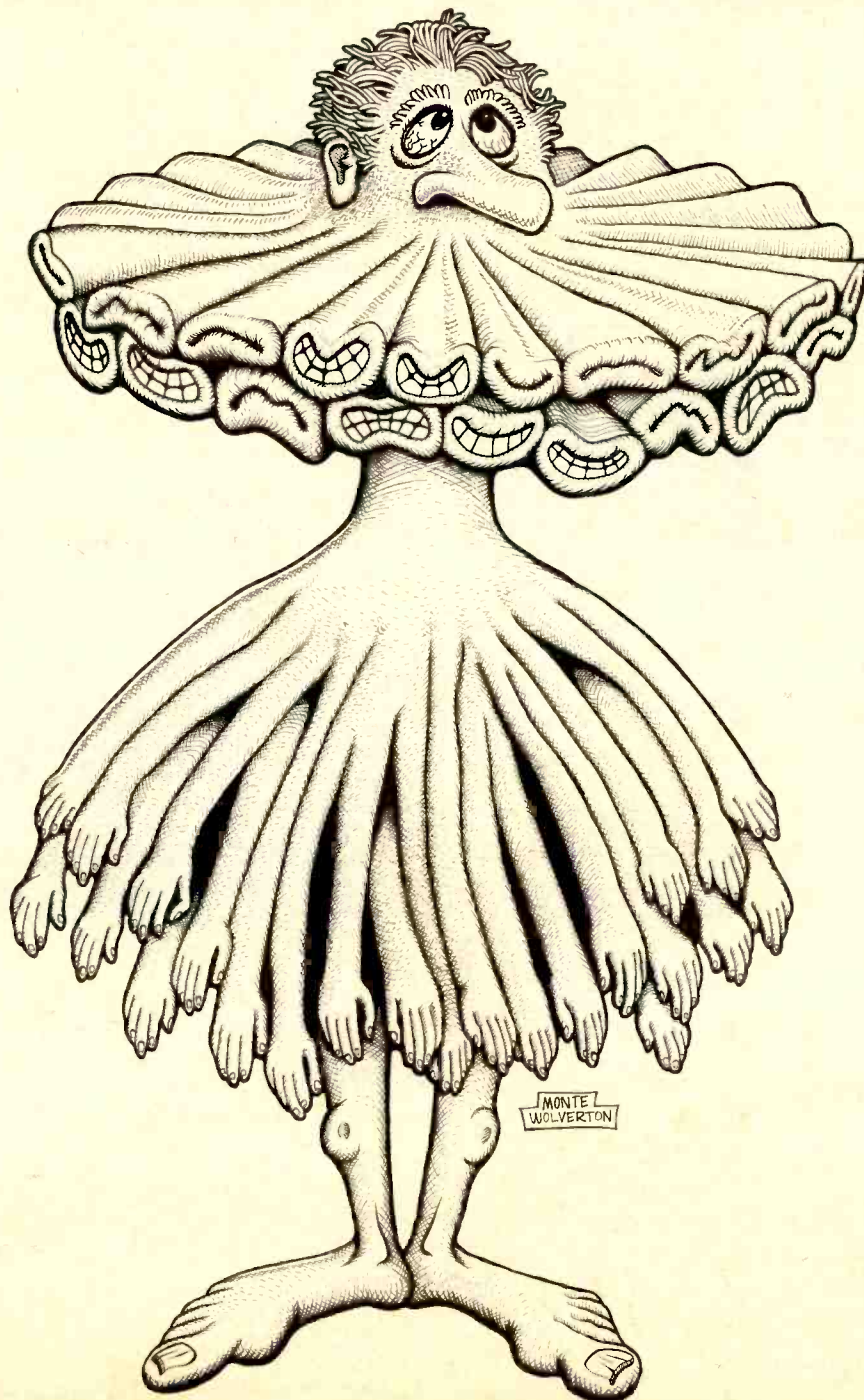

Americans have been using Motorola 2-way radios to find campsites for years.



It's a fact that the people who first put radio on wheels also made the first radio on wheels on the moon.

But it's not surprising.

Because Motorola® makes more radios for police, firemen, taxis, and lunar rovers than anybody.

And now Motorola makes a 40-Channel CB radio that shares much more than a name with our professional 2-way radios.

The clean, uncluttered lines of the Motorola CB, for instance.

Features that many manufacturers leave on the outside of their sets (or don't offer at all) are built into a Motorola CB.

Gain control, noise limiting, audio compression, even a TV interference filter are built-in, fully automatic circuits that actually make communication better.

And operation easier.

A digital phase lock loop

synthesizer provides precise tuning (automatically, of course).

A professional-quality 3½-inch top-fire speaker gives the Motorola CB an audio quality that must be heard to be fully appreciated.

And every Motorola CB gives you the added advantage of a power mic that doesn't need batteries. That doesn't cost 50 bucks extra.

The Motorola 40-Channel CB radio.

We believe it's the most sensibly engineered CB radio on the market. We believe it will deliver years of service at a level of performance few could match.

Put a Motorola CB radio under your dash and you'll believe, too.



Motorola CB

From the voice of experience in 2-way radio.

To find the dealer nearest you, write: Customer Relations Manager, Motorola, Inc., Automotive Products Division, 333 Northwest Ave., Northlake, Illinois 60164. Sale or lease of Motorola 40-channel CB radios is subject to FCC type acceptance.



... Use S9 READER SERVICE.

MIDLAND

IT'S WHAT YOU GET WHEN YOU

And once you get it, it's going to be all you'll ever need. Because Midland gives you what CB is supposed to give you. The power to communicate. The power to reach out and pull in your own personal horizon. And the clarity to be understood wherever you reach.

For 1977, the power comes to you in an entirely new generation of 40 channel CB radios. Spearheaded by the remarkable Midland 838.

With it comes switchable automatic noise limiter, noise blanker and audio filter—three noise elimination systems that let you receive with greater

clarity. The 838 is also power in your hand with an automatic channel advance and volume control right on the mike. And it's the power to know exactly where you're heading with our large, bright L.E.D. digital channel indicator.





RUN WITH NUMBER 1. MIDLAND CB.™

The 838, though, is only one aspect of Midland Power.

We offer a complete line of CB's, from base stations to portables, to every kind of mobile transceiver that will put our power in your hands at a very reasonable price. Compare. We don't think anybody, anywhere will give you such quality at such an affordable price.

And we back up that quality with our Midland warranty and convenient service centers from Carolina to California.

And finally, Midland Power is the way we put our 15 years of CB experience into every set we build.

Good experience, obviously. Or we couldn't have done what we did last year. Sell over 2 million Midland CB radios, to

make us the number one selling CB in the world.

Midland Power. It's what you want from a CB.

It's what you get when you run with number 1.



A member of the Beneficial Corporation Family.

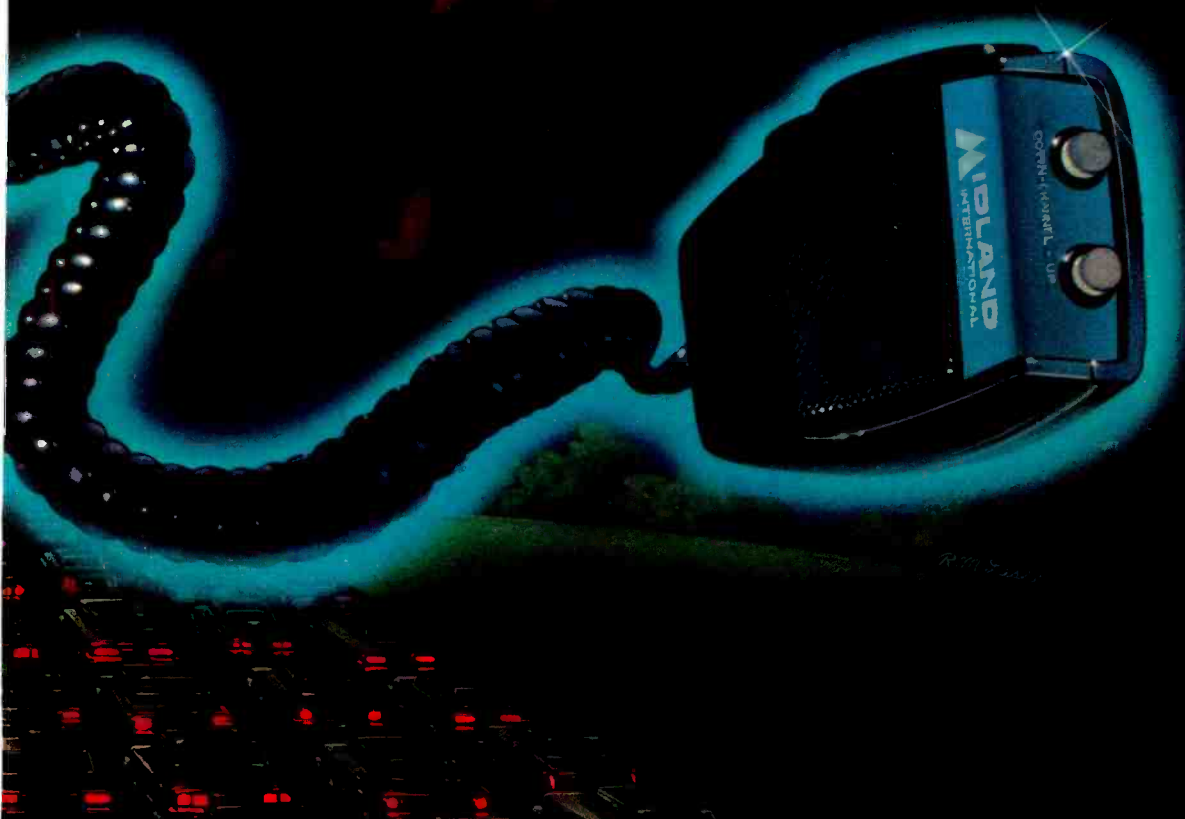

COMING EVENTS!

If you wish your Jamboree or Coffee Break listed in this column, the information must be sent to S9 at least 4 months in advance.

MARCH

Panama City, Florida, Jamboree, March 4-6, Panama City Municipal Auditorium, Sponsored by Florida State CB Radio Assoc., Dist. #7 & The Bay County CB Radio Council. For more information contact: Jamboree Control, P.O. Box 10203, Panama City, FL. 32401.

Bronx, New York, Super CB Jamboree, March 6th, Desert Inn, 30-80 White-stone Pkway. Contact American CB Radio Club, Inc., P. O. Box 321, Bronx, New York, 10469.

Starkville, Mississippi, Coffee Break Jamboree, Sunday March 20th, Mississippi State University Campus, Mississippi State Animal Husbandry Bldg. For more information: Oktibbeha County Communication Club, P.O. Box 1082, Starkville, Miss., 39757. John Manuel—President.

APRIL

Texarkana, Texas. Twice As Nice 2nd Annual CB Jamboree, April 2-3, Four States Fairgrounds. Sponsored by Twin Cities CB Club. For more information contact Chairman, Bennie Cornelius, Rt. 2, Box 347, Texarkana, Texas. 75501.

Hopkinsville, Kentucky, 7th Annual Coffee Break, April 3, Western Kentucky Fair Grounds Convention Center. Monitor Channel 11-K1Z-1934. For more information contact Hopkinsville CB Club & React, P. O. Box 112, Hopkinsville, Ky. 42240.

Lake Jackson, Texas, Jamboree, April 3, Lake Jackson Farms Pavillion, Hwy. 332. For more info contact: John Stanford, Sr. P.O. Box 186, Lake Jackson, Texas 77566. Phone: 713/265-4005.

Milford, Illinois, Fourth Annual "Spring-time" Coffee Break, April 3, Milford Grade School, Ill. State Route 1. For more information contact: Faye M. Thomas, 208 S. Grant St., Milford, Ill. 60953.

Lackawana, New York, April 6th, Annual Jamboree. At Col. John B. Weber Post No. 898, 2909 S. Park Ave. Rt. 62, 1/2 mile South of Ridge Rd. Erie



399B(CDE)

For Information About Our Advertisers . . .

County Hawks, Inc., Monitor CH 10, KEK-0787. Call 675-0517, Chr. William Baker.

Greenfield, Indiana, 5 Watters Jamboree, April 17, Greenfield Fairgrounds, 4-H Building. For more information contact, Al Simpson R.R. 1, Box 317A, Reelsville, Ind. 46171. (317) 672-8367.

Bronx, New York, Super CB Jamboree, April 17th, Desert Inn, 30-80 White-stone Pkwy. Contact: American CB Radio Club Inc., P.O. Box 321, Bronx, New York, 10469.

Manitowoc, Wisconsin, Coffee Break-Dinner & Dance, April 30, Club Bil Mar, Hwy. 141. Sponsored by West of the Lake C.B. Club. For info: West of the Lake C.B., P.O. Box 163, Manitowoc, Wi. 54220.

MAY

Johnson City, New York, Annual Coffee Break, May 1st, Lutheran Fellowship Center. Exit 71 N. from Rt. 17 North, Stella Ireland Rd. #3, .8 mile. For information: Susquehanna Valley CB Club Inc., Box 364, Vestal, N.Y. 13859.

Columbus, Indiana, Jamboree, May 7 & 8, Barthomeu County 4H Fair Grounds, Junction US 31A S. & State Rt. 58. Sponsored by Town & Country Citizens Band Radio Club Inc. Contact: Floyd Whitehead 1-812-372-3524.

Bronx, New York, Super CB Jamboree, May 15, Desert Inn, 30-80 Whitestone Parkway. Contact: American CB Radio Club Inc., P.O. Box 321, Bronx, N.Y. 10469.

JUNE

Ottumwa, Iowa, 2nd Annual Armadillo Flats National Jamboree, June 3rd-5th, Ottumwa Coliseum. Hosted by Armadillo Flats Iowa. For more information contact Armadillo Flats, Inc., P.O. Box 313, Oskaloosa, IA.

Great Bend, Kansas, Jamboree, June 4-5, sponsored by Kansas Flatlanders C.B. Club. For more information contact: Bob Shanks, The Budman, 1209 8th, 792-2209 or Box 114, Great Bend, Kansas, 67530.

Wichita, Kansas, 3rd Annual Good Guys Jamboree. June 17-19th, Cotillion Ballroom, 11120 W. Highway 54. For more information contact: William Weber, Chairman, P.O. Box 1694, Wichita, Kansas, 67201.

(continued on page 103)

★ DEALERS WANTED ★

—All Major C.B. Lines—

SELL CB FULL OR PART TIME

GORDON ELECTRONICS

Box 513 Johnstown, N.Y. 12095

FREE (914) 762-1811 CATALOG

EASY MOUNT DELUXE MAGNETIC CDE CB RADIO MOUNT



The CDE Easy Mount is truly the luxury way to use and protect your CB radio. It is the first mount designed expressly for two-way communications equipment and is far superior to ordinary slide brackets. A unique design utilizes magnetic power to automatically hold your transceiver in place and provides a quick connect, disconnect system for both antenna and power allowing instant, easy removal of the radio to prevent theft.

The Easy Mount uses three powerful permanent magnets to make positive contact assuring maximum signal transfer with perfect VSWR match. Ordinary slide brackets use flexible metal strips which can easily bend and wear to produce mismatch causing loss of signal or even "blow" the RF output stage of your transceiver.

Installation is as simple as 1-2-3 and gives you a neat, flush mount appearance. You also have the flexibility of using your Easy Mount under the dash or on the transmission hump. With an optional lock section, you can instantly transfer your transceiver from vehicle to vehicle...to your boat or home.

Ease of use...maximum performance...flush mount design...plus a one year warranty all add up to make the Easy Mount your best investment in transceiver protection...don't settle for anything less.



CORNELL-DUBILIER ELECTRIC CORPORATION
SUBSIDIARY OF FEDERAL PACIFIC ELECTRIC COMPANY
1605 Rodney French Blvd., New Bedford, Mass. 02744

33EA(CDE)

... Use S9 READER SERVICE.

afs® / Kriket® CB speaker Sound and Safe!



Hump-mount speaker

**Speakers are our only business.
They have to be better!**

Designed with security and superior sound in mind, the AFS / KRIKET KAMEL KC-3085 hump-mount external speaker rests snugly on the transmission hump while driving. CB dials are readily visible.

CB transceiver mounts on speaker base forming single unit. No installation problems. For maximum security, unplug antenna and power leads, lift unit and place in trunk. No screws to unscrew. No hassle. No annoying rattles while driving. Solid!

"WORKING WALL" enclosure of cross-laminated fiberboard deadens static and channel noise. Eliminates voice distortion.

AFS makes having an expensive CB rig in your car or truck safe and worthwhile. Isn't it about time somebody did?

Kriket Cares

Available at CB dealers everywhere



ACOUSTIC FIBER SOUND SYSTEMS, INC.
7999 KNUE ROAD, SUITE 116 INDIANAPOLIS, INDIANA 46250 (317) 842-0620

Canadian Distributor Muntz Canada Ltd. 1149 Pioneer Road Burlington Ontario, Canada (416) 639-5373

All AFS®/KRIKET® speakers are manufactured in the U.S.A. using American materials and craftsman.

Copyright 1976 Acoustic Fiber Sound Systems, Inc.

Our new PHASE 40™ CB's are supported by very strong words.



When a CB manufacturer supports his transceivers with a big 2 year warranty* program, you can be sure he has faith in his product's performance, reliability and durability—that's Channel Master. Behind every PHASE 40 transceiver is more than a quarter century of Channel Master engineering experience in electronic communications. These new units are top performers. And they're built to last. We don't just say it, we put our warranty where our mouth is.

With PHASE 40 CB you get the very latest state-of-the-art transceiver technology: phase lock loop circuitry, automatic noise limiter, noise blanker, ceramic filters, delta tune, anti-theft alarm switch plus all the outstanding features you would expect to find in a quality, high-performing CB transceiver. You can pay more for a CB... but you can't find a better buy.

Channel Master has it all!

Channel Master 

* Limited Warranty (Installation not included)
Division of Avnet, Inc., S9377, Ellenville, N.Y. 12428

This year over a million people...

Made in the USA by Radio Shack®, a leader in quality CB since 1959

Radio Shack's antenna supermarket makes it easy to choose the perfect antenna for your CB. And because we control quality from raw materials to carton, you can count on top performance and low, uninflated prices. Available anywhere you go in USA and Canada.



Archer antennas are hand-crafted for quality. This expert is putting the final touches on loading coils.



A spectrum analyzer is used to check new and experimental antenna designs.



An engineer field-tests a new model using a laboratory reference antenna.

BASE ANTENNAS

For your home or business station, Archer has a complete selection of dependable, easy-to-install antennas. Choose an omnidirectional model for up to 4 decibels gain. Or use a directional for up to 9 decibels gain — exactly where you want it!

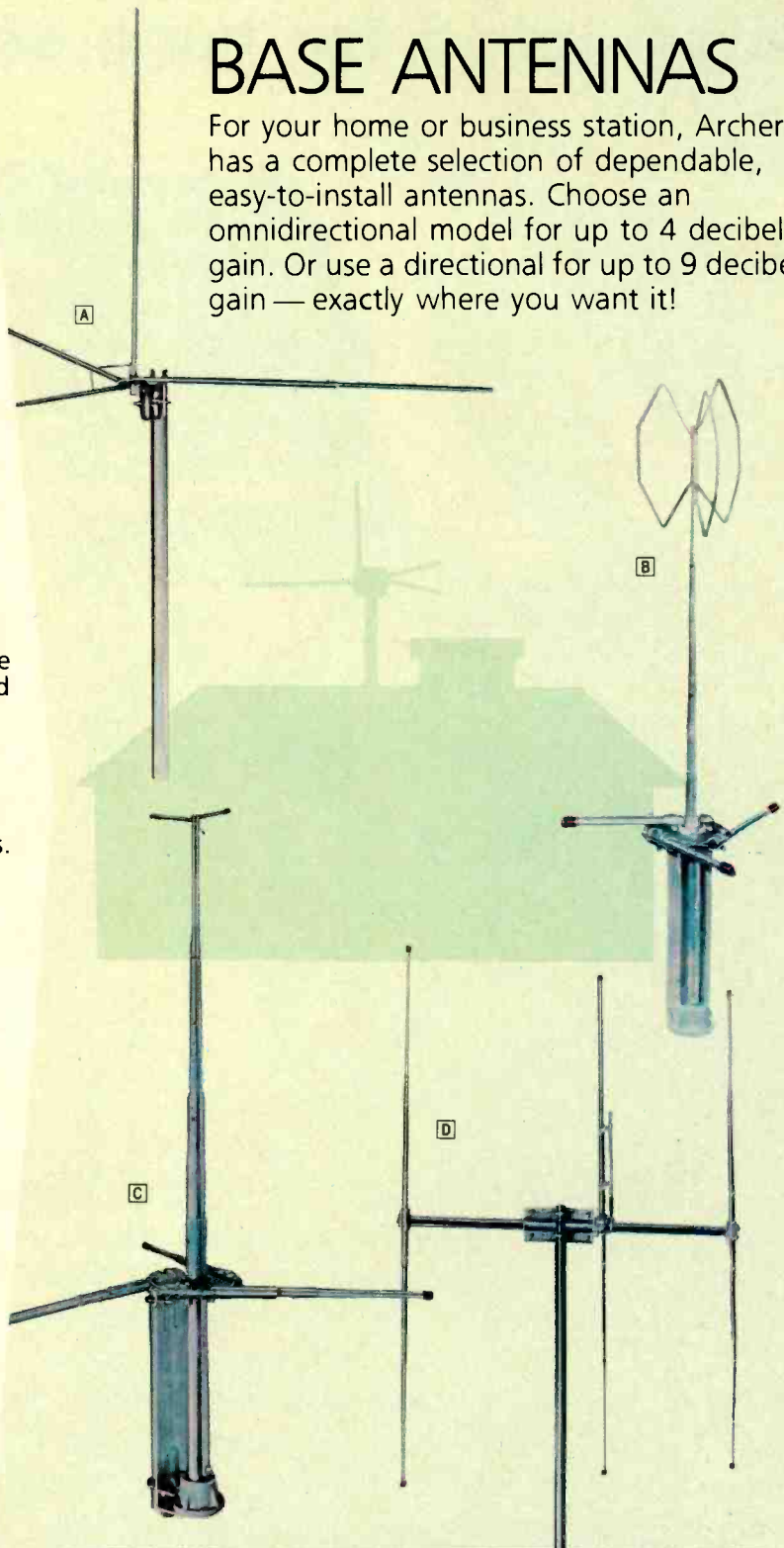

BASE ACCESSORIES

Support your Archer antenna with Radio Shack cable, adapters, connectors, testers, receive and transmit crystals, mikes, books — everything in CB! All made to meet Radio Shack's exacting standards.

will choose an Archer® antenna!

MOBILE ANTENNAS

Archer mobile antennas combine ruggedness, ease of installation, and top signal-grabbing performance. There's an antenna for mounting on any car, truck or RV — often without drilling a hole or lifting a tool. There's even a disappearing model!

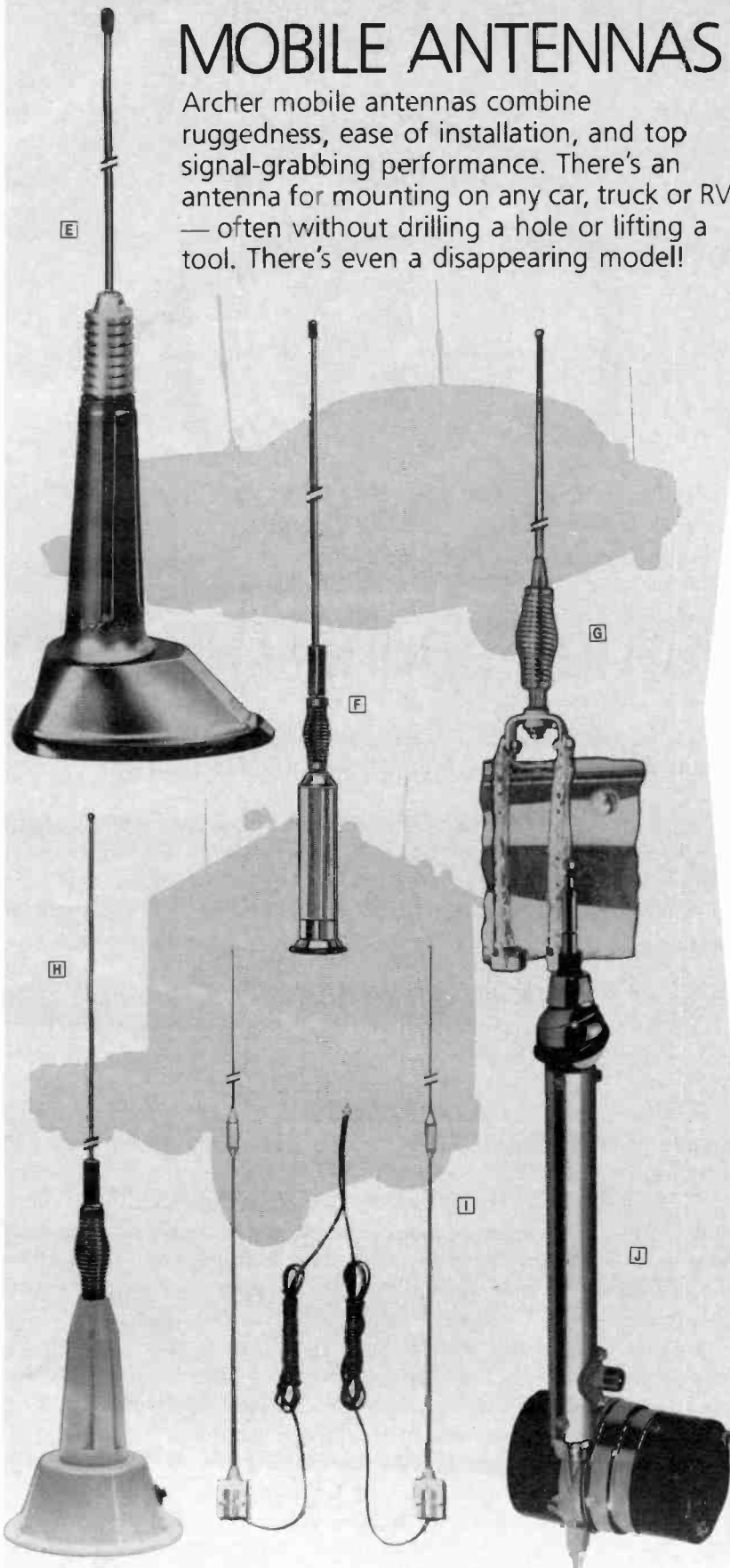

BASE STATION ANTENNAS

Ⓐ ¼-Wave Ground Plane. An omnidirectional that's beta-matched for very low SWR and high efficiency. With U-clamp for masts up to 1½" diameter. 12.95*

Ⓑ ½-Wave Gain-Type. 3.75 dB gain in all directions for more range and reliability. U-clamp. 24.95*

Ⓒ ¾-Wave. Our finest omnidirectional, with 4 dB gain and a low radiation angle for greater signal capture. Fits up to 1½" diameter masts. 34.95*

Ⓓ Crossbow III. Super-directional — lets you aim your power where you need it most, for a minimum of 9 dB gain, with a high 25 dB front-to-back ratio. 12' boom, three 18' elements. Gamma matching. All hardware included. 39.95*

MOBILE ANTENNAS

Ⓔ Graphite Whip. A Radio Shack breakthrough! Base-loaded and springless, it remains more vertical at highway speeds for greater signal output and range. No-holes trunk mount. 41" total height. With 16' cable and connector. 29.95*

Ⓕ 40" Fiberglass Roof-Mount. For cowl, trunk, and fender, too. Base-loaded. With stainless steel shock spring. ¾" snap-in mount. 16' cable and connectors. 19.95*

Ⓖ 102" Stainless Steel Bumper Mount. Full length gives maximum range and efficiency. With hardware to fit most bumpers. Chrome-plated spring. Less cable, connector. 19.95*

Ⓖ Base-Loaded Magnetic Mount. Mounts instantly on any flat metallic surface, won't slip off at normal highway speeds. With cable and connector. 21.95*

Ⓙ Twin Truckers II. Get superior coverage, stronger signal pattern from ahead and behind. Stainless steel, adjustable tip rods. Easy attachment to West Coast-style mirrors. With 18' dual phasing harness, connector. 34.95*

Ⓚ Motorized Disappearing Antenna. Custom-manufactured for Radio Shack to protect you from CB ripoffs. Flip a switch to extend antenna to full 33" length and turn your CB on! Flip again to turn your rig off and retract the antenna. Center loaded. With all installation hardware. 59.95*

SOLD ONLY WHERE YOU SEE THIS SIGN:

Radio Shack®

A TANDY COMPANY • FORT WORTH, TEXAS 76107
5000 LOCATIONS IN NINE COUNTRIES

*Prices may vary at individual stores and dealers.

Channel 9: Aftermath

Reader's
Comments
on Last
November's
Questions:



“Should We Dump Channel 9?”

by Tom Kneitel, TOMCAT, CB RADIO/S9's Editor

IN the November issue we featured a timely topic as our lead feature; discussing the snowballing abuses of the CB emergency channel, Channel 9. I couldn't help but wonder if, in view of how many CB'ers were disregarding its intended use, CB'ers *really* wanted to continue with it—if they felt it needed modification—or if (despite its many abuses) they felt it should remain just as it is. Part of the story was prepared by Gerald Reese, National Director of REACT, whom I invited to say whatever he liked on the matter—he was not limited to the amount of words he could use.

I asked readers what they thought. The results were interesting, to say the least.

Reader response was *enormous*—I knew that folks had opinions on the matter, but I had no idea how wide a range of thoughts would be forthcoming! Several major categories could be determined—those letters from REACT and other Channel 9 monitors which summarized the good work which they were doing on Channel 9 and saw few (if any) problems connected with its use; letters from REACT and other Channel 9 monitors which acknowledged that there were problems and either did or didn't endorse taking any steps to correct them; letters from CB'ers who wanted it continued as is, who wanted some changes made to help straighten it out, and letters from readers

who did not see any need for it at all. There were other categories, and countless variations and sub-categories.

There were even a smattering of letters from highly irate people who, unfortunately, didn't take the trouble to read the article very carefully to see what I said—these people fell into the following categories: those who thought that I was endorsing the discontinuation of Channel 9; and those who looked upon any discussion of Channel 9 which said that there were problems connected with it as blasphemy. One reader even sent me a clipping, apparently from some sort of CB “newspaper” (I don't know which one) in which the “Editor” was accusing me of “doubting the viability or necessity of an allocated emergency channel,” and demanding that his readers write to me to complain about my position (a stunt, I might add, which he himself did not take the time to do!). Well, *one* person sent me the clipping, but I don't know how much of a protest that was! However, it all goes to show that even “Editors” sometimes can have reading comprehension problems.

The fact is that an examination of the November story will reveal that I took no position at all except to state the problem, enumerate *many* possible solutions, and then ask for reader opinions. Any of you who felt that your first read-through of the story had me

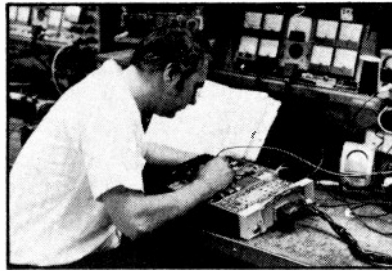

You can turn the CB boom into income...with NRI's complete communications course.

NRI can train you at home for a part-time job or a full time career in communications.

The field of communications is bursting out all over. Millions of CB sets are in operation with millions more being sold annually. That means countless careers in design, installation and maintenance. Start training at home now, the NRI way, to get your all-important First Class FCC Radiotelephone License and qualify for one of these openings.



covers AM and FM Transmission Systems; Radar Principles; Marine, Aircraft, and Digital Electronics; and Mobile Communications. You must earn your First Class Radiotelephone FCC License or you get your money back.

™McGraw Hill CEC

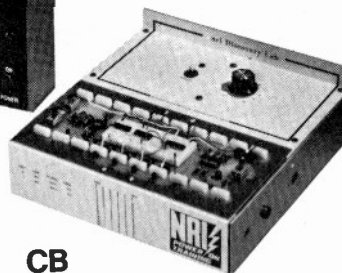

CB Specialist's Course also available.

NRI now offers a special 37-lesson course in CB Servicing. You get your own 40-channel CB Transceiver, AC power supply, and multimeter for hands-on training.

Also included are 8 reference texts and 14 coaching units to make it easy to get your Commercial Radio-telephone FCC License—enabling you to test, install and service communications equipment.



Over a million have enrolled with NRI.

Send for the free NRI catalog and discover why more than a million people like yourself have chosen the NRI way as the right way to get ahead. You learn at home with bite-size lessons, progressing at your own speed to your FCC License and then into the communications field of your choice. There's no obligation and no salesman will call.

If coupon is missing, write: NRI Schools, 3939 Wisconsin Avenue, Washington, D.C. 20016

Learn on your own 400-channel, digitally-synthesized VHF Transceiver.

The 48-lesson NRI Complete Communications Course teaches you to service and adjust all types of two-way radio equipment (including CB), using the one unit that is best equipped to train you for CB, Commercial, and Amateur Communications: a "designed-for-learning" 400-channel, two meter VHF transceiver and AC power supply. Then we help you get your FCC Amateur license, with special instructions so you can go on the air. The unit can be mounted in your car, or you can use it as a base station.

The complete program includes 48 lessons, 9 special reference texts, and 10 training kits. Also included are: your own electronics Discovery Lab™, a new Antenna Applications Lab, an Optical Transmission System, CMOS Digital Frequency Counter, and TVOM. The course

... Use S9 READER SERVICE.



NRI SCHOOLS
McGraw-Hill Continuing
Education Center
3939 Wisconsin Avenue
Washington, D.C. 20016



Please check for one free catalog only. No salesman will call.

- Complete Communications Electronics with CB • FCC Licenses • Aircraft, Mobile, Marine Electronics
- CB Specialists Course

RUSH for FREE Catalog

38-037

- Amateur Radio • Basic and Advanced
- Digital Computer Electronics • Electronic Technology • Basic Electronics
- TV/Audio Servicing • Choose from 5 courses
- Electrical Appliance Servicing
- Automotive Mechanics • Master Automotive Technician and Basic Course
- Auto Air Conditioning
- Air Conditioning, Refrigeration, and Heating • Basic and Master Courses.

Approved under GI Bill if taken for career purposes. Check box for details.

Name _____ Age _____
(Please Print)

Street _____

City /State /Zip _____

A National Home Study Council Accredited School

cancelling Channel 9 should go back and try to read it carefully. And think to yourself that if I were suggesting the cancellation of Channel 9, would I have had the National Director of REACT there to contribute to the story?

So, in poured the letters, some serious and factual with an abundance of statistics, some constructive, some funny, some highly impassioned and emotional, some abusive, some complimentary. While some readers felt that I took a positive approach, others felt I was too negative. And while a few correspondents were unhappy that I mentioned it at all, others thanked me for approaching a tacky problem with the intent of getting a dialog going on the matter.

One reader asked, "If you wanted to be neutral, why did you negatively entitle the story *Should We Dump Channel 9?*" I replied by asking if he would have thought a more positive title would have been *Should We Keep Channel 9?* He didn't answer my letter.

Countless readers told me the story about how the man with the heart attack was saved via Channel 9—the story alternating between the writer's father or friend, or friend's father. Was this *one* heart patient or *many*? Suppose I'll never know.

Of course, one of the basic problems with presenting any timely topics concerns the fact that I'm usually damned if I do and damned if I don't. If I mention that there are people operating on the so-called HF channels, I get letters from readers asking why I am *endorsing* HF operation. If I say that there are problems on Channel 9, I get letters asking why I am *knocking* it! Last year I ran a story on how the FCC was monitoring for people operating on out-of-band frequencies—some readers wrote to say *thanks for the warning*—they were stopping the practice, but others wrote to say that I was being used as a tool of Uncle Charlie for their scare tactics, and still other readers wrote to say that I was running that information in order to *encourage* out-of-band operation. You figure it!

My responsibility to my readers, the way I see it, is to present as much information as possible on the subject of CB—the good and the bad, the sane and the insane; how else can you know what is going on? If I think something is good, I say so—if I think something or someone is stupid, I say so—and it is for my readers to take it from there and make their own decisions. While one month I may run a story explaining HF operation and why many CB'ers prefer it—the following month I may run a story on how the FCC busted a bunch of HF operators and took in \$65,000 worth of radio gear!

If you wanted to learn anatomy, you wouldn't learn much if you studied only *one* side of the body; you couldn't learn medicine unless you studied the body in its healthy *and unhealthy* states—does a medical professor get accused of promoting disease because he mentions that sickness exists! Does a newspaper editor get accused of promoting and endorsing crime when he reports on a burglary? This is the philosophy I have

in bringing you CB RADIO/S9—it's the way I've been doing it since 1962—any of you who wish me to present only a superficial and one-dimensional goody-goody fairy-tale picture of CB radio are going to learn that in CB RADIO/S9 you get it *all* layed out in front of you—CB in all of its glory, in all of its agonies. Would you *really* want less?

So, to me, Channel 9 and the problems therein were simply too important to ignore and—even though I knew there would be a small segment of my readership who would run for the barf bag at my mention of the topic—I dared to discuss it. For those of you who couldn't handle it—*sorry about that!* For those of you who took a serious look at the situation and gave me your thoughts—*thanks!*

More than a few readers wrote with a novel suggestion that the FCC allocate a "secret" emergency channel, the exact frequency of which would not be revealed to the public. The idea being that CB'ers using the frequency could not find it on regular CB equipment. Unfortunately, this defeats the purpose of CB radios—and what would there be to prevent anybody from buying one of the "secret channel" sets and conducting the same type of abuses currently found on Channel 9? And how much trouble would it be to measure and determine this "secret" channel's exact frequency on equipment as simple as a communications receiver. Sorry, poor idea.

I did receive a number of letters bringing to light further agonies connected with the use or attempted use of Channel 9, only strengthening my original contention that something must be done by *someone, somewhere, somehow*, if mobile emergency communications are to achieve *significant* recognition, use, and value.

I'm going to offer you a look into my mailbag, giving you a quickie peek at the range of thoughts sent in by readers—the opinions brought forth by the Channel 9 story, even the letters from readers who couldn't understand or handle my coverage of the topic. I'm sorry I can't run *all* of the letters which came in because they far outnumber the amount of space I can devote to them here. I had to leave out a lot of good ones, and even with those I am going to mention, I have had to capsize down the general sentiments (with fidelity) to get them in. I tried to select those whose ideas were most representative of the ideas sent in by several other readers.

I have generally not included here the large number of letters received from REACT Teams which simply restated or reinforced those opinions previously presented by Gerald Reese, National Director of REACT—these letters supported the concept of continuing Channel 9 on a mandatory basis without change. The overwhelming endorsement of continuing Channel 9 in a status quo position by REACT Teams should therefore be kept in mind when evaluating the comments of others.

Following are some of the thoughts and opinions of our readers:

Gerald G., (SKELETON), of Calistoga, Calif., tells how he had a flat while on *Interstate 5* between San Diego and Los Angeles. His health not permitting him to change a tire, he called for aid on Channel 9, no response! He switched over to Channel 15 (a local in-transit channel), only to be told that he was lying about his location. Another try on a local channel brought him the advice from a base station that he should call the AAA on Channel 9. A second try on the same channel included his saying that he had a 10-33—someone came back and gave him the correct time. A third try got him chewed out for tying up the channel with requests for time checks while others were trying to conduct conversations! A try on another channel brought him a reply from mobile CB'er CON-DOR, who offered to change the tire since he was in the vicinity. Gerald says, "The answer to Channel 9? I think it is the answer to the attitude and helpfulness of people, regardless of the channel they are on!"

Terry W. (QUICKSILVER), Red Ash, Va., says that too many newcomers don't fully understand how Channel 9 is to be used and any operating errors they make involving its use get them "ordered to leave" in an offensive way as they are threatened "with the horrors of breaking the FCC rules and regulations." Terry feels that it starts off a bad impression of those who monitor the channel and perhaps creates a disrespect for the entire Channel 9 concept. Terry adds, "Most CB'ers don't realize that there is a deathly serious side to CB as well as a fun . . . side."

Lee S., (MR FLASH), President of REACT Team #3280, is fully aware of the abuses of Channel 9 but feels that this is the result of public unawareness of the intent of the channel combined with a selfish attitude found with some operators. Lee would like the FCC to intervene, but realizes that there aren't enough dedicated souls across the nation to monitor all the time for emergencies. Nevertheless, Lee feels "It's a mess, yet why should we who care abandon the effort because we aren't 100% effective? Quitters never win; winners never quit!"

Rod B., a CPO in the U.S. Navy, says "Don't give in to channel hogs!"

Charles E., New Orleans, La., claimed that by discussing the problems on Channel 9 I have "done a great disservice" to CB, and done "more harm with this one article than all the good . . . trying to get the channel to begin with."

Walter T., Wayne, N.J., says he'd love to help out on Channel 9—in fact he has attempted to call in several 10-33's but has been unable to get any response in the northern N.J., N.Y. City, and Connecticut areas.

John S., (LIL PUMPKIN), East Northport, N.Y., comments, "My first reaction was to say to dump it, but after thinking your article over a bit I realized the point you were getting at. Maybe you can't get a REACT Team every time, but you still have a better chance of getting a 10-33 through on Channel 9 than on any other channel. Even though it's becoming cluttered, it still gives the average CB'er a route for 10-33's."

Mel T. (PROSPECTOR), Salem, Ohio, comments that Channel 9 should be maintained, but on a voluntary basis—that state police, plus local fire and police agencies should be required to monitor the frequency. Mel also says that they "answer a call for help even though the caller does not announce a call sign" (apparently in Mel's area you can't get a 10-33 through unless you give the monitor a call sign).

John B. (FRIAR TUCK), Grangeville, Ind., suggests that DX enthusiasts be given their own channel(s) to do their thing and that might help to eliminate skip shooting on Channel 9. John also thinks that parents might take a little more interest in some of the things their own youngsters are doing with their CB gear.

Frederick M. (THE OMEGA MAN), Forest Hills, N.Y., says that "If only 1 or 2 lives are saved via Channel 9, then its existence as the mandatory emergency channel is justified."

John B. (THE ROCKIN' CHAIR), Spartanburg, S.C., says "We do NOT need Channel 9 as a mandatory emergency-only channel. FCC 95.85a mandates priority on ANY channel in an emergency and since in many areas you can raise someone on every channel 24 hours a day, 7 days a week, it follows that Channel 9 serves no distinct purpose. A fringe benefit would be to reduce the number of self-appointed cliques on Channel 9 who guard it like Centurians and talk mainly

to one another with the exclusiveness of the angels. On the other hand, such would not deter the truly sincere types who could still monitor Channel 9, however minus the Providential decree. I have called for help several times, and using *any* handy channel, worked every time!

John C., Painesville, Ohio, says it's easier for him to get 10-33's handled on "other channels" with no questions asked. He complains that "on Channel 9 they want to know your life history—and many people simply don't have CB licenses. I don't have a license. Wonder what they would say on Channel 9 if I told them that I don't have a license!"

Thomas H. (SYLVANIA), Eastchester, N.Y., comments that the story on Channel 9 was "loaded with errors" (although he didn't specify any) and "incited youngsters to believe the FCC given the right to regulate radio as an organization of incompetents" (sic). He says that like "most Editors", I am "ruthless and uneducated to our democracy", and that he deprecates my writings as trash.

Peter W. (SPAGHETTI BENDER), Fairborn, Ohio, comments that the story on Channel 9 "was really an honest assessment of the issue which does have a great deal of *sacred cow* to it." Peter has felt a growing frustration with abuses of Channel 9 and is working towards improving the situation.

B. W. (WINN), President of Brazoria Co., Texas, REACT #2988, comments that he read the story with "considerable interest," and that "much of what [was written] is undeniably true." He feels, however, that I took an attitude that some "people are going to break the law regardless of the punishment, so why not bend the rules to make it easier for them to do what they want to." He says that if there were 100 CB channels there would always be violators who would want to do their thing on the emergency channel. In summing up, WINN decided that CB RADIO/S9 is a "fine magazine," and even though the story was basically and undeniably true, he was "sorry to see that you have taken a negative response toward a problem that needs to be met with positive action!"

Henry S. (THE RED ROOSTER), Strongsville, Ohio felt that my discussion of Channel 9 supported its use rather than put it down—and he agreed with that stand. He said, "Even with the few problems that exist with Channel 9, it is still the quietest channel and is still used efficiently."

Melvyn M. (GULLIBLE TRAVELER), Norristown, Pa., feels that "The FCC should be staffed to better enforce the existing regulations which would relieve the crowding on other channels."

Lee Q., Old Bridge, N.J., felt that I was suggesting that Channel 9 be killed—complaining that I said that "some Channel 9 monitors act improperly so they should all be eliminated." (I cannot myself find where I ever said such a thing, or even implied such a scheme—but Lee says that if Channel 9 becomes voluntary, then speed laws should also be voluntary." Whatever that means—Editor.)

Philip W. (THE BIG WHEEL), Springfield, Va., says that Channel 9 should be kept as mandatory—that the minority should not be permitted to punish the majority."

David W. (REBEL), Bellevue, Ky., wants Channel 9 preserved, but says "let's make these idiot monitors understand that REACT nor anyone else is sole guardian of the channel."

Jerry and Linda S., (THE SUBMARINE and THE BINKY BOMBER), Buffalo Grove, Ill., say that the few times they felt the need to use Channel 9, they received no assistance. They added, "If Channel 9 is to continue, we would like to assist in establishing on an *active* national basis."

Bill H. (WILD BILL POLOCK), a PD radio dispatcher in Texas, says, "Keep Channel 9 open, we need it!"

Alice D., (WONDER WOMAN), Merrick, N.Y. says one night she was driving in an unfamiliar area—with her 2 children (one being car sick), lost and afraid, and past the time she was supposed to pick up her OM at the airport. She called for info on Channels 10, 12, and 19—no response. Maybe her rig was dead. She called on Channel 9, she was desperate and felt that her situation was an emergency. She received an immediate reply, however it was that "this channel is used for emergencies. Please change to another channel." She was not advised which particular other chan-

nel to use, nor did the guardian of Channel 9 offer to meet her on another channel to help. She adds that all of the stories she has read about women being helped when late at night are "a crock." She asks, "What is an emergency? I firmly believe that a lost woman with a sick child is in an emergency situation, at least as much as a man with a flat tire!"

Charles C. (SEQUOIA), Pleasant Grove, Utah, says to leave channel 9 alone, "just enforce the FCC rules effectively." He feels that "Channel 9 *Kings*, *private owners*, and *pseudo-cops* should be stopped, but these weirdos are no different than those wanting to abolish channel 9 for their own personal reasons."

Harvey T. (SAVAGE), Va. Beach, Va., observes that it is "obvious" that I am "against the use of Channel 9" and that I "have nothing better to do than find something wrong with Channel 9."

Mrs. J. M. (BIG MAMA), Chicago, Ill., says "should we dump Channel 9, my answer is YES!" BIG MAMA observes that her son belonged to an area REACT team years ago when Channel 9 was "new." Used to spend at least 4 hours per day monitoring—and when the truckers were on Channel 10 all they had to was to easily switch down one channel for aid in a 10-33. She observes "now seldom is anyone on Channel 9, emergencies are handled on Channel 18, which she monitors—she says that even the Smokies seem to be giving preference to monitoring channels other than Channel 9—such as Channel 19!"

Joe S. (C. C. PALM TREE), Corpus Christi, Texas, agrees with maintaining Channel 9, but feels that "there should be some procedures on how to get help from REACT," since too many CB'ers are not sufficiently hip to how to do it.

C. A. C. (TURTLE), President of Mountaintop REACT, in Mountaintop, Pa., observes he can "see both sides," he goes on to say that he thinks "there is a natural tendency to be self-important and we constantly fight this phenomenon but I acknowledge that your readers have very justifiable complaints and I think that some Channel 9 monitors ought to feel ashamed and take heed." One of the solutions he sets forth is to have national leaders offer "more coordination," to head off further abuse of the channel by users and monitors alike.

Jack D. (KINGFISH), Levittown, Pa., wants to know "what special training other than an elementary education and the ability to dial a phone is needed to monitor Channel 9?" He further comments "The CB vigilante groups patrol and respond automatically to anything. These types were known as *ambulance chasers* before the CB boom. Today they join monitoring organizations and wear funny, loud jackets . . . [have] flashing lights, tickets to the latest dance, coffee break, penny sale or whatever else they do between *emergencies*. I would suggest that Channel 9 remain exactly as it is. It's good therapy for frustrated groups that monitor it and since most of that type are self-appointed channel monitor types, the remaining channels get an added bonus of having these people out of the way listening to the eerie silence on Channel 9—while the rest of us on the lively channels answer untold numbers of emergency calls—without jackets, letters, etc."

Thomas P., member of a central Ohio REACT Team complains that REACT should make a greater effort to obtain national publicity on the uses and advantages of a well-run Channel 9. He thinks that most of the problems on Channel 9 are caused by those who just don't know any better.

John C. (GRAY GOOSE), Waterford, Ct., says that my "SWR is high" and so am I.

John C. (EARLY BIRD), a member of the Montgomery County REACT Team #2477 in Texas, says he invites more and more people to use Channel 9, adding that "the majority of people are afraid to break on it because they have been led to believe some sore-head may run them off." He further adds that even if the channel becomes totally overrun with nonsense in the future, his Team will still be "in there trying to help the breakers."

John I., (QUICKSILVER), New York, N.Y. (an employee of a major radio network's news staff) was in Florida for the big hurricane last August. A call came through on a local CB channel from a CB'er requesting aid for a woman hit by a car. He landlined the police, as did two other CB'ers. Soon after someone else asked for help with an auto accident. John then switched over to listen on Channel 9 to see what was



happening there—what he heard made him “sick.” He says he heard “what I presume to be local REACT bases keeping a virtual constant chatter with a lot of number codes thrown in. I can’t say whether what they were saying was important, but I did feel that if I wanted to break Channel 9 that night, I would probably have given up and gone to one of the local channels . . . which was apparently just what everybody was doing!” A few nights later John heard a break from an operator who required a tow truck, so John asked the mobile unit to switch over to Channel 9 with him. When he got there “local REACT bases kept stepping on our traffic, so I took the mobile unit to another channel where it took me about 10 minutes to copy vital info through the noise. Whatever the truth of what happened those two nights, it is high time that REACT and whoever else has self-appointed themselves as Guardians of Channel 9 come to realize that they have no official status, no right to interrupt a legal CB base operation from handling a 10-33. I personally would think twice about giving any assistance to REACT. ALL channels are for ALL licensed CB’ers. They would do well to heed the message.”

Robert S. (BOBCAT), Brooklyn, N.Y. wants Channel 9 made voluntary “providing those who are chatting there sign off when someone wants to use it for a 10-33.

Joseph M. (CRAZY HORSE), Oakdale, N.Y., finds “with respect to REACT we should all bow our microphones in a minute of silence and then remove Channel 9 from the untouchable list.” He says that “in the few instances that I needed help for myself or someone else; as a good CB’er I went to Channel 9. I found the channel dead and couldn’t get help there, but could easily get helped on 10 or 19 where I was aided by a Smokey with ears. So if help can’t be obtained on a channel reserved for help, it’s a dead channel. It it’s dead, let’s bury it now!”

Alfred H. (J-A), Levittown, Pa., is a member of several Channel 9 monitor groups and is aware that “some REACT and ALERT Teams try to be official, but you have to use consideration and try to be both friendly and firm; without these ethics you cause hard feelings.”

As you can see, feelings are running high on the matter, and somefolks really did become emotional on the topic. I suppose that we could have sat back and ignored it all, played it safe—but that’s not going to solve any problems, is it?

I would say that if Channel 9 is to be continued as a mandatory emergency channel then there are some changes in attitude, procedures, and concepts which are going to have to be “adjusted” in order for it to be fully successful.

These adjustments are going to have to be made by those who monitor the channel, by those who use it, by those who *abuse* it, and even by the FCC. But to pay lip service to the *promise* of a National Emer-

Peter A. (MOUNTAIN MAN), Lyndonville, Vt., criticizes CB RADIO/S9 for the story, says we have sold-out to the “masses,” those people we mention would pass by a stranded motorist. He says that in his area the REACT Team to which he belongs requires “positive identification from any caller. Handles won’t do, unless we know the CB’er involved.”

Carson S. Mesa, Ariz., comments that “the lack of understanding or consideration for Channel 9 monitors does not deter the critics from requesting emergency assistance.”

Michael T., an officer of San Jacinto REACT #2860 in Texas, wrote to say that the story “made the hair on the back of my neck raise up many times.” He finally decided that I must have “been crossed at some time or another on Channel 9 and that is why you are taking the position you are. I have been receiving this feeling, reading your articles, for the last 2 or 3 months, and feel that you might be trying to settle a score, in your magazine, rather than going to the source of the problem.” He says that in his area they “do not have the problem with people using Channel 9.”

Bruce M., a member of REACT in Louisville, Ky., noted “your comments on Channel 9 are very valid and should not be taken lightly,” and it is his feeling that it would be a “fatal mistake” to reduce the status of the channel. He says “Let’s leave it alone!”

Ralph S. (HARLEY MAN), a Missouri State Highway Patrol trooper, says that Channel 9 is vital to him because “it is impossible to copy any 10-33 traffic on Channel 19 with numerous 4-wheelers trying to give your location.”

Richard P. (TAO MOBILE), Huntington, N.Y., wants “Channel 9 . . . given back to general usage unless the FCC can guarantee that there will be a responsible monitor to *receive* all transmissions and transmit only in emergencies. This monitor should not think he is one step below God.”

James B., Esperance, N.Y., says that CB needs a channel for 10-33’s where there are no music-players or poets to jam up 10-33’s.

James O., Bamberg, S.C., observes “Delete Channel 9: Serious operators are capable of taking 10-33’s. As for REACT, they monitor Channel 11 in this area. The

Police are on Channel 9.”

Michael R., St. Louis, Mo., claims that “many of the claims” of REACT are “unfounded, at least in the St. Louis Area.” He does however belong to another Channel 9 monitoring group which he says has provided better service and which has never been written up in CB RADIO/S9. For this and many other reasons, including the fact that we did not print a picture he sent us of his station, that we are “inciting arguments” with ham operators, tolerate the use of CB handles, have tried to exploit prostitution via CB, run disgusting ads, he is “sick and tired of the crap” we print.

Martin R. (UNIT 1477-C), Chattanooga, Tenn., felt that our analysis of Channel 9 took a lot of “intestinal fortitude but was something that was badly needed.” He felt that “certainly to bury one’s head in the sand and pretend that there are no problems connected with Channel 9, or to be afraid to discuss them, is to become qualified for the *Chicken Award*.” Martin predicted that the story would “for sure, let everybody know that CB RADIO/S9 is there with its fingers on the pulse of CB, anxious to create a dialog between CB’ers which will result in effective communications.”

Pati R. (PEPSI), Secretary of Montgomery REACT #3481, in New York, admits that they have had their “share of problems with the misuse of Channel 9. The good outweighs the bad. Channel 9 is there to help the people. How about the people helping Channel 9?”

Ed (Unit 977-E) Arlington, Tex., says that the Channel 9 story not only “hit the fan, it also hit the spot and was sorely needed, especially by some of the monitors in the Dallas-Ft. Worth area,” whom Ed finds “arrogant beyond belief and convinced that they were given a mandate to control all emergency communications.” Ed says that S9’s comments regarding Channel 9 were received “rather poorly by some of these folks” who were running around for weeks clucking like a bunch of stirred up chickens, telling everybody that you had come out *against* Channel 9.” (Editor’s note: We received a larger-than-proportionate amount of mail from the Dallas-Ft. Worth area. Apparently more than one group is monitoring since some correspondents offered praise, however the majority of writers felt much improvement was needed).

gency Channel, without *everybody* in full agreement as to how, when, where, and why to use it seems, to me, to be an exercise in time-wasting. Unless you’ve got nothing better to do with your time!

There are many factions in CB—somehow or other we are going to get it all together and work towards providing fully adequate mobile emergency communications. Of course—CB RADIO/S9 can always look the other way and pretend that there are no problems; then again a few of you get upset with us when we do speak about them. That will do as much good as the fellow who discovers the early symptoms of what might be a serious illness, but avoids going to see a doctor because he doesn’t want to hear the diagnosis!

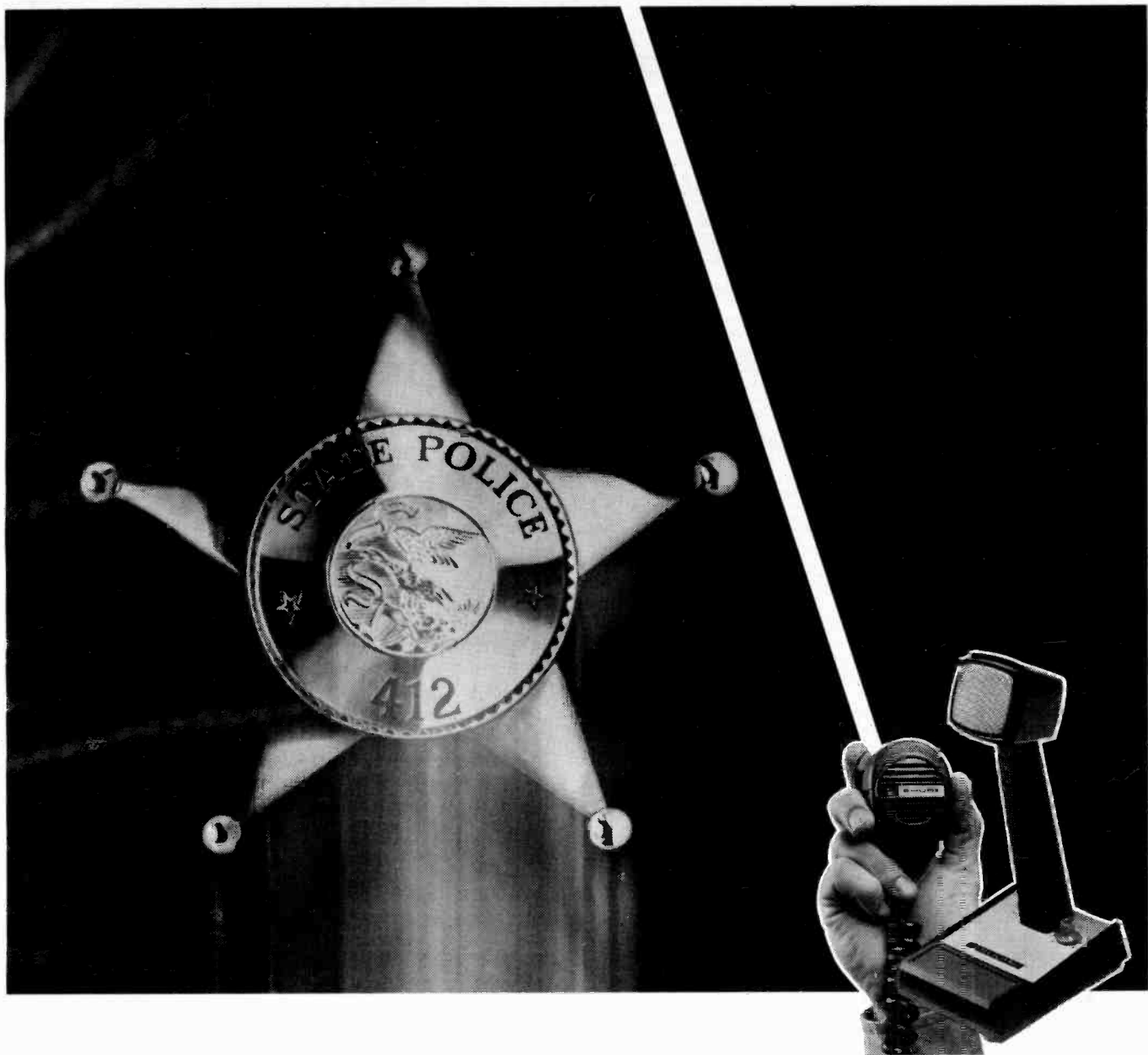

The microphones of the stars.

Now you can have professional reliability in a Shure CB microphone. This means 100% more "talk power" than the utility mics usually supplied with CB rigs.

More men behind the stars—state and local police—use Shure professional hand-held and base station microphones than all other brands combined. And for good reason: They rely on their Shure mics as if their lives depended on them!

The exclusive ARMO-DUR® case stands up against intense heat, humidity, rust, acid corrosion, and

shock. Crucial wear points—cable, talk switch, and hang-up button are specially engineered and tested for extraordinary durability.

There is no quicker way to upgrade your CB transmission. Just ask the "stars." Send for our complete CB microphone brochure (AL556).

Shure Brothers Inc.
222 Hartrey Ave.
Evanston, IL 60204

In Canada:
A. C. Simmonds & Sons Limited

MANUFACTURERS OF HIGH FIDELITY COMPONENTS, MICROPHONES, SOUND SYSTEMS AND RELATED CIRCUITRY.

TECHNICORNER

MOBILE CB MICS: Dual impedance to match virtually any transceiver without extensive rewiring.

CONTROLLED MAGNETIC® element for greater output.

Base Station CB Mics: Model CB41 has a CONTROLLED MAGNETIC® element, dual impedance for use with electronic or relay switching.

Model 526T has a transistorized preamplifier, dynamic element, variable output level control, and is usable with electronic or relay switching.





PALOMAR East. Ltd. WORLDWIDE ELECTRONIC DISTRIBUTORS

Palomar Square, 80 Blaisdell Rd., Orangeburg, N.Y. 10962

2629 North 24 Drive, Phoenix, Arizona 85009

FOR SPEED SERVICE: phone (914) 359-8800 plus the new Arizona No. (602) 257-8404



PALOMAR East. Ltd. WORLDWIDE ELECTRONIC DISTRIBUTORS

Palomar Square, 80 Blaisdell Rd., Orangeburg, N.Y. 10962

2629 North 24 Drive, Phoenix, Arizona 85009

FOR SPEED SERVICE: phone (914) 359-8800 plus the new Arizona No. (602) 257-8404

15 16 17



S9's Monthly Column for Sidebanders

ON THE SIDE.....

by Bill Sanders,
1849, KW-5304
SSB-295

FIXEM-UP DEPT.: SIDEBAND ID NUMBERS

Single Sideband operators don't use AM type handles or unit numbers for identification purposes. Instead they use special Sideband ID numbers. Those many readers who have written to us asking about how they may obtain a set of these numbers are advised that we recommend joining the SSB Network, which is the nation's oldest and largest group of Sidebanders. A self-addressed stamped envelope sent to the Sidebanders' Service Bureau, P.O. Box 381-R, Smithtown, N.Y. 11787, will bring you information telling how you can become a part of this vast network. Their national "SSB" ID numbers can be obtained without cost or fee. We suggest that all Sidebanders avail themselves of this opportunity to join this network—even if you are a future Sidebander, or an old-timer who already has "local" numbers.

CLARIFICATION

Some operators have written asking about problems in adequately clarifying incoming signals to the point where they can be understood—a most unpleasant effect upon the eardrums!

Several things can take place which would result in your inability to clarify the other station—and they are not quite so horrifying as malfunction of your equipment. So before you panic—your problem might be caused, for instance, by the fact that the station you are attempting to clarify might be on the "other" sideband. Maybe everybody in the world is on 16-Lower, and that's where you're monitoring—but perhaps he's on 16-Upper, either deliberately or because he doesn't realize that folks are on 16-Lower, or maybe he *thinks* he's on 16-Lower but selected upper-side on his selector switch—perhaps he forgot altogether and is still using Ancient Mary! Well, those are *some* reasons why some stations seem to defy clarification. *More* reasons? Sure!

Maybe while you're cussing him out in your mind you had better check out how you have your own rig switched—perhaps you clicked to upper sideband while you thought you were on the lower—or maybe you're still listening on AM!

UPPER END

As mentioned previously, most sideband operators are staking out the lower sides of Channel 36 through 40, in addition to any previously established sideband channels. In a few areas we have heard that they are attempting to set up all the way from as low as 32 through 40—which seems to us to be unrealistic when you consider the ratio of Sidebanders to the total number of 11 meter operators crowding onto the channels. If you remove Channels 9 and 19 from the running, you've got a total of 38 channels remaining. By setting up on 32 through 40 (plus say 2 other previously used channels from the original 23), you have sidebanders proposing to set up on a minimum of 11 channels from a total of 38—that's saying that about 30% of all 11 meter operations are on sideband! I don't think that this is a realistic figure at this time and I also don't think that we are reasonable in attempting to expect any cooperation at all from AM'ers in respecting *our* channels if we propose *claiming* a lopsided and unrealistic share of channels.

It seems to me that right now Sidebanders may consist of about 15% to 20% of the total number of stations on the air—some estimates are only 10%!

I'm the first one to stand up and shout for and defend channel space for Sidebanders, but I haven't been sold on irresponsible gobbling up everything in sight. Thus far I have received a considerable amount of mail in support of using 36 thru 40 and it seems that in some areas Channel 36-Lower is establishing itself as a calling channel in addition to 16-Lower.

MAILBAG

Bill, SSB-1427, of San Diego, passes along word of a new sideband rig known as the CP-300, made by Communications Power Inc., 2407 Charleston Rd., Mountainview, Calif. 94043. The specs look really good and we hope to have additional data on this unit soon.

Joseph, from Nutley, N.J., SSB-1956, asks about the Q-Codes—when/where/how did they originate? He says that he hears only ones starting with QR, QS, and QT—and asks if that covers them all. Well, Joe, I understand that the Q-Codes (or Q-Signals) go back to pre-radio days into the realm of landline telegraph where

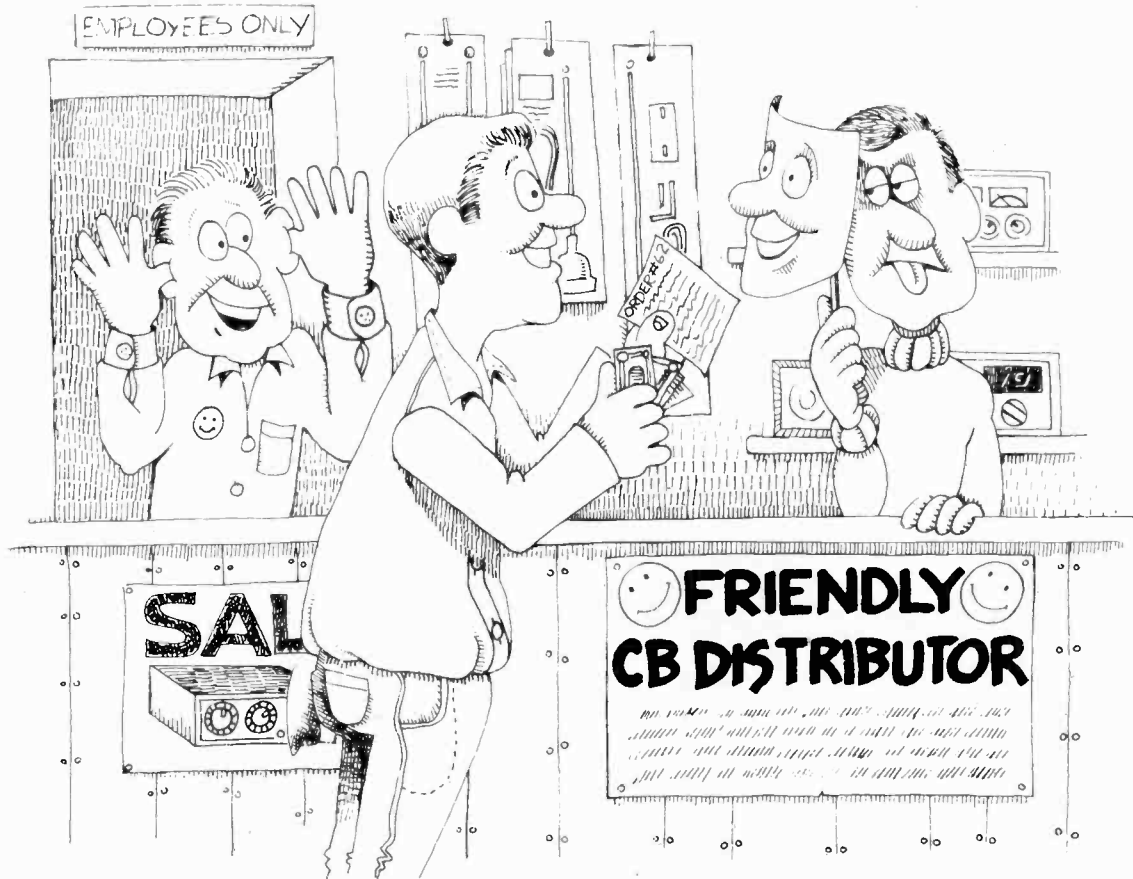

DEALERS, DOES YOUR DISTRIBUTOR REALLY CARE?

We really can't say anything about the "other guy," but at **BENNIES**, your business counts. Every dealer we handle gets the best service possible, including a weekly mailer of specially priced items you'll have to see to believe! Send \$5.00 (deductible from your first order if made within 90 days) and your tax number for our giant new 248 page catalog, and see the difference for yourself. **BENNIES**. We're the distributor who cares. Sorry, catalog only available to dealers.



Serving Quality-Conscious Dealers and Distributors Coast to Coast

BENNIES

WAREHOUSE DISTRIBUTION CENTER
R.D.1 BERWICK, PA. 18603 717-759-2201

they were originally devised as communications short-cuts. The exact date or their origin and who their inventor was may well be lost in antiquity, however most of the 3-letter combinations starting with the letter "Q" are actually used for communications, even though only a small number of them are suitable or ever heard on the sideband channels. Some starting with QA are strictly for aeronautical use, there are also dozens of others relating to maritime direction finding, to the handling of telegrams, etc. One of the gag ones which is sometimes heard on the CW Ham bands is QLF, said to mean, "Now try sending with your left foot."

Gene, SSB-3289, of Marrero, La., wonders about the oncoming sunspot/skip situation—and asks if stations wishing to take fullest advantage of long-haul DX reception would do better by tilting their antennas upward towards the ionosphere. It's really a rather complex matter, Gene, but there would be *no* advantage to doing this, and leaving the antenna parallel to the ground's surface would offer best all-around results. Tilting the antenna upwards might well cut down on that incoming long-haul stuff, while also ably hindering local coverage. Some 6-meter Ham operators even claim that tilting the base station beam 5° downward is really *better* than leaving the antenna parallel to the ground, as this compensates for ground surface signal distortion which might shape the signal upwards.

Jack Gould, formerly of the metro New York area (he was the Radio/TV Editor of the *New York Times*

for many years) is now basking in the sun in California. He passes along the information that in the northern part of the state the Sidebanders seem to like to congregate on Channel 23!

Bill, NY4113/WW232, of Marietta, N.Y., informs me that the upper *and* lower sides of Channels 16 and 17, as well as 18-Lower are used in the northern parts of New York State. Some of the local clubs in this area include WX, WW, UFO, WR, NY, YZ, and TSS. This would include from above Watertown south to Binghamton, and between Rochester and Albany.

A few issues back I mentioned *The Coyote*, well known Sidebander from Bermuda. Harold has subsequently dropped us a note to say that his actual ID's are BDA-064, 78W64, and VOB-64—and that he was honored to be mentioned in *CB RADIO/S9* since he is always amazed to find out that he gets his signal off the island! Harold uses a SBE Console II with a power mike. Harold has just erected the first and only Avanti Moonraker IV on Bermuda—has brought in Brazil, the Canal Zone, South Africa, Switzerland just about every state in the union. We'll be listening for you, *Coyote!*

Mary, NB-306-1/2, who gives out NB numbers in the area of Fremont, Nebraska, passes along the suggestion that when members of clubs give out ID numbers over the air they also give the recipient a quickie outline of some of the local operating customs and channels. We second the motion, Mary—and anybody else listening in who *isn't* a newcomer might also be reminded too!

PAL
PAL

Firestiks™ "Rabbit Ears"

make you hear YOU HEAR!

NEW SUPER TIP!

NO TUNING NEEDED

TOP LOADED FIBERGLASS



NEW LOW 50 CH. SWR

THE SIDEBANDER'S CREED

Here's a creed sent to us by the SSB Network—conceived for the Sidebander. We present it here because we feel it is an admirable guideline, one which if followed by all on the sideband channels, would make for top-notch QSO conditions.

You can cut this right from the pages of *CB RADIO/S9* and hang it in your radio room, looks nice framed. If you don't want to slice up your magazine, we've made arrangements with the *SSB Network* for readers of *CB RADIO/S9* to obtain a beautiful copy of this printed on nice color stock. There isn't any cost—however you'll have to enclose a *self-addressed stamped* No. 10 (that's one of those 3 X 4½ jobs) *envelope*. If you *don't* enclose the self-addressed stamped envelope you *won't* receive this. Indicate in your request if you are a member of the *SSB Network* (state your *SSB Network* ID numbers)—while these Creeds are available to *all* who properly request them, they ask that those who are members of the *SSB Network* please identify themselves!

Here's a welcome addition to any Sidebander's radio room, and *CB RADIO/S9* makes it possible for you to have one—*no cost, no catch!*

To receive your *free* copy, send a request including a *stamped self-addressed No. 10 return envelope* to: Sidebanders' Service Bureau, P.O. Box 381, Smithtown, N.Y. 11787.

PAL "Firestik" Antennas are for quality-minded CB radio operators.



ELECTRONICS CO.

A Div. of Fire Comm. Corp.
2614 E. Adams
Phoenix, Arizona 85034

SEND FOR FREE **PAL** FULL LINE CATALOG AND DECAL INQUIRIES INVITED

PLEASE CHECK: USER DEALER DISTRIBUTOR
(Please Print)

NAME: _____

ADDRESS: _____

CITY: _____

STATE & ZIP: _____

THE SIDEBANDERS' CREED

As an 11 Meter Sideband Operator, I recognize my obligations:

To my fellow operators, who depend upon me to follow established good practices, procedures and courtesies.

To my neighbors, who may be required to entrust their lives and safety to my skill and judgment during times of emergency.

To the Sideband organization of which I am a member, which relies upon me to present myself to other operators in a manner which will be a credit to that organization.

To discharge these responsibilities, I will at all times observe the highest standards as an 11 Meter Sideband Operator.

I will never knowingly cause interruption or interference to another Sidebander engaged in communications.

I will make all efforts to respect the proper use of any channel(s) established in my area for the purposes of calling only.

I will operate only on those channels which are normally used for single sideband transmission, and will endeavor to advise others of these channels in order to keep them clear of non-sideband transmissions.

I will use only those sidebands which are normally used by other Sideband operators in my community.

I will aggressively maintain my proficiency as a Sideband operator and keep abreast of electronics and communications developments so that my operation, which largely depends on such knowledge, may be of the highest order.

I will conduct myself on the air to reflect credit upon myself and other Sidebanders.

I will constantly strive to keep my standards high.

I pledge adherence to these principles, so that I may contribute my part to more efficient communications, and advance the dignity and continued growth of the national Sideband movement on the 11 Meter Band.

Operator's Signature

SSB Network ID # _____

Which 40 Channel Antenna Do You Need?



By Herb Friedman

If you spend even a few minutes monitoring the old 23 channels you're certain to hear at least one self-styled expert running the 17 expansion channels into the ground. It isn't some comment to the effect the new 40 channel rigs "ain't built like the old ones", at the very least our expert will spout endless technical gobblegook proving a 40 channel transceiver won't work too well with a 23 channel antenna, or a 23 channel transceiver won't load "all the soup" into a 40 channel antenna.

Getting transceivers out of the way first, just about any 40 channel transceiver, because of tighter F.C.C. type-acceptance requirements, is *better* than its 23 channel counterpart (in the same price and quality category). As for antennas, a few antenna manufacturers trying to play the game fair and square gave the CB experts the opportunity to confuse many CB'ers with technical expertise straight out of Alice In Wonderland.

The plain truth is that most of you already have a 40 channel antenna, or at the very least an antenna capable of efficient performance from one end of the band to the other. Those of you who don't have full-40 coverage with your present antenna at the very least have sufficient efficiency to get by until you can afford an antenna capable of high efficiency on all 40 channels. At most, only a handful of CB'ers in any neighborhood have an antenna so inefficient on the new channels it calls for immediate replacement.

The key to antenna coverage is the antenna system's VSWR, or SWR as it is more commonly known to CB'ers. Bear in mind that contrary to anything you have heard or read, in a mobile CB installation a VSWR of 2:1 or less is good. Fact is, there is no receiving station that will discern any difference from a mobile with a 2:1 or 1:1 VSWR. In actual practice transceivers usually deliver good-to-excellent performance working

into mobile antenna systems with a VSWR as high as 3:1, but as a general rule we can say and prove that a VSWR or 2:1 or less is the desired value.

Now this means that any transceiver will work efficiently on *any channel* if the antenna system VSWR is 2:1 or lower. It makes no difference whether the antenna is a "23 channel model", a "40 channel model", or a bent coathanger; if the VSWR is the same for each antenna the transmitter loads just as efficiently into one as it will into the other two.

How the energy the transmitter feeds into the antenna is radiated is determined solely by the antenna design and usually has nothing to do with the channel in use. For example, the 108 inch CB whip will outperform any 42 inch base loaded whip on any channel if they are compared from the same mounting location.

Okay, at this point you might logically ask: "Is there really a reason I should buy a 40 channel antenna?" The answer depends on what type of antenna you're presently using.

Though 40 channels might sound to the ear like a large number, they represent only 440 kHz of spectrum, a bandwidth easily handled by virtually any 108" ($\frac{1}{4}$ wavelength) whip. For example, the worse-case VSWR measurements from five different size cars using $\frac{1}{4}$ wavelength 108" whips was 1.7:1 across all 40 channels. On some cars the VSWR ran no higher than 1.5:1 across all 40 channels when using a full length whip. So you see, if you're using a full length whip you've probably got the best 40 channel antenna you can buy.

The problem in channel coverage comes in when we start to use loading coils in order to reduce the physical length of the antenna. Though the antenna remains an *electrical* $\frac{1}{4}$ -wavelength its size can be shrunk down to 18-inches through proper application of loading coils and matching networks. But the greater the loading

the narrower the antenna's bandwidth. As the loading coil inductance is increased, and depending on the position of the loading coil, the higher the VSWR at frequencies removed from the precise resonant frequency of the antenna. As a general rule, the lower the loading coil the narrower the bandwidth: a base loaded antenna has less bandwidth than a top loaded antenna.

Now it is easy to claim that since a "loaded" antenna has a less narrow bandwidth than a full length whip a new antenna is required for 40 channels. The real truth, however, is that every loaded antenna we tested, regardless of type, that was 48 inches or longer worked efficiently across all 40 channels. Top loaded, center loaded, or base loaded, if the antenna could be "tuned"—adjusted for lowest VSWR—to channels 19 and/or 20 the worse-case VSWR at any frequency was less than 2:1. The 48-inch top loaded helicalwound whips which have no tuning adjustment had a VSWR less than 2:1 within the old 23 channels, but no higher than 2.8:1 VSWR on channel 40, so even this antenna could perform with acceptable efficiency on the expansion channels.

Problems come in with loaded antennas less than 48 inches, and the shorter the antenna the greater the possible problem. The common 42 inch loaded antenna (measured from the mount to the tip) can easily handle 40 channels if center or top loaded. Base loaded models might have a slightly high VSWR on channels 1 or 23 if not tuned for the precise center of the band. They cannot cover all 40 channels efficiently; base loaded antennas with VSWR as high as 6:1 is not uncommon if channel 1's VSWR is under 2:1. (Getting a 2:1 or lower VSWR from center or top loaded 42 inch whips takes some very careful adjustment of the tuning stub, but as we said, it can be done.)



More than ever a VSWR check of mobile antenna systems is required to insure optimum radiation. Make certain you check for a low VSWR on channels 1, 19/20 and 40. Don't accept a low VSWR in the middle of the band and assume it's okay on the ends. That used to be true for most 23 channel installations; for 40 channels you can't make any assumptions.

... Use S9 READER SERVICE.

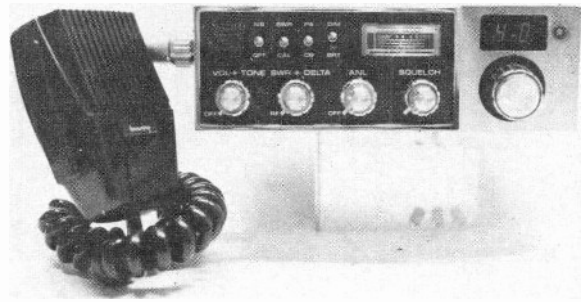

That 40 on the channel indicator of this Browning "Sabre" represents just another seventeen channels to some CB'ers, to others it means reduced antenna efficiency and the need for a new or different antenna. As you'll see, it's really "48" that turns out to be the magic number.

As the antenna gets shorter than 42 inches the VSWR gets completely out of hand. We've seen antennas in the 18 to 25 inch range running VSWR values higher than 10:1 on channels 1 and 40.

In short, 48 inches appears to be the minimum size for a standard antenna to cover all 40 channels; so if you already have an antenna 48 inches or longer it probably requires only a slight "tuning" for full-40 coverage. As a general rule, if you tune the antenna for minimum SWR on channels 19 or 20 you'll probably pull in the entire bandwidth of the 40 channel CB band.

As for the shorter antennas; the old models simply won't hack it. But if you need a short full-40 antenna don't worry too much, technology has a habit of catch-

(continued on page 79)

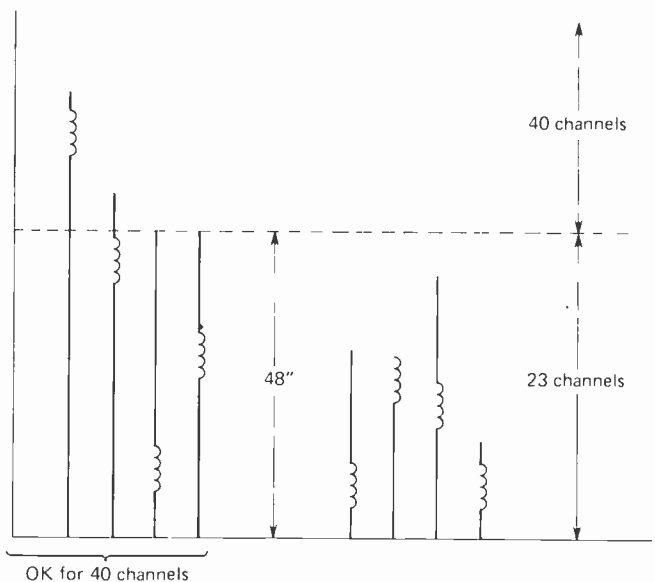

48-inches is the magic number regardless of antenna type. Full length 108-inch whips, top loaded, center loaded, base loaded, it makes no difference, if the antenna is 48-inches or more from base to tip it will most likely work very well on all 40 channels. Antennas less than 48 inches cannot give full-40 coverage; and the smaller the antenna the fewer the number of channels covered with low VSWR. But we can expect the antenna manufacturers to soon come up with short (less than 40-inches) antennas that will be efficient on all 40 channels.

Bill Orr on Antennas

PART 13: THE QUAD BEAM ANTENNA

LAST month this column started a discussion on *gain antennas*. The popular Yagi beam was discussed in detail. And this month we'll have a penetrating look at the *Quad beam antenna*.

In order to start off on the right foot, the definition of *power gain* is given once again: power gain (or signal gain) is a term used to express the power increase noted in receiving or transmitting of one antenna as compared to a standard reference antenna. By comparing all antennas to a standard antenna it is possible to make comparisons between individual antennas and to determine a figure of merit for the antennas, based upon the signal gain.

The reference antenna used in the industry may be either a dipole antenna or an isotropic antenna and the manufactured antennas are compared against one or the other in terms of power gain. The unit of reference is the *decibel*.

One more point: a beam antenna is an antenna that concentrates radio energy in one direction at the expense of radiation in other directions. (Remember the searchlight comparison?).

The Quad Beam

Of great interest to the active CBer and the radio ham alike is the famous *Quad* antenna (sometimes called a *Cubical Quad*). The name comes from the square, or diamond, shape of the antenna. Originally developed by a radio ham, and first used at the short-wave broadcast station HCJB in Ecuador, the Quad is probably the only gain antenna that was not developed in the antenna laboratory.

The full story of the amazing Quad antenna is told in the book, "*All About Cubical Quad Antennas*"¹ written by the author of this column. As the discovery of the Quad principle is of interest to CBer and radio ham alike, a short excerpt from the book is given herewith:

In the year 1939 a group of radio engineers installed radio station HCJB at Quito, Ecuador to transmit programs to North America. The station radiated 10 kilowatts, but it was found that the

Yagi beam antenna erected for the station was useless at the 10,000 foot elevation in the Andes that was the home of HCJB. The beam wouldn't work because of the enormous corona discharge at the tips of the elements which eventually melted the aluminum tubes.

Clarence Moore, the engineer of HCJB, took the problem to task, and after a great deal of thought evolved the idea of a pulled-open folded dipole (Figure 1), devised from an early form of television antenna. The advantage of the pulled-open dipole, or quad-shaped loop, was that it had no ends to the element, thus preventing the formation of corona.

A Quad antenna consisting of two elements was hastily built and put on the air. As Moore remembers, "Warily, the crew of tired builders watched the new antenna through the long operating hours of the night. The vigil continued during the evening hours as the jungle exhaled its moisture collected during the hot daylight hours. The tension of the onlookers grew as a film of dew collected on the antenna wires and structure, but not once did the new Quad antenna flash over or break into a deadly corona flame. The new Quad antenna design distinguished itself in a short time

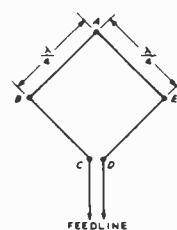
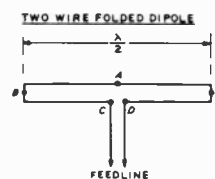

Fig. 1—Derivation of the Quad loop. At top is the folded dipole, a simple antenna developed for TV reception before World War II. The dipole is normally fed with TV-type "ribbon line". If the dipole is "pulled open", as shown in the bottom drawing, a Quad loop is formed. Points A through E correspond with the same points shown for the dipole. (Drawing courtesy of Radio Publications, Inc.).

¹"All About Cubical Quad Antennas", William I. Orr, Radio Publications, Inc., Box 149, Wilton, CT 06897. \$4.75 plus 35¢ postage and handling.

as reports flooded the station, attesting to the strength of the signal”.

Clarence Moore patented his antenna, and other shortwave broadcast stations—as well as radio hams—built the new, amazing antenna, born in the wilds of Ecuador. It shortly became “topic number one” wherever radio hams and antenna engineers gathered to discuss antennas and DX.

After World War II, the Quad was widely accepted as an effective shortwave beam antenna and various models of it have been made by manufacturers the world over. And by 1965, it was one of the more popular CB base station antennas.

The Quad—How Does it Work?

For purposes of this discussion, let's examine the driven element of the Quad, forgetting about the reflector and director for a moment. It is convenient to borrow the description of the Quad element given by Clarence Moore—“a pulled-open, folded dipole”. This antenna consists of two closely spaced half-wave dipoles connected in parallel at their tips. One of the dipoles is fed at the center with a transmission line (Figure 2).

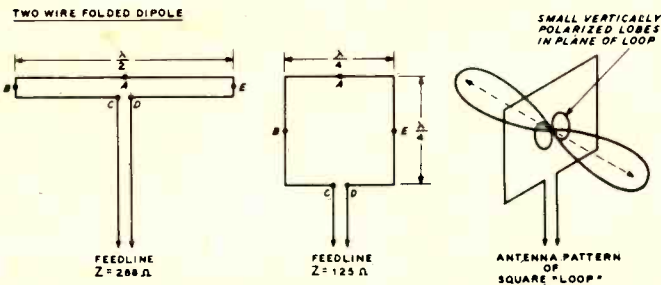

Fig. 2—The folded dipole (left) may be pulled open in the form of a square (center) as well as a diamond. Operation is the same in either case. The Quad loop has much the same radiation pattern as the dipole (right) with the addition of minor lobes at right angles to the main lobes of radiation. These “ears” usually disappear when the Quad elements are formed into a beam antenna. In this illustration, the Quad loop is fed at the bottom and horizontal polarization results. If the loop is turned on its side, polarization is vertical. (Drawing courtesy of Radio Publications, Inc.).

The folded dipole works exactly the same as a simple dipole, except that the radiation resistance at the feed point is four times the value of a single dipole. The single element has a radiation resistance of about 72 ohms, and the folded dipole element has a radiation resistance of about 288 ohms. The folded dipole was a very popular antenna in the early days of TV and it is one reason why TV “ribbon line” is commonly called “300 ohm line”. It was designed to be used in conjunction with the folded dipole.

Moore made the discovery that when the folded dipole was pulled open into a diamond-shape, or a square, the radiation resistance dropped sharply and the loop exhibited the usual characteristics of the dipole, *except that it showed a power gain of nearly 2 decibels over the dipole!*

(continued)

the end of the drab CB antenna

MAYCOM ColorWhip™

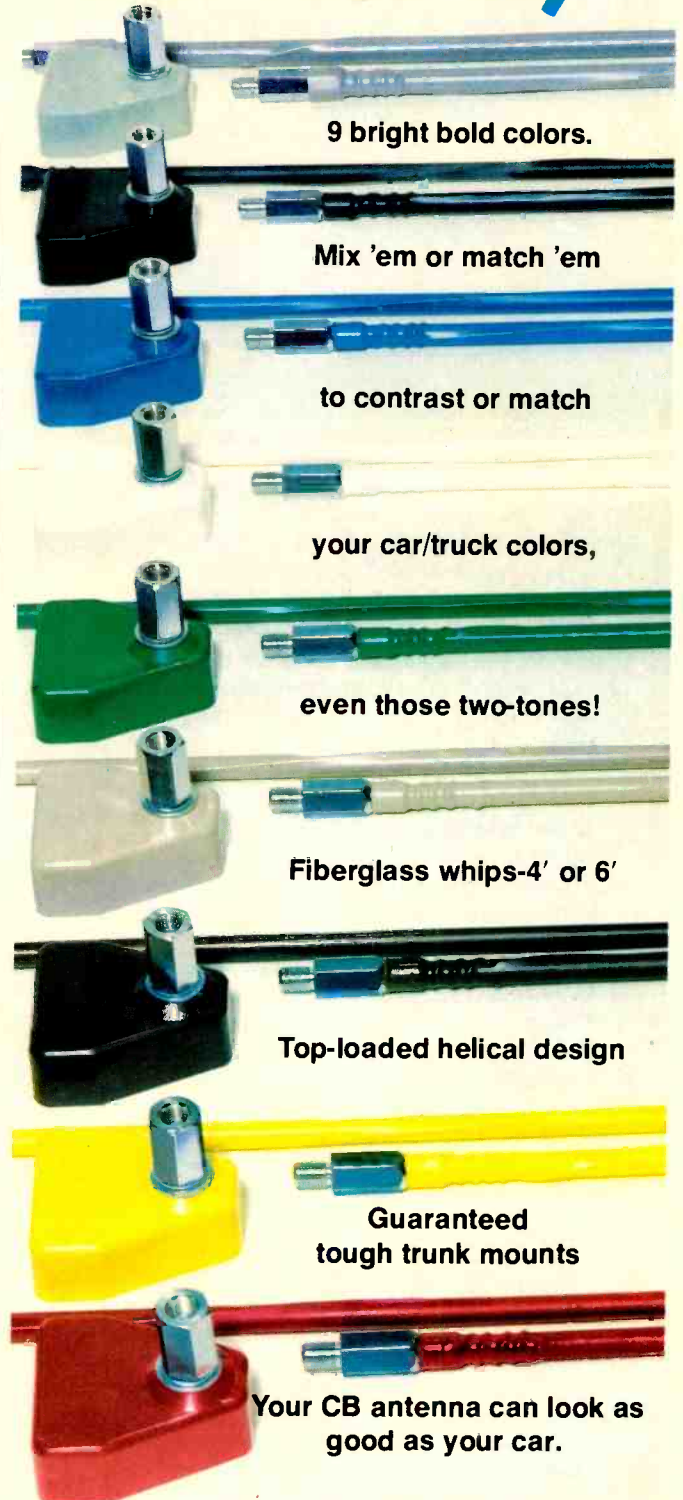

9 bright bold colors.

Mix 'em or match 'em

to contrast or match

your car/truck colors,

even those two-tones!

Fiberglass whips-4' or 6'

Top-loaded helical design

Guaranteed
tough trunk mounts

Your CB antenna can look as
good as your car.

Ask for ColorWhip at your dealer.

Dealer and distributor inquiries invited

MAYCOM

Communications Products

Stevensville, Mich. 49127 (616) 429-8541

Ride with the No.1 Traffic Radar Detector...

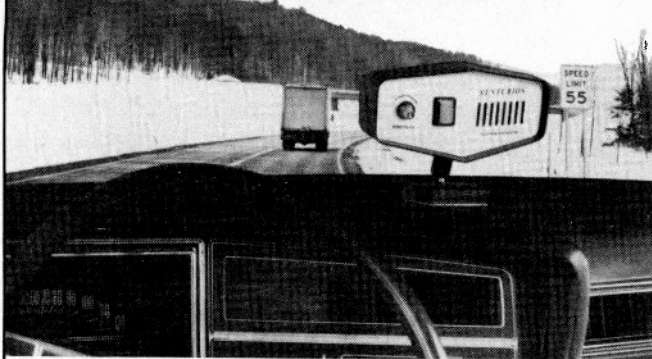

SENTURION by Radatron

Why settle for anything less! Choose Senturion, the traffic radar detector designed for professional drivers, and put safety up front.

- Continuously monitors all types of highway radar
- Gives advance warning of radar-controlled speed and danger zones
- 12-volt operation — plugs into cigarette lighter (positive or negative ground)
- Exclusive extra-long-range antenna design
- Simultaneous dual warning — light plus audible tone
- Exclusive automatic noise limiter circuit
- Mounts on dashboard or clips onto visor
- Rugged die-cast metal case with glare-free black finish
- Handsome modern design blends with all car and cab interiors
- Made by Radatron, the company which pioneered traffic radar detectors fifteen years ago.



SENTURION IS AVAILABLE nationwide from dealers who handle the finest quality automotive and electronic products. And it's realistically priced. See it at your nearby dealer, or write for literature to

senturion

RADATRON CORPORATION

2424 Niagara Falls Blvd. • North Tonawanda, N.Y. 14120 • Phone (716) 731-4171
In Canada: Len Finkler Ltd., 25 Toro Rd., Downsview, Ontario M3J2A6

Helping you put safety first on the highway.

BILL ORR ON ANTENNAS (continued)

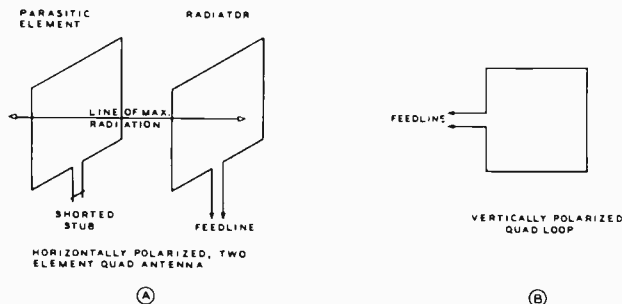

Fig. 3—Original Quad beam design provided horizontal polarization (A). A small stub was added to the parasitic element to tune it either as a reflector or as a director. By turning the radiator (driven element) on its side, the array is vertically polarized (B). The parasitic element "doesn't know" whether the polarization is horizontal or vertical, so it does not have to be turned. It works equally well with either polarization. (Drawing courtesy of Radio Publications, Inc.)

This was a *very* interesting discovery, as it led the way to a beam antenna composed of a number of loops, acting as directors or reflectors. The original Quad antenna was horizontally polarized (Figure 3), but by simply turning the antenna on its side, with the feedline at the middle of one side as shown in the drawing, the antenna became vertically polarized.

The early Quad antennas were tuned up with an adjustable stub, or variable wire section, in the parasitic elements, but additional design work has rendered this stunt unnecessary. The two element Quad was found to have a power gain of nearly 7.5 decibels over a dipole, and that gain is approximately equal to the power gain of a three element Yagi antenna!

Moore's development of the Quad element has led to many interesting variations of gain antennas. Adding reflector and director Quad elements to the Quad loop has produced a powerful beam antenna, one that is relatively easy to adjust. Today's Quad beams boast as many as three or four director elements, in addition to the reflector element and many base stations make use of this interesting antenna.

Quad Versus Yagi—Is There Any Significant Difference?

A direct comparison between the effectiveness of a Quad and that of a Yagi is difficult to make and the results of on-the-air checks between the two types of antennas are often inaccurate and confusing. Laboratory field strength measurements of the power gain of the Quad over a test dipole may lead to confusing results and are often open to various forms of interpretation. Unless such tests are run by unbiased observers on a well-calibrated antenna range, the difference in power gain between two gain antennas of about the same physical size will be lost in the inherent measurement error of the test set-up. Antenna tests repeatable to an accuracy of a decibel, or better, are difficult to manage even under the best of circumstances.

Extensive tests over the years imply that the Quad antenna exhibits an advantage over a Yagi (having an equal number of elements) of nearly two decibels. Is

(continued on page 73)



This is an in-dash
40-channel CB
and an AM/FM multiplex stereo
and a stereo cassette player.

We call it
The Clarion Car System™

It's the 40-channel CB you've been wanting. It's the car tape player you've been looking for. And it's the superior AM/FM stereo you've been needing.

All in one.

It's Clarion's inspired idea: a sophisticated music and communications center, without under-dash clutter—the Clarion Car System.™

The system is modular for compactness and security. The in-dash unit measures just 2¼ by 7½ inches! Most of the CB controls are on the mike, for safety, so you can operate with one hand.

The separate transceiver can be mounted anywhere in your car for maximum security and easy access. This ingenious modular approach gives you flexibility, and

obsoletes the bulky under-dash add-ons that have made so many cars unsightly—and vulnerable.

The Clarion power antenna adjusts to any position with a flick of the finger. And, for security, it

retracts out of sight. Our power antenna can replace your present antenna, eliminating the need for a separate CB installation.

And of course, a wide selection of fine Clarion speakers completes The System.

The Clarion Car System gives you a choice of three models: with AM/FM Multiplex cassette, with 8-track or AM/FM Multiplex alone.

And the big plus: you get Clarion's 30 years of engineering and experience: Clarion is the largest maker of car stereo systems in the world. You may not have heard of Clarion—but you've heard Clarion!

The Clarion Car System is that 40-channel, compact, high quality music and communications system you've been waiting for.

Clarion also gives you *Instant CB!*™ It's our super-compact unit that converts any existing car stereo into a 40-channel CB.

Wait no longer. Get with your nearest Clarion dealer now.



1 The CB/AM-FM multiplex tape player goes in-dash.

2 The mike contains CB function controls.

3 The CB transceiver module goes anywhere, out of sight.

4 The speakers come in a wide range of types and styles.

5 The motorized antenna adjusts to any height—or disappears.

The Clarion Car System



The most listened-to, unheard-of car music systems in the world.

©1976 by Clarion Corporation of America, 5500 Rosecrans Avenue, Lawndale, Ca. 90260

Shakespeare's White Knight. The best antenna going. And coming.

Shakespeare comes on strong for the new 40 channel era. With high performance CB antennas that turn on the power on all 23 or 40 channel CB transceivers.

Shakespeare's new White Knight Antenna combines the rugged, mechanical strength of gleaming white fiberglass with precision engineered electronic components. Components like the high quality loading coil permanently fused in a solid polycarbonate thermoplastic base. Totally impervious to the environment. And pre-tuned to an SWR of 1.9 to 1 or less over the 40 channel band (1.3 to 1 or less at the center). To assure maximum range and peak performance everytime you key the mike. That's what sets the White Knight antenna apart from all the others.

Ride full tilt into the 40 channel era with the new White Knight CB Antenna. And take the Shakespeare performance route home.

The White Knight Antenna, Style 4125/available in a variety of pre-assembled mounting styles. Complete with cables and connectors. Under \$25.



Shakespeare

Coming on strong for the Knights of the Road.

Shakespeare Company/Antenna Group, P.O. Box 246, Columbia, S.C. 29202
In Canada: Len Finkler Ltd., Ontario.



TRAM

Why settle for less?

The new 40-channel mobiles are here! It's a new generation of high performance Tram CB radios with PLL circuitry and more useful features than ever before. If you're ready to move up to Tram, you can have full 40-channel operation, mic gain, adjustable ANL, adjustable tone control and modern digital channel display.

Ask your CB dealer about the new mobiles by Tram. He'll tell you that dollar-for-dollar, feature-for-feature, you can't find any better than Tram. They're the mobiles with Tram base station quality and craftsmanship built in. And that is what makes Tram the standard of excellence in the CB industry.

The mark of CB quality since 1960

TRAM/DIAMOND CORPORATION, Lower Bay Road, P.O. Box 187, Winnisquam, N.H. 03289

This device has not been approved by the FCC. This device is not and may not be offered for sale, lease or sold or leased until the approval of the FCC has been obtained.

Telex CB power mikes deliver control tower performance on all 40 channels.

The power mike you hold

The power mike you wear.

CB-73

Handy Double-Header feature allows use as a conventional power mike or a superior, noise-cancelling power mike.

Built-in variable gain amplifier.

Front mount ends mike fumbling. Mike comes off bracket in talk position. Rear mount also included.

Long-life coil cord.

Fits every hand. The style used by pilots around the world.



CB-88

Includes eyeglass clip for use without head band.

Noise-cancelling variable gain power mike.

Boom adjusts for precise mike position, pivots for left or right use.



Telex CB-1200 Headset

Experienced Cber's can tell the difference. Telex CB power mikes give you the talkpower and range to make the most of your rig...without over-modulated distortion. And, they deliver the reliability and performance that has made Telex the quality standard in aviation communications.

Take the CB-73 Double-Header power mike, it actually "processes" voice signals for maximum clarity. The noise-cancelling mode brings you through crisp and clear by blanking out surrounding noise.

Or consider the aviation-type Telex CB-88 power mike headset. So light, you'll almost forget you have it

on. It puts the receiver sound right into your ear and assures that your power mike is in the proper transmit position. Others around you can relax, sleep or visit while you listen in private.

If you're operating in noisy areas, check out the Telex CB-1200 headset. It really blocks out highway and vehicle noise.

Whatever your CB use...cars, vans, RVs or long-haul rigs...if you're serious about CB, consider upgrading to Telex. You'll come through loud and clear.

Write for free Telex microphone fact book.

The Pilot People

TELEX

COMMUNICATIONS, INC.

9600 Aldrich Ave. So., Minneapolis, MN 55420 U.S.A./Europe: 22 rue de la Legion d'Honneur
93200 St. Denis, France/Canada: Telak Electronics, Ltd., Scarborough, Ontario.

Introducing the Hy-Gain 40-channel CB System.

We make the whole works to make it work better.

Model 426. 40-channel
FM/AM/CB disguise
antenna. 40."



Model 2683A. 40-channel mobile transceiver. Phase Lock Loop. Automatic modulation control. Switchable Automatic Noise Level. Combined illuminated S/R/SW-R meter. True noise blanker.

There are two important parts to 40-channel CB radios. The transceiver and the antenna. It's important for you to know that. Because unlike ordinary radio, CB radio band waves are much more subtle and sensitive.

In order that you get the maximum in clear transmission and reception, you should buy your CB transceiver and antenna the same way you buy the coat and pants for a suit. Together.

Of all the people who make 40-channel CB radios, only one is a major manufacturer of both radios and antennas. That's Hy-Gain.

So when you buy a Hy-Gain CB radio and antenna, you're buying a CB system that's been made for each other. When something is made together, it works better. That's our CB system.

Model 2680A

Model 2683A



Model 2682A

Model 674C

hy-gain
WE KEEP PEOPLE TALKING.

Johnson CB is all new for 1977. Quietly efficient, beautifully uncomplicated.

Our new 40-channel Messenger CB radios are a study in electronic elegance. With a clean uncluttered appearance; with engineering advances and features you can't get on any other CB. The quietest, most fully featured CB's Johnson has ever designed. The perfect blend of form and function.

But that's what you'd expect from a company that's been making CB radios longer than anyone else in the business. A company that designs and builds the most sophisticated, professional 2-way radio equipment money can buy... the E. F. Johnson Company.

And for 1977, Johnson delivers more quality, more features and more value per dollar than ever before. We deliver more because we design and build every Messenger CB right here in the U.S.A. We watch every

operation. We control quality every step of the way. We operate every radio before we release it, then we back it up with a one year parts and labor warranty plus more than 1,000 Authorized Johnson CB Service Centers.

We started fresh with our 40-channel line. We devised a totally new frequency synthesis system: our exclusive X300D CMOS IC chip... a single chip with a complete phase-lock-loop circuit for greater accuracy and reliability.

Other Johnson quality features are: a completely redesigned receiver for quietest operation... our exclusive Tapered Automatic Noise Limiter (TANL), the only noise limiting system in CB that adjusts itself for optimum clarity and quieter listening all the time... our own voice tailored audio circuitry to drop off unwanted frequencies... our unique electronic speech compression for maximum transmit range.

Johnson CB is quality CB. Quiet, efficient, beautifully functional.



JOHNSON

PERSONAL COMMUNICATIONS DIVISION
E. F. JOHNSON COMPANY, CLEAR LAKE, IOWA 50428



Johnson. The 40-Channel CB you can take seriously.

this advantage in power gain that the Quad shows over the equivalent Yagi worth the effort of building (or assembling) the Quad, which some frustrated builders classify as a mechanical monster? After all, a Quad is a three dimensional object having length, width and height. The Yagi, on the other hand, is a two dimensional object having only length and width. Addition of the third dimension (height) to a construction project immensely increases assembly and erection problems and also increases the wind resistance of the antenna. No doubt about it, the Quad is a bulky, unruly, hard-to-handle assembly, usually of fragile construction. The Yagi, on the other hand, is simple to assemble, rugged and easily moved about on the ground and atop the tower.

The Quad Wins!

The conclusion drawn by this writer from both objective and subjective tests over the years is that the Quad antenna has a definite advantage over the Yagi. The extra two decibels of power gain, element for element, does make a difference over the long run. Under difficult conditions, the Quad seems to out-perform the Yagi most of the time in a matter that is not readily explained by a mere comparison of antenna gain. Sometimes a Yagi seems to be better than an equivalent Quad, but the reverse seems to be true under more circumstances and over a longer period of time.

Element for element, the power gain difference between the Yagi and the Quad is shown in Figure 4. The advantage seems to grow less as the number of elements are added to each antenna. As an example, a comparison of the two element Quad with the two element Yagi shows the Quad is better by about two decibels. The five element Quad, on the other hand, is better than the Yagi, but only by about one decibel. An examination of the chart shows that a two element

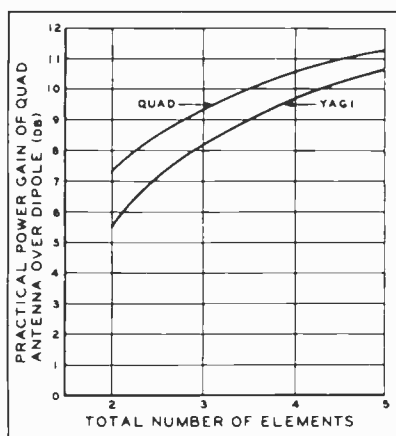

Fig 4—A comparison of power gain between the Yagi and the Quad antenna. For an equivalent number of elements, the Quad exhibits a power advantage over the Yagi of nearly two decibels. Expressed in terms of overall boom length, the Quad has about two-thirds the boom length of a Yagi for equivalent power gain. As seen from the chart, a two element Quad is about equal to a three element Yagi, as far as power gain goes. (Drawing courtesy of Radio Publications, Inc.).

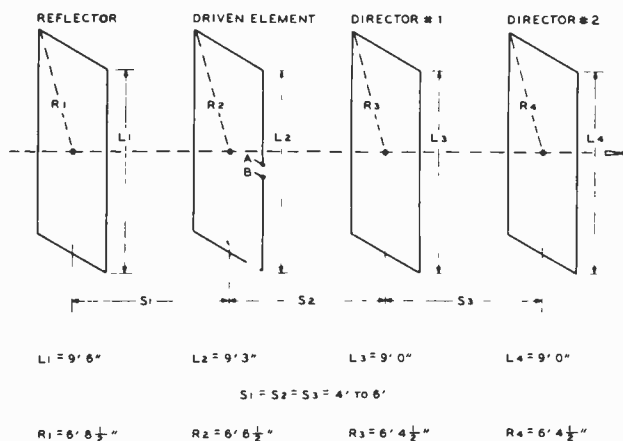

Fig. 5—Electrical diagram of the Monster Quad. A reflector and two director loops are used in this effective beam antenna. Driven loop (second from left) is fed by a coaxial transmission line at points A-B for vertical polarization. Parasitic loops (reflector and directors) are continuous wires, having no electrical connections made to them. Loops are square, with top and bottom wires parallel to the ground. Side wires are in the vertical plane. Loops are made of #14 enameled copper wire. Approximate dimensions from center of loop to corner (R1-R4) is given to aid in drilling the Quad arms. (Drawing courtesy of Radio Publications, Inc.).

Quad is about equal to a three element Yagi, a three element Quad is about equal to a four element Yagi, and so on.

The Monster Quad—King of CB Antennas

Several manufacturers sell a four element Quad antenna for CB service. The original design for this antenna is shown in Figure 5, with the dimensions derived by the author of this column. The Monster Quad makes a 5 watt CB transmitter equivalent in “talk power” to one of nearly 125 watts input working with a ground plane antenna. That is to say, substitution of the Monster Quad at your station for a ground plane antenna is equal to boosting your transmitter power input to 125 watts in a completely legal manner. Best of all, the impressive power gain of the Monster Quad (over 10 decibels better than a dipole or ground plane) is also achieved on received signals as well as during your transmission. The Monster Quad can literally make a weak signal jump right out of the noise level and interference often encountered when using a low gain, nondirectional antenna for receiving. (continued)

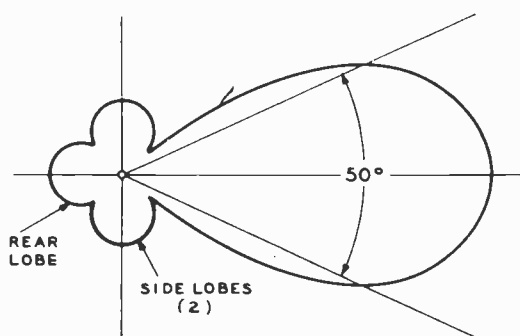

Fig. 6—Polar plot of the Monster Quad shows a tight, 50 degree radiation pattern as seen from above the array, looking down. Reduction of signals from sides and back is very good. Array must be aimed accurately for best results. (Drawing courtesy of Radio Publications, Inc.).

BILL ORR ON ANTENNAS (continued)

The Monster Quad also cuts down interference received from signals arriving off the sides and back of the beam, as it provides a narrow, tight 50 degree pattern, as shown in the polar plot of Figure 6.

The Monster Quad is a complex antenna assembly and its construction is recommended only to those knowledgeable CBers who have gained experience in building beam antennas and who, in addition, have the yard area available to assemble the beam. If you have the know-how and the space, be assured that your efforts and the expense will be amply rewarded by the signal power gain of this hefty beam antenna.

The basic electrical design of the Monster Quad is shown in Figure 5. It is a four element array using two director loops, a driven element loop and a single reflector loop. Each loop is about nine feet on a side (a quarter-wavelength at 27 MHz).

Spacing between the loops is not particularly critical and may be as little as 4 feet or as great as 6 feet, with only minor change in beam performance. When the smaller element spacing is used, the power gain of the Monster Quad is decreased about one decibel from maximum value, but the front-to-back signal ratio is maximum. At the greater element spacing, the power gain is at maximum value at the expense of a slightly decreased front-to-back ratio.

Realistically speaking, element spacing really depends upon the available overall boom length. If six foot spacing is used, a boom length of over 18 feet is required. Aluminum tubing (rectangular cross-section) may be purchased up to 21 foot lengths but round tubing seems to be available only up to 12 foot lengths. Round aluminum *pipe*, on the other hand, may be obtained in 21 foot lengths.

For those who wish to build their own Monster Quad antenna, some assembly hints and suggestions will be given in next month's column. For those CBers with a fat purse, various Quad antennas can be purchased from a number of manufacturers.

A Quick-Disconnect UHF Connector

In closing, I'd like to draw your attention to a nifty, new gadget. It is a quick-disconnect coaxial plug (Figure 7). This new *Amphenol* product is especially suitable for CB work as it provides a fast, simple means of making a termination for cables which are frequently disconnected. For example, mobile CB rigs can be quickly disconnected and removed from a vehicle which will be left unattended, to help prevent a rip-off.

Assembly procedure is identical to that for the standard PL-259 plug and for use with RG-59/U cable a reduction adapter is needed.

Don't forget, however, that a slip-on plug can be a slip-off plug, too. It remains to be seen if vibration will loosen this useful gadget, and until it is determined

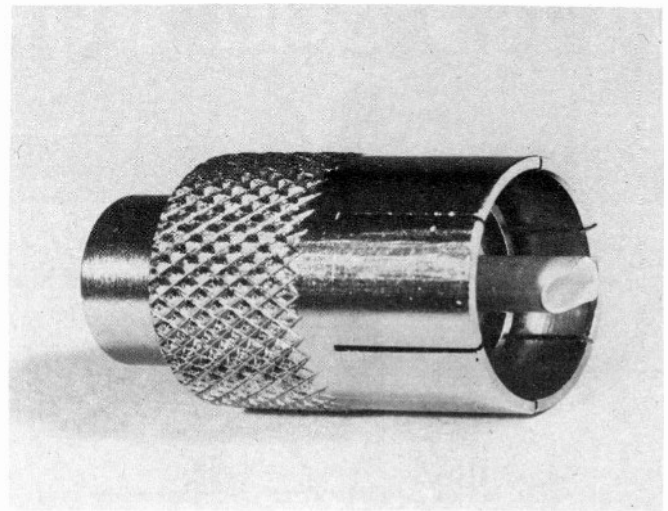

how reliable the new plug is under vibration, it should be used with caution in a mobile application. In any event, it is a great idea, and the push-on *Amphenol* coaxial connector should prove to be a popular CB item.



Para Dynamics Corporation

A Subsidiary of
OEA, Inc.

RF Power Scanner PDC 700	RF Power Scanner PDC 600
	
RF Power Scanner PDC 137	PDC 2812 Frequency Counter
	

FEATURES ON THESE QUALITY AMERICAN MADE PRODUCTS INCLUDE:

- * **Power Function**...output power is indicated directly on the power meter. The power switch positions 10, 100, and 1000, correspond to 0 - 10, 0 - 100 and 0 - 1000 watts on the meter.
- * **Modulation Function**...modulation level is indicated directly on the modulation meter. This allows full time monitoring of modulation during transmission. The operator can make compensation of his voice level by making an adjustment in the microphone position or through the use of modulation boosters.
- * **SWR Function**...the Standing Wave Ratio is indicated on the SWR meter and allows continuous monitoring of the forward and reflected power ratio. This function is a must for CB'ers to determine how well their Antenna mismatch may occur because of weather conditions, poor contacts of antenna sections, oxidation, cable leakages, etc.

PDC 500 & 600 FEATURE SIMULTANEOUS READ-OUT. PDC 137 FEATURES POWER AND SWR FUNCTIONS ONLY.

PDC-2812 FREQUENCY COUNTER

1. Frequency Range DC-40 MHZ (Minimum)
2. Power Source 10-15V DC or 117V AC
3. 4 MHZ Crystal Oscillator
4. Large, easy to read, Five Digit Print-Out
5. BNC and Through Line Inputs

14501 N. 73rd St., Scottsdale, AZ. 85260 (602) 991-1600

Nuts and Bolts Dictionary

By Harold Perry

A Special THANKS to our Goodbuddies who sent in these great CB Slang words.

Bob Larson KHK - 1360 (Buckeye Hobo) Monclova, Ohio

P. J. Shea (The One Turkey Buzzard) Sarasota, Florida

LADY BUG STATE



The Lady Bug is the state insect of Ohio.

DOLPHIN MOUNTIE



That's the Florida State Marine Patrol. Other Names for Marine Police are "Waterbear" and "Smokey the Fish"

HAVE YOU GOT A CB SLANG WORD THAT I DON'T HAVE? (You probably do!) Then send it to me and I'll put it in the next issue of S9 with your name and handle. In case of duplicate definitions the one postmarked first will be used. SEND postcards to: HAROLD PERRY c/o S9 Magazine 14 Vanderventer Ave. Port Washington, New York 11050

CB SPECIALS-R.F. DRIVERS-R.F. POWER OUTPUTS-FETS

2SC481	1.85	2SC767	15.75	2SC866	5.85	2SC1449-1	1.60	40081	1.50
2SC482	1.75	2SC773	.85	2SC1013	1.50	2SC1475	1.50	40082	3.00
2SC495	1.10	2SC774	1.75	2SC1014	1.50	2SC1678	5.50	2SC608	4.85
2SC502	3.75	2SC775	2.75	2SC1017	1.50	2SC1679	4.75	SK3046	2.15
2SC517	4.75	2SC776	3.00	2SC1018	1.50	2SC1728	2.15	SK3047	3.75
2SC614	3.80	2SC777	4.75	2SC1173	1.25	2SC1760	2.15	SJ2095	3.50
2SC815	3.90	2SC778	3.25	2SC1226A	1.25	2SC1816	5.50	SK3048	3.25
2SC616	4.15	2SC779	2.50	2SC1237	4.50	2SC1908	.70	SK3054	1.25
2SC617	4.25	2SC798	3.10	2SC1239	3.50	2SC1957	1.50		
2SC699	4.75	2SC781	3.00	2SC1243	1.50	2SF8	3.00	2SK19	1.75
2SC710	.70	2SC789	1.00	2SC1306	4.75	HEP-S 3001	3.25	2SK30	1.00
2SC711	.70	2SC796	3.15	2SC1306-1	4.90	2SD235	1.00	2SK33	1.20
2SC735	.70	2SC799	4.25	2SC1307	5.75	MRF8004	3.00		
2SC756	3.00	2SC802	3.75	2SC1307-1	6.00	4004	3.00	3SK40	2.75
2SC765	9.50	2SC803	4.00	2SC1377	5.50	4005	3.00	3SK45	2.75
2SC766	10.15	2SC839	.85	2SC1449	1.30	40080	1.25	3SK49	2.75

JAPANESE TRANSISTORS

2SA52	.60	2SB187	.60	2SC458	.70	2SC815	.75	2SC1569	1.25
2SA316	.75	2SB235	1.75	2SC460	.70	2SC828	.75	2SC1756	1.25
2SA473	.75	2SB303	.65	2SC478	.80	2SC829	.75		
2SA483	1.95	2SB324	1.00	2SC491	2.50	2SC830	1.60	2SD30	.95
2SA489	.80	2SB337	1.00	2SC497	1.60	2SC839	.85	2SD45	2.00
2SA490	.70	2SB367	1.60	2SC515	.80	2SC945	.65	2SD65	.75
2SA505	.70	2SB370	.65	2SC535	.75	2SC1010	.80	2SD68	.90
2SA564	.50	2SB405	.85	2SC536	.65	2SC1012	.80	2SD72	1.00
2SA628	.65	2SB407	1.65	2SC537	.70	2SC1051	2.50	2SD78	1.50
2SA643	.85	2SB415	.85	2SC563	2.50	2SC1061	1.65	2SD151	2.25
2SA647	2.75	2SB461	1.25	2SC605	1.00	2SC1079	3.75	2SD170	2.00
2SA673	.85	2SB463	1.65	2SC620	.80	2SC1096	1.20	2SD180	2.75
2SA679	3.75	2SB471	1.75	2SC627	1.75	2SC1098	1.15	2SD201	1.95
2SA682	.85	2SB474	1.50	2SC642	3.50	2SC1115	2.75	2SD218	4.75
2SA699	1.30	2SB476	1.25	2SC643	3.75	2SC1166	.70	2SD300	2.50
2SA699A	1.75	2SB481	2.10	2SC644	.70	2SC1170	4.00	2SD313	1.10
2SA705	.55	2SB492	1.25	2SC681	2.50	2SC1172B	4.25	2SD315	1.75
2SA815	.85	2SB495	.95	2SC684	2.10	2SC1209	.55	2SD318	.95
2SA816	.85	2SB507	.90	2SC687	2.50	2SC1213	.75	2SD341	.95
		2SB511	.70	2SC696	2.35	2SC1226	1.25	2SD350	3.25
2SB22	.65			2SC712	.70	2SC1243	1.50	2SD352	.80
2SB54	.70	2SC206	1.00	2SC713	.70	2SC1293	.85	2SD380	5.70
2SB56	.70	2SC240	1.10	2SC732	.70	2SC1308	4.75	2SD389	.90
2SB77	.70	2SC261	.65	2SC733	.70	2SC1347	.80	2SD-390	7.50
2SB128	2.25	2SC291	.65	2SC739	.70	2SC1383	.75	2SD437	5.75
2SB135	.95	2SC320	2.00	2SC715	1.75	2SC1409	1.25	MPS-U31	
2SB152	4.50	2SC352	.75	2SC762	1.90	2SC1410	1.25	at 4.00 ea.	
2SB173	.55	2SC353	.75	2SC783	1.00	2SC1447	1.25	MPS 8000	
2SB175	.55	2SC371	.70	2SC784	.70	2SC1448	1.25	at 1.25 ea.	
2SB178	1.00	2SC372	.70	2SC785	1.00	2SC1507	1.25		
2SB186	.60	2SC394	.70	2SC793	2.50	2SC1509	1.25		

POWER TRANSISTORS HIGH-VOLT. TV. TYPE

BU204	1300V	3.90	BU207	1300V	5.40	2SC1172B	1100V	4.25
BU205	1500V	4.70	BU208	1500V	6.25	2SC1308	1100V	4.95
BU206	1700V	5.90	2SC1170	1100V	4.00	2S91325	1100V	4.95

OEM SPECIALS

1N270	.10	2N960	.55	2N2219A	.30	2N2913	.75	2N3740	1.00	2N4401	.20
1N914	.10	2N962	.40	2N2221	.25	2N2914	1.20	2N3771	1.75	2N4402	.20
		2N967	.50	2N2221A	.30	2N2916A	3.65	2N3772	1.90	2N4403	.20
2N173	1.75	2N1136	1.35	2N2222	.25	2N3019	.50	2N3779	3.00	2N4409	.20
2N178	.90	2N1142	2.25	2N2222A	.30	2N3053	.30	2N3819	.32	2N4410	.25
2N327A	1.15	2N1302	.25	2N2270	.40	2N3054	.70	2N3823	.70	2N4416	.75
2N334	1.20	2N1305	.30	2N2322	1.00	2N3055	.75	2N3856	.20	2N4441	.85
2N336	.90	2N1377	.75	2N2323	1.00	2N3227	1.00	2N3866	.85	2N4442	.90
2N338A	1.05	2N1420	.20	2N2324	1.35	2N3247	3.40	2N3903	.20	2N4443	1.20
2N398B	.90	2N1483	.95	2N2325	2.00	2N3250	.50	2N3904	.20	2N4852	.55
2N404	.30	2N1540	.90	2N2326	2.85	2N3375	6.50	2N3905	.20	2N5061	.30
2N443	1.75	2N1543	2.70	2N2327	3.80	2N3393	.20	2N3906	.25	2N5064	.50
2N456	1.10	2N1544	.80	2N2328	4.20	2N3394	.17	2N3925	3.75	2N5130	.20
2N501A	3.00	2N1549	1.25	2N2329	4.75	2N3414	.17	2N3954	3.50	2N5133	.15
2N508A	.45	2N1551	2.50	2N2368	.25	2N3415	.18	2N3954A	3.75	2N5138	.15
2N555	.45	2N1552	3.25	2N2369	.25	2N3416	.19	2N3955	2.45	2N5198	3.75
2N652A	.85	2N1554	1.25	2N2484	.32	2N3417	.20	2N3957	1.25	2N5294	.50
2N677C	6.00	2N1557	1.15	2N2712	.18	2N3442	1.85	2N3958	1.20	2N5296	.50
2N706	.25	2N1560	2.80	2N2894	.40	2N3553	1.50	2N4037	.60	2N5306	.20
2N706B	.40	2N1605	.35	2N2903	3.30	2N3563	.20	2N4093	.85	2N5354	.20
2N711	.50	2N1613	.30	2N2904	.25	2N3565	.20	2N4124	.20	2N5369	.20
2N711B	.60	2N1711	.30	2N2904A	.30	2N3638	.20	2N4126	.20	2N5400	.40
2N718	.25	2N1907	4.10	2N2905	.25	2N3642	.20	2N4141	.20	2N5401	.50
2N718A	.30	2N2060	1.85	2N2905A	.30	2N3643	.15	2N4142	.20	2N5457	.35
2N720A	.50	2N2102	.40	2N2906	.25	2N3645	.15	2N4143	.20	2N5458	.30
2N918	.35	2N2218	.25	2N2906A	.30	2N3646	.14	2N4220A	.45	C103y	.25
2N930	.25	2N2218A	.30	2N2907	.25	2N3730	1.50	2N4234	.95	C103d	.40
2N956	.30	2N2219	.25	2N2907A	.30	2N3731	2.75	2N4400	.20	C106b1	.50
										C106di	.75

SILICON UNIUNIONS		INTEGRATED CIRC.		RECTIFIERS	
2N2646	.50	2N4871	.50	UA703C	.40
2N2647	.60	2N4891	.50	709C OP. AMP.	.25
2N6027	.55	2N4892	.50	741C OP. AMP.	.25
2N6028	.70	2N4893	.50	7400	.15
D5E37	.25	2N4894	.50	TA7061P	at 3.50 ea.
2N2160	.65	MU10	.40	TA7205P	at 10.00 ea.
2N4870	.50			UPC1001h2	at 6.00 ea.
				NE555	at 1.25 ea.
				IN4001	.60 5.00
				IN4002	.70 6.00
				IN4003	.80 7.00
				IN4004	.90 8.00
				IN4005	1.00 9.00
				IN4006	1.10 10.00
				IN4007	1.20 11.00



New-Tone Electronics
P.O. Box 1738 A
Bloomfield, N.J. 07003
Phone: (201) 748-6171

ALL PARTS GUARANTEED

748-6172
748-6173

N.J. residents add 5% sales tax. Minimum order \$5.00. All orders add \$1.00 postage. Dealers write or phone for discount prices.

TOMCATTIN' with "Tomcat!"



Across The Channels With
S9's Editor, Tom Kneitel (Tomcat/ KEZ5173)

I was talking to a trucker recently who told me that he didn't have a CB rig. I was surprised, since this fellow made regular cross country trips. "I tried it," he said, "but I wasn't interested in listening to the jabbering." His solution was to remove the CB—and how did he keep abreast of the Smokey situation? Easy, he said, he just never went faster than any truck with ears he saw on the road! . . . Big inside secret is that about 80% of the country music stars who have been receiving a lot of publicity as CB'ers, together with their *handles*, have never seen a CB rig except for the times they've posed for photos, have never even heard a CB rig in action! . . . Most novel QSL from a novel CB club—*The Chain Gang CB Club*, all prison inmates. They can't use their ears, but would like to receive some QSL's. President is *Hustlin' Hitchhiker*, J. DeFabritis #48505, P.O. Box 1, Block R-I-A, Yardville NJ 08620. . . . A smokey told one of our readers that he doesn't hassle CB'ers when they zip past his picture taker (unless they are doing over 65 MPH) because of the fact that CB'ers have been so helpful in calling in accidents. He said that he does, however, just love to hassle those speeding wiseguys who tailgate CB'ers because they figure that the CB'ers all slow down when they get to *Kojak's Kodak*. . . . CB radio has been featured in recent segments of the TV shows *One Day At A Time* and *Law and Order*. . . . On a sour note, the *New York Times* ran a story which I think made CB'ers look like a lot of jerks. . . . Forget those rumors about the FCC supposedly banning power mikes—I don't know how they got started but at this time there isn't any truth to them. . . . One of the most unusual reception reports I ever received came in the other day—from a reader in Indiana who was monitoring the VHF mobile telephone channels and heard S9's author Gordon West ("Anatomy of A Scanner") and I chatting—Gordon had called me from his car phone! . . . Ziggy, UNIT 455-Kilo, tells me that he's gotten much better results with

his QSL (wallpaper) efforts—and a lot more use and fun out of his gear since he started using a Unit Number ID. Says he used to alternate it with his handle, but of late he has been using the Unit Number ID most of the time instead of his handle! . . . While riding along the entrance ramp to one of the parkways recently, I could see a smokey parked on the side up ahead of me. For sure, he called me on the channel—"Hey white Mustang II, gotcha ears on?" Not believing this was really happening to me, I came back to him—his reply was to ask me to pull off the road. I had been driving at 20 MPH—couldn't imagine how I might have earned greenstamps. I was happily surprised when I pulled over and smokey told me that that day was the very first day that smokeys had ears on that road and that they had an NBC News film crew there interviewing CB'ers as to what they thought of the idea. So instead of getting greenstamped, I got interviewed!! . . . The *Holiday Inn* at Framingham, Mass., has installed a CB rig so that motorists can call in via CB for room reservations, on a 24-hour a day basis! . . . A reader in the United Kingdom informs me that they've formed an association to campaign for CB Radio or something like it, for truckers. Those interested in this project can get in touch with The Citizens' Band Association, 16 Church Road, St. Marks, Cheltenham, Gloucestershire, England. . . . We received a QSL card (1959 vintage) from reader Jim Harris of Johnstown, Pa. Jim's card reads 20W1343—but he also included his current card (same design) reading KIE0514. Jim has been a reader of our publication since the first issue back in 1962! Jim comments with some amusement on the odd sounding new-style 4-letter/4-numeral CB callsigns. . . . "Not so funny," those new style callsigns, says reader Scott Peters, *WATERGATER*, of Potomac, Md. Scott's a commercial broadcast newsman, 10 of those on a national network—and he still stumbles and stutters when it comes to the awesome task of attempting

Hey, CB'ers, Got Your Ears On?

WIN A FREEBIE CB FROM A-B

Sketch-a-"Fun"-Patch Contest

1st PRIZE



A MIDLAND CB

2nd PRIZE & 3rd PRIZE

A SHAKESPEARE ANTENNA
Single 4' top loading trunk mount

TUNE IN TO THESE
SIMPLE INSTRUCTIONS

1. Sketch your ideas of CB "fun" emblems. Any shape, size or colors. See sample.
2. Decision of the judges is final. Contest ends 2/15/77.
3. Submit as many ideas as you want. None can be returned, all become the property of A-B Emblem Corp.
4. Winning sketches will be made into "fun" patches; copyrighted and available only from us.

How about it?



9
MORE
PRIZES

Complete sets of official
Apollo Flight Patches
7 through 16 in full color



Sample Idea

Breaker, Breaker

What's Your Handle?

Your handle is uniquely your own, so why not wear it! Let A-B Emblem put your handle on a 2" x 5" embroidered patch. Just send us your handle along with \$3 for each patch and 50c for postage and handling.



Breaker, Breaker

10-44 CB Clubs . . .

A-B Emblem, the nation's foremost designers and manufacturers of stock and custom emblems, will reproduce your club's insignia in a distinctive embroidered patch. Just send a sample of your club's insignia, and quantities desired, and we'll return our quotation. Or, for assistance in creating a new design, write for our free Design-an-Emblem Guide.

Give us a big 10-4 on this. Come on.



A-B emblem Division of
CONRAD INDUSTRIES, INC.

P.O. Box 78695 • Weaverville, NC 28787

to say KAAH7386. He says that his problem can't be fully appreciated until you attempt to say the KAAH aloud—all of the letters end up sounding alike! Scott also wants to give some public recognition to a CB'er whose handle is *HUSHPUPPY* who acts as a clearinghouse for some of the communications on Channel 19 on the north end of the 495 Beltway in Washington. *HUSHPUPPY* handles accidents, highway reports, and much other work. Scott doesn't know who or where he is—but says he's on the air all of the time. Scott also says that he's worked the *Hole In The Wall Gang* (Baltimore Tunnel gang) on Channel 3! . . . At broadcast station WCOD on Cape Cod, in Mass., the New Director (Deven Black) enlisted 60 CB operators to relay primary election results from 15 Cape Cod communities to a couple of base stations. Black commented that he used CB'ers instead of the usual landline volunteers because CB'ers are "more willing to help." He added, "Besides, it's more fun to do it by radio!" . . . Ed Wilberg (SSB-826, also Unit 219-F) comments that it's really weird that any time he goes to a certain CB shop with some problem—the dealer always claims to be able to solve the problem with "just the right combination of products, which are fortunately right in stock." Except that it *isn't* too fortunate that too often these on-hand products don't do the job. Ed wonders if other CB'ers have ever been faced with the situation of a dealer being more anxious to deplete inventory than seriously consider a customer's problem. Or is it just this one dealer? . . . I noticed on the boob tube the other night a commercial for a particular brand scanner monitor. Showed the supposed interior of a newspaper office—a cub reporter has the scanner hidden away in a closet, and when the ace reporter gets sent out by the Editor to cover a crime, the cub reporter sneaks off to his closet to listen-in on the police channel. He then writes a news story based upon his information and hands it in to the Editor, thus scooping the ace reporter. Nice little story, except it presents a clear violation of Section 605 of the Communications Act (secrecy of communications) which this manufacturer should have realized! And I wonder if Uncle Charlie is going to lean on TV stations which permit this type of advertising! Same outfit has an ad for their CB equipment which shows a guy driving along laughing as he listens to the antics on Channel 19—next thing you know he's smashed his wheels into the side of another vehicle amidst clouds of swirling steam. Really makes you want to get a rig, doesn't it! . . . Guess I've gotten cynical in my old

age—takes a lot to make me laugh, I mean *really* laugh. But they did it with something called *Instant CB*, an outrageous novel produced by Good Karma & Co., P.O. Box 65, Larkspur CA 94939. It's available through dealers and less than \$3—I think you'll really get a charge out of this insane development in the art of CB. And if you're a dealer selling to the CB market—I suggest you contact the manufacturer to find out how to carry *Instant CB*. Tell 'em Tomcat sent you! . . . Stu, a reader, from Dallas, Tex., comments that he's had to change his handle about 4 times because he wanted something unique, only to find that someone else had the same or similar. Stu's given up on handles and is now registered as Unit 142! . . . There seem to be countless scores of CB newspaper columns cropping up across the land—but I think that one of the best written and most informative is syndicated weekly throughout most areas of Michigan and written by Bill ("Wild Bill") Cote, also known as KIE2509, and also as SSB-2656 on the sideband channels. If you live in Michigan, check out Bill's column in your local newspaper!

Tomcat!

WHICH 40 CHANNEL ANTENNA DO YOU NEED?

(continued from page 63)

ing up with needs, particularly when there's a waiting market. While there aren't any very short 40 channel antennas available at the time this article is being prepared, there might well be several models available by the time you get to read it.

Finally, keep in mind there is always an exception to every rule. Somewhere out there is a CB'er using a very short antenna that does a great job on all 40 channels—and there probably isn't an engineer anywhere who can explain why it works. Before you rush out to buy a "40 channel mobile antenna" check your system with a VSWR meter. Tune the antenna to channel 19 or 20 and measure the VSWR on channels 1 and 40. If you're real fussy about your signal get a new, longer or "40 channel" antenna if the VSWR is greater than 2:1. If you're not all that fussy get a new antenna if the VSWR is greater than 3:1. But if the VSWR is greater than 3:1 and you choose to go with your old antenna to save a few dollars don't start complaining about the transceiver if your signal gets walked on by a station across town. Even the best transceiver/transmitter doesn't do much good if a good part of the RF gets lost on its way to the antenna. An antenna system can radiate only the RF energy that actually gets into the antenna.

... Use S9 READER SERVICE.

Hey, CB'ers got your ears on?



CHANNEL BEACON

IS HERE!

Now you can let your good buddies know when your ears are on, and on which channel — even at night! **CB CHANNEL BEACON** is a compact lighted unit that beams the channel of your choice from 1 to 40, inviting other CB'ers to get a copy on you. Great for those times when most regular channels of contact are overrun with modulators. Readily visible day or night, and mounts anywhere. Uses 12v DC power from car or truck.

Order Today and COME ON!

Please RUSH _____ complete CHANNEL BEACON unit(s) at \$12.95 ea., including my choice of three (3) channel cards circled below. Additional cards available at 50¢ ea. I include \$1.00 post. & hdg.

1 2 3 4 5 6 7 8 9 10 11 12 13 14 15 16 17 18 19 20
21 22 23 24 25 26 27 28 29 30 31 32 33 34 35 36 37 38 39 40

Enclosed: Check Money Order
 Master Charge number
 Bank Americard number

Total Order Amt. \$ _____

Card # _____ Mail to: DIMA Corporation
Expiration date _____ 700 E. Baseline C-2
Master Charge bank number _____ Tempe, Az. 85282

Signature ✓ _____
Name _____
Street _____
City _____ State _____ Zip _____

AZ Residents add appropriate sales tax. Allow 3 to 4 weeks for delivery.

Dealers, Here are 7 good reasons why Centennial is your best single source for all your CB needs...

1 Centennial stocks virtually every major brand of radio, antenna and accessory in depth. This means that you can order whatever you need, when you need it, and be assured of immediate delivery.

2 Centennial stocks all major brands in such large quantities that the savings we enjoy are passed on to you with the best competitive prices in the industry.

3 Centennial has specialized in CB and personal communications for more than fifteen years. Our experience and guidance can save you valuable time and dollars.

Electra Bearcat



Bearcat III



Bearcat 8



Bearcat 101

Bearcat Portable Scanner



Centennial Communications Inc.
585 Yonkers Avenue, Yonkers, N.Y. 10704

Our 35th year in business

Dealers ask for Johnny or Len

914/476-2100



Bearcat IV

4 Centennial

maintains a full-time working staff of trained CB sales experts. This means instant service when you call or drop in to place your CB equipment orders.

6 Centennial

plans to remain in the CB two-step business for many years. When the late comers have abandoned the market, we'll still be here to serve you.

5 Centennial

backs up every product sold with superior service. You need never worry about being stuck with inferior merchandise or factory rejects. —The most liberal dealer policy in the industry.

7 Centennial

sales and service personnel love their work. We enjoy dealing with our dealer customers. This is reflected by the cordial and courteous reception we extend to all our customers, no matter how large or small.

MIDLAND



Model 13-893

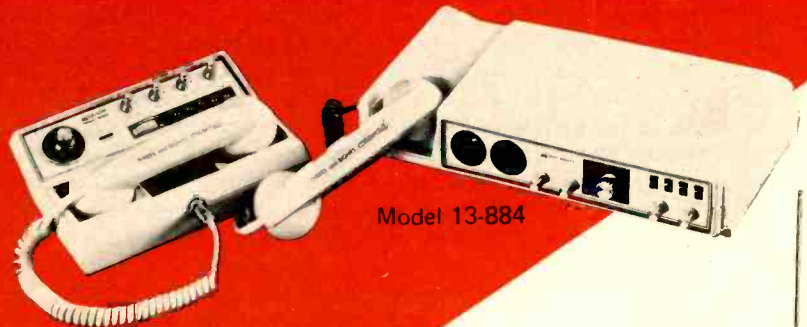

Model 13-884



Model 13-892



Model 13-955

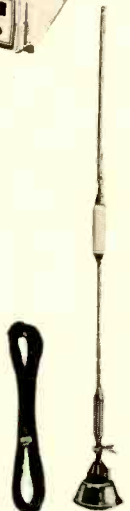

Model 18-279



**Centennial
ommunications inc.**

585 Yonkers Avenue, Yonkers, N.Y. 10704

Our 35th year in business

Dealers ask for Johnny or Len

914/476-2100

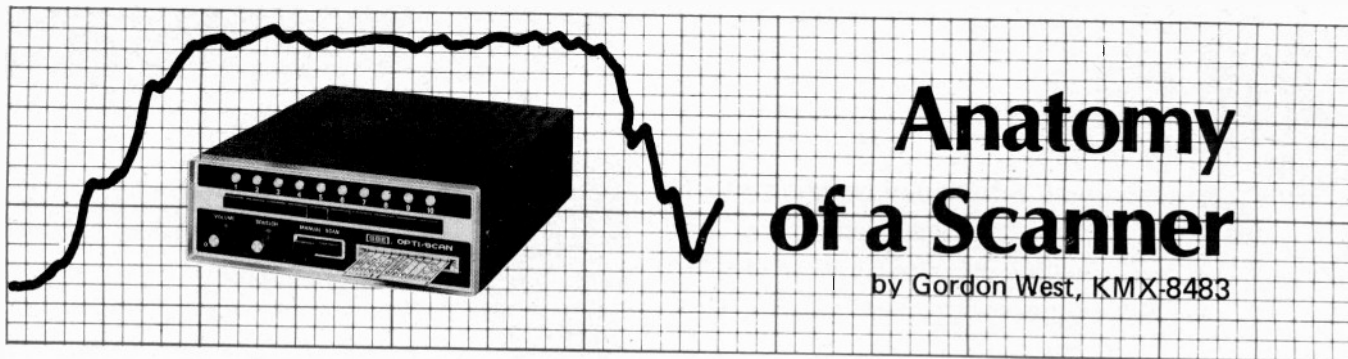

Anatomy of a Scanner

by Gordon West, KMX-8483

PART 4: PROGRAMMABLE SCANNERS

PROGRAMMABLE Scanners only amounted to fifteen percent of the Scanner business last year. Seventy-five percent of the business went to crystal type Scanners, ten percent to pocket Scanners, and the remainder to programmable Scanners. Why such low figures for such a unique Scanner, you say? Obviously, the price! Most pocket scanners loaded with 4 channels run around \$100; most mobile crystal type scanners run about \$175 with several channels of crystals installed. Most programmable scanners approach the \$350 mark.

There are four well known manufacturers of programmable scanners—SBE, Tenneltec, Electra and Regency. There's much debate among these manufacturers as to who really came up with the programmable scanner idea, but all four units appeared on the market at the same time about a year and a half ago. When these first units were brought out, they were plagued with minor problems in their complex receiver sections. All four had the same type of problems—"spurs" making the scanner lock-up on frequencies not actually being broadcast on, and "intermodulation." I'm happy to report that all four manufacturers have pretty well cleaned up these problems of "spurs," and all four manufacturers are attempting to solve the intermodulation problem at the present time.

Here is a list of who makes what in programmable scanners:

SBE—"Opti-Scan"

Regency—"Whamo" and their Direct Frequency Entry Adaptor

Electra—"Bearcat 101"

Tenneltec—"Memory Scan MS-2" and their Direct Frequency Dial-N Scanner, the "MCP-1."

By the time you read this, there will probably be at least three new programmable scanners on the market by several other manufacturers who want some of this new and exciting business.

What exactly is a programmable scanner? It's much like those crystal type scanners that I described in my

earlier articles about scanners, except the programmer has a big advantage of not requiring the use of crystals for determining the exact frequency to be monitored! What this means for you is that when you get your scanner at home, you'll never have to make another trip down to the scanner store to buy more crystals when you want to change frequencies. All the frequencies are derived by specialized micro-chip circuits within the scanner itself—utilizing no crystals!

All programmable scanners cover the 30-50 MHz band, the 150-170 MHz band, 450-470 MHz, and the 490-512 MHz band. Some of the programmable scanners also cover the 2-meter ham band below 150-50 MHz. Additionally, some programmable scanners also cover, without interruption, the "T" Band which is in-between 450 and 512 MHz. For those programmable scanners that may not tune into a band located near these major frequencies segments, they may usually be specially ordered from the factory to cover that elusive band of frequencies that are not advertised as being able to be received by the scanner. Take for instance the SBE Opti-Scan. Although the specifications of the scanner do not include the 144 to 148 MHz two-meter band, nor the 470 to 490 MHz "T" Band, special SBE

Opti-Scans may be ordered from the factory to take in those frequencies at no additional charge. Other programmable scanners claim to take in all of those frequencies without any further modification. Review the specifications carefully before you decide which programmable scanner you want, to ensure that the frequency you wish to monitor is available in that certain type of programmable scanner you have ordered.

"We are just beginning to see a new era of scanners," states SBE's David Thompson, President. "As micro-processing circuits become less expensive to build, and the components for those circuits more readily available, the price of the programmable scanner in the next few years will drop dramatically. Probably in two or three years from now a programmable scanner will cost only a bit more than a conventional crystal scanner. Programmable scanners will soon dominate the scanner market, and we are seeing the change beginning now."

Yes, I agree with David Thompson of SBE, the programmable scanner will soon replace most mobile and base station crystal scanners as the prices will sure drop in the next few years. However, don't put off purchasing that programmable scanner today—it's still going to be a few years off before we see any major price breakthrough!

How does a programmable scanner work? Let's take a look at it from a non-technical standpoint—so I don't bore a lot of readers that might want to know the basics, but not the esotericities. Today's programmable scanner is much like the new breed of CB transceivers that don't use crystals—utilizing phase-lock-loop circuitry for the generation of frequencies. On a CB set you enter the frequencies on a 40-channel dial selector into the phase-lock-loop circuitry, and magically, the frequencies are at your command. With a scanner, it's the same principle, except you have a lot more than 40 channels! Some scanners that are utilizing the new micro-pro-

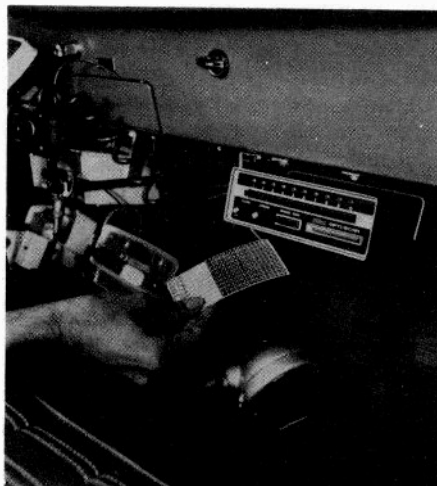

essing circuitry may have the frequency entered directly in MHz, such as 155.160 MHz. Simply dial it up, or push the appropriate keyboard buttons, and the frequency is automatically entered. Another popular way of entering the frequency is through the use of computer type "binary codes." We'll describe what they are in just a moment, but first, let's take a look at our friend in both CB and Scanners, the "phase-lock-loop circuit." Remember, the phase-lock-loop circuit is the one that is pretty much common to all new 40-channel CB sets, as well as common to all programmable scanners, so now is a good time to review exactly how this circuitry works.

The basic invention of phase-lock-loop, commonly called "PLL," is nothing new; it's been around since 1930. Early phase-lock-loop equipment utilized discrete components for its circuitry, and because these components were quite costly, there were few ap-

plications to this system for the personal communications field.

With recent developments of the integrated circuit, prices immediately began to drop for phase-lock-loop equipment. Just recently, Citizens Band and programmable scanners have begun to employ this new circuitry.

A PLL system contains four basic circuits; the phase comparator, the low pass filter, the DC amplifier, and the voltage controlled oscillator (VCO) (Fig. 1). An input signal is first introduced to the phase comparator stage. At the same time, the phase comparator is also being fed a voltage from the VCO output, and these two signals are mixed and will produce a phase difference that will result in an error voltage. The phase comparator output is filtered, amplified by the DC amplifier, and applied as a control voltage to the VCO. The control voltage, or error voltage, is used to slightly shift the VCO frequency in the direction that reduced the phase

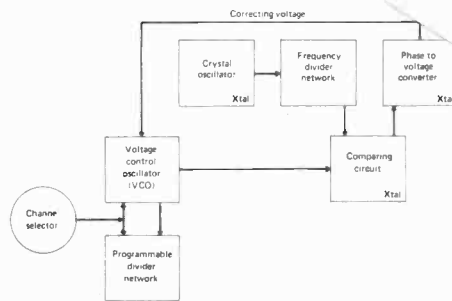

Fig. 1—Conventional phase lock loop circuit utilizing three crystals (P.L.L.).

difference between the input signal and VCO output. This "corrective feedback" circuit will automatically synchronize, or "lock," the input signal and will track it over small frequency variations. It takes only microseconds for this entire complex circuit to "lock-in" on a signal, and even if the signal should drift slightly, the circuits will automatically track it. The actual range of frequencies over which the PLL circuit

HOW TO DETERMINE PROGRAMS FOR FREQUENCIES—1 MHZ AWAY FROM SPECIFIED BANDS IN SBE OPTI-SCAN

Band	Band Code	Formula
30-50 MHz	11	$f_o = f_i + 16.9 \text{ MHz}$
150-170 MHz	01	$f_o = f_i - 103.1 \text{ MHz}$
450-470 MHz	10	$f_o = f_i - 403.1 \text{ MHz}$
490-510 MHz	00	$f_o = f_i - 443.1 \text{ MHz}$

f_i = input frequency. The frequency you wish to monitor.
 f_o = oscillator frequency.

Step 1. Find f_o for the band you wish to program a frequency on.

Example: $f_i = 154.325$ then $f_o = 154.325 - 103.1 = 51.225$

Step 2. Divide the above result by .05.

Example: $\frac{51.225}{.05} = 1024.5$

Step 3. Take the number to the right of the decimal point in the above result and using chart A find the four digit code.

Example: 5 = 0010

Step 4. Take the number to the left of the decimal point in the result in Step 2 and subtract it from 1409.

Example: $1409 - 1024 = 385$.

Step 5. Take the above result and determine its 9 digit code using the method described on the following page.

Example: $385 = 1000\ 00011$

Step 6. Write out complete 15 digit code as in example below.

4 Digit Code	9 Digit Code	Band Code
0010	1000 00011	01

CHART "A"

0 = 1001	5 = 0010
1 = 0001	6 = 1100
2 = 1110	7 = 0100
3 = 0110	8 = 1000
4 = 1010	9 = 0000

Step 5

TO CONVERT DECIMAL TO BINARY

$385 \div 2 = 192$ with a remainder of 1	Left
$192 \div 2 = 96$ with a remainder of 0	
$96 \div 2 = 48$ with a remainder of 0	
$48 \div 2 = 24$ with a remainder of 0	
$24 \div 2 = 12$ with a remainder of 0	to
$12 \div 2 = 6$ with a remainder of 0	
$6 \div 2 = 3$ with a remainder of 0	
$3 \div 2 = 1$ with a remainder of 1	
$1 \div 2 = 0$ with a remainder of 1	Right

LEFT → RIGHT

Written 1000 0001 1

Notice: This step should have 9 digits. It is sometimes necessary to add zeros to the right of your answer to give you 9 digits.

Note 1: When programming one of the new split channel frequencies, such as 470.6875 MHz, compute your program for the frequency 2.5 KHz above or below the desired frequency. Example: 470.685 or 470.690.

Bodacious! New Red Cloud Antenna Booster.

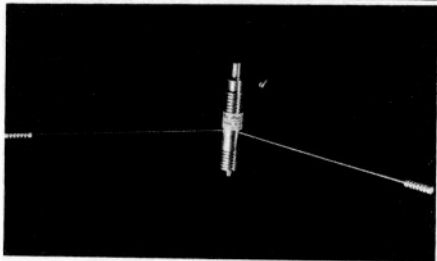

Base Unit

What does it do to your ears? Helps increase modulation, boost reception and stabilize SWR.

How does it work? Through a revolutionary combination of a liquid core and solid aluminum housing. Ever notice how you copy better near a lake or stream? Liquid's a good ground, and that's why the liquid-core Red Cloud Antenna Booster works so good.

How do you know it does what we say? Don't take our word for it. Write for names and addresses of CB'ers using Red Clouds. Ask them.

What kind of warranty do you get? One year on materials and workmanship plus . . . listen to this . . . **full refund** if you're not satisfied and return the Red Cloud to your dealer within 30 days from date of purchase.

Is it expensive? Negatory.

Can it be used with any antenna? Affirmative.

Red Cloud Corporation
P. O. Drawer 2030
Shelby, N.C. 28150
704/482-0324

Sold Only Through Dealers Distributor Inquiries Welcome.

ANATOMY OF A SCANNER (cont'd)

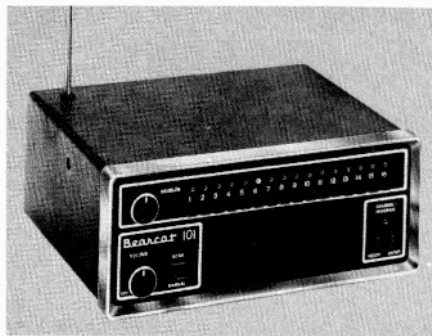

can maintain "lock" with an input signal is defined as the "lock range" of the scanner. Take a look at your scanner specs and those bands that they list are within the "lock range" of the PLL synthesizer.

The advantages of PLL circuitry in a programmable scanner over the circuitry of a crystal type scanner are very important to know.

PLL circuitry only requires about three crystals in a scanner which will generate up to ten thousand individual frequencies. Hence, we don't need any more crystals than three to generate all of these channels. What with the crystal shortage in the United States, this is a definite benefit, plus it doesn't cost you a cent more to dial up a new frequency to monitor.

PLL circuitry is precise and extremely stable. You know what it's like to have a crystal scanner in an automobile and try and listen to the UHF Band when you first get into the car after a snow storm. Generally the crystal is quite cold inside the scanner, and you will not hear the incoming calls clearly. After the set warms up—sure—all is well, but temperatures do adversely effect crystal type scanners. A PLL programmable scanner is virtually unaffected by temperature, and the precise frequency is "on target" each time the scanner is turned on. There's no worry about off-frequency reception with a programmable scanner.

Another advantage of PLL circuitry is the way in which we enter the "program." Some programmable scanners use binary code buttons—and these work out fine in entering the program. Still using the concept of binary coding, another approach is to use combs that have certain teeth removed which is the equivalent of binary "ones" and "zeros." This is another way of entering the program.

A very unique is one that SBE employs—the use of a card in which certain stickers are removed to allow light to shine through to photo-cells; the light shines through only those holes that

represent binary "zeros." The stickers are left in place for each binary "one."

And of course, the micro-processor circuitry is a fun one to play with, in that it lets you dial up the precise frequency without having to use binary codes—a time-saving method.

What's all this about binary codes, you say. Why are binary codes necessary, and why do I have to use them to enter frequencies? Unless the programmable scanner you select has the new micro-processing circuit which automatically does the binary "counting" for you, you need to first look up the frequency, and then enter the resultant binary code information into the scanner in order to receive that frequency. That's a job very easily done either by pushing buttons, breaking teeth off of combs, or removing stickers on an optical card.

Unfortunately, electronic devices do not have the ability to read directly such numbers as 12, 14 or 19. In order for us to assist these electronic counting marvels, we need to reduce the information to either open circuits, or closed circuits. This type of "on-off" circuitry is easily deciphered by the scanner. By using this "on-off" type of numbering system, we arrive at a two-digit system called binary coding. Those individual digits, either ones or zeros, are called "bits." Short for *binary digits*.

Counting in binary code, we find that: Zero is Zero, 0; One is One, 1; Two is One-Zero, 10; Three is One-One, 11; Four is One-Zero-Zero, 100; Five is One-Zero-One, 101; Six is One-One-Zero, 110; Seven is One-One-One, 111; Eight is One-Zero-Zero-Zero, 1000; Nine is One-Zero-Zero-One, 1001.

Obviously, the list goes on from here, but if you study the progression of ones and zeros, I think you'll see how binary code is derived from our numerical system more conventional to us.

Whether you enter the information into your scanner via binary code or actual frequency, both systems work out well. Each has its advantages. And obviously, the most prominent advantage of a programmable scanner is the fact that it does not need any crystals for which to generate the frequencies you wish to monitor.

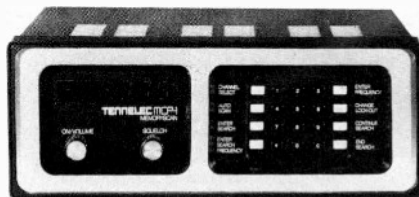

For Information About Our Advertisers . . .

40-Channel CB Transceivers Pass FCC Laboratory Technical Tests

The Commission announced that as of the end of November samples of the following models of Class D, Citizens Radio Service, 40-channel transceivers have been tested by the Commission and found to be in compliance with applicable technical requirements for type acceptance and certification.

Applicant or Brand Name	Type No.	Meishoh Electronics Co., Ltd.	ME-400
Applicant or Brand Name	Type No.		ME-402
Applicant or Brand Name	Type No.	Meriton Electronics, Inc.	RS-5111
Applicant or Brand Name	Type No.	Midland International Corp.	63-240
Applicant or Brand Name	Type No.		77-853
Applicant or Brand Name	Type No.		77-857
Applicant or Brand Name	Type No.		77-882
Applicant or Brand Name	Type No.		77-883
Applicant or Brand Name	Type No.		77-888
Applicant or Brand Name	Type No.		77-955
Alpine Electronics Co. Ltd.	BR-640	Pathcom, Inc., Pace Communications Division	1000B
Benjamin Electronic Sound Co.	200		8041
Channel Master	CB6835		2300CA
Colt Communications Inc.	COLT 290		CB-166
Commando Communications Corp.	CC4040	Pearce-Simpson, Inc.	SUPER COUGAR 40
	CC4086		SUPER CAT 40
Dynascan Corp.	21XLR		SUPER TIGER 40
	89XLR	J. C. Penney Co.	TIGER 40
	138XLR		6203
	139XLR	Pioneer Electronics Corp.	6237
Fanon/Courier Corp.	FANFARE 100F	President Electronics Inc.	GT-6600
	REBEL 40		DWIGHT D ZACHARY T
General Electric Co.	3-5801A	Radio Shack	21-1520
	3-5811A		21-1521
	3-5811B		21-1524
	3-5812A		21-1526
	3-5812A		21-1542
	3-5819A	RCA Corporation	14T270
	3-5821A		14T304
	3-5825A	Royce Electronics Corp.	1-648
General Motors Corp.	GM CBD-10A	SBE, Inc.	BRUTE 40
Hy-Gain de Puerto Rico, Inc.	682A	Sears, Roebuck & Co.	2862674
	2700		2862676
	2702		CM 2378SA
	2703		CM 6000LA
	2705		CM 6000LB
Ray Jefferson	CB-740		CM 6100S
Kris, Inc.	XL-45		CM 6200S
Lafayette Radio & Electronics	HB-640	Shakespeare Co.	TA 4501
	HB-740	Sharp Electronics Corp.	GBS-240
	HB-940		CB-2260
Mars Radio Corp.	CON 400		CB-2460
	CON-450	Sony Corp.	ICB-2500
	M-368	Standard Communications Corp.	HORIZON 2900
	M-374	Superscope, Inc.	CB-340
	M-375	Teaberry Electronics Corp.	4001
	M-379		4002
Matsushita Communication	CR-B4700EU		4006
	CR-B4701EU	Toyota Motor Sales USA, Inc.	00860-00001
	CR-B4747EU		00860-00020
	CR-B4748EU	Tran Sonic Industries, Inc.	MCB-41
Maxon Electronics Co., Ltd.	MAXON 40	Well, Inc.	W-605
			W-705

Bodacious! New Red Cloud Antenna Booster.

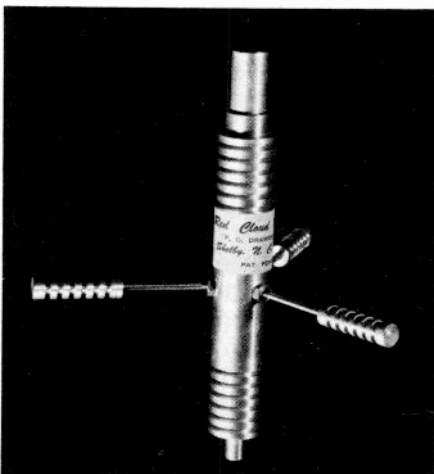

Mobile Unit

Where can you get it? Your CB dealer. He can show you how to install the Red Cloud . . . it's quick and easy with no wires to hook up. He can also help check for problems in the antenna that could keep you from coming through loud and proud.

Do you need a Red Cloud Antenna Booster? Does bear bait feed the bears? Trailer truck on down to your CB dealer for your Red Cloud. You'll be bodacious, good buddy!

Red Cloud Corporation
P. O. Drawer 2030
Shelby, N.C. 28150
704/482-0324

Other Red Cloud products are on the way. Stand by.

Sold Only Through Dealers. Distributor Inquiries Welcome.

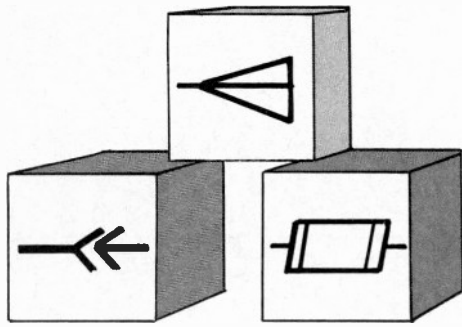

Basic Radio

by Irving Tepper

Part 13 Alternating Current

IN all the previous descriptions of electrical circuits, they were always shown as, in Fig. 4.1(A), with the polarity of the voltage source fixed and the electrons flowing from the negative terminal to the positive terminal. This voltage source, whose polarity never changes and so whose current always flows in one direction, is defined as a *direct current* source, abbreviated as D.C. Direct current is plotted graphically as shown in Fig. 4.1(B) and (C). Graph (B) is a plot of voltage versus time while graph (C) is a plot of the current versus time. Usually the voltage and current levels of DC remain constant.

In alternating current, abbreviated as A.C., the polarity of the voltage source does not remain constant but changes, usually at a constant rate. As shown in Fig. 4.2, the current flows first in one direction and then, when the voltage reverses polarity, the current also reverses and flows in the opposite direction. Not only does the alternating cur-

rent reverse direction but it also changes its voltage value constantly.

AC compared to DC—While alternating current is different from direct current, it is not in any sense better or worse. AC serves purposes that cannot be met by DC and in other instances, DC performs functions that cannot be accomplished by AC. Some applications, however, can be served by either AC or DC.

AC has the advantage in that its voltage value can be increased or decreased using a device called a transformer. If, for example we require 220 volts AC, the house power line, normally 117 volts AC can be stepped up to the required 220 volts AC using a transformer. If, however, the power line in the home was 117 volts DC the process of increasing it to 220 volts DC would be comparatively complex requiring electronic circuitry to do the job. Using transformers permits changing the AC power line from 117 volts to any desired value greater or less than the power line.

There are, however, many functions in electronics where DC *must* be used. Many circuits and devices can only op-

erate when powered by DC and applying AC to such equipment results in non-operation or damage. In most pieces of electronic equipment it is not unusual to find several types of voltage such as DC, AC from the power lines, and AC voltages that represent the intelligence such as *audio signals* and *radio signals*. There may also be combinations of AC and DC voltages as well as AC voltages of various shapes as shown in Fig. 4.3.

Generating AC Voltages

There are several methods of generating alternating voltages but the most common method is by magnetic generators that are driven by mechanical means. This basic system is the heart of the power station used to generate and distribute electricity to our homes and industries. The magnetic generators

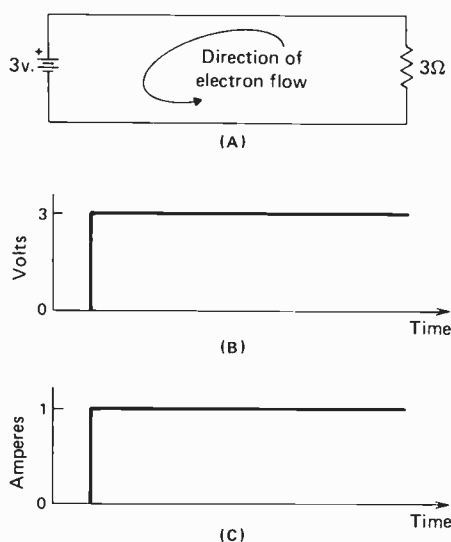

Fig. 4.1(A)—A circuit in which the electrons flow in a single continuous path without changing direction is defined as direct current, DC. (B)—A plot of DC voltage versus time shows the rise of the voltage to its value at which point it remains constant. (C) The current also rises and remains unchanged.

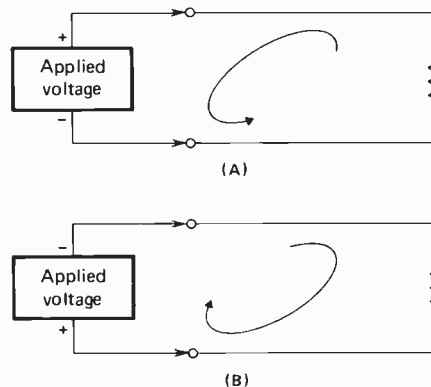

Fig. 4.2—Direction of electron flow reverses when the polarity of the applied voltage changes. During the process of reversing polarity the voltage must drop to zero and so the amplitude of the voltage also changes. This type of voltage and its resulting current is defined as alternating current or AC.

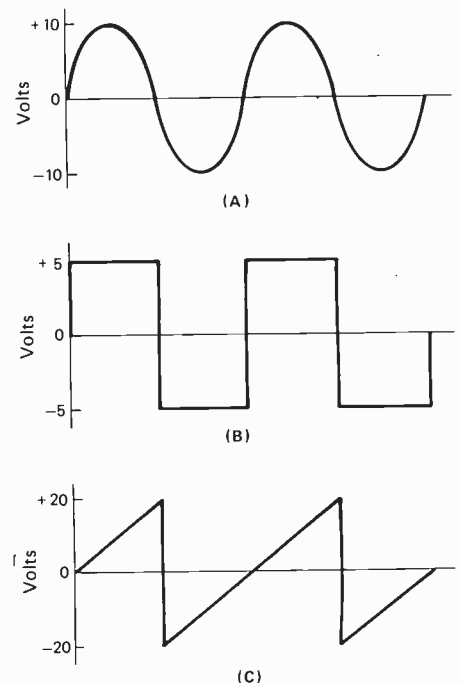

Fig. 4.3—Various waveshapes of AC voltage. (A) a sine wave, (B) a square wave and (C) A sawtooth (also called a ramp voltage). The one common feature of all the waveforms is change of polarity.

are rotated by steam or water turbines.

In order for us to understand the nature of AC it is necessary to understand how it is generated. Earlier we explained how an electron flow through a wire generated a magnetic field. Now we will describe how a wire, passed through a magnetic field, can generate a voltage that can cause an electron flow.

Electromagnetic Induction—Electromagnetic induction occurs whenever a wire is passed through a magnetic field in such a way that it *cuts across* the lines of force. As the wire passes through the magnetic field a voltage is induced or developed across the wire. As shown in Fig. 4.4(A), when the wire is moved upward through the field the electrons in the wire will be forced to end B making that end negative with respect to end A while at the same time end A becomes deficient in electrons making it positive with respect to end B. The effect is that a difference of potential exists across the wire as long as it is in motion through the magnetic field.

If the direction of movement is reversed, that is the wire is moved downward, end A will become negative and end B positive as shown in Fig. 4.4(B).

If the wire is moved *parallel* to the lines of force as in Fig. 4.4(C), no voltage will appear across the wire as no lines of force are actually being cut in the magnetic field.

Strength of the Induced Voltage—The amount of voltage induced in a wire that cuts through a magnetic field is determined by four factors. These are:

- 1—The *speed* at which the wire moves through the magnetic field.
- 2—The *strength* of the magnetic field.
- 3—The *angle* at which the wire cuts through the magnetic field.
- 4—The *length* of the wire in the magnetic field.

The greater the speed at which the wire moves through the magnetic field, the greater will be the effect on the free electrons in the wire. More electrons will be moved to one end of the wire and a greater difference of potential will be developed across the wire. Recall that electrons in the wire have a magnetic field about them and so respond to the external magnetic field.

If the wire moves through the magnetic field at right angles to the lines of force the greatest possible voltage will be induced across that wire (Fig. 4.4A). If the wire is moved through the magnetic field parallel to the lines of force no voltage will be induced (Fig. 4.4C). If the wire is moved through the magnetic field in a direction between parallel and right angles,

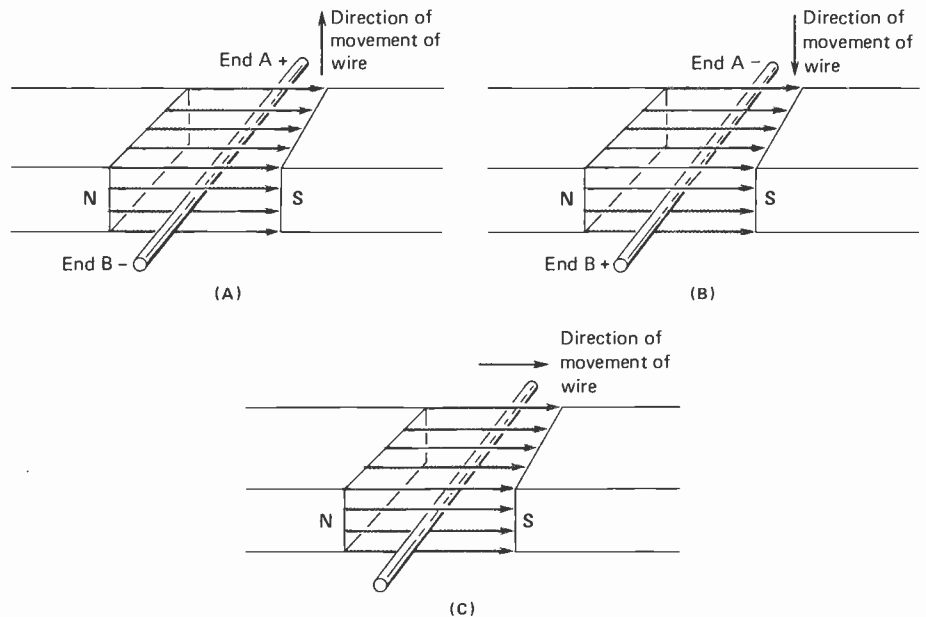
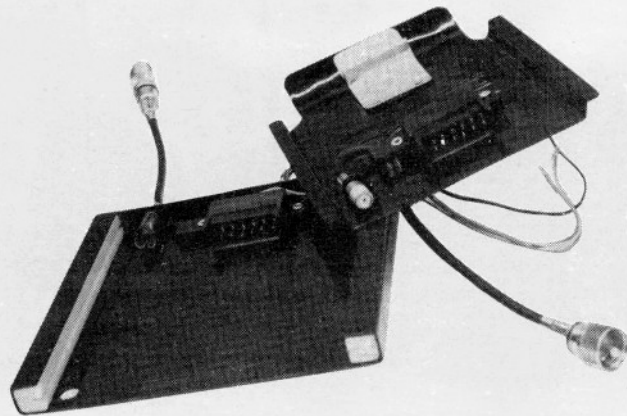

Fig. 4.4—When wire is moved through the magnetic field in the direction shown in (A) a voltage is induced of the polarity indicated. When the direction of movement is reversed as in (B) the induced polarity is reversed. When the wire is moved parallel to the lines of force (C) no voltage is induced.

a voltage somewhere between zero and maximum will be induced.

The Simple Generator—The AC generator, also referred to as an alternator, consists of two parts as shown in Fig. 4.5. The first part is the generator itself and the second part, called the *prime*

mover, provides the power to rotate the generator. The prime mover may be powered by water flow—such as at waterfalls or dams, or by steam generated by coal, oil or atomic power. Some generators are driven by gasoline or diesel engines.



ONLY ONE slide mount connects your antenna through an internal coaxial connector to insure no loss or SWR.

Only one gives you antenna **plus** six wires, automatically and securely connected.

Only one actually gives you "permanent installation" performance **and** instant in/out convenience.

Only one, out of the hundreds of slide mounts on the market, gives you these features in a heavy-duty steel, ultra-smooth slide mount. Ask your dealer for the one from . . .

SouthCom, Inc.
P. O. Box 11212
Ft. Worth, TX. 76109

Dept. 103

Guaranteed Delivery Of 40 Channel CB's January 3rd

That's right dealers. Once again "Big John" and the gang at Electronic Parts Company, Denver, has made that super effort to help keep you competitive and profitable. Give us a call at 303-744-1992 for details.

Distribution Headquarters
For  **JOHNSON CB**



Messenger 123A



Messenger 352D

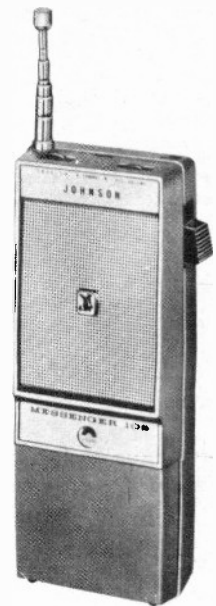

Messenger 109



electronic parts company inc.
1212 South Broadway • Denver, Colorado 80210

Don't forget to ask about our prepaid freight policy, and our watts line number.

303-744-1992

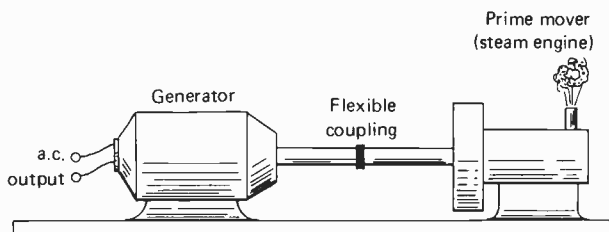

Fig. 4.5—Physical arrangement of the generator and the prime mover. The flexible coupling allows for slight errors in shaft alignment.

The internal construction of the simplest possible generator is shown in Fig. 4.6. It consists of a loop of wire placed in the magnetic field developed between two magnets. One end of the loop is connected to the prime mover through a non-conducting shaft. The other end of the loop is connected to two slip rings. Slip rings are round pieces of copper which rotate with the loop. Two brushes, usually made of carbon, ride on the rings, making electrical contact. This permits the voltage developed by the rotating loop to be removed from the generator without any tangled or twisted wires.

Looking at Fig. 4.7A, again we can see that the wire loop in the magnetic field really consists of two wires, A-B and C-D. Each of these wires will develop a voltage as they move through the field and each voltage will be opposite in polarity compared to the other. When A is positive and B is negative D will be negative and C positive. This happens because when wire A-B is moving downward wire C-D must be moving upward. Referring back to Fig. 4.4(A) and (B) we can see that wires moving through the magnetic field in opposite directions induce voltages of opposite polarities. When analyzing the operation of the generator, however, it is simpler to consider the voltage induced in a single wire to see how the AC is developed.

The operation of the generator can be understood from the drawings in Fig. 4.7. In (A) we have removed the drive shaft that connects to the prime mover and the slip rings and brushes for the output, all of which are understood to be necessary if operation is to take place, but is done to help simplify the drawing. We have also darkened one half of the loop so that we can determine the position of the wire between the two magnets. Since we are going to rotate the loop, the most logical way to determine and indicate its position is by means of the circle which we can divide into 360 degrees. We can then rotate the loop and determine the effect every 30 degrees. The following conditions must exist for our explanation to be valid:

1—The magnetic field must be uniform in strength across the faces of the opposing magnets.

2—The loop must be rotated in a counter clockwise direction.

3—The loop must be rotated at a constant speed.

As the loop is rotated at a constant speed it passes through the zero degrees position as shown in Fig. 4.7(B). Since the wire is moving parallel with the lines of force at this point no voltage develops across the loop.

As the loop rotates from zero to thirty degrees (Fig. 4.7C) the loop begins to cut across lines of force at an angle. While the angle at which it cuts the lines of force is not close to ninety degrees it is no longer zero degrees or parallel and so a small voltage is induced in the loop. As the loop advances to sixty degrees, as shown in Fig. 4.7(D), it begins to cut across more lines of force at an angle closer to ninety degrees. This results in a larger induced voltage. As the loop continues to rotate another thirty degrees to move through the ninety degree position, it is now cutting through the lines of force at right angles to induce maximum voltage.

Continuing its rotation from ninety degrees to 180 degrees causes the voltage induced in the loop to decrease as the angle of passage through the field moves closer to parallel.

From 180 degrees, through 270 degrees and back to 360 degrees (zero degrees, the starting point) the induced voltage is identical to that of the first 180 degrees (0° - 180°) except that the polarity of the output voltage is reversed because the loop is cutting

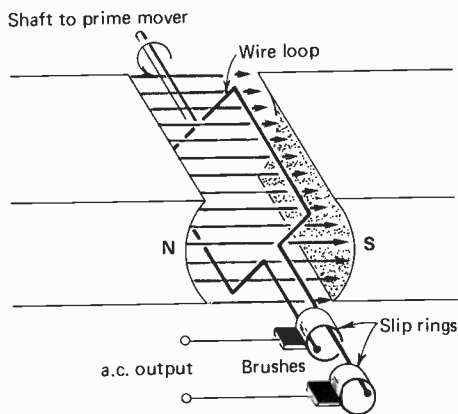
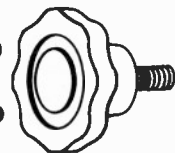

Fig. 4.6—Construction of the basic AC generator. Loop is rotated in the magnetic field by the prime mover. The AC output is taken off the slip rings by the sliding brushes so wires are not entangled by the rotation.

HUSTLER
No-Rob Knob
SAVES YOUR CB RADIO
 for only **\$1.95**
 get fast out-of-sight
 CB Antenna storage...

No-Rob Knob theft proofs your CB radio



In seconds, install or remove your Hustler rain gutter antenna for quick, out of sight storage. Retain the superior electrical performance and mechanical security of a permanently mounted antenna. Easy conversion; just replace the regular locking bolt with the No-Rob Knob. Fits all Hustler rain gutter mounts and rain gutter mount antennas manufactured since 1962.

AVAILABLE FROM ALL DISTRIBUTORS WHO RECOGNIZE THE BEST!

new-tronics corporation

Brookpark, Ohio 44142

BASIC RADIO (continued)

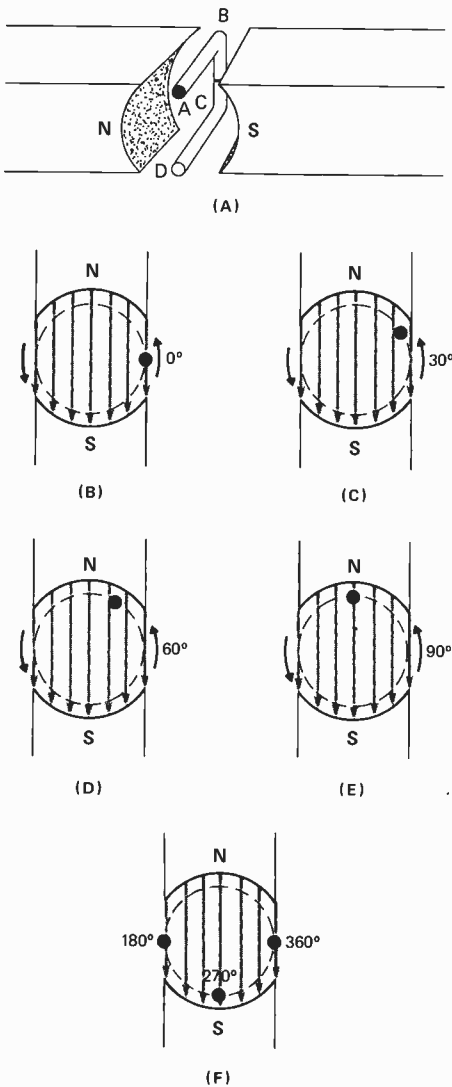

Fig. 4.7(A)—Structure of the loop in the generator field. The voltage across A and B adds to the voltage across C-D to provide the total output from A to D. (B) to (F)—Position of the top portion of the loop every 30° of the rotation.

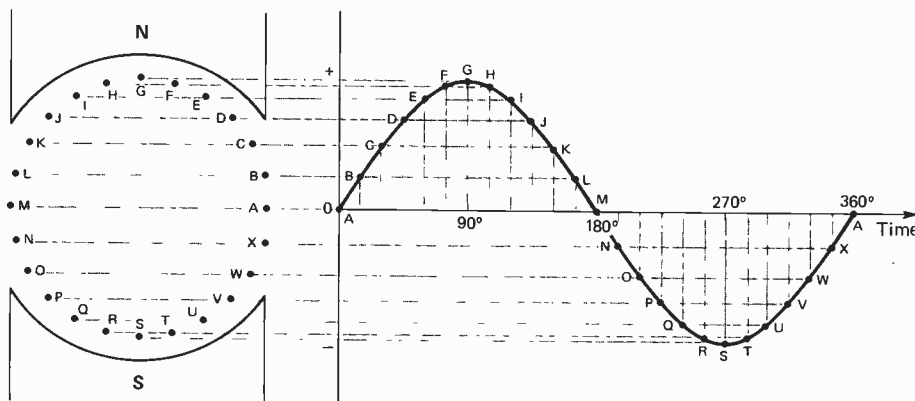

Fig. 4.8—The full rotation of the loop shown on the left produces the sine wave on the right. The horizontal axis of the sine wave is marked off in degrees rather than time in seconds because different frequencies would each have a different time but for all frequencies the loop must rotate 360° regardless of its speed.

through the field in the opposite direction.

The entire rotation of the loop and the resultant output voltage is shown in Fig. 4.8. To the left is the generator with the position of the rotor marked off every fifteen degrees, lettered from A to X. To the right is the resultant output voltage. The horizontal axis is marked off every fifteen degrees (from 0° to 360°). The vertical axis is marked off in voltage, positive above the zero line, negative below the zero line. The plotted voltage is the result of one rotation of the loop.

Further examination of Fig. 4.8 shows that the maximum positive voltage is generated as the loop passes through ninety degrees and the maximum negative is generated as the loop passes through 270°; as the loop passes through 0° and 180° zero output voltage is developed; from 0° to 180°, rotation of the loop produces only a positive output; from 180° to 360° rotation produces only a negative output.

AC Terminology

Because an AC has continuously changing values of voltage and current and the rotor of the generator can be driven at various speeds it is necessary to carefully define this type of voltage or current. The following terms must be understood.

Cycle—The rotation of the loop in the generator through 360° produces an output voltage defined as one *cycle*. As shown in Fig. 4.9(A), one cycle consists of the positive alternation (from 0° to 180°) and a negative alternation (180°-360°).

Sine Wave—The shape of the output waveform shown in Fig. 4.8 is called a *sine wave* (or a sinusoidal wave) because the voltage induced in the rotating loop is determined by the *sine* of the angle, a trigonometric function.

Frequency—By increasing the speed of the prime mover and thus the speed of the loop in the generator field, it is possible to increase number of alterations or cycles in a given period of time. The standard unit of measurement is *one second* and so *frequency is the number of cycles completed in one second*. Therefore, if 60 cycles are completed in one second, it is noted as 60 Hertz, Hertz meaning the cycles per second. This is abbreviated as 60 Hz.

If, as shown in Fig. 4.9(B), three cycles are generated in one second, the frequency of the output is 3 Hz. If the generator rotation is increased twenty times the output would contain 60 cycles in one second or 60 Hz. As the frequency of the AC increases, new units are used to simplify notation. For example:

- 1000 Hz = 1 kilohertz = 1 kHz
- 1,000,000 Hz = 1 megahertz = 1 mHz
- 1,000 mHz = 1 gigahertz = 1 GHz

The frequency of most power systems is low, most often 60 Hertz. On occasions it may be 25, 40 or 50 Hz but 60 is most popular because it is equally suitable for lighting and operating motors. Some generators are built to provide 400 Hz (a popular frequency for aircraft use) and some, for special purposes, produce 20 kHz.

Period—If the frequency of a generator output is 60 Hz, this tells us that 60 cycles are being produced in one second. Each cycle, therefore, must be occurring in 1/60 of a second. This time duration of one cycle is defined as the *period*. There is a simple mathematical relationship between time and frequency.

$$t = 1/f$$

where t = the time duration of one cycle in seconds

f = the frequency in Hz.

Thus, if an AC voltage has a frequency of 5000 Hz, the period of one cycle is found by

$$\begin{aligned} t &= 1/f \\ &= 1/5000 \\ &= 0.0002 \text{ seconds} \end{aligned}$$

By rearranging the formula (transposing) we can solve for f if t is known.

$$f = 1/t$$

To illustrate, we can find the frequency of an AC voltage if we know, for example, that it has a period of 0.005 seconds.

$$\begin{aligned} f &= 1/t \\ &= 1/0.005 \\ &= 200 \text{ Hz} \end{aligned}$$

Methods of Measuring AC

When DC is applied to a resistance it is very simple to calculate the current flow and power dissipation. As shown in Fig. 4.10(A), the applied voltage is a constant 10 volts resulting in a constant current of one ampere which in turn results in a constant power dissipation of 10 watts. In the circuit shown in Fig. 4.10(B), an AC voltage is applied to a 10 ohm resistor. (Note the symbol for the AC generator.) The AC voltage rises to plus ten volts and drops to minus 10 volts. Will the resistor also dissipate 10 watts as in example (A)? No, because the 10VDC caused a *constant* current of 1A while the AC voltage causes 1A to flow only twice each cycle. The rest of the time the current is rising up to 1A or dropping down to zero. Clearly then, we must have a different system of measuring AC so that we will have a true idea of the work it can accomplish. Some methods of measuring AC are outlined below.

Peak Voltage—The peak voltage of a sine wave is the maximum voltage reached during an alternation or cycle. For a sine wave the positive peak voltage is always equal to the negative peak voltage and each alternation is a mirror image of the other. The peak voltage is indicated as E_{pk} or E_{max} . While the peak voltage is important in some calculations and applications it is not the standard unit of measurement. The peak voltage measurement is shown in Fig. 4.10(C).

Peak-to-Peak Voltage—The peak-to-peak

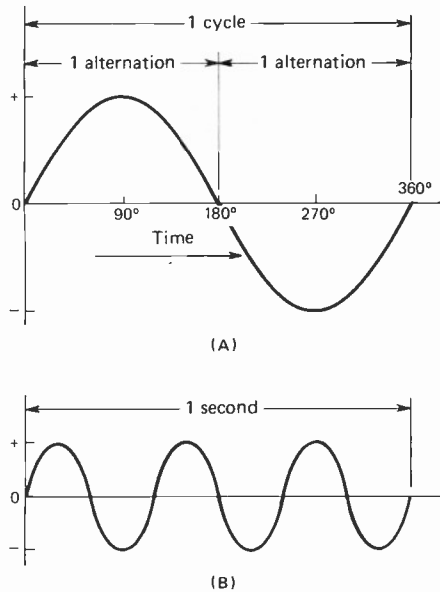

Fig. 4.9(A)—One cycle consists of two alternations, the positive from 0° to 180° and the negative from 180° to 360°. (B) When 3 full cycles occur in one second the frequency is 3 Hertz or 3 Hz.

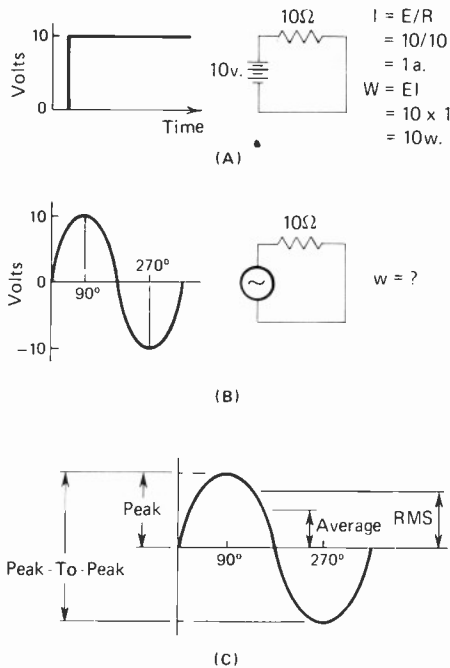

Fig. 4.10(A)—A DC voltage produces a constant current and so a constant power dissipation. (B) A sine wave does not provide a constant voltage and so the current must also vary. (C) A sine wave with the various ways of measuring the voltage marked off.

voltage is the sum of the positive peak and the negative peak as shown in Fig. 4.10(C). Since the negative and positive peaks of a sine wave are always equal, the peak-to-peak voltage is always equal to $E_{pk} \times 2$. Again, the peak-to-peak voltage, abbreviated E_{p-p} , is not the standard unit of measurement but is encountered in some calculations.

Instantaneous Voltage—The instantaneous value of an AC voltage is the voltage that exists at any one instant. The instantaneous voltage will have a specific amplitude (height) and polarity. The instant of time is specified in degrees between 0 and 360. For example, in

Degrees	sin	cos
43.0	0.682	0.731
43.5	0.688	0.725
44.0	0.695	0.719
44.5	0.701	0.713
45.0	0.707	0.707
45.5	0.713	0.701
46.0	0.719	0.695
46.5	0.725	0.688
47.0	0.731	0.682
47.5	0.737	0.675
48.0	0.743	0.669
48.5	0.749	0.663
49.0	0.755	0.656
49.5	0.760	0.649
50.0	0.766	0.643

Table 1—Extract from a typical Sine and Cosine table.

CRAZY Harvey's CB SHOPPE

We've got the "Big" NAME BRANDS for the smallest dollars.

Whether it be CB, Marine, Car Stereo etc... Crazy Harvey's has it, and with **BIG DISCOUNTS**, not just a few dollars off!

Send for our Free Catalog of prices and brands. Our new address:

**CRAZY HARVEY'S
CB SHOPPE**
8848 Orchard Tree Lane
Towson, Maryland 21204
(301) 821-0792

Name _____
Address _____
City _____ State _____ Zip _____

ATLANTIC SPEED CENTER

2 East 39th Street, Wilmington, DEL. 19802 — 302/762-9040 & 762-6827

Dealer Inquiries Invited

To Sell These Famous Lines:

- Antenna Specialists
- Astatic
- Avanti
- CDE Rotors
- D & A
- Hy-Gain
- Johnson
- Kris
- Midland
- Panasonic
- Para Dynamics
- Pearce Simpson
- Robyn
- Royce
- Shakespeare
- Stam-Comm
- Turner
- Vanco

DEALERS - Call
TOLL FREE
800-441-7630

Fig. 4.10(B), at 90° the instantaneous voltage is +10V; at 180° it is 0V; at 270° it is -10V and at 360° it is 0V again. To determine the instantaneous voltage at any point other than those marked in Fig. 4.10(B) we use the formula

$$e_{inst} = E_{max} \times \sin \theta$$

where e_{inst} = the instantaneous voltage at some angle between 0°-360°

E_{peak} = the peak or maximum voltage of the sine wave

$\sin \theta$ = the value for any angle determined from the Sine and Cosine Tables found in a math text or by the use of a calculator with scientific functions.

For example, to find the instantaneous value of voltage at 45° for the sine wave of Fig. 4.10(B) we first refer to the Sine and Cosine Tables and find the sine of 45°, 0.707. Substituting, we have

$$\begin{aligned} e_{inst} &= E_p \times \sin \theta \\ &= 10 \times 0.707 \\ &= 7.07V \end{aligned}$$

Again, this calculation is rarely required in the field, if ever, but permits us to understand the basis for the measurement standards to be explained below.

Average Voltage—The average voltage

of a sine wave is determined by calculating the large number of instantaneous voltage values from 0 to 90°, adding these voltages and then dividing by the number of voltages added. If, as shown in Fig. 4.11, we calculate the instantaneous voltage every 5° from 0° to 90°, we will have 19 voltages. Adding these voltages and dividing by the number of voltages added, 19 in this instance, will provide us with the average voltage. The answer will always be 0.636 of the peak voltage. Thus:

$$E_{average} = 0.636 \times E_{peak}$$

For example, if the peak voltage of a sine wave is 47 volts, E_{av} would be

$$\begin{aligned} E_{av} &= 0.636 \times E_{pk} \\ &= 0.636 \times 47 \\ &= 29.89V \end{aligned}$$

It should be noted here that while the average value of one alternation (either one) is $0.636 \times E_{pk}$, the average of an entire cycle is 0V since the negative and positive peaks cancel. However, the average value referred to is *always* for one half cycle. Again, this is not the major measurement for an AC voltage but it is encountered in some calculations.

Effective Voltage—All the previous methods of measuring the AC voltage or current are used for calculations and

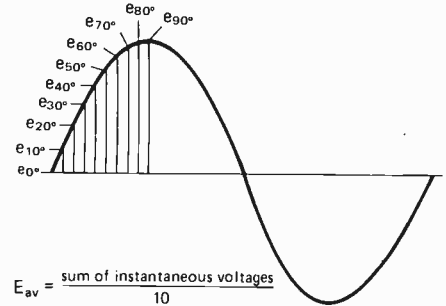

Fig. 4.11—The average voltage is computed by averaging a large number of instantaneous voltages.

simple design work but are not used in practical work because they are not comparable with DC. The AC that is the equivalent of DC is defined as the effective or root mean square voltage (abbreviated rms). The effective value of an AC voltage is determined by calculating a large number of instantaneous voltage values from 0° to 180°, squaring each, adding them, dividing by the number added to get the average and then taking the square root of that average to give us the root mean square or rms value. It is this value of voltage which will have the same effect as an equivalent value of DC. The calculated value of rms voltage will always be 0.707 of the peak voltage. Thus

$$E_{rms} = 0.707 \times E_{peak}$$

If we wish to determine the rms, or effective value of an AC voltage with a peak voltage of 75 volts, we substitute as follows:

$$\begin{aligned} E_{rms} &= 0.707 \times E_{pk} \\ &= 0.707 \times 75 \\ &= 53.025V \end{aligned}$$

AC Voltage Conversions—Since it is often necessary to convert from one AC voltage or current measurement form to another, particularly when learning basic electronics, it would be helpful to see the conversion procedures clearly. These are summarized below.

Unknown	Known	Method
Peak	Peak-to-Peak	÷2
Peak-to-Peak	Peak	×2
rms	Peak	×0.707
Peak	rms	×1.414
Average	Peak	×0.636

The ordinary household outlet provides us with 117VAC. Is this voltage value peak-to-peak, peak, rms or average? It is rms, the effective value. Any time an AC voltage is given and the unit of measurement is not indicated, it is automatically understood to be rms. The 117VAC available from an outlet can then be converted to the other measurement forms using the formulas above. (continued)

Tired of Crowded CB Channels?

Then you want a

GRC-11 RANGE CONTROLLER

Eliminates

- INTERFERENCE ON CROWDED CHANNELS
- EAVESDROPPING ON PRIVATE CONVERSATIONS
- BLEEDTHROUGH FROM OTHER CHANNELS



\$39.95

PLUS . . .

Fantastic "Private Mode" bonus feature allows you private conversations car to car. Installs in 5 minutes. Requires no power. Connects between any CB set and CB antennas.

You Can't Steal What You Can't See

Operate your CB with your regular car antenna.

No CB antenna necessary.



\$49.95 The PROFILE ANTI RIPOFF costs more but works better.

No complex extra meters to buy. Has built-in traffic light indicator. Green light, everything's right. Red light, simple knob adjustment. Listen to your AM/FM radio even while transmitting!



Send Check, Money Order, Bank Americard or Master Charge Number With Expiration Date. Now in Stock for Immediate Shipment.

Glatzer Industries Corp.

268-I Huguenot Street • New Rochelle, N. Y. 10801

(914) 576-2700 Dealer Inquiries Invited!



5

great reasons

why *YOU*
should subscribe to
(if you aren't already doing so)



1. You'll save a bundle. Newsstand copies are \$1.50 each, or \$18 for a year's supply. Your subscription costs only \$12 — that's 33% off!
2. You'll get S9 earlier. Subscriber copies will reach you as much as two or three weeks ahead of newsstand or store copies.
3. You'll be sure of getting your copy. Many times S9 is sold out before you can find it. Your subscription is like an insurance policy of fun reading.
4. You'll get a bonus. Right on! A 24 page copy of the FCC Part 95 CB regulations. The Commission says it's a must for every CBer.
5. You'll make our editor very happy. And there's nothing more important than having a happy Tomcat (that is, if you're going to keep a Tomcat on the premises, as we do.)

So, indulge yourself. S9 is the CB magazine that doesn't quit when it comes to giving CBers all the scoop on what's happening out in the CB world. Do it now! Today! Before you forget!! After all, spreading joy is what CB's all about, now, isn't it?

S9 MAGAZINE
14 Vanderventer Avenue
Port Washington, N.Y. 11050

Here's my\$12 for a 1 year sub,
.....\$20 for 2 years. This is a.....new
sub, or a.....renewal. Please include my FREE
copy of FCC Part 95 CB Regulations.

Allow six weeks for delivery of first subscription copy.

Name _____ Call _____

Address _____

City _____ State _____ Zip _____

BASIC RADIO (continued)

Rate of Change—Examining any of the sine waves shown in Figs. 4, 8, 9 and 10, one can see that they do not have a constant rate of change. This refers to the voltage increase or decrease for any unit of time, measured in degrees. This is more clearly laid out in Fig. 4.12. At 30° the instantaneous voltage is 5V. At 60° e_{inst} is 8.66V and at 90° it is 10V. The change in voltage from 0° to 30° is 5V. This is noted as $\Delta 5V$, or delta 5V, the Greek letter delta meaning *change of*. From 30° to 60° the voltage rises from 5 to 8.66V, a change of 3.66V. From 60° to 90° the voltage rises from 8.66 to 10V, an increase of 1.34V. Comparing the voltage changes we have:

- 1—For the first 30° $\Delta 5V$
- 2—For the second 30° $\Delta 3.66V$
- 3—For the third 30° $\Delta 1.34V$

An important point to observe in the rate of change concept is that it also changes with frequency. As shown in Fig. 4.13, the higher the frequency the greater the rate of change.

Frequency Spectrum—AC voltages and currents can be generated at frequencies lower than 1Hz to as high as 5×10^{20} hZ (5 followed by 20 zeros, a number too cumbersome to write). We have already listed those frequencies used for power systems. AC at other frequencies are used for radio communication, medical purposes, navigation and so on. The range of frequencies available for these purposes is called the *frequency spectrum* or sometimes the *radio spectrum*. A partial listing of the spectrum is shown below.

- 1 to 10 Hz
Below audible threshold
- 10 Hz to 20 Hz
Audio frequency range
- 10 to 600 Hz
Power system frequency range
- 15 kHz to 1.5 MHz
Ultrasonic range
- 5 to 30 kHz
Very low radio frequency (VLF)
- 30 to 300 kHz
Low radio frequency (LF)
- 300 kHz to 3 MHz
Medium radio frequency (MF)
- 3 to 30 MHz
High radio frequency (HF)
- 30 to 300 MHz
Very high radio frequency (VHF)

Suggested Reading

Schrader, Robert L. *Electronic Communication*, Third Edition, New York: McGraw-Hill, pp. 62-66.
Tepper, Marvin, *Basic Radio*, Vol. II, Second Edition, New Jersey: Hayden, pp. 2-8 to 2-18.

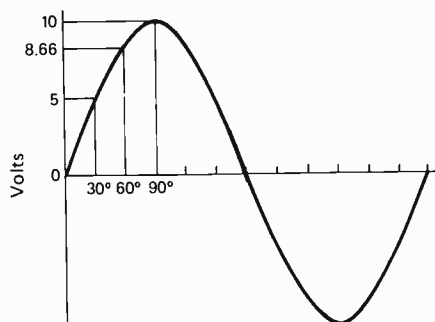

At 30° $e_{inst} = E_{pk} \times \sin 30^\circ = 10 \times 0.5 = 5v$.
 At 60° $e_{inst} = E_{pk} \times \sin 60^\circ = 10 \times 0.866 = 8.66v$.
 At 90° $e_{inst} = E_{pk} \times \sin 90^\circ = 10 \times 1 = 10v$.

Fig. 4.12—The rate of change of voltage in a sine wave is not constant. As shown above, the first 30° segment produces a change of 5 volts while the third 30° segment produces a change of 1.34 volts.

- 300 mHz to 3 GHz
Ultra high radio frequency (UHF)
 - 3 to 30 GHz
Super high radio frequency (SHF)
 - 30 to 300 GHz
Extremely high radio frequency (EHF)
 - 3×10^{11} Hz to 4.3×10^{14} Hz
Infra red (heat)
 - 4.3×10^{14} Hz to 1×10^{15} Hz
Visible light
 - 1×10^{15} Hz to 6×10^{16} Hz
Ultra violet
 - 6×10^{16} Hz to 3×10^{19} Hz
X-Rays
 - 3×10^{19} Hz to 5×10^{20} Hz
Gamma Rays
- Above this lies the cosmic radiation range.

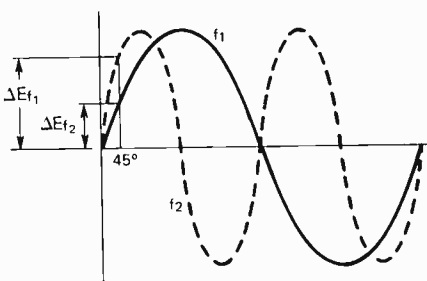

Fig. 4.13—The rate of change is greater for a higher frequency signal for the same given time.

Generation of AC Experiment

Experiment #2B, April, 1976, page 109, described how to generate voltage magnetically. Review the results or perform the experiment over again.

SELF-CHECK QUESTIONS

- 1—In direct current circuits the polarity of the voltage source _____.
(Changes; remains unchanged).
- 2—In alternating current circuits the polarity of the voltage source _____.
(Changes; remains unchanged).

3—Alternating current is not as desirable as direct current. T or F.

4—Alternating current voltages can be stepped up or down by the use of a transformer but DC cannot. T or F.

5—A wire moved through a magnetic field at right angles to the lines of force will develop a voltage across it. T or F.

6—The amount of voltage induced in a wire moving through a magnetic field is a function of the speed of movement, the strength of the magnetic field and the polarity of the magnetic field. T or F.

7—If a wire moves through a magnetic field parallel to the lines of force, the voltage induced in that wire will be _____. (maximum; minimum; a moderate value).

8—The function of slip rings and brushes is to remove the output of the rotor of the alternator without tangling the wires. T or F.

9—The output wave shape from the generator shown in Fig. 4.6 is called a _____ wave.

10—The first 180 degrees of rotation of the loop generates the positive _____.

11—How many degrees is represented in one cycle of AC?

12—One cycle of an AC wave consists of one positive and one negative alternation. T or F.

13—The speed of the prime mover has little or no effect on the output frequency of the generator shown in Fig. 4.6. T or F.

14—Frequency is defined as the number of cycles completed in 360°. T or F.

15—1,000 kHz is the same as 1MHz. T or F.

16—1,000 mHz is the equivalent of 1gHz. T or F.

17—The time duration of one cycle is its period and the period is measured in degrees. T or F.

18—Find the period of a 2.7 kHz sine wave.

19—Calculate the frequency of a sine wave whose period is 0.0001 seconds.

20—If the peak positive voltage of a wave is 25 volts, its negative peak

may be 25 volts, plus or minus 10 volts. T or F.

21—The instantaneous voltage of a sine wave at 43.5° given a peak voltage of 30 is _____.

22—The average voltage of a sine wave is

- a — equal to the effective voltage
- b — one-half of the peak voltage
- c — equal to $0.636 \times E_{\text{peak}}$
- d — equal to $0.636 \times E_{\text{peak-to-peak}}$.

23—Given a sine wave with a peak-to-peak voltage of 70 find the following:

- A — E_{peak}
- B — E_{average}
- C — $E_{\text{effective}}$
- D — E_{rms}

24—The rate of change of voltage for a sine wave is the same regardless of frequency. T or F.

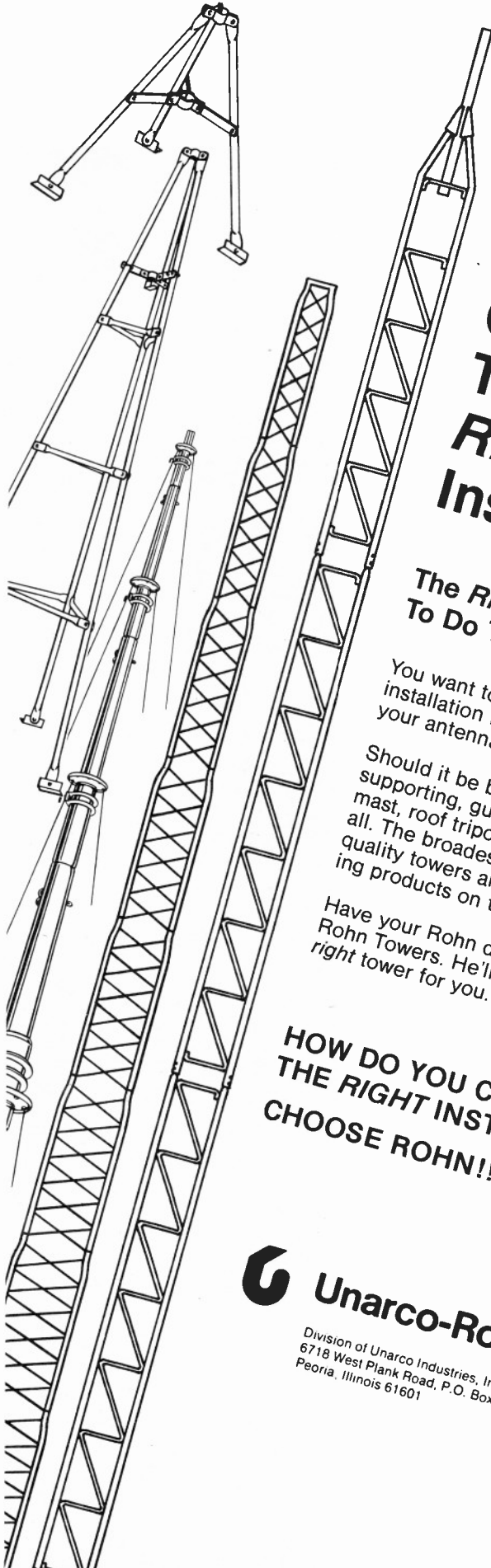

Choose The Right Installation

The Right Product To Do The Right Job

You want to know what kind of installation is the best for your antenna.

Should it be bracketed, self-supporting, guyed, telescoping mast, roof tripod? Rohn has them all. The broadest selection of quality towers and antenna supporting products on the market today.

Have your Rohn dealer show you Rohn Towers. He'll help select the right tower for you.

HOW DO YOU CHOOSE THE RIGHT INSTALLATION? CHOOSE ROHN!!

Unarco-Rohn

Division of Unarco Industries, Inc.
6718 West Plank Road, P.O. Box 2000
Peoria, Illinois 61601

ANSWERS TO SELF-CHECK QUESTIONS

- 1—remains unchanged.
- 2—changes.
- 3—F.
- 4—T.
- 5—T.
- 6—F. The polarity of the field only affects the polarity of the induced voltage, not the amount.
- 7—minimum.
- 8—T.
- 9—sine.
- 10—alternation.
- 11—360°.
- 12—T.
- 13—F.
- 14—F. It is the number of cycles completed in one second.
- 15—T.
- 16—T.
- 17—F. Period is measured in seconds.
- 18— $t=1/f=1/2700=0.00037$ seconds.
- 19— $f=1/t=1/0.0001=10$ kHz.
- 20—F. If the positive peak is 25 volts the negative peak must also be 25 volts.
- 21— $e_{\text{inst}}=E_{\text{pk}} \times \sin \theta = 25 \times \sin 43.5^\circ = 25 \times 0.688=17.2\text{V}$.
- 22—c.
- 23—A— $E_{\text{pk}}=E_{\text{pp}}/2=70/2=35\text{ V}$
- B— $E_{\text{av}}=E_{\text{pk}} \times 0.636=35 \times 0.636=22.26\text{V}$.
- C— $E_{\text{eff}}=E_{\text{pk}} \times 0.707=35 \times 0.707=24.745\text{V}$.
- D— $E_{\text{rms}}=E_{\text{eff}}=24.745\text{V}$.
- 24—F. The higher the frequency the greater the rate of change.

CB RADIO/S9 FIX'M-UP

TAKE ADVANTAGE OF THESE USEFUL SERVICES:

HAVE TV INTERFERENCE HEADACHES?

A free TV interference instructional kit has been prepared which details how to tackle this tricky problem. Write to TVI, P.O. Box 21, Hartford, CT 06101.

DO YOU HAVE AN A.M. UNIT NUMBER ID YET?

Many AM operators are now using Unit Number ID's in addition to or instead of "handles." They have dozens of advantages. For more information and an application to receive your own personal Unit Number ID, send a self-addressed stamped envelope to Z-Tech, P.O. Box 70-FXM, Hauppauge, NY 11787.

SIDEBAND ID NUMBERS?

They don't use "handles" to ID on the sideband channels, stations use "Sideband ID Numbers." If you're an active Sidebander you may already have several local or regional group ID numbers—if you're a newcomer or a future Sidebander, you may not have any Sideband ID numbers at all! Whether you have a dozen numbers or none at all, it's easy and important to you to get yourself a set of national ID numbers from the SSB Network, the oldest (1964) and most prominent national sideband group. Old timers, newcomers, and future Sidebanders should obtain information and an application for national SSB Network numbers by sending a self-addressed stamped envelope to: Sidebanders' Service Bureau, P.O. Box 381-XF, Smithtown, NY 11787.

DOUBLE CB OUTPUT POWER -- LEGALLY!



WITH...

the GBP-X2 Booster Power Supply

Allows you to take your mobile rig inside and operate it like a base station while doubling your output power, increasing your range, and reducing any interference to your neighbor's TV sets by more than ten times.



\$79.95

- The only power doubling power supply on the market!
- Increases your average power twice as much as the best power mike!
- Works with all rigs — 23 channel, 40 channel, AM, and sideband!
- All solid state!

Now in stock for immediate shipment.

Dealer inquiries invited.

Glatzer Industries Corp.

268-I Huguenot Street New Rochelle, N.Y. 10801
See us at PC-77, Booth No. 754 (914) 576-2700

Glatzer Industries Corp.

268 Huguenot St., New Rochelle, NY 10801

Please rush _____ GBP-X2(s). I've enclosed \$ _____
(which includes \$2.00 postage & handling. NY residents add 5% sales tax. I am enclosing (check one) Check Money Order. Or

 Card No. _____ Exp. _____

 Card No. _____ Exp. _____

Name _____

Address _____

City _____ State _____ Zip _____

Ordered by _____

(your signature if using BAC or MC).

THE HAM BANDER

Get Your Ham License -- PRONTO!

It's Easier Than You Think!

PART 3 OF A SERIES



By Lee Aurick, KNE7802, W2LE

HOW is your c.w. practice coming? Can you call off all the letters by now? More importantly, if someone sends the letters to you, can you identify them? By now you should be able to write all the letters, all the numbers, and should have a good grasp on the operating symbols. I *know* you've got the three punctuation symbols down cold.

Is There a Plateau?

If you've had any recent contact with friends who may be hams it's likely that you've been asked, "Have you reached the plateau yet". This refers to a certain point many people reach in learning c.w. which they just can't seem to move beyond. No matter how hard they try, they are unable to improve their speed by even one word-a-minute. To these people, the ability to increase their c.w. speed is gone. They seem to have reached a level plateau, and can go no further. It takes a great effort and considerable time to "climb" above this plateau, but it can be done with perseverance. The plateau does exist—and for those individuals who have experienced it, it is very real. The pity is that it doesn't have to be there at all.

The plateau is usually the result of improper practice technique. For example, you are now at the point, or have just passed it, of learning the alphabet and number symbols. It is only natural to have someone send the letters and

numbers slowly and laborously while you are practicing and learning. And here is where the groundwork is laid for the plateau which can plague you for months, and even years. Your friend is sending the letters of the alphabet to you in a dragged-out sequence—dah—dah—dit—dah. OK, you'll eventually learn to recognize "Q". But it will be difficult to get beyond the plateau he is building for you. As you advance, you'll have to *relearn* the sound of the symbols at *each* increase in speed. Six words, seven words, eight words-per-minute, and so on. How can you avoid the plateau?

It's easy. You'll recall that in the second part of this series (S9 for February) it was suggested that each *letter* be sent either by mouth or key, at an *average* speed of *one second*. That would be sixty letters per-minute, which, at five letters-per word, is twelve words-per-minute. So—what you've been doing up to this point is learning *letters* at a speed of twelve words-per-minute (if you've followed the suggestion). It makes no difference that the letters may have been spaced far apart so that the words were sent at three or four per minute. Practice will improve that, but the letters were being *learned* at twelve words-per-minute.

If you kept on until your speed reached twelve *words-per-minute* you *might* be at a plateau. It's possible. Most people who learn improperly plateau-out at about eight words-per-

minute. From here on, no matter how slowly the *words* are sent, the letters should be sent at a speed of twenty words-per-minute. You'll find that you will never reach a plateau. Steady practice (as much as you wish to invest) will result in steady improvements in c.w. speed. "Isn't it possible to reach a plateau at twenty words-per-minute?", someone asks. It's not likely, since by the time you reach that speed you'll already be copying by whole words, not just letters. So, pick up the sending speed now to the point where the letters are being sent in about three-quarters of a second, each. It's unimportant how many letters you send or receive in a minute. That speed will continue to improve with practice. And remember, practice is the answer. You're on the right track now, and you'll never have a difficult plateau to climb. Promise.

Geographical Areas, Call Signs, and What They Mean

In part two we learned that it is important to learn numbers because you will be involved with them as soon as you get on the air. All amateur call signs have a number as a part of the prefix. In the U.S., as in many countries, that number is assigned by the government dependant upon the area in which you live. The U.S. is divided into ten call areas, and the number which appears in an amateur call will give you a pretty good idea as to the



Fig. 1—This multi-band high frequency transmitter is available in kit form, and may be constructed with a great savings over commercially manufactured gear.



Fig. 2—Solid-state linear amplifiers such as this will step up a 5 watt mobile signal to 100 watts at 2-meters.

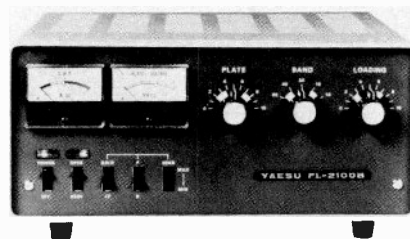

Fig. 3—Linear amplifiers are used at fixed locations to boost SSB signals to 2,000 watts PEP, and 1000 watts c.w.

CBSAMSEZ



IF YOU COPY HOKEY WHEN THE TRANSMISSION WAS SMOKEY, WHAT YOU NEED ARE **MAGITRAN CB SPEAKERS** -- SPECIALLY DESIGNED **DUAL-PURPOSE** JOBS FOR **REMOTE AND PA VOICE (200-3000HZ) COMMUNICATIONS.**

THEY'RE ALL **WEATHERPROOF** AND HANDLE A **BIG 10 WATTS RMS** -- MORE THAN OTHER CB SPEAKERS



THE **CB51** AND **CB10-69** ARE ONLY **1-3/8" THIN**. AN ALUMINUM SWIVEL BRACKET IS SUPPLIED WITH THE **CB51** FOR HANG OR STAND-MOUNTING. MODEL **CB10-69** HAS CLIPS FOR SUN VISOR MOUNTING OR YOU CAN HANG IT ON A WINDOW FOR PA USE.

FOR CUSTOM **FLUSH-OR SURFACE-MOUNTING** ON KICK PANELS AND REAR DECKS OF BEAVER BUGGIES AND COMPACTS, YOU CAN'T BEAT **MAGITRAN'S CB10-4**.

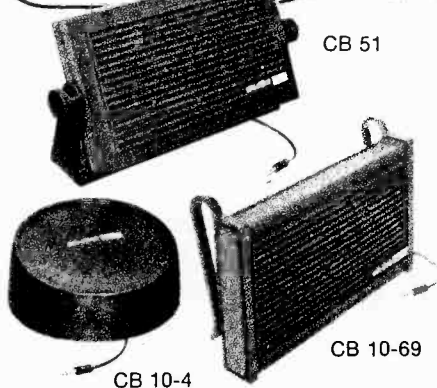

MAGITRAN COMPANY
311 EAST PARK STREET
MOONACHIE, N.J. 07074

location of a station, just as soon as you hear it. There are now many prefixes assigned to amateurs in the U.S., and as the number of amateurs grows there will be even more.

Prefixes presently in use in the U.S. are W, K, WA, WB, WD, N, and A. The latter two are recent assignments. WC is reserved for commemorative stations, and is assigned to aid in celebrating a specific event; such as the centennial of your home town. The number of the call area follows the first letter, or letters, and together they comprise the prefix. The remainder of the call, the suffix, is generally assigned by the FCC in alphabetical order. Recently, Extra Class licensees were given the privilege of requesting their choice of any unassigned calls, and many thousands took advantage of the opportunity. As you progress you will learn that each country, by international agreement, has a distinctive prefix that serves to identify amateurs of that country the moment you hear them. For example, F for France, G for Great Britain, PY for Brazil, VE for Canada, XE for Mexico, and so on. If you decide to become a DXer (specializing in contacting foreign countries) you will come to know the prefixes of many exotic, far away countries as well as you know your own name.

There is even a special contest and award, sponsored by *CQ—The Radio Amateur's Journal*, to amateurs who make contact with three hundred or more stations with different prefixes.

Scoring The Novice Exam

At the end of the study in any course one must expect to take an exam, and this Novice course is no exception. The twenty questions on the exam have multiple-choice answers. That is, five answers are provided only *one* of which is absolutely correct. Your task is to determine the correct answer and then place a mark on the answer sheet alongside the number that corresponds to this answer.

Some of the answers may appear to be partially correct, but only *one* will be entirely correct. The FCC requires a grade of at least 74 per cent to pass any of its exams, so this means that at five points for each of the twenty questions on the Novice exam you may miss no more than five correct answers.

Unit Relationships

Some of the terms used in electronics, such as volt, ampere and farad (unit of capacitance) are frequently too large for easy use. Other terms, such as hertz (cycles-per-second) are too small. Standard prefixes have been established

Call Area	States
1st	Connecticut, Maine, Massachusetts, New Hampshire, Rhode Island and Vermont
2nd	New Jersey and New York
3rd	Delaware, Maryland, Pennsylvania and the District of Columbia
4th	Alabama, Florida, Georgia, Kentucky, North and South Carolina, Tennessee and Virginia
5th	Arkansas, Louisiana, Mississippi, New Mexico, Oklahoma and Texas
6th	California
7th	Arizona, Idaho, Montana, Nevada, Oregon, Utah, Washington and Wyoming
8th	Michigan, Ohio and West Virginia
9th	Illinois, Indiana and Wisconsin
10th	Colorado, Iowa, Kansas, Minnesota, Missouri, Nebraska, North and South Dakota
KL7	Alaska
KH6	Hawaii

Chart I
The ten call areas of the U.S. and the states they comprise.

INTERESTED IN HAM RADIO?

Then
S9's
 Sister
 Publication



is for YOU

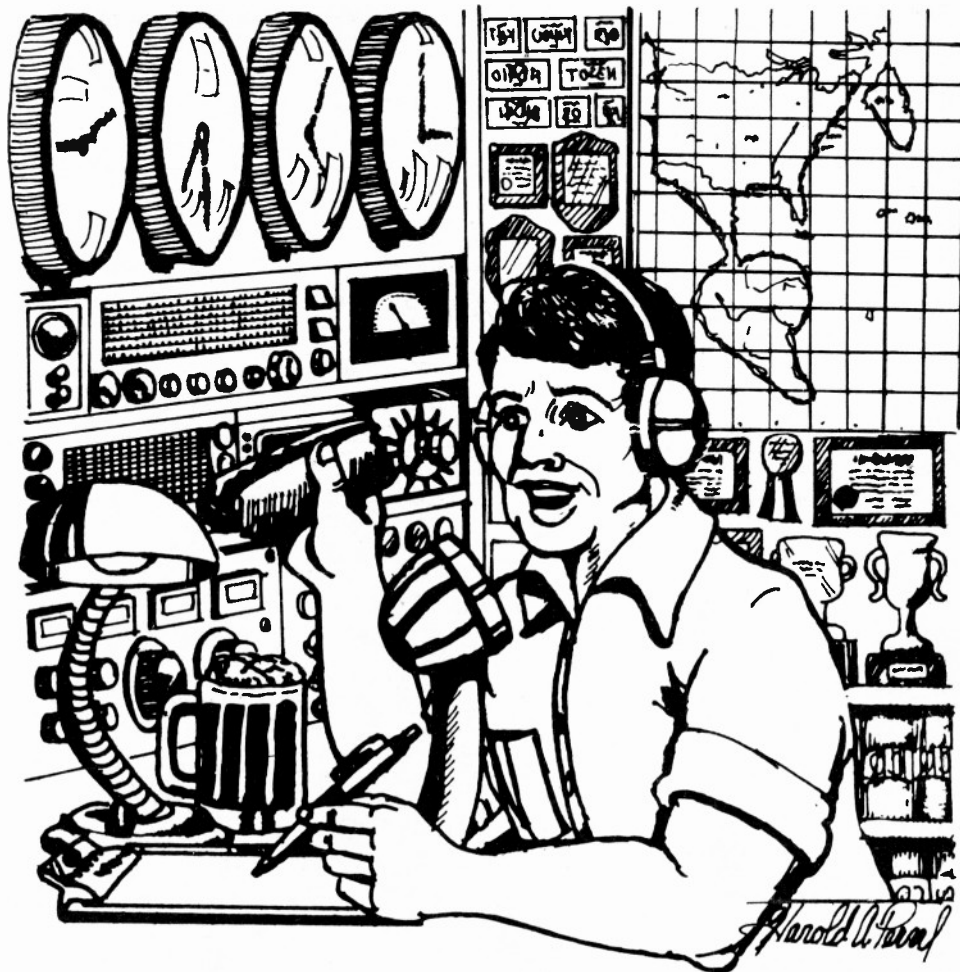

A recent survey of S9 readers indicated that two out of every three replying to our questionnaire would like to become an amateur radio operator. And we're all for that, because CQ, The Radio Amateur's Journal, is the oldest magazine in our company's stable.

CQ is not just another ham publication; it's the only ham publication aimed at the beginner as well as the old timer. It's the only ham magazine that recognizes that every new ham isn't an electronic engineer. The editorial features in CQ are aimed at people — people like yourself who turn to amateur radio as a means of having fun.

CQ caters primarily to the operating end of radio, with just a smattering of technical material to keep you up to date on what's happening. And even the technical portions of CQ are presented in a manner that every new amateur will understand.

In other words, CQ is the fun magazine in the amateur radio field. It's the amateur magazine that you'll enjoy from cover to cover. And remember, CQ is brought to you by the same folks who bring you S9. What more could you ask for?



The
 Radio
 Amateur's
 Journal
 Since 1945

14 Vanderventer Ave.
 Port Washington, L.I.,
 N.Y. 11050

Dear OM:

Enclosed please find \$ for Year(s) Subscription to CQ,
 The Radio Amateur's Journal.

NEW: Start with issue
 RENEWAL

Name Call
 Address
 City State ZIP

	Domestic	Foreign
One year	<input type="checkbox"/> \$7.50	<input type="checkbox"/> \$8.50
Two years	<input type="checkbox"/> \$13.00	<input type="checkbox"/> \$15.00

THE HAMBANDER (continued)

which make it easier to use these terms. You will need to know them, and their relationship to each other. They are shown in Chart II.

milli-thousandth
micro-millionth
pico-millionth of
a millionth
kilo-thousand
mega-million
giga-billion

Chart II—Prefixes frequently used when the value of a unit is otherwise too small or too large.

Pico is pronounced *peek-oh*, and giga is pronounced *jig-ah*. Terms which you will normally encounter are milli-ampere (thousandth of an ampere—mA), picofarad (a millionth of a millionth of a farad—pF), kilohertz (one thousand hertz—kHz), megahertz (one million hertz—MHz).

Q Signals

In part two, Q signals were discussed very briefly in connection with a question on the written exam.

Q signals are internationally-agreed-upon abbreviations. Their meaning is the same in every language in the world, and their primary purpose is to aid operators in exchanging information quickly, sometimes under poor conditions, and often where language might otherwise be a barrier. There are many of them, and you will, in time, learn those that you will use most frequently. Only a few are really needed for the Novice exam and they are shown in chart III. Q Signals may be used to ask a question, or to answer one. For example, "QRQ?" means "Shall I send faster?" If the receiving operator wants the other station to send faster he may send "QRQ 20" which means "Send faster, 20-words-per-minute."

The Written Exam

In part two, you saw just how simple the written exam really is. The Novice license requires only basic arithmetic, a minimum technical knowledge, and just enough understanding of the Rules and Regulations of the FCC to keep you out of trouble. The idea is that once you get your license and get on the air your knowledge will mushroom with your experience, and you'll be well on your way to becoming a well rounded amateur operator.

If you're ready for the next installment of questions—standby. Here it is.

Rules and Regulations

The Amateur Radio Service is best described as:

a) A radio communication service of self-training, intercommunication and

technical investigation carried on by amateur radio operators.

b) An emergency radio service manned by volunteers.

c) A service dominated by highly skilled engineers.

d) A service dedicated to communications in the public interest.

e) A training ground for military operators.

The correct answer is a). While many amateurs do participate in emergency communications and preparedness, b), and amateur radio exists because it is a public service, d) and many young amateurs do eventually find

SELECTED HAM RADIO "Q" SIGNALS

Abbreviation	Question	Answer or Advice
QRA	What is the name of your station?	The name of my station is.
QRC	Will you tell me my exact frequency (or that of . . .)?	Your exact frequency (or that of . . . is . . . kc/s(or Mc/s).
QRH	Does my frequency vary?	Your frequency varies.
QRI	How is the tone of my transmission?	The tone of your transmission is . . . (1. Good; 2. Variable; 3 Bad).
QRK	What is the readability of my signals (for those of . . .)?	The readability of your signals (or those of . . .) is . . . (1. Unreadable; 2. Readable now and then; 3. Readable, but with difficulty 4. Readable; 5. Perfectly readable).
QRL	Are you busy?	I am busy (or I am busy with . . .) Please do not interfere.
*QRM	Are you being interfered with?	I am being interfered with.
*QRN	Are you troubled by static?	I am troubled by static.
*QRQ	Shall I increase power?	Increase power.
*QRP	Shall I decrease power?	Decrease power.
*QRO	Shall I send faster?	Send faster (. . . words per minute).
*QRS	Shall I send more slowly?	Send more slowly (. . . words per minute).
*QRT	Shall I stop sending?	Stop sending.
*QRU	Have you anything for me?	I have nothing for you.
QRV	Are you ready?	I am ready.
QRX	When will you call me again?	I will call you again at . . . hours (on . . . kc/s(or Mc/s)).
*QRZ	Who is calling me?	You are being called by . . . (on kc/s or Mc/s)).
QSA	What is the strength of my signals (or those of . . .)?	The strength of your signals (or those of . . .) is . . . (1. Scarcely perceptible; 2. Weak; 3. Fairly good; 4. Good; 5. Very good).
*QSB	Are my signals fading?	Your signals are fading.
QSD	Is my keying defective?	Your keying is defective.
QSK	Can you hear me between your signals?	I can hear you between your signals.
QSL	Can you acknowledge receipt?	I am acknowledging receipt.
*QSO	Can you communicate with . . . direct or by relay?	I can communicate with . . . direct (or by relay through . . .)
QSP	Will you relay to . . . free of charge?	I will relay to . . . free of charge.
*QSY	Shall I change to transmission on another frequency?	Change to transmission on another frequency (or on . . . kc/s (or Mc/s)).
*QTH	What is your position in latitude and longitude (or according to any other indication)?	My position is . . . latitude . . . longitude (or according to any other indication).

Chart III

Selected International Q Signals. Those with an asterisk* are likely to be of most importance to Novice operators.

The Pisces CB Personality

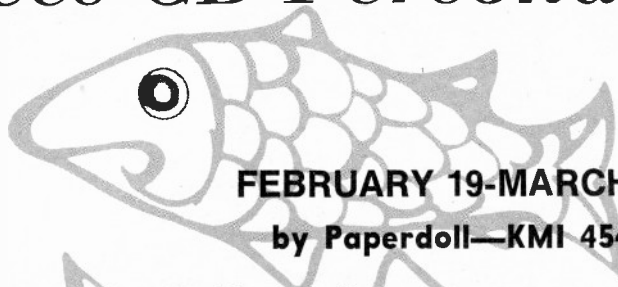

FEBRUARY 19-MARCH 20

by Paperdoll—KMI 4549



Poetic, mysterious Pisceans will lure you to find their 20 as they lazily drift down the boulevard engrossed in a never ending daydream. Ruled by the king of the seas, Neptune, Pisces' natural habitat is usually found close to water. Catch them modulating on marine channel 14 on their "sea-B" radios. These submarinal creatures have a strong psychic sense and use their built-in sonar to detect your very private thoughts. This keen sixth sense of these natural born mystics is used in the psychic arts of forecasting, healing and aurism. Dual sign Pisceans are generally extremists in one way or another and at times completely change course in midstream and swim against the tide. Many of the ambitious have reached high political office, namely President of the U.S. The other extreme may be found in the Bowery. A good motto for them is, "I had a dream." Their capacity for sympathy and solace overwhelms their good buddies. They'll suffer right along with you while giving a helping hand. Catch an eyeball on *their* eyeballs because they have the largest and most beautiful eyes of all the signs. No wonder this sign excels in the TV/movie world. Pisces, also ruler of feet, produces the best dancers, skiers and ice skaters. Typical Piscean handles might be: Waterbug, Lorelei, Charley Tuna, The Great Carnak, Bright Eyes.

MARCH STAR CHECK

PISCES—Creative Pisceans have the ability this month to turn their thoughts into greenstamps. Just before the new moon of the 19th, though, thinking processes may be blocked as sun sign ruler, Neptune, does a flip flop. You make a mental comeback end of March. March 2nd is a good time for a complete physical checkup to assure that you're in 10-4 condition.

ARIES—Active Aries has really got the hammer down on personal activities and has to back up on the 16th after stepping too fast. Personal magnetism pins the needle and you find yourself overmodulating all month. As March goes out like a lamb, you charge out like a ram taking some new followers along.

TAURUS—Docile Taurus keeps busy all month trying to keep some deep dark secret quiet. Behind the scenes activities flourish. March 29th tests your patience and confidence. The 19th introduces a new good buddy to modulate with. Last chance this month to capitalize on opportunity that's been knocking at your front door for the past year.

GEMINI—Jubilant Geminis use their gift of gab to best advantage at work 20 this month. Suggestion box is full of idealistic Geminian concepts. End of March brings you together with former YL or buffalo who instantly attracts your attention.

CANCER—March brings an early spring flurry of activity at work 20. Your new philosophies and ideas are on the table. Things look good till the 16th when a co-worker may throw the curse of the dreaded carrier. Usually quiet Cancer will just have to turn up the volume and walk all over them, fer sure.

LEO—March definitely comes in like Leo the Lion, 10 roger! You and better half or business partner come to meeting of the minds over the company piggybank. Many greenstamp transactions this month, some quite unexpected. Entertainment may have to take a back seat around the 16th, something Leo has been learning to live with for the past year.

VIRGO—Merci sakes! Mercurial Virgos be mighty restless this month waiting for a break from motor mouth better half. Usually just the opposite. Commotion could be over some household loss discovered around March 18th. Be forewarned that the 16th is no day to haggle over other half's lettuce. March you put an eyeball on some attractive YL or buffalo to whom you are irresistibly drawn.

LIBRA—Librans fall out of the weekend ski convoy and all of its social events as the season comes to an end and spring begins to emerge. The frequency is crystal clear for communication now and receptivity between you and loved one is at its peak all month. You won't even have to key the mike to be heard or understood.

SCORPIO—An early spring flurry of frolic awaits all Scorpios who kick their everyday pressures and throttle down to play around. Refreshed and re-energized, you are welcomed back to the junkyard by co-workers. Watch the buzzards, though, on the 16th when your over-enthusiasm may be taken advantage of.

SAGITTARIUS—Sagittarians March scenario is home 20 for a month. People coffeebreak all day with you, while other half is on hand to give a helping hand with friendly modulations and entertaining. Don't be surprised if a cottonpickin' good buddy upsets a good time for you on the 16th. Your excellent sense of humor transforms the situation to your advantage, though.

CAPRICORN—Usually quiet and reserved Capricorns hog the channel this month and meet someone influential on the boulevard who might give a push up the ladder to success. Watch for misrepresentation, though, on the 11th and 16th. With all the travelling you'll be doing now, truck 'em easy, truck 'em slow.

AQUARIUS — Everthinkin' Aquarians capitalize on a super streak of inventiveness this month. Piggybank gets several donations. Considerable wheeling on the boulevard puts extra stress on that mobile which may need some routine work done on the 16th. A preventative spring tune-up is best protection. End of March is a good time to thaw out and make a last minute investment in real estate or improve home 20 if you haven't already this past year.

Paperdoll

stop them from passing on to the antenna and being radiated.

Circuit Components

A tetrode tube contains _____ elements.

- a) two.
- b) three.
- c) four.
- d) five.
- e) no specific number.

The correct answer is c). A diode contains two elements, a cathode and an anode (also called a plate); a triode contains, in addition, a control grid; a tetrode, in addition, a screen grid; and a pentode, in addition, a suppressor grid.

Antennas and Transmission Lines

A dipole is an antenna to which the signal is applied at:

- a) the end.
- b) both ends.
- c) a third of the way from one end.
- d) two-thirds of the way from one end.
- e) the center.

The correct answer is e). Dipoles are usually one-half wavelength in length. In part two it was learned that a half wavelength is 126 feet at 80 meters, 66 feet at 40 meters, 22 feet at 15 meters, and 17 feet at 10 meters. These are the four bands in which Novices may operate.

Radio Communication Practices

Precautions to reduce shock hazard in your station should include:

- a) all equipment grounded to a common external ground (water pipe).
- b) three conductor wiring.
- c) enclosed equipment.
- d) use of interlock switches.
- e) all of the above.

The correct answer is e). There are other precautions that should be observed, as well, and they most definitely include the placement of antennas and transmission lines so that these external parts of the amateur station can not contact power lines under any circumstances. 73, W2LE.

Questions From Readers

Q: I understand that the code test is given for a period of five minutes. How much of that time must I copy correctly?

A: One minute, which figures out to 25 letters at 5 words-per-minute (WPM). The FCC is testing a new concept in code testing. It involves showing the applicant five different samples of copy, and asking him to identify the copy that most nearly resembles the copy actually sent. This is *really* multiple choice testing. It has not been announced as yet whether the FCC plans to have

volunteer examiners conduct this new type of testing, and at this writing you are still expected to copy down 25 letters correctly, and in sequence. Incidentally, it doesn't matter whether those 25 letters are in the beginning, the middle, or at the end.

Q: How many diagrams are required to be drawn on the Novice exam.

A: Diagrams are no longer required to be drawn for any amateur exam. However, diagrams will be provided and you will be expected to identify components, and calculate their values by Ohm's Law.

Q: Is there someplace where I may read about what Novices are doing on the air, right now?

A: Yes, there is a fine Novice column which appears each month in *CQ Magazine*, *The Radio Amateur's Journal*. Written and edited by some of the countries most experienced and knowledgeable amateur radio operators, *CQ* is must reading each month for the *active* amateur. It is available on newsstands everywhere, and from *CQ Magazine*, 14 Vandeventer Avenue, Port Washington, NY 11050. Twelve monthly issues are just \$7.50.



Bargain Hunting?

Send 35¢ to Dep't. 9

FOR BARGAIN CB CATALOG!

HENSHAW'S

7622 Wornall
Kansas City, Mo 64114

COMING EVENTS

(continued from page 45)

JULY

Beatrice, Neb., NEB Sidebanders Club 1st Annual Jamboree, July 2, 3, 4 at Gage County Fairgrounds. For more information contact: NEB Club, Box 81, Holmesville, Neb. 68357.

Whitney Point, New York, Electronic Show & CB Jamboree, July 8-10, Whitney Point Fairgrounds, Rt. 11, Exit 8 I 81. For more information: International Order of Chiefs & Squaws QSL Club, P.O. Box 25, Binghamton, New York 13903. (607) 722-3536 or 722-8860.

Jacksonville Beach, Florida, July 16 & 17, Jacksonville Beach Coliseum. 4th Annual Voice of the Beaches Jamboree. For information: Bill Jackson, P.O. Box 50906, Jacksonville Beach, Fla. 32250 or 904-285-2937.

Bristol Ind., Jamboree, July 16-17, Eby's Pines, Rt. 2, Junction U.S. 131 & Interstate 80-90. Contact Chairman, R. M. Shipman, P.O. Box 7092, Toledo, Ohio 43615.

NEW WAY TO "ADVERTISE" YOUR CB CHANNELS



Displays any of the 23 channels you monitor, in big, bright digital numerals. Highly visible day or night. Selector control installs next to CB — turn knob to change numerals. Complete with flat rainbow cable, polarized snap-together connector. 12V DC. Easily installed.

Invite "breakers." Avoid overcrowded channels. Ideal for clubs.

Patent Pending



BILLBOARD CB CHANNEL ADVERTISER

BILLBOARD

P.O. Box 522, Logansport, IN 46947

- Please send me more information.
- Rush me _____ complete Billboard "Channel Advertiser(s)" @ \$39.95 each, plus \$1.55 each for postage & handling. Check or MO enclosed.

Please charge to: Master Charge BankAmericard Exp. date _____

Acct. # _____

Signature _____

Name _____

Address _____

City _____ State _____ Zip _____

Allow 3 weeks for delivery.

S9

Readers... We need your help!

In addition to S9, we also publish a trade magazine for CB dealers. It's very important to us to have this magazine reach every CB dealer in the country, no matter how large or small.

We'd like you to help us by filling in the names and addresses of every CB dealer that you know about. In return for your time and effort, we'll extend your subscription to S9 by one month for every new dealer name you send us that isn't already on our list.

If you're not a regular subscriber, or if the names you send us are already on the list, we'll still send you a gift in appreciation of your efforts.

The dealers names you send need not be exclusively CB stores. They can be department stores with CB departments, or any other type of store that retails CB equipment.

The accompanying card next to this message requires no postage. Be certain that you include your name and address fully so your gift will reach you properly.

Tnx and best 73's.



Dick Cowan

Publisher, CB Radio/S9



WASHINGTON OUTLOOK

ALBUQUERQUE CB PROCEEDING TERMINATED

The FCC Review Board has dismissed an order to show cause why the license of John K. Mollert, of Albuquerque, N.M., for Citizens radio station KGX-9897 should not be revoked. It terminated the proceeding.

The Board said it did not "believe that permitting Mollert to continue as a Commission licensee will in any way adversely affect the Commission's continuing need and ability to enforce its rules governing the citizens service."

The show cause order, released July 23, 1975, charged Mollert with various violations of FCC rules including Section 95.95(c)—failure to identify his station and the station he communicated with—and 95.41(d)(2)—operating on a frequency (Channel 21) not authorized for communications between units of different Citizens stations. Mollert also was charged with failing to make his station available for inspection by authorized FCC personnel in willful violation of Section 95.103 of the rules and Section 303(n) of the Communications Act.

In an initial decision released June 10, 1976, FCC Administrative Law Judge Joseph Stirmer dismissed the show cause order. While finding that Mollert had violated the rules and the Act as charged, Judge Stirmer concluded that Mollert's conduct was not sufficiently flagrant to justify revocation of his license.

The Commission's Safety and Special Radio Services Bureau appealed the judge's decision.

The Review Board said it had reviewed the initial decision and all other matters of record, and agreed with Judge Stirmer's decision not to revoke Mollert's license. It said it was satisfied that the judge's findings adequately and fairly reflected the evidence of record.

However, the Review Board said, the Bureau's appeal, which contested the failure of Judge Stirmer to impose the

ultimate sanction of revocation, required additional comment.

It noted that during the hearing (at which Mollert represented himself), Mollert admitted to the operating violations. However, regarding his failure to allow inspection of his station, Mollert said he had received conflicting advice regarding the authority of FCC representatives to come into his home to check equipment.

Mollert explained that within one or two weeks prior to the FCC personnel coming to his residence to inspect his station, he heard rumors that Commission inspectors were in the area. He said he called the American Civil Liberties Union in an attempt to find out if FCC personnel could enter his premises and was told they could not without a search warrant.

In addition, Mollert said he had some doubts whether the inspectors were authorized Commission representatives, and local authorities had advised against allowing strangers into homes and apartments. This, he said, together with the fact his wife was not appropriately dressed and nervous, contributed to his decision not to allow the inspectors into his home.

The Bureau, in appealing the decision, contended that Judge Stirmer's failure to revoke, in light of Mollert's operating violations, was contrary to FCC precedent, and that although two of the rules which Mollert was charged with violating subsequently were deleted, the significance of the willful violations was not diminished.

It also contended that FCC precedent required revocation for Mollert's refusal to allow an inspection, and that effective regulation of the citizens service was impossible unless rule violations such as Mollert's were dealt with by imposing significant sanctions.

The Review Board said the Communications Act does not require the imposition of the revocation sanction in every case of a rule violation. Instead, it said Congress left to the Commission

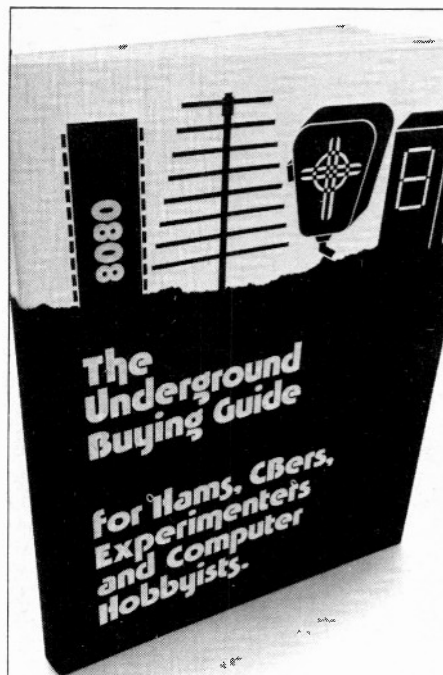

Where to get it.

Equipment, parts, supplies and services. Hard to find and standard items at bargain prices.

Over 600 places to find transceivers, antennas, surplus, new and used equipment, μ Ps/computers, ICs, components, assortments, assemblies, discounted items, test equipment, peripherals, etc. Hundreds of large and small mail order sources.

A complete directory divided by sources, items and locations. Saves countless hours of shopping. Easily pays for itself through comparative buying. Contains no advertising.

Rush my order. I enclose \$5.95 plus 55¢ postage and handling. Californians add 39¢ sales tax. Full refund if not completely satisfied within 10 days.

Name _____

Address _____

City/State/Zip _____

Primary interest: Amateur Radio CB
Experimenting μ Ps/Computers

Send to: **Peninsula Marketing**
Dept. E
12625 Lido Way
Saratoga, CA 95070

Why it pays to buy CB equipment where you see the CEDA Seal



CEDA, the Communications Equipment Distributors Association, is composed of the major wholesalers in the personal communications industry, working together to maintain standards of quality, service and consumer protection.

When you see the CEDA Seal in a CB dealer's window, it means you've found a CB specialist, one you can trust, because he's pledged to uphold CEDA's standards. Associate Dealer Members of CEDA are equipped to handle your problems and answer your questions, and serve your CB needs not only before you buy, but *after*.

Look for the CEDA Seal before you buy. It pays.



COMMUNICATIONS EQUIPMENT DISTRIBUTORS ASSOCIATION.



*Dealers: Write for information on how to qualify
as an Associate Dealer Member of CEDA*

P. O. BOX 1118, CARBONDALE, IL, 62901;
OR PHONE (618) 549-1242.

the task of weighing the nature of the violations and surrounding circumstances to determine whether the ultimate sanction of deprivation of all operating authority should be invoked.

In this case, the Board said, it believed the extreme sanction of revocation was unwarranted.

It said while Mollert willfully refused to allow inspection of his station, he was not motivated by a conscious intent to violate or defy FCC rules. Of particular significance, the Board said, was Mollert's unrefuted testimony that he relied on the erroneous advice of the American Civil Liberties Union to the effect that FCC inspectors could not enter his home without a search warrant; that he believed the station was his van since his transceiver was kept there; that he subsequently allowed a complete inspection except for power and frequency measurements, and that his wife had a "nerve problem."

The Review Board added that Judge Stirmer's demeanor findings also were of particular importance. It noted that the judge stated that "having seen and heard Mollert testify [he] was convinced that Mollert's refusal to allow inspectors into his home was predicated more on a genuine misunderstanding of the inspectors' authority and his desire not to upset his wife than from a willful design to violate the applicable Commission regulation."

Absent any conflicting testimony, the Review Board said it could find no basis to reject Mollert's testimony.

Mollert's operating violations, the Review Board said, were an isolated incident. It pointed out that examination of Mollert's approximately eight years as an FCC licensee revealed that he has had no history of violations and the Commission has not received any complaints concerning the operation of his station.

While he did not believe that the fact that two of the four violations were deleted from the rules in any way excused Mollert, the Board said it did tend to show that those rules were not of critical importance in the Commission's regulatory scheme.

The Review Board said it did not condone Mollert's behavior, but added, however, that in light of the mitigating circumstances, the public interest did not require revocation of license because it believed Mollert could be relied on to operate his CB radio in full compliance with FCC rules.

The Board concluded that its decision should not be construed as a lessening of the FCC's determination to continue to enforce its rules governing CB radio, adding that any licensee who

violates those rules did so at great risk to the continuation of his licensed operation.

MAN FINED FOR SELLING LINEAR AMPLIFIER

Carl A. Wilbur, of the Sarasota CB Center, Sarsota, Fla., has been fined \$250 by U.S. Magistrate Ben Krentzman of the U.S. District Court, District of Middle Florida, for selling an illegal radio frequency power amplifier for use on Citizens Radio Service frequencies in violation of FCC rules and the Communications Act.

Wilbur, on October 22, 1976, pleaded guilty to willfully and knowingly selling the amplifier which did not meet the criteria specified in Section 2.815 (c) of the rules in violation of Section 302 of the Communications Act.

The case was presented by Assistant U.S. Attorney Gary Takacs of the office of U.S. Attorney for the District of Middle Florida, following an investigation by engineers from the Commission's Tampa, Fla., District Office.

This case, which results in the first conviction for violation of the FCC's current marketing regulations which were implemented on January 23, 1975, was the result of the Commission's continuing program of enforcement of the radio frequency device rules and regulations.

CURRENT LICENSEES DON'T NEED NEW LICENSES TO OPERATE 40 CHANNEL CB RADIOS

The Federal Communications has received inquiries as to whether an additional Class D citizens band license will be required to operate 40 channel CB radios. Persons holding valid Class D Citizens Radio Service station licenses need **not** apply for a new station license in order to operate the new 40 channel sets which will be available on January 1, 1977. CB operators are cautioned not to transmit on the expanded channels until January 1, 1977.

CRACK DOWN ON CB OPERATORS IN ALABAMA AND GEORGIA

U.S. Attorneys Ira DeMent (Middle District of Alabama) and Ronald T. Knight (Middle District of Georgia) have cracked down on illegal Citizens Band (CB) operators in the Phoenix City, Ala., and Columbus, Ga., areas. While no arrests have yet been made as a result of the crack down, illegal equipment valued in excess of \$7,000 has been seized.

The illegal operations were interfering with authorized U.S. Government frequencies, industrial radio and international public radio services, as well as nearby television reception.

Under the direction of Assistant U.S.

Stop TV Interference!

with **B&W** CB Filters

- Less than 0.3 db power loss
- Match 52-ohm coax line
- Cut off frequencies above 35 MHz
- SO-239 connectors

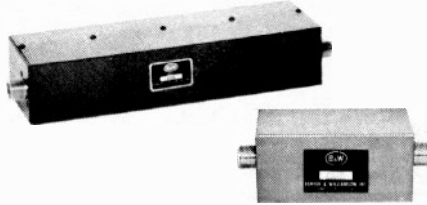

Model	CB-244	CB-245
Minimum Harmonic Attenuation	60 db	70 db
Power Safety Factor	100 W	1000 W
Price	\$18.50	\$32.50

Write for distributor list.

B&W Barker and Williamson
Canal Street, Bristol, PA19007



The perfect CB gift for your "good buddy"

Order Today!
\$9.95

INCLUDES POSTAGE AND HANDLING

Wondering what to give that "good buddy" of yours who's into CB? Well, here's the perfect gift. A beautiful golden colored CB Mike on a richly finished, walnut base. And for the personal touch, we'll engrave your good buddy's CB "handle" on a brass plate on the base. Drop us a line, order as many as you want for your "good buddies." We'll catch you on the flip-flop (by speedy return mail) with a gift you're sure to be remembered for.

KOVOLOFF INDUSTRIES INC.

35 E. Wacker Dr.
Chicago, IL 60601

Upon credit approval, please accept my order for the "Good Buddy C.B. Trophy." I have enclosed my check for the total cash price of \$9.95 or indicated my credit card charge preference.

Illinois residents add 6% sales tax.

Name _____
Address _____
City _____ State _____ Zip _____
Signature _____
 American Express Bank Americard
 Master Charge Bank ID
Handle _____ Expiration Date _____

S9 # 7

IT'S HERE!

The Most Advanced Design CB Base Antenna!

Anixter-Mark introduces the new Mark AMB-2 . . . the space age version of the famous Mark II Super Beacon, with more advanced features than ever before in a base station antenna.

- Full half-wave design
- Tuneable to reduce the effects of nearby objects & the detuning as height varies
- Four piece construction for easy handling & shipping by UPS
- Eliminates noisy precipitation static
- Improves signal-to-noise ratio
- Affords up to 20 db operating gain
- Increases receiver sensitivity
- Extends intelligible coverage
- Easiest to install design
- No unsightly ground radials

The Mark AMB-2 will step up the efficiency of any CB base station. The reactive tuner eliminates matching problems, reduces the effects of nearby objects and gives the *lowest* possible VSWR—all with one simple adjustment! That's truly tuneable . . . and that's just *one* reason why this is the most advanced base station antenna ever. For more information and a free copy of "The CB, Amateur, Two-Way Antennas & Accessories Catalog," send the coupon today.

You bet I'd like a free catalog!

Name _____
Title _____
Company _____
Address _____
City _____
State _____ Zip _____

Anixter-Mark, 5439 W. Fargo
Skokie, Ill. 60076

S9-3-77

ANIXTER-MARK

Manufacturers of a
Full line of Point-to-Point Antennas
Microwave • Two-Way • Amateur • CB
5439 W. Fargo, Skokie, IL 60076 (312) 675-1500

Made in U.S.A.
Visit us at booth 394 & 395 during the
PC-77 Show!

Attorney Robert C. Watson, Montgomery, Ala., and the U.S. Attorney of Macon, Ga., FCC agents from the Atlanta District Office and Powder Springs, Ga., Monitoring Station, conducted extensive investigations into the operations of illegal CB equipment on unauthorized frequencies.

Search warrants issued by U.S. Magistrates John V. Danson II, Opelika, Ala., and William L. Slaughter, Columbus, Ga., which were served November 10, 1976, by U.S. Marshals from Montgomery, Ala., who were accompanied by FCC agents, resulted in the seizure of a number of transmitters, receivers

and radio frequency power (linear) amplifiers.

The Communications Act provides a maximum penalty of \$10,000 fine and/or one year imprisonment for operators of unlicensed stations and a \$500 per day maximum penalty for operators of licensed stations who operate in violation of FCC regulations.

UNLICENSED OPERATIONS

The Commission announced that the number of unlicensed CB radio operations is decreasing, which indicates a desire by the majority of users to comply with FCC licensing requirements.

A special survey of 773 fixed and mobile CB stations conducted September 18 by the FCC's Field Operations Bureau (FOB) indicated that 10 percent were unlicensed. In Fiscal Year 1974, however, the number of unlicensed CB operations hit a peak of 34 percent.

RADIO THEFTS

The FCC receives many complaints from CB licensees concerning stolen CB equipment. CB equipment thefts should be reported to the local police, not to the Federal Communications Commission.

The Commission has acted to assist public and law enforcement officers to recover stolen CB radios by requiring that manufacturers engrave serial numbers on all new 40 channel CB sets.

The Commission anticipates that the introduction of new 40 channel CB radios may increase CB radio theft. In order to prevent such thefts, a CB radio owner should consider removing the radio when his vehicle is unattended. If this is not convenient, a CB owner might consider installing a vehicle protection alarm.

APPLICATION AND LICENSE STATISTICS, OCTOBER, 1976

Applications received during the month	314,682
Total licenses issued during the month	297,340
New licenses issued during the month	292,985
Licensed stations at the end of the month	7,101,776

ERECTING ANTENNAS CAN CAUSE DEATH AND INJURY

The FCC has been advised by the Consumer Product Safety Commission that during the years 1973-1976 there were over 200 reported electrocution deaths, resulting from inexperienced persons mounting antennas on metal masts or poles which came in contact with power lines. The FCC recommends that if a CB user plans to mount a CB antenna on any fixed structure, professional guidance and assistance should be obtained, such as from local power companies and antenna equipment dealers. Any persons erecting or adjusting antennas should use extreme caution when working near power lines, especially on windy days.

REVOKED

The Commission, by its Safety and Special Radio Services Bureau ordered the following license be revoked, for violation of Section 1.89 of the rules by failing to respond to official communications:



JMR's MOBIL-EAR CLEAR-1™ Microphone

Electret-Capacitor
Microphone



MODEL 40
Output -42 dB
Re: 1 Volt/microbar

Compact unit tucks neatly in your palm. Lets you drive and switch with the same hand.

No need to hold microphone up to mouth. It picks up perfectly when held at steering wheel — lets you keep both hands on wheel as you talk.

This is a superior fidelity, variable gain Electret-Capacitor power microphone that punches through interference, delivers crisp, broadcast-quality sound.

Built-in velcro pad lets you mount microphone anywhere.

JMR SYSTEMS CORP

168 Lawrence Road, Salem, N.H. 03079
Tel. (603) 898-5941

Chula Vista, Calif., Del Baker Towing,
KXB-1565.

SHOW CAUSE NOTICES

The Commission, by its Safety and Special Radio Services Bureau ordered the following licensees to show cause why their licenses should not be revoked for violation of Section 1.89 of the rules by failing to respond to official communications.

Nome, Alaska, Alaska Cab Company,
KEY-7121.

Kansas City, Missouri, Dennis P. Paice,
KTV-2657.

Saint Joseph, Missouri, Beverly A. Beckwith, KJL-9765.

CHARGES DISMISSED, SET ASIDE, ETC.

Fort Worth, Tex., Marvin L. Searcy,
KDZ-4198.

Paramus, New Jersey, Richard P. Bracciodieta, KHT-2405.

Santa Clara, Calif., Eddie Herro, KXK-2727.

Baltimore, Maryland, George E. Deaver, Sr., KYY-0318.

Plainfield, N.J., Judkins Colonial Home,
KAB-0712.

The Commission, by its Field Supervisors, on behalf of the Safety and Special Radio Services Bureau, issued Notices of Apparent Liability to Monetary Forfeiture to the following radio station licensees for willful violation of various sections contained in Part 95 or a repeated violation of Section 1.89 of the Commission's Rules:

Coral Gables, Fla., Robert Berrellez,
\$100, KIB-3361.

Fort Lauderdale, Florida

Richard M. Gale, \$150, KJB-3675.

Raymond J. Gruber, \$150, KQO-0863.

Woodruff E. Maupon, \$50, KNM-3481.

Keith A. Schunert, \$50, KPJ-3259.

Hallandale, Fla., David M. Withrow,
\$150, KLP-2288.

Hialeah, Fla., Lawrence A. Fantozzi,
\$150, KMD-9801.

Hollywood, Florida

Janis E. Alderson, \$100, KLC-2619.

Charlton H. Blocker, \$100, KEI-9706.

Branch and Abernathy Office Service, \$100, KAAX-0384.

Drew W. Causey, \$100, KLG-1485.

Colin J. Condon, \$50, KYR-0762.

Arthur S. Courter, \$100, KZD-1485.

Janace Ellis, \$150, KWU-8287.

Donald A. Gavagni, \$100, KOE-1442.

Ralph F. Mariano, \$50, KBV-9424.

James S. Speer, \$100, KXQ-7219.

Miami, Florida

Roland G. Haines, \$50, KTP-1034.

Severn T. Wallis, \$50, KMS-9473.

... Use S9 READER SERVICE.

ALUMA TOWERS

LOW PRICED

MADE IN ALUMINUM

- ★ TELESCOPING
(CRANK UP)
- ★ WALL MOUNTED
- ★ GUYED

QUALITY MADE FOR:

TV — CB — HAM
MARINE — MOBILE
RADIO TELEPHONE
& COMMERCIAL

10 MODELS MFG.

Towers to 100 feet. Specials designed & made. See dealer or send for free catalog.

ALUMA TOWER DIVISION

FRED FRANKE, INC.

BOX 2806S9
VERO BEACH, FLA. 32460
PHONE (305) 567-3415

**JAN
CRYSTALS**

**"Right
on"
with
Jan
Crystals**



for

- General Communication & Industry
- Citizen's Band
(Standard & Synthesized)
- Two-Meter - Monitor - Scanners
- Marine VHF • Amateur Bands

Depend on Jan Crystals
made in U. S. A. for

- Frequency Control • Frequency Stability
- High Performance

Send 10¢ for our latest catalog
Write or phone for more details



2400 Crystal Drive
Ft. Myers, Florida 33901
all phones (813) 936-2397

Two Exciting New Books From the Publisher of S9

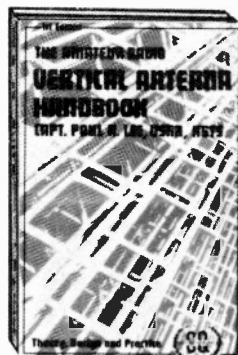

THE
**VERTICAL
ANTENNA
HANDBOOK**

\$5.00 postpaid USA

Compiling in one reference source 22-years-worth of material on vertical antenna theory, design, installation, construction. Covers vertical arrays, feeding and matching, short verticals, ground effects, multi-band and single-band verticals, and answers many of the most commonly-asked questions about vertical antennas. 6" x 9" 136 pages.

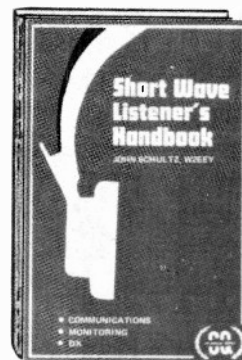

THE
**Short Wave
Listener's
Handbook**

\$5.00 postpaid USA.

Whether you're a CBER, an s.w.l., or just like to eavesdrop on police and fire department calls, you'll find this new book to be the complete source for information on frequency assignments, radio propagation, transmission modes, antennas, receiver design and operation, large-scale receiving installations, transmission schedules, test equipment and procedures. . . in short, all you need to know about every aspect of receiving. 6" x 9" 152 pages.

S9 Magazine, Dept. C

14 Vanderventer Avenue, Port Washington, NY 11050

(516) 883-6200

Please send me.....copies of The Vertical Antenna Handbook

The Short Wave Listener's Handbook

Enclosed is Check Money Order for \$.....

Name _____

Address _____

City _____

State _____

Zip _____

Eliminate Your C.B. Antenna



MODEL T8003

CONVERT ANY CAR ANTENNA TO OPERATE BOTH CB SET AND CAR RADIO (AM-FM). TAKES MINUTES TO INSTALL. TUNING INDICATOR SHOWS OPTIMUM MATCH.

MOUNTING BRACKET INCLUDED

ONLY **\$19.95** At Your Local CB Dealer

Distributor Inquiries Invited

AVA Electronics
LANSDOWNE, PA. 19050

Hey Good Buddy!

Let your CB friends know who you are with your own inside rear window engraved plaque. Take it with you everywhere.

KHEK 1639
"TEDDY BEAR"

Actual Size 3" x 9"
Heavy Duty Acrylic Available In:
White, Red, Blue, Black,
Green, Walnut
Satisfaction Guaranteed
Order Now—\$7.95 Plus
\$1.00 For Fast Handling

Send To:
Pinpoint Mailing
150 E. Hartsdale Ave., Hartsdale, N.Y. 10530

Handle & Call Letters _____

Name _____

Street _____

City & State _____ Zip _____

Payment Must Accompany Order

- Miramar, Florida
Neil Caraway, \$150, KJH-7110.
Manuel J. Henrick, \$100, KNR-0615.
- N. Miami Beach, Florida
James H. Alford, \$150, KHF-2987.
Milton Mamber, \$50, KMM-33179.
Emil Pagola, \$50, KFK-8653.
Kurt A. Phillips, \$50, KABL-4726.
- Plantation, Florida
Jacqueline L. Mancinelli, \$100, KZR-1890.
William S. Robinson, \$100, KJU-9423.
- W. Hollywood, Fla., Robert A. Bowers, \$100, KQV-3770.
- Phoenix, Ariz., Robert T. Myers, \$100, KQK-2500.
- Beaverton, Ore., Thomas J. Fohl, \$100, KFW-0633.
- Gresham, Ore., Charles H. Elder, \$100, KEN-8320.
- Portland, Oregon
Frederic A. Bot, \$100, KFZ-9602.
Howard W. Browning, \$50, KIR-4211.
Dennis P. Danielson, \$100, KLM-0434.
Jim Delano, \$50, KGG-5123.
George A. Hall, \$150, KFC-4474.
Tracy A. Ditmars, \$100, KVE-0481.
Robert W. Donshue, \$100, KXT-8217.
Bobby L. Gillian, \$150, KFA-0251.
James E. Hankins, \$50, KPB-4417.
Raleigh Hills Locksmith, \$100, KOM-8561.
Jerry C. Marcus, \$100, KKL-9399.
Robert M. McGilvary, \$100, KLM-4510.
Dale Russel, Jr., \$100, KPC-1604.
Donald E. Siemssen, \$100, KGG-1291.
La Verne E. Thompson, \$100, KBN-1915.
Andy Davidson Trucking, \$100, KBD-7824.
Wilson's Refrigeration Repair, \$50, KKN-8209.
Gary R. Worthington, \$50, KDG-5273.
- Tigard, Ore., Walter L. Otto, \$100, KJR-4148.
- Spokane, Wash., John H. DeLange, \$50, KJD-99207.
- Vancouver, Washington
Donald C. Curry, \$100, KGN-1888.
James S. Dickerson, \$100, KOT-2896.
William L. Landis, \$100, KJU-9618.
Herbert J. Ledbetter, \$100, KCC-9252.
Robert A. Maxwell, \$100, KFG-8448.
Jack M. Pollard, \$100, KHW-8218.
Gerald M. Walsh, \$50, KLC-0536.
- S. San Francisco, Calif., Richard A. Marlowe, \$150, KEF-1954.
- Washington, D.C., Ellsworth Williams,



YOU GOT EARS?

THEN YOU NEED THE OFFICIAL CB BOARD
No mobile CBer should be without this handy car desk!

Now you can get a written copy on that good buddy wherever you are. This sturdy 6"X9" kneebord has been adapted from the type used by pilots. Made of heavy anodized aluminum, it features an adjustable leg strap and low profile spring clip. All common CB words, phrases and 10 codes are printed on the board.

For the softer CBers, the Lady Breaker Board is printed in lavender and the leg strap is a pretty garter. The Good Buddy Board is the same high quality kneebord, but with that good old buddy's portrait.

FREE! If you act now we will include a 156 page dictionary explaining CB words and phrases, 10 codes, regulations and much more.

International Flight Institute, Worldway Postal Center
P.O. Box 91212 Dept. C Los Angeles, CA 90009

Please rush me _____ each of the models below.
_____ Official CB Board _____ Lady Breaker _____ Good Buddy

Name _____

Address _____

City _____ State _____ Zip _____

Mastercharge BankAmericard Check Enclosed

Card No. _____ Exp. Date _____

Interbank No. _____

Signature _____

ONLY \$9.95

Add \$1.00 for postage and handling plus state sales tax.

Dealer & salesman inquiries invited.

\$50, KBD-3911.
 Ft. Belvoir, Va., Ronald R. Lacasse, \$50, KBZ-1456.
 Ft. Myers, Fla., Paul C. Duke, \$50, KFY-5354.
 Chicago, Ill., Timothy L. Sawyer, \$50, KYH-4799.
 Park Ridge, Ill., Gregory P. Gallios, \$50, KEI-4350.
 Goshen, Ind., Alvin L. Ottman, \$50, KMH-0040.
 Cleveland, Ohio, Robert D. Lovas, \$50, KJM-4459.
 Lake Oswego, Ore., Benjamin E. Thompson, \$100, KIR-3241.
 Philadelphia, Pa., Paul E. Graeser, \$50, KZG-5813.
 Jackson, N.J., Edward J. Isdanovich, \$50, KVA-3729.
 Levittown, Pa., Joseph E. Morrison, \$50, KTM-5565.
 Caguas, P. R., Julio Torres, \$50, KET-3715.
 Manati, Puerto Rico
 Ramon Freytes Castro, \$100, KSW-3111.
 Freddie Ocasio Cortes, \$50, KACO-2057.
 Ponce, P.R., Roberto J. Marguez, \$150, KABA-8422.
 Vega Baja, P.R., Jaime Figueroa, \$50, KDI-0821.
 Pocatello, Idaho, Charles K. Burke, Jr., \$50, KWN-1786.
 Brownsville, Texas
 Amigo Flooring Co., \$50, KMF-5272.
 Tiodolo Falcon, Jr., \$50, KTF-78520.
 David F. LaChance, \$200, KEX-6590.
 Corpus Christi, Texas
 Ruben Garcia, \$50, KCK-2811.
 Joseph L. Garnett, \$50, KBN-5478.
 Dallas Tex., Warren F. Alcott, \$50, KOR-5502.
 Galveston, Texas
 Terry D. Clark, \$50, KPZ-0782.
 Jay C. Heichelmeim, \$100, KNV-3697.
 Harlingen, Tex., Lawrence C. Berry, \$50, KYW-1479.
 Washington, D.C.
 Raymond F. Hamilton, \$50, KADB-7669.
 Robert F. Pringle, \$50, KXT-8940.
 Baltimore, Md., Leslie W. Walter, \$50, KYD-4294.
 Glen Burnie, Md., William Griffin, \$50, KADT-6133.
 West Newton, Pa., Robert L. Koontz, \$50, KNM-6498.
 Greenville, Pa., Samuel P. Genovesi, \$50, KIT-4613.
 Warminster, Pa., Lowell H. Marxham, Jr., \$50, KLO-7000.
 Naguabo, P.R., Emiliano Lebron Morales, \$50, KAAC-7411.
 Great Falls, Montana
 Robert A. Armstrong, \$100, KRA-59401.
 Jerry L. Christianson, \$50, KIM-0149.

Rex E. Cowie, \$50, KAAR-0472.
 James R. Frye, \$100, KZR-0808.
 Jay J. Plant \$150, KWV-1229
 Russell J. Wick, \$100, KSA-1402.
 Minot, N.D., Thomas L. Rage, \$100, KWW-8786.
 Des Moines, Iowa, South Town Day Care Center, \$50, KAAX-2200.
 Spencer, Iowa, William J. L. Mingo, \$50, KOA-9686.
 Hays, Kan., Rober Barman, \$50, KSC-8641.
 Kinsley, Kan., Eldon W. Unruh, \$50, KMA-8985.
 Schoenchen, Kan., James F. Pickle-

simer, \$50, KZT-0282.
 Burlington, N.J., Paul J. O'Brien, \$50, KTZ-1091.
 Spokane, Washington
 Gerald P. Duft, \$100, KJV-6359.
 Andrew J. Ehlis, \$150, KGB-5008.
 Kevin Getchell, \$100, KKG-99208.
 Dexter, Iowa, William A. Stephens, \$50, KDF-2830.
 Iowa City, Iowa, Rolland R. Ostrander, \$50, KKG-4538.
 New Virginia, Iowa, Mary L. Douglas, \$50, KAAH-9682.
 Harlingen, Tex., Roy G. Robinson, \$50, KABU-1185. (continued)

QUESTION:

Which car still has the CB?

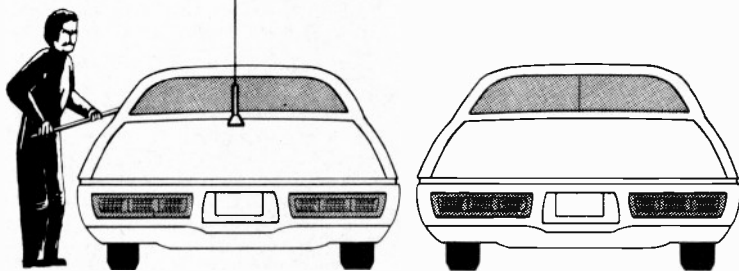

ANSWER:

The car on the right

because it's equipped with "THE INSIDER"—the hidden antenna that does not flag down thieves! There's nothing to disconnect, flip into trunk or forget to lower.

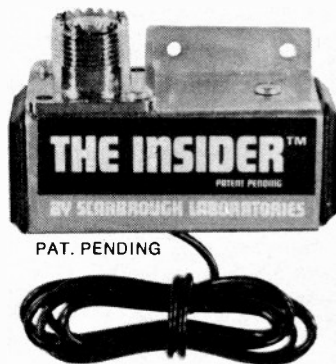

See us in Booth 648 at P.C. 77 at Las Vegas in February

NOT an expensive retractable antenna.
NOT a device to adapt your factory installed car radio antenna.
THE INSIDER is a specialty antenna designed for all 40 channels with excellent range and SWR match. It installs inside your vehicle—is small enough to hold in the palm of your hand. It's the first true security antenna on the market that combines easy installation, top performance and modest price.

If your dealer still does not have **THE INSIDER**, order direct complete with 20' COAX cable, mounting hardware and instructions . . . \$25.95 (Check or Money Order)



SCARBROUGH LABORATORIES

P.O. Box 605, 540 South St., Piqua, Ohio 45356
 Phone 513-773-2464 or 3705

Dealer and Distributor inquiries invited!

Bleedthrough? Skip Interference? Crowded CB Channels?

Wipe away CB interference with....

CHANNEL-KLEAR
\$19.95



Connect between CB set and antenna. Works with all sets - 23 or 40 channel, base, mobile, AM, SSB.

Want a private rendezvous with that beaver? Have private conversations in convoys?

Up to 40 private channels are now yours with....

PRIVAT-EAR
\$19.95



Connects between CB set and antenna. Unit off, normal operation. Unit on, 1000 ft. range transmit and receive, to make 23 or 40 "private" channels.

*Now in stock for immediate shipment.
Dealer inquiries invited.*

Glatzer Industries Corp.

268-1 Huguenot Street, New Rochelle, NY 10801
See us at PC-77, Booth No. 754 (914) 576-2700

Bank Americard and Master Charge accepted.

POWER GAIN EXTENDED RANGE PROFESSIONAL C.B. ANTENNA

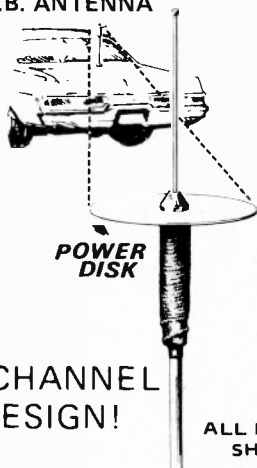

40 CHANNEL
DESIGN!

ALL METAL
SHAFT

The Power Gain is designed to bring in the weakest signal while increasing R.F. output. The heavy duty, commercially rated 600 watt coil is designed to give the highest efficiency R.F. power transfer. Unlike base loaded mobile antennas the Power Gain actually provides a gain up to 6 DB. This is a benefit normally only achieved on base station antennas.

Features include the exclusive Power Disc capacitive hat, top loaded mast, quick tuning tip and high quality anodized aluminum, chromed brass and stainless steel parts. Corrosion resistant, will withstand winds and all weather conditions.

Available in 6 colors and 3 sizes— 25", 35" and 45".

AAA ADVANCED PRODUCTS INC.
P.O. Box 5275, Fullerton, CA 92635
714-870-9832

ATTENTION DEALERS: WIDEST SELECTION — BEST PRICE — FASTEST SERVICE!

Beltek	Tram
Browning	Xtal
Courier	Yaesu
Gemtronics	A/S
Hy-Gain	Avanti
J.I.L.	CPD
Johnson	Everhardt
Midland	Hustler
Pace	Shakespeare
Palomar	Wilson
Pearce-Simpson	Astatic
Royce	CDE
SBE	Goldline
Siltronix	Rohn
Standard	Turner

COMPLETE LINE OF ACCESSORIES
SEND \$1.00 FOR DETAILS

HENSHAW'S

7622 Wornall, Kan City, MO 64114
1644 E. McDowell, Phoenix, AZ 85006
5050 E. Belknap, Ft. Worth, TX 76117

DO YOU KNOW WHAT THIS IS ?

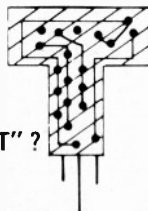

This Is The Delta "T"
OK, What's The Delta "T" ?

The Delta "T" is the very best way to cure adjacent and spurious channel bleedover and increase receiver sensitivity. The Delta "T" is not just a filter but a network designed to give your CB set a minimum of 80% reduction in bleedover and increase sensitivity at the same time. The Delta "T" is designed for any CB with a ceramic filter at 455KHZ.

Simple installation in your set with complete instructions make your set have as good a receiver as those costing \$400 to \$800 at nowhere near the price. Install the Delta "T."

\$49.95 (Conn. Residents add 7% sales tax)

Send check or money order to:

DELTA ELECTRONICS INC.
180 MAIN STREET
NORWALK, CT 06851

DEALER INQUIRIES INVITED !

All orders add \$1.00 postage and handling.
(Be sure to tell us what type of CB you have.)

Houston, Texas

Edward A. Stallman, \$100, KTC-1541.

Larry R. Brecheison, \$50, KYM-1470.

Meryl Preston Hunter, II, \$100, KMH-77047.

David F. Smith, \$50, KTS-1345.

Kingsville, Tex., Delores M. Aday, \$50, KRU-3730.

McAllen, Tex., James M. Scribner, \$100, KRK-7814.

Mercedes, Texas

Odilin Saenz, \$50, KRI-5390.

Serg's Fried Chicken, \$50, KIG-3418.

Pharr, Tex., Jaime, Luna, \$50, KFH-4776.

San Bernadino, Tex., A to Z Brake Service, \$50, KMR-3571.

San Benito, Texas

John L. Billue, \$50, KXW-5765.

Rudolf P. Carey, \$50, KHT-9076.

Carl Gentry, \$50, KADO-4736.

Virginia Beach, Va., James A. Alexander, Jr., \$100, KGT-3592.

Seattle, Wash., Louis R. Snyder, \$100, KHW-1193.

Lubbock, Texas

Shelby W. Jones, \$50, KNF-3737.

Michael G. Keeney, \$100, KYU-6284.

Harold J. Lindley, \$50, KTX-6875.

Horace McMahan, \$50, KGM-4323.

Leonard R. Mantooth, \$50, KWG-9283.

Neil Molsbee, \$50, KJK-5078.

Joan Nash, \$50, KAAO-4966.

Mark A. Neagle, \$50, KXP-0034.

Randall J. Owens, \$50, KBD-8937.

Johnny L. Parr, \$50, KXQ-7440.

John T. Rainwater, \$50, KJM-1115.

Young Sales, \$50, KMR-2643.

Luther W. Scoggins, \$100, KYJ-9164.

Henry E. White, \$100, KJV-8530.

Charles S. Williams, \$50, KRQ-4767.

Imojean Wood, \$50, KCL-8380.

Slaton, Tex., Allen D. Cline, \$200, KTL-6151.

Livermore, California

Richard O. Wood, \$100, KCQ-5446.

Bill J. Zearing, \$100, KYO-6296.

Daly City, Calif., Roy Kerobi, \$100, KFF-0556.

Redwood City, Calif., Tom Kent Auto, \$150, KHI-9631.

Vallejo, Calif., Marion G. Ricks, \$100, KAAJ-6861.

Ft. Myers, Fla., Thomas A. Goerner, \$50, KACA-8168.

N. Ft. Myers, Fla., Carl V. Gibson, \$50, KTC-3544.

Pinellas Park, Fla., Linda D. Crighton, \$50, KWL-7844.

Port Charlotte, Fla., Johnny Crews Ford, Inc., \$50, KYN-8188.

Pineville, N.C., Carl E. Eaton III, \$50, KCJ-5475.

The Commission, by its Safety and Special Radio Services Bureau sent no-

tices of apparent liability for monetary forfeiture to the following licensees for violation of Section 95.95(c) of the rules by failing to identify radio station by the assigned call sign.

Winter Springs, Fla., Vicki C. Baker, \$50, KWX-7852.

John C. Espey, \$100, KHP-1603. Orlando, Fla., Condy L. Alley, Jr., \$150, KEB-9976. For violation of various sections of Part 95 of the rules including Section 95.95(c) by failing to identify radio station by the assigned call sign.

Winter Park, Fla., Richard A. Phillips, \$150, KMW-6755. For violation of various sections of Part 95 of the Commission's rules including Section 95.55(c)(2) by operating radio station with transmitting equipment not authorized by the Commission.

Orlando, Fla., John T. Hall, \$100, KLE-4010. For violation of Section 95.95 (c) of the rules by failing to identify radio station by the assigned call sign and Section 95.43 of the rules by operating radio station with power in excess of that authorized.

Eugene, Oregon, Johnson Sales Co., \$100, KQB-9871. For willful violation of Section 95.95(c) of the rules for failure to identify subject radio station by the assigned call sign.

Salem, Oregon, Virgil E. Sly, \$100, KCS-1589. For willful violation of Section 95.95(c) of the rules for failure to identify subject radio station by the assigned call sign.

Louisville, Ky., Howard L. Bagley, \$150, KTH-7857. For violation of various sections of Part 95 of the rules including Section 95.95(c) by failing to identify radio station by the assigned call sign.

Louisville, Ky., Jerry W. Porter, \$50, KEO-5931. For violation of Section 95.95(c) of the rules by failing to identify radio station by the assigned call sign.

Kearny, N.J., Richard C. Pierce, \$50, licensee of Citizens radio station KRP-07032 (Temporary). For violation of Section 95.95(c) of the rules by failing to identify radio station by the assigned call sign.

Orlando, Fla., Louis A. Floyd, \$150, KQM-9364. For violation of various sections of Part 95 of the Commission's rules including Section 95.41 (d) by operating radio station on a frequency not authorized by the Commission for use by such station.

Winter Park, Fla., Bernard E. Trager, \$200, KJG-7245. For violation of various sections of Part 95 of the rules including Section 95.44 by operating radio station with transmitting equipment not authorized by the Commission.

YOU CAN COUNT ON REDCO FOR

- RELIABILITY
- QUALITY
- PERFORMANCE



Models:	
RPA-1, CB Receiver Pre-amplifier	59.95
New dual relay protection system	
C-40, 5-digit Frequency Counter	139.95
RFC-50, 6-digit Frequency Counter	179.95
RFC-250, 7-digit Frequency Counter	259.95

REDCO RELIABLE ELECTRONIC DESIGN CO.
11823 E. Slauson, #26, Santa Fe Springs, CA 90670
Phones: (213) 698-0017 • (213) 693-5577

REDCO PRODUCT DISTRIBUTORS

- | | |
|--|--|
| A-B-C Electronics
Seattle, WA | MHZ Electronics
Phoenix, AZ |
| Alpha Omega Dist.
Alsip, IL | Merrill Elect.
Chicago, IL |
| Autco Dist.
St. Louis, MO | Mitee Electronics
Houston, TX |
| Britts
Smyrna, GA | Majestic Comm.
Memphis, TN |
| CBC Wholesale Club
Lexington, NC | Maynard's Comm.
Stevensville, MI |
| CB Sales & Service
Minneapolis, MN | No. Tampa CB Center
Tampa, FL |
| CB Unlimited
Miami, FL | Northwest CB Center
Vancouver, WA |
| Calif. Radio Sales
Montebello, CA | Ohio Browning
Akron, OH |
| Capitol Electronics
Oklahoma City, OK | Path Comm.
S. Williamsport, PA |
| Clark CB Dist.
Salina, KS | R.R.G. Dist.
Reno, NV |
| Commtron
Houston, TX | R. T. & E. Inc.
Lexington, KY |
| Commtron
Cleveland, OH | Radio City Warehouse
Corpus Christi, TX |
| Commtron
Des Moines, IA | Roanoke Electronics
Salem, VA |
| Communications Prod.
Spokane, WA | Royal Radio & TV Dist.
Des Moines, IA |
| Communications Syst.
Albuquerque, NM | S.P.S. Sales
Omaha, NE |
| Ed Consruck Sales
Hastings, NE | Sherman Elect.
San Antonio, TX |
| Dowcom
Carbondale, IL | South Eastern Spec.
Forest Park, GA |
| Electronic Parts
Denver, CO | Specialty Distributors
Mechanicsville, VA |
| Forbes Elect.
Yonkers, NY | T & B Sales
Beardstown, IL |
| Graham Radio
Reading, MA | Warnocks
Salem, OR |
| Henshaw Electronics
Fl. Worth, TX | Western States Comm.
Salt Lake City, UT |
| Henshaw Electronics
Kansas City, MO | Wren House Elect.
Downers Grove, IL |
| Henshaw Electronics
Phoenix, AZ | Wright Elect.
Hattiesburg, MS |
| Ideal Enterprises
Wessington, SD | Yukon Radio/Elect.
Anchorage, AK |
| John's Comm.
Thorofare, NJ | Zimco Inc.
Augusta, GA |

Move up from CB to Amateur Radio with NRI home training.

Amateur radio means virtually unlimited frequencies, working "skips" legally, quiet FM communications, and the freedom to talk to your next door neighbor or around the world.

But you need an FCC Amateur License to get into Amateur Radio, and NRI home training will help you pass your FCC licensing test. NRI training provides you with a code practice oscillator, LP records, transmitting and receiving equipment. Included is your own Novice Class 15-watt transmitter and a matching 3-band superheterodyne receiver, plus a transistorized code practice oscillator with code key and headset.

Send for the free NRI catalog. No salesman will call.



- NRI SCHOOLS
McGraw-Hill Continuing
Education Center
3939 Wisconsin Avenue
Washington, D.C. 20016
- Basic Amateur Radio
 Advanced Amateur Radio
 Complete Amateur Radio

Send me the free catalog indicated:

Name _____ Age _____

Street _____

City/State/Zip _____

A National Home Study Council Accredited School
51-017

WE HAVE THE KEY TO PROFIT

There's tremendous profit in the exploding C.B. market - land, marine, everywhere! We have huge inventories of top brands - and 24 hour service. We also have the KEY to turning merchandise - effective marketing programs! Our proven know-how will assure what you want - a good bottom line!
Write or call today!

UNIVERSAL COMMUNICATIONS, INC.
1722 Terrace Drive
St. Paul, Minnesota 55113
In Minnesota, call collect:
612/636-1771
Outside Minnesota, call free:
800/328-9600



ON THE COUNTERS (continued from page 39)

concepts only recently found in professional aircraft weather radar and police radar equipment. These new innovations insure the unit will be reliable and ultra-stable in operation even when subjected to the large temperature and input voltage variations commonly found in an automotive environment. High selectivity RF filtering eliminates any possible interference from CB transceivers and high power broadcast transmitters.

Operation of the Beartector PR-7 is quite simple with the volume and squelch controls adjusted just like on a CB transceiver. When a radar signal is received, the squelch breaks, a clear audio warning tone is heard and the bright front panel light flashes on. The light remains bright even in direct sunlight and the tone volume is sufficient to command instant attention.

The unit is 4½" x 6" x 3½", requires a minimum of current and is powered from either plus or minus twelve volts. Installation involves simply placing the unit on the dash of the vehicle with self-adhesive pads and then plugging the power cord into the cigarette lighter. To guard against possible theft, the Velcro pads allow instant mounting and removal of the unit for temporary storage in the trunk or other safe place. The unit carries a full ninety day parts and labor warranty and will be sold through CB and electronics dealers and distributors nationwide.

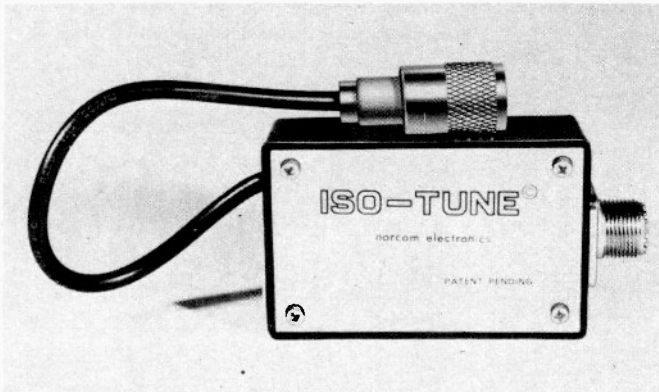

CB ANTENNA TUNER

Designed primarily for mobile use, although it can be used for the single antenna base operation, is an ingenious new device that is placed in-line for optimum and safe single or co-phased CB antenna operation, announces Norcom Electronics Inc., a Division of Ideas Inc., Northfield, Ohio.

Known as the ISO-TUNE Antenna Tuner, it is possibly the simplest and most efficient device yet for obtaining 1:1 SWR readings, regardless of coax length. In fact, the manufacturer recommends using the shortest coax possible to eliminate unnecessary costs and clutter. The new ISO-TUNE Antenna Tuner is so simple it's difficult to believe it does such a great job, states the manufacturer. Instead of the coax going directly to the transceiver or antenna matcher, the ISO-TUNE tuner is placed in-line and is adjustable similar to a matcher. However, a matcher actually raises and lowers resistive

force which in turn raises or lowers the SWR. With an ISO-TUNE Antenna Tuner, there are no direct internal contacts, performance is accomplished with an adjustable conductive field. Thus, there's no fear of burning out finals due to excessive SWR or coax shorts.

ISO-TUNE Antenna Tuners can be installed and calibrated in a matter of minutes to provide the optimum in transmit and receive power. They also perform as TVI filters and they are also claimed to eliminate unwanted coax signal radiation to provide the cleanest and most intelligible signal possible. ISO-TUNE Antenna Tuners are complete with tuning box with PL-258 connector, a short length of coax with a PL-259 connector on the end. To use, it is merely placed in-line nearest the antenna lead and set with the aid of a SWR meter. In most cases, even with co-phased systems, a flat 1:1 SWR can be obtained across all 11 meter frequencies. Unit size is only 3⅞" by 2½" by 1⅞" with a 7½" coax lead which includes a PL-259 connector. Weight is only 5 ounces each. Suggested retail price is \$29.95.

For details, contact Norcom Electronics, Inc., P.O. Box 332 Northfield, Ohio 44067.



MONITOR LETS YOU LISTEN WHILE YOU TALK

You won't have to wonder whether or not your signal is getting out when you use The Magitran Company's CB 10-43 Radio Check Monitor. The CB 10-43 is a self contained (including earphone) receiver that picks up your actual "off-the-air" transmissions.

More than just a monitor, the CB 10-43 also lets you know if your signal is being modulated properly. The built-in meter lets you read relative transceiver power output and percentage of modulation. It can even be used to measure and plot antenna radiated "Polar" pattern, so you can tune your antenna for optimum performance.

The CB 10-43 operates on a low-cost 9-volt battery and can be used inside your vehicle or some distance away. Operation is on all 40 channels without the need for tuning.

Suggested retail price for the CB 10-43 is \$39.95.

Contact Magitran Co., 311 East Park, Moonachie, N.J. 07074.

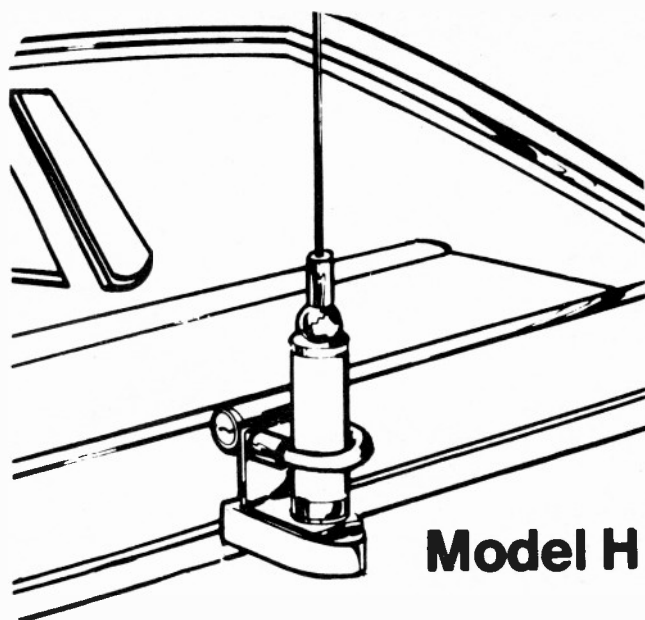

ANTI-THEFT ANTENNA LOCK

"Tenna-loc", a unique new product development said to provide maximum anti-theft protection for CB mobile antennas, has been introduced by the Consumer Products Division of Vernitron Corporation, a leading manufacturer of medical electronic instruments as well as computer and communications equipment, of Great Neck, New York.

"Tenna-loc" is available in a choice of models to fit most antenna styles, domestic and imported, reports Vernitron, and represents a positive protective device which allows CB mobile antennas to remain intact and in place, year round, and in all kinds of weather.

The company claims that "Tenna-loc" retails for less than \$12 and features a turn-proof locking stud that is integrated into a specially notched, U-shaped locking bolt. It features an extra heavy-duty, chrome-plated holding bracket designed to conform to individual antenna styles as well as a 5 tumbler, corrosion-resistant, key lock which mates with the special, notched U-bolt. An additional convenience offered with "Tenna-loc" is its electro-polished stainless steel replacement cup which is used, where needed, to facilitate quick, easy installation.

Vernitron says that "Tenna-loc" is designed to maintain SWR efficiency of the antenna and that all of the metal components utilized are chrome-plated to automotive specifications. The product may be removed, where desired, for car wash or long term storage. But no need to remove an antenna every time you park. You don't have to go into the rain, snow or biting cold in order to temporarily protect your antenna. What's more 'Tenna-loc' permits the user to mount an antenna at the center of the car to avoid any directional receiving problems. The anti-theft antenna lock is also

supplied with a special adhesive substance which will permanently bond any component parts such as the antenna spring and ball joints which may be located, depending upon make and model, between the antenna coil and antenna whip.

"Tenna-loc" is offered in convenient shrink wrapped, multi-color, self-service packages and is being made available through major distributor and dealer organizations.



RADAR DETECTOR TEST SET

Prime Electronics, Inc., 8605 Quivira Road, Lenexa, Kansas, announced the introduction of the PR-7 hand held test set for radar detectors. Capable of thoroughly testing and demonstrating all radar detectors on the market today, it is styled after the Bearactor PR-7 extended range radar detector also manufactured by Prime Electronics. Besides providing the test equipment ability to service radar detectors, the PR-7 test set will dramatically demonstrate the effectiveness of a radar detector to a prospective customer. It will also prove the correct (or incorrect) operation of an already purchased radar detector to a customer who, for some reason, thinks his unit is defective or low in sensitivity. Exchange and return to the factory of radar detectors that actually have nothing wrong with them is expensive in both lost profit and customer dissatisfaction. A PR-7 test set should pay for itself in a very short time.

Operation of the PR-7 test set is quite simple with a low power X Band signal emitted by pressing the trigger button located in the pistol grip handle. The unit is self contained, light weight and internally powered by an easily replaceable 9 volt transistor battery. Output range is calculated as a direct ratio with 50 paces simulating ½ mile and 100 paces simulating one mile of a typical moving or fixed speed radar.

The PR-7 test set, classified and offered as a repair shop signal generator, requires no license to operate. The unit carries a ninety day parts and labor warranty and is being purchased by dealers, distributors and service shops nationwide. Dealer cost is \$149.95.

CB BUMPER STICKERS

Now CBers can tell the world that they are CBers and proud of the fact. The new S9 bumper stickers come in a variety of slogans.

The bumper stickers are available in the following slogans:

- (1) CBers Do It Better
- (2) CB RADIO SAVES LIVES
- (3) EMERGENCY CB 2 WAY RADIO
- (4) MONITOR 9—CB RADIO

Price is \$1.00 each or 3 stickers for \$2.00. Add 25 cents on all orders for postage and handling. Dealers—we can accept large orders for resale. Write for dealer prices.

Send all orders to:

S9

Bumper Sticker

14 Vanderventer Avenue
Port Washington, NY 11050

cb mobile cb base

COVER 40 CHANNELS NOW!

CX-1000 3.75 dB GAIN CITIZEN'S BAND BASE ANTENNA

Designed to withstand nature's abuse ... CX-1000 is an 18' high "package of dynamite performance" for AM or sideband. This omnidirectional base antenna has a precision tuned coaxial stub system for perfect match and low ohmic losses. Made of heavy wall, bright finish seamless aluminum tubing and stainless steel fasteners.

TRUNK BUSTER FIBERGLASS MOBILE

Our 48" Top loaded or tunable tip antenna with solid one piece no hole trunk lip mount. The mount has foam protective pad and spring loaded cable contact. Complete high performance systems preassembled with 18' cable and connector.

CM-403 Trunk mt. with 48" whip
CM-404 Trunk mt. with 48" tunable whip

*Cushcraft products are stocked by
dealers throughout the world.*



cushcraft
CORPORATION

P.O. BOX 4680, MANCHESTER, N.H. 03108

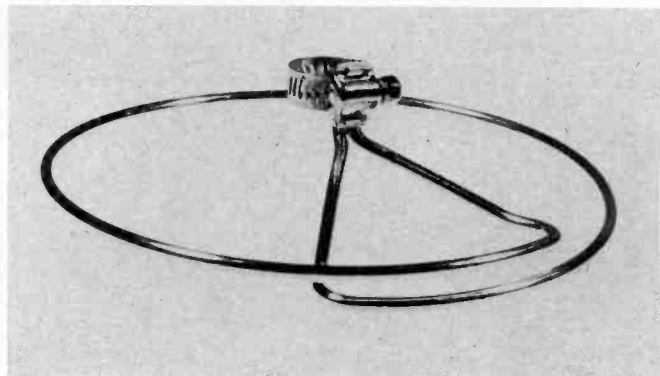

THE ZING RING

A new antenna accessory, the Zing Ring (cat. #1114) has been introduced by Gold Line Connector.

A Gold Line spokesman commented that the Zing Ring can improve a CB antenna's performance by providing a 360° launching pad for the signal. In order to launch a signal properly, a mobile antenna should be mounted over the metal surface of the vehicle such as with the centered roof mount or a centered trunk lid mount. The metal of the vehicle acts as the primary ground plane, establishing the radiation strength and pattern.

A gutter, mirror or bumper mounted antenna is not centered and does not offer these necessary performance features. Without a 360° primary ground plane, the signal has a lop-sided and weak radiation pattern in certain directions.

The #1114 Zing Ring provided this 360° primary ground plane and centering effect to enhance the omnidirectional radiation pattern.

The Zing Ring not only zips up the signal but, it also reduces antenna vibration and whiplashing caused by vehicle motion or wind.

For further details, contact: Charles Brainard, Gold Line Connector, Inc., P.O. Box 893, East Norwalk, CT 06855. (203) 853-1211.



IN-LINE CB PERFORMANCE INDICATOR

CiBco, the new product and R & D division of Southwest Factories, Inc., has announced production on two in-line indicators that monitor the performance of an antenna-transceiver system. The CPi I model monitors transmission only. A green light emitting diode glows when 3.5 watts or more is being transmitted. The CPi II not only indicates proper transmission, but IMPROPER SWR by energizing a red

L.E.D. when reflected power exceeds 1.8 to 1 ratios. CPi in CiBo language is explained as Constant Performance Indicator and can be read anytime the CB mike is engaged. The CPi's are light in weight, only 5 $\frac{5}{8}$ " wide x 1 $\frac{1}{8}$ " high and 1 $\frac{1}{2}$ " deep, and are easily secured to the CB set, above or below, or fastened under the vehicle dash by adhesive strips supplied with the units. Installation is quite simple . . . the PL259 to the transceiver is re-located to the receptacle on the CPi and the 18" cable and PL259 from the CPi is fastened to the transceiver.

Patent is pending. Further information may be sought by contacting Mr. Joyner, Southwest Factories, Inc., CiBo Division, P.O. Box 12279, Oklahoma City, Oklahoma 73112.

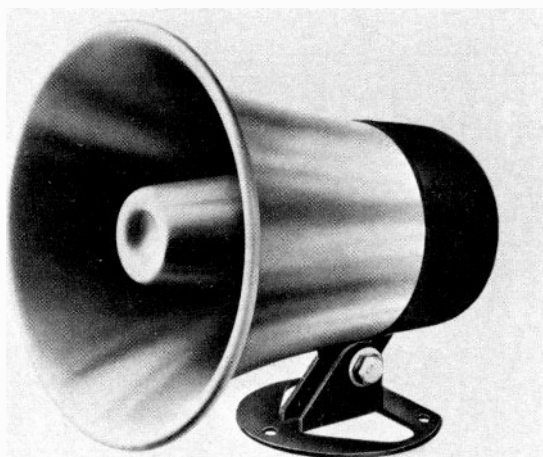

GOOD-BYE ELECTRIC MOTORS

Kolin Industries has eliminated the electric motor normally required in sirens. The manufacturer states their alarm kits use different sirens than most kits available today. The sirens are special electronic type. They are unlike other units since they work on a different principle. Electric motors are not used. There is no rotor for producing sound. The sirens are claimed to be more reliable because they have completely eliminated moving parts.

The siren uses special solid state circuitry, driving a weather-proof speaker to create the automatic rise and fall sound, similar to modern emergency vehicles.

Since electric motors aren't used, the EARSPLITTER sirens drain twenty times less power from the standard vehicle battery. They are waterproof and can be exposed to inclement weather.

Kolin Industries is presently using the new type sirens on its full line of CB and vehicle alarms.

They are available in different sound outputs, including a unit reported to be audible at one mile in still air.

Contact: Kolin Industries, 59 W. Pondfeld Rd., Bronxville, NY 10708.

... Use S9 READER SERVICE.

KHEK 1639 "TEDDY BEAR"

CBers GET YOURSELF SOME RECOGNITION!

You're tooling down old Interstate 99 with your ears on and your C.B. set cocked and out of nowhere a foxy lady in a white 'vette beckos: "Hey, there Out-rigger in the Green Vega, how about coffee at the next exit?"

Your dreams come true, good buddy, with something like a little old portable window plaque that states your handle and call letters. The 3X9 acrylic plaque is handengraved and can adhere to the inside of your rear window. The distinctive plaques are available in black, green, red, white, and blue. \$7.95 plus \$1.00 for fast handling.

For more information contact: PinPoint Mailing, 150 East Hartsdale Ave., Hartsdale, NY 10530 or call (914) 723-1748.



JFD MAGNETIC MOUNT model 10-MM

- No drilling or holes required
- Attaches instantly and securely to any flat metal surface of vehicle by means of heavy duty built-in base magnet
- Stays put at highway speeds
- Instantly removable when needed. Prevents theft
- 1/8" coaxial cable and connector

15/64-1906

NEW MAGNETIC MOUNT CB ANTENNA

A mobile CB antenna that can be mounted instantly on flat metal surfaces without drilling holes or marring paint is now in production at the JFD Electronics Corporation.

The new model 10-MM grips tightly even at high speeds as a result of its powerful ceramic magnet. Yet the 10-MM can be removed quickly despite its magnetic grip when the radio is not in use. This helps deter theft by removing entirely from view the antenna which signifies presence of a CB radio.

(continued)

The Sonar FS-2340 CB base station is, perhaps, the world's only limited-edition citizens band radio. We build fewer than 10,000 of these extraordinary pieces of professional communications equipment each year.

That's because each unit is painstakingly assembled by our highly-skilled technicians to the most exacting specifications in the industry. With the same hand-crafted care and attention for which Sonar has been famous, for over thirty-five years.

Only the finest available compon-

ents go into the 2340's sophisticated circuitry.

The 2340 can field even the weakest signal. It will zero-in on any of its forty channels with unparalleled reception. Without adjacent-channel spill-over

Its extremely high audio output will come through loud and clear in even the most noisy environments.

And its unique 12-tube design makes it the most rugged, long-lasting CB radio on the market (in fact, 99% of all Sonar FS-model CB's sold since

1964 are still on the air today.)

Which is why so many discriminating CB'ers throughout the country use Sonar CB's as their base stations.

To learn more about this exceptional citizens band radio, contact your professional communications dealer. Or write us directly.

Like the finest automobile, you can expect to pay more for the opportunity of owning a Sonar FS-2340.

But it's a small price to pay for what is, quite possibly, the best CB radio the world will ever know.

SONAR MAKES ITS CB RADIOS LIKE ROLLS ROYCE MAKES ITS CARS.



Sonar Radio Corporation, 73 Wortman Ave., Brooklyn, New York 11207, (212) 649-8000

ON THE COUNTERS (continued)

Other 10-MM features include: a precision-wound permanently sealed copper wire base loading coil that provides a typical VSWR of less than 1.3 to 1 for optimum transmission and reception of CB 26.8-27.4 MHz frequencies; corrosion-proof, high strength 37" solid stainless steel radiator whip; heavy duty stainless steel shock spring; heavy gauge ABS cup that can never rust, corrode or stain; chromed brass screw machined parts; tough high dielectric nylon insulation for low loss performance; and 18-ft. 95% copper-shielded RG58/U coaxial cable sweep-tested to assure maximum signal transfer, with factory-assembled PL259 connector.

The antenna is handsomely skin-packaged for self-merchandising pegboard display sales. Suggested list is \$33.00. For brochure contact: JFD Electronics Corporation, Pine Tree Road, Oxford, NC 27565.

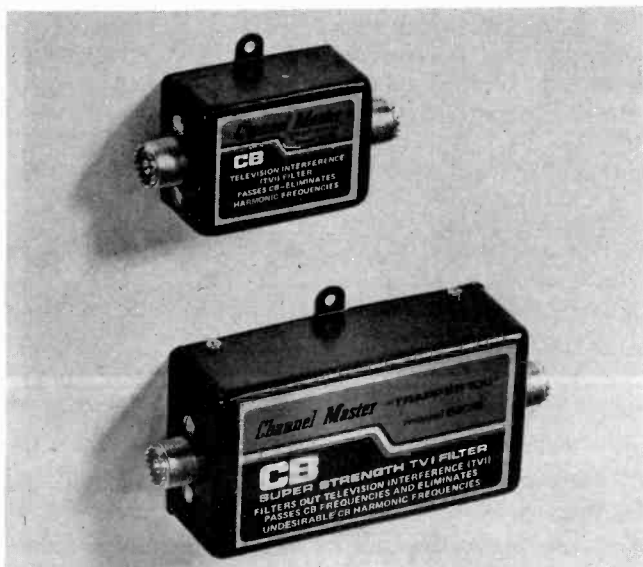

NEW CHANNEL MASTER "TRAPPER" TVI FILTERS END CB-CAUSED TV INTERFERENCE

Channel Master has announced the introduction of the "Trapper" line of low-pass TVI filters, which effectively screen out television interference while passing the CB frequencies, thus eliminating undesirable harmonically-induced TV interference.

Two models are available, either of which can be used on mobile transceivers or base station units. Both models have metal housing for improved shielding and are easy to mount and to connect.

"Trapper 45" is a compact low-pass TVI filter designed for average situations. Attenuation is 45 db at 54 MHz, and 40 db at 81 MHz. Model 5271, suggested retail, \$9.95.

"Trapper 100," super strength, low-pass TVI filter. Designed for severe interference problems. Attenuates 100 db at 54 MHz, and 75 db at 81 MHz. Model 5272, suggested retail, \$14.95.

Contact Channel Master, Ellenville, N.Y. 12428.

TAB POPULAR CB BOOKS

- **CB Radio Operators Guide - 2nd Edition**
Tells what CB is, how it is used, how to buy and install equipment — PLUS Part 95, the FCC rules regulating CB. 256 pps
Order No. 799
Paper \$5.95 Hardbound \$8.95

- **Practical CB Radio Troubleshooting & Repair**
Complete details on CB operation, installation and repair, including 21 programmed troubleshooting charts and complete schematics for 18 popular transceivers. Also an in-depth section on antennas and feedlines. 238 pps.
Order No. 754
Paper \$5.95 Hardbound \$8.95

- **Pictorial Guide to CB Radio Installation & Repair**
Step-by-step guide to car and base systems installation and basic maintenance. 256 pps.
Order No. 683
Paper \$5.95 Hardbound \$8.95

- **Citizens Band Radio Service Manual**
All-in-one troubleshooting and maintenance guide for all types of CB sets, including a 36-page schematic foldout section. Step-by-step repair procedures and trouble-analysis charts. 192 pps.
Order No. 581
Paper \$5.95 Hardbound \$8.95

----- ORDER FORM -----

S9 Magazine
14 Vanderventer Ave.
Port Washington, N.Y. 11050

Ship the books listed below. To cover shipping, I've added 50¢ for the first book and 25¢ for each additional book. Enclosed \$ _____

No.	Price	Name _____
—	—	Address _____
—	—	City _____ State _____ Zip _____



DX Korner

Send SWL reports to:

Don Jensen
c/o CB Radio/S9 Magazine
14 Vanderventer Ave.
Port Washington, NY 11050

YOU'VE been asking . . .

What kind of shortwave receiver should I buy? What features should I look for? How much should I pay?

Good questions all! They suggest a growing number of S-9 readers who cut their teeth on CB are now discovering there are other aspects of this radio hobby that are just as fascinating . . . including DXing!

And so, according to the mail received here in DX Korner, many of you are interested in buying a receiver for SWLing.

Very basically there are two types of receivers used by SWLs. One is the multi-band portable. The other is the so-called communications receiver.

The multi-band portable is just that. It is a portable receiver, meaning it is lightweight, small, battery-powered and has its own built-in whip-type antenna. Multi-band means that several segments of the radio spectrum can be tuned; sometimes several transmission modes, usually amplitude modulation (AM) and frequency modulation (FM) can be received.

Some multi-band portables tune the regular AM broadcast band, 540-1600 kHz, plus one or several shortwave bands; perhaps the FM broadcast band or the several VHF public service bands are included.

Price-wise, it is possible to buy this sort of receiver for as little as \$25 or \$30, but a more realistic bottom-line price is \$50. The price can range up to around \$300, though I have seen one rather astounding Japanese portable priced at about \$2,500!

A communications receiver, on the other hand, is primarily designed for receiving the shortwave frequencies. While some can be operated on batteries, essentially they are not designed for portable use and don't have built-in whip antennas. They have special features intended to overcome the specific problems encountered by the SWL.

Prices for a communications-type receiver can be

considered to begin at about \$150. A second level of newly designed receivers of this sort can be found priced between \$250 and \$300. A professional-class of communications receivers makes up a third level in the \$500 to \$700 range. And then there is an out-of-sight price range above that that can top \$4,000!

Why buy one receiver and not another? What should you look for when shopping for a rig?

Price, clearly, is one important—perhaps the most important—factor for most of us! A shortwave receiver doesn't go for pennies. The initial outlay of cash can be considerable but consider it a long term investment in a fascinating hobby. With proper attention and care, periodic replacement of tubes (if it uses them in this solid-state age), a realignment when that's called for, there's no reason why your receiver shouldn't be perking away like new a decade hence. (Here in the DX Korner I use a "hot" '60's vintage tube model by choice.) And a \$300 receiver's cost spread over a ten to fifteen year span of listening enjoyment brings that "per-year" cost way down.

Because price, the initial outlay, is a factor, many beginning SWLs choose a multi-band portable. Other reasons for doing so are the portability factor—you're on the go and want to take your SWLing with you—and the choice of several types of listening, SW, FM, the police action bands on very high frequency (VHF) and ultra high frequency (UHF).

But if you have the money to spend; if you believe you have more than just a passing fancy for shortwave listening, you should really consider a communications type receiver. They are specialized sets primarily intended for shortwave reception and designed, to varying degrees, to overcome the problems inherent in SWLing.

Lets look at the three basic problems facing a SWL and how various types of receivers attempt to cure them.

*There are many strong easily heard SW signals, but many more weak ones. Any receiver will bring in the strong signals, the so-called international broadcasters. But the more sensitive a receiver, the more of the weaker, lower powered shortwave voices of the world you'll hear, all other factors being equal.

One way to obtain sensitivity in a receiver is with a tuned radio frequency (RF) amplifier stage. Except for the budget units, most communications receivers have an RF stage in their design.

A preselector can improve a receiver's sensitivity. It isn't until you get into the \$250-plus designs that you begin to find preselector units built into a receiver.

*In order to know where you're tuning—to find a station known to be operating on a certain frequency, or to find again a station you heard yesterday—you must have a receiver with reasonably good frequency readout.

Frequency readout is never a problem for a CBER. Changing frequency is simply a matter of switching from one pre-tuned frequency to another, designated as channels. For most listeners to the regular AM radio band, frequency isn't worth worrying about. There are, perhaps, a half dozen or so local area stations you listen to regularly. They are heard easily, with loud and clear signals. You know, roughly, the section of the dial where you'll find them. Tune to that general vicinity and, when they come blasting in, you peak the tuning by ear.

It is, however, a different matter when it comes to shortwave. Bands are crowded, stations are located "close to each other" on the dial. A few powerful outlets can be "tuned by ear," but for the most part it is necessary to know, at least to within 5 to 10 kHz, where you're really tuning.

This is virtually impossible with the inexpensive portable type receivers. You must, for all practical purposes, tune at random for whatever you happen to. It is very difficult to look for a specific station on a specific frequency.

Because of recent design breakthroughs, in some Japanese-made portables in the \$150 class, frequency readout to about 10 kilohertz or a bit better is possible. Newer communications receivers in the \$250-300 category provide rather good frequency readout directly. Older designs in communications receivers allow decent frequency readout but it is not direct and is a bit more cumbersome. When you pay \$500 or more you can expect to get a receiver that will allow you to directly read out a frequency to at least one kilohertz accuracy and, often, better.

* A receiver with good sensitivity allows you to hear a lot of stations on SW. The real trick, however, is to be able to hear them one at a time.

The quality that allows this is receiver selectivity, perhaps the most important factor to the SWL. Bands are crowded with signals. On the simplest sort of receiver, many weaker signals are obscured by a handful of strong voices on a band. The better selectivity a receiver has, the better it is able to sort out all these signals.

Let's say there are, at a given time, ten different signals, of varying strengths, between 9,600 and 9,650 kHz. The most powerful outlet, in our example, is on

The COMMUNICATOR

14 Vanderventer Ave., Port Washington, New York 11050

DEALERS

If you haven't yet subscribed to THE COMMUNICATOR, you're missing out on vital news important to *your* business. THE COMMUNICATOR is the only newsletter in the industry directly devoted to CB marketing.

The latest issue of THE COMMUNICATOR includes these features:

- Latest FCC license figures for Class D CB
- Latest news on the Status of Class E CB
- Equipment availability lists for all major CB Distributors. You can't sell 'em if you don't stock 'em.
- New product roundup of CB transceivers, antennas and accessories.
- New marketing ideas for increasing CB sales.
- A market survey questionnaire directly aimed at getting more information to aid your sales.

So don't put off entering your subscription to THE COMMUNICATOR.

Every issue you miss can mean \$\$\$\$ lost.

**TODAY! NOW! BEFORE YOU FORGET!
PRONTO!**

THE COMMUNICATOR

Suite 1, 14 Vanderventer Ave.,
Port Washington, New York 11050

Please enter my subscription for 1 year to
THE COMMUNICATOR.

Enclosed find check money order
 cash, in the amount of \$15.

Name (individual)

Title

Company Name

Street Address City State Zip

Dealer Distributor Amateur Radio CB



NEW KODIAK DX QUADS

- Full wave DX quad built with ham technology for today's CB'er.
- Full 40 channel-plus coverage.
- Super DX range due to our unique diagonal polarization.
- Superior side noise rejection.
- Available in two, three, and four element models
- Front-to-back ratio up to 35DB with maximum forward gain.
- Light weight—7 to 15 lbs.

American Modular ELECTRONICS

6964 Plainfield Rd. Cincinnati, Ohio 45236
(513) 891-7511

Dealer and Distributor inquiries invited

DX KORNER (continued)

9,625 kHz. With an inexpensive receiver with poor to mediocre selectivity, the strong signal splashes all the way from 9,600 to 9,650 kHz, making it virtually impossible to receive the other nine stations.

With a top flight set with excellent selectivity, you should hear all the stations; with some interference but still intelligible nearer 9,625 kHz, with little difficulty the further you go from that frequency.

To a great extent, when you pay more for a short-wave receiver, you are paying for improved selectivity.

Selectivity is obtained in a number of ways. A superheterodyne receiver uses an intermediate frequency (IF) amplifier to produce basic selectivity. A double or triple conversion receiver with multiple IF stages will provide better selectivity. There are several types of filters, crystal, ceramic and mechanical, which serve as "signal gates" to shave off the unwanted interferences on either side of the desired frequency. Some receivers use a tunable "notch" that can be tuned to null out particularly annoying interferences. These design factors are often used in combination to improve selectivity. And, they add to the cost of a receiver.

These, then, sensitivity, frequency readout and selectivity are the important considerations when you look for a SWL receiver. Since, money will usually be an important consideration, you will try to maximize the features within the price bracket you choose.

There are a limited number of receiver kits on the market which might prove to be the answer to your particular set of circumstances. Basically you can get more for your money with a kit because you provide the construction labor that otherwise must be paid for by the receiver manufacturer. A kit can be a good buy



Here is young Scott Freiman of Lakewood, NJ ready for a nighttime DX session.

if the finished product of your handiwork contains those receiver features you feel you really want.

Another way to save money is by keeping you eyes open for a used communications receiver of an earlier vintage. Some real buys are possible. But some used receivers, because of the way they have been treated or because they never were especially good rigs even when new, are dogs. So it is a case of caveat emptor—let the buyer beware. On the used market there are buys to be had. You can also get stung badly.

WHAT'S NEW?

Word from Gerry E. Wood, DX editor of "DX Corner" (hmm, there's another "kornor" heard from), the weekly broadcast for SWLs aired by South Africa's Radio RSA, about a contest for listeners. A DX quiz question is presented during the "DX Corner" program on Saturdays. You can hear the English language schedule of Radio RSA on 9,585 kHz between 2230 and 2320 GMT. The writer of the first correct answer to the question will receive an LP recording. Radio RSA's address is P.O. Box 4559, 2000 Johannesburg, South Africa.

Want to learn Hebrew by Radio? Hebrew Language lessons began on Israel's shortwave outlet last fall. Because the Israel Broadcasting Authority has been known to change its frequencies quite often, I'd suggest you drop a note to the IBA, Box 204, Cheltenham, PA 19012, for a schedule and free script of the language lesson program.

IN THE MAILBOX

From Jon Whiteman, Corpus Christi, TX, a question that I often receive here in the "DX Kormer."

"How," asks Jon, "do you get those DX cards from the stations you listen to?"

Okay, Jon, first off, most listeners call them QSL cards or verifications. They are sent by many stations to verify or confirm correct reports of reception. Basically, these are the steps:

(1) Hear a station.

(2) Take notes on the programs you hear and the conditions of reception.

(3) Write a letter to the station, reporting your reception. To prove that you actually did hear the station, you must include careful details of the programs you heard. Also tell the station when you heard it, date and time in Greenwich Mean Time, and the frequency tuned. Include a report on the conditions of the reception; in other words, how well was the signal coming through. Finally, politely request a confirmation or verification of your report. If writing to a major station probably no return postage is necessary. If you are writing to a smaller station, it is wise to include one or more International Reply Coupons (available for 42 cents at your post office) to prepay the postage costs of the station's reply to you.

(4) Wait patiently. A reply from a station overseas

can take from a few weeks to many months.

That is a bit of an oversimplification, but it w you started on the QSL card collecting route.

Oh, by the way, to answer the question of John Marcos, San Angelo, TX there are several sources for station addresses. One of the best is the annual *World Radio TV Handbook*, available from several sources, including Gilfer Associates, Inc., Box 239, Park Ridge, NJ 07656. The price is \$10.95.

DOWN THE DIAL

FINLAND—Radio Finland again has its North American transmission on the air at 0330 GMT on 6,120, 11,755, 15,110 kHz. Or try the latter two frequencies at 1330 or 1430 GMT, or at 2000 GMT on 9550 kHz.

INDONESIA—The foreign service from Jakarta, the Voice of Indonesia can be heard with its English language program at 1400 GMT on the frequency of 11,789 kHz.

DENMARK — Radio/Denmark isn't reported that often, probably because the station has no regular programs in English and because only one frequency is in use at any given time. But Radio Denmark does have occasional English language identification announcements on the half hour between 1530 and 1730 GMT on 15,165 kHz.

YOU CAN'T BEAT THE BEST!

Fiberglass Antennas Work Best — And Francis Makes The Best Fiberglass Antennas.

That's because Francis Industries holds the original patents on Fiberglass CB Antennas as well as fiberglass marine antennas. We make a complete line of whips, mounts, co-phase harness and complete antenna systems to fit every CBer's needs.

Ask your local dealer about our reputation for quality and performance. We think you'll be impressed enough to join thousands of CBer's who are already enjoying the best.

FRANCIS INDUSTRIES
431 W. Broad St., Pataskala, OH 43062
614/927-4091

CB Usage Tips From S9

(CUT OUT & PLACE AT OPERATING POSITION)

- Preferred & Designated Channels
 Channel 8 Agricultural operations
 Channel 9 Emergencies only
 Channel 13 Maritime
 Channel 16 Single Sideband only
 Channel 18 Single Sideband only
 Channel 19 Trucks/Vehicles in transit*
 Channels 36 thru 40 Single Sideband Only

*Note that in many areas there are also 1 or more additional channels designated and/or normally used for in-transit vehicles, most often Channels 10 and/or 12. This is especially true in metro areas and their suburbs where Interstate Highways are on 19 and secondary roads such as parkways are on alternate channels. It is not the practice for mobile units on such channels to request breaks. Base stations are requested to avoid using all area in-transit vehicle channels in order to permit their full, free, unobstructed and exclusive use by in-transit vehicles. "Channel Monitors" are neither required nor desired on in-transit channels and are requested to honor any in-transit channels which may have been so designated in local areas by the operators by means of their customary and general usage habits.

Those operators who feel the need to function in CB by establishing themselves as "Channel Monitors" should not expect to monitor or control distant stations which are being received at S-3 strength or lower. They should also be aware of the fact that even those local stations in their area may not wish to avail themselves of their services; all stations having

free access to the channels may elect to bypass the monitor should they wish to do so. Those who attempt to pass themselves off as "Channel Monitors" as a ploy to hog the channel for their own purposes should expect to be ignored by most stations. Those monitors who are successful are those with a good signal and good ears, who earn the respect of other operators by keeping their own transmissions as brief as possible, by giving up their own rights to hold conversations while acting as monitor. ALL transmissions from the monitoring station should consist solely of acknowledging breakers who wish to use the channel, and NOTHING more. During busy periods monitors should deny requests for 10-36's and radio checks on their channel.

Those seeking 10-36's should be encouraged and instructed in the art of telling time by means of wristwatch, clock, or broadcast radio station. Those whose primary interest in CB is chucking carriers and/or playing music are requested to consider the pleasures and benefits to be derived from finger painting and shock therapy, respectively.

Stations using power mikes should be cautious that their audio levels are set to a level which will not cause voice distortion, over modulation, or splashover on adjacent channels.

Single Sideband stations generally operate on Channels 16, 18, 36, 37, 38, 39, and 40, although this may vary in specific areas. Stations using standard AM transmission are requested to avoid use of local Sideband channels, likewise Sidebanders are requested to confine their transmissions to those channels established locally for their use.

Dealer Business Card Advertisement

This advertising section is reserved exclusively for CB dealers who wish to keep their name in front of their local customers, but who would otherwise not advertise in a national publication. The ads included are limited to one column inch; advertising copy is limited to non-mail-order type. The costs for business card ads are \$45.00 prepaid. In addition to the ad in the business card section, each dealer participating receives twenty five copies of the issue containing his ad, to sell or pass out in his store. For further information, dealers should contact the publisher, S9 Magazine, 14 Vandeventer Ave., Port Washington, NY 11050. Phone: 516/883-6200.

C.B. RADIOS POLICE & FIRE MONITORS
ESSEX ELECTRONICS CO.
 705 SOUTH MARLYN AVENUE
 BALTIMORE, MARYLAND 21221
 WHOLESALE DISTRIBUTORS
 DEALERS WELCOME
 301-686-8080 RADIO & TV PARTS

Mon., Wed., Thur. (11AM to 5PM)
 Fri. (12 Noon to 9PM) Sat. (10AM to 5PM)
 Closed Tuesdays CB. AM - SSB
D.S.K. Communications
 C.B. Radios
 All makes and models - Fully Guaranteed
 3834 E. Tremont Ave., Bronx, NY 10465
 Phone: (212) 324-4900

ENJOY THE THRILL OF UNDERPAYING
COBRA-TRAM-BROWNING
 QUALITY LINE ELECTRONICS INC.
 STONY HILL PLAZA, RT. 6
 BETHEL, CT 06801
 203-792-7750
 WHOLESALE RETAIL

SPEED EQUIPMENT INC. (516) 883-7819
 One of L.I.'s fastest growing C.B. Dealers carrying a full line of C.B. equipment in stock. We install what we sell!
 Sales: 139 Main St. Installations: 137 Haven Ave. Port Washington, New York 11050

Maspeth Communications
 C.B. Specialists
 (212) 382-4375
 7142 66th St. Glendale, NY 11227
 Between Myrtle & Central Ave.

"KRIS RADIO ACCESSORIES"
 Authorized World-Wide Service Center
 Out of production equipment, hard to get manuals, schematics and parts
General Precision Electronics Inc.
 207 Rhine St., P.O. Box 216
 Watertown, Wis. 53094 (414) 261-8148

(212) 379-2450 AM-SSB-FM SCANNERS
J & R COMMUNICATIONS SERVICE CENTER
 Authorized Warranty Repair
 Johnson-S.B.E.-High-Gain-Courier
 Cobra-Pace-Unimetrics-Royce
 Browning-Motorola-Robyn
 1439 E. Gun Hill Road Bronx, NY 10469

"Dealer Business Card Advertisement"
 Accessories * Antennas * CB Radios
RRR ELECTRONICS, INC.
 2010 Elwood Avenue
 South Bend, Indiana 46628
 219-232-4688 Send for Wholesale price list

TOP OF THE LINE RADIOS
 AT BOTTOM OF THE LINE PRICES
QUALITY LINE ELECTRONICS INC.
 Transit Town Plaza
 Williamsville, N.Y. 14226
 716-631-2332
 RETAIL WHOLESALE



The Monitor Post

by Rick Maslau, KNY2GL

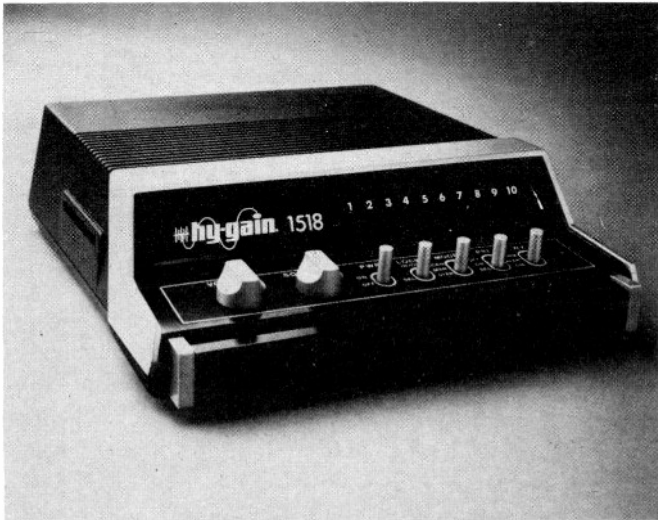

10 BAND MONITOR WITH ELECTRONIC LOCKOUT

The Hy-Gain 1518 scanning monitor combines futuristic technology with striking styling for monitoring of local PSB transmissions.

There are 10 electronically programmed RF bands ranging from 30.0 MHz to 520.0 MHz covering VHF Low, VHF High and UHF programmable frequencies. Weather alert fixed priority on channel one provides for immediate and continuous automatic weather information. And selectable priority (second priority) allows switching to any other channel when the scanner is not operating in priority one.

Electronic channel lockout eliminates individual lockout switches allowing the need for a modest 5 toggle switch configuration. Any channel may be reactivated by manually selecting the desired channel and depressing the lockout-select/reject switch.

There's LED channel scan indicator, memory battery to preserve programmed channels in the event of power failure, quick scan to by-pass locked out channels, external audio jack, and internal or external antenna operations.

A 117VAC w/charger adapter, 6AA batteries and 9V memory battery are supplied. The Hy-Gain 1518 is available at \$139.95 manufacturer's suggested retail price.

MOTOROLA NEW SCRAMBLER

Motorola's Digital Voice Protection System was designed to insure two-way radio communications with a high level of security. This system is currently being used by government agencies and law enforcement units outside of the United States.

The Motorola Digital Voice Protection System is expected to generate a lot of interest because it offers police departments the highest security level possible among commercially-available voice scramblers. While less-sophisticated analog scramblers have been marketed for several years, they are easily decoded.

Motorola's Digital Voice Protection System provides a high level of security with virtually no chance of unauthorized monitoring.

Motorola's Digital Voice Protection System utilizes Motorola's MICOR mobile, base and repeater stations, along with the advanced Motorola MX-300 Series "Handie-Talkie" portable two-way radios.

800 MHz NEWS

The new Motorola 800 MHz two-way radio communications package is being offered in response to an earlier Federal Communications Commission decision to allocate 115 MHz of spectrum within the 806-94/MHz band to land mobile radio service.

The allotment is intended to provide public service agencies such as police and fire departments with relief from the channel congestion which exists in many urban areas. The allocation also permits public safety agencies to add needed new services such as data communications to existing systems without overloading the present communications channels.

Being offered in the 800 MHz spectrum is the Motorola MICOR Mobile Two-Way Communications System, Control Stations, Base Stations, and Repeaters, Base Station Duplexers, and High Gain Base Station Antennas.

For further information on Motorola's products, contact Barbara Bennett, Marketing Services Motorola Communications and Electronics, Inc., 1301 E. Algonquin Road, Schaumburg, Illinois 60196.

(continued)



Electronic Fleamarket

*a new monthly publication
from the publisher of S9*

THE ELECTRONIC FLEAMARKET is a complete new shopping source for anyone interested in buying, selling or swapping used electronic equipment of any kind.

It will appeal to CBers, hams, experimenters and professionals.

THE ELECTRONIC FLEAMARKET will contain thousands of classified ads on transmitters, receivers, transceivers, test equipment, amplifiers, antennas, towers, stereo equipment, etc.

It will also contain ads from retailers, wholesalers, and manufacturers offering used equipment for sale.

Classified ads will be published free of charge to all regular subscribers of S9. Free ads will be limited exclusively to individuals. Commercial ads may be ordered at a rate of 25 cents per word, with a \$3 minimum. Non-commercial ads for non-subscribers are 10 cents per word, \$1 minimum. THE ELECTRONIC FLEAMARKET will be available on a paid subscription basis only at a cost of \$10 per year. All issues will be mailed by first class mail on the tenth of each month.

SPECIAL CHARTER SUBSCRIPTION rates available to S9 subscribers at a saving of 20%. Use the special sub blank below and get your first year's subscription for just \$8. But don't delay!



ELECTRONIC FLEAMARKET
14 Vanderventer Avenue
Port Washington, NY 11050

Please enroll me as a charter subscriber to

"ELECTRONIC FLEAMARKET" at the rate of \$8.00

Name _____

Address _____

City _____

State _____ Zip _____

THE MONITOR POST (continued)



GLOBE INTRODUCES SCANNER

A mobile scanning receiver, capable of monitoring both Hi-Band and Lo-Band as well as a maximum of 16 channel, is Globe Electronics newest unit.

The two bands of the Globe 9700 Scanner (18-9700) accommodate 16 standard crystals, providing you with eight Lo-Band or eight Hi-Band channels, or any combination of the two. A convenient band selection switch allows instant and safe band switching while the scanner is in operation.

Other features include a 3-way scanning switch with an automatic, manual or delay setting, as well as a selector button to allow instant channel selection during manual scanning. The dual superheterodyne scanner also features a squelch control and easy to read LED channel indicators.

The Globe 9700 Scanner may be operated from either AC/DC supply and comes complete with AC/DC Power Cords, Mounting Bracket, Antenna and hardware, less crystals. It is 100% solid state and UL listed.

Globe Electronics, Division of Hydrometals, Inc. 400 S. Wyman, Rockford, IL 61101.

FIRST FULLY SYNTHESIZED AIRBORNE VHF/FM RADIO

The new Motorola SYNCOM-10 VHF/FM Two-way radio makes it possible for government and public service band radio users to instantly select any frequency they need in the range of 150 to 174 MHz.

Nine thousand five hundred ninety-eight channels, with 2.5 kHz spacing, are available by simply tuning the desired frequency on a thumbwheel selector. An electronic digital readout gives positive indication of the frequency in use, whether transmitting or receiving. Frequency synthesis is the basic design feature which allows the large number of channels to be selected so rapidly.

Primarily designed for aircraft installation, the radio's

lightweight ruggedized construction makes it ideally suited for many other applications such as communications vans and ground stations. It is particularly useful for emergency missions which sometimes require up to 50 different channels. This new transceiver has been operationally tested for use in coordinating spotter planes, slurry aircraft, and groundbased units during large fires.

The SYNCOM-10 features pre-selection of up to 8 channels and built-in 2-channel guard receiver. Selection of simplex or half-duplex/split frequency operation is an important feature of this new unit.

Other important features include excellent receiver intermodulation and selectivity, all-solid-state design, 12- or 24-volt DC operation, night lighted controls, 10-watt output power, and standard 1/2 ATR mounting for aircraft installation.



DUPLEX PARAMEDIC PORTABLE RADIO

A new EMS (Emergency Medical Services) full duplex/multiplex portable radio was recently introduced to aid the paramedic with crucial lifesaving communications. The APCOR Radio is the smallest and lightest EMS duplex portable available today. Weighing only 13 pounds, the unit can be carried to the scene of the emergency to aid the stricken patient.

Duplex/multiplex operation is featured, providing simultaneous transmission of ECG and voice from the site of the patient back to the hospital. Capable of two-way repeat, this 8 transmit/10 receive unit has the flexibility to work with most EMS systems. A full two watts of audio power, extended range via vehicular repeaters, one full hour of continuous operation, one hour rechargeable battery, Private-Line squelch encode/decode capability, and reliable plug-in hybrid modules, are other features of the APCOR radio.

For further information, write Barbara Bennett, Marketing Services, Motorola Communications and Electronics, Inc., 1301 E. Algonquin Road, Schaumburg, Illinois 60196. *(continued)*

Free Classified Ads

Your classified ad may be run Free of Charge in *THE ELECTRONIC FLEAMARKET* — this offer is good for all S9 and/or Fleamarket subscribers every month. Please limit ads to thirty words or six lines and not more than two ads per month. You can buy, sell, swap or advertise for QSLs. Your ad may cover ham gear, CB gear, test equipment, stereo, or anything else an electronic hobbyist may find of interest.

Remember, this service is absolutely *free* to subscribers who use the coupon below (or a reasonable facsimile thereof). *THE ELECTRONIC FLEAMARKET* will be read by thousands of electronic hobbyists, so don't miss out.

After all, could the price be better?

ELECTRONIC FLEAMARKET

14 Vanderventer Avenue
Port Washington, NY 11050

Please run the classified ad listed below in the first available issue:

Name _____

Address _____

City _____

State _____ Zip _____

HAVE YOU MADE CONTACT WITH THE



STAFFERS

"ON THE CHANNELS?"

NAME	HANDLE	PRIMARY CHANNELS
Tom Kneitel	Tomcat SSB13, KW146 CLI73	10, 12, 19 16L, 18U
Lori Ressa	Loreli	12, 19
S.R. Cowan	Gramps	19
Richard Cowan	Trainman	13, 16L, 19
Cary Cowan	Green Dragon Sleeping Beauty	12, 17, 19
Marc Gilman	Deacon CLI34, KW339 SSB30	12 16L
Gordon West	California Dreamer	9, 16L
Gary Deckelnick	Baby Bull	7, 19
Bill Sanders	SSB295, CLI1849 KW5304	16L, 18U
Hal Keith	Flasher	12
Pat Hartman	Six Pack	4
S9 Office Station	Deadline Base KW4405 SSB250	8 16L, 18U

HOW 'BOUT IT? GIVE US A SHOUT!

THE MONITOR POST (continued)

VA. POLICE TO USE FOUR HIGHWAY MAINTENANCE FREQUENCIES

The FCC has granted the Commonwealth of Virginia rule waivers to allow the assignment of four Highway Maintenance Radio Service frequencies for use in Virginia's planned state police communications system.

The FCC said the Highway Maintenance frequencies selected—158.985, 159.000, 159.135 and 159.165 MHz—could be used in Virginia without causing interference to existing stations in that state or in adjoining states, with one possible exception.

That exception, it noted, would be the frequency 159.135 MHz, which now is used in Westminster County, Md. To avoid interference, the Commission said, the Commonwealth of Virginia has proposed to use a directional antenna and thus minimize the signal in the direction of Westminster County.

Since co-channel stations on the remaining frequencies are located at distances of 150 miles or more, the Commission said co-channel interference was not anticipated.

While recognizing that this action will reduce the number of Highway Maintenance frequencies in the area and may cause some interference to Westminster County, even with the use of a direction antenna, the Commission said these disadvantages had been weighed against the need of the Commonwealth of Virginia to expand and modernize its state police communication system. Furthermore, it said in spite of a diligent search, sufficient frequencies for the state's police communication system could not be cleared from those available under the rules.

The Commission pointed out there had been no showing that the four selected frequencies would be needed in the foreseeable future for any specific planned Highway Maintenance communications system. Therefore, it found that waiver was appropriate and justified.

(continued)

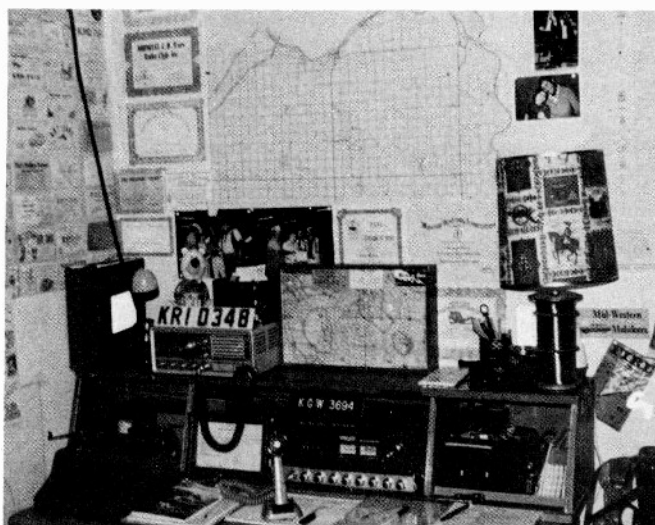

Kris Kringle describes his operating position as "nice, compact, and cozy." We agree. Kris hails from Plattsmouth, Nebraska. (Kris' real name is Jackson).

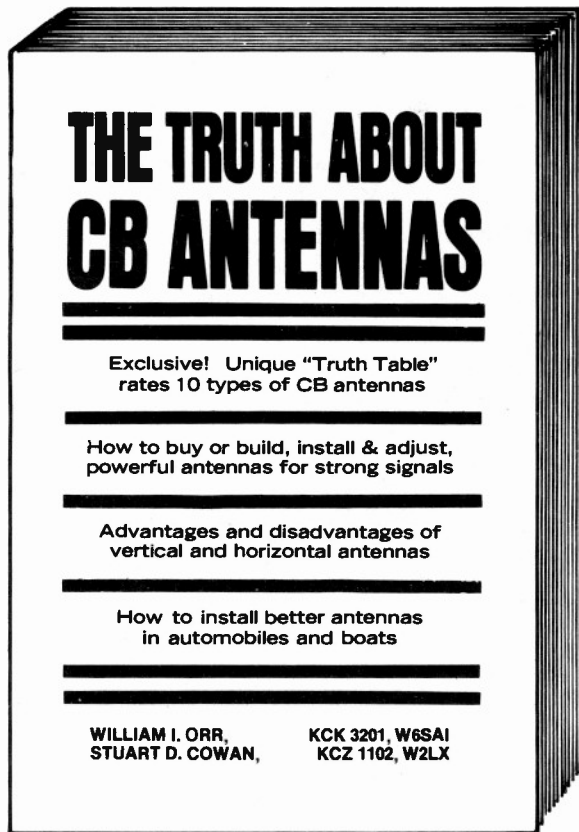

*New
Handbook
Reveals*

**THE
TRUTH
ABOUT
CB ANTENNAS**

\$5.95

*(postpaid)

- * Exclusive "Truth Table" gives actual Db gain from 10 types of CB antennas.
- * 240 pages – 146 illustrations – 18 chapters.
- * "A great CB Antenna Handbook!" - George R. Wood, KBI-3274 - W1SR, RCA.

Your CB antenna is the key to clear, reliable communications. Most CB antennas are improperly installed and adjusted. They do not work anywhere near peak efficiency. Moreover, to impress buyers a barrage of non-facts about inferior antennas is

used by some antenna manufacturers to gain quick sales. Now, for the first time, this new Antenna Handbook exposes false claims and gives you a unique "Truth Table" so you can determine for yourself the true power gain of any CB antennas!

Book Division, Cowan Publishing Corp.
14 Vanderventer Avenue
Port Washington, N.Y. 11050

- Check
- Money Order

Sirs:

Please send me.....copies of **THE TRUTH ABOUT CB ANTENNAS**

Name _____ (Please Print Clearly)

Street Address _____

City _____ State _____ Zip _____

* Residents of N. Y. State include appropriate Sales Tax

Chirping CARS?



The "EARSPLITTER BIRDY"

can be activated at your leisure by a switch under your dash, or controlled automatically when the car is put into reverse. Now, watch the people smile—guaranteed to attract lots of attention. Sounds like a nest of happy, chirping birds. A great safety device too!



HOUSE OF POWER
P. O. Box 306, Merrick, N.Y. 11566



Your Help Is Needed!

The Associated Humane Societies, in an effort to prevent the needless suffering of animals injured on the roads, is trying to reach CBers. A statewide network would be formed to set up emergency service whereby injured dogs, cats and wildlife can be saved from an agonizing death on the roads when there is no one available to pick them up. If you care about animals, won't you please help? For further information on this volunteer animal ambulance corps, please write Roseann Trezza, Asst. Director, the Associated Humane Societies, 124 Evergreen Ave., Newark, NJ 07114 or the Society's Monmouth County Branch located at 2960 Shafto Rd., New Shrewsbury, NJ 07724.

THE MONITOR POST (continued)

As two last matters, the Commission noted there has been some question about the transmitter power proposed for some of the stations, particularly those near adjoining states, and that four of the proposed repeater stations are to be located within the "quiet zone" surrounding the National Radio Astronomy Observatory in Greenbank, W. Va., which has found two of the sites "are not feasible."

With respect to the power question, the FCC instructed its staff to explore the matter with the Commonwealth of Virginia and make any adjustments in power as might be appropriate. In addition, the Commission instructed the staff not to grant any licenses for sites within the "quiet zone" until coordination with the Observatory has been completed.

FIRE RADIO SERVICE FREQUENCIES

The FCC amended its rules by raising the power limitation on Fire Radio Service frequencies 33.42, 46.30 and 153.830 MHz from 3 watts to 10 watts output.

This action was proposed in a rulemaking notice adopted last July 7, in response to a petition by the International Municipal Signal Association.

In its rulemaking notice, the Commission noted that the three frequencies in question had been reserved for on-the-scene fire fighting communications only, resulting in the low 3 watt power limitation. However, it found that the scale of on-scene fire fighting operations had increased dramatically since the adoption of this limitation and in some instances where widely dispersed fire fighting units were involved 3 watts could not provide the coverage needed.

Based on the record in this proceeding, the FCC concluded that the public interest would be served by adopting the rule amendment as proposed.



Gary Hickerson's monitor post in Ft. Smith, Ark. is compact and effective. Regular coverage to Tulsa (125 miles away) can be obtained—however when the skip is in, Gary has heard Boston!

CB SHOP



Rates for CB SHOP are 10 cents per word for advertising which in our opinion, is obviously of a noncommercial nature. A charge of 75 cents per word is made to all commercial advertisers or business organizations (minimum ad, \$30.00). Regular S9 display advertisers are exempt from the classified ad minimum rate. A 5% discount is in effect for an advance insertion order for six consecutive months.

We do not bill for advertising in CB SHOP. Full remittance must accompany full orders

sent in; otherwise, ad will not be run or acknowledged.

Closing date is the 5th of the third month preceding publication.

Because the advertisers and equipment contained in the CB SHOP have not been investigated, the publisher of S9 cannot vouch for the merchandise or services listed therein.

All paid classified ads must be sent to the attention of Eileen Lucey, Classified Ad Manager.

CB'ERS: AVOID SUNSPOT BLACKOUT. Many more channels. More power. Uncrowded. More fun. Qualify! Copyrighted report tells why, where and what to do. \$2.00 Moneyback guarantee. Alpha Research Consultants, Suite 125-S, 7715 Chevy Chase Dr., Austin, TX., 78752.

SPECIAL - 100 QSL IRC's, only \$1.00. Tower -SQ, Drawer 10083, Charleston, S.C., 29411.

CB RADIOS, VHF/UHF monitors, crystals, antennas. All brands. Lowest pricing possible. Southland, PO Box 3591-F, Baytown, TX., 77520.

FCC TEST ANSWERS \$10.00 any class. Specify, Dixie Tec, Box 8352, Savannah, GA., 31402.

NEW CHANNELS! Copywrited book details how to install sliders, increase power, add new channels to most new and old units. Many pages. \$9.95. Tecom, Box 696, Welcome, N.C., 27374.

WANTED: Car telephones and mobile telephone parts, heads, cables etc. Greg Hyman, 87 Yonkers Ave., Yonkers, N.Y., 10701. 914-476-4330.

CALL SIGN AND HANDLE engraved on 1x3 plastic badge with pin/clutch. Choice of colors, all with white lettering - maplewood, green, red, black, blue, orange - \$1.75. H & H Plastic Engravers, PO Box 6606, Pine Bluff, ARK., 71601.

DEALERS WANTED. Most major CB brands, scanners, Ham gear. Large inventory, low prices, fast courteous service. JRD Distributors, 131 Harbor Circle, New Orleans, LA., 70126., 504-241-8500.

GUARANTEED 100% QSL Cards with numbers only. Buddy packs to 100. Extras appreciated. KCO-2682, PO Box 8726, Boston, Mass. 02114.

SWAPPING QSL CARDS? Wallpaper your walls. Join the Carnival QSL Club of the world. Write for application. We have CB pins, patches, rosters and stamps. 1124 High Bluff, Dubuque, Iowa. 52001.

S-9 P.R. REPORTED PATCH, send \$3.00 plus 25 cents postage to William Davidson, 26 Knight St., Glens Falls, N.Y. 12801.

ASSOCIATE MEMBERS WANTED to join American CB Radio Club. Receive attractive club buckle, membership card, permanent club ID number, 10-code, CB language, bumper sticker, etc. Associate membership only \$8.00 a year-- mail check to: American CB Radio Club Inc., PO Box 321, Bronx, N.Y., 10469.

CAN WE HELP YOU with good Wholesale Prices. Most major brands CB radios, and accessories. Same day shipping. Send or call for price list. RRR Electronics, Inc., So. Bend, IND. 46628. 219-232-4688.

CALL SIGN Rubber Stamp, 1" high, \$2.50. Call, name, address stamp, \$3.00. Manufacturer, P.O. 506, Capitola, Calif., 95010.

CB BREAK "The Citizens Bander's Newspaper", published every 2 weeks. Get the news while it's "HOT"! FCC, Gadgets, Jamborees, Awards, New Products, Tests, Antenna, and more! \$8.00 per year. CB Break, Box 378, Brackettville, TX., 78832. Call toll free: (800) 531-7156, Texas- call collect: (512) 563-2432.

ATTENTION All Tram, Browning, LTD, and Cobra owners. If you own a Tram Diamond 60 or D201 or Cobra 132 or 135 your radio is only operating on one half of its capabilities. To learn about 100% improvement on your radio write, B & R Electronics, PO Box 1241, Waynesboro, VA. 22980.

CB'ERS PROTECT YOUR Investment. Make your Rotating or Omni antennas Stay Up. New Support System will add needed wind protection and strength to your Mast and Tower. Detail plan copies for 10 and 15 ft. towers and do it yourself instructions, \$9.95 each or both \$18.50. Patent Pending. N.J. Res. add 5% Tax. RAM Home Improvement Corp. Box 1209, Toms River, N.J. 08753.

QSL's!...Sample Kit 25 cents. Immediate attention and courteous service. G.E. French, PO Box 101, Poestenkill, N.Y., 12140.

DELCO AM-FM Auto radios, original factory, for 65-70 Buick, Pontiac, Cadillac, \$30.00. AM-FM stereo for 65-68 Cadillac-\$70.00. A. Svirnic, 6601 S. Whipple, Chicago, 60629.

CB DEALERS- Send today for our price list, same day service. Reputable company in CB business for over 8 years. Over half-million dollar inventory. CB Distributors, Box 15883, Baton Rouge, LA. 70815.

ZANY CB BUMPER STICKERS!! No. 5005- CBers Do It With Frequency. No. 5006- Honk If You Love CB. No. 5007- We Brake For Beavers. \$1.00 each. 3 for \$2.50. Add 25 cents /order postage & handling. Write for club discounts. U.S. Publications Service, PO Box 34911, Dept S. Washington, D.C., 20034.

CB DEALERS- Send letterhead for complete wholesale catalogue on all communications equipment. Four Wheeler Communications, 10 New Scotland Ave., Albany, N.Y., 12208. 518-462-0202.

SMOKEY'S RADAR BUGGING YOU? Loaded with speeding tickets? Insurance gone up? We have the answer. H & B Enterprises, Box 477, Candler, N.C., 28715.

ATTENTION C.B. DEALERS: Having a hard time getting CB sets? We carry a full line, including Pearce-Simpson, Robyn, Browning, Johnson, Royce, Police Monitors, Crystals, New-Tronics, Antenna Specialists (E & S CB Sales & Service) R4, Winchester, IN. 47394. Phone 317-584-0343.

-NEW- CB CARD SWAP DIRECTORY Current updated listings of active swappers. Increase percentage of returns. Order includes your listing. Send your QSL, Call(s), name-handle and 10-20. \$1.50 postpaid. California, \$1.60. Harold A. Morgan, 801 South UI, Santa Ana, CAL., 92704.

MAIL-IN CB REPAIR: Write or call for procedures and flat-rate price schedule. Most radios in return mail within 48 hours. Communications Unlimited, PO Box 55, I-70 & US 42, London, Ohio 43140. 614-852-9446.

SUFFOLK COUNTY CB'ERS: Join Suffolk Emergency, a non-profit volunteer channel 9 monitoring organization looking for dedicated people to help fellow citizens in time of need. For more information on membership, send to: Suffolk Emergency Monitor Team, PO Box 91-X, Huntington Station, NY., 11746.

BEST PRICES- On Johnson, SBE, Tram, Browning, Midland, Antenna Specialist, Avanti, Antenna Inc., Shakespeare, Turner, Astatic, Mura, CDE, Para-Dynamics, Vanco, and Gold-Line. Write for free price list. CRS Communications, 1552 Central Park Avenue, Yonkers, N.Y., 10710.

CB'ers - WOULD YOU LIKE to be a "ham" and shoot legal skip world-wide on thousands of channels? Join ARC to learn how! Life Membership: \$4.00 (or 25 cents brings info). American Radio Council, Box 1171-E, Garland, TX., 75041.

QSL CARDS- Something completely different! Nothing even close to it on the market! The "Cadillac" of QSL's! Samples: \$1.00. Fully refundable with order. Mac's Shack: Box 1171-B, Garland, TX., 75041.

PERSONALIZED BADGES With name, Handle, Call Letters, only \$1.50 Postpaid. Mac's Shack, Box 1171, Garland, TX., 75041.

JOIN THE BROTHERHOOD OF CB'ERS a Nationwide organization. Equipment and handle registry, overnight accommodations, bi-monthly magazine published by us, ID Card, 5x7 wall card, bumpersticker and more. Complete membership \$5.00 or free details. Box 461, New Haven, Connecticut, 06502.

CB RADIO SLIDING CAPABILITIES- Ham radio conversions to CB easily achieved using simple tools. Step by step illustrated instructions available. Details \$1.00, refundable. Technical Publications, Box 649-S3, Milwaukee, WIS., 53201.

DEALERS WANTED: Profitable spare time business, best wholesale prices, CB radios/antennas/monitors/accessories. Central USA for best shipping. Send card or letterhead for price sheet. Sunridge Electronics, Inc., Rt. 2, Box 375 S, Hillsboro, MO., 63050.

MOBILE IGNITION SHIELDING provides more range with no noise. Available most engines in assembled or kit forms, plus many other suppression accessories. Free literature. Estes Engineering, 930 Marine Drive, Port Angeles, Wash., 98362.

MISSISSIPPI Communications Systems, 423 B Pass Road, Gulfport, Ms., 39501. If we don't already have it chances are we can get it CB, UHF, VHF, VHF Marine amplifiers, scanners, snoopers, ultrasonic burglar alarms, much, much, more. We communicate with you.

BE AN EMERGENCY CHANNEL 9 MONITOR! If you live in California, we invite you to join Cal-State Emergency Radio. For information and membership application, send self-addressed, stamped envelope to CSER, PO Box 1956-A, San Jose, CA., 95109.

A CUSTOM DESIGNED Carrying Case for 2 way Radio, The Carryer. Carry your radio, extra mike, tools, meters in separate foam compartments. A quick mount antenna cigarette lighter plug and any rig can be safely portable. Send \$24.95 plus \$1.50 for cost of handling to Alli Industries, PO Box 68, Centereach, NY., 11720. Phone 516-588-6695. Allow 4 weeks for delivery.

CB HAM DEALERS: Send your letterhead for free catalog. Siltronix, Swan, Midland, Pearce-Simpson D & A, Black Cat, Hustler, Avanti, etc. Appliance & Equipment Inc., 2331 Vance Jackson, San Antonio, TX., 78213. 1-512-733-0334.

BECOME A RADIO AMATEUR— Read "From CB to Ham Beginner". All you need to know in one easy-to-understand book. Only \$4.95 at all stores handling "Sams" publications. Or order autographed copy latest edition direct from author (add 50 cents for handling). J.A. Stanley, 855 B South Fillmore St., Denver, Colorado, 80209. Money back guarantee.

HIGH FREQUENCY CRYSTALS -Huge inventory, all radios AM & SSB. Write giving radio make, model and frequencies desired. Same day shipping \$5.95 each. Dealer inquiries invited. Xtals, Box 42, Prospect Heights, ILL. 60070.

ELECTRONIC DISCOUNTERS CLUB CO., Here it is, the club everyone is looking for. Discount electronic merchandise at prices 20 to 40% below retail plus one year full warranty on all equipment and we pay shipping. Send \$6.00 plus name of favorite manufacturer for one year subscription in check or money order to: Electronic Discounters Club Company, 610 North Cumberland, Lebanon, TN., 37087.

MAKE MONEY JUST LISTENING! To "CB" or Police Monitor radio. New report shows many ways. No broadcasting. Works anywhere, anytime, for anyone! Little risk, small investment, earns excellent income for years! Report only \$5.98. Economy, Box 23-S9, Highland, MD., 20777.

FUZZBUSTER RADAR DETECTORS. tremendous discount, Master Charge. Immediate shipment guaranteed. H & B Enterprises, Box 477, Candler, NC., 28715.

ANTENNA PLANS. Save and build your own. No Gamma Match or Loading Coils. Base station ground plans \$2.50. Two, three or four element beam plans \$4.50. Both plans for \$6.25. Send check or money order to Antenna Plans, Box 372, Fort Atkinson, Wis., 53538.

QSL CARDS— 2 color 12 pt. glossy white, 500 for \$10.00, 1,000 for \$18.00. Over 300 designs. Catalog & Samples, \$1.00. Lile Guill-Rustburg, VA., 24588.

BE AN EMERGENCY CHANNEL 9 MONITOR. Send self-addressed, stamped envelope for information and membership application for U.S. EARS (United States Emergency Assistance Radio System), a new nationwide monitoring team. U.S. EARS, Headquarters, PO Box 1956-A, San Jose, CAL., 95109.

HORNET ANTENNAS SELL BEST. Immediate delivery. Dealer inquiries invited. Hornet Antenna Products, Box 880, Duncan, OK., 73553.

POLICE SCANNERS, MONITORS. Choose from name brands like Regency, Bearcat and others. Also crystals, antennas, and frequency directors. Complete selection of Citizen Band transceivers, antennas, and accessories. Harvey Park Radio, PO Box 19224, Denver, CO., 80219. CEDA Member Dealer.

SCANNER CRYSTALS \$2.99 each. TUG8-D104 microphones \$39.00. PL259's 2/\$1.00. 3 amp/12 volt Power Supply \$15.00. TVI Filters \$1.98. RG8 Foam Coax 19 cents/foot. CB/Ham/SWL Discount Catalogs for 1 year, \$1.00. Check, M.O., C.O.D.'s, OK. Jemcom Radio, PO Box 206, New Egypt, NJ. 08533.

QSL CARDS— Top quality, reasonable prices, 12 colors, gloss-coated, custom made for you. Free Catalog. Write to CBC Club, Dept. S9, Box 703, Lexington, N.C., 27292.

DEALERS: We specialize in distribution of Tram Products. We have Tram D201 in stock. Write for our low prices on Tram Products. Buy from the distributor who has them in stock. BTL Radio, Box 17192, Louisville, KY. 40217.

WOW! \$1.00 Engraved Handle Pins for coffee breaks. No minimum. Fast. 1x3 plastic. White letters on red, blue, black, green. Black on white or yellow. Max line (1 or 2) :16 letters, spaces. Guaranteed. Holly Engraving, Box 3926-W, Hollywood, FLA. 33023.

OFFICIAL CB BUMPER STICKER "You bet your sweet (donkey) I'm a CB'er." \$1.00. Two for \$3.00. Four Seasons, Route 16, Dept. CB, Dover, N.H., 03820.

150 TWO COLOR COMIC QSL CARDS printed with your name, address and call letters, only \$4.00 plus 85 cents postage. Check or money order. Pack includes 30 different comics. Albert Wilson, Rt. 9, Murfreesboro, Tenn., 37130.

CB SECURITY PLAN: Protect valuable mobile, base investment. Total cost protection plan \$1.00, stamped envelope. Ripoff Safety. Geyer, 230 East Grand, Rahway, NJ., 07065.

CRYSTALS

Same Day Shipping
From
America's
Largest Inventory of

Standard C.B. Crystals/Ham Crystals

Special Cut C.B. Crystals*

Crystal Box Converters/Ham Gear*

NATIONWIDE DISTRIBUTORS—DEALERS WANTED

CALL TODAY

TENNESSEE
CRYSTAL COMPANY

P.O. BOX 73

LEBANON, TENNESSEE 37087

(615) 449-1856

*For monitoring purposes only.

WANTED ANTIQUE GLASS—Looking for old milkglass purple, slag, carmel and green-town too. Tell me what you have—I pay the highest prices. Write, Jack Schneider, c/o Cowan Publishing, 14 Vanderverter Ave., Port Washington, NY 11050.

SIDEBAND DECALS! Tell the world that Sideband is the greatest! Spectacular new 3-1/2 inch 3-color water transfer Sideband decals! One decal only \$1.25 ppd.! Two or more only \$1.00 each ppd. Dealers wanted! Sidebanders' Service Bureau, Box 381-Y, Smithtown, NY 11787.

POLICE/SHERIFF SHOULDER PATCHES! Authentic! Exclusive! Rare! Limited Supply! Multi-colored embroidered uniform patches from actual agencies. No lists, our choices sent, while supply lasts! 5 different only \$5, ppd. CRB Research, Inc., P.O. Box 56-X, Commack, NY 11725.

WANTED FOR \$\$\$CASH! Back in 1957 the Lionel Train Company made a small set of toy trains specifically designed for girls. It had a pink locomotive and several other cars, all in pastel shades. The set wasn't very popular, hence not too many sold. However, I need this set for my collection, and am willing to pay up to \$400 cash for a complete set in mint condition. If you have this item please write: Dick Cowan, S9 Magazine, 14 Vanderverter Ave., Port Washington, NY 11050.

SIDEBANDERS! Old Timers! Newcomers! Future Sidebanders! Affiliate with the largest, oldest and most well known SSB Network! No charge for SSB ID numbers from current numbering blocks. Lots of extras and goodies available! Send self-addressed stamped envelope for FREE info and application. No obligation! Sidebanders' Service Bureau, P.O. Box 381-X, Smithtown, NY 11787.

SECRET SCANNER FREQUENCIES? Many public safety and federal gov't. agency frequencies are "unlisted"—that is, "missing" from frequency listings available to the general over-the-counter buyer! What good is a scanner without ALL of the frequency data? Get those unlisted frequencies and lots more ONLY in CRB Research directories, the original Official "insiders" directories used by public safety agencies and scanner users since 1967! Exclusive directories for many other services (mobile telephone/private detectives/aero/railroad/remote broadcast pick-up/etc.) also available! Still only \$3 each, or send a postage stamp for fantastic BIG new catalog! CRB Research Inc., P.O. Box 56-X, Commack, NY 11725.

LOOKING FOR OLD LIONEL TRAINS. Interested only in "0" Gauge, excellent to like-new condition. Primary interest is locomotives prior to 1952, but will consider complete sets or more recent models. Am willing to buy outright for cash or swap radio gear to meet your needs. Write Dick Cowan, WA2-LRO, c/o S9 Magazine, or call 516/883-6200.

LISTEN!!! to your car stereo and CB at the same time. Tape CB calls automatically. "A.V.A.S.C." the hottest new communication assessor on the market. Write: Project Support Engineering, 750 N. Mary Avenue, Sunnyvale, CAL., 94086.

BEAUTIFUL QSL CARDS... Want your custom designed QSL card to truly stand Tall among the rest of the "Ordinary Wallpaper"? Breathtaking samples and information only \$1.00, refundable with first order. Back-Acre CB Printers, Box 18608-S3, Milwaukee, WI., 53218.

WHOLESALE REPRESENTATIVES Needed: Join our nation-wide sales staff for big commissions. CB's, auto stereos, auto parts and tools. \$25.00 cash required with resume. Receive confidential catalogs, pricing, etc. Alamo Wholesalers, 1313 Sam Houston Dr., Victoria, TX., 77901.

"CB OWNERS DO IT MORE FREQUENCY" Bumper Stickers. CB'ers show the world your a proficient operator in more ways than one. Printed on 3"x12" weatherproof vinyl. Bold red on white. Peel-off backing for quick, easy application. \$1.00 each. Send to: Romano, 23741 St. Elena, Mission Viejo, CA., 92675.

SCANNER OPERATORS! Are you registered? Be assigned your own personal monitoring ID letters inscribed on beautiful 2-color bordered certificate, plus discounts and goodies! Thousands already registered! Only \$5, ppd. from CRB Research, Box 56-X, Commack, NY 11725.

NOW FROM THE LARGEST WAREHOUSE IN THE EAST. Same day delivery for on the shelf stock. All major brands. 24-hour service. Send for dealer catalog and free gift offer. Send letterhead to: PALOMAR EAST LTD., Palomar Plaza, P.O. Box 148, Congers, NY 10920.

PROTECT GEAR with bold burglar alarm warning stickers. Strong self-stick vinyl striking green/yellow design. Only \$2 for 5. Enclose self-addressed stamped envelope. CRB Research, Inc., P.O. Box 56-XC, Commack, NY 11725.

FOR THE BEST IN CB & AMATEUR GEAR. Tempo One. Siltronix 1011B & Skipper 73. For immediate delivery, call or write: PALOMAR EAST LTD., Palomar Plaza, P.O. Box 148, Congers, NY 10920. (914)268-9258.

UNIT NUMBER ID'S! Everybody's using them these days! Don't you have yours yet? Your existing Unit Number registered or a new one assigned to you by the national registry for ALL Unit Number ID's; PLUS a 2-color official Certificate of Registration showing Unit Number, your name and/or handle, the date of registration; PLUS exclusive special report on how thousands of CB'ers are now getting more use and enjoyment from their hobby by using Unit Number ID's in addition to or instead of "handles." Everything for only \$2.95, plus self-addressed stamped envelope. Z-Tech Enterprises, Box 70-W, Hauppauge, NY 11787.

OFFICIAL ID CARDS/CREDENTIALS for Police Dept./Deputy Sheriff/Highway Safety Patrol/Volunteer Ambulance Corps/Rescue Squad/Fire Dept.! Beautiful professional 2-color wallet size ID cards. Sent blank (we do not inscribe name). Available in large or small quantities. Sample set of all 6 cards only \$3, ppd., PLUS FREE BONUS Official CB Operators ID Card. Civil Defense credentials also available to authorized CD units. Order now! CRB Research Inc., P.O. Box 56-X, Commack, NY 11725.

NASSAU COUNTY CB'ERS: Don't sit back... Join REACT!! Central Nassau County REACT, one of the first and largest teams in the nation would like you as a member. We are an independent, non-profit volunteer public service team dedicated to aiding you, our fellow CB'er in time of need. Send today for more information and a membership application to: Central Nassau County REACT, P.O. Box 406-S, Westbury, NY 11590.

WANT TO BUY: Will pay top dollars—hard cash—for old Lionel Trolleys in any condition. Also want Old Lionel or Ives Standard Gauge trains. Your old clunker may be a collector's dream. Don't be bashful. Write Dick Cowan, c/o S9 Magazine, 14 Vanderverter Ave., Port Washington, NY 11050. Phone: 516/883-6200.

SCANNER CRYSTALS from America's leading supplier—sent to you postpaid and factory fresh from an inventory stock of 100,000 crystals! \$3.95 for multiple orders! Send postage stamp for free catalog and special order form! Z-Tech Enterprises, P.O. Box 70-A, Hauppauge, NY 11787.

CB RADIOS AT WHOLESALE PRICES! Listing 50 cents. Going Ham? YAESU FT-101 E in stock. Sideband Specialty, Box 573 DC, Oak Harbor, WA. 98277.

JOIN INTERNATIONAL EMERGENCY RADIO PATROL. Details free. Write Box 434, Saint John, New Brunswick, Canada, D2L4L9.

DEALERS—Check our extremely low prices and same day shipping for Midland, Shakespeare, Turner, Breaker, Amphotel, Consolidated Towers and more. Send for free catalog. Sugar Shak Distributors, 1025 N. King St., Hampton, Va. 23669. 804-723-7024.

HEY! Getcha Giant Skipland Map Poster!

The **CB Skipland Map** in our November issue has been souped-up and reprinted by popular demand! We made a more detailed (lots more things—including most major cities with their CB handles) huge size version (17 by 23 inches) on high quality, colored stock—just right for the wall of your CB shack! It's sort of a limited edition, so now's the time to move if you want one! Here's how to get your own highly detailed version: fill in the coupon below, enclose only **\$1.75** (includes postage and mailing) and send it back to us! This map will really blow smoke with everybody who sees it!

Please send me _____ copies of the
Giant Skipland Map Poster.

Name _____

Address _____

City _____

State _____ Zip _____

Return order to:

CB Skipland Map
c/o S9 Magazine
14 Vanderverter Avenue
Port Washington, N.Y. 11050

ADVERTISER'S INDEX

New Reader Service System

To speed information to you on products shown in S9 advertising a new computerized Reader Service system has been designed. For additional information on a particular ad in this issue, tear out the Reader Service postcard bound between pages 104 and 105, and circle the numbers on the card which correspond with the Reader Service numbers listed in the advertiser's index below. **DON'T CIRCLE THE PAGE NUMBERS!** Fill in your name and address, and mail. We'll have your information on the way in short order.

MANUFACTURERS

R.S. No.	Page
1 AAA Advanced Products	112
2 Acoustic Fiber Systems	46
3 American Modular Elect.	122
4 Anixter Mark	107
5 Antenna, Inc.	116
6 Antenna Specialists Co.	13
7 AVA Electronics	110
8 Avanti Rsch. & Dev., Inc.	Cov. IV
9 Barker & Williamson	107
10 Browning Labs, Inc.	8
11 CDE	2, 3, 44, 45
12 CPD Industries	5
13 Channel Master CB	17, 47
14 Cobra Comm., Div. Dynascan	4
15 Communications Power, Inc.	35
16 Cush-Craft, Inc.	116
17 Delta Electronics	112
18 Dima Corp.	79
19 Francis Industries	123
20 Franke, Inc., Fred	109
21 GC Electronics	37
22 Glatzer Industries Corp.	92, 96, 112
23 Hy-Gain Electronics	71
24 JMR Systems Corp.	108
25 Jan Crystals	109
26 Johnson, E.F., Co.	72
27 KRIS	11
28 Magitran	98
29 Maycom	65

R.S. No.	Page
30 Midland	42, 43
31 Motorola	41
32 Mura Corp.	19
33 Newtronics Corp.	14, 15, 89
34 Pal Electronics	60
35 Palomar Electronics	21
36 ParaDynamics Corp.	75
37 President	Cov. II, pg. 1
38 Radatron	66
39 Radio Shack	48, 49
40 Red Cloud Corp.	84, 85
41 Redco	113
42 Rohn Manufacturing	95
43 SBE	Cov. III
44 Scarbrough Laboratories	111
45 Shakespeare Company	68
46 Shure Bros.	55
47 SouthCom, Inc.	87
48 Sparkomatic	24, 25
49 Standard Communications	29
50 Telex	70
51 Tennessee Crystal Corp.	132
52 Tram/Diamond Corp.	69
53 Turner Div., Conrac Corp.	7
54 UTAC	136
55 Wilson Electronics	23

DISTRIBUTORS

56 Atlantic Speed Center	91
57 Bennies Comm.	59
58 CB Warehouse	101
59 Centennial Comm., Inc.	80, 81
60 Crazy Harvey	91
61 Downstate Comm.	74
62 Gordon Electronics	45
63 Henshaw's	103, 112
64 New-Tone Electronics	76
65 Palomar East, Ltd.	56, 57
66 Universal Communications	113

MISCELLANEOUS

67 A-B Emblem	78
68 Billboard (Controls Inc.)	103
69 CEDA	106
70 Clarion Corporation	67
71 Contemporary Security Inc.	135
72 Electronic Parts Co., Inc.	88

R.S. No.	Page
73 Int'l Flight Institute	110
74 Kovoloff Industries, Inc.	107
75 NRI	51, 113
76 Peninsula Mktg. Services	105
77 Pin Point Mailing	110

COWAN PUBLISHING ADS

Associated Humane Society	130
CB Radio Marketing	118
The Communicator	121
Electronic Fleamarket	126, 127
House of Power	130
Interested in Ham Radio?	99
S9 Staffers	128
Subscription Form	93
Tab Popular CB Books	119
The Truth About CB Antennas	129
Two Exciting New Books	109

BUYER BEWARE!

The publisher of S9 accepts advertising from manufacturers, dealers and distributors who, in our opinion, offer readers a high level of quality in products and/or service. Wherever possible we attempt to publish additional information on these products in the form of technical equipment evaluation reports.

Readers should be aware that, at the present time, the CB radio market is drastically backordered in almost every product category, but especially so in transceivers and antennas. We wish to remind our readers that we carefully screen all potential advertisers. In the event that a company's products do not appear within our advertising pages, there's a strong likelihood that it has not passed our minimum standards.

We strongly urge readers to purchase from those companies whose advertising appears in S9; by doing so, you will be assured that the company with whom you're doing business is a reputable one. You'll also be supporting those companies that help make S9 possible. Now, we recognize that many advertisers cannot advertise in every issue. If you don't see the company's ad in the current issue, check back two or three issues to be certain, since almost every major advertiser appears six or more times in one year. If you have doubts about the reliability of any particular product or company, feel free to contact our publisher for information. This service is offered as a safeguard to our readers.

WILL YOU BE NEXT?

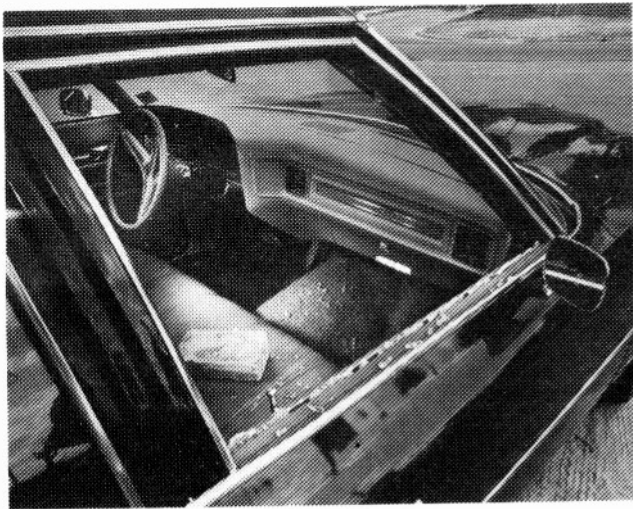

Becoming one of the MILLIONS . . . yes, MILLIONS of people who each year have their cars or trucks stolen or vandalized is not an uncommon occurrence these days. After joining this unfortunate group, I did a little research and found:

OVER ONE MILLION CARS ARE STOLEN EACH YEAR

- Many times this number are burglarized, resulting in BILLIONS of dollars worth of property losses to people like you and me.
- Houston, Texas has reported over 2,000 car break-ins in one month.
- Half of all reported crimes in the Pittsburgh area have been auto related.

After learning these startling statistics, my concern over getting ripped off **again** sent me searching for an automobile burglar alarm that 1) protected everything in and on my car, 2) was easily installed, 3) carried a guarantee and 4) didn't cost an arm and a leg.

BUT I COULDN'T FIND ONE! Every alarm I found was expensive, difficult to install, and offered only partial protection for my car. I was lost, until I found the CAR-COP alarm system.

THE CAR-COP SECURITY ALARM WAS JUST WHAT I WAS LOOKING FOR.

It was easily installed in 30 minutes with ordinary household tools and carries a two year guarantee against defects in parts and workmanship.

The alarm itself is a vibrational mechanism which is designed to go off when **any** part of your car or truck is tampered with. Unlike most alarms which are designed to go off after the vehicle is actually entered, the CAR-COP device activates as soon as a thief **begins** to bother your car, thereby preventing the damage caused by a forced entry. Now that's **full protection!**

The CAR-COP alarm also has a vibrational adjustment for individual needs. It can be set so sensitively that a cat jumping on your car will activate it. Great for discouraging hupcap and CB thieves!

And the price? Only \$19.95! That's right. Only \$19.95 and you've got the **peace of mind** of knowing your car and its contents are no longer a "sitting duck" for any rip-off artist that comes along.

GUARANTEE

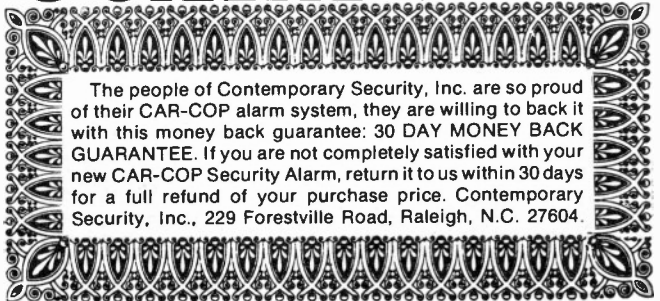

The people of Contemporary Security, Inc. are so proud of their CAR-COP alarm system, they are willing to back it with this money back guarantee: 30 DAY MONEY BACK GUARANTEE. If you are not completely satisfied with your new CAR-COP Security Alarm, return it to us within 30 days for a full refund of your purchase price. Contemporary Security, Inc., 229 Forestville Road, Raleigh, N.C. 27604.

WHO BUYS THE CAR-COP ALARM SYSTEM.

Everybody! Contractors, plumbers, carpenters, painters and electricians, to protect their tools and equipment on their trucks . . . CB and tape deck owners . . . Salesmen, for their samples and belonging . . . Housewives, for their shopping trips . . . Sportsmen . . . Policemen . . . Vacationers . . . College Students . . . Luxury and sports car owners . . . EVERYBODY!

Please don't delay, order your CAR-COP Alarm System today! Not sold in stores.



Satisfaction guaranteed or Money back

MAIL TO: CONTEMPORARY SECURITY, INC.
229 Forestville Road, Raleigh, N.C. 27604

Please send me ___ CAR-COP burglar alarms at amazingly, low price of \$19.95 plus \$1.00 for shipping and handling. (N.C. residents add 4% for sales tax)

Check Enclosed _____ Bill my credit card account.

Master Charge # _____ Inter Bank # _____

Bank Americard # _____

Card Expiration Date _____

Name _____

Address _____

City _____ State _____

Zip _____

S-9-3



For information on direct distributorships, contact above address. CAR-COP is a trademark of Contemporary Security, Inc. Raleigh, N.C. 1976

You Asked For It
You Got It...

UTAC Consumer Designed
C.B. Transceivers, They Are All New
And They Are Exclusive! Their Superior Cir-
cuitry Approaches The Limits Of Perfection!



TRX-400

FEATURES:

- DIGITAL CHANNEL READOUT
- PHASE LOCK LOOP CIRCUITRY
- DUAL CONVERSION SUPERHETERODYNE RECEIVER WITH CERAMIC FILTERS FOR SUPERIOR SENSITIVITY
- COMBINATION SWR/RF POWER METER
- VARIABLE SQUELCH
- VARIABLE RF GAIN
- VARIABLE MIC GAIN
- SWITCHABLE NB
- SWITCHABLE ANL
- CB/PA SWITCH
- EXTERNAL PA SPEAKER JACK
- REMOTE SPEAKER JACK
- TRANSMIT/RECEIVE INDICATOR LIGHTS
- FUSED CIRCUITS TO PREVENT DAMAGE CAUSED BY IMPROPER CONNECTIONS
- POSITIVE/NEGATIVE GROUND OPERATION—13.8Vdc



TRX-500

FEATURES:

- DIGITAL CHANNEL READOUT
- PHASE LOCK LOOP CIRCUITRY
- DUAL CONVERSION SUPERHETERODYNE RECEIVER WITH CERAMIC FILTERS FOR SUPERIOR SENSITIVITY
- COMBINATION SWR/RF POWER METER
- VARIABLE SQUELCH
- VARIABLE RF GAIN
- VARIABLE MIC GAIN
- SWITCHABLE NB
- SWITCHABLE ANL
- CB/PA SWITCH
- EXTERNAL PA SPEAKER JACK
- REMOTE SPEAKER JACK
- TRANSMIT/RECEIVE INDICATOR LIGHTS
- FUSED CIRCUITS TO PREVENT DAMAGE CAUSED BY IMPROPER CONNECTIONS
- POSITIVE/NEGATIVE GROUND OPERATION—13.8Vdc
- TWO POSITION VHF-MONITOR SWITCH
- SWITCHABLE DELTA TUNE

FOR INFORMATION REGARDING DISTRIBUTION AND SALES, PLEASE CONTACT:

JERRY ZALIN, Marketing/Sales Manager

UTAC Communications Equipment

766 Lakefield Road, Westlake Village, California 91361

805-497-3966

213-889-4774

Visit Our Booth at PC/77 Show, No. 239

Convenience is only half the story.

SBE TOUCH/COM 40

SBE adds the ultimate luxury to 40-channel operation: the convenience of microphone control that puts all CB functions right in the palm of your hand.

Quickly scan up or down through all 40 channels, or move channel by channel with the 2-speed channel selector. Identify your channel with the extra-large, high-intensity LED readout, clearly visible even in bright daylight. Adjust volume and squelch with the flick of a finger. And to transmit, simply push the "Press-to-Talk" control. It's all on the microphone.

But the convenience of TOUCH/COM 40 is only half the story. With such sophisticated features as SBE's "Speech Spander" voice-operated modulation level control, "Anti-Blast" audio burst protection circuit, 4-pole IF filter, delta tune, and MIC gain control, Touch/Com 40 offers top performance under the toughest operating conditions, plus dependability backed by 100 per cent quality control.

And that's the half of the story that is the most important to you.



Better Communications through Creative Technology

For complete information, visit your nearest SBE Dealer, or write SBE, Inc. 220 Airport Blvd., Watsonville, CA 95076
INTERNATIONAL OFFICES: E. S. Gould Marketing Co. Ltd., Montreal, Canada/Linear Systems S.A. Geneva 1 Switzerland



SBE-43CB



Quality the heart of **avanti** CB antennas

**40
CHANNEL
ENGINEERED**

ASTRO PLANE ANTENNA Model AV-101

Co-inductive design of this patented antenna gives longer, more noise free performance.

ASTRO PLANE has top radiation which means that your signal gets out from the highest part of your antenna. Your signal radiates about 15 feet higher than with other antennas which radiate near the bottom.

The ASTRO PLANE has a lower angle of radiation which makes more efficient use of the radiated signal by allowing it to hug the curvature of the earth instead of shooting your power up into the sky.

The ASTRO PLANE has 4.46 db gain over isotropic which gives you a stronger signal and better, clearer reception.

You'll get long lasting, trouble free performance because it is compact in design — without long drooping radials, without coils to burn or short out, and with direct ground construction to dissipate static charges and lightning.

The only omni-directional antenna that radiates from the top . . . not the bottom • Stainless steel radials concentrate signal power on top • Rigid heavy-duty aluminum tubing • No long drooping radials to ice up or break off • So unique it's backed by a U.S. Patent (Patent #3587109) • No coils to burn out or detune • Easy Assembly • Lightweight — easy to install on simple pipe mast



Ordinary collinear or ground plane antenna signals are blocked . . . they radiate from the bottom.



ASTRO PLANE gets its signal over obstacles . . . It radiates from the top.

SPECIFICATIONS

Total Length—12 feet
Weight—4 lbs.
Power Gain—4.46 db
Impedance—50-52 ohms
Omnidirectional—needs no rotor

Vertical Polarity
Aircraft Quality Aluminum
SWR—Pre-tuned—Less than 1.2:1 on 23 CB Channels and will operate on expanded channels.

high performance **CO-INDUCTIVE** antennas

Avanti makes a complete line of high performance mobile CB antennas and accessories. For free color catalog, write:

avanti

RESEARCH AND DEVELOPMENT, INC.
342 Stewart Avenue, Addison, IL 60101

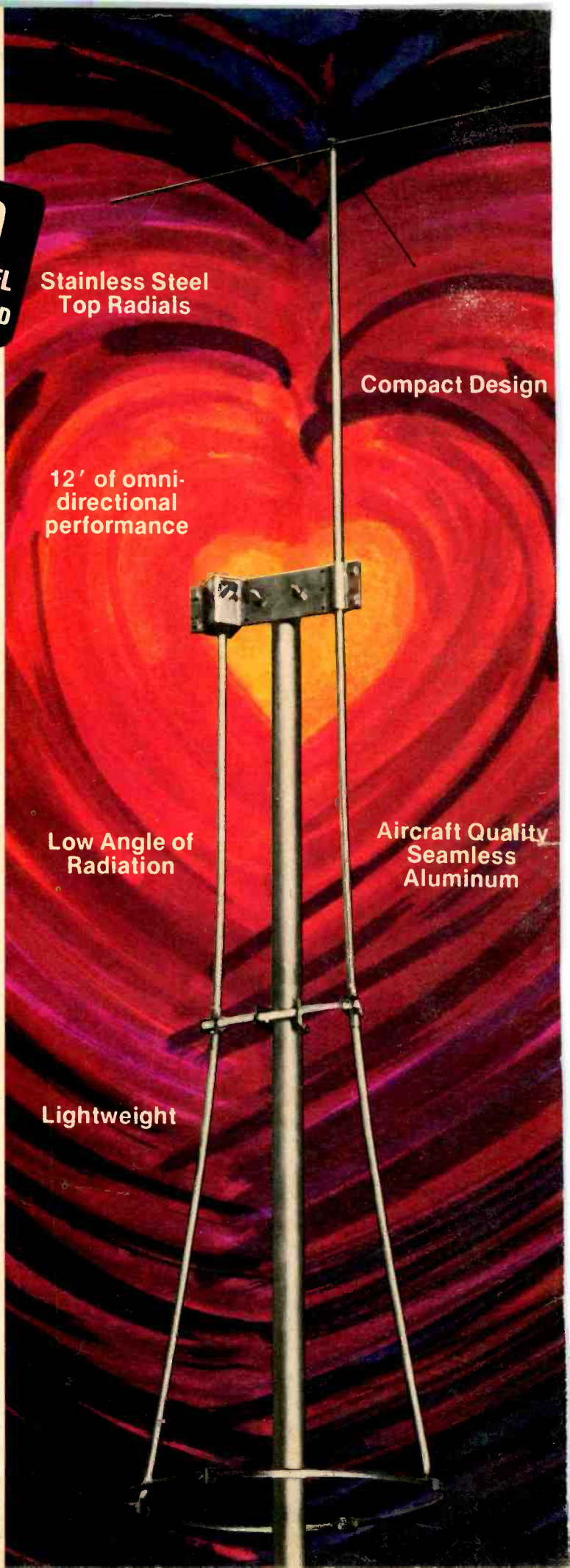

Stainless Steel
Top Radials

Compact Design

12' of omni-
directional
performance

Low Angle of
Radiation

Aircraft Quality
Seamless
Aluminum

Lightweight