

AMERICA'S OLDEST AND LARGEST CB MAGAZINE

Since 1962 nearly 20,000,000 copies sold!

CB RADIO

\$9

JANUARY 1977

\$2.00

BIGGEST VALUE
IN CB RADIO!

including
CB
Newswire

"Antique" CB Rigs — Newest Fad!
Buy 'em Up While They're Cheap

CD 08818

New: Get Your Ham License!

Lost Art: CB Etiquette

Wall-To-Wall Signals

**Rock & Roll Star
On CB!**

& Lots More

WHAT'S YER HURRY, KID?
I'M NOT ON THE SIDE YET...
BESIDES MY GOOD BUDDIES ON
THE "OLD" 23 CHANNELS WILL BE
MODULATIN' LONG AFTER
I'VE GONE 10-7...
FOR SURE - **FOR SURE!**

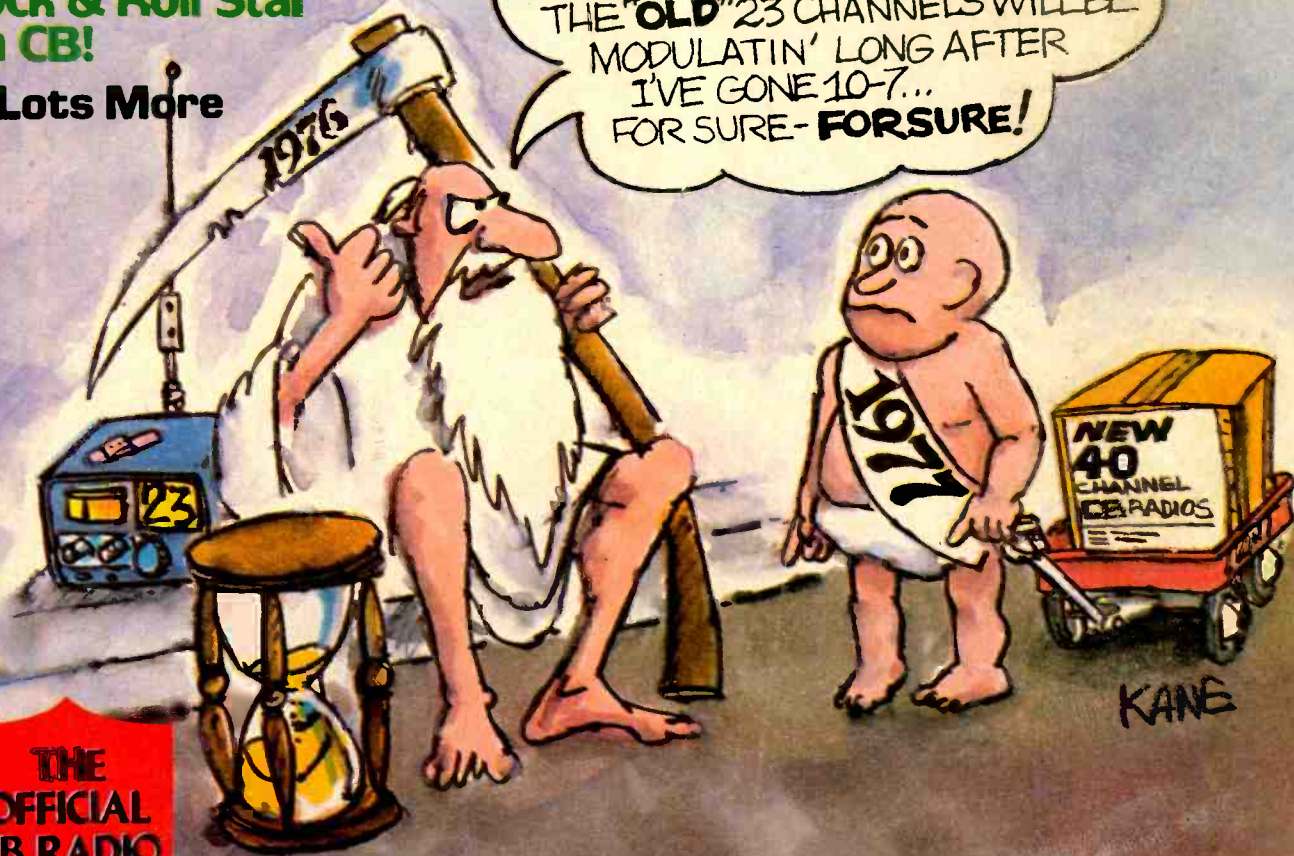

THE
OFFICIAL
CB RADIO
Magazine

more articles than ever





President CB.
Because there are those
who won't settle for
anything less than the best.

That's why every President model has 40 channels.

That's why every President gets thoroughly tested to make sure it works perfectly before it leaves the factory.

That's why every President comes with all the power the law will allow. And why every President comes with sophisticated electronic features like Phase Lock Loop circuitry for superior on-frequency performance.

That's why you'll find that our engineers have done just about everything known to man to give you a better, stronger, clearer signal.

And that's why—no matter who you are or how much money you have to spend—you might as well start by looking at the best.



PRESIDENT

Engineered to be the very best.

16691 Hale Avenue, Irvine, Calif. 92714. (714) 556-7355.

This device has not been approved by the FCC. This device is not and may not be offered for sale or lease or sold or leased until the approval of the FCC has been obtained.

afs / **Kriket**® Communications Speakers
means superior sound -- and that's a big 10-4!



Tired of garbled voices and CB static?
 Now, you can hear better with our KC-3035 KRIKET® mobile speaker. Better than you believed possible.

Because AFS offers the first acoustically designed voice communications speaker. And, that means you get outstanding intelligibility across the entire voice range.

AFS — the only company with the "WORKING WALL"® speaker enclosure. Cross-laminated tubular fiberboard deadens channel noise, eliminates voice distortion by controlling rebounding sound waves. Brings the voice through — clean and clear.

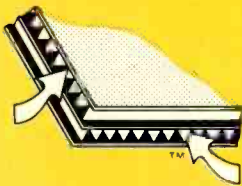

Available at CB dealers everywhere

Speakers are our only business. They have to be better!



World Wide Headquarters
 Acoustic Fiber Sound Systems, Inc. 7999 Knue Road, Suite 116 Indianapolis, IN 46250 (317) 842-0620

Exclusive Canadian Distributor
 Muntz Canada Ltd. 1149 Pioneer Road Burlington Ontario, Canada (416) 639-5373

All KRIKET® speakers are manufactured in the U.S.A. using American materials and craftsmen.
 Copyright 1976, Acoustic Fiber Sound Systems, Inc.

Experience is the best teacher. You might settle for any CB first time around. Understandably. A lot of people think they're all pretty much alike. But you'll soon discover that, like everything else, there are exceptions.

Ask the pros. America's long distance truckers. These guys talk CB day in and day out. And they demand the best. That's why truckers refer to the Cobra 29 as "The Diesel Mobile"

Listen to Cobra. You'll hear a big difference. Because the Cobra 29 gives you features which assure crystal clear reception. Like switchable noise limiting and blanking, to cut out practically all pulse and ignition interference. Add squelch control and RF gain and you've got exceptional — adjustable — receiver clarity. Even in the heaviest CB traffic. You also get Delta Tuning which makes up for the other guy, because even off-frequency transmitters are pulled in. Perfectly.

Talk to Cobra. And you know you're punching through. One glance at the

29's over-sized illuminated meter tells you just how much power you're punching out and pulling in. For voice modulation the DynaMike delivers at 100%. Same way with power: The 29 transmits at maximum power levels.

Sooner or later you'll get a Cobra. And you'll get engineering and craftsmanship second to none. Performance that will make your first CB seem obsolete. Reliability and durability that have set standards for the industry. Above all, you'll get power. The power to punch through loud and clear like nothing else. Because when it comes to CB radio, nothing punches through loud and clear like a Cobra.



Punches through loud and clear.

Cobra Communications, Products of Dynascan Corp.
1801 W. Belle Plaine, Chicago, Illinois 60613

**IF YOUR FIRST CB ISN'T A COBRA
YOUR SECOND ONE WILL BE.**



Something New Under the Sun

POWER WING™

Now comes a revolutionary concept in CB...
POWER WING ...the first compact, 16" capacitively
top loaded CB antenna capable of out-performing
antennas more than twice its size. POWER WING
...It's everything a CB antenna should be!

POWER WING delivers PERFORMANCE,
STYLING, and FEATURES, plus: capacitive top
loading, high Q coil design, greater average current,
highly efficient radiating pattern, average SWR of
1.4:1 across 40 channels, factory installed connectors,
tough marine acrylic weather-proof coating, and a
CB antenna that will not detune at highway speeds,
for a stable radiating pattern.

It's all yours with POWER WING. So put some eyes
on your ears...put a POWER WING on today!
Available wherever Channel Master products are sold.

For more information write:

Channel Master 

Division of AVNET, Inc., S9177, Ellenville, New York, 12428.



14 Vanderventer Avenue
Port Washington, N.Y. 11050

America's Oldest & Largest CB Magazine

VOL. 17, NO. 1 January, 1977

COVER STORY

Cartoonist John Kane reminds us that although 40 channel rigs may be on the way, there's still plenty of life left in the original 23 CB channel rigs!

Table of Contents

NEWSWIRE 10
CB GATHER 'EM UP 27
CB TYPES 36
COMING EVENTS 37
ON THE COUNTERS 41
ROCK STAR ON THE RIG 50
S9 READERS WANT TO KNOW 60
CB ETIQUETTE: A LOST ART 63
BASIC RADIO, PART 11:
Measuring Instruments - Milliameters 69
CB TRIVIA QUIZ 78
CB USAGE TIPS FROM S9 84
TOMCATTIN' WITH TOMCAT 87
THE HAMBANDER 90
BILL ORR ON ANTENNAS, PART 11:
40 Channel Antennas? 94
BREAK ... LOWER SIDE 99
ANATOMY OF A CB SCANNER, PART 2: Radio Bands 101
THE CAPRICORN CB PERSONALITY 105
WASHINGTON OUTLOOK 106
DX KORNER 126
MONITOR POST 131
CLASSIFIED ADS 139

The entire contents of this publication are fully protected under the U.S. Copyright laws. No portion of this publication may be reproduced in any manner whatsoever without the express written permission of Cowan Publishing Corp. Violations of our Copyright are actively pursued by our Legal Department.

CB RADIO/S9 (Title registered U.S. Post Office) is published monthly by Cowan Publishing Corp. Executive editorial and advertising offices at 14 Vanderventer Ave., Port Washington, L.I., NY 11050. Telephone: (516) 883-6200. Subscription Rates: One Year \$12.00, Two Years, \$20.00, in the United States and Possessions, APO, FPO. Canadian and foreign rates: One Year, \$13.00, Two Years \$22.00. Printed in U.S.A. Entire contents copyright 1977 by Cowan Publishing Corp. CB RADIO/S9 does not acknowledge or return unsolicited material. We regard all material sent to us by and about CB clubs or organizations (whether in club bulletins or otherwise), and from manufacturers or distributors of commercial products, as being submitted for publication as a public relations or publicity gesture. While we pay for stories and articles specifically written for our exclusive use and accepted for publication, we do not pay for any public relations or publicity material which we publish. Stories or articles sent by Registered or Certified Mail are not accepted. All circuits, designs and construction projects in CB RADIO/S9 are strictly experimental and we do not guarantee the results which can be expected from their use or application.

Controlled Circulation Postage Paid at Glasgow, KY and Port Washington, NY

SEND FORM 3579 TO: CB RADIO/S9
14 Vanderventer Ave., Port Washington, L.I., N.Y. 11050

Service with a Smile

That's What You Can Expect When You Deal With Sandro's - The LARGEST Distributor on Long Island.

Factory Distribution Center for these major brands:

- * Mura * Sharp * Courier *
* Turner * Gold Line * Astatic *
* Regency * Shakespeare * Hy Gain *
* Johnson * SBE * Vancor *
* Pace * Antenna Specialists * Pride *
* Robyn * Royce * Antenna Inc. *
* Amphenol * Valor * RMS *

You can also call us for your hi-fi, tv appliance and tape recorder needs.

SANDRO'S ELECTRONICS INC.

1559 BRENTWOOD ROAD
BAYSHORE, N.Y. 11706

(516) 666-4434

Send \$3.00 for Dealer Catalog - refundable with first purchase.



Getting there is half the fun... with Robyn CB

Enjoy getting there—with Robyn CB. Add action and excitement, call your friends, give directions and helpful advice. Whether you're on the road or around town, have fun getting there with Robyn CB.

Robyn is a pioneer in the CB field. For over 15 years, CB beginners and pros have been looking to Robyn—and finding just what they want. Whatever *you* want in a CB: pure basic performance or feature-loaded top of the line, you'll find one of Robyn's many models is the CB you've been looking for. And to insure top performance, Robyn also makes a full line of mobile and base CB antennas;

Robyn makes FM scanners, too.

See your nearest Robyn dealer, he's got the CB you've been looking for.



ROBYN  **INTERNATIONAL INC.**

10901 Northland Drive, Rockford, Michigan U.S.A. P.D. Box 478, 49341, TWX 22-6393 (616) 866-1557

Over 15 years of CB leadership

Ad# 1251-C Prepared by Spectrum Advertising



EDITORIAL STAFF

editor

TOM KNEITEL, KEZ5173

contributing editors

DON JENSEN

RICK MASLAU, KNY2GL

GARY DECKELNICK, KCS0994

BUSINESS STAFF

chairman of the board

S. R. COWAN, KCV7359

president and publisher

RICHARD A. COWAN, KGB4096

associate publisher

RICHARD A. ROSS

circulation manager

GLORIA FORSYTH

circulation assistant

NANCY GOLD

controller

CARY L. COWAN, KZR4375

accounting

SARAH GREENBERG

public relations

MARC GILMAN, KSU7373

ADVERTISING STAFF

adv. representatives

RICHARD A. COWAN

JACK N. SCHNEIDER

west coast adv. rep.

BILL SLAPIN & CO.

16200 Ventura Blvd., Suite 209
Encino, CA 91436 (213) 995-0257

PRODUCTION STAFF

production manager

LORI A. RESSA, KBH2503

production assistant

BONNIE BROWN

production consultant

CARY L. COWAN, KSR4375

classified advertising

EILEEN LUCEY

art director

WILLIAM H. TRAVIS

art staff

LIZ BEENER

SHERYL STERN

HAROLD PERRY

The rules of the game have changed!



And the road to better CB signals is far smoother!

Right on! Now, under the new FCC regulations, you can mount any omnidirectional CB antenna a full 60 feet above ground. No more need you be handicapped by the old 20 foot limitations.

Greater heights means greater signal power—not only on your transmitted signal, but on receiving the weak signal, as well.

And when it comes to providing CBers with towers to do the job, we at ROHN are the champs. After all, we build more communications towers for CBers than all other manufacturers combined.

Whatever you're looking for in a tower, chances are a ROHN will do the best job at the best price.

So ask your local distributor for the ROHN story. The new rules were meant to bring you and ROHN together.

 **Unarco-Rohn**

Division of Unarco Industries, Inc.
P.O. Box 2000, Peoria, Illinois 61601

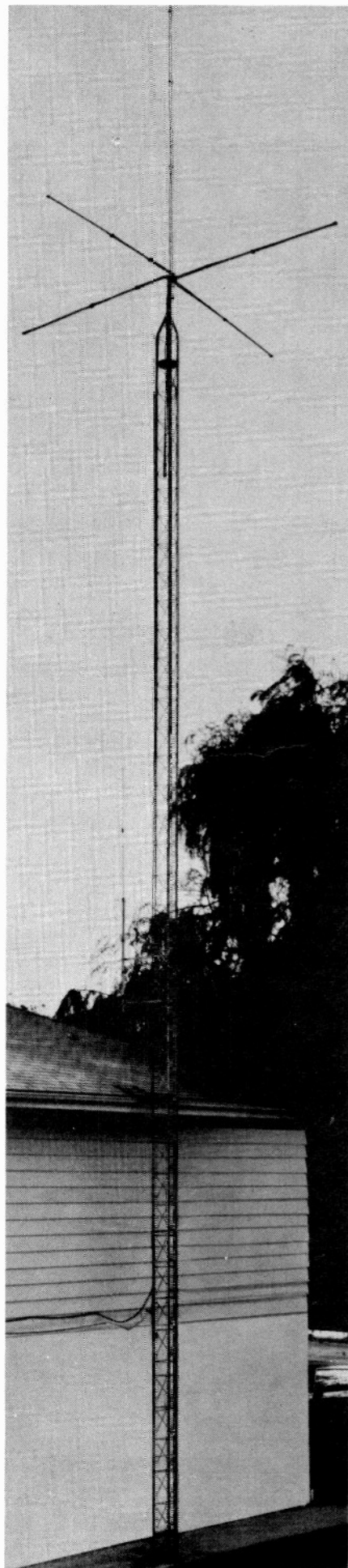

**ORIGINAL
HUSTLER**



Get base station reports from your mobile with this 74" original Hustler antenna.

Model CB-111—fender or deck location

Model CB-211—bumper mount location



**First and
with
CB**

WITH HUSTLER ANTENNAS YOU BUY FOR THE FUTURE! GET TOTAL 40 CHANNEL COVERAGE PLUS MORE!

From the original Hustler of 1961 to the newest CB-AM/FM design, get superior 40 channel coverage plus reserve for future channel expansion.

HUSTLER ANTENNA PRODUCTS—for sixteen years—original designs—created and manufactured by American ingenuity, labor and materials—used by communicators throughout the world.

Hustler designs are patented under one or more of the following assigned to New-Tronics Corporation 3287732, 3513472, 3419869, 3873985, 3327311, 3599214, 3582951.

Graphs shown with each antenna are plotted from actual mobile installations and illustrate the ratio of forward to reflected voltage (VSWR) over a total of seventy (70) channels.

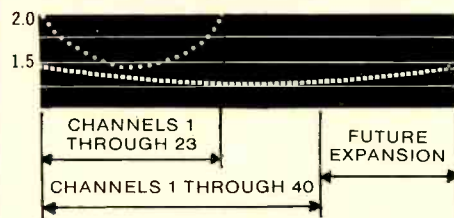

..... average antenna with limited channel use.
— antenna with total channel coverage.

TRUCK & RV's

HI-Q" Twin Huskies for rugged performance. Dual 51" antenna system attaches to all West Coast style mirrors.

Model HTM-1

Single Husky with mirror mount

Model HSM-1

**DELUXE
MOBILES**



Choose from four versions of this popular 48" antenna for trunk lip or roof/deck mounting location.

Trunk lip mount
Models XBLF-3, XBLF-4

Roof/deck mount
Models XBL-3, XBL-4

CB-AM/FM

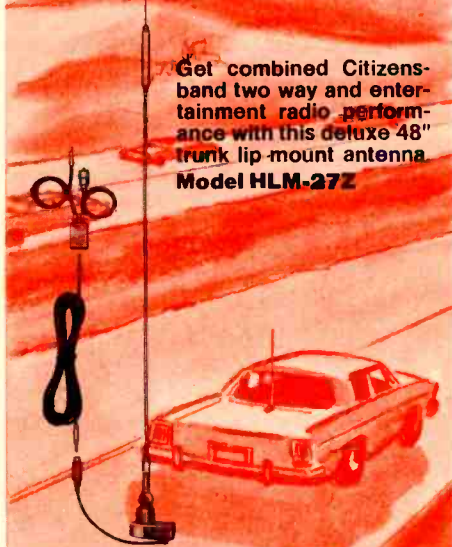

Get combined Citizens-band two way and entertainment radio performance with this deluxe 48" trunk lip mount antenna
Model HLM-27Z

Foremost TOTAL Coverage!

"the home of originals"



Available from
all distributors
who recognize the best.

**new-tronics
corporation**

15800 Commerce Park Drive
Brookpark, Ohio 44142
(216) 267-3150

Exporter: Roburn Agencies, Inc., New York, N. Y.

ULTRA PERFORMANCE

Custom assemble your Hustler for the ultimate in mechanical and electrical performance — lowest SWR, outstanding signals, transmitting and receiving.

Model MO-1 or MO-2
mast and **RM-11S** Super Resonator

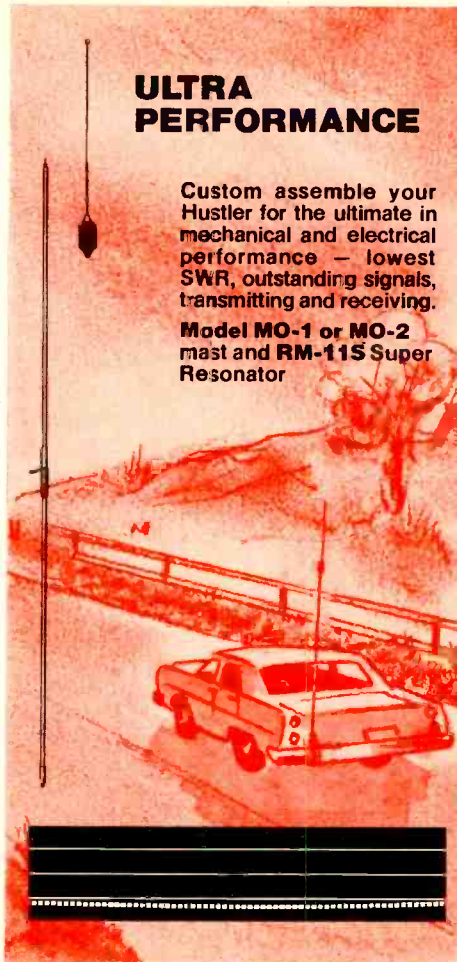

SUPER-FLEX STAINLESS

Cowl or trunk groove mount, super-flex stainless steel 48" antenna for excellent performance and economy.

Model FGB-27L with cowl mount

Model TGF-27L with trunk groove mount



DELUXE DUALS

Get optimum all directional coverage. Easy to install 48" antennas with trunk groove mounts.

Model SDTs



SPECIAL DESIGN

Trunk lip mount 48" white vinyl covered stainless steel antenna. Easy to install, no holes to drill.

Model TLA-27L

Antenna only-3/8"-24
base **Model FG-27**



"POWER-PACKER"

Super flex stainless steel 55" antenna and deluxe trunk lip mount with 180° swivel adjustment.

Model HQ-27M

Antenna only-3/8"-24
base

Model HQ-27



CB Newswire

YOUR CB NEWSPAPER

JANUARY, 1977

INCLUDED IN S9

Livingston Lacer Elects Officers Announces Progress of Emergency CB Monitoring

At a recent meeting, the Livingston Chapter of the Louisiana Civil Emergency Radio Network, officers for the 1976-77 year were elected. They included Hollis Cutrer, President, Barbara Campbell, Vice-President, Sharon Van Atta, Secretary, Charlotte Herrin, Treasurer and Leo Matherne, Jr. and Donald Breland as Sgt. at Arms. A Board of Directors were also elected to serve staggered terms. They are Garry Dier, Burrel Fridge, Robert Van Atta, Bill Herrin and Francis Stacey Jr.

During the first few months of monitoring emergency calls and assistance to motorist on the CB channel 9, Sharon Van Atta reported that the organ-

ization had handled in excess of 1100 calls. The more frequently handled categories included 378 accidents, 195 stalled autos, 78 faulty traffic signals, 77 road hazards and 69 DWI suspects. These calls are received throughout the Livingston and East Baton Rouge area. Van Atta said "it is hoped that these calls will result in safer driving conditions for everyone in the metropolitan area."

President Hollis Cutrer announced that proceeds earned from activities at a local CB Break have been used to purchase CB equipment for use by the Denham Springs Police Dept. It will be used to monitor channel 9 during the hours of 12 midnight to 6 AM. A remainder of the proceeds were used to purchase and install a base station and antenna. This equipment is to be used for training purposes and also for those members who do not have base stations for monitoring channel 9. Cutrer said that Livingston Parish Lacer has accepted membership from over 89 people. For more information call (504) 665-2207.

Marriage Begun Over CB Ends In Death Of Wife

Slick Chick, the woman Top Cat had fallen in love with and married over the CB airways, won't be coming home again.

Victoria Seaton Fuller, 24, rushing back to Top Cat after a seven-week separation, died instantly in a car crash 14 miles outside of Philadelphia, Miss.

Slick Chick and Top Cat—the CB "handles" for Victoria and her 45-year-old husband Thomas, were married last summer in a ceremony broadcast over the CB channels. Three days later the bride left for South Dakota to visit her dying father on the Rosebud Indian Reservation.

Top Cat never saw her again.

Slick Chick just dropped out of sight after he had wired her \$2,000 to buy a car.

Finally, she telephoned from Neshoba County Hospital in Philadelphia, Miss., saying she was hospitalized for treatment of a minor illness. She was released Thursday.

Top Cat sent her \$100 and she rented a car for the trip to Miami.

"Don't worry about nothing, baby. I'm on the way," she told him about an hour before the 2 a.m. crash.

"I wish it was me instead of her," Top Cat said upon hearing the news of her death. "I wish I was going with her."

Driving south on U.S. 19, Slick Chick's car collided with one driven by a 17-year-old Mississippi youth. Both were killed.

"We were only married three days," Top Cat said. "But, oh my God yes, I still love her."

Big Mama, Margaret Smith, a friend who had helped at the wedding said of Slick Chick, "She was a delightful, happy girl. Having her around could make you happy, she had such a delightful personality.

"She was coming home to try to make a go of things," she added.

Barberton Ohio Police Get CB

Police are monitoring CB radio—but not to keep track of truck convoys.

The department's new CB base station will be tuned 24 hours a day to channel nine, which is the national emergency band.

The \$260 station, which can send and receive emergency calls, was donated to the city by Barberton fireman Gary Sutton who is owner of Tri-City Communications Inc., 4632 Bliss Dr., Norton.

Sutton said an estimated one out of 10 cars and trucks are equipped with CB radios and there are organizations monitoring channel nine around the clock.

When a motorist spots an accident or any emergency, calls for help are relayed to police or fire departments by the monitors, he said.

"With its own CB radio, Barberton police can pick up the emergency call immediately and the response time will be a matter of seconds instead of minutes or more," Sutton said.

"It could save a person's life or his home or place of business."

Police said they often receive phone calls from monitors who have picked up calls for help on channel nine.

One such call a year ago was from a Doylestown man rushing a baby with breathing difficulty to Citizens Hospital. Police met the man near the city limits and escorted him to the fire station, where firemen were waiting with lifesaving equipment.

By the time the driver reached the hospital, firemen had restored the baby's breathing and possibly saved his life.

"Up until now, the only police monitoring CB broadcasts has been the state patrol," Sutton said. "Operators are anxious to cooperate with police and firemen and will welcome the opportunity to report emergencies directly to the Barberton police."

**SPECIAL
OFFER!**

**Buy 23-channel
CB now. Get new
40-channel later
at 1/2 price!**

UPON FCC TYPE ACCEPTANCE

"Don't be without CB while waitin' for the FCC"
NO MODIFICATION FEES—NO MODIFICATION DELAYS—OWN AND KEEP TWO UNITS



handic[®]

handic USA, Inc., 14560 NW 60th Ave., Miami Lakes, FL 33014

**THE ORANGE EQUIPMENT KNOWN FOR
PROFESSIONAL QUALITY THE WORLD OVER**

CB Newswire

YOUR CB NEWSPAPER

JANUARY, 1977

INCLUDED IN \$9

Peapicker and a Lot of Good York, Pa. Folks Save the Day!

A York scalawag, who in effect kidnapped a Long Beach, Calif., family and cost them two weeks out of their lives in driving him to York, ended up robbing his victims of their last cent and stranding them here with only their clothes, car and citizen band radio.

But thanks to a CB radio and a host of instant friends made over the radio, including incredibly, Tennessee Ernie Ford, the California couple and their two young daughters left with nearly \$500 for a weeklong drive back to Long Beach.

The end of the unfortunate odyssey occurred when Allen and Gladys Suschanke and their babies, April and Cindy, were left sitting in their car at Pine and Philadelphia Streets, unknowingly deserted by the man who'd induced them to drive him almost 3,000 miles to York.

Suschanke described his and his family's feckless friend as looking much like 'Fonzie' of "Happy Days," a post-adolescent cool guy who "looks like he stepped right out of the 1950's" Suschanke said.

The family has known who they thought was "Steve" for about seven months, from a day when Suschanke met him at a service station in Long Beach and their mutual interest in automobiles and mechanics fostered a friendship that included many nights in the Suschanke home along with "Steve's" girlfriend, playing cards and Monopoly.

The only truth "Steve" may have told the Suschankes is that he is very likely a Yorker. Gladys Suschanke said "Steve" described York to a T long before they got here and saw that he was right. He knew where everything was and so, they conclude, he is either a native or has lived here for a long time.

In any event, the Suschankes set out for York with "Steve" on his pledge to get Suschanke a better-paying job as a mechanic and the promise of a house to live in that "is just sitting in York, waiting to be moved into." Maybe the Suschankes were gullible, but "Steve" had been a friend for over a half year and, after all, he was coming along to

see that everything worked out as he promised it would. They can't be blamed for taking a chance on more money and the possibility of a better life for their little daughters. Suschanke quit his job.

"'Steve' drove into York and I was sleeping," Suschanke recounted. "He stopped at Philadelphia and Pine Sts. where that big empty lot is and told my wife he had to go get a key to the house. When he didn't come back in about 45 minutes, my wife woke me. We waited about two more hours and then something told me to look for my wallet and it was gone."

Suschanke had left California with about \$495 and all his money was in the wallet hidden in a spring under the front seat. "Steve" had obviously discovered the hiding place.

Alone and in the midst of total strangers, Suschanke turned to his CB radio. Contact with York REACT on Channel 9 led to further contact with city police. An officer led the family in his cruiser to York Rescue Mission for a place to sleep and squeezed a \$10 bill into Suschanke's hand "to get something to eat."

It was a few days later that Victor Caruso got into the picture—through contact on CB radio. Caruso marshalled CBers' cooperation over Channel 23 to gather funds and contact various agencies seeking aid.

The first contact was with Catholic Charities, which contributed a tank of gasoline and money for food.

Meanwhile the plight of the Suschanke family spread over Channel 23

and CBers from many channels—along with CB clubs—pledged and made contributions. The pending Channel 23 Club, Channel 2 Club and CB Assistance Clubs were major contributors to the sudden Suschanke Fund. Individuals gave amounts ranging from \$2 to \$20. There were other kindnesses extended, too, like oil for the car's return trip.

One of the CBers who helped the Suschankes was just passing through town on a visit to York Fair. His CB handle is "Peapicker" and it's believed that he made some calls of his own in rounding up assistance for the caught Californians.

"Peapicker" is Tennessee Ernie Ford, and not only did we talk with Suschanke by radio, but he called them by phone and invited them to meet with him at Thomasville Airport before he departed. Last of all, the country-western-gospel singer pressed money into Allen Suschanke's hand and wished them a safe trip home.

Suschanke, 22, and his 18-year-old wife were the unwitting victims of a Yorker's mad deception, but "Steve" caused a distress that other Yorkers resolved.

"We appreciate all the help we've received here in York," Suschanke said Tuesday. "It just goes to show that there are still some wonderful people in the world.

"We thank all of you from the bottom of our hearts. We'll always remember you as friends of ours and loved ones in time of need. All 'good numbers' to you people. We love you all."

The Suschankes—known as "The Explorers" left for home, back to Suschanke's old job, he hopes.

And "Steve" has got back to York, what we wanted all along, plus a pocketful of money. One wonders how he can be a Yorker, from a place where generosity and concern can be so willingly offered to strangers.

Besides the CB Assistance Club which donated \$25 to the Suschankes, Channel 2 and Channel 23 Clubs were respectively donated \$100 and \$150, the family was aided by at least 35 individual CBers.



Antenna Specialists introduces the "Problem Solvers"

Seven new solutions for CB Antenna mounting problems

When it comes to CB antenna installations, not all vehicles are created equal. There are times when the conventional roof or trunk mount just won't fill the bill. For those of you with such special mounting problems, we proudly dedicate our new line of "Problem Solvers".

Here's a new angle

Keeping a hatchback mounted mobile antenna in the vertical position sounds impossible. But our new M-275 has a swivel-ball whip adaptor that permits vertical adjustment with the touch of a set screw. A new permanent installation without drilling holes.

How not to be noticed

There are times when you'd rather not advertise that you've got a CB radio. Like when your car is left unattended. Our MR264 3-way disguise antenna not only keeps your secret, it also doubles as an AM/FM broadcast antenna. And for a non-disguise 3-way antenna that gives great CB performance, check out our M-267. Both models feature easily detachable stainless steel whips.

Now you see it, Now you don't

What do you do for a CB antenna when you change cars constantly? Just take along our MS178 magnetic mount. It mounts and unmounts in seconds without leaving a trace.

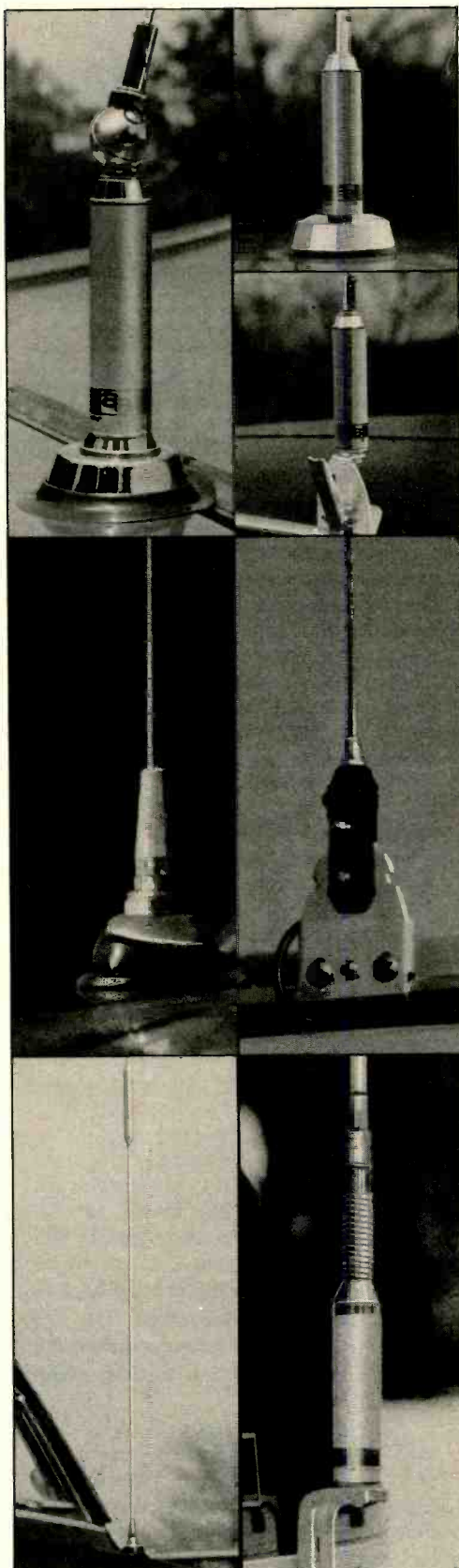

Powerful ceramic magnets grip firmly even at highway speeds. And it won't scratch the paint. Another solution is to clamp on our MR131 rain gutter mount. Its heavy duty spring loaded clamp grabs like a vise but releases with just a squeeze.

When you've gotta keep it down

Low hanging branches and garage doorways just aren't forgiving of CB antennas. That's why our MR180 uses the famous "Flipper" gutter mount. The "Flipper" permits vertical, horizontal and in-between positioning of the antenna in either direction. Mounts easily on rain gutter without drilling holes.

Good news for the fiberglass crowd

Getting a CB antenna to perform well on a non-metallic vehicle used to be impossible. Not any more. The M-306 utilizes a unique "no ground plane" design that makes it the perfect choice for owners of motorcycles, snowmobiles, sailboats and just about any other fiberglass vehicle. Fiberglass whip, stainless steel shock spring and weatherproof molded coil total only 53" overall.

When it comes to choosing the right antenna, don't settle for less than the best. Look for the Stripes of Quality.



The best-selling CB antennas going.
We'll bet our AS on it.



® "Stripes of Quality"

the antenna specialists co.

12435 Euclid Ave., Cleveland, OH 44106. a member of The Allen Group, Inc.,

CB Newswire

YOUR CB NEWSPAPER

JANUARY, 1977

INCLUDED IN S9

New York State Escapee Caught; Boy Gets Credit

An escapee from the Ulster County Jail in Kingston was nabbed by sheriff's deputies but authorities gave credit for the arrest to a 15-year-old boy using a citizen's band radio.

"It was actually David Dirks, a 15-year-old from Bloomington, who actually spotted him and kept us informed through his portable CB radio," said Sheriff Thomas Mayone.

Mayone said Charles Eberman, 25, of the Bronx, was flushed out of a wooded area in Bloomington after a tip from Dirks. Mayone said two deputies fired shots over Eberman's head and that he came out of the woods unarmed and was captured here on a road. About 70 deputies participated in the search, along with bloodhounds and a State Police helicopter.

...Hey, buddy, How's the corn?

Farmers are joining truckers on the radio airwaves. And the farmers are staking out channel eight as their own.

"We know that nothing can be designated officially, it's not permitted by the Federal Communications Commission," said Dale Hull, extension agricultural engineer at Iowa State University.

But farmers are being encouraged to monitor that channel on their CB's as they work around the farm.

"In agriculture, we have so many things that can happen to us," Hull said. "If a man gets caught in a machine, he might be bleeding badly from an accident. He might come in contact with farm chemicals that could cause loss of coordination. Accidents can occur."

The Rural Traffic Committee of the National Institute for Farm Safety recently agreed to promote channel eight for the farmers at their meeting in Berkeley, Calif.

BLEEDING ARIZONA YOUTH IS RESCUED

A youth who slashed his wrist in a hunting accident was saved from serious injury by the combined efforts of citizens band radio operators and a private pilot.

Miles Swain, 13, of Bagdad, was field dressing an antelope he had killed near Bagdad when his knife slipped and slashed deeply into his wrist.

His father, Manfred, and a third hunter were with him when the accident occurred. They applied compresses to the wound and the elder Swain called for help on a CB radio in his truck.

Mrs. Lucille Ricks of Bagdad said she and two other CB operators picked up the message. Working together, they contacted Bob Manifee of Bagdad, who agreed to fly out to rescue the boy. He landed his light plane on a nearby ranch airstrip, picked up the youth and flew him to Bagdad Hospital.

"He's in good condition," the boy's father said. "He bled pretty bad for a while."

The elder Swain was grateful to those who helped in the rescue. "It was a good cooperative effort by the people," he said.

"It would have been a hard row to hoe" without the radios, Swain added. "They ain't worth much till you need 'em."

"This is merely a thing to follow up on what the trucking industry has done," Hull said. "My feeling is that use of channel 19 by those people has a lot of plus."

Hull said a group of 150 farmers in Illinois originally promoted use of channel eight by farmers, and he later brought it up at the California farm safety meeting.

"One of the big problems is for the tradesman, making feed, fuel and fertilizer deliveries, to reach the farmer when he's working in the back 40," Hull said. "There's also communication between the wife and her farmer husband in the field."

Hull said at least one Iowa farmer's

Astatic Corporation Announces \$5,000 Scholarship

The Astatic Corporation of Conneaut, Ohio announced a newly instituted annual award of \$5000, The James Ross College Scholarship.

Eligible for this merit award is any son, daughter or grandchild of an Astatic employee, current or retired. It will be presented each year to the high school senior who achieves the highest score in the American College Testing Program Examination (ACT).

James Ross, a long-time resident of Youngstown was one of the founders of The Astatic Corporation which had its beginnings there nearly 40 years ago. He was a pioneer in the electronics industry.

Making the announcement, Astatic's Board Chairman, Michael Chait, stated: "James Ross was a philanthropist and a humanitarian. He believed and encouraged young people to continue their life-long education. It is fitting that this award be given in his memory."

"The present winner," Chait continued, "is Sara Paull, daughter of Charles and June Paull of Conneaut. Mr. Paull had worked for Astatic 30 years, and recently retired."

eyesight has been saved this year because he had a CB radio with him in the field.

"Last spring a central Iowa farmer was sprayed in the face in an anhydrous ammonia accident," Hull said. "A call to his wife brought prompt help and his eyesight was saved."

The agricultural engineer said about 10 per cent of the farmers now have CB units.

He said one reason that channel eight is so useful for the farmer is that it is next to channel nine, the emergency channel, on the CB dial.

"One click and he can give a call on channel eight and another on channel nine and someone is going to hear it," Hull said.

You can own the finest in CB if you buy Tram.

You can save a lot of money if you buy now.



This is your Tram opportunity!

Your once in a lifetime chance to own the finest CB you can buy... and save money, too.

When you select the Tram XL, XL5 and Diamond 40 or 60 base station-quality mobile sets, you get all the outstanding features, high performance and prestige that have made Tram the standard of quality in the industry. And you'll find the price on these 23-channel mobile units a very pleasant surprise. Take advantage of this Tram opportunity at your CB dealer. There will never be a better time than now to trade up to Tram at substantial savings.

CB Newswire

YOUR CB NEWSPAPER

JANUARY, 1977

INCLUDED IN S9

Angry Calif. CBers Do Battle On Misuse of Airwaves

Citizen band radio operators in the Santa Clara Valley, angered by increasing misuse of CB bands that interrupt legitimate operators and could possibly cost a life in an emergency, are trying to form a CB policing unit.

The "H&D" (hate and discontent) element admittedly is small compared to the number of law-abiding users of CB bands, but their jamming of airwaves poses a danger, according to Bill Cantrell, one of the organizers of the drive to put the outlaws off the air.

Cantrell, operator of two building maintenance firms who was involved in CB radio long before it became a fad, said at an informational meeting Wednesday evening that the Federal Communications Commission has not responded to pleas for action against the troublemakers.

Cantrell explained that a single radio operator can jam by simply keeping his transmitter button depressed or by using a signal.

Also, high-power equipment or sim-

ply a normal CB radio used from high elevation can shut down practically all radios in the valley, he added.

Jamming air lanes has occurred during emergencies here, but fortunately has not resulted in loss of life, Cantrell said.

He cited an example. He said that he saw a Volkswagen turn over. As he tried to summon help over his radio, he was cut out by someone jamming. The anonymous troublemaker dogged him as he moved to Channel 9, the national emergency channel.

Fortunately, the driver of the VW was not injured, was able to right his vehicle and drive away. Cantrell said. "But the potential for death was there, and I was helpless."

CB operators also were responsible recently for the recovery of a lost child, the removal of a stalled automobile from a freeway off-ramp and the apprehension of a man who had stolen gasoline from a service station, Cantrell said.

A California Highway Patrol officer attending the meeting said that he caught four drunken drivers in five weeks through tips from CB owners.

CB operators know the names and addresses of at least two of the worst offenders in the valley, Cantrell said, but the only response from the FCC has been "send them a letter."

One of the renegade CBers, he said, is a former mental patient who has

threatened the lives of several CB users.

A South San Jose man who belongs to a truckers' CB group said he was told by the FCC, "Don't try to be a federal agent."

The watchdog unit the CBers want to form would use "snoopers" (directional finders) to locate either mobile or stationary CB stations that are misusing CB bands (there are 23). Misuse also includes use of profanity and attempts to advertise.

The information, they said, would be turned over for investigation and possible prosecution to the FCC.

It is not that easy, however, according to Ney Landry, head of the FCC district field office in San Francisco.

The problem is manpower, Landry said: "By 10 a.m. each day we have enough complaints to keep us going for two months. There are a million of them (CBers) out there and we have only six officers, including myself, to handle all Northern California and Nevada.

"Everyone's complaint is 'the worst' of course."

Then, he added, the evidence required to convict in court must be obtained by FCC personnel, not other sources.

"We're concerned about CB problems," Landry said, "but the best solution, given the manpower problem, is self-discipline by the CB operators themselves."

CB-Congressional Business

In 1971, Dale Milford left his job as a television weatherman to run his first successful race to represent the newly-formed 24th Congressional District in the U.S. Senate.

Now, almost five years later, Milford is back on the air forecasting weather again. Only this time he operates under an assumed name.

When he returns to the 24th Congressional District, Rep. Milford assumes his alter ego—"The Old Weatherman, KVV-9522"—and broadcasts weather forecasts on request over the CB radio in his car.

With his handle displayed on the car's back window and his Congressional license plates, Milford's blue four-wheeler is easily recognized as he drives around his home district.

"Folks often see the car and raise me on their CB's," Milford said, recounting his experiences on the "big slabs" of the Dallas-Fort Worth area.

"When they have me on the air," he continued, "the first thing they usually ask for is a weather report."

The radio—a Christmas gift from his wife, Mary—is also useful in feeling the pulse of the 24th Congressional District, the two-term Democrat said.

"Sometimes, people who want to know what Congress is up to will ask for a 'Congress forecast,'" Milford said. "Constituents often see the car, and call me to discuss politics in general."

"The political questions asked the

most deal with CB regulations and laws," he added, grinning.

Getting his ears has allowed "The Old Weatherman" a chance for more personal contact with his constituents as well.

"Many times," Milford said, "they will ask me to stop for a cup of coffee in order to discuss personal problems."

"We'll meet somewhere and go over whatever trouble they might be having," Milford said, "whether it's with their social security benefits, veterans' payments, some hassle with a federal agency or just trouble in general."

Can CB-equipped motorists count on "The Old Weatherman" for "Smokey Reports"?

"I'm a lawmaker, not a lawbreaker," Milford said. "If I don't like a law, I write my Congressman a note, asking for change."

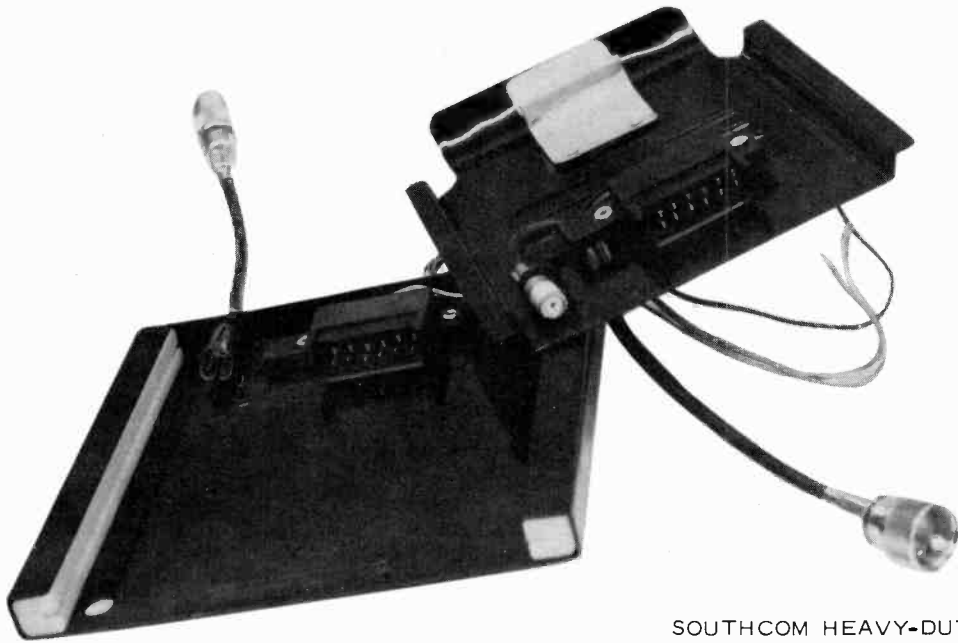

SOUTHCOM HEAVY-DUTY SLIDE MOUNTS ARE DIFFERENT. HEAVY-GAUGE STEEL SLIDES ON PLASTIC GUIDES FOR SMOOTH OPERATION. POWER AND SPEAKER CONNECTIONS ARE SECURE THROUGH COMPUTERTYPE CONNECTORS. A STAINLESS STEEL LATCH HOLDS THOSE CONNECTIONS UNTIL YOU REMOVE YOUR UNIT. PROVISION IS MADE FOR LOCK-BY A USER-PROVIDED PADLOCK.

FOR TWO-WAY RADIO USERS, THE MB-3 PROVIDES A NEW MINIATURE COAX CONNECTOR DESIGNED FOR DEMANDING UHF APPLICATIONS. OTHERS MAY CLAIM NO SWR OR LOSS. . .WE CAN GUARANTEE IT!

WHETHER YOUR UNIT IS A "MICRO" OR A HEAVYWEIGHT. . .MOUNTED IN CAR, TRUCK OR BOAT, A SOUTHCOM SLIDE MOUNT INSURES "PERMANENT INSTALLATION" OPERATION WITH INSTANT IN/OUT SAFETY AND CONVENIENCE. ASK YOUR DEALER FOR A SOUTHCOM SLIDE MOUNT TODAY.

HEAVY-DUTY SLIDE MOUNTS

MB-3 (ILLUSTRATED) FOR 2-WAY RADIO	\$19.95
MB-2 (NO ANTENNA CONNECTIONS) FOR TAPE DECKS	\$14.95
MB-1 MOUNT ONLY, WITH NO WIRING	\$ 7.25

SOUTHCOMM, INC.
P.O. Box 11212, Dept. 112
Ft. Worth, TX 76109



CB Newswire

YOUR CB NEWSPAPER

JANUARY, 1977

INCLUDED IN S9

Pennsylvania Emergency Team

When Lula Robinson's husband, Harold, got himself a CB rig a couple of years ago he threatened to get her into the act too.

"He told me he was gonna get one for my car, and I told him 'nothing doing,'" the lively 66-year-old King of Prussia woman recalls. "But then one day he just happened to leave his set in my car, and I turned it on, just out of curiosity, and now I'm hooked."

One of the things that impressed Lula most about Cbers—even more than their sociability—is their willingness to help out when trouble strikes. She and Harold found themselves benefitting from this concern on three separate occasions in the last two months. And as a result the two have laid the foundation for a King of Prussia-Norristown area REACT team—a full-scale emergency radio service manned entirely by volunteers.

The team is open for membership by any interested, licensed Cber.

"We, in King of Prussia, are in a unique position to help," Lula and Harold said in a statement they issued to prospective REACT volunteers.

"Being at the confluence of three heavily traveled highways, we can render invaluable assistance. Individuals can help, but an organized group is needed. That organized group is already in existence. If we wish, we can join them and benefit from their experience and know how."

Lula, whose "handle" is "No-Name," said the range of a REACT team's potential helpfulness is "incredible."

"We already have about 25 people coming on Sunday, and many of them are husbands and wives or some Cber and his mother or father," she says. "This means that whoever's turn it is to be on call has someone to stand in if he has to leave his radio. That means 24-hour coverage."

"The most important thing to Cbers is helping. And with REACT it'll always be there when you need it."

It was Harold Robinson, a King of

Vt. CB'ers Help A Youngster

A 400-vehicle convoy raised \$800 to \$1,000 for a disease-stricken boy in Shelburne Falls whose leg was amputated at the hip. The CB folks also supplied him Tommy or Wonder Dog—with his own rig.

It all began in late June when Jimmy Weller came home from school one day and told his mother that a school friend, Tommy K—was going to a Boston hospital and would lose a leg.

The Wellers are CB enthusiasts. Tommy (his parents asked his last name not be printed and that his disease not be identified) often listened in on CB sessions with the Wellers.

He was fascinated by talking with people passing by his home near the Mohawk Trail—people from all parts of the country.

Then word started going out on the CB airwaves about the 10-year-old boy who was going to have an expensive operation.

People like Batman, Batlady, other little Bats in the Bat Cape, the Leprechaun, the Kid, Blue Streak, the Purple People Eater and Mr. Clean got on the air and began planning.

The CB people thought they might be able to help. And since Tommy was going to be recuperating for a while, maybe something should be done to make his days cheerful.

One by one the people with the peculiar names drifted to a Greenfield address for a meeting.

A stream of workers showed up at Tommy's house in Shelburne Falls and

installed a base radio and base antenna for him.

And in Greenfield at the I-91 traffic circle, 400 or more CB enthusiasts joined a procession led by an 18-wheel tractor-oil tanker decorated with red, white and blue streamers. The convoy lined the Mohawk Trail for four miles.

Tommy rode at the head of the line.

The convoy moved with state police blessings and help to a point opposite the school in Shelburne Falls, where it halted.

There, Tommy was saluted by hundreds of tourists who slowed or stopped to see what was going on.

They saw two parachutists leap from a plane over the trail, one spiraling down with a trail of brown smoke, both landing on the school's playing fields. A lot of the tourists left donations with the convoy leaders.

Tommy hoisted himself out of the high seat of the 18-wheeler to watch the "chutists." Then the convoy moved onto State Street and down into town.

En route, the 18-wheeler pulled off near Tommy's house and became a reviewing stand for him.

As each car, truck or van (the Tri-State Van Club was there with dozens of members) passed Tommy, the CB operators barked out their handles and their greetings to Tommy.

Included in the convoy were CB people from northern Berkshire and the rest of Massachusetts, from New York, Pennsylvania, Vermont, New Hampshire, Maine, a few from Virginia and Ohio and one from Nova Scotia.

The affair wound up with a shindig at the VFW hall in Shelburne Falls, complete with band and refreshments donated by McDonald's. The CB radio was donated by a dealer friend of Tommy's.

Prussia contract painter, who got Lula to put her "ears" on, but the two of them credit their 35-year-old son, David ("Squad 51"), paramedic for first getting this family affair off the ground.

"Why, it was David who christened me "Rembrandt," says Harold, explaining the origin of his CB "handle."

"And actually my desire to get involved with community service goes back to 1956 when I was asked to join the King of Prussia Rotary Club.

"In all fairness, anything I do for this community grows out of my Rotary connection and the club's 'service above self' and 'he profits most who serves best' mottoes."

Lula, retired clerk to a Montgomery County judge, traces her community spirit to a "desire to help people."

"I like people, and I wouldn't be happy if I wasn't involved with them," she says simply. "If I can help someone, so much the better."

New names, new products, new claims. There's a lot of shouting going on about CB accessories.

The serious CBER isn't confused.

Quietly, he's buying Siltronix accessories. Siltronix—not exactly a household word. But that's where the serious CBER knows something important.

He knows that Siltronix accessories were developed by a top name in radio electronics. Swan Electronics. The same standards of craftsmanship and technical innovation that have made Swan amateur radios outstanding for the past ten years, make Siltronix a name you can get serious about today.

Siltronix accessories are built to improve talkpower and reception clarity of even the highest performance set. Under the toughest conditions.

And Siltronix has a full line to choose from. Everything you need to custom design your rig to your own specifications.

Meters, like the FS-600A SSB Peak and AM Power meter pictured here. True peak power is the only real indication of the power of your SSB signal. Ours gives it to you within an impressive 7% accuracy.

Plus antennas, antenna accessories, filters, speakers and microphones.

So now that you've laid out a bundle for that high performance set, don't let all the shouting confuse you. Good CB communications isn't just a lot of shout-power. It requires a good match between your set and the accessories you buy. Take a look at what other serious communicators are buying. And why.

Quietly, the serious CBER is buying Siltronix.



A Division of Cubic Corporation, 330 Via El Centro
Oceanside, CA 92054 (714) 757-8860

Quietly,
the serious CBER
has been buying
Siltronix accessories.



CB Newswire

YOUR CB NEWSPAPER

JANUARY, 1977

INCLUDED IN S9

The Regal "Bonus Sodalis" (BS) Story

Regal Lapidaries, Inc. has been involved with Citizen's Band radio long before its current popular explosion. In 1972 a jewelry line was proposed and tested at the grass roots level, in the clubs, the jamborees and coffee breaks—wherever CB'ers met to "eyeball" each other. The response was fantastic.

However, we at Regal felt that something was missing. Because of the many requests we had been getting from other countries: Brazil, Colombia, Italy, Israel, Argentina, Mexico, Canada, Panama, etc., because CB was going international, we felt that there was need for a slogan and symbol that would be readily recognizable to CB'ers all over the world. An idea that would be able to portray the affectionate closeness that all people who have "ears" feel toward each other. "Good Buddy" is the expression used by everybody today so that's where it seemed to be the logical place to start.

"Good Buddy" is an expression of sodality—it is a term identified with a special group or movement. Buddy

therefore means sodality which in turn stands for fellowship, comradeship, association. "Sodalis" is its direct Latin equivalent—Latin being the basis for French, Spanish, Portuguese, Italian and a partial root of the English Language too. "Bonus" is Latin for good, and thus was conceived the perfect international slogan—"BONUS SODALIS"—incorporating a language readily familiar to most everyone and embracing the idea of "Good Buddy"—one of the finest and most welcome greetings in America today. As for the symbol, what is more friendly or easily identifiable than a gesture of fellowship than a handshake?

We would also like to point out that the first two letters of the slogan "BONUS SODALIS" are BS which is a perfect pitch for the original CB'ers, since everytime you've got your ears on you are usually transceiving some "BS" whether it be with the north bound eighteen wheeler; the "backdoor" in your convoy; or just the familiar voice of somebody along your route to work

or in your home-20, the BS is the part of CB which makes it so enjoyable—the party line that's always "on."

Copyright steps have been taken, a logo has been designed and trademarked. Our product line was expanded from one to six items—the five new items bearing the "BONUS SODALIS" slogan and symbol. The new products include a man's and woman's ring which will be cast in solid bronze, 14 Kt. gold electroplated and then antiqued to allow the detail to be clearly visible.

The other three items are: a pendant, key chain and belt buckle which are handsomely struck in solid bronze by one of the foremost private mints in the country. All items are of highest quality—and yet will be priced so that every "BONUS SODALIS" can afford one. High quality and popular pricing have been Regal trademarks—we simply wouldn't know how to do it any other way.

Contact Regal Lapidaries, Inc., 420 Madison Ave., New York, N.Y. 10017.

Chesapeake, Va. 'Good buddies' get way with council on CB Law

You could have found the City Council meeting by following the caravans of antennaed cars and trucks.

A proposal which would have affected ham and citizens band radio operators was on the council's agenda and the signal was out. The operators turned out by the hundreds to protest.

The council obliged by rejecting a proposal to limit to 35 ft. above ground the height of an antenna, mast or tower for transmitting and receiving hobby radio signals. And it instructed the Planning Commission to study the original ordinance requiring such operators to seek use permits to build the towers in residential areas.

The city's professional planners were seeking clarification of a law which has been on the books since August 1970. That law requires the permit before a

hobby radio tower can be built and the permit and hearing process costs applicants \$100.

Since that law went into effect only three such applications have been made, according to Planning Department Director Milton A. Perry.

Last summer an abuse of the zoning law was prosecuted by city inspectors in court. The legal test proved the language of the ordinance too vague in its definition of radio towers.

Perry said 35-ft. limits were intended to match height of most houses, making towers unobtrusive in residential areas.

But William R. Shaw reminded the council that amateur radio operators supply communications on election days between remote polling places lacking telephones and the central registrar's office.

He termed the use permit filing fee "an arbitrary tax" and said no other Tidewater city has such laws.

Other speakers suggested the proposal would be in conflict with Federal Communications Commission law which limits such towers to 60 feet above the ground.

Councilman Thomas S. Henderson, who predicted CB radios would soon be standard equipment in most American cars, made the motion to deny the amendment. It carried unanimously.

Councilman Edw. B. Speers moved to refer the original ordinance to the Planning Commission for study to make it coincide with federal law.

Only Vice Mayor Hugo A. Owens and Councilman C. William Draper of the nine council members voted against that proposal.

THE DYNAMIC DUO.

POWER BOOSTED
MIKE

SUPERTRANSCIEVER

**INTRODUCING THE
SENSATIONAL NEW
PALOMAR 21 2-WAY
RADIO!**



Not since Batman and Robin has there been a team that worked this well together.

The Palomar 21's microphone . . . with its new gain control puts out absolute modulation. Adds so much broadcast power that you'll have to turn it down!

And the Palomar 21's exceptional transceiver . . . with crystal filter, dual conversion receiver and 60dB adjacent channel rejection that give you strong, clear transmission and reception on all 23 AM channels. Extra large Power S Meter allows easy performance monitor-

ing, even when the unit is mounted in the dash.

Palomar 21. The 2-way radio with the added power to put real PUNCH in your voice, and ZAP your message clearly to the outer limits of your range.



PALOMAR Electronics Corporation
'We're Wired for Progress'

665 Opper Street • Escondido, Calif. 92025 • Telephone: (714) 746-2666

CB Newswire

YOUR CB NEWSPAPER

JANUARY, 1977

INCLUDED IN \$9

Patrolling Team Aids Motorists; Seeks Members

"We're known as the 'Good Samaritains' of the road," says Richard Sachs of River Edge, president of North Jersey REACT, the civilian volunteer team that patrols the highways and offers emergency assistance to the motorist in distress.

The 30-member group works rotating shifts, mostly on weekends, patrolling a dimly-lit stretch of Route 3 from the Lincoln Tunnel to the Passaic River as well as a newly routed section of Route 20 near the meadowlands sports complex.

Made up mostly of Bergen County residents, young men in their early twenties, the REACT team looks for disabled cars in need of tow, reports hazardous road or traffic conditions,

alerts local police to the scene of an accident, sets up road flares, and renders first aid whenever needed.

"We're basically a communications team," Sachs says. "In a sense, you might call us qualified dispatchers. Our members monitor Channel 9, the nationwide emergency frequency of the citizens band radio."

While on patrol, the mobile REACT team keeps in touch with their base headquarters—the Regional Emergency Communications Center for Metropolitan New Jersey—located in Martland Medical Center in Newark. When an emergency arises, a call requesting aid is relayed by them to the local police, fire, or ambulance detail nearest the scene.

"We'd like to interest more people in joining our group," says Sachs, who is constantly looking for new members. "We need people who are public service-minded—people who are genuinely interested in helping others. Eventually, we hope to offer our service on a full 24-hour, round-the-clock basis.

"It would be an asset to hold a Class D citizens band license, but it's not absolutely essential," he says. "We hold training sessions for prospective members, teaching them our standard operational procedures and assigning shifts that are convenient to their working hours."

North Jersey REACT has been called upon to supply communications and manpower at the scene of major fires, floods, rescues, and searches, assisting the Red Cross and Civil Defense, as well as police and fire departments.

The group works closely with other emergency radio teams such as Rockland ALERT, City-wide REACT, and Westchester County REACT—all of which form ESRA, the Eastern States Radio Association. This allows them to borrow the highly specialized emergency equipment that might be needed during widespread catastrophe. They are also a member of the Bergen County Council for Emergency Medical Services, a group which includes most hospital and volunteer ambulance corps units in the area.

"We use lots of gasoline, as much as two tankfuls on a busy holiday weekend when we can be on the road for as long as 16 hours," Sachs says. "And the cost is paid for entirely out of the pockets of our team volunteers. That's why we're always grateful for any donations—whether they be flares, gasoline, equipment, or money. It makes the burden a little lighter on our members who are already giving their time.

"As a word of caution, however, I'd like to remind all citizen band radio operators to use their FCC call letters when reporting an emergency to REACT," Sachs stresses. "That way, they comply with FCC regulations and at the same time keep our Channel 9 band open just for legitimate emergency use."

To send contributions or membership requests, write to: North Jersey REACT, Unit 122, P.O. Box 1330, Secaucus, N.J. 07094.

CB CLUB Gives \$1,880

Barking Water (Okla.) CB Club members voted to give a total of \$1,880 away to "good causes," including the Heather Dawn Davis Fund.

Club members voted to give \$300 to the Heather Dawn Davis Fund and have challenged all other clubs in the Wewoka area to contribute to the fund also.

The newly organized 150 member club, voted \$200 each to the two Holdenville families injured this week while putting up a CB antenna. Gary "Push Rod" Bell's widow will receive \$200 from the club, and so will the Joel "Sandman" Pinion family.

Bobby Porter's family who recently lost their home and all their belongings will receive \$200 from the club also.

A total of 10 Wewoka girls were able to go to summer camp this year thanks to the club after the members voted to spend \$300 on the Campfire Girls.

The club voted to purchase the chain mesh fencing needed to build a backstop for the Little League Baseball program in Wewoka at a cost of \$180.

Wewoka Light Horsemen will re-

ceive \$300 from the club to help build their rodeo arena between Roller Coaster Road and Highway 56.

Missionary Cosmopolitan Children's Home in Butner will receive \$200 from the club for pews for their new chapel.

Barking Water club members have raised the money in their breaks held in Wewoka at the Civic Center the first Saturday night of every month. General meetings are held on Thursday night at 7:30 following the regular monthly breaks at the Civic Center. Board meetings are held on Thursday night before the monthly breaks.

Club members originally earned money to hold their monthly breaks by holding garage sales in November and December of 1975.

President of the club is Jim "Goldwing" Mitchell, manager of the Coca Cola Bottling Company in Wewoka. Vice-president is Joe "Road Runner" Forsee, Secretary Olive "Lady of the Lake" McIntyre, Treasurer Mary "Snowbird" Reich, and Parliamentarian Mac "Wewoka Sailor" McIntyre.

So far this year, the club has raised \$3,800 at their breaks.

DISAPPEARING ACT

MOTORIZED CB ANTENNA by FAMOUS ARCHER[®]



Flip its switch, and the Archer electric antenna extends to its full 33" length *and turns your CB radio on*. Flip again, and it retracts into the fender *and turns your radio off*. Nobody will know you've got ears — it's Archer's automatic answer to CB rip-offs. A top performer that ends the bother of removing your antenna. Adjustable SWR. Center loading coil, excellent for mobile use.

Quality materials and workmanship. Installation hardware and instructions included. Our "disappearing act" is another reason why a million CB'ers will choose Radio Shack's Archer brand this year. Get 21-970 and you'll have something to hide and nothing to lose. Only 59.95*.

**now you see it.
now you don't.**

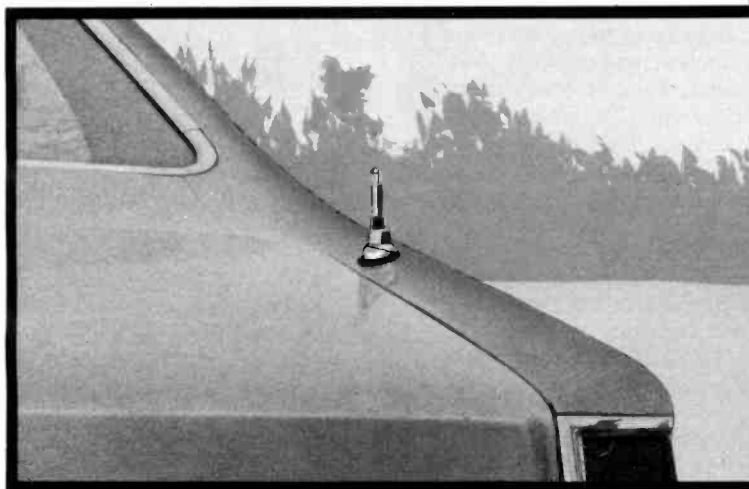

ASK FOR OUR '77 CATALOG



FREE! 164 pages, full color, 2000 exclusive items. Come in for your copy today!

LEADING THE WAY IN QUALITY CB SINCE 1960

Radio Shack[®]

A TANDY COMPANY • FORT WORTH, TEXAS 76107

5000 LOCATIONS IN NINE COUNTRIES

*Price may vary at individual stores and dealers.

CB Newswire

YOUR CB NEWSPAPER

JANUARY, 1977

INCLUDED IN S9

ZAP! You Were A CBer!

Not all CB radios are going into trucks and cars. Many are being operated in residences. And that's where a serious problem has surfaced.

The Nationwide Insurance Companies have found that the careless installation of CB radio antennas is causing crippling shocks, painful burns, and even death.

Nationwide Insurance has received reports in the last 16 months of 26 accidents in which do-it-yourself installers have let metal CB radio or television antennas touch uninsulated 7,200-volt power lines over or abutting their properties. Fifteen of 31 people involved in the 19 most serious accidents were electrocuted, and most of the 16 survivors suffered severe burns.

During the early part of the 16-month period, most accidents resulted from installation of television antennas. More recently, with the growing popularity of CB radios, most mishaps (11 of the last 13) involved CB antennas.

Home installation of CB radios require antennas, usually mounted atop metal masts standing upright on the ground and rising to 50 feet or more in height. It's easiest for installers to "walk" their antenna/masts into an upright position, supporting them above by guy wires or the eave of a house.

Unfortunately, the antenna/masts are so long that unwary installers walk them into contact with power lines which, by law, are 20 to 28 feet above ground in most locales. All but one of the 15 fatalities reported involved people standing on the ground, holding antenna/masts, when electrocuted.

A case in a small Florida town last June was typical. A 28-year-old woman and her brother, 21, were putting up a CB antenna alongside her home. The antenna was 17'7" long and was connected to a 20-foot mast. The antenna/mast combination was being walked into an upright position by the brother, with the sister holding the base to the ground, when its tip touched a power line. Both installers were killed instantly.

The lethal situation has been most prevalent, Nationwide has found, with lightweight, vertical, omni-directional CB antennas that measure 17 to 18 feet before being mounted atop long, metal masts.

Chase nets 2 charged in van theft

An 18-year-old man and a 16-year-old boy, both of Pickney, Mich., are being held by law enforcement authorities in connection with an auto larceny following a foot chase and search in the northeastern portion of the county last July.

Dennis L. Jones, 18, was held in the county jail on the charges pending arraignment in Municipal Court and the juvenile was being held in the Juvenile Detention Center to await action by juvenile authorities.

The incident began at 10:45 a.m. when Findlay police notified area law enforcement agencies that a van had been stolen in that community.

At 11:19 a.m. Highway Patrolman Edward Reiss of the Lima Post was traveling north on I-75 when he spotted a van fitting the description of the stolen vehicle in the southbound lane.

When Patrolman Reiss gave chase, the driver of the van pulled to the side of the road and he and another occupant fled into the fields just south of the I-75 State Road interchange.

When Reiss approached the abandoned van he found another person in the vehicle, a 20-year-old Detroit man who said he was hitch-hiking and was picked up by the two men.

Other patrolmen joined in the search and a Highway Patrol plane from Columbus, a member of the Allen County Sheriff Department K-9 Corps and his dog and several members of REACT with portable radio equipment also were called in.

The search bore fruit at 1:51 p.m. when Jones was apprehended by Patrolman Rod Painter in a wooded area west of I-75.

The search came to an end at 5:01 p.m. when members of REACT with the assistance of Sgt. Max Wood cornered the juvenile in a nearby field.

Patrolman said the hitch-hiker from Detroit had not known the van was stolen and he was released after his story was confirmed.

Antenna manufacturers provide general directions with their wares that call for installations to be made "in clear areas" away from wires, other antennas, etc., *to maintain efficiency of the CB antennas.* Few, if any, manufacturers enclose specific warnings to avoid power lines or give a description of the potential hazards.

Because most electrocutions resulted from carelessness or ignorance of existing danger, awareness would be a strong preventive. Nationwide advises CB radio enthusiasts to be aware that primary power lines are not insulated and that contact of those lines with home-installed antennas may very well be fatal.

Nationwide recommends keeping all antennas far away from power lines. If there is any doubt about the safety of making an installation, hire professional help to do the job. If existing antennas need to be moved and there's the danger of touching power lines, call the electric company for help beforehand. Don't take chances! No amount of time or money saved is worth the risk of your life.

Help Us Publish CB Newswire!

Be an S9 Reporter! Get your hometown CB news in the pages of S9. Send your news clippings to us and we'll try to bring your area news on to the national CB newswire—through the pages of the nation's oldest and largest CB publication. If you enclose a self-addressed, stamped envelope with your news clippings and we'll send you an S9 PRESS CARD! Address your news clippings to:

**Tomcat, CB Newswire
CB Radio/S9 Magazine
14 Vanderventer Ave.
Port Washington, N.Y. 11050**

Pacer asks you. Do you own a disposable antenna?

Your CB antenna is about to become outdated unless you own a Pacer!

You must have thought about it and wondered.

"The radios are changing.

Will the antennas change?

Will I be able to find a 40 channel antenna?"

Every new 40 channel CB radio will need an antenna equipped to handle 17 new frequencies. The radios aren't ready. One antenna is! Pacer is waiting!

Disposable Antennas

Base loaded antennas currently available will need "readjustment." This means a reduction in length. Bring out the hacksaw.

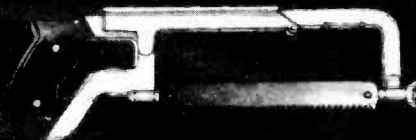

Cut off too much? Up goes the SWR. Better buy a new antenna.

Top loaded and center loaded antennas currently available will need "readjustment." This means lengthening the antenna.

Anybody have a paper clip?

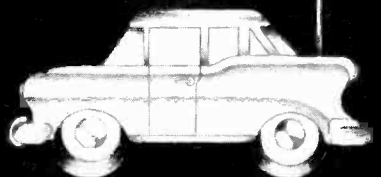

Do you really want to use a paper clip?



Pacer has the answer

Avoid the "readjustment" blues! Because of custom engineering and unique fingertip tuning, the Pacer people offer you an antenna that will perform across 40 channels.

"40"

Make the adjustment from 23 to 40 channels in seconds with the Pacer tuning stud. No need to improvise. Still the best looking, best performing antenna with minimum SWR.

Think about it.

- 1** Fingertip tuning across 40 channels with minimum SWR
- 2** Top coil loading for greater transmitting distance.
- 3** Military grade fiberglass and coaxial cable for assurance of quality.

**Pacer is ready
Are you?**

For the name of your nearest Pacer dealer or distributor, call or write:
Progress, Inc., 3321 N.W. 79th Avenue,
Miami, Florida 33122, (305) 592-8242



Pacer

Patent Pending

...sets the pace in big talk power



How can you be sure which crystal is best?

Graham Electronics in Indianapolis knows crystals. They carry nothing but CTS Knights. "We previously stocked other brands," General Manager Larry Stein (above, right) said, "but we found we couldn't meet all of our customers' needs for changing and growing frequencies except from our CTS stock." While CTS crystals are known for highest quality all across the land, here's one place that leaves no doubt of it whatsoever.

Stein and Bruce Gibson (above, left), Graham's Communications Department Manager, agree that CTS is a "finer crystal than anything in the market. CTS has the broadest line," they said, "and we have no problems. Our percentage of return is nil!"

"Is this crystal accurate?" is the most asked question. The answer is "absolutely yes," thanks to CTS gold frequency calibration and mil-quality features. That really convinces radio enthusiasts that CTS is best, the Graham management believes. "We can give them any CTS crystal they need... for any set... right at our counter," Stein and Gibson agreed.

You can enjoy this same fine quality and constant satisfaction, wherever you are. Take a tip from this full line electronic parts and equipment wholesaler. See your nearby CTS dealer for any crystal you might need.

And for a handy reference book on CB, monitor and 2-meter crystals, send the coupon now with \$1 for **CTS Knights Crystal Guide**. And from now on, you too will rely on CTS Knights, 100%.

CTS KNIGHTS, INC.

SUBSIDIARY OF CTS CORPORATION, ELKHART, INDIANA

402 REIMANN AVE., SANDWICH, IL 60548, PHONE: (815) 786-8411



CTS Knights, Inc.

402 Reimann Ave., Sandwich, IL 60548

I enclose \$1. Please send my copy of CTS Knights Crystal Guide.

NAME _____

ADDRESS _____

CITY _____ STATE _____ ZIP _____



GATHER 'EM UP

CB

Gather·em·up

**Got an old CB Rig in
the attic? It's worth
money. For sure!**

WE'VE seen folks collect electric pole insulators, we've watched them gather tractor seats and hang them on their walls, and we have even observed a number of people rounding up old beer cans as collectors' items. Yes, unusual hobbies to you and I because perhaps we don't view any of these items as things to collect—maybe a beer can is considered more or less something to be disposed of rather than an ornament for a collection shelf. Well, *to each his own!*

And maybe it's a matter of *to each his own* that has started a mass stampede to collect old time CB rigs! Yes—or haven't you heard yet? Old CB rigs are worth big greenstamps to a collector, and the number of CB'ers now gobbling up old CB rigs is multiplying at an amazing rate!

WHA HOPPEN?

Unlike the problem faced by collectors of real *antiques* (for example, things more than 50 years old), where few *real* finds are still available and most stuff has to be purchased from a dealer who probably bought it from another dealer—each dealer adding to the price—CB gear collectors are seeking out items which were manufactured only 10 to 18 or 19 years ago. You might wish to call them *collectables* rather than *antiques*—you know, too new to dump in the rubbish and too old to be worthy of use!

WHAT'S IN A NAME

Doesn't make much difference what you call them, people are starting to drag them out of attics, garages, barns, basements, and closets and either put them on display or sell them to others!

It's not too difficult to see why this is happening—CB radio has caught the fancy of millions of people, and a lot of these people would like to own a little piece of the heritage of something, such as CB, which means so much to them. And, while at this time it isn't too difficult, you must take into account that in not too many years it may be almost impossible to secure a little piece of CB's past without spending a rather enormous amount of loot. Here's why:

1) Early CB rigs were not produced in large quantities, some were hand assembled and may have lasted through only 100 to 500 production units. Even those which were big sellers were produced in rather small quantities when compared to modern day production runs—there just weren't that many CB'ers around to buy the stuff new in the old days.

2) Even of those sets which were released into the market and placed in use, a great many are not presently available for reasons of being cannibalized for parts, scrapped because they were "old and no good," or because they were "put away" for fixing at a later date—but that later date never came and the sets and their locations have long since been forgotten, perhaps those who put them away have gone to that big eternal coffee break in the sky!

3) Those who are now starting to collect this old equipment—right from the start—far outnumber the number of sets produced for any given make and model, even the entire production run of the most popular old time CB rigs, such as the *Johnson Messenger I*—if every set were still available—could not possibly satisfy the current collector demand for this particular unit. And the *Johnson Messenger I* was one of the most popular sets around, having been manufactured over a period lasting more than 10 years! However, if you're looking to pick one of these up you're certainly going to have a better chance of finding one now than you will in even a year or two as the sets get older and the number of collectors competing with you continues to skyrocket!

RARITY

How rare (and valuable) any of these sets are is a 2-headed axe. On the one hand, you might (for instance) come across a low production unit such as the *Maxwell 27C-2* or *27C-3* (sold for \$159.50 in 1963) but since the set is relatively unknown it might well not be as sought after as some of the more plentiful units which made their mark on the history of CB by being the earliest successes as the band was first being opened for use, sets such as the first *International Crystal Executive* (the famous *Icebox*), *The Globe CB-100*, the single channel *Vocaline*, the *Heath CB-1 (Lunchbox)*, the old *Polytronics Polycomm*, and a few others.

Some people specialize in assembling collections of these particular rigs—after all, you can't attempt to collect *everything!* Of course, you might wish to consider collecting *only* the real rarities, those rigs which were either short runs from major manufacturers or from smaller or short lived outfits. Those sets which might fit into this category would include units such as the *Arkay SQ-9 Sky Vox*, *Biggs LA-101-A*, *Davis 5W4*, *International Communications Mercury Mark IV*, *Lakeland D-11*, *Lakeshore D-55*, *Miratel CR-117*, and the like.

(continued on page 33)

CB's Honored Ancestors

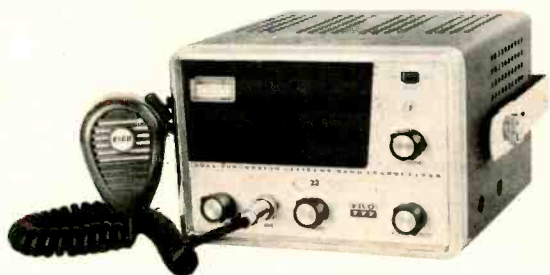

EICO'S 777 was a relatively inexpensive rig which was rather popular. They are still plentiful and sell for about \$25.



This early BROWNING contender is an entire base station consisting of the R-2700A receiver (\$149) and the 23/S-9 transmitter (\$144). This station is still valued at more than \$100 even though it's 12 years old!



DEMCO'S RAVELLE was a not too well known mobile unit from the producer of a base station similar to the Sampson modular station. Today this mobile unit is valued at \$25.



Now if you can dig up this little gem you have found yourself in an enviable position. This HARMON MORSE MODEL 15 is rather a rarity and we saw one pass from one collector to another for over \$100!



LAFAYETTE'S HE-20 was immensely popular in the early days and is therefore plentiful in the collectors' market, a good starter for someone starting to acquire early rigs. They are usually available for \$25 to \$35.

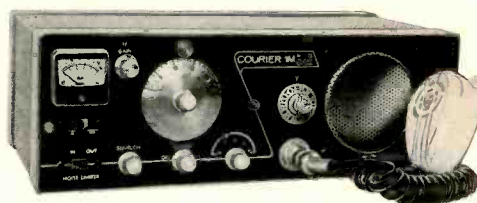

This set is the famed e.c.i. COURIER IM, a legend in it's own time. Although many were made and still exist, few people will part with this ugly duckling with the reputation for excellence. You'll find that these sell for about \$75 today if you can get one.



Here's the HAMMARLUND CB-SIX, produced by the well known Hammarlund Mfg. Co. Despite an early start in the CB field, their CB products never achieved sufficient popularity for them to continue production. Their sets are hard to find and are collectable in the \$40 to \$50 range.



The DEWALD MODEL R-1050 was an early cheapie which did achieve some popularity and actually worked rather well considering it as inexpensively made. Today it's valued at \$25.



One of the stars of the collectors' market is this JOHNSON MESSENGER 1 which easily fetches \$75 if you can find one!



Nobody has ever seen one of these in the flesh. It's the INTER MARK CIPHER 1000, which was supposed to be brought out but possibly never was. If one was ever located it would probably realize a high price.

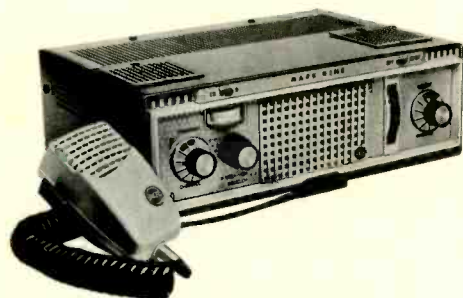

The MARK 9 was an early RCA entry which had a nicely designed brushed-steel faceplate. Today this set is valued at \$40.



The HAILMARK 2-12 came out of Texas with a price tag of \$149.50—but it didn't create much of a stir. They still pop up in the antique market for about \$35.



The Tram TR-70 tipped the scales at \$225 back in 1963, and today it is one of the more desirable units at about \$85.



The KNIGHT C-11 was an inexpensive kit unit from the early days of CB radio which still appears at flea markets—and they can be obtained for \$15 or less!



AMPHENOL tried its hand in the CB transceiver field for a while with sharp looking units like this MODEL 777. These are valued in the current market at about \$45.



BURSTEIN-APPLEBEE offered this low-cost MODEL BA-23 for a while, but it is still a relative rarity. Several have been seen around in the \$15 to \$20 range, despite the fact that they aren't seen very often.

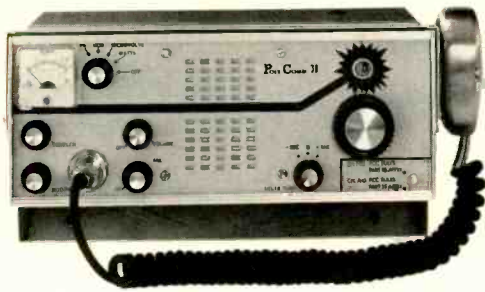

POLYTRONICS MODEL 30 was a big, brawling, class rig which offered not only all 23 CB channels, but also low power output on the in-between radio control channels. Nice try, but it didn't sell. Today it sells for about \$50.



Heath produced one of the least expensive CB stations ever, the GW-12, available in kit form in the \$40 to \$45 range when new! Rig is still around on the flea market circuit for \$20.



KAAR was an early manufacturer which produced units for a few years. This is their TR-327 D-PHONE which sold for \$179 and looked kinda nice for it's time. Today it would bring \$40 to \$50.



Far ahead of its time, the INTERNATIONAL CRYSTAL MO-23 was a mobile rig designed for trunk mounting with a remote control head under the dashboard. A clever idea about 12 years ahead of its time—originally sold for \$245 today. None have yet been spotted in the used market, but it would command top dollar. Photo shows the remote control head.



THE ALLIANCE GENIE-FONE was a rig produced by the well known manufacturer of antenna rotors. Whether this unit was ever actually marketed, or if it exists in only the handful of units known to collectors (possibly engineering prototypes) is difficult to determine. Because of their rarity, they are valued at over \$100 these days.



The HALLCRAFTERS CB-3 was an early entry in the CB field by one of the major electronics manufacturers. Hallicrafters eventually left the market (is about to return by the way) and this early relic is valued at \$45.

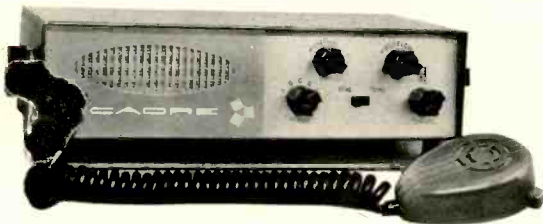

CADRE'S MODEL 500; a nice looking set which did not achieve much popularity. For its day (1963) it was novel—being fully solid state. Sold for \$200, but today its valued at \$30.



An early contender in telephone handset design, Pearce-Simpson offered this nice Companion IV. Current value \$50.



INTERNATIONAL CRYSTAL'S EXECUTIVE MODEL 10 was an inexpensive but clever little rig with 3 transmit channels, a tunable receiver and the transmit-recvie functions switched via front-panel selector. We've seen them offered for \$25 recently.

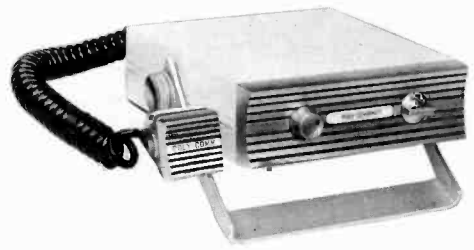

The POLY COMPACT was an early experiment in a sub-miniature rig, despite slick styling for its day it was a flop. Because few ever saw the light of day, they're hard to locate—current value about \$40.

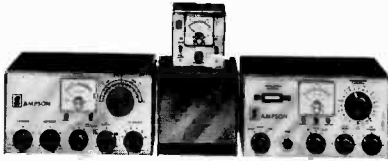

The SAMPSON modular station attained some minor popularity about 1963—today if you can locate the complete station (4 pieces) it should be worth about \$70.

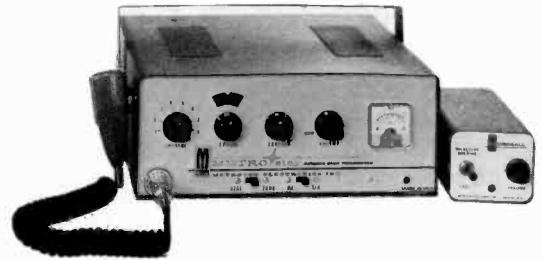

If you can still locate anything from METROTEK it would be miraculous. These were cheapie sets which had a short popularity, however much of the equipment was not found to be rugged enough to cut the mustard with CB'ers. Probably not too many of these left, but if you could find one in decent condition it might go for \$20.



The POLYTRONICS N was a set which arrived on the market very shortly before its manufacturer departed, so there aren't too many of them around. Original price \$189.50—current collectors' are paying \$50.



VOCALINE'S COMMAIRE ED-27M was a 4 channel version of their earlier single channel unit. Although well constructed, none of their models ever really caught the fancy of buyers. Originally \$189.50 back in 1963, today about \$30.

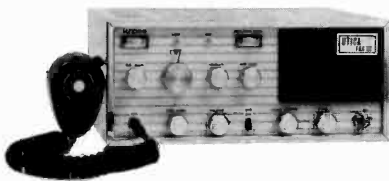

Utica was a midwestern manufacturer which achieved some popularity in the early 1960's. This TOWN AND COUNTRY III was their top of the line and has a current market value of \$50.



The WEBSTER 440 transceiver was an early attempt at luxury. It had 10 transmit channels, a tunable receiver, decorator styling and wood-grain trim. Today it is worth about \$60 to a collector.



The GENERAL RADIODIOTELEPHONE CO. MODEL VSM (VSM stood for Very Small Mobile, in case you were wondering) was clever—6 channels, PA system, and a local/distant communications switch. And it was built like a rock. Current value is \$50.

CB GATHER 'EM UP (continued from page 28)

CONDITION

Although some CB rigs can still be located in near perfect condition, you're going to have to expect that the majority are going to be in various stages of disarray, ranging from some scratches on the cabinet all the way to something that looks as if an elephant did a fandango on the thing.

Naturally, a set in working condition will be of more value than one which isn't working, even if the working condition rig might not look as slick on the outside.

Another thing to take into account in evaluating an old rig is whether or not it has been defaced by extensive modifications. One particular thing to notice is that some of the really early sets were designed for single channel operation and their original owners had wired crystal sockets to the front panel so frequencies could be changed by the plug-in method. An unmodified rig is more desirable, however one which has been modified only by the addition of external crystal sockets is the next best thing.

VALUE

Despite inflation, CB rigs of 15 or so years back did not sell at prices which are vastly different than prices you would pay today, and in those days you still were not getting a full 23 channels with no additional cost for crystals. So, in a sense, you are really getting much more today than you were getting many years ago. Looking back at 1962 prices we can see the *International Model 100A* selling for \$199.50, a top notch model at a substantial price, especially when you consider the buying power of \$200 then versus today. Some other random prices originally charged for early rigs would include the Browning *Mobilair* at \$159.50, the *e.c.i. Courier 1* at 189.50, the *Eico 760* (110 volts only) wired for \$89.95, and in kit form \$59.95, the *Pearce Simpson Companion* at \$189.50, the *Tram R-27* at \$249—so you can see that better equipment still brought top dollar.

Today these sets can be found at all prices averaging from \$5 to \$50 or \$75—not discounting the fact that sometimes you can talk someone out of an old set for free and they think you are doing them a favor by carrying it away! But as more and more of these sets get gobbled up the prices are sure to rise, and that old *e.c.i. Courier 1* that you can locate today for \$75 will undoubtedly be valued at double that price in the not too distant future.

OWNING A PIECE

Besides the thought that you are investing in something that will increase in value, you also are assembling

your own little piece of communications history—and if you're not the kind of person who is turned on by collecting butterflies, bubble gum cards, stamps, coins, and whatever—you might consider getting in on this before it becomes so popular that the only old CB rigs which are to be found are ones sold by professionals who traffic in this gear—and we have heard that there are already a number of folks who earn a very handsome hunk of greenstamps by searching out old CB rigs and reselling them at flea markets, CB jamborees, coffee breaks.

STARTING A COLLECTION

One of the best ways to start assembling a collection is by digging back through issues of magazines (such as *S9*) which were there in the early days—seeing what was available. At least you'll get some idea of the age of the set. Then you might also decide which areas you want to specialize in—or if, to get yourself started, you want to grab up everything in sight with the thought of selling or trading off later for specific sets that you are seeking.

Start asking around your friends and relatives to see if they have or know of any dusty old CB rigs hidden away in the family archives. If you've got a CB shop in your area which has been in business for a number of years, they might even have some sets available—perhaps ones brought in for repairs and never picked up, or traded in on new equipment. One collector I knew walked into a CB shop and asked if they had any old equipment and was treated to the surprise of having the dealer poke through some long-forgotten corner of the basement and appear carrying a factory new unopened carton containing a *Tel-Rad*, which is so rare a unit that nobody had ever even seen one in the flesh—it had been advertised back in 1961 by an outfit called *Telephone & Electronics Corp.*, but until this one set was located it was strictly a fabled or legendary bird. The set had a telephone headset—5 channels.

So there are many areas open to you for exploration—and perhaps that's even part of the fun of it all! Tracking down the elusive CB rigs. In any event, try to stick with pre-1965 units.

You might also search out flea markets, but unless you have unlimited funds stay clear of those who deal exclusively in old rigs—seek out the guy that has cleaned out his garage and spreads out an array of 3-wheeled baby carriages, broken roller skates, unstrung tennis rackets—perhaps in the midst of all of this trash you may also find a lost and befuddled pioneer CB rig! Make him an offer—maybe he'd take something in swap, hey—perhaps he'd just love to own that lovely purple vase that your Aunt Fredericka gave you—make him an offer! You're on your way!

Dealers, Here are 7 good reasons why Centennial is your best single source for all your CB needs...

1 Centennial stocks virtually every major brand of radio, antenna and accessory in depth. This means that you can order whatever you need, when you need it, and be assured of immediate delivery.

2 Centennial stocks all major brands in such large quantities that the savings we enjoy are passed on to you with the best competitive prices in the industry.

3 Centennial has specialized in CB and personal communications for more than fifteen years. Our experience and guidance can save you valuable time and dollars.

MIDLAND



Model 13-955

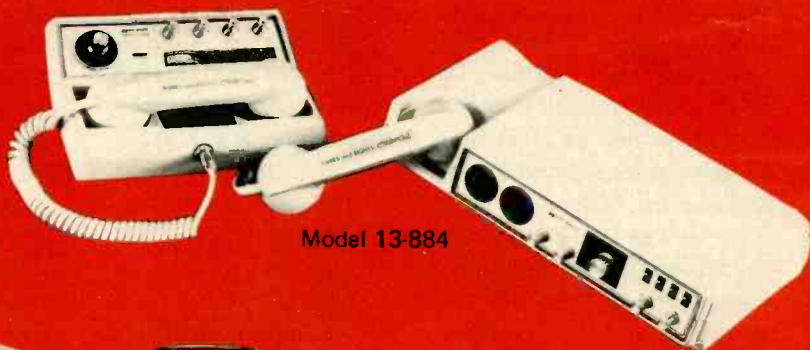

Model 13-884

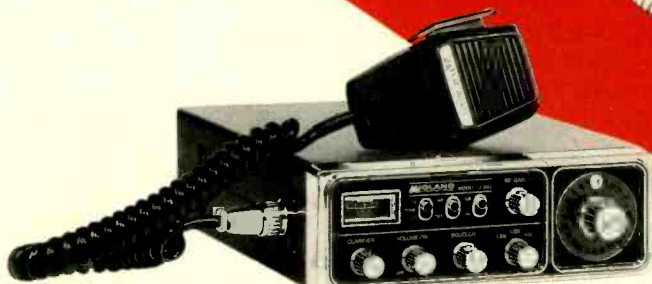

Model 13-892



Model 13-893

Centennial Communications Inc.
585 Yonkers Avenue, Yonkers, N.Y. 10704

Our 35th year in business

Dealers ask for Johnny or Len

914/476-2100

Model 18-279



4 Centennial

maintains a full-time working staff of trained CB sales experts. This means instant service when you call or drop in to place your CB equipment orders.

6 Centennial

plans to remain in the CB two-step business for many years. When the late comers have abandoned the market, we'll still be here to serve you.

5 Centennial

backs up every product sold with superior service. You need never worry about being stuck with inferior merchandise or factory rejects. —The most liberal dealer policy in the industry.

7 Centennial

sales and service personnel love their work. We enjoy dealing with our dealer customers. This is reflected by the cordial and courteous reception we extend to all our customers, no matter how large or small.

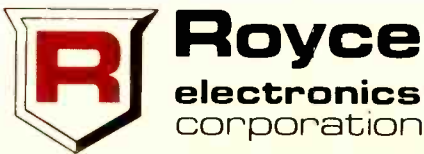

Royce
electronics
corporation



Model 1-624



Model 1-653



Model 1-650



Model 1-640

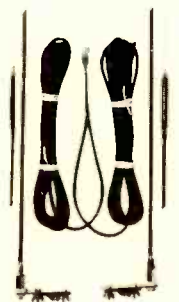

Model 2-224



Model 1-620

Centennial
Communications Inc.
585 Yonkers Avenue, Yonkers, N.Y. 10704

Our 35th year in business

Dealers ask for Johany or Len

914/476-2100

CB Types: Number 1 of a Series

WOLVERTON ON THE LOOSE!

The name **WOLVERTON** is one which is familiar to any and all self-respecting art lovers. **BASIL WOLVERTON'S** unusual illustrations appeared in publications since 1926, with a heavy concentration of effort being directed towards science-fiction, horror and comic books between 1938 and 1954. (Anybody remember what Lena The Hyena looked like, along about 1947? That was **BASIL WOLVERTON'S** creation!) The **WOLVERTON** style has only gotten further into the realm of the weird as time has progressed and still pops up in a variety of places, sometimes

creating some interesting psychological effects in the heads of viewers of the unique style.

MONTE WOLVERTON, son of the great **BASIL**, continues in the outrageous **WOLVERTON** style. **CB RADIO/S9** has commissioned him to prepare an exclusive series for our pages featuring little-known equipment designed especially for certain less-than-desirable characters which **CB'ers** are likely to hear while tuning the channels. I think that you'll get quite a charge from **WOLVERTON'S** series, watch for it each month in **CB RADIO/S9!**

TOMCAT

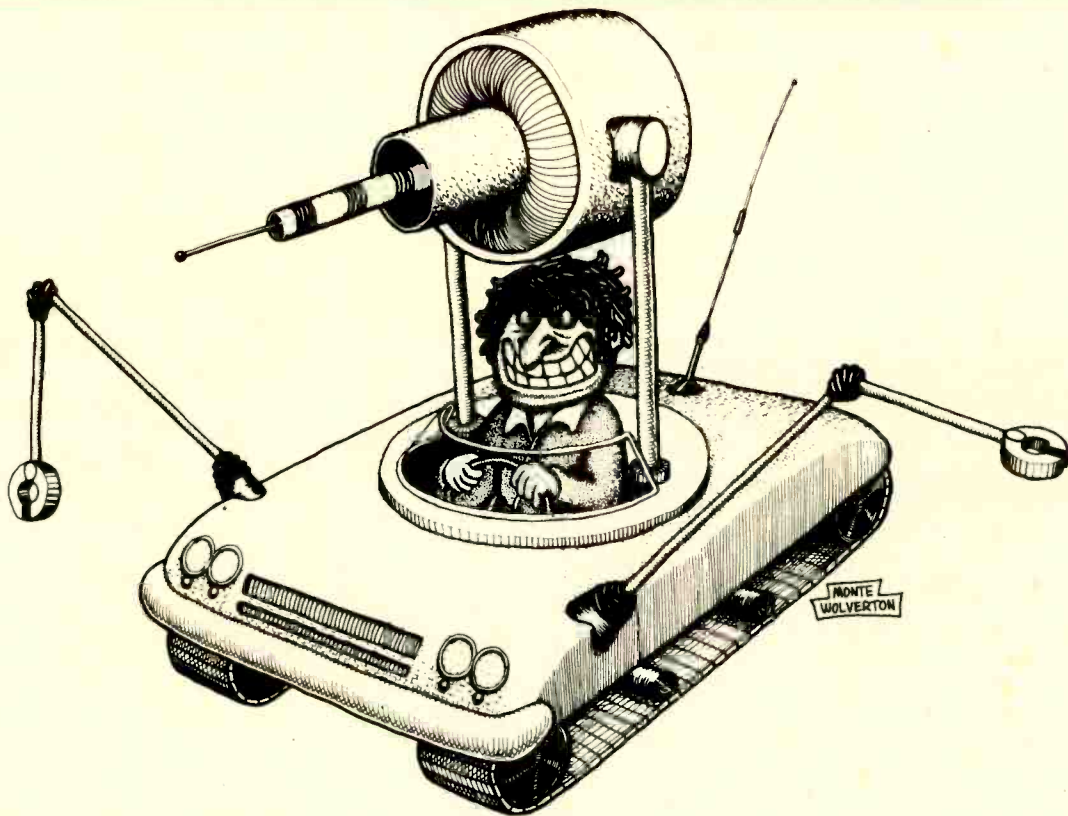

Soon to be available from Motor City is this new vehicle designed for channel monitors who insist upon maintaining total control and iron-grip discipline over their particular channel.

Should someone attempt to use their designated channel without paying due homage to their supreme authority, this fully tracked vehicle can be used to locate the offender. It is capable of penetrating through vegetation, fences, even steel-frame buildings if necessary, to search out even the most remote and well hidden base station, or it can attain speeds far in excess of 4 or 18-wheelers should there be a need to overtake a mobile heretic.

Having located the offending station, the outraged monitor can destroy antennas or otherwise ruin equipment and operators with remote-controlled mechanical pincers. For those who are not stopped by these measures and still continue to use the channel without asking for permission, or for repeat offenders, there is a disintegrator ray cannon. A well irritated channel monitor could, if he wished to do so, use this device to clear his channel of ALL stations and traffic, both necessary and unnecessary.

COMING EVENTS!

If you wish your Jamboree or Coffee Break listed in this column, the information must be sent to S9 at least 4 months in advance.

JANUARY

Jamboree, January 9, Desert Inn, 30-80 White-tone Pkwy., Flushing, NY. Sponsored by American CB Radio Club, Inc., Box 321, Bronx, NY 10469.

FEBRUARY

6th Annual Communications Conference, Feb. 17-20, Mayflower Hotel, Washington, DC. For more information contact Lionel C. Barrow, Jr., Ph.D., Dean, Ms. Peggy D. Pinn, Conference Director, Howard University. *Jamboree*, Feb. 26. Event is for charity. Vendors contact: WSM Sidebander 77 Jamboree, Box 12431, Jackson, MS 39211.

APRIL

5 Waters Jamboree, April 17, Greenfield Fairgrounds, 4-H Building, Greenfield, IN. For more information contact, Al Simpson, R.R. 1, Box 317A, Reelsville, IN 46171. 317/672-8367.

Fourth Annual "Springtime" Coffee Break, April 3, Milford Grade School, IL. State Rte. 1, Milford, IL. For more information contact: Faye M. Thomas, 208 S. Grant St., Milford, IL 60953.

Coffee Break-Dinner & Dance, April 30, Club Bil Mar, Hwy. 141, Manitowoc, WI. Sponsored by West of the Lake CB Club. For more information contact, West of the Lake CB, P.O. Box 163, Manitowoc, WI 54220.

MAY

Jamboree, May 7 & 8, Barthomeu County 4H Fair Grounds, Junction US 31A S. & State Rt. 58, Columbus, IN. Sponsored by Town & Country Citizens Band Radio Club, Inc. Contact: Floyd Whitehead, 1-812-372-3524.

JUNE

2nd Annual Armadillo Flats National Jamboree, June 3-5, Ottumwa Coliseum, Ottumwa, IA. Hosted by Armadillo Flats Iowa. For more information contact Armadillo Flats Inc., P.O. Box 313, Oskaloosa, IA.

★ DEALERS WANTED ★

-All Major C.B. Lines-

SELL CB FULL OR PART TIME
GORDON ELECTRONICS

Box 313 Johnstown, N.Y. 12095

FREE (518) 762-1811 CATALOG

Two-way improvement



Avoid CB radio theft with magnetic mount antenna. Just lift off and lock inside vehicle. Extra-strong magnet has 90-lb. pull.



Has your CB ever let you down? Right when you needed it the most?

It could be that "good deal" antenna. Or the lightweight mike that came with the set. To get the most out of your CB, switch to Turner at both ends.

Try a Turner amplified mike. You'll find out how much talk power your set can really deliver. For full range when you need it.

Make sure your antenna is dependable. Step up to a Turner. Turner builds them tougher. There are 43 models for all kinds of base and mobile installations.

Ask anybody who has been around CB for awhile. They know us. Wherever CB is sold, Turner.

The talk of the road

TURNER

MICROPHONES
ANTENNAS

CONRAC
CORPORATION

716 Oakland Road N.E., Cedar Rapids, Iowa 52402

More Walk Power!

New Realistic walkie-talkie with exclusive range-boost antenna system



and provision for push-to-talk mike

You know what mobile CB does for driving—think what it can do for on-foot activities like hunting, camping and hiking. If you're with friends, walkie-talkies let you spread out without losing touch. And if you're alone, two-way radio may be your *only* way of getting through for help. The Realistic TRC-200 is the perfect choice for the CBER who demands no-nonsense performance. Five watts input and a loaded telescoping antenna for maximum range. A high-low output switch saves on batteries during short-range use. With batteries and crystals for Channel 14 and provision for up to 5 more channels—just add optional-extra crystals. Ceramic filters. Adjustable squelch. Battery/RF power meter. Built-in speaker and condenser mike. Jacks for a full range of accessories. Just 99.95* for the handiest CB ever. Sold only at Radio Shack!

Provision for push-to-talk mike

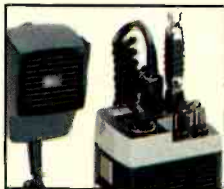

Special jack lets you use optional push-to-talk dynamic mike for one-handed communications with TRC-200 out-of-the-way. Just 11.95*. 21-1172.

Exclusive range-boost antenna

Range Boost: Grip the TRC-200 and the side panels electronically couple your body to the antenna for extra signal power on Receive and Transmit.



FREE NEW 1977 CATALOG

- Exciting New 56th Anniversary Edition
- Over 2000 Exclusive Products
- Full Color • 164 Pages

AT OUR 4200 USA STORES AND DEALERS

EVERYTHING IN QUALITY CB SINCE 1960

Radio Shack®

A TANDY COMPANY • FORT WORTH, TEXAS 76107
5000 LOCATIONS IN NINE COUNTRIES



Use your credit card at most stores

*Prices may vary at individual stores and dealers.

The Best Houses depend on Wilson Antennas

When you hook up your radio to a Wilson antenna, for example the **Shooting Star**, you combine the best electrical and mechanical characteristics you can get in a switchable polarity antenna. The combination of scientifically spaced elements with a quad reflector gives it truly excellent gain, front-to-back ratio, and low radiation angle.

Mechanically, it's just as impressive • Solid fiberglass reflector arms • 2" OD heavy wall aircraft tubing • No holes drilled in elements • Will not rust or generate electrolysis • Built to withstand high wind stress.

When you see your local dealer, insist on Wilson. You're sitting on top of the world with a Wilson antenna.

SHOOTING STAR SPECIFICATIONS:

- Gain—14.5dB
- SWR—1.2 to 1
- Switchable polarity
- Impedance—50-52 Ω
- Front to back ratio—38dB
- Weight—29 lbs
- 2 KW capability; adjustable gamma match
- Vertical to horiz. separation 25dB
- Power Multiplication—28X
- 40 channel capacity
- Boom—16'
- Turned by medium duty rotor

Write for our complete catalog of base and mobile antennas, towers and rotors.



Wilson Electronics Corp.

4288 S. Polaris Ave., Las Vegas, Nev. 89103
(702) 739-1931

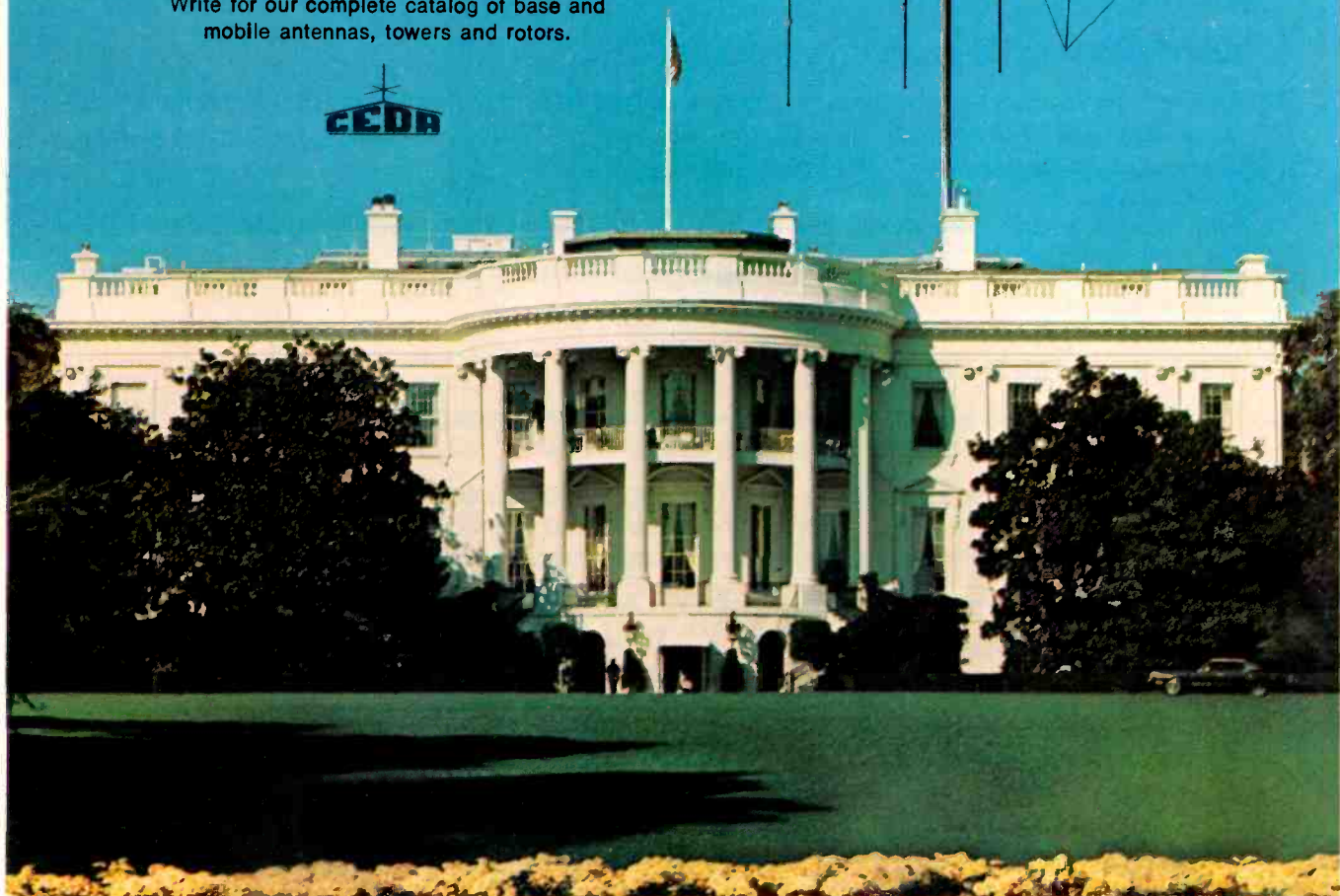
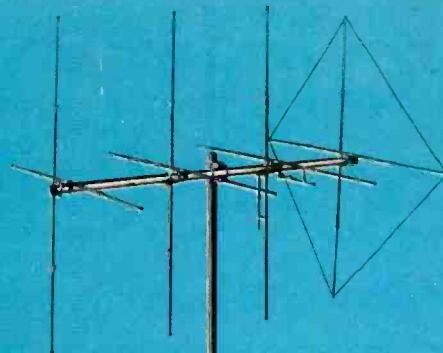



some straight answers about Citizens Band

Q. How much should I spend for a good CB set?

A. Cost will vary dependent upon brand, model and features. For example, you can buy a Browning for as little as \$140 or as much as \$750. Your decision – whatever the brand – should be based upon your intended use.

Q. With so many brands from which to choose, how can you know you are making a wise decision?

A. The best course is to ask the advice of knowledgeable CBers – your personal “survey” will be well worth the effort.

Q. Where should I go to purchase a CB radio?

A. The CB specialty store is built on electronics know-how and able to give sound advice, installation, service and a wide selection of antennas and accessories.

Browning may not be your first set, but – when you do get serious about CB and begin to discover Browning's superior performance ... you'll begin to understand why CBers have relied upon the name Browning since Citizens Band began almost two decades ago.

See Browning's entire line of products at your nearby CB specialty store.

browning[®]
bringing people together

browning laboratories, incorporated, laconia, new hampshire 03246



ON THE COUNTERS



VERSATILE MOBILE RADIO

Teaberry Electronics Corporation has expanded its line of Citizens Band radios to eleven with the introduction of the new RACER "T" mobile radio. The company said the new CB rig is a strong contender for any mobile application and is expected to be a leader in the mid-price category.

The RACER "T" features phase lock loop circuitry for on-target communications and an exceptionally quiet receiver. Designed for outstanding adjacent channel rejection, the 23 Channel radio also features delta tune, automatic noise limiter switch, quick disconnect DC power plug and quick-release mounting bracket. It also has a large "S"/RF meter, public address function and positive/negative ground. The radio is completely solid state. It has been type accepted by the FCC.

Finished with a rich brushed gold face and gold trim, the RACER "T" carries a suggested retail price of \$175.00.

Contact Teaberry Electronics, 6330 Castleplace Dr., Indianapolis, IN 46250.

NEW CB RIG

The EBC-RT-23 CB is the ultimate CB Transceiver. It incorporates the latest in "state-of-the-art" design including a removable control head which allows installation of the transceiver in car trunk for permanent safekeeping and shorter antenna wiring for better transmission and reception.



Outstanding features: A SINGLE CRYSTAL SYNTHESIZER (digital phase locked loop) permits future expansions. DELTA TUNE to bring in those off-frequency stations. A RECEIVER using a dual gate Mosfet R.F. amplifier makes it less susceptible to intermod and overload. DUAL CONVERSION, using ceramic filters in the first I.F. stage, for better selectivity and image rejection. AUTOMATIC GAIN CONTROL CIRCUITRY that keeps the speaker volume constant over wide variations in signal strength. A NOISE BLANKER that truly gets rid of ignition noise, plus a noise limiter to reduce other types of noise. A TRANSMITTER with a fast acting mic compressor that gives better results than a power microphone. AN AUTOMATIC MODULATION limiting circuit to increase talk power without splatter. A TRANSCIEVER that includes the smaller things as well: glass epoxy board, pre-aged crystal, and all solid state. No bulbs, meters, or relays. And it's all U.S. made.

RECEIVER

Circuit Type: Dual conversion superheterodyne, digital frequency synthesizer provides 23 transmit and receive channels. Sensitivity: 0.5 uv for 10 dB signal to noise plus noise at 30% modulation 1000 Hz. Selectivity: 60 dB down at plus or minus 10 KHz. Spurious Responses: Greater than 50 dB down. Image Rejection:

ON THE COUNTERS *(continued)*

Greater than 60 dB. AGC: 1 dB level change between 2 uv and 10 mv. Noise Limiter: Automatic. Noise Blanker: Switchable RF noise blanker effectively removes ignition noise pulses. Squelch: Adjustable, minimum signal to open squelch 1 uv. Audio Power Output: 4 Watts into a 4 ohm load with less than 10% distortion. Delta Tune: Continuously tunable plus or minus at least 2 KHz. Frequency Stability: $\pm .005\%$ (-5°C to $+50^{\circ}\text{C}$).

GENERAL

Size: $2\frac{5}{8}$ " High x $7\frac{3}{4}$ " Wide x $1\frac{1}{4}$ " Deep. Power Requirements: 11.5 to 14.5 VDC, switchable negative or positive ground. Approximately .55 amps receive, 1.2 amps transmit. Accessories: Push to talk dynamic microphone, D.C. power cable, Mobile mounting bracket Microphone clip.

Contact: Emergency Beacon, 15 River St., New Rochelle, NY 10801.



POCKET CB

A 2-way citizen's band transceiver so small it fits into pocket or purse is being offered by KingsPoint Corp., Jersey City, N.J.

Known as the CB-150, the unit, which weighs only 5.5 oz. and measures $5\frac{1}{2}$ " x 2" x 1", has a full 23-channel capability and is powered by a low cost 9-volt battery which by virtue of a power shut-off feature lasts for weeks and weeks.

Changing crystals is made easy by a convenient slide-open compartment which lets one snap out and snap in alternate channel crystals.

Ideal for executives, foremen, dispatchers, security guards, fishermen, campers, hikers, motorists, home owners, coaches, etc., KingsPoint, CB-150 retails for under \$40. For complete details, write KingsPoint Corp., 106 Harbor Drive, Jersey City, N.J. 07305.



OFFICIAL CREDENTIALS

Each of these ID cards is an attractive, professionally designed, official credential, printed on heavy colored card stock, wallet-sized. These official and authentic credentials are especially well suited for use by volunteer agencies and patrols, temporary forces pressed into service during emergencies, smaller communities and counties, industrial and private departments and agencies, and others who wish to have professional and authentic ID credentials without having to go to large print-runs of expensive custom designed credentials. They are also available to collectors of public safety memorabilia—police and fire buffs. Credentials are of *universal* design, and specify no agency or location name, although ample room is available for this information to optionally be added by the purchaser. Credentials sent blank, purchaser fills in members' names. These credentials are of sufficient high quality to be laminated by the purchaser if desired. The following designs are available: RESCUE SQUAD, VOLUNTEER AMBULANCE SQUAD, HIGHWAY SAFETY PATROL, FIRE DEPARTMENT, SHERIFF DEPARTMENT, POLICE DEPARTMENT. There are credentials also available for CIVIL DEFENSE units, however these are distributed only to authorized CD agencies.

A sample set of all 6 credentials (one of each, no CD included except for CD agencies) is available to collectors and also to those interested in obtaining larger lots for agency and department use. The sample set is \$3, postpaid. Bulk orders (may be all the same style or mixed, please specify) are at the rate of 35¢ per card for 10 to 25 pcs., 30¢ per card for 26 to 50 pcs., 20¢ per card for 51 to 100 pcs., 15¢ per card for more than 100 pcs. Dealers wanted. Order from CRB Research, P.O. Box 56-XR, Commack, N.Y. 11787.

(continued)



NEW CB ALARM

Would-be antenna thieves are in for a shock when they try to rip-off a mobile antenna protected by a Magitran Antenna Anti-Theft Alarm Activator.

This new accessory from The Magitran Company activates a car horn or auto alarm system the instant a protected antenna is lifted from its base. The CB 10-57 will work with any auto alarm system, car horn or for extended range an external trumpet or siren. As soon as a thief lifts your antenna, the activator triggers the appropriate alarm and keeps it going until you shut it off.

The CB 10-57 is compact and can easily be concealed inside the car—almost anywhere. It can be used with all grounded antennas having a base loading coil and is powered by the vehicle's regular battery.

For added protection, the CB 10-57 comes with an antenna retention strap that keeps the antenna attached to the vehicle even after it has been unscrewed and the thief flees.

Contact Magitran Co., Moonachie, N.J. 07074.

ROYCE DIGITAL READOUT MOBILE TRANSCEIVER

The Royce Model 1-660 incorporates THE WIRELESS chassis—Royce's revolutionary innovation in citizens band radio design. THE WIRELESS is a manufacturing procedure utilizing automated assembly of modules on modern production lines. Each module is automatically tuned and tested to strict computer programs. There are no wires connecting modules. Not one point on the modules or chassis is soldered by hand. And, each circuit module is mated to the master board by precision assembly techniques.

The Model 1-660 features: Digital readout dial that gives the channel selection in bright L.E.D. numerals; Gyro-Lock (PLL)—23 channel operation; large 1 3/8" x 3/8" S/R meter; exclusive IC audio stage with 6 watts RMS; amplified AGC circuit; three ceramic filters; dual conversion receiver plus tuned RF stage; metal case



RF output transistor; positive or negative ground operation for any vehicle, with plug-in DC cord; relay switching; L.E.D. transmit light; AMC circuit; fully variable squelch control; large 3" speaker; pushbutton ANL and PA/CB switches; full-size, plug-in mike; accessory jacks for external speaker, antenna, DC power cord; and a rugged, scuff-resistant vinyl-clad metal cabinet.

For more information, contact Royce Electronics Corporation, 1746 Levee Road, North Kansas City, Missouri 64116.



CB ANTENNA ELIMINATOR

Numark Electronics Corp. has developed and introduced their exclusive CB Antenna Eliminator, Model CB-160 (U.S. Pat. Pending).

The Numark Antenna Eliminator converts an AM car radio antenna to a perfect dual purpose antenna for radio and CB use. This device greatly reduces CB theft, and eliminates CB antenna vandalism. No additional CB antenna installation is necessary.

The CB-160 Antenna Eliminator features tunable SWR, easy installation, and dependable performance.

Numark reports that initial consumer response has been extraordinary.

Contact them at 503 Raritan Center, Edison, N.J. 08817.

(continued on page 46)

An Open Letter From Mike Dale of Palomar East Ltd. To: All Present and Prospective CB Dealers.

As you are all aware, there is a great deal of uncertainty at the consumer level concerning the present and future status of the CB Radio market. We receive hundreds of calls daily from our present dealers, and from many would-be dealers, all pertaining to the advisability of stocking inventory on twenty-three channel radios. We believe that it's our duty to keep our dealers aware of current market trends on the premise that a well-informed dealer is a valuable asset to the public as well as to his suppliers.

To begin with, I'd like to emphasize that the demand for twenty-three channel radios is not only remaining strong, it's actually growing every day. When the forty channel sets become available next year, there will probably be a tremendous demand for those twenty-three channel sets still available. The reasons are obvious; the twenty-three channel sets cost less, they are available for retrofit to forty channels in most cases, and the need for more than a few channels actually doesn't exist in most areas of the country. In fact, I wouldn't be a bit surprised if a demand for twenty-three channel sets were to build for several years yet,

much the same as the demand for six and twelve channel sets lasted for many years after the twenty-threes hit the market.

In addition, reliable sources predict that there will be no great abundance of forty channel sets well into 1977, and we can't visualize millions of new CBers waiting six months or more to get on the air. We at Palomar East have not curtailed our inventory of twenty-three channel sets; to the contrary, we have increased our inventory with the expectation of being a vital source to our dealers, present and future. We anticipate a drastic shortage of twenty-three channel sets beginning within the next month, and lasting well into next year. When that shortage occurs, Palomar East will be here to serve your needs—in all areas.

Unfortunately, the CB Radio Service has received some very unwarranted and erroneous bad press from several of the nation's largest newspapers. Reports that sun-spots will restrict CB usage are gross exaggerations designed to sell papers. So too, are reports that forty channel sets will make present sets obsolete. But the public has been exposed to these wild and incorrect statements, so it's up to us, as marketers to make the public aware of the true facts. If you need assistance in educating your consumer customers, call on us for help. We're here to service you in many ways, and that's just part of our job. This is what has made Palomar East one of the largest two-step distributors in the country, and why we'll continue to be just that. Your best supply for all your needs.



PALOMAR East Ltd.

Worldwide Electronic Distributors

Palomar Square, 80 Blaisdell Road, Orangeburg, N.Y. 10962
2629 North 24 Drive, Phoenix, Arizona 85009

For Speed Service: phone (914) 359-8800

Plus the new Arizona number: (602) 257-8404



SBE



COURIER



REGENCY

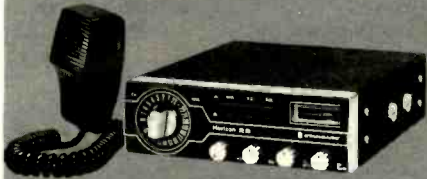

STANDARD



KRIS



XTAL



ROBYN



ROYCE



TEABERRY



HY-GAIN



TRAM



SILTRONIX



GEMTRONICS



PEARCE SIMPSON



PALOMAR



BROWNING



JOHNSON



PACE

**Palomar East stocks all these lines...
and many more!**



Wilson Electronics Corporation

TURNER



avanti



PALOMAR East Ltd.

Worldwide Electronic Distributors

Palomar Square, 80 Blaisdell Road, Orangeburg, N.Y. 10962
2629 North 24 Drive, Phoenix, Arizona 85009

For Speed Service: phone (914) 359-8800

Plus the new Arizona number: (602) 257-8404

new-tronics corporation



WISPEE PRIVACY SPEAKER

Prime Electronics, Inc., 8605 Quivira Road, Lenexa, Kansas, announced the introduction of the WISPEE CB mobile privacy speaker/external speaker. Normally worn comfortably over one ear, WISPEE becomes a highly efficient external speaker by hanging it on the rear view mirror and turning up the receiver volume. Either worn over one ear or hanging at ear level on the rear view mirror, WISPEE provides the user a substantial improvement in receive signal readability over an external speaker mounted under the dash (with the sound pointed at the floor or seat) or the average speaker found in a CB transceiver (same problem, only worse).

WISPEE solves the common problem of the wife or passenger not wanting to listen to the CB when the driver does (or vice versa) and the truck driver whose partner would rather sleep than listen to CB chatter all night. Improved receive signal readability plus privacy listening are provided by WISPEE. It plugs directly into the external speaker jack found on the rear of almost all CB transceivers. It's very rugged, built for many years of daily mobile use.

Unlike headphones built for home stereo use, WISPEE is designed with the CBer in mind. Common complaints associated with very pretty (but uncomfortable) stereo headphones that have one headphone removed to make them legal for mobile use are (1) they're too heavy, (2) the leather, plastic or rubber headband is extra hot and uncomfortable when worn outside, (3) frequency response is great for stereo music but only increases the volume of unwanted heterodynes and noise when listening to CB and (4) they're too expensive. WISPEE solves all this. It only

weighs four ounces (20% of a standard headphone), it has a specially designed thin metal headband and ear cushion for comfortable all day use, frequency response is electronically tailored to pass voice frequencies and tune out unwanted heterodynes and noise and WISPEE sell for only \$14.95 suggested retail! WISPEE carries a five year warranty and will be sold through CB and electronics dealers and distributors nationwide.



DOUBLE CB POWER LEGALLY AND REDUCE TVI!

Sound impossible? Not so. Its easy with the GBP-X2 Booster Power Supply from Glatzer Industries Corp. This looks like the first of a new breed of intelligent power supplies. Its sort of a dual voltage power supply. When you are receiving, it produces 12.6V, just right for good strong reception and making sure your rig runs cool. When you transmit this brainy power supply senses your need for extra power and supplies it . . . 15.6V, which just about doubles your power output. Its all legal, too, because all CB sets are capable of withstanding at least 15.6V without damage. In fact, it is not uncommon to get that much voltage out of a car with a fully charged battery and a good alternator. Think you'll have problems interfering with the neighbors' TV set with all this extra power? WRONG! The X2 has a built-in TVI filter which actually reduces TV interference by more than ten times. This rugged supply not only increases your power output, but its conservative design features a pass power transistor with over 100 watts dissipation for reserve capability. The unit is factory set for 15.6V. Internal screwdriver adjustment can produce even more power.

The people at Glatzer Industries aren't afraid to use something conservative if its best. As an example, they have included a fast acting fuse which provides absolute protection for your CB rig. Most power supplies merely limit the current they supply in the event of a shortcircuit or malfunction in your rig, hoping that you

For Spare Time Income, Your Own Business or a Career... LEARN TO SERVICE COMMUNICATIONS/CB EQUIPMENT...THE NRI WAY

Career opportunities are opening up fast for the man trained in communications.

The field of communications is bursting out all over. In Citizens Band alone, class "D" licenses grew from 1 to over 2.6 million in 1975, and the FCC projects about 15 million U.S. CB'ers by 1979. That means countless careers in design, installation and



CB Specialist Course now available

NRI now offers a special course in CB Servicing. You get 37 lessons, 8 reference texts, your own CB Transceiver, AC power supply and multimeter . . . for hands-on training. Also included are 14 coaching units to make it easy to get your commercial radio telephone FCC license—enabling you to test, install and service communications equipment.



maintenance. Start training now, the NRI way, to get your FCC license and qualify for one of these openings.

Learn on your own 400-channel, digitally-synthesized VHF Transceiver.

The NRI Complete Communications Course teaches you to service and adjust all types of two-way radio equipment (including CB), using the one unit that is best equipped to train you for CB,

Commercial, and Amateur communications: a digitally-synthesized 400-channel VHF transceiver and AC power supply. This 2-meter transceiver gives you "Power-On" training. Then we help you get your FCC Amateur License with special instructions so you can go on the air.

The complete program includes 48 lessons, 9 special reference texts, and 10 training kits. Also included are: your own electronics Discovery Lab, a new Antenna Applications Lab, an Optical Transmission System, CMOS Digital Frequency Counter, and TVOM. The course covers AM and FM Transmission Systems; Radar Principles; Marine, Aircraft, and Digital Electronics; and Mobile Communications. You must earn your first class radio telephone FCC license or you get your money back.

Over a million men have enrolled with NRI

Send for the free NRI catalog and discover why more than a million men like yourself have chosen the NRI way the right way to get ahead. Read how you learn from bite-size lessons, progressing at your own speed to your FCC license and then into the communications field of your choice. There's no obligation and no salesman will call.

Send coupon now for FREE NRI catalog



If coupon is missing, write to: NRI Schools, McGraw-Hill Continuing Education Center, 3939 Wisconsin Avenue, Washington, D.C. 20016

Rush the free catalog of my choice (select only one, please). No salesman will call.

- Complete Communications Electronics with CB • FCC Licenses • Aircraft, Mobile, Marine Electronics
- CB Specialists Course
- Amateur Radio
- Basic and Advanced
- Industrial and Business Electronics
- Digital Computer
- Electronics • Electronic Technology • Basic Electronics
- TV/Audio Servicing
- Choose from 5 courses
- Appliance Servicing
- Homeowner & Professional Repairs
- Automotive Mechanics
- Master Automotive Technician • Tune-Up and Basic Repairs
- Auto Air Conditioning
- Air Conditioning & Refrigeration
- Basic Air Conditioning Servicing • Master Course in Air Conditioning, Refrigeration & Heating



NRI SCHOOLS
McGraw-Hill Continuing Education Center
3939 Wisconsin Avenue,
Washington, D.C. 20016

38-017

APPROVED UNDER GI BILL if taken for career purposes.

Check box for details.

Name _____ Age _____
(Please Print)

Street _____

City/State/Zip _____

Accredited Member National Home Study Council

will detect the situation and be able to turn off the power supply before your expensive rig is destroyed. Not so with the X2. It uses a fast acting common fuse—the most proven reliable protective circuitry used in the electronic industry. As everyone knows, current limiting circuitry can fail just as easily as other circuitry, but when you overload it the old faithful fuse blows and protects your precious CB rig. As the people at GIC say, "Don't chance your rig to a transistorized current limiter. Be safe, be sure, trust a fuse and don't be sorry." They also remind us that at the present time current limiters are not approved for household protection, but fuses are.

Some power supplies sense the current and supply more voltage when you draw more current. This can be dangerous in the receive mode because the extra surge of current can blow out a speaker or damage an audio transistor. For your protection the X2 gives you extra power ONLY when you are transmitting.

So, if you really want the ultimate in CB'ing, bring your rig in with you, connect it up to a GBP-X2 power doubling power supply, and operate that big signal from the comfort of your home 20 without fear of upsetting the neighbors' TV.

Available from Glatzer Industries Corp., 268 Huguenot Street, New Rochelle, New York, 10801.



BASE STATION

Introducing the golden faced GTX-3000 23 channel CB Base Station. Aesthetically and functionally a beautiful unit backed with a one year warranty on all parts and labor.

A powerful, sturdy and comprehensive unit designed for base use. The GTX-3000 is 9" W x 13½" L x 4¾" H. It features a 5 watt maximum power input (4 watt output), and is frequency synthesized giving full 23 channel capability. A quiet, sensitive and selective receiver; a powerful and efficient transmitter, this handsome unit operates on 12 V D.C. or 120 V A.C. It includes a switchable noise blanker and switchable noise limiter, a digital clock, PA capability, PTT microphone, SWR and RF/S meters, 3 position delta tuning, squelch and RF gain controls.

For more information write: Gemtronics, Post Office Box 1408, Lake City, South Carolina, 29560.



GET THIS CATALOG!

Radio Shack's sensational new 1977 Electronics Catalog, featuring their exclusive line of products for home entertainment, hobbyists, CBers and experimenters, is now available from Radio Shack stores and dealers, nationwide.

The all-new 164-page catalog includes 100 full-color pages describing the company's complete line of products. Prices in the new catalog, which marks Radio Shack's 56th year in business, are reported to be, on the average, within 1% of the company's average 1975 prices.

Among the new items introduced in the catalog are: eight new stereo FM/AM receivers, led off by the Realistic STA-2000 75-watt per channel receiver, the Optimus T-100 Tower speaker system, the new LAB-300 tuntable and several new stereo tape cassette recorders.

Radio Shack is also introducing an all-new line of pocket calculators ranging in price from \$10.95 for a 5-function model, to \$39.95 for a scientific slide-rule calculator.

Other items featured in the catalog include: Realistic-brand CB two-way radios, automotive tape players, portable radios and scanning monitors, Archer antennas, Micronta test instruments and ArcherKit and Science Fair electronic and hobby kits.

In addition, the new catalog lists hundreds of specialized electronics items, parts and accessories, tools, tubes, semiconductors, wire and cable, home security products, intercoms, microphones, timers, batteries and a complete library of Radio Shack's own books on electronics and related subjects.

The catalog also includes bonus coupons good for a 50% savings on the company's own Supertape and Realistic brands of tape, and a coupon worth \$1.00 on the purchase of their \$1.25 book, All About CB Two-Way Radio.

In announcing the new catalog, Radio Shack president Lewis Kornfeld stated: "That great old American institution, the Radio Shack catalog, has just been published again, entirely revised, available in all our stores, and still free! Free to you. To us it represents an investment over \$3 million.

"The total printing comes to 2,132,000,000 pages," Kornfeld continued. "Stretched end to end: 1,777,777,777 linear feet or 336,700 miles, or 13.525347 times around the world at the equator. The new 1977 edition consumed 3787.5 tons of paper and 1,222,000 pounds of ink. These statistics are revealed to discourage our competition. And to give cheer to America's postmen who don't have to deliver the catalog since none are mailed—you'll have to get your copy at one of our stores."

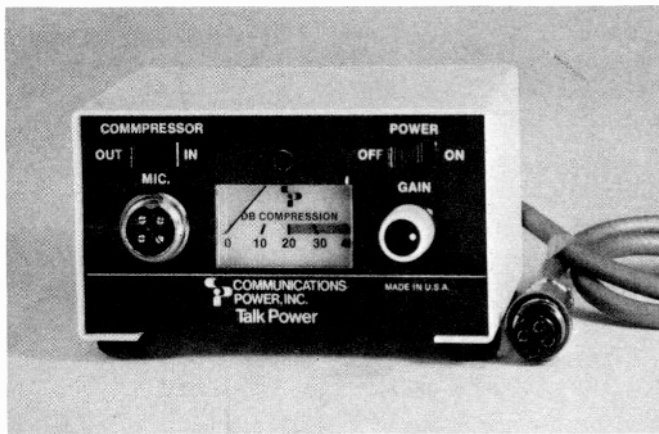

SPEECH PROCESSOR

A new, add-on speech processor from Communications Power, Inc., can provide a substantial increase in average speech talk power for CB transceivers without "spillover" and with minimum distortion.

Termed "Talk Power", this All-American-made logarithmic speech compressor plugs into existing 4-conductor microphone receptacle, requires no other CB set connections or alterations. Existing microphone is retained.

Solderless internal patch panel adjusts for different microphone connections. Panel meter simplifies, monitors correct compressor gain setting. Operating power can be either from vehicle battery or AC mains. Small: Only 2 $\frac{5}{8}$ "H, 4 $\frac{7}{8}$ "W, 3 $\frac{1}{4}$ "D. Price range: \$69.95.

For literature/information, contact Communications Power, Inc., 2407 Charleston Road, Mountain View, CA 94043 (415) 965-2623.

BROWNING INTRODUCES NEW POWER SUPPLY

The PS-200R, an all new regulated Power Supply priced at \$39.50, has been introduced by Browning Laboratories, Inc.

Model PS-200R is a very important addition to this company's select line of Citizens Band accessories. Browning now offers the customer the use of 12V



DC mobiles in the home with no worry of unstable power.

The unit's stabilized voltage supply offers "Hum" free operation and improved filtering for extended component life. This Power Supply is recommended for all mobiles, and works exceptionally well with SSB operation where the No Load to Full Load demand is quite large.

The PS-200R measures 6.5" D x 4.75" W x 3" H with a shipping weight of 4 lb. 3 oz. For more information, write Browning Laboratories, Inc., Laconia, New Hampshire 03246.

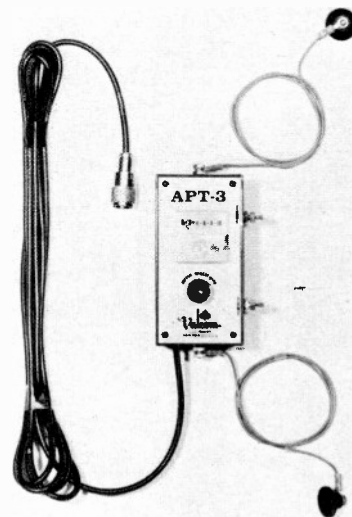

'SHOESTRING ANTENNA'

With thefts up on car CB units, more owners are bringing their mobile units inside at night. For putting the "ears up" in an apartment (many leases carry "no CB antenna" clauses in small print), home, or business office, try the Valcom, Inc. APT-3 "Shoestring Antenna," a tunable-base antenna for citizen band radios. The unit attaches to any metal-free window or wall by suction cups with one "shoestring" antenna suction-cupped 33 inches above and one 33 inches below or to the side. A 12-foot cable attaches to the CB unit which, naturally, must also have an independent power supply. The gain on the unit is equal in distance to that of a mobile antenna on a car. The only alternatives to the inside \$29.95 APT-3 are outside-mounted Marine Antennas or the rooftop antenna. The unit is available from Valcom, Inc., 607 West Amador Avenue, Las Cruces, New Mexico 88001.

(continued on page 116)

ROCK STAR ON THE RIG

by Tom Kneitel/TOMCAT, S9's Editor



FOR sure, CB is BIG business—and many who are prominent in the public eye have recently come into CB radio, not only as a means of communications, but also as a good means of getting some personal publicity, since the news media eagerly seeks to produce personal interest stories for a public which is hungry for CB news.

As a result, a great many of the CB good buddies you see in publications and on TV, mike in hand and posing for the cameras, had learned about CB perhaps only minutes before the cameras started doing their thing! No harm done, but it makes a lot of people sort of wonder if there were any newsworthy people into CB *before* it became such an *in* thing!

Well, I've got news for you—there were several, and one guy in particular has been around on the channels for a lot of years—and a good buddy of mine for more of those years than you can shake an antenna at. Unfortunately he has been so busy with his career that I haven't had too many chances to pin him down to do the smiling in front of the camera lens with the microphone routine.

So it was especially refreshing when after much trying to pin him down for a few quotes and photos, I was finally able to zero in on Gary U.S. Bonds—known to fellow CB'ers as *Baby Cakes*.

A ROCK & ROLL REVIVAL CHILD

Now, if you're into pop music, Gary's name will immediately bring into sharp focus a lot of top tunes, plus about 6 which were gold (million selling) platters—*New Orleans*; *Quarter To Three*; *School Is Out*; *Dear Lady Twist*; *Seven Day Weekend*; *Twist Twist Twist Senora*. If you're into funky flicks, Gary was featured in movies like *Don't Knock The Twist*; *Beach Party Twist*; and *Two Tickets To Paris*.

If your a watcher of the tube, for the past 16 years or so you've been eyeballing Gary on *The Tonight Show*, *Upbeat*, *What's My Line*—and if you're really into TV, you can't help but recall the many times Gary broke it up on *Dick Clark's American Bandstand*. In addition, Gary has starred at the Flamingo Hotel in Las Vegas, the Newport Hotel in Miami, Madison Square Garden in New York (3 times), every major club in the U.S., Canada, and Europe, and countless performances at conventions, stage shows, industrial shows.



Rock superstar Gary U.S. Bonds has been a busy entertainer for many years now—but he's also been an active CB'er for a good many years!

And, when he has a few moments of time not in front of a camera or audience, Gary U.S. Bonds has been known to write a bit of music. An accomplished and established songwriter, Gary's song *She's All I Got* was nominated for best song of the year, and Gary himself was up for best songwriter at the 1972 Country Music Awards. *She's All I Got* was eventually recorded by at least 22 artists.

So you can see why he's a hard guy to catch up with—in fact after a dozen double-L's to Gary's 20 (and even manager) to pin him down for some photos, and being told, "Yes, Gary wants to talk to you—but right now he's in London (or Kansas City, Toronto, Atlanta, Chicago, etc.—take your pick), but he'll get back to you," I decided that it was almost a lost cause. I had an ace in the hole, for I knew that there was one *sure* way I'd hook up with Gary without having to get through the barrier of assorted buffer people which are apparently necessary to surround many popular performers.

Y'see—for about 15 years now, Gary has been a CB buff—that's how I first met him, and that's how I knew I'd eventually hook up with him again—for Gary U.S. Bonds is most definitely an active CB'er—and I mean active, base and mobile, both AM and single sideband!

A LITTLE ENGINE TROUBLE

I guess it was in 1963 that I became possessed by a strange obsession to own a vintage *Jaguar* car. I was testing out my prize by driving (or at least *attempting* to drive) it from New York City to see some people in Cleveland. The testy old *Jag* got only a part of the way through Pennsylvania when it casually *chugged* and *gurgled* a few times and coasted to a dead stop, absolutely refusing to do anything more than *clunk* or *whirr* upon all attempts to get it started again. There was nothing left to do but get on the CB rig to summon help—and after countless attempts on each available channel I got to figuring that maybe the CB rig had caught the same disease as the *Jag*.

On my final shout I got a response—someone had obviously recognized the panic in my voice as I faced the prospect of spending the night in the wilds of rural Pennsylvania. Help was on the way—and when I saw a large bus type vehicle sporting a CB whip

Dealers, Here are 7 good reasons why Centennial is your best single source for all your CB needs...

1 Centennial stocks virtually every major brand of radio, antenna and accessory in depth. This means that you can order whatever you need, when you need it, and be assured of immediate delivery.

2 Centennial stocks all major brands in such large quantities that the savings we enjoy are passed on to you with the best competitive prices in the industry.

3 Centennial has specialized in CB and personal communications for more than fifteen years. Our experience and guidance can save you valuable time and dollars.

Electra Bearcat



Bearcat III



Bearcat 8



Bearcat 101

Bearcat Portable Scanner



Bearcat IV

Centennial Communications Inc.
585 Yonkers Avenue, Yonkers, N.Y. 10704

Our 35th year in business

Dealers ask for Johnny or Len

914/476-2100

4 Centennial

maintains a full-time working staff of trained CB sales experts. This means instant service when you call or drop in to place your CB equipment orders.

5 Centennial

backs up every product sold with superior service. You need never worry about being stuck with inferior merchandise or factory rejects. —The most liberal dealer policy in the industry.

6 Centennial

plans to remain in the CB two-step business for many years. When the late comers have abandoned the market, we'll still be here to serve you.

7 Centennial

sales and service personnel love their work. We enjoy dealing with our dealer customers. This is reflected by the cordial and courteous reception we extend to all our customers, no matter how large or small.



Plus
AFS ■ Anixter Mark ■ Antenna Specialists ■ Avanti ■ Cobra ■ Cush Craft ■ Electra ■ Francis
Midland ■ Mosley ■ Mura ■ New Tronics ■ Pearce Simpson ■ Regency ■ Robyn ■ Royce
Shakespeare ■ Standard ■ Tennelec ■ Turner ■ Wilson ■ Xtal and many more!

Centennial
Communications Inc.
585 Yonkers Avenue, Yonkers, N.Y. 10704

Our 35th year in business
Dealers ask for Johnny or Len 914/476-2100



Gary has shown deep concern for the betterment of the CB service—he has been known to remind more advanced rule violators that they may be causing interference to others.

An inveterate tinkerer, Gary is constantly "fixing and adjusting" even though he seldom has any real gripes about his installation, he just likes to keep "improving" it.



lumbering towards me I knew that help had arrived. In fact it was a group of musicians enroute to a concert in Cleveland when my call popped through their rig.

I disremember what the exact car problem was, but the bass guitar player knew how to patch it up with a spare electric guitar string—suggesting that it wasn't too permanent a repair. The head of the group, the one who had spoken to me on the CB, told me that I had better not stray too far from his bus until we all arrived at Cleveland. To tell the truth, he told me that his name was Gary, and in my moment of vehicular crisis, I was too caught up in my own problems to either recognize him or seek out further ID. Little did I realize that I was tagging along in back of Gary U.S. Bonds, a heavy-weight rock star who was shortly to be welcomed lovingly into the waiting arms of several thousand near-hysterical fans.

So on the way we chatted (via CB) and I learned that *Baby Cakes* always travelled with his ears on and that he was happy to learn that I was the Editor of *S9 Magazine* since he was an *S9* reader who had some rather strong opinions against some particular editorial stand I was taking at the time.

It was when we arrived at the theatre in Cleveland that I realized that Gary wasn't simply one of the guys in the band, but someone whose music had been



BABY CAKES doing his thing—over the years Gary has made a galaxy of on-the-air friends via CB, both via AM and SSB, from both base and mobile. Here he is shown from the mobile unit which is used to transport his band's musical instruments from one concert to another.

While we were shooting these pictures a 10-33 crackled through the handset of Gary's Realistic TRC-53 mobile rig—expressing serious concern, for a few minutes there (until another operator announced that he was on the scene) it appeared that BABY CAKES was going to be cutting out to lend a hand if needed.

familiar to me and most other people for a couple of years. I was impressed—and especially in that he wasn't what I would have imagined a rather important entertainment personality to be—he was—well, a *regular guy*.

So Gary went to do his gig, and I went to see the people I had driven to Cleveland for, and also to see about getting the car fixed. Unfortunately, I sadly learned that (at least in Cleveland) one does not readily obtain replacement parts for ancient foreign cars. In fact, I couldn't get the car fixed at all.

I had little to fall back upon but to return to the stage door at Gary's show and humbly ask him if I could tag along on his return trip to New York. He happily agreed and as I followed him on the road we again talked (via CB) about a vast array of topics. We got to be buddies, and over the years the friendship has continued both on and off the channels.

SIDEBAND TOO

In 1964 I had been tinkering around with one of the early sideband rigs which had appeared on the market—only to learn that Gary had one too. In fact, he was one of a handful of fellows in the New York area who were into sideband at the time—a group which got together that year and became the popular *SSB Network*, which still exists. Gary's original SSB ID number was SSB-17 (he still carries it). Gary is also known on sideband in the Long Island area from his base station as CLI-837 (he's a member of the Central Long Island Division of the Central Radio Communications Club, a



group now sporting about 4,500 or so members in the New York area).

From his mobile unit, Gary is on AM-side—finding CB useful for the times he's mobilizing along between a hectic schedule of tours, concerts, shows, TV shows, etc. For really distant quickie appearances, Gary flies to his engagements and the band leaves a few days earlier in the bus with all of the instruments. But, more often than not, it's *Baby Cakes* himself at the mike—and he can be quite a ratchet jaw.

CONTACT, AT LAST

So I simply waited for Gary to show up on the CB channels as I knew he would—and sure enough there he was one afternoon checking out a new rig he was installing in his mobile unit. I quickly went back to him and in a few minutes I was over at his 20 eyeballing his new rig, a Realistic (Radio Shack) TRC-56 CB-FONE 23, the mobile set with the slick telephone type handset, plus a pair of Realistic twin trucker antennas. Gary was really worked up about the equipment—it had been sitting there waiting for about two months until he had the time to install it! Gary told me that a call to me was next on his list anyway, but he simply couldn't wait to get that new rig on the air—you know that feeling!

"*Baby Cakes*," he said to me (*Baby Cakes* not only is his CB handle, but also the name he calls most people he knows—although he does sometimes use a special

"Autographs, right now? Can't I just clear with the station on the other end of the line?" Gary is constantly surrounded by a throng of fans—many know that he's an active CB'er and try to shout him on the channels when they learn he's appearing in their community.



name for me which I think would probably be a bit tacky in print). "It's been too long since we had a chance to modulate!"

I agreed—and since it had been 2 or 3 months since our last chance to chat, I asked Gary what he thought about the state of CB. "I really dig it—ten or even five years ago we were all wondering if CB would ever get discovered by the general public then—bingo—look what happened! I sit by my rig in total amazement at all of the fellows and gals on the channels today—those 17 new channels are here none too soon to handle the load!"

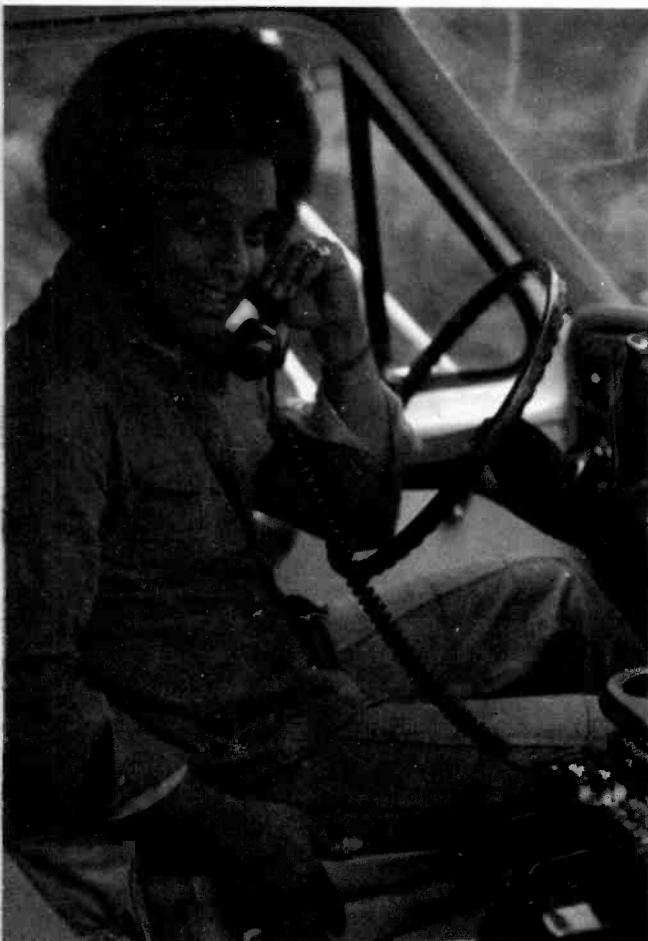

Gary enjoys hearing a shortie break from one of his good buddies, RED LABEL, who popped through to say hello and remind BABY CAKES about an inside joke they've had going about TOMCAT for several years.

Did he have any complaints? "Well, said *Baby Cakes*, after a few seconds of contemplation, "I think that some of the people tend to get a little too impatient with others on the channels—sometimes they hassle—and that's not really in the spirit of CB. So I'd have to say that rudeness and short tempers would be my major complaints, but I think that everybody on the band eventually learns that friendship is the name of the game and it isn't too long before they figure out how we do it here."

Gary on equipment: "Look at it! (pointing to the newly installed rig) It's just beautiful! Equipment de-



Portrait of a dedicated CB'er, Gary U.S. Bonds, always ready to extend the hand of friendship and aid—BABY CAKES has been a CB'er for about 15 years now!

sign had been progressing along at its own leisurely pace when CB caught on with the public then it seemed as if the manufacturers were all out to outdo everybody else to capture the market. When I look at sets like this one I can't imagine what they can think of to offer next!"

Gary on sideband: "I was a bit let down when the FCC announced the new channels. Along with many other guys I had hoped that sidebanders were going to get a few channels set aside for our own exclusive use—center slot is already groaning under the load and it's getting worse by the minute. I'm hoping that sidebanders will stake out a few of the new channels, say Channels 36 through 40."

And what does *Baby Cakes* have on tap for the immediate future? Well, he's one of the judges in Radio Shack's \$100,000 Realistic Song Search Contest which recently ended—and with 8,000 entries on hand that seems to be a healthy project. "You should hear some of those songs," he comments, "they're really good, very professional!" Besides this monumental undertaking, there are an unusually heavy concentration of concerts and club bookings coming up—and all of the good buddies may shortly be given a rare treat—a CB song from the maestro himself—but Gary has something special in the works. Even the ol' *Tomcat* has tossed in a few cents' worth on that project. I think you'll really dig it!

So, next time you catch a glimpse of superstar Gary U.S. Bonds wowing an audience—keep in mind that there's a good possibility that he may be itching to finish up his encores and get back on that new CB rig—the slick Realistic with the telephone handset.

Baby Cakes, we'll definitely be looking forward to modulating with you!

NOW YOU CAN REGISTER YOUR HANDLE

THE ONLY NATIONAL REGISTRATION YOU NEED

First we search our files to see if your requested handle is available.

Then we register your handle.

YOUR HANDLE IS REGISTERED WITH THE

National Bureau of Search and Call Registration

Box 1976 INTERNATIONAL FALLS, MINN. 56649

00001

IS REGISTERED WITH THE

National Bureau of Search and Call Registration

Box 1976 INTERNATIONAL FALLS, MINN. 56649

00001

RECOGNIZED AS THE ONLY RIGHTFUL USER OF THE HANDLE

SIGNAL SUCKER

BY THE

National Bureau of Search and Call Registration

Non-governmental clearing and registration house serving the CB Fraternity since 1958

National Bureau of Search and Call Registration

Box 1976
International Falls,
Minnesota 65549

\$2⁰⁰

**OVER
300,000
HANDLES
ALREADY**

MAIL THIS INFORMATION TODAY

- Registration avoids confusion over multiple use of the same handle.
- Establishes your claim to prior usage under law.
- Each handle is registered to only one person in the country.
- All bureau records are absolutely confidential.
- The bureau is not a government agency.
- Your registration is a beautiful document suitable for framing.
- Registration fee is \$2.00.
- Your fee is returned if your requested handle is unregistrable due to prior registration.
- Your handle can be changed at any future date, free of charge, by simply returning your registration document along with your request for a new handle.

Enclose Check for \$2.00 + 25 cents postage

National Bureau of Search and Call Registration

Box 1976
International Falls, MN 56649

FIRST NAME INIT

LAST NAME

NUMBER AND STREET

CITY STATE ZIP

REQUESTED HANDLE

IS THIS HANDLE BEING HELD FOR YOU YES NO

WOULD YOU LIKE ADDITIONAL FORMS FOR FRIENDS YES NO

WOULD YOU LIKE A GROUP OR CLUB REGISTRATION KIT YES NO

\$2⁰⁰

Shakespeare

**THE ROYAL LINE
OF FIBERGLASS
ANTENNA**

Style 4104

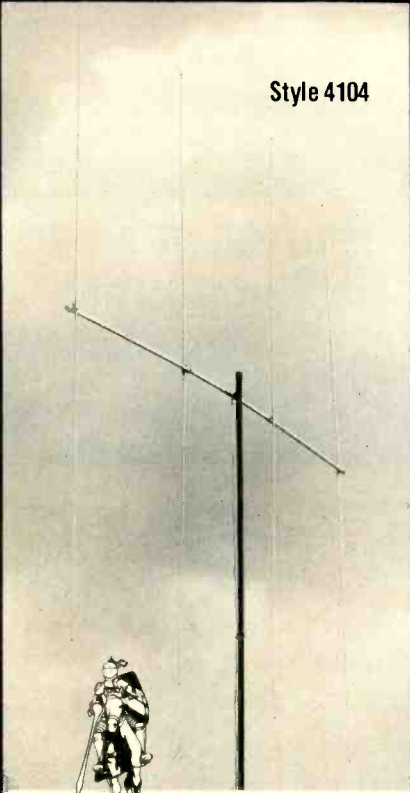

**MegaBeamTM
Antenna**

Shakespeare introduces the first and only fiberglass directional beam antenna for base station CB operation.

Exclusive Shakespeare fiberglass tapered elements screw in place simply and firmly. No drooping or bent elements on this beam. And fiberglass elements reduce precipitation static better than aluminum or stainless steel.

This wide spaced beam, designed for maximum performance, breaks apart at mid-point for easy shipping or storage. Takes corrosion, wind and ice with no damage at all to reception. And comes complete with pretuned phasing harness. MegaBeam Antenna sets a new standard in directional beam antennas.

Shakespeare

The Shakespeare Company/Antenna Group,
P. O. Box 246, Columbia, S.C. 29202
In Canada: Len Finkler, Ltd., Downsview, Ont.

**S9 CB
RADIO**

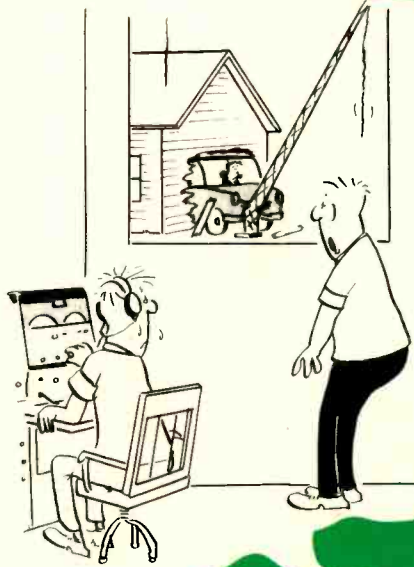

"I think I know why your rig won't load up."

**CARTOON
CORNER**

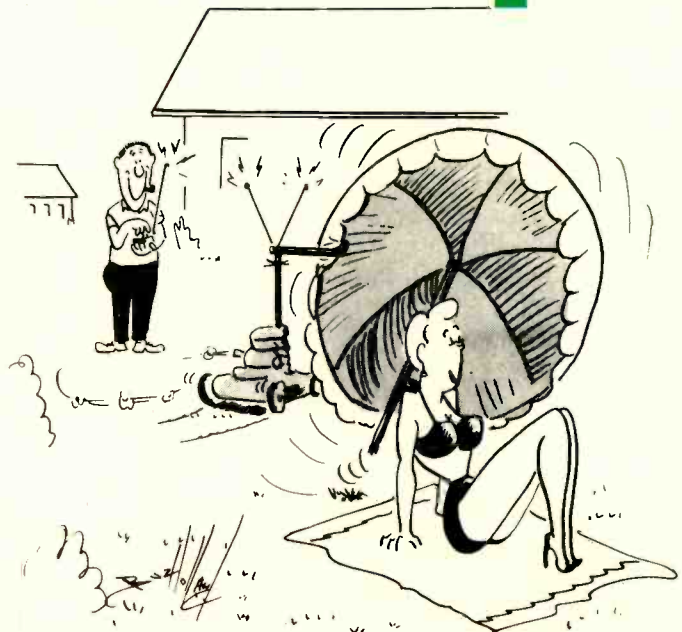

Sooner or later you're gonna be up to your ears in heavy traffic, endless static, and bein' walked on.

Ham it up with the S225.

The "S" stands for *synthesized*, which means you get the whole band, without the need for expensive crystals. The first "2" means this band is in the 2-meter wavelength area of the spectrum. And the "25" tells you power output, variable from 1 to 25 watts, continuous wave. AMCOMM's S 2 25. The most advanced, synthesized VHF-FM transceiver available, providing communication capabilities CB can't approach.

A taste of honey.

800 channels. Not 23, or 40 but EIGHT HUNDRED channels, of virtually static free FM communication. With this choice of frequencies available, why are you still waiting to break? If the 25 watt output power of the S 2 25 isn't enough, it can be amplified up to one KILOWATT, legally. But with the S 2 25 that isn't necessary, due to an impressive device called a *repeater*, which is capable of transmitting and receiving signals concurrently.

The S 2 25 has a range of 20 to 30 miles, and a repeater 25 or 30 miles away can rebroadcast your signal 30 to 40 miles, to the "other side". That's a total of 70 miles.

The AMCOMM connection.

The S 2 25 has an optional accessory which in conjunction with a repeater, will enable you to call home *without* your having a base station. The device with push buttons is a *touch-tone encoder*. It allows you to communicate with anyone having access to a telephone in the repeater's local calling area. (Limited to non-business communication). These repeaters are maintained by amateur radio clubs, and you as a member of one club would enjoy this advantage all over the country, through automatic "courtesy membership" in all repeater clubs. With the addition of the touch-tone encoder, your S 2 25 combines the mobility of radio with the accessibility of the telephone system. No base station. No mobile operator. And no phone bill which reads like the Gross National Product.

Seizin' of the switch.

It appears now that many people want something *beyond* CB, such as the ham communication features of the S 2 25. In view of the growing interest in ham radio, the American Radio Relay League (ARRL) expects thousands of CBers to cross over to amateur radio next year. And to make it easier for you to get started, they have put together a basic course package, including an orientation manual, a Morse code practice cassette, and a U.S. call area wall map. You can get this package from your dealer in exchange for seven of your hard earned dollars, or, you can

Stash the cash.

When you purchase the AMCOMM S 2 25, we'll give you this ARRL package free and include the official ARRL License Manual. All the information you'll need to get your Technician Class ticket. Bodacious, indeed! For more information write to Steve Fried, V.P., AMCOMM, 730 W. McNab Road Fort Lauderdale, Florida 33309.

800 CHANNELS. 25 WATTS. LEGAL.



Look Out for CURVES

Some curves are nice . . . but in CB, they spell trouble. The new 40-channel models require a true broad-band antenna with a flat SWR curve if you want the best transmission and reception over all 40 channels. You'll find the answer in a completely new antenna called the . . .



antler
Super-Broad
Best for all 23 and 40 channel CB's

For every channel, you'll find less variation . . . so broad and flat that you'll think your SWR meter is stuck.* And . . . the efficiency delivered by the new Antler is wall-to-wall and tree-top-tall. For the new 40's . . . or your present 23 channel CB. You'll be pushing a signal that slashes through the clatter and chatter of today's CB airways.

Got your Antlers on?



*Every CB installation uses the ground plane of the auto body causing variations in SWR and efficiency . . . but tests prove that Antler out performs other antennas in most installations.

Model
1C90



BETTER THAN SWR?

Someone once told me that there is a better way of getting maximum performance from a CB antenna than by using an SWR meter when tuning up. Is this true, and if so, what else might be used instead of the SWR meter. Isn't SWR the all-important factor?

Easy Slider (Unit 966-J)
Kokomo, Indiana

We're not sure what they had in mind, but another way which is popular is forgetting about the minimum SWR and trying for maximum signal output—after all maximum signal is what it's all about anyway, isn't it? It can happen that your maximum signal output might not be hand-in-hand with the point in your tune-up where you have minimum SWR. So, instead of using an SWR meter, you might try tuning up by checking your outgoing signal on a Field Strength Meter (FSM) placed near the antenna. Trim the antenna radiating element in 1/4-inch steps until you hit a maximum FSM reading and that's the spot where you've got your best signal—regardless of SWR. Many operators have come to feel that this method is a more positive approach to the matter, and so long as the SWR isn't above 3:1 or so, the maximum signal approach beats being a slave to an SWR meter. Well, anyway, it's another approach.

TOGETHERNESS?

Your magazine has often mentioned that certain channels (most often Channels 16 and 18) are for Single Sideband (SSB) operation only and that AM operators should stay clear of them. Why? My license authorizes me to operate on any and all channels—what's the matter with my operating AM on these SSB channels? I honestly don't savvy.

Ron Marquardt (Band Blaster)
Orange, Texas

CB was founded upon cooperation and mutual respect. In recent years these precepts have been somewhat squashed into the ground, but they are still good to try to remember. AM and SSB transmission are not compatible on the same channel in a given local area, they interfere with one another. SSB operators seem far more able to live with AM interference than the other way around. SSB operators have long used their own favorite few channels in an effort to avoid lousing up AM transmissions—and to keep to themselves. Nobody tells you that you don't have the right to let a door slam in the face of the person entering it behind you, however common courtesy seems to call for taking the other person into consideration. There is no law against puffing cigar smoke into the face of another person, but many people would find it unthinking and inconsiderate. Likewise, no law exists which keeps AM operators off the few channels which the SSB operators use, however most operators seem to respect this unofficial agreement which has been in effect for more than 10 years. Of course, some operators don't give a damn—just as some folks let doors slam into the faces of those walking behind them. It's all a matter of a person's outlook on life and their consideration for others.

A PUZZLEMENT?

Why don't some CB'ers stop their car when they are asking for directions so you can tell them where to turn before they pass it? What is wrong with speaking English once in a while instead of trying to sound like Smokey with the 10-4's, 10-76's, 10-50's? Why does anyone think that overmodulation through a poorly adjusted power mike sounds better than a clear signal?

John B. Black
Spartanburg, S.C.

John, as soon as they're through solving the Riddle of the Sphinx, they have promised to tackle your questions!

UNIT NUMBER NEWS

I want to get one of those AM Unit Numbers everybody is using to identify their CB stations. Please let me know the details and how I can get some information on using these numbers.

Barbara Wolfe, (Bunny Nose)
Caldwell, Idaho

Your problem solved in a jiffy. You can get a unit number assigned for your own use, plus a neat looking 2-color Official Certificate of Registration which is inscribed with your Unit Number, the date of issue, and your AM handle; plus an exclusive report on how thousands of AM operators are now using Unit Number ID's for maximum coverage, fun, and effectiveness on the channels. Even though many S9 readers have recently "discovered" Unit Numbers, they have been around for a number of years. To get your own Unit Number assignment (or to register one you may already be using) and receive the Certificate and exclusive report, send \$2.95 and a self-addressed stamped return envelope to: Z-Tech Enterprises, P.O. Box 70-N, Hauppauge, NY 11787. Z-Tech has long been the central registry of all U.S. and Canadian stations using Unit Number ID's. By the way, if you are in a club which uses club membership numbers for AM ID's, you might wish to register these with Z-Tech, as many clubs are now doing—those seeking details, request this data when registering for your own number. It will be included.

BUDDY PACK

Sometimes when I receive a QSL card from another CB'er it is accompanied by several other QSL's from assorted CB'ers I never heard of—all packed into the same envelope with the card from the station I spoke to. I'm not quite certain as to what this is all about and would appreciate some clarification.

Kurt, UNIT 785-M
Imperial, Calif.

These are called "Buddy Packs"—and when you receive one you are getting a "hello" from several other friendly operators who didn't have a chance to speak with you. Sometimes a buddy pack will contain a handful of QSL cards all from the other operator himself, rather than from an assortment of his friends—in that case, he hopes that you will pass along some of his cards when you send your own QSL card out to other stations. If you want to send out buddy packs, ask your pals to let you have some of their cards to mail out with your own, or instead of sending another station only one of your cards, send him 6 or 10.

... Use S9 READER SERVICE.

This is the Legendary

FUZZBUSTER®

POLICE RADAR MONITOR



PEACE for the Professional Driver

(Ask any long-haul trucker . . . he'll tell you about it.)

A military type radar receiver that works two to ten times farther than radar. Parametric design provides unparalleled sensitivity, but rejects false signals. No installation or antenna. Adopts to positive or negative ground vehicles.

A unique AUDIO CUEING system announces radar lock-on with a short beep. The visual indicator is then used to estimate where and what type of speed trap is being encountered. The receiver is especially effective against the new moving radar.

Proven by thousands of truckers over billions of miles, nationwide, and now available to the general public!

IF IT DOESN'T SAY:



IT'S BOGUS!

DEDUCT 10% if you have paid a SPEED RADAR TICKET in the preceding 12 MONTHS. Send ticket or cancelled check with order. Copies O.K.; original returned.

Please rush me a Fuzzbuster. My check for \$89.95 is enclosed. Wenover Associates P.O. Box 231 Burlington, Mass. 01803

Name _____
Street _____
City _____
State _____ Zip _____

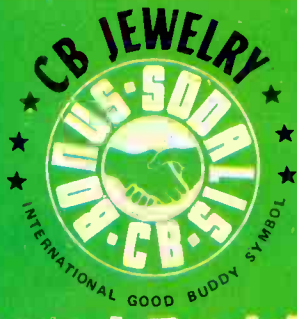

**Good Buddy
BONUS SODALIS™**

Regal Lapidaries, Inc.
BONUS SODALIS TRADE MARK OF REGAL LAPIDARIES INC.

All Rings are Solid Bronze 14kt. Gold Plated, Antiqued

BS MEN'S / LADIES RING



Solid bronze universal Good Buddy symbol.

503



502

\$14.⁹⁵

\$12.⁹⁵

CB RING



Solid bronze antiqued. Instant recognition of friendship anywhere.

303

\$9.⁹⁵

BS BELT BUCKLE

Handsomely minted in solid bronze.

\$9.⁹⁵

500



BS KEY CHAIN & PENDANT

504 # 501

\$4.⁹⁵ either or



Handsomely minted in solid bronze.

SPECIAL for CB CLUBS - Club name inscribed, inquire

Telephone (212) 758-8068

* Copyright 1976 Regal Lapidaries, Inc.

Check Item number box. Enclose check or money order payable to:

REGAL LAPIDARIES INC.
420 Madison Avenue
New York, N.Y. 10017

Check Item	Number Desired	Amount Enclosed
500 <input type="checkbox"/> Belt Buckle	_____	_____
503 <input type="checkbox"/> Men's Ring	_____	_____
502 <input type="checkbox"/> Ladies Ring	_____	_____
501 <input type="checkbox"/> Pendant	_____	_____
504 <input type="checkbox"/> Key Chain	_____	_____

All items except buckle available in Sterling - \$10.00 extra!

Total

DEALERS AGENTS - INQUIRE

Why it pays to buy CB equipment where you see the CEDA Seal



CEDA, the Communications Equipment Distributors Association, is composed of the major wholesalers in the personal communications industry, working together to maintain standards of quality, service and consumer protection.

When you see the CEDA Seal in a CB dealer's window, it means you've found a CB specialist, one you can trust, because he's pledged to uphold CEDA's standards. Associate Dealer Members of CEDA are equipped to handle your problems and answer your questions, and serve your CB needs not only before you buy, but *after*.

Look for the CEDA Seal before you buy. It pays.



COMMUNICATIONS EQUIPMENT DISTRIBUTORS ASSOCIATION

Dealers: Write for information on how to qualify as an Associate Dealer Member of CEDA



P. O. BOX 1118, CARBONDALE, IL, 62901;
OR PHONE (618) 549-1242.

A Lost Art: CB Etiquette

Have You Tried Doing It "By The Book?"

By **GARY DECKELNICK** (Baby Bull KCS 0994)

WHEN White Rock keyed the mike, he had no idea he was going to make instant enemies. A kindly man who coaches a Little League baseball team in his spare time, he would have taken great pains not to offend, had he only known how. But all he knew was that he wanted to talk to his friend, Mighty Mouth.

"Breaker, Breaker, one-nine, breakity broke," he said. "How about ya, Mighty Mouth. You got White Rock calling collect. Ya got your ears on? Come on?"

It was an all too typical start for a CB conversation these days. And White Rock was lucky, or unlucky, as the case may be.

"Go ahead, White Rock. You got Mighty Mouth here. We accept the charges, goodbuddy. Come on."

While they talked, two other hobbists fumed. They were the two that White Rock and Mighty Mouth had stepped on when they began their conversation. They needed only a few seconds more to finish talking and they were determined to get their time.

"Come on back, Big Moose," urged Big Mac, one of the two who had been stepped on. "They walked all over you."

It took two minutes for Big Mac and Big Moose to finish their conversation. When they finished, Big Moose stayed on the channel to transmit dead carriers. His only goal was to make things difficult for White Rock and Mighty Mouth.

"Go to one-eight," shouted Mighty Mouth, in obvious distress. "We got some joker here who don't want to let anyone else talk."

And neither White Rock nor Mighty Mouth understood why.

"That is one of the big problems with CB today," said a spokesman for the Federal Communications Commission. "We give the people a license with no test. We give them an instant, temporary license as soon as they buy their set. We require them to have the rules.

"But no one explains what the rules mean and no one teaches them anything about how to use a radio politely. Most CBers are good guys and they want to belong to the club. But they never understand what

they are doing is wrong. It's impolite. And that's worse than breaking the rules to most CBers."

To most persons buying their first CB—and there are hundreds of thousands of them now—the words "break" or "breaker" are the accepted ways of getting on a channel.

That's what it says in the booklets that many prospective hobbyists buy when they purchase their first sets. But the booklets don't really give an explanation of "break" or many of the other operating procedures all CBers should know.

"Break" means, "Excuse me, I'd like to interrupt," and it is used the same way as the phrase "excuse me" is used when a third party must interrupt a face-to-face conversation between two other persons. It's optional,



but if others are using the channel many operators say "break."

Just as the third person should not continue talking until he is excused, the breaker ought not to continue his radio conversation until he receives his break from those using the channel. If the channel is not in use, *no break is suggested!*

"It's clear when you put it like that," said White Rock, a high school history teacher, during a recent interview. "I never realized what the words meant. It's funny because this morning I scolded my son for interrupting and here I was doing the same thing. I never realized it."

The rules of etiquette are important to the future of CB radio because the channels are becoming crowded in metropolitan areas. But there still is more than enough air space if all hobbyists remember that CB works on shared time.

They may begin with the initial "break," but they don't stop there. It's important for the person requesting the break to identify his station, preferably by giving his call letters when he begins talking.

First of all, it's required by law. Anyone who fails to give a call sign invites a call from the Uncle Charlie. And there can be a more personal benefit. If your radio is slightly off frequency or if you're interfering with someone's television, your call letters provide a way of identifying you. A friend can ask you to correct your transmission problem before your nasty neighbor isn't so friendly about it. Even if you use your handle or a unit number, I suggest tossing in the FCC call sign too!

The persons using the channel have a responsibility too. Try to give the other station his break as rapidly as possible. If you must keep the breaker waiting, tell him so. A simple, "breaker acknowledged, please stand by" goes a long way toward keeping the breaker happy and your own conversation uninterrupted.

Remember, too, that it is usually proper for the break to be given only by a person who was talking when the break was requested. Go back to that face-to-face conversation again. A fourth person cannot give the third permission to interrupt the first two. But that is just what is happening when a break is granted by a person not talking.

However, that rule is sometimes avoidable. Occasionally, a break is requested by someone close at hand and the only talkers are a good distance away transmitting a weak signal. In that case, it's proper for someone nearby who is not talking to give the break. The chances are that the breaker will never interrupt the distant conversation.

It's also important to carefully select the channel on which you are going to talk. If you are operating a regular AM transceiver, try to avoid channels 16, and 18. If you are operating on SSB, try to restrict yourself to those channels.

Sure, there is no law requiring either the AM or the SSB operators to accept those restrictions. The FCC license gives any CB operator the right to use any of the channels.

But adopting the restrictions makes sense. A conventional AM transmission can interfere with SSB and

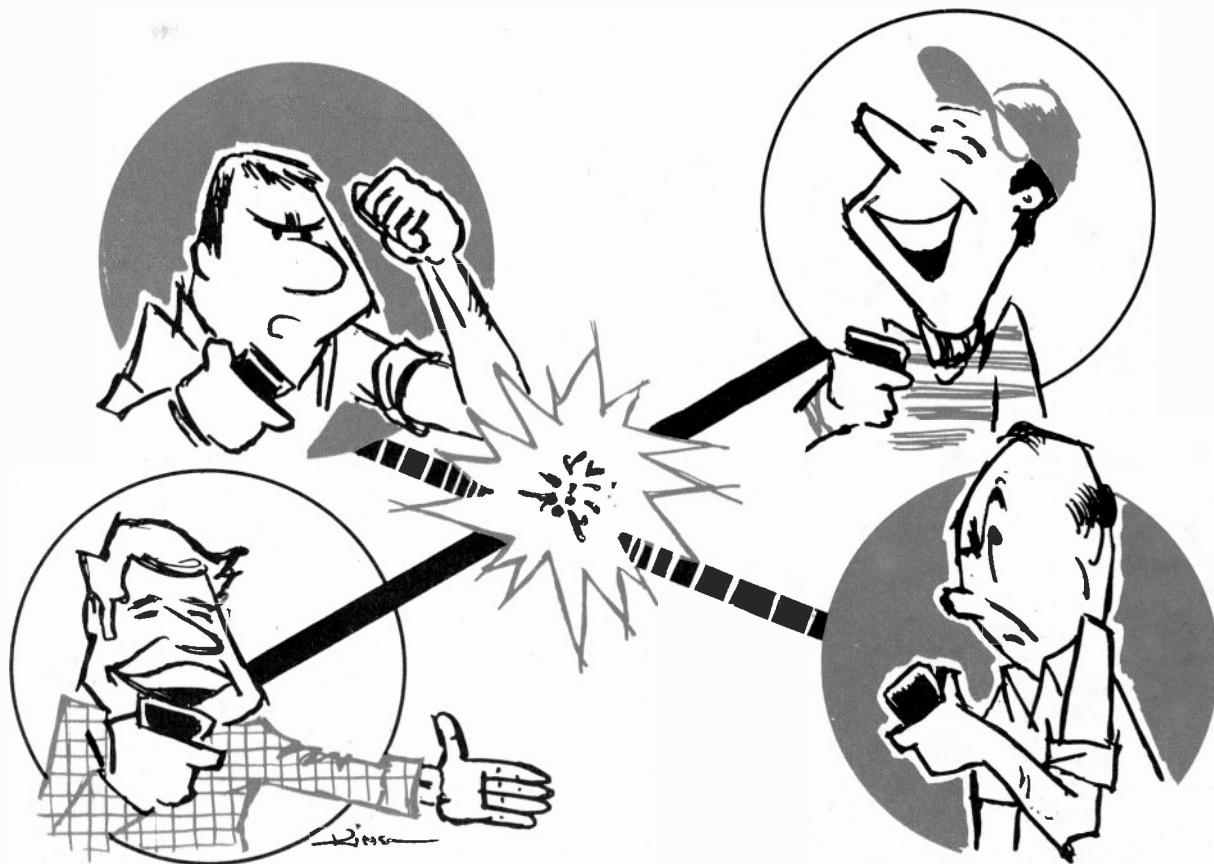

vice versa. But it's impossible to ask for a break because the two transmissions will not be understood by anyone not operating in the same mode.

The limits are suggested by various SSB organizations. Their members are willing to try and limit their conversations to those channels if the AM operators will keep them free.

And there are more restrictions.

If you're operating a big base station, with a high, power antenna, perhaps a beam, try to avoid channels 10, 12 and 19 as these are popular mobile transit channels. And stay off of Channel 9 unless it's an emergency.

Regardless of how polite you are, it is certain that you are going to meet a few people whose handles should be Obnoxious Ollie. When that happens, keep your cool. Big Moose was just as wrong for throwing those carriers around as White Rock was for the way he came on the channel.

Arguing on the radio or seeking revenge just makes life more difficult for other hobbyists merely trying to communicate. And that goes double for anyone who insists upon using profanity.

Assume in all your conversations that some family man is listening on his mobile with his 4-year-old daughter in the front seat.

The basis of CB radio must be cooperation. If it changes to competition, we'll all be stepped on.

ATTENTION CB'ers

NOW YOU CAN HAVE YOUR
C.B. SETS REPAIRED by
PROFESSIONALS!

- We will repair any AM C.B. set for \$25.00 plus parts.
- We will repair any SSB C.B. set for \$35.00 plus parts.
- All sets will be shipped back to you C.O.D. plus shipping within 72 hours after receipt.
- If we feel a set is beyond repair, it will be returned to you collect for shipping charges plus \$5.00 inspection fee.

Please include schematic, board layout, and instruction manual if you have them. They will be returned with repaired set.

CB REPAIR CENTER INC.
980 EAST 35 STR.
BROOKLYN, NEW YORK 11210
212-253-8787

Authorized warranty repair for
UNIMETRICS HYGAIN FANON/COURIER MIDLAND CRAIG ROSS
MOTOROLA GEMTRONICS ZODIAK WESTLAND COBRA KRIS

Manufacturers, distributors, sales outlets, we will
do your repairs, warranty & non warranty.

Please contact Leonard Krigin

Can You Believe Same Day Shipping?

90% of all dealer orders
placed before 2 p.m.
will be shipped on the same day.

We stock most
of the major brands
of C. B. radios and accessories.

We Are The Largest C. B. Distributor In Central Kansas

We have been
in the C. B. business
Since 1964

Direct all inquires to:

Clark's C. B.
Distributors, Inc.

1550 S. Broadway
Salina, Kansas 67401
(913) 825-7171

INTERESTED IN HAM RADIO?

Then
S9's
 Sister
 Publication

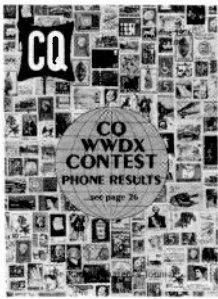

is for **YOU**

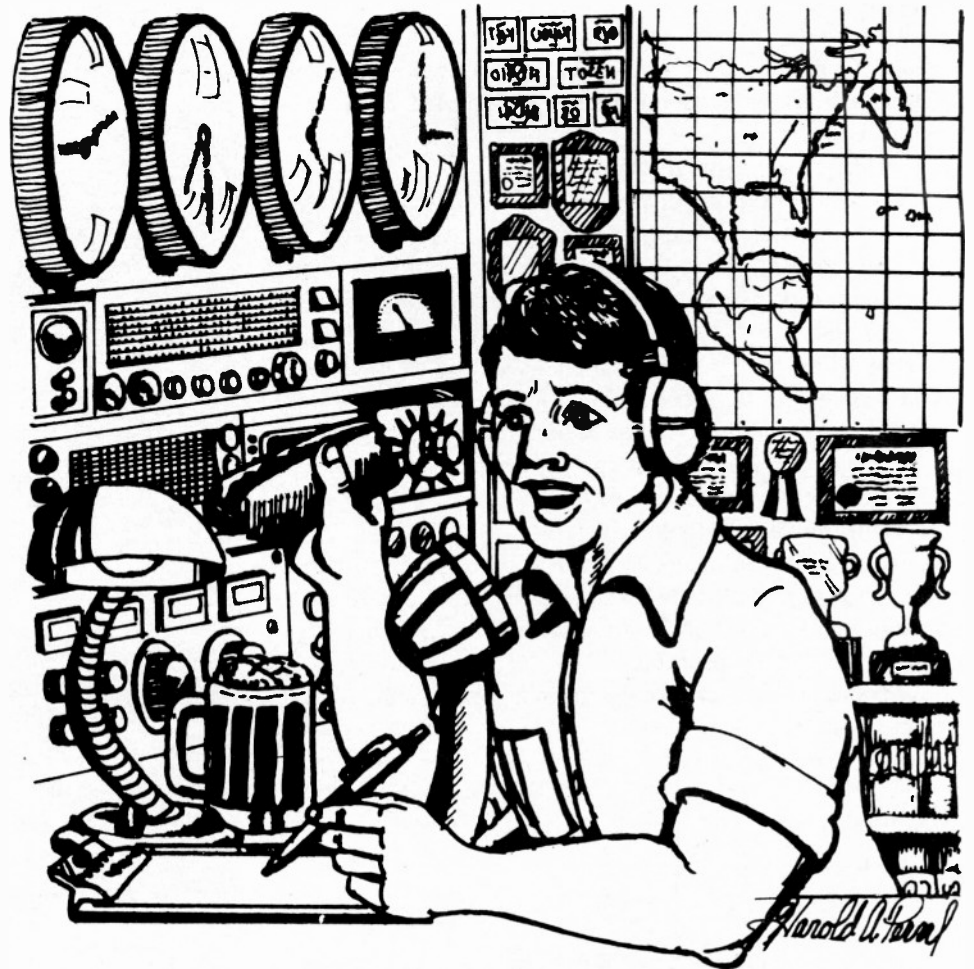

A recent survey of S9 readers indicated that two out of every three replying to our questionnaire would like to become an amateur radio operator. And we're all for that, because CQ, The Radio Amateur's Journal, is the oldest magazine in our company's stable.

CQ is not just another ham publication; it's the only ham publication aimed at the beginner as well as the old timer. It's the only ham magazine that recognizes that every new ham isn't an electronic engineer. The editorial features in CQ are aimed at people — people like yourself who turn to amateur radio as a means of having fun.

CQ caters primarily to the operating end of radio, with just a smattering of technical material to keep you up to date on what's happening. And even the technical portions of CQ are presented in a manner that every new amateur will understand.

In other words, CQ is the fun magazine in the amateur radio field. It's the amateur magazine that you'll enjoy from cover to cover. And remember, CQ is brought to you by the same folks who bring you S9. What more could you ask for?



The
 Radio
 Amateur's
 Journal
 Since 1945

14 Vanderventer Ave.
 Port Washington, L.I.,
 N.Y. 11050

Dear OM:

Enclosed please find \$for Year(s) Subscription to CQ,
 The Radio Amateur's Journal.

NEW: Start with issue
 RENEWAL

Name Call.....
 Address.....
 City State..... ZIP.....

	Domestic	Foreign
One year	<input type="checkbox"/> \$7.50	<input type="checkbox"/> \$8.50
Two years	<input type="checkbox"/> \$13.00	<input type="checkbox"/> \$15.00

CB-LOK:

Joe and John Booth of American Diversified Enterprises install CB radios on referral from major department stores and other CB retail outlets in Phoenix, Arizona

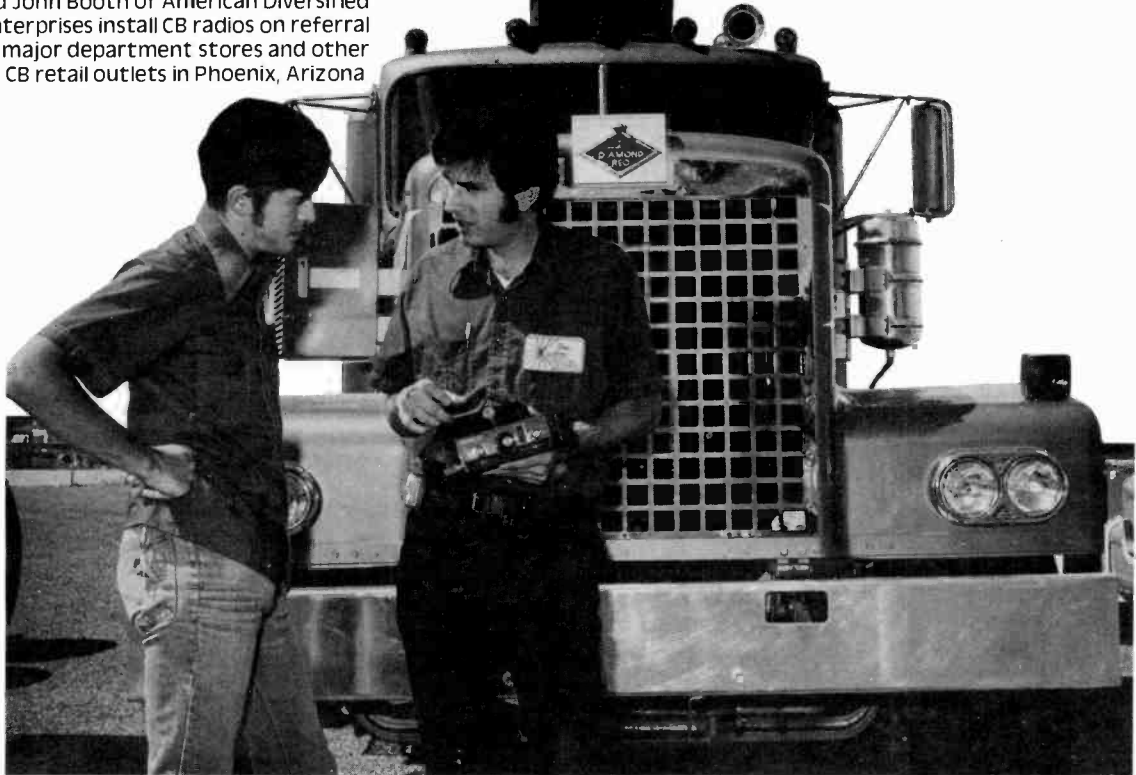

THE PROFESSIONALS' CHOICE

The Booth brothers have been installing CB units for years. They're pros. Small wonder they beat a path to our door the first time they saw CB-LOK.

The secret? Heavy gauge steel construction. A built-in pick-resistant lock. Hinged mounting brackets to hide all bolts and screws. A flat black urethane finish that looks great in any interior. Plus a complete line of accessories.

"CB-LOK's the best locking device on the market — and Joe and I have seen a lot of them. The idea of combining the slide and lock brackets makes CB-LOK simple, versatile and effective. It's a real crime deterrent!"

Protect your CB investment by taking a tip from the pros. Order CB-LOK now!



DASH OR ROOF & FLOOR MOUNT. Angled slope fits most cars or trucks. Makes inaccessible areas mountable.



QUIK DISCONNECT KIT. One connection does it all, hot wire, ground and antenna. Just plug and unplug.

COLAR SYSTEMS
119 Industrial Drive
Tempe, AZ 85281 (602) 967-1997

Please send me the following CB-LOK kit(s). Enclosed is \$_____. Money back guarantee if not fully satisfied.

- check money order
- ___ CB-LOK for units 4½" to 8" wide @ \$19.95
___ CB-LOK for units 8" to 12" wide @ \$21.95
___ CB-LOK catalog

NAME _____

ADDRESS _____

CITY _____ STATE _____

ZIP _____ PHONE _____

Made in U.S.A. Patent pending.

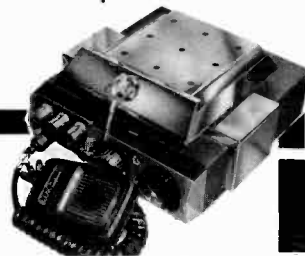

EXTRA MOUNTING PLATES. With the turn of a key you can switch your unit to a second vehicle, boat or home.



COLAR SYSTEMS
P.O. Box 3576
Scottsdale, AZ 85257
Phone: (602) 968-1345

PEARCE-SIMPSON COMES ROARING THROUGH THE CB JUNGLE.

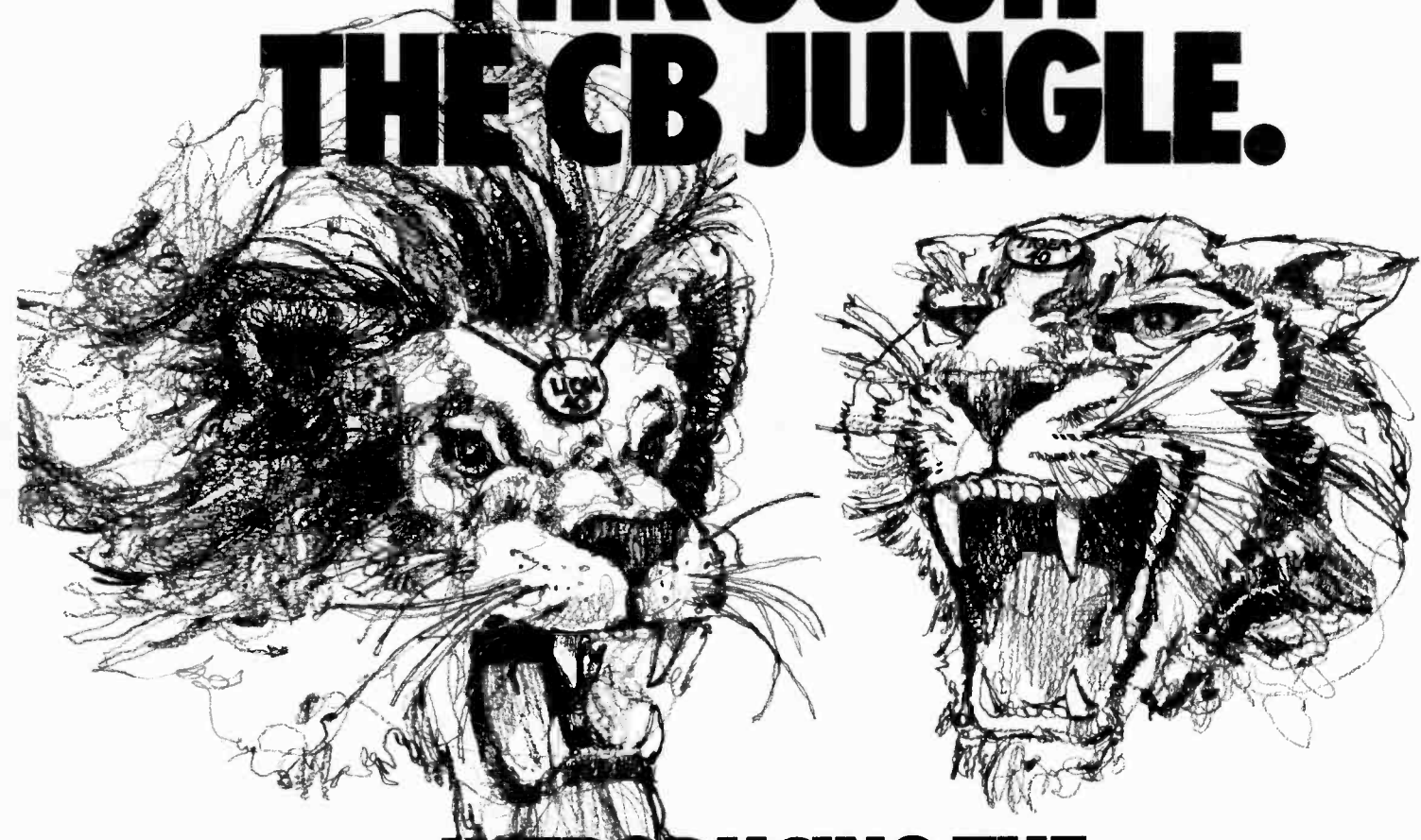

INTRODUCING THE LION 40™ AND TIGER 40™.

When the Lion and the Tiger speak, everybody in the CB jungle listens. Because our new 40-channel CBs have all the latest features to command attention. And they're both from Pearce-Simpson — a leader in personal communications for over a quarter of a century. So stop by your Pearce-Simpson dealer today. And make a Lion or a Tiger roar. For further information, write Pearce-Simpson, 4701 N.W. 77th Ave., Miami, FL 33166. In Canada, Scotcomm Radio, Inc., 4643 Levesque Blvd., Chomesday, Laval, Quebec.

PEARCE-SIMPSON
DIVISION OF **GLADDING CORPORATION**
THE CB RADIO • MARINE RADIO • ANTENNA PEOPLE.

At press time, we are obliged to make the following disclaimer: "These devices are not offered for sale until the anticipated formal approval of the FCC has been obtained."

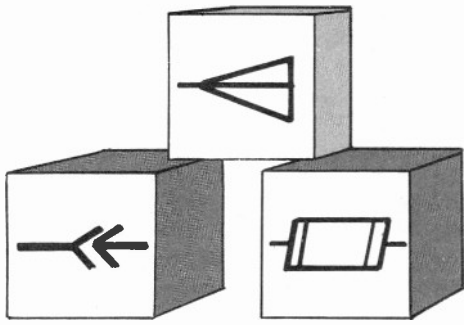

Basic Radio

by Irving Tepper

PART 6

Resistance and Ohm's Law

AFTER studying the fundamentals of magnetism, fixed magnets and electromagnets, it is now possible to understand the operation of a meter movement, the indicator portion of the multimeter (VOM) we have been working with. This device is an excellent example of the application of both the fixed magnet and the electromagnet. The type of meter movement we will discuss is the *D'Arsonval* also referred to as the *moving coil meter* or *galvanometer*. While the moving coil meter is basically a current indicating device, we will show how it is also used to read voltage and resistance.

Construction of the Moving Coil Meter
—The various parts of the D'Arsonval moving coil meter are shown in Fig.

3.16. The fixed magnetic system shown in (A) illustrates a horse-shoe magnet with *pole-pieces attached*. The purpose of the pole-pieces is to extend the magnetic poles as close as possible to the fixed core leaving only enough room between them to pass the moving coil.

Part (B) of Fig. 3.16 shows a top and side view of the moving coil portion of the meter movement. The electromagnet consists of several hundred turns of very fine copper wire wound around an aluminum form called a *bobbin*. The coil and form are shaped so that they fit over the fixed core in drawing (A) between the pole pieces, touching neither. The moving coil is held in place by the upper and lower pivots which turn freely in jewel bearings. Connections are made to the mov-

ing coil through the upper and lower coil springs. The coil springs also serve to position the moving coil and return it to its rest position after the moving coil has rotated. Attached to the moving coil is the *pointer* which is used to indicate the position of the moving coil. The short bottom end of the pointer has a small weight attached to counter-balance the weight of the long upper section thus reducing side wear on the bearings and pivots.

A completely assembled meter is shown in Fig. 3.16(C) indicating how the moving coil, the fixed core, pole pieces and horseshoe magnet are assembled.

Operation—The magnetic field pattern between the two pole-pieces is shown

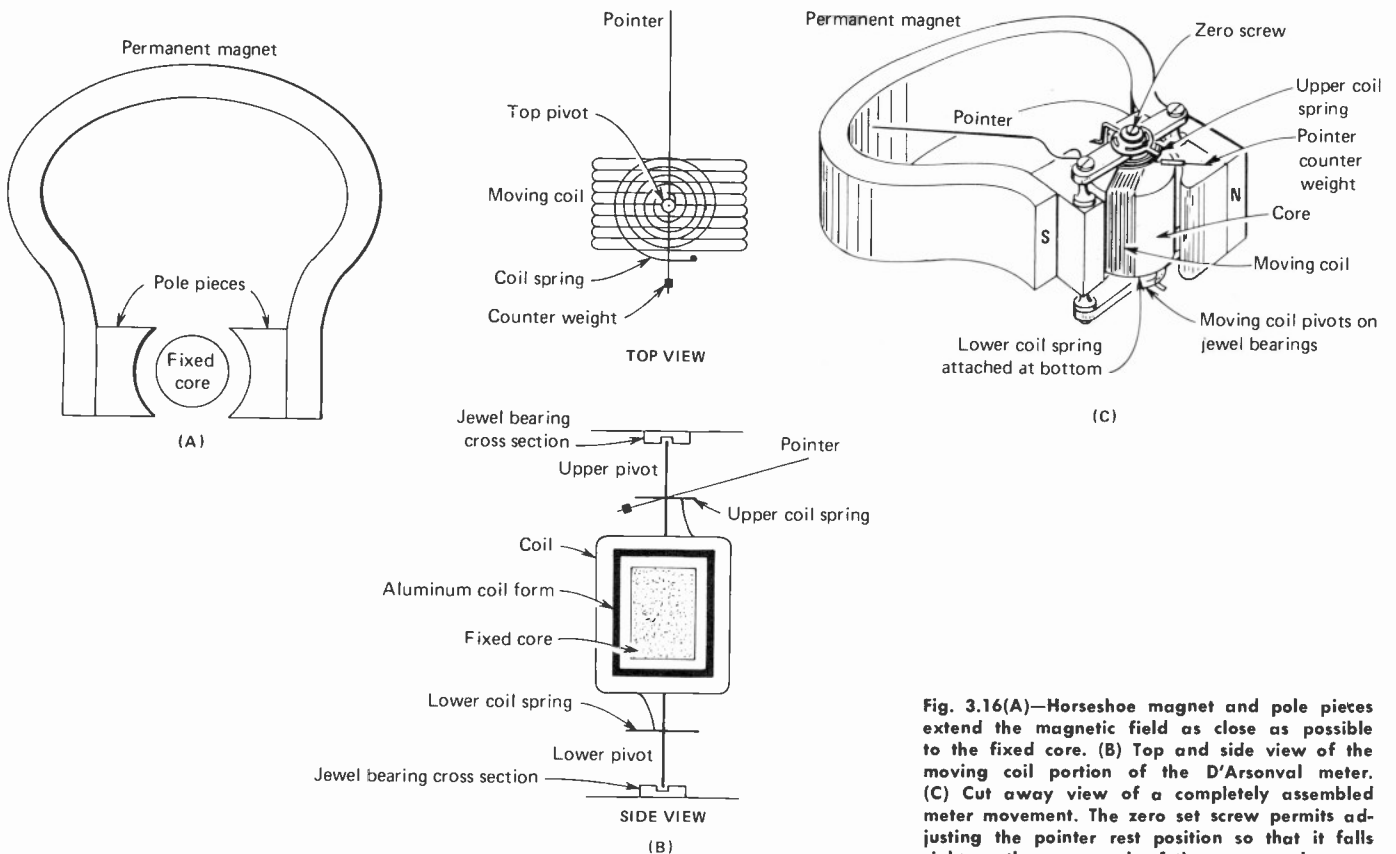

Fig. 3.16(A)—Horseshoe magnet and pole pieces extend the magnetic field as close as possible to the fixed core. (B) Top and side view of the moving coil portion of the D'Arsonval meter. (C) Cut away view of a completely assembled meter movement. The zero set screw permits adjusting the pointer rest position so that it falls right on the zero mark of the meter scale.

in Fig. 3.17. The fixed core is omitted for the purpose of clarity. Since its function is to lower the reluctance of the magnetic path between the two pole pieces, its omission will not affect the description of the operation. A single turn of wire representing the moving coil is also shown. With no current flow through the coil the magnetic pattern is undistorted and the coil remains in the position determined by the two (upper and lower) coil springs.

When current is caused to flow through the moving coil, a magnetic field builds up around that coil over its entire length. Only the field in the vertical portion of the wires are effective and, as shown in (B) of Fig. 3.17, the two magnetic fields interact changing the total field pattern. Note carefully the two spaces in the new field pattern A and B as the coil will rotate to move

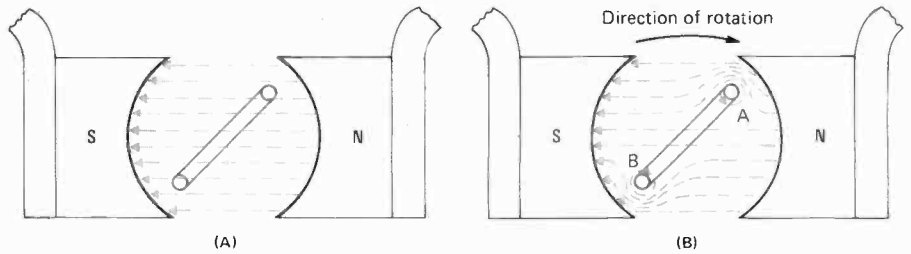

Fig. 3.17(A)—Top view of the area between the pole pieces shows the rest position of a single turn coil and the magnetic field. (B) Lines of force show the distorted pattern caused by a current flow through the moving coil. The coil will move in the direction shown by the arrow. The stronger the field around the moving coil the further it will move.

toward this neutral area. The pointer, attached to the coil, swings from left to right. If the current is increased, a stronger electromagnetic field is developed and the coil rotates further. If the

direction of current flow is reversed the direction of rotation is also reversed.

Meter Scales—The pointer travel will be directly proportional to the magnetic field strength generated by the moving coil and this, in turn, is directly proportional to the current flow through the moving coil. If, as shown in Fig. 3.18, it requires 10 mA to move the pointer fully across the scale (noted as 10 mA Full Scale) it only requires 5 mA for half scale deflection and 2.5 mA for

Information Sheet #6—Switches

Switches are used to open or to complete one or more circuits. Symbols for switches are shown in Fig. 1; symbol (A) is the *single pole single throw* (SPST) the simplest type. It is used to make or break a single circuit. The switch consists of a fixed terminal and one moveable arm called a pole and indicated by the line and arrow.

The switch in Fig. 1 (B) is used to connect a circuit from one point to another. As shown, when the switch arm is in the upper position I_1 will light. When the switch is thrown to its other position I_2 will no longer light but I_2 will. This type of switch is called a *single pole double throw* (SPDT).

The switch in Fig. 1(C) is a *double pole single*

throw (DPST). This type of switch can control two separate circuits turning them both on or off. Both circuits make or break together.

The switch in Fig. 1(D) is a *double pole double throw* (DPDT) designed to control two separate circuits switching them from one set of points to another.

The switch depicted in (E) allows one circuit to be switched to four different points and is called a *single pole 4 position switch*. The switch shown in (F) is a combination of two SP 4 position switches and is called a *2 pole 4 position switch*.

Typical switch construction methods are shown in Fig. 2.

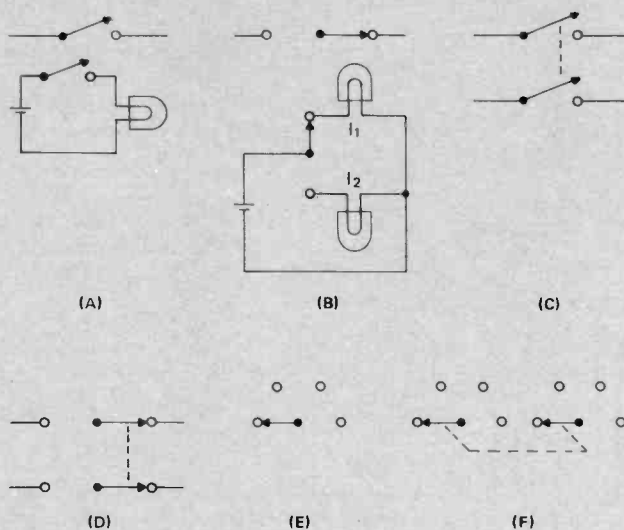

Fig. 1—Symbols for various types of switches (A) SPST, (B) SPDT, (C) DPST, (D) DPDT, (E) SP4T, (F) DP4T. The dotted lines in C, D and F indicate mechanical connection (ganging) but no electrical connection.

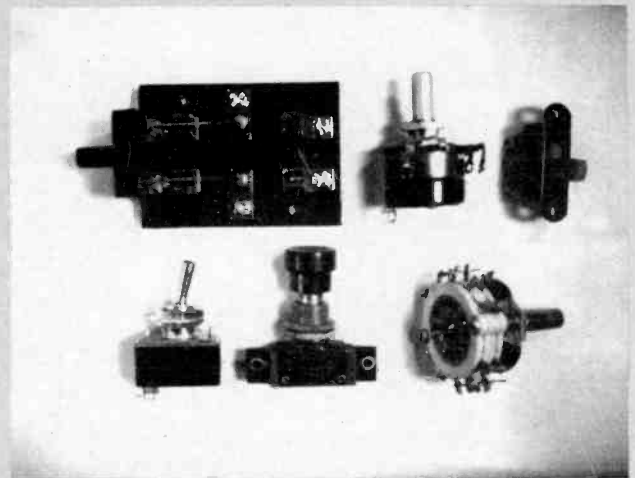

Fig. 2—Typical switch construction (from L to R) Top Row: DPDT knife switch; SPST switch on rear of potentiometer (typical ON-OFF volume control for a receiver), Slide switch (connecting lugs are beneath switch). Bottom Row: SPST toggle switch, DPST Push button momentary contact switch (when released, switch returns to its normal position), Rotary switch used when there are more than two positions or throws.

Information Sheet #7—Potentiometers

Every receiver makes use of an adjustable control to set the volume level or loudness of the sound output. This control is basically a variable resistor with three terminals rather than two. There are connections at each end of the resistance and a third connection to a wiper contact that can slide over the full length of the resistance element. A variable resistor of this type is called a *potentiometer* or *pot* for short. Fig. 1 shows typical pot.

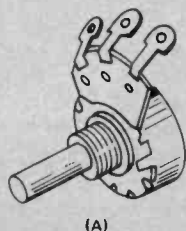

Fig. 1—Typical potentiometer.

symbols and a switch that can be added to the rotary type of pot.

The internal construction of a rotary pot is shown in Fig. 2(A). A circular section of plastic or fiber insulation material is coated with carbon and a wiper arm rotates along the surface making contact to the resistance element. Fig. 2(B) shows the equivalent electrical circuit of the carbon element. By connecting an ohmmeter between lugs 1 and 3 you can measure the total resistance of the pot. The resistance will remain the same no matter where the wiper arm is positioned.

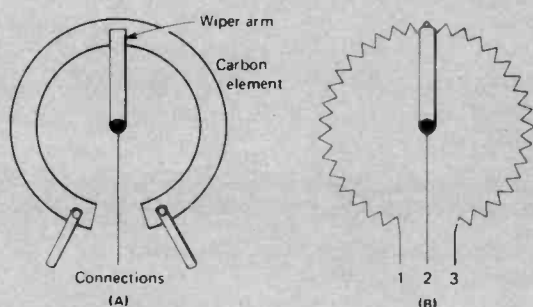

Fig. 2(A)—Circular resistance element in a potentiometer. (B) Equivalent electrical circuit of the pot.

By connecting an ohmmeter between lugs 1 and 2 you will read only that portion of the resistance between end 1 and the location of the wiper arm. If the arm position is varied the resistance reading will vary from zero ohms to the maximum value of the element. Connecting the ohmmeter to lugs 2 and 3 will produce the same effect but reverse the positions of the high and low readings.

A potentiometer is essentially a variable voltage divider as shown in Fig. 3(A) and (B). In (A) where the arm is set in the center of a 10K element we have the equivalent of 5K resistance on either side of the wiper. If 9 volts are applied across the whole potentiometer half the voltage will appear above the arm and half below the arm. With the

output taken from between points 1 and 2 we will read 4.5 volts. If the arm is rotated so that the resistance is divided 2/3 to 1/3 as in (B), the output voltage will drop to 1/3 of 9V or 3V. The output obtainable from this circuit is from zero to 9 volts between points 1 and 2.

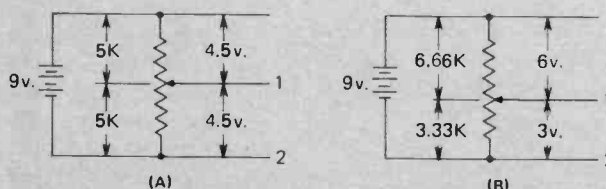

Fig. 3(A)—With the pot set at half rotation there is equal resistance on either side of the wiper arm resulting in equal voltages across each portion of the pot. (B) With the resistance divided 2/3 and 1/3 the voltages also divide 6V and 3V.

Wattage—It should be apparent that with a voltage applied to the resistance element, current will flow and heat will be dissipated. A standard potentiometer can handle 2 watts of power. For greater power dissipation heavy duty wire wound resistance elements are constructed.

Tapers—Potentiometers are constructed so that their resistance varies in a linear or non-linear relationship to its shaft rotation. In a linear potentiometer the change in resistance is the same for a shaft of a given distance anywhere over the element. This is shown graphically in Fig. 4, curve A and is defined as a *linear taper*. The taper of a potentiometer defines the resistance change *versus* the angular rotation.

Curve B is defined as an *audio taper* and this non-linear rate of change in resistance is necessary to get a smooth change in sound level as you vary a volume control. Because the human ear is not linear the power level change must also be non-linear to appear smooth. This subject will be discussed at greater length under audio amplifiers.

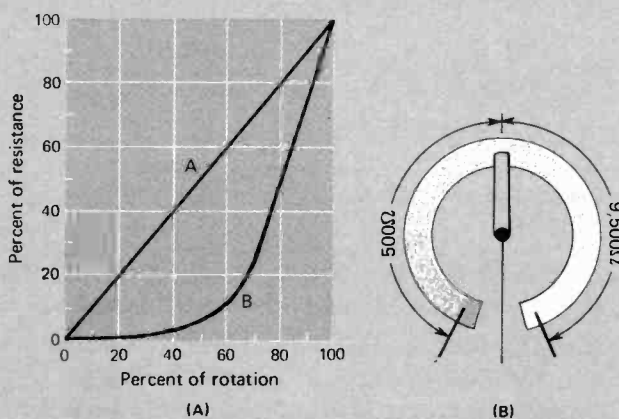

Fig. 4(A)—Typical tapers for potentiometers. Curve A is linear, curve B is a non-linear audio taper used for volume controls. (B) Construction of the audio taper resistance element has about 500 ohms resistance in the first half of the resistance element and the balance, 9.5K in the last half. Heavy concentration of carbon produces the low resistance while a light layer of carbon produces the higher resistance.

quarter scale deflection. Thus it may be seen to be a *linear scale*.

There are other types of meter movements (not to be discussed here) that have non-linear scales and the D'Arsonval meter when used to measure resistance also produces a non-linear scale. **Meter Ranges**—The maximum current a meter can measure is referred to as its full scale or F.S. range. The meter face

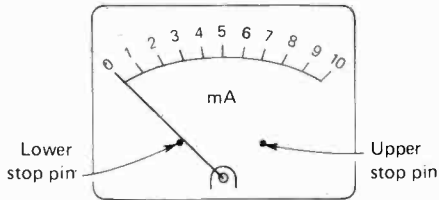

Fig. 3.18—A typical linear milliammeter scale.

illustrated in Fig. 3.18 has a F.S. range of 10 mA. If this current is exceeded, the pointer will try to rotate past the 10 mA point and it will strike the upper stop pin. If it hits this pin hard enough, the pointer will bend. If F.S. is *greatly* exceeded there is a possibility of burning out the moving coil winding or overheating the coil springs which must conduct the current into and out of the moving coil. The coils sometimes lose their spring tension when they overheat.

If the current is made to flow through the moving coil in the reverse direction, the pointer will slam left against the lower stop pin possibly bending the pointer. Current overloads should be scrupulously avoided and correct polarity observed in order to prolong meter life.

Ammeters and Milliammeters—As we stated earlier, the D'Arsonval meter is a current measuring device. A specific amount of current must flow through the moving coil to produce full scale deflection. If the meter requires one milliampere to move the pointer from the zero rest position to full scale, then the meter is said to have a full scale reading of 1 mA or a 1 mA sensitivity.

When we need a current meter with a F.S. of 1 A the wire used to wind the moving coil would have to be heavy (about a #20) and the moving coil would be bulky. It is not usual to find meters built for high current ranges in this manner. A low range milliammeter can be wired in a circuit such as that shown in Fig. 3.19. By properly selecting the value of R_s , which is in parallel

Experiment #10—How to Test a Potentiometer

Materials:

- 1—VOM—Radio Shack #22-202A
- 1—Linear Taper 10K Potentiometer—Radio Shack #271-1715
- 1—Audio Taper 10K Potentiometer—Radio Shack #271-1721
- 1—Knob—Radio Shack #274-391

Very few potentiometers have their resistance value stamped on their case and none ever indicate their taper. It is necessary, therefore, to determine the resistance and taper of a pot by using the ohmmeter portion of the VOM.

Procedure—Determining the Resistance of a Pot.

1—Select the linear taper 10K pot (Radio Shack #271-1715) and measure the value of the carbon resistance element from A to C as shown in Fig. 1.

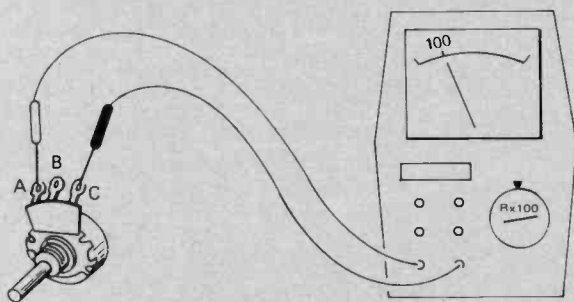

Fig. 1—How to measure the resistance of a pot using an ohmmeter.

Do this with the shaft turned fully counter clockwise. Enter the reading in Chart I.

2—Rotate the shaft halfway and measure the resistance from A to C. Enter the reading in Chart I.

3—Rotate the shaft fully clockwise, measure the resistance from A to C and enter the value in Chart I.

We may conclude that the *overall resistance of a pot is not affected by the position of the wiper arm.*

4—Rotate the potentiometer shaft fully counter clockwise. Measure the resistance from A to B and enter the value in Chart I.

5—With the shaft in the same position measure the resistance of the pot from B to C and enter the value in Chart I.

6—With the ohmmeter connected from B to C vary the shaft position and note the change in resistance.

Measuring the Taper of a Pot

7—Mount the knob on the potentiometer shaft so that it will be possible to estimate the amount of rotation.

8—Connect the ohmmeter to lugs B and C and rotate the shaft fully counter clockwise. You should measure zero ohms.

9—Gradually rotate the shaft in a clockwise direction until you have reached the mid-way point. This must be estimated by gauging the position of the arrow on the knob. Note the resistance value. It should be about 5K.

10—Repeat the procedure with the 10K audio taper pot and note that the mid-point is close to 700 ohms. Vary the shaft through its full rotation slowly and note how the resistance changes versus the rotation particularly on the CCW end.

From	To	Shaft Pos.	Res.
A	C	CCW	
A	C	Center	
A	C	CW	
A	B	CCW	
B	C	CCW	

Chart I

Chart I—Resistance readings versus rotation.

Experiment #11—How to Measure Meter Resistance

Material:

- 1—VOM—Radio Shack #22-202A
- 1—0-1 mA meter—Radio Shack #22-052
- 2—10K potentiometers—Radio Shack #271-1715
- 1—3.3K ½ W resistor ± 10%—Radio Shack #271-000
- 1—10 ohm ± 10%—Radio Shack #271-000
- 4 Fahnestock clips—Radio Shack #270-393
- 1—9V battery connector—Radio Shack #270-325
- 1 Perfboard

Assorted hardware, wire and solder

In order to be able to calculate shunts for milliammeters, it is necessary that we know the resistance value of the meter's moving coil. It is rarely, if ever, marked on the meter so that if a meter is acquired by swapping or removal from other equipment its internal resistance is unknown. We should not measure the meter resistance with an ohmmeter as the ohmmeter current is frequently greater than the FS current range of the meter and could damage the movement. Since most meter resistances are 100 ohms or less we would have to use the R×1 or R×10 ranges to measure them. The normal current flow on the R×1 setting of the Radio Shack 22-202 is 60 mA, on R×10 it is 6 mA and R×100 0.6 mA. The two useable ranges would overload the meter by 60 times for R×1 and 6 times for R×10; both ohmmeter ranges would destroy the meter.

There are two useable methods for measuring meter resistance and both are presented below.

Method A for Measuring Meter Resistance

- 1—Set up the circuit shown in Fig. 1 placing the VOM on its highest current range, 300 mA.
- 2—Connect the battery and adjust R_2 for a current flow of ½ mA. Gradually lower the current range of the VOM in order to get an accurate reading.
- 3—Disconnect the VOM and wire the 0-1 mA meter into the circuit as shown in Fig. 2. Now, adjust R_2 for full scale reading of 1 mA.

Fig. 1—Simple circuit used to set up a current flow of one mA. The purpose of R_1 is to limit the current to a maximum of about 2.7 mA in the event R_2 is accidentally set at maximum (zero) resistance.

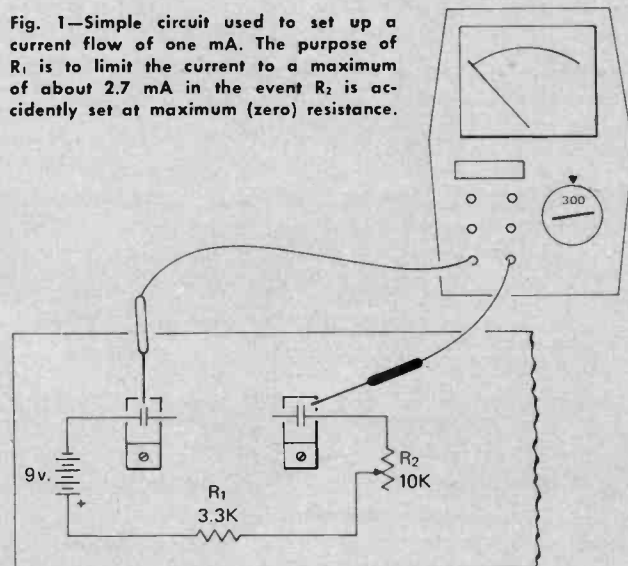

- 4—Connect R_3 , the second 10K pot, across the meter terminals and adjust R_3 until the meter reads exactly 0.5 mA. This means that the 1 mA is being split precisely between the meter and R_3 . Since each has the same current flow, the resistances of each must be equal.

- 5—Remove R_3 from the circuit without disturbing the shaft setting and measure its resistance on the R×1 range of the VOM. It should read about 73 ohms.

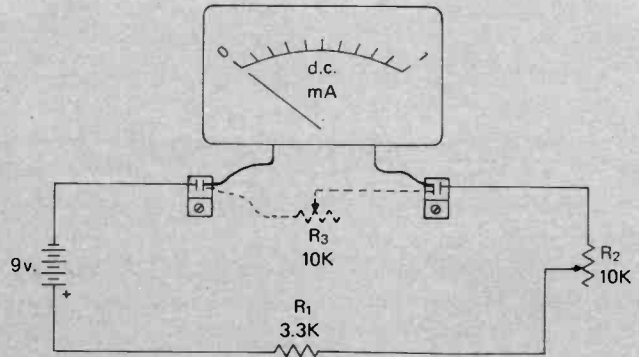

Fig. 2—Meter whose resistance is to be determined is substituted for the VOM. A one mA current flow is set up. R_1 is added and adjusted for a 0.5 mA reading on the meter. At this point, its resistance equals the meter movement resistance.

Method B (Without Parallel Potentiometer)

- 6—Repeat steps 1, 2 and 3 of the above procedure.
- 7—Connect the 10 ohm ± 10% ½ watt resistor across the 0-1 mA meter terminals and note the new current reading, 0.12 mA.
- 8—As shown in Fig. 3, it is now possible to calculate the current flow through the 10 ohm resistor. It is 1 mA less the current shown on the meter or 1-0.12 = 0.88 mA.

From this we can calculate the voltage drop across the 10 ohm resistor.

$$E_{R_3} = I_{R_3} \times R_3 = .00088 \times 10 = 0.0088V$$

Since the meter is in parallel with the 10 ohm resistor it must also have 0.0088V across it. We know the current and voltage; therefore resistance is

$$R_m = E_m / I_m + .0088 / .00012 = 73.333$$

It is not necessary that a 10 ohm resistor be used; any value between 10 and 100 ohms will do, but the most accurate resistor possible should be used.

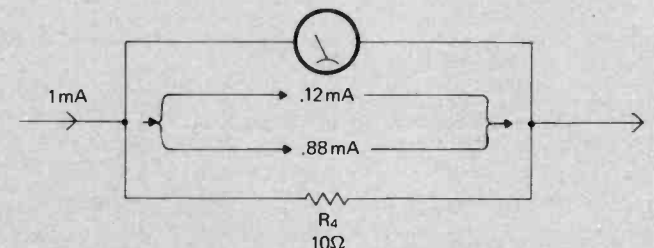

Fig. 3—Once the division of current between the meter and fixed resistor is calculated, the use of Ohm's Law will enable you to determine the meter resistance as explained in step 8.

Experiment #12—How to Make a Milliammeter Shunt

Material:

- 1—0-1 mA meter—Radio Shack #22-052
- 1—Roll of #32 Enameled wire—Radio Shack #278-011
- 1—VOM—Radio Shack #22-202A
- 1—10K Potentiometer (linear) Radio Shack #271-1715
- 1—High value (250K and up) 1 watt resistor
- 5—Fahnestock clips—Radio Shack #271-1715
- 1—9V Battery connector—Radio Shack #270-325
- 1—Perfboard

Assorted hardware, wire, solder and emery cloth

To prepare a meter shunt we must know the full scale range of the meter, the resistance of its movement and the new full scale range desired. We will use the 0-1 mA meter from Experiment #11 whose internal resistance was calculated at approximately 75 ohms and we will increase its range to 200 mA.

Procedure:

1—The first step is to determine the resistance the new shunt will have to be. This is determined from

$$R_s = R_m / N - 1 = 75 / 200 - 1 = 0.37688 \Omega$$

2—Checking a complete wire gauge table we find that #32 wire has a resistance of 167.3 ohms per thousand feet. For one foot we have a resistance of $167.3 / 1000 = 0.1673$ ohms per foot.

3—To determine how many feet we need to obtain the required 0.37688 ohms we divide this figure by

the ohms per foot rating of the wire. Feet required = $0.37688 / 0.1673 = 2.25$ feet.

4—Remove a 3' length of #32 wire from the roll and wind it around a piece of cardboard 1" x 2" being sure to leave both ends free.

Carefully remove the insulation from each end for at least $\frac{3}{8}$ " using emery cloth or fine sandpaper. 5—Wire the circuit shown in Fig. 1. Before connecting the battery set the 10K pot so that it is at maximum resistance. Failure to do this will result in a defective meter. Now, connect the battery. The meter will read about 0.8 mA.

6—Connect the 3' length of #32 wire between terminals A and B where it will shunt the meter. Observe that the meter reading drops very nearly to zero.

7—Lower the resistance of the 10K pot until the 0-1 mA meter reads full scale. Read the VOM 0-300 mA range scale to find the new FS reading of meter M_1 . (The current through each meter is the same since they are in series.) The reading will be approximately 150 mA indicating the shunt resistor must be reduced in value.

8—Increase the 10K pot to its maximum resistance lowering the current back to 0.8 mA so that it will be safe to remove the shunt wire. Cut off 1" of the wire, remove the insulation and reconnect the shunt to terminals A and B.

9—Lower the resistance of the 10K pot until M_1 is at full scale and read the actual current on the VOM. It should read very close to 200 mA.

10—Repeat steps 7 and 8 until the VOM reads exactly 200 mA when M_1 is at full scale. Be sure not to remove too much wire or you will have to begin again.

11—To keep the wire from tangling we wrap it around the body of a 1 or 2 watt high value resistor (250K or higher). Solder one end of the #32 wire to one end of the resistor as shown in Fig. 2A. Wind the wire around the body in a scrambled fashion and solder the second end to the other end of the resistor. (See Fig. 2B).

12—To keep the wire in place it can be dipped in lacquer or smeared with Duco cement.

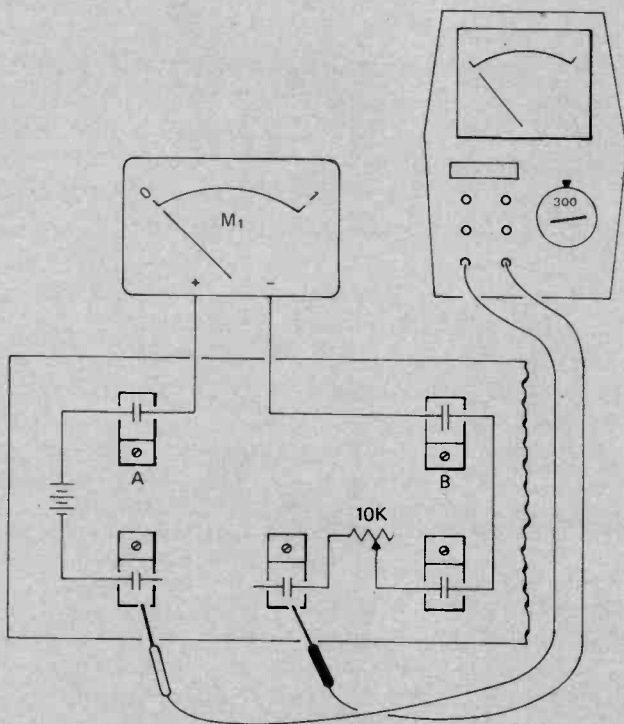

Fig. 1—Circuit set-up needed to prepare a shunt for meter M_1 . The shunt will be connected between Fahnestock clips A and B, in parallel with the meter.

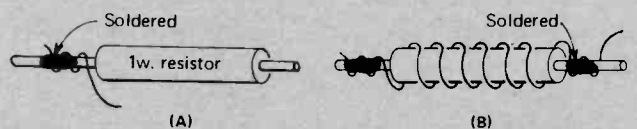

Fig. 2(A)—Connect one end of the shunt wire to one end of a high value resistor. (B) Wind the shunt wire tightly around the body and solder the free end to the other side of the resistor.

with the meter, we can increase the range of the meter to any new full scale value desired. As shown in Fig. 3.19, the current range is to be raised from 1 mA to 100 mA. Since the maximum allowable current through the meter *at any time* is 1 mA, the remaining 99 mA must flow *around the meter through* R_s . It is simply a matter of setting a proper ratio between the meter resistance and the shunt resistance. The correct value of shunt resistance is determined by the following formula:

$$R_{\text{shunt}} = \frac{R_m}{N-1}$$

where R_m = resistance of the moving coil winding
 N = factor by which the meter range is increased.

If, for example, the resistance of the meter in Fig. 3.19 is 50 ohms, the value required for R_{shunt} would be

$$R_{\text{shunt}} = \frac{R_m}{N-1} = \frac{50}{100-1} = 0.505\Omega$$

The higher the new F.S. current range required the lower the value of R_{shunt} will be. If the same meter was to have its range increased to 750 mA the shunt needed would be

$$R_{\text{shunt}} = \frac{R_m}{N-1} = \frac{50}{750-1} = 0.06675\Omega$$

This is a critical value and one that is impossible to purchase. Such a shunt would have to be custom made. How this is done is described in Experiment #13, "How to Make a Meter Shunt."

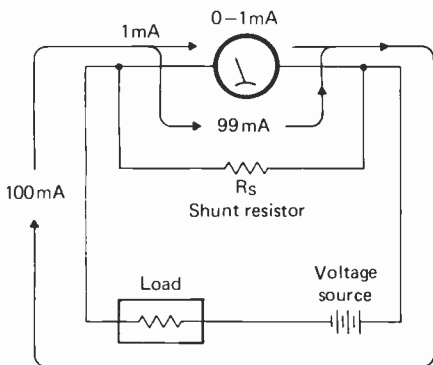

Fig. 3.19—A meter shunt, R_s , permits a low range milliammeter to be used to measure higher currents. The 0-1 mA meter is wired so that it will read 0-100 mA.

Multi-range Milliammeters—Often it is practical and economical to use a single meter cover more than one current range. This is called a *multi-range milliammeter*. It is accomplished by the use of several shunts and a selector switch. (See Information Sheet #6 for a discussion of switch types and nomenclature). A typical circuit of this type is illustrated in Fig. 3.20. In position

The World's Classiest Mount for CB Radios.

The "Ten-Two" CB radio mount is handsomely designed and rugged. Made of tough, finely textured black thermoplastic that will complement any auto interior, it has everything a quality mount should have.

BETTER SOUND: Communications speaker improves clarity, filters out noise—mount directs sound at the driver, not the floor. **SAFETY:** Controls and mike are easily reached and visible from normal driving position.

PORTABILITY: Radio is detached quickly and easily. Nothing to unplug—antenna, power and speaker cables are wired through contacts in the mount. **INSTALLATION:** Mounts securely to the transmission hump or roof.

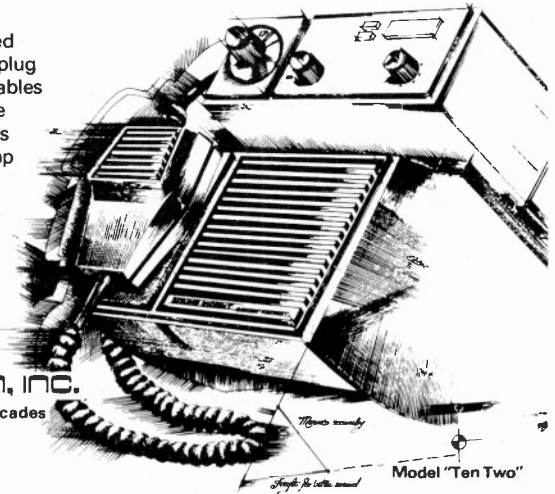

GAMBER-JOHNSON, INC.

Quality Manufacturers for over 2 decades
 801 Francis Street
 Stevens Point, Wisconsin 54481
 (715) 344-3482

SOUND MOUNT

BREAKER-GOOD BUDDY! IT'S HERE!!

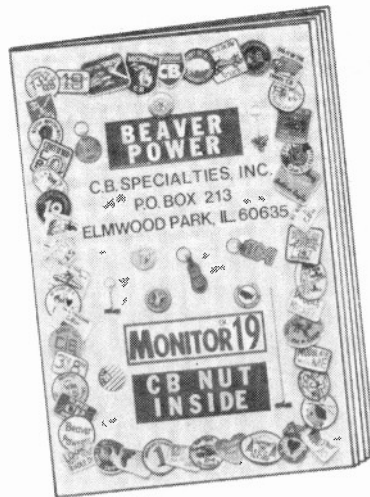

- ★ THE FIRST COMPLETE SPECIALTY CATALOG FOR CBERS'
- ★ OVER 350 ITEMS OF OUTSTANDING VALUES
BUMPER STICKERS • PATCHES •
JEWELRY • BUTTONS • T-SHIRTS, Etc.
- ★ MOST ITEMS CUSTOMIZED OR PERSONALIZED
YOUR HANDLE • GROUP/CLUB EMBLEM
- ★ WIDEST CB SELECTIONS TO DAZZLE & DELIGHT
YOU!
- ★ CHECK US OUT FOR QUALITY, SERVICE & FAST
DELIVERY
- ★ MAIL FOR YOUR FREE EXCLUSIVE SHOP-AT-HOME
CATALOG NOW!

WRITE TO:

73's 88's

CB SPECIALTIES, INC.

P.O. BOX 213

ELMWOOD PARK, ILL. 60635

WHOLESALEERS WRITE FOR SPECIAL PRICE LIST

No-Rob Knob theft proofs your CB radio

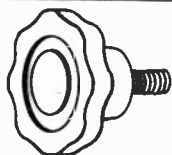

In seconds, install or remove your Hustler rain gutter antenna for quick, out of sight storage. Retain the superior electrical performance and mechanical security of a permanently mounted antenna. Easy conversion; just replace the regular locking bolt with the No-Rob Knob. Fits all Hustler rain gutter mounts and rain gutter mount antennas manufactured since 1962.

AVAILABLE FROM ALL DISTRIBUTORS WHO RECOGNIZE THE BEST!

new-tronics corporation
Brookpark, Ohio 44142

#1 of the selector switch there is no shunt connected into the circuit and the F.S. range is that of the basic meter movement 0-1 mA. In position #2 of the switch, shunt R_{S1} is placed in parallel with the meter and raises the F.S. reading to 10 mA. To determine the required value for R_{S1} , we use the formula

$$R_s = \frac{R_m}{N-1} = \frac{50}{10-1} = 5.55\Omega$$

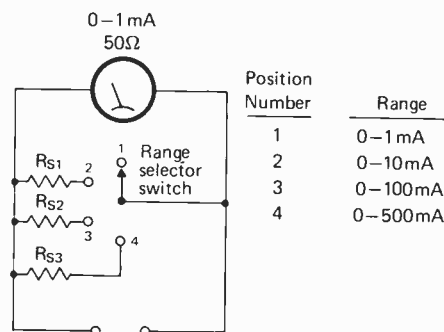

Fig. 3.20—Circuit of a multi-range milliammeter. The current range is chosen by the setting of the selector switch.

In position #3 the required shunt resistance would be $50/100-1 = 0.505$ ohms. For the 500 mA range, position #4, the required shunt would be $50/500-1 = 0.1$ ohms.

A serious drawback to the system just described is that when switching ranges *with current flowing* there is a brief period of time, between two switch contacts, when *no* shunt is connected across the meter. If the current flow is greater than 1 mA the meter will be overloaded during this brief period. There are two ways used to avoid this problem. The first is a special type of switch known as a *make-before-break* and the second is a universal shunt circuit shown in Fig. 3.21. Note that in this type of circuit even though the *switch rotor is in transit the shunts are never removed from the circuit*. Observe also the more reasonable values of resistance required for this type of shunt.

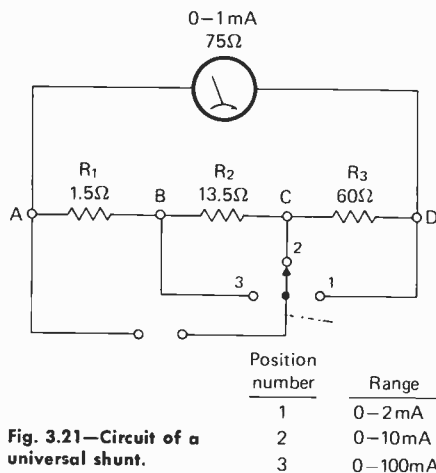

Fig. 3.21—Circuit of a universal shunt.

Universal Shunt Calculations—The sum of the resistances in the universal shunt must equal the meter resistance. Thus in Fig. 3.21, R_1 plus R_2 plus R_3 equals 75 ohms. The formula used to calculate the resistance of the various sections is

$$R_{\text{section}} = 2R_m/N$$

where R_m = meter resistance

N = the range multiplying factor

With the range selector switch in position #2 we can calculate the resistance of the section from A to C

$$R_{A-C} = 2R_m/N = 150/10 = 15\Omega$$

Since the entire shunt resistance (A to D) is 75 ohms, if A to C is 15 ohms, then the remainder must equal $75-15 = 60$ ohms. Thus $R_3 = 60$ ohms.

Switching to position #3 we can calculate the resistance of Section A to B.

$$R_{A-B} = 150/100 = 1.5\Omega$$

If A to C equals 15 ohms and A-B equals 1.5 ohms, then B-C must equal $15-1.5 = 13.5$ ohms. A quick check is to add up the resistance values; they must equal R_m , 75 ohms. If they do not you have made an error.

SELF CHECK QUESTIONS

1—Two other names for the D'Arsonval meter are _____ and _____.

2—The D'Arsonval meter is made with a _____ magnet and an _____ magnet.

3—The purpose of the pole pieces on the horseshoe magnet are to reduce the reluctance of the magnetic path. T or F.

4—The only function of the coil springs is to make electrical connection to the moving coil. T or F.

5—The function of the pointer is to indicate the distance the moving coil has rotated. T or F.

6—Movement of the coil in the D'Arsonval meter occurs due to the interaction between the magnetic fields of the fixed magnet and the moving coil electromagnet. T or F.

7—The D'Arsonval movement is a current indicating meter with a non-linear scale. T or F.

8—All meter movements, of any type, produce linear scale operation. T or F.

9—A 0-10mA meter can be wired into a circuit that will lower its range to 0-1mA. T or F.

Suggested Reading

Schrader, R. L., *Electronic Communications*, Third Ed., New York: McGraw Hill, pp. 233 to 237.
Tepper, Marvin, *Basic Radio*, Second Ed., Vol. 1, Rochelle Park, New Jersey: Hayden Book Co., pp. 122 to 127.
Technical Illustrations by K&S Graphics, Island Park, NY.

For Information About Our Advertisers...

10—A 0-10mA FS meter is more sensitive than a 0-1mA unit. T or F.

11—A 0-10mA meter with an internal resistance of 100Ω must have its range increased to 0-100mA. (A) Draw the circuit required to do this. (B) Calculate the value of the part(s).

12—The higher the new current range in a shunted meter, the lower the shunt resistance must be. T or F.

13—Calculate the values for R_1 and R_2 in the circuit below.

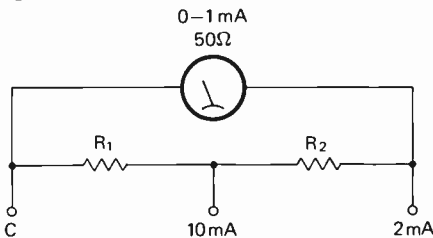

14—Draw the symbol for a DPDT switch.

15—The number of poles a switch has indicates the number of circuits it can control directly. T or F.

16—A six position switch is usually built as a toggle switch. T or F.

17—Define what is meant by the taper of a potentiometer.

18—There is no difference between a rheostat and a pot. T or F.

19—In Experiment 12, Fig. 4, if the meter had read 0.2mA when the 10 ohm resistor was added instead of the reading indicated, what would the internal resistance of the meter be?

19—40 ohms. A rheostat has two connections whereas a pot has 3.

18—F. A rheostat has two connections so in a non-linear pot.

17—The taper of a potentiometer is usually built rotary style. For more than two positions, the switch possible third position, center being OFF.

16—F. A toggle can have no more than two positions, left or right with a

15—T

(D). 14—Fig. 1 in Information Sheet #6, 13— $R_1 = 10$ ohms, $R_2 = 40$ ohms.

12—T (B) 1.01 ohms

3.19 11—(A) The circuit is that of Fig. 11

ment is. for FS the more sensitive a meter move-

10—F. The lower the current needed can only be increased.

9—F. A milliammeter's basic range

8—F. 7—F. It has a linear scale.

6—T 5—T

tion after use. tion and return the coil to the rest posi-

4—F. They also determine rest posi-

3—T 2—Fixed or permanent, electro-

1—Moving coil meter and galvanometer.

ANSWER KEY

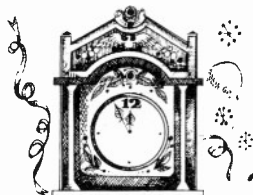

Happy 1977

BARGAIN HUNTING?
Send 35¢ to Dept. 9
FOR BARGAIN CB CATALOG!
HENSHAW'S
7622 Wornall, Kansas City, Mo.

ANTENNAS

ATTENTION DEALERS...
"you need a Dealers Distributor!"

Clercom does not claim to be No. 1 or even No. 2, however, we are big enough to serve you and small enough to know you and appreciate your business. We are a "DEALERS DISTRIBUTOR" as we do NOT retail out the front door, publish retail catalogues, mail out "Discount Price List" or encourage sale of lines sold in "Discount Stores." Your business is our business. Your success is our success.

STEREOS



CR-123B



ACT-E 8 H/U



CR-185

ACCESSORIES

CLERCOM INC. 131 C Route No. 1--- Williamsburg, Ohio 45176 54 Major Lines
513-724-2285

A CHARTER MEMBER OF  THE COMMUNICATIONS EQUIPMENT DISTRIBUTORS ASSOCIATION.

CB RADIOS

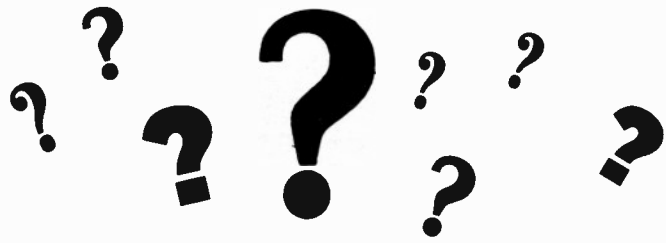

CB TRIVIA Quiz

Think You Know ALOT About CB?
We'll See!!

OK, here's a chance to test your knowledge of CB radio—a Trivia Quiz!
Bet you don't score 100!

Each of the questions has one answer which is correct—although you may be surprised at some of them. Here's a kicker—one question has ALL correct answers shown, so you must score at least a 4, even if you bomb out on all of the others!

So, go to it—we'll give you a little explanation of some of the answers at the end of it all (answers are given on page 80 of this issue, but NO cheating!). Just circle the answers you think are correct, or use a separate sheet of paper if you think others will want to take the quiz in your copy. This isn't a contest, so *don't* send your results to us here at CB RADIO/S9, *there aren't any prizes!*

1. If you were an early CB'er and you were issued an FCC callsign with a prefix of 18W, you would be located in:
 - A. Texas or Oklahoma.
 - B. Illinois or Indiana.
 - C. Alaska.
 - D. None of the above.
2. The highest number of FCC actions against CB'ers is for:
 - A. Failure to be licensed.
 - B. Running too much power.
 - C. Failure to reply to letters from the FCC.
 - D. Working skip.
3. CB operations on the 27 MHz band are either Class D (regular CB) or Class C (radio control). At one time in the early 1950's the FCC had established a Class B CB band for 2-way voice communications which was located at which frequency?
 - A. 465 MHz.
 - B. 225 MHz.
 - C. 21 MHz.
 - D. 146 MHz.
4. The FCC fees for the original CB licenses were:
 - A. \$19
 - B. \$20
 - C. No charge
 - D. \$4
5. The original CB callsigns which the FCC used to assign, such as 18A6171, 12Q1747, 2W1965, were eventually discontinued because:
 - A. CB'ers found them hard to remember and pronounce.
 - B. The FCC had no authority to issue them and they were "illegal."
 - C. There weren't enough number combinations to go around.
 - D. They were easily bootlegged.
6. When the FCC first switched over to the 3-letter 4-digit system of CB callsigns (KQD4552, KEZ5173, etc.), it was easy to learn much about the licensee from just hearing the callsign because:

- A. The letters in the callsign revealed the area of the country and the year of issue of the license.
- B. The CB'ers had their initials included in the callsign.
- C. New operators were not allowed to use callsigns, so anybody with a callsign had to be active on the band for at least a year.
- D. None of the above, since the statement is untrue.
7. At the present time it is legal to work a station 200 miles distant so long as the communication is via ground wave and not via "skip."
- A. True.
- B. False.
8. Early CB rigs sometimes had a front panel button which could be pressed to send out a strange sounding signal tone. This was called:
- A. The channel clearer.
- B. Brickbat.
- C. Screaming Meemie.
- D. Q-Bird.
9. The first commercially produced CB Single Sideband unit was the:
- A. Johnson 350.
- B. Mark SSB-27 Sidewinder.
- C. Essco Side Splitter.
- D. Lafayette HE-19A.
10. There is no CB regulation which calls for stations to request a "break" before using a channel, such requests are strictly optional.
- A. True.
- B. False.
11. A motorists' aid program was once proposed which called for a modification of the CB rules. This was called HELP and the idea was to:
- A. Permit mobile units to use 25 watts.
- B. Permit mobile units to work skip.
- C. Permit mobile units to install special automatic code signalling devices which could summon help in an emergency.
- D. Permit mobile units to operate on Channel 22A and 22B (now called Channels 24 and 24) for communications with special high powered base stations.
12. In the early to mid 1960's there were several base stations marketed which ran 1/10th of a watt (input), sometimes with a switch which would also permit full 5-watt (input). The purpose of these rigs was:
- A. To allow low power transmission for local use.
- B. For use with certain delicate and sensitive test gear which could not handle the full power of a CB rig.
- C. Some manufacturers had started a protest movement against high powered CB use.
- D. Such rigs were intended for 1/10th of a watt legal skip working, use of voice communications on radio control channels, and CW (code) transmission, by CB operators.
13. A written CB operators' exam was:
- A. Never considered by the FCC.
- B. Given to early licensees, but the practice was soon discontinued.
- C. Once proposed and considered by the FCC.
- D. Still available as an option to those who wish to use certain reserved channels not available to all operators.
14. Ham operators perform self-policing to keep their frequencies clear of rule breakers. The status of such a program in relation to CB is:
- A. The FCC is considering this program.
- B. It is not permitted under federal law.
- C. Ham operators also monitor CB frequencies and are authorized to put dead carriers on rule breakers.
- D. It is also done by a select group of CB operators whose identity is never revealed.
15. A CB rig was designed with a cathode ray tube (like a TV picture tube) so that the CB'er could look over the band the activity status of the various channels.
- A. True, it could also receive any single pre-selected local TV broadcast station.
- B. It was announced many years ago, but never put on sale.
- C. It is shortly to be placed on sale.
- D. None of the above, there is no indication whatsoever that such a product was ever designed.
16. The very first person ever licensed for CB operation received his FCC authorization in:
- A. 1947.
- B. 1958.
- C. 1936.
- D. 1952.
17. The letters CEMA once had a significance in the world of CB radio. They stood for:
- A. Citizens Emergency Monitoring Association.
- B. Clarified Electronic Modulation Amplifier.
- C. Communications Equipment Manufacturers Association.
- D. Cooperative Effort Motorists' Aid.
18. You're monitoring on Channel 12 one day and you hear station KAA9987 asking for a break. Why might this be highly unlikely?
- A. Nobody asks for a break on Channel 12.
- B. This station isn't authorized for operation on Channel 12.
- C. Channel 12 is too noisy to hear other stations.
- D. The FCC never issued calls with KAA prefixes.
19. An idea which appeared first in S9 Magazine and was later "picked up" by industry for commercial application was:
- A. Push to talk circuits without relays.
- B. Diode power supplies.
- C. SWR meters built into CB rigs.
- D. Vandal-proof mobile antennas imbedded in the windshields of automobiles.
20. Most CB'ers are familiar with the FCC's Part 95, but what is or was Part 19?
- A. The original name for the FCC's CB rules.
- B. FCC rules covering the use of scanners.

Antenna Incorporated

U.S. MANUFACTURERS OF
**THE BEST IN
 CITIZENS BAND
 ANTENNAS**

Excuse us for bragging . . .
 But the PROS did it
 again. We are now
 making a Trunk Lip
 Mount with pre-
 assembled cable, inline
 connector and mount.

Fast, simple installation!

PERSUADER
 MODEL 17610
 (STAINLESS STEEL WHIP) \$25.95



TRUNK LIP MOUNT



A Antenna, Incorporated
 23850 Commerce Park Road, Cleveland, Ohio 44122
 In Canada: E.S. Gould Marketing Co., Ltd.
 109 Montee De Liesse - Montreal, Quebec H4T 1S9 Canada
 Antenna, Incorporated, International Division
 P.O. Box 1002 - Rockville Centre, New York 11571

BREAKER . . . BREAKER . . .

LUCKY CB 73 MEDALLION

House of Collingwood, 1976



Reverse Side

Individually Registered

Solid Bronze
 CB ID Medallion
 Engraved with your
 Handle and FCC Call Sign
 (Registered Free for 5 Full Years!)

Minted in Solid Bronze
 Each Medallion 1 1/2" Wide

Front Side

DOUBLES
 AS A PENDANT
 AND KEYTAG!

Catch This, Good Buddies!

Identifies you as a CB'er . . . at coffee breaks, and all the time! Lucky CB Medallion, of satin-finish, die struck solid bronze, complete with 24" goldtone pendant chain, and "can't break" Superloop to be used as a Keytag. WE'll engrave your Handle, or FCC Call Sign and Handle (any combination, up to twenty letters!) ABSOLUTELY FREE.

FREE REGISTRATION — Each medallion is individually numbered; return it to the Commemorative Mint, where we'll keep registration of your Handle, Call Letters and number on file for five years. If lost, the finder is instructed to drop in the nearest mailbox; the Commemorative Mint will then return it to you promptly by mail WITHOUT CHARGE.

ACT NOW — Fill out, and return the coupon with your check or Money Order — and we'll catch you on the flip flop! Good numbers to you — 10-4!

Call Letters: _____

Handle: _____
 (or any combination up to twenty letters)

Enclosed please find Check Money Order for \$ _____

Please send _____ LUCKY CB 73 MEDALLIONS \$7.95 each (or \$14.95 for two) Postage and Handling charge for 1 Medallion 50¢ extra. Postage and Handling charge FREE when ordering 2 or more Medallions.

NAME: _____

ADDRESS: _____

CITY: _____ STATE: _____ ZIP: _____

HOUSE OF COLLINGWOOD
 DEPT. CBR-17 • 44 WARREN STREET • PROVIDENCE • RHODE ISLAND 02901

- C. A proposed but never implemented FCC radio service for high powered single sideband walkie-talkies.
- D. The CB service has become so important to the FCC that they will soon move us forward from 95th place in importance to the 19th position, and will rename Part 95 as "Part 19."
21. In Canada there is a radio service called the General Radio Service (GRS) which is roughly equivalent to CB in the U.S.
- A. There are more CB'ers in Chicago than there are GRS operators in all of Canada.
- B. GRS operators are authorized only in Quebec and Ontario, operators in less populated provinces are authorized in the Rural Radio Service.
- C. GRS stations are permitted to use 50 watts and work skip.
- D. Single sideband is not permitted in Canada.
22. Prior to its allocation for CB use, the Class D CB frequencies had many other uses, among them:
- A. Amateur Radio.
- B. Industrial, Scientific & Medical Devices.
- C. Nazi Panzer units in North Africa.
- D. Used by Arctic explorers in the early 1930's.
23. At one time there was a noisy movement afoot for thousands of CB'ers to march on Washington, D.C. to angrily protest the CB rules.
- A. No such idea was ever proposed.
- B. It was proposed but fizzled.
- C. It was tried and resulted in new and better rules.
- D. It was tried but resulted in harsh restrictions added to the rules.
24. The first CB rig was:
- A. A 5 tube AC/DC unit with a super-regen receiver.
- B. A Motorola unit with a telephone type handset, having a 16 mile range.
- C. The now famous Excello Model A-1, with an early attempt at a power mike incorporated into its design.
- D. Given to the Smithsonian Institution.
25. The BC-645 was:
- A. A World War II surplus transceiver which early CB'ers used to modify for CB operation.
- B. A Korean War surplus unit which could be operated on CB without modification.
- C. An electronics device which was used to jam Viet Cong CB transmissions.
- D. The first CB rig produced by E. F. Johnson, which appeared in May, 1964, hence the designation 64-5.

ANSWERS TO TRIVIA QUIZ

1. The correct answer is B, the early callsigns indicated the 24 FCC districts, and CB calls were prefixed with the district number followed by the letters A, Q, W, QB or QA.
2. Surprisingly enough, the answer is C—most people are eventually done in by their failure to reply to a let-

ter from the FCC questioning their possible violations of one or more CB rules. They don't answer the charges or complaint, then the FCC simply pulls the rug out by claiming that not answering such a letter is a violation of the rules.

3. The Class B CB band was authorized on 465 MHz, so the correct answer is A. It was a short-lived service which never got off the ground. It was eventually cancelled by the FCC.

4. When CB first was conceived, licenses didn't cost a single cent.

5. The only answer acceptable is B, although the FCC might not wish to own up to it. The original concept of CB "callsigns" was that they were more in the nature of serial numbers than strict callsigns, such as were in use by broadcast, ship, ham, etc., radio stations. Because of this concept, the FCC failed to consider that some of the prefixes being issued to CB'ers usurped the callsign prefixes assigned to various nations by international agreement. The FCC got away with it for a while, but after a few years a howl went up and they re-aligned the CB callsigns to conform to those prefixes assigned to the U.S.A.

6. Still stuck on the idea that callsigns should reflect the geographic area of the CB licensee, the FCC came up with a plan mentioned in Answer A. Each of the 24 districts had had a unique prefix, and each year the prefixes for each district would change as new licenses were issued. So if you heard a station with a particular callsign you could tell where he was and the year in which his license was issued. The idea proved to be unworkable and was abandoned after a few years. Current CB callsigns do not reflect either location or year of issue.

7. False, so Answer B is correct.

8. This was popularly called a Q-Bird—answer D—some operators called them Turkey Calls or Tweety Birds, however these were later modifications which did not achieve much popularity.

9. Answer B, the Mark Sidewinder was the first in line.

10. Answer A—although there are still some operators who insist that a break is required. It isn't.

11. The idea was called Project HELP, and is summarized in Answer D. A mid-1960's brainstorm, the FCC didn't buy it.

12. Answer D—Some operators had a good time with these units, but it was an idea ahead of its time. There weren't enough buyers out there to support this early attempt (early 1960's) at legalized hobbying on 27 MHz and the several manufacturers marketing the equipment discontinued it.

13. Answer C reflects the FCC's thinking of the mid-1960's, and a written operators' exam was seriously suggested by one of the FCC Commissioners. The feeling was that it would force CB'ers to read the rules since they were apparently not doing it voluntarily.

14. Although it has been tried locally, and once even nationally, the correct answer is B—'tain't legal, being a violation of Section 605 of the Communications Act;

make it with



Radio & Accessories

B & J TWO-WAY LTD.

1516 SE 44th

Oklahoma City, Oklahoma 73129

(405) 672-1381



Dealer Inquiries Invited!

Send \$2.00 with company letterhead.
Refunded with first order.

What a way to go!



New Target Fold-Down Side Mount for
Recreational Vehicles by S&A Electronics.

Target CB-35 makes antenna travel easy with this specially engineered mount. It snaps into the travel position and holds firm for the road—or snaps down to get in and out of tight spaces, with a single simple adjustment.

Installs easily and comes complete with a weather-proof through the wall connector.

Go with the Target CB-Antenna for your R. V. Quality products by the designers of the famous Target 360 RV/TV Antenna.

S&A has a way of always giving you the best!

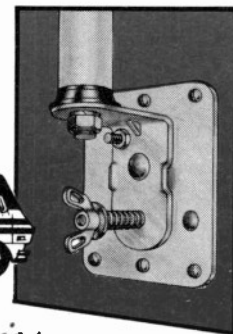
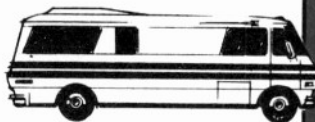

S&A Electronics

202 W. Florence Street, Toledo, Ohio 43605
DIVISION OF THE SCOTT & FETZER CO.

CB'ers are entitled to "secrecy of communication," unlike ham operators and broadcasters.

15. Answer B—it was announced, even advertised—but nobody ever saw one actually offered for sale. This was an early 60's idea which is still an interesting concept based upon the old panoramic adapter idea.

16. The first person licensed as a CB'er was John M. Milligan, who (under the callsign W2XQD) had his license on February 14th, 1947—as an experimental station in what evolved into the CB service. John later became licensed as 20W0853 when the service was formally established.

17. Answer C, naturally! The Communications Equipment Manufacturers Association was an early (1964) attempt at getting it together.

18. Would you believe, Answer B? Yup! Stations with a KAA prefixes are authorized for Class A CB operation only and are not authorized for operation on any of the 27 MHz channels!

19. Ah yes, we remember it well. About 2 or 3 years before Detroit decided it would be jolly to imbed antennas in the windshields of autos, S9 ran an article on rigging up your own CB antenna—it was a hunk of wire which was Scotch Taped to the inside of the vehicle's window. So Answer D is the right one.

20. Part 19 was the way CB got its start, several years later the FCC reorganized its files and they renamed Part 19 as Part 95. But Answer A is the only correct one here!

21. Again, it's Answer A all the way!

22. A jackpot! All answers are correct for this one, take your pick. The 27 MHz band had some pretty far out uses—but, on the other hand, CB is pretty wierd itself!

23. Yes, back in the protesting 60's, there was a hooligan club which tried to gain a national footing based on the premise that the FCC must be demoralized and all of its rules trampled. Verbally attacking Uncle Charlie's officials and running highly inflammatory anti-FCC articles in their publication, they once attempted to organize a CB march on Washington to bug Uncle Charlie. The plan was a total flop, the club dissolved amidst much hysteria, and I understand that the founder and former head of the club is now (can you handle this?) a member of the FCC's PURAC (Personal Use Radio Advisory Committee)—of course it's more than 10 years later now and I don't think they realize who he is. Twelve years ago they were sticking pins in his doll down at Charlie's place! Correct answer is B.

24. You got this one wrong because you didn't select B, which is the correct answer. Yes, this set was featured on the front cover of S9's August 1962 issue. This set actually had a handset, and the whole thing was salvaged from junk boxes in 1947. There were actually two sets built, being modulated oscillators with super-regen receivers—starring 6J6's in the front end. Range was about 5 miles, however the signals were very unstable and seemd to be poorly affected by trees, buildings, and just about everything else. But they were a creation of Motorola's engineers—strictly experimental—and the base station was located at Motorola's shop.

25. The BC-645, as per Answer A, was a World War II relic which was widely sold at one time with the hope that CB'ers would modify it for Class B operation. Containing a "lighthouse" type tube, the rig was designed originally for aircraft "IFF" (Identification Friend or Foe) use in connection with radar. Great effort was required to convert one of these sets, but if you struggled through it you did actually have a Class B CB rig—but it was hardly worth the trouble!

SCORING

C'mon now, you didn't get them ALL correct! But you might well have gotten almost all of them. For sure you couldn't possibly have gotten them all wrong because it was impossible to screw-up on Question 22 since all of the answers were correct. So each correct answer is worth 4 points. Add up your correct answers (no erasing please) and multiply by 4 for your score. We chart them as follows:

88 to 100%	Spectacular!
72 to 84%	Bodacious!
56 to 68%	Better than average.
40 to 52%	Average.
24 to 36%	Keep plugging!
8 to 20%	Read up on CB history!
4%	Thank God for Question 22.



**cb mobile
cb base**

COVER 40 CHANNELS NOW!

CX-1000 3.75 dB GAIN
CITIZEN'S BAND BASE ANTENNA

Designed to withstand nature's abuse... CX-1000 is an 18' high "package of dynamite performance" for AM or sideband. This omnidirectional base antenna has a precision tuned coaxial stub system for perfect match and low ohmic losses. Made of heavy wall, bright finish seamless aluminum tubing and stainless steel fasteners.

TRUNK BUSTER
FIBERGLASS MOBILE

Our 48" Top loaded or tunable tip antenna with solid one piece no hole trunk tip mount. The mount has foam protective pad and spring loaded cable contact. Complete high performance systems preassembled with 18' cable and connector.

CM-403 Trunk mt. with 48" whip
CM-404 Trunk mt. with 48" tunable whip

Cushcraft products are stocked by dealers throughout the world.

cushcraft
CORPORATION
P.O. BOX 4680, MANCHESTER, N.H. 03108

INTRODUCING THE 102" WHIP YOU PUT IN YOUR POCKET.

Now, you can have a full-sized whip whenever and wherever you want it without worrying about storage or theft. Thanks to Whip-A-Way™ — the unique new CB antenna from SST. Using a design originally developed for the military, it folds to a pocket-sized 15 5/8" when closed... yet opens to a full 102" in seconds.

The secret is Whip-A-Way's tension-lock construction. A series of precisely-fitting interlocking hollow sections are "strung" on a sturdy, spring-loaded cable. Collapsed by pulling each section out of the next one and folding the antenna in zig-zag fashion, Whip-A-Way can be stored in your trunk, briefcase... even your pocket.

When you're ready to go on the air, the antenna assembles in seconds, simply by flicking the whip out. The precision brass fittings seat themselves automatically, insuring secure mechanical and electrical connections. (Whip-A-Way is rated at 500 watts, and can withstand a 180° bend... same as its military counterpart. It outperforms many conventional stainless steel and fiberglass whips.)

Ruggedly finished in satin-black, Whip-A-Way has an integral 3/8"-24 screw fitting that's compatible with all standard spring-loaded bumper mounts, and works with most gutter clips where temporary hold-down is desired.

If you're looking for a more versatile, more efficient CB whip, look no further: order your Whip-A-Way today. Use the handy coupon or call — major credit cards accepted.

ACTION Electronics

P.O. Box 104, 3300 Park Avenue, Wantagh, N.Y. 11793. (516) 481-1411

Please send me _____ Whip-A-Way Antenna(s) at only \$29.95 postpaid.
(qty.)

Check or money order enclosed Total \$ _____

Charge my credit card checked below 8% Sales Tax

BankAmericard (N.Y.S. residents only)

Master Charge TOTAL \$ _____

Credit Card No. _____ Exp. Date _____

Bank Charge Bank No. _____ (4 digits)

NAME _____

ADDRESS _____

CITY _____ STATE _____ ZIP _____

SIGNATURE _____

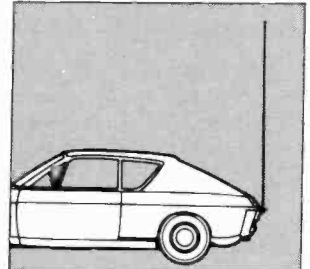

A full 102" — compatible with all standard bumper mounts.

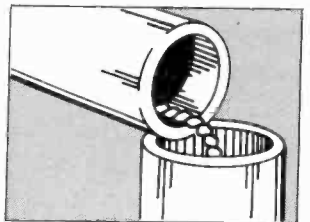

Spring-loaded cable provides easy assembly, disassembly.

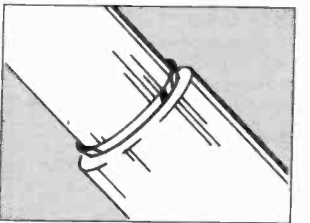

Precision metal ferrules, for best electrical and mechanical connection.

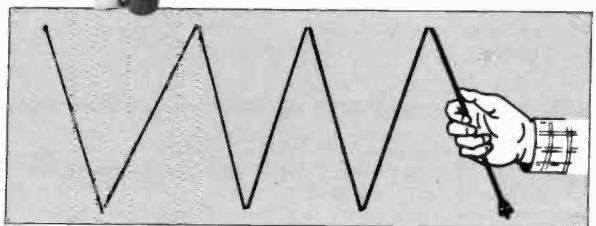

Flip it out! Whip-A-Way locks itself together in seconds.

CB Usage Tips From S9

(CUT OUT & PLACE AT OPERATING POSITION)

Preferred & Designated Channels

- Channel 8 Agricultural operations
- Channel 9 Emergencies only
- Channel 13 Maritime
- Channel 16 Single Sideband only
- Channel 18 Single Sideband only
- Channel 19 Trucks/Vehicles in transit*
- Channels 36 thru 40 Single Sideband Only

*Note that in many areas there are also 1 or more additional channels designated and/or normally used for in-transit vehicles, most often Channels 10 and/or 12. This is especially true in metro areas and their suburbs where Interstate Highways are on 19 and secondary roads such as parkways are on alternate channels. It is not the practice for mobile units on such channels to request breaks. Base stations are requested to avoid using all area in-transit vehicle channels in order to permit their full, free, unobstructed and exclusive use by in-transit vehicles. "Channel Monitors" are neither required nor desired on in-transit channels and are requested to honor any in-transit channels which may have been so designated in local areas by the operators by means of their customary and general usage habits.

Those operators who feel the need to function in CB by establishing themselves as "Channel Monitors" should not expect to monitor or control distant stations which are being received at S-3 strength or lower. They should also be aware of the fact that even those local stations in their area may not wish to avail themselves of their services; all stations having

free access to the channels may elect to bypass the monitor should they wish to do so. Those who attempt to pass themselves off as "Channel Monitors" as a ploy to hog the channel for their own purposes should expect to be ignored by most stations. Those monitors who are successful are those with a good signal and good ears, who earn the respect of other operators by keeping their own transmissions as brief as possible, by giving up their own rights to hold conversations while acting as monitor. ALL transmissions from the monitoring station should consist solely of acknowledging breakers who wish to use the channel, and NOTHING more. During busy periods monitors should deny requests for 10-36's and radio checks on their channel.

Those seeking 10-36's should be encouraged and instructed in the art of telling time by means of wristwatch, clock, or broadcast radio station. Those whose primary interest in CB is chucking carriers and/or playing music are requested to consider the pleasures and benefits to be derived from finger painting and shock therapy, respectively.

Stations using power mikes should be cautious that their audio levels are set to a level which will not cause voice distortion, over modulation, or splashover on adjacent channels.

Single Sideband stations generally operate on Channels 16, 18, 36, 37, 38, 39, and 40, although this may vary in specific areas. Stations using standard AM transmission are requested to avoid use of local Sideband channels, likewise Sidebanders are requested to confine their transmissions to those channels established locally for their use.



DOES IT AGAIN
... SUPERIOR QUALITY
Our 13th Year Serving the CB Market

"Moving' up" with

PAL
Firestiks™
NEW
LOW
50 CH. SWR

- FOR CARS, CAMPERS, TRUCKS, MOTORCYCLES, RV'S, BOATS, ETC.
- TRUE HIGH GAIN WHIP MADE IN PHOENIX, ARIZONA
- TUNED FROM 26.965 TO 27.405 PLUS
- 3/8 WAVE TOP LOAD
- AVERAGE SWR 1.5 TO 1
- MORE EFFICIENT THAN CENTER OR BASE LOAD TYPE ANTENNAS
- RUGGED FIBERGLASS CONSTRUCTION
- 3/8-24 HEAVY DUTY THREADED BASE
- FITS ANY SINGLE OR CO-PHASE ANTENNA SYSTEM
- FIRE RED WITH WHITE TIP OR WHITE WITH RED TIP

NEW SUPER TIP!



- ALWAYS USE COAX CABLE 18'-20' LONG
- NO TUNING NECESSARY
- NOISE LIMITING STATIC SHEATH COVERING REDUCES NOISE UP TO 50%

IT TAKES A TOP ANTENNA TO MAKE A TRANSCEIVER DO ITS BEST WORK

KW3 \$13⁹⁵

SUGG. LIST
A 3' HEAVY DUTY EQUAL TO MOST 6' ANTENNAS

KW5 \$15⁹⁵

SUGG. LIST
A 5' HEAVY DUTY WHIP THAT WILL MAKE YOU SOUND 10' TALL

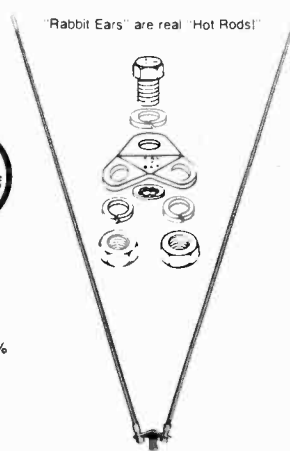

"Rabbit Ears" are real "Hot Rods!"

PAL
V-Bar Mount™ K-10 LIST \$2⁹⁵

(TO MAKE RABBIT EARS)

INSTALL V-BAR ON ANY SINGLE OR CO-PHASED TRUNK, ROOF, MIRROR OR BUMPER MOUNT. WITH 3/8-24 THREADED BASE!

V-BAR IS SCIENTIFICALLY FORMED SO THAT WHEN USED WITH 2 PAL FIRESTIKS YOUR AUDIO TO THE STATION YOU ARE TALKING TO IS INCREASED UP TO 40%. YOUR RECEPTION WILL INCREASE UP TO 25%.

PHOTO SHOWS "RABBIT EARS" SET-UP USING 2 PAL "FIRESTIKS". PAL V-BAR ASSEMBLY, ON STUD MOUNT. FITS ALL 3/8-24 THREADED MOUNTS

WATCH FOR NEW "FIRESTIK" UFO BASE STATION ANTENNA

SEND FOR FREE PAL FULL LINE CATALOG INQUIRIES INVITED

PLEASE CHECK: DEALER DISTRIBUTOR USER
(Please Print)

NAME: _____

ADDRESS: _____

CITY: _____

STATE & ZIP: _____



ELECTRONICS CO.
2962 W. WELDON, PHOENIX, ARIZONA 85017
(602) 264-0214
A Division of Fire Communications Corporation

ATTENTION DEALERS! Is your present distributor "Missing the C.B. sales target?"

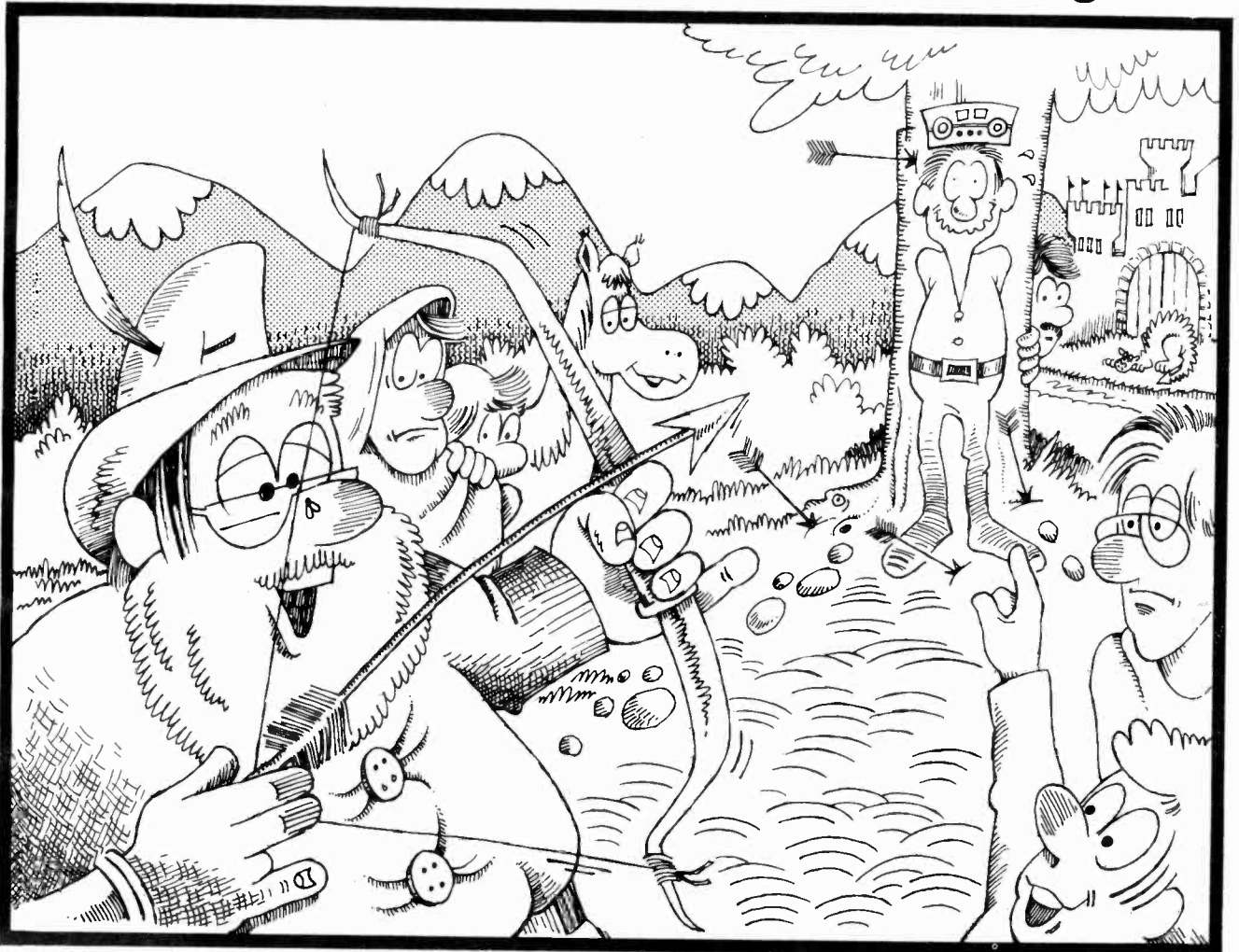

AT BENNIES, WE AIM TO PLEASE!
Send \$5.00 (deductible from your first order)
and your tax number for your copy of our
new 248 page catalog. It's a sure shot.



YOUR FULL SERVICE **Royce** DISTRIBUTOR

BENNIES

40 CHANNEL
CITIZENS BAND RADIOS!

WAREHOUSE DISTRIBUTION CENTER
RD No. 1 Berwick, Pa. 18603 Phone 717-759-2201

YOU CAN'T BEAT THE BEST!

Fiberglass Antennas Work Best – And Francis Makes The Best Fiberglass Antennas.

That's because Francis Industries holds the original patents on Fiberglass CB Antennas as well as fiberglass marine antennas. We make a complete line of whips, mounts, co-phase harness and complete antenna systems to fit every CBer's needs.

Ask your local dealer about our reputation for quality and performance. We think you'll be impressed enough to join thousands of CBer's who are already enjoying the best.

FRANCIS INDUSTRIES

431 W. Broad St., Pataskala, OH 43062
614/927-4091

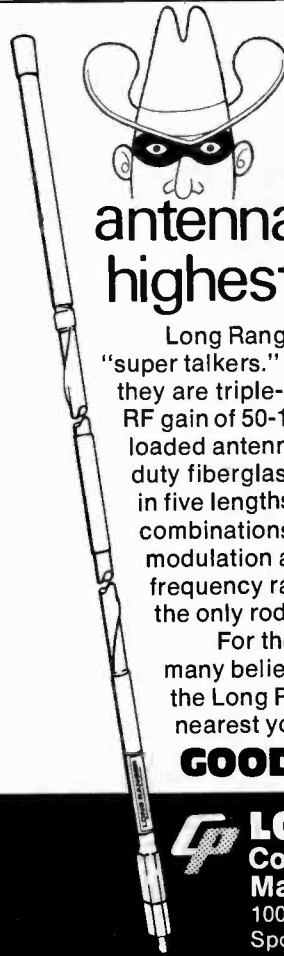

Long Ranger antennas get highest RF gain.

Long Ranger CB antennas are "super talkers." Pre-tuned and pre-tested, they are triple-loaded for unbelievable RF gain of 50-100% over most base loaded antennas. Constructed of heavy-duty fiberglass, Long Rangers come in five lengths and eight package combinations. Engineered for increased modulation and clarity, they have a frequency range of 26-28 MHz. They're the only rods in a choice of seven colors.

For the finest CB antennas, many believe, on the market, call on the Long Ranger distributor nearest you.

GOOD BUDDIES...



LONG RANGER
Communication Products
Manufacturing, Inc.
10025 East Montgomery Drive
Spokane, WA 99206 (509) 928-3313

FRAME YOUR HANDLE, CALL LETTER AND CHANNEL.

You've probably blared breaker, breaker, what's your handle more times than you care to think about. So end the breaker blues by ordering your personalized license plate frame and let the world know your handle, call letters and channel.

Each Smith Personalized License Plate Frame is permanently engraved with your message. No cheap peel-off/stick-on letters to fuss with. Smith Frames are available in white or black durable ABS plastic and black anodized brushed aluminum. The Smith Personalized License Plate Frame is also a perfect display piece for clubs and organizations. A white or black plastic frame is available for just \$5.95. And for you rich apples, a black anodized brushed aluminum frame will cost you \$9.95. So order a Smith Frame today and let the world know your handle, call letters and channel. 10-4? 73 and 88 from Smith Manufacturing.

Plastic frame engraved lettering available in white, black, gold, fluorescent yellow, or fluorescent red.

Anodized-brushed aluminum frame lettering in silver only. Fill in boxes with your letter requirements and leave a space where needed.

ORDER FORM PLEASE PRINT CLEARLY

YOUR HANDLE

(This coupon is for top mounting. For bottom mount turn coupon upside down and fill in.)

NAME _____

ADDRESS _____

TOWN _____ STATE _____ APT. _____

ZIP _____

KOS 8888 CH 40

ENCLOSED IS _____ PLUS 70 CENTS SHIPPING AND HANDLING. CHECK, BANKAMERICARD, MASTER CHARGE, OR MONEY ORDER B. OF A. NO. _____

M.C. NO. _____ CARD EXPIRATION DATE _____

SIGNATURE _____

WHITE PLASTIC BLACK PLASTIC ALUMINUM

LETTER COLORS: W B G FY FR

Mail check or money order payable to:
SMITH MANUFACTURING
1550 A. Linda Vista Dr., San Marcos, CA 92069
(714) 744-2071

TOMCATTING with “Tomcat!”

Across The Channels With
S9's Editor, Tom Kneitel (Tomcat/ KEZ5173)



THINK you picked a clever handle for yourself? There's a YL in my neck of the band whose handle is (I kid you not) *Break One Five*. Every time someone pops on to the channel with a break—station *Break One Five* feels compelled to respond! How's them apples? . . . CB'ers in the Bikini State are more than a bit unhappy about the fact Highway Patrol Smokeys are no longer permitted to use their own personal CB gear in patrol cars, as had been the case before it became outlawed last August. A number of petitions are now circulating in CB circles which implore the Florida Highway Patrol to permit such use until the FHP itself can equip all cars with state owned CB gear! For more information on how you can support these petitions, drop a note to Nancy F. Lanier, P.O. Box 570446 Perrine Branch, Miami FL 33157 . . . Some CB poetry came pouring out of the rig one day recently while I was accelerating in West Virginia—it was direct from the *Diesel Weasel*, who asked that I pass it along to S9'ers. The message was: *Smokey in the bushes/Smokey in the trees/Smokey's got radar/But we've got CB!* . . . Somebody I know applied for a CB license renewal, but made a typing error on the application when writing in his existing CB callsign. After the inevitable wait, Uncle Charlie dutifully renewed the CB license, wrong callsign and all. Somethin's probably out of kilter in the poor overworked computer down at Uncle's place and there's a good chance that there are a number of duplicate CB callsigns floating around if something like this took place! . . . *Apple Cheeks* called on the *double-L* from Tacoma to tell me a story which is *supposed* to be true—but somehow it sounds like a famous CB tall tale—seems that there was a great deal of friction between two guys who lived down a rural road a few hundred yards from one another. One guy was a TV addict who lived in a fringe area and couldn't see much of anything, the other guy was a CB'er who wasn't too worried about TV since he was too interested in his CB gear, which had as it's crowning glory a 1,000 watt boot (*linear*, for

those of you who aren't familiar with the term). Well after many months of angry confrontations and hostile double-L's the TV viewer finally found a solution. He put a batch of signs along the road reading: *WARNING! EXPLOSIVES! TURN OFF RADIO TRANSMITTERS!* That seemed to end the problem! . . . Many folks who seem to be in the know are predicting that it won't be too long before Uncle Charlie announces a new CB band, using FM transmission, and located in the frequency band which runs from 218 through 222 MHz. . . . A number of readers have written me to ask about the term "SASE" or "SSAE" which often appears in classified ads in *CB RADIO/S9* and many other publications. Nothing mysterious—it means that the advertiser requests that you furnish a self-addressed stamped envelope with your inquiry . . . Many CB'ers across the country are familiar with the CB sales and repair shop in Bascom (Florida) operated by IRONSIDE and his brother RED BARRON. Both of these fellows, confined to wheelchairs with Muscular Dystrophy, nevertheless were able to lead surprisingly active lives. However, on August 21st, IRONSIDE, who was 29 years old, passed away from a heart condition. RED BARRON will continue in the CB business . . . In reply to the readers who have written in to ask us about writing for *CB RADIO/S9*—yes, we do pay for articles and stories we publish if they are written exclusively for our use. And, no, you don't have to be a professional writer to be published in this publication—just a CB'er with a story to tell, hopefully one who owns a camera and who is willing to take a few pictures of the events and people connected with the story. Or maybe you've built a fantastic antenna or other CB device—well, share it with all of us! If possible, type your story, double spaced, and in upper and lower case letters . . . I have been looking with a slightly befuddled and squinting eye at Uncle Charlie's Personal Use Radio Advisory Committee (PURAC), established with the intention of advising poor Uncle how to live with the enormous CB ser-

vice. While members of this group come from various corners of the CB industry, there are also members who are part of the TV broadcast and cable TV industry. Be it known that the TV broadcast industry and affiliated interests are *no* friends of CB'ers, having a long history of attempting to kick us all the hell off the air for various assorted reasons including highly exaggerated claims of interference from our equipment. What has now come to pass is that most of the reports and proclamations which I see coming out of this PURAC group seem to be hogged by the TV industry puppets on the panel who *seem* to spend countless hours bewailing the cause that CB'ers are screwing up TV reception. The PURAC members who are representing the CB interests are not half as vocal in defending CB as the TV cable and broadcast people are in running us into the ground. I don't know where it's all going—but I think that the CB'ers deserve a bit more of a vocal group defending their interests—or at least more space in the press releases which issue forth from PURAC! . . . Many 18-wheeler CB'ers have had it *up to here* with the so-called truckers' channel, Channel 19, because of overloaded conditions and their claimed inability to conduct the same type of communications they had prior to the invasion of the channel by 4-wheelers. As a result, lots of these fellows have started abandoning Channel 19 for quieter frequencies. I've heard them on Channel 30, also a number have been heard on 26.885 MHz, which is *80 kHz below Channel 1!* . . . As expected, CB'ers are swarming in great hordes to have technically inclined buddies modify their equipment for 40-channel operation, this *not* being permitted under the new rules, but available at less expense in many instances than shipping the rig back to the manufacturer for remanufacturing. Also, those manufacturers who are providing this service are only willing to do so for selected models and not their complete line. Many local CB shop owners are absolutely enraged at the fact that Uncle Charlie did not permit the use of plug-in accessories for achieving 40-channel operation of older CB gear—several I know of are rather active in *underground* modification of sets to 40 channels, primarily as a protest against what they claim is Uncle Charlie's *sellout* of the many thousands of small CB dealers who had pinned their hopes on the channel expansion to provide an instant add-on channel expander market. Sorry about that, Unk—that's one part of your bounty of new channels which has gone over like a lead balloon! And many CB'ers have told me that they don't think too much of it either. Well, back to the ol' drawing board! . . . I always get a charge out of CB'ers who ask other CB'ers, "Can you copy

me?" My question is, if they couldn't copy the other station, how would they be able to answer that question?? Would they say, "No, I can't copy you—don't understand a word you're saying!" . . . Last jamboree season we had several clubs call us on the double-L to try to get their jamborees listed in our Coming Events—we advised them, as I am letting clubs know for the forthcoming jamboree season, that *all* jamboree and coffee break notices must be submitted *in writing*, we can't take 'em over the landline—nor can I accept the responsibility of running such information when it is given to me over the channels or in person, and for those of you who couldn't understand why your jamborees didn't make it into our pages, I hope that you take pen or typewriter in hand to drop us even a postcard *this* time! . . . I had a chance to visit *Music City* for a couple of days recently—first time for me in Nashville and it was a great town! . . . Last September I had an advance copy of a new book entitled *CB BABY*, which should be on sale by the time you read this. It's a novel by Clark Whelton, published by Avon Books (paperback \$1.75), about a whacky Pennsylvania town where all residents are CB-crazy—all topped off when *CB BABY* rolls on in with some tough hoods in pursuit. That turns the place into a carnival of scandal, racy stuff, intrigue, massage parlors. If you haven't yet read this book, I think that you'll get a kick out of it! . . . Willie, *Unit 988*, writes to ask why nobody has yet come up with the idea of marketing a pop-in-the-oven quickie type meal called a *CB Dinner*—like a TV dinner. Dunno, Willie, could be that too many CB'ers get indigestion from listening on the channels to the antics. Have no fear, fore sure someone will eventually bring it out!! . . . Hey if you live around Elgin, Ill., you've got it made—you can order from *RADIO MAC* via Channel 11 and have your Big Mac, soda, French Fries, ready and waiting for you when you roll up to Jerry Bear's MacDonald's Restaurant at 401 Summit. Jerry got the idea while listening to a couple of truckers ratchet jaw about eats on Channel 19, then he cleared the idea with Uncle Charlie—next he installed the gear (which gives him a 15-mile radius)! A clever idea! . . . Speaking of clever—some folks have had problems trying to figure how to mount a rig for 2-wheeling operation. Bob Ekholm figured out how to mount his Craig rig during his trip to Canada last summer—he put it right on his chest where he had easy access to mike and rig. And they said that nobody ever took CB to heart! . . . A plague be upon the inventor of the 4-pin miniature mike plug, and may he have to hook up 3-million of them to erase the evil deed from his Karma! . . . We heard from a few more CB old timers—one was William

B. Wood, who hails from Alabama. Back in the beginning he was 11W7890 from Shakey Side way. When the new callsigns came in he received the call KEG3673, then he became KDI5728, which is his current callsign, although locals may know him as *Diamondback Piecemaker* on the channels! Another golden oldie is Douglas R. Ream. Doug, who is presently in military service, was originally licensed as 6W3118 in Atlanta, Ga. (1960). But he's still in there "pushing the mike button," he sez—says he thinks S9 is "the best." Thanks, Doug—we tryin!...A new CB flick is on the way, it's called *CITIZENS BAND* and was filmed last October on location in Marysville, Calif., by Paramount. Starring Candy Clark and Paul LeMat, the color feature is a comedy-drama and is an original screenplay by Paul Brickman, produced by The Fields Co., directed by Jonathan Demme. Scheduled for Spring release nationally, watch for it! . . . By the way, one of our usually reliable west coast reporters tells me that Marlon Brando has the CB bug and is quite active on the channels, sometimes using disguised voices to permit contacts without recognition—he also utilizes several different handles . . . *Buckshot* told me about the guy who was having marital problems, so he and his wife went to a marriage

counselor. After discussions and tests it was determined that the problem was that the fellow had an IQ of 150 while his wife had an IQ of only 85. The husband had a great solution, that being to send his wife to a special school to bring her IQ up to his level—but the marriage fixer said that it would be an impossibility to substantially increase her IQ. His solution was to use a new electronic device which would lower his IQ to be the same level as his wife's. It was a quick and painless trick, a helmet (like a football helmet with wires coming from it to a large wall panel) is placed on the head, and the IQ thusly drops at the rate of 5 points per minute—in less than 15 minutes they would be in tune! So the helmet was placed on the fellow's head—but unfortunately the doctor received a telephone call and totally forgot about the poor fellow. When he remembered him about a half hour had passed! Leaping from his desk, he ran excitedly into the room where the husband was still sitting with the helmet. Yanking it from his head, he grabbed the fellow by the shoulders and shook him, shouting, "I'm sorry, I'm sorry! Are you alright?" The husband, simply looked at him with a big beaming ear-to-ear smile and said, "That's a big-10-4, goodbuddy!"

So what else is new?

BIG MOUTH

CB mobile/base station speaker

ENGINEERED FOR VOICE INTELLIGIBILITY
BIG MOUTH IS ALL GUTS

- Crisp • clean voice reception.
- BIG 5 inch heavy-duty speaker.
- Rugged 3/8" wood enclosure with handsome walnut vinyl finish, just like the professional systems.
- Swivel bracket mounting hardware.
- For all base stations, cars, RV's, Vans, Trucks.

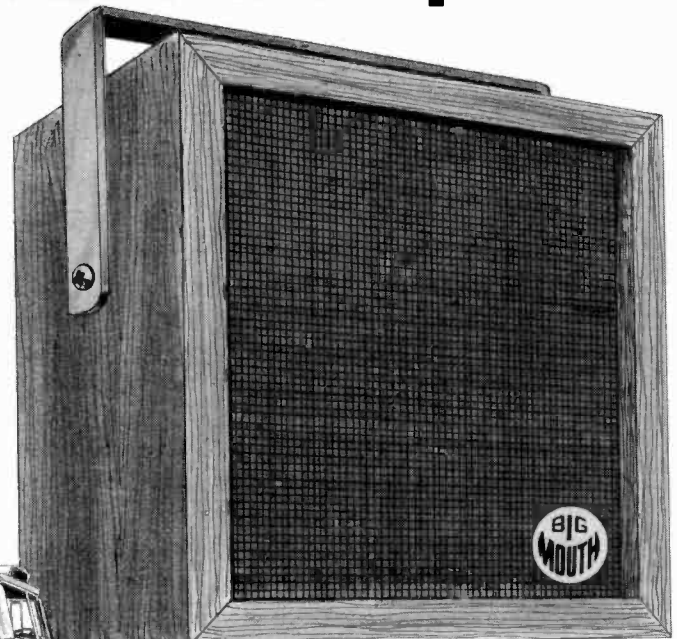

The ideal CB speaker
for RV's • Vans •
Trucks • Cars

Argos
SOUND

A Division of Argos Products Company
600 So. Sycamore St., Genoa, Illinois 60135

THE HAM BANDER



By Lee Aurick, KNE7802, K2LS

About the Author

Lee Aurick is particularly well qualified to conduct this series designed to interest and help you in becoming a ham.

A pre-teen interest in Amateur Radio interrupted by schooling and WW II (in which Lee saw service as a Signal Corps Communications Chief), blossomed into a General Class ham license in 1946, an Advanced Class license in 1951, and

one of the first Amateur Extra Class licenses in 1952.

Lee has helped hundreds of people to learn the code, and to acquire sufficient knowledge to pass their ham license exam. He brings to these pages more than thirty years of experience as organizer and officer of numerous amateur radio clubs, background in administrative, technical and legal affairs at the national and

international level, and a sincere conviction the amateur radio is the greatest service/hobby in the world.

CB Radio/S9 is proud to present this paper, the first of a series, and your invitation to new fun and adventure.

Follow along with this experienced ham as he opens the door for you to the exciting, and challenging world of amateur radio.

SO you want to run 1000 watts? OK. You want to work skip? Talk to foreign countries? You would like to help out on hurricane, flood and earthquake communications. Actually "see" the other fellow, and have him "see" you. Talk 100 miles, by means of a repeater, or perhaps 5000 miles by satellite—from your car. It's possible, you know. And what's more, it's legal!

Yup, The Friendly Candy Company (otherwise known as the Federal Communications Commission—FCC) not only says it's legal, but even makes it easy for you by providing special channels (frequencies) and rules. There's no catch. It's called "Ham Radio", or more formally, Amateur Radio.

No matter what you call it, Ham Radio is where it's at, as far as communications is concerned. And you're a communicator, or you wouldn't be in CB. Here's your invitation to join that "other" world of communications.

What is Amateur Radio?

While the numbers have been growing slowly in comparison to CB radio, recent FCC data shows almost 300,000 licensees, and the number is expected to be about one million by 1980. Most of this increase will come from CB Radio. For this huge number of amateurs to occupy essentially the same frequencies they have always had, new and challenging technical developments are required. They are already being

worked on, and are just waiting the need that will make them essential.

Why are these developments necessary when CB has many times this number of stations operating on only

23 channels (40 channels as of January 1977)? CB is primarily a low power, local service, and thousands of CB stations may operate on one channel and never be heard by stations just a few short miles away. In contrast, most amateur radio frequencies are international in coverage, and amateur stations operate with power levels in the hundreds of watts. Amateurs may use 1000 watts (1kW) on CW (code) and 2000 watts (2kW) on SSB. When an amateur station transmits it is capable of being heard by thousands of potential listeners, and thereby interfering with their communications, worldwide.

Amateurs operate on many "bands" of frequencies, and unlike CB, which is "channelized", amateurs have many frequencies on which they can operate within each band. Advanced and Extra Class amateurs enjoy the privilege of operating on certain frequencies reserved for them.

What Can You Do With It?

Today, amateurs are able to communicate with just about every corner of the earth, at will, by a variety of methods including CW (code), SSB (voice), radioteletype (RTTY) and television. It's probably safe to say that any two amateurs who desire to communicate with each other, no matter where on this earth they may be, may do so today.

Within each band of frequencies, the

Chart I

Frequency	Amateur Band Wavelength (meters)
kHz	
1800-2000	160
3500-4000	75/80
7000-7300	40
14000-14350	20
MHz	
21.000-21.450	15
28.000-29.700	10
50-54	6
144-146	2
220-225	1 1/4
420-450	3/4
1215-1300	From this point on up
2300-2450	in frequency, amateur
3300-3500	bands are not referred
5650-5925	to by wavelength in
	meters. They are
	usually identified by
	the lower frequency
	limit such as: the
	2300 MHz band.
GHz	
10.0-10.5	
24.0-24.25	
48-50	
71-76	
165-170	(Note: One Gigahertz
All above 300	equals one thousand
	Megahertz)

Complete List of Amateur Bands

regulations prescribe the kind of transmission (emission) which may be used.

CW (code) is permitted on every amateur frequency, but by "gentlemen's agreement" it is not used on those frequencies on which voice communications are permitted. CW is still considered the basic means of communications (perhaps 50% of all amateurs still use code) and this is one of the reasons a knowledge of the code remains as one of the requirements for an amateur license. There has been more heat (and less light) generated about the code than almost any other facet of amateur radio. A knowledge of the code is also required under the provisions of the International Telecommunications Union (ITU—a regulatory body supported by all civilized countries) agreement which this country has signed. However, the treaty provides that each country may determine the code-speed requirements for the various amateur licenses.



This young man is typical of the many young Novices to be heard on the amateur bands.

Classes of License

Each of the five classes of amateur radio license requires an increasing level of knowledge. However, additional operating privileges are the reward for the effort in attaining the next higher class. These rewards include higher power authorization, the opportunity to use certain types of communications (for example, TV), and the privilege of operating on certain desirable frequencies reserved for the highest classes of license.

The introductory level license is called the Novice. It is the only one we will discuss thoroughly here, and if you follow these and future pages in this series you will have no trouble in passing the exam.

Other classes of license are: Technician, General, Advanced and Amateur Extra, in the order of their technical and operator requirements.

Where Will Ham Radio Be Tomorrow?

How's your crystal ball? If you don't pin me down too closely on what "time" tomorrow certain things will happen,



Many amateurs exchange TV pictures with stations here, and in other countries.

I'll toss out a few predictions on the future of amateur radio.

1) Simultaneous voice and television contacts with amateurs in all civilized areas of the world will be a common and daily occurrence.

2) Communications with pioneer colonies on both the Moon and Mars will be conducted daily with equipment about the size of your present CB transceiver, and with antenna no larger physically than a TV Antenna.

3) Amateur operators will be the first to pick-up signals from a civilization on a planet in deep space. (Because of the vast number of amateurs, and their total listening time, they stand a much better chance than the few professionals with their limited time for such activities.)

4) One hundred amateur repeaters will link hams on both coasts, border to border, in a network that will enable low power mobile and home stations to provide disaster-proof emergency communications.

Science fiction? Absolutely not. Several thousand amateur stations already have the capability to do most of these things, and in just a very short time you could be among them. It won't take that much effort, and it also won't cost that much money.

What Can Ham Radio Mean To Me?

For one thing, it can make your world the size of an orange. It can



Amateur antennas come in all sizes. This one required a helicopter to raise it into place.

HEY "GOOD BUDDY"

STOP

LOOK

LISTEN - Are You Having Trouble Locating Those CB'ers You Spoke With Last Month or Last Year?

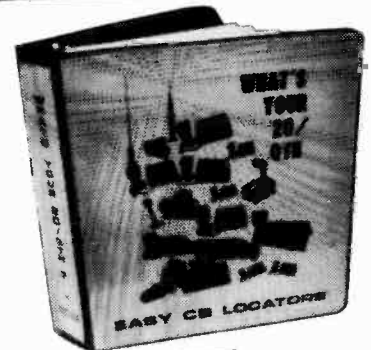

\$14.95

Complete + Postage

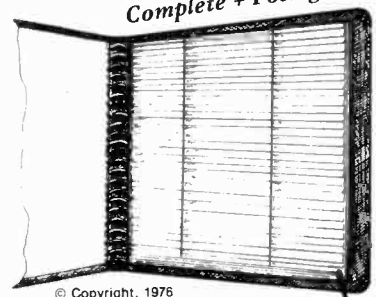

© Copyright, 1976

INSTANTLY LOCATE THEIR CALL NUMBERS OR HANDLE WITH EASY CB LOCATORS™

a beautiful book, custom designed to easily locate call number, personal/handle, 20/QTH and other info on all your CB Buddies. With this system you only write the information ONCE and you have it for a LIFETIME. You can move it ANYPLACE in the Book at ANYTIME.

—NOT AN ORDINARY LOG BOOK—

LOCATE THEM INSTANTLY

We include 10 code, CB Lingo Sheet, instruction brochure and other items.

START YOUR PERMANENT FILE ORDER NOW

EASY CB LOCATORS, INC.
Huron Trail, Oak Ridge, N.J. 07438

Your Name.....

Address..... Street.....

Town/City..... State..... Zip.....

Please send me..... EASY CB LOCATORS™ @ \$14.95 ea. + \$2.45 postage

Enclosed is my check/money order in amount of \$.....

bring medical missionaries in Africa or the Amazon into your "shack". Instead of reading about their exploits in a newspaper or magazine, they'll tell you themselves of the strange and interesting lives they lead, and what they saw or did *this afternoon*. Amateurs are with the explorers of several countries now engaged in discovering the secrets of Antarctica, the last frontier on earth. They, and the other scientific and support members of these expeditions, are hungry to talk with their loved ones at home. Amateurs provide these communications, handling thousands of phone calls every year to relatives who live nearby—in every state in the union.

If you are young and soon will be looking for a career, amateur radio can open a door for you to a world that is almost beyond measure. Thousands of today's professionals first discovered their interest in what we now call "electronics" as a result of ham exposure.

If you are already established, you may well need the diversion and change of pace that amateur radio can provide. There is enough there to challenge the gray matter, and to stimulate it beyond anything you have ever imagined.

If you have reached the point in life where the search for material rewards (a weekly paycheck) no longer occupies

most of your time, just forget that old adage about teaching an old dog new tricks. A grandmother of 76 young years recently received her Novice license, and opened up a new life, filled with new ideas and new friends.

Age and physical infirmity are no barriers to the enjoyment that an amateur license can bring. There is no age limit. The Novice Class license is administered by amateur volunteers, not government examiners. Even with the higher class examinations the FCC makes special allowances for legitimate handicaps, including blindness. Yes, many blind amateurs share the airwaves with their sighted friends. A national organization called Handi-Hams has members in every state who are blind, bedridden or parapalegic.

So, regardless of your circumstances, young, old or in between; looking to the future, now busy keeping the wolf from the door, or enjoying the golden years, amateur radio is for you.

If you've been turned-on to ham radio at this point, and are wondering how to get started—it's easy. You already have.

Getting Started

Don't worry about the fact that you're not an engineer. Eighty percent of all hams are *not* engineers, and they come from every walk of life. Whether

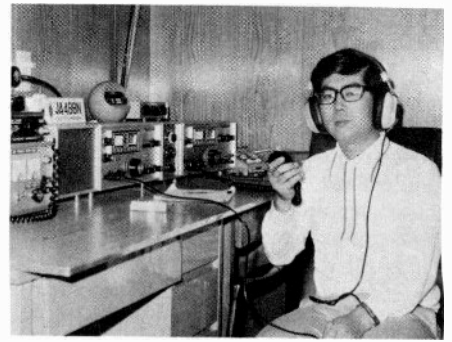

This young Japanese amateur is typical of thousands of stations you can talk to throughout the world.

you're thirteen or eighty-three, everything will be presented here that will be needed for your Novice license preparation. Though we can't give you code practice in these pages there will be many tips on how you can train yourself, very easily, and in a surprisingly short time.

Novice Class amateurs have their own frequencies on which they operate and they are assigned distinctive call letters, though the FCC has indicated that this distinction may vanish soon. The advantage to a call sign which identifies an operator as a Novice is found chiefly in the extra consideration which "old timers" bestow on newcomers. Slow sending and an extra dose of patience usually greet the Novice operator when an "old timer" decides to talk with the new operator. Perhaps some of this advantage will be lost when Novice operators can no longer be so easily identified.

Learning the code is easy. In fact, it's so easy that you will know more than 25% of the alphabet by the time you finish this introduction.

The code that radio operators throughout the world use is called "International Morse," or simply, the code. If you were to squeeze the button on the mike of your CB rig just long enough to say "one", you would be sending a dot—a long dot perhaps, but nevertheless, a dot. Now if you were to squeeze the mike button long

COMMANDER BASE ANTENNAS

Professional Performance

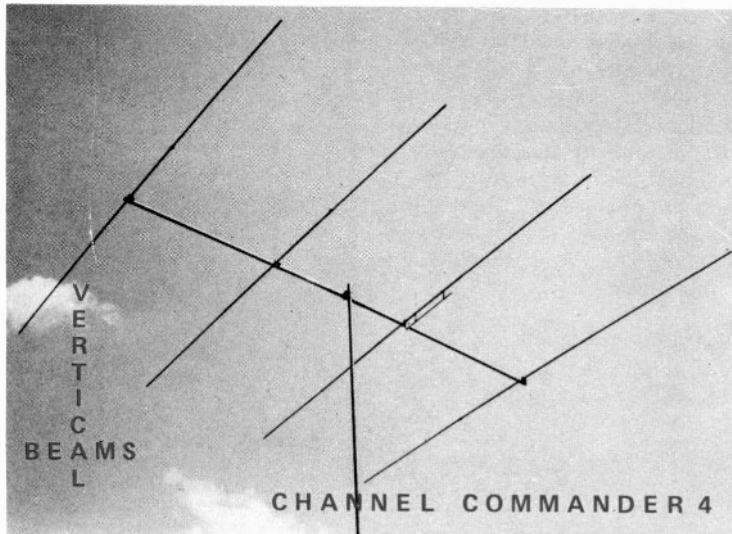

Proven Yagi design for long-range Base Station coverage. A DX antenna with heaviest walled aluminum tubing of any CB antenna. All hardware and clamps are steel. Easily assembled and tuned to low SWR across all 40 channels. A rugged, professional antenna.

- Gain 14.5 dB
- Front to back ratio 38dB
- Boom length, 15.5 ft.
- Weight, 22 lbs.
- Horizontal or vertical polarity
- Twin 50Ω Gamma Match
- Power capability, 2,000 watts

See Your Favorite Supplier

NCC-2706 National Circle—Garland, TX 75041

(214) 271-3651



Not all hams are guys. Many thousands of the fairer sex are to be found on CW as well as SSB.

For Information About Our Advertisers . . .

enough to say "one, two" you would be sending a dash. Except that as a Novice, there is no microphone, no modulator to impress your voice on the carrier, and instead of a microphone button, you now have a key—a radiotelegraph key—at your finger tips. That is how CW is sent. It is the carrier, interrupted by the key, which enables messages to be sent. For example, a short and a long (pronounced dit dah), and you've sent the letter "A". You'll notice that it isn't said, "dot dash". When CW is heard over the air it more nearly sounds like dits and dahs, and learning the code for you can take a giant step forward just through this simple procedure, alone. What's the sense of learning the code by dots and dashes when, in the end, listening on the air, you will be hearing *dits* and *dahs*.

Unfortunately, many books and pamphlets on learning the code still show the letters of the alphabet and their respective code symbols in dots and dashes. The learning process is severely strained in learning CW this way, and for some it will take years to break the habit. Others never will break with their early learning method, and will have trouble with CW for the rest of their lives.

Chart II

E dit
I ditdit
S ditditdit
H ditditditdit

T dah
M dahdah
O dahdahdah

Seven letters of the alphabet arranged in two progressive groups to aid in learning.

Here is one suggestion on how you may go about learning CW. It will enable you to learn seven letters almost instantly, and put you more than 25% along the road toward your goal. Here's how it's done. We take the letters E, I, S and H. Each letter is composed of dits only, and each letter has one more dit than the previous letter. Starting with one dit, then two dits, then three dits, and finally four dits, we have now sent, and started to learn these four letters. Try saying them out loud. Not too fast, at this time. We're not in a race. OK? Already you can send several words, including I, he, she, his, is, hiss. You Scrabble fans will find others.

The next three letters are composed of dahs. They are T, M, and O. Start by saying dah, then dahdah (it's best to try this one in a room all by yourself) and finally dahdahdah. As with the other letters containing the dits, kept on saying them slowly to yourself.

Now your vocabulary of words has taken a leap forward. You can now

"send" words like toss, mit, miss, me, and them. You can even send such great sentences as: "She is the miss I hit", and "He hit it to me".

To further help you to learn CW as it sounds "over the air" a complete code-practice oscillator, including key, should be purchased or borrowed. This should not be a key and buzzer combination, as the tone will not be similar to what is heard on the air. Inexpensive models are available at both Radio Shack and Lafayette stores.

As promised, you already have a grip on more than 25% of the alphabet. The remaining letters will be covered next, as well as the numbers. Numbers and punctuation are not required for the Novice examination, but you will need to know and be able to send numbers eventually as they are used in all amateur call signs, and are necessary for the exchange of signal reports. Numbers are simple, rarely give anyone any trouble, and besides there are only ten of them.

Additional tips on learning and copying CW will be next, and we'll have the first discussion on the written exam. It's even easier than learning CW, and there are only twenty questions that you will be asked on the FCC examination.

If you have any questions about ham radio, fire them along. We'll try to answer them all here. 73, K2LS

Q: When I get my ham license would it be possible for me to use any of my CB equipment on the ham bands?

A: Just about all necessary equipment, including rotators, microphones and SWR bridges can be used. Many transceivers, and just about all CB antennas can be easily modified to work on the 10-meter amateur band (28-29.7 MHz). However, this band requires a General Class license and is not available to you as a Novice.

Q: What amateur bands may I operate on when I get my Novice license?

A: Novices may operate on portions of four amateur bands, CW only, as follows: 80 meters (3700-3750 kHz); 40 meters (7100-7150 kHz); 15 meters (21.1-21.2 MHz); 10 meters (28.1-28.2 MHz).

Q: How much power may I use as a Novice operator?

A: The FCC has recently authorized the use of 250 watts of power for Novice operators. This enables a Novice to buy equipment for use as a Novice that will be of use when moving to a higher class of license.

**RAISE YOUR POWER ON A
UNIVERSAL
TOWER**

FREE STANDING
ALUMINUM TOWER

10' to 100'
Prices from \$110.00 (30')

**MOST
POPULAR
TOWER
EVER MADE!**

REQUEST
**NEW CATALOG
OF TOWERS & ANTENNAS**

COMMUNICATION SPECIALISTS
For Over 38 Years

Write for Free Catalog
and Wholesale Prices!

ELECTRONIC DISTRIBUTORS, INC.
1960 Peck Muskegon, MI 49441
TEL: (616) 726-3196—TELEX: 22-8411



DO YOU KNOW WHAT THIS IS ?

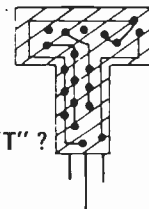

This Is The Delta "T"
OK, What's The Delta "T" ?

The Delta "T" is the very best way to cure adjacent and spurious channel bleed-over and increase receiver sensitivity. The Delta "T" is not just a filter but a network designed to give your CB set a minimum of 80% reduction in bleedover and increase sensitivity at the same time. The Delta "T" is designed for any CB with a ceramic filter at 455KHZ.

Simple installation in your set with complete instructions make your set have as good a receiver as those costing \$400 to \$800 at nowhere near the price. Install the Delta "T."

\$49⁹⁵ (Conn. Residents add 7% sales tax)

Send check or money order to:

DELTA ELECTRONICS INC.
180 MAIN STREET
NORWALK, CT 06851

DEALER INQUIRIES INVITED !

All orders add \$1.00 postage and handling.
(Be sure to tell us what type of CB you have.)



Bill Orr on Antennas

PART 11: 40 CHANNEL ANTENNAS?

HOO, boy! Last summer the FCC announced that as of January 1, 1977 the CB channels would be expanded from 23 to 40. This has caused a real problem in the industry, confusion among the CBers and a built-in anticipation of less interference and better two-way communication.

One of the side effects of all of this uproar is that some over-eager antenna manufacturers are advertising new "40 channel" antennas, the "sales pitch" being that your present antenna is presumably worthless on the new channels and that you had better buy the new *Belchfire Wonder-rod* or you won't be able to punch a hole in a paper bag, as far as radio talk goes.

Well, maybe so. But before you rush out and buy a new antenna, or rip your old one down, let's have a close look at the problem and see if some guidelines can be drawn. It's *your* money that's on the line, so before you spend it on something you don't need—*think about it!*

A 40 Channel Antenna?

True, the manufacturers of yesterday's antennas weren't thinking about 40 channels and the "old" antenna designs were probably tested for only 23 channels. Where does that leave you? Fortunately, it is possible to test an existing antenna to determine just how it will function over the new channels. And this is how you go about it.

While the FCC has been a bit coy (as of this writing) to exactly spell out the frequencies of the new channels, it is known that the highest channel will be about 27.43 MHz. Thus the CB channels will eventually encompass a frequency range of 26.96 MHz to 27.43 MHz. That's a total span of 470 kHz from channel #1 to channel #40. The question, then, is will your CB antenna cover 470 kHz and if it does, how do you determine it?

Until you get a 40 channel transceiver in your hot hands, or can get a signal generator and antenna measuring device to cover all 40 channels, the best you can do is to measure your antenna over the existing 23 channels and then interpret your results for 40 channels. And this can be done with your CB radio and an SWR meter.

The plan is to measure the SWR on the existing CB channels, plot a graph of the SWR readings, and then extend the graph out to include the new channels. You don't need to measure the SWR on *every* channel (although you can do it if you wish to).

Making the Graph

The graph is drawn on squared paper. The paper I used had quarter-inch squares on it. The horizontal axis of the graph is labelled "channel" and marked as shown in Figure 1. Notice that there is a gap in the marking between channel 4 and channel 11. That's because there is a jump in the regular distribution of channel frequencies that falls between channels 7 and 8. (The missing channel is reserved for radio control of models). Other "missing channels" for radio control exist, but don't affect our graph. The channels are marked every other square, so that there are two divisions between the indicated channels, with the exception that the space between channels 38 and 40 is half as large as the other spaces.

The vertical axis of the graph is labelled SWR (Standing Wave Ratio) and runs from a low value of 1.0 up to a high value of 2.5. These are the readings you'll measure with your SWR meter. (For more information on the SWR meter, see my last two columns in S9 magazine). Switch your CB rig to channel 1, make an SWR reading and then plot it on the graph. For example, if the "reverse" SWR reading is 1.5, make a point on the graph at the intersection of the graph lines for channel 1 and SWR = 1.5. OK?

Now repeat the SWR "reverse" reading on channel 4 and mark your reading on the graph at the intersection of the channel 4 and SWR graph lines. Continue this procedure for channels 11, 14, 17, 20 and 23. If you have done this properly and your antenna is in good working condition, you should be able to draw a line through the graph points to make a smooth curve, such as shown in Figure 2. This example probably isn't the curve you'll get, it is merely representative of what the curve *could look like*.

If your antenna is properly balanced to work on the present 23 channels, you should find that your lowest value of SWR (and the lowest point on the curve)

should fall about channel 12 or 13. These two channels are just about at the middle of the present CB range. The SWR curve should rise smoothly and equally towards channels 1 and 23.

A perfectly matched antenna will show an SWR reading of 1.0 at its design frequency, which should fall around channels 12 or 13. A simple antenna such as a ground plane, or 5/8-wavelength whip (base station) will probably show an SWR reading very close to 1.0 at the mid-channels and the reading will rise to perhaps 1.5 at channels 1 and 23. If the mid-channel reading at channels 12 or 13 is higher than 1.0, the whole curve will be shifted upwards on the graph.

Thus, the lower the SWR at the mid-channel frequency, the lower will be the SWR at the extreme end channels.

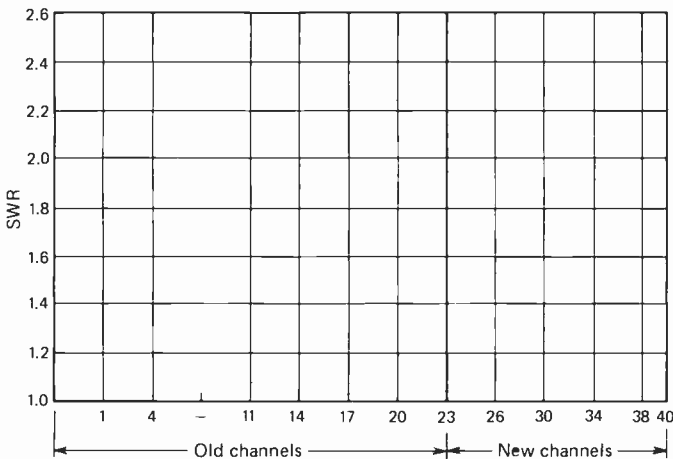

Fig. 1—A graph you can use to plot the SWR of your antenna for channels 1 through 23. See text for details. The graph can be extrapolated for channels 24 through 40. You can make your own graph, or run this one through a copying machine. Plot the "reverse" SWR reading of your antenna and draw a smooth line through the measured values, as shown in Figure 2.

Channels 24 to 40

It is possible to arrive at a close approximation of the SWR of your antenna on the new channels by extending the graph you have just measured. Since you can't tune to the high channels, the next best thing to do is to extend the graph by eye. Just extend the line you have graphed so that it crosses the coordinates for channels 26 through 40. An example of this is shown in Figure 2.

The resulting curve is a very good approximation of what your particular antenna will do when it comes to operating on the new channels.

How high an SWR reading is permissible? Ah, that's the question! The instruction manual of your transceiver should tell you the maximum SWR rating of the transceiver. If your antenna is of the vertical, ground-plane type it will perform in an acceptable manner regardless of the SWR reading. And that goes for full-size mobile whips, too.

Mini-whips (coil loaded devices), as well as base

station beam antennas provide a much steeper SWR curve than do the more basic antennas. This doesn't mean that the antenna won't function on the new channels, however. In most cases, the limiting piece of equipment is the CB transceiver. If your CB set is of an older design, it probably uses tubes instead of transistors. The old tube sets are much more tolerant of SWR than are the newer transistorized designs. Most solid state CB sets provide internal protection for the power transistors so that a high SWR on the antenna system won't damage the transistors. The penalty that is paid is that the output power of the transmitter drops as the SWR of the antenna rises!

The instruction manual of most CB transceivers states the maximum value of SWR that the set can stand. And no doubt the new 40 channel sets will have the same information supplied with them. However, if you find that the SWR curve covering channels 1 and 40 is low enough to pass the SWR limit set by your present 23 channel set, it means that your antenna is probably OK for the new 40 channel sets.

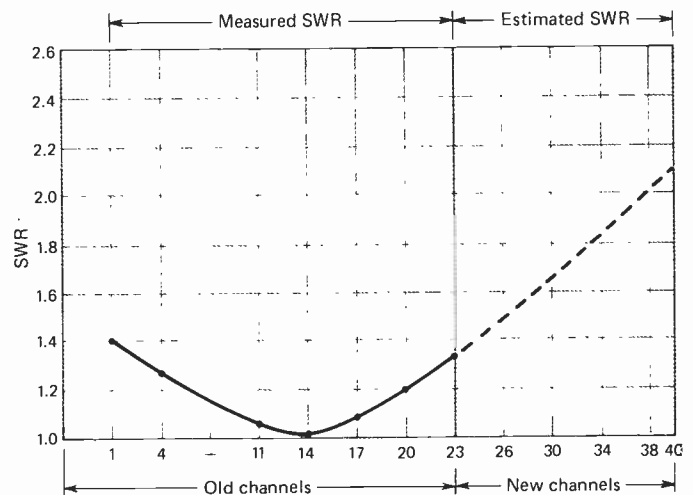

Fig. 2—A representative plot for a CB ground plane antenna. The lowest value of SWR occurs about channel 14. SWR rises gradually and smoothly as the transceiver is switched from channel to channel. At channel 23 the antenna SWR is about 1.3. By extending the graph by eye, the estimated SWR rises to a value of about 2.1 at channel 40.

Antenna Adjustment

Sometimes you'll find that your CB antenna is tuned too low in frequency (Figure 3) or possibly too high (Figure 4). The SWR curve tells you that by disclosing the point of lowest SWR. If you wish to move the design frequency of the antenna higher, the antenna must be shortened a bit. Conversely, if you want to move the design frequency lower, the antenna must be lengthened. Some whip antennas have an adjustable section to alter the length. This makes everything easy. You can change antenna length a bit, remeasure the SWR as discussed earlier in this article, replot the SWR curve and look at the results. *The lowest point of SWR on the curve should fall about the middle of your chosen operating channels.* For example, if you work mainly on channels 17 through 23, you might wish to adjust the length of your whip or ground plane an-

HIDE-IT™

CB ANTENNA QUICK DISCONNECT TRUNK MOUNT

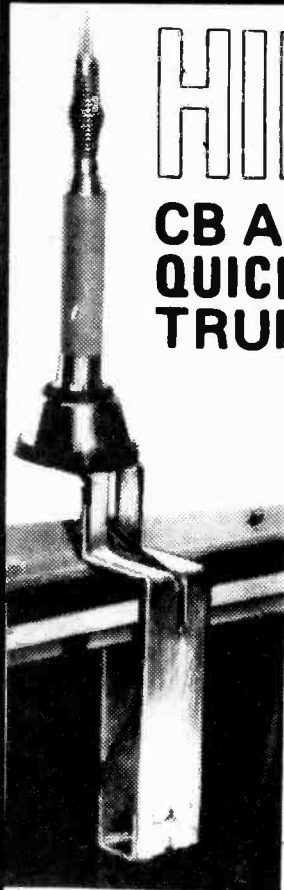

DETACHABLE!...PLACE ALMOST ANYWHERE IN TRUNK!... DOES NOT INTERFERE WITH TIRE, JACK, LUGGAGE, ETC. ATTRACTIVE CHROME FINISH!

Hides CB Antenna in trunk- prevents theft and damage. Simple installation. Detaches quickly for storing. No need to unscrew antenna from mount. Easily attached into secure operating position. Adjustable bracket fits most cars- accepts most CB antennas.

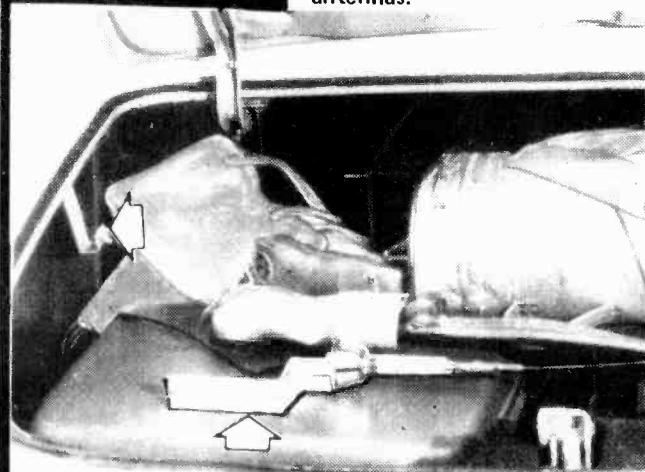

Includes self-adhering rubber cushioned strip to protect car finish. Secures cable in place. Self grounding. Does not rattle in trunk when stored. Peg-Hang Packaged in a Four Color Printed Carton. Complete with fool-proof instructions.

Pat. Pend.
Model #CBTM-20



Write for Catalog...
RMS ELECTRONICS, INC.
50 Antin Place, Bronx, N.Y., 10462
Tel. (212) 892-6700



tenna so that the design frequency (frequency of lowest SWR) falls about channel 20. If your main operation is centered about channels 1 through 10, the design frequency of your antenna should be centered about channel 5. And if you are interested in operating on all channels, shoot for channel 12 or 13 as the design channel.

Now, as far as the new channels go, you may be able to cover 'em as well as the old channels with your antenna, particularly if it is a vertical whip, ground plane or 5/8-wave extended design. These antennas are quite tolerant of the operating frequency and many of them will work OK over the new channels, as well as over the old ones.

Mini-whips and beam antennas are a different situation, however. In the case of the mini-whip, the whip is brought to frequency by winding the missing portion of the antenna up into a coil. The coil may be either at the base of the antenna, or at the mid-point. Now, while the antenna is in a resonant (or tuned) condition with the addition of the coil, the coil doesn't

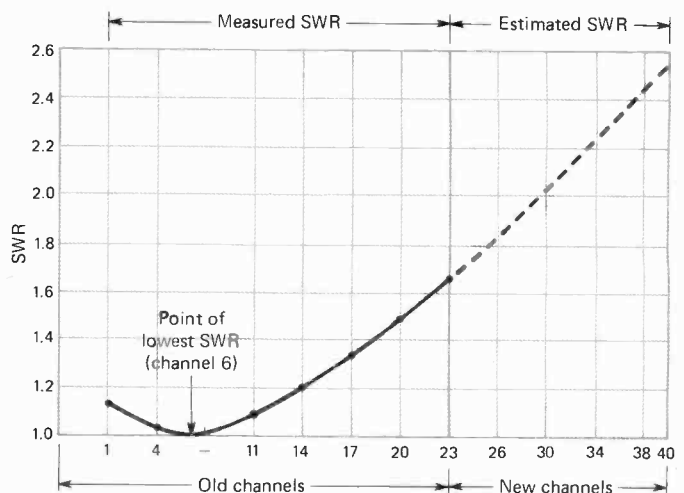

Fig. 3—An example of a CB antenna tuned to channel 6. The SWR curve is shifted lower in frequency than that of Fig. 2. By projecting the curve, it is estimated that the SWR will reach a value of nearly 2.6 at channel 40.

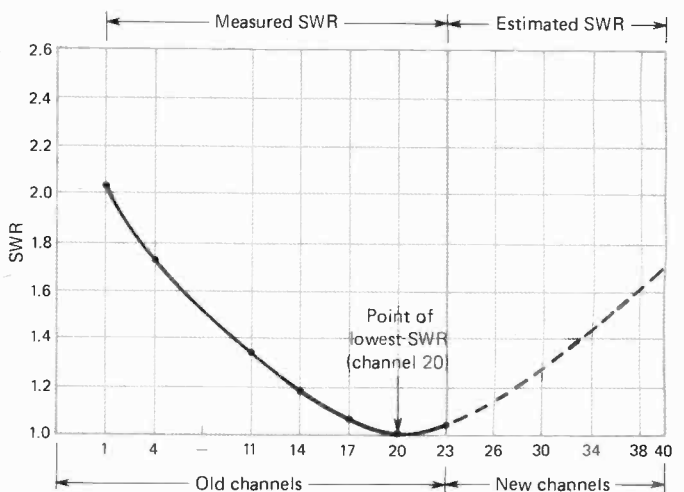

Fig. 4—CB antenna tuned to channel 20. The SWR curve is shifted higher in frequency and point of worst SWR occurs at channel 1. Notice that SWR is quite low across channels 24 thru 40.

"SEE IT AT PC '77 LAS VEGAS, BOOTHS 481 - 482"

radiate any signal: that's the job of the antenna. Since only a portion of the overall antenna system is radiating energy an unfortunate result is that the antenna becomes more frequency sensitive. Look at Figure 5. This graph compares the SWR curve of a 102" mobile whip with the SWR of a coil-loaded 24-inch mini-whip. Obviously the big whip will work on the new channels with ease. The mini-whip? No way! The only way you can get the mini-whip to work on the new channels is to reduce the length of the whip. Some whips have an extension tip and you can do it quite easily. But you'll find that you have merely shifted the curve upwards, as shown in the drawing. And now you can't use the mini-whip on the lower frequency channels! The only way to use the whip on both high and low channels is to change the length when you shift back and forth between the old channels and the new ones. What a drag!

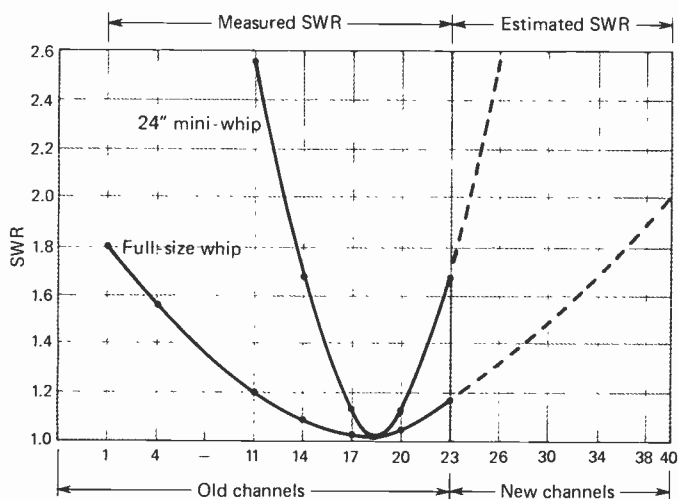

Fig. 5—Comparison of SWR curves for a full-size whip or ground plane antenna and a 24-inch "mini-whip". Mini-whip shows very steep SWR curve and antenna is useful only over a few channels. Mini-whip must be readjusted for operation over the new channels, or over channels 1 through 14.

What About Base Station Beam Antennas?

Unfortunately, each beam antenna will have to be judged on its merits. Normally, the Yagi-style of beam, which uses linear elements made of aluminum tubing, will work OK on the new channels *provided* the manufacturer matched the beam properly and it shows a low value of SWR at the design frequency. Some inexpensive Yagi beams have little or no matching device. In that case, you're in trouble. A well designed Yagi beam should cover the new channels with no sweat.

The same remarks apply to a simple Quad antenna. It should cover the new channels. Some tricky antennas, with dual polarization, or flaky designs are open to question. There's no way of knowing how they will work on the new channels until you get equipment that will work on the channels, and then run yourself an SWR curve. As long as your SWR curve is low enough on the new channels, you can use the antenna without damage to antenna or equipment. By "low

enough", I mean the limitation set for SWR as given in the instruction manual of the equipment.

A Quick Summary

So all is not lost. Most, but probably not all, CB antennas in use today will function on the new channels. Some, mainly the mini-whips and possibly big beam antennas, may require some adjustment of the matching system to work on the new channels. Or, in the case of the mini-whip, adjustment to whip length may be called for. The limiting factor in all cases is the amount of SWR your equipment is designed to withstand. After all, the 40 channels cover only 470 kHz, and that's about equivalent in width to the radio amateur 15 meter band, and is only about one-third as wide a range as is the amateur 10 meter band. And experience has shown that most popular antenna designs have worked well for hams on both the 10 and 15 meter bands.

So there's no real cause to get excited about the forthcoming "new" channels. I suggest you refrain from purchasing a new antenna until you determine how your present one works on channels 24 through 40. You may be pleasantly surprised!

Gain Antennas

I think next month should start a discussion of "gain antennas" for base stations. There's a lot of interest in gain antennas and a lot of CBers use 'em. A lot of puffery has been written about gain antennas, and a lot of bum dope is floating around. We'll try and cover the important aspects of gain antennas and discuss some of the better ones. Also included will be some simple rules to determine the amount of gain (if any) in a gain antenna!

(Note): Bill Orr is the author of the popular handbook *The Truth About CB Antennas*. This handbook may be obtained from Radio Publications, Inc., Box 149, Wilton, CT 06897. Price of the Handbook is \$4.95 plus 35¢ to cover handling and postage.

EMBLEMS

EMBLEMS

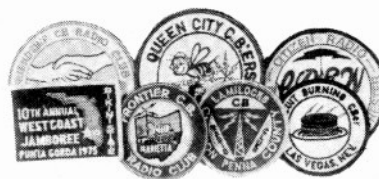

Beautiful, washable, swiss embroidered emblems custom made to your design. Send your design today for a firm quote. Any number from ten to thousands. Ideal identifiers for clubs, organizations or events. Write now for free booklet with design hints and ordering information. Your satisfaction guaranteed. A. T. Patch Co., 334 Bethlem Rd., Littleton, NH 03561.

HALT

STOP

URGENT
MESSAGE

CEASE

DESIST

5

great reasons

why *YOU*
should subscribe to
(if you aren't already doing so)

CB RADIO
S9 

1. You'll save a bundle. Newsstand copies are \$2.00 each, or \$24 for a year's supply. Your subscription costs only \$12 — or half as much.
2. You'll get S9 earlier. Subscriber copies will reach you as much as two or three weeks ahead of newsstand or store copies.
3. You'll be sure of getting your copy. Many times S9 is sold out before you can find it. Your subscription is like an insurance policy of fun reading.
4. You'll get a bonus. Right on! A 24 page copy of the FCC Part 95 CB regulations. The Commission says it's a must for every CBer.
5. You'll make our editor very happy. And there's nothing more important than having a happy Tomcat (that is, if you're going to keep a Tomcat on the premises, as we do.)

So, indulge yourself. S9 is the CB magazine that doesn't quit when it comes to giving CBers all the scoop on what's happening out in the CB world. Do it now! Today! Before you forget!! After all, spreading joy is what CB's all about, now, isn't it?

S9 MAGAZINE
14 Vanderventer Avenue
Port Washington, N.Y. 11050

Here's my\$12 for a 1 year sub,
.....\$20 for 2 years. This is a.....new
sub, or a.....renewal. Please include my FREE
copy of FCC Part 95 CB Regulations.

Allow six weeks for delivery of first subscription copy.

Name _____ Call _____

Address _____

City _____ State _____ Zip _____



15 **16** 17

by *Bill Sanders,*
CLI-1849, KW-5304
SSB-295

S9's Monthly Column for Sidebanders

BREAK... LOWER SIDE

FIXEM-UP DEPT.: SIDEBAND ID NUMBERS

Single Sideband operators don't use AM type handles or unit numbers for identification purposes. Instead they use special Sideband ID numbers. Those many readers who have written to us asking about how they may obtain a set of these numbers are advised that we recommend joining the SSB Network, which is the nation's oldest and largest group of Sidebanders. A self-addressed stamped envelope sent to the Sidebanders' Service Bureau, P.O. Box 381-R, Smithtown, N.Y. 11787, will bring you information telling how you can become a part of this vast network. Their national "SSB" ID numbers can be obtained without cost or fee. We suggest that all Sidebanders avail themselves of this opportunity to join this network—even if you are a future Sidebander, or an old-timer who already has "local" numbers.

POOR postman, he's getting a sprained back from dragging in stacks of mail concerning the new channels. The general thought from coast to coast seems to be that Sidebanders are going to have to make a stand on a slice of this pie in view of the FCC's failure to function in allocating any of the 17 new channels for exclusive sideband use. The feeling is that we should sort all of this out right now from the outset, then coordinate and support our efforts behind one proposal.

An assortment of varied plans has been received, some suggesting that Sidebanders stake out Channel 32, since that frequency (27.235 MHz) has been in use by HF operators for quite some time now. Most of the mail supports the idea that because of the fact that Sidebanders are such a rapidly growing fraternity, several channels will have to be selected, and with an eye towards additional channel expansion at such future time as may be necessary.

One of the very first plans to come forth was called TAKE FIVE and sent in to us by the SSB Network. They propose that Sidebanders claim rights on Channels 36, 37, 38, 39, and 40—lower sideband. These are the top 5 channels on the band and were suggested for several reasons. For one thing, those operators who are

into HF and VHF will find that their equipment will be more easily operable on the channels which have the highest frequencies. Also, should the need arise in the future to expand sideband operations to additional channels, then it would be possible to move southbound a-channel-at-a-time as necessary—35, 34, 33, 32, etc. This avoids any possible problems with attempting to expand in two directions, higher and lower frequencies. Since Channel 40 is the high frequency edge of the band, the only expansion required is in one direction. Also, a solid block of 5 channels at one (dead) end of the band reduces the possibilities of AM'ers moving in on these channels from both sides—we will have to guard only the southern border!

This, coupled with the fact that many sideband operators already have equipment with capabilities on these frequencies, has made us come to feel that this is a pretty good idea and one which we can set forth to our readers and suggest that they utilize and repeat to their clubs and friends. Let me not forget to add, that this TAKE FIVE idea does *not* mean that we kill off center slot (Channel 16L) or 18 or whatever other existing sideband channels may be currently in use. For the time being, those existing sideband channels are needed for those operators not having HF capabilities—and who well might not have such capabilities for many years to come!

What we are suggesting that those operators who have HF capabilities, start making use of Channels 36 through 40—start concentrating sideband traffic on these channels. Sad as it may be, and difficult as it is to say goodbye to an old friend, let's give Channel 32 (27.325 MHz) up—make it a gift to the AM'ers, and concentrate our efforts on 36 through 40! Unless we consolidate all of our efforts on the same channels we are going to be left out in the cold—and we have to take care of ourselves since it doesn't appear that the FCC is!

Now here's the catch. In many areas, the only thing which keeps sideband channels clear of AM'ers is station activity. They hear a dead channel and bingo—they jump on it like a dog on a bone! I've heard AM stations on center slot saying to each other, "Sure, I know it's a sideband channel, but there's nobody on it—they'll ask us to leave when they want to use it." My

SWITCH



Professional Quality

with the BEST!

Ceramic Antenna Selector Switches

- Low SWR to 150 MHz
- Power Safety Factor 1000 Watts
(52 Ω to 75 Ω non-reactive loads)
- Isolation @ 30 MHz
60 db alternate outlets
30 db adjacent outlets
- 2 Models—Connect your transceiver to . . .

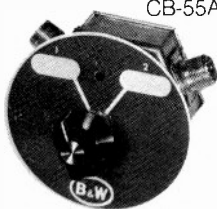

CB-55A2

2 antennas (side connectors):
CB-55A2 \$12.45

6 antennas, automatically grounds
unused antennas:
CB-59 \$18.50

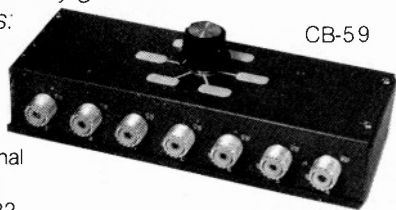

CB-59



Professional
Quality
Since 1932

Barker & Williamson □ Canal Street □ Bristol, PA 19007

WE CAN DELIVER
SERVICE & PRICE
TO OUR DEALERS

**40 Channel
CBs in Stock.**

SEND FOR FULL PRICE LIST

**AB Electronics &
Communications**

1660 W. 31st Place, Hialeah, Florida 33012

(305)-558-1671 (305)-558-1672

point is, that unless these new channels are actually used by Sidebanders, unless we lay claim to them by actually putting them into use, then we will not be able to make them ours! Today perhaps these new channels might not mean much to you, but as CB continues to expand, for sure these new channels are going to mean A LOT to you in the future—meanwhile, we must also continue to devote effort to continue using 16L, 18U and/or which ever other existing sideband channels are used in the various local areas.

We ask your support for this proposal, which we feel is in the best interests of sidebanders present and future! Please pass it along. If you have one of the many SSB Network informal gabfests at 8 PM (local time) Sundays on 16L in your area, why not toss it around at that time? If you don't already have such a gabfest—start one. Keep our channels in use! Just hit the mike button and call *QRZ-The SSB Network*—see who's out there!!

Words of welcome to any sideband operators in the Missouri Boot Heel, Arkansas, and Western Tennessee. These salutations from the 200 members of the Boot Heel Sidebanders Club, via member Eston O. Poorbaugh, who is stationed at Blytheville AFB in Arkansas. Give him a shout—he's known as BH-1211—also a member of the SSB Network. When home in Long Island (N.Y.), he's sometimes known as KW-1022!

Another sideband operator in the armed forces is Bill Mamich, now in West Germany. Bill, a member of the SSB Network, says that he's been a CB'er for 10 years now and that there is considerable contact now between Yanks stationed in West Germany and the local CB'ers—but the channels are still relatively quiet!

Here's a gadget we like, it's called the *Easy CB Locator*, and it's a natural for the sideband operator! This is a beautiful book which lets you instantly locate the data you want and need on your fellow operators—and permits you to write in new data and stations as desired—their sideband ID numbers, QTH, names, hobbies, equipment, or whatever you want to remember! Just jot down the data once and you can then move, shift, and re-arrange it anywhere in the book in any order you want for maximum convenience! Ends those forget-me-not blues—you know, was SSB-8802 Harry, Harold, Herman, or Hank? You don't have that problem? Well, most of us do! This large volume is not an ordinary log book, it's really something special. Costs \$14.95 per copy plus \$2.45 postage from *Easy CB Locators, Inc.*, Huron Trail, Oak Ridge, N.J. 07438.

See you next month!

**Happy
New Year!**



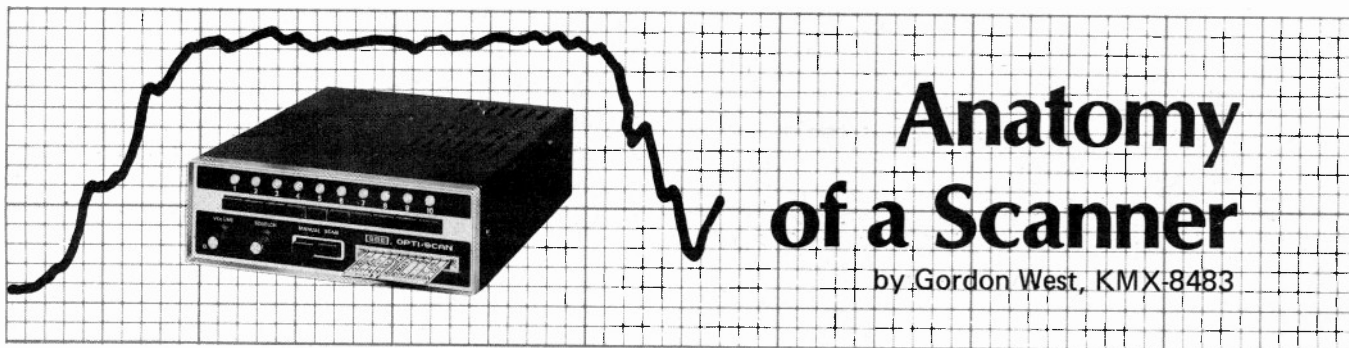

Anatomy of a Scanner

by Gordon West, KMX-8483

PART 2: RADIO BANDS

"BANDS" in radio lingo mean a specific spread of frequencies. Citizens band covers from 26.965 MHz to 27.405 MHz—that's Channels 1 through 40. These frequencies, and those in between are considered a "band" of frequencies.

In scanner lingo, the following bands are available for monitoring: Low Band, 20-50 MHz; Aircraft Band, 108-135 MHz; High Band, 150-175 MHz; Ultra High Band, 450-470 MHz; "Television-T" Band, 470-490 MHz; UHF Band, 490-512 MHz.

These are the most frequently monitored bands by scanner enthusiasts and except for the aircraft band, many scanners may pick up all of them.

The reason one would require a separate scanner receiver for the aircraft band is because aircraft transmissions are double sideband, and emission quite different from FM-frequency modulation. All of the other bands employ FM except the aircraft fellows—and this is why one would need a separate scanner to hear that elusive aircraft band.

Also, citizens band at 27 MHz is one that a conventional scanner will not be able to tune-in—they too employ double sideband or single sideband transmissions—quite different than FM again.

Let's now take a look and see what the scanner enthusiast will find on these different bands.

LOW BAND, 30-50 MHz. To identify a user of the low band, take a look at his vehicle and see if it is sprouting a 54-inch whip antenna. If it is, chances are he is utilizing his two-way radio equipment on the low band. These users could be business radio operators, mobile telephone subscribers, forestry vehicles, highway patrols, and state police.

Low band signals tend to hug the earth and penetrate around trees and mountains. Low band is generally used by rural state police and highway patrols because of the increased range it offers over the other bands. It is possible, on a small scanner receiver with a built-in antenna, to hear low band base stations up to 50 to 75 miles distant. Sometimes mobile units on the low band (vehicles) may be heard up to 15 to 25 miles away.

Most users of low band equipment transmit no less than 75 watts of power—more than capable of going long distances.

During the summer months, it's possible to hear "skip" transmissions from low band base station transmitters. You might be listening to your local police department and then hear a police department a thousand miles away come through. This is a fairly common occurrence during the peak of the sun spot cycle. These skip signals are actually radio signals on the same frequency being reflected by the ionized ionosphere "E" layer.

As I mentioned before, most rural police and fire agencies utilize low band for longer range communication between mobile units and their base stations. Once again, if the vehicle has a 54-inch whip antenna mounted on a spring, it's bound to be a low band installation.

AIRCRAFT BAND, 108-135 MHz. For scanner enthusiasts that wish to purchase a separate scanner to listen in on the airlines and tower, this is indeed an exciting service. It's possible to hear giant airliners talking to the tower when the airliner is still at 40,000 feet and 200 miles away! If you tune in on the right frequencies with a scanner, you can even hear aeronautical phone calls being placed when the airship is many miles high in the sky. If you live near an airport, chances are you would probably want to install 1-1.5 MHz in your scanner—the aircraft emergency channel. If ever you hear anything on that channel, chances are it's of pretty important nature.

Remember, to pick up the aircraft band on a scanner that employs crystals, you'll probably have to purchase a separate scanner monitor because transmissions on the aircraft band are double sideband, AM.

HIGH BAND, 150-175 MHz. If you like to listen in on your local police and fire department, chances are they may be broadcasting on high band. High band exhibits good range in moderately populated cities, and it's possible to hear mobile units up to 5 miles away with an inside scanner antenna and base stations up to 40 miles away.

Take a look and see if the vehicle you wish to monitor

Hey, CB'ers, Got Your Ears On?

WIN A FREEBIE CB FROM A-B

Sketch-a-"Fun"-Patch Contest

1st PRIZE



A MIDLAND CB

2nd PRIZE & 3rd PRIZE

A SHAKESPEARE ANTENNA
Single 4' top loading trunk mount

TUNE IN TO THESE SIMPLE INSTRUCTIONS

1. Sketch your ideas of CB "fun" emblems. Any shape, size or colors. See sample.
2. Decision of the judges is final. Contest ends 2/15/77.
3. Submit as many ideas as you want. None can be returned, all become the property of A-B Emblem Corp.
4. Winning sketches will be made into "fun" patches; copyrighted and available only from us.

How about it?



9
MORE
PRIZES

Complete sets of official
Apollo Flight Patches
7 through 16 in full color



Sample Idea

Breaker, Breaker

What's Your Handle?

Your handle is uniquely your own, so why not wear it! Let A-B Emblem put your handle on a 2" x 5" embroidered patch. Just send us your handle along with \$3 for each patch and 50c for postage and handling.



Breaker, Breaker

10-44 CB Clubs . . .

A-B Emblem, the nation's foremost designers and manufacturers of stock and custom emblems, will reproduce your club's insignia in a distinctive embroidered patch. Just send a sample of your club's insignia, and quantities desired, and we'll return our quotation. Or, for assistance in creating a new design, write for our free Design-an-Emblem Guide.

Give us a big 10-4 on this. Come on.



A-B emblem Division of
CONRAD INDUSTRIES, INC.

P.O. Box 78695 • Weaverville, NC 28787

ANATOMY OF A SCANNER (continued)

has an antenna about a yard long fixed to a 5-inch grey loading coil. If they do, chances are that vehicle is operating equipment on high band. Another variation of a high band antenna will be the single 12-inch piece of wire emanating from the cab or trunk of the vehicle.

There are many exciting services to monitor on high band to include the marine VHF radio service, 24-hour weather reports, police and fire agencies, as well as special emergency ambulance channels.

Most mobile units transmit at least 50 watts of power, and some high band base stations transmit up to 250 watts of power that can be heard over great distances.

Skip signals are seldom heard on high band, except during the absolute peak of the sunspot cycle—so your chances of hearing distant city stations of the same frequency are nil.

Almost every city in the United States has a wealth of high band activity on it, and whether it's mobile phone calls, tow-truck calls, or police calls, you're bound to hear some exciting action on the high band.

UHF BAND, 450-470 MHz. When cities began to encounter interference on the high band due to channel "loading" by the FCC, they recently began to come up on new frequencies in the UHF band. In densely populated cities, the UHF band is a particular favorite because of the ability of radio waves at these ultra high frequencies to reflect back and forth from tall buildings. It's not common on the UHF band to receive signals when you are 5 stories down in an automobile garage!

The UHF band will be an exciting one for you to listen to! Police Departments operating on the UHF band generally "repeat out" their mobile units from their base station. What this means is that you'll be able to hear mobile units loud and clear—just as you would the base station, in that the base station is actually re-transmitting the mobile unit.

Because of the ultra high frequency, range of mobile units is quite limited and this is why they "repeat out" on the base station transmitter. Take a look and see if the vehicle that has two-way radio equipment has a small antenna on its roof, with a grey loading coil in the center of that antenna. If it does, chances are it is broadcasting on the UHF band. Another variation of a UHF antenna, might be a tiny 4-inch piece of wire emanating from the roof of the vehicle.

Larger metropolitan police departments, and fire departments are flocking to the UHF band to help relieve some of the congestion they have experienced before on other frequencies. If your local public service agencies are on the UHF band, you're really going to hear all of the action of each and every mobile unit, as it is repeated out by the base station. You can probably receive base stations on the UHF band up to 40 miles distant on an inside scanner antenna.

"TELEVISION T" Band, 470-490 MHz. In 10 major cities of the United States, a group of frequencies have

been opened up on some of the unused television frequencies. Generally these frequencies are available to police departments, fire departments, and business radio users—and only the largest of cities have these frequencies available.

The range and antenna systems of the UHF—"T" band are similar to those of the standard band.

"T" band public service agencies also repeat out their mobile units for easy listening on a scanner receiver with an inside antenna.

EXTENDED UHF BAND, 490-512 MHz. In areas where channel "crowding" is at an all-time high, frequencies have been allocated in this band for public safety and other two-way radio services. Once again, this band exhibits the same range and same antenna considerations as the standard 450-470 UHF band.

Years ago, anything above 450 MHz was called the UHF band, but now, as you can see, it's broken up into three distinct parts. Most radio transmitters, antenna systems, and operating modes are the same on all three segments of the UHF band.

900 MHz. I haven't seen any scanners yet that will pick up 900 MHz signals, but probably sometime in the next few years, there will be enough stations on the air to warrant a manufacturer coming up with a scanner for those frequencies. Right now 900 MHz is just being explored as a new area to go to when all other frequencies are overcrowded and filled up. Range at 900 MHz is going to be extremely short, and "cellular" systems will be the major modus operandi. Presently, there is a battle going on between the business radio users group as to who is going to have the most frequencies—and until this battle is settled in court, only a few stations have been permitted licences on 900 MHz.

BUT WHICH BAND IS BEING USED IN MY AREA? Now that we have talked about the many different bands available for two-way radio users to broadcast on, we now need to steer you down to your local scanner speciality shop to find out who in your area is utilizing what frequencies and on which band.

The most effective (and popular) way of determining which frequencies for various services are in use in any given area is by means of one or more of the excellent frequency directories available. I recommend those published by CRB Research, Inc., these are the original publications offering this data, which started back in 1967 and seemed to inspire the several others which were later offered by others. CRB Research directories seem to have a lot more useful data than the others, are less expensive, and are arranged in an easy-to-use manner.

CRB Research directories cover not only police, fire, and many other emergency radio services, they also (exclusively) list many U.S. Government communications channels. They also have special publications covering railroad communications, aeronautical communications, mobile/marine telephone operators, private detectives, airlines, mobile news units, and lots more.

... Use S9 READER SERVICE.

Some of their directories also list those hard to get frequencies used by power utilities (gas/water/electric/telephone repair and emergency), frequencies used by environmental (forestry/fish and game), also those "unlisted" highway public safety channels.

No matter how much frequency data you might have managed to gather on your own, no matter how much you have checked out in various over-the-counter frequency publications available to the general public, you'll still add a wealth of data to your knowledge with these exciting "insiders" publications. Their interesting catalog will be sent to you if you send them a self-addressed stamped envelope (put 24¢ postage on it, it's a hefty catalog). Address your request to CRB Research Inc., P.O. Box 56-X, Commack, N.Y. 11725.

With one or more of these directories, there won't be much which will escape your ears!

So accumulate your frequency data and then carefully study it before you purchase your first (or next) scanner. You can then decide which bands are right for you—you might be quite pleasantly surprised to learn that there are many more interesting things to listen to than your local police and fire dispatchers! Well, a good set of frequency directories will clue you in on the most interesting frequencies around!

Good listening—see you next month!

MOBILE LED CLOCK

12 OR 24-HOUR OPERATION

12 VOLT AC or DC POWERED FOR FIXED OR MOBILE OPERATION.

KIT OR ASSEMBLED

MODEL #1036

QUARTZ CRYSTAL TIME BASE

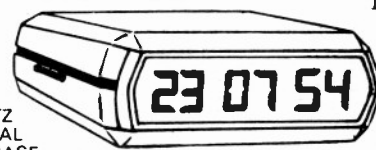

Approx. Size:
1 1/4" H x 4" W x 4 1/2" D

BATTERY BACK-UP FOR POWER FAILURE OR TRANSPORTING FROM HOUSE TO CAR, ETC.

- 6 Jumbo LED Digits Hours-Min.-Sec.
- Set Time from Front via hidden switches
- Stylish charcoal gray case of moulded high temp. plastic
- Bridge power input circuitry - two-wire no polarity hook-up
- Optional connection to blank display (Use when key off in car, etc.)
- Easy 3-wire hook-up to any 12 Volt Battery vehicle
- Mounting Bracket included.

KIT # 1036 COMPLETE KIT (Less 9V. Battery)	29 ⁹⁵ EA	3 OR MORE	\$27 ⁹⁵ EA	115 VAC Power Pack #AC-1	\$2 ⁵⁰ EA
ASSEMBLED UNITS ORDER # 1036WT	WIRED & TESTED (LESS 9V. BATTERY)	3 OR MORE	\$39 ⁹⁵ EA	Assembled Units May Be Mixed With Kits for Qty. Price	

OPTOELECTRONICS, inc.
BOX 219 • HOLLYWOOD, FLA. 33022 • (305) 921 2056

ORDER BY PHONE OR MAIL
COD ORDERS WELCOME
\$1.00 CHG.
Orders Under \$15 Add \$1.00
Handling
Fla. Res. Please Add 4
Sales Tax

WE PAY ALL SHIPPING IN CONTINENTAL USA - OTHERS ADD 5% (10% FOR AIRMAIL)

**Just Because You Were There First
Doesn't Make You A Professional**



This challenge was thrown at us by the publisher of a brand new CB monthly, that's making its debut this month. And you know what?

He's right!

But when we reminded him that: **S9 is printed by R.R. Donnelley the world's largest commercial printer and that ...**

S9 is distributed by ICD (a division of the Hearst Corporation), the country's largest newsstand distributor and that ...

S9 is sold by more than three thousand professional CB retailers, and that ...

S9's publisher has been turning out magazines for slightly more than thirty six years ...

He didn't have much more to say.

Published since 1962 by professionals

CB RADIO
S9
CB RADIO

The Capricorn CB Personality

DECEMBER 22-JANUARY 19

by Paperdoll—KMI 4549

CAPRICORNS truck 'em easy, truck 'em slow to the mountaintop of their desires. Then it's midnight overdrive all the way. Goals—and this ambitious sign has them—are first and foremost in their life. These mountain climbers reach for the pinnacles of success and usually attain their next to impossible goals. Obstacles and hurdles only tend to make the climb more interesting and worthwhile to persevering Capricorn. Cautious creatures, they think before they speak and are deliberate about everything they attempt to do. They're often the first to install burglar alarms and other safety devices to protect their hard-earned luxuries. Dignified Capricorns do rise to great heights and really get out good to open ears. Check your channels in the wee hours for this nightowl who is the natural teacher of the zodiac. He'll probably be ratchet-jawing on a clear one about the technicalities of CB-ing. Listen carefully. He asks questions later. You'll also find them in their executive chairs keying their lollipop mikes from behind their presidential desks. Likely you'll be caught unaware at times by their dry humor, often misunderstood because of the serious expression on their faces. You never know when they're putting you on. Habitual hesitators and procrastinators, you need your PA bullhorn to get them to put the pedal to the metal and get movin'. They're the genuine last minute wrap 'em ups. Typical handles might be: Dark Eyes, Treetop, Mountain Man, The Hermit, Nightowl, Dracula, Tomahawk.



CAPRICORN—'77 sees you taking off on the wrong foot and winding up the month on the right. A bodacious blowup on the 5th with loved one upsets you till mid-January when everything is levelled off and straightened out. You've got the green light from there. Generosity at the work 20 is extended in the form of a company four-wheeler and extra expense greenstamps for the business travel you'll be doing. All eyes are on you this month. Someone special is watching you singles and waits till mid-month to pounce.

AQUARIUS—Fast spending Aquarius needs some dollar sense this month as money earned goes out as fast as it comes in. Mid January sees you retreating to home hideaway to hibernate till Groundhog Day anyway. Interplanetary aspects brightly guide you in the right direction this month.

PISCES—Your psychic awareness is tuned up this month and brings you all the answers except for January 19th when dreamy Pisces gets lost in the crowds and has to turn up that power mike for a super shout out. Friends, new and old, surround you with excitement all month.

ARIES—Jackpot! Prior investments and hard work result in those extra glorious greenstamps for luxuries you've been yearning for. You get together January 14th with a good buddy who does some psychic work for you. Better go 10-7 January 5th when you'll have to get through some raucous ratchet-jawing at work 20.

TAURUS—A real good buddy lends help-

ing hand on that important project you've been working on. Major decision regarding new course of study may be made January 17th. Definitely will be a profitable one, fer sure. Homey Taurus may be entertaining or even boarding a foreign friend for a while.

GEMINI—That special good looking someone you meet at work 20 this month could become your lifelong exciting soulmate, you single beavers and buffalos. Love at first sight! After January 17th your head is clear and decisions that were shelved are finally made. Lost papers are also found to complete your tax return. IRS taps those hard-earned greenstamps you've saved this year. Be honest, dual Gemini, even though you've kept double sets of books.

CANCER—A real good buddy comes to your emotional aid as your better half gets the best of you now. Fear not. Mood lasts only till end of month. Make sure plumbing and everything in basement is in good repair at home 20 or January 21st could find you cleaning up some unforeseen mess. Children provide pleasure this month as favorable aspects in that area prevail—10-fer.

LEO—After a rough and uncertain four months at work 20, lucky Leo finally irons out problems and moves up another rung in the ladder to success. Also on the plus side, you get a tax break that you didn't expect. Planetary positions promote more domestic tranquility this month than you've had for a while.

VIRGO—Highlight is on children and recreation all of January. Much activity in that area is indicated. On the 17th you may come face to face or mike to mike with a former love of your life. Be prepared with a most appropriate comeback, since you now have the cue. Foreign travel intrigues you after mid January and you ight find yourself in exotic faraway places.

LIBRA—Sentimental Libra just can't put away the holiday decorations and esprit de corps so continues to entertain close friends and relatives all month. Better half gets extra generous with greenstamps now. Soft-spoken, sweet-talking Librans need only ask at this propitious time.

SCORPIO—Usually methodical Scorpios are just leaping into wedded bliss now with their main squeeze. Unlike them not to plan eons ahead of time for such serious matters. A lot of travel—and traffic—lies ahead this month. Thumb gets key caloused from all those 10-13's. Be extra careful with mail till after January 17th. Make sure important papers are registered and certified. All communications may seem to go awry till the 17th.

SAGITARRIUS—Domestic Sagittarians do some home 20 cleanup and redecorating this month. Mid January brings an end to those work 20 blues with the good word of a new position that offers more greenstamp potential.

73's and 88's
till next month
PAPER DOLL

ATLANTIC SPEED CENTER

2 East 39th Street, Wilmington, DEL. 19802 — 302/762-9040 & 762-6827

Dealer Inquiries Invited

To Sell These Famous Lines:

Antenna Specialists
Astatic
Avanti
CDE Rotors
D & A
Hy-Gain
Johnson
Kris
Midland
Panasonic
Para Dynamics
Pearce Simpson
Robyn
Royce
Shakespeare
Stam-Comm
Turner
Vanco

DEALERS - Call
TOLL FREE
800-441-7630



WASHINGTON OUTLOOK

LICENSE IN SAN LORENZO, CALIF. REVOKED

FCC Chief Administrative Law Judge Chester F. Naumowicz, Jr. has recommended revocation of the Citizens Radio license of Carson A. Reagin (KFO-9418) of San Lorenzo, Calif., for refusing to allow Commission engineers to inspect his station.

In an order to show cause issued February 26, 1976, the Chief, Safety and Special Radio Services Bureau alleged that Carson was operating his CB station in violation of Sections 95.95(c) of the rules (failure to identify radio station by the assigned call sign) and 95.103 of the rules and Section 303(n) of the Communications Act (failure to permit an inspection of the station by authorized Commission personnel).

The prehearing conference and hearing were held in San Francisco, on June 18, 1976, and the record was closed August 2.

Judge Naumowicz said that on October 31, 1975, the Commission's San Francisco Field Office notified Reagin of complaints received from his neighbors of interference to telephones and home entertainment equipment. Reagin was asked to have certain tests and measurements performed by a licensed technician and forward the results to the San Francisco office.

Reagin replied to the request but did not include the measurement data, the judge said. Reagin's neighbors continued to file complaints which led to a decision by the FCC to conduct an on-site investigation.

On December 1, 1975, two FCC investigating engineers, using highly accurate direction-finding equipment traced a strong, intermittent signal consisting of whistling and grumbling sounds heard in their vehicle to a ground plane antenna at the rear of Reagin's house.

The investigators determined that no official call sign had been given to

identify the station, but were satisfied they had located the station they were monitoring. They approached Reagin's residence to make an inspection of the station.

Although shown the investigator's identification, Reagin refused to permit an immediate inspection and told the engineers to come back at a later date. The investigators cautioned Reagin that his refusal to permit an inspection could result in revocation of his license. Nevertheless, inspection was refused.

Judge Naumowicz said that from the evidence available, it was clear that the radio licensed to Reagin was used in violation of Rule 95.95(c), but it could not be determined if Reagin actually was the operator who transmitted in violation of the rule since no voice was heard which might have been identified. Moreover, there was no evidence to indicate how many others were in Reagin's house at the time of the violation or the attempted inspection, he said.

The judge concluded, therefore, he could not determine that Reagin, himself, had violated Rule 95.95(c).

However, there was no dispute that Reagin had refused to permit an inspection of this station, the judge said, and such a refusal was a rule violation.

Reagin contended that the attempted inspection would have constituted an unreasonable search within the meaning of the Fourth Amendment to the Constitution and that the inspectors were obligated to obtain a search warrant before they had a right to enter his home to inspect his equipment. He based his defense on a previous court decision which he contended outlaws administrative searches conducted without a warrant.

Judge Naumowicz explained that, in general, that court decision outlawed administrative searches conducted without a warrant or without probable cause to believe that a violation of the administrative regulation being enforced

CRAZY Harvey's CB SHOPPE

We've got the "Big" NAME BRANDS for the smallest dollars. Whether it be CB, Marine, Car Stereo etc. ... Crazy Harvey's has it, and with **BIG DISCOUNTS**, not just a few dollars off!

Send for our Free Catalog of prices and brands. Our new address:

**CRAZY HARVEY'S
CB SHOPPE**
8848 Orchard Tree Lane
Towson, Maryland 21204
(301) 821-0792

Name _____

Address _____

City _____ State _____ Zip _____

had occurred. He said it pertained to wide-area searches, but excluded the need for a warrant in situations where time was of the essence.

Such was the case here, he said. The engineers had just traced an offending signal to Reagin's house and they needed to inspect immediately to determine who had transmitted the signal or if unauthorized equipment had been used.

Therefore, the judge concluded that the investigators' request to inspect Reagin's station was within the law and that Reagin's refusal to permit an inspection constituted a violation of Rule 95.103.

Judge Naumowicz added the "Commission has often stated why it is absolutely essential that it have the right to conduct immediate inspections of the stations it is charged with regulating," particularly in the already "disorderly" CB band. To do away with that right would carry the threat of total anarchy with the effective loss to the public of CB service, he said.

FINED FOR ILLEGAL OPERATIONS

Four Alabama Class D Citizens Band radio operators were fined in U.S. Magistrate's Court in Birmingham, Ala., after pleading guilty to charges of operating illegal transmitting equipment on unauthorized radio frequencies.

The cases arose from an April crack-down on illegal operations ordered by United States Attorney Wayman G. Sherrer.

The illegal operators were monitored by FCC field investigators while transmitting on authorized frequencies and interfering with bands used by U.S. Government, business, and special industrial services.

A number of transmitter/receivers were seized by U.S. Marshalls accompanied by FCC engineers from the Commission's Atlanta and Powder Springs, Ga., offices.

On April 23, U.S. Magistrate Edwin L. Nelson fined Raymond C. Tyler and James C. Leathers \$200 each, and John O. Overstreet and William R. Sexton \$10 each. The latter two waived possession of their seized transceivers to the U.S. Government. The equipment in each case was valued at \$400 to \$500.

The cases were presented by Assistant U.S. Attorney Bill L. Barnett.

SHOW CAUSE NOTICES

The Commission, by its Safety and Special Radio Services Bureau ordered the following licensees to show cause why their licenses should not be revoked for violation of Section 1.89 of the Commission's rules by failing to respond to official communications:

\$1,000
REWARD
\$1,000

I will pay a \$1,000 reward as compensation for a like new or mint Lionel train engine Number 5344 if accompanied by the original full scale freight cars or red "rail chief" passenger cars that were originally catalogued with this engine. The engine mentioned above is also referred to as the "scale Hudson", and sometimes is referred to by the Lionel catalog number 700E, although that number doesn't appear on the engine itself.

I will also pay top cash for any of the following pre-WWII Lionel engines in really fine condition:

250E Hiawatha # 255
256 # 260E # 263

Many prewar Lionel engines are worth hundreds of dollars to a true collector, and thousands of these engines gather dust in attics and basements across the country. I'm willing to pay hard cash to get them for my collection.

If you have **any** old Lionel trains or accessories, please get in touch with me. But please, make certain that you list the numbers on the side of the engine or cars, since this is the key to determining the collector's value.

Dick Cowan
CB Radio/S9
14 Vanderventer Avenue
Port Washington, N.Y. 11050
Phone: (516) 883-6200

TOP Choice

**IN 40 CHANNEL
ELECTRIC
CB, AM/FM
ANTENNAS!**

CPD top loaded Electric Mobile Antennas outperform other electrics for important reasons:

100-plus-watt *top mounted* loading coils efficiently get your signal *above* your vehicle!

Only CPD's coils are *always* connected to prevent radio "burn out" damage.

CPD's drive motors are protected against moisture and debris for long, dependable operation.

- TOP LOADED FOR OUTSTANDING 40 CHANNEL PERFORMANCE!
- PREVENTS THEFT!
- REPLACES EXISTING ANTENNAS ON MOST VEHICLES!
- SWR 1:5 OR BETTER
- EXCELLENT AM/FM RECEPTION!
- AUTOMATICALLY EXTENDS & RETRACTS!

Models

- EMA-100
 - EMA-100C
 - EMA 11
- FROM \$69.95

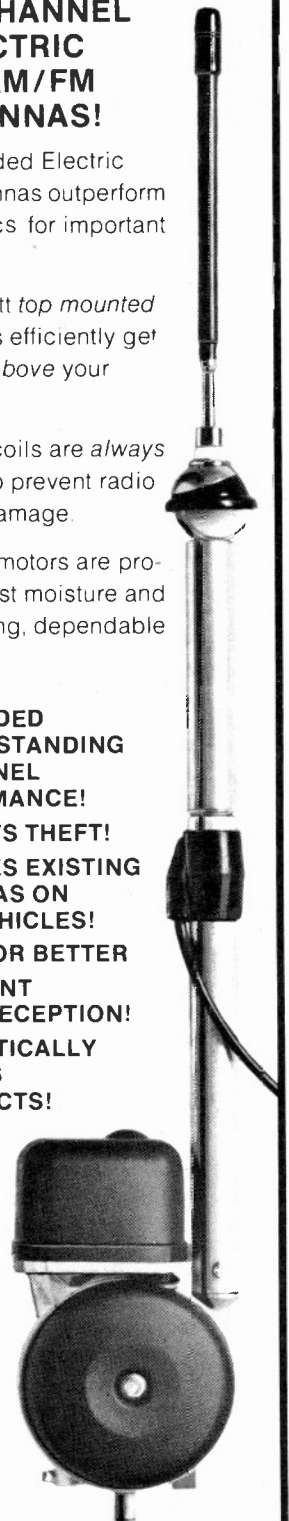

CPD INDUSTRIES
2100-A E. Wilshire Ave.
Santa Ana, Ca. (714) 542-7228
Manufacturers of
Blue Streak and Ramm
Antennas and Hardware



SENTURION from RADATRON

THE ULTIMATE
RADAR DETECTOR

\$109.95

The manufacturer's of the world famous, patented Radar Sentry introduce the professional drivers Model "SENTURION". Look at these advanced features:

- Deluxe die cast metal case
- 12 Volt Operation — connects to vehicle ignition — positive or negative ground
- Visual and audible warning
- Computer designed horn antenna
- Utilizes integrated circuitry
- Maximum Sensitivity and Long Range
- Dual mounting brackets
- Detects moving radar and speed gun, plus "standard" traffic control radar.
- Complete with instruction/operation manual
- Automatic Noise Limiter

Complete distributor/dealer promotion program available.
Write for details today!

PLEASE SEND _____ SENTURIONS AT \$89.95 EA. PLUS POSTAGE AND TAXES
 WHERE APPLICABLE PAYMENT BY: CASH C.O.D. MASTER CHARGE
 AMERICAN EXPRESS DINERS CLUB CARTE BLANCHE

Credit Card Number _____ S-9
 Name _____
 Address _____ City _____ State _____ Zip _____
 RADATRON CORP., 2424 NIAGARA FALLS BLVD., N. TONAWANDA, N.Y. 14120

WANTED

CB'ERS FOR NATIONAL TEST of 40 CHANNEL CB EQUIPMENT

Research Association requires CB'ers to test experimental 40 channel mobile antenna prior to public sale. Purpose of test to confirm manufacturer's and major university reports of superior performance over current antenna designs. All participants will be paid for completing reports following receipt and use of equipment but must agree to keep all data confidential. All rights to consumer test reports, comments, and written suggestions become property of RTC. Write:

RESEARCH TEST CENTER

"Testing Communications for Industry and Research"
1945 South Street, Elgin, IL 60120

- Newark, Calif., Roger M. Nelson, KSM-9227.
 Novato, Calif., Lester E. Denham, KWW-9240.
 Rhonert Park, Calif., Richard L. Parks, KBI-5777.
 San Jose, Calif., Sanford A. Conley, KBJ-7930.
 Jacksonville, Fla., Kenneth M. Gray, KSR-0390.
 Santa Clara, Calif., Eddie Herro, KXX-2727.
 Baltimore, Maryland, George E. Deaver, Sr., KYY-0318.
 Rancho Cordova, Calif., Jerry L. Brown, KTE-1120.
 Arlington, Va., Mike S. Price, KZT-9210.
 Forestville, Maryland, Marshall Thornton, KTD-7885.
 Hayward, Calif., Timmy A. Ermay, KXN-8963.
 Stockton, Calif., Philip R. Cardoza, KSP-4708.
 Mt. Edgecumbe, Alaska, Island Taxi Co., Inc., KBK-4690.
 Waterford, Calif., Richard L. Shepard, KHP-9025.
 Milpitas, Calif., Jay M. Preskitt, KHT-5932.
 Oakland, Calif., Jimmie L. Wilkins, KGT-7353.
 San Leandro, Calif., Eugene J. Lopes, KGT-0840.
 Rockville, Maryland, Joseph Grover, KYV-1151.
 Hollywood, Fla., Dennis F. Koch, KJV-7776. Ordered to show cause why licenses should not be revoked for violation of various sections of Part 95 of the rules including Section 95.95(c) of the rules by operating without being identified by its assigned call sign at the beginning and conclusion of each transmission or series of transmissions.
 Santa Ana, Calif., Adrian L. Taylor, KGT-9497. Ordered to show cause why the licenses should not be revoked for violation of various sections of Part 95 of the rules including Section 95.41(d)(2) of the rules by transmitting communications to other radio stations on a frequency reserved for communications between units of the same Citizens radio station.
 Paducah, Kentucky, Gillmer H. Griggs, Sr., KEO-8741. Ordered to show cause why the license should not be revoked for violation of various sections of Part 95 of the rules including Section 95.95(c) of the rules for operating without being identified by its assigned call sign at the beginning and conclusion of each transmission or series of transmissions and for violation of Section 97.37(c)(2) of the rules for operat-

ing by means of an antenna, with its supporting structure, which exceeded by more than 20 feet the height of the man-made structure to which it was mounted.

Rockville, Maryland, Stephen R. Robinson, KER-8674. Ordered to show cause why the licenses should not be revoked for violation of various sections of Part 95 of the rules including Section 95.95(c) of the rules for operating without being identified by its assigned call sign at the beginning and conclusion of each transmission.

Sacramento, California, Kenneth K. Schutt, KFZ-0609. Ordered to show cause why the licenses should not be revoked for violation of various section of Part 95 of the rules including Section 95.95(c) of the rules for operating without being identified by its assigned call sign at the beginning and conclusion of each transmission or series of transmissions.

REVOKED

The Commission, by its Safety and Special Radio Services Bureau, ordered that the licenses be revoked for violation of various sections of Part 95 of the rules including Section 95.95(c) of the rules by failing to identify call signs at the beginning and end of each transmission or series of transmissions.

Birmingham, Alabama, John A. Tolera, KFT-7798.

Fontana, Calif., Kenneth Fox, KEP-0143.

Spokane, Wash., Gary B. Farnworth, KGS-8511.

NOTICES OF APPARENT MONETARY LIABILITY

Binghamton, N.Y., Edward S. Wilmot, \$50, KOY-9703. For violation of Section 95.95(c) of the rules for failure to identify by the assigned call sign.

Camuy, Puerto Rico, Benedicto Tosado, \$150, KFD-8749. For violation of Section 95.41(d) of the rules for operating on a frequency not authorized for use by station.

The Commission, by its Field Supervisors, on behalf of the Safety and Special Radio Services Bureau, issued Notices of Apparent Liability to Monetary Forfeiture on various dates to the following radio station licensees in the Citizens Radio Service for willful violation of various sections contained in Part 95 or a repeated violation of Section 1.89 of the Commission's rules:

Aumeville, Oregon, William D. Raue, \$100, KBI-0428.

Eugene, Oregon

**Charles K. Holland, \$50, KHE-2629.
Billy B. Nasura, \$100, KGM-0015.**

Monmouth, Oregon, Florence G. Griffin, 50, KEL-3252.

Salem, Oregon

Rodney Anderson, \$50, KHA-97302.

L. Ilene Nelson, \$50, KCS-1373.

Jasper N. Randall, \$50, KJR-97301.

James E. Reed, \$50, KFA-6081.

Leon B. Scott, \$100, KTV-7163.

James C. Seagrove, \$100, KBT-1211.

Patricia I. Wallace, 100, KDK-5450.

Springfield, Oregon, Randy Alan Davis, \$50, KPT-9254.

American Fork, Utah, Michael R. Searle, \$150, KNE-0521.

Ft. Wainwright, Alaska

David W. Johnson, \$50, KJB-1067.

Bobby G. Shaw, \$50, KDQ-4047.

Kenneth E. Stevenson, \$50, KYL-5135.

Washington, D.C., Tyrone E. Jackson, \$50, KMR-1500.

North Miami Beach, Florida, Kathleen P. Gietzen, \$100, KYV-9564.

Wake Village, Texas, Gary L. Raines, \$150, KWW-4910.

Baltimore, Maryland, John H. Chwas-tiak, \$50, KSG-7049.

Millersville, Maryland, John A. Norville, \$50, KSH-3646.

Norfolk New York, Ronald A. Hebert, \$50, KSU-9023.

Albany, Oregon

George F. Cunningham, \$100, KZI-4929.

John R. Freeman, \$150, KRO-3297.

Houston, Texas, Johnnie H. Carter, \$50, KBQ-9072.

Long Beach, Calif., James C. Howell, \$100, KGK-3945.

Lynwood, Calif., Raymond Bullette, \$50, KSH-4553.

Oakdale, California

Howard G. Decavit, \$50, KBN-8365.

Sidney R. Lieb, \$50, KJW-7400.

James O. Owen, \$50, KXN-8217.

Donald C. Willey, \$50, KQK-0102.

New Port Richey, Fla., Irene M. Barrow, \$50, KGS-0276.

Orlando, Fla., William L. Jett, \$50, KAAR-6509.

Seminole, Fla., T-Shirt Town, \$50, KPI-4116.

Tampa, Florida

Charles L. Harrison, \$50, KWN-0570.

Wesley C. Nelacliff, \$50, KEO-7687.

Baltimore, Md., George W. Hipp, \$50, KRH-3556.

Corvallis, Or., William H. Gundy, \$50, KWC-9302.

Medford, Oregon

John W. Berry, \$100, KCY-0238.

Leo C. Cook, \$100, KER-5820.

Charles W. Ray, \$100, KHU-7465.

Milwaukee, Or., George M. Johnson, \$100, KZL-7496.

Portland, Oregon

Stanley C. Hintz, \$50, KFN-7883.

(continued)

CB SAM SEZ

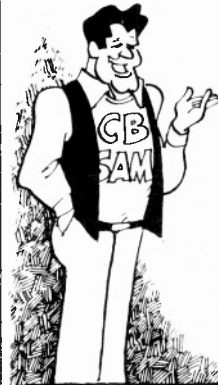

I WANT TO TELL ALL MY GOOD BUDDIES OUT THERE HOW TO CONVERT THEIR MOBILE CB TO A DELUXE HOME BASE STATION. IT'S MAGITRAN'S DELUXE SUPER REGULATED POWER SUPPLY WITH BUILT-IN SPEAKER.

MODEL CB123 WILL HANDLE A FULL 3AMPS CONTINUOUSLY AND 6AMPS SURGE - THAT'S ENOUGH TO RUN ANY MOBILE CB AND YOUR 8-TRACK STEREO TOO!



THIS DELUXE BABY'S ALSO GOT A SPECIALLY DESIGNED BUILT-IN VOICE COMMUNICATION SPEAKER THAT IMPROVES VOICE CLARITY-WALL-TO-WALL

AND THERE'S A POWER BOOST FEATURE THAT IMPROVES RECEPTION AND MAXIMIZES YOUR TRANSMISSION TO THE LIMIT OF THE LAW.

SO TAKE IT FROM CB SAM-IF YOU WANT YOUR MOBILE RIG TO PACK A HE-MAN PUNCH, COMIN' AND GOIN' AS A BASE STATION, GET YOURSELF A MAGITRAN CB123.

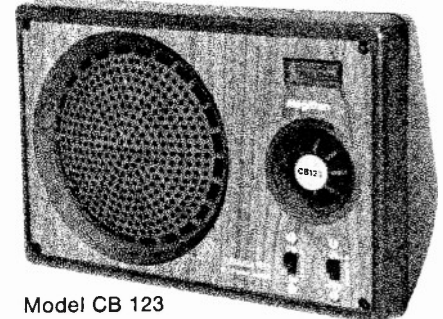
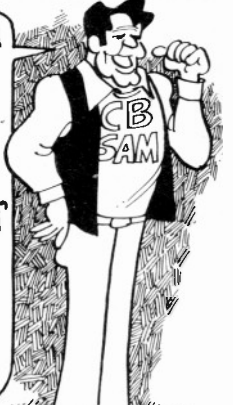

Model CB 123

MAGITRAN COMPANY
311 EAST PARK STREET
MOONACHIE, N.J. 07074

Move up from CB to Amateur Radio with NRI home training.

Amateur radio means virtually unlimited frequencies, working "skips" legally, quiet FM communications, and the freedom to talk to your next door neighbor or around the world.

But you need an FCC Amateur License to get into Amateur Radio, and NRI home training will help you pass your FCC licensing test. NRI training provides you with a code practice oscillator, LP records, transmitting and receiving equipment. Included is your own Novice Class 15-watt transmitter and a matching 3-band superheterodyne receiver, plus a transistorized code practice oscillator with code key and headset.

Send for the free NRI catalog. No salesman will call.

	<input type="checkbox"/> Basic Amateur Radio <input type="checkbox"/> Advanced Amateur Radio <input type="checkbox"/> Complete Amateur Radio
	Send me the free catalog indicated: Name _____ Age _____ Street _____ City/State/Zip _____ A National Home Study Council Accredited School 51-017

ATTENTION DEALERS:
WIDEST SELECTION —
BEST PRICE — FASTEST SERVICE!

Beltek	Siltronix
Browning	Tram
Courier	Unimetrics
Gemtronics	Yaesu
Hy-Gain	A/S
Johnson	Avanti
Midland	CPD
Pace	Everhardt
Palomar	Hustler
Pearce-Simpson	Mark
Royce	Shakespeare
SBE	Goldline
Standard	Xtal

COMPLETE LINE OF ACCESSORIES
SEND \$1.00 FOR DETAILS

HENSHAW'S

7622 Wornall, Kan City, MO 64114
 1644 E. McDowell, Phoenix, AZ 85006
 5050 E. Belknap, Ft. Worth, TX 76117

WASHINGTON OUTLOOK (cont'd)

- Robert E. Keyes, \$100, KFM-8782.
 Silverton, Or., Donald M. Greene, Jr., \$100, KJJ-9736.
 Dallas, Tex., Bobby W. Welch, \$100, KXS-0250.
 Grand Prairie, Tex., Carlton Tate, \$50, KHR-0164.
 Mesquite, Tex., Charlie Gandy, \$50, KCB-3961.
 Odessa, Tex., Sommie B. Draughan, \$50, KZP-1774.
 San Antonio, Tex., George R. Askey, \$50, KLK-2259.
 Franklinville, N.J., Wayne A. Kerwood, \$50, KZG-7693.
 Chalfont, Pa., Russell Denner, \$50, KHM-5258.
 Lightfoot, Va., Dennis J. Workman, KCO-5183.
Colorado Springs, Colorado
 Francis E. O. Dirscoll, \$50, KYT-5175.
 James D. George, \$100, KNP-4429.
 Gerald A. Gortmaker, \$50, KMCH-6587.
 Billy G. Griffin, \$50, KXK-7680.
 Kenneth D. Hartley, \$50, KJA-7565.
 Winfield F. Hutchinson, \$50, KBO-4034.
 Lyle T. Jones, \$50, KMQ-6214.
 K&S Servicecenters, Inc., \$100, KXL-3792.
 Gary A. Lind, \$100, KXZ-1467.
 Patricia D. McClendon, \$50, KWK-7905.
 Dewaine C. Perkins, \$50, KSZ-7433.
 Thomas F. Purdon, \$100, KCT-7181.
 Del Roy E. Reiss, \$50, KHf-8271.
 Leroy W. Schmidt, \$100, KDX-9873.
 William J. Smith, \$50, KYX-6021.
 Jon M. Spauding, \$100, KSC-5651.
 Dwayne I. Sutton, \$50, KNB-2475.
 David G. Swope, \$50, KXK-5961.
 Ralph D. Wales, \$50, KXX-5276.
 Stephen F. Yates, \$100, KNQ-8670.
Denver, Colorado
 Matthew Lee, \$150, KOG-2309.
 National By-Products Inc., \$50, KKY-2686.
Fountain, Colorado
 William A. Massey, Jr., \$50, KTO-1128.
 Robert J. Moore, \$50, KGD-8131.
 Gordon R. White, \$50, KJY-8976.
Lakewood, Colo., Robert W. Musser, \$100, KKR-4674.
Pueblo, Colo., Gary E. Alexander, \$50, KHW-4393.
Security, Colorado
 John W. Peer, Jr., \$100, KIF-9345.
 Aaron L. Gauze, \$50, KZM-6773.
Wheatridge, Colo., Kenneth A. Palumbo, \$50, KQI-3948.
Buffall Grove, Illinois
 Ronald A. Othick, \$50, KPF-6435.
 Arnold H. Schmidt, \$50, KCG-2835.
Dolton, Ill., Theodore E. Sousa, \$150, KfV-6939.
Robinson, Ill., Roy E. Pethel, \$50,



Cash in on the CB Radio Market.

**YOU'LL MAKE A BARREL
FULL OF BUCKS!**

ONE STOP FOR:

RADIOS - Over 15 different manufacturers - million dollar inventory
ANTENNAS - 4,000 in stock
ACCESSORIES - 10,000 parts in stock
SERVICE - Authorized warranty station for most major brands
REPLACEMENT PARTS - Midwest's largest distributor of CB component parts and CB semi-conductors

**BEST PRICES
SAME DAY SHIPPING**

Dealers Phone (312) 481-3446 for free catalog and price list/Or write: **CB Warehouse**
 1607 Western Ave.
 Chicago Heights, IL 60411

- KRJ-6700.
 Munster, Ind., Joseph N. McShane, \$50, KJM-46321.
 Erie, Kansas, Ronald L. Chase, \$100, KZK-2817.
 Jeanerette, La., Arlen C. Alexander, \$50 KYM-8947.
 Bloomfield Hills, Michigan, Edmund Steeves, \$50, KEW-1039.
 Flint, Mich., Scott D. Groom, \$50, KTS-8341.
 Paterson, New Jersey
 Domenick A. Crapello, \$50, KEC-3818.
 Billy W. Duvall, \$50, KTB-8453.
 Donald A. Geise, \$100, KBP-4247.
 Vincent J. Giaquinto, III, \$50, KJT-4308.
 Raymond M. Lombardi, \$50, KCB-0394.
 Patrick F. Montrose, \$100, KHK-3954.
 Michael R. Salvado, \$50, KMD-1237.
 Martin Yodice, \$50, KHC-0389.
 Saddle Brook, N.J., Joseph V. Black, \$100, KKC-9182.
 Verona, N.J., John J. Morris, \$50, KGS-2230.
 West Caldwell, New Jersey
 Terrell L. Elrod, \$50, KEJ-4931.
 Samuel C. Fortunato, \$50, KIH-7142.
 Salvatore P. Montagna, \$50, KSM-07006.
- Duane L. Stivale, \$50, KLM-4564.
 Alfred Defuria, \$50, KAD-07424.
 Joseph Fett, \$50, KYX-0073.
 Phoenix, Ariz., George W. Gormey, \$50, KGT-8423.
 San Pedro, Calif., Mike A. Frye, \$50, KSO-9073.
 Stockton, Calif., C&O Welding Co., \$150, KTI-9777.
 West Covina, Calif., Mark S. Shook, \$50, KET-8586.
 Arvada, Colo., Edward Martinez, \$150, KIH-1312.
 Aurora, Colorado
 Paul R. Radmacher, \$100, KCU-9453.
 Riley V. Robinson, Jr., \$150, KIP-0660.
 Broomfield, Colo., Lloyd D. Nauta, \$50, KCZ-0195.
 Colorado Springs, Colorado
 Allen E. Bailey, \$100, KRT-1995.
 Larry R. Bishop, \$100, KOC-9516.
 Paul N. Blakely, \$100, KOX-5915.
 Jack H. Breedlove, \$100, KEE-2877.
 Mary K. Brotherton, \$50, KRE-0828.
 Monte R. Burgher, \$100, KMB-80915.
 Charles R. Carter, \$100, KEA-0790.
 William K. Clark, \$100, KOA-7764.
 Claude L. Cox, \$100, KXO-3842.
 Jon A. Dainty, Sr., \$50, KSG-9417.
 Donald D. Denman, \$100, KXH-8903. (continued)

Now you can boost your 2-way CB range 10 times legally

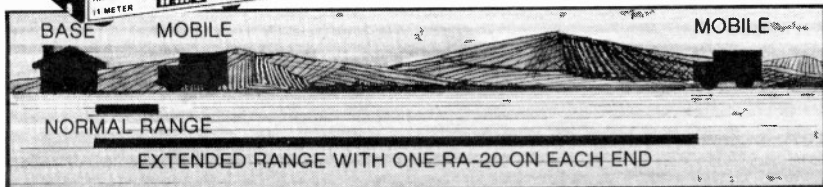

with 2 RA-20 receiver amplifiers \$29⁹⁵ each*

That's right! Put an HME RA-20 receiver amplifier at each end of your 2-way communications, either base or mobile, and hear each other at distances up to 10 times longer without having to increase your transmitter power. How about that!

*Suggested retail price



Other CB products from HME

TV Interference Filter

Model TVI-60 reduces undesired radiation 1,000,000 times on TV channels. Pretuned and simple to install.

Power Distribution Unit

Model PD-15 lets you connect any number of accessories with quick-connect banana jacks. Has remote switch for hidden accessories and master off/on switch.



HM ELECTRONICS INC.
 6151 Fairmount Avenue
 San Diego, California 92120
 Telephone (714) 280-6050

DEALER AND DISTRIBUTOR INQUIRIES INVITED



HEAVY DUTY CB ANTENNA

FIBERGLASS WHIP

- EXTRA STRONG SIGNAL
- STANDARD THREAD
- TOP LOADED
- LOW VSWR

AVAILABLE
 IN

5
 SIZES

Ideal for:
 • AUTO
 • VAN
 • BOAT



ORDER
 TODAY!

SCIENTIFIC ANTENNAS CO.

2732 Wisconsin Avenue
 Downers Grove, IL 60515
 (312) 960-0567

Enclosed is my check/M.O. for \$ _____

- 3 Foot Whip Antenna \$12.00
 - 4 Foot Whip Antenna \$12.50
 - 5 Foot Whip Antenna \$13.00
 - 6 Foot Whip Antenna \$13.50
 - 8 Foot Whip Antenna \$14.95
- Add \$1.00 for shipping & handling

Name _____

Address _____

City & State _____

DISTRIBUTOR INQUIRIES INVITED!

ALUMA TOWERS

LOW PRICED

MADE IN ALUMINUM

- ★ TELESCOPING
(CRANK UP)
- ★ WALL MOUNTED
- ★ GUYED

QUALITY MADE FOR:
TV — CB — HAM
MARINE — MOBILE
RADIO TELEPHONE
& COMMERCIAL

10 MODELS MFG.

Towers to 100 feet. Specials designed & made. See dealer or send for free catalog.

ALUMA TOWER DIVISION
FRED FRANKE, INC.
BOX 2806S9
VERO BEACH, FLA. 32460
PHONE (305) 567-3415

Audio Interference Filters



C-505-R Audio Interference Input Filter eliminates interference by CB transmitters or radio stations to hi-fi equipment or PA systems. Set consists of one pair.

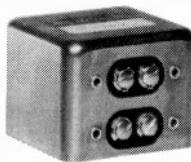

C-506-R Audio Interference Output Filter eliminates interference by CB transmitters or radio stations to hi-fi equipment or PA systems.

Look for these and other Miller CB filters and accessories at your electronic outlet.

Write for full line brochure.



BELL INDUSTRIES
J. W. Miller Division
19070 REYES AVE. ■ P.O. BOX 5825
COMPTON, CALIFORNIA 90224

HEY! Getcha Giant Skipland Map Poster!

The **CB Skipland Map** in our November issue has been souped-up and reprinted by popular demand! We made a more detailed (lots more things—including most major cities with their CB handles) huge size version (17 by 23 inches) on high quality, colored stock—just right for the wall of your CB shack! It's sort of a limited edition, so now's the time to move if you want one! Here's how to get your own highly detailed version: fill in the coupon below, enclose only **\$1.75** (includes postage and mailing) and send it back to us! This map will really blow smoke with everybody who sees it!

Please send me _____ copies of the Giant Skipland Map Poster.

Name _____

Address _____

City _____

State _____ Zip _____

Return order to:

CB Skipland Map
c/o S9 Magazine
14 Vanderventer Avenue
Port Washington, N.Y. 11050

- WASHINGTON OUTLOOK (cont'd)**
- Clearwater, Fla., Roger P. Damron, \$50, KTW-9367.
Longwood, Fla., Claudette Fella, \$50, KKK-6059.
Maitland, Fla., Thomas Walker, \$50, KWY-4658.
Orlando, Florida
Jackson L. Bailey, \$150, KMK-3874.
Eddie D. Blake, \$150, KLE-3259.
Nelson Cooper, \$100, KJM-9998.
William D. Boyle, \$150, KGJ-0229.
Robert F. Galyon, \$100, KKG-2685.
Wayne W. Grant, \$50, KWG-3868.
Johnny E. Lemons, \$50, KGB-6539.
Manuel L. Maxwell, \$150, KIX-5975.
Clifford D. Millison, \$50, KWM-7551.
David Olivier, \$50, KWW-9611.
Eddie L. Worthington III, \$50, KIA-0763.
Winter Park, Fla., James V. Humphrey, \$100, KWY-2957.
Silver Spring, Md., James C. Beattie, \$50, KYI-2754.
Belleville, N.J., Nicholas M. Massa, \$100, KJC-3957.
Bergenfield, N.J., Arthur B. Holmes, III, KIP-5469.
Cedar Grove, N.J., Robert A. Davidson, \$50, KYO-5996.
Clifton, New Jersey
George M. Curreri, Jr., \$100, KKB-2331.
Frank Ferrer, \$50, KWC-9557.
Robert D. Kender, \$50, KFI-5396.
Frank Spychaj, \$150, KHO-4328.
East Hanover, New Jersey
Jerry Masino, \$100, KDZ-4473.
Raymond R. Simber, \$100, KGF-8896.
East Rutherford, N.J., Josephine M. Britton, \$50, KYM-9212.
Garfield, N. J., John D. Kimak, \$150, KXB-2808.
Glen Ridge, N.J., Thomas S. Phillips, \$50, KHZ-0007.
Hoboken, N.J., Glenn C. Patterson, \$100, KWP-4222.
Lodi, New Jersey
Peter L. Manzo, \$50, KYV-9185.
John A. Pera, Jr., \$50, KEC-7458.
Edward R. Tucker, \$50, KPA-9898.
Montclair, N.J., Alfred R. Tomlin, Jr., KCC-1658.
Montvale, N.J. Arthur Norton, \$150, KIR-4943.
North Bergen, N.J., Gary Willis, \$100, KDQ-5097.
Oakland, N.J., Maxine D. Fetchik, \$50, KXD-9497.
Paramus, N.J., Arnold Markowitz, \$50, KLC-4613.
Passaic, N.J., Leonard Cavotto, \$50, KQI-7573.
Paterson, N.J., Capitol Sign and Display Co., \$50, KGE-6052.
Louisville, Kentucky
Gordon E. Gregory, \$50, KEM-9590.

(continued)

merchandising magazines have
their place...retailing
magazines do too...in their limited
capacity... **but** what you need
to sell your message is a magazine
that covers...



That's it in a nutshell. You need CB Radio Marketing, the only monthly magazine that gives your distributor and your dealer the editorial guidance he needs to grow and prosper.

Compare CBRM's editorial content with that of either the "merchandising" or "retailing" magazine in the CB field. Frankly, it puts the others to shame. Only CBRM guides your customer on how to advertise, how to regulate inventory, how to run a service shop, how to run a better business. Compare CBRM with the others, and ask yourself which magazine you'd read if you were a CB dealer or distributor. We know you'll choose CBRM because it's got better content and more of it.

And then compare ad page rates. You get 22,000 CB trade coverage for only \$710 per page on a 12 time basis. That's many hundreds less than the cost for merchandising or retailing magazines.

And wouldn't you expect the best value in a CB trade publication to come from Cowan Publishing? After all, our CB RADIO/S9 is the largest and best CB consumer book in the field!

End of message

WE HAVE THE KEY TO PROFIT

There's tremendous profit in the exploding C.B. market - land, marine, everywhere! We have huge inventories of top brands - and 24 hour service. We also have the KEY to turning merchandise - effective marketing programs! Our proven know-how will assure what you want - a good bottom line!
Write or call today!

UNIVERSAL COMMUNICATIONS, INC.



1722 Terrace Drive
St. Paul, Minnesota 55113
In Minnesota, call collect:
612/636-1771
Outside Minnesota, call free:
800/328-9600

Crystalit

The crystal mounting box expands the channel receiving capability of your crystal controlled receivers, scanners, etc.

Hear the new channels with your present set and save having to purchase a new one.

Also available special cut crystals.

Manufactured by:

Sparke Mfg. Co.
7420 Stonehurst Ct.
Indianapolis, In. 46256

WASHINGTON OUTLOOK (cont'd)

- Habitant Systems, Inc., \$100, KBD-9795.
George E. Long, \$50, KGZ-2891.
Noble D. Murphy, \$50, KXI-7597.
John C. Parifitt, \$150, KXJ-4718.
Daniel J. Parrish, \$100, KYJ-2895.
Edwin R. Phelps, \$50, KJE-6686.
Willie F. Shofner, \$100, KPK-1127.
Homer J. Smith, \$50, KIC-7831.
Roy L. Smith, \$50, KYW-0121.
Otto E. Stoner, \$50, KJD-0448.
Robert W. Storns, \$100, KYD-6891.
Daniel E. Yager, \$50, KCA-4079.
Kenneth E. Russ, \$100, KHI-3808.
Jack S. Vance, \$50, KZW-3365.
Leo J. Scheurich, \$50, KLS-40214.
Pleasure Ridge Park, Kentucky, Earl J. Miller, \$100, KCW-5406.
Lodi, N.J., Gloria E. Summers, \$50, KOU-0039.
Colorado Springs, Colo., Darrell R. Barnes, \$50, KKI-4077.
Pueblo, Colo., Keith C. Allen, \$100, KRT-7152.
Lincoln, Neb., Randall R. Bollinger, \$100, KYJ-8006.
Tulsa, Okla., James D. Meadors, Sr., \$100, KTU-6147.
Bells, Texas, Robert E. Brattain, \$50, KYY-5364.
Clarksville, Indiana
Charles R. Akers, \$50, KII-4301.
James H. Castile, \$150, KIP-9352.
Larry F. Dillard, \$100, KTA-8778.
Bill R. Engle, \$50, KKH-4351.
Niles E. Werbio, \$50, KNB-7040.
Jeffersonville, Indiana
William H. Baker, \$50, KQF-7439.
Leroy J. Maloft, \$150, KYX-2633.
Andrew L. Williamson, \$50, KOA-0282.
New Albany, Indiana
John E. Gibson, \$100, KIS-6471.
John L. Goodman, \$50, KLX-2598.
John F. Klink, \$50, KBU-4696.
Jesse L. Ross, \$100, KFJ-4575.
David L. Smith, \$50, KJC-9927.
Ranney D. Tucker, \$50, KGM-7646.
William P. Zurschriede, \$50, KOH-3641.
Fern Creek, Ken., Carl J. Lee, \$50, KXG-8965.
Louisville, Kentucky
Emmett Jackson, Jr., \$50, KVC-3507.
Gerald D. Jewell, \$100, KTV-2538.
William C. Marmillot, \$50, KTV-7363.
Gene B. Martin, \$50, KJQ-9669.
Terry L. Seaton, \$100, KBM-9539.
Clarence J. Stone, \$100, KWZ-3215.
George T. Webb, \$100, KBW-5020.
Julian H. Allgood, \$50, KEB-3129.
Wayne T. Avery, \$100, KCS-3450.
Bryant F. Birge, \$100, KBQ-3288.
Jimmie M. Brady, \$100, KSY-5519.
Harvey T. Burton, \$50, KCP-0283.
William E. Cox, KYC-7518.
Douglas L. Glass, \$100, KDE-1229.

CONVERT MOBILE CB TO "HOME BASE" INSTANTLY!

NEW STACO HEAVY DUTY
POWER SUPPLIES CONVERT
AC TO CONTINUOUS 13.8VDC
FOR FULL TRANSMIT POWER!

Powers CB, SSB, Stereos, Tape Decks and other auto accessories. Hook-up 2 wires, antenna and plug into standard AC outlet. No background hum, reliable, economical and quiet. Choice of 3 models.

Features: Automatic Dual Overload and Short Circuit Protection, Solid State Reliability, Integrated Circuit Regulation Control, 90 Day Warranty, Made in U.S.A.

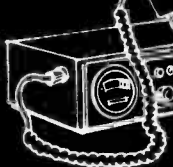

AVAILABLE NATIONWIDE FROM:
LEADING CB RADIO DEALERS & STORES!

"40 years of Electronic Experience"

STACO
INCORPORATED
2240 E. Third St. Dayton, Ohio 45403
(513) 253-1191 • TWX: 810/459-1798 • TELEX: 288-032

DISTRIBUTOR INQUIRIES INVITED!

Granada Hills, Calif., Carl J. Keller, Sr., \$50, KIV-0847.
 Belmont, Calif., Zachary D. Scbior, \$100, KNZ-1148.
 Dale City, Calif., Francis V. Bodegraven, \$100, KCN-6695.
 San Francisco, Calif., Forrest R. Mills, \$100, KTV-4171.
 South San Francisco, California
 Charles Elauria, \$50, KXT-3096.
 Frisco J. Newton, \$100, KOL-3755.
 Thomasville, N.C., Tom F. Marlowe, Jr., \$50, KXF-8974.
 Sarasota, Fla., William K. Turner, \$50, KABU-9318.
 Baltimore, Md., Oscar F. Simon, \$50, KBZ-1709.
 Millersville, Md., John A. Norville, \$50, KSH-3646.
 Racine, Minn., Gene C. Hillman, \$50, KPP-5339.
 St. Paul, Minn., Benjamin F. Silva, \$100, KTU-7523.
 Sauk Rapids, Minn., Jay Hardy, \$50, KZH-3007.
 Braddock, Pa., Richard R. Schellman, \$50, KWH-5690.
 Lockport, N.Y., Joseph Scinta, \$50, KEZ-5835.
 Webster, N.Y., Howard Zeitlin, \$50, KDO-2216.
 Portland, Oregon
 Warren J. Dean, Jr., \$100, KHI-2296.
 Milan C. Faulkner, \$100, KDL-6113.
 William M. Price, \$100, KXL-0028.
 Dallas, Texas
 Frank R. Brown, \$100, KSF-1210.
 Sky Hi Oil Co., & Amme Investments, \$150, KJV-2887.
 David T. Steward, \$100, KTK-7715.
 Irving, Texas
 Fred R. Lidecker, \$100, KYG-5990.
 Robert A. Tompkins, \$50, KZU-1552.
 Galveston, Texas
 Doris J. Hall, \$50, KGB-0681.
 Joseph S. Hypolite, \$50, KJH-77550.
 Charles E. Williams, \$50, KPA-1773.
 Houston, Texas, Frank Rocha, \$50, KLE-4066.
 Irving, Texas, Dorothy J. Benningfield, \$50, KNU-9278.
 Flint, Mich., Frank S. Neumann, \$50, KTT-0224.
 Sedalia, Mo., John R. Warren, \$50, KWI-7932.
 Columbus, Neb., Kenneth J. Wangler, \$50, KBB-3214.
 Fremont, Neb., Kenneth C. Albers, \$50, KIQ-5509.
 Hershey, Neb., Virgil A. Burris, Jr., \$50, KBY-2431.
 Schuyler, Neb., Wilbur D. Mousel, \$50, KCJ-6802.
 Grand Forks, N.D., Raymond A. Bonemeyer, \$100, KJA-5658.
 Lawton, Okla., James W. Moch, \$100, KTY-4849.
 Allentown, Pa., Donald H. Seagreaves, \$50, KKS-4077.

Anton, Texas, Ronald E. Byers, \$50, KWZ-0299.
 Houston, Texas, Charles A. Cooper, \$50, KQZ-9875.
 Lexington, Ky., Ewings Rentals Apt. & Housing, \$50, KGL-3925.
 Baltimore, Md., Alva C. Madairy, \$50, KZY-0485.
 Silver Springs, Md., Thomas A. Chitenden, Ill., \$50, KMI-1821.
 Vienna, Virginia, Norman L. Dunbar, \$50, KND-8030.
 Orlando, Fla., Rovell A. Dekema, \$50, KND-6595.
 Endicott, N.Y., Oakford Z. Smith, Jr., \$50, KYS-4717.
 Salem, Oregon
 Eugene McCoy, \$100, KEH-5764.
 Capitol Monument, \$50, KYY-7662.
 Guy M. Morley, \$50, KJS-8906.
 Springfield, Oregon, Michael J. Paris, \$100, KHN-2022.
 Orange, Calif., Donald J. Marshall, \$50, KGZ-6606.

Stockton, California
 Randal W. Debates, \$50, KSH-0664.
 Karl L. Loftis, Sr., \$50, KFH-3154.
 Sanford, Fla., Doxn P. Sieg, \$50, KJG-5305.

OTHER ACTIONS

The Commission, by its Safety and Special Radio Services Bureau dismissed proceedings on order to show cause for the following:
 Phoenix, Ariz., Gilbert Davis, KQQ-3255.
 New Fairfield, Conn., Robert L. Barbour, KIU-9978.
 The Commission, by its Safety and Special Radio Services Bureau set aside orders to show cause and terminated the proceedingse for the following:
 Hillcrest Heights, Md., Larkin P. Davis, KGM-3773.
 Forestville, Md., Marshall Thornton, KTD-7885.
 Hightstown, N.J., New Jersey Automatic Door Co., KAB-1207.

COMING NEXT MONTH

Exclusive interview by Gordon West with the FCC, KFCC-1000, who is now on the air talking to illegals.

Tired of Crowded CB Channels?

Then you want a
GRC-11 RANGE CONTROLLER



Eliminates

- INTERFERENCE ON CROWDED CHANNELS
- EAVESDROPPING ON PRIVATE CONVERSATIONS
- BLEEDTHROUGH FROM OTHER CHANNELS

\$39.95

PLUS . . .

Fantastic "Private Mode" bonus feature allows you private conversations car to car. Installs in 5 minutes. Requires no power. Connects between any CB set and CB antennas.

You Can't Steal What You Can't See

Operate your CB with your regular car antenna.

No CB antenna necessary.



\$49.95 The PROFILE ANTI RIPOFF costs more but works better.

No complex extra meters to buy. Has built-in traffic light indicator. Green light, everything's right. Red light, simple knob adjustment. Listen to your AM/FM radio even while transmitting!



Send Check, Money Order, BankAmericard or Master Charge Number With Expiration Date. Now in Stock for Immediate Shipment.

Glatzer Industries Corp.

268 Huguenot Street • New Rochelle, N. Y. 10801

(914) 576-2700 Dealer Inquiries Invited!

ON THE COUNTERS

(from page 49)



CB TRANSCEIVERS OFFER PPL

Channel Master's deluxe Model CB 6832 CB transceiver is a 23 channel unit with Phase Lock Loop circuitry. Its features include switchable noise blanker and automatic noise limiter, delta tune, and full range RF gain control.

The receiver section's sensitivity is .5 microvolts for 10 DB signal to noise ratio, and selectivity is ± 3 KHz at -6 DB. RF power output to the antenna is a full 4 watts, with 100% modulation capability.

For operator convenience, the smartly styled CB 6832 has easy to read, back-lighted channel indicator numbers, LED transmitting light, and an illuminated signal strength meter. Other features include switchable external CB receiving monitoring capability, squelch control, automatic modulation limiter, CB/PA switch, and reversible polarity for all positive/negative 12 volt DC systems.

The 3" round ceramic speaker has a sound-engineered, angled enclosure. A detachable 500 ohm dynamic hand mike is included.

The transceiver measures 6½" wide, 2½" high, and 8½" deep. Suggested retail price of the Model CB 6832 is \$179.95.

A similar unit, Model CB 6830, offering the same features and specifications, but without an RF gain control, has a suggested retail price of \$159.95.

ANTENNA NEEDS NO GROUNDING

A Citizens' Band fiberglass antenna for marine applications which requires no ground plane has been introduced by Antenna, Incorporated, Cleveland-based manufacturer of antennas and antenna accessories.

The Torpedo (Model 38820) is a seven-foot fiberglass whip designed as a half-wave antenna so it will

work equally well on wood, fiberglass or metal surfaces without grounding.

The antenna is molded into a self-locking fold-down white mounting base. The base is made of durable plastic and will not stain. A leveling plate, made of the same material as the base, is included for mounting the antenna on sloping boat decks.

Each Torpedo antenna comes with 7' of coaxial cable, connector and rubber grommet to seal the hole in which the antenna is mounted. For installations requiring more than 7' of cable, the cable may be lengthened without adversely affecting antenna performance.

Suggested resale price of the Torpedo is \$39.95.

All Antenna, Incorporated products are manufactured in the United States and are completely tested and inspected before leaving the factory to ensure the highest quality.

For further information on the Torpedo Citizens' Band marine antenna and the complete line of Antenna, Incorporated products, contact Randall J. Friedberg, Antenna, Incorporated, 23850 Commerce Park Rd, Cleveland, Ohio 44122.

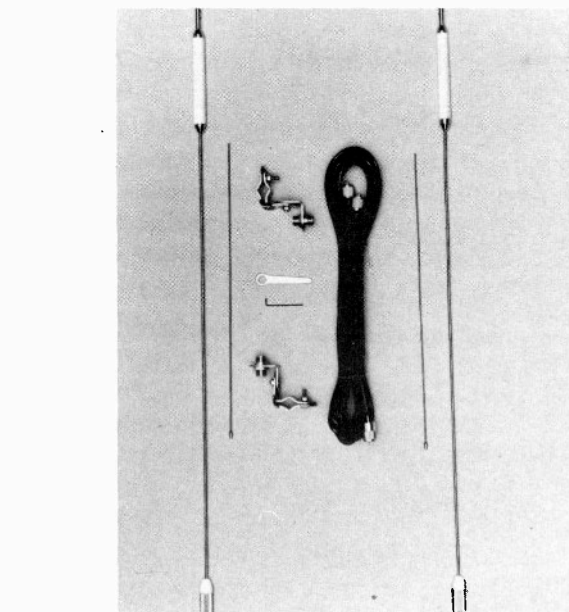

TRUNK-MOUNTED ANTENNA

The Mura Corporation announces an economical new mobile antenna which boasts many of the features found on higher-priced models. Under its tough plastic outer wrap, the CBA-6 consists of a *heavy gauge copper coil helically wound* around a solid fiberglass core. This

construction allows for extreme flexibility, ruggedness and operating efficiency. The whip portion of the CBA-6 is made of 17-7Ph stainless steel for high tensile-strength. Additionally, the antenna can be adjusted to achieve the *lowest possible SWR*. The 15-foot coaxial cable comes with pre-wired tabs for easy assembly to the CBA-6's plastic base, and is fitted with a standard PL-259 connector. The manufacturer's suggested list is \$23.95. For further information write Mura Corporation, 177 Cantiague Rock Road, Westbury, N.Y. 11590.

ADJUSTABLE TRUNK LIP MOUNT

The unique versatility of the S&A AT-5 adjustable trunk lip mount makes it perfect for CB antennas on hatchback and fastback automobiles. The AT-5 can be mounted on either the forward lip or rear lip of a hatchback by simply reversing the heavy duty, chrome plated steel mounting bracket.

Thus whatever the slope of the car, it can be adjusted to a "straight up" position for fine reception.

The AT-5 will fit cars such as Chevrolet Monza and Vega hatchback, Buick Skyhawk, Pontiac Sunbird, Oldsmobile Starfire, Honda Civic and any similar rear hatchback vehicle.

S&A designed the AT-5 for the Target CB-5 tapered stainless steel whip antenna, and Target's CB-308 fiberglass tunable tip antenna. It can be used with AK-14 or AK-38 adapter kits.

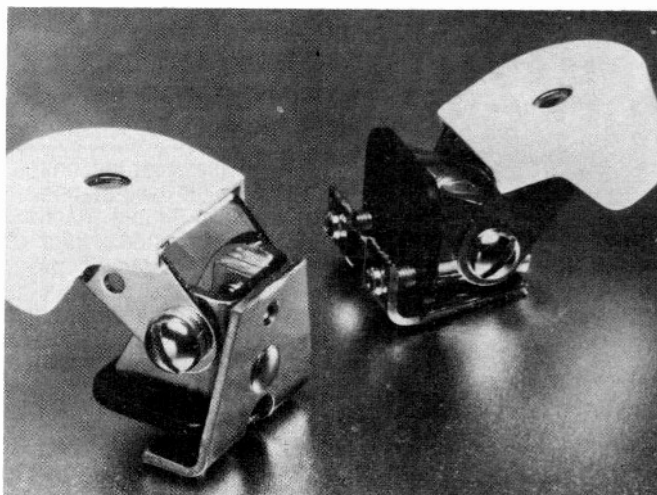

The new AT-5 adjustable trunk lip mount is a product of S & A Electronics, Division of The Scott & Fetzer Company, with headquarters at 202 W. Florence Ave., Toledo, Ohio 43605.

TWO-POSITION COAX SWITCH PERMITS FAST ANTENNA CHANGES

Quick change-over from single to duals, or other CB antenna arrangements, can be accomplished with the flick of a switch on the new Model 13-200 Coax antenna switch just released from the Breaker Corporation, Arlington, Texas.

The Coax switch is housed in an attractive black

HEY CB'ers! KNOW THE BEAR FACTS! WITH YOUR NEW GOOD BUDDY™ YOU'LL NEVER FORGET THOSE BEAR 20's AGAIN!

The "GOOD BUDDY" will record and describe 4 hazards with a flick of a finger. Simply set the dials to record mile-marker or mileage, direction, highway or exit, and describe the hazard with one of 10 settings:

Hazard Codes	TX Tijuana Taxi	BR Bad Road
	PW Plain Wrapper	RC Road Construction
	RA Radar	DV Disabled Vehicle
	AC Accident	DD Dangerous Driver
	HH Hitchhiker	OH Other Hazard

Special features:

- illuminated dials for nite use
- emergency flashlight - (G.E. bulb incl. - Batteries not incl.)
- safe one finger operation with vibration proof dials
- high impact styrene body that mounts on any flat surface (adhesive backing)

AVAILABLE BY MAIL ONLY

The "GOOD BUDDY" plus a FREE 10 CODE AND SLANG TERMS is yours for only \$6.95. Satisfaction guaranteed. If not satisfied within 10 days, return for full refund. Just fill out and mail the coupon with check or money order.

DON'T FEED THE BEARS! ORDER NOW!

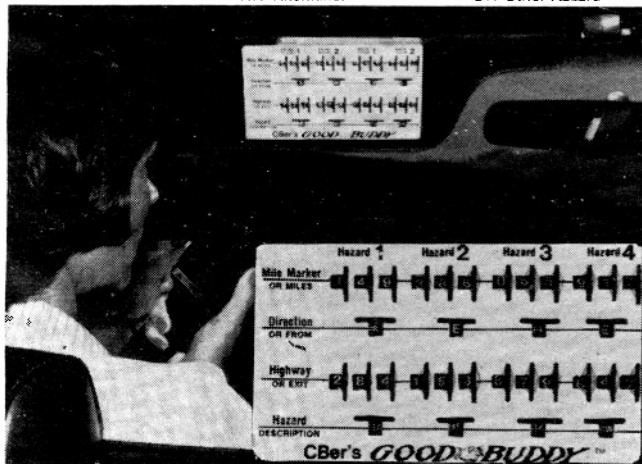

RECORD ACCURATE INFORMATION

Your fellow CB'ers are counting on you!

From: BiWays, Inc. P.O. Box 16174 Pittsburgh, Pa. 15242

That's a big 10-4! I'd like _____ "GOOD BUDDYS" at \$6.95 each. I'll also receive a free 10 code and slang term listing with each "GOOD BUDDY." Enclosed is my check or money order for _____ (No cash please.)

Name _____

Address _____

City _____ State _____

Zip _____

MAIL TO: BiWays, Inc.
P.O. Box 16174
Pittsburgh, Pa. 15242

Allow 4-6 weeks for delivery. / Pa. residents add \$.42 sales tax.

AMAZING APARTMENT ANTENNA!



APT-3, the *shoestring* antenna that ends the CB base-station antenna hassle! Simply attach the APT-3 to the inside of your window with the suction cups provided, connect to your transceiver and tune for maximum power! *GAIN: Range on ground level equal to mobile antenna. Increases dramatically with height.*

SEND **\$29.95**

Valcom INC.

Money back guarantee within 30 days upon written request. Please allow 60 days for delivery.

Check or Money Order APT-3's at \$29.95 ea. = \$ _____

BankAmericard

Mastercharge Signature _____

Interbank No. _____ Address _____

Card No. _____

Expiration Date _____ City, State, Zip _____

VALCOM, INC. P.O. BOX 937 LAS CRUCES, NM 88001

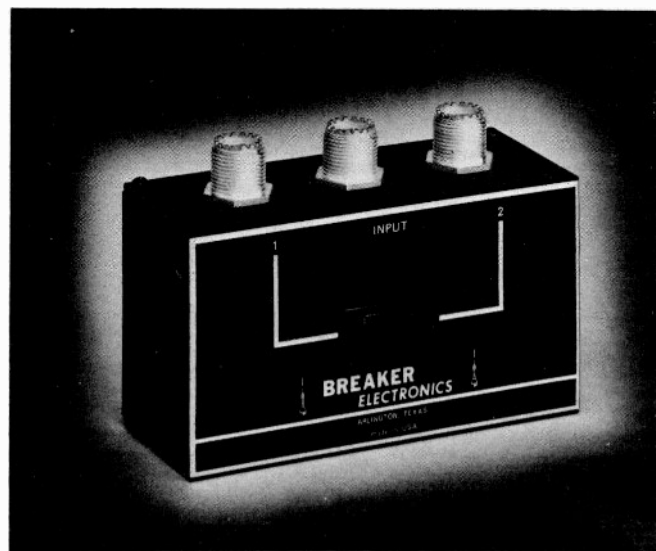

metal case 4 $\frac{3}{4}$ " L x 2 $\frac{1}{2}$ " H x 2" D. It has a single SO-239 transceiver input connector and is switchable to either of the two SO-239 antenna cable connectors. Ideal for mobile or base station usage, the Breaker switch eliminates tedious changes in transmission line connections and concern about proper impedance matching when it is desirable to utilize a different antenna.

The Model 13-200 is just one of Breaker's new "Freedom Line" of 27 MHz CB antennas and accessories. These quality products are skin-packed on Bi-Centennial inspired red, white and blue display cards at your local electronic distributor, CB truck stop departments and many CB retail outlets. The Model 13-200 lists for only \$7.95.

For further information, contact the Breaker Corporation, Marketing Department, 1101 Great Southwest Parkway, Arlington, Texas 76011.

MIKE:

Telex's "Double Header" CB Power Mike, produced to exacting professional standards, offers the CBer a choice of use as either a noise-cancelling mike or a standard power mike.

Telex is the world's leading manufacturer of communications equipment for the aviation industry.

The Double Header, model CB-73, has a self-contained battery-powered IC amplifier with variable gain. This allows the operator to adjust the mike to his radio for maximum volume at normal speech level without distortion.

For optimum noise suppression, the user talks with the mike close to the lips. The noise cancelling feature assures clear, distortion-free transmission in even the noisiest traffic environment.

When to be used as a standard power mike some distance from the mouth, the user simply flicks the mode selection switch at the top of the unit.

For quick, easy handling while driving, the front nameplate serves as a hanger bracket. A conventional rear hanger bracket also is provided. The mike is de-

Your Base Station Deserves the Best Power Meters ...and that means power scanners from Para Dynamics

check

the specs on these great new units and then compare prices with others in the field. The quality, styling and value of the power scanners will sell you at once. And power scanners are available right now at your local CB dealer. Drop in and get the full story.

Model PDC-600



Suggested retail \$ 79.95

- Capable of monitoring up to 1000 Watts Output Power
- Factory Calibrated at 27 Mhz
- Frequency Range Capability Extends to 220 Mhz
- Modulation Level 0 to 100% and Over Modulation Indication to +3db
- Standing Wave Ratio (SWR)
- 100% solid state design minimizes size, increases reliability and accuracy while providing THE UNIQUE SIMULTANEOUS READING OF RF POWER, MODULATION, AND SWR

RF Power Scanner PDC-700

The RF power scanner PDC-700 is a must for the most discriminating 2-way communication and CB operator.

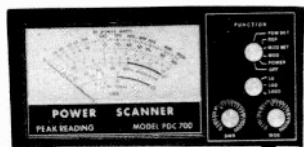

Suggested retail \$ 89.95

RF power scanner model PDC-700 is designed for CB and 2-way communication operators to check out the performance and functions of their transceivers.

PDC-700 offers the following:

1. Up to 1000 watts output power, peak reading.
2. Frequency range capability extending to 220 Mhz.
3. Factory calibration that is set at 27 Mhz (CB band).
4. A modulation cover to 100% and over modulation indication to +3db.
5. Standing Wave Ratio (SWR).
6. One large easy to read 4 x 6 meter for increased accuracy.

Distributor and Dealer Inquiries Invited: (602) 991-1600

Para Dynamics Corporation

A Subsidiary of OEA, Inc. — **OEA** — Scottsdale, Arizona 85260



signed to fit comfortably and securely in the hand.

The CB-73 comes in three versions, providing full compatibility with the switching circuit of any CB radio.

Suggested retail price of the CB-73 is \$39.95. Contact Telex Communications, 9600 Aldrich Avenue South, Minneapolis, Minn. 55420.

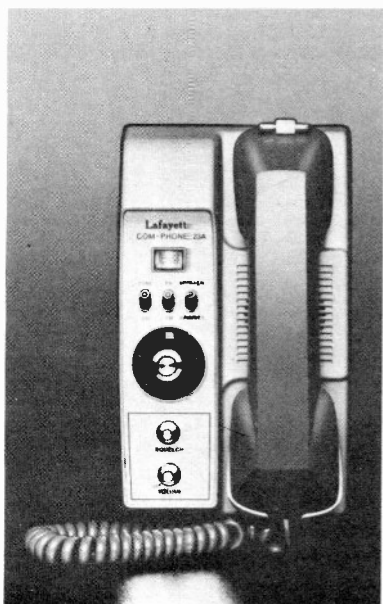

PLL MOBILE TRANSCEIVER

Lafayette Radio Electronics Corp. has introduced the Com-Phone 23A, an improved model of its famous hand-set style Com-Phone 23. Stock No. 99-33342W. Price \$189.95.

Utilizing the latest technological advances in micro-circuitry, the Com-Phone 23A now features a digital phase lock loop synthesizer to transmit and receive all 23 channels precisely on-frequency using only 3 crystals.

New also is an illuminated S/PRF meter and a Hi-Low Tone switch which is used to adjust the audio tonal response of the receiver.

The Com-Phone 23A maintains its convenient telephone handset-type styling and 3-way operation which permits private listening while minimizing external noise, or use of the built-in speaker or both. In addition the dual conversion receiver has a RF stage and ceramic filter for a razor-sharp selectivity and rejection of unwanted adjacent channel interference, illuminated channel indicator, variable squelch and automatic noise limiter. Range-Boost circuitry provides an increase in the effective range of the transmitted signal.

Other features include provision for PA operation with volume control, external speaker jack and "floating" type chassis for choice of negative or positive ground 12Vdc operation without switching. The unit includes a universal mounting bracket for horizontal or vertical use.

SPECIFICATIONS: *Sensitivity:* 0.7 uV for 10dB S/N; *Selectivity:* 45 dB \pm 10kHz; *Image and Spurious Response Rejection:* -40 and -50dB; *Audio Output:* 3 watts @ 8 ohms; *RF Power Output:* 4 watts; *Modulation:* 90%; *Current Drain:* (Standby) 170 mA; (Transmit) 1 amp or less; *Overall Dimensions:* 5 3/8 W x 9 7/16 D x 3 9/16 H; *Net Weight:* 3 lbs., 4 oz.



NEW PRODUCT DISPLAY

A new antenna merchandising program designed to help CB distributors establish new dealerships is now available from The Antenna Specialists Co. The new merchandising program will be especially helpful in setting up dealers who do not have any traditional electronics background.

The central feature of the program is an attractive, free standing product display with a complete antenna product mix and full color graphic panels showing application. The panels can be easily changed to coincide

with the product displayed immediately beneath.

The program provides a full set merchandising materials including ad mats, price lists, consumer literature and point of purchase displays to give the dealer a step-by-step introduction to the antenna business.

Details on the dealer merchandising programs are available from Antenna Specialists representatives.

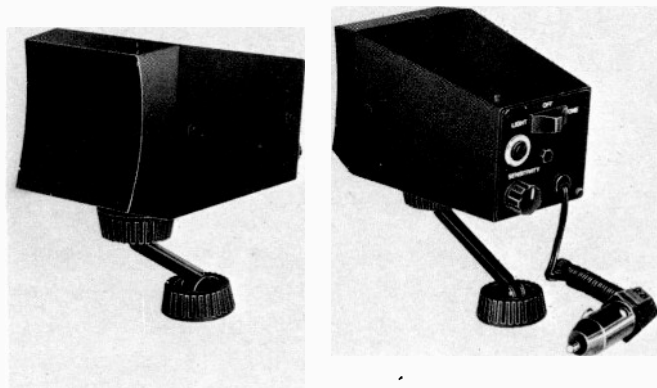

"BEAR HUNTER"

Universal Machine Company, Inc., announces the "Bear Hunter", radar detector. The "Bear Hunter",

capable of receiving both "X" and the new "K" radar bands, has an extremely high sensitivity both in its antenna as well as its electronic design, enabling it to receive signals up to three (3) miles in distance. Twin computer designed antennas offer maximum gain at both frequencies. Special filtering screens out unwanted signals giving the unit virtually no false triggering. Mounting is done to either the dash or windshield of the automobile and a cigarette lighter plug allows temporary installation. Indication of a radar zone is chosen by a slide switch on the rear of the unit, selecting either the red lamp or an audible tone. A variable sensitivity control is mounted on the rear panel for operating convenience. More information available from Nelson Roberts, Communication Products Manager, Universal Machine Co., Inc., 2300 Reagan Street, Dallas, Texas 75219, or your local UMC representative.

CB SWITCH

A new Amphenol® two-position CB antenna switch—that allows switching one rig between two antennas or one antenna between two rigs—has been introduced by Bunker Ramo Corporation, Danbury, Connecticut.

Designated Amphenol Model 83-2SW, the new device also permits switching an antenna between a CB rig and a monitor or scanner. A dummy load or power output indicator can also be incorporated into the sys-

CB SPECIALS—R.F. DRIVERS—R.F. POWER OUTPUTS—FETS

2SC481	1.85	2SC767	15.75	2SC866	5.85	2SC1449-1	1.60	40081	1.50
2SC482	1.75	2SC773	.85	2SC1013	1.50	2SC1475	1.50	40082	3.00
2SC495	1.10	2SC774	1.75	2SC1014	1.50	2SC1678	5.50	2SC608	4.85
2SC502	3.75	2SC775	2.75	2SC1017	1.50	2SC1679	4.75	SK3046	2.15
2SC517	4.75	2SC776	3.00	2SC1018	1.50	2SC1728	2.15	SK3047	3.75
2SC614	3.80	2SC777	4.75	2SC1173	1.25	2SC1728	2.15	SK3048	3.25
2SC615	3.90	2SC778	3.25	2SC1226A	1.25	2SC1816	5.50	SK3048	3.25
2SC616	4.15	2SC797	2.50	2SC1237	4.50	2SC1908	.70	SK3054	1.25
2SC617	4.25	2SC798	3.10	2SC1239	3.50	2SC1957	1.50		
2SC699	4.75	2SC781	3.00	2SC1243	1.50	2SF8	3.00	2SK19	1.75
2SC710	.70	2SC789	1.00	2SC1306	4.75	HEP-S 3001	3.25	2SK30	1.00
2SC711	.70	2SC796	3.15	2SC1306-1	4.90	2SD235	1.00	2SK33	1.20
2SC735	.70	2SC799	4.25	2SC1307	5.75	MRF8004	3.00		
2SC756	3.00	2SC802	3.75	2SC1307-1	6.00	4004	3.00	3SK40	2.75
2SC765	9.50	2SC803	4.00	2SC1377	5.50	4005	3.00	3SK45	2.75
2SC766	10.15	2SC839	.85	2SC1449	1.30	40080	1.25	3SK49	2.75

JAPANESE TRANSISTORS

2SA52	.60	2SB187	.60	2SC458	.70	2SC815	.75	2SC1569	1.25
2SA316	.75	2SB235	1.75	2SC460	.70	2SC828	.75	2SC1756	1.25
2SA473	.75	2SB303	.65	2SC478	.80	2SC829	.75		
2SA483	1.95	2SB324	1.00	2SC491	2.50	2SC830	1.60	2SD30	.95
2SA489	.80	2SB337	2.10	2SC497	1.60	2SC839	.85	2SD45	2.00
2SA490	.70	2SB367	1.60	2SC515	.80	2SC945	.65	2SD65	.75
2SA505	.70	2SB370	.65	2SC535	.75	2SC1010	.80	2SD68	.90
2SA564	.50	2SB405	.85	2SC536	.65	2SC1012	.80	2SD72	1.00
2SA628	.65	2SB407	1.65	2SC537	.70	2SC1051	2.50	2SD88	1.50
2SA643	.85	2SB415	.85	2SC563	2.50	2SC1061	1.65	2SD151	2.25
2SA647	2.75	2SB461	1.25	2SC605	1.00	2SC1079	3.75	2SD170	2.00
2SA673	.85	2SB463	1.65	2SC620	.80	2SC1096	1.20	2SD180	2.75
2SA679	3.75	2SB471	1.75	2SC627	1.75	2SC1098	1.15	2SD201	1.95
2SA682	.85	2SB474	1.50	2SC642	3.50	2SC1115	2.75	2SD218	4.75
2SA699	1.30	2SB476	1.25	2SC643	3.75	2SC1166	.70	2SD300	2.50
2SA699A	1.75	2SB481	2.10	2SC644	.70	2SC1170	4.00	2SD313	1.10
2SA705	.55	2SB482	1.25	2SC681	2.50	2SC1172B	4.25	2SD315	.75
2SA815	.85	2SB495	.95	2SC684	2.10	2SC1209	5.55	2SD318	.95
2SA816	.85	2SB507	.90	2SC687	2.50	2SC1213	.75	2SD341	.95
		2SB511	.70	2SC696	2.35	2SC1226	1.25	2SD350	3.25
				2SC712	.70	2SC1243	1.50	2SD352	.80
2SB22	.65			2SC713	.70	2SC1293	.85	2SD380	5.70
2SB54	.70	2SC206	1.00	2SC732	.70	2SC1308	4.75	2SD389	.90
2SB56	.70	2SC240	1.10	2SC733	.70	2SC1347	.80	2SD390	.75
2SB77	.70	2SC261	.65	2SC733	.70	2SC1387	.75	2SD437	5.50
2SB128	2.25	2SC291	.65	2SC739	.70	2SC1383	.75		
2SB135	.95	2SC320	2.00	2SC715	1.75	2SC1409	1.25	MPS-U31	at 4.00 ea.
2SB152	4.50	2SC352	.75	2SC762	1.90	2SC1410	1.25	MPS 8000	at 1.25 ea.
2SB173	.55	2SC353	.75	2SC783	1.00	2SC1447	1.25		
2SB175	.55	2SC371	.70	2SC784	.70	2SC1448	1.25		
2SB178	1.00	2SC372	.70	2SC785	1.00	2SC1507	1.25		
2SB186	.60	2SC394	.70	2SC793	2.50	2SC1509	1.25		

POWER-TRANSISTORS HIGH-VOLT. TV. TYPE

BU204	1300V	3.90	BU207	1300V	5.40	2SC1172B	1100V	4.25
BU205	1500V	4.70	BU208	1500V	6.25	2SC1308	1100V	4.95
BU206	1700V	5.90	2SC1170	1100V	4.00	2S91325	1100V	4.95

OEM SPECIALS

1N270	.10	2N960	.55	2N2219A	.30	2N2913	.75	2N3740	1.00	2N4401	.20
1N914	.10	2N962	.40	2N2221	.25	2N2914	1.20	2N3771	1.75	2N4402	.20
		2N967	.50	2N2221A	.30	2N2916A	3.65	2N3772	1.90	2N4403	.20
2N173	1.75	2N1136	1.35	2N2222	.25	2N3019	.50	2N3773	3.00	2N4409	.20
2N178	.90	2N1142	2.25	2N2222A	.30	2N3053	.30	2N3819	.32	2N4410	.25
2N327A	1.15	2N1302	.25	2N2270	.40	2N3054	.70	2N3823	.70	2N4416	.75
2N334	1.20	2N1305	.30	2N2322	1.00	2N3055	.75	2N3856	.20	2N4441	.85
2N336	.90	2N1377	.75	2N2327	1.00	2N3227	1.00	2N3866	.85	2N4442	.90
2N338A	1.05	2N1420	.75	2N2327	1.00	2N3247	3.40	2N3903	.20	2N4443	1.20
2N398B	1.90	2N1483	.95	2N2325	2.00	2N3250	.50	2N3904	.20	2N4452	.55
2N404	.30	2N1540	.90	2N2326	2.85	2N3375	6.50	2N3905	.20	2N5061	.30
2N443	1.75	2N1543	2.70	2N2327	3.80	2N3393	.20	2N3906	.25	2N5064	.50
2N456	1.10	2N1544	.80	2N2328	4.20	2N3394	.17	2N3925	3.75	2N5130	.20
2N501A	3.00	2N1549	1.25	2N2329	4.75	2N3414	.17	2N3954	3.50	2N5133	.15
2N508A	.45	2N1551	2.50	2N2368	.25	2N3415	.18	2N3954A	3.75	2N5138	.15
2N555	.45	2N1552	3.25	2N2369	.25	2N3416	.19	2N3955	2.45	2N5198	3.75
2N652A	.85	2N1554	1.25	2N2484	.32	2N3417	.20	2N3957	1.25	2N5294	.50
2N677C	6.00	2N1557	1.15	2N2712	.18	2N3442	1.85	2N3958	1.20	2N5296	.50
2N706	.25	2N1560	2.80	2N2894	.40	2N3553	1.50	2N4037	.60	2N5306	.20
2N706B	.40	2N1605	.35	2N2903	3.30	2N3563	.20	2N4093	.85	2N5354	.20
2N711	.50	2N1613	.30	2N2904	.25	2N3565	.20	2N4124	.20	2N5369	.20
2N711B	.60	2N1711	.30	2N2904A	.30	2N3638	.20	2N4126	.20	2N5400	.40
2N718	.25	2N1907	4.10	2N2905	.25	2N3642	.20	2N4141	.20	2N5401	.50
2N718A	.30	2N2060	1.85	2N2905A	.30	2N3643	.15	2N4142	.20	2N5457	.35
2N720A	.50	2N2102	.40	2N2906	.25	2N3645	.15	2N4143	.20	2N5458	.30
2N918	.35	2N2218	.25	2N2906A	.30	2N3646	.14	2N4220A	.45	C1039	.25
2N930	.25	2N2218A	.30	2N2907	.25	2N3730	1.50	2N4234	.95	C1039	.40
2N956	.30	2N2219	.25	2N2907A	.30	2N3731	2.75	2N4400	.20	C106b1	.50
										C106di	.75

SILICON UNIUNIONS		INTEGRATED CIRC.		RECTIFIERS		
2N2646	.50	2N4871	.50	UA703C	.40	
2N2647	.60	2N4891	.50	709C OP. AMP.	.25	
2N6027	.55	2N4892	.50	741C OP. AMP.	.25	
2N6028	.70	2N4893	.50	7400	.15	
D5E37	.25	2N4894	.50	TA7061P	at 3.50 ea.	
2N2160	.65	MU10	.40	TA7205P	at 10.00 ea.	
2N4870	.50			UPC1001h2	at 6.00 ea.	
				NE555	at 1.25 ea.	
					10	100
				IN4001	.60	5.00
				IN4002	.70	6.00
				IN4003	.80	7.00
				IN4004	.90	8.00
				IN4005	1.00	9.00
				IN4006	1.10	10.00
				IN4007	1.20	11.00

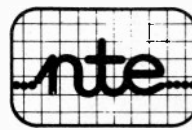

New-Tone Electronics
 P.O. Box 1738 A
 Bloomfield, N.J. 07003
 Phone: (201) 748-6171
 748-6172
 748-6173

ALL PARTS GUARANTEED

N.J. residents add 5% sales tax. Minimum order \$5.00. All orders add \$1.00 postage. Dealers write or phone for discount prices.

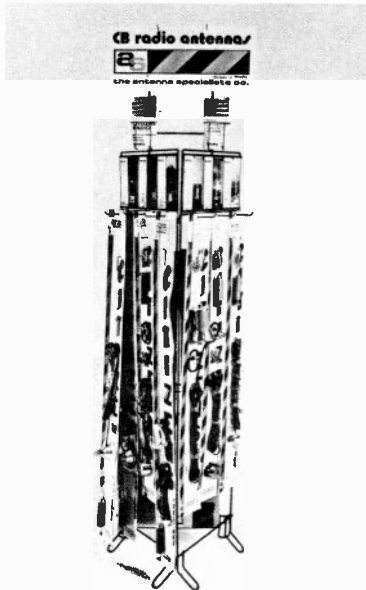

tem by using position 1 of the switch for the station antenna and position 2 for the dummy load. This provides maximum operating convenience, and allows checking of transmitter performance without illegal and annoying interference with other stations.

Rated for maximum legal CB power, Model 83-2SW also can handle a ham kilowatt (2 KW PEP, SSB), and is designed to match both 52 and 75 ohm transmission lines.

The switch is supplied with mounting nut, flat washer, and lockwasher, for either panel or cabinet mount applications. The entire switch case is metal for rugged performance, superior shielding, and low VSWR.

Frequency range is 0-108 MHz, and voltage rating is 500 V peak. The switch mates with standard PL-259-type connectors (5/8-24 thread).

The switch body and SO-239 connectors are plated with Amphenol's lustrous ASTROplate®, non-tarnishing finish.

For additional information about the new Amphenol Model 83-2SW CB switch, contact: Amphenol Connector Systems, Bunker Ramo Corporation, 33 E. Franklin Street, Danbury, Connecticut 06810.

"TOUCH/COM"

SBE's one-of-a-kind Touch/Com is a unique 23-channel transceiver in which controls for all key functions usually found on the front panel are brought out on the microphone.

Complete CB operation is now possible entirely from the microphone. Two up/down buttons on the top of the microphone control channel changing—one for advancing to higher channels, and the other for reversing to lower channels. By momentarily pressing the appropriate button, the set will "step" to each channel, up or down. By depressing the button and holding it in, the channels will continue to change rapidly. The channel readouts on the microphone are large base-station sized

... Use S9 READER SERVICE.

COM-ON WE'VE GOT IT

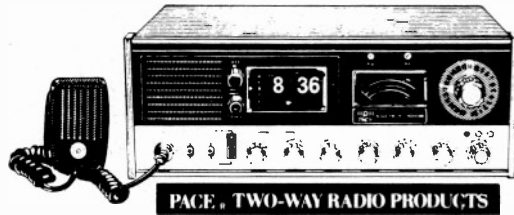

NORTH TAMPA C. B. CENTER, INC.'S.

UNITED COMMUNICATION SUPPLY CO.

Wholesale Only

HOT LINE! CALL 8A.M. to 8P.M. 813/971-1648
13748 Nebraska Avenue Tampa, Florida 33612



"THE NEXT GENERATION" SPEED RADAR DETECTOR

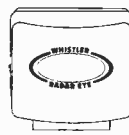

- SUPERIOR ENGINEERING IN A GOOD LOOKING PACKAGE.
- LONG RANGE / NON-FALSING / HANDS-OFF OPERATION.

FROM THE EXPERIENCED RADAR PEOPLE!

SOLID DISTRIBUTOR SUPPORT
FROM FACTORY AND NATIONWIDE SALES FORCE.

ASK TO SEE OUR
"BIG EYE"
PROFIT PLAN!

- ADVERTISING CO-OP PLAN.
- ONE-DAY FACTORY SERVICE.
- PROFIT-PRICING PLAN.
- CONTROLLED DISTRIBUTION.
- P.O.P. PACKAGING.

WHISTLER, INC. 410 GREAT RD. BOX 37
LITTLETON, MA 01460 617/486-3579
MARINE RADAR • RADAR RECEIVERS • MICROWAVE CONTROL
SYSTEMS • ELECTRONIC GAS/FIRE/INTRUSION ALARMS

Chirping CARS?

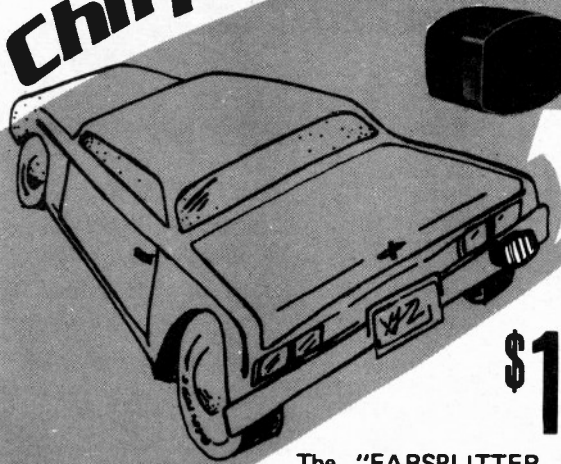

\$14⁹⁵
Postpaid

The "EARSPLITTER BIRDY" can be activated at your leisure by a switch under your dash, or controlled automatically when the car is put into reverse. Now, watch the people smile—guaranteed to attract lots of attention. Sounds like a nest of happy, chirping birds. A great safety device too!



HOUSE OF POWER

P. O. Box 306, Merrick, N.Y. 11566



Your Help Is Needed!

The Associated Humane Societies, in an effort to prevent the needless suffering of animals injured on the roads, is trying to reach CBers. A statewide network would be formed to set up emergency service whereby injured dogs, cats and wildlife can be saved from an agonizing death on the roads when there is no one available to pick them up. If you care about animals, won't you please help? For further information on this volunteer animal ambulance corps, please write Roseann Trezza, Asst. Director, the Associated Humane Societies, 124 Evergreen Ave., Newark, NJ 07114 or the Society's Monmouth County Branch located at 2960 Shafto Rd., New Shrewsbury, NJ 07724.

red LED's, polarized for easy daylight viewing. Full range volume and squelch thumbwheel controls, both fully adjustable, are located on the right side of the microphone. A push-to-talk switch is located on the left.

The Touch/Com, engineered with the famous SBE "Formula D" circuitry, includes phase-lock-loop with digital synthesis for 23-channel precise-frequency operation. The dual-conversion receiver contains an extremely selective 4-pole ceramic I.F. filter for sharp selectivity. Field Effect Transistors in the receiver RF section lead to optimum sensitivity with a low noise ratio. Receiver automatic gain control yields smooth undistorted audio under varying signal conditions. Audio tone is adjustable.

The transmitter features the maximum legal output power with peak modulation, derived from a built-in speech processor.



The transceiver is equipped with front panel controls for audio tone, public address volume, local/distance switch control, delta tune, noise limiter, "on air" transmit light, and a large illuminated combination power output/S meter.

The receiver section utilizes dual conversion which enhances selectivity and decreases adjacent channel interference.

The unit operates on either 13.8 volts direct current positive or negative ground systems.

Priced at \$289.95, the SBE "Touch/Com", identified as Model No. SBE-32CB, comes with full control microphone, mounting bracket, connecting cables, and PA speaker plug.

For further information, write SBE, Inc., Dept. S9, 220 Airport Blvd., Watsonville, CA 95076.

POWER CONVERTER

The Shakespeare GBS/3 AC Power Converter is all you need to turn your mobile CB unit into a base sta-



not garbled. You get outstanding clarity across the entire voice range, with less static and interference.

Mounted in a rugged cabinet, the GBS/5 comes complete with positioning brackets and 10' of cable. Ideal for four wheelers, 18-wheelers and vans. Perfect for boats, campers or any vehicle where normal reception is less than optimum.

"LITTLE DEVIL"

This new addition to the line of products from Anixter-Mark is designed to conveniently allow "CBers" to upgrade to a higher performance antenna such as

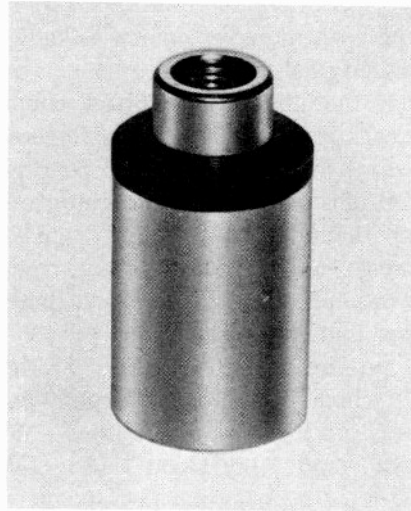

tion transceiver. Compact and easily installed, the GBS/3 is designed to convert conventional 110-115 volts AC to 11-15 volts DC. The same operating voltage found in most automobiles. Now you can enjoy CB communications in your home without the added cost of a base station transceiver.

The Shakespeare GBS/5 extension speaker makes a dramatic difference in your CB reception. Voices come through clean and clear. Easy to understand. Natural,

READER SERVICE
 WANT MORE INFORMATION ON PRODUCTS IN ADS OR ON THE COUNTERS SECTION? The handy new Reader Service Coupons below, if used properly, will get this information to you in the shortest time possible. A coupon must be filled in for each new product or advertised product of interest. The name of manufacturer must be included as well as your name, address, etc. We will forward these requests on the same day received. Send to S9 Reader Service, 14 Vanderveer Avenue, Port Washington, NY 11050.

PLEASE LIST NAME AND ADDRESS OF LOCAL CB DEALER:
 Name.....
 Address.....
 City..... State..... Zip.....

Please send me information on _____ *Page No.* _____
 Manufacturer _____
 Name _____
 Address _____
 City _____ State _____ Zip _____
 An S9 Magazine Reader Service JAN. '77

Please send me information on _____ *Page No.* _____
 Manufacturer _____
 Name _____
 Address _____
 City _____ State _____ Zip _____
 An S9 Magazine Reader Service JAN. '77

Please send me information on _____ *Page No.* _____
 Manufacturer _____
 Name _____
 Address _____
 City _____ State _____ Zip _____
 An S9 Magazine Reader Service JAN. '77

Please send me information on _____ *Page No.* _____
 Manufacturer _____
 Name _____
 Address _____
 City _____ State _____ Zip _____
 An S9 Magazine Reader Service JAN. '77

Please send me information on _____ *Page No.* _____
 Manufacturer _____
 Name _____
 Address _____
 City _____ State _____ Zip _____
 An S9 Magazine Reader Service JAN. '77

Please send me information on _____ *Page No.* _____
 Manufacturer _____
 Name _____
 Address _____
 City _____ State _____ Zip _____
 An S9 Magazine Reader Service JAN. '77

Please send me information on _____ *Page No.* _____
 Manufacturer _____
 Name _____
 Address _____
 City _____ State _____ Zip _____
 An S9 Magazine Reader Service JAN. '77

Please send me information on _____ *Page No.* _____
 Manufacturer _____
 Name _____
 Address _____
 City _____ State _____ Zip _____
 An S9 Magazine Reader Service JAN. '77

Please send me information on _____ *Page No.* _____
 Manufacturer _____
 Name _____
 Address _____
 City _____ State _____ Zip _____
 An S9 Magazine Reader Service JAN. '77

Please send me information on _____ *Page No.* _____
 Manufacturer _____
 Name _____
 Address _____
 City _____ State _____ Zip _____
 An S9 Magazine Reader Service JAN. '77

Anixter-Mark's "Heliwhip."

No new mount or cable assembly is needed with Anixter-Mark's "Little Devil" adapter. It fits almost all 5/8"-24 threaded mounts. Simply remove the base loading coil and stainless steel whip antenna from the mount and screw the "Little Devil" onto the threaded section of the mount. It is now converted to accept any 3/8" antenna including the "Heliwhip."

Contact Anixter Bros., 4711 Golf Rd., One Concourse Plaza, Skokie, IL 60076.

HEY SHIRLEY . . .

"All Ears", the latest release on Radio Shack's own Realistic label, celebrates America's fascination with citizens band two-way radio, otherwise known as "ears", with ten new original songs.

To produce the album Radio Shack commissioned a select group of professional writers, singers and musicians. The result is an exclusive CB concert in special tribute to CB fans and easy-listening music lovers.

"All Ears" includes contemporary music for every taste—pop, rock, soul and country—sung and told in the vernacular around which CB "good buddies" have built a cult of togetherness.

Featured on the album are "Hey Shirley (This is Squirrely)", which has already become popular as a single, "The Night I Talked to the Lord", "The Handles Hall of Fame", and "Hey Good Buddy (Where's My



Baby)", which are also expected to be released as singles.

Other songs on the album are: "Honey Bee (Please Answer Me)", "Come On, Come On, CB Baby", "Everybody's Somebody (In Our CB World)", "Listenin' CB Blues", "Ain't Ever Gonna Be Lonely Again", and "L.J.'s CB Radio".

"All Ears", priced at \$3.49, is available in a stereo LP or 8-track tape exclusively from Radio Shack stores and dealers, nationwide.

FIRST CLASS
Permit No. 392
Port Washington
New York

BUSINESS REPLY MAIL

No postage stamp necessary if mailed in the United States

Postage will be paid by



MAGAZINE

14 Vanderventer Avenue
Port Washington, NY 11050

FOLD HERE

FOLD HERE

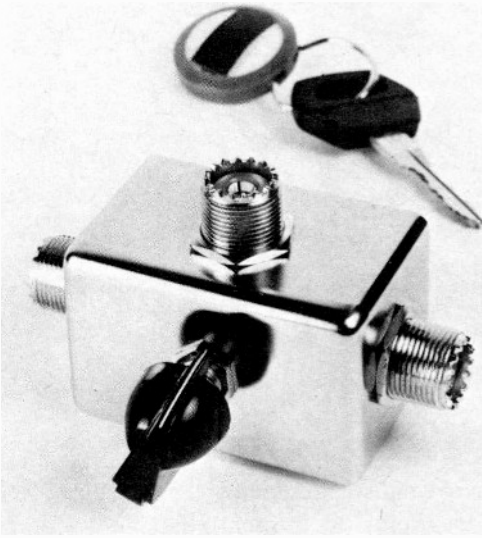

IN-DASH CB TRANSCEIVER

Royce has introduced a new combination in-dash CB transceiver and AM/FM stereo entertainment radio, all packed together into one in-dash unit. It provides for maximum security against theft.

The Model 1-614 is a space-saver, too. It's the world's smallest in-dash combination, measuring only 7" wide x 6" deep x 2" high.

The unit has several Royce design and engineering features, such as: Royce Gyro-Lock (PLL) CB oscillator, that delivers full 23-channel CB operation from only 2 crystals; AM/FM lighted slide rule tuning dial; fully variable slide-type tone control; and slide-type balance control.

And, Royce has several unique design features. The local-distant switch for FM is also an RF gain switch on CB. And the L.E.D. acts as a stereo indicator light on FM and as a transmit light on CB.

Other features include: large $1\frac{1}{8}$ " x $\frac{3}{8}$ " CB meter which measures output power and receiver input signal strength; pushbutton automatic noise eliminator to reduce static and ignition noise on CB; fully variable squelch control to silence CB receiver between calls; pushbutton AM/FM model switch; pushbutton CB/entertainment radio switch; full-size, plug-in mike; adjustable shafts with non-disengage shaft controls; deluxe CB dual conversion receiver with ceramic filter for razor-sharp selectivity; intergrated circuit audio stage; separate antenna inputs for CB and AM/FM radio reception; reliable relay CB transmit-receive switching; AM/FM antenna peaking control; and universal trim plate, which matches decor of most cars.

For more information, contact Royce Electronics Corporation, 1746 Levee Road, North Kansas City, Missouri 64116.

MOBILE ANTENNA COMPARISON BROCHURE

Emphasizing the importance of the antenna to good CB communications performance, a new brochure compares the quality differences between an Avanti Racer

27 base loaded mobile antenna and a typical imported base loaded antenna. Full-color cut-away photographs with call-out descriptions of each component illustrate and explain the importance of each feature to satisfactory CB performance. The brochure also illustrates and describes other Avanti mobile antennas including the Fazer co-phased dual antenna system. AVANTI RESEARCH & DEVELOPMENT, Inc., 340 Stewart Ave., Addison, IL 60101.

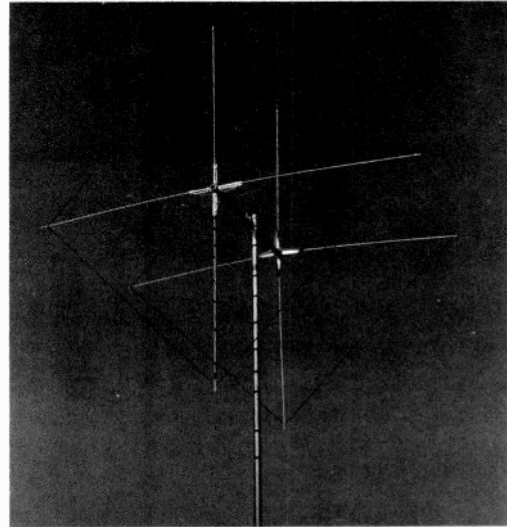

BASE STATION ANTENNA

Signal Engineering located in Los Altos California, recently introduced the first of a product line of high-performance CB antennas. Its Sky Hawk model is a two element quad-type beam for base station or portable use. Outstanding features of this antenna are high forward gain and excellent directivity along with light weight and low wind resistance.

The antenna is designed to allow stations to communicate point-to-point more efficiently on a crowded channel by reducing interference from other stations on receive, and by increasing the effective radiated power by a factor of ten on transmit.

The pattern from the antenna is uni-directional, having a major "lobe" about 35 degrees wide off the front where the gain is greater than 10 db over a quarter-wave ground plane on both transmit and receive. In addition, a very deep null of greater than 32 db is present off the back side, and somewhat lesser nulls off the sides. No matching adjustments are required.

The Sky Hawk weighs 8 lbs. and can be rotated by a light-duty TV rotator. It is designed to accept masts up to 2 inches in diameter. Construction is of lightweight aluminum frame members in conjunction with solid fiberglass spreader arms. Wind survivability is rated at 100 mph.

Availability of the Sky Hawk is immediate from Signal Engineering and it will soon be available from dealers throughout the U.S. and Canada. Suggested retail price is \$62.95. Dealer inquiries are invited.

For further information please do not hesitate to contact Signal Engineering at 1354 Greenwich St., San Francisco, Calif. 94109.

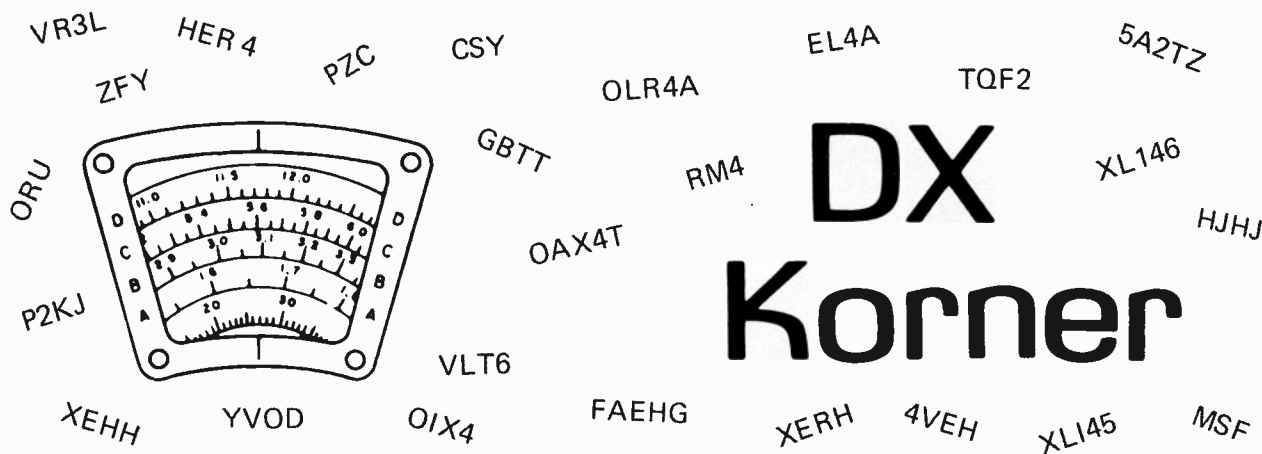

Send SWL reports to:

Don Jensen
c/o CB Radio/S9 Magazine
14 Vanderventer Ave.
Port Washington, NY 11050

SWLs, like most Norte Americanos, tend to think of Latin America as being right next door.

Like many other images of that part of our globe, it is only partially correct.

Yes, Mexico, Cuba and the Central American republics are our southern neighbors. But Latin America also includes countries like Argentina, Brazil and Chile, perhaps more distant than we think.

New York, for example, is closer to Moscow than it is to Rio. From San Francisco it is nearly 6,000 miles to Santiago, Chile, and only 5,100 miles to Tokyo. A beeline from Chicago to Istanbul is shorter than one between the Windy City and Buenos Aires.

In the common stereotype, a Latin American country is purely Spanish in flavor and language. Yet the largest country in South America, Brazil is a Portuguese-speaking nation. In French Guiana, Guyana and Surinam French, English and Dutch, respectively, are the prominent languages. There are native born citizens in the southern tier of South American nations to whom German, Italian, even Japanese, are their first language. Add to these the creole tongues and the Indian dialects of the jungles and altiplano and the lie is put to the notion of Spanish-only.

On the shortwave bands there is no typical sound of music from Latin America. The Argentine tango, the Mexican mariachi, the Peruvian huayno are no more alike than Beethoven and the Beatles.

What all this means is that, when it comes to DXing the shortwave stations of Central and South America, there is a tremendous variety awaiting you. And as in the past several months I have focused on specific stations you can hear from Europe and Africa, this month's DX Korner spotlight has Latin America in its beam.

I'm afraid that beginning SWLs tend to shy away from tuning the stations of Central and South America.

First of all, while there are literally hundreds of stations to be heard on shortwave, only a relatively

few have English language transmissions. And novice DXers are a bit slow in facing the challenge of listening to programs aired in languages other than English, notably Spanish and Portuguese.

Secondly, the majority of the Latin American SW outlets operate on the Tropical Bands, the lower short-wave frequencies below 6 MHz. With reception generally limited to the hours of darkness, higher static (QRN) levels typically, and, in short, tougher reception factors using less sophisticated receivers, newer SWLs don't flock to the low frequency SW bands.

But if you are bold enough to at least try your hand at DXing some Spanish and Portuguese language programs, are willing to battle the more crowded band conditions and hunt for weaker signals than the powerful European broadcasters push out, there is much listening excitement awaiting!

Some tips on stations to hear from Latin America? Sure, here are some you can track down on shortwave from south of the border. Some programs are in English—but not many. Some stations are ultra easy catches, others may be found if you exercise patience and care in tuning and listening. A few will be tough enough to challenge even the most experienced DXer.

Almost as certain as death, taxes and the fact that H. Cosell will turn up on the tube every Monday night, is the likelihood that the first South American station you will hear is HCJB, the Voice of the Andes, in Quito, Ecuador.

HCJB, a missionary religious station, has been on the air from the Ecuadorian capital since the 1030's. It was the very first SW station your DX Korner editor tuned back in 1947, hence it has a special place in my heart and memories. Signals are powerful and there are English language programs aplenty. From right after the supper hour on the east coast to the witching hour in California, you should find HCJB pounding through on 9560 kHz. During the early part of the evening you can also try 11915 kHz, during the latter portion, up until 0700 GMT, 6095 kHz is a possibility.

Also with an English schedule is the governmental station in Buenos Aires Argentina. RAE—meaning Radiodifusora Argentina al Exterior, Argentine radio to foreign countries—airs English programs Mondays through

Fridays at 2300 GMT on 11710 kHz, and on Tuesdays through Saturdays 9690 kHz at 0300 and 0600 GMT.

In the harder-to-hear category, but with a half hour of English at 0130 GMT Mondays, is La Cruz del Sur, Southern Cross Radio in La Paz, Bolivia. Its frequency is 4875 kHz. On other days at different times you may find this one with Spanish programming. As with all foreign language shortwave programming, listen carefully for station identifications.

For Brazilians, don't shy away from Portuguese programming. The late afternoon and early evening period seems to be best. Several to watch for are Radio Brasil Central, reported by SWLs on both 4985 and 11815 kHz; Radio Tupi on 6095 kHz; Radio Globo on 11805 kHz; Radio Clube de Pernambuco on 11865 kHz and Radio Bandeirantes, 11925 kHz.

The strongest of the Columbian stations and, because of its out-of-the-way frequency the easiest to find, is Radio Sutatenza. Though owned by a Roman Catholic agency, its programming is not typically religious in tone. It uses two frequencies above the 60 meter band. If you don't find it on 5075 kHz, tune up 20 to 5095 kHz.

There are a number of Peruvian SW outlets. Depending on the night there are a number that could be dominant. One that often does a nice job is Radio Andina, 4996 kHz, located at Huancayo. One reason I suggest this one is because you'll commonly hear typically Andean music which you'll quickly peg as the

origin of the sound of Simon and Garfunkel's "El Condor Pasa."

There are a string of Venezuelan stations between 4800 and 5000 kHz, all rather easily heard during evening hours, mostly featuring popular Latin rhythms and Spanish announcements. They include Radio Lara, 4800; Radio Popular, 4810; Radio Maracaibo, 4860; Radio Universo, 4880; Radio Juventud, 4900; Radio Rumbos, 4970 and Ecos del Torbes, 4980 kHz.

Cuba? How can you miss this one. Radio Havana Cuba sometimes seems to be everywhere, all the time. If you haven't been everywhere yet, take a look on 11930 kHz between 0100 and 0430 GMT. You'll find English programming.

Zip, zip, zip . . . three countries, three religious type stations, each with English programming. For Costa Rica it is TIFC, Faro del Caribe or the Radio Lighthouse of the Caribbean at 0300 GMT on 6035 or 9645 kHz. The Guatemalan entry is TGNA, Radio Cultural on 3300 kHz. Try after 0400 GMT. And, in Honduras the station is La Voz Evangelica, HRVC, Tegucigalpa on 4820 kHz at 0330 GMT.

Now to a French speaking station somewhat harder to hear than most of those mentioned above. It is France Region 3, broadcasting from Fort de France on the island of Martinique in the West Indies. Listen to 3315 kHz. The station leaves the air at 0400 GMT.

There are, as I noted, hundreds and hundreds more

CB RADIOS

Dealers Needed

*The New Source
of Supply you've
Been looking for*

We're a New Factory Direct Distributor, carrying the Complete Regency Line and 48 Other Major Lines. We offer quick courteous service and are well stocked. Please your wallet with our prices and your customers with fast delivery. We are looking forward to serving you. Our goal is to help you build your business.

ACCESSORIES

STEREOS



CR-123B



ACT-E 8 H/U



CR-185

POPLAR ELECTRONICS

5030 Poplar Level Road - Louisville, Kentucky 40219

Phone: 502-966-2106

CHARTER MEMBER
CEEA
COMMUNICATIONS EQUIPMENT
DISTRIBUTORS ASSOCIATION

ANTENNAS

CB BUMPER STICKERS

Now CBers can tell the world that they are CBers and proud of the fact. The new S9 bumper stickers come in a variety of slogans.

The bumper stickers are available in the following slogans:

- (1) CBers Do It Better
- (2) CB RADIO SAVES LIVES
- (3) EMERGENCY CB 2 WAY RADIO
- (4) MONITOR 9—CB RADIO

Price is \$1.00 each or 3 stickers for \$2.00. Add 25 cents on all orders for postage and handling. Dealers—we can accept large orders for resale. Write for dealer prices.

Send all orders to:

S9

Bumper Sticker

14 Vanderventer Avenue
Port Washington, NY 11050

TELL THE WORLD YOUR CHANNEL!



WITH A CHANNELTAG™

Identify your channel at a glance to other "Good Buddies" with this 2 x 7½ inch highly reflective metallic sticker. The CHANNELTAG is easily visible day or night on your window or bumper. It is made of the finest weather resistant material with an adhesive backing. Our designs feature bold letters on your choice of a red, white, or blue background. Choose your favorite channel or channels from 1 to 23 and order today!

(Dealer Inquiries Welcome)

CHANNELTAG™		P. O. BOX 4196 MALIBU, CALIFORNIA 90265	
\$150 each or three for \$400			
available in channel numbers 1 thru 23			
PLEASE SEND ME:			
<input type="checkbox"/>	<input type="checkbox"/>	NAME _____	
QTY.	CHANNEL NUMBER(S)	ADDRESS _____	
<input type="checkbox"/>	<input type="checkbox"/>	CITY _____ STATE _____ ZIP _____	
RED	WHT	BLU	CHECK M.O.

to hear from Latin America. There's no way I can list even a small proportion of them. But let me toss out one final tip for atruly exotic—and of late, not too difficult—catch on SW. It is La Voz de Galapagos, on 4810 kHz, broadcasting from Isla de San Cristobal, one of the Ecuadorian-owned Galapagos Islands far out in the Pacific. As DX it's a dandy!

VOLMET KEEPS 'EM FLYING

It isn't too often that I manage to squeeze a bit of information into DX Korner about the shortwave utility stations. Ute DXing is a fascinating aspect of the listening hobby, though it probably is not as well known as shortwave broadcast band station monitoring (SWBC).

Time for a bit of a review? Okay. Shortwave broadcast stations are those which air program type material, including music, news, commentaries, entertainment, propaganda and so forth, to a general radio audience.

The utility stations, on the other hand, are everything that SWBC is not. These transmitting operations are not looking for you, the listener. They have specific communications purposes. Some are used in ship-to-shore communications, some by the military, some stations carry point-to-point traffic between fixed stations. The utility stations make use of various transmission modes, amplitude modulation (AM), continuous wave Morse code (CW), and in great numbers, single sideband (SSB) transmissions.

One specific type of station I want to mention this time around is the VOLMET type. These stations operate in the aeronautical service and they regularly broadcast weather information and flight conditions to pilots.

VOLMET stations on the same flight routes usually operate on the same frequencies but at different times during each hour. On 5519 kHz, for example, you'll find VOLMET transmissions from stations at Oakland, CA; Tokyo; Hong Kong; Honolulu and Anchorage, Alaska. The same network of stations use 2980, 8903 and 13344 kHz.

Each station transmits weather data for a five minute period each half hour. Oakland is heard at 5 and 35 minutes past the hour; Tokyo at 10 and 40 minutes after each hour; Hong Kong at H+15 and H+45; Honolulu at H+20 and H+50; and Anchorage at H+25 and H+55.

The VOLMET operation at Gander, Canada, is widely heard with weather 'casts on 3001, 5652, 8868 and 13272 kHz at 20 and 50 minutes after each hour. Try also New York Radio on the hour and half hour.

Or listen for Shannon Aeradio's VOLMET airings, also on the hour and half hour on 5533, 8833 or 13312 kHz.

Harder to hear, but worth looking for are VOLMET stations in Sydney, Australia; Algiers, Algeria; Tel Aviv, Israel; Kano, Nigeria; Bangkok, Thailand; Dakar, Senegal and Singapore, to name a few. *(continued)*

You Asked For It
 You Got It ... **Announcing The UTAC Design**
A CB Transceiver Contest

This is the first opportunity known for you the public to help design a CB transceiver with the features you need and want to see on your UTAC COMMUNICATIONS EQUIPMENT.

INSTRUCTIONS: Check the box for the features you would like to have. There are two units. (A) Standard Model. (B) Deluxe Model. Both units are mobile type.

- | (A) | (B) | |
|--------------------------|--------------------------|--|
| <input type="checkbox"/> | <input type="checkbox"/> | Phase Lock Loop Circuitry
or |
| <input type="checkbox"/> | <input type="checkbox"/> | Crystal Controlled Transmit/Receive |
| <input type="checkbox"/> | <input type="checkbox"/> | Digital Readout Channel Indicator
or |
| <input type="checkbox"/> | <input type="checkbox"/> | Variable Squelch Control |
| <input type="checkbox"/> | <input type="checkbox"/> | Variable Microphone Gain Control |
| <input type="checkbox"/> | <input type="checkbox"/> | Variable RF Gain Control |
| <input type="checkbox"/> | <input type="checkbox"/> | Noise Blanker Switch |
| <input type="checkbox"/> | <input type="checkbox"/> | Automatic Noise Limiter Switch |
| <input type="checkbox"/> | <input type="checkbox"/> | CB or PA Position Switch |
| <input type="checkbox"/> | <input type="checkbox"/> | Delta Tune Switch |
| <input type="checkbox"/> | <input type="checkbox"/> | Two Channel VHF Monitor Position Switch |
| <input type="checkbox"/> | <input type="checkbox"/> | External PA Speaker Jack |
| <input type="checkbox"/> | <input type="checkbox"/> | Remote Speaker Jack |
| <input type="checkbox"/> | <input type="checkbox"/> | Combination SWR/RF Power Meter |
| <input type="checkbox"/> | <input type="checkbox"/> | Fuse Protected 13.8 vdc/Positive/Negative Ground Operation |
| <input type="checkbox"/> | <input type="checkbox"/> | Exclusive Circuitry and Styling |

Mail your completed entry with your name, address, and telephone number to:

UTAC COMMUNICATIONS (Att.: Karen)
 766 Lakefield Road
 Westlake Village, California 91361

Name _____
 Address _____
 City _____ State _____ Zip _____
 Telephone _____

Contest winners will be announced at PC/77 Show, February 1977. Winners names will be published in S9 Magazine.

First Prize: New Utac Deluxe Mobile CB
Second Prize: New Utac Standard Mobile CB and
Fifty other prizes awarded

Employees/Families are not eligible.

Contest ends January 15, 1977

TAB POPULAR CB BOOKS

- **CB Radio Operators Guide - 2nd Edition**
Tells what CB is, how it is used, how to buy and install equipment — PLUS Part 95, the FCC rules regulating CB. 256 pps
Order No. 799
Paper \$5.95 Hardbound \$8.95

- **Practical CB Radio Troubleshooting & Repair**
Complete details on CB operation, installation and repair, including 21 programmed troubleshooting charts and complete schematics for 18 popular transceivers. Also an in-depth section on antennas and feedlines. 238 pps.
Order No. 754
Paper \$5.95 Hardbound \$8.95

- **Pictorial Guide to CB Radio Installation & Repair**
Step-by-step guide to car and base systems installation and basic maintenance. 256 pps.
Order No. 683
Paper \$5.95 Hardbound \$8.95

- **Citizens Band Radio Service Manual**
All-in-one troubleshooting and maintenance guide for all types of CB sets, including a 36-page schematic foldout section. Step-by-step repair procedures and trouble-analysis charts. 192pps.
Order No. 581
Paper \$5.95 Hardbound \$8.95

----- ORDER FORM -----

S9 Magazine
14 Vanderventer Ave.
Port Washington, N.Y. 11050

Ship the books listed below. To cover shipping, I've added 50¢ for the first book and 25¢ for each additional book. Enclosed \$ _____.

No.	Price	Name _____
___	___	Address _____
___	___	City _____ State _____ Zip _____

DX KORNER (continued)

A LOOK AT THE MAIL

I'm always looking to hear from you because I'd like to know, and pass along to other readers, what you're hearing, what's new for you in DXing. Also I try to work in a few questions, when possible, and dig up the answers to those DX queries. If you have a good snapshot of you and your DXing set up, send it along to DX Korner and I'll see if I can get it in print on these pages. Sorry, I can't return any of the photos. Please identify any of the gear shown in the photograph. If there is one thing other DXers enjoy seeing and reading about is another person's DXing equipment.

Right on top this month is a letter from Greg A. Watts of Plainfield IN. Back home again in Indiana, Greg says he's hearing the West German station, Deutsche Welle (the Voice of Germany) relaying its transmissions from a powerful transmitter at Kigali in the central African country of Rwanda. Greg says to listen in between 0330 and 0530 GMT on 7225 kHz.

Greg, who has been DXing for about six years, also has a few addresses for QSL hunters who wish to send reception reports to stations they hear.

The African outlet, La Voix du Zaire has a mailing address of Boite Postale 3171, Kinshasa, Gombe, Zaire. You may hear this one in French programming around 1900 to 2030 GMT on 15245 or 15350, Greg reports.

Radio Budapest (heard evenings, 9833 kHz), he adds, can be reached by writing Radio Budapest, 1800 Budapest, Hungary.

Fourteen-year-old Herman J. Fuselier Jr. of Opelousas, LA, says he has given up CBin because of "channel hogs" and CB "disc jockey freaks," and has turned to SWLing. He has logged stations in about 40 countries on SW.

Among his recent loggings, Herman notes, is one of the Latin stations I mentioned earlier in this DX Korner go-around, RAE, Buenos Aires.

"RAE was heard on 9690 kHz at around 0610 GMT with Argentine Folk Music, and announcements in English," Herman reports.

Lee Hanson, Bremmerton, WA, writes with a question about a European outlet he has been looking for without success.

"I'd like to be able to hear Radio Norway," Lee says. "Being of Norwegian descent there's a bit of the recapturing of my ethnic background in this request. But, unfortunately I don't know any of the Norwegian language. Can you help?"

Sure, Lee, from one Scandinavian to another, listen for Radio Norway's English language half hour on Sunday at 1400, 1600, 1800 or 2200 GMT on 15175 kHz, or Monday at 0000, 0200, or 0400 GMT on 9645 kHz, or 11870 kHz at 0600 GMT.

Until next month, I'll be looking forward to hearing from YOU!



The Monitor Post

by Rick Maslau, KNY2GL

"SEAGOING" RADIOTELEPHONE

Full 25-watt power output—plus superb receiver sensitivity—is available on all twelve VHF FM marine channels with SBE's Del Mar radiotelephone, identified as Model SB-M225. In addition, there is a choice of two ESSA weather channels on the unit.

This powerful marine radiotelephone is housed in a weather-proof package about the same size as one of the hard-cover U.S. Coast Guard Light Lists—only eight inches wide, nine inches deep and two-and-three-quarters inches high. Thus it can easily fit any kind of boat.

Handy front-panel controls include adjustable squelch and adjustable volume, ESSA weather selector switch, power output selector switch (choice of 1 watt or 25 watts) and illuminated rotary channel selector. Neoprene gaskets seal out spray, moisture and dust; and tough, vinyl coatings protect the unit from the corrosive effects of marine weather. Its rugged construction, together with its all solid-state circuitry, provide years of reliable communications under every kind of adverse sea and weather condition.

The SBE Del Mar comes with an SBE dynamic microphone, coil cord and plug. A mounting bracket of corrosion-resistant heavy-duty metal holds the radio securely in any position, yet permits easy removal for maintenance or storage.

For complete information on the Del Mar, write, SBE, Inc., Dept. P., 220 Airport Blvd., Watsonville, California 95076.

RUGGED PAGERS

Motorola's recently introduced METRX paging line heralds the new shape and size of today's contemporary styling. In addition, this dual-function alert, tone-only pager is extremely rugged to assure continuous operation in rough environments.

The new pager utilizes customer Large Scale Integrated Circuits (LSI) and a combination of discrete components and Dual-In-Line Packaging (DIP) techniques. This results in extreme reliability, while achieving the small size and ruggedness available in this economically serviceable package.

Using two separate tones, messages from two different locations may be received by the user, increasing the versatility and efficiency of the paging system. The coding system consists of a preamble and six sequential tones and provides a maximum address capability of 1,000,000 codes, each with the dual-function capability.

Other features include the Mem-o-Lert deferred paging memory; inexpensive standard AA penlight cell operation; an electronic extended battery life circuit for up to six months use per battery; a unique battery replacement method; a battery condition indicator and various colored housings.

For further information, write Barbara Bennett, Marketing Services, Motorola Communications and Electronics, Inc., 1301 E. Algonquin Road, Schaumburg, Illinois 60196.

(continued)

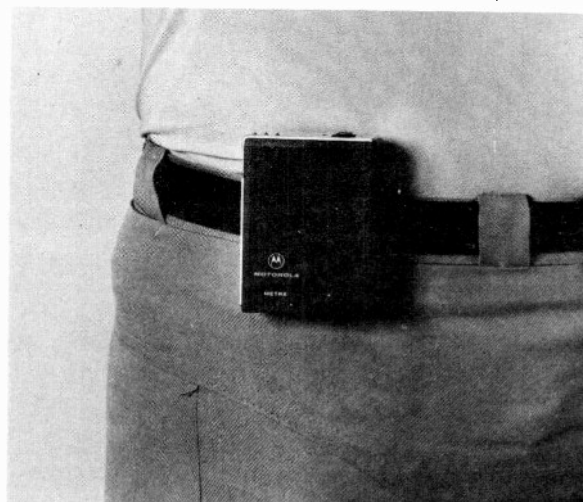
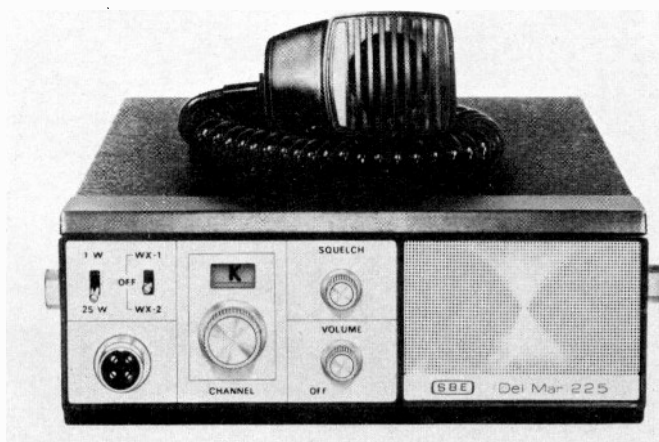

HOW ABOUT THAT

Vol. 1, No. 1

July, 1962

S9

the citizens band journal

S. R. COWAN, PUBLISHER

300 West 43rd Street

New York 36, N. Y.

CB

MAGAZINE

MARCH 1964

VOLUME 1 NUMBER 1

PUBLISHED MONTHLY, ON BEHALF OF THE CITIZENS
BAND RADIO USERS OF THE UNITED STATES AND
THE WESTERN HEMISPHERE, BY COMMUNICATIONS
PUBLISHING CORPORATION,

In their latest advertising, CB Magazine claims to be the oldest, most widely read magazine in the CB radio market.

The evidence is quite clear that S9 was on the scene almost two full years earlier.

HOW ABOUT THAT!

CB Magazine's advertising also claims the largest circulation and best cost per thousand.

HOW ABOUT THAT?

THE MONITOR POST (continued)

UHF MAXAR INTRODUCED

Motorola Communications and Electronics Inc., has expanded its MAXAR Mobile Radio line with the introduction of the new MAXAR Two-Way Mobile Radio. This new radio is the smallest, lightest, most powerful, low-priced UHF mobile radio ever offered by Motorola.

Featuring modern, low-profile styling, the new UHF MAXAR Mobile Radio's standard full 15 watts of RF power assures effective two-way communications coverage over a large geographic area. Other standard features include a 100% solid state receiver/transmitter, single layer modular construction, easy metering accessibility and repeater talk-around.

Like the high band MAXAR, the new addition to the line can be mounted almost anywhere—in practically any type of vehicle. The unit's escutcheon can be ordered with standard or inverted graphics depending on where the customer plans to mount it. This guarantees that operator convenience need never be compromised because of mounting restrictions.

An external metering socket permits all FCC required maintenance checks from a single connector without removing the unit from its mounting. However, if necessary, the radio can be removed from its housing without removing any screws or pins. The chassis simply slides out from the back of the housing once the unit is removed from its mounting.

Human engineered for safety and ease of operation, the MAXAR radio features a sleek "no-edge" molded housing. Made of cyclac, the same material used in crash helmets, the housing provides maximum durability.

The UHF MAXAR Two-Way Mobile Radio has the versatility to serve as either a mobile or base station radio. A mobile can be removed from a vehicle and directly substituted for a control station. These radios are part of a complete line of Motorola low-cost, high quality radios aimed at cost conscious customers in all commercial markets, such as agriculture, taxi, industrial, hotel/motel and others. For many customer applications, another important feature of the MAXAR radio is that it can be utilized as a paging central when incorporated with a Motorola paging encoder and at the same time, serve as a base station. This dual and triple role that the MAXAR radio can play adds to the overall economy and capability of the radio.

Popular options include: two channel capability; "QUIK-CALL II" selective signaling; "PRIVATE-LINE" tone-coded squelch; and "DIGITAL PRIVATE-LINE" coded squelch.

NEW BUSINESS RADIO

A new 25 watt transceiver with 6-channel capability was introduced by PACE Landmaster Two-Way Radios. The PACE BI 4025 can be operated either simplex or semi-duplex. It has a channel spread on transmit of 5.5 MHz, without loss of power, which adds flexibility to the system by permitting direct mobile-to-mobile as well as mobile-to-base communications. (continued)

... Use S9 READER SERVICE.

HAVE YOU MADE CONTACT WITH THE



STAFFERS

"ON THE CHANNELS?"

NAME	HANDLE	PRIMARY CHANNELS
Tom Kneitel	Tomcat SSB13, KW146 CL173	10, 12, 19 16L, 18U
Karen Fusco	One Duster LIS813	13 16L, 18U
Lori Ressa	Loreli	12, 19
S.R. Cowan	Gramps	19
Richard Cowan	Trainman	13, 16L, 19
Cary Cowan	Green Dragon Sleeping Beauty	12, 17, 19
Marc Gilman	Deacon CL134, KW339 SSB30	12 16L
Gordon West	California Dreamer	9, 16L
Gary Deckelnick	Baby Bull	7, 19
Bill Sanders	SSB295, CL11849 KW5304	16L, 18U
Hal Keith	Flasher	12
Pat Hartman	Six Pack	4
S9 Office Station	Deadline Base KW4405 SSB250	8 16L, 18U

HOW 'BOUT IT? GIVE US A SHOUT!



Electronic Fleamarket

*a new monthly publication
from the publisher of S9*

THE ELECTRONIC FLEAMARKET is a complete new shopping source for anyone interested in buying, selling or swapping used electronic equipment of any kind.

It will appeal to CBers, hams, experimenters and professionals.

THE ELECTRONIC FLEAMARKET will contain thousands of classified ads on transmitters, receivers, transceivers, test equipment, amplifiers, antennas, towers, stereo equipment, etc.

It will also contain ads from retailers, wholesalers, and manufacturers offering used equipment for sale.

Classified ads will be published free of charge to all regular subscribers of S9. Free ads will be limited exclusively to individuals. Commercial ads may be ordered at a rate of 25 cents per word, with a \$3 minimum. Non-commercial ads for non-subscribers are 10 cents per word, \$1 minimum. THE ELECTRONIC FLEAMARKET will be available on a paid subscription basis only at a cost of \$10 per year. All issues will be mailed by first class mail on the tenth of each month.

SPECIAL CHARTER SUBSCRIPTION rates available to S9 subscribers at a saving of 20%. Use the special sub blank below and get your first year's subscription for just \$8. But don't delay!



ELECTRONIC FLEAMARKET
14 Vanderventer Avenue
Port Washington, NY 11050

Please enroll me as a charter subscriber to

"ELECTRONIC FLEAMARKET" at the rate of \$8.00

Name _____

Address _____

City _____

State _____ Zip _____

THE MONITOR POST (continued)

The Pace BI 4025 is a high performance UHF/FM mobile transceiver designed for simple operation and easy maintenance. Standard features include 6-channel capability, provision for optional tone coded squelch, a seven segment LED (light emitting diode) digital channel readout, a separate speaker for individual placement, full 25 watt of RF power output, 5 watts of audio output, and performance specifications to match those found in more expensive radios.

A full range of accessories which include tone coded squelch, antennas, and add-on power amplifiers extends the versatility of this transceiver.

The unit is easily adapted to control station operation with the use of a matching power supply and optional desk-top microphone.

For further details contact Business Radio Marketing Manager, PACE Landmaster Products, PATHCOM INC., 24049 South Frampton Avenue, Harbor City, CA 90710.

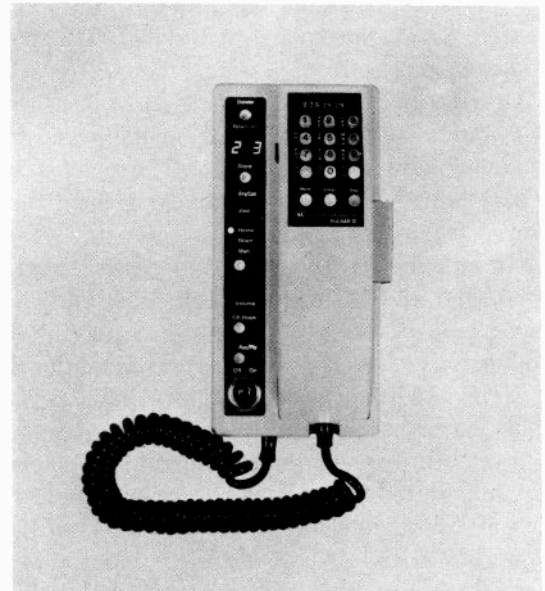

MOBILE TELEPHONE CONTROL HEAD

New during this year's USITA National Convention is Motorola's Microprocessor Controlled Pulsar II Mobile Telephone Control Head.

The deluxe version of the Pulsar II control head allows a subscriber to have abbreviated dialing for up to ten numbers. These ten numbers are selected and programmed by the subscriber from the dial pad and can be easily changed. The underside of the hand set contains a handy reference directory to identify the stored numbers and their memory location digit.

The new unit features push button dialing which allows the subscriber maximum ease and speed of dialing. The Push Button Pad is conveniently located on the back of the handset allowing the subscriber to dial the phone number in complete safety and with one hand.

On Hook Dialing allows a telephone number to be entered from the dial pad with the handset in the

cradle and will hold the number in the microprocessor. When the subscriber wishes to place the call, he obtains dial tone and by pressing the "SND" button initiates the dialing.

If the dialed number cannot be completed for any reason and the subscriber wants to try again, the last dialed number is held in the microprocessor (until replaced by another number). This number can be easily redialed by obtaining dial tone and depressing the "SND" button to re-initiate the call.

The most compact and versatile unit available, the Pulsar II control head contains an L.E.D. channel number display to identify the particular channel being sequenced in the manual mode or to review the channels programmed in the Roam or Home mode of operation.

Both the key pad and control panel graphics are softly illuminated for user convenience at night. When the unit is activated an electronic ringer provides a pleasant call alert with sufficient volume to be heard even in high ambient noise environments.

If the subscriber removes the hand set from the cradle or pushes the "Off-Hook" button and the channels are occupied the busy light will provide visual indication of the condition along with a busy tone in the hand set.

The Pulsar II features Home, Roam, and Manual modes of operation.

In the Home mode the radio scans and selects only those channels available in the Home city. These channels are Hardwire programmed in the radio and prevent the radio from locking on a foreign unwanted channel.

In the Roam mode the subscriber selects the channels to be scanned in the city (other than Home city), where he is operating. This selection can be simply changed as the subscriber travels from city to city.

The Manual mode is used in systems where automation does not exist. The subscriber individually selects an open channel to contact the mobile operator. The control head can be programmed to scan the desired channels while on hook.

SCANNERS BECOMING POPULAR WITH RURAL FIRE DEPARTMENTS

An increased use of scanning monitors by fire departments in small towns and cities throughout the country was reported by the RCA Distributor and Special Products Division.

In a survey of recent purchases, RCA reported that a fire department in Whitefish, Montana has bought 20 scanning monitors while another fire company in Wiscasset, Maine has purchased 11 units. Other scanners are being used by fire fighters in Markleville, Ind., Lakewood, N.J., Auburn, Wash., and Kingston, Pa.

Fire Chief Gordon Merry of Wiscasset, Maine states that scanning monitors enable members of his department to keep in contact with all local fire, police and

Free Classified Ads

Your classified ad may be run Free of Charge in *THE ELECTRONIC FLEAMARKET* — this offer is good for all S9 and/or Fleamarket subscribers every month. Please limit ads to thirty words or six lines and not more than two ads per month. You can buy, sell, swap or advertise for QSLs. Your ad may cover ham gear, CB gear, test equipment, stereo, or anything else an electronic hobbyist may find of interest.

Remember, this service is absolutely *free* to subscribers who use the coupon below (or a reasonable facsimile thereof). *THE ELECTRONIC FLEAMARKET* will be read by thousands of electronic hobbyists, so don't miss out.

After all, could the price be better?

ELECTRONIC FLEAMARKET

14 Vanderventer Avenue
Port Washington, NY 11050

Please run the classified ad listed below in the first available issue:

Name _____

Address _____

City _____

State _____ Zip _____

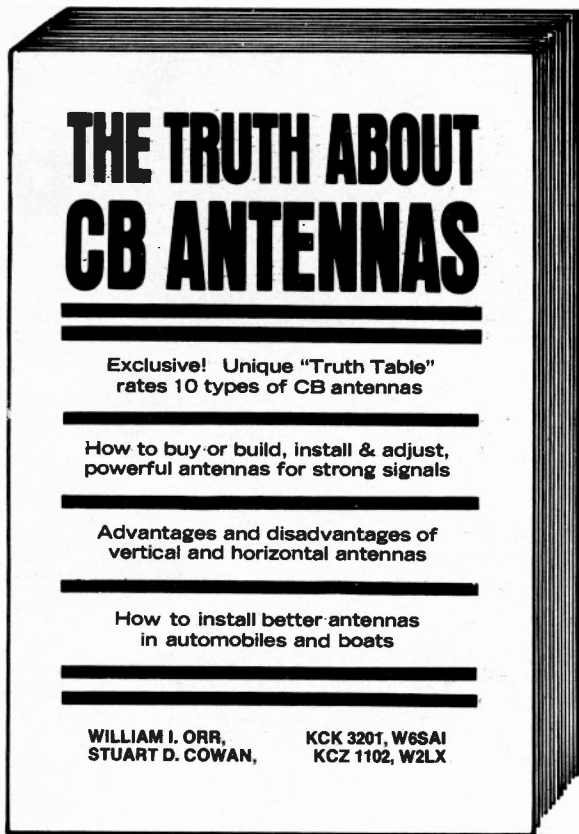

*New
Handbook
Reveals*

**THE
TRUTH
ABOUT
CB ANTENNAS**

\$4.95

*(postpaid)

- * Exclusive "Truth Table" gives actual Db gain from 10 types of CB antennas.
- * 240 pages — 146 illustrations — 18 chapters.
- * "A great CB Antenna Handbook!" George R. Wood, KBI-3274 - W1SR, RCA.

Your CB antenna is the key to clear, reliable communications. Most CB antennas are improperly installed and adjusted. They do not work anywhere near peak efficiency. Moreover, to impress buyers a barrage of non-facts about inferior antennas is

used by some antenna manufacturers to gain quick sales. Now, for the first time, this new Antenna Handbook exposes false claims and gives you a unique "Truth Table" so you can determine for yourself the true power gain of any CB antennas!

Book Division, Cowan Publishing Corp.
14 Vanderverter Avenue
Port Washington, N.Y. 11050

- Check
- Money Order

Sirs:

Please send me.....copies of **THE TRUTH ABOUT CB ANTENNAS**

Name _____ (Please Print Clearly)

Street Address _____

City _____ State _____ Zip _____

* Residents of N. Y. State include appropriate Sales Tax

ambulance calls. He says the scanners have helped on three recent emergencies when calls for an ambulance came in on the wrong frequency. If it had not been for the scanners, he explained, the calls would have been missed.

Chief Merry reports that the scanners cover a range of 25 miles with an antenna on a truck or car.

Aside from their use by fire departments, scanning monitors have been sold for a variety of other applications.

The news director of a radio station in Joplin, Missouri uses a 10-channel scanner to uncover local stories as emergency calls are being reported. His unit is kept tuned to fire, police and ambulance frequencies as well as ones of the highway patrol and sheriff's office.

EXPERIMENTALS OF INTEREST

KS2XIG, RCA CORPORATION, Cherry Hill, New Jersey. Mobile experimental research station to operate on 121.6, 121.7, 121.8, 121.9 and 122.2 MHz for demonstration of aviation weather radar equipment at air shows throughout the United States.

KS2XIH, ANTENNA RESEARCH ASSOCIATES, INC. Beltsville, Maryland. Fixed experimental research station to operate on 2104.9, 8650.0, 12889.5, 16909.7 and 22527.0 kHz to conduct experimentation required by a contract with the U.S. Government.

KS2XII, CARDION ELECTRONICS, Woodbury, New York. Experimental developmental station to demonstrate equipment for sales purposes using frequencies specified in Part 94 of the Commission's Rules:

KS2XIL, RCA CORPORATION, Cherry Hill, New Jersey. Mobile experimental developmental station to operate on 30.84 MHz for research and development of radio equipment for use in licensed services.

HOUSTON ADDED TO PROTECTION AREAS

The FCC has amended its maritime services rules by adding the Port of Houston to the designated radio protection areas for Vessel Traffic Services (VTS) purposes and assigning the frequency 156.6 MHz for exclusive use in the Houston protection area for VTS purposes.

The action was proposed in a rulemaking notice released last March 16, as requested by the U.S. Coast Guard.

The establishment of a VTS system for the Houston port area is part of the Coast Guard's program to implement the provisions of the Ports and Waterways Safety Act of 1972.

As part of the same program, the Coast Guard had requested, and the Commission recently adopted in Docket 20444, an amendment designating radio protection areas for VTS purposes in the New York and New Orleans port areas. In that same proceeding, the FCC provided the frequencies 156.55, 156.6 and 156.7 MHz for use in VTS systems.

The Commission said it was "incumbent upon us,

and in the public interest, to further the Coast Guard by amending the rules as proposed."

FCC PROPOSES TWO-WAY FREQUENCY USE FOR ONE-WAY ONLY PAGING

The FCC has proposed amending its rules relating to the availability of frequencies in the Domestic Public Land Mobile Radio Service (DPLMRS) to allow use of two-way frequencies for exclusive one-way signaling service without regard to primary and secondary requirements of the rules.

(DPLMRS are voice or signaling communication services between base stations and mobile units either in vehicles or hand-carried, offered by radiotelephone common carriers.)

The Commission said the use of the terms "primary" and "secondary" had caused some concern among wireline and radio common carriers. It said that in some areas no additional one-way only frequencies are available and that in other areas, especially along the Canadian border; available exclusive one-way channels cannot be used because of frequency conflicts with Canadian licensees.

The Commission explained that the rule changes would allow the use of the two-way frequencies for "exclusive tone and tone plus voice operation." However, potential users would be required to file a formal application requesting authority to use the two-way frequencies for exclusive one-way service, it said. They must include an explanation as to need and why present one-way frequencies, if available, cannot be used, the Commission added.

The Commission also stated that those wishing to operate on the paired mobile frequencies would have to provide protection from electrical interference to existing of pending facilities.

This proposal is being made to protect co-channel two-way base stations using the same mobile frequency for two-way operations.

AERO COMMUNICATIONS ON A STANDARD SCANNER

We all know of the tried and true VHF Aero band (108 to 136 Mhz), wherein—with a special receiver designed to tune those frequencies, one may hear all manner of interesting chatter relating to commercial and general aviation. But did you know that there is a great amount of *really* interesting commercial aviation communications to be heard—*not* on the special VHF Aero band, but within the frequency range of standard high (150 to 174 Mhz), low (27 to 50 MHz) and UHF (450 to 470 MHz) band scanner monitors? Bet ya didn't know *that*—most monitors seem to be unaware of it—and those involved have not been unhappy about this information being left *unpublicized*.

For instance, most monitors are unaware of the fact that a great many airlines have one or more private and *strictly* confidential "Company Frequencies" over which they can communicate with their in-flight aircraft with

messages not permitted on the regular VHF Aero band. For these purposes, they operate their own networks of ground stations, which are also used for communications with ground personnel (including security forces). The aircraft can be heard over great distances—we understand that many aircraft can be heard from *several hundred* miles distant.

Well, that's *some* of the little-known stuff which is to be heard—and we have tuned in on it here at the Monitor Post lab and can report that it's *no wonder* they have kept these channels under the lid! The airlines make generous use of *all three* frequency bands, high, low, and UHF!

What turned us on and opened the door to all of this is a publication called FLIGHTCOMM; truly a juicy tidbit, containing callsigns, airline names, locations, channels of these stations around the U.S., stations operating within the frequency range of standard high, low, and UHF band scanners. *None* of the stations listed require a special 108 to 136 MHz Aero band receiver. Along with the airline stations, the publication lists all manner of other commercial aviation stations to be tuned with a standard scanner—Air Taxis, Crop Dusters and Sprayers, Commuter Lines, Private Flying Services, Skywriters and Aerial Advertising Companies, Helicopters, Aerial Surveyors, Aero Ambulances, and even many airport security departments and crash trucks at airports large and small. Callsigns, licensee names, lo-

cations, frequencies are shown for hundreds upon hundreds of such stations!

It sure opened our eyes up to some of the really *fascinating* behind-the-scenes chatter which is taking place, secluded quietly away from the regular Aero band—and right under the noses of all of us with regular scanners who never knew it was there! Well, *now* we do!

FLIGHTCOMM is available at \$3 per copy, post-paid, from CRB Research Inc., P.O. Box 56-MP, Com-mack, N.Y. 11725.

We think you'll like it!

WANTED

CB'ERS FOR NATIONAL TEST OF 40 CHANNEL CB EQUIPMENT

Research Association requires CB'ers to test experimental 40 channel mobile antenna prior to public sale. Purpose of test to confirm manufacturer's and major university reports of superior performance over current antenna designs. All participants will be paid for completing reports following receipt and use of equipment but must agree to keep all data confidential. All rights to consumer test reports, comments, and written suggestions become property of RTC. Write:

RESEARCH TEST CENTER

"Testing Communications for Industry and Research"
1945 South Street, Elgin, IL 60120

Dealer Business Card Advertisement

This advertising section is reserved exclusively for CB dealers who wish to keep their name in front of their local customers, but who would otherwise not advertise in a national publication. The ads included are limited to one column inch; advertising copy is limited to non-mail-order type. The costs for business card ads are \$45.00 prepaid. In addition to the ad in the business card section, each dealer participating receives twenty five copies of the issue containing his ad, to sell or pass out in his store. For further information, dealers should contact the publisher, S9 Magazine, 14 Vanderventer Ave., Port Washington, NY 11050. Phone: 516/883-6200.

ENJOY THE THRILL OF UNDERPAYING
COBRA-TRAM-BROWNING
QUALITY LINE ELECTRONICS INC.
STONY HILL PLAZA, RT. 6
BETHEL, CT 06801
203-792-7750
WHOLESALE RETAIL

C.B. RADIOS POLICE & FIRE MONITORS
ESSEX ELECTRONICS CO.
705 SOUTH MARLYN AVENUE
BALTIMORE, MARYLAND 21221
WHOLESALE DISTRIBUTORS
DEALERS WELCOME
301-686-8080 RADIO & TV PARTS

★ **AED** ★
COMMUNICATIONS SERVICENTER
CB & FM 2-Way Radios - Antennas - Scanners - Crystals
SALES - INSTALLATION - SERVICE
2517 Wyandotte Road Willow Grove, Pa. 19090
(215) 659-3754

SPEED EQUIPMENT INC. (516) 883-7819
One of L.I.'s fastest growing C.B. Dealers carrying a full line of C.B. equipment in stock. *We install what we sell!*
Sales: 139 Main St. Installations: 137 Haven Ave. Port Washington, New York 11050

**TOP OF THE LINE RADIOS
AT BOTTOM OF THE LINE PRICES!**
QUALITY LINE ELECTRONICS INC.
Transit Town Plaza
Williamsville, N.Y. 14226
716-631-3332
RETAIL WHOLESALE

"Dealer Business Card Advertisement"
Accessories * Antennas * CB Radios
RRR ELECTRONICS, INC.
2010 Elwood Avenue
South Bend, Indiana 46628
219-232-4688 Send for Wholesale price list

CB SHOP



Rates for CB SHOP are 10 cents per word for advertising which in our opinion, is obviously of a noncommercial nature. A charge of 50 cents per word is made to all commercial advertisers or business organizations (minimum ad, \$20.00). Regular S9 display advertisers are exempt from the classified ad minimum rate. A 5% discount is in effect for an advance insertion order for six consecutive months.

We do not bill for advertising in CB SHOP. Full remittance must accompany full orders

sent in; otherwise, will not be run or acknowledged.

Closing date is the 5th of the third month preceding publication.

Because the advertisers and equipment contained in the CB SHOP have not been investigated, the publisher of S9 cannot vouch for the merchandise or services listed therein.

All paid classified ads must be sent to the attention of Eileen Lucey, Classified Ad. Manager.

HIGH FREQUENCY CRYSTALS— Huge inventory, all radios AM & SSB. Write giving radio make, model and frequencies desired. Same day shipping \$5.95 each. Dealer inquiries invited. Xtals, Box 42, Prospect Heights, IL 60070.

C/B HAM DEALERS: Send your letterhead for free catalog. SILTRONIX, SWAN, MIDLAND, PEARCE-SIMPSON D & A, BLACK Equipment Company, Inc., 2331 Vance Jackson, San Antonio, TX 78213. 1-512/733-0334.

ANTENNA PLANS. Save and build your own No Gamma Match or Loading Coils. Base station plane plans \$2.50 Two three or four element beam plans \$4.50 Both plans for \$6.25 Send check or money order to Antenna Plans Box 372 Fort Atkinson Wis. 53538.

"GOOD BUDDY POCKET ATLAS & CB GUIDE" contains 10 Codes, Channel 9 glossary of CB terms, color maps of all states, more! VINYL CASE. \$.99 plus \$.30 postage. Mail check to "Good Buddy" 2 Hapgood Hill Huntington, WV 25705.

MAIL-IN CB REPAIR: Write or call for procedures and flat-rate price schedule. Most radios in return mail within 48 hours. COMMUNICATIONS UNLIMITED, P.O. Box 55, I-70 & US 42, London, Ohio 43140 614/852-9446.

QSL WITH US. Join the Lillac QSL and Coffee Pot Control Sidebanders of NH. Receive your sidebander's number's be a puddle dock-er. Join the both clubs and receive certificates, ID card, unit numbers, SB numbers, WSL cards plus other goodies. Write for information to Robert F. Starratt, 3 Kent Ave., Dover, NH 03820.

JOIN THE BROTHERHOOD OF CB'ers a Nationwide organization. Equipment and handle registry; overnight accommodations; bi-monthly magazine published by us; ID Card; 5x7 wall card; bumpersticker and more. Complete membership \$5.00 or free details. Box 461, New Haven, Conn. 06502. **BEAUTIFUL QSL CARDS...** Want your stand TALL among the rest of the "Ordinary Wallpaper"? Breathtaking samples and information only \$1.00, refundable with first order. BACK-ACRE CB Printers, Box 18608-S, Milwaukee, WI., 53218.

MOBILE IGNITION SHIELDING provides more range with no noise. Available most engines in assembled or kit forms, plus many other suppression accessories. Free Literature. Estes Engineering, 930 Marine Dr., Port Angeles, Wash. 98362.

WYOMING RANCH LAND. 10 acres \$30 down, \$30 month. Owner: Mike Gauthier, 9550 Gallatin, Downey, CA. 90240.

SOUTHEAST DEALERS AND DISTRIBUTORS: Best Prices. Same day service. Most Major Brands Available. HUSTLER, TURNER, ROYCE, ROBYN, REGENCY, JOHNSON, XTAL, MIDLAND, S.B.E., KRIS, and many more. Call or write for price list. L.E.S. Wholesale Dist. 16773 S.W. 304 St. Homestead, Fla. 33030. 305/248-6304.

CBers! MANY MORE CHANNELS. More power. Uncrowded. More fun. Qualify! Copyrighted report tells why, where, and what to do. \$2.00. Moneyback guarantee. Alpha Research Consultants, Suite 125-S, Chevy Chase Drive, Austin, Texas 78752.

THE JUNK BOX— Interesting to CB'ers. Sample copy \$.75. Placement on latest junk mail list \$1.00. The Junk Box, P.O. Box 872, Peabody, Mass. 02149.

STOP CB THEFT Security Alarm becomes permanent part of CB radio. 110 db alarm sounds when radio is moved beyond a certain point. Simply attaches to rear or side of radio. Difficult to remove by thief. Welded steel construction. No wiring required. Electric key lock and test button. Less AA batteries, only \$19.95. Dealers and distributors wanted. Electronic Research & Production 35 Ayers Point Road, Old Saybrook, Conn. 06475.

CBers' PROTECT YOUR INVESTMENT Make your Rotating or Omni antennas STAY UP. New Support System, will add needed wind protection and strength to your mast and tower. Materials approx. \$10.00. Copy detail plans and do it yourself instructions. \$9.95. Patent Pending. RAM Home Improvement Corporation, Box 1209, Toms River, NJ 08753.

A CUSTOM DESIGNED CARRYING CASE for 2 Way Radio, The CARRIER. Carry your radio extra mike, tools, meters in separate foam compartments. A quick mount antenna cigarette lighter plug and any rig can be safely portable. Send \$24.95 plus \$1.50 for cost of handling to ALLI INDUSTRIES, P.O. Box 68, Centereach, N.Y. 11720 Phone 516/588-6695. Allow 4 weeks for delivery.

YOU SAVE BIG MONEY! Surplus, bankruptcy, inventory, deals. Catalog \$1 (refundable). ETCO, Dept. S9, Montreal, Canada H3 C 2 V2.

INTRODUCTION TO CB SIDEBAND — Undecided? This comprehensive 65 page primer covering radios, equipment, antennas and proper on the air procedures will help you— Also contains Q-code, 10-code and pertinent Part 95 rules. Send \$2.00 to P.O. Box 396 Reseda, Calif. 91335.

FREE CB HANDLE RECORD BOOK with purchase of CB HANDLES WITH HUMOR, over 300 handles, short stories and poems. Send \$3.00 to Billy R. Smith 616 Sixth St., Hilltop Ct., Bloomington, IL. 61701.

CB DECALS: 12 new designs, all in color, individually polybagged, self-adhesive, weatherproof vinyl. Retail at \$1.00 each. Wholesale prices available to dealers, clubs and associations that offer 100% and more profits. Prices include free display racks, free advertising placards, and free shipping in USA. Fantastic for coffee breaks and jamborees. Send for FREE full-color catalog sheet to: WALKING TALL, P.O. Box 659, Bronx, N.Y. 10469 or call 212/863-4848.

C.B. CLUBS— 3-Line Engraved Pin Badges, \$1.50. Free sample and information to clubs. WHARTON PLAQUES, Worcester, N.Y. 12197.

ALABAMA DEALERS: we carry most major brand CB radios and accessories. Same day shipping from on the shelf stock. Dealers only. Ask for "SANDEE" or send letterhead to TUCKER BROTHERS: Box 177 Cropwell, Alabama 35054. Tel. 205/525-5341 or 525-5808.

NEW CHROME MYLAR colorful bumper decals, from designers and manufacturers. Interwagen Corporation 8819 SW 129th Terrace Miami, Fla. 33156. 305/233-3470. Distributors wanted, send \$13.00 for sample kit (35.00 retail value).

CB DEALERS— Send letterhead for complete wholesale catalogue on all communications equipment. Four Wheeler Communications, 10 New Scotland Ave., Albany, N.Y. 12208. 518/462-0202.

JOIN INTERNATIONAL EMERGENCY RADIO PATROL. Details free. Write Box 434, Saint John, New Brunswick, Canada.

CB RADIOS AT WHOLESALE PRICES! Listing \$.50. Going Ham? YAESU FT-101E in stock. SIDEBAND SPECIALTY, Box 573 DC, Oak Harbor, Wa. 98277.

I'LL WRITE YOUR CB HANDLE into a poem. Send \$2.50 to Billy R. Smith, 616 Sixth Street, Hilltop Court, Bloomington, IL. 61701.

DEALERS WANTED. Most major CB brands scanners, Ham gear. Large inventory, low prices, fast courteous service. JRD Distributors, 131 Harbor Circle, New Orleans, LA 70126. 504/241-8505.

CBers— SHOOT LEGAL "SKIP" WORLD— WIDE on thousands of channels! Join ARC to learn now. \$4.00 Life Membership or \$.25 brings information. AMERICAN RADIO COUNCIL; Box 1171; Garland, Texas 75040.

QSL CARDS — SOMETHING COMPLETELY DIFFERENT! Nothing even close to it on the market! Not made of paper or card stock! The "Cadillac" of QSL's! Samples: \$1.00 — Fully refundable with order. MAC'S SHACK Box 1171B; Garland, Texas 75040.

LOOK! \$1.00 1 inch x 3 inch ENGRAVED PLASTIC PINS. Colors. No minimum. 3" x 12" white reflective plastic sign. 1 inch black letters. 2 lines \$5.50. Transmitter identification plates, 4 lines \$2.00. 1 inch x 3 inch Colors. Brochure by return mail: send stamp. HOLLY ENGRAVING Box 3926-Z, Hollywood, Florida 33023

BE AN EMERGENCY CHANNEL 9 MONITOR! If you live in California, we invite you to join Cal-State Emergency Radio. For information and membership application, send self-addressed, stamped envelope to CSER, P.O. Box 1956-A, San Jose, CA, 95109.

BEST PRICES— On Johnson SBE, Tram, Browning, Midland, Antenna Specialist, Avanti, Antenna Inc., Shakespeare, Turner, Astatic Mura, CDE, Para-Dynamics, Vanco, and Gold-Line. Write for free price list. CRS COMMUNICATIONS 1552 Central Park Ave. Yonkers, New York, 10710

SET OF FOUR SWELL BUCKLES—Only \$4.95 ea. or \$18.95 for set. A. American B. Breaker-Breaker. C. CB Radio. D. Super Operator. Add \$1.05 for handling. Send to: Buckleman Kelly 1076 Palmer Ave., Larchmont, NY 10538.

C'MON...YOU CAN HAVE A COLOR CARTOON CARICATURE of you and your handle drawn by a top national cartoonist! Big 9" x 12" size Color Artwork...Only \$9.95 (Black & White Version Included Free) Perfect gift idea! Send photo, handle and M.O. today to: "Big Bad Wolf" Box 275, Lincoln, RI 02865.

ZANY CB BUMPER STICKERS!! No. 5005 CBers do it with frequency. No. 5006 Honk if you love CB. No. 5007 We brake for beavers. \$1.00 ea. 3/\$2.50. Add \$.25/order postage & handling. Write for club discounts. U.S. Publications Service, P.O. Box 34911 Dept. S Wash. D.C. 20034.

FEDERAL GOVERNMENT DIRECTORY, 1300 Channels. Lists nationwide frequencies for FBI, Secret Service, etc. \$5.00. Bearcat 101 programs for 700 channels not in owners manual, including Federal Government channels, \$5.00. Channel directories for Colorado, Nebraska and Wyoming, \$3.00. Blakeman Electronics Box 288, Dupont CO 80024.

ATTENTION CB DEALERS: Having hard time getting C.B. sets? We carry a full line, including Pearce-Simpson, Robyn, Browning, Johnson, Royce, Police Monitors, Crystals, New-Tronics, Antenna Specialists (E&S C.B. Sale & Service) R4, Winchester, IN 47394. Ph. 317/584-0343.

CBers! MANY MORE CHANNELS. More power. Uncrowded. More fun. Qualify! Copyrighted report: tells why, where, and what to plastic card. Read at a glance. Send \$2.00 each PPD. to SPORT TECH CORP., P.O. BOX 14008, Dept. C West Allis, WI. 52314.

CB DEALERS WANTED. We sell to dealers only: No retail sales. Call or write for information on our dealer program. DRAGON COMMUNICATIONS, 411 Kansas City Ave., Excelsior Springs, MO 64024. 816/637-6011, OR—2244 NW 39th Street, Oklahoma City, OK 73112. 405/525-8844.

WE NEED DEALERS! Get on our mailing list for weekly dealer specials on Citizens' Band radios & accessories. Over 100 major lines. Our dealers enjoy same day-service, dealer-support aids, plus access to dealer discounts on several hifi and other consumer electronic merchandise. You will PROFIT as a 10-4 dealer. Write today: 10-4 Communications, 704 W. Buffalo St., Ithaca, N.Y., 14850.

FACTORY DIRECT CB ACCESSORIES; DE-102 filters for superior CB reception through interference. DE-102A for base station \$51.95. DE-102B for mobile \$39.95. Increase your talk power 10 times with our DE-120 speech compressor \$59.95. DE-112A power supply converts mobile into a powerful base \$36.95. Other accessories available. Add \$2 for shipping. Dynamic Electronics Inc., Box 896, Hartselle, AL 35640.

QSL CARDS—2 color 12 pt. glossy white, 500 for \$8.00, 1,000 for \$14.00. Over 300 designs. Catalog & Samples, \$1.00. Life Guill, Rustburg, Va. 24588.

SMOKEY'S RADAR BUGGING YOU? Loaded with speeding tickets? Insurance gone up? We have the answer. H&B Enterprises, Box 477, Candler, N.C. 28715.

FORTY-PLUS CONVERTER for your base/mobile/portable transceiver. Converts XMT/RCV to XTAL—controlled op on up to 22 addl. channels AM, 44SSB. Kit: \$49.95. Patent. Guaranteed. Forty-Plus Converter, 11301 Melody Dr. No. 308, North Glen, Co. 80234

YELPING SIREN ALARM for your car. Activated by existing door buttons for courtesy lights, stays on once door opens until deactivated. Use existing P.A. speaker or install separate speaker. 12 Volt with 5 watts output. Highest quality PC board and components. Unit assembled, tested, less speaker on/off switch \$14. Simple installation instructions included. Siren Alarm also available whereby interruption of grounded trigger line activates unit \$12. Stop Burglar Alarms Box 500 Hiawatha, Iowa 52233.

MAKE MONEY FOR YOUR CLUB OR YOURSELF. T-shirts custom printed. Any message or design. Send a sketch or drawing. These are not Iron-on transfers. 1 dozen - \$4.00 ea., 12-72- \$3.00 over 72-\$2.50. CLUBS- Inquire about special rates for fund raising. buy 500 at \$2.00 ea. and sell for \$4.00 ea.- Quick \$1000 PROFIT. Hardy Screen Printing, 2805 W. Pullen, Pine Bluff, Ark. 71601. 501/536-6657.

ENGRAVED I.D. PLATES— 4-Color Anodized Aluminum, 3 1/4" x 1 3/4". Handle, call number, social security number, name. - Send \$2.00 to Cobble's Gifts, Dept. S9, P.O. Box 2, Deal, NJ 07723.

IF YOU ARE A SERIOUS CBER, you need the Handy Helper! Made of unbreakable plastic, it lists the full CB 10 code, Ham Q signs, truckers "Slanguage", Technical terms, and compares 23 to 40 channels in MHz. The Handy Helper attaches to your sun visor, dash or "shack" table. Send \$2.98 to Spectrum Communications, Dept A, 1522 Indigo, Oshkosh, Wisconsin 54901. Handy Helper with call sign personalized—\$3.98.

WANT TO BUY: Will pay top dollars—hard cash—for old Lionel Trolleys in any condition. Also want Old Lionel or Ives Standard Gauge trains. Your old clunker may be a collector's dream. Don't be bashful. Write Dick Cowan, c/o S9 Magazine, 14 Vanderverter Ave., Port Washington, NY 11050. Phone: 516/883-6200.

NEW CHANNELS! COPYWRITED BOOK details how to install sliders, increase word power, add new channels to most new and old units. Many pages. \$9.95 TECOM Box 696 Welcome, N.Car 27374.

CRYSTALS

**Same Day Shipping
From
America's
Largest Inventory of**

Standard C.B. Crystals/Ham Crystals

High Frequency C.B. Crystals

Crystal Controlled Sliders/Ham Gear

NATIONWIDE DISTRIBUTORS—DEALERS WANTED

CALL TODAY

**TENNESSEE
CRYSTAL COMPANY**

P.O. BOX 73

LEBANON, TENNESSEE 37087

(615) 449-1856

1—PAIR LAFAYETTE Dyna-Com 3-watt, 3 channel Walkie-Talkies— 1 antenna broken, needs replacing. Both for \$69.00. You ship. Bondurant, Box 7171, Tampa, FL 33603.

GET THIS! CIGAR CITY 'Tampa' Jamboree Souvenir patch—dime each plus S.A.S.E. w/order. Bondurant, P.O. Box 7171, Tampa, FL 33603.

FOR SALE: JOHNSON MESSENGER 223 in good condition, \$200.00. Orlan Cain, Griswold, Ia. 51535.

GUARANTEED 100% QSL. Cards with numbers only. Buddy packs to 100. Extras appreciated. KCO-2682, PO Box 8726, Boston, Mass. 02114.

Q.S.L.—Q.S.L.—Q.S.L.— Worldwide Q.S.L.— send Q.S.L. Cards to: Philip Steven Kurland, 357 E. 201 St., Apt. 1-F, Bronx, NY 10458.

S—9 P.R. REPORTER PATCH, Send \$3.00 and \$.25 postage to: William Davidson, 26 Knight St., Glens Falls, N.Y. 12801.

SCANNER OPERATORS! Are you registered? Be, assigned your own personal monitoring ID letters inscribed on beautiful 2-color bordered certificate, plus discounts and goodies! Thousands already registered! Only \$5, ppd. from CRB Research, Box 56-X, Commack, NY 11725.

NOW FROM THE LARGEST WAREHOUSE IN THE EAST. Same day delivery for on the shelf stock. All major brands. 24-hour service. Send for dealer catalog and free gift offer. Send letterhead to: PALOMAR EAST LTD., Palomar Plaza, P.O. Box 148, Congers, NY 10920.

PROTECT GEAR with bold burglar alarm warning stickers. Strong self-stick vinyl striking green/yellow design. Only \$2 for 5. Enclose self-addressed stamped envelope. CRB Research, Inc., P.O. Box 56-XC, Commack, NY 11725.

FOR THE BEST IN CB & AMATEUR GEAR. Tempo One. Siltronix 1011B & Skipper 73. For immediate delivery, call or write: PALOMAR EAST LTD., Palomar Plaza, P.O. Box 148, Congers, NY 10920. (914)268-9258.

UNIT NUMBER ID'S! Everybody's using them these days! Don't you have yours yet? Your existing Unit Number registered or a new one assigned to you by the national registry for ALL Unit Number ID's; PLUS a 2-color official Certificate of Registration showing Unit Number, your name and/or handle, the date of registration; PLUS exclusive special report on how thousands of CB'ers are now getting more use and enjoyment from their hobby by using Unit Number ID's in addition to or instead of "handles." Everything for only \$2.95, plus self-addressed stamped envelope. Z-Tech Enterprises, Box 70-W, Hauppauge, NY 11787.

OFFICIAL ID CARDS/CREDENTIALS for Police Dept./Deputy Sheriff/Highway Safety Patrol/Volunteer Ambulance Corps/Rescue Squad/Fire Dept.! Beautiful professional 2-color wallet size ID cards. Sent blank (we do not inscribe name). Available in large or small quantities. Sample set of all 6 cards only \$3, ppd., PLUS FREE BONUS Official CB Operators ID Card. Civil Defense credentials also available to authorized CD units. Order now! CRB Research Inc., P.O. Box 56-X, Commack, NY 11725.

NASSAU COUNTY CB'ERS: Don't sit back... Join REACT!! Central Nassau County REACT, one of the first and largest teams in the nation would like you as a member. We are an independent, non-profit volunteer public service team dedicated to aiding you, our fellow CB'er in time of need. Send today for more information and a membership application to: Central Nassau County REACT, P.O. Box 406-S, Westbury, NY 11590.

SET OF FOUR SWELL BUCKLES— Only \$4.95 each- or \$18.95 for set. A. American Club. B. Breaker-Breaker. C. CB Radio. D. Super Operator. Please add \$1.05 for handling Buckleman Kelly, 1076 Palmer Ave., Larchmont, N.Y. 10538.

ASSOCIATE MEMBERS WANTED to join American CB Radio Club. Receive attractive club buckle, membership card, permanent club I.D. number, 10-code, CB language, bumper sticker, etc. Associate Membership only \$6.00 a year. Mail check to American CB Radio Club Inc., P.O. Box 321, Bronx, NY 10469.

WANTED ANTIQUE GLASS—Looking for old milkglass purple, slag, carmel and green-town too. Tell me what you have—I pay the highest prices. Write, Jack Schneider, c/o Cowan Publishing, 14 Vanderventer Ave., Port Washington, NY 11050.

SIDEBAND DECALS! Tell the world that Sideband is the greatest! Spectacular new 3-1/2 inch 3-color water transfer Sideband decals! One decal only \$1.25 ppd.! Two or more only \$1.00 each ppd. Dealers wanted! Sidebanders' Service Bureau, Box 381-Y, Smithtown, NY 11787.

POLICE/SHERIFF SHOULDER PATCHES! Authentic! Exclusive! Rare! Limited Supply! Multi-colored embroidered uniform patches from actual agencies. No lists, our choices sent, while supply lasts! 5 different only \$5, ppd. CRB Research, Inc., P.O. Box 56-X, Commack, NY 11725.

WANTED FOR \$\$\$CASH! Back in 1957 the Lionel Train Company made a small set of toy trains specifically designed for girls. It had a pink locomotive and several other cars, all in pastel shades. The set wasn't very popular, hence not too many sold. However, I need this set for my collection, and am willing to pay up to \$400 cash for a complete set in mint condition. If you have this item please write: Dick Cowan, S9 Magazine, 14 Vanderventer Ave., Port Washington, NY 11050.

SIDEBANDERS! Old Timers! Newcomers! Future Sidebanders! Affiliate with the largest, oldest and most well known SSB Network! No charge for SSB ID numbers from current numbering blocks. Lots of extras and goodies available! Send self-addressed stamped envelope for FREE info and application. No obligation! Sidebanders' Service Bureau, P.O. Box 381-X, Smithtown, NY 11787.

SECRET SCANNER FREQUENCIES? Many public safety and federal gov't. agency frequencies are "unlisted"—that is, "missing" from frequency listings available to the general over-the-counter buyer! What good is a scanner without ALL of the frequency data? Get those unlisted frequencies and lots more ONLY in CRB Research directories, the original Official "insiders" directories used by public safety agencies and scanner users since 1967! Exclusive directories for many other services (mobile telephone/private detectives/aero/railroad/remote broadcast pickup/etc.) also available! Still only \$3 each, or send a postage stamp for fantastic BIG new catalog! CRB Research Inc., P.O. Box 56-X, Commack, NY 11725.

LOOKING FOR OLD LIONEL TRAINS. Interested only in "0" Gauge, excellent to like-new condition. Primary interest is locomotives prior to 1952, but will consider complete sets or more recent models. Am willing to buy outright for cash or swap radio gear to meet your needs. Write Dick Cowan, WA2-LRO, c/o S9 Magazine, or call 516/883-6200.

SINCERE CH.9 MONITORS—We need one Chartered team in each county in the U.S. Canadians welcome. Write Highway Assistance Modulators, 5221 Creekwood Dr., Harrisburg, PA 17109. Team protection assured.

ARE YOU 10-1? AT LAST— The standardized CB 10-codes accepted coast to coast. Complete version, including phonetic alphabet on a rigid, durable, waterproof, 5" x 8" plastic card. Read at a glance. Send \$2.00 each PPD. to Sport Tech Corp., P.O. Box 14008, Dept. C West Allis, Wisconsin 53214.

SCANNER CRYSTALS from America's leading supplier—sent to you postpaid and factory fresh from an inventory stock of 100,000 crystals! \$3.95 for multiple orders! Send postage stamp for free catalog and special order form! Z-Tech Enterprises, P.O. Box 70-A, Hauppauge, NY 11787.

FCC test answers \$10 specify class Dixie Tec Box 8352 Savannah, Georgia 31402.

WANTED: CAR TELEPHONES AND MOBIL TELEPHONE PARTS, HEADS, CABLES, etc. Greg Hyman, 87 Yonkers Ave., Yonkers, N.Y. 10701. 914/476-4350.

CALL SIGN AND HANDLE engraved on 1x3 plastic badge with pin/clutch. Choice of colors, all with white lettering— mapplewood, green, red, black, blue, orange— \$1.75. H&H Plastic Engravers, P.O. Box 6606, Pine Bluff, ARK, 71601.

BECOME A RADIO AMATEUR— Read "From CB to Ham Beginner". All you need to know in one easy-to-understand book. Only \$4.95 at all stores handling "Sams" publications. Or order AUTOGRAPHED copy latest edition direct from author (add \$.50 for handling). J.A. Stanley, 855 South Fillmore St., Denver, Colorado 80209. Money-back guarantee.

CB RADIOS, VHF/UHF monitors, crystals, antennas. All brands. Lowest pricing possible. Southland, P.O. Box 3591-F, Baytown, Texas 77520.

CALL SIGN—HANDLE molded in durable pressure sensitive plastic. 3x12 1 line \$2.95 5x12 2 lines \$4.50 Red or black on white. NO COD's. We pay shipping. Club emblem molds available for clubs. Gene's Signs P.O. Box 7852 Midfield, Al. 35228.

DEALERS— Check our extremely low prices and same day shipping for Midland, Shakespeare, Turner, Breaker, Amphonel, Consolidated Towers and more. Send for free catalog. Sugar Shak Distributors, 1025 N. King St., Hampton, Va. 23669. 804/723-7090.

SWAPPING Q.S.L. CARDS? Wallpaper your walls, join the Carnival QSL Club of the world. Write for application. We also sell patches, 1124 High Bluff, Dubuque, In. 52001.

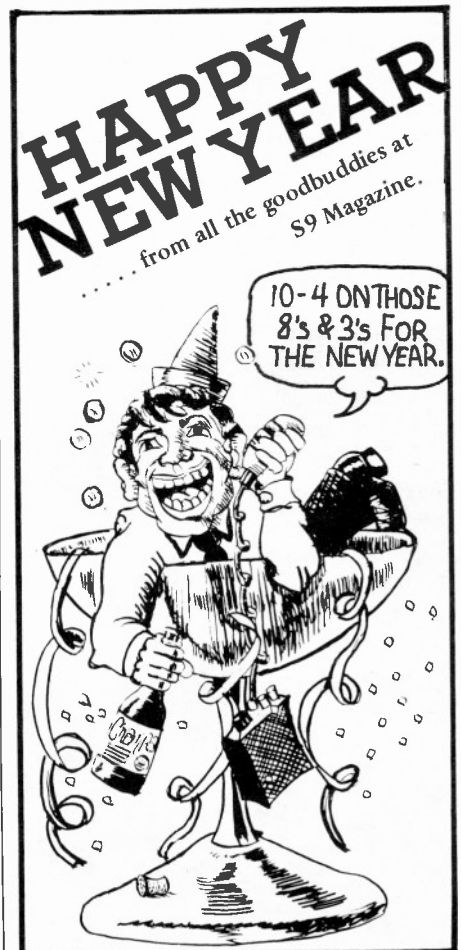

ADVERTISER'S INDEX

MANUFACTURERS

Acoustic Fiber Systems	2
Action Electronics	68
AmComm	59
Antenna, Inc.	80
Antenna Specialists Co.	13
Argos Sound	89
Avanti Rsch. & Dev., Corp.	Cov. IV
Barker & Williamson	100
Barry Electronics	129
Browning Labs	40
C & C Electronics	129
CPD Industries	107
CTS Knight	26
Channel Master CB	4
Cobra Comm., Div. Dynascan	3
Colar Systems	67
Communications Porudcts	86
Cush Craft Inc.	82
Delta Electronics	93
Francis Industries	86
Franke, Inc., Fred	112
Gamber Johnson	75
Glatzer Industries Corp.	115
HM Electronics	111
Handic of USA	11
I.A. Sales Co. of Calif.	144
MCM Manu., Inc.	60
Magitran	109
New-Tronics Corp.	8, 9, 76
Optoelectronics Inc.	103
Pal Electronics	84
Palomar Electronics	21
ParaDynamics Corp.	118
Pearce-Simpson	83
President	Cov. II, pg. 1
Progress Inc.	25
RMS Electronics, Inc.	96
Radatron	108
Radio Shack	23, 38
Robyn International	6
Rohn Manufacturing	7
S & A Electronics	81
SBE	Cov. III
Sandro's Electronics	5
Scientific Antenna	111
Shakespeare Co.	58
Smith Manufacturing	86
Southcomm	17

Southcomm	17
Staco Inc.	114
Tennessee Crystal Corp.	140
Tram/Diamond Corp.	15
Turner Div., Conrac Corp.	37
Valcom Inc.	118
Wenover	61
Wilson Electronics	39

DISTRIBUTORS

AB Electronics	100
Atlantic Speed Center	106
B & J Two-Way Ltd.	81
Bennies Comm.	85
CB Warehouse	110
Centennial Comm., Inc.	34, 35, 52, 53
Clark's CB Dist.	65
Clercom	77
Crazy Harvey	106
Electronic Dist.	93
Gordon Electronics	37
Henshaw's	77, 110
New-Tone Electronics	120
Palomar East, Ltd.	44, 45
Spark Sales	114
United Communications	121
Universal Communications	114

MISCELLANEOUS

A-B Emblem	102
Bi-Ways Inc.	117
CB Pendant	80
CB Repair Course	65
CB Specialties	75
CEDA	62
Channel Tag	128
Contemporary Security Inc.	143
Easy CB Locators	91
Global	128
J. W. Miller	112
NCC	92
NRI	47, 110
Nat'l. Bur. of Sch. & Call Reg.	57
Patch, A.T.	97
Poplar	127
Regal Lapidaries	62
Research Test Center	108, 138
Whistler Inc.	121

COWAN PUBLISHING ADS

A Professional-	104
CB Radio Marketing	113
Electronic Fleamarket	134, 135
How About That?	132
House of Power	122
Interested in Ham Radio?	66
Old Lionel Trains	107
Reader Service	123, 124
S9 Staffers	133
Subscription Form	98
Tab Popular CB Books	130
Tomcat's Skipland Map	112
The Truth About CB Antennas	136

BUYER BEWARE!

The publisher of S9 accepts advertising from manufacturers, dealers and distributors who, in our opinion, offer readers a high level of quality in products and/or service. Wherever possible we attempt to publish additional information on these products in the form of technical equipment evaluation reports.

Readers should be aware that, at the present time, the CB radio market is drastically backordered in almost every product category, but especially so in transceivers and antennas. We wish to remind our readers that we carefully screen all potential advertisers. In the event that a company's products do not appear within our advertising pages, there's a strong likelihood that it has not passed our minimum standards.

We strongly urge readers to purchase from those companies whose advertising appears in S9; by doing so, you will be assured that the company with whom you're doing business is a reputable one. You'll also be supporting those companies that help make S9 possible. Now, we recognize that many advertisers cannot advertise in every issue. If you don't see the company's ad in the current issue, check back two or three issues to be certain, since almost every major advertiser appears six or more times in one year. If you have doubts about the reliability of any particular product or company, feel free to contact our publisher for information. This service is offered as a safeguard to our readers.



This car had a CB radio...

... but, not anymore! Some rip-off artist got it! And, chances are good, if the owner had a CAR COP™ security device under his hood his CB would still be under his dash.

The CAR COP™ security system is an amazing new automobile alarm that out does the rest hands down. Just a touch of your car, the slightest movement, and the CAR COP™ device sounds the alarm.

That's right! Now you can leave your car anytime, anywhere, and be sure that it will be there, safe and in one piece, when you return.

Why take a chance on losing that expensive CB radio (or tape deck or mag wheels for that matter)? Now you can do something about theft . . . with a CAR COP™ security device.

Especially designed for today's vehicles. The CAR COP™ device is unique: truly the state-of-the-art in automotive alarms. A CAR COP™ device is easily installed in 15 minutes waiting to scare away rip-off artists, thieves and street hoodlums—anyone that touches your car.

Don't hesitate! Don't delay! Every minute you do, you're running the risk of having your car look like

the one above.

Protect your car, and that valuable CB. Order your CAR COP™ security device today!

**MAIL THIS TODAY — PROTECT YOUR
CAR AGAINST RIP-OFF ARTISTS!**

Contemporary Security, Inc.

229 Forestville Road
Raleigh, North Carolina 27604

The CAR COP™ security device sounds too good to be true, but too good to pass up! Send me mine today, so I can protect my car (and my CB) against rip-off artists and thieves.

I am enclosing \$19.95 for each CAR COP™ device order. (NC residents add 4% sales tax)

Check Money Order Cash Enclosed
No CODs accepted (Please allow 3-4 weeks for delivery) S9-1

Name _____ Initial here _____

Address _____

City _____ State _____ Zip _____

No order will be honored unless zip is included.

For Flexible Station Design

and

Total Spectrum Coverage from 160 thru 2 Meters



YC-601
DIGITAL DISPLAY UNIT



FT-101E
TRANSCIVER



YO-100
MONITOR SCOPE



FL-2100B
LINEAR AMPLIFIER



FV-101B
EXTERNAL VFO



SP-101PB
PHONE PATCH SPKR.



FTV-250
2-M TRANSVERTER



FTV-650B
6-M TRANSVERTER

There are many reasons for you to choose Yaesu and they are best summed up as **PERFORMANCE AT THE RIGHT COST**. Your dealer will proudly demonstrate why the finest sounding signals heard around the world originate from **YAESU**.

YAESU
The radio.

AVAILABLE AT:

BARRY ELECTRONICS CORP. WORLD WIDE AMATEUR RADIO SINCE 1920.

ALL LINES IN STOCK —TEMPO, KENWOOD, DRAKE, COLLINS, SWAN, SILTRONIX, BIRD, TURNER, ASTATIC, ETC.,
DEALER INQUIRIES INVITED

BARRY ELECTRONICS • 512 BROADWAY, NEW YORK CITY, NEW YORK 11012 212-925-7000
BARRY INTERNATIONAL • TELEX 12-7670

Introducing... SBE Touch/Com

The mike that does it all!

SBE adds the ultimate touch of sophistication to CB with the new SBE Touch/Com. It puts all the functions of CB two-way radio communication in the palm of your hand. Change channels, adjust volume and squelch, receive or transmit... all with the flick of a finger on the mike. It features up/down two-speed channel selection and a bright base-station-size LED digital channel readout for fast identification.

The Touch/Com, with the circuitry of the now-famous Formula D, incorporates all of SBE's most advanced CB technology: digital synthesis to cover all 23 channels with a single crystal; phase-lock-loop circuitry for "on-target" frequency stability; positive or negative ground for RV, boat and truck voltage systems; dual conversion for sharp selectivity and rejection of adjacent channel interference. The Touch/Com also features delta tune: crisp, clear audio output; a large, combination power output/"S" meter, night-lighted for easy viewing.

SBE'S finest CB—now made unquestionably the best by the unique convenience of Touch/Com.



SBE-32CB

SBE Better Communications through Creative Technology

For information write: SBE, Inc., 220 Airport Blvd., Watsonville, CA 95076

CHECK OUT THE SBE "FUTURE-40" CB UPDATE PROGRAM FOR UPDATING 23-CHANNEL TO 40-CHANNEL CB IN 1977.

Quality the heart of **avanti** antennas

The Sigma 5/8 is designed by AVANTI R & D engineers as an antenna without compromises. It is a full 22 foot long 5/8 wavelength ground plane. The 22 foot length is necessary to give the ultimate performance in an antenna of this type.

The Sigma 5/8 uses a special matching loop to achieve an efficient impedance match. Coils are not used because they can create problems. Coils can detune due to age or weather conditions or can burn out due to nearby lightning strikes or power surges. The Avanti matching loop eliminates these problems. This means quieter performance and longer life for the antenna.

The upright radiating element of the Sigma 5/8 is pre-marked for quick and easy assembly. The mechanical construction of the Sigma 5/8 is also of the highest quality... all the aluminum tubing used in the antenna's construction is seamless aircraft type; the center hub which holds the radials in place is pressure cast aluminum.

The quality and materials of the Sigma 5/8 assure you of an antenna that will give the maximum in performance for many years.

SPECIFICATIONS:

*Gain 5.14 db over isotropic
4.17 over 1/4 wave ground plane
3.00 db over 1/2 dipole

V.S.W.R. 1.3:1 or less

Power Multiplication Factor—3.2

Impedance—50-52 ohms

Omnidirectional—no rotor needed

Height—22 feet Radials—9 feet Weight—9 lbs.

avanti

AVANTI RESEARCH AND DEVELOPMENT, INC.
340 Stewart Avenue, Addison, Illinois 60101

creators of the
famous



SIGMA 5/8

AV-170

NO COILS TO BURN
OUT OR DETUNE

MATCHING LOOP

ALUMINUM HUB
CASTING

AIRCRAFT
QUALITY HEAVY
DUTY TUBING

MILITARY GRADE
FIBERGLASS
INSULATOR

CADMIUM PLATED
NUTS & BOLTS

HEAVY DUTY
1-5/8 BASE TUBE
FOR SECURE
MOUNTING