

20+ CB MOBILE FEATURES & PROJECTS

S9

May 1963

50¢

the citizens band journal

CB MOBILE HANDBOOK ISSUE

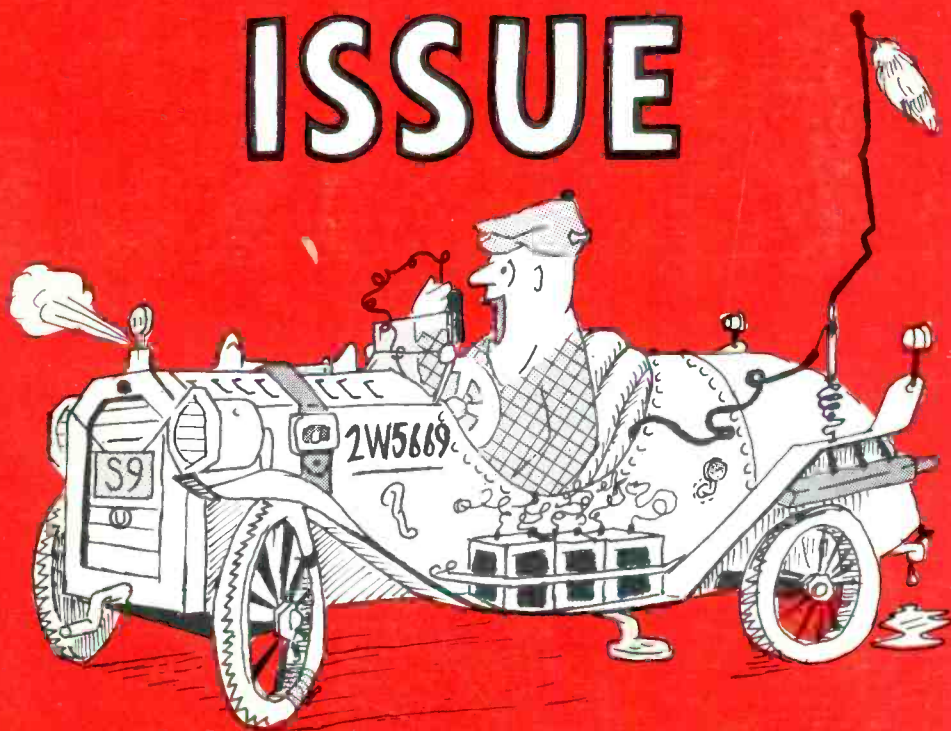

NEW!

INTERNATIONAL



Model 1500 . . . for the Hobbyist . . .

Now . . . you can be on the air, and operate a two-way radio, without a license. The new International Model 1500 Executive transceiver is certified to meet all FCC Part 15 requirements for short range radio communication within the 27 mc frequency range.

Designed and engineered for phone and cw (code), you can talk 1 to 10 miles with other Part 15 stations depending on the height of the antenna. You are also permitted to work skip signals 1,000 miles or more with other Part 15 stations when a band opening occurs.

The Model 1500 Executive puts the maximum RF power into the antenna by combining the transmitter and antenna for rooftop mounting, thus eliminating loss through a transmission line.

A second unit houses a field proven supersensitive receiver and exciter, while a receiver preamplifier located at the antenna boosts weak signals for better reception. Another feature of the Model 1500 is a special crystal filter for reducing interference from adjacent channel Class D two-way radios.



EXECUTIVE TRANSCEIVER

No License Required!

- Certified for FCC Part 15 communication
- 100 milliwatts input / 60 inch antenna
- 27 mc frequency range
- Operates on phone and cw
- Eight channels . . . all crystal controlled
- 115 vac operation
- Quality components and construction

The Model 1500 is a complete package, ready to go on the air. The package includes: ① receiver/exciter complete with 8 sets of crystals, ② transmitter/antenna assembly, ③ antenna mount, ④ 5 foot mast, ⑤ 100 feet of control cable, ⑥ microphone, ⑦ key for (cw).

Model 1500 Transceiver complete \$299.50*

See this exciting new transceiver at your International dealer. You can be on the air tomorrow with International's Model 1500.

*other models from \$80.00

Write for International's complete catalog of radio crystals and equipment.

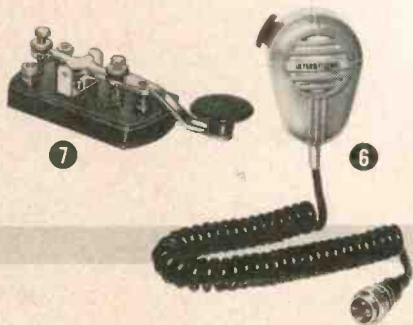

INTERNATIONAL
CRYSTAL MANUFACTURING CO., INC.

18 NORTH LEE • OKLAHOMA CITY, OKLA.

Detailed description: This block contains the company logo and address. The logo features a globe with the company name 'INTERNATIONAL CRYSTAL MANUFACTURING CO., INC.' overlaid. Below the logo is the address '18 NORTH LEE • OKLAHOMA CITY, OKLA.' The entire logo and address are set against a dark background within a rectangular frame.

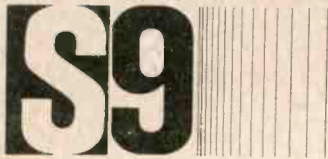

the citizens band journal

Vol. 2, No. 5

May, 1963

S. R. COWAN, PUBLISHER

300 West 43rd Street New York 36, N. Y.

Cover by Kenny Kneitel

FEATURES

Kill That Mobile Noise! Charles Schavers 9
 Even in Foreign Cars and Other Stubborn Cases

Build The Unperplexed Duplexer Herb Friedman, 2W6045 13
 Two Antennas For The Price of One

The Magnificent 7 Ron Girard, 7Q2024 16
 7 Simple 1-Evening Mobile CB Projects

Build The Mobil-Mitter Jim Gibson, 2W7610 20
 A 2 Tube Part 15 Mobile Transmitter

Install That Rig! David Tanner 23
 Professional Tips and Hints

What's Watt? Hank Miltenberg, 2W9299 26
 Getting The Most From Your Mobile Power Supply

CB QSL Swappers Unlimited 40
 You Wanted to Swap Cards, Here's Your Chance

S9 Reader Survey 29
 Let's Get To Know Each Other

Mobile Whips ARE Directional Arthur E. Judd 32
 Despite What You Have Heard

Part 15 Callbook 35
 This Month's Installment

Noll On Mobile Antennas Ed Noll, KCC2618 44
 'Nuff Said!

How's My Battery Herb Friedman, 2W6045 49
 Watch That Mobile Power Supply

DEPARTMENTS

Reader Mail 4

KBG4303 Rides Again/Tom Kneitel, KBG4303 7

Part 15 Korner/Dean Detton, N-17 42

On The Counters 37

Antennas/Ed Noll, KCC2618 44

Test Gear/Herb Friedman, 2W6045 49

CB Answerman/Len Buckwalter, KBA4480 47

CB Casebook/Lee Aurick, 2W2870 50

CB Club Notes/John Krejc, 2W4586 52

Washington Outlook/Ed Frederick, 2W4580 56

STAFF

editor Tom Kneitel, KBG4303

- contributing editor Lee Aurick, 2W2870
- contributing editor Ed Noll, KCC2618
- contributing editor Edwin Frederick, 2W4580
- contributing editor Paul Arnovitz, XM52127
- contributing editor John Krejc, 2W4586
- editorial asst. Diana W. Merkle
- advertising representative Dick Cowan
- advertising representative Jack Schneider, 2W5669
- circulation manager Hal Weisner, KBG4528
- production manager Cary L. Cowan, KBG4036
- edit. production Sol Nussbaum, KBG4903
- publication consultant David Saltman

S9 (title registered U.S. Post Office) is published monthly by Cowan Publishing Corp. Executive, editorial and advertising offices at 300 West 43rd Street, New York 36, N. Y. Telephone JU 2-4460.

Subscription Rates: One year \$5.00, two years \$9.00, three years \$13.00 in United States and Possessions, APO, FPO, and Canada.

Printed in U.S.A. Entire contents copyright 1963 by Cowan Publishing Corp. S9 does not assume responsibility for unsolicited manuscripts. We regard all material sent to us in CB club publications as being intended for publication in S9 as a public relations gesture of the club. We cannot pay for the use of this public relations material, although we do pay for editorial material which is specifically written for us and accepted for publication.

Controlled Circulation Postage Paid at New York, N. Y.

POSTMASTER: SEND FORM 3579 TO: S9, 300 WEST 43rd STREET, NEW YORK 36, N. Y.

23 crystal
controlled channels with
"spectramatic tuning"
Adjustable modulation
control
Selective listening
and Calling
Public Address facility

POLY-COMM

'23'

\$349.50

price includes
mike and
mounting bracket

CITIZENS CB CB BAND

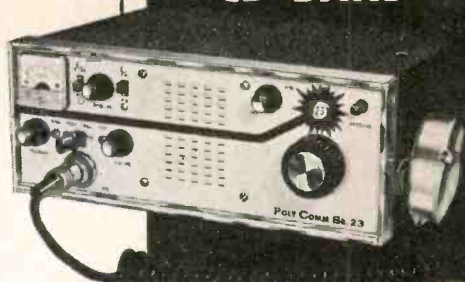

POLY-COMM®

'n'

\$189.50

price includes
mike and
mounting bracket

GUARANTEED PERFORMANCE



Dual Conversion
Superhet Circuit
Sensitivity:

.1uv for 6 db S/N

Supersensitive squelch

Advanced design
noise limiter

Nuvistor RF front end

In five short years, Poly-Comm circuitry has become the most imitated in the field. The reason is simple. TECHNICAL SUPERIORITY! Poly-Comms have Nuvistor front ends for unparalleled sensitivity in addition to more tubes than any other CB unit for more even distribution of gain, for greater immunity to variations in battery and line voltages and for greater AGC control. And that's not all — there are three .455KC IF stages plus a 6 Mc IF stage (16 tuned circuits) for better than 70 db adjacent channel rejection. Topping it all off, there's an ultra-sensitive noise limiter, supersensitive squelch, teflon wiring, steel case and weatherproof speaker. (It's no wonder that Poly-Comms are called the work horses of the industry).

The Poly-Comm Sr. 23 has the same basic guts of the N right down to the Nuvistor amplifier in addition to being the first set to bring "frequency synthesis" to CB . . . exclusive 23 channel crystal controlled tuning for immediate operation on all 23 CB channels. The features don't stop there . . . you can completely silence the Sr. 23 until one of your own units call . . . a nite-volume control monitors incoming calls at a pre-set volume . . . a message light indicates calls . . . an adjustable modulation control assures 100% voice modulation. Of course, there is an illuminated meter that indicates incoming signal strength, modulation and R.F. power output.

In every respect the Poly-Comms are designed by professionals for professionals that want value and rugged performance — not gingerbread and trim. We suggest you check the circuits yourself. Write for complete catalog and specifications.

Polytronics Lab, Inc.

388 GETTY AVENUE • CLIFTON, NEW JERSEY

*Registered trademark

READER MAIL



S9's FCC FILING

Tom:

All of the CB'ers in the Bowie area admire S9's stand on the FCC rule-change proposal. We, like other concerned CB'ers, believe that the FCC proposal involves a little matter of "freedom" to all U.S. citizens. Thanks.

Roy F. Brown
Bowie, Texas

CHOOSING YOUR MIKE

Dear Tom,

I have just finished reading "Choosing Your Mike" by Jim Gillespie in your March issue and liked it very much.

I am sure that there are many people confused on the subject of what microphone to purchase, not only of Jim's wife, but I'm sure that there are many Citizens Band operators who only know you have to push a button and talk.

Thanks for including Astatic microphones in your article and if there is any further information you require on our products, please drop me a note.

Robert Burdick
The Astatic Corporation
Conneaut, Ohio

GETTING PERMISSION

Hi Tom,

I would like to obtain copies of the "CB Flickers" photos on pages 24 and 25 of the February issue of S9.

George Masciarelli
Clinton, Mass.

Sorry George, the originals of those photos were loaned to us from the private archives of a leading motion picture organization and we had to return them right after their use.

HELP!!!

Sirs:

Can any S9'ers lend me a schematic of a Transpace Model C-27A CB rig? I understand that this company is no longer in business.

William Brooks, 12Q2424
1924 Evergreen Ave.
W. Sacramento, Calif.

PART 15 COMMENT

Editor:

Congratulations on your Part 15 Korner column. Before I first saw S9 I thought it was going to be "just another CB magazine," but it has now taken on real color to it with the addition of the Part 15 coverage. Even though I am a Ham operator, I am very interested in Part 15 and feel it will give me some real pleasure working on this band. My main interest is CW because of its increased range. I fully intend subscribing to S9, it's the official "Part 15" magazine (in addition to Part 19 CB) as far as I am concerned.

John C. Marty, W9BTZ
Kendallville, Ind.

WADDYA MEAN, "S9"?

Sirs:

I am a very pleased subscriber, but, pray tell, where did you get the title, "S9"?

Bill Voliva, 11W7036
El Cerrito, Calif.

We thought it was much better than "S8," Bill.

CALL AREA MAPS ANYONE?

Tom,

Where can I obtain a 1963 CB call area map?

Mrs. Marilyn Younger
Sarasota, Fla.

The only 1963 CB call area map ever to be published was included in the November, 1962, issue of S9. Some of these issues are still available from our Circulation Department at 50¢ each. The map contains all prefixes ever assigned to each area.

Nothing fits all your
 CB needs like
 Hallicrafters' versatile
 new transistorized CB-5



AC Pedestal Power Supply, Battery Pak and Tone-Coded Squelch accessories optional at extra cost.

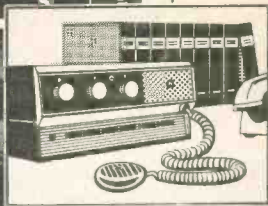

Wherever and however you use citizens band, no transceiver made gets around with the effortless efficiency and consistent high performance of the new CB-5.

A fraction over 3 inches high, 10 inches wide and 8 inches deep, its 18-transistor design solves all normal space problems in mobile or airborne use.

Weight: 6¾ lbs. It has no vibrator, of course, and battery drain is negligible.

Specifications: 5 watts in; 100% modulation capability; 6 crystal-controlled channels; 1 μ v sensitivity for 10 db. S/N ratio; 45 db. adj. channel rej.; PTT ceramic mike; 6 kc. selectivity at 6 db.; 18 transistors, 9 diodes, 3 instant-heat transmit tubes. Price: \$199.95.

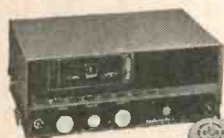

Hallicrafters CB-3A . . .
Unsurpassed for range
and reliability. \$159.95.

- 8 channel, crystal-controlled convenience.
- Dual conversion for maximum rejection without loss of sensitivity.
- Optional S-Meter and "Racket Buster" Noise Eliminator with knock-out front-panel mounting.
- 100% modulation capability; output over 2 watts; 6 kc. selectivity; sensitivity less than 1 μ v for 10 db. S/N ratio.

the new ideas
 in communications
 are born at . . .



hallicrafters

5th & Kostner Aves., Chicago 24, Ill.

Overseas Sales: Contact Export Dept., Hallicrafters.
 Canada: Gould Sales Co., Montreal, P. Q.

It's Bound To Be The Best ...It's A Browning

... all tube circuitry assures famous Browning base station quality and performance of Drake mobile unit!

NEW BROWNING DRAKE

... the smallest 23-channel mobile transceiver you can buy — has tube circuitry for utmost reliability.



Here's the one you've been waiting for — the Drake mobile unit designed and manufactured by Browning with the same components, tubes and features found in our base station equipment. Two models available for 6 and 23-channel operation. Crystal controlled transmit and re-

DRAKE M-523 8" x 3" x 9"

ceive, plus fine tuning. Price includes all crystals factory installed (on M-523), microphone, and DC transistorized power supply. Six-channel Drake M-506 also available. Same features as M-523 except six-channel operation.

The Greatest Pair On The Air

... for CB'ers who demand the very best.



R-2700-A BASE STATION RECEIVER

R-2700-A is the world's most up-to-date CB receiver. Has antenna tuning control; planetary ball drive all-channel tuning control; silicon rectified power supply. Selective, sensitive, sensational!

For detailed information, send for free copy of full color catalog. Browning Laboratories, Inc., Dept. S9 100 Union Avenue, Laconia, New Hampshire.

23/S-NINE brings all-channel operation to your base station. Has standing wave indicator; Pi network circuitry; TVI trap; spotting switch and many other features that make it "the talk of the airwaves". Also available: Famous S-NINE and Compact transmitters.

23/S-NINE BASE STATION TRANSMITTER



browning

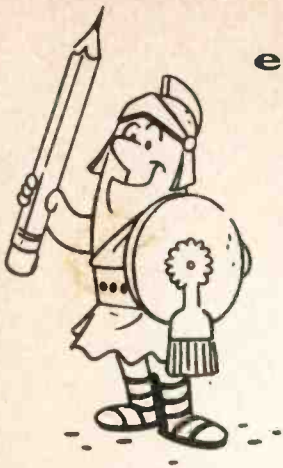

editorial

KBG4303 rides again!

by TOM KNEITEL

EDITOR, S9
300 WEST 43rd STREET
NEW YORK 36, N. Y.

BRANCHING OUT

Considerable reader mail has indicated that today's CB'er is keenly interested in and aware of the goings on between the microphone connector and the antenna socket of his rig—after all, it's almost impossible to be in contact with something as fascinating as electronics for very long without wanting to learn more.

S9 has always tried to encourage this, giving our readers copious amounts of Stoner, Noll, Friedman, Buckwalter and other professionals. From what we hear from you, you have really put the "meat" of these articles to good use—many of you have recently become avid SWL's (short wave listeners), active Ham operators or budding new "Second Class Radiotelephone Licensees."

Last month we casually mentioned the fact that we would welcome readers to send in articles for possible publication in S9. In the articles came, from Macon to Medicine Hat. Guess what? A healthy segment of the articles were concerned with all manner of clever electronics gadgets and ideas—*non-CB!*

Of course, CB features were in the majority, but WOW! those others. Real experimenters' stuff, simple to construct and very useful gear.

Obviously, this is what's on your minds out there. So we came to a decision on the subject. From time to time we will run some of these articles under the heading "An Experimenters' Special." We think that you will like these features and find them to be of genuine value.

OLD BUDDIES

Back in the "bad old days" when we toiled as a disc jockey and studio engineer at now-

defunct radio station WTTT in Coral Gables, Fla., our writing efforts were given great encouragement by Wes Wolfe of the station's staff. Last week, after lo these many years of silence, Wes dropped up to the S9 offices.

Wes, as fate would have it, is now a CB'er. It's funny how CB seems to "hook" all of us sooner or later. Wes is only one of many long lost buddies to turn up as a CB'er after many years of silence. Has this ever happened to you?

PART 15

We put one of those International Crystal EXECUTIVE 1500 Part 15 rigs on the air a few weeks ago. Prior to that we were using a homebrew rig without all of the refinements of the 1500.

We worked quite a few stations using both fone and CW but, unfortunately, there weren't any band openings which would have given us a chance to work some skip. There should be plenty this summer.

You know, we're issuing Part 15 identifiers at the rate of more than 1000 per month now and as a result, there are some 5000 Part 15's out there in CB land. Many Part 15 clubs are formed and we understand that there are about a dozen intra-city Part 15 networks already in operation.

All-in-all, Part 15 is a ball and it really is a kick to find that you can really "get out" with such low power. If you hear NORTHERN 13 on the air, give us a call!

NEXT MONTH

See, last month we promised you a snazzy "Mobile Handbook" issue and we came through. Now here's something to look forward to for next month: a wild-wild-wild antenna issue.

Continued on page 58

NEW FROM HEATHKIT

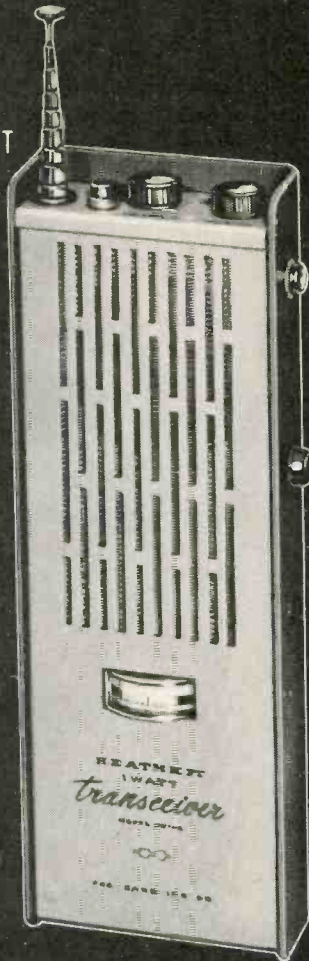

1 WATT WALKIE- TALKIE

ONLY \$74.95
ea.
Includes \$20 heavy-duty
rechargeable battery!
Order a pair and save!
Only \$139.95

Attention CB fans! Here is a tremendous new value in a portable two-way radio transceiver! . . . the new Heathkit GW-52. Nowhere will you find a transceiver of such outstanding quality, with so many high performance features at so low a price! Designed for rugged duty and reliable two-way radio communications over extended ranges, the new Heathkit GW-52 features a powerful 10-transistor, 2-diode circuit . . . long-range transmitter with 1-watt input . . . sensitive superheterodyne receiver with 1/2 microvolt sensitivity for 10 db signal-to-noise ratio . . . crystal-controlled transmitter and receiver . . . built-in squelch and automatic noise limiter for crisp, clear communications . . . a heavy-duty 10-cell rechargeable nickel-cadmium battery with 500 milliampere-hour rating that will outlast conventional batteries many times over . . . built-in battery condition meter . . . built-in battery charger . . . "Solid" communications may be established at angles of three to five miles between units and even more when used with Class "D" CB stations or external antenna. Batteries may be charged from 117 VAC source with built-in charger or from 12 volt car battery. Battery life is 1500 hours minimum (90% receive, 10% transmit duty cycle) and life expectancy is as high as 5000 hours (over two years in normal workday use) . . . a tremendous savings in operating costs! Easy circuit board assembly. Complete with two-tone aluminum case, shoulder and elastic hand straps, crystals for one channel (specify), rechargeable battery, power cords, earphone, FCC license pack and instructions. Order a pair and save!

Kit GW-52, 4 lbs., no money down, \$8 mo. \$74.95 ea. Kit GW-52-2 (pair) 8 lbs., \$13 mo. \$139.95



FREE 1963 HEATHKIT CATALOG
100 pages, over 250 easy-to-build kits to fit your hobby, to give you better equipment at 50% savings. Send for your free copy today.

HEATHKIT

a subsidiary of Daystrom

HEATH COMPANY
Benton Harbor 43, Michigan

Please Send My Free Heathkit Catalog

Name

Address

City Zone State

Prices & specifications subject to change without notice. Dealer & export prices slightly higher.



KILL THAT MOBILE NOISE!



EVEN IN FOREIGN CARS & OTHER STUBBORN CASES

by CHARLES SCHAUERS

Foreign cars are notorious for the radio noise which they generate, anyone who has tried to operate a CB rig in one of these imported devils can attest to this.

This is in addition to other non-imported cars (sports, compacts as well as standard size vehicles) which never seem to be fully rid of the assorted *whines*, *buzzes*, *crackles*, and *pops* which infest the loudspeakers of CB rigs mounted therein. In addition to actually "noise proofing" the VW, Porsche, MG, etc., we have taken the time to contact those who are responsible for the proper operation of radio equipment in various types of vehicles. Piecing together each bit of good solid advice and technical information and then trying out various suggested techniques resulted in a high level of success.

But believe it or not, *no two vehicles of the same make* always required exactly the same elimination measures! So this article is directed in a general way toward the measures which have been found effective; with suggestions for a few "cut and try" procedures for the various makes.

Vehicular noise can be caused by: the ignition system; the generator; wheels; loose metal mass such as fenders, hood, etc.; improperly grounded coaxial antenna feeder; loose or defective light bulbs; defective door-

light, ignition and headlight switches; voltage regulator "feedthrough"; "floating grounds" (as found on the instrument panel); corrosion of electrical contacts through galvanic or electrolytic action (when two dis-similar metals are brought together under moisture conditions); loose bonding strips at the engine proper; and tires or brakes.

Noise is of two types, either conducted or radiated. Radiated noise is usually from the ignition system while the conducted can either be from the ignition system, generator or mechanical parts.

In the VW and other cars with rear mounted engines, radiated interference is the big headache. This is so because the antenna is usually installed on the rear close to the engine and its ignition system. But have hope, it can be licked!

Many sports car enthusiasts want their car engines to deliver maximum power at all times and often shy away from using resistor sparkplugs such as those manufactured by Autolite. REAL tests indicate they have nothing to worry about if resistor plugs are cleaned and checked every 2500 miles. Yes, there is a tendency for the built-in resistors to change value over a period of time but not so much that the change cannot be tolerated.

So the first thing that must be done in

eliminating the noise generated by the ignition system in any car is to install resistor plugs. Make certain that the connections to all plugs are solid; do not depend upon wire crimped lugs—solder them.

In the VW, a resistor loaded distributor rotor is a *must* and can be obtained from Robert Boschs Corp., 225 7th Street, San Francisco 3, California. The stock number is ZVVT5Z5Z.

Before installing the new resistor rotor however, make certain that the distributor cap contact points are clean and even.

The next thing to do (on all cars) is to install a Sprague 48P18 Hypass feed-through type VHF bypass capacitor. This condenser is rated at 40 amps and is connected in series with the generator output lead—NOT THE FIELD LEAD! Make sure that it is grounded to the generator frame proper. On the VW and Porsche 1600 there is plenty of space by using existing mounting holes.

Shield the two "hot" or supply leads to the high-tension coil and install *two* Sprague 80P3 condensers in series with *both* leads. Install the condensers as close as possible to the coil and distributor. Make certain that the shielded leads are grounded at both ends near the condensers.

Install a Mallory AS 145 (.1 mfd) on the engine (VW) as close as possible to the oil signal switch and connect one lead to the top screw. MAKE CERTAIN you do not break the seal.

Bypass the ignition switch (all cars) with a Mallory AG451 condenser (.5 mfd). Bypass the input lead to the light switch with the same type of condenser. (Ceramic condensers may be used on the MG with success.)

A trap consisting of number 8 enamelled wire is wound on a 1 inch form and shunted with a 3-35 mmfd compression type condenser. Grid dip the assembly prior to installation for the band you are interested in and install it in either one of two circuits. If you have generator whine, connect it in series with the condenser (48P18) and adjust for minimum noise. If you are bothered with "ignition ringing," install it in series with the hot lead leading to the distributor—not the high tension lead. For the 11 meter band about 8 turns of wire are sufficient for the coil.

Now try the installation. If you still have noise, do this: in the VW, bypass the license plate light with a 1 mfd Mallory AG452;

place a piece of copper screen over the wires in the engine compartment leading to the front of the car (make sure the screen is grounded at a number of points); in some installations, shielding of wires leading from the engine compartment has been found effective.

Try your receiver again, if you still have noise check for loose connections on *all* lights; check bulbs by substitution (not for light but for noise); push in the brake pedal and see if that stop the noise. If it does, take another AG452 Mallory condenser and bypass the brake switch.

If your antenna is mounted on the left rear, move it over to the right rear. Doing this solved one ham's noise problem after all other measures failed.

Make sure that your coaxial cable going to the antenna is grounded TO THE CAR FRAME! NOT THE FLOOR PLATE ON THE VW.

If you have regulator noise, wind a coil of about 40 turns with Number 16 bell type wire (double cotton coated) and install this coil at the regulator terminal (series) and place a 4 ohm resistor in series with a .002 mfd ceramic across the field terminal to ground. NEVER use either one alone! The coil diameter can be either 3/4" or 1".

Still noisy? Then suspect the choke control (on the VW). Make sure it as well as other mechanical rods, etc.) are bonded to the FRAME. But this bonding is the last resort because it is so hard to do.

Noise elimination is not an easy task if it is to be effective. Recognizing the various noises helps. Electro-mechanical noise is better found on real rough wash-board type roads where there is lots of vibration. Generator noise can be identified by slipping off the fan belt for a few seconds; this noise will not be present if the generator is not turning and usually is a fairly high pitched whine like that of a sewing machine; wheel or tire static can be identified by turning off the engine and coasting, it will usually have a peculiar "impulse" type sound and will vary in frequency as the car is slowed down or speeded up.

When the ignition switch is turned on (without motor running) and there is noise, you can safely bet that you have a loose or arcing connection or a connection thermally or galvanically affected.

In cars with rear-mounted engines, make certain that the door or hood which covers the engine is making good electrical contact at all times. To check this, use some aluminum foil (such as is used in the kitchen) and make a few wedges out of this material which are inserted between the hood (cover) and the car proper. If this stops the noise, shield braid may be soldered to the cover and the inside of engine compartment and left long enough so that the cover can be opened and closed easily.

Those cars having ammeters, tach gauges, etc. present more trouble. All electrically operated gauges must be bypassed with at least .5 mfd condensers; this being especially true of gas gauges.

Speaker leads should be shielded (when the speaker is not an integral part of the set—if you are using a converter). Leads to antenna switching relays, electrically operated loading coils, etc., should be shielded.

If you are an "unbeliever" in resistor plugs, shield each plug cable as well as those to the high tension coil—aircraft fashion. This is a lot of work, however, and requires careful grounding.

In the MG and Porsche, make certain that tailpipes are bonded properly and not floating (in part). Because a mechanical (or electrical) member is grounded at one end does not mean that it is always *effectively* bonded. In the 300 SL (Mercedes), check for proper engine bonding before you do anything else.

One piece of aluminum foil wrapped around the middle of the high tension (center) lead of a distributor on a Porsche, and grounded with a piece of wire cut the ignition noise to a listenable level. The foil was taped to the lead and gave no trouble.

Wheel, tire and brake static are easily eliminated. High conductance graphite powder is squirted into tires; this usually eliminates tire noise. Wheel and brake noises are usually eliminated by utilizing pressure springs inside of hub caps. American made pressure springs can be cut with a pair of good tin shears to fit into foreign hub caps (wheel bearing caps).

There are few easy approaches to complete noise elimination. However, if the above measures are taken, you can sail down the highway only hearing the other fellow's noise and the interference from commercial power supply systems.



THIS MISTAKE IS NUMBER 11 OF A SERIES



We finally decided to have an S9 stamp issued in honor of our forthcoming first anniversary—some of them are pictured above.

Wouldn't you just know it, such a big occasion and someone goofed at the print shop. Yup, a very few of these stamps were run-off with the centers inverted. This is pretty embarrassing to us, naturally, and we would like to make it up to you in some way if you were one of the unfortunate ones who received an "inverted" issue.

What can we do? Well, we can let you kick us while we're sulking with the miseries by offering you a subscription to S9 for the ridiculous pittance of only \$5 for a full year! At this price we will probably lose money and will survive only because of the great volume of orders we will get as a result of the printer's goof.

Alright, so there it is. Your BIG chance to subscribe to the leading CB publication in the nation—true, it has more pages; true, it has more articles; true, it has cornered the market on all of the top professional authors—but to have you get involved in this behind-the-scenes big-time New York publishing company scandal, it's just too terrible.

If you don't subscribe, you won't be "in" on our future mistakes, and won't you be the sorry one when all of your friends are having a good laugh and you're still a grouch!

Go ahead, take advantage of us. Do it NOW while we're suffering. Use the postage-free envelope between pages 48 and 49.



300 West 43rd Street New York 36, N. Y.

FLEET COURIER



NEW, EASY-TO-USE COMMERCIAL CB

Here's low cost, reliable, 2 way radio control for transportation, trucking, taxi, marine and agriculture operations . . . large or small, independent or fleet! This good looking, rugged transceiver gives dependable, drift-free contact . . . whether mobile or base. There are no circuits to tune, no complex operations. It's another quality-first from e.c.i., makers of the famous Courier 1M.

Check These Features:

- 5 CHANNEL TRANSMIT & RECEIVE
- 3.5 WATTS OUTPUT
- GLEAMING CHROME CABINET
- NOISE-CANCELLING MIKE
- SIMPLE 3 KNOB CONTROL
- \$159.50 LIST*

F L A S H ! FLEET COURIER-30B NOW AVAILABLE FOR 30 WATT BUSINESS AND INDUSTRIAL RADIO SERVICE (FCC TYPE APPROVAL APPLIED FOR). \$229.50 LIST

Write For Full Details. Dealer and Distributor Inquiries Invited.

**Slightly higher west of the Rockies*



e.c.i. electronics communications, inc. 325 no. macquesten pkwy., mt. vernon, n. y.

THE UNPERPLEXED DUPLEXER

TWO MOBILE ANTENNAS FOR THE PRICE OF ONE

by HERB FRIEDMAN, 2W6045

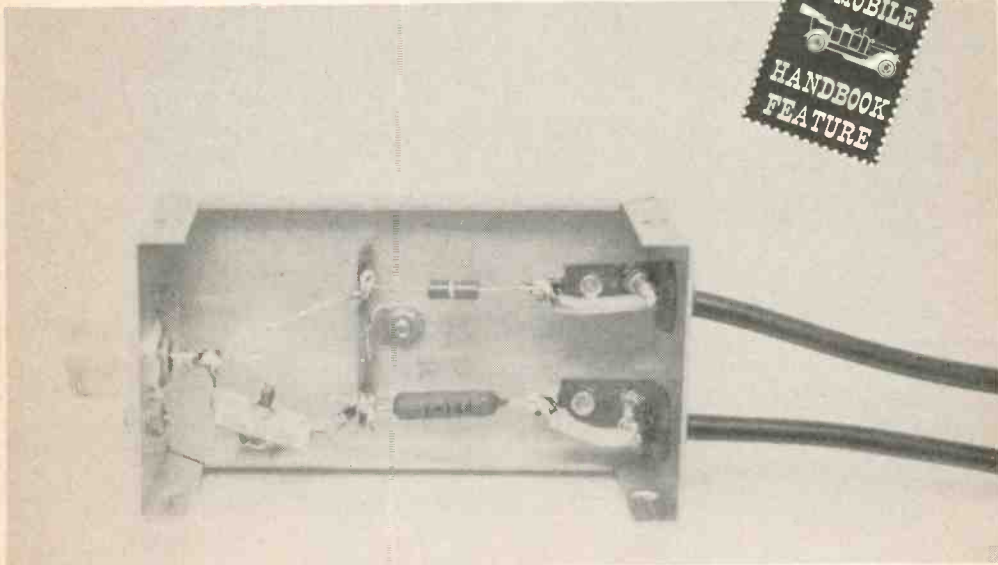

Back in the early days of CB an operator wouldn't be caught dead without a full-length whip. Of course, some had to give in to the XYL but the 108 inches of steel was the thing. After the initial burst of enthusiasm died and many CB'ers realized they could lose up to seventy-five bucks on trade-in for a body mount hole, or they had to keep lowering the whip to get into garages the short efficiency-loaded whip became very popular. Today, the short whip, which mounts like a standard auto antenna is most popular. Now is the time to go one step further and keep the car looking like a car, not an antenna farm.

With an antenna duplexer you can now use one antenna (CB) to handle both the CB transceiver and the auto radio. The duplexer is a device which automatically switches the antenna between the transceiver and the radio; actually, you can listen to the radio while your passenger uses the rig—how's that for convenience—all from one antenna.

Fig. 1 shows a low cost, easy to build duplexer. There's no wiring difficulty other than

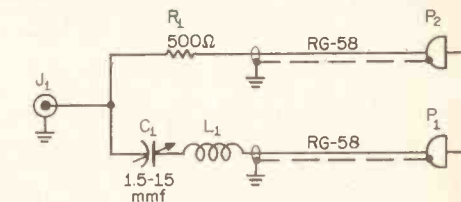

PARTS LIST

- R₁ 500 ohms, 1/2-watt, see text
- L₁ Ohmite Z-144 choke.
- C₁ 1.5-15 mmf trimmer, Arco 460 or equiv.
- J₁, P₁, P₂ see text
- Misc. Cabinet, coaxial cable, terminal strips, etc.

the usual associated with RF (mobile) connections; secure everything with lockwashers and make good solder joints.

J₁ and P₁ are coaxial connectors which mate with your existing equipment, P₂ mates with the auto radio connector. The connecting cables must be no longer than two feet, the shorter the better, use either RG-58A/U or RG-58/U.

Don't try to crowd everything into a sub-

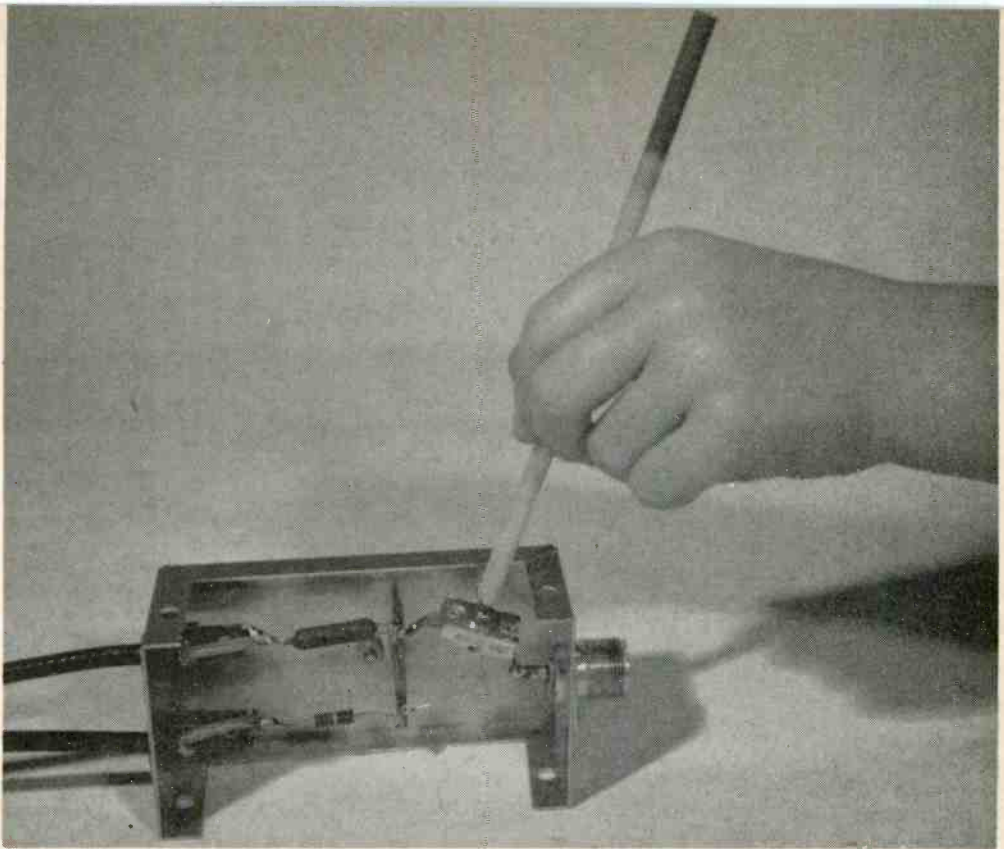

An insulated alignment screwdriver must be used when adjusting the duplexer. Adjust C_1 for minimum SWR, or maximum field strength.

miniature box, for maximum ease of construction a 2 x 1½ x 4" Bud *Minibox* is suggested. The unit shown is rock-bottom priced and there is a *slight* loss in BC performance. If you want to go for another half-buck you

can pick up the BC performance by replacing R_1 with a 22 microhenry, ferrite core RF choke.

Connect the CB antenna to J_1 , the transceiver to P_1 and the BC radio to P_2 . You must adjust C_1 *properly* or the CB rig will work neither receive or transmit. The best method is to connect an SWR meter into the line, turn the transmitter on and with an *insulated* alignment screwdriver adjust C_1 for minimum SWR; the duplexer will have no adverse effect on performance if the adjustment is carefully done.

If you do not have an SWR bridge C_1 is adjust for maximum field strength *from the antenna*. Be certain to place the FSM on the sidewalk as far as possible from the rig. Do not set the FSM on the car, you might read the internal radiation from the rig not the antenna, and if C_1 is incorrectly adjusted the rig will show RF while the antenna won't.

After adjustment is completed place the cover on the *Minibox* and mount the duplexer, preferably to the transceiver or fire-wall, don't let it hang.



"Don't mind us, Mrs. Smythe, we're just helping your husband put up the new beam."

FEATURE FOR FEATURE — DOLLAR FOR DOLLAR YOUR BEST BUY IN CB RADIO

THE NEW RCA MARK VIII

27-Mc CITIZENS BAND 2-WAY RADIOPHONE

UP TO 9 FIXED, CRYSTAL-CONTROLLED TRANSMIT-AND-RECEIVE CHANNELS. PLUS ALL-CHANNEL TUNABLE RECEIVER.

CONVENIENT ACCESS TO CRYSTALS FOR QUICK CHANGING.

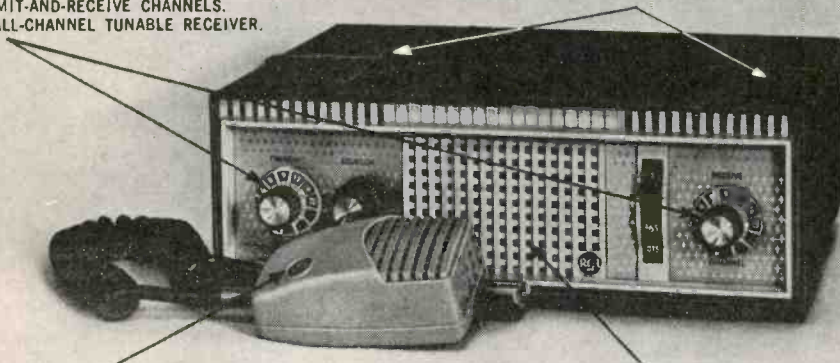

PUSH-TO-TALK CERAMIC MICROPHONE with coiled cord.

EXCELLENT VOICE REPRODUCTION—high intelligibility.

EXCELLENT TRANSMITTER MODULATION CHARACTERISTICS

IMPROVED AUTOMATIC NOISE LIMITER reduces effects of ignition and similar interference.

COMPACT AND LIGHTWEIGHT 3½" high, 9 pounds. Fits easily under any auto dashboard.

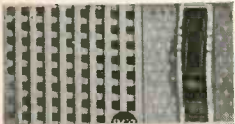

Continuously tunable receiver picks up any of the 23 C-B channels. Tunes either by channel number or frequency.



Illuminated working channel. Pilot lamps behind the fixed-channel dials show the channels being worked.



Separate mobile power supply. (Optional) 6- or 12-volt, for car or boat. All units contain AC power supply.



Channel-marker kit. Select channels best for your area, then mark them with the self-adhering labels included.

ONLY \$149.50*
*OPTIONAL LIST PRICE

Get all the Facts Before You Buy,
Mail Coupon Today. Paste on 4¢ Post-Card.

RCA ELECTRON TUBE DIVISION
Commercial Engineering Dept. E-132-R
415 South Fifth Street, Harrison, N. J.

Please send more information on the RCA Mark VIII C-B Radiophone

Name _____

Address _____

City _____ Zone _____ State _____



The Most Trusted Name
in Electronics

THIS MONTH'S BRAINWASHING: *Subscribe!*

May 1963 • 59 • 15

Build The

"Magnificent 7"

by RON GIRARD, 7Q2024



SEVEN SIMPLE 1-EVENING MOBILE PROJECTS

Here are seven handy one evening construction projects for the mobile CB operator (if you're a base station CB'er we won't squawk too loudly if you want to make use of some of them along with the mobileers).

Most of these projects center around semiconductors (transistors, diodes, etc.) which are readily available and easy to work with. Grab those smoldering soldering guns boys, here are some useful projects which will add not only to the convenience of your mobile CB'ing, but also to your working knowledge of electronics.

PROJECT No. 1. SPEECH CLIPPER

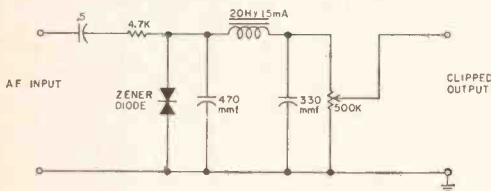

The easiest-to-build of the projects is a speech clipper employing a zener diode. This diode will clip both the positive and negative modulation peaks. The zener diode chosen should be chosen to be $\frac{1}{2}$ to $\frac{1}{3}$ the value of the peak audio input voltage. The 4.7K resistor is used to limit the current when the diode arrives at its conduction voltage. A low pass filter follows the clipper to attenuate frequencies above 3,000 cycles that are generated by clipping action. The output is adjustable and as much as 20 DB of clipping can be used before the readability suffers.

PROJECT No. 2. MOBILE THIRD HAND

This is a small but nice item to have when operating mobile. It acts as a third hand for adjustment of the gain control as the speed of the car is increased.

With mike in one hand and having to more-or-less control the car, your wife, the kids, the transceiver, it makes for too many extra hands. This unit will aid in the adjustment of the gain control on the receiver.

The pot can be anything from 50K to 100K ohms and before anything else is done, spray it with weather protection like *Glug* or *Krylon*.

The aluminum is light enough to be bent around the shaft, which should be the long style, and secured with the screws.

The next step is to mount the unit between the radiator and the front grill with wires running from the pot to the volume control of the rig.

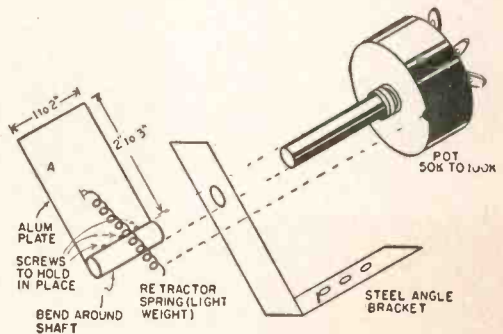

After all adjustments have been made you're free and clear for good reception no matter what your speed may be, the wind blowing around the windows will not bother the volume of the receiver because the gain will go up as the speed is increased. The spring will return the gain control to normal or decrease gain as speed is slowed down. If the unit does not function properly, you can vary the size of the aluminum plate for better wind pickup or you can experiment with springs of different strengths.

PROJECT No. 3. MIKE PREAMP

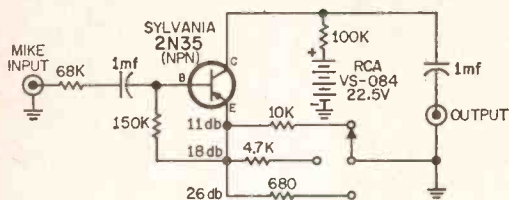

Project 3 is a high gain single transistor mike preamp which can be constructed in a small Bud *Minibox*. The transistor indicated in the schematic is a 2N35, but you should get good results with any of the following types if a '35 isn't handy or available: 2N169, Tung-Sol ET-10, General Electric GE-8, General Transistor GT35, Semitronics NR5, Workman SK7, Sylvania SYL103.

The switch will vary the gain from 11 to 26 DB. A 40 DB gain is attainable if the 68K resistor is eliminated.

PROJECT No. 4. SQUELCH ADAPTER

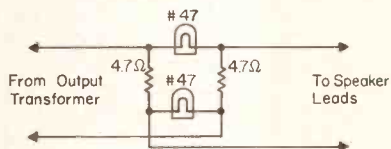

Those of you who use converters in conjunction with your standard AM broadcast receivers for mobile use won't be troubled with too much ignition noise and therefore won't have to make use of additional noise limiting, however you will be bothered by lack of squelch circuit. This is also true if you intend using your existing AM broadcast receiver for use with the MOBIL-MITTER transmitter.

Here's a simple squelch unit which will give surprisingly good results on any receiver which doesn't already include one, be it AM, communications type, CB, superhet or superregen.

The entire circuit can be constructed on a 4 lug terminal strip and consists of nothing more than 2 #47 pilot bulbs, 2 resistors and the strip.

The unit is installed by cutting the existing speaker leads and soldering the squelch at the cut point as indicated on the schematic. With no signal you should have complete silence. A signal will allow the audio to pass from the transformer into the speaker.

There is some loss in audio to be expected as a result of using this squelch, although this is easily compensated for by increasing the audio gain.

PROJECT No. 5. MODULATION INDICATOR & FIELD STRENGTH METER

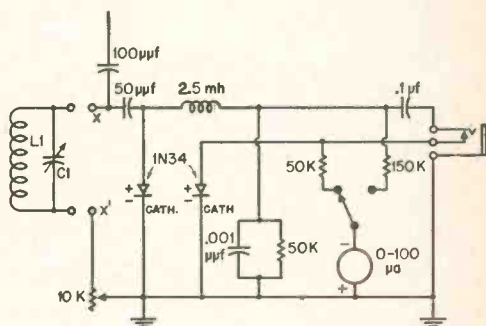

This is a handy little gadget that is simple to build and yet is very effective. While a 0-100 microammeter is shown, a larger meter will work but will lack the sensitivity. The whole unit is easily assembled in a small Bud *Minibox*.

With the SPDT toggle switch thrown to the right, the carrier level is indicated on the meter. This reading may be varied by adjusting the 10K pot. Once set, it will always remain the same. Throwing the switch to the left brings the meter back to a zero setting, and then any modulation will be shown as an upward reading. If hum or noise is present on the carrier, it will also register on the meter under *no modulation* conditions.

An idea of the percentage of modulation may be obtained, since 100% modulation is represented by the meter reading obtained with the switch thrown to the right. Mead-phones plugged into the jack allow the signal to be monitored.

The modulation measurements are made with a "short" across the points marked with an "X." When this short is removed and a

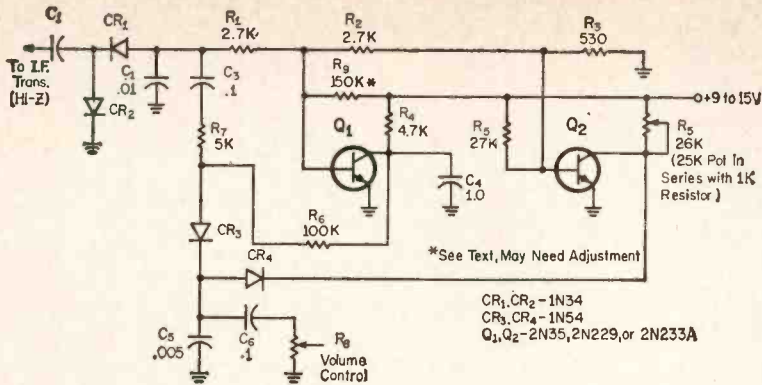

tuned circuit substituted, the gadget will read field strength. The tuned circuit consists of L_1 (a Miller 9320-18) and C_1 (a 20 mmfd. variable).

PROJECT No. 6. TRANSISTORIZED "TNS" NOISE SILENCER/SQUELCH

Alright, so you have a transistorized CB rig and you've written to ask "what about a 'TNS' for me?" The tube version was described in detail in our August, 1962, issue on page 18. The device has the characteristics as the TNS in addition to providing the additional features of full limiting and receiver compression.

The parts used in the construction should be as small as possible. The size 0.1 mfd. capacitors were tried but they proved unsatisfactory because of noise pulse radiation and pickup, due to their large size. Parts are mounted on both sides of a phenolic sheet measuring 1¼" by 2½" by drilling holes in the proper locations. Transistors and diodes are soldered in last, using short insulated sleeving over the leads. Use tweezers or long nosed pliers to hold the leads while connections are being made to prevent damage or change in semiconductor characteristics.

Both transistors should be the same type.

The squelch threshold adjustment characteristic can be varied by slight changes in R_3 , R_4 , and R_6 . A higher output from the receiver IF requires higher bias on the transistors. Resistor R_8 should be selected to give a "no signal" collector current of 1 to 3 ma. through Q_2 .

Note that a positive supply line has been used since most automobiles have the standardized negative ground.

PROJECT No. 7. PART 15 BOOSTER

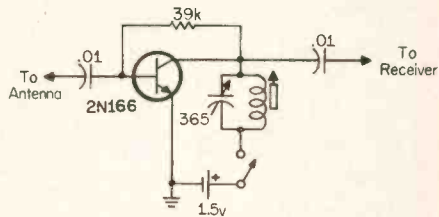

While this little receiver-booster was designed for use with the MOBIL-MITTER described elsewhere in this issue, it will soup-up any receiver covering the frequency range of 540 to 1700 kc/s. It actually adds an extra stage of RF amplification.

The booster is installed between the receiver antenna terminal and the antenna, or in the case of the MOBIL-MITTER (if the same antenna terminal and the receiver side of the relay).

Construction is extremely simple and the booster goes together in a very short time with no headaches. Build it in a small Bud Minibox and mount it near the receiver (preferably with the Minibox grounded to the metal cabinet or chassis of the auto radio).

Other transistors which will perform well in this circuit are: 2N94A, 2N139, 2N170, Tung Sol ET-9, General Transistor GT948R, Semitronics NR5, Workman SK7. The coil is a Miller 6300 High-Q ferrite type. The capacitor is a Lafayette MS-214 midget 1 gang variable.

In operation, the unit is hooked into the circuit as described above and the receiver is tuned to the desired frequency. The variable capacitor and the slug in the coil are then tuned for maximum signal.

HERE'S HOW POPULAR ELECTRONICS SCORES THE HAMMARLUND CB-23

| BOX SCORE | | | | |
|----------------|-----------|------|------|------|
| | Excellent | Good | Fair | Poor |
| Talk Power | ✓ | | | |
| Selectivity | ✓ | | | |
| Sensitivity | ✓ | | | |
| Squelch | ✓ | | | |
| Noise Limiting | ✓ | | | |
| Stability | ✓ | | | |
| Operating Ease | ✓✓ | | | |



We tried, but the Popular Electronics editors said it so much better:

"Here's a CB transceiver that deserves the accolade: 'something new under the sun'."

"With no extra crystals to buy (and possibly misplace) the CB-23 puts the CB'er about as far up the ladder of 'operating convenience' as he can expect to go."

"The double conversion receiver section is so sharp that it has a vernier tuning adjustment on the front panel for zeroing in the other station on receive."

"IN BRIEF—A TRULY PROFESSIONAL CB RECEIVER—BUILT TO LAST"

Remember, the one low price of \$229.50 buys a complete, ready-to-go unit which includes all crystals, S-Meter, squelch and cables for both 117v. AC and 12v. DC operation. All you need is the antenna and you're on the air!

See for yourself—send today for a reprint of Popular Electronics' Equipment Report, together with descriptive literature on this outstanding unit.



AMATEUR RADIO EQUIPMENT
 COMMERCIAL
 COMMUNICATIONS EQUIPMENT
 OUTERCOM 2-WAY RADIO
 VARIABLE AIR CAPACITORS
 SUPERVISORY REMOTE
 CONTROL SYSTEMS

HAMMARLUND Manufacturing Company.

A Giannini Scientific Company
 53 West 23rd Street, N. Y. 10, N. Y.

Please rush Popular Electronics' CB-23 Equipment Report and descriptive literature to:

NAME _____

ADDRESS _____

Build the

MOBIL-MITTER

MINIATURE TRANSMITTER

PERMITS COMMUNICATION WITH NEARBY VEHICLES

by **JIM GIBSON, 2W7610**

Now and then, just about everybody takes off on a motor trip accompanied by one or more vehicles. If all vehicles are CB-equipped, there's no problem in keeping in touch. If they aren't—tough luck! Besides, with FCC rules governing permissible communications of Part 19 stations, there's a good chance that your chatter about *Howard Johnson's*, who's running low on gas, etc., will earn you a "wish you were here" card from an FCC monitoring station.

Here's a novel solution—a miniature Part

15 (no license needed) transmitter which not only permits you to chit-chat to your heart's content, it gives you a communications system for only the cost of a 2 tube transmitter. This is because the MOBIL-MITTER issues forth signals on the standard broadcasting band which can be received on any vehicle's existing broadcast radio.

The unit is constructed in a Bud CU-3005 *Minibox* with the tubes mounted on top. The unit's self contained batteries are housed within the *Minibox*.

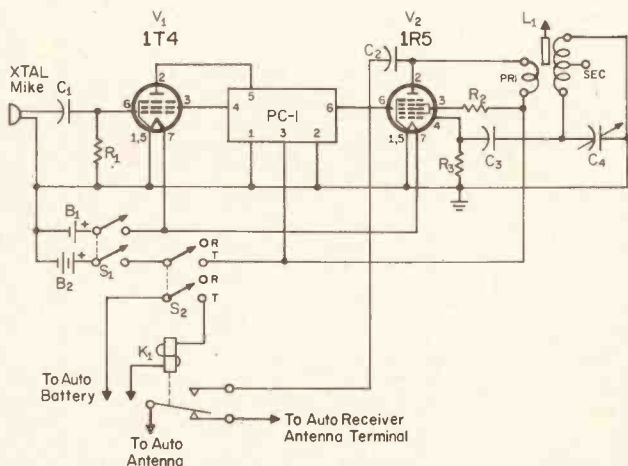

PARTS LIST

- C₁ .005 mfd., 200 v. capacitor
- C_{2, 3} 100 mmfd. tubular ceramic capacitor
- C₄ 50-380 mmfd. trimmer (Lafayette C-375 or Allied 60L344)
- R₁ 10 Meg., ½-watt resistor
- R₂ 3.9 K ohm, ½-watt resistor
- R₃ 100 K ohm, ½-watt resistor
- L₁ Miller 70-OSC min. RF coil

- K₁ P&B MC5D relay (6 or 12 volt types)
 - PC₁ Centralab type PC-91 encapsulated circuit
 - S_{1, 2} DPST toggle switches
 - V₁ 1T4 tube
 - V₂ 1R5 tube
 - B₁ 1½ volt "A" battery (Eveready 720)
 - B₂ Two 90 volt "B" batteries (Eveready 415) in series
- Crystal mike, Bud CU-3005 Minibox, misc. wire, sockets, hardware.

**CERTIFICATE OF COMPLIANCE WITH
FEDERAL COMMUNICATIONS COMMISSION
REGULATIONS, PART 15, PAR. 205**

S9 Magazine certifies that this low power transmitting device can be expected to comply with the requirements of Paragraph 15.205 of the FCC regulations under the following conditions: (A) When this device is assembled according to the diagrams and instructions published by this magazine, using components of the exact specifications described. (B) When in use for the purpose and in the manner indicated in the Instructions. (C) When operated on a frequency between 510 kc/s to 1600 kc/s and using an antenna limited to a single element not more than 120" long.

Thomas S. Kneitel

S9 Magazine, New York 36, N. Y. Dated: April 15, 1963

I hereby certify that I have assembled and adjusted this device in strict accordance with the above.

Owner's signature.

Date:

The finishing touch! To comply with FCC regulations it will be necessary for you to sign this tag, cut it from the magazine, and paste it firmly on the rear of the unit.

A lucky break for the CB constructor comes from the use of an encapsulated printed circuit — a complete sub-miniature circuit sealed into a composition material. It looks like a rectangular ceramic capacitor with six leads. Inside the capsule are 3 resistors and 3 capacitors, all wired together and waiting for you to hook the leads into your circuit. This is a great time and effort saver and the circuit board costs only about 90¢ from Lafayette, Allied and other major suppliers. The board used in this circuit is a Centralab type PC-91 (do not substitute). The schematic diagram indicates the lead numbers on the circuit board and their proper connections.

All components are mounted inside the *Minibox*, keeping all leads as short as possible. The crystal microphone is wired directly into the circuit.

You will be able to use the existing auto antenna for both transmitting and receiving by the installation of relay K_1 . When switch S_2 is in the *transmit* position, the relay is switched so that the auto antenna is connected to the MOBIL-MITTER. When the switch is in the *receive* position, the relay is in its relaxed position and connects the auto radio to the antenna. Naturally, the existing connection from the antenna terminal of the auto radio to the antenna will have to be broken and each component connected to the relay S_2 also kills the B+ in the MOBIL-MITTER during receive periods, permitting battery conservation. Relay K_1 is operated from the auto battery. Use a Potter & Brumfield MC5D relay, there are 6 and 12 volt types.

The controls which will extend through the panel of the Minibox are: the on/off switch (S_1), the transmit/receive switch (S_2), and the frequency selector (C_1).

With a receiver tuned to the frequency which you have selected for your communications, and an antenna not more than 10 feet in length (including lead-in) connected to the MOBIL-MITTER, tune C_1 while speaking into the microphone. You should hear your voice come through the receiver as C_1 tunes the MOBIL-MITTER to the receiver's frequency. Next, peak the slug in L_1 for maximum signal output using an S-meter or field strength meter.

To operate this unit in accordance with FCC regulations, it will be necessary for you to use the "FCC Coupon" out of this issue of S9 and attach it to the cabinet of the MOBIL-MITTER.

You may find that souping up your receiver with an extra stage of RF amplification and a squelch will give your MOBIL-MITTER installation additional range and convenience. Suitable circuits for these features can be found in the feature, "Build The MAGNIFICENT 7," which appears in this issue.

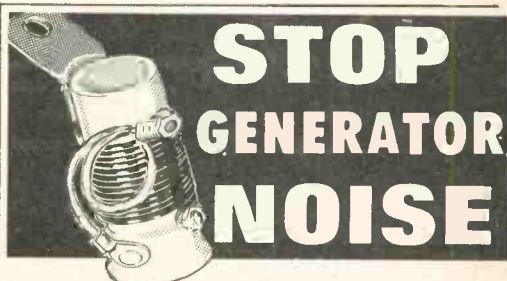

STOP GENERATOR NOISE

GLOBE GENERATOR NOISE SUPPRESSOR For C-B and AMATEUR BANDS



Covers 10-11-15-20 meter bands. Attaches to auto generator output (armature lead) in minutes. Takes the "whir" out of your receiver. Small

and completely weatherproof, complete with mounting bracket attached. See your distributor.

No. 65-510 Generator Noise Suppressor... CB Net 4.95

FREE CATALOG of the entire Globe CB line. Send to GLOBE dept. 28, 400 So. Wyman St., Rockford, Ill. USA

Name _____
Address _____
City _____ State _____



GC ELECTRONICS CO. DIVISION OF TETRON ELECTRONICS, INC.
ROCKFORD, ILL. U.S.A.

**N
E
W**

UNI:LINEAR by Mosley

Here is an Omni-Directional Vertical Ground Plane antenna which over shadows all other antennas of similar type available today . . . Why? . . . because of an extreme low angle radiation. A completely revolutionary matching system, featuring Grounded Element for lightning protection and drastic reduction of Rain Static Noise. These superior features combined with the world famous Mosley Construction assures the CB'er of an outstanding antenna for dependable communications.

SPECIFICATIONS AND PERFORMANCE DATA:

- Gain over standard ground plane - up to 4Db.
- VSWR - 1.5 : 1 over entire band.
- Feed Point Impedance - 52 ohm coax unbalanced line.
- Assembled Weight - 8 pounds.
- Wind Load (EIA STD.) - 50 pounds.
- Antenna Height - Less than 20 ft.
- Number of Radials - Three.
- Antenna mounting fits masts up to 1½".

Mosley UL-27 LIST \$45.80

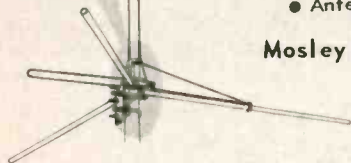

A-311-S

SCOTCH-MASTER

A-511-S

For The CITIZENS BAND!

Here are two new beams for the CB'er who wants the best point-to-point communications at lower costs. Mosley SCOTCH-MASTER A-311-S, three element & A-511-S, five element beams are designed for the economy minded CB'er who wants the world famous Mosley quality.

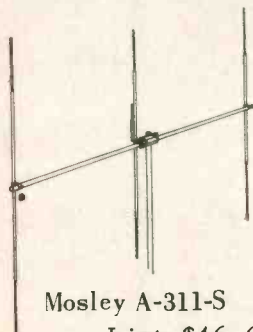

Mosley A-311-S
List \$46.68

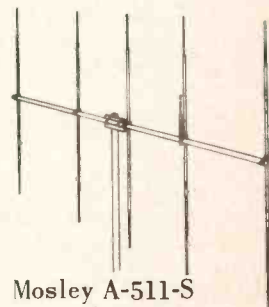

Mosley A-511-S
List \$73.35

- No. of Elements - 3
- Antenna Weight - 12.5 lbs.
- Boom Length - 12'
- Maximum Element - 18' 8½"
- Front-To-Back - 20 db.
- Vert. Wind Load - 65 lbs.
- Hor. Wind Load - 35 lbs.
- Forward Gain - 8 db.
- Type Matching - Gamma
- Impedance Point - 52 ohms.
- Radiation - Uni-Directional

- No. of Elements - 5
- Antenna Weight - 16.5 lbs.
- Boom Length - 24 ft.
- Maximum Element - 18' 8½"
- Front-To-Back - 20 db.
- Vert. Wind Load - 112 lbs.
- Hor. Wind Load - 62 lbs.
- Forward Gain - 9.5 db.
- Type Matching - Gamma
- Impedance Point - 52 ohms.
- Radiation - Uni-Directional

Mosley
Electronics Inc.
4610 N. LINDBERGH BLVD.,
BRIDGETON, MISSOURI

INSTALL THAT RIG!



PROFESSIONAL TIPS ON HOW AND WHERE

by DAVID TANNER

You've got a brand new CB signal belter, and an *ether beater* second to none, so why do you need an article on how to put wheels under it? Any intelligent four-year-old boy's father could spend a sunny Sunday with a screwdriver and shoehorn and that evening crack a crystal telling the boys how he put wheels on a rig.

Possibly in your anxiety to operate that chrome and grey marvel; the result of all the engineering the communications industry has developed for us, you wasted about half the output power capable of getting into the skywire by not splitting a few hairs.

All the theory, tips and tricks have been set down repeatedly, but they merit repeating once again because: 1. CB is a relatively new service and, 2. Hams, the other large group of private users of mobile communications, usually have a mobile as a "second rig"; whereas, by the nature of CB service and its restricting statutes, the proper and efficient operation of a mobile unit is a downright necessity.

PLACING THE UNIT

The first order of business is placing the unit in the vehicle. The fact that we have a three figure investment in communications and a four figure investment in transportation commands respect for the care of both (at least in my income bracket). Installation methods will vary with rig and vehicle. Thought should be given to several factors: 1. Safety-locate the rig or its control unit so that it will not be necessary to lean over or have your eyes stray in order to change channels only to find that a telephone pole is more efficient at stopping a car than are power brakes. 2. If you're a tinkerer, as I am, or the rig is to be used only part of the time in the mobile, rapid installation and removal is a blessing, and, 3. Let's not forget the pretty young lass who prefers your personal warmth, no doubt, to that of a well shielded final.

Items 1 and 3 will vary with the individual requirements of your equipment, however, on item 2 I know that I am on safe ground when I suggest the use of phonograph drawer slides. They sustain a good deal of weight in lateral tension and are easily installed. In some cases, existing holes may be used. They can be purchased in various lengths at most Hi-Fi emporiums and radio supply houses, cheaply! The average rig will slide under the dash and out just as a drawer does.

POWER LEADS

The lead from the battery, and it should come directly from there, and should be as short in length and as heavy in conductor size as you can possibly make it. Try, try to visualize the heaviest cable you can snake through—then try to make it larger. I'm not saying that I have stock in a wire and cable company, simply that well known rule of thumb, "In a 12 volt car system, a 1 volt drop from the battery due to resistance of the power lead is an 8% loss in RF input to the final stage of the transmitter." This is to say nothing of what good voltage regulation means to a tunable receiver.

Let's not forget the return path for that 12 volts and an RF ground. For this use at least 1 inch wide braid and anchor one end to the rig chassis (as close to the antenna terminal as possible) and bond the other end firmly to the chassis of the vehicle. Braid is used here for two reasons. First, it completes the power supply feed amply and, secondly, it provides an RF ground reference for the rig. RF, unlike DC and low frequency AC, is a funny animal. Its actions over a conductor are called "skin effect," that is to say current flow at radio frequencies is over the outer surface of the conductor and wide braid provides that surface at a very low RF resistance (which is exactly what we want here).

The car chassis is used as the RF ground point (there should be only one common

carries a whisper
 ... yet cuts out
 background noise



the exciting new
Hot Head

The new Hot Head is the highest output ceramic microphone available. Transmits voice sharply and clearly in the noisiest areas where other microphones fail. Average level: -48 DB, twice the output of conventional ceramic mikes. Response: 300-4000 cps. Polar Pattern, differential to 600 cps; cardioid, 600-4000 cps. Covers a host of applications: CB, Ham, Radio, Marine and Commercial. Heavy duty, DBDT push-to-talk switch can be re-wired for special applications. Has Cylolac, hi-impact, take-apart case. With nickel-plated brass hardware, 3-conductor neoprene coil cord and spring hang-up clip. **Model C47D Hot Head** List Price **\$16.00**

**EUPHONICS C47
 MICROPHONE**

A new general-purpose ceramic mike, same as the C47D except for noise-cancelling feature. Polar Pattern, essentially non-directional. Provides high level response curve for maximum intelligibility in all voice communication.

Model C47 List Price
Hot Head **\$14.00**



See your distributor
 for complete details or write

Euphonics CORPORATION
 Dept. S-9
 GUAYNABO, PUERTO RICO, U.S.A.

point) because it is one of the only places on a car that is common electricity to other parts of the frame. Rubber gasketing and shock mounts between fenders and body and doors etc. do not provide the sufficient metal-to-metal contact. Got an ohmmeter with low range and long leads? Test this. We told you so!

CONNECTING TO THE ANTENNA

To get that precious RF from the transmitter to the antenna, 50 ohm coaxial cable is the best bet here. The length of this line is important, it should be 1/2 wave length or an integral multiple of that length if necessary. How long did you say your Rolls was? Anyway, if two 1/2 wave-lengths are too much, leave it coiled up somewhere. If you trim it to an odd length, you've cut it into some real grief. The formula for computing this length is for RG8/U or RG58/U transmission line length (in feet) = $\frac{.33 \times 984}{\text{freq. (mc/s)}}$ If this is too short, multiply your answer by any whole number, ie 2, 3, 4, etc.

Once you have selected your antenna location and gotten the courage to punch the hole in your beautiful, 1963 *Hardly Able*, place a piece of 1/4" sheet metal of as large an area as you can make it under the car metal so as to distribute the stresses from antenna flexing and provide a better point for a ground. A word here about the high priced hole into which you are going to screw the whip: A coax fitting underneath is handy, but a few words about the PL-259, a very cute gadget for RF plumbers and dandy on the rig end of the transmission line, but they are an impedance bump and, most important, they are NOT moisture proof. Consequently, with an abrupt change in climate between the inside of the trunk and the primed painted and polished point of public perusal, it is safe to assume that the connector is going to sweat and make an *A number 1* gremlin grotto for you. 'Nuff said. Get a mount with lug connectors and PLEASE, PLEASE, PLEASE—loose, bouncy springs are great for many things, not the least of which are PHONY whips on cars. If your antenna is NOT a phony and if you have a "springy" spring you cannot have an antenna, at least not one that works well. Why? Many reasons, but primarily there is such a thing as antenna polarity. Our whip is intended to be vertically polarized and with a loose spring at

about 50 mph it is no longer vertical! As a matter of fact, unless you are standing still on a calm day, polarity of the antenna isn't very much of anything; not for very long anyway. We can't all live in Texas and you'll find that terrain tilts us around enough as it is.

In securing the mount to the car body, take some more braid and make a spider web starting from the ground lug of the antenna mount and radiating as far as possible in all directions. Now attach another piece of braid to the ground lug of the mount and tie the other end securely to the chassis. Connect one side of a variable inductor of 0.3 uh. between the antenna lug and the center conductor of the transmission line. The reasons for this will be discussed later.

As far as a choice of antennas goes, the minute you place anything at CB frequencies on a car you are at a compromise, due to the ground losses, capacitive losses and environmental resonance changes. Let's work our way out of this hole as best we can.

What you want to do is end feed a 1/4 wave vertical whip (resonant at 11 meters) which presents a feed point impedance of 50 ohms

to the transmitter line. There are many ways to do this, for custom says that ANY line can be matched to ANY radiator and ANY radiator made to accept power at MOST ANY frequency.

Let's say that we are using "old-fashioned" 1/4 wave whip in our installation. One made of fiberglass is used, as this type will take a beating far better than a steel one, considering that we are using a tight spring, or none at all. After installing the whip, check it for resonance with a grid dip meter at the base to be sure that it is tuned to the proper frequency. About 103 inches is a theoretical figure and the whip frequency will vary with location on the car.

Now we come back to the variable inductor and the reasons for it. If you have done everything right up to this point the only thing left to do is match the feed point impedance of the antenna to the transmission line. A 1/4 wave will present about a 20 to 30 ohm feed point impedance at 27 mcs. (unless, of course, your car is one of the rare foreign jobs and the antenna is so located

Continued on page 58

CITIZENS
CB
BAND

IN ACTION!

Getting things done—
QUICKLY... That's CB.

ECONOMICALLY—That's still CB.

DEPENDABLY—That's CB, too!

Put them all together—Speed, Economy, and Dependability.
That's Pearce-Simpson's rugged "COMPANION."

Another way of saying "CB IN ACTION!"

Read Len Haas' Column "CB in Action," in S-9 Magazine every month

**PEARCE
PS
SIMPSON**

**PEARCE-SIMPSON
INC.**

2295 N. W. 14th STREET
MIAMI 35, FLORIDA

See your authorized Pearce-Simpson dealer or write us for his name.



"Companion" Citizens Band Transceiver

**"Sound" Reasons for Buying
the "Companion"**

- Channels—5, plus front panel crystal socket for use on any channel.
- Transistorized Power Supply—5 watts input, 3 watts into 50 ohms output.
- Adjustable squelch control. Modulation—high level limited to 95%.
- Pre-set automatic noise limiter, gated squelch.
- Ultra-sensitive Superhet receiver—1/2 microvolt.

WHAT'S WATT?



GETTING THE MOST

FROM YOUR MOBILE POWER SUPPLY

by HANK MILTENBERG, 2W9299

You probably know much less than you might imagine about the power supply in your vehicle, so here's a run-down on getting the maximum utility from said supply.

We'll start off by giving you a handy chart of the voltages in popular model cars. This should save you considerable grief when you're considering the purchase of a new or used buggy and are carrying an already-owned CB rig under your arm.

| Year | 12 volts | 6 volts |
|------------------------|---|--------------|
| 1952 (and prior years) | — | All vehicles |
| 1953 | Cadillac Chrysler Imperial Buick 50 Buick 70 Oldsmobile | All others |
| 1954 | Cadillac Chrysler Imperial Buick Oldsmobile Nash Metropolitan | All others |
| 1955 | Nash Metropolitan Packard Chrysler Imperial all General Motors | All others |
| 1956 (to 1963) | All vehicles | — |

This chart is for American cars only. There is a possibility of cars switching over to 24 volts in the future, at least that's the back-room talk in Detroit these days.

MAKING DO

All is not lost if you wind up with a 6 volt

car and a 12 volt rig, a 12 volt car and a 6 volt rig, or (horrors) a 110 volt rig and a 6 or 12 volt car. Here's how you can fake out fate in these most unfortunate instances:

6 VOLT RIG/12 VOLT CAR. This was described in the September, 1962, issue of S9, but we've had so many requests for it we're repeating it for this special article.

Let's start off by saying that it is not particularly desirable to try to run a 6 volt rig in a 12 volt car, and our method is only a *fair* one at best. If the car has a good condition ignition system and you don't intend operating the 6 volt rig in the vehicle on a permanent basis go ahead and try this.

The method is to insert a resistor in series with the *hot* power lead of the transceiver. The resistor is a wire wound type with a slider.

Compute the value of the resistor by checking the instruction manual and find the ampere rating of the 6 volt rig (usually between 7 and 10 amperes). Now, divide the number of amperes into 6. For example, if the set is rated at 10 amperes the answer would be .6 (ohms), the resistance required.

You must also find out one additional value, the power rating of the resistor. To find it, multiply the current in amps by 6. For the 10 ampere rig mentioned above, the result would be 60 (watts). Whatever wattage you come up with, double your answer when selecting your resistor. Actually, a 120 watt resistor is not a standard value and you would have to select a standard 100 or 160

watt type. These types are found in all electronic supply house catalogues under "Wire-wound Power Resistors," and sell for \$2 to \$3.

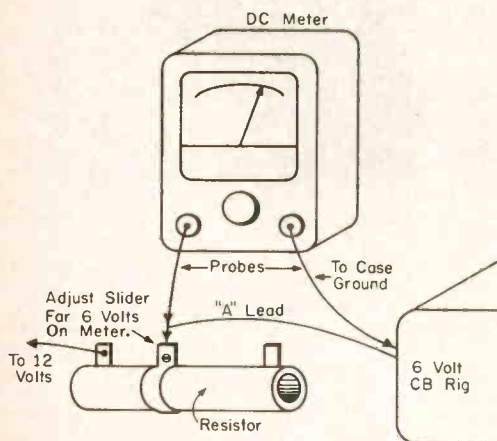
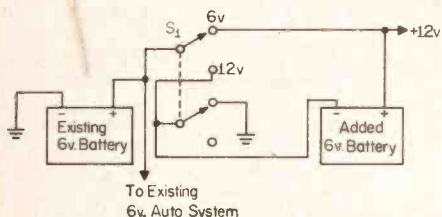

Fig. 1 shows the connection of the resistor in your circuit. The slider on the resistor permits the exact amount of resistance to be selected, a job done in conjunction with a DC voltmeter. The meter should read 6 volts (exactly) between the *hot* lead and *ground*. The rig should be turned on during this adjustment.

12 VOLT RIG/6 VOLT CAR. Fig. 2 depicts the method of adding 6 volts to an existing 6 volt system to obtain 12 volts.



The DPDT toggle switch, S_1 , must have a rating of about 35 amps, 15 volts. The switch is located in a spot where it can be worked while the vehicle is in transit.

The newly added battery should be the same type as the existing battery and in about the same electrical condition.

This system is shown for negative ground systems but can be used with positive ground systems if the battery polarity is reversed.

110 VOLT AC RIG/6 OR 12 VOLT CAR. Unless you want to "roll your own" inverter, your best bet is to purchase one of the com-

mercially made units such as those made by ATR. For example, the ATR Model 6-RMF will convert 6 volts DC into 60 watts of 110 volts AC for about \$32. The Model 6C-RMF delivers 60 watts of 110 volts AC from either 6 or 12 volts for about \$36.

THE REGULATOR

A common "old wives" tale of CB states that you can get more output from your CB rig if you step up the output from your car's voltage regulator. The theory being that a little more "juice" into the old megacycle maker will *certainly* bring forth at least a *little* more "juice" out.

While it is a fact that this will work in accordance with the claims made, it will cause overheating of the filaments in your rig and also damage the tube cathodes. Unless you are in the mood for replacing all your rig's tubes every few days you might abandon this idea. In other words, in the long run, the most you'll get out of your rig is the tubes.

THE GENERATOR

If your CB rig pulls so much out of the poor old battery that the generator can't seem to replace the lost power by charging, don't be afraid to install an oversized generator to compensate for the CB rig. Units are manufactured specifically for this use and will charge the battery at a high rate, even while the engine is running slowly. Check your local auto supply shop for specifications on your existing DC generator or alternator-rectifier generator and find out what might be available in a large economy size.

VIBRATORS

While not specifically part of your car's electrical system, the vibrator is in the power supply of the rig itself and can cause its share of aggravation.

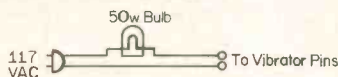

Often the contacts of the vibrator oxidize and stick, refusing to operate. Fig. 3 shows a simple method of un-sticking such an ornery vibrator.

Subject the vibrator to this treatment for about 5 minutes and you're back in operation (or vibration, as it were)!



UTICA



THERE IS NO SUBSTITUTE FOR RELIABLE SERVICE!

Every T&C II and MC-27 has the extra built in feature of dependability. Every time you switch on a Utica product, you tune in on quality.

The deluxe T&C II features all the performance you could possibly want. Dual conversion 6 channel crystal controlled transceiver with tunable receiver. S meter and signal strength output indicator, external crystal socket, auxiliary speaker terminal and universal power supply are only a few of the many plus features that make T&C II a terrific buy at only **\$199.95**

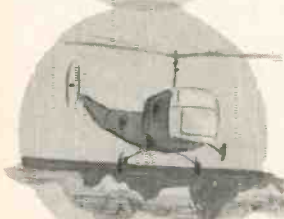
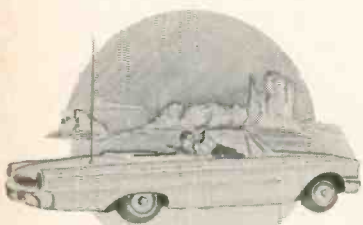

Town & Country

MC-27 TRANSCEIVER

Dual conversion 6 channel crystal controlled. Exceptional sensitivity and selectivity. Double Gated Noise Suppression circuit, AVC with improved squelch circuit. Universal power supply. Deluxe chrome cabinet.



UTICA COMMUNICATIONS CORP.

2917 IRVING PARK RD., CHICAGO 18, ILL.

Rush me free information on the T & C II transceiver, MC-27 transceiver.

NAME _____

ADDRESS _____

CITY _____ STATE _____

S9 READER SURVEY

We're always looking for ways to bring S9 closer to our readers (and vice versa). Going to CB jamborees when there is a spare moment, reading the mail (over the air and in the office) and eyeball QSO's are our old standby methods. Nevertheless, there is still quite a bit of information which we would like to know about you and your CB'ing which will enable us to bring you each month an S9 of continuing high interest. In addition, many manufacturers have been hounding us to ask you some questions about your marketing interests. Well, several months ago we started collecting likely questions to ask you. Today the question-basket overflowed and we decided that it was time for our long-awaited Reader Survey.

So here it is. We ask that you cooperate in this survey by filling out the accompanying form as completely as possible and returning it to our office, mucho pronto! If you have a weak stomach about slicing up your cherished copy of S9, you may send in a type-written sheet.

1. Do you use CB for personal or business purposes? Personal ___ Business ___ Both ___
2. How old are you? ___ Years.
3. How long have you been active on CB? Since _____
4. List name and address of CB club to which you belong, if any: _____
5. Have you had any formal training in electronics? ___ If "yes," where: _____
6. What is your occupation? _____
7. How much did you spend on CB in the past 6 months? \$ _____
8. How much do you anticipate spending in the coming 6 month period? \$ _____ What make(s) and model(s) are you considering? _____
9. What make(s) and model(s) of transceiver(s) do you use? _____
Were they purchased new or used? _____ Where purchased? _____
10. What make (brand) of antenna do you use at your base station (also model or type)?
Mobile station? _____
11. If you had an unlimited choice, which CB rig would you like to own? _____ Why?

12. Are there any brands of CB gear which you would never purchase? _____
If "yes," which ones and why? _____

13. Do you have a ham license in addition to your CB license? ___ If "yes," what is your
callsign and class of license? _____
14. On which ham bands do you operate? ___ Fone ___ CW ___ Both ___
15. If you do not have a ham license now, do you intend to eventually get one? _____
If "no," why not? _____

16. If you are a licensed ham, which brand of equipment do you now use? _____
 If you intend adding to your station in the near future, which make(s) and model(s) will you purchase? _____

17. Did CB radio spur your interest in ham radio? _____
18. Are you interested in the hobby of monitoring the short wave bands? _____
19. Which technical electronics and hobby magazines (CB, ham, etc.) do you read regularly? Please circle those to which you now have a monthly subscription.

20. How many read your copy of S9 each month? _____
21. What specific feature articles would you like to see in S9 in future issues?

Name: _____ CB Call: _____

Street Address: _____

City: _____ Zone: _____ State: _____

This is the
NUVISTAPLUG

The NUVISTAPLUG is a highly effective nuvistor amplifier designed as an exact replacement for the present rf amplifier tube in most communications receivers.

The NUVISTAPLUG will replace 7 pin miniature pentodes only. It will operate in almost 80% of all receivers using a 7 pin miniature pentode as the rf amplifier, reducing the noise level quite noticeably, and thus making weak signals pop out above the noise level.

The NUVISTAPLUG is sold on a money-back guarantee in the event that it doesn't improve your particular receiver. More than 2,000 Nuvistaplugs are currently in operation, and the manufacturing facilities have been stepped up heavily.

NUVISTAPLUGS are now available in large quantity for immediate delivery. Be certain to specify exactly which model is desired. Don't delay! Your receiver most likely will be greatly improved by adding a NUVISTAPLUG. You'll never know unless you try it.

ONLY \$19.95

postpaid
 (No C.O.D.'s)

RAYTRONICS

Post Office Box 672
 Times Square Station
 New York 36, New York

N.Y.C. Residents add 3% City Sales Tax

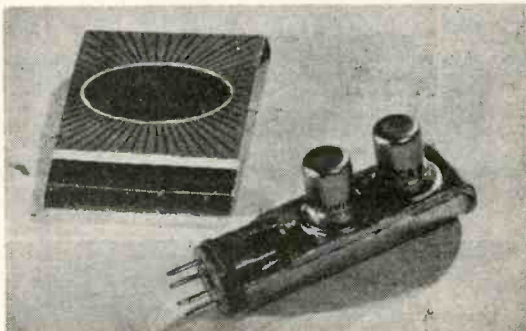

new and available now!

"MESSENGER TWO" CB TRANSCEIVER

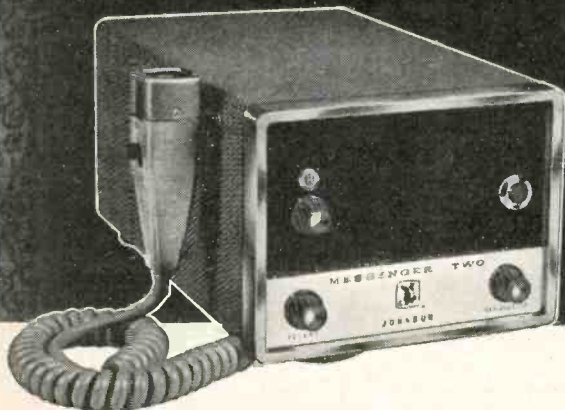

"TONE ALERT"



SELECTIVE
CALLING
SYSTEM

- 10 channels at flip of a switch — illuminated indicator!
- Increased sensitivity, high adjacent channel rejection!
- New . . . high efficiency noise limiter circuit!
- Provision for plug-in selective calling system!

Here's the new "Messenger Two" — with everything you've ever wanted in CB transceiver! Basic circuitry is patterned after the popular "Messenger". Highly efficient circuit design makes full use of maximum legal power . . . delivers a penetrating signal that "outperforms 'em all!" Looking for maximum receiver sensitivity? This unit is hot — pulls in signals you wouldn't know were around with less sensitive equipment . . . and adjacent channel rejection is tops! Tired of noisy receiver? New, noise limiter circuit in the "Messenger Two" lets you know what QUIET really means in a CB rig! Positive acting "squelch" and automatic volume control circuits — 10 channel coverage — push-to-talk microphone. Only 5 $\frac{1}{2}$ " x 7" x 11 $\frac{1}{2}$ ", easy to install anywhere.

Cat. No. 242-162 115 VAC and 6 VDC \$169.95
Cat. No. 242-163 115 VAC and 12 VDC NET

5 CHANNEL "MESSENGER" TRANSCEIVER . . . Now at a new lower price, the big seller in the CB field! Excellent sensitivity and selectivity — punches out a power-packed signal! "Squelch" circuitry.
Priced from \$139.95 NET

1 WATT AND 100 MILLIWATT "PERSONAL MESSENGERS"—Compact, 11 transistors and 4 diodes. Superhet receiver with exclusive tuned RF amplifier gives twice the sensitivity and 40% more range than similar units with conventional circuitry—more output than similar units with same rated inputs! Priced from \$109.50 NET

SEE YOUR DEALER-DISTRIBUTOR
AND ASK FOR A DEMONSTRATION

BRAND NEW! A complete selective calling system with 37 different available tones!

The ultimate for any CB installation — designed for serious industrial, police and emergency use. Mutes speakers on your units until one calls another — then automatically your stations receive audio note and indicator light flashes "on", remaining lighted until call is answered. Eliminates annoyance of hearing "skip", electrical noise, or transmissions not meant for you!

- Not a kit, ready to go! Plugs into "Messenger Two", fast hook-up to your existing equipment!
- Sharp selectivity guards against random triggering which broad response units can't prevent!
- Wide range of tones permits 37 different systems to operate on the same channel without overlap. Plug-in reed locks unit "on # channel"—no missed calls due to "wrong" position on selector switches!
- Universal mounting bracket for left, right, or remote mounting under dashboard or desk!
- Tone signal heard beyond normal voice communication distance, increasing coverage by miles!

Only 1 $\frac{1}{2}$ " wide x 4" high x 7 $\frac{3}{4}$ " deep — wired with all cables and hardware.

Cat. No. 250-810 115 VAC and 6 VDC \$59.95
Cat. No. 250-811 115 VAC and 12 VDC NET

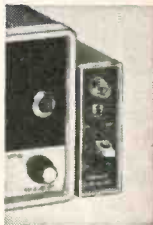

FREE! 4-COLOR BROCHURE!



E. F. JOHNSON CO

® 7010 10th Ave. S.W. • Waseca, Minnesota

Please rush "Messenger" details to:

NAME _____
ADDRESS _____
CITY _____ STATE _____



REGARDLESS OF WHAT YOU HAVE HEARD,

Mobile Whips ARE Directional

by ARTHUR E. JUDD

You can't work 'em if you can't hear 'em, and you can't hear 'em with the beam in the wrong direction. Don't fall out of your Thunderbirds, mobile CB'ers, but this applies to you, too. For the average mobile installation can work like a beam if one just knows how to turn it.

Most of us who work mobile have had the experience of turning the car while in motion and having the station worked grow much weaker or much stronger in our receiver. This happened to me so often my curiosity overcame me, so I undertook a study and review of the situation to learn just how and why my mobile rig worked directionally.

Here are some findings from 3½ years of tests, reading, study and figuring:

1. The average mobile radio installation is highly directional regardless of theories about omnidirectional vertical antennas.

2. This directivity appears due mainly to an increase in field strength in the air above a metal car body and a decrease in radiated signal intensity at the sides of the car when the antenna is bumper or shoulder-mounted at the rear of the vehicle.

3. The directional effect increases as the car moves in line toward the signal source. This appears due to eddy currents in the car body.

4. Signals sent and received are weakest when the car body is at right angles to the station being worked.

5. While mobile directional characteristics are altered somewhat by such things as surrounding objects and ionospheric variations, the main directive characteristics of the installation will not vary too much under most operating conditions.

I went into this study to learn how to get the most out of my mobile antenna. I hope this article will help you likewise to make the best possible use of yours.

When a vertical antenna is mounted on an automobile, some significant changes take place from the theoretical condition of an omnidirectional quarter-wave vertical an-

tenna over a perfectly conducting ground or an infinite copper sheet. We all know about the effects of such things as antenna loading changes due to whip sway while in motion, trees, buildings, wires and changing ground conditions. But the greatest effect on field intensity usually does not result from any of these causes. It results from the car's metal body.

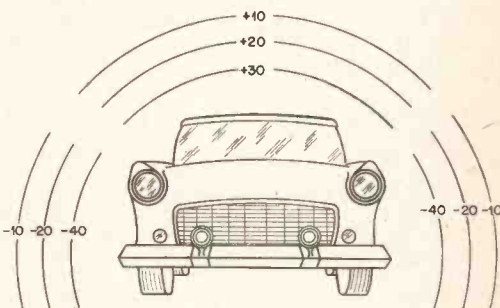

Fig. 1

Field-strength measurements of others have indicated that, *Fig. 1*, in the area above an all-metal car the field strength increases 10 to 30 per cent over that at the antenna, while at the sides of the car there is a decrease in intensity of some 40 per cent. The pattern of variation in strength seems generally independent of frequency.

This distortion of the RF field can be attributed to induced currents or secondary fields caused by the metallic surfaces of the car.

DURING CONTACTS

After observations of the author and other operators confirmed this phenomenon, I decided to measure the directive pattern of mobile antennas.

A field pattern is three-dimensional, so it was out of the question—without a balloon—to make measurements in all directions. I debated whether to take measurements at a far distance or in a near field (Fraunhofer pattern or Fresnel pattern). The latter won out.

Early one morning I got a buddy to bring along his mobile rig and accompany me as I drove to a nearby smooth and open area, clear of trees and other obstructions for about 30 wavelengths on 11 meters. My rig was installed then in a 1947 Dodge club coupe.

We operated my rig on the way out, and it was thoroughly warmed up. We parked my car in the middle of the open area, turned on the carrier and took off with a surveyor's tape, a compass and a Model 200 field-strength meter (Measurements Corporation, Boonton, N. J.). Thus we plotted the relative strength of the signal from my rig at a distance from the car.

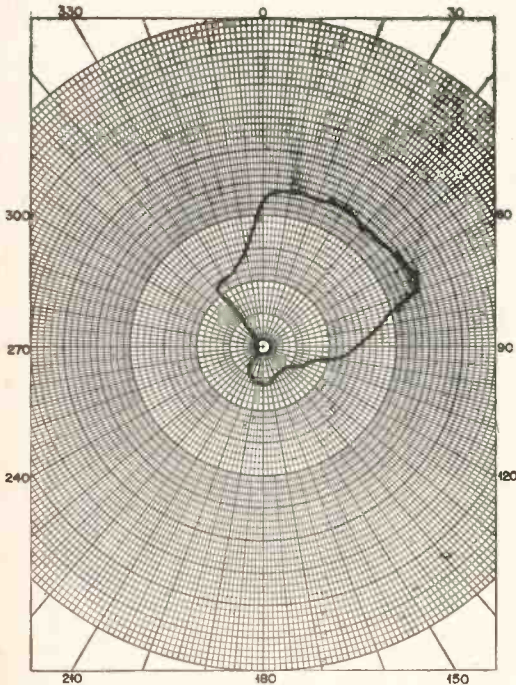

Fig. 2.

We then made plots of the mobile signal. Results were astonishing! As shown in Fig. 2, we found a highly directional major lobe to the right of the car's front center. Directivity was most pronounced with the car's broadcast receiving antenna fully extended. Apparently it acted as a director.

SIGNAL INTENSITIES

Note received signal intensities when turning your car. You should transmit well in the directions from which you hear strong signals.

In any case, more fun to you from your mobile beam!



CB IN ACTION

By Len Haas,
Sales Manager,
Pearce-Simpson, KBG7527



Mobility—the whole country is on wheels. And CB is moving right along with the trend.

Two weeks ago we had to make an auto trip from Miami to Denver and back again. That's a lot of driving in a two week period—and it gave us plenty of opportunity to tune in on "CB in Action" across the country.

Traveling up the Florida coast we had a QSO with a vacationing CB'er on wheels, heading south. He told us of construction ahead on Route 27 and we saved several hours by taking a spur road and cutting back in 30 miles further upstate.

As we passed through the Florida Panhandle, we monitored a conversation between a moving concrete truck and his home office. We would tell you what they said, but it would be a violation of 605 Title 47 USC!

We got a skip all the way from Miami in the evening—but couldn't return the contact.

In Shreveport the next day, we got the low-down on the town's best hotel from a friendly CB'er. Also the best place to avoid ptomaine poisoning! Passing through Dallas we tuned in on a CB network, used by a taxicab fleet. They were nice enough to steer us through town via traffic-free back roads. On the way to Amarillo we spoke with a dozen farmers and cattlemen, using CB systems to help run the vast agricultural part of Northern Texas. And finally, on to Colorado, where I was guest speaker to a group of wonderful CB dealers and enthusiasts in Denver.

Let us point out that during the trip we were using our CB to help gather information on CB usage, which can be utilized by Pearce-Simpson in improving the design of future CB equipment. We were not engaged in meaningless "visiting" by air. The first citation of Part 19 violations has just been awarded by the FCC in Fort Lauderdale, Florida—\$300 for idle chit-chat! Pretty expensive conversation.

WIN A "COMPANION" CB

You can help to keep the air clean of jamming and talk about the weather. Help to prevent restrictive changes in Part 19. Tell us the many ways that CB is being used in the public interest. If we use your story in our column or in Pearce-Simpson advertising, you will win a brand new "Companion" CB. The first award will be made next month, and another will follow every four months thereafter. Send your "CB in Action" story to: Len Haas, PEARCE-SIMPSON, INC., 2295 N. W. 14th Street, Miami, Florida. See you next month with tips on tune-up and preventive maintenance!

e RaTtLe Hum-m-m-m-m-m-m-m-m-m-m RaTtLe RaTtLe
BOOM! BOOM!

**stops
noise!**

murmur CLATTER!
 murmur CLATTER!
 murmur murmur

BANG!

honk! Honk! Honk!

THUMP!

POP! POP! POP!



Electro-Voice Model 717 Noise-Cancelling Microphone \$19.50 List (less normal trade discounts)

E-V Plug a new E-V 717 into your transceiver and get up to 15 db more protection against noise pickup. Not just big noise, but every sound that reduces the effectiveness of your signal. Even the effect of poor acoustics is reduced by the 717.

How does the 717 cut down on lost messages, repeated calls and wasted time and money? It has a sound-cancelling port on the back that rejects sound arriving at the rear of the microphone. Random noise pickup is reduced up to 67%.

How does the 717 sound? Crisp, smooth and peak-free for highest efficiency and articulation. There's plenty of output for any transceiver on the market. And *no noise!* But don't take our word for it. Test the new E-V 717 on your rig today. We guarantee you'll like how you're heard. Electro-Voice, Inc., Dept. 532SN, Buchanan, Michigan

HERE'S HOW THE 717 STOPS NOISE



Ordinary microphone pickup pattern



E-V 717 noise-cancelling pickup pattern



PART 15 CALLBOOK

We will be keeping this on a constantly revolving basis, calling on each call area every few months to bring it up to date with the latest additions. If you subscribe to S9 you will be assured of having a complete Part 15 callbook as we have no plans at present to issue these calls in one single volume.

Entire contents copyright 1963 by Cowan Publishing Corp.

| | Western | Ch | Atlantic | Ch |
|---------|---|--------------|--|----------|
| 3-10 | TEMPORARY EXPERIMENTAL STATIONS OPERATED BY: G. Beyers, 3208 N.W. 36th St. Oklahoma City, Okla. | A-H | 125-127 R & R Audem-Brinke, 9304 Colesville Rd., Silver Spring, Md. | VFO |
| 11 | R. R. Freeland, Int'l. Xtal Mfg. Co., 18 N. Lee, Oklahoma City, Okla. | A-H | 128-129 R. Widenhouse, 651 Mayview Dr., Charlotte, North Carolina | 10-11 |
| 12-15 | Int'l Xtal Mfg. Co., 18 N. Lee, Oklahoma City, Okla. | A-H | 130-131 J. Haley 110 Havron St., McMinnville, Tenn. | 7 |
| 16 | G. Beyers, Int'l Xtal Mfg. Co., 18 N. Lee, Oklahoma City, Okla. | A-H | 132-133 T. M. Close, BOQ Rm. 101, Naval Air Station, Moffett Field, Cal. | 6 |
| 17-18 | R. & J. McDonald, 110 N. Main St., Cleburne, Texas | 11 | 134-135 R. Parton, Rt. 2, Box 117, Huntsville, Alabama | A |
| 19-22 | J. B. McIntire, Box 285, Frisco, Texas | 18, 11, 5, 5 | 136-137 T. D. Craven, Rt. 1, Box 32, Royston, Georgia | A |
| 23-26 | S. Lewis, Route 4, Box 101E, Broken Arrow, Okla. | 18 | 138-141 G. O'Dell, Box 486, Craigsville, West Virginia | A-H |
| 27-31 | J. Wegner, Jr., 137 E. 68th St., Los Angeles, Cal. | A, C, D | 142-143 V. C. Angel Jr., 741 Colonial Dr., Rock Hill, S. C. | A |
| 32-33 | M. W. Seavey, 7137 Kittyhawk Ave., Los Angeles, Cal. | 6 | 144-150 J. King Sr., 1623 Rutland Ave., Baltimore, Md. | 11-13 |
| 34-35 | J. W. Kinsey, 256 W. Highland Ave., San Bernardino, Cal. | 6 | 151 E. Courtney, 1916 Decatur St., Richmond, Va. | 7 |
| 36-39 | L. E. Brewer, 8233 E. 37th St., Tulsa, Okla. | A & B | 152-167 L. Phillips, 110 Kenwood Pl., Smyrna, Ga. | |
| 40-45 | O. Conder, 29191 Arrowhead Ave., Barstow, Cal. | A | 168-169 M. O. Wade, 1120 Penn St., N. E., Apt. 4, Washington, D. C. | |
| 46-47 | H. M. Woien, 4204 Los Feliz Blvd., Los Angeles, Cal. | 9 | 170-172 M. J. Cullinan, 1529 Craig St., Augusta, Ga. | 7, 9, 10 |
| 48-49 | G. L. Bright, 366 W. 8th St., Beaumont, Cal. | B | 173 K. Brown, 227 Wallace Ave., Wilmington, N. C. | A |
| 50-59 | D. L. Webster, 10321 Loma Rancho Dr., Spring Valley, Cal. | 6 | 174-179 R. Guyton, 207 McAdory Ave., Bessemer, Ala. | 7, 14 |
| 60-61 | E. W. Pinard, Box 10, Lucerne Valley, Cal. | 2 | 180-181 B. L. Howington, 323 Swannanoa River Rd., Asheville, N. C. | 10 |
| 62-65 | E. L. Walker, Box 250, Espanola, N. Mex. | 2 | 182-183 A. J. Herring, RFD 2 Box 18F, Kingston, N. C. | A, B |
| 66-67 | M. J. Floyd, 733 W. Philadelphia St., Ontario, Cal. | D | 184-185 R. S. Trudell, Box 59, Southern Pines, N. C. | A, F, G |
| 68-69 | C. L. Miller, 124 Fir St., Henderson, Nevada | 14 | 186-187 G. Hillbatten, 802 North Lee St., Whiteville, N. C. | 11 |
| 70-71 | K. J. Hughes, 1804 Hood St., Carrollton, Texas | C | 188-189 A. Hall, 534 Front Ave., Draper, N. C. | |
| 72 | D. Stoner, Box 7388, Alta Loma, Cal. | 10 | 190 D. E. Watson, 3401 52nd St., Hyattsville, Md. | A |
| 73-76 | R. C. Green, 1305 W. Glenwood Pl. Santa Ana, Cal. | 10 | 191-192 R. Ferrell, 615 E. 10th St., Roanoke Rapids, N. C. | 7 |
| 77-82 | R. F. Maynard, 8049 E. Garvey Ave., San Gabriel, Cal. | 14 | 193-194 J. L. Daughtry, Rt. 1, Box 259, Dudley, N. C. | 7 |
| 83-85 | C. Horn, 423 S. Summit, Fort Worth, Texas | 11, 20 | 195-197 B. Carter, 325 W. Oakdale St., Mt. Airy, N. C. | A, B, D |
| 86-87 | L. M. Ligon, 3917 Modina, Fort Worth, Texas | 9 | 198-200 J. C. Vice, 307 Coffee St., Talladega, Alabama | A |
| 88-89 | F. R. Macy, 13286 Dyer St., Sylmar, Cal. | 14 | 201-202 J. Caniford, 414 Brunswick St., Brunswick, Md. | A |
| 90-91 | G. R. Strainline, 3571 Miracle Mile Strip, Tucson, Ariz. | 5, 7, 11, 15 | 203-205 J. M. Blow, 546 Evans St., Greenville, N. C. | |
| 92-93 | R. E. Mack, 571 N. 'N' St., Oxnard, Cal. | 9-11 | 206-207 G. T. Shavers, Rt. 6, Box 60, Shelbyville, Tenn. | A, B |
| 94-97 | M. A. Lublin, 834 N. Formosa Ave., Los Angeles, Cal. | A | 208-208 W. C. Hayes Jr., St. Andrews College, Box 540, Laurinburg, N. C. | |
| 98-101 | P. Phillis, Box 1054, Walsenburg, Colo. | C | 210-212 J. Clem, 1150 Elkton St., Box 902, Athens, Ala. | A, B |
| 102 | B. Duff, 10911 Elm Ave., Lynwood, Cal. | | 213 B. Willets, 500 Alexander Ave., Morganton, N. C. | |
| 103-104 | W. E. Ware, 415 Muscatel N. E., Albuquerque, N.M. | | 214-215 I. Williams, 313 Jarrell St., Shelbyville, Tenn. | A, B |
| 105-108 | F. Franks, 10582 Silver Crl., Garden Grove, Cal. | 14 | 216 M. E. Sagman, 10 Fleming Cr., Newport News, Va. | A |
| 109-110 | C. E. Young, Box 862, San Luis Obispo, Cal. | A | 217-218 G. E. Rollins, 224 Fleece Rd., Thomasville, N. C. | A |
| 111-113 | G. F. Gonzales, 14900 Polk St., Sylmar, Cal. | 14 | 219-223 J. Cheatham, 420 Richland Cr., Gallatin, Tenn. | |
| 114-117 | R. J. Corbett, Box 750, Boulder, Colo. | 7 | 224-227 L. Earnest, 125 Griffin Ave., Bessemer, Ala. | 7, 14 |
| 118 | M. Duff, 10911 Elm Ave., Lynwood, Cal. | 14 | 228-229 T. Woodall, 321 Front St., Draper, N. C. | |
| 119 | G. Snow, Pinedale, Wyoming | | 230-231 G. Easter, Route 6, Reidsville, N. C. | |
| 120-122 | R. V. Cole, Box 84, Pinedale, Wyoming | B, C | 232-233 F. G. Scarford, 320 Riverview Ave., Westover, West Virginia | A |
| 123 | T. C. Cole, Box 84, Pinedale, Wyoming | | 234-235 William W. Lee, 403 12th St., Alma, Ga. | VFO |
| 124 | E. Falter, Box 44, Pinedale, Wyoming | | 236 C. L. Halley, 101 N. Maple Ave., Brunswick, Md. | A |
| 125 | C. E. Cole, Pinedale, Wyoming | | 237 B. T. Halley, 20 East D. St., Brunswick, Md. | A |
| 126 | J. Peterson Jr., 1118 Jefferson, Box 545, Ajo, Arizona | VFO | 238-239 E. Doyle, 410 Glenn St., Leaksville, N. C. | 9 |
| 127-130 | H. S. Bond, 102 E. Holland Dr., Irving, Texas | A | 240 C. E. Martin, Route 3, Box 104, Fairmont, W. Va. | B |
| 131-140 | J. Sidler, 1118 Magnolia Ave., Los Angeles, Cal. | 7 | 241-242 G. H. Cathey, 21 Beechwood Dr., Jackson, Tenn. | 4 & 11 |
| 141-144 | B. Messersmith, 854 Liberty Ave., Ogden, Utah | 7 | 243-246 K. A. Nelson, 212-1/2 Armisted Ave., Hampton, Va. | 7 |
| 145-148 | W. C. Godsey, 1015 N. Iowa, Colorado Spgs., Colo. | 7 | 247-250 B. A. Harris, 217 Lebanon Dr., Kingsport, Tenn. | |
| 149-152 | C. L. Flaharty, 105 W. Bellevue #301, Englewood, Colo. | A | 251-253 J. Garigues, P. O. Box 481, Glencoe, Alabama | |
| 153 | L. McDonald, 1506 Chevlotdale Dr., Pasadena, Cal. | A | 254 R. R. Bowers, 509 S. Waccamavuarie, Columbia, S. C. | C |
| 154-153 | C. C. Fuller, 149 Wildrose Ave., San Antonio, Tex. | 10 | 255 D. Faunt, Jr., 310 Holly St., Columbia, S. C. | C |
| 160-163 | R. T. Rafter, 8421 Abbotshill Rd., San Diego, Cal. | 4 | 256-257 R. K. Ferguson, 2045 Johnston Rd., Huntington, W. Va. | 7 |
| 164-165 | H. J. Haus, 1428 S. Owasso St., Tulsa, Okla. | 4 | 258 F. Richmond, 1310 N. Augusta St., Staunton, Va. | |
| 166-167 | R. D. Nielsen, 5565 N. Federal, Denver, Colo. | 15 & 7 | 259-261 W. J. Dickens, 1628 Redwood Dr., Kingsport, Tenn. | |
| 168-170 | F. W. Wilson, 412 W. Fairview Blvd., Ingleswood, Cal. | A, B, C | 262-263 R. P. Brake, 324 Fairmont Rd., Morganton, W. Va. | B |
| 171 | G. H. Rosenberg, 816 Van Buren, Amarillo, Tex. | 7 | 264-265 J. W. Case, 913 E. Washington St., Athens, Ala. | A |
| 172-173 | T. O. Sullivan, 8515 Lockwood Dr., Dallas, Tex. | 7 | 266-267 R. L. Toothman, Box 121, Kingmont, W. Va. | 12 |
| 174-178 | B. Davis, 2829 Jackson, Denver, Colo. | 7 | 268-271 J. E. Belch, 428 Fairview St., Mannington, W. Va. | A & B |
| 179-181 | L. Wong, 3825-1/2 Stockbridge Ave., Los Angeles, Cal. | 9 & 10 | 272-273 J. Saurborn, 306 Suncrest Blvd., Fairmont, W. Va. | |
| 182-184 | C. Caston, 10607 Orion Ave., Grenada Hills, California | 7, 14, 22 | 274-275 D. W. Cassell, Box 1731, East Side Station, Fairmont, W. Va. | A & B |
| | | | 276-277 A. F. Cassell Jr., Box 1731, East Side Station, Fairmont, W. Va. | A & B |
| | | | 278-279 F. Jenkins, H16 N. 27th St., Richmond, Va. | |
| | | | 280-281 R. Collins, 200 Belvedere Ave., Cambridge, Md. | H |
| | | | 282 C. Mathews, Route 4, Reidsville, N. C. | |
| | | | 283-284 W. H. Brown, 200 34th St. Cr1., Chattanooga, Tenn. | 11 |
| | | | 285-289 L. Falcone, 31 Rehoboth Ave., Rehoboth, Del. | |
| | | | 290-293 A. L. McMurtree, Jr., 1308 C Church St., N. W., Huntsville, Ala. | C, A, D |
| | | | 294-295 H. B. Blach, Jr., 220 Beech Cr1., Birmingham, Ala. | 7, 9, 11 |

Write to our advertisers for special product news

May 1963 • S9 • 35

TRAM

**CB EQUIPMENT
PERFORMS
BEST . . .**



BECAUSE . . . THERE IS MORE PUT INTO IT!

TR-70B MOBILE SPECIFICATIONS

RECEIVER

Sensitivity - .1 uv. for 300 milliwatts of audio
Selectivity - 5 kc. @ 6 db. Adjacent channels 60 db. down
Signal to Noise Ratio - .3 uv. for 10 db.
Incredible weak signal readability-plus the unmistakable signs of Quality.

TRANSMITTER

70% or better Transmitter efficiency provides 3.5 watts guaranteed minimum RF Output with 100% High Level Modulation.

As well as standard TRAM Features and Performance!

To hear from TRAM by return mail, write for detailed information and specifications.



TRAM ELECTRONICS

P. O. BOX 187, DEPT. 5B, WINNISQUAM, N. H.

add more
voice punch
to your
CB rig...

less
10-9 and 10-1
more "solid"
10-4's

SHURE
201 CB
ceramic
improvement
microphone

"SHAPED" VOICE RESPONSE

... patterned after professional mobile and SSB amateur radio response curves
... assures maximum intelligibility.
PROFESSIONAL QUALITY DESIGN, CONSTRUCTION ... performs as good as it looks.

"ARMO-DUR" VIRTUALLY INDESTRUCTIBLE CASE ... shock-shatter-corrosion-rust-and-weather-proof.



LONG-LIFE SWITCH ... guaranteed a full year.

"SUPERIOR COILED CORD ... won't kink, crack, peel or lose resiliency.

"LIFETIME" HANG-UP BRACKET ... positive lock in, easy snap out.
CB net model 201—\$10.80

Write for literature:

SHURE BROTHERS, INC.

222 Hartrey Avenue, Evanston, Illinois



ON THE COUNTERS

C-Y Electronics (3810 E. 365th, Wiloughby, Ohio) has a new speech processing unit known as the "Chatterbox." Used with any type of CB unit, the manufacturer claims that the "Chatterbox" will provide additional gain, reduce low frequency response, clip off unnecessary voice transients, and finally filter out any clipping products and voice frequencies above 2500 cps. This maintains a higher average modulation level and utilizes only those audio frequencies which are most effective in giving "audio" punch or modulation effectiveness. It can be used with CB rigs, phone patches, PA systems, and tape recorders.



Several models are available with all kinds of common mike connectors. The prices are about \$25 for most models. Further details are available upon request.

While looking through the materials being offered by Telemarine Communications Co., Inc. (142 West Broadway, New York 13, N. Y.) we came across a most interesting antenna, one somewhat different than any other we had ever seen.

This particular unit was manufactured originally for Uncle Sam for radio beacon

use under the unassuming name of Model RC-163 and is of the *Adcock* type. In plain and simple a-b-c's, it's a novel type of vertical 3 element beam.

In the center base of the radiating element there is a "phase-load" box which will permit you to peak the antenna (without snipping the element ends) right on your frequency. This is easily accomplished with the aid of a field strength meter or a receiver having an S-meter.

Now here's a novel aspect, the RF is fed into the phase-load box whereupon it is distributed to the antenna in such a manner that the elements are fed out of phase to obtain maximum directivity in the desired direction. In other words, the reflector and director elements are not wholly "passive" elements, but are part of the radiating system. The antenna can be fed with either 52 or 73 ohm cable with proper adjustments and connections in the phase-load box.

Constructed from heavy-duty materials, the beam can be used with standard low-cost rotors and will provide your station with excellent forward gain with a high front-to-back ratio. The antenna sells for less than \$25 (less rotor and cable). A complete flyer is available by writing to the company.

Speaking of cable, our article on coaxial cable in the February issue brought in a number of letters from readers and manufacturers questioning the article's statement that RG8/U, RG58/U and RG58A/U coaxial cables were *not* to be recommended to CB use, rather, the CB'er should use RG8A/U, RG58B/U or RG58C/U.

Perhaps our author got a little too carried away with his discouragement on old standby

Globe Star CB TRANSCEIVER
and **Hi-gain COLINEAR**
GROUND PLANE ANTENNA



Reg.
\$159.95

Reg.
\$29.95

BOTH FOR \$164.95
Save \$25.00

Globe Star CB Transceiver with new dual conversion, superhetrodyne, adjustable squelch. "Push-to-talk" mike, call cord. 5 channel provisions—16 tube functions. Specify 115VAC and 12.VDC, or 115 VAC and 6 VDC. Regular \$139.95.

Hi-gain CLR Colinear Ground Plane Antenna concentrates power at lower angles to horizon and doubles radiated power (3 db gain, use 52 ohm coax). Heavy double wall aluminum, cycalac base insulation—Model CLR—Regular \$29.95.

Low Loss Polyfoam Coax—12.00 HD., 15c Ft.

Special Offer—LIMITED TIME

IMPROVE CB RECEPTION
SATISFACTION GUARANTEED!

MODEL NA-27

\$11.95
POSTPAID

WRL'S 2 STAGE
NUVISTOR PRE-
AMPLIFIER

Improves Reception on any CB
Transceiver, Receiver, Superhetrodyne
or Regenerative Circuits.

Small (2 1/4" x 2 3/4") install internally

Fixed or Mobile — 6 or 12V

Finest printed Circuitry

WRITE FOR FLYER

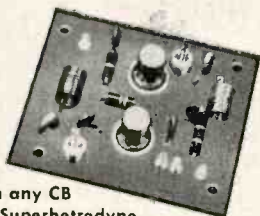

QUANTITY
DEALER
DISCOUNTS

WRL

WORLD RADIO LABORATORIES

3415 W. Broadway
Council Bluffs, Ia.

Send STAR/CLR deal F.O.B. WRL \$164.95 enclosed.
 Charge. Send NA 27 postpaid. Send 3 color CB
map 50c postpaid. Send personalized CB-QSL Card
Sample, Free.

NAME _____ CALL _____

ADDRESS _____

CITY _____ STATE _____

cables such as RG8/U and friends. While it is true that RG8A/U, RG58B/U and RG58C/U are excellent for CB use, there isn't any cause to shy away from the three other types. We have seen competent and convincing statistical reports which prove, beyond any doubt, that RG8/U, RG58/U and RG58A/U are not only quite suitable for CB applications, but will provide substantially the same service as the other three types mentioned.

A new ground plane vertical for outstanding coverage of the citizen band has been developed by Mosley. Model UL-27 does not employ a top hat and has an extremely low angle of radiation.

The new matching system puts all elements at ground potential and affords lightning protection and ground return for normal static build up. This omni-directional ground plane is fed with 52 ohm coaxial line and will give full 360 degree coverage. SWR 1.3 to 1 across the entire band. 3.5 db gain over a standard ground plane. The antenna is slightly less than 20 feet high.

S9 Lab
Reports

THE OLSON RADIO
AUDIO-VISUAL SPOTTER

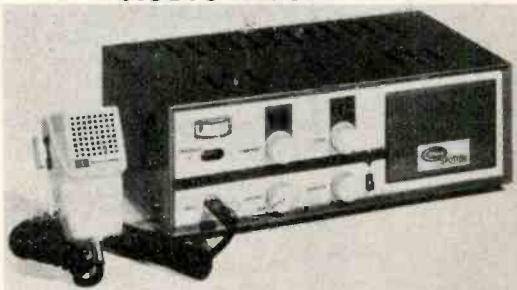

The Audio-Visual Spotter (AVS) transceiver is unique in that it offers the high styling and performance, usually found in high priced rigs, at the low price of \$119.95. This is a slick looking rig—its cream and biege cabinet would harmonize with virtually any surrounding. But do not think that the attractive styling is meant to hide an empty shell, the performance is strictly first class.

The receiver is double conversion with two stages of 595 kc. in the second IF strip. As

you would expect, selectivity is very good. An S7 channel 9 signal cannot be heard on channels 8 and 10; and S9 signal is just barely discernable on adjacent channels. Sensitivity is good, easily on a par with contemporary units. The receiver is only variable tuned, there are no crystal receive positions. To permit pre-setting the receiver with crystal control accuracy an audio-visual spotter is employed (now you know where the name came from). The spotter produces a modulated signal which is controlled by the transmit channel selector. To precision pre-set the receiver to, say, channel 9, you set the transmitter to channel 9 and flip the spotting switch. You then tune the receiver for maximum speaker signal and/or maximum S-meter reading—and the receiver is right on channel 9.

An adjustable squelch is provided, also an effective noise limiter. An unusual feature is a terminal strip on the rear apron which permits either the in-built or a remote speaker (or both simultaneously) to be used.

The transmitter, which utilizes overtone crystals delivered 3 + watts to a dummy load; connecting an antenna did not require transmitter re-tuning.

Provision is made for twelve crystals, eleven mounted on the internal crystal socket assembly and the twelfth position appearing at a front panel socket.

The push to talk circuit is wired in such a manner that the S-meter is connected as a relative modulation meter when the transmitter is energized. (In our tests, 100% modulation occurred when the meter read to the S7 mark.) With 100% modulation capability and reserve mike gain the AVS has plenty of "talk power."

The power supply is normally connected for 115VAC and 12VDC operation. Instructions are supplied for the minor changes needed for 6VDC use.

As you can see, at \$119.95 the OLSON Audio-Visual Spotter can give you quality performance at low cost.

THE ELDECO PORT-O-GEN

Here's a nice little gadget which fills a multitude of needs around any type of radio shack. It's the ELDECO (4212 Ponce de Leon Blvd., Coral Gables 46, Fla.) "PORT-O-GEN."

It's a tiny oscillator, or signal generator. The object is to place a crystal in the socket

THE ANSWER TO THE BIG

C-B QUESTIONS:

1. Is your receiver properly tuned?
2. Is your transmitting crystal functioning?
3. How do you predetermine a setting on your tuneable receiver?

THE ANSWER IS . . . PORT-O-GEN.



\$14.95 NET
BATTERY INCLUDED

About the size of a pack of cigarettes, the Port-O-Gen serves as a completely self-contained transistorized modulated crystal controlled

generator. A simple matter of inserting a C-B crystal in the socket, and you have a reliable signal source for spotting tuneable receivers, as well as an alignment generator for tuning the entire receiver from the front end right on through the IF strip. As an added feature, the Port-O-Gen will also operate on marine frequencies.

Available at your local dealer, or send your orders to:



ELECTRONIC DEVICES CORPORATION
4212 PONCE DE LEON BLVD. • CORAL GABLES, FLA.

GIANT CB SALE!!!

- COMMAND SUPER III-3-Element**
Heavy Duty Beam, mounts vertically or horizontally (Reg. \$30) SALE **\$11.99**
- COMMAND SUPER V-5-Element**
Beam (same construction as above) (Reg. \$50) SALE **\$29.95**
- COMMAND CORSAIR ANTENNA-102"**
Whip, Single Chain Bumper Mount and Chrome Spring (Reg. \$15) SALE **\$ 8.99**

PUT UMPH IN YOUR SIGNAL WITH LOW LOSS FOAM COAX CABLE

- RG58U** 50 ft. \$2.49 100 ft. \$3.99
- RG8U** 50 ft. \$4.95 100 ft. \$8.99

- COMMAND WHIP II-102"** Whip, Body Mount, Spring (Reg. \$12) \$ **5.89** SALE
- Top Quality - Name Brand - ANTENNA ROTATOR** with 100 ft. Rotor Cable (Reg. \$36) SALE **\$22.95**

Check items wanted. Return ad or order with check or money order. Include postage, excess refunded. 50¢ service charge on orders under \$5.00. Beams and Contact II shipped Railway Express.

CB DEALERS: Write for Quantity Prices!

GROVE ELECTRONIC SUPPLY COMPANY
4115 W. Belmont Avenue
Chicago 41, Illinois Ph. 283-6160

- Rush items checked
- Send **FREE** catalog of giant CB Values

Name (please print)

Address

City Zone State

THIS IS OUR SUBSCRIPTION MANAGER!



He will get you if you don't seek out the handy coupon between pages 48 and 49, fill it out and send it in.

By subscribing to S9 right now you will be assured of receiving each and every information-packed BIG issue. You will be able to keep abreast of all new products, construction projects, FCC news, equipment reviews, humor, feature stories concerning Citizens Radio. All articles are written in easy-to-understand style by the most well known CB authors in the country.

By subscribing to S9 you can be receiving the magazine for as little as about 36¢ per issue—a real saving for the biggest value in CB radio. YES! The big switch is to S9!

| | |
|-------------------|------|
| Rates: 12 issues— | \$5 |
| 24 issues— | \$9 |
| 36 issues— | \$13 |

S9 MAGAZINE
300 West 43rd Street
New York 36, N. Y.

on the front panel and out comes a signal on the crystal's frequency.

The unit really throws a wallop of a signal for something so small (less than the size of a package of cigarillos) and will be handy for aligning receivers, checking on crystals, crystal "spotting," it makes a nice adaptor for receiving single sideband signals or can be used as a beat frequency oscillator for the reception of CW signals.

Operating from its own self-contained batteries, the PORT-O-GEN, unlike other similar units have been offered before to CB'ers, will operate well using any crystal from the 2 megacycle band straight through and past the 11 meter band. This makes it a handy device for Hams, SWL's, and others who want the advantages of this type of unit. We really have become quite fond of this unit and are continually finding new uses for the thing. For about \$15, you can't go wrong.

S9

CARD SWAPPERS UNLIMITED

The following CB'ers would like to swap their CB QSL cards with other CB operators. If you're proud of your QSL's, why not send one along to these S9'ers?

If you would like to be listed in the July issue as a "Card Swapper Unlimited," just send us a post card or QSL (no letters please) to reach us by not later than the 15th of May. In order to keep the list as current as possible each month, we ask that you send us a new card to reach us for each month you would like to be listed (and you can list yourself in this manner each and every month if you wish). There isn't any charge for being listed, it's just one more free reader service of S9.

If you send your beautiful cards to any of the CB'ers listed below and they don't send one back to you, please don't write us a nasty letter. All we know is that the following CB'ers have told us that they would like to swap cards, we can't be responsible if they run out of cards or change their minds.

By the way, do you have one of the S9 cards in your collection yet? We'll be happy to send you one if you ask for it.

Who will be the first one to have swapped

QSL's with all 50 states, Puerto Rico and the District of Columbia?

6Q1085 Judson Clem, P.O. Box 902, Athens, Ala.
 9Q1209 Lee Lichtenstein, Procter Acad., Andover, N. H.
 18Q1500 Dick Range, 265 Slade, Elgin, Ill.
 18Q6589 Al Haseman, 727 Woodward, Beecher, Ill.
 18W8741 Larry Engle, 418 W. Ft. Wayne, Warsaw, Ind.
 20Q3527 Frank Gibson, 254 Shearer, Butler, Pa.
 20Q5209 Bernie Rosenson, 1225 Leeds, Monessen, Pa.
 KBA3169 Cal Thomas, 108 Oakland, Arlington, Mass.
 KBA8619 Doug Fleury, 110 High, Lowell, Mass.
 KBA8939 Bill Fleury, 52 W. 4th St., Lowell, Mass.
 KBB0809 Jim Ashworth, 157 Washington, Berlin, N. H.
 KBC0106 Ronnie Loeser, 46 Wesmur, Malden, Mass.
 KBC0540 Claus Colm, 161 N. Church, Rutland, Vt.
 KBG5463 John Zeman, Box 164, Fords, N. J.
 KBG8649 R. Ishkanian, 270 E. Shore, Massapequa, N. Y.
 KBG8741 Herb Klein, 1305 Dickerson, Teaneck, N. J.
 KBG9040 Marc Joondeph, 419 Beverly, Ridgewood, N. J.
 KBG9090 Bill Morgenegg, 392 Piping Rock, Seaford, N. Y.
 KC10348 W. C. Hatcher, 713 Parrott, Kinston, N. C.
 KC16095 George Cline, 1530 Grove, Pulaski, Va.
 KDB0371 Bill Howell, Jr., 545 Palmetto La., S. W., Aiken, S. C.
 KCF2762 Robert Gallery, 4424 Montgomery, Bethesda 14, Md.
 KCF0823 Jim Cross, 755 S. Potomac, Hagerstown, Md.
 KDB1435 Dan Guthrie, Box 362, Spruce Pine, N. C.

KDB3573 John Bryant, 1429 Carolina Ave., Kingsport, Tenn.
 KDH1144 Jay Ciampi, 17700 S. W. 111 Ave., Miami 57, Fla.
 KEJ5651 Jim Bowles, 2528 2nd St., National City, Calif.
 KEJ5904 Dave Canfield, 2010 E. 11th St., National City, Calif.
 KEJ6381 Roy Fox, 4715 Landis, San Diego, Calif.
 KEJ6431 Dick Wright, 12 Via Veneto, Chula Vista, Calif.
 KGB1790 Frank Emerick, 5253 E. Bayaud, Denver 22, Col.
 KGF0109 John LaFond, 3302 22 Ave., Rochester, Minn.
 KGH0156 Les Doss, 307 Linda Lane, Wentzville, Mo.
 KGH3933 Thos. Atkinson, 795 Central Pkwy., Florissant, Mo.
 KHA7859 Bonnie McGrew, Box 104, LeClaire, Iowa
 KHC1006 James Miller, 2704 Pine, Mattoon, Ill.
 KHC1466 Gene Swearingen, 2501 Richmond, Mattoon, Ill.
 KHC1607 Jim Cole, 830 N. 16th St., Elwood, Ind.
 KHG0393 Beverly Fodor, 8147 W. Jefferson, Detroit 17, Mich.
 KHG2567 James Heflin, Jr., 213 Cottage, W. Union, W. Va.
 KHG6103 Jim Whobrey, 161 S. Venoy, Garden City, Mich.
 KHG7575 Clayton Cary, Rt. 2, Box 132, Forest, Ohio
 KHH0139 Ruth Ayotte, 3356 S. 3rd Ave., Alpena, Mich.
 KHI2482 Jean Heflin, 213 Cottage, W. Union, W. Va.
 KIC3788 Richard Allen, 1111 Louisa, Williamsport, Pa.
 KIC4127 Edward Gruber, 168 Arthur, Horseheads, N. Y.
 KIC6739 Irvin Bitner, 363 S. Carlisle, Greencastle, Pa.
 Todd Welty, RD #4, Greensburg, Pa.

FREE

Word sure gets around in the S9 crowd—we gave them out at the International Communications Fair and ever since then we've been swamped with requests from all over the country. Anyway, they're FREE as a reader service of S9—all you do is send us a stamped, self-addressed envelope (make it at least 7 by 10 inches if you don't want your certificate folded). Address your request to "Wall Certificate," % S9 Magazine, 300 West 43rd St., New York 36, N. Y. One to a customer, although clubs may request bulk amounts if an officer writes on the club letterhead.

If you throw in a paltry 25¢ per certificate, we will have your call sign boldly imprinted in large block letters on your certificate(s). Order as many as you like, but don't forget to send 25¢ for each one.

Watch for next month's big issue



you asked for it

May 1963 • S9 • 41

PART 15 KORNER

by DEAN DETTON, NORTHERN 17

% S9 MAGAZINE
300 WEST 43 ST.
NEW YORK 36, N. Y.

Jerry Greathouse (short wave listener WPE5CJT) of Enid, Okla. wants to know if it is possible to have a 100 mw. with a 5 foot antenna mounted atop a 100 foot pole. This question was also asked by a number of other readers. The answer is that it most certainly is legal if you don't mind climbing up and down to change the batteries every few months. Other considerations: changing frequency, running cables for mike/key, speaker and transmit/receive switching, also volume control. Jerry further asks about using a 1 element beam (that's called a "dipole" where I come from) 5 feet long on a 100 foot pole. There's no problem with the antenna itself, however, you would prob-

| PART 15 CHANNELS | |
|------------------|-------------|
| Channel A | 26.995 mc/s |
| Channel B | 27.045 mc/s |
| Channel C | 27.095 mc/s |
| Channel D | 27.145 mc/s |
| Channel E | 27.195 mc/s |
| Channel F | 27.235 mc/s |
| Channel G | 27.245 mc/s |
| Channel H | 27.265 mc/s |

ably have to figure out a way to mount at least the transmitting portion of the transceiver up at the antenna because the power loss in that length of coaxial cable would kill the signal before it left your backyard.

Paul Bassiri, NORTHERN 267, Morristown, N. J. wants some skeds with other Part 15 stations. Look for him on Channels 10 and 18 after 6 p.m. every evening.

APPLICATION FOR FREE PART 15 STATION IDENTIFIER CERTIFICATE

To register your Part 15 "unlicensed" CB station with S9 and receive your special station identifier certificate, do the following:

- Fill in the application below, or facsimile if you don't want to cut your copy of S9.
- Enclose your completed application form together with a self-addressed stamped (5¢) envelope, in another envelope addressed as follows:

Part 15 Department
S9 Magazine
300 West 43rd Street
New York 36, N. Y.

- Please do not request special identifying words for your station as all identifiers are issued in alphabetical rotation for ease of recording on our records.

APPLICATION FOR PART 15 IDENTIFIER

Name: _____ CB Call: _____

Address: _____

City: _____ Zone: _____ State: _____

Part 15 Channel: _____ Type of unit: _____

No. of units: _____ Date: _____

Signature: _____

William Duke of Woodford, Va., has a good idea. He uses the transmitter portion only of a hand-held unit in conjunction with a sensitive communications receiver (his is a Hallicrafters). This combo gives him pretty much the *livin' end* in a Part 15 station.



We certainly got a quick response from four recent requests for Part 15 shack photos. No sooner had the issue hit the stands when we received a nice photo from John Moore, CENTRAL 390, of Omaha, Nebr.

John's basic unit, a Heathkit DX-60 transmitter, is used mainly for his Ham station, WN0FHE. For Part 15 use the DX-60 is received on a Heathkit GR-91 receiver and the resulting signal is fed into a Lafayette model LA-23 wireless broadcaster/amplifier. The signal is then run through a loud-speaker and then into a Mayfair hand-held transceiver. Note John's copy of S9 on the operating table.

If you want to work a sked with John, drop him a card or letter at 2017 South 107 Avenue in Omaha.

ORDER NOW

IMMEDIATE DELIVERY FROM STOCK

CADRE

most Powerful
Portable
2-way
Radio
MODEL C-75

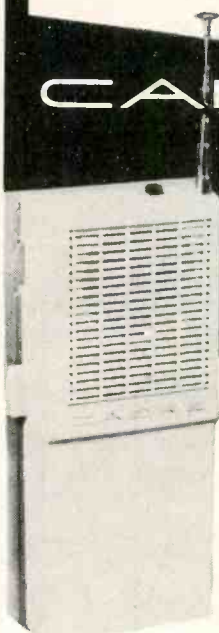

INCOMPARABLE FEATURES

- Two channel crystal Transmitter and Receiver • One-half watt of audio output power • Fully automatic overload protection • Two-tone high impact cabinet • Built-in, retractable antenna • Push-to-talk switch • Operates continuously up to 12 hours

- Complete with attractive carrying case, plus many other perfect performance features.



10% Down \$11.00 (\$109.95)

ORDER NOW FROM HAMATEUR HEADQUARTERS

THE LEW & BONN CO

Distributors of Nationally Known Amateur Equipment

Dept. S9-463 67 South 12th St., Minneapolis 3, Minn.

Call, write or use coupon

Attn: Joe Hotch Federal 9-6351
 Place my order for scheduled delivery.
 Enclosed find \$_____

Send further details and literature on CADRE MODEL C-75

Name _____ Call letters _____

Address _____

City _____ Zone _____ State _____

" 1 0 0 MESSAGES "

CENTRAL

1134

* S-9 I.D.

Date MAR 4 1963 Comments:
 Time _____ (est)
 Channel 17

Ken Hing
 34 Chestnut St.
 Ph. 363-0815

Ken Hing, CENTRAL 1134, sent us his Part 15 QSL, a real first for us! Ken, who hangs out his signal in Delaware, Ohio, runs a modified Lafayette HE-37 walkie-talkie to a 60 inch base loaded whip atop a 20 foot mast. He receives on a Lafayette

Continued on page 59

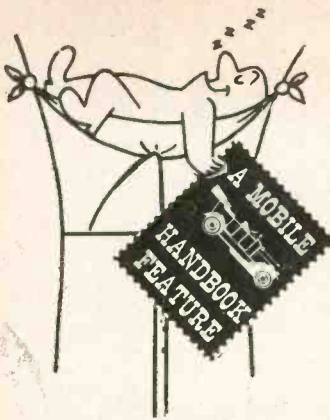

ANTENNAS

by ED NOLL, KCC2618
BOX 23
CHALFONT, PA.

THE MOBILE ANTENNA SYSTEM

The mobile antenna is yet another important cog in a citizens band system. Selection of antenna proper is only one part of a good mobile antenna installation. The actual mounting position on a vehicle is important, as are proper line installation and the adjustment of the overall system. No less significant to good performance is the suppression of vehicle noises. These are the topics we will consider in this column over the next several months.

Let us first make mention of the important factors that contribute to the overall performance of a mobile antenna system. A good general picture of the problems and techniques involved will launch us into the individual topic discussions to be covered in this and succeeding columns.

1. *Distance and Antenna Types*—The mobile antenna has two-way responsibility. It must pick up the signal from the base station and other mobile stations well and, must deliver the highest possible percentage of this extracted signal to the input of the CB transceiver. It must also make full use of the transmit power made available at the antenna receptacle and, must radiate as high as possible percentage of this radio energy.

It is a fact that the physical length of an antenna should preferably be a given percentage of the wavelength of the radio-frequency signals it must handle. In terms of citizens band operation this requirement becomes involved with some very practical space limitations. Fortunately, any possible drawbacks of rather short citizens band antennas are overcome with sensitive and well-matched units, good noise suppression and clipping, and the use of a highly efficient base station antenna.

Actually there has been a definite trend toward shorter and shorter mobile antennas. Well designed, installed and matched antennas of this type can be made as good and sometimes better than the older quarter-wave whips.

Furthermore the "distance fad" appears to be tapering off. As a matter of fact practically all personal and most business fringe communications are unnecessary or relatively unimportant. In fact some of the woes of citizens band operation could be eliminated if this "reach for distance" would stop. In those cases where rather long range is mandatory the directional base station antenna is the answer, instead of spewing out signal in all directions.

How important is it that you obtain good communications from every dip and hollow in your area? At the most, several minutes will take you to a spot where propagation will be good between your mobile unit and the base station.

When you extend your range several miles, others attempt to do likewise. In so doing have you solved your problem or have you multiplied it? If everyone extends their range, more stations enter the interference circle. If all planned their systems so as not to carry beyond a practical maximum "needed range" there would be a sharp drop in interference problems. If transmitters came through with adjustable outputs it is quite possible that even a "fraction-of-a-watt" output might be adequate for your major CB needs.

The big mobile antennas *can* be unsightly; appearance is at its worst on a compact car. Is there any sense in having the family car look like an "antenna laboratory on wheels"? Why put up with this when a

small antenna, well installed, can do the job? Antennas and suitable dividers are now available that permit a single antenna to serve the dual purpose of CB antenna and AM car radio antenna. This is also a wise choice. Certainly it is a type of antenna that the CB sales and service business should emphasize for personal use, particularly in association with the family dress-up car.

2. *Antenna Mounting Positions*—Mounting position influences the antenna pick-up ability and output efficiency. The mounting position also sets the length of transmission line that must be run between antenna and CB unit. It is also a factor in impedance matching. The mounting position also affects the horizontal and vertical radiation patterns of the antenna. The car metal must act as a ground plane and the effectiveness of that ground plane is related to antenna position.

The long vertical antenna has severe practical limitations as to mounting position. Bumper mounting is popular for a passenger car and side mounting for commercial vehicles. These are not ideal mounting positions with relation to ground plane performance. Here again an advantage of a short antenna shows up because it is adaptable to cowl and roof mounting.

3. *Installation and Adjustments*—How much line is used, and how it is routed affects the CB installation. The short antenna is again favored for many vehicles because a mounting position can be chosen that requires a short length of line and a path that does not come close to sources of noise.

No less important is the antenna tune-up. A simple test set and the tune and load controls of the transmitter can help you derive every bit of signal possible. Some antennas are adjustable and they should be peaked on your most important channel.

4. *CB Transceiver*—Our thinking would be incomplete if we did not consider the CB unit itself. For best mobile performance the receiver should be sensitive and have good noise limiting. Add-on noise limiters and squelchers can be purchased for less expensive models. The transmitter should have good matching versatility and output efficiency. Distinct and high-level average modulation is very significant in terms of clear and reliable contacts. A good unit minimizes many of the problems that can arise in mobile installations.

5. *Noise Suppression*—Noises can be sup-

Special club subscription rates for \$9



ANTENNA EQUIPMENT

Proven For Performance and Value

| | Amateur Net each |
|---|---------------------|
| MOBILE | |
| Type CA Bumper Mounting, Chain Style | \$6.60 |
| Type R-200 Universal Ball Mounting — Coax type | 6.90 |
| Type R-300 Universal Ball Mounting — Standard | 6.90 |
| Type SA-2 Heavy Duty Stainless Spring Adaptor | 7.50 |
| Type RS-300 Comb. Ball and Spring Mounting — Standard Type | 13.50 |
| Style BX5 — Center loaded Antenna for standard frequencies — 72" S. S. Whip | 9.00 |
| Style B55 — Same as BX5 with SA-2 Spring | 15.00 |
| TS-896 — 96" one piece Stainless Whip — taper ground | 4.50 |
| TS-884 — 84" Same description as above | 4.50 |
| TS-872 — 72" Same description as above | 4.20 |
| BASE STATION | |
| GP-430 — Light weight Aluminum Ground Plane Antenna fully adjustable from 40-60 MCS | 30.00 |
| GP-450 — Same as above — adjustable from 20-40 MCS | 24.00 |
| GP-312 — Civil Defense VHF Ground Plane Antenna — Efficient and inexpensive — 108-120 MCS | 4.80 |
| GP-314 — Same as above — 144 MCS | 4.80 |
| GP-315 — Same as above — 152-162 MCS | 4.80 |

Types M, AL and SS Telescoping Vertical Antennas are available in Steel, Aluminum and Stainless ranging from 12' to 35' in height.

Safeguard your Base Station Equipment with a Premax Ground Rod, 3/8" to 3/4" diameters, up to 8' in length.

See your dealer or write for catalog

PREMAX PRODUCTS

DIV. CHISHOLM-RYDER CO., INC.

6014 HIGHLAND AVE. • NIAGARA FALLS, N. Y.



Sweet Talking...



THE GLOBE MASTER CITIZENS BAND TRANSCEIVER

A new Achievement in CB transceiver excellence. 22 Channel Reception, 11 channel broadcast. Built-in S-Meter, spot switch, superior modulation with adjustable clipping, are all part of this great unit. Send for free spec sheet now. See coupon below.

FREE WHEN YOU BUY the MASTER

The Globe Citizens Band Book tells you everything you must know to operate CB. What you can and can't do. Installation tips, which antenna, base or mobile, CB language. It's all here. A regular 2.00 value, compiled by experts. Free with every CB transceiver from Globe exclusively.

SEND \$1.00 FOR A COPY NOW...

Like a copy of this great book now? Use the coupon below and enclose 1.00 cash or money order for each copy.



GC ELECTRONICS CO., 400 S. Wyman, Rockford, Illinois,

Rush me the Globe Master Spec sheet

Send me _____ copies of the CB Book. I enclose 1.00 for each copy.

Name _____

Address _____

City _____ State _____

May 1963 • \$9 • 45

pressed at their source or, if present, their effect can be minimized in the CB receiver. The best overall performance is obtained by suppression at both locations. Components are available that will do a good job on almost any type of ignition system. Generator noise, meter noises, wheel static, etc. are all problems that can be combatted. Step-by-step your receive noise level can be brought down. The suppression of noise can have a very significant influence on reliable range and trouble-area performance. Signals may be there but if you can't read them they are useless.

Antenna mounting position, plus line length and routing are factors in the noise susceptibility of an installation.

A receiver with a good noise clipper can do much to cut down the impulse type of interference generated by vehicular electrical systems. A good squelch system is helpful in reducing the annoyances of noise when the mobile receiver is monitoring the operating channel.

6. *The Base Station*—Mobile performance is of course closely linked to base station performance. Simpler and less troublesome mobile installations are necessary when the base station does its job well. In many of the previous columns we have stressed those factors that affect base station performance. In fact, mobile problems can very well disappear with a good high base station antenna that is properly installed and adjusted. Never overlook the directional base station antenna if your services are dominantly in one or two directions from your base station.

Don't forget the basic fact that citizens band operation is "two-way radio" and in the attainment of reliable operations it is the overall system performance that must be always kept in mind. Simple changes at one end of the link may do more good than costly and elaborate changes at the other end.

SOME ANTENNA TYPES CONSIDERATION

The quarter-wave whip, Fig. 1, is the great granddaddy of CB mobile antennas. It is an "on paper" good antenna. Theoretically it has an antenna resistance of 36 ohms, rather ideal for matching a 50 ohm transmission line and a Pi-network transmitter tank circuit. However, the antenna resistance, its resonant frequency, and bandwidth are influenced by ground. There is nothing so indefinite as the

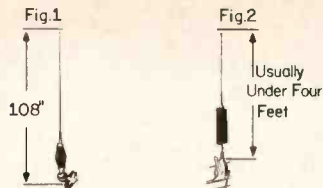

Fig. 1. The basic 108" whip for mobile use. Fig. 2. shows a base loaded short antenna.

ground conditions of a vehicle. The length of line between antenna and CB unit is quite short and there can be definite interaction between antenna resonant conditions and impedance and, the rather close-coupled antenna and tuning circuits of the transmitter.

All of these shaky conditions mean that there is very little delineation between antenna and transmission line. Often, changing the length of the transmission line has the same influence as changing the antenna length. This means that the antenna system is far from well matched and the belief we have a quarter-wave vertical antenna against ground can be a rather far-fetched interpretation. Coupled with this we have the whips long length and physical mounting limitations.

For all of these reasons one can anticipate a trend to reduction in antenna length. The shorter antenna can be mounted at locations more favorable to a good ground performance. Roof and cab-mounted types have rather favorable ground planes beneath them. Thus we can come nearer to calling such an antenna a quarter-wave resonant type even though its physical length is shorter than a quarter-wavelength.

Electrical quarter-wave operation is obtained by other means than making the element have a physical length comparable to a quarter-wavelength (100-inches plus). You are familiar with the popular technique of adding an inductor to the base of an antenna; this adds electrical length without increasing physical length as shown in Fig. 2. This simple technique can bring the overall antenna length down to under 60 inches. The more-than-half decrease in physical length permits more choice in mounting position. This aids in obtaining a good ground and an antenna that has a definite resonant characteristic plus an impedance that will at least provide a substantial minimization of some

Continued on page 59

CB ANSWERMAN

by LEN BUCKWALTER, KBA4480



Editor's Note: Readers are invited to ask the CB ANSWERMAN any questions which they have regarding the CB service. Address your questions to Len Buckwalter, KBA4480, Wilridge Road, Georgetown, Conn.

IGNITION SWITCH

How can I hook my CB rig to the ignition key so it will shut off when the key is turned off? Also, I should be able to operate the rig without the motor running.

R. L. D., Yuma, Arizona

This is easy on a late-model car that has an accessory position on the ignition key, the type that permits you to operate the regular radio and other accessories when the key is turned to the left. The CB rig can be connected in the same way.

Bend your arm like a pretzel and reach behind the dashboard. Run your fingers over the three terminals on the rear of the ignition switch and pick out the longest one. This is the "hot" accessory terminal, purposely made longer so additional wires can be tied to it. Loosen the nut and place the hot lead from the rig under it.

Sometimes it's difficult to feel the longest terminal because of a rat's nest of wires at the rear of the switch. If so, try this second method. Set up by connecting the rig's ground lead (to bare metal on the dashboard, for example) and turn on the set's power switch. Now turn the ignition switch to the accessory (left) position. Take the hot power lead from the rig and touch it to each of the three terminals at the rear of the ignition switch. The one that causes the rig to go on and off when the key is turned between accessory and off is the correct one.

During these operations, you'll be touch-

ing live ignition wires. Voltage, however, is 6 or 12 and perfectly safe to handle with the fingers. (It only starts to tickle up at about 40 volts—like the "Electricity-Is-Life" machine at the amusement park.)

Old-fashioned buggys, with no accessory-type ignition switch, can be updated by installing a new switch. These are easily installed and usually cost less than \$2.

HITTING THE BOTTLES

My old car really shakes up my rig's tubes. Are there any vibration-proof types made?

K. A. D., Peekskill, N. Y.

All the major tube companies make ruggedized versions of popular tubes; RCA's "Premium" and "Special Red," GE's "Five-Star," and Sylvania's "Gold Brand" are examples. Price of these tubes is generally two to three times higher than for standard types.

Here are some typical CB tubes and their ruggedized versions (shown in parentheses): 6AQ5 (6005); 6AU6 (6AU6-WA); 6AL5 (5726); 6AU8 (7060); 6BE6 (5750); 6U8 (7731); 12AT7 (12AT7-WA); 12AX7 (5751).

In addition to the above, it might be a good idea to shock-mount your rig with some resilient material like foam rubber.

D AND C FOR R/C?

Can I operate my Class D unit on one of the Class C channels to radio-

...THE STANDARD FOR COMPARISON!

MODEL CD-7 CITI-FONE

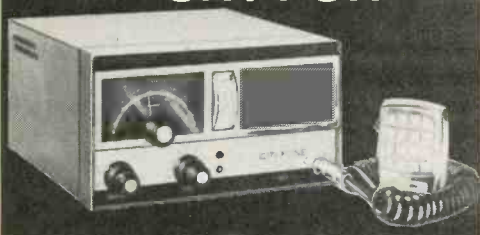

• DESIGNED FOR THE DISCRIMINATING USER WHO DESIRES QUALITY AND RELIABILITY AT A REASONABLE PRICE. COMPARE PERFORMANCE BEFORE YOU BUY AND YOU'LL BUY CITI-FONE.



See your nearest dealer today or write for full specifications to Dept. M-10

MULTI-PRODUCTS COMPANY

21470 COOLIDGE HIGHWAY • OAK PARK 37, MICHIGAN

ANTENNA TESTER 520A

- Read Forward Power and Reflected Power DIRECTLY IN WATTS—0-10, 0-100 and 0-1,000 watts ranges
- Read antenna efficiency in SWR from 1:1 to 8:1, in per cent or in GOOD-POOR
- For 50 ohm coaxial lines
- Inserts no error in coax up to 160 MC
- Dual air coupler rated at 1,000 watts maximum



TRANSMITTER TESTER 510B

- Read both positive and negative modulation peaks from 0-120%—no scope needed
- Read RF output on 0-5 watts and 0-400 ma scales
- Also serves as field strength and remote RF indicator
- High impedance input for Handy Talkies
- Jack for headphone or scope



"10-2" SUPREME WITH THIS NEW TESTING TEAM

Here's a matched set that will help you quickly develop maximum sending and receiving performance from your equipment. Handsome professional set with components especially selected for dependability and accuracy. Easy to own, too—each under \$50. See them at your electronic dealer's—or send coupon below.



SECO ELECTRONICS, INC.
1241 S. Clover Drive, Minneapolis 20, Minn.

Please rush information on this matched testing team for my rig.

NAME _____
ADDRESS _____
CITY _____ ZONE _____ STATE _____

control my garage door?

J. T., St. Louis, Mo.

From the technical viewpoint it is practical; you would use a channel 23 crystal to match the 27.255 MC frequency of the radio-control receiver in the garage. The only wrinkle occurs when you use your rig with one of the newer systems. Recent garage-door openers utilize tone signalling (to prevent the receiver from triggering on strong carriers from other stations). If this is the case, an audio oscillator must modulate the CB transmitter at a frequency precisely matched to that of the control receiver.

The other consideration is a legal one. The rules state that a Class D station may use tone signals only to establish and maintain voice communications between stations. This appears to rule out your system. However, if you had a Class C license, there is nothing in the regulations that forbids the operation of your rig, since it meets Class C requirements. In fact, the Commission does accept so-called "composite" equipment for type approval if the manufacturer wants it certificated. (This procedure is not mandatory for either Class D or C equipment.)

S9



ALVIN HALE

"He just walked across the room to dim the lights, Mother—now he's making us drinks."

A MOBILE
HANDBOOK
FEATURE

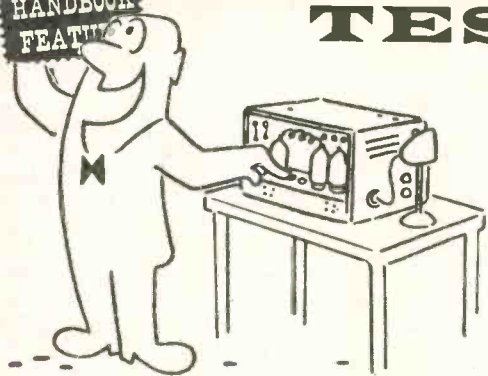

TEST GEAR

by **HERB FRIEDMAN, 2W6045**
2271 KNAPP STREET
BROOKLYN 29, N. Y.

HOW'S MY BATTERY?

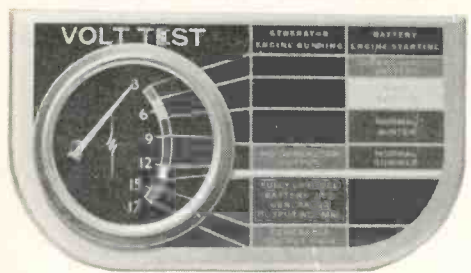

One of the things that seem to be a recurrent "CB phobia" is concern over the condition of the car battery. Actually, intermittent use of a mobile CB rig should have, at most, the effect of a normally used auto radio. However, it is conceivable that heavy, and in some instances practically continuous use, of the mobile transceiver would be a reason for concern over the battery's condition.

If you want to forever end all concern about your battery the Lafayette "Volt-test" is probably the best answer. The "Volt-test" (Price class \$7) will tell you not only the condition of your battery but also how the generator/regulator system is functioning. To understand how the "Volt-test" works it's only necessary to know a few things about your battery/charging system.

For our discussion we'll set the voltage of a fully charged battery at 12.6 volts. If you connect a voltmeter across the battery and turn over the starter the voltage will read down to 9 volts. Now this 9 to 12 volt range applies to warm weather. In the winter the battery is still good (fully charged) if the voltage falls as low as 7.5 volts. Between 4 and 7.5 volts the battery is weak; below 4

volts you better hustle down to the garage because the next cold-snap is going to leave you stranded. Notice the wide voltage range, with the starter on, which indicates a good battery—too often the inexperienced sees an 8 volt reading and panics, and he throws enough charge into the battery to melt the plates.

Now to the charging circuit. Under normal conditions the generator, to properly charge the battery, will deliver somewhere in the vicinity of 14.2 volts; the exact value depends on your make of car, but under normal driving speed your battery will be properly charged if the voltage is somewhere around 14.2 volts. Some CB'ers, to their regret, assume that if a little charge is good a lot is better. As they find out (when they write the check) overcharging a battery can kill it just as fast as undercharging. In addition, when a battery is overcharged sulphuric acid vapor is vented in large amounts. This settles out on the wiring under the hood and eats through wire insulation, battery case, and battery. The vapor is the sulphuric acid/water mix used by the battery. You will replace this with *water*, further diluting the acid concentration (specific gravity) and thereby reduce the ability of the battery to be charged to its normal value.

Notice that voltages have been the key to battery and charging conditions. If you connect a voltmeter permanently across the battery and mount it on the dash you'll have a constant check on the electrical system; only you will have to remember all the voltage references. The "Volt-test," however, will do all the remembering for you.

Continued on page 58

CB CASEBOOK

by **LEE AURICK, 2W2870**
MT. PLEASANT RD. RFD 1
COLUMBIA, PA.

WOULD YOU LIKE TO READ ABOUT YOUR COMMERCIAL USE OF CB IN S9? IF SO, WRITE TO US.



Fred Luckenbaugh, 3W1569, "at the helm" of wide-spread business interests via CB radio.

"Yes Ma'am, bus seven is running about five minutes late due to the bad weather. They should be coming down your road now."

"Yes Ma'am, bus three was delayed due to heavy traffic just west of town. The driver reports that he is now in the clear, and only about three minutes behind schedule. The children should be home very soon."

Your S9 reporter listened, fascinated, at the calm and efficient way in which parental fears were being quieted by Fred Luckenbaugh, 3W1569, of Spring Grove, Pennsylvania. Bad weather had snarled traffic, and already anxious mothers were calling the bus company to inquire as to when the children would be home.

During a brief lull, Fred filled in the details on what is the largest CB set-up reported in this column to date. As the President of *Luckenbaugh Chevrolet Co.* in Spring Grove, Fred is under contract to supply school-bus service to the Spring Grove Area Schools. To do the job efficiently, Fred operates fourteen buses, each equipped with CB radio.

"Before CB, we never were able to give a satisfactory answer to calls of this type. The simple reason was that we just didn't know

A MOBILE
HANDBOOK
FEATURE

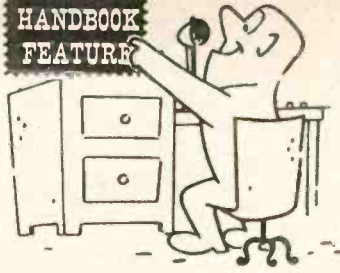

why a particular bus was late. Any number of things *can* happen, none of them serious, and yet the bus will be delayed a half hour or so. If it is nothing serious, we would likely be the last people to know that a bus was late. We put in the CB radios in 1959, and believe me, things took on a different complexion right away. Now, we know immediately if a driver is detained for *any* reason, and follow each bus to the completion of its route. The peace of mind to parents, not to mention ourselves, plus the renewed public confidence that we now enjoy, was more than worth the investment."

"Mothers, I guess, begin getting concerned even a few minutes after a bus is due, and now when they call, we can not only tell them what happened to cause the delay, but where they are at that moment, and just when to expect the children at home."

"The improvement in efficiency in the way that we now operate has been another bonus too. On occasion, a particular school will decide to dismiss the students at an earlier hour than usual. This decision is often made in the morning, and I am usually able to notify the drivers concerned before they have even completed their morning run. This permits them to make the necessary arrangements, and everyone adjusts to the new schedule. No longer do we have to trust that a man will receive a telephone message. We have direct confirmation from him."

"Surprisingly though, at least to us, was our discovery that CB saved us so much money in the way of maintenance. Naturally, we attempt to balance the miles that each driver and bus travels. As a result, most of our vehicles come due for periodic checks at

almost the same time. When the Service Manager finds, on a particular day, that the service load is lighter than he had anticipated, he is able to pick up the microphone and request the driver to head for the garage immediately upon the completion of his run. In this way, we are able to keep our shop at peak load at all times, without either mechanics or buses sitting idle."

"We have had some fringe benefits in this department too. In the past, when a driver had a flat tire, he was naturally reluctant to leave a bus full of small children. As a result, we had our share of ruined tires. The driver would just keep on going until he came to a place where he could telephone. On at least one occasion, a driver discovered an engine oil leak and kept going until he reached a point from which he could notify us. Scratch one bus engine. Since we installed a CB radio in each bus, we have lost neither a tire nor an engine."

"Prior to CB, we took a fling at both the *Miscellaneous Common Carrier*, and the *Industrial Radio* services. The equipment for these bands cost about \$500, and actually did nothing for us that CB doesn't do. We

found it unnecessary to spend so much money when CB radio gives us the coverage we need. Our buses range as far as fourteen miles, and we have solid communications with them at all times."

"Our school bus operations have been so successful since the advent of CB radio that we have extended it to include five of our service vehicles, and two new cars used as demonstrators. In this connection, we have found it desirable to put a 'walkie-talkie' in a car before taking it out for a road test, particularly if the customer has complained of intermittent motor failure, or if the mechanic feels that he may need assistance before he returns to the shop. It has saved more than one of our mechanics a long walk to a 'phone booth to summon aid."

"Of course, the unit I keep in my car is now an absolute necessity to me in the conduct of my business. A new enterprise I am now opening will also make extensive use of CB radio. It will be a sales and service type of business, and I plan to keep on top of things there as well as here, by radio. I just wouldn't know of any other way to operate, and in fact, I wouldn't want it any other way. [S9]

COMTRAN for Greater talk Power!

COMTRAN II COMPRESSION AMPLIFIER

Designed to meet the needs of the CB service, the fully-transistorized COMTRAN II audio compression amplifier gives you maximum talk-power. Yes, and it requires no internal wiring in your rig — just plug it into your rig's mike socket and plug your mike into the COMTRAN II. Blast 'em all off the air with your COMTRAN II. Write for further details.

Only 4½" x 1½" x 1½" and uses self-contained 9 volt battery. **ONLY \$29.95.** Write for descriptive catalog. Dealers Inquiries Invited.



ONLY \$29.99

**For further information
or your nearest dealer, write . . .**

| | |
|--------------------------------|-------------------|
| COMTRAN ASSOCIATES INC. | |
| 2847 Cropsy Ave. | |
| Brooklyn 14, N. Y. | Tel. 212-266-1490 |
| NAME _____ | CALL _____ |
| ADDRESS _____ | |
| CITY _____ | STATE _____ |

CLUB NOTES

**INDIVIDUALS AND CLUB MEMBERS!!
SEND US ITEMS FOR THIS COLUMN!**

TO JOHN KREJC, 2W4586

40 LANZA AVE.
GARFIELD, N. J.

WANT TO MAKE MONEY? S9 has a nationwide staff of AREA PUBLIC RELATIONS EDITORS who act as our representatives in the field. We are always looking to expand this force with good workers. Our A.P.R.E.'s can earn some nice money too, and many are already supplementing their regular incomes substantially by representing us. We're especially interested in persons to act in this capacity in the following call areas: 2, 6, 9, 14, 16, 17, 18, 19, 22, and 23, although ambitious S9'ers in all other areas will also be most welcome. Drop us a note and tell us about yourself.

Bristol County CB Radio club of R. I. officers for the coming year are: President, Edward Cardota, 1W-8130; Vice President, Tony Goulet, KBA4207; Treas. and Recording Sec'y., Mike Mello, 1Q5758, and Executive Sec'y., Seth B. Paull, 1W1717.

Bill Wootan, KHB1722, A.P.R.E., would like all clubs in the 18th area to send him their monitoring channels, addresses, meeting nights, etc. Write: Bill Wootan, 331 Granada Place, New Whiteland, Indiana.

An S9 exclusive.

Feb. 9th, The Bay State Channel Wizards, Chapter #2, Fall River, Mass., held their annual installation dinner.

Narragansett Bay CB club of Newport R. I. held a real blow-out, having a Valentine's Day buffet.

Largest Shoemobile in U.S. goes CB . . . The Yankee Shoemobile, run by Warren Seymour, KBA3567, of Warren, R. I. will cover the state with all types of corrective shoes and services. The mobile unit will carry over 1800 pairs of shoes. Dig that crazy mobile.

Alaska 49'ers CB Association on Feb. 1st moved approximately \$10,000 during the Mothers March for Dimes. A base station was set up in the March of Dimes Headquarters and delivered from collections by the block captains. Looks like the 49'ers can really move the loot! On Feb. 2nd and 3rd the group assisted in setting up traffic and safety control for the sports car races, which was held at Willow Alaska.

REACT division of the 49'ers were called out after the March of Dimes project to assist on a fire in which two children lost their lives. The REACT team set up traffic control, keeping mobiles and spectators out of the area. Two days later the team again was in action during a search for a missing 5 year old girl. Thanks to Ray Williams, KJB0035.

Glad to see that the El Camino Real CB club has been reactivated. Discussed were—proposed changes in the original by-laws, which were read and adopted.

Well—The formation of the CB Council of Southern California are complete, officers elected, and meetings set for once a month. The Council will be composed of two representatives from each club in the district, that cares to affiliate themselves with the council. Temporary chairman of the council is SNAPPER, KEJ3867.

President of the Santa Barbara Citizen Band Radio Club for this year is Jim Hartley, KEJ2431. A beautiful gold plaque and gold trimmed gavel was presented to the club at their January 24th meeting. The presentation was made by Les Magann, KEJ7214, on behalf of the membership. THANKS, LES. Club paper is the CB FLASHES. Editor, Jim Carroll, KEJ4433, Herb and Jim Hartley, KEJ6466 and KEJ2431, respectively.



Good luck to the out-going president of the Southern California 11 Meter League, Lou Ellis, 11W3242. The club is beginning of what they hope to be the largest blood bank in S. California. Your help is needed. Any organization in the area who is in need of communications can feel free to call upon the club. The club is a non-profit organization and are willing and able to help. Write: Southern California 11 Meter League, P.O. Box 2012, Bell Gardens, California.

THE BEAM, club paper of The Middle Georgia Citizens Band Radio club of Macon Georgia, Bibb County and vicinity. The organization is a non-profit group. The unit was organized by citizens band operators of Macon and vicinity, in the interest of service and cooperation of the users of the Citizens Radio Service. The club furnished excellent communications during their cities Christmas parade. President of the fine club is Harrold Norman, KDB3912.

The Spokane CB 7-11 Radio club, which is a club designed to promote good will with CB and the community and acquaint the CB populous with the rules and regulations of the FCC.

NorCRES—(Northwest Citizen Radio Emergency Service) This club is a division of Civil Defense. A majority of the members are Spokane County C.D. Sheriff's. This is a well organized club because its objective is to provide other CD organizations with communications. To obtain membership in the group is strict requirements. CB license and mobile and base station equipment, at least a standard First Aid card and in the process of completing the advanced course, instruction in police procedures, laws, traffic course, fire fighting, water safety, and rescue. Ed. note—What, no 50 mile hike.

The GRANDE RONDE CB'ers helped to make the January, 1963, March of Dimes Drive in LaGrande, Oregon, a big success by using all mobile units to collect pledges during the 18 hour local Radio Marathon.

President of the Dixie Communications club, Georgia, is Bud Horton, 6W1458. The Big Voice of the Dixie Communications club, will be located on the 5th floor of the seven story tower now under construction. "Stone Mountain," sixteen miles from Atlanta, is a solid piece of granite 1686 feet above sea level, will be the home.

From M. (King) Berdine, 19Q3833, comes the news that a new CB club is being formed in the Lawton, Okla., area. Seems that it is the remains of an old one, but with a different name. The club will be known as the S. W. Okla. 11 Meter Radio Service. Some of the projects areff Club insignia patches and jackets, Red Cross and CD work, Aux. Police and a 24 hour monitoring system. President of the newly organized group is Tom Thomas, KEG1859. King is stationed at Fort Sill, Okla., but his permanent base is the Roundtable CB Club of Cleveland, Ohio.



There's a young man living in Cumberland Mills who sits by a Citizens Band Radio for hours on end waiting for a chance to be of some assistance to anyone who might ask. David Powell, KC15103, is one of the dozens of CB'ers in Cumberland County who became keenly interested in CB last summer. Late last month David heard a distress call from a motorist on highway 195 near St. Pauls. David answered the call, he phoned a local towing service and helped make arrangements with a local motel for reservations for the couple. Aiding motorist with all forms of car trouble, relaying messages via phone and radio gives David his greatest pleasure. These activities don't sound like a great deal for a healthy 33 year-old man until you consider—David Powell has been totally blind for almost 20 years.

The Tri-County Emergency Communications Net, Inc., Dover, N. H., is made up of a group of men and women who are bound together by a common interest—CB Radio. The Tri-County Bulletin, a truly good paper, boasts a technical column, First Aid, Civil Defense, and last but not least, Household Hints. President of the Dover, N. H. club is Robert F. Durnin, 1W7200.

The Otter Valley Citizens Radio club of Rutland, Vermont are recruiting members into the REACT program and have picked 12 of these for a rescue squad. These members are now taking a First Aid course, (basis) and have started on their advanced course. The club meets on the last Wednesday of each month. Membership is presently at 73. The club hopes to sponsor a Tri-State Jamboree (Northern N. Y., Vermont and New Hampshire) in the very near future. President of the club, Charles Pallutto, 1W3478. REACT Chairman and Captain of the Rescue Squad is Alex Nagy, 1W8329.

Newly elected officers of the Raisin Valley CB club, President, Raymond Wright, KHG2066; Vice President, Dean S. Downing, 19Q3538; Secretary, Louis Loesch, 19Q6066; Treasurer, Don Geringer, 19Q9853. The Michigan club monitors channel 9.

The South Jersey Citizens Band Radio Club, Inc., one of the nations oldest and most widely recognized CB clubs is having a membership drive. How about bringing a guest to their next meeting!

Sonar's, Louis Perlmutter, 2W6255 was the guest of the Delaware Valley Citizens Radio League meeting of February 12, 1963. Lou will show two films, one on CB and the other will be on marine radio equipment. Good luck to the club as being one of the Top Ten in the nation.

The Citizen Banders Journal, club paper of the Illinois Valley Citizen Banders comes the news that the Celestial Citizen Banders of Pekin will hold their dinner (smorgasbord) on Feb. 23rd at Westbrooks. 100 FREE orchids will be given to the first 100 ladies arriving.

Finally comes the news—The Five Watt Whips of Lowell, Mass. will hold The Massachusetts State Jamboree on JULY 21, 1963 at CONNY OUTING GROUNDS rear of Mammoth Rd., Dracut, Mass. A CB unit will be given as a gate prize, also many other CB prizes. All CB'ers and their friends are welcome. Hope to see you all. General Chairman of the event is JOE

BIGOS, 1Q4939, which will take place RAIN OR SHINE. Plenty of free parking—Follow the QSO signs—Monitor Channel 5-9-11. REMEMBER—July 21, 1963. See you there. What say DEVEAU, lets GO.

WELL, Good luck to Maryland Staff Member, Jim Cross, KCF0823 and the monthly publication of the Hagerstown Unit of REACT. The group is associated with community rescue squad and Civil Defense in Washington County. FINE JOB, Jim.

The Southern California Citizens Band Association recently with other CB'ers turned out in force by setting up a communications net and searching in the rugged canyons leading to the Calif. Western University Campus and area, among the steep ocean cliffs, up and down the beach house to house, for miles for a lost 2½ year old boy, Murphy, Curly Wallace, KEJ3298 was the prime CB communications controller during the search and did a wonderful job in getting the net functioning quickly. From W. S. Sharp, Chief of Police, "I appreciate the efforts expended by you and the men of your organization in providing a real public service during this emergency."

REACTSHUN! March 6th is the date of the presentation of the Pacific Telephones TELESTAR film and talk. REACT of Costa Mesa, California, the helping hand of Citizens Band, has obtained the Glendale Federal Savings and Loan at 320 North Harbor Blvd., Fullerton, to show the film.

The Cee Banders Radio Phone Club of Birmingham, Ala., in a regular meeting, Sunday, February 10, 1963, elected the following officers for 1963: President, Dick Ackerman, 6Q4434; Vice President, Roy Rhodes, 6Q-0447; Treasurer, Jake Levine, 6Q3604; Secretary, Wesley Liles, KDB3339. The club is composed of CB'ers in the Birmingham area and have a membership of 75.

The evening is over but the memories still remain. On February 9, 1963 the North Jersey Chapter of MCEU honored Bert Endress, 2W9623, Governor of MCEU, State of New Jersey, at a gala event held at the Clifton Casino, Clifton, N. J. Bert Endress was honored for unselfish and tireless time he devoted toward making 1962 a success. The D.S.A. award and many special awards were presented to the Governor. Dinner Chairman was Mike Borisuk, who was assisted by Paul Calderio, KBG3817 and Lou (Crash) Folia, 2Q6211. George Deveau, Governor of Conn., and Frank Joseph, Governor of Long Island also attended. Toastmaster, John Krejci, 2W4586.

A series of eight Auxiliary Police classes will be conducted under the sponsorship of the Summit Township unit of the Civil Defense and in cooperation with the CB RANGERS. The club Call Book and Club Directory is now being printed by Floyd McCoy, KIC4059. Should be ready by March 1st. Get your order in early as possible, because half are already gone. To order: Call Book, Box 284, Bulter, Penna. PARATI SUMUS, "We are ready" club motto of the RANGERS, who feel that they lived up to the motto through the existence of their Emergency Squad. The members of the Squad stand by to act in any emergency or any other way in which they can serve the communication needs of the Bulter, Pa., area. To the police authorities, Civil Defense Officials, various Fire Depts., and to the public in general who might find need for the CB RANGERS EMERGENCY SQUAD—"We Are Ready"

The 2112 CB Radio Club of Rutherford County, Forest City, North Carolina. As all other club papers, they are looking for reporters for their paper. Editor of the news, M. T. Frady, 6Q0428. From the paper comes the news of a new club in S. C., "Four Square Club." President of the unit, C. D. Roach, KDD0210. The 2112 Club wishes all the success to the newly organized CB club.

COMING EVENT—West Coast CB Jamboree, June 16, 1963, sponsored by the Citizens Emergency Mobile Patrol. The event will be held at Brookside Park, Pasadena, California. Prizes and more prizes. For more info contact—Scott Stucker, C.E.M.P. Unit 22, P.O. Box 924, Reseda, California. Remember, June 16, 1963.

"STATIC," the official Newsletter of the CB Radio Cruiser's of Oceanside, California, brings the news that the March issue of the newsletter may be its last. Seems that very few people are really interested in the paper. The paper boasts many articles among, Mr. CB Know it all, Secretary Report, Message from the President, Swap Shop, Static Mobile, Photographers report, Project report, Safe driving thoughts, and last but not least, Treasurers (MONEY) report. How about it boys, let's rally and help the editor. The club has membership in Oceanside, Vista, Carlsbad, Camp Pendleton, Fallbrook, and Encinitis, California.

The first ARFAX meeting of the new regime was held at the McLean Bowling Center. Meetings are held on the last Thursday of every month. Past editor of the paper was Art Stamler. Next month the paper will come out under the watchful eye of Bob Howison.

Midland, Michigan, home of a new CB club called, The Midland County Citizen Band Club. President of the group is Vincent Robel Jr., 19B0135; Vice President, Antoinette Hollenbeck, KHH0836.

COMING EVENT—Citizens Band Radio and Electronic Equipment Show . . . Amvets Home, Montgomery St., Chicopee Falls, Mass. Saturday, June 1, 1963 . . . 10 A.M. till ????? Monitor Channel 9. Also—Family Style Picnic, June 2, 1963. Same address. Sponsored by the WESTERN MASS. REACT TEAM . . .

Massachusetts State Jamboree, Sunday, July 21, 1963. PLACE—Conny using Grounds—Mommouth Rd., Dracut, Mass. Sponsored by the Five Watt Whips of Lowell, Mass. Monitor Ch. 5-9-11. CB rig given as gate prize.

New club—South Shore CB club from the 1st area meets at the Roger Williams Bank, Wakefield, R. I. President of the new club is Stanley Taylor, KBA5188.

Many members of the Bristol County Citizens Band club have received their restricted radio telephone licenses and most are working for their 3rd Class licenses.

President of the Citizens Assistance Relay League, Herb Wright. The club is from Long Beach, California. The club has acquired a fine, new meeting place through the assistance of Gregg Artz, 11Q2545 and the courtesy of Community Savings and Loan, 1535 Paramount Blvd., Paramount, California.

The Birmingham Radio Emergency Assistance Club, meets every other Wednesday at the Homewood Elks Lodge. President is Dr. Sam Shafferman, KDB8588. Mailing address of the new club, P.O. Box 5713, Homewood, Alabama.

The Jackson Citizens Band Radio Club a collection of radio "bugs" enters a new organization year this week with a desire to expand activities into a state-wide network. They have a fine program planned for this year and hope to have a Statewide CB Jamboree. The club keeps a scrap book of all the activities that they are involved in which dates back to August, 1961. President is Bill Fowler, KEA2258; Vice President, George Vicory, 8W1351; Secretary, L. D. Chaney, KEA-1000; Treasurer, Tom Stringer, KEA0498.

With the assistance of Citizens Band Radio operators, four pints of B negative blood were donated within three hours Sunday night for a patient in Saddle Brook, N. J. Hospital. It was an odd circumstance that brought the radio operators into the picture. At 6:30 p.m. Sunday, Marge Katz, KBG1472, made a telephone call to Dr. Bart Maggio, whose office is near the Katz home. The doctor heard the radio in the background and told her of the need for B negative blood. She broadcast it and before 9 p.m. members, including Bert Endress, Governor of MCEU offered blood. Marge and Larry are members of the Bergen County Chapter of MCEU. Fine job again was done by these two people, who have constantly helped in community emergencies.

Great—The Delaware Valley CB Association, Wilmington, Delaware, is 3 years old this past Feb., 1963. The club is proud to join with two of our greatest Presidents in celebrating a birthday in Feb. On February 26th, 1960, their association ratified a very impressive set of by-laws, installed their first officers and accepted a motto, which in a few simple words, tells the world for what they stand for. From that day, they have made every effort to never lose sight of their aims and ideals. "SERVICE THRU UNITY," their motto, has been deeply etched in the minds of those who have accepted leadership in the organization. The club was one of the first to organize in this part of the country. The group feels that they have a stated principle in their motto, and sincerely hope that such will always be a challenge to their officers and entire membership.

A new look—The Carrier, club paper of the Cambria County Citizens Communication Club, Johnstown, Pa., sports a new and flashy cover with real crazy WOW—pictures. What ever page I turn to, it always is the inside cover. With the newly appointed staff, they are planning to put out a monthly edition. Future plans call for a roving reporter and an advertising solicitor. It is their intention to promote good will, not only among their members, but to arouse interest in their community. The staff of the "CARRIER," each month will chose a CB'er of the month. Bud Singer, KIC5629, Control Director of the club, is a systems technician for Bethlehem Steel Co.

It was a balmy evening temperature near the 70° mark, when close to 700 CB'ers including their families,

gathered at the Ramada Inn, in Pico Rivera, California, Saturday night, February 23rd, for a coffee break. There have been numerous large rallies for CB'ers in the past, but this gathering sponsored by Master Electronics Corp., of Downey, Calif., can lay claim to the largest CB coffee break held anywhere. The program got underway about 8 p.m. and was MC'ed by Pico Rivera's own Gene Grant, KEJ6251. Loyd Manning, 11W6258, past Mayor of Pico Rivera, and a present city councilman, welcomed the CB'ers to the city. Bob Forster, KEJ5806, A.P.R.E. for S9, extended greetings from the Citizens Band Journal. Ross, KFA0930, installed the public address system handled the transportation and display of "goodies" that were given away, during the evening, by drawings. Chuck Spaulding, KEJ5225, handled the registration desk, without a single dissatisfied customer. Cards were issued to each licensee, entitling them to a free crystal, any make and frequency of their choice. During the evening, several "phantoms of the band," CB'ers that were well known by voice and call signs, but seldom seen by many, were introduced to the enjoyment of the group. Door prizes included many CB Radio necessities and useful "goodies." The main prize was a Golden Colinear antenna. Master Electronics is to be commended for a terrific job well done and for providing the time and place to bring so many CB'ers together. The Ramada Inn is one of a chain of 30 motels. It was a very enjoyable evening and one that will long be remembered by the CB'ers in this area. Great job, BOB.

L. W. Hallar, 18QA1471, tells of the Illinois Valley Citizen Banders have set June 9th, 1963, for their Jamboree to be held at the Exposition Gardens, Peoria, Ill.

Bartholomew County Citizens Band Radio Club will have their Jamboree May 24-25 and 26 at the 4-H Fair Grounds, State Roads, 31A & 58, Columbus, Indiana. There will be dancing 'p.m. through midnight, Friday and Saturday, May 24 and 25. Mrs. Maunitta Forrest, 1424 California St., Columbus, Ind., is secretary-treasurer. President is Berl DuBois.

Montclare Citizens Band Club of Chicago is having their picnic June 23 at Fox River Grove, Cary, Ill. President of the group is Fred Ruedy, 3222 W. Olive St., Chicago, Ill.

The communities of Fullerton, Costa Mesa, Orange, Anaheim and Santa Ana are represented in the 10-99 Club which held their meeting at the Copper Penny, Santa Ana, California. Each one has two members on the board, and they rotate the ten members in handling these coffee breaks.

The club has a very active BOAT AUXILIARY, for the members that are boaters and fishing enthusiasts. Channel 10 is the official channel for the 10-99 club of Orange County. The club held a breakfast outing March 3rd, at Irvine Park. Annual Swap and Auction Pot Luck Picnic will be held in June.

Meetings of the Seminole Citizens Band Radio Club of Florida are held the 3rd Sunday of every month at the V.F.W. Hall, Palmetto Ave., 8 p.m. The club met at Marvel's for a picnic dinner this past Jan. 27th. Elections are to be held in March.

COMING EVENT—The Twin City Channel Masters are holding their Jamboree, May 25th, the last Saturday in May, at Dedham, Maine.

COMING EVENT—The first annual Fort Findlay CB Fest, sponsored by the Findlay CB Radio Club will be held at the Hancock County Fair Grounds, Route #15, on June 9th, 1963. Findlay, Ohio.

COMING EVENT—York Citizens Band Assistance Club will hold their State Jamboree, June 30, 1963 at Manchester, Pa. Call—3Q0078, monitoring on channel 11. See the latest in CB equipment.

We also hear the Piedmont Citizen Band Radio club will hold their Jamboree sometime in August. More info will follow.

The Ramsey County Five Watters Radio club of St. Paul, Minnesota, held their annual election of officers January 18th at their club room, Navy Island, St. Paul. President, Robert W. Metzger; Vice President, Ralph Hughes; Sect'y., Norma Olsen; Treas., John Picha.

Located in Warwick, Mass., is the Citizen Radio Mobilers'. President of the newly reporting club is Malcolm Rice, of Millers Falls, 1Q6236.

On February 18, 1963 the Montclare CB CLUB started its traffic information survey for Radio Station WLS. They have set up five stations as monitors and only those five will be recognized as official reports. If you wish to report any road conditions or accidents, please call. KHA1377, 18A8162, 18Q1085, KHA5228, and 18A-9417.

Sunday, March 2, 1963—Polio Vaccine Clinics in R. I. The Narragansett Bay CB club of R. I. and the Seaside CB club of Middletown, R. I. combined with local radio stations to give taxi service to anyone calling 2 given numbers via CB dispatch. These clubs have worked this in the past very well.

New club—South Shore CB club, P.O. Box 453, Wakefield, R. I. Anyone interested please contact above.

"DVERT TRENDS," club paper of the Delaware Valley Emergency Radio Team, N. J. The club has courtesy cards for all members when they have the opportunity to aid or assist any motorist in need, present a DVERT card.

The Five Watters of Lake County Inc., Ohio, have jackets available for club members. Aggie Johnson who attends all meetings is ready and willing to take orders for the jackets for those interested. How about it gang. At the clubs last meeting a film titled "Atomic Attack" was shown through the courtesy of the CD.

Motto of the Lycoming CB Radio club, "A helping hand in time of need." The club was also selected as one of the top 10 in the U.S. Each year they publish a area call book. This book brings up-to-date all licensees in the area. All questionnaires should be returned promptly.

Keystone Profile of the Month, 3W4471, Jim Rowland, "The Golden Voice of Pumpkintown," Jim is well known in the Pottstown area, having served on the police force for 16 years and later an ambulance driver for the Pottstown Goodwill Fire Co.

COMING EVENT—The southwestern Ohio CB Association will hold their first annual NATIONWIDE Jamboree, August 25, 1963, at the Fairgrounds in Lebanon, Ohio.

The Dayton Area Citizens Radio Association held their meeting at the Dayton Public Library Building. There were door prizes awarded to attending members by drawing. All prizes were donated by local distributors. President of the group is Richard H. Wagner.

The Modulator, club paper of the Five-Eleven Radio Club Inc., Pa., tells of Mr. Richard Pack, president of the Valley CB Club of Wheeling W. Va., was made an honorary member of the Five-Eleven club at a small party held in his honor. All rights and privileges of an associate club member are hereby extended to Dick as a token of their friendship with him and their CB neighbors to the south. The club is willing to exchange club papers with any CB club in the U.S. Write: Marshall W. Jones, 654 Shady Drive East, Pittsburgh 28, Pa. This writer will 10-4 the article by 20Q3080. Page 2.

The first Wednesday of each month is the regular meeting date of the Middle Georgia Citizens Band Radio Club. Channel 3 is their CD emergency freq. The club would appreciate if all CB'ers would cooperate with them and not use 3 except for emergencies. President, Harrold Norman, KDB3912, 642 Bodwen St., Macon, Ga. "The Little Beam" is their club paper.

A blazing car was seen by Leonard Dubey, of Sauk Village, an electrician. Dubey immediately broadcast a distress signal on his citizens band radio emergency channel. The call was received by Albert Howerton of Griffith, Ind., who called the local police.

The Central Savannah River Area Radio club meets at their club house, the first of each month. The club is 2 years old with a membership of 64. President of the club, Bill Bailey, 6Q2419—Won't you please come home, from Evans, Ga.

COMING EVENT—The Springfield CB club is holding their Jamboree, June 30, 1963 at New Berlin Junior Fair Grounds, New Berlin, Illinois. The club is 60 strong and monitor channel 9. Their president is Bill Bowlin, KHA6760. Thanks to Theodore A. Margwarth, KHA3346.

The CB Radio Patrol of Burlington, Vermont was formed in Oct., 1960 for the purpose of getting better acquainted with fellow CB'ers, and to serve the public in any possible way. The club has mobile units equipped with First Aid kits, ropes, tow chains and all types of emergency equipment. The club has worked with the Burlington Police, Fire Dept. in assisting them in searches and exhibitions, on a 24 hour call basis.

International Falls, Minnesota may well have more CB units than any other American city, when considered in proportion with its population. Of the approximately 50 units in the same city, about 30 have formed a club and go by the name, CRYSTALS. The club holds on the air meetings in addition to their regular club meeting which is held the first of each month. The official club channel is 7, how about that Walt. An accurate record of station activities is kept by all members and an award will be given to the first member who reaches 1,000 contacts.

CB'ers help in Bessemer, Ala. CB mobile units from Bessemer and the Birmingham area were on hand within a short time after a tornado hit the area. The units were under the direction of Russell Findley, KDB-4385, President of the Channel 4 Breaker's Club. Units from the CEE BANDERS Radio club and the Birmingham Radio Emergency Assistance Club and many others helped. The work of patrolling, setting up road blocks, and helping clean-up, went on all night. To everyone concerned the Mayor and the people of the City of Bessemer, said "Thanks, for a job well done."

Kern County Citizens Radio Association, with headquarters in Bakersfield, California, has approximately 100 active members. President is Barry Aubrey, KEJ-3995. The club is a member of REACT and their functions are mainly search and rescue. They are planning a Jamboree for the middle of July, to be held at Tejon Pass. We'll check this one out further.

The El Cameno Real CB club held another of their successful "Coffee Breaks" March 16th at the Colonial Pancake House in Duarte, California.

The Southern California CB Coordinating Council held their March meeting in Ventura. It was attended by about 75 delegates and alternates. If the affiliated clubs have not notified the council secretary, Bill Garrett, KFA0781, of the names of their delegates, please do so on one. Running separate file for Bob Forster, KEJ5806. Don't worry about nuthing, BOB.



Officers of The Fairfax-Prince William CB Club. Left to Right: Vice President, Ed Barnes; President, Reggie Martin; Sergeant-at-Arms, Ray Kidwell; Secretary, John Mohr.

The 5 Watt Wizards of San Bernardino, California are off and running for another year. The CARRIER, official club paper, has been out of print for a month while several changes were made. It will again see print about the middle of March in a new and larger format. There will be better construction articles with a few about Part 15 transmitters. Members are reminded that club decals are available at 50¢, and they may subscribe to S9 at special club rates. The club has recently been appointed the Official REACT Headquarters for the San Bernardino Valley.

Bear Valley CB'ers were found in all parts of the mountain area on March 3rd. They were on a very successful hidden transmitter hunt, trying their best to find the mysterious voice using a Part 15 walkie-talkie. After the hunt, the club held its regular bi-monthly meeting and warmed up with coffee and donuts.

A new club, not as yet named, is forming in the desert area near Palm Springs. A informal meeting was held, and from all reports it should develop into a smooth running organization. Anyone in the area interested, should monitor channel 11 for more info.

New appointments in the Area Public Relations Editor's Dept. include: W. R. Wootan, 331 Granada Place, New Whiteland, Indiana; Lou Grasso, KBF7877, 455 Main St., Farmingdale, N. Y.; Ralph F. Dougherty, Scott County, Gate City, Virginia; M. R. Fenily, 11204 Mansel Ave., Inglewood, Calif.

William F. Harms, KIC4374, 928 E. Delavan, Buffalo, N. Y.; J. Pat Pike, KDB0815, 907 Euclid Ave., Birmingham 13, Ala.; Lloyd E. Apitz, 14Q0219, East 2709 Columbia, Spokane 28, Washington; David E. Morrison, 63 E. College St., Alliance, Ohio; James E. McCoy, KEB0298, 248 Briarwood Dr., Jackson 6, Mississippi. How 'bout you?



WASHINGTON OUTLOOK

by EDWIN FREDERICK, 2W4580

Let us take the opportunity of this *Mobile Handbook Issue* to remind you that all vehicular installed CB rigs must bear a filled-in FCC Form 452-C "Transmitter Identification Card" in order to comply with the law. These little labels are free for the asking from any FCC office.

As expected, the American Radio Relay League came out against the International Crystal proposal for a "Hobby" class of Amateur Radio Service license. This decision was made by the Executive Committee of the League without taking a referendum of the membership. The ARRL, in case you didn't know, is an organization of Amateur Radio Operators.

The FCC is again in the process of whipping up a new Form 505 (the CB license application) for Class B, C and D stations. This time the applications will be made to adapt the licensing to the FCC's new electronic data processing procedures.

The word is that the new forms will be available sometime around the beginning of July this year. Currently acceptable application versions (April and October, 1962) will not be accepted by the FCC after August 31 this year.

The FCC "set aside" its November 14, 1962, announcement giving notice that an initial decision revoking the license of Warren J. Currence, 4W0152, of Elkins, W. Va., became effective November 8th, 1962. A timely-filed letter from Currence, though procedurally defective, will be treated as exceptions to the initial decisions; accordingly, the license remains in effect pending dispositions for the exceptions.

This month shows a considerable number of revoked CB licenses in relation to the number of FCC "show cause" notices issued. These CB'ers felt the sting of the FCC's wrath for violations this month:

2Q1670, operated by Michael Anthony of Jersey City, N. J. A show cause notice, reason not available.

2Q3878, operated by Michael A. Schwartz, Croton on Hudson, N. Y., revoked for non-compliance with 19.61(g); communications not directed to a specific station or person within the direct ground-wave coverage area.

2W6620, operated by Paul Hayes (doing business as Paul Hayes Service Center), West Long Branch, N. J., revoked for ignoring the FCC's requests for information as to persons engaged in the operation of the station and the measures taken by the licensee to assure that the station was operated under his supervision, direction and control.

4W1224, operated by Alfred L. Kerr, Elkins, W. Va., was revoked for violations of 19.61(a) and 19.61(g). This involves transmission of communications to another station which were not necessary for the exchange of substantive messages related to the business or personal activities of both licensees, and also for violation of the anti-skip regulations.

6Q1691, operated by Alvin Willis and Robert Garrison (doing business as Willis & Garrison), Brunswick, Ga., revoked for failure to post the station license or a photocopy thereof at the location of the fixed transmitter and for failure to affix proper transmitter identification cards or plates.

7Q0259, operated by the Greater Miami Outboard Racing Association, Miami, Fla., revoked for transmission of unsubstantive messages 19.61(a).

7Q0919, operated by George M. Beane of Miami, Fla., ordered to show cause why the license should not be revoked for violation of rules 19.61(a) and 19.61(b).

9Q0786, operated by Marvin Wold, Austin, Texas, asked to show cause why the CB license should not be revoked (reason not available).

11Q0687, operated by Herbert Jefferey of Los Angeles, Calif., revoked for transmission of non-substantive messages 19.61(a).

11W7945, operated by Ray H. Brace, Burbank, Calif., ordered to show cause for repeated failure to respond to FCC notices concerning alleged violations of 19.61(g).

11W8521, operated by John Stewart, Los Angeles, Calif., hearings terminated on the possible license revocation of this station.

12W2215, operated by Phyllis F. Kaiser, Oakland, Calif., revoked for 19.61(a) (non-substantive messages) and for 19.61(f) (overlength transmissions without proper silent period).

13W1064, operated by Water T. Mabe, Toledo, Ore., asked to show cause why his license should not be revoked (reason not available).

15Q1314, operated by Francis C. Baxter, Denver, Colo., revoked for same reasons as 4W1224.

17Q0944, operated by Bill Smith, Hosington, Kans., ordered to show cause why the license should not be revoked (reason not available).

KEJ1808, operated by Monte R. Ariola, Santa Ana, Calif., ordered to show cause why the license should not be revoked for repeated failure to respond to FCC notices concerning alleged violation of 19.33.

The Communications Equipment Manufacturers Association ("CEMA") submitted their FCC petition on February 25th. CEMA is the communications industry organization that was formed at the International Communications Fair—this petition on the FCC rule change proposal is their first official action.

Over the signatures of Dick Salam, CEMA Secretary-Treasurer, and Harry N. Reizes, Attorney for CEMA, the petition offered the following comments and suggestions on the proposed rule changes:

1. Recommended to extend legal height of antenna to a maximum of 20 feet above any natural geological formation, tree, or man-made structure (other than an antenna supporting tower) on which it is mounted, or any geological formation or manmade structure which may reduce the transmitting or receiving efficiency of the operating station below that authorized in the service. Determination and approval of such installations to be made by the FCC.

2. The following channels for intercom-

munications between units of the same station between 6:30 a.m. and 6:30 p.m. everyday except Sunday: 6, 8, 10, 12, 14, 16, 17, 18, 19, 20, 23. At times other than those mentioned previously, the frequencies are available for intercommunications between all stations.

3. The following channels to be restricted to intercommunications between units of the same station: 1, 2, 3, 4, 5.

4. The following channels for intercommunications between all stations: 7, 9, 11, 13, 15.

5. The following channels to be used for intercommunications between all stations for the purpose of checking the performance of CB equipment and for the exchange of information of specific interest to the parties communicating: 21, 22.

6. Power for Class D stations to be set at 5 watts input.

7. Recommended that the proposed restrictions on permissible communications in 19.61(a) be vacated in favor of the already existing 19.61(a) with the addition of a clause restricting intercommunication between units of different stations in compliance with the changes suggested in 19.31(d).

8. Recommended that 19.62(a) concerning prohibited uses be modified to reflect authorized use for performance checks, etc., as suggested in 19.31(d) (see #5 above).

9. Recommended that transmission time be 5 minutes on and 5 minutes off.

They also suggested that the Commission establish an "unofficial and honorary" monitoring station network manned by holders of First or Second Class Radiotelephone licenses. These monitors would send *courtesy* notices to errant stations, however the *courtesy* would curdle after three such notices to the same station and he would then be tossed to the mercy of the FCC.

They also asked that the Commission establish a "point system" for violations with an automatic license revocation when you hit the lucky number.

As we go to press this month we learn that the Commission finally got their controversial "Small Forfeitures" bill on the road. They kicked off the program by notifying Vincent Banville, KDHI734, Ft. Lauderdale, Fla., that he owed them \$300.00 for rule violations involving unauthorized communications, improper identification and transmitting a false call sign.



INSTALL THAT RIG

Continued from page 25

that the car body extends out from the antenna base for about 103 inches in all directions and at an angle down 45° from the horizontal plain.) If you have a car such as this, your antenna feed point is 50 ohms, attach the coax and go! But, since most of us have only one-traffic-lane-wide cars, we have to use this variable inductance to raise the feed point of our antenna to 50 ohms. It might be worth a thought to note that placing a 50 ohm transmission line to a resonant antenna whose feed point is 25 ohms (all other things being equal) will cause an SWR bridge to swing up on reflected AS WELL AS forward readings showing a net SWR of 2:1. So, use the bridge and vary the inductor until you show a flat line (1:1 SWR) or as close as you can make it. Now go back and check the whip for resonance again with the inductor in the circuit. Keep juggling the two variables until you get your line resonant. A word here about VSWR indicators, a line that shows 1:1 will show 1:1 anyplace on the line. If the line has standing waves, it is possible to find a spot on the line that looks like 1:1. Don't be fooled. Check at both ends of the line!

READY TO GO

If S-meter reports haven't convinced you that all this hair splitting has helped, grab an FS meter and check Joe's mobile. Now, check yours. For the same input power, your radiated output may be as much as 50% greater. After all, having someone repeat the name of our magazine over the air every time you get a signal report is one of our best advertisements!



TEST GEAR

Continued from page 49

The "Volt-test" is simply an expanded scale voltmeter which is supplied on a bracket permitting mounting to the underside of the dash. Actually, the bracket is the "heart" of the instrument since it contains a color-coded chart which indicates electrical condition.

Values are given for conditions of engine running and battery-starting. The meter scale is color coded matching the conditions given on the chart. If you look down (quickly) and see the meter is in the green (summer—or winter) you know the batter of charging

is OK. If the pointer rests on red with the engine running it's time to have the electrical system checked. If the pointer reads yellow (or red) when you start on a warm day you can bet the first cold day will have you waiting for the mechanic.

If you want to rest easy as you mobile along we suggest you look into the Lafayette Radio "Volt-test."



4303 RIDES AGAIN

Continued from page 7

You're probably saying to yourself right now, "They're going to re-word a lot of manufacturers' sales literature, and run bland articles on how good all the commercially made antennas are." This may be what you have come to expect if you've read the "Special CB Antenna" issues that have been put on the market during the past few years (not by S9, thankfully). Yes, we at S9 agree that the commercially produced antennas are, for the most part, excellent—and we even go out of our way now and again to talk about a specific unit which strikes our fancy (I had one strike my fancy several weeks ago and it still hurts).

The June S9 will contain a big batch of articles about interesting CB antennas not usually seen in operation on 11 meters—ones which you can build yourself if you are from the "smashed thumb" school of CB'ing. All are simple and can be easily put on the air. There will also be articles on getting the most from your present antenna system.

Even if you're content with the sky hook you are now using, you will want to have a copy of S9 for June to keep as a reference manual around your CB shack, whether you're a base station or mobile fan. Join us in June, it's going to be a real bash!

SUBSCRIBE

We don't want to belabor the point, but if you haven't yet subscribed S9, you might try strolling over to a mirror for a chat with yourself.

"You handsome devil," say to the mirrored image, "how dashing and well informed you'll be with a subscription to S9. Five bucks is little enough to spend to become part of the S9 gang. It's time you treated yourself to a gift."

Then, without hesitation, open this copy of S9 to page 49, remove the postage-free envelope and fill out the subscription form

thereon. Still watching yourself in the mirror, insert your loot, seal it, place it in your pocket for mailing this very day. Now, don't you feel better?

S9

PART 15 KORNER

Continued from page 43

HE-40 with a World Radio Labs Nuvistor preamp and a Gotham vertical antenna.

Ken wants to know if speech compressors are legal for Part 15. They are, Ken, however many of the little CB hand held units just can't handle all the audio you'll get from a speech compressor.

While we're in a mobile issue this month, reader Elmer Bailey (your return address wasn't on the slip of paper you enclosed with your subscription Elmer, and that's all we received from the Circulation Department) wants to know about antennas for Part 15 mobile stations. Other than using a vertically polarized antenna, we can suggest a horizontal whip on stand-off insulators running down the center of the roof. While this should work out very well, the XYL may not go for it in a big way if the family wagon is of recent vintage.

Still the most popular question asked by readers is regarding the availability of crystals for Part 15 operation, so we'll repeat the answer. Crystals are plentiful from most suppliers in the form of radio control rocks. The Part 15 frequencies coincide with the radio control (Class C CB) frequencies so check the ads, catalogues and other literature from manufacturers on these crystals. You won't find them called *Part 15* in the ads and we suggest that you order them by frequency (in Mc/s) rather than by the S9 Part 15 channel designator.

Bill McLaughlin, WESTERN 352, of Los Angeles, Calif., has an interesting experiment cooking. He's got Part 15 rigs 500 feet high in the Pico Verdes Hills. The units will be located 90° from each other and sending fone and CW. Bill is also Amateur WB6ABC. He promises to keep us posted on his progress.

A letter from S. D. Taylor, CENTRAL (also W9LDK/9) tells of his homebrew Part 15 station which consists of a 12AU6 oscillator, 50L6 buffer and 50L6 final with a pi-net output. The modulator is also homebrew.

His receiver is an old "all American five" with an outboard 2nd IF stage. The RF

stage was changed to a 12BA6 to make the unit crystal controlled on 27 Mc/s by installing Lafayette RF and oscillator coils in series with the crystal to give a plus or minus 10 Kc/s deviation. The 365 mmfd capacitor was replaced with a 250 mmfd ceramic in parallel to a 10 mmfd variable. A BFO was also added to the receiver. He's working on a sideband Part 15 rig now. Wow!

Nice letter in from Bob Bowers and Doug Faunt, Jr., of Columbia, S. C. They have CW rigs on the air, homebrew jobs with 2 2N372 transistors. If anyone would like to work up a sked with them, contact Doug Faunt, Jr., ATLANTIC 255, 310 Holly St., Columbia, S. C.

S9

ANTENNAS

Continued from page 46

of the variables that plague mobile installations. In general a shortened antenna of this type has a narrower bandwidth as compared to a full quarter-wave. It is possible to set such an antenna to resonance either by varying the inductance of the loading coil or the overall length of the antenna.

The shorter the overall length of a shortened antenna, the more narrow the bandwidth. Therefore for a short type the actual antenna tuning becomes very important.

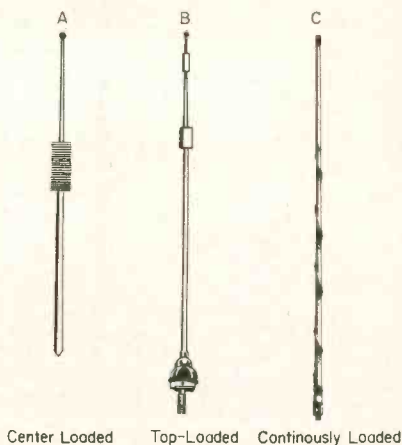

Fig. 3. Three popular types of loaded whip antennas.

Three popular versions of a loaded antenna are given in Fig. 3. In examples A and B the loading coil is placed at the center or top of the element. Some antennas of this type have small telescoping sections. Thus

the overall length can be adjusted critically to obtain a resonant condition with relation to both the channel used and the electrical characteristics of transmitter and transmission line.

The "wound-on-Fiberglas" helical type of example C is very popular. Its characteristics are similar to those of a top-loaded type. This style of antenna can be resonated by removing a few of the top turns of the helix, if necessary, in peaking its performance for mobile operation.

Helical and top-loaded antennas are available in lengths from about 6 feet down to less than 2. Keep in mind, the shorter the antenna length, the narrower the bandwidth of the antenna and the more critically it should be adjusted and peaked on a desired operating channel.

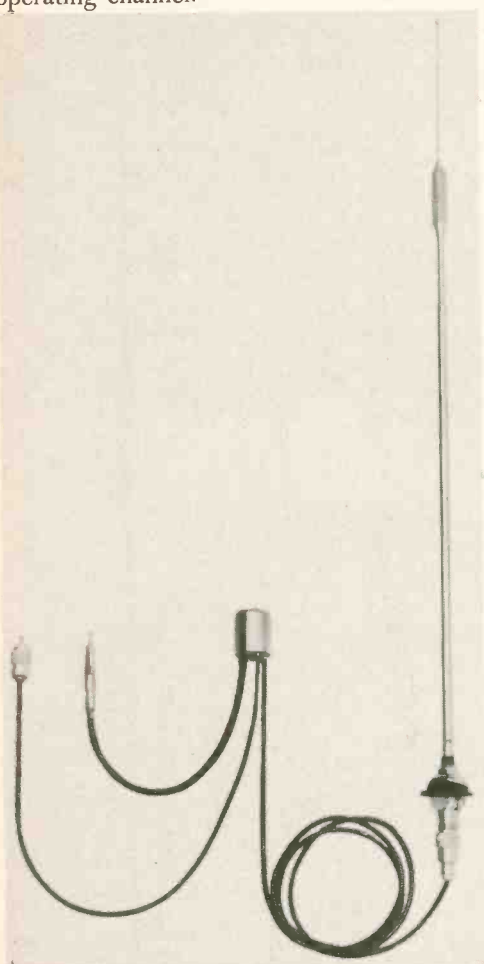

Fig. 4. An antenna designed for reception of AM broadcast signals which can also be used for CB transmitting.

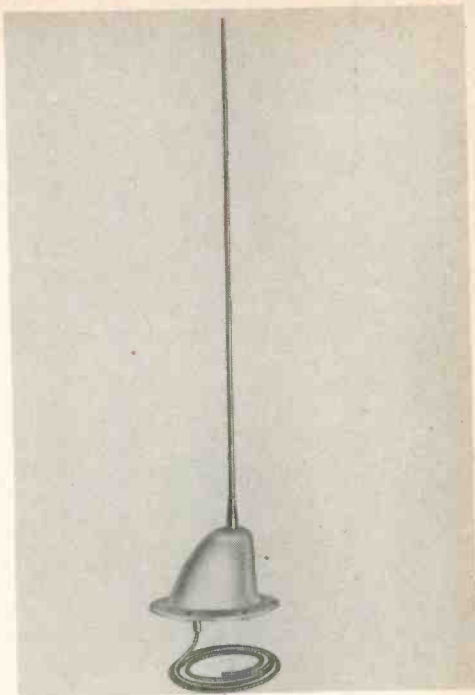

Fig. 5. A CB aircraft antenna.

Loaded short antennas can also be designed to present an optimum impedance at the base. Thus they are better able to match the 50-ohm impedance of the usual CB transmission line. The performance of these short antennas has been proven in the field. Recent tests made on models varying in length from 4 to 6 feet all showed better results than that obtained from a full-length whip. Shorter models of good design are found to be only slightly poorer than a full length version. This small amount of loss is usually overcome because of the more favorable mounting position of a short antenna and the more effective ground-plane action.

An example of a CB/AM antenna is given in Fig. 4. In terms of CB operation this style of antenna is center-loaded and has an overall length of only 46 inches. There is a very small telescoping section above the loading coil. If necessary, this can be adjusted critically to obtain peak performance on a given channel. The antenna is also dimensioned for good operation on the AM band. In some cases it is necessary to peak the antenna trimmer of the AC car radio for peak performance.

The antenna is complete with all connections and a non-adjustable dividing harness.

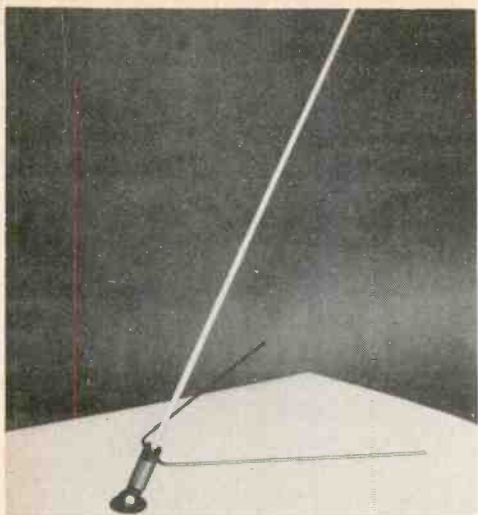

Fig. 6. A CB marine antenna.

The function of the divider is to channel the received signal to AM radio or CB unit as a function of frequency. Such a division can be made very cleanly because of the great separation in frequency between the AM (approximately 1 megacycle) band and the CB band (approximately 27 megacycles). In transmit, the divider also maintains the proper isolation between the AM radio and the CB transmitter, channeling the CB transmit signal up to the antenna.

Such an antenna style does not mar the appearance of your car and can be substituted in the mounting position of the regular car antenna. It is anticipated that this style of antenna will become increasingly popular on new cars that come through with personal CB band radio facilities.

As you well know CB operation has taken to aircraft and boats. Manufacturers now make available special models for these applications. A 17 inch model is shown in Fig. 5. This antenna is base-mounted and is designed for maximum speeds up to 250 miles per hour.

Both full-length whip and shorter models are available for boat installations. A five-foot center-loaded model is shown in Fig. 6. This model includes its own counterpoise ground-plane to minimize the ground variables of a boat installation. Because length is of less concern for a boat installation some of the longer high-gain antennas are used for marine operation. Half-wave length models are popular because of their added gain. This gain is of substantial help because of the low mounting position and rather indefinite ground.



Write to our advertisers for special product news

HI-EFFICIENCY CB BEAM BARGAIN!

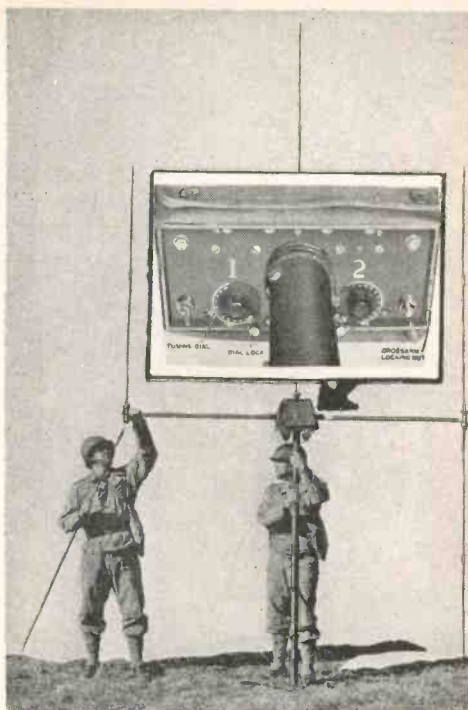

PRICE \$19.95

TELEMARINE discovered this outstanding 3-Element Adcock Type Beam Antenna in Army Surplus. It includes a vertical dipole and phase-load tuning box, which permits tuning and phasing in the radiator and director elements, and phasing out the reflector element so that an unusually high front-to-back ratio results along with exceptionally high forward gain. Plug-in inductors permits use of this antenna over a frequency range of 20 to 40.0 MC. Operates with 52 or 72 ohm transmission line. Sturdy, weather-resistant construction! Operates satisfactorily with CDR-AR-22 Beam Rotator, or equivalent. New-Unused, with Instruction Book which covers complete equipment for which antenna was intended, but provides full installation and tuning-up data. Net wt. of beam 39.5 lbs. Shpg. wt. 102 lbs. Supplied with 2 plug-in inductors to cover 25-30 MC, installed in phase-load box. COILS, PER PAIR (2 required) for 20-22.5 MC; 22.5 to 25.0 MC; or, 30-40 MC., specify freq. \$4.95

PREMAX TELESCOPIC VERTICAL ANTENNA, Chrome plated Monel Metal, 3 telescoping sections with collet type chucks to lock each section to desired length. Extends from 6'9" to 19 ft. when fully extended. Excellent for Marine, or Marine CB, as well as Ham application. Originally priced at over \$90.00. New-Unused, Shpg. wt. 12 lbs. Supplied less mast base. EACH\$14.45

30 MC MOTOROLA COAXIAL ANTENNA. Heavy-duty, hi-power construction. Modify to CB by extending top radiator to 108". Equipped with female receptacle for P1-259 connector and 52 ohm coax cable. UNUSED, with hardware and instructions. Shpg. wt. 140 lbs. PRICE, EACH\$19.95

All Above Material Subject to Prior Sale. 25% Minimum Deposit with All C.O.D.'s. Min. Order—\$5.00 All Prices F.O.B. Our Address.

— **TELEMARINE** —
COMMUNICATIONS
 142 West B'WAY, NEW YORK 13, N. Y.
 PHONE: Cortland 7-5444



advertisers index

| | |
|--|------------|
| Browning Laboratories | 6 |
| Comtran | 51 |
| Cramer | 63 |
| e. c. i. electronics communications, inc. | 12 |
| Electronic Devices | 39 |
| Electro Voice | 34 |
| Euphonics | 24 |
| G. C. Electronics | 21, 45 |
| General Radiotelephone Corp. | Cover 4 |
| Grove Electronics | 39 |
| Hallicrafters | 5 |
| Hammarlund Manufacturing | 19 |
| Heath Co. | 8 |
| Hy-Gain Antenna Products | Cover 3 |
| International Crystal Mfg. Co. | Cover 2, 1 |
| E. F. Johnson Co. | 31 |
| Lafayette Radio | 64 |
| Lew Bonn | 43 |
| Mosley Antennas | 22 |
| Multi Products Co. | 48 |
| Part 15 Identifier | 42 |
| Pearce Simpson | 25, 33 |
| Polytronics Labs | 3 |
| Premax | 45 |
| RCA | 15 |
| Raytronics | 30 |
| S9 Subscriptions | 11, 40 |
| Seco | 48 |
| Shure Bros. | 36 |
| Sonotone | 45 |
| Telemarine | 61 |
| Tram Electronics | 36 |
| Utica Communications | 28 |
| World Radio Labs | 38 |

CB SHOP

Rates for CB SHOP are 10¢ per word for advertising which, in our opinion, is obviously of a non-commercial nature. A charge of 25¢ per word is made to all commercial advertisers or business organizations. A 5% discount is in effect for an advance insertion order for six consecutive months.

We do not bill for advertising in CB SHOP. Full remittance must accompany all orders and orders sent in otherwise will not be run or acknowledged.

Closing date is the 15th of the 2nd month preceding date of publication.

We reserve the right to reject advertising which we feel is not suitable.

Because the advertisers and equipment contained in the CB SHOP have not been investigated, the publishers of S9 cannot vouch for the merchandise or services listed therein.

CB QSL CARDS . . . Samples Free . . . Will also print special cards from your description. Special QSL Rubber Stamps, FCC warning decals, catalogue. SMART PRODUCTS, 277 Neptune Avenue, Brooklyn 35, New York.

QSL CARDS, EYEBALL CARDS. The latest designs, colors, cardstock. FREE SAMPLES. APRIL SIGN 56290 Van Dyke, Washington, Mich.

CBers—As described in feature article of March S9; Speech clipper-kit complete \$17.85. Also, our famous Dual Conversion easy-do adapter-kit, improves selectivity, increases sensitivity. For HE-15, A, B, 800, 910, B, etc. HE-20, A, B, C; Mark VII, 770, 1, 2. Messenger. GW-10, etc. All parts, schematic, pictorial complete; \$15.50, with tubes \$7.50 or \$5.00 deposit plus C.O.C. Order now! Free literature Dept. "4S" Bainbridge Radio Electronics, 2839 Briggs Ave., New York 58, N. Y., or your local dealer.

CB transmitters \$6.00. Other bargains, send 10¢ for list. Vanguard, 190-48 99th Ave., Hollis 23, N. Y.

WALKIE-TALKIE RADIOS; CITIZEN BAND EQUIP.; INTERCOMS; RADIO-TV PARTS—FREE CATALOGUE—ALLEN ELECTRONICS, 4142A Main, Flushing 55, N. Y.

SELLING Antique Wireless Radio Collection; getting too old to continue collecting. Terrific Hobby for Citizen Bander. Details, lists, for large stamped addressed envelope and 5¢ Stamp. Hurry! W6LM, Wrightwood 308, California.

QSL CARDS, 100 for \$3.00. Samples 25¢. Red-bird Printers, Freedom, Indiana.

Heathkit owners, our preamps double reception! SK-3 Preselector kit fits GW-10, GW-11, \$8.99. SK-4 Preselector kit fits inside GW-12, \$8.99. Wired, \$11.99. Postpaid! HOLSTROM ASSOCIATES, Box 8640-S, Sacramento 22, California.

CB transmitters \$6.00. Other bargains, send 10¢ for list. Vanguard. 190-48 — 99th Ave., Hollis 23, N. Y.

CB QSL CARDS—100 two color \$3.00 postpaid, samples 10¢. Rupsrint, Box 7507, Kansas City 16, Missouri.

\$10 DOWN DELIVERS your CB equipment with 12 to 24 months to pay balance. This month's specials . . . RG8/U coaxial cable only 7¢ per foot (FOB New York) . . . also, any CB transmit or receive crystal, for any type of CB transceiver . . . \$2 each. Include 25¢ additional with order for postage and handling of crystal. House of Sound, 2119 Starling Avenue, New York 62, N. Y.

Free Samples CB QSL Cards \$2.50 per 100 in 3 colors. Garth, Jutland, New Jersey.

CB QSL CARDS. New, cute designs. Three-day service. Low as \$1.50 for 100. Free Samples. M. Hellwig, Box 425, Lake Wales, Florida.

QSL CARDS. Many sharp, cartoon designs . . . send for FREE brochure. F. B. Mathews Printing & Advertising, 1616 Rural Street, Rockford, Illinois.

MODULATION BOOSTER—It's new! It's terrific! As much as doubles your transmit and receive range with no violation of FCC power requirements. Compact, easy to install, with instructions. Net \$14.95. Dealers write too. ROKO Products, Inc., Box 3766, Baltimore 17, Maryland.

ANTENNA SWITCH—Operate one CB on two Antennas or two CB on one antenna. Attractive stainless steel, Takes PL-259 plugs. Net \$7.95. ROKO Products, Inc., Box 3766, Baltimore 17, Maryland.

"Audio-Aid-All" Clipper-Filter kit, fits any transceiver, boosts modulation. \$10.99 complete. 29" Hy-Gain Omni-Topper, \$10.97. DP-2 BC/CB Antenna Coupler-Duplexer kit, \$4.99. Noisejector, N.J.-7 \$4.49. Postpaid! Free kit list. HOLSTROM ASSOCIATES Box 8640-S, Sacramento 22, California.

WANTED: CB TRANSCEIVERS. CASH WAITING. STAN KRZAK, PAWTUCKET, R. I.

CB REPAIRS—CALIBRATION, reasonable prices, FCC licensed technicians. ELECTRONIC SPECIALTIES, Box 13, East Patchogue, N. Y. ATLantic 6-9467.

CREATIVE CBL CARDS—Free, new catalog and samples. Personal attention given. Wilkins Creative Printing, P.O. Box 1064-9, Atascadero, California.

CB-QSL's over 100 designs, samples 10¢. Roger KOAAB, 961 Arcade, St. Paul 6, Minn.

Healthkit owners, our preamps double reception! SK-3 Preselector kit fits GW-10, GW-11, \$8.99. SK-4 Preselector kit fits inside GW-12, \$8.99. Wired, \$11.99. Postpaid! HOLSTROM ASSOCIATES, Box 8640-S Sacramento 22, California.

CB-QSL Cards — Brownie — W3CJI/3W1974 — 3110—D Lehigh, Allentown, Pa. Catalogue with samples 25¢.

ELECTRONICS COURSE only \$14.95. Includes all tubes, parts, tools, instructions. Write for full information. Progressive "EDU-KITS" Inc., Dept. 501 CM, Hewlett, New York.

CB QSL CARDS—CALL LETTER D-CALS—all thick glossy cards. Many colors. Samples 25¢ (re-funded), Dick, 19QA0625/W8VXK 1996 "S" N. M-18, Gladwin, Mich.

FOR SALE—One General MC-5 CB Transceiver complete with 2 power cords (117 volts. AC & 12 volts DC) 22 Transmit Xtals & 2 Receive Xtals. Mobile Mounting Rail bracket, complete with instruction booklet and shipping carton . . . Will ship pre-paid anywhere in U.S.A. . . . Price wanted unit complete, ready to operate; \$225.00 or will deliver in N.Y.C. area. Stanley Schneider—KBG-6254, 754 Bronx River Rd., Yonkers, N. Y.

Quality QSL's—New Designs monthly, Samples 10¢, Giant 25¢. Savory, 172 Roosevelt, Weymouth, Mass.

STONE SIGNALS. Legal. New "High-Level" pulse. Adaptable all units. \$4.95 each, complete. Ideal Enterprises, Box E, Wessington, S. D.

IMPROVE GW-10 PERFORMANCE! — Better transmission, reception! Reduce mobile noise! Instructions \$1.00, postpaid. FRANKEL, Box A-143, Wantagh, New York.

CB QSL card. Samples 10¢—MALGO PRESS, Box 375—Toledo 1, Ohio.

CB, QSL, SWL Cards that are different. Quality Card Stock. Samples 10¢ Home Print, 2416 Elmo, Hamilton, Ohio.

GLOSSY 3-color QSL cards 100 — \$4.50. Free samples. Rutgers Vari-Typing Service, 7 Fairfield Road, Somerset, New Jersey.

HEAR THE WORLD! The Hammarlund HQ-170, 17 tube triple conversion receiver, with clock is for sale. It is in A-1 condition just 3 months new. This superhet. receiver lists for \$369; I will accept \$250. Write: Dan Parnes, 184 Huntington Terrace, Newark 12, New Jersey.

CITIZENS BAND

CLEARANCE

| Description | Reg. | Sale |
|---------------------------|--------|--------|
| GLOBE, CB200 | 189.95 | 133.00 |
| GLOBE, Star | 159.95 | 119.95 |
| HALLICRAFTERS, CB-1 | 119.95 | 89.95 |
| EICO, 762 wired | 99.95 | 89.95 |
| JOHNSON, Messenger | 139.95 | 111.95 |
| GONSET, G12 | 149.95 | 99.50 |
| MOSLEY, S103 10-meter | 39.50 | 28.00 |
| MOSLEY, VPA S203 | 66.37 | 46.95 |
| HY-GAIN TH2 all band | 69.95 | 49.95 |
| CUSH-CRAFT A28-3 10-meter | 28.50 | 19.95 |
| ANT. SPEC. MC27 C-B | 15.95 | 10.95 |

Discontinued Models, Floor Samples, Demonstrators

Mail Orders Direct (Incl. Postage)

CRAMER ELECTRONICS, INC.

817 BOYLSTON ST., BOSTON 16, MASS. CO 7-4700

LAFAYETTE CB

Spectacular

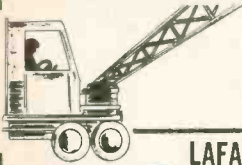

New!

**LAFAYETTE 10-TRANSISTOR
PORTABLE CITIZENS BAND
"WALKIE TALKIE"**

33.95 ea 2-for-62.90



HE-29B

- 50% More Powerful — Receives and Transmits Up to 2 Miles
- Extra RF Stage
- 10 Transistors plus 1 Diode
- No Licenses, Tests or Age Limits (As per FCC Regulation 15)
- With Carrying Case, Earphone, Antenna, Batteries, Crystals

New!

**LAFAYETTE HE-20C CITIZENS
BAND TRANSCEIVER**

Officially Approved
for Use in
CANADA
Type Approval
No. 169361029

109.50



HE-20C

- 8 Crystal Controlled Transmit Positions plus 8 Crystal Controlled Receive Positions
- 14 Tube Performance
- Tuneable over all 23 Channels
- Built-in Power Supply for 110V AC or 12V DC
- Complete with Matched Crystals for Channel 9

New!

**LAFAYETTE HE-15B
CITIZENS BAND
TRANSCEIVER**

Officially Approved
for Use in
CANADA
Type Approval
No. 169361034

54.50



HE-15

- 8 Crystal-Controlled Transmitting Positions
- Tunable Superhet Receiver Over All 23 Channels
- Effective Full-Wave Variable Noise Limiter
- Front Panel RF Jack • 12 Tube Performance
- With Transmitting Crystal for Channel 9

New!

**LAFAYETTE 4-TRANSISTOR
CITIZENS BAND
"WALKIE TALKIE"**

**19.95 ea
2 for 38.95**



HE-66

- Sensitive Superheterodyne Circuit
- Crystal-Controlled Receive and Transmit
- Push-to-Talk Switch
- No License Required When Used Under Art. 15 FCC Regulations.

LAFAYETTE RADIO ELECTRONICS

SYOSSET, N. Y.
JAMAICA, N. Y.

NEW YORK, N. Y.
BRONX, N. Y.

SCARSDALE, N. Y.
PLAINFIELD, N. J.

PARAMUS, N. J.
NEWARK, N. J.

BOSTON, MASS.
NATICK, MASS.

Free!



MAIL THE
COUPON FOR
YOUR FREE
1963 LAFAYETTE
CATALOG

LAFAYETTE RADIO ELECTRONICS DEPT. S9E-3
P.O. Box 10, Syosset, L. I., N. Y.

Send me the
Free 1963 388-
Page Lafayette
Catalog

\$ _____ enclosed for Stock No. _____
shipping charges collect.

Name _____

Address _____

City _____

Zone _____

State _____

For
3.86db Additional Gain
A Lower Angle of Radiation
Signal Attenuation ...

PHASE 'EM

COLINEARS

The World's Most Popular C.B. Base Station Antennas

We don't claim to have discovered the advantages of Phasing ... up to 3.86db gain ... a lower angle of radiation ... beam-like signal attenuation. But, we've done a lot of research, a lot of experimenting and a lot of field testing and we have developed a very comprehensive Engineering Report on Phasing that takes the "guesswork" out of making a Phased installation that will deliver optimum performance for you.

Here are some of the advantages you'll get by Phasing two Hy-Gain Colinears:

- 3.4db Gain from a Hy-Gain Colinear
- Low angle radiation from a Hy-Gain Colinear
- 3.86db additional gain through Phasing
- Greater low angle radiation through Phasing
- Beam-like signal attenuation through Phasing
- Antennas built to withstand winds of 80 mph upward

**Hy-Gain Colinears
start at \$29.97**

*See them today at your
favorite Hy-Gain Distributors.
Write for Hy-Gain Engineering
Report on Phasing.*

 **Antenna Products Corp.**
9101 N.E. Highway 6, Lincoln, Nebraska

Announcing.....The rugged

General VS2



**First vibration resistant,
two-way radio.**

Your dealer or write:

GENERAL RADIOTELEPHONE COMPANY

Dept. S95, 3501 Burbank Boulevard, Burbank, California

General Radiotelephone, already known and respected as quality leaders in the communications field, again prove themselves "years ahead in craftsmanship" in bringing you this compact two-way radio unit which has proven itself sturdy enough for outdoor use on all types of industrial and agricultural vehicles. VS 2 offers these special features at **no** extra cost:

1. Transistorized power with automatic short circuit protection.
2. Electronic switching—eliminates relay problems.
3. Microphone with coil cord and moisture proof cartridge.
4. Triple plated chassis—Copper, Cadmium and Gold Iridite.
5. Rugged black Vinyl cabinet finish.
6. Etched aluminum panel.
7. Designed especially for rough and tough service operation.

Net price including microphone, crystals for one channel and 115 volt power cord...only \$139.95.

General's VS 2, because of its Vibration Rated Service, will meet every outdoor requirement and can be used with utmost confidence on jeeps, tractors, fork lifts or on any type equipment needing rugged dependability.



300 West 43rd Street
New York 36, N.Y.

Controlled Circulation Postage Paid at New York, N. Y.

62M13-64DEC 65
 AL BROWDY-11Q3968
 1962 S STEARNS DR
 LOS ANGELES 34 CALIF