

VIEW!

APRIL 1981

CB

Only 60p

Citizens' Band

Britain's Leading CB Monthly

**IT'S LEGAL? FIND OUT
WHAT IT MEANS TO YOU!
WE GIVE YOU
THE FACTS**



**FREE
COMPETITION INSIDE
WIN A CB
AERIAL!**

- **WHAT WILL THE NEW LAW ALLOW?**
- **CORDLESS TELEPHONES - THE NEXT STEP?**
- **CB CLUBS - WHERE TO FIND THEM**

**DESIGNED IN EUROPE, MADE IN
EUROPE FOR EUROPEAN
CONDITIONS.
THE ALL NEW DPA 11 VR
FROM ALCOM.**

MODEL:	DPA 11 VR
ANTENNA TYPE:	½ wave telescopic
IMPEDANCE:	50
FREQUENCY:	27 MHz
GAIN:	±4dB
BANDWIDTH:	1,5 MHz
POLARIZATION:	Vertical
VSWR:	less than 1,5
MAX. POWER:	500 W
CONNECTOR:	UHF female
TOTAL LENGTH:	±5,8 m
WEIGHT:	±1,9 kg
MOUNTING:	±25-44 mm mast tube

ONLY TOP
QUALITY
ALUMINIUM
USED.

SOLE UK DISTRIBUTORS



103, HIGH STREET,
SHEPPERTON, MIDDX.
TW17 9BL. ENGLAND.
TEL: WALTON-ON-THAMES
(STD 09322) 48145.

FOR 24 HOUR ANSWER
SERVICE RING
TELEDATA ON 01-200 0200.

ALL WEATHER
SEALS.

SMALL
GROUND PLANE.

SWR
ADJUSTER.



APRIL 1981

CB

Volume 1 Number 5

Citizens' Band

Editor:
Rick Maybury
Group Art Editor:
Paul Wilson-Patterson

Advertisement Manager
Roy Perryment
Managing Editor
Ron Harris BSc.
Managing Director:
T.J. Connell

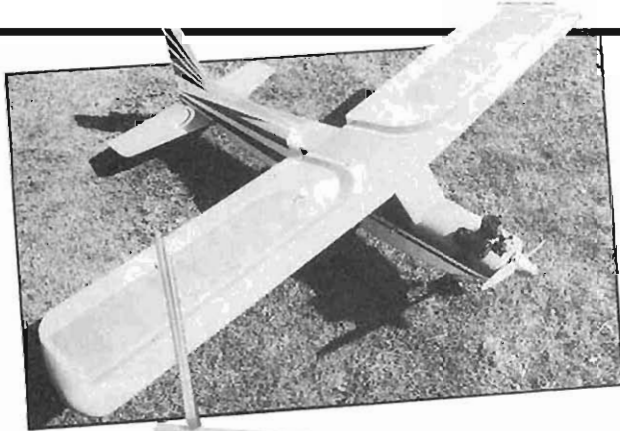

Editorial	5
CB FM UK OK?	
Update	6
Have you heard about.	
Mack Chat	9
Never Heard Of Him Officer, Honest!	
Cordless Telephones	10
Ringing The Changes	
The Other CB Dictionary	15
The Small Dummy's Guide	
R/C Modellers — Sold Down The River	17
Pete Christy Has His Say	
On The Side	19
SSB And All That	
Next Month's Citizens' Band	25
Wot A Lot We Got	
Legalsation — Now What?	26
Is This What We Want?	
Base Station Antenna Review	28
Damp-Proof Dipole	
Competition	32
Get Kitted Out	
Scanner Update	34
1200 Channels In One Minute!	
CB Soapbox	38
Unity For The Clubs	
Channel Check	42
TVI Filter	
DF Loop Antenna Project	44
Be A Stool Pidgeon	
Backchat	47
Letters Begin Here	
Club News	50
Emergency Monitoring	
Club Directory	54
Is Your Club In Yet?	

Copyright. All material in this publication is subject to world-wide copyright protection. Permission to reproduce any material in part or whole must be sought from the publisher. All reasonable care has been taken in the preparation of this magazine to ensure accuracy but Modmags cannot be held legally responsible for any omissions or mistakes that may occur. © 1981 Modmags Ltd.

CITIZENS BAND is normally published on the third Friday of Each Month prior to cover date.

CITIZENS BAND, 145 Charing Cross Road, London WC2H 0EE. 01-437-1002. Published by Modmags Ltd. Distributed by Argus Press Sales & Distribution Ltd., 12-18 Paul Street, London EC2A 4JS. Printed by Alabaster Passmore & Sons, Maidstone, Kent.

The publishers of CITIZENS BAND would like to point out that it is at present a contravention of the Wireless Telegraphy Act of 1949 and 1968 to use, manufacture, install or import CB transmitting equipment. It is not the intention of Modmags Ltd to incite, encourage or condone the use of such equipment.



KNIGHT

CB SPECIALISTS

201 DUNSTABLE ROAD, LUTON BEDS.
TELEPHONE: (0582) 425722/3

CONVERT YOUR 40ch RIG TO AN 80ch RIG

With The **UFO-40** PIGGYBACK BOARD
1 1/4" Square Board will fit inside all rigs
Full instructions. Easy to fit.

£19.95

INC. VAT, P&P

TRADE ENQUIRIES WELCOME

How to Select & Install
CB ANTENNAS
The Staff of CB Test Labs
A complete guide for getting the most from
your CB radio - most important in a crisis

CBers'
SSB HANDBOOK
TOM "TOMCAT" KNEITEL
Editor CB RADIO / S9 MAGAZINE

ALL YOU NEED TO KNOW
TO KEEP YOUR RIG
ON

CBers' FACT BOOK

By ANGEL T. SMITH

Modern CB Radio Servicing

MARVIN BROWN
HAYDEN

HOW TO
SELECT &
INSTALL
ANTENNA'S
£3.95
INCL. P&P

CB'ers
SSB
HANDBOOK
£4.95
INCL. P&P

CB'ers
FACT
BOOK
£3.50
INCL. P&P

MODERN
CB RADIO
SERVICING
£5.95
INCL. P&P

WE ARE THE MAIN U.K. AGENTS FOR THE FAMOUS
REDCO RELIABLE ELECTRONICS DESIGN CO.

ILLEGAL ALL OVER
THE WORLD
DIGI-SCAN UFO ELITE
1200 CHANNELS SIDEBAND
400 CHANNELS AM

£89.95

INC VAT P&P



**QUAD WOUND CLEAR
ANTENNAS - 14 DB GAIN**
The ONLY Antennas
Designed for 200 Channels

QS464 - 4 1/2'	£17.95
QS504 - 5'	£18.95
QS564 - 5 1/2'	£19.95

Only available at our Showroom - No mail order.

AVAILABLE NOW!



KNIGHT

CB SPECIALISTS

TO: KNIGHT CB SPECIALISTS, 201 DUNSTABLE ROAD, LUTON, BEDS.

Please send me the following items:

1. _____ £ _____

2. _____ £ _____

3. _____ £ _____

Use separate sheet if necessary. TOTAL £ _____

Please allow up to 21 days for delivery.

NAME _____

ADDRESS _____

I enclose Cheque/P.O. Payable to
KNIGHT CB SPECIALISTS for £ _____

I wish to pay by BARCLAYCARD ACCESS tick.

Card No. _____

SIGNATURE _____



Editorial

Nice Megs, shame about the pace

CB on 27 FM is OK BUT I reckon that there are one or two problems (about half a million actually) that the Home Office may not have considered. Very few AM breakers will be willing to give up their rigs which after all, have served them well, in favour of the new service. I know FM is cleaner, clearer etc, etc but it all comes down to hard cash. If you have just invested the best part of one hundred pounds on equipment you would be understandably reluctant to chuck it in the bin. The Home Office and Post Office cannot hope to catch all the offenders so it would seem to be a stalemate. I have a suggestion, it's not very original but it could be a viable solution. How about a one year amnesty for AM. I'm sure that the majority of AM breakers are not hardened criminals and do not enjoy being on the wrong side of the law. They would be perfectly willing to see how the FM service works before committing themselves. I am equally convinced that FM is a good choice, PROVIDED that there is a sufficient number of channels, the power output is adequate and most importantly, the equipment is reasonably priced. So how about it HMG and AM breakers, all it needs is a little give and take on both sides!

Now that the major part of the campaign is over, ie, this Government recognises that the British people are responsible enough to be let loose with two-way radios, I would like to take this opportunity to say thank you to the people that have worked so hard and so long on this project. At the centre of the campaign there have been about a dozen individuals and I know personally how hard these people have worked. I would also like to put on the record the fact that we came pretty close to getting nothing at all and for this, at least, we should be grateful. I will not name these people, we all know who they are by now, thanks for a job well done.

A sad case of sour grapes has been brought to my attention, you may recall that over the last few months I have been hinting at an announcement. My predictions were necessarily vague due to the delicacy of the negotiations and the secrecy that had to be maintained. It would be churlish of me to suggest that a certain magazine Editor was frustrated by the timing of the announcement and felt this magazine's inside knowledge was unfair. So, I won't!

Time now for a look at what's on offer this month. As you might expect we have included several features on the recent announcement. Keith Townsend poses the question **Legalisation** — **Now What?** and has a few comments to make on the subject. **Pete Christy**, radio modeller of this parish also has a few words to say on how the new frequency will affect his hobby. **Mack The Hack**, as ever puts his libellous thoughts into print, who is this man? Just for a change **Rig Review** this month casts a critical eye over an amazing multi-mode rig that features, you guessed it, **FM**. I suspect we won't be seeing many of these around. **On The Side**, our new regular feature on sidebanding begins in earnest this month and **Antenna Review** looks at an extremely interesting base station antenna. Don't miss **Cordless Telephones** by Andy Giles, could be some interesting developments in that field pretty soon (930 MHz perhaps?). The project this month is a **DF Loop Antenna**, wonder if the Home Office will use this design as it's pretty good at locating radio transmitters. All of our regular features are here, so I'll shut up and let you find out for yourself. Thanks again to everyone and hope to see you all again next month. Stay Lucky.

HANSARD
26 FEBRUARY 1981
Home Department
Open Channel Radio

Mr. Wall asked the Secretary of State for the Home Department if he has now reached a decision on the introduction of a legal citizens band service.

"Mr. Whitelaw: After careful consideration I have decided to permit a 27 MHz FM citizens band service, provided that the equipment meets the standards we shall set. The 27 MHz AM equipment currently used in this country will remain illegal. Further evaluation of 930 MHz equipment has confirmed that this should provide a good service with minimum risk of interference, and accordingly I shall also be making available a frequency band around 930 MHz. Users will be required to hold a licence which will permit the use of both types of equipment, and which will be renewable annually. Consultations are taking place with the Post Office with a view of their issuing licences on my behalf.

It will now be necessary to discuss draft equipment specifications with manufacturers, to seek the advice of the statutory Advisory Committee under section 10 of the Wireless Telegraphy Act 1949 on the technical requirements to ensure the minimum of interference, and to reflect the outcome of this in regulations setting equipment standards to which manufacturers, importers and assemblers will have to conform. Arrangements will also have to be made for the setting up of the licensing system. The adoption of a frequency in the 27 MHz range may affect existing authorised users of this band, and the implications for them are being taken into account in the detailed planning.

I hope to be able to introduce this authorised service by early Autumn."

Rick Mayhew

Update

News from the world of CB

Getting The Hump

Two new lines from georgous Glynn Hall at Wintjoy for your consideration. First away is the charmingly named 'Hump Mount' CB speaker. No guesses required to discover what this goody is for. Just bolt on your transceiver and slap it across your car's transmission tunnel. No screws, fuss or hassel. The built in speaker has an 8 ohm impedance and can handle up to 5 watts RMS, enough for most people. This delightfully named object can be all yours for just £12.90. Second item of interest is a *power reducer*. Yes, I can hear you all saying 'what do you need a power reducer for?'. The answer is quite simple, you don't but you neighbours TV does. Confused? Then let me tell you that the only way to cure persistant TVI is either

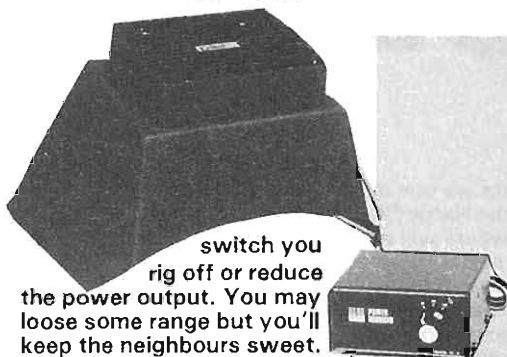

switch you rig off or reduce the power output. You may loose some range but you'll keep the neighbours sweet. You can select on of three outputs, 100% which means full power 50% means you loose half your power and 10% which means only 10% of your RF ends up getting out. Sounds drastic doesn't it but then so does the knock on the door from the Post Office man coming to take you away. Price for this peace of mind is a mild £20 (plus VAT). Wintjoy are still lurking at 103 High Street Shepperton.



CB Diary

Yet another new feature in Citizens' Band. Each month we will publish an up-to-date list of the forthcoming CB attractions. We know there are about half a dozen exhibitions coming up in the next few months and those that we are aware of will appear right here. If you are organising an exhibition, mass eyeball etc then why not drop us a line. Please mark your letter CB Diary and give us at least 6 weeks notice for it to appear in the magazine in time. Here's this months Diary.

Month	Event	Venue
March 8	Radio Fair & Mass Eyeball	Lincoln Exhibition Centre (details on Long Eaton 62247)
22	First National Eyeball	Donnington Part Race Circuit (details on Lichfield 23212)
April 10	National Ten Four Day	Heathrow Hotel London (details on 01-561-5778)
10	CBers Weekend	Caister Holiday Centre (details on 01-886-4112)
May 2-4	CB Radio Show	Royal Showground Kenilworth (details on Kenilworth 512737)
17	CB Fair & Eyeball	Shoulder Of Mutton Inn Hardstaff
June 6-7	CB Trade Fair	Malvern Winter Garden (details on Astwood Bank 3852)
7	CB Radio Accessory Trade Fair	Grand Hotel Torbay (details on St Dominick 50335)

All these details are correct at the time of going to press. Readers are urged to contact the organisers to confirm the dates and venues mentioned.

CB On Video

Few people will actually admit it but the CB scene in this country is almost certainly due to the interest created by a record and film by the name of *Convoy*. Back in 1975 when the record by C W McCall was released CB was known only to a few hundred people in this country. By the time the film of the same name was released people had begun to ask questions about the distinct lack of personal communications in this country. From 1976 onwards it began to happen and the rest is now history. For those of you that missed out on the film *Convoy* you may be interested to know that it is now available on a video cassette, which in itself is a good enough reason to go out and rent or buy yourself a machine.

Convoy is still the classic CB film (though recent releases like *Smokey* and the *Bandit* have used the theme of CB) and is well worth watching as a film in its own right, even if you're not interested in CB. (What are you reading this for?). *Convoy*, along with a host of other very good films is now available from *Thorn EMI Video Programmes Ltd*. You can buy the film outright for £39.50 or, wait a little while and rent it for about a fiver a week from one of the dozens of rental companies springing up. The film is available on both of the two most popular video formats; VHS and the code is *EVH 20231* and Betamax, *EVX 40231*. If you want to know more about video in general then you could do worse than take a look at our sister magazine *Video Today*.

Korekshun

A number of readers have pointed out that the calling channel for Hull is in fact 19 and not 14 as we said. Sorry to all concerned, promise not

to do it again and all that. (It wasn't our fault, really, as we only went on the information supplied to us by a resident of that fair city, but we'll check it up next time.)

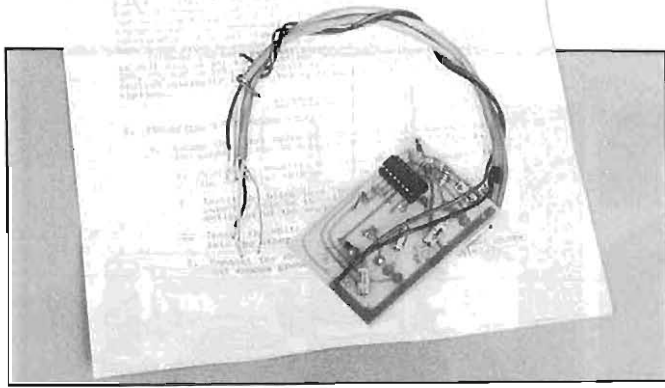

Clip On Tuning

This clever little gadget is called an Antenna Tuning Indicator. The idea is that it just clips on to the base of your antenna and, once adjusted, will give you an indication of relative power output via the colour-coded edgewise meter. Basically this is a field strength meter but the lack of connections and the ability to clip it in to place allow for very accurate readings. It is therefore an invaluable aid to SWRing and the old game of antenna adjustment. The Antenna Tuning Indicator is made by Algon and is available from Wintjoy Ltd for £11.50.

Tape Reviews

Due to pressure on space in this issue we will not be featuring our tape reviews this month. Worry not though fair reader, it will be worth waiting for.

Speakeasy

Just received an intriguing package from the guys down at Chelsea CB Centre. It's called the VSB-1 Voice Signal Booster and tacks on to just about any rig you care to name. As you can see from the picture this single board PCB has a number of wires (6 in all) that have to be soldered into your rig. The VSB-1 is actually a very sophisticated expander/compressor that should improve

the audio on your rig. Installation of the unit should only be attempted by someone with experience in these matters but from all accounts the results are well worth striving for, even if that means paying someone to install it for you. We hope to be putting the VSB-1 through its paces when we get time, until then you can get one of these interesting looking devices from Chelsea CB Centre. 73-77 Britannia Road, Fulham, London SW6.

Breaker Burger 2

After our plea last month for someone to produce a 'Breaker Burger' we actually had some interesting responses from a couple of restaurants. *Good Buddies CB Fast Food Shop* in Leicester have invited us to sample his 'Boiled Buzbys' and 'Cups Of Sludge'. *Good Buddies* also tell us that they stock an impressive range of CB accessories. Exactly what a Boiled Buzby tastes like will have to remain a mystery until we can get up to Leicester. One other burger restaurant in Shepperton, called 'Heaven' is also considering adding a CB related delicacy to its menu. We will report on the outcome of these gastronomic delights in the next month or two. In the meanwhile we have yet to hear of anyone selling a CB cocktail until they do you may like to try this concoction our resident drunkard has come up with. It is called 'Ratchet Jaw' and when you try one you'll know why. It is made up from 1 part whisky, 1 part vodka, 1 part rum, 1 part gin a dash of bitters, a dash of Worcester sauce and orange juice to taste. It sounds absolutely disgusting but we're assured it loosens up the vocal chords a treat. anyone else got any suggestions. Just invite us over to your pub, club, etc, and we'll tell you what we think of it.



Meet The Dealers

Way down South, just outside Aldershot is the famous CB City accessory shop. It's run by Peter and Linda Rolf (that's Peter in the pic) and I can say with complete confidence that their range is just about the most comprehensive in the area. CB City are an authorised Tandy stockist so they can supply virtually all of the Radio Shack and Archer range of equipment.

CB City opened on the 15th of October last year though Peter and Linda had been in the business for some time previously. Peter has got a bit of a reputation locally for his dealings with the authorities and he has been 'visited' on at least two

occasions. Both times he lost a large number of radios, mainly in for repair but to his credit Peter re-imbursed all the owners which he assures us cost a fair bit. Visitors to CB City often ask Peter's technical advice on CB and the kettle is always on for the serious browser. CB City are able to supply all of the most common spare parts plus a few uncommon ones too so if you want some advice, accessories or just a chat about the airwaves get yourself along to CB City which is at 85 Ash Hill Road, Ash, near Aldershot. You can telephone Peter or Linda on 0252 318141. By the way, CB City offer substantial discounts to recognised CB clubs so take your card along with you.

New Books

We have two new books for you this month. The first is called *Practical CB Radio Troubleshooting and Repair*. It is written by David F Norman and is available for NIC for £5.35. As you might expect this book is of American origin and so certain chapters are not wholly relevant to our situation. However, where it does score is with the simple and straight-forward technical explanations and clear diagrams. At the end of the book are numerous circuit diagrams for complete rigs including sidebanders. All in all this book should prove extremely valuable to anyone interested in the technical side of CB and the circuit diagrams make it an essential reference book for all repairmen. NIC can be found at 61 Broad Lane Tottenham, London N15.

Our second book is again of American origin and is called *Citizens Band Radio Digest*. This is another one of those 'everything you ever wanted to know about CB' books. It comes from the pen of one William J Bradley and is published in this country by Arms and Armour Press Ltd. It retails for around £3.00 and although much of the content is predictably American it is reasonably up to date and a little more technical than most similar books. Worth thinking about for your collection if only because of the good illustrations. *Arms and Armour Press* can be found at 2-6 Hampstead High Street, London NW3.

JACKET OFFER

We had hoped to bring you the final details of our CB jacket offer but the response has been so enthusiastic that we're still sifting through the replies. Rest assured, those of you that filled out the priority order form published last month will be hearing from us shortly.

COMPETITION NUMBER TWO

Hundreds of you entered our competition last month and we hope to have the results in next month's Update. Just to set everybody's minds at rest, question 5 has been omitted due to the number of possible answers. Until then take a look at Competition number 3 on page 22.

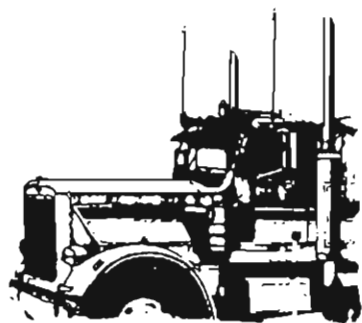

SSE



FOR ALL CB AND AMATEUR RADIO ACCESSORIES
DORKING (0306) 883314
SURREY SUSSEX ELECTRONICS
27 MEADOWBROOK ROAD
DORKING SURREY

Trade + Retail Sales
 Mon-Sat 9.30 — 6pm
 Sun 10.00 — 2.30 pm
 Send 12" x 9" stamped,
 self-addressed envelope
 for catalogue



NEW
 High Channel Board
 FM Board
 Complete
 40 Channel has
 capabilities of 160CH

	<i>Retail Price inc. VAT</i>		
VERTICAL 1/2 WAVEDIPOLE BASE & ANT.	£12.50	NEW ANTENNAS	
K40 STEEL WHIP ANT.	£24.95	ANIXTER MARK MOD AAF 113 S/STEEL WHIP & MATCHER. Ask for the "LITTLE FOOLER"	
K40 SPEECH PROCESSOR MIKES	£24.95	This is the latest and will cover HI-BAND Freq. (MOBILE OF COURSE)	£10.95
6" BROADSTICK ANTENNA WAVE	£9.50	HARADA PILLAR MOUNT & SPLITTER TELESCOPIC	£10.95
7" FIRESTICK ANT.	£10.00	HARADA FENDER MOUNT & SPLITTER TELESCOPIC	£10.95
5" FIRESTICK ANT.	£8.50	HARAD BODY MOUNT & SPLITTER TELESCOPIC	£10.95
4" FIRESTICK ANT.	£7.50	BONE PHONE STEREO AM/FM RADIO ROUND YOUR NECK	£31.00
2" FIRESTICK ANT.	£6.50	"Come in for a DEMO YOU WON'T BELIEVE IT"	
TELCO BOOs TWENTY MOBILE PRE-AMP	£16.00	YOU WANNA LISTEN TO CB 40 channels plug in a SOLITRON TO YOUR CAR RADIO	
AUTO THREE IN ONE CIG LIGHTER ADAPTER	£9.75	FOR JUST	£7.95
6" BROADSTICK ANTENNA WAVE	£9.50	THE BEST T.V.I. FILTERS that we know of	
5" BROADSTICK ANTENNA WAVE	£9.00	"ULTIMATE" EXPENSIVE BUY THE BEST	£32.50
4" BROADSTICK ANTENNA WAVE	£8.50	Channel Guard XL 1000 TUNEABLE	£22.50
SSE LAZER 150 WATT AM/SSB SWITCHABLE PRE-AMP	£94.87	DRAE 12-20 AMP BRITISH MADE POWER SUPPLY (overload cut-out)	£75.00 inc. VAT
GOLD LINE 100 WATT IN LINE & SWRMETER	£6.25	DRAE 4-7 AMP BRITISH MADE POWER SUPPLY (overload cut-out)	£28.50
GOLD LINE TWIN RIG COUPLER	£5.25	KRACO SLIDE MOUNT	£4.50
GOLD LINE PHONE PATCH	£10.75	PA HORN 5 WATTS POWER	£4.95
GOLD LINE MULTI BAND COUPLER	£8.25	KRACO EXTENSION SPEAKER 3" CERAMIC	£4.95
SSE AUTOMATIC CB AM/FM ELECTRIC ANT	£25.60	GOLD LINE TURNABLE TUI FILTER LOW PASS	£4.25
ALARON 4 TRANSISTOR W/TALKIES	£22.50	MAG MOUNT TOP LOADED WHIP	£9.50
3 PIN DIN POWER LEADS	£1.25	VARMIT 40 DB PRETUNED TUI FILTER	£18.50
"NEWMARK" ALTERNATOR FILTER	£2.00	VARMIT 60 DB PRETUNED TUI FILTER	£22.50
TELEX 1200 headset & BOOM MIKE	£19.00		



Mack Chat

Mack The Hack is still totally non-existent, Perhaps when it is finally legal we'll admit he is real. Until then . . . He's nothing to do with us.

So now we know, was all the waiting worth it? 27MHz OK. This is the frequency that most breakers wanted and towards the end of our campaign we shouted and waved our banners for 27 megs. So we won, or did we? I personally would have liked VHF but my voice was small, and shouted down by others who thought they knew better. FM, fair enough, but this is where the fun starts. I don't mind FM, we all know by now that the interference problems are reduced. The majority of people who scream for 27 megs do so because they already own 27 megs AM rigs, you should have been shouting 27 AM!

So now the powers that be at Westminster have got you by the 'short and curlies', if I may use such a vulgar expression. If one fella up the road has a legal 27 FM rig and the breaker down the road has an illegal AM rig, and bleeds over our legal friends transmissions, will he complain to the authorities with the result that the breaker gets a visit from the radio regs people?

It looks as though the people in the Home Office aren't exactly stupid, by giving us 27 megs FM it is possible they will solve the AM problem. I might give the impression that I'm taking sides but this is not so, I already have FM equipment. When I brought it I realised that it might soon be obsolete. I have heard the screams and shouts already on channel. 'what am I going to do with my rig that I paid £70 for?' Ten Four mate, you could have it converted to FM, at a price but you will still be running an unapproved rig. My advice would be stash it in the garden shed, you've had your fun, put it down to experience and forget it. Let your Grandchildren re-discover it and you can tell them all about the bad old days. Put it another way, how much did that holiday cost you last summer? All you have left now are happy memories and a few snapshots.

There are still lots of questions that I want answered. For instance, why must we wait six months? How long exactly does it take to print licences? What happens to the warehouses full of rigs that we have been hearing about? Will we be allowed sideband if suitable filters are fitted? How about a National Emergency Service, we have at present three or four un-coordinated organisations up and down the country, who will control them? I will be reporting next month on any answers that come my way. Now back to some more mundane matters.

I think now that I'll have a couple of moans if I may. The first is about the foul mouthed individuals that have now appeared on the frequencys. I knew it would happen and dreaded the time when these brainless morons would interfere with our enjoyment. I already know of one young lady breaker that has been driven off the channels because of the obscenities that were directed at her when on channel.

The breakers in the Worcester area it seems have one answer to the solution when they catch the abusers of the channels, they take it in turn to jump on the 10-1 breakers rig. I wonder what they do to the breaker.

In the old days it was fairly easy to recognise the breakers

voice or their rigs peculiar tone when one abused the channels, so it only needed a mention over the air of a first name or a street and the abuser got the message. With so many breakers on channel these days recognition is very difficult. So how does one try to curb this type of QRM?

One effective method that I try to use is to totally ignore the creep and when he finds that he is not getting through he starts to think that perhaps there is a fault in the rig so either he will go down and attempt to find the fault or just give up. You see this sort of person must have an audience and without one his game is played out. So next time you hear or get verbal on channel please ignore it and I promise you they will go away. I had a chat with my good buddy 'Bubble and Tweek' about these problems and his answer was in the form of a direction finding loop. All I can say now is that it works, so beware you lost souls without the ability to use CB. Your number is nearly up.

Obituary

I don't know if one can write obituaries about magazines but I would like to.

It is with deep regret that I record the death of 'Bandstand'. Well it's not dead yet but it's 'On the gate'.

About Two years ago when CB was all about hiding in dark streets in one's mobile, a quick ratchet then a fast ride to another spot a couple of miles up the road to hide away so that the nastys could not find you. There appeared in the 'Exchange and mart' an advert for subscriptions to a CB mag. Fearless as I was in those days I sent my postal order and a friends address and by return I received issue one of the duplicated journal appropriately named Bandstand. It was full of CB news from around the country which most CBers were keen to obtain at that time. As the CB eyeballs materialised so did Mike and Wendy Evens, the producers of Bandstand with bundles of the mag under their arms which were eagerly bought by the breakers. With the production of the now easily obtainable glossy CB mags, Mike told me that it is unrealistic to continue the kitchen table production of his mag, and no more subscriptions will be accepted. Thanks to Mike and Wendy, Bandstand was the first and you brought us the CBER the news and views that we needed at the time that most others dared not publish.

Wiping away the tears, let me tell you about Father Christmas. No not the one with the reindeer powered mobile, but a breaker of the same handle. So this part time smokey said to him 'That's a CB radio and I'm nicking you'. Innocently Father Xmas replied 'Is it?' To which the special constable told him 'It is, I recognise it as my mates have them' so after reinforcements had arrived F.X. was carted off to the local bear cage and relieved of his rig. F.X. was released and told to return later to be charged or something. But when he did return the rig could not be found so no charges were brought against Father Christmas. Holy Moses' I wonder who's got that rig now, Copy on the part time bear? ●

Equipment Review

Cordless Telephone Survey

Now that the Post Office, or British Telecom as they call themselves, has agreed to allow subscribers to attach some of the more exotic types of accessories to their lines, dozens of shops specialising in telephone accessories have sprung up. One of the most popular items in their range is the Cordless Telephone. Andy Giles takes a look at some of the current models and explains how they work.

Have you ever wished that you could afford to install an extension telephone in every room of your home? Crawling out of bed in the early hours of the morning just to find out that some inebriated idiot has mis-dialled the number of a mini-cab company tends to make most people wish that the telephone was not so far from the bedroom, and it's only the cost that prevents most of us from installing five or six extensions. One telephone with a lead that has a jack plug fitted to it and that can be carried around and used in any room that has a socket in it is a cheaper alternative, but how nice it would be if we could do away with the lead and just carry the telephone, and use it anywhere, even out in the garden.

This idea is not as far fetched as it sounds because telephones have been on sale for several years in America that enable you to do just that, they are called Cordless Telephones and they consist of a base station and a remote, walkie-talkie style unit.

The Base Station

This is the half of the set that has to remain on one place, because it is connected to the telephone lines and to the AC mains.

When a call comes in and the ordinary telephone rings, the base station senses the ringing pulses and transmits a radio signal that activates a bleeper inside the remote unit, which tells you that your telephone is ringing.

When the remote is switched on and the call answered, the base station transmits the incoming half of the conversation to the remote, and receives from the remote the outgoing half, which it sends down the telephone lines to the exchange.

At the end of the call, the remote is switched off and the base station then automatically disconnects from the exchange and resets itself, ready for the next call.

When the remote unit is used to initiate an outgoing call, the base station automatically connects itself to the exchange and obtains a dialling tone, and then dials the number by converting the encoded radio signal from the remote into pulses that it sends down the line to the exchange.

Some base stations incorporate a very useful paging facility in the form of a 'CALL' button. This activates the bleeper inside the remote unit whenever it is pressed, and if the remote is then turned on, a radio link is established between the house telephone and the remote unit, and they can be used as an intercom. All of the units we've seen connect to the 'phone line with just two wires. The existing wiring (usually two wires) is left in place.

The Remote Unit

This is the half of the set which looks like a small walkie-talkie and which you carry around with you. It has a built-in telescopic aerial, microphone and

speaker, and it is held just like a telephone, with one end next to your ear and the other end next to your mouth. It has its own internal power supply, usually Ni-Cad batteries, and most units have a low battery warning light. The batteries are usually recharged by plugging the entire remote unit into a special socket in the base station.

Most remote units have two switches, 'ON-OFF' and 'STANDBY-TALK'. The 'ON-OFF' switch controls the power supply and the 'STANDBY-TALK' switch selects the operating mode. When the remote is being carried and you are ready to receive calls, the two switches should be set to 'ON' and 'STAND-BY'. Then only the part of the receiver that controls the bleeper is turned on, and very little power is being drained from the batteries. If the base station then transmits the activating signal, the receiver will turn on the bleeper to let you know that there is an incoming call. To answer the call, set the second switch to 'TALK' and this will turn on all the rest of the unit, and it can then be used like a normal telephone. At the end of the call, returning the switch to 'STANDBY' instructs the base station to hang-up and reset.

To dial out from the remote unit, set the switch to 'TALK', wait until you hear the dialling tone and then punch in the digits of the telephone number on the calculator style keypad on the front of the unit. The remote transmits the

Below: The Mura MP300.



digits as tones and the base station converts the tones into the type of pulses that the exchange can handle.

Some of the more expensive sets have a 'Last number re-dial' facility. This is a button which, when pressed, re-dials the whole of the last telephone number that was entered on the keypad, very useful when trying to get through to an engaged number.

Simplex

All cordless telephones operate in one of two ways, either **Simplex** or **Duplex**. The Simplex ones use only one frequency for both transmitting and receiving, which limits their usefulness, because only one person can talk at any one time. This means that they have to be used more like a CB rig than a telephone. The remote unit has a Push-To-Talk (PTT) switch which has to be pressed while you are speaking, and while it is depressed it is not possible to hear the person on the other end of the line.

Another serious disadvantage that most Simplex cordless telephones suffer from is their inability to dial out, they can only receive incoming calls.

Because of their limitations, Simplex cordless telephones are usually far cheaper to buy than Duplex ones.

Duplex

Duplex cordless telephones are more versatile because they use two widely separated frequencies, usually 1.7MHz and 49MHz, which not only allows both people to speak at once, but also enables the remote to make outgoing calls.

Because different frequencies are used for transmitting and receiving, the base station and the remote unit each have two separate aerials.

When the base station transmits to the remote, it does so on 1.7MHz and it uses the AC house wiring as an aerial, which is why it is important to test it in different sockets in your house. The performance will vary according to how much of the house wiring is radiating the signal and sometimes, especially if the wiring is enclosed in metal conduit piping, none

of the signal can get out. To overcome this problem some manufacturers recommend the use of an extension led that is at least 25ft. long. Metal framed buildings will also attenuate the signal. To maximise the range, the base station should be sited as high as possible within the building.

The remote unit receives the 1.7MHz signal on a small internal ferrite rod aerial similar to those used in small transistor radios, which is why it is not necessary to have the telescopic aerial extended when on **STANDBY**. The external aerial is only used to transmit from the remote to the base station, on 49MHz. The base station receives this signal on its own telescopic aerial. Cordless telephones, just like any other radio transmitters and receivers, are susceptible to the usual sources of radio interference such as light dimmers, electrical storms, fluorescent lighting, electric motors etc., but there is another source of interference that is only becoming apparent as more and more people are using these telephones, mutual interference. Because these



Left: The Freedom Phone FF1500.



★ PLEASE NOTE: — Because cordless telephones are radio transmitters, it is an offence under the *Wireless Telegraphy Act of 1949* to operate one in Great Britain. Also, the Post Office, despite relaxing their attitudes towards some other pieces of equipment, will not authorise the use of these devices and they have recently issued a statement in which they warn subscribers that they will disconnect anyone who attaches an unauthorised piece of equipment to the telephone lines.

telephones only operate on one of four or five different frequencies, it is all too easy to hook your remote into another persons base station. This is not only the high technology way of getting a crossed line, it also warrants a word of warning. It has not taken long for some people to realise that it is far cheaper to make calls on someone else's telephone. In America it has become quite a craze to buy just a remote unit and to cruise around with it set on 'TALK' until a dialing tone is picked up. That line, whoever it belongs to, is then used to call Zimbabwe or Luton or wherever, and the householder then finds himself with an inexplicably large bill to pay. If your telephone bill has increased dramatically since you installed your cordless telephone, now perhaps you know why. Some manufacturers are experimenting with digitally encoded signals in an attempt to stop this happening, but it is still a problem with most of the sets on sale today.

Although it is illegal to use a cordless telephone in this country, large numbers are being sold, perhaps they make good conversation pieces.

(I'll do the jokes around here — Ed). Here's a selection of some of the models that are readily available in this country and a guide to the sort of performance you can expect from them. ►

Mura MP300/301

This is a Simplex telephone but unlike most of the others, it can be used to dial out, and again unlike the others, it uses Amplitude Modulation instead of the more usual Frequency Modulation. Tests have shown its range to be approximately 400ft. in town. It has no re-dial or paging facilities but at only £65 it is one of the cheapest sets on the market and represents good value for money. The Mura MP300/301 is available from *Casptronics Ltd., Cathedral Road, Armagh, Northern Ireland.*

The Cordless Plus Freedom Phone FF1500

Made by Electra, the makers of the well-known Bearcat range of scanners, this is a Duplex cordless telephone that has a claimed range of 300ft. but which tests have shown to be in excess of 400ft. around town. It has a re-dial facility and a low battery warning light. The batteries can be re-charged in the usual way, by placing the entire remote unit into the base station, or by using the separate charging stand that is also supplied with the set, a good idea if you keep your base station at the office and your remote at home.

The FF1500 is available for around £130. Orders should be sent to *Intercall Ltd., 5 Hampton Court Parade, East Molesey, Surrey.*

The EMP 4001

This is one of the most stylish cordless telephones currently on sale in this country. The base station looks much the same as most of the others but the handset has a really futuristic look about it, as can be seen from the photograph. The makers claim a range of 750ft. but testers were unable to get more than 600ft. in a built-up area. as with all radio signals, the range would undoubtedly be greater in open countryside, but the testers deliberately tried to make life as difficult as possible for the sets they were testing.

This is a Duplex set that has a paging facility, low battery warning light, list number re-dial and a dual charging rate for the batteries.

Users of this telephone have commented on its shape and the general consensus of opinion seems to be that this is a good set to use as an extension telephone in whichever room you happen to be in, but for outdoor use the angular handset is quite difficult to carry round, especially in an inside jacket pocket. Kay Hill at *Larrest Ltd* (see below) has told us that a PVC jacket pouch is now available. The maximum range that one of the testers managed to achieve was 1 mile, but that was only for the paging bleep, speech was not possible over that range.

The EMP 4001 costs £120 and it is available from *Larrest Ltd., Avon House, 360-366 Oxford Street, London W1.*

The Superfone CT505

This really is a superb cordless telephone. It is a Duplex set, but instead of the usual 1.7MHz and 49MHz frequencies, it uses 49MHz and 70MHz, which must be why it is the clearest one to use and why it has such a terrific range. Most cordless telephones sound 'hollow' to the person at the other end of the line, almost as though the speaker has a bucket over his head, but the Superfone is virtually undetectable in use, it sounds just like a normal telephone.

The greatest range that was achieved in town was 2 miles, but that was for the base station activating the bleeper on the remote, the remote was not strong enough to get back. Two-way conversation was possible up to about 1 1/2 miles away.

A most unusual feature of this set is the two-way paging facility, not only can the base station call the remote, but the remote unit also has a call button that can be used to page the base station, a feature that I have not seen on any other set.

The base station uses two tuned whip aerials that are screwed into two standard S0293 aerial sockets on the back of the unit. The use of standard sockets makes it very easy to plug in external aerials should you wish to improve the range.

The remote unit has a last number re-dial button and a *STANDBY-ON/AIR-OFF* function switch. A novel idea is the battery cassette which is a self-contained removable battery pack. Two of these are supplied with each set so that one of them can be left on charge in the base station and the other plugged into the remote unit. Then,

when the batteries in the remote go flat, it is only necessary to swap cassettes instead of waiting for 15 hours for the Ni-Cads to recharge. There is an overcharge protection circuit built into the base station.

The only adverse comment that I have heard about this set is that the handset is too bulky, and although I must agree that it is larger than some, I think that this is a minor disadvantage when compared to the overall quality of this set.

The Superfone CT505 costs £325 and is available from *Intercall Ltd., 5 Hampton Court Parade, East Molesey, Surrey.*

The Lake Model 3000C

This is a 1.7MHz/49MHz Duplex cordless telephone that has a tested range of approximately 200ft. in a built-up area. The handset, which is quite large, has a low battery warning light and the batteries are recharged by plugging the entire remote unit into the base station.

The base station is unusual in that it incorporates a digital alarm clock. When the alarm goes off it makes a very pleasant electronic warbling sound which can be turned off by pressing the 'Alarm Off' button. Unfortunately, because all the clock's control buttons are very close together, it is all too easy to press one of the other buttons, i.e. 'Fast Set' or 'Slow Set', by mistake, which causes the clock to read a totally different time. This could be most confusing first thing in the morning, but it is a minor irritation that could be rectified quite easily by the manufacturers if they were to move the buttons.

Below: The EMP 4001. One of the most stylish cordless telephones currently on sale!





Above: The amazing Superfone CT505.

This is a neat and attractive set and it is available from *Kramer & Co.*, 9 October Place, Holders Hill Road, London N15 for £130.

Range Extender

The range of most of the currently available cordless telephones varies between 300ft. and 300 yards, depending on the terrain, which is more than enough to cover the average home and garden, but not enough for you to be able to take it as far as your local. The easiest way to improve the range of any radio transmitter is to improve the aerial, and with this in mind the Firestik Company of Arizona has introduced the **49 VIP Cordless Telephone Base Station Antenna System**. A 49MHz fibreglass ground plane aerial with three solid aluminium radials is supplied for reception of the signal from the remote, and a 60ft. long wire antenna is used to transmit the 1.7MHz signal to the remote. The range could be further increased by extending the wire aerial, but its overall length must always be a multiple of 60ft. ie. 120ft., 180ft., etc.

Firestik claim that this aerial system will increase the range of a cordless telephone by 5 to 10 times and tests have shown that this is a realistic estimate. The set comes complete with instructions that explain how to attach the aerials to several of the popular makes of cordless telephone.

The **49 VIP Antenna System** is available from *Wintjoy Ltd.*, 103 High Street, Shepperton, Middlesex TW17 9BL, and costs £38.50.

Like the Superfone, this set has a two-way paging facility, not only can the base call the remote, the remote unit also has a call button that can be used to page the base. The base station also has a built-in loudspeaker.



Above: The Lake 3000C.

To prevent interference from other cordless telephone users, and to overcome the problem that I mentioned earlier, i.e. other people using your telephone for nothing, the base station has a set of tiny binary switches hidden underneath it, and they can be set to any two digit number and that number must be punched on the keypad before the dialling tone can be obtained. The switches are hidden from sight but they are easily accessible, and the code number can be changed as often as you like. We have not been able to test one of the telephones yet, but from the look of the specifications, and because of the two-way paging and security dialing code facilities, the price, £130 inc., would appear to be very reasonable.

Late News

We've just received a press release from *Thanet Electronics*, 143 Reculver Road, Herne Bay, Kent CT6 6PL about the **Finecall M801 DX cordless telephone** but unfortunately it was not accompanied by a photograph and so we are not able to show it to you, but because it has some unusual features, we thought that it was worth mentioning.

It is a 1.7MHz/49MHz Duplex cordless telephone that has a range that varies between 300ft. and 300 yds., depending on the terrain, and the NiCad powered handset, which has a low battery warning light, is recharged by plugging it into the base station. ●

Editor's note. You are reminded that cordless telephones are not licensable for use in the UK.

CALLING ALL CB ENTHUSIASTS

Wholesale prices direct to the public

**COMPARE OUR PRICES
WITH OTHER RETAIL
SHOPS**

COMPLETE BEGINNER'S KIT

*Extra special 40 channel
CB disguised aerial with
splitter box, patch lead,
SWR meter, and big
dummies guide to CB
£87.50, mail order
available*



Telephone:
Chelmsford 87698



DV27 £4.50
MS 264s and 610s, disguised
aerials £23.50
Hirshman (with Splitter)
..... £17.50
PA Horns £5.25
Splitter Box £6.00
CB Receiver £9.25

Hours of opening
Monday-Saturday
10 a.m.-6 p.m.
Late night Thursday till 8 p.m.
Sunday 10 a.m.-1 p.m.

Full Range
Firestik Antenna

Viceroy's Midland
Sharp, Ham Int.
Major, Highgain
5s, President
Adams, Fanon
Fanfairs, Formal
120s, Tristar
747s Concordes

SPECIAL OFFER

SWR Meters incl. free
patch lead.
Usual SWR
Meter Price **£7.50**
~~£8.95~~

Co-axial RG58U

22p per metre
Co-axial RG8 58p per metre
K40 Power-mikes . . . £29.70
Turner Powermikes £19.25
Cheap Powermikes from £5.75
Extension Speakers . £4.50
Burners from £23.00
Slide Mounts £3.75
Pre-amp £14.95
Complete suppression kit
£11.95
PL259 55p

**QUICK REPAIR SERVICE
AVAILABLE**

CHELMER CB ACCESSORIES

New shop now open!
50 Duke Street, Chelmsford, Essex.
LARGER SHOP, LARGER STOCK!
Trade enquires welcome.
Telephone Chelmsford 87698 or 351359

MULTIBAND CITIZENS BAND MONITERS FROM THE *HIRA* GROUP



Vote of Best
Buy February
Issue

**Shamp, Tristar, Fanon, Midland President, La Fayette CBS
& CB Accessories. Contact Hira (Ireland) Ltd Dublin 265472**

**CB MONITORS CONTACT THE
HIRA CO LTD, HIRA HOUSE
1 ELIZABETH STREET, MANCHESTER M8 8PR
061-834-2868.**

**STRICTLY TRADE ONLY
IMPORTERS, WHOLESALERS, EXPORTERS, DISTRIBUTORS**

The OTHER CB Dictionary

Confused by CB jargon? Logan's Run makes a few observations and some alternative definitions of some of the more commonly used terms.

A NON DEFINITIVE EXPLANATION OF CB JARGON BY LOGAN'S RUN

BREAKER — A fearsome inhabitant of the twilight world of *CEEBEELAND* who upon receiving the magical chicken box changes overnight to a different creature.

PLANK — A *BREAKER* with the intelligence of a two year old.

MODULAYSHUN — The strange language of the inhabitants of *CEEBEELAND*. Some examples are as follows:

"GIZZANYNE"
"THUSAFOR" "THUSARODGE"
"WAZZYERUFT-WENTI"
"WUMYHITTINYA"
"YERGORNTENWUN"
"GOUPTA"
"GUDOWNTA"

AYEM-EFEM-ESSBEE — Various dialects of *CEEBEELAND*.

I BAWL — The mating cry of *BREAKERS* when they find one another despite being totally unable to understand their own directions.

JER KOPEE — The hunting call of a *BREAKER* repeated continuously until answered.

WHEELS — A metallic box-like device used by *BREAKERS* to move from one place to another. Can be recognised by its unusual porcupine appearance and roaring noise. Not known for its reliability.

YERGORNTENWUN — This has several meanings: 1) My wheels are noisy, but I'm not telling you; 2) My rig is better than yours; 3) I'm fed up with talking to you.

THUSAFOR — I don't know what you said but I sure agree.

MOSHUNLOSHUN — A fiery liquid in great demand when *BREAKERS* use their *WHEELS* throughout the night chasing *PLANKS* having *I BAWLS*.

THE KOMMITTE — High Priests and Priestesses of the largest tribe of *CEEBEELAND*.

NAYBERZ — A hostile people living near to *BREAKERS* and who pray to their God *GOGULBOKS* every night.

TEEVEEYE — A mysterious secret ray

that Zaps the God *GOGULBOKS* and sends *NAYBERZ* into a mad frenzy. Guaranteed to attract Buzby to Home 20's.

O'MOFFIS — The home of an evil band of *BANDITS* who descended into *CEEBEELAND*, robbing and pillaging, much to the delight of Buzby.

SMOKY — A member of a race of hunters that prowl *CEEBEELAND* in dark robes with chequered headresses looking for unsuspecting and innocent *BREAKERS* so that they can feel their collars.

BUZBY — A form of humanoid being with a paranoic hatred of *BREAKERS*. Usually disguised as a normal friendly human being, but has the ability to instantly change into a ferocious enemy. Noted for stealth and cunning.

JAMSAMWITCH — A brightly coloured striped mobile metal box containing a number of humanoid alien beings who roam *CEEBEELAND* hunting for *BREAKERS*.

PORCUPINE — A yellow spiked mobile metal box used to transport *BUZBY*'s. This box emits mysterious rays which sends any nearby *BREAKERS* into instantaneous bursts of activity and causes *WHEELS* to burn rubber rapidly.

EARWIGGER — A normal *BREAKER* who is temporarily smitten with the dreaded *NON-MODULAYSHUN* disease.

BUSTED — The term given to a *BREAKER* who has been snatched by one of the members of the *BUZBY TRIBE*, tortured unmercifully by them and forced to part with more green shield stamps.

WHYELLS — Neglected girlfriends of *BREAKERS*.

ESSDOUBLEUARWUNTERWUN — An elusive magical condition which if achieved sends a *BREAKER* into immediate ecstasy, and all his good buddies green with envy.

HANDLE — The name you try to

remember when you modulate and try to forget when you don't.

RIG — A small mystical metal box-like device which is sweated over by all *BREAKERS*. Upon saying the magic words *WUNFORFORAKOPEE*, it will immediately burst into life and can usually speak intelligently to *BREAKERS* in *MODULAYSHUN*.

TWIG — These come in many forms but which ever one a *BREAKER* has, it always out-performs anyone else's, until he gets another one. The bigger it is, the better it performs, but that's the old, old story.

ILL GIVEUABELL — I'll ring you, but what I can't understand is why is my telephone account getting bigger ever since I've been into *CEEBEELAND*.

BYBYANGORN — Cherie for now, I'm going, but don't you worry you can be sure I'll be listening to you talk about me when I've gone.

EX-WHYELLS — Wives of *BREAKERS* who constantly chant till the early hours of the morning *WHYELLDONTU-LEEVETHATDAMMEDTHINGALONE*.

GREEN SHIELDS — What everyone else has except you. Green Shields can also vary in value. For example, if you sell a *RIG* to a good buddy, it always works out that he bought it from you cheaper than you sold it to him.

GOOD BUDDY — Is a CB friend for whom you would do anything from the moment of the first *MODULAYSHUN* provided: 1) It didn't cost you anything; 2) You had the time; 3) You didn't have to stick your neck out; 4) You haven't got to pick up the *WYELL*.

AMMS — Alien beings who think they have higher intelligence than *BREAKERS* but frequently *EARWIG* on *CEEBEELAND MODULAYSHUN*.

QUEUE ESSELLES — Strange events only occurring in a certain group of *BREAKERS*, familiar with *ESSBEE* dialect. A trophy much prized by lowly straight 40 *BREAKERS*'

**NOW
OPEN!**

Britain's
foremost
CB specialists

MASSIVE NEW TRADE PREMISES!



**WE ARE THE
SUPPLIERS,
IMPORTERS
DISTRIBUTORS
& WHOLESALERS!**



Overnight
delivery
service.



**-SPECIAL-
SURPRISE OFFER
... must end Easter**

TRADE ENQUIRIES PHONE DIRECT ON 01-907 3666
All other enquiries 01-907 1106/7.

Send £1 for 60 page
fully illustrated
catalogue.

CITIZENS' BAND
Radio Centre Ltd.

337 Kenton Road, Harrow, Middlesex.

OPEN: MON-SAT
9.00 am -
6.00 pm



Radio Modellers- A Raw Deal!

Pete Christy, a well known radio modeller makes a few observations on the recent Government announcement

As you can probably imagine, the announcement concerning CB on 27MHz has caused a considerable amount of reaction amongst the R/C fraternity. Details are as yet very sketchy, but it would appear that the news could have been worse. Certainly it was not entirely unexpected.

Right up until Christmas, enquiries to the Home Office concerning possible CB allocations were met with rather vague replies. The only point on which they would make any definite statement was that no way would 27MHz ever be permitted. After Christmas similar enquiries were met with 'No Comment'. Considering how adamant they had been only a few weeks earlier, the writing was clearly on the wall! By this time 35MHz had been approved for R/C aircraft, which certainly has eased the situation considerably, but converting a few hundred thousand R/C outfits is not an overnight job. Further, some equipment is not suitable for conversion, nor are cars or boats permitted on 35MHz, so there will be a considerable R/C presence on 27 MHz for some time to come. In view of this what does the future hold?

The answer to this question depends to a large extent on the precise nature of the CB allocation, and as yet no technical specification has been released. I have spent a morning on the 'phone to the Radio Regulatory Dept., and other likely sources, and drawn a complete blank. However some fairly heavy hints have been dropped over the past few weeks, so we can take some educated guesses.

Firstly, we do know that the intention is that FM only will be permitted. (I would dearly like to know how they intend to enforce that, but that's another story. . .!) There have been some indications that the allocation should start at 27.255 MHz (Ch23) and work upwards. This would leave the bottom part of the band free for the existing users (R/C, paging etc). As such it is an excellent idea. However, during an adjournment debate in the House of Commons in mid February, Timothy Raison placed great emphasis on the desirability of specifying equipment that would be acceptable in other European countries. This would allow enthusiasts to take their equipment abroad. He specifically mentioned

France, Holland and Germany, all of whom operate 27MHz FM. Compatibility with these countries would not be achieved if Britain adopted a system starting at ch23.

The handling of the whole situation by the Home Office reeks of sheer incompetence. Their stubborn refusal to accept the inevitable has led to considerable ill-feeling between two factions within the community. A little bit of fore-sight and intelligent planning could easily have avoided this. Even now, having effectively admitted defeat, their attitude seems to be to try and make things as difficult as possible by withholding essential information. However, it is no good crying over spilt milk!

PROVIDED they now come up quickly with a reasonable technical specification, and provided everyone sticks to the rules, there is a chance of a measure of co-existence on 27MHz.

The factor that worries me most of all is the reaction of the 27 AM or bust brigade. I find it highly galling that having told the modellers, in effect, that they must spend up to £80 to convert to a new band, these cowboys are now protesting when their equipment in turn is made obsolete. They have been given the frequency they asked for. If they have wasted money by jumping the gun and buying the wrong equipment, then it is THEIR OWN FAULT, and I have no sympathy whatsoever.

Estimates of the number of pirates now on the air vary widely, but ignoring the extremes, 300,000 to 500,000 would seem a reasonable guess. (I'm referring to active pirates, not tacit supporters.) A number have said that whatever happens they will stick to their AM equipment. They may change their tune in 12 months time when there are 1½ million legal FM CBers that they find they cannot talk to.

The European standard allows for 22 channels, although the Government's Open Channel Discussion document indicated that 40 may be more appropriate. However FM operation improves channel 're-useability' because of the 'capture effect' in FM systems. This effect means that in an FM system, signal A incoming to the receiver only has to be slightly stronger than signal B to completely capture the receiver, and not a trace of signal B will be heard!

Thus background noise and interference during reception is considerably reduced. Thus 22 channels of FM should be of more use than 40 channels of AM. So let's assume, as seems reasonable, that we end up with a 22 channel FM system of say 4 watts on 27MHz. (The top channels of a 40ch system are out of the R/C band anyway.) Further let's assume, as once again seems likely, that 5 spot frequencies in 27 MHz band are nominated as exclusive to R/C (26.995, 27.045, 27.095, 27.145, 27.195) This is the standard that has been adopted world-wide. where does that leave modellers?

The specification for the 35MHz model control band states that the sidebands from the transmitter should be at least 40dB down, 7.5KHz from the carrier frequency. Most outfits actually achieve 50 to 60 dB without difficulty. There is no reason why an FM CB rig should not achieve the same performance on 27MHz. In this case there is no reason why an FM CB and an FM R/C should not co-exist on 27MHz. Because the CB will be putting out a lot more power, there will still be a chance of destructive interference if the CB is on an adjacent channel to the model, and approaches closely to the flying site. At least the risks have been minimized.

What about AM R/C systems? Well, these are generally intended for 20KHz adjacent channel operation, not 10KHz, and will be much more susceptible to CBs on the adjacent channel. However if the CB is an FM rig, then the modulation will not be detected by the R/C receiver. The carrier will cause some disruption, but much less than an amplitude modulated carrier would. Provided the carrier is not too strong, then there is a fair chance of survival if the pilot is experienced enough. Once again the interference will have been minimized.

The problem is worst with AM CB rigs. Firstly they 'splatter' more into the adjacent channels anyway, and by the very nature of the modulation it gets in everywhere.

Whenever two or more transmitters try to occupy the same or very closely spaced frequency there is bound to be mutual interference. However, by adopting inherently cleaner FM systems, such as mutual interference can at least be minimized. ●

On the side

Albie Vickers, President of the British Sideband Network introduces a new regular monthly feature devoted to followers of 11 metre SSB operation. But first a few non-technical words on what single sideband operation entails.

Whenever you key the mike on an AM CB transceiver you generate radio waves. If, for instance you are using channel 14 you are generating radio waves with a frequency of 27.125 megahertz. (If only life were this simple we would all be happy). What you may not know is that you are also generating two other radio signals called sidebands. One sideband is slightly higher than the centre frequency (in our case 27.125MHz). The difference is equal to the frequency of the modulation going into the mike (ie your voice etc) and this is called the Upper Sideband. The other sideband (would you believe the Lower Sideband) is transmitting on a frequency equal to our centre frequency *minus* the frequency of the modulation. Now, why should we tell you all this? The answer lies in a recent move towards CB transceivers using single sideband operation. Unlike a conventional AM transceiver a single sideband (SSB) transceiver only transmits one signal, either the upper or lower sideband. The reasons for doing this are many and varied but it all comes down to one thing — efficiency.

Let's look at an AM transmission, rated at 12 watts. The first thing we have to define is what's a watt. In most cases an AM RF output figure has the letters PEP after it. This stands for peak envelope power. The envelope in question contains the three signals, ie centre frequency (or carrier), upper sideband and lower sideband. So our figure of 12 watts is divided over these three signals. As the receiver only needs one sideband and the carrier to reproduce the modulations one side-

band is going spare and in effect is just wasted. Now consider this. If we arrange for one of the sidebands and the carrier wave to be suppressed at the transmitter, and only transmit one sideband we have saved two thirds of our power. In real terms a 12 watt SSB transmitter is pushing out one signal at 12 watts not three with 12 watts PEP between them. I can hear you asking why we bother to use ordinary AM when SSB is so efficient. The answer comes down to economy and simplicity. It is easier and cheaper to design and build AM equipment. Although the same information is being transmitted it is more difficult to send it in the first place and harder to decode once it has reached the receiver. You may have heard an SSB transmission on AM, it sounds like Donald Duck with a speech impediment!

Looking at SSB logically we have a number of things to consider. On the plus side we are saving a considerable amount of power by only transmitting one signal as opposed to three on AM. Because we only transmit on half of the space allotted to each channel it is possible to have two simultaneous transmission on that channel, ie upper and lower sidebands, without them interfering with each other. And thirdly, because we are using the transmitter more efficiently by only transmitting one signal, the effective range is increased.

On the minus side SSB equipment is often much larger than ordinary AM equipment. SSB equipment is more expensive (up to 50% more expensive) and it is harder to decode the signals as the carrier wave is missing. On most



Right: A selection of QSL cards used by CB DXers. The idea is to confirm a transmission between two DXers by swapping these cards via the post. It has become a hobby in its own right to collect these colourful cards.

SSB transceiver there is a control marked 'clarifier' which is in effect a manual de-coding control for the incoming signal.

That then is very simplified view of SSB. In fact there is more than enough technical information on SSB to fill half a dozen books but it is beyond the scope and space of this article to go into them more fully. Let us now look at how sidebanding has developed into a quite separate and distinct part of CB and two-way communications.

Due to the ability of SSB signals to travel great distances with relative ease a number of organisations have been formed to encourage and develop sidebanding as a serious international hobby. In this country there are a number of clubs and associations devoted to sideband operation but by far the largest is the British Sideband Network.

British Sideband Network

The BSN was formed in 1978 by Albie C. Vickers and here in his own words is what the Network is all about.

'Gooday Bruce, ya got a copy?'
'Ooya Bruce or Brian, whatever ya name is, you still on channel?'
'I don't think he can. . . ing hear me.'

So went the conversation between two mobiles, one obviously in Australia and one is this country. The Australian station was working very hard to get a contact with a British station. I could make out most of the Australian's transmissions but the British station was not really trying. I called QSK (station on the side) and the



WORLD-WIDE RADIO GROUP

LOWESTOFT, SUFFOLK
ENGLAND

26WW9 "BOB"
6/01 GREENFIELD ROAD
BRITISH OPEN CHANNEL RADIO STATION.

73's

AND ALL THE GOOD NUMBERS FROM

HIGH ROLLER

TO STATION CITIZENS BAND MAGAZINE

DATE 7th February 1981

REACT U.K. C.B.A. E.I.D.X.C.

MILLER 316 GARTH ROAD, MORDEN, SURREY SM4 4NW U.K.

ROB ROY U.K.

OP.
R. LITTLE,
NESSPOINT C.B. CLUB,
LOWESTOFT,
ENGLAND



Hi, Good Buddy.

Rick Maybury

Copy me sometime

Copied you on 23 19 81

Heard you on channel 6P0

Eyeballed you at _____

Tell your friends to copy me

Pass this card to a friend

Let me have your card

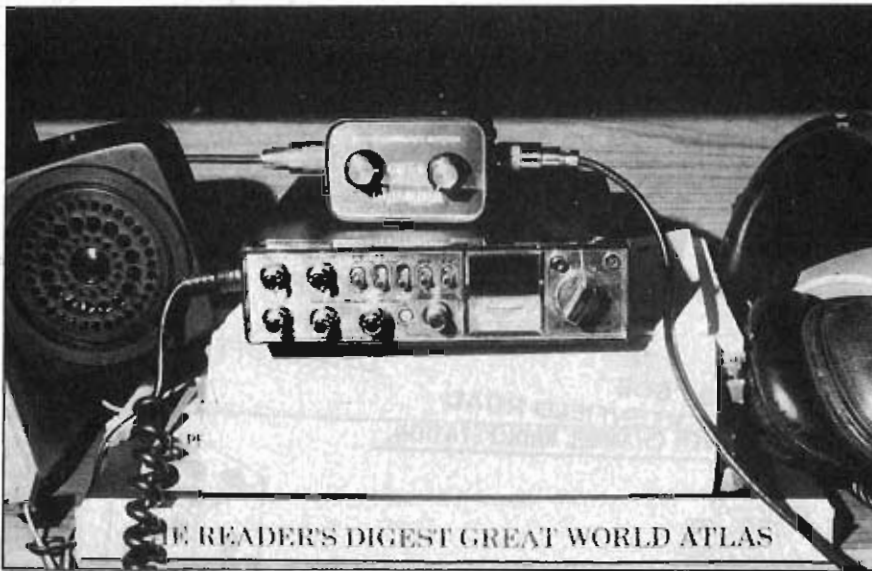

A typical CB SSB station.

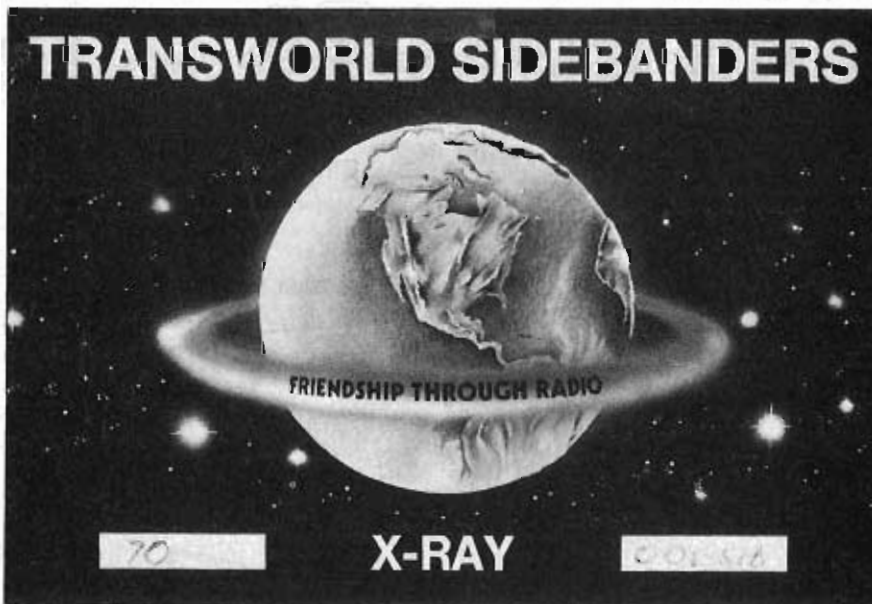

British station asked me what it meant. After I had explained I was told to **** off. End of story?

No, it's not the end of the story. There are lots more people like that and they make me feel ashamed. Something has to be done!

The British Sideband Network was founded to help establish a firm and unified base for British 11 metre DX operators (outbanders) to work from. We encourage the spirit of friendship and co-operation among our members and help each other to persue our rights as members of a free democracy. We want to choose our own means of communications but without in any way undermining the Government's position. By our actions we say: *No compromise. 11 metres or bust!*

On the application form for enrolment to the BSN it states quite categorically that the Network will only accept for enrolment those operators committed to thoughtful, considerate and responsible operation of single sideband equipment. Every time an operator uses his or her microphone it is possible for them to be heard in every corner of the globe. The ability to speak freely to people of other nations is a very special thing and something not to be abused. Being a serious DX operator can be a pretty solitary pastime. It's not easy to find like-minded people. AM operators often do not understand the challenge of working a rare and distant station. Indeed the 'skip' is often regarded as a pain in the neck by AM users but to the DXer skip is the whole essence of the hobby.

Every member of the BS Network is a moving part of the whole mechanism. Every member encourages each other and organising regular local networks (nets) in their own areas is an integral part of the hobby. Above all, each member is responsible for setting a standard of operation that others will want to follow.

Aside from the social activities the BS Network is also able to offer its membership help and technical advice. We as an organisation have considerable influence over the equipment manufacturers and I sincerely believe that the current upsurge of interest in CB in this country has played a major part in helping a number of small companies back on their feet after the depression in the CB market in the early seventies.

Some more examples of QSL cards produced by DX enthusiasts.

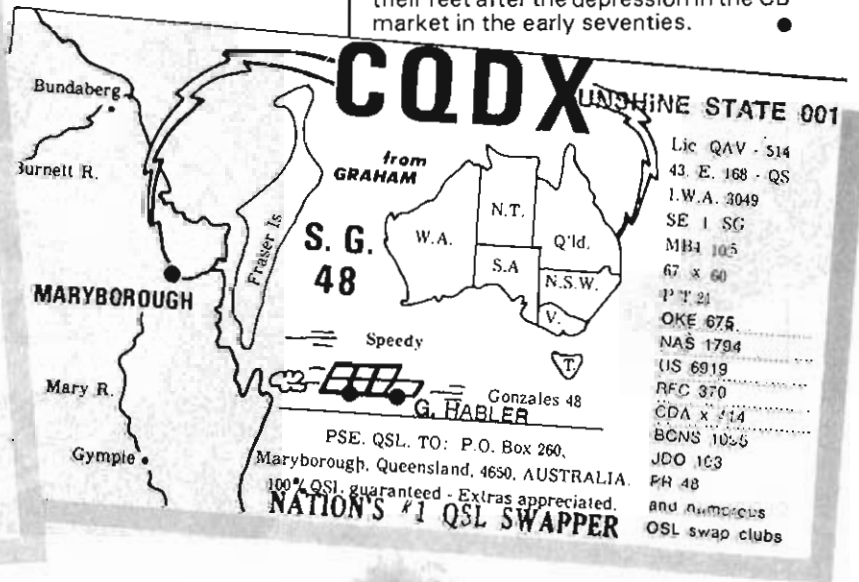
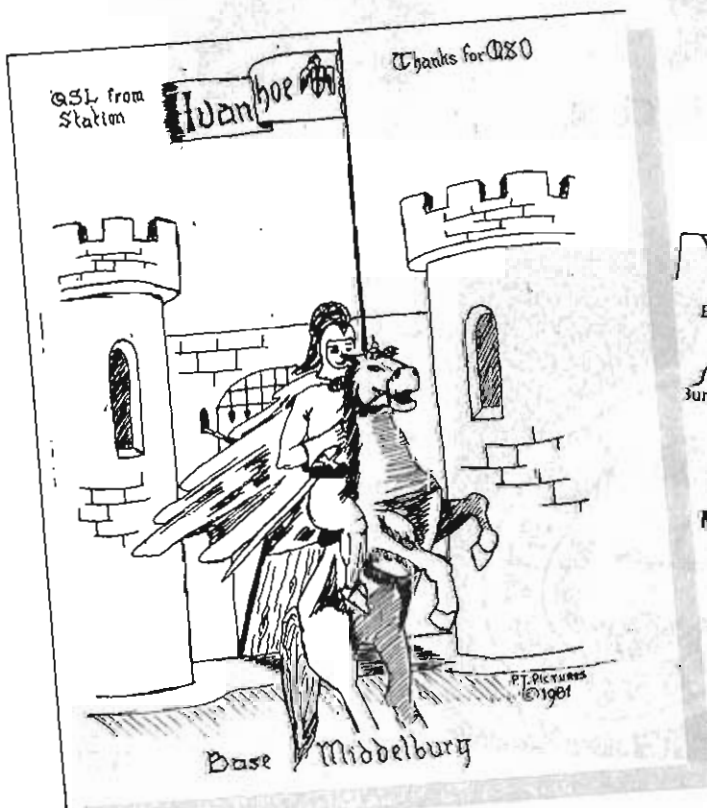

New from Casio, world leaders in creative technology combined with high quality and reliability

A CLASSIC IN IT'S TIME

You don't have to be a highbrow to appreciate the beauty of this clock. Battery powered, it is ideal for office, lounge, bedroom, caravan or boat.

MA-1 ALARM CLOCK



ONLY £9.95

Large blue LCD display of full digital time. Symphonic alarm or buzzer, with snooze facility. Hourly time signal. Integral loudspeaker and amplifier with 3 position volume control. Built-in night time illumination. Alarm "Symphonie Nr. 40 G moll" (W.A. Mozart, K.550) for about 30 seconds or buzzer for 60 seconds. Three AA size batteries last approx 15 months. Quartz accuracy. Dims: 43 x 115 x 76mm (1 3/4 x 4 1/2 x 3 inches).

CASIOTONE MT-30



RRP £115

ONLY £95*

Full polyphonic playing of 22 instruments and sounds over 3 octaves. 4-position sound memory lets you switch between pre-selected sounds without pause. Built-in vibrato and sustain functions greatly enhance the overall musical effect. Compact 2 1/4 x 2 3/4 x 6 1/2 inches, with built-in amplifier and loudspeaker. Battery / mains power source and light weight (6lb) allows playing anywhere.

RRP £345

CASIOTONE 401 ONLY £295

Polyphonic playing of 14 instruments over 4 octaves. With 16 different auto rhythm accompaniments and Casio Auto Chord — one finger playing of major chord and bass accompaniment. Also minor and 7th chords. Built-in vibrato, delayed vibrato, sustain and hold and amplifier/speaker. Compact 4 1/4 x 3 1/4 x 1 1/2 inches and lightweight (28.2lb). AC only.

CASIOTONE 301 Simplified version of 401 without auto chords. £245

CASIO BQ-1100 BIOLATOR/ WATCH



Clock, calendar, 2 alarms, countdown alarm stopwatch, time memory, three date memories, biorhythm and date calculations, calculator

Clock: Hours, minutes, seconds, am/pm. Day/date. Universal calendar. Pre-programmed 1901 to 2099. Day, date, month and year display.

Alarm: Two separate alarms. 24-hour system. Countdown alarm: 1/10 second to 24 hours, or Stopwatch 1/10 second to 24 hours. Net times, or Time memory. Dual time facility. 24-hour system.

Calculator: 8 digits. Full memory. Sq roots, % Date calculations. Any monthly calendar from 1901 to 2099 can be displayed and utilised.

Biorhythm calculations. Forecast your physical, emotional and intellectual performance potential. Chart your peak ebb and crucial days and reschedule to avoid mistakes. Two silver oxide batteries last approx 1 year. Dims: 1 1/2 x 2 7/8 x 4 3/8 inches. Leatherette wallet.

ALL THIS FOR ONLY £14.95*

MG-880 SPACE GAME/CALCULATOR

Our best selling calculator. Thousands sold! An action packed speed game that will give you hours of skilful entertainment and chair-gripping excitement. Also an 11-note melody calculator with full memory. % £10.95

Price includes VAT, P&P. Send your company order, cheque, P.O. or phone your ACCESS or BARCLAYCARD number to:

TEMPUS

Dept. CB, FREEPOST, 164-167 East Road, Cambridge CB1 1DB. Tel: 0223 312866.

KEEP A DATE WITH CASIO

You always wanted a musical calculator with date memories and date, time alarms — HERE IT IS!

UC-365 UNIVERSAL CALENDAR



Clock, universal calendar, date memories, daily alarm, 2 daily or date/time alarms, hourly chimes, stopwatch, countdown alarm, time memory, calculator.

Clock display: Hours, minutes, seconds, am/pm, or hours, minutes, full calendar.

Calendar: Pre-programmed from 1901 to 2099. Full month display.

Date memories: Any day or days pre-settable within 12-month period. (Birthdays, etc.)

Alarms: Alarm 1 — Daily alarm. Alarm 2 & 3 — Daily alarms or time alarms on pre-set dates. (Pre-programmed melodies or electronic buzzer.)

Stopwatch: 1/10 second to 24 hours; net, lap and first and second place. Or Countdown alarm: 1/10 second steps, settable in minutes up to 24 hours. Or Time memory: 24 hour system. The time of any other zone can be stored.

Calculator: Optional musical keys, full memory and percentage.

Two silver oxide batteries last approx. 1 year. RRP £22.95

1/4 x 4 1/2 x 2 1/2 inches. Leatherette wallet with window. £19.95*

UC-360. Card sized version of above. 7/32 x 3 1/4 x 2 1/8 inches. £19.95*

UC-3000. Office desk version. Angled display. 1 1/4 x 4 x 6 1/4 inches. £27.95*

CASIO'S AMAZING NEW FX-3500P

Programmable. Non-volatile memories and stores. Statistical regression and integrals.

38 functional (non-volatile) steps. 2 programme storage capability. Unconditional and conditional jumps. 7 (non-volatile) memories, one independent. 6 constant memories. 18 pairs of parentheses, nestable in 6 levels.

61 built-in functions including: Integrals (Simpson's rule). Linear regression, logarithmic regression, exponential regression and power regression.

Hyperbolics, sexagesimal and co-ordinates conversions. 10 digit mantissa or 10+2 exponent. Two silver oxide batteries give approximately 1,000 hours continuous use with power-saving automatic cut-off, with data and memory protection.

Dims: 9/32 x 2 1/4 x 5 1/4 inches. Supplied with leatherette wallet.

ALL THIS FOR ONLY £22.95*

FX-180P. Hand held version without hyperbolics. 2 x AA batteries. 1/4 x 3 x 5 1/4 inches. £19.95*

FX-2700P. As FX-3500P but 8+2, without integrals, regression. 1 programme. £18.95*

FX-8100. Scientific with clock, calendar, alarm, chimes, stopwatch, etc. £24.95*



CASIO'S BEST SELLING WATCHES



AA81



M1200



W150B

LCD ANALOGUE/DIGITAL ALARM CHRONOGRAPH with countdown alarm. AA-81 chrome s/s bracelet £29.95. AA-81G. Gold plated £49.95. AA-82. All s/s £39.95. 12 MELODY ALARM CHRONOGRAPHS with countdown alarm. M-12 resin case/strap £24.95. M1200 all stainless steel £29.95. 100 METRE WATER RESISTANT Alarm chronographs with countdown alarm. W100. Resin case/strap £19.95. W150C Stainless steel case, resin strap £25.95. W150B. Stainless steel case/bracelet £32.50.

SEND 20p (POSTAGE) FOR OUR ILLUSTRATED CATALOGUE OF CASIO AND SEIKO

*PRICES

We will beat any lower advertised price by 5% providing we still make a profit! Just send details and your remittance for the lower amount. Prices include VAT and P&P.

EVERYTHING CAN BE

GROVE

(0243) 861705

ELECT

UNBEATABLE VALUE!!

SAVE
£22.50

FULL
RANGE OF
SPARES AVAILABLE
RING/SEND
FOR LIST



1 x K40 Speech Processor
1 x K40 Antenna
Special price for the two:
£49.95 + postage £1.95

RETRACTABLE TELESCOPIC
C.B. ANTENNA



£9.99 + .65 postage

SLIDE MOUNT

£3.99

+ postage .85p

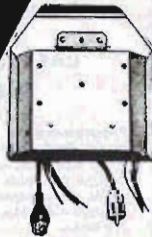

Lower part of the mounting support in the car, whilst the upper part is mounted onto the mobile unit. A simple sliding action installs or removes the unit. All connections such as antenna, power supply and loud-speaker are made over reliable contacts. The valuable mobile unit no longer remains in the car when leaving the car for short periods, the mounting support is also lockable. Various fixing holes.

TRADE ENQUIRIES WELCOME

Hobbs

MODERN CB RADIO SERVICING

By Mervin Hobbs

This book reviews the most recent trends in CB transceiver design, including PLL and microprocessor control techniques. There is a chapter on trouble-shooting techniques that are applicable to either 40-channel or 23-channel transceivers. And an appendix of figures giving the various crystal combinations in 23-channel transceivers with multicrystal synthesizers are included.

CONTENTS: Introduction to CB Transceivers. AM Transceiver Circuitry. SSB Transceiver and Receiver Support Circuitry. PLL Frequency Synthesizers and Microprocessor Controllers. Discrete CB Test Instruments. CB Text Systems, Analysers and Testers. Transceiver Alignment Procedures. CB Transceiver Tests. Troubleshooting — Initial Checks. Troubleshooting by Symptom. RF Interference and Noise Elimination. Printed 1979. £5.95 inc p&p 176 pages

Smith

CBers' FACTBOOK

By Noel T. Smith

This book tells how easy it is to select, purchase and set up the kind of equipment best for you. It explains and illustrates basic operating practices for both base and mobile stations. You'll find CB rules and regulations, and a listing of CB clubs, organisations and publications.

CONTENTS: An introduction to Citizens Band Communications. Operating on the Citizens Band: Fixed Service. Operating on the Citizens Band: Mobile and Portable Service. Antennae for the Citizens Band. Improving CB Communications. Accessories For Fun and Security. £3.50 inc p&p 128 pages

CB ACCESSORIES YOU CAN BUILD

By Ronald M. Benroy

Here's an opportunity to build some terrific improvements into your standard CB equipment — novel but practical additions perfectly within the law. You'll have simple, complete procedures for building an auxiliary 120 VAC-to-12 VDC power supply . . . an unusual antenna system . . . a low-cost maintenance selector switch . . . a super-sensitive base-station mike . . . a basic phone patch . . . a hi-fi headphone adapter . . . an inexpensive automatic "ON THE AIR" light . . . and other valuable accessories to increase the fun and convenience of your CB equipment.

A bonus project section at the end of the book offers directions for building 10 CB accessories, including coaxial jumper cables, antenna switch, antenna tuner, AC power supply, external speaker, dummy load, and more. 1978. £3.95 inc p&p

C.B. BOOKS

ALSO AVAILABLE:
Inc. P&P.

CB LINGO BIBLE £0.75
BIG DUMMYS GUIDE £2.95
S.S.B. HANDBOOK £4.95

Staff of CB Test Labs

HOW TO SELECT AND INSTALL CB ANTENNAS

Staff of CB Test Labs

You can have the most expensive CB transceiver in the world, but unless your antenna is high quality, and properly installed and maintained, your transmission will be poor. This all-points guide enables you to handle an antenna like an expert. You'll see just how the antenna works — how it radiates and intercepts radio signals. Then you'll see the many kinds of antennas available — both mobile and base station types — enabling you to wisely select the one you really need. Even transmission lines are covered. The handbook then maps out complete installation and check-out procedures aimed at optimum transmission. For the hobbyist, techniques are given for building your own antenna — mini-10ft, dipole, long wire and indoor. £3.95 inc p&p 112 pages

VISIT OUR NEW SHOP

AT
118 HIGHLAND ROAD
PORTSMOUTH, HAMPSHIRE

EVERYTHING YOU
NEED FOR CB

Name Address

PLEASE RUSH ME:

I enclose P.O./Cheque value £

- MODERN C.B. RADIO @ £5.95
- CBer's FACT BOOK @ £3.50
- S.S.B. HANDBOOK @ £4.95
- CB ANTENNAS @ £3.95
- LINGO BIBLE @ 0.75
- BIG DUMMYS GUIDE @ £2.95
- CBer's WORDBOOK @ £3.50
- CB RADIO ACCESSORIES YOU CAN BUILD @ £3.95

To: GROVE HOUSE ELECTRONICS, 14 Arcade Chambers, High Street, Bognor Regis, Sussex (0243) 861705.

ORDERED BY POST

HOUSE

RONICS

(0243) 861705

SWR/FIELD STRENGTH/ANTENNA MATCHER

£17.95

+ postage .80p



3-Function CB/Ham Tester
 1. SWR: 1:1 to 1:3 ($\pm 5\%$) o 2. Antenna
 Matcher: less than 5% power loss o 3. Field
 Strength: 0-10 scale o Frequency:
 1.5M-30MHz. (SWR/FS), 25M-30MHz
 (Matcher) o Impedance: 52 o Connectors:
 SO-239, UHF type o Antenna: 5" bar type o
 Meter: 200uA, core magnet type o Size and
 Weight: 160x60x65mm, 625g.

Quality Power Supply

Input 240v, 50/60Hz
 Output 12, 8v, 3A fully regulated, 5A surge

Also available
 5/7 amp, 12 amp, 20 amp (See listing).

£12.95

+ £1.25 postage



MULTI-BAND MONITOR

MONITORS
 40 CB Channels
 T.V. Band
 Aircraft Band
 F.M. Radio
 Etc., Etc.



WITH FULL
 SQUELCH
 FACILITY
 Hand held

£17.95

+ £1.00 postage

IN STOCK NOW

FULLY
 ILLUSTRATED
 ACCESSORIE
 CATALOGUE
 AVAILABLE
 68 PAGES
 SEND £1.25
 (REFUNDABLE
 OFF 1ST
 ORDER
 OVER
 £6.00)

ITEMS IN STOCK NOW:

MOBILE ANTENNAS

DV27	£6.95
DX27	£10.95
K27	£11.95
T27	£9.99
Fully Retractable Disguise	£14.95
Electric Retractable (inc. Splitter), the best	£32.50
Avanti Astro Phantom (on glass)	£17.50
Pacer Megnet Mount	£9.95
Avanti Moonraker (mag.)	£44.50
Avanti Moonraker (whole)	£38.50
Hy-Gain Twin Truckers	£19.95
Firestick	P.O.A.
K40	£39.95
Rubber Ducks	£10.95
Centre Load Magnetic	£10.25
Base Load Magnetic	£18.95
ASP (Disguise) MS264	£24.95
Whip Ant. with Splitter	£19.95
ASP MS610	£24.95

Roger Bleep Boards	£8.95
Mini Whisky BASE Antenna	£23.95
Neon Lights for Antenna Tops	£0.99
Hawaii 50 Siren - 81 different sounds complete with P.A.	£24.95
Horn only	£3.95
Generator Filter	£3.95
Antenna Matcher	£5.95

BASE STATION ANTENNAS

Starduster/Skylab	£25.95
Whisky Indoor/Outdoor	£24.95
Firestick Pal Mecho	£44.50
Silver Rod	£29.95
Boomerang	£22.95

SWR METERS

A.E.C. SWR 9 SWR/FS	£9.95
A.E.C. SWR 50A, also power FS.	£14.95
SWR 20 SWR/FS	£9.80
SWR 75	£19.95
SWR 78 SWR/MOD/MACH	£26.95
SWR 171 SWR/FS/POWER	£16.95
SWR 175	£14.95

POWER SUPPLIES

13.8V 3/5 Amp	£17.95
13.8V 5/7 Amp	£22.95
7.2 Amp 13.8V	P.O.A.
20 Amp 13.8V	P.O.A.

MIKE CLIPS

Screw Type	£0.35
Self Adhesive Type	£0.55
Magnetic Type	£0.55

LINEAR AMPS

AP 25	£28.95
AP 60	£65.95
Skipmaster 100 watt	£119.95
Skipmaster 150 watt	£155.95
Tornado 1000 watt	£399.99

PRE-AMPLIFIERS

RP 20/EV 80	£16.25
EV 15	£24.95
MICROPHONES	
K40 Speech Processor	£32.50
Mura DX116 Power	£15.95
Altei Standard Mike	£4.95
DM 510 Power/Roger Bleep	£16.95

DM 510 Power	£8.95
Hammaster 4200 Base	£29.95
Versatile Base	£32.95
Hy-Gain Telephone Type	£32.95
Turner M + 38	£33.25
Turner JM + 2U	£22.95
7 volt Battery	£2.95

ANTENNA ACCESSORIES

Splitter Boxes	£6.50
C.B. Ant. Converters	£15.50
Gutter Mount Brackets	£4.25
Magnetic Mounts	£7.95
Ant. Selector 2 to 1	£5.25
Ant. Selector 3 to 1 (built-in 10W Dummy Load)	£6.75
DV Base Adaptor to Firestick	£1.75
C.B. Co-Phasar	£9.95
TVI Filter (Low Pass)	£5.50
High Pass Filter	£2.55
DV 27 Bass Plug	£1.55
DV Magnetic Mount	£8.95
DV Base	£2.60

CONNECTORS

PL259 + Reducer	£0.55
-----------------	-------

Chassis Socket for PL259	£0.55
Double Female	£0.75
Double Male	£0.75
Right Angle PL259	£1.10
"T" Piece	£1.45
RG58U Co-Axial Cable per m.	£0.75
RGB Co-Axial Cable per m.	£0.75

OTHER ACCESSORIES

Extension Speaker	£8.50
Slide Mount C.B.	£5.95
Patch Cable 60 CM	£1.70
Suppressor Kits for Complete Vehicle	£11.95
Frequency Counter	£59.95
AM Radio Converter	£10.95
Cigar Lighter Plug	£0.50
6-Core Mike Leads	£1.10

Jaws 11 Kit complete
 £79.95

TRADE OUTLETS
 SOUGHT

OPEN SUNDAYS

P&P on Orders over £5 free - under £5 - £1 except special offers

VISIT OUR NEW SHOP AT 118 HIGHLAND ROAD SOUTHSEA PORTSMOUTH
 Also at: PORCHESTER CAR CARE UNIT 7, WEST STREET, PORCHESTER

MAIL ORDER FROM: GROVE HOUSE ELECTRONICS, 14 ARCADE CHAMBERS,
 HIGH ST., BOGNOR REGIS, SUSSEX. (0243 861705)

Teach Yourself C.B.

(A BRITISH GUIDE TO C.B. LANGUAGE)



**GOT YOUR EARS ON?
DO YOU COPY?**

Don't be 'RUBBERBANDER!' Discover the difference between a 'BEAVER' and 'SMOKEY BEAR' or a 'GRANNY' and a 'FRONT DOOR'. Learn the colourful, crazy language of CB NOW with this educational and entertaining cassette tape. Learn also the more serious aspect of Citizens Band Radio. For example: How to deal with an emergency situation. In fact everything you need to know from choosing a 'HANDLE' and 'BREAKING A CHANNEL' to going 'DOWN AND ON THE SIDE'. Be an 'ACE' in time for legislation *THEN* join a convoy with confidence.

TEACH YOURSELF CB (A BRITISH GUIDE TO CB LANGUAGE)

Also included is a reference list of traditional ten code, phonetic alphabet and glossary of familiar phrases. SEND cheque or money order to the value of £3.99p inc P&P.

BRIDAIR AUDIO PROMOTIONS

BASEMENT STUDIOS, 158 NEW BRIDGE STREET
NEWCASTLE-UPON-TYNE NE1 2TE

Trade enquiries welcome Tel: 0632 22331 Allow 28 days for delivery

video TODAY

The Home Entertainment Magazine For The Eighties

VIDEO TODAY is the monthly magazine for anybody who owns or rents a video cassette recorder. Each month we give you detailed test reports on all sorts of home video equipment, plus Letters, Problems, News and reviews of all the latest movies on videotape.

VIDEO TODAY is on sale on the fourth Friday of every month price just 70 pence. Remember — the world of video is fast-growing and fast-changing — let

VIDEO TODAY put you in the picture.



CB Citizens' Band

NEXT MONTH

CB Monitor Revivers

Andy Giles, our resident smart Alec looks at a selection of some of the CB monitor receivers on the market. We have everything from the Everco hand portable to the Realistic DIY kit. We tell you which ones are worth having

FM Vs AM

Following the Government's decision to introduce an FM service we take a close look at what FM actually is and how it will differ from the existing AM setup. For those of you that are technically minded we will try to explain some of the more salient points concerning this mode of transmission.

Music On The Move

Have you noticed how many people are walking around with headphones clamped to their heads these days? We look at some of the equipment on the other end of these headphones. In next month's Citizens' Band we look at portable and personal stereo systems. With equipment costing between £30 and £100 we survey a selection of the equipment currently on sale.

May issue on sale April 17th

Competition

Yes, that's right, another fabulous competition with millions of pounds worth of prizes, well a good few quids worth anyway. Star prize next month is the Elco Multi Mode test meter that will measure everything from SWR to modulation. We might even have a few other prizes if we can find some generous CB accessory dealers to co-operate.

Regular Stuff

They'll all be here, Mack The Hack with his regular slanderous column. On The Side begins in earnest next month, sidebands and all that. Update will keep you in touch with the latest of new products and our phenom... phinum... penom... fantastically popular Club News will have reports from up and down the country. Look out too for the equipment and antenna reviews and just before I fall off the bottom of the page, Rig Review has something REALLY SPECIAL to show you, right here, same time next month.

THE NEW PLACE FOR CB RADIO ACCESSORIES

Connexions open as Nationally appointed distributors of the world famous Shakespeare, Vanco & K40 Ranges, with large UK stocks of the latest and best in CB accessories at the most competitive prices.

But don't just take our word for it. Come and see for yourself, or give us a ring. Trade and Agents enquiries welcome.



K40

K40 Mike

The mike that's been described by (US) CB Magazine as "A CB technological breakthrough". Transmitting more power than any microphone made it's *guaranteed* to out perform any mike on any radio. Hearing is believing!



Rebel 500

CB Mobile Antennas

The incredible Shakespeare pretuned mobile antenna that delivers full 5/8 wave performance with a power rating of 500 watts. Add continuous loading for continuing power with the renowned Shakespeare fibreglass construction and you have a porcupines delight!

8 Furrow Way,

Cannon Lane, Maidenhead, Berks.

Tel: Littlewick Green (062-882) 4338/9.



VANCO

SWR/Power Meter

Accurate, beautifully designed meter with on the air indicator, meter illumination and a dual antenna switch - for those who want to use two antennas. The SWR-8 has a frequency range of 3.5-150 MHz.

OPEN 9.30 am-7.00 pm Mon-Sat.
11.00 am-2.00 pm Sun.

Connexions

Legalisation- Now What?



Keith Townsend, no stranger to these pages has a few words to say about the recent announcement from the Home Office (Above).

So now we've heard the long-awaited announcement. What a load of rubbish! What is the Government playing at? How much longer must we listen to vague promises as to what they intend to do at some future date?

Despite the protests from a number of politicians I am forced, once more to the conclusion that there is little political will to honour all the fine sounding promises to increase the freedom of the individual.

In its infinite wisdom the Home Office has decided to allow us the dubious honour of not one, but two frequencies. But when? In the autumn, so they say. Bit vague, isn't it? And do they really expect each and every breaker to sit and wait patiently until, in their beneficence the minions of Waterloo Bridge House, having returned, rested and sun-tanned from holidays, finally decide to get off their superannuated butts and decide on a few simple things, such as how much a licence might cost, how many channels are to be permitted and how much power we might be allowed to transmit.

Pathetic, isn't it? After two years of earnest deliberation they have finally come up with the incredible combination of a mind-boggling frequency which nobody wants, together with the reluctant admission that perhaps 27MHz is not so evil, after all. Even if only on FM.

I see that the statement suggests

that there are currently some 60,000 breakers in Britain. This statement alone demonstrates the Government's total lack of understanding of a situation in which over a quarter of a million people have already decided for themselves that they can wait no longer for a lethargic administration to wake up to reality and perhaps a further quarter of a million will lose patience before the provisions of the statement are implemented.

As I write I am constantly having to leave my typewriter in order to answer telephone calls from irate enthusiasts and potential manufacturers alike. It is already obvious that the announcement has offended just about everyone with any interest whatsoever in CB.

So where does it leave us? Absolutely nowhere. Despite the very considerable efforts of Mr. Patrick Wall and his Parliamentary colleagues CB is still not legal. I do not for one moment accept the lame excuses that there are administrative details still to be settled. Were the Government even half-competent, they surely should have a fully-detailed specification available for distribution to the industry, as well as a properly formulated timetable for its implementation.

There is only one word which adequately describes this ridiculous shilly-shallying. INCOMPETENCE!

Most experts seem to agree that 27MHz FM will offer a technically

superior service. What really concerns me is that we are not to be given the opportunity to find out for ourselves until well after the summer holidays, by which time attitudes will inevitably have hardened and the number of AM rigs in circulation will have increased by an incalculable amount. Do those in power truly not realise that the situation is rapidly going beyond their control. Or do they have an unshakeable faith in their own ability to vacillate for as long as they like without being noticed.

After all, everybody knows that all you law-abiding breakers are going to lay down your rigs and content yourselves with quiet games of cricket through the long summer evenings, aren't you? Like Hell you are! So what do those shining protectors of society at the Home Office intend to do to persuade you that they really do know best? Their options would appear somewhat restricted. They might buy a few more shiny new detector vans with public money which might be better spent sorting out their "administrative difficulties", or they might equip every enforcement officer with an instant DV27 recognition chart. On the other hand they may well find themselves overwhelmed by the sheer weight of numbers as they attempt to play an Oscar winning version of King Canute.

What the supposed problems which continue to deny us the right to

freedom of communication? If we are to believe the Home Secretary's own words then his subordinates do not yet know exactly how the system should operate. How can they justify their abysmal failure to produce a simple specification when they have the example of over sixty other countries to illustrate the possibilities to them.

Surely licencing does not present a problem. They appear to have little difficulty implementing increases in TV licence fees with indecent speed, so what is so difficult about issuing an entirely new form of licence. And while we are on the subject of licences, what sort of statement tells you that you must buy a licence but pointedly fails to tell you how much it will cost?

The statement goes on to explain that all rigs must bear a stamp to certify that they conform to proper specification before they can be licenced. This provision appears fine in theory but I am willing to bet that it will not be long before some enterprising gentleman finds a way of reproducing whatever design chosen.

It is almost certain that the Government will wish to devise a simple code of practice for CB operators before the first licences are issued. This is something else which should have been dealt with before the making of an announcement which raises more questions than it answers.

Why are so many simple questions left unanswered? Having spent a great deal of its energies over the last two years in trying to find new ways to deny the legitimate wishes of a large section of the populace the Home Office appears to have suddenly discovered that they have failed. Their reaction has been one of blind panic, leading to the publication of as half-witted an

announcement as any since Chamberlain's "Peace in our time."

Patrick Wall asked, during a recent Adjournment debate, for the introduction of licenced CB by the second anniversary of the last General Election (May 5th). His wish should be honoured and the Home Office must make a serious effort to recoup its lost credibility. We are all utterly fed-up with half-baked promises. We need definite answers and positive action from a Government elected on its promises to increase the freedom of the individual. I wonder just how much money has been wasted in the futile attempt to ward off the inevitable and just how much licence revenue has been lost as a result of Home Office inability to deal with a simple matter in a straightforward, efficient manner.

If I sound bitter please excuse me. I am bitter. I am suffering from a congenital inability to understand the motives of those officials who seem to believe that we can only cope with good news in small doses. The Home Secretary has bungled yet another opportunity to bring a simple hobby within the law and he must now bear the responsibility for every single prosecution resulting from his own and his officials ineptitude. I have always opposed the use of the courts for the making of political points but the time has come when every breaker unfortunate enough to be busted should go to court in the company of a good solicitor and a reporter from the biggest newspaper he can contact. The Home Office has created a situation which must be shown to be untenable. The most effective means to this end is the creation of as much publicity as can effectively be arranged.

There are a number of events

planned for the forthcoming holiday weekends and provided they are well supported by the average breaker they will attract the best possible publicity.

Keep up the barrage of letters to individual MPs and particularly to the Home Office. Let them know that you were dissatisfied by the ambiguity of today's announcement and that you will be satisfied with nothing less than the immediate legalisation of all forms of CB. Let's make the 12,000 odd responses to the Green Paper look like nothing more than a normal morning's post. We have only come this far by being a constant irritant to the Home Office. We will only progress further by turning that irritant into an open wound.

Manufacturers and others with a commercial interest must pile on the pressure for the speedy production of a specification in order that they may make the necessary preparations to enable them to supply a huge new demand.

I am tired of being told that we must understand the Government's difficulties. It is high time they began to understand the joint demands of the public and the electronics industry. Until now I have considered myself a fairly moderate campaigner but today's example of arrogant ineptitude has convinced me that our guardians cannot be reasoned with and we must use every ounce of muscle we possess to make them realise that no further delays will be accepted.

If Messrs Whitelaw and Raison cannot handle such a simple task as the legalisation of CB in a speedy and efficient manner then it is time they handed the job to someone more competent and bought themselves a market garden to potter about in. ●

Far Right: Strange looking antennas, DV27 perhaps?



Antenna Review

Base station

Antenna

Antenna Review this month looks at a very 'European' antenna that is designed to withstand the rigours of our less than tropical winters.

There are some experiences that remain with you all your life. The first cigarette, the first drink of beer, you know the sort of thing. Earlier this month I had an experience, one I won't forget for a long time. It involved erecting a base station antenna with an overall length of 19.029 feet. 'No problem' I hear the assembled masses chorus. Not normally, no, it was just that the day I did it a force ten gale was blowing.

The antenna in question is the **DPA 11 VR** from **Alcom**. It is manufactured in Europe specifically for the European market and is probably one of the best base antennas around. The mast is made up of three sections of plated aluminium tubing, just over 19 feet long. In technical terms this is an end-fed half-wave dipole. The spiral business at the bottom (not too technical I hope) is a sort of ground plane thingy but more of that later. Each of the three sections clip neatly together and the joints in the tube are well protected against ingress of moisture by tight fitting rubber seals. Assembly of the mast is pretty straightforward, the only thing to watch out for is the occasional gust, don't bother putting one up if there is any wind, you'll end up doing the dance of the half-crazed fisherman if you do. The **DPA 11 VR** can be bolted to any firmly rooted pole, 2 inches or less in diameter via the sturdy clamps that are supplied with the kit. The spiral 'ringo' slips over the bottom section of the mast but should not be tightened up until the antenna is 'swered' in. Connection to the rig is made via a meaty looking **SO239** socket fitted to the base of the ringo and this has been well protected from the elements so there shouldn't be any problems here.

SWR adjustment is accomplished by shortening or lengthening a short telescopic section of the mast. Once the SWR has been set the adjustment and the ringo assembly can be tightened up.

Performance

You should all know your antenna theory by now. The most efficient aerials are those that have a physical relationship in length to the wavelength of the transmitted signal. Hence this antenna is 5.8 metres long which at half wavelength makes one wavelength 11.6 metres, a touch over the desired 11 metres due to the gubbins at the bottom. Our European research team have been playing around with the **DPA 11 VR** for a couple of weeks now and whilst we are unable to give you any precise figures just yet, the initial results have lived up to the manufacturer's specifications. The 3db gain figure quoted on the instructions actually seems a little pessimistic. Our test sample may be a little better than the manufacturer's own reckoning. For a full run down of the specs see the table that should be somewhere on this page.

This antenna gets our highest rating in terms of performance and ease of operation (except installation in strong winds) and the close attention paid to weatherproofing should ensure it will still be working after a couple of our miserable winters. A worthwhile buy for anyone in the base station antenna market. The **DPA 11 VR** is available from Wintjoy Ltd for £24 (plus VAT). **RM**

SPECIFICATIONS

Type End-fed half wave dipole. Gain 3db. Impedance 50 ohm Frequency 27MHz Bandwidth 1.5MHz Polarisation Vertical VSWR Less than 1.5:1 Max Power 500 watts Length 5.8 metres Weight 1.9kg Mounting 25-44mm mast tube.

A shortened version of the **DPA 11 VR** designed to fit onto our page. The genuine article is over 19 feet high.

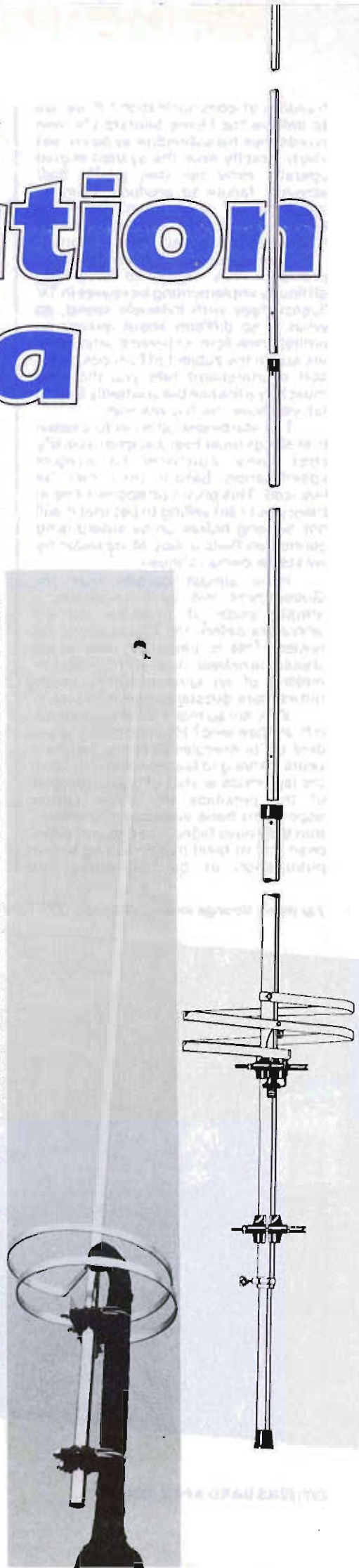

O.C.T.

OPEN C TELECOMMU

THE NUMBER ONE CITIZENS BAN

01-808

407 LORDSHIP LA

SEND FOR COMP

IMPORT

•SKIPMASTER•E

•K40•ANVANTI•HAN

O.C.T.

CHANNEL COMMUNICATIONS

DISTRIBUTORS OF CIB EQUIPMENT

03-5656

100, LONDON N. 17

COMPLETE PRICE LIST

MEMBERS OF

BREMI-TURNER

MEMBERS INTERNATIONAL



No. 3!

How do we do it? Can we keep it up? Yes, of course we can, once more we offer you the chance to win one of our fabulous prizes completely free of charge. We should be registered as a charity with all this generosity, how many other magazines are so good to you?

Are there any other CB magazines?

OK, enough of the self congratulation, let's look at what's on offer this month.

FIRST PRIZE. A complete base station kit. This consists of a **Commant AR15** base station antenna, no rubbish 'ere. An **AF 13.8** volt mains power supply, up to 5 amps no less! and all the connecting wire, plugs etc you are likely to need.

SECOND PRIZE. A genuine **SSE ATU** and Splitter box. Real British craftsmanship this, they work too!

THIRD PRIZE. A year's subscription to *Citizen's Band*.

BOOBY PRIZE. A year's subscription to some other CB magazine, if we can find one!

Suppose you want to know the questions now? Awkward lot aren't we? What did you expect, charity?

Brians in top gear, there's only one question. How many words of four or more letters can you make from the words Citizens' Band. We reckon there must be about 30 at least. Remember all words must be genuine 'cos we'll look them up in our Ladybird Dictionary of difficult words if we think they're 'sus. Plonk them down onto a piece of paper, pop it into an envelope and send it to:

CITIZENS' BAND COMPETITION No 3
145 Charing Cross Road,
London WC2H 0EE.

RULES

Must have rules, there would be chaos otherwise. Rule number one is that the Editor's Decision is Final, can't argue with that can you? Won't do you any good if you do anyway 'cos I won't listen. Rule number two is for any smart Alecs that work for us or any of our other companies, mags etc, don't try entering this competition because I know all of your names and addresses and I'll send the CB heavies round if you do. The third rule concerns how soon you send in your answers, if it's not on the Editor's desk by April 6th you don't qualify. Lastly we have the fourth rule, that simply says that no correspondence will be entered into, see? OK, get to it.

We would like to thank *Chelsea CB Centre* and *Solid State Electronics* for donating this month's prizes.

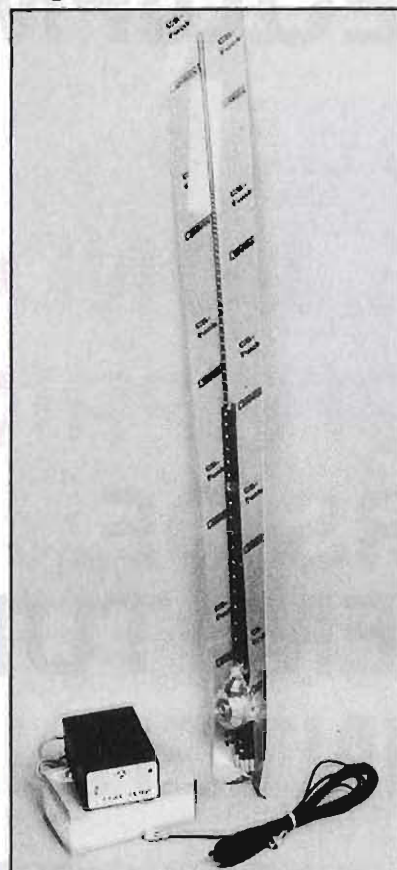



590/2 Bristol Road, Selly Oak,
Birmingham B29 6BQ

**021 Radio & Electrical
Wholesalers Ltd.**

**The Largest CB Wholesalers in the West Midlands
For the best prices, come to the Birmingham CB Centre.
Time is money, why go to London when you can
purchase stock in the Midlands?**

Telephone our hot line 021-472-6448.

Get a good COPY each month

How many times have you ran to the newsagent, eager to purchase the latest copy of Citizens'Band only to find the last copy has been sold.

What can you do in a situation like this? The only solution is to take out a regular subscription to your favourite CB mag right here and now. Just fill out the form below and send it to us, together with your cheque or Postal Order to the address below.

A subscription to Citizens' Band costs just £8.25 per year. We will ask the Post Office to deliver it to your door each month. Just fill in the form on the right, remembering to include a cheque or Postal Order for the correct amount made out to Modmags Ltd.

**CITIZENS'BAND
SUBSCRIPTION SERVICE**

**MODMAGS LTD.
145, Charing Cross Road
London W.C.2.**

I would like to take out a year's subscription to **CITIZENS BAND** starting with the issue. I enclose a cheque/Postal Order for £.....

Name

Address

.....
Applies only to UK, overseas and airmail rates on application.

Scanner

In response to the enquiries we received about our scanner review last month here are two more. The first is the UFO Digi-Scan, of special interest to CBers, and secondly the Semicom SE101 B from SSE as mentioned in last month's Update.

Digi-Scan UFO Elite

This rather uninspiring little black box is probably the most amazing CB accessory we've ever seen. As the name implies it is a scanner and if you read last month's *Citizens' Band* you'll know all about them. This device extends the normal frequency range of a 27 MHz rig up to 28 MHz. In terms of an AM/SSB rig operating in 5kHz channel steps this means that any rig fitted with this device is capable of receiving and transmitting on an almost unbelievable 1200 channels and an ordinary AM rig 400. That alone is mind blowing but when I tell you that it also displays the frequency of each channel on an LED display and that it can scan up to 20 channels a second you may begin to understand why we're so impressed.

It must be said straight away that the *Digi-Scan* is not just another 'plug-in' accessory, it has to be installed by a competent engineer or, at best, someone who knows how to read circuit diagrams and use a soldering iron. The *Digi-Scan* is designed to hardwire into a CB rig's electronic innards and, although there are only four wires, we wouldn't recommend anyone even thinking about fitting one without knowing exactly what they are doing. Once installed (and you do need some basic test equipment to align the unit) a number of options are available. When it is first switched on it locates the 'home channel' which is nominally set to channel 16. This is, however, pre-settable to any desired channel. The 'scan' switch allows you to scan up or down at the rate of 3 channels a second and releasing the switch holds it on the required channel. By pressing the 'fast' button the scan rate is increased to 20 channels a second. Pressing the 'home' button resets the scanner to the pre-selected channel. On the left hand side there is a switch marked 'step'; this allows you to change channels one at a time in either direction.

The specifications for the unit are most impressive, depending upon your rig. It has a frequency range of 24.995 MHz to 28.000MHz. The digital readout is accurate to the least significant digit in 1 kHz. The unit measures just 5" x 5 1/2" x 1 1/2". The



instruction manual that accompanies the unit lists over 60 different types of rigs that it can be connected to. In practice it will fit almost any rig but check with the retailer before you part with your money. This unit is available from *Knight CB Specialists Ltd, 201 Dunstable Road, Luton, Bedfordshire* and costs £89.95. Just in case you are wondering, the *Digi-Scan* is illegal in every country in the world. Marvellous innit? **RM**

Above: The Digi-Scan front panel. The dark area in the centre of the front panel conceals the LED digital frequency display.

Below: Specifications for the Digi-Scan.

SPECIFICATIONS

Frequency Range	25.995 MHz to 28.000 MHz* in 5 KHz steps
Readout	1/2" high, 5 digit, 7 segment LED
Resolution	least significant digit = 1 KHz
Power Consumption	450 Ma at 13.8 VDC (27.155)
Size	1 1/2" x 5" x 5 1/2"
Scan Rate	3 steps/sec.
Fast Scan Rate	20 steps/sec.
Operating Temperature Range	10° to 40°C
Storage Temperature Range	- 40° to 75°C

* Frequency range is dependent on the type of radio used.

Update

Semicom SE 101B

This is a true pocket-size scanner, it measures approximately 5 1/2" x 3" x 1 1/4", and can cover up to 10 channels, with lockout available on channels 1, 2 and 3. There are three models available, Marine, amateur and Commercial, and the frequencies to be scanned are selected by inserting the appropriate crystals. Two aerials are supplied with the set, a helical rubber ducky and a short telescopic whip, and for use in a car, a mobile mounting bracket with its own aerial socket is supplied.

This set is delightful to use and the lockout facility is well worth whatever it has cost to incorporate it. In Central London lockout is vital when trying to test a 2m. scanner that has a crystal fitted for GB3SL which, for those of you who are fortunate enough not to know, is an Amateur repeater that never, ever seems to be off. If this set had not been fitted with lockout, it would have been almost impossible for me to test it, because I can only take GB3SL in small doses.

Another feature not often found on sets this size is the switchable delay. This stops the set zooming off channel as soon as the carrier disappears, it waits a couple of seconds and then if there is still no carrier present, it resumes scanning.

SPECIFICATIONS

Sensitivity:	1 μ V for 20 db quieting
Squelch sensitivity:	0,8 μ V
Modulation Acceptance:	5 KHz
Audio Output:	100 mW (10% distortion)
Power consumption:	0,4 watt
Adjacent channel rejection:	50 db
Scanning speed:	15 ch/sec
Delay time:	2 sec
Intermediate frequency:	1 st: 10,7 MHz. 2nd: 455 KHz
Dimensions:	145 (H) x 73 (W) x 35 (D) mm
Weight:	250 g
Accessories Supplied:	Helical antenna, wire antenna, Earphone, Leatherette case, 240 Volt charger.

In use, I found this set to be better than many others that I have tried and at £85.67 it represents good value for money. It comes complete with 10 crystals, 2 aerials, carrying case, earphone, re-chargeable batteries and charging unit and it is available from **Solid State Electronics (UK) Ltd, 6 The Orchard, Bassett Green Village, Southampton or Ambit International, 200 North Service Road, Brentwood, Essex.** AG

Below: The Semicom in its leatherette carrying case with 'rubber ducky' antenna fitted. The telescopic antenna shown comes with the outfit.



Above: Top panel of the Semicom showing the various switching functions. The two sockets on the left hand side are both for external antennas.

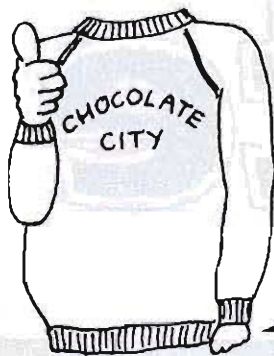

AMERICAN
SWEATSHIRTS PRINTED
WITH YOUR HANDLE
IN FLOCK LETTERS

ONLY
£5.99 + 35p
p&p

Top Quality Tees Only £2.99 + 25p p&p
Club Secretaries send for pricelist —
your club logo expertly screenprinted
at wholesale rates (minimum quantity — 10)

To: 'FEELGOOD' 39, Goodramgate, York YO1 2LS
Please rush T-shirt(s) Sweatshirt(s)

Size	Colour of Shirt
32/34"	State 1st Choice
34/36"	2nd Choice
38/40"	
42/44"	

MAKE CHEQUE/POSTAL ORDER PAYABLE TO
FEELGOOD DESIGNS

The Breakers Yard

CB ACCESSORY CENTRE

We stock a wide range of CB
equipment and accessories.
Come and talk to our
experienced and helpful staff.

OPEN 2-8 pm Weekdays
10 am - 6 pm Saturday

Telephone (0242) 39783

Croft Street,
Leckhampton,
Cheltenham, Glos.

Whatever you drive.



FAIRFIELD BROKERS
4/6 Princes Street,
Queen Square,
Bath. BA1 1HL.
Tel (0225) 330644

WE EXPECT YOU PAY TO MUCH FOR INSURANCE WE OFFER . . THE FAIRFIELD DISCOUNT SCHEME

ALSO
INTRODUCTORY DISCOUNTS for young and new drivers.
DISCOUNTS for older vehicles. UP TO 65% No Claim Bonus
discounts where applicable.

COMPLETE THE FOLLOWING OR TELEPHONE FOR A QUOTATION

Name
Address Tel:
Cover required: Comprehensive/TPF&T/TPO Age:
Use: SD&P/Business/Commuting to work
Drivers: Any/Insured and spouse/Owner only
Age of youngest driver years
Full/Provisional licence held years Years in UK
Occupation NCB years
Garaged yes/no Year cc value
Car make model
Present Insurance Co
Present Insurance Expires
Existing premium

Enclose details of all convictions and accidents

CHELSEA CB CENTRE

73-77 BRITANNIA ROAD FULHAM LONDON SW6

OPEN 7.45 TILL 4.30
MONDAY TO FRIDAY
MAIL ORDER AVAILABLE

DISCOUNTS GIVEN
TO CLUB MEMBERS
WITH CLUB CARDS



"OUR PRICES ARE EVEN MORE COMPETITIVE THAN OUR CAR"

SEE US AT THE DONINGTON PARK EYEBALL, SUNDAY, 22nd MARCH WHERE OUR CAR WILL BE DRIVEN AROUND THE CIRCUIT DEMONSTRATING DRIVER TO BASE TWO-WAY COMMUNICATIONS.

CHELSEA CB CENTRE UK DEALERS

01-731 0027

ASK FOR
STEVE OR TONY

Trade enquiries welcome

WE DO NOT SELL NOR
CAN WE SUPPLY RIGS
'UNTIL LEGAL'

SPECIALISTS IN ALL CB ACCESSORIES

A WIDE SELECTION OF:
AERIALS, MOBILE & BASE, POWER SUPPLIES, PRE-AMPS,
BURNERS & SO ON.

AVANTI SKINNY STICKS NOW IN STOCK

★ SPECIAL OFFER £9.50 ★

ALL AVANTI NOW ON CLEARANCE PRICES

3 AERIAL KIT, COMPRISING OF T27, DV27, DX27 AND
BASE KIT AND CABLE £14.25p INC VAT

DIRECT FROM THE U.S.A. "THE FABULOUS VSBI UNIT"

a voice compressor and signal expander, 'has to be heard to be
believed' (easily installed in any rig.)

- Ackrington-Geartecks Ltd., 30-32 Bernleigh Road, Akrrington, Lancs. 0254 392 366
Barnstaple-Barnstaple CB Centre, 4 Barum Arcade, Beer Street, Barnstaple. 0271 78911
Chessington-Chessington CB Centre, Oakcrust Road, Chessington, Surrey. 391-0088
Cwmbran-Cwmbran CB Centre, 10 Newton Wynd, Fairwater, Gwent, Wales. 06333 5683
Gillingham-Tellywise Ltd, 17 Canterbury Street, Gillingham, Kent. 0634 52670
Glasgow-Brian A Pearson Ltd, 66 Moncur Street, Glasgow, Scotland. 041 552 4348
Kent-CB Scene, 13a High Street, St.Mary Cray, Orpington, Kent. 66 22491
Leatherhead-Reproprint Leisure, 7a Gravel Hill, Leatherhead, Surrey. 537 7850
London-Cliff Davies Cars, Goldhawk Road, London W4. 741 2817
London-The Panel Shop, 164, Southwark Bridge Rd, London SE1 261 9674
Luton-Luton Communications, Airlink House, 10 Rockley Road, Luton, Beds. 0582 412513
Orpington-CB Scene, 13a High Street, St. Mary Cray, Orpington, Kent. 66 22491
Stanley-Perth & Fife CB Centre, Perth Road Garage, Stanley, Perthshire. 073 882 291
Watford-Watford Video, 126 Queens Road, Watford. Watford 40495
New, just opened — Horley CB Centre 02934 74 997
Battersea CB-Ken, Northcote Rd, London SW11 — opening soon!

CB Soapbox

With well over 200 CB clubs up and down the country there is a definite case for some kind of rationalisation. William Snell has a few ideas.

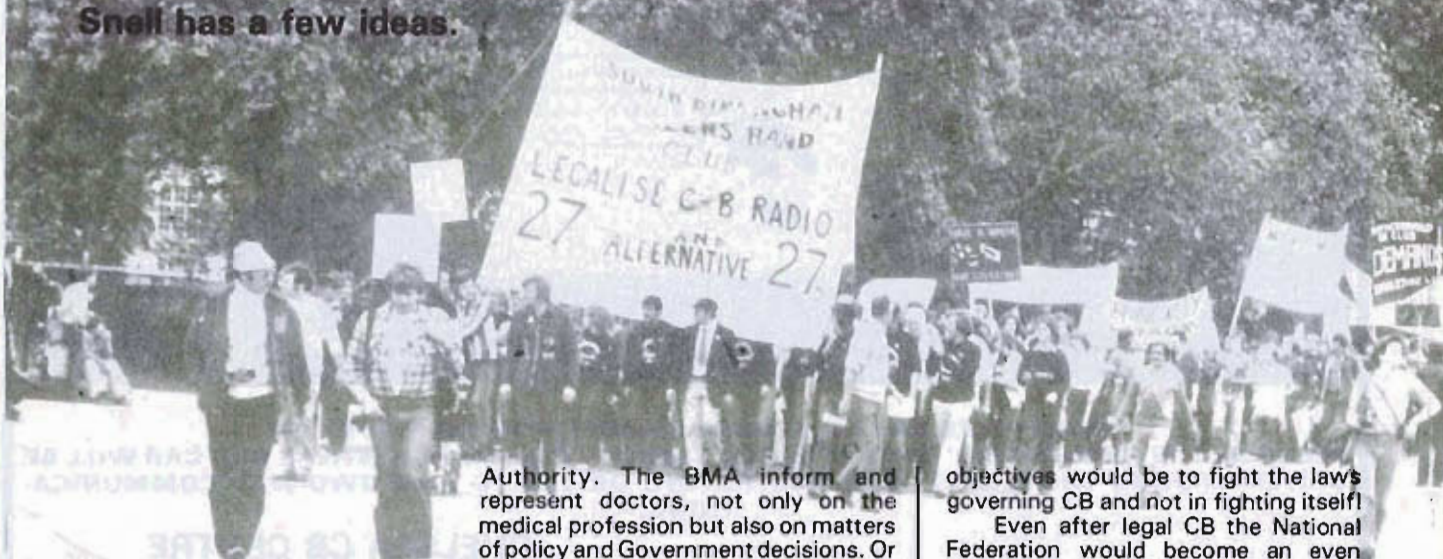

Considering all the various clubs, organizations, magazines and pressure groups devoted to the beloved subject of CB, it would seem that the time is ripe for the formation of a **NATIONAL FEDERATION OF CB CLUBS**, united and speaking with one voice, loud enough to overcome the opposition and delay tactics of the present Government.

Some clubs would like to expand their activities to include demonstrations and collecting signatures for a CB petition etc, but how do they co-ordinate their efforts? How do local clubs and CB groups find out what is truth and what is rumour? One way of informing and co-ordinating these clubs is by establishing a National Federation.

If you take a look at the number of clubs that are now starting up, some of which are listed in this magazine, some method of co-ordinating their efforts and aims would be very desirable. A National Federation has many practical advantages. Take for example doctors. All the doctors in this country are on the register of the British Medical

Authority. The BMA inform and represent doctors, not only on the medical profession but also on matters of policy and Government decisions. Or politics, any one interested or involved with politics is a fully paid up member of a National club called the House of Parliament. A very old and very well established club.

Having drawn your attention towards the overwhelming advantages of a National Federation and your imagination is sufficiently stirred with the prospect of unlimited power over us mere mortals, let's get down to the real problem.

Any society, federation or Government relies 100% on people. Without people very little would happen at all. At present, there are various clubs meeting up and down the country, discussing and organizing themselves towards legal CB. The problems of co-ordinating these individual clubs and groups is not to be underestimated. The differences of opinion and the clash of personalities that would be inevitable in the formation of a National Federation, could form an obstacle between legal CB and actually getting it. These differences would of course have to be sorted out. A National Federation's

objectives would be to fight the laws governing CB and not in fighting itself!

Even after legal CB the National Federation would become an even more important body of opinion. Any future changes in the laws and regulations governing CB would come from the breakers through the National Federation. The National Federation will in reality become the *establishment* but its membership will be made up from the breakers, and not from the civil service. That's an important point to remember. YOUR National Federation will be on *your* side right from the start and will belong to YOU. You will be able to have your say and not be told what to do by a Government that has opposed CB and even now, is attempting to prevent it becoming legal in this country.

So this is where we now stand, in general most people would agree that forming a National Federation would be a good idea. Certainly the advantages are obvious, but what can you or I do. Well the basis already exist. The CB clubs already represent breakers in the local area. By using the organization in the local clubs, it would be reasonable to assume that by contacting a local CB club and exchanging information you could reach most of the breakers all

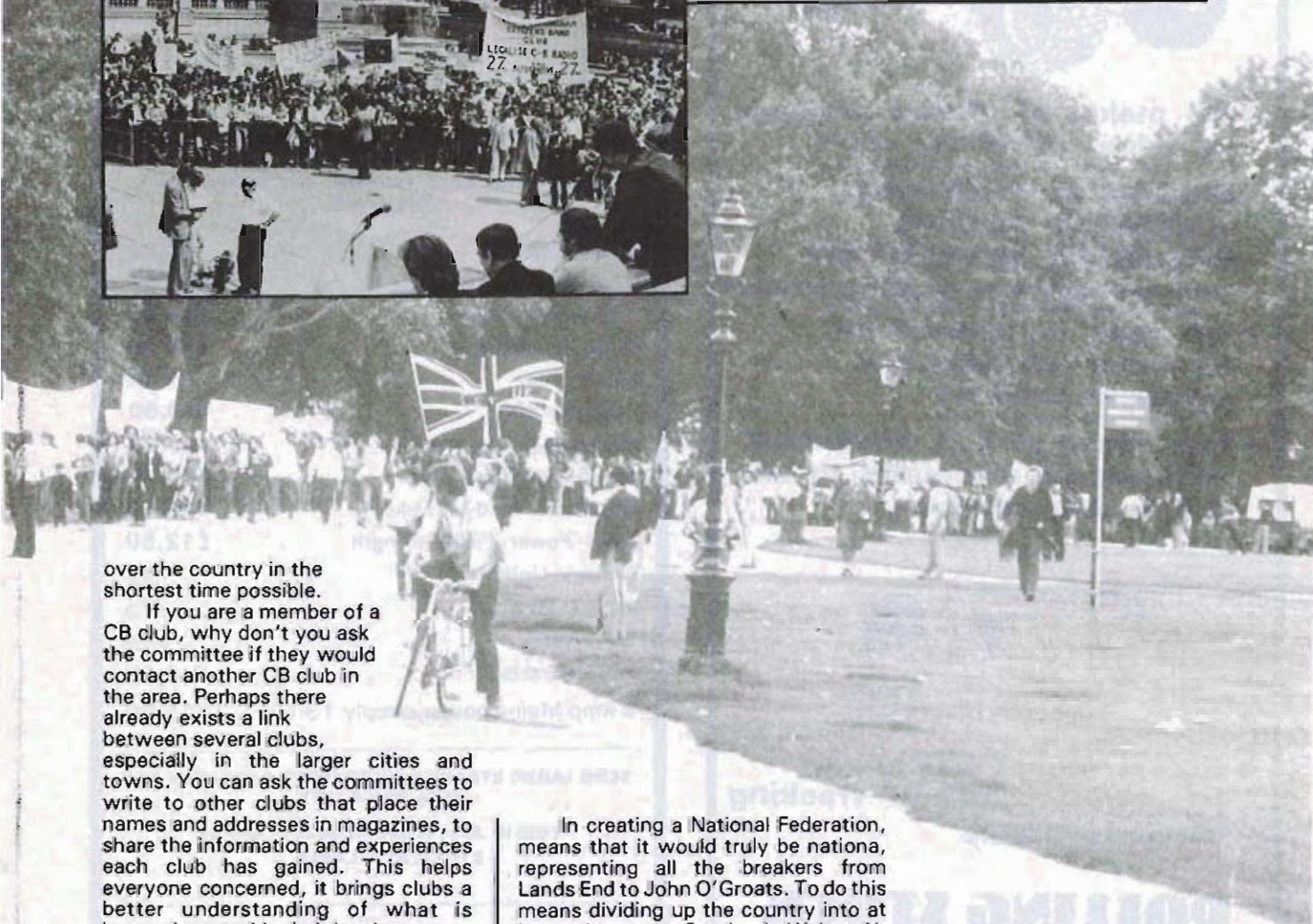

over the country in the shortest time possible.

If you are a member of a CB club, why don't you ask the committee if they would contact another CB club in the area. Perhaps there already exists a link between several clubs, especially in the larger cities and towns. You can ask the committees to write to other clubs that place their names and addresses in magazines, to share the information and experiences each club has gained. This helps everyone concerned, it brings clubs a better understanding of what is happening outside their local area.

Many CB clubs operate like a secret society. Finding out about these clubs is very difficult and these clubs should consider what good this actually does. After all, if this magazine and the others like it were only sold at secret locations once a month then I doubt very much if it would sell many copies at all. Make sure that the people that are interested in CB can find out about your local meetings. You might find that you can increase your membership and discover how popular CB is.

In creating a National Federation, means that it would truly be national, representing all the breakers from Lands End to John O'Groats. To do this means dividing up the country into at least six areas. Scotland, Wales, N. Ireland, N. England, Midlands, and S. England. These divisions would each have an area committee and would be responsible to the breakers in their area. Each area committee would decide how to best use the Federation's influence for the most effective way to inform and organise the local CB clubs.

As an independent organization, the National Federation could provide a useful meeting place for the widely diffused and different sources of opinion, including the manufacturers,

retailers, clubs, the Government and perhaps even international links with other National Federations. A National Federation can provide a stronger united voice to change the governments policies, it can provide a greater pool of information for the use of the breakers and it can provide a powerful influence for the type of CB that this country should have. It could turn an amusing pastime into something a little more substantial than CB is at present. ●

ROLLING STOCK

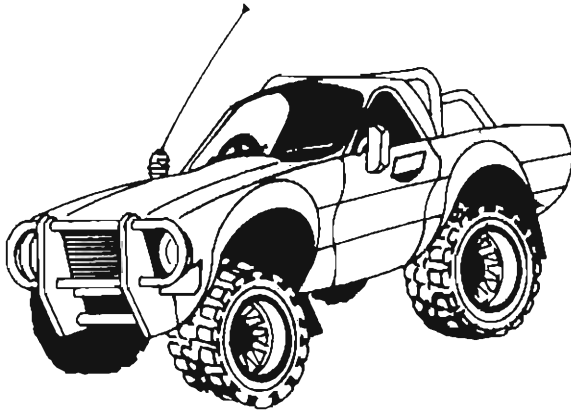

- * All makes of TYRES available including American sizes
- * Stockist of KEYSTONE, AMERICAN RACING, WOLFRACE, REVOLUTION and most makes of alloy wheels
- * Off road equipment for Japanese European, and American vehicles
- * Full range of C.B. equipment with special discounts to all U.B.A. club members

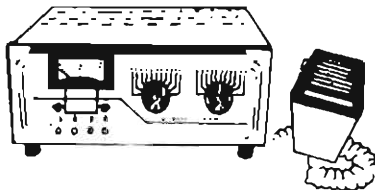

- * Expert wheel balancing, puncture, repairs and tracking service available

ROLLING STOCK

826 Wickham Road, Shirley, Croydon
Telephone 01-776 0277

24 Hour Answering Service

Open 9am - 5.30pm Weekdays
9am - 4pm Saturdays

**TRADE ENQUIRIES
WELCOME**

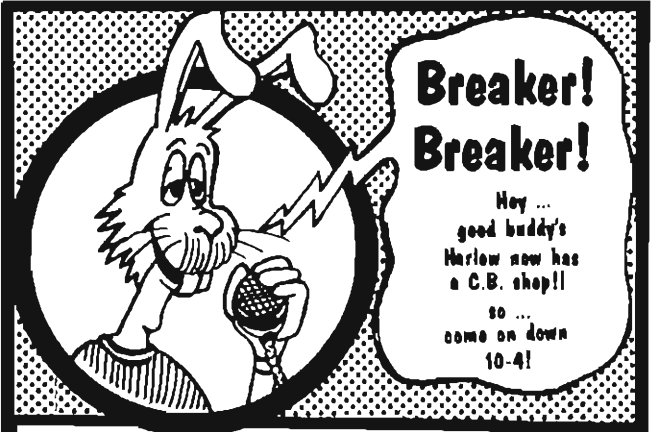

MAIL ORDER

P.&P. £2

Access and Barclaycard holders

Phone your card number for same day despatch

DV 27 Antenna	£6.55
Silver Rod Base Antenna	£21.95
K40 Power Mike	£35.00
Twin Truckers	£21.90
Slide Mount	£4.50
Expander 500	£43.00
Skylab Base Antenna	£27.00
AL 25-watt Power Amp	£21.90
Telephone Hand-set Mike	£10.50
SWR/Power/Field Strength	£12.50
Antenna Light	95p
RG 58 (yard)	23p
RG 8 (yard)	65p
Fully Retractable	£12.50
2 amp Mains power supply 13.5v . . .	£13.00

SEND LARGE STAMPED ADDRESSED ENVELOPE FOR FULL PRICE LIST

THIS IS JUST A SMALL SELECTION OF STOCK AVAILABLE

OPENING HOURS:

9.30 a.m. to 5.30 p.m., MONDAY to SATURDAY
SUNDAY, 10 a.m. to 1 p.m. Closed all day Wednesday

FREE, EASY PARKING



CB AND COMMERCIAL
RADIO SYSTEMS

E|M|C

ESSEX MOBILE
COMMUNICATIONS LTD.

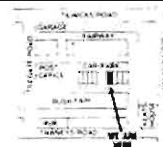

SERVICE BAY 5
BUSH FAIR
HARLOW, ESSEX

TELEPHONE
HARLOW
441661

Rig Review

How does the ability to say '10-4 good buddy' 480 different ways sound? You could with this 120 channel rig from Lafayette.

Lafayette 1200M

In keeping with our policy of reviewing new and unusual CB rigs we thought you might be interested in having a look at this very strange transceiver from Lafayette. It is quite a large rig by comparison with some we've seen but the really outstanding feature in this case is the extraordinary number of channels and types of transmission modes it uses.

The number of actual channels, ie separate frequencies, is 120. That is made up of three bands of 40 channels each. The 'Low' channels range from 26.515MHz (ch. 1 low) to 26.955MHz (ch. 40 low). the next 40 channels are the conventional FCC CB channels and they go from 26.965MHz (ch. 1 mid) to 27.405MHz (ch. 40 mid). The final 40 channels go from 27.415MHz (ch. 1 high) to 27.855 (ch. 40 high). Each channel can use one of four different transmission modes. They are: AM, FM, USB and of course LSB (upper and lower sideband). Now, if you take all these options into consideration you have 480 different ways to transmit. That is almost obscene, especially when you consider that the low and high channels are banned almost everywhere. The surprising thing,

however, is that our investigations have shown that virtually every channel and transmission mode is in almost constant use!

In operation this rig is a delight to use. The controls are kept to an absolute minimum, even so changing from, say, channel 40 high USB to channel 25 mid FM involves a considerable amount of knob twiddling. The reports our testers received were almost unanimously favourable and both modulation and power were up the manufacturers specs. One small improvement that could be obtained on modulation, however, was the addition of a K40 processor mike. It seems that this is rapidly becoming a standard addition to almost every rig, and the amazing thing is how much better the modulation comes across with one of these mikes. One small gripe with the 1200M concerns the built-in speaker. This was

found to be too 'bassy', perhaps it is due to the large cabinet but we did find that connecting an external speaker (the SEUCS-1B from SSE is our favourite at the moment) made the copies just that little more readable with the higher treble content. ●

Front panel controls of the Lafayette 1200M. The band selector switch can be seen next to the channel change control and the mode switch is to the right of the band switch. The microphone plays into a socket on the left hand side of the rig.

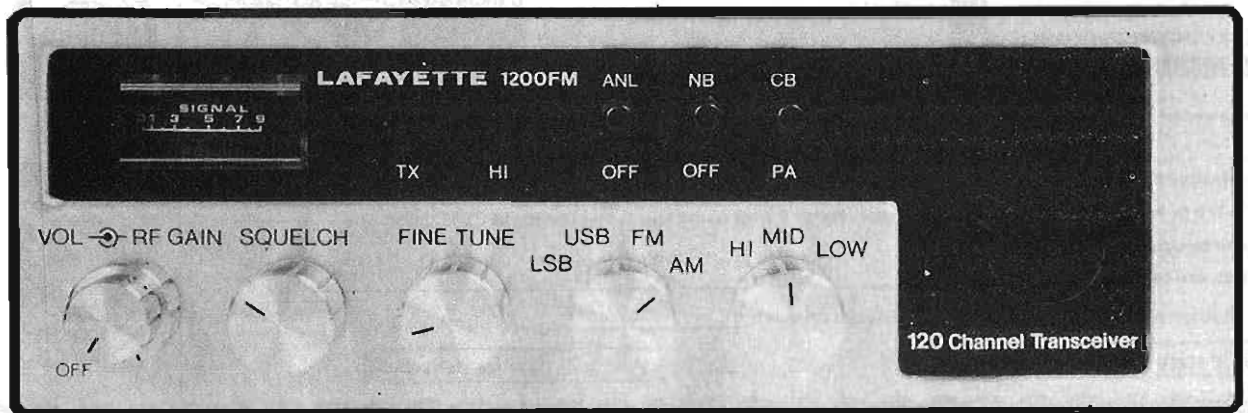

Channel Checks

BY 'Bubble And Tweek'

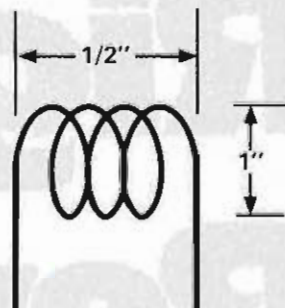

DETAILS OF L1-L4
18 swg ENAMELED
COPPER WIRE

TVI FILTER NUMBER 3

Interference to domestic TV receivers is arguably the second greatest nuisance posed by CB equipment. Here we have a very simple design for a TV filter that fits into the aerial lead of a TV set. The unit consists of three coils made up of three turns each of 18 swg enamelled wire. Four ceramic capacitors each of 1000 pf connect between each coil and the input and output sockets. This unit should be built into a metal case or tin and can be fitted either way round into the aerial lead of your TV set.

Please note that this unit will only cure low level TVI. If you are running 100 watt boots a couple of feet away from your TV then the only real cure will be to move your equipment further away. One last point, this unit will only work in the TV aerial lead, NEVER try to fit it into the rig antenna lead.

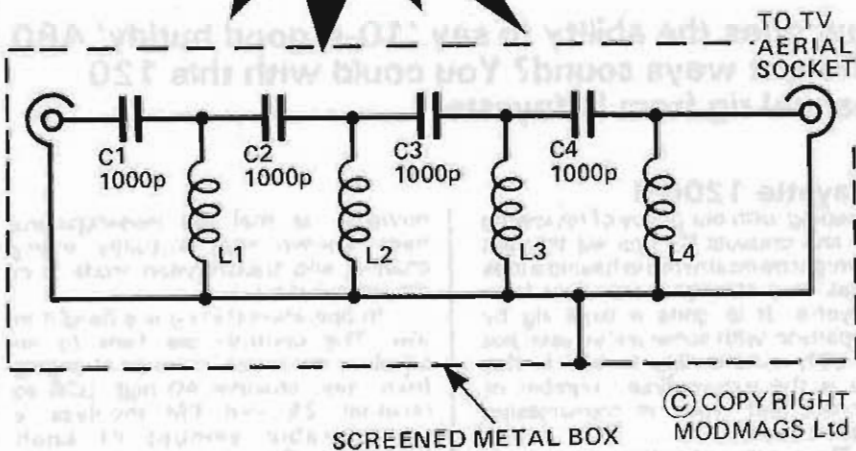

YOUR HANDLE AND BREAKING CHANNEL PRINTED FREE

USA. IMPORTED FLEECY LINED LONG SLEEVED SWEAT SHIRTS AND COTTON T-SHIRTS

With a choice of 3 Super exclusively designed motifs.	
DESIGN: A	BREAKER <small>ONE NINE, ONE SEVEN, ONE FOUR for your regional breaking channel</small>
DESIGN: B	Topical 10/4 - 27MHz.
DESIGN: C	CQDX. World Radio Communications



PLUS your own Personal Handle printed in RICH FLOCK LETTERING

YOUR OWN MOTIF DESIGNED FOR
BREAKER CLUBS & SOCIETIES
(BULK ENQUIRIES WELCOME)

Colours - Sweat Shirt,
Gunmetal Grey Sky Black Navy or Denim
Colours - T Shirt. Black, Sky, White, Yellow & Red



Please send me Ex Small Small Medium Large Ex Large T SHIRTS £3.25+25p.p.&p. _____

Ex Small Small Medium Large Ex Large SWEAT SHIRTS £6.95+40p.p.&p. _____

MY HANDLE IS _____ Cheque/PO No. _____ TOTAL _____

PRINTED IN WHITE/RED Made payable to GREAT BRITISH T-SHIRT Co. 52 River St Rhyl Clwyd Tel. (0745) 51964

Colour required _____

Please send to: Name _____ Address _____

With design A, B or C _____ My Breaking Channel is _____ (design A only)

Please state 2nd choice of colour _____ Allow 21 days for delivery

(or any channel of your choice)



RIGS OF ALL KINDS IMMEDIATELY AVAILABLE AS SOON AS LEGALISATION ANNOUNCEMENT IS MADE!!

EVERCO

Multiband Receiver plus 40-channel CB Monitor. Frequency coverage:
54-87 MHz 145-176 MHz
88-108 MHz Plus H1 40 CB Channels
108-145 MHz

This unit has a telescopic antenna and squelch control, sockets for earphone and external DC power source.

£21.95 inc.

Walkie Talkies
These beautifully designed walkie talkies incorporate the latest integrated techniques to ensure maximum range. The stylish 'rubber ducky' antenna simplifies the overall design and enhances the futuristic look. These sets operate on 49 MHz FM and are not licensable for use in the UK. Each pair costs just **£34.95 inc. p&p.**



See enquiries. Please allow up to 21 days for delivery. ALL PRICES INCLUSIVE



N.I.C.

UNIT 6
61 BROAD LANE, LONDON N.15 4DJ
Day 01-808 0377; Eve 01-889 9736

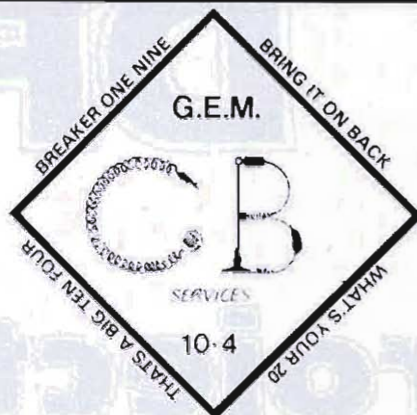

Contact us for all your CB requirements. We stock components for all types of rigs. The best repair specialists in the Midlands.

**239A Wellingborough Road
Northampton
Phone: Northampton
(0604) 33936**

K40

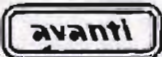

AGENTS AT:
WALKFORD HARDWARE
98 RINGWOOD ROAD,
WALKFORD,
HIGHCLIFFE, DORSET
04252-5368.
JANAWAY HOBBIES
AND MODELS,
5 GLEBE PLACE,
HIGHWORTH,
NR. SWINDON, WILTS.
0793-763907.

Send or Phone
for Catalogue

Citizen Band Antennas and Accessories
for Marine, RV, Truck, Auto, Van,
Motorcycles . . . Mobile and
Indoor/Outdoor Base Applications

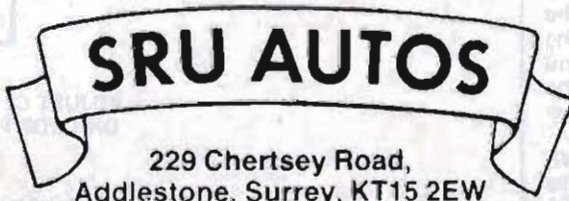

229 Chertsey Road,
Addlestone, Surrey, KT15 2EW

CB ACCESSORIES

- ★ Disguised Antenna's
- ★ Microphones
- ★ S.W.R. Meters
- ★ T.V.I. Filters
- ★ P.A. Speakers
- ★ Patch Leads
- ★ Plugs & Sockets
- ★ CB Monitors

TRADE ENQUIRIES WELCOME

TEL: CHERTSEY (STD 093 28) 62556

24 HOUR ANSWERING SERVICE

9-6.30 Mond.-Sat., 10-1 Sunday.
Closed TUESDAY

DF Loop

Project

Build in this simple DF antenna and track down that CBer. Just a joke, actually this antenna can be the basis for some interesting outdoor fun and games.

At first glance you could be pardoned for asking why you should need such a strange looking antenna. Under normal circumstances you wouldn't but let's look at a few of the tricks this device can do.

- Find the compass bearing of a transmission.
- Fix the exact location of a transmission.
- Play 'Fox Hunting' games.
- Check radiation patterns of antennas.

The antenna is made up from a 31 inch length of $\frac{3}{8}$ inch copper tubing bent into a loop, (refer to figs 1, 2 and 3 for mechanical details). The tubing is relatively easy to bend around a solid former. The trick is to bend it little and often otherwise it may collapse. Choose a rigid tubular former about two or three inches in diameter. Fix the former to a bench and place the tubing against it. Then, with a very slight pressure bend the tubing from the centre outwards. Aim for a very slight bend each time and repeat the process several times until you formed a circle. You should then be able to correct any abnormalities in the circle with a gentle twist.

Once you are satisfied that it is as near circular as you will get, screw the tubing into a wooden handle as shown in fig. 3. Now, by gently twisting the tubing, close the gap in the top of the loop so that you can solder on the trimmer capacitor C1. Now all you have to do is fix the coax cable to the handle, leaving a 6 inch length of inner conductor free for the crocodile clip.

The last step is to adjust the SWR of the antenna by sliding the crocodile clip along the tube and adjusting C1 (see last month's CB for SWRing details). Once you're satisfied you are ready to DF.

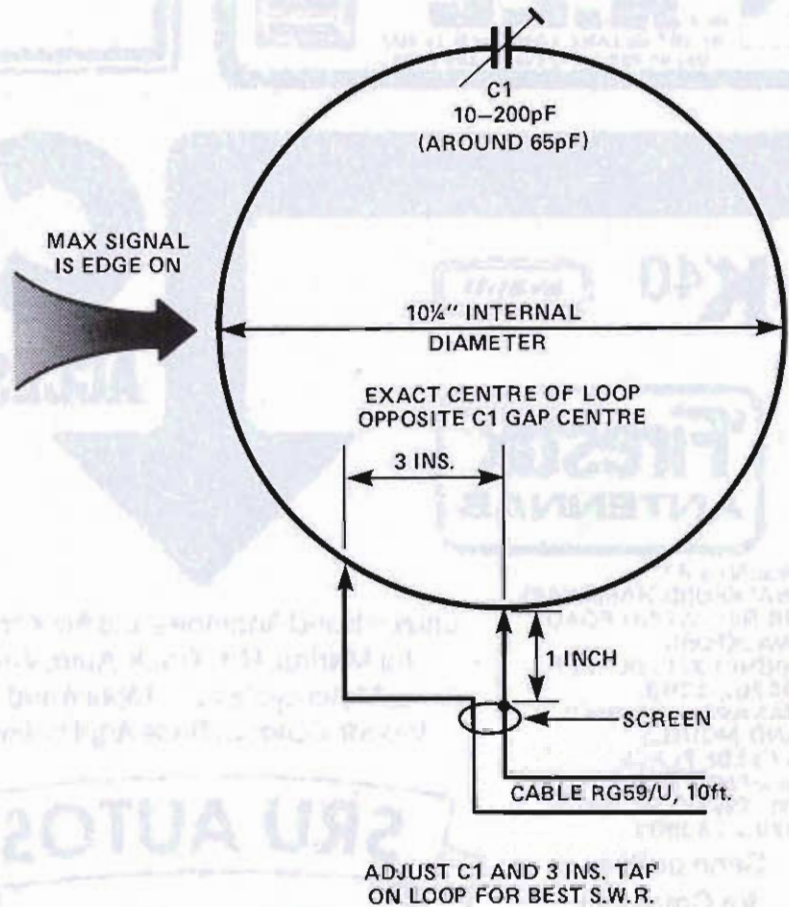
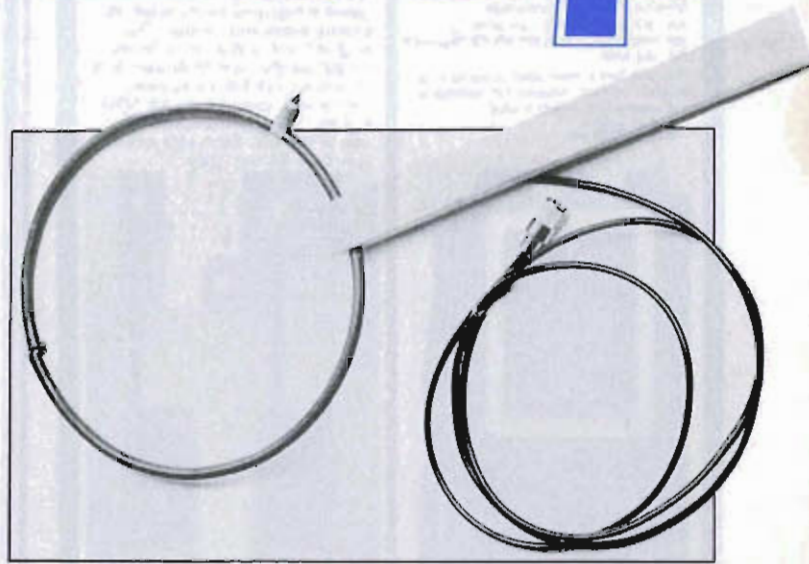

Top: Our prototype DF Loop antenna designed by 'Bubble and Tweek'. You can see the clip used for SWR adjustment on the lower side of the loop.
Centre: Basic dimensions for our loop antenna. These sizes are critical and should be adhered to as closely as possible.

Antenna

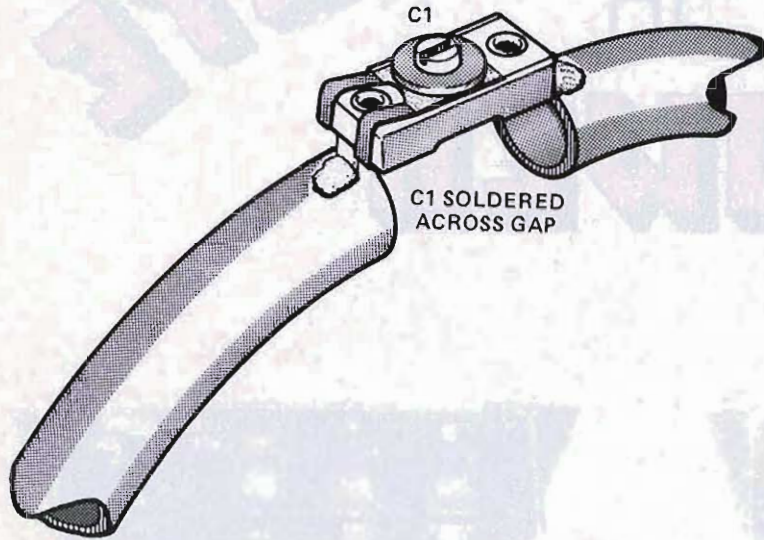

Above: Mounting details for C1 positioned at the top of the loop. This is used in conjunction with the crocodile clip for SWR adjustment.
Below: How the DF loop is mounted on to the wooden handle. Allow at least 6 inches of free cable for the crocodile clip.

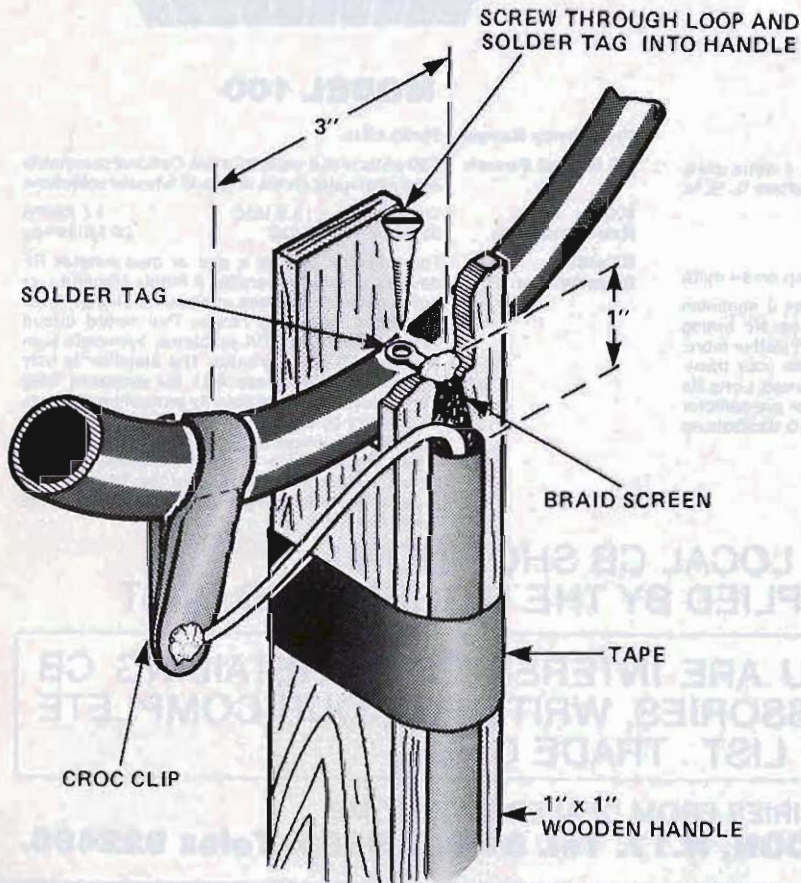

How to DF

This antenna is designed to operate in one plane only, it will be most sensitive to signals that strike it edge on. It is therefore possible to determine the bearing from which the signal originates. With the aid of a compass and a good map (an Ordnance Survey Map is best) you can take two bearings about half a mile apart and by drawing two lines, plot the exact position of the transmission. Amateur radio enthusiasts use similar antennas for 'Fox Hunting' games whereby a number of contestants race to locate a hidden radio transmitter that can be either stationary or mobile.

Under most signal conditions (up to S6, say), the antenna is rotated and a rise in the signal level (ie peak) denotes the direction. If the signal is over S6 it is easier to use the antenna to look for a dip or null, in which case you will get the bearing by taking the direction from the face of the antenna. Bearings should be taken with a compass relative to magnetic North and this can be drawn on your map as a straight line. If the same transmission is then received at another location about half a mile away the two lines drawn on your map should cross at the point from where the transmitter is located. This type of antenna will pin-point a transmission to within 5 degrees or less. If a number of bearings are taken at different locations it should be possible to fix the position to within a few yards.

This antenna will only work outdoors as large metal objects, water pipes etc, will produce misleading readings.

PARTS LIST

C1 10 to 200 pF postage stamp trimmer (non critical value)
31 inches of $\frac{3}{8}$ inch diameter copper tubing.
10 feet of RG 59/U Coaxial cable.
1 x 1 x 12 inch softwood for handle.
Large crocodile clip.

BUYLINES

Almost all of the items for this antenna can be found in your local hardware and radio shops.

Skip Master

THE ULTIMATE in POWER

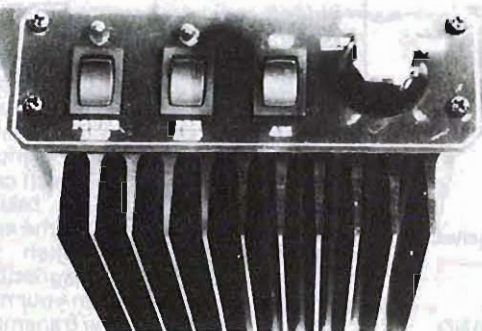

MODEL 150

Frequency Range: 1-30 MHz

R.F. Output: 150 watts AM 190 watts SSB with 4 watts drive. Optional selectable power switch allows 1/4, 1/2, 3/4, or a maximum output setting.

Input Power: Transmitting, 13.6 VDC 20 amps
Standby, 13.6 VDC 20 mills.
With preamp on 44 mills.

Description Stable solid state circuitry provides a minimum transmitted power gain of 45 times. No tuning required. Will work on any signal of 1 watt or more. Automatic switching, using RF from your transmitter, no internal connections required. Long life solid state LEDs. Silicon transistor pre-selector provides an approximate gain of 10 decibels on received signal.

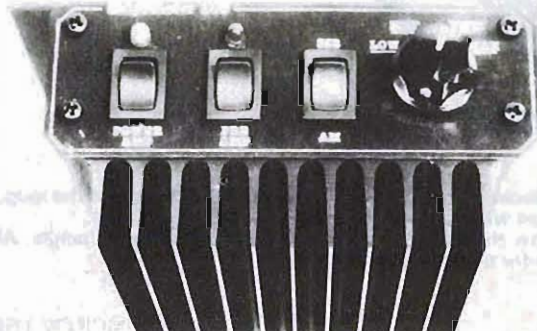

MODEL 100

Frequency Range: 25-30 MHz

RF Output Power: 100 watts with 4 watts RF drive. Optional selectable input attenuator allows 1/4, 1/2, and 3/4 power selections

V.C.C. Requirements: Transmitting - 13.6 VDC 17 AMPS
Standby - 13.6 VDC 20 Milliamps

Circuit Description: The amplifier utilizes a pair of dual emitter RF devices running in parallel. A highly efficient L-pi tuned network provides unequalled stability over the entire operating range. This tuned circuit virtually eliminates TVI problems, harmonic suppression 60 db or greater. The amplifier is fully biased operating class AB1 for excellent SSB transmission, reverse polarity protection protects all circuitry by destroying fuse. Pre-amplifier utilizes J-FET device. The preamp is a tuned circuit which eliminates instabilities and interference from other RF sources. The pre-amp is capable of improving the signal to noise ratio in many exciter.

AT YOUR LOCAL CB SHOP NOW
IMPORTED AND SUPPLIED BY THE BIGGEST AND BEST



IF YOU ARE INTERESTED IN RETAILING CB ACCESSORIES, WRITE FOR OUR COMPLETE PRICE LIST . TRADE ONLY.

TRADE ENQUIRIES FROM DEALERS WELCOME.

407 LORDSHIP LANE, LONDON, N.17. Tel. 01-808 5656. Telex 922488.

Backchat

Backchat time again. This is THE letters page that lets you have YOUR say. Quite a selection for you this month as you can see!

Hello again, time for another selection of your letters. Before we get down to business a quick word about some of the letters we have been getting lately. Each month we get several hundred letters and we do try to read them all. The trouble is that quite a few of you send in four, five or even six page letters that take half an hour or so to read. Could you help reduce eyestrain in the CB office by either writing legibly, typing your letters or keeping them short. Consider your wrists slapped, those people who do it, you know who you are. Can't all be budding Shakespears. OK, nuff said. The radio control controversy is still raging, here's a couple of more letters on the subject.

Dear CB,
I have just read your first-class letters page regarding CB and R/C. The argument can not be fought on the assumption that R/C aeroplanes are toys.

I have been an R/C aeromodeller since I was seventeen. I am now thirty seven, how many CB enthusiasts will be playing around with CB in twenty years time? Once the thing becomes legal and the skip on 27MHz drives them all crazy it will seem less attractive.

In our aeromodelling club there are 27 of us who have all been involved with our hobby for over 20 years each. If the boot were on the other foot and R/C invaded the CB bands (which would have existed for over 30 years) I wonder what you ill-informed correspondant would say?

However, I would like to point out that most R/C enthusiasts run 27MHz AM sets. It costs, about one third of the purchase price to convert to 35MHz. On a set with 10KHz channel spacing that could be as much as £70.00. Most of us own more than one outfit so you can imagine our dilemma. It's not as easy as just swapping crystals!!

Your correspondant MED has pointed out that CB clubs and R/C clubs should 'sort it out amongst themselves', I agree. I would suggest all CB clubs send a representative to the local model shop to introduce themselves. I also suggest that CB clubs should buy a cheap CB rig and set it up as a ground station and donate it to a local R/C club as a protective monitor to help them know when the channels are clear.

Our R/C club (I am the secretary) has, through myself, contacted the local CB club. I have purchased with the club funds, an 80 channel CB rig. I also run a straight 40 channel rig and I am in touch with all the local CBers. In fact my model workshop is often full of CBers having an eyeball. You, the CBers must make the first move, through, the aeromodellers will not come to you. Please consider aeromodellers, if you know where their flying sites are give them at least one mile radius and don't transmit within the mile.

My final point concerns the use of CB in an emergency situation as this is the only merit. As far as I can see you still need a telephone to get the emergency services. I have to ask CBers this question; during the day when you are out on a lonely road and you come across the accident all CBers seek, you put out your call. I will race you from the spot to find a Post Office telephone. I bet I get the services first. I know about all the arguments for this and that, but I must put this to you; how many CBers can build a 'toy' aeroplane from plans, install an engine, install the R/C gear and then fly it in a precise manner and then land it! Every aeromodeller in the world can buy a CB rig, put it into his car and mouth off into the mike. Please don't misunderstand me, CB is good fun, my Dad and I have two rigs and soon my wife and kids will be modulating, but get things into perspective.

I like aeromodelling, I like CB, they don't mix. So, keep away from R/C, they are both legitimate hobbies.

A.J. Bull.
(Address withheld by request)

Hmmm, seems a touch contradictory in places, hope you don't use your CB when flying your plane.

Here's another letter on the same subject.

Dear Sirs,
In reply to the R/C aeromodeller in last month's mag I must point out that I do not condone deliberate interference by CBers, neither do the majority of CBers.

However, having been struck by one such plane on a public footpath and having another bounce off my car on a main road they hardly raise my sympathy. I have friends serving in Northern Ireland who have had experience of R/C equipment being used by terrorists.

On a recent drive I actually saw an R/C pilot using his model to chase livestock.

I feel sure many CBers would be happy to co-operate with the radio modellers. If not I can see some cause for complaint by the modellers. CBers should have some kind of insurance against claims for damage plus a call sign that will be mandatory to use every time the mike is keyed. If this was established and funded by a licence fee, radio modellers would have a way of reclaiming damages. Alternatively, a fund could be set up to compensate the modellers with safeguards for CBers.

So, how about it CB men. Lay off the radio control mens toys.

M. Charleston
(address withheld by request)

CB insurance, that sounds like an interesting idea, any comments you lot?

Following our review last month on the Firestik Antenna we have heard from ▶

the UK distributors of Firestik, Wintjoy Ltd. As we mentioned in the article Firestik is one of the most copied antennas in the world. Glyn Hall has a few words to say on the subject.

Dear Editor,
As the sole U.K. Distributor and Agent for FIRESTIK antennas, we would like to avail readers of Citizens' Band of a few facts that have come to light over the past few months.

First and foremost Firestik are manufactured in the USA by PAL Manufacturing Inc. The name FIRESTIK is registered all over the world and is only allowed to be used by them on their products. It is a name that spells quality and, because of this, their products have been copied by many manufacturers who have tried to produce an imitation at half the price — unfortunately they cannot match or beat the performance.

The latest gimmick to come out of these crude copies is to place stickers (decals) on their antennas stating they are full wave mobile antennas.

When Firestik say their antennas are $\frac{1}{2}$ and $\frac{3}{4}$ wave, they are referring to the performance characteristics of antenna radiation fields, which is the key factor as to how well the antenna performs. The $\frac{1}{2}$ and $\frac{3}{4}$ wave lengths deliver optimum power and keep the signal down at surface level where it works best for the user. The companies advertising $\frac{1}{2}$ and full wave antennas are referring only to wire length used to wind the antenna. . . . not performance characteristics.

For mobile installations it is not practical to have $\frac{1}{2}$ or full wave antennas — electrically or physically. Electrically they would require complete matching to the vehicle, which no manufacturer can feasibly accomplish as each type of vehicle in existence would require its own custom-designed antenna. Antennas that are physically $\frac{1}{2}$ wave at CB frequencies would be about 32 feet high and full wave antennas would have to be over 36 feet high! As one can see this is not practical.

Anytime one sees $\frac{1}{2}$ or full wave associated with CB Mobile antennas it is totally meaningless with respect to performance. All Firestiks are wound for performance . . . not marketing or advertising purposes. For instance a $\frac{1}{2}$ wave model from Firestik has a wire length that physically exceeds one full wave and the $\frac{3}{4}$ wave 7 foot Firestik is designed for peak radiating power at the $\frac{3}{4}$ wave point with the added plus of a large area to transmit and receive radio signals.

Basically these manufacturers are using the same technique as the legendary company that sells the stripes to customise your car that gives you that extra 5 to 10 m.p.h. when fitted. . . .
Glyn E. Hall Wintjoy Ltd.

Thanks to Wintjoy for clearing this matter up. Now on to a more basic problem.

Dear Sir,
Can you advise me on a matter concerning different CB transceivers. I recently read in your magazine, in an article by Mack The Hack, that breakers in his 10.20 were changing over the FM. Could you tell me the differences between AM, FM and SSB.

J Wood
Brighton

I wish the answer was as short as the question. Unfortunately the limited amount of space at our disposal means that I cannot give you any more than a cursory idea of what those terms mean. SSB or single sideband operation is outlined this month in 'On The Side' which you will find on page 22. As for AM and FM the major differences lie in the way the carrier wave (generated by the transmitter) is modulated. In an AM signal the amplitude or size of the signal varies according to the volume of the modulation or speech. The speed at which it varies is proportional to the frequency of the transmitted signal, you can see from Fig. 1. (below) roughly what is happening. Frequency modulation or FM is different kettle of fish, the amplitude of the carrier wave is constant, but the frequency of the carrier itself varies up and down around a fixed centre frequency. The amount by which it varies is proportional to the amplitude of the modulation and the rate at which the frequency deviates around the centre frequency is proportional to the frequency of the transmitted signal. See Fig. 2. for a simplified representation of an FM signal. In the next few months we will try to explain in greater depth some of the technical bits that people keep asking us. We'll try to keep it as straightforward as possible, not only for your benefit, but for ours as well, because we get confused very easily. Look out for a new series of Inside CB next month.

Fig 1



Fig 2



Our last letter this month concerns that perennial problem, TVI or television interference.

Dear Sir,
I am writing to you with regard to a recent article in the February issue of your magazine.

I have already tried various

types of TVI filters but they all have their drawbacks. I have heard that certain types of TVI filter restrict your transmission, dramatically in some cases, so that you can only copy nearby breakers. However, I have been told that fitting a burner will replace the power but not the TVI. Is this true?

As well as TVI I also have stereo interference which I have heard cannot be avoided, is there anything I can do?

Does the Gold Line TVI filter (February Update) reduce transmitting power and is it possible to replace this reduction in power. In this article you mentioned that extra filters could be added to increase its effectiveness but does this reduce the power even further?

D Collins
Manchester

Questions, questions, I feel like Marj Proops sometimes. Firstly a telling off for you Mr Collins. The word burner is banned from this magazine, mustn't encourage irresponsible behaviour must we? In any case fitting such a device will only make all your interference problems much worse. Not only that but you will make plenty of enemies, especially the next door neighbours and others on channel.

TVI filters come in two varieties. The type that fits onto the TV set is called a high pass filter, ie it will only pass the high frequencies used by the TV transmitters, low frequency signals (27MHz CB) are filtered out before the signal gets into the telly. The second type of TVI filter is the low pass filter this fits on the rig itself. It will only allow the relatively low frequency if your rig get out to your antenna. Any high frequency harmonics will be cut out. At the moment the high pass filters that fit onto TV sets are mainly designed for the American market and as their TV systems uses VHF they are not always suitable for use on our UHF TVs. The second type of filter, like the Gold Line etc, that fits onto the rig is the only type worth having. They suppress the high frequency harmonics before they get onto the antenna, high pass filters only help individual TVs. It is true to say that most TVI filters do reduce power output, but a well designed filter should produce more than a 1% loss in power which in practice would go unnoticed. You mention that you are suffering from interference to your stereo, this could be RF breakthrough. The only cure is to keep rig and stereo away from each other, that goes for speaker leads, FM antennas, CB antennas and mains leads. Breakthrough will occur if any of the components of your stereo and CB systems are closer than ten feet to each other. Hope that answers your questions we will be publishing a major feature on interference in the next couple of months. This should outline all of the major problems and cures for all of the various types of interference.

That's it for another month, keep your letters coming but please try to keep them short.

ALL DX'ERS BE ORIGINAL!



PHOTO QSL CARDS!

Send Full Colour Personalised QSL Cards from your own 35mm Colour Negative of you your Rig/Base Stn, Folks, wheels etc. etc.....

* * * * *

JUST send us the 35mm Colour Negative of your choice with your name, address, handle/station no, and personal greetings as shown, together with your cheque, postal order or ACCESS No. just £24.95 and we will send you 100 Top Quality PHOTO QSL CARDS within 14 days of receipt

Send to:

Wilderman Ltd
Dept R
37 St Cuthberts St
Bedford
MK40 3JG

For details of CLUB deals, or any other information, use the landline on 0234 60601 or 023 03 344 anytime (almost!)

40-CHANNEL CB RECEPTION

An exceptionally high performance receiver, CB/Air — PB — WB/TV, FM Bands.

Features include:

- Squelch control
- Band selector
- Telescopic antenna
- Earphone jack
- DC adaptor jack

ONLY **£18** P&P **FREE**, 12-month guarantee

BIRMINGHAM C.B. ACCESSORIES CENTRE

**590-592 Bristol Road, Selly Oak
Birmingham B29 6BQ**

Call on us for **ALL** your C.B. requirements.

C.B. RADIO ACCESSORIES ARE NOW AVAILABLE AT WHOLESALE PRICES TO THE PUBLIC!!

Compare these unbeatable prices!!

DV27	£5.75
DX27	£8.63
T27	£7.50
GPO Mag. Mount	£8.50
MS 264	£23.00
Retractable	£11.50
Electric Retractable	£25.00
Silver Rod	£21.85
Starduster	£27.60
Whisky	£19.00
Sigma 4	£56.00
Sigma 2	£46.00
3/5 watt Power Supply	£12.95
Standard Power Mike	£11.50
Turner + 3B	£23.00
Turner + 2	£17.25
Ham Master 4200	£23.95
Ham Master 4500	£34.50
Expander 500	£43.50
Splitter	£4.95
NFS 1000	£8.50
Slide Mount	£4.50
Extn. Speaker	£4.95
P.A. Speaker	£4.95
SWR/Power	£12.65
SWR Meter	£6.75
5/7 watt Power supply	£13.95
AP 25 watt	£25.50
AP 60 watt AM/SSB	£46.00
BV 150 watt AM/SSB	£86.00
Pre amp "On The Air"	£24.50
PG 58 (Metre)	£0.23
RG 8 (Metre)	£0.65
PL 259	£0.34
Barrel Connector	£0.65
5 watt Dummy Load	£0.90
T Connector	£1.05

PLUS MANY MORE LINES



MAIL ORDER
POSTAGE & PACKING—£1 PER ITEM
3 OR MORE ITEMS—£3
ALL PRICES INCLUDE V.A.T.



GLOBE COMMUNICATIONS LTD.

**110 Hoe Street, Walthamstow, E.17
01-520 7282**



Club News

Here we go again with the most complete and up-to-date club service ever published. This month we hear from two of the emergency monitoring organisations.

You may remember a letter we printed a couple of months ago from Louise Briscoe of the UBA. After the mag was published Louise was inundated with requests for more information. Being an extremely resourceful lady she, and her hubby Graham set up CRIS. That stands for the Citizens Radio Information Service and they will attempt to operate an information bureau for anyone that needs to know anything about CB. Here, in her own words is what CRIS is all about.

The main function of CRIS will be to introduce people to clubs and help with any other enquiries about CB. Until legalised CB is really off the ground we can guarantee that all enquiries are dealt with in the strictest confidence. We want as many clubs as possible to register with us so we can help with enquiries from all over the UK. No matter how small your club may be, let us know about it. To register please send us full details of your club and outline any activities you may arrange and please enclose an SAE so that we may confirm in writing that we have your details. Only when we have received your approval will we pass on any details.

This service is not sponsored by anyone, neither is it connected with any club or organisation. We hope

that you will find this service useful. If you wish to use CRIS to obtain information we would appreciate enclosure of an SAE and a small donation to help with expenses.

CRIS will be at the 1st International CB Radio Show on the 2-4th May in Warwickshire so see you there.

**Directors: Graham Briscoe
Louise Briscoe.**

**55b Brook Road,
Southwark,
London SE11 4TU
(01-582-9479. Not after 11 pm
please)**

Still with CB aid organisations we have had a letter from Hot Dog who is running THAMES. Several people have asked for more information on THAMES so who better to fill you in?

*Dear CB,
May I congratulate you on producing such a good magazine, and also take this opportunity of writing to you, to ask you to include this letter in your next issue, as I want to tell your readers about 'THAMES'.*

'THAMES' stands for Traffic Help And Monitoring Emergency Services. And consists of a team of base CB radio stations or Units as they are

known, all monitoring channel 9 for 10 33's (Thanks to Mack The Hack in Februarys issue you now all know what they are, I hope.) THAMES has been operating for nearly 6 months and we now have Units covering the following areas; Croydon, South Coast, Devon, Cornwall, Milton Keynes, Birmingham, Manchester, Liverpool, Warrington, Newcastle, and West Yorkshire. As you can see we do cover a large area and on average each area deals with 3 calls per day. Obviously, the Units near main roads and built up areas are kept busier than those in quiet areas. The Fire, Ambulance and Police have been informed that if they receive a Buzby 99 call, and the caller states that he or she is a THAMES Unit then the call is genuine. They are aware that the caller cannot give their name and address. I have letters, from the emergency services thanking us for our help and even one from the Home Office saying that they hope we will still be able to offer our service when CB is legalised.

Please keep channel 9 clear, even if you do not monitor it, keep it free for those who do. If you would like more information about THAMES please write to me or ring me at the number below. If you do monitor channel 9 please let me know, also.

This is your invitation to become a lifetime member of the NESS POINT C.B. CLUB. Send 10 of your QSL cards and you will receive:

1. 8 1/2 x 11 wall certificate.
2. Membership cards (xyl free).
3. 10 QSL cards from others.
4. Application cards from other clubs when available.
5. Club Stamp. Complete package £5.00.

PLEASE PRINT

Handle xyl
 Name xyl
 Address
 City Country
 Send to: T. WOOLNOUGH, 115 MONTGOMERY AVENUE,
 LOWESTOFT, SUFFOLK. ENGLAND.

10-10 HOT DOG.
 Mr. Hooper,
 9, Selsdon Crescent,
 South Croydon,
 Surrey. BR2 8NA.
 Phone 01-651 4092.

Before we have this month's round up of the clubs a few words from another emergency monitoring team, this time going under the name of:

BEST

Dear Sir,
 As an avid reader of your magazine, I would like to acquaint you and your readers with BEST. That stands for Breakers Emergency Service Team, which is organised and operated by members of local CB clubs.

Although we have not as yet achieved 100% coverage, we have an enthusiastic and ever-increasing membership.

The group's intention is to provide a 24 hour monitoring service to all 10.33 and 10.34 calls with speed and efficiency. We are also able to broadcast weather and traffic reports.

Due to day-time skip levels, reaching S9 at times, it has been found that we are only able to cover a radius of about 3 miles. This means that we need a large number of base and mobile units to remain effective. If any of your readers wish to set up similar aid facilities we would be happy to assist with all the information and experience we have gained. If you would like more information then please write to the following address enclosing an SAE.

Mr. J.A. Foster,
 140 Granby Road,
 Sunny Side Estate,
 Nuneaton,
 Warwickshire CV10 8EW.
 (NB. Envelope should be at least 8 x 11 inches).

More stickers and newsletters from up and down the country. We hope to have a report from the Spiretown Breakers (right) in the next issue. A report from the Ness Point Club appears on page 52.

The number of aid organisations has been on the increase just lately, there would seem to be a lack of co-ordination between these various groups. Is there a case for a governing body to look after all these organisations? We would like to hear from anyone with a proposal for a national emergency monitoring service with a view to setting up such an organisation.

International Section

Clube CB De Lisboa Internacional
 Dear Friends,
 I'm sending you some news about a Portugese CB Club. I think that this might interest some UK CBers. Our club has more than 400 members in over 40 countries. Any UK CBER visiting Protugal might like to give us a call and we will be happy to help with any tourist information etc. Membership to the CBL costs just US \$8 or local currency to the same value. Please send a stamped addressed envelope for an application form. Hoping to find you with a lot of health, thanks a happy '81.
 Pedro José
 CBL President.
 PO Box 5172-1704 Lisboa Codex.
 Portugal.

CB CITIZENS' BAND CB



NEWSLETTER No. 6

You've got DUSTY BIN here good buddies and fox convers! A 10-44 to all breakers who have been out on the rollerskate park. THANKS GOOD BUDDIES, you have done a fantastic job! Needless to say we have still had rigs stolen recently but the patrol have helped tremendously to keep the prowlers away. Let's keep up the good work. We still need volunteers and would like to put four people at one time on patrol. Last week we had a 10/11 and the culprits were nearly caught, however not quite, so this is why we need extra people Roger? Anyway thanks again good buddies!
 We are all concerned about this problem, no-one wants their vehicle broken into. For those who don't know and might be interested, our vehicle SHRETSKIN' who puts his great stall on for us each week, does sell very good stereo systems one part of which fits to your car and the other in your pocket. If your car is interfered with, the thief in your pocket goes off and the best part about it, is that the thief is not aware of this and therefore there is a good chance that you can catch him in the act. We, the committee have also discussed making alarm available at the club at a very reasonable price. However none of you seem good advice but I would just like to give you a little more! Come clean and green to meetings! No rigs or traps! 'WARNING' It's for your own good! Looking your rig is bad for your 'HEALTH' COME CLEAN!
 10/39, 10/10

DUSTY BIN
 CLUB CHAIRMAN



Contents

EDITOR: JENNY #REN .
 ARTICLES BY: DUSTY BIN
 MAGIC BRE
 JENNY #REN
 SUBSCRIPTION BY: BIG D.
 CANTONS BY: BITCH'S DAD!

*DON'T FORGET:
 In to a committee member. It does not need to have been fixed, no will that for you. Always can be included also. Complete these on the form available.

And now for something a little closer to home.

Sandwell Area CB Club

Dear Editor,
 Having written to you on several occasions we find that, to date we have not been included in your CB mag.

Could it be that our Chairman, the Ace Of Spades is included on some blacklist as a blackleg? If this is the case, we the committee understand because he came from Jamaica in 1960 dressed in traditional dress (starkers), with a tom-tom drum under his arm manufactured from the tree he perfected his swinging techniques on as a child.

Immediately on arrival in this country he signed on for Social Security Benefits, claiming for his 26 brothers and countless sisters. He was educated at the University of Baghdad, gave up cannibalism and became the Chairman of our CB club after realising that CB was a more efficient way to communicate other than the drum he still uses to indulge in makeshift tribal activities in Sandwell.

Being the only Chairman we know with two-tone hands, a vinyl! ▶



roof and ivory grille we think he deserves a mention in your magazine.

We hold our meetings on alternate Thursdays at the Liberal Club, Nimmings Lane, Blackheath. Visitors are more than welcome if they remember to bring their passports.

Karen Hocknull (PR)
Tom-Tom, we gone.
4 Baldwin Close,
Tividale,
Wareley,
West Midlands.

Hey man, you no give me dis jive bout dem letters you sent. Dis am de first letter I get bout dis club. I's a cummin to de conclusion dat you tink we pre-judised, dis am totally wrong, we aint fussy, long as you don't use dat jive on channel cos de brothers don unnerstand dat chat. (Not bad for grey-meat eh?)

Now listen you lot, we'll give anyone a mention just get your letters to us in good time and we'll do our best. With over 200 clubs on our books and a severe limitation on space we just can't get everone in so please be patient, OK bawss?

Beech Breakers Demo

Only just time for a quick mention of the demo held in the heart of Epping Forest by the Beech Breakers Club. It was organised just a couple of days after the great announcement so the theme was understandably geared towards the introduction of an AM service. Power Hammer was in charge of the proceedings and some

500 breakers amassed to hear the good word. In all it was a well organised demo, save for the horse and cart that overturned after being frightened by the amazing cacophony of motor horns. Well done to all the organizers, good demo and your message has been noted.

And finally Cyril

Ness Point Cee Bee

Dear Sir,
A cheque for One Thousand Pounds was handed over by Nigel Carter (Blue Eagle) Action Committee Chairman, at a ceremony held in the club on January 22nd. the cheque was presented to Warren Special School

and Blue Eagle emphasised that this was not a 'one-off' but part of an ongoing support for the school.

The school is for local handicapped children and the Headmaster Mr Fred Heddle presented two cups, donated by a local businessman, Mr John Easter, to the member that raised the most sponsorship money. The bulk of this money was raised on a ten mile sponsored walk. Further fund raising a activities are under way. Terry Woolnough.

Secretary: Ness Point Cee Bee Club
115 Montgomery Avenue,
Lowestoft,
Suffolk.

Good to hear efforts were so fruitfull. Any other clubs emabrking on similar ventures might like to drop us a line and enclose a black and white photograph of the proceedings if possible. Catch you all next month. ●

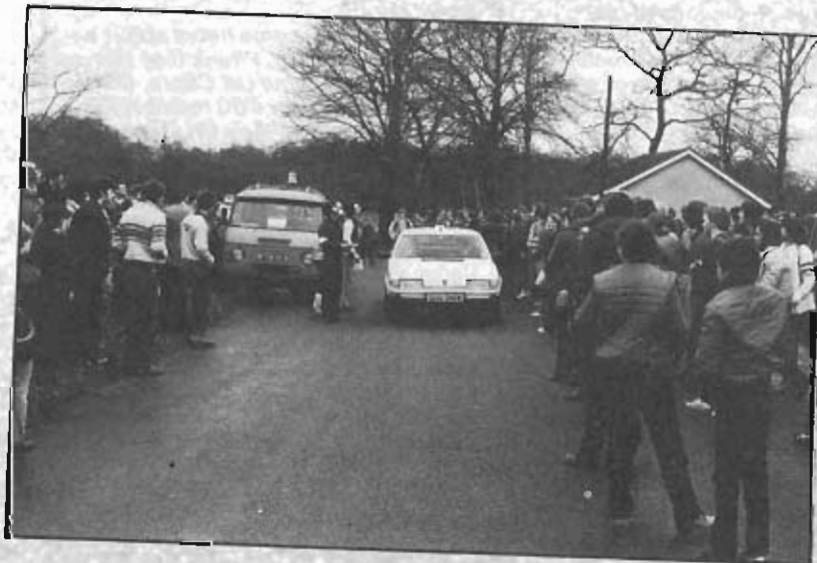

"SKYWAVE"

FOR

COMMUNICATION ANTENNAS BY H.M.P.

'Firestik'
ANTENNAS

Shakespeare

ALSO
ALL CB EQUIPMENT
TEST GEAR & ACCESSORIES
OPEN SIX DAYS A WEEK
LATE OPENING THURSDAY & FRIDAY
TO 8 p.m.

Telephone: Bournemouth 302080
73 Curzon Road, Boscombe
Bournemouth
CALLERS WELCOME

40 CHANNEL CB RECEIVER WITH FM RADIO

FREQUENCY RANGE
AIR 108-145 MHz
P.B 145-176 MHz
W.B 162-5 MHz
TV 54-87 MHz
FM 88-108 MHz
C.B. 1-40 channels



SPECIAL FEATURES
INCLUDE:
Squelch Control
Telescopic Antenna
D.C. Adapter Jack or
Battery Operated
Earphone Jack
Telescopic Antenna

Special mail order offer
to readers of Citizens
Band £16.50 including
C.O.D. p&p.
24hr Answer Service.

**S.M. ELECTRONICS
GLASGOW**

Tel: 041 881 3824
for immediate despatch

IT'S HERE!

THE **K40** SPEECH PROCESSOR

- Clips anywhere without a clip
- Processes speech with a computer circuit
- Sound sensitive 2 inches or 2 feet
- Two mics with one switch
- Fresh charge with no batteries
- Noise cancelling!
- Guaranteed 12 months against chipping, rusting, cracking and electrical failure

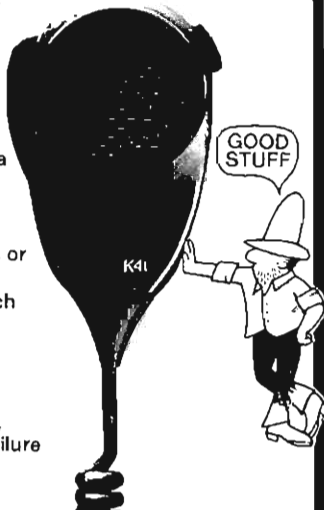

DON'T BE FOOLED BY IMITATIONS
THIS IS THE REAL THING!
Send £25.50 inc. VAT 15% + packing
to NORTHERN COMMUNICATIONS

NORTHERN COMMUNICATIONS

299 - Clarendon Road, Halifax HX36 AW, West Yorkshire.
Tues - Sat 9.45 am - 5.30 pm
24 hr Ansafone Service



**HEH GOOD BUDDIES
WE'RE STILL BRITAIN'S NO 1 C.B. BOOK
YOU GOT A COPY?**

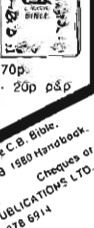
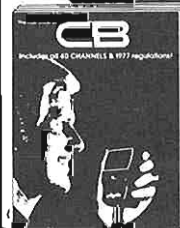

Kona
PUBLICATIONS LTD

TRADE PRICES AVAILABLE
Please send me The Big Dummies Guide to C.B. The C.B. Bible.
 The Best Book on C.B. The C.B. Lingo Bible. The C.B. 1980 Handbook.
 C.B. Slang Language Dictionary. I enclose £
Postal Orders only made payable to KONA PUBLICATIONS LTD. Cheques or
335 CITY ROAD, LONDON EC1 Tel: 01-278 8914
Mr/Ms/Ms Address

Club Directory

Now you can see at a glance if there is a CB club in your area with this, our biggest-ever Club Directory.

LONDON 1

BIG E CLUB
PRO: Rubbar Plant,
Devonshire Hall,
Devonshire Hill Lane,
Tottenham,
London N17.

CITIZENS BAND RADIO ACTION GROUP
Chairman: Steve James,
55 Dartmouth Road,
Forest Hill SE23.

HARROW AND WEMBLEY CITIZENS BAND GROUP

Secretary: Bill Ridgeway,
7 Sandringham Crescent,
Harrow,
Middlesex HA2 9BW.

NORTH LONDON BREAKERS ASSOC (UBA)

Secretary: G.F. Coxshall,
19 Deepdene Court,
Winchmore Hill,
London N21 2NH.

10-4 CLUB
Secretary: Ian Leslie,
BN/10.4
London WC1

UNITED BREAKERS ASSOCIATION (UBA)
Chairman Andy Donovan,
50 Gaskell Street,
Clapham SW4

YORKSHIRE 2

AIRE VALLEY BREAKERS
Secretary: Ms C. Cardwell,
53 Albert Road,
Saltaire,
Shipley,
W. Yorks.

BIG H LUDDITES
Secretary: D. A. Jappy
6 Fieldhouse Road,
Huddersfield,
HD1 6NX.

DOCKLANDS BREAKERS CLUB

Secretary: A. Cooke,
8 Gifford Street,
Middlesbrough,
Cleveland.

DON VALLEY BREAKERS
282 Eccleshall Road,
Sheffield S11 8PE.

MALTBY CAMPAIGNERS FOR OPEN CHANNEL RADIO

Chairman: C. Crosby,
37 Malwood Way,
Grange Meadows,
Maltby, Rotherham,
S. Yorks.

MILKTOWN BREAKERS
Chairman: F.W. Bradbeer,
48 Kennedy Avenue,
Fixby,
Huddersfield.

STAG TOWN BREAKERS CLUB

Secretary: A. Cooke,
8 Gifford Street,
Middlesbrough,
Cleveland.

WETHERBY DISTRICT BREAKERS CLUB

Secretary: D. M. Moment,
9 Norfolk House,
Wetherby,
West Yorks.

WORTH VALLEY BREAKERS

B. Widdop
c/o 19 Woodhouse Road,
Kilghley,
Yorks.

SUFFOLK 3

ANGLIA BREAKERS CLUB
The Great White Horse Hotel,
Travern Street,
Ipswich,
Suffolk.
(7.30 pm second Sunday each month)

BURY CITIZENS BAND CLUB

Secretary: Shady Lady,
Ripley House Hotel,
Northgate Avenue,
Bury St Edmunds,
Suffolk.

JOLLY BREAKERS CB CLUB

Secretary: Lynne Houghton,
10 Viburnum Green,
Lowestoft,
Suffolk NR32 2SN.

NESS POINT CEE BEE CLUB

Chairman: M.A. Thacker,
77 Ship Road,
Lowestoft,
Meet at Oulton Broad Sporting Club,
Thursday nights.

ESSEX 4

BAT BREAKERS (UBA)

Vice-President: D. Nairn,
15 South Parade,
Canvey Island, Essex.

CANVEY ISLAND BREAKERS

Vice-President: D. Nairn,
15 South Parade,
Canvey Island, Essex.

EAST COAST BREAKERS ASSC

Tartan House,
Frating,
Nr Colchester.
(7.30 pm first Sunday each month)

KENT & ESSEX BREAKERS ASSOCIATION

Secretary: Charlie,
c/o 24 Mill Lane,
West Thurrock,
Grays, Essex.

UBA (ESSEX)

Chairman: Ted Cheneler,
24 Bryony Close,
Witham, Essex.

SUSSEX 5

BIG FOUR CLUB

Secretary: Steve Barker,
40 Brunswick Square,
Have BN3 1EF,
East Sussex.

BRITISH SIDEBAND NETWORK

Chairman: A. Vickers,
15 Carman Walk,
Broadfields,
Crawley,
West Sussex.

HARBOUR BREAKERS CLUB

Secretary: M.F. Lynch,
The Harbour Tavern,
Transit Road,
Newhaven, Sussex.

HASTINGS BREAKERS

Secretary: Kevin Jones,
c/o 95B Marina,
St Leonards-on-Sea,
East Sussex TN38 0BL.

WARWICKSHIRE 6

BLACK COUNTRY BREAKERS

Chairman: Goldfish,
c/o 21 Spring Hill,
Birmingham B18 78H.

CBCB

Chairman: Keith Townsend,
1183 Yardley Wood Road,
Birmingham B14 4LE.

CAMPAIGN FOR BRITISH CITIZENS BAND

Keith Townsend,
1163 Yardley Wood Road,
Birmingham B14 4LE.

HARTSHILL CB CLUB

(Shakeytown Breakers)
Chairman: D.S. Alched,
c/o Conservative Club,
Chapel End,
Nuneaton, Warks.

JUNIOR BREAKERS CLUB (COVENTRY)

Chairman: Mark Cleaver,
Clifford Bridge Road Scout HQ,
Clifford Bridge Road,
Coventry.

NORTH BIRMINGHAM CB CLUB

Secretary: Bob Barber,
58 Foulmere Road,
Great Barn,
Birmingham B24 2EA.

NORTH COTSWOLD CB CLUB

23 Greenhill Street,
Stratford-on-Avon.

NORTH COTSWOLD CB CLUB

Secretary: Scott Lewis
25 Greenhill Street,
Stratford-Upon-Avon,
Warwickshire.

OPEN CHANNEL CLUB COVENTRY

Chairman: B. R. Gray,
87 Segemoor Road,
Coventry CV3 4EA.

SQUARE FOUR CB CLUB

Chairman: R. M. Kemp,
90 St Leonards View,
Polesworth,
Warwickshire.

SHAKEYTOWN BREAKERS

Secretary: Snow Queen,
Stratford-upon-Avon,
Warwickshire.

MERSEYSIDE 7

BOTTLE CITY BREAKERS

Secretary: Barry Hatton,
22 Robinson Place,
St Helens,
Merseyside.

MERSEYSIDE 27 CLUB

PRO: Golden Eagle,
c/o 34 Micklefield Road,
Liverpool L15.

ST HELENS CB CLUB

33 Broadway,
Grange Park,
St Helens,
Merseyside.

WIRRAL CB ASSC CLUB

Secretary: Pat Sears,
31 Belgrave Street,
Liscard, Wallasey,
Merseyside L44 1BP.

BERKSHIRE 8

BRACKNELL BREAKERS ASSC

Secretary: Kestrel,
The Bridge House,
Workingham Road,
Bracknell,
Berkshire.

STEEL CITY CB CLUB

Chairman: Alan Taylor,
SSCBC,
PO Box 123,
Reading.

SURREY 9

BREAKERS TOWN CB CLUB

Secretary: Flaxton,
c/o Stanley Club,
Stanley Road,
Carshalton, Surrey.

MOLESEY OPEN BREAKERS

Wednesday nights at 8.00 pm,
Royal Oak in Molesey.

HERTS 10

BRICKET BREAKERS CLUB

Watford Component Centre,
7 Langley Road,
Watford, Herts.

HEMEL HEMPSTEAD BREAKERS CLUB

Secretary: Heather Rutt,
2 Crofts Path,
Hemel Hempstead,
Herts.

AVON 11

BRISTOL CITIZENS BAND CLUB

1a St Paters Rise,
Headley Park,
Bristol BS13 7LU.

WEST COUNTRY BREAKERS

Secretary: R. C. Cockle,
10 Bramley Square,
Congresbury,
Nr Bristol.

WESTON BREAKERS CLUB

Weston-super-Mare,
(Ch 30 daylight hours,
14 after dusk)

NOTTINGHAMSHIRE 12

BULWELL AND HUCKNELL BREAKERS CLUB

Secretary: Mrs C. Willetts,
14 Thorndale Road,
Stockhill, Basford,
Nottingham.

INDEPENDENT TOP VALLEY CB CLUB

Secretary: The Coachman,
c/o Bestwood Lodge Hotel,
Bestwood Lodge Drive,
Arnold, Notts.

NACB CLUB

Chairman: K.J. Stabler,
14 Wilford Crescent West,
The Meadows,
Nottingham.

NORTH NOTTS BREAKERS

Secretary: J.H. Stanley,
4 Farm Grove,
The Paddocks,
Thaivesdale Lane,
Worksop, Notts.

STAFFORDSHIRE 13

BURTON AND DISTRICT RADIO CLUB

Chairman: D. Allen,
6 Rosliston Road,
Stapenhill,
Burton-On-Trent,
Staffs.

GLOUCESTERSHIRE 14

THE CITIZENS BAND ASSOCIATION (CBA)

President: James Bryant,
16 Chruoh Road,
St Marks Road,
Cheltenham, Glos G15 1.

CHELTENHAM BREAKERS ASSOCIATION

Chairman: John Baxter,
c/o The Crown & Cushion,
Bath Road,
Cheltenham, Glos.

CHESHIRE 15

CBA MANCHESTER

Secretary: Paul Lewis
7 Bowland Road,
Woodley,
Stockport, Cheshire SK6 1LJ
(Please include SAE)

CANAL SIDE BREAKERS CLUB

PRO: Niall Shanks
c/o Cotebrook House,
Oughtrington Lane,
Lymm, Cheshire.

CREWE BREAKERS CLUB

Secretary: A. J. Lockhart,
1 Main Road,
Wybunbury, Nantwich,
Cheshire CW5 7NA.

MOTION LOTION BREAKERS CLUB

Secretary: Twaaky,
11 Farmstead Way,
Great Sutton,
South Wirral.

LANARKSHIRE 16

CBA SCOTTISH REGION
Ron Warbrick,
10 Manse Road,
Stone House,
Lanarkshire.

GLASGOW CB CLUB
President: Ian Patterson,
147 Troseachs Road,
Rutherglen,
Glasgow.

GLASGOW CB CLUB (CBA)
Chairman: Normund Cram,
3 Erskine Road, Whitecraigs,
Glasgow G46 6TQ

MONKLANDS BREAKERS CLUB
Chairman: Peter Mulheron,
78 South Commonhead Avenue,
Airdrie, Lanarkshire.

SOMERSET 17

CBA SW.
Chairman: D. J. Bennet,
7 Woolkey Hole Road,
Walls, Somerset.

BUCKINGHAMSHIRE 18

CB MUSKETEERS
Pro: J. L. Smith,
61 Gibbwin,
Great Linford,
Milton Keynes,
Bucks.

NEW CITY BREAKERS CLUB (UBA)
Secretary: Heartbreaker,
c/o CB Centre,
9 St Ledger Court,
Linford Local Centre,
Great Linford,
Milton Keynes, Bucks.

NORTH BUCKS BREAKERS
c/o 20 Pightle Crescent,
Buckingham.

NORTHERN IRELAND 19

CLEAN AIR ASSC
Secretary: Sid Maguire,
113 Malone Avenue,
Belfast 9 6EQ.

EAST ANTRIM CB CLUB
PO. Box 4,
Antrim,
Northern Ireland.

LAGAN VALLEY CB CLUB
Poste Restante,
GPO,
Lisburn,
N. Ireland.

LAZY K RADIO CLUB
PO Box 55,
Portadown,
Northern Ireland.

NORTH SIDE BREAKERS
Chairman: Live Wire,
c/o Landsdown Court Hotel,
Antrim Road,
Belfast BT 14.

SMOKECITY CB CLUB
Secretary: Sid Maguire,
113 Malone Avenue,
Belfast 9 6EQ.

TUNNEL TOWN BREAKERS CLUB
Secretary: J. R. Millen,
PO Box 28,
Coleraine, BT52 1NR,
N. Ireland.

LANCASHIRE 20

CLOG TOWN BREAKERS
Secretary: Sex Kitten,
c/o 33 Pendle Court,
Astley Bridge,
Bolton BL1 6PX.

CDPY CATS CLUB
Martholme Grange,
Altham,
Accrington,
Lancs.

FLIXTON, URMSTON, & DAVYHULME
GOOD BUDDIES ASSC
PO Box 2,
164-166 Corn Exchange Buildings,
Manchester 4.

GBA
Chairman: Bob,
Coronation Service Station,
Middleton Road,
Haywood,
Lancs.

NORTH MANCHESTER CB CLUB

Pro: Blaster Bates,
Belmont Hotel,
Middleton Road,
Crumpall, Manchester 8
(Meet alternate Mondays 8 pm)

OPEN CHANNEL CB CLUB, PRESTON AND DISTRICT
(Formerly Preston CB Club)
Chairman: F. W. McKeown,
Secretary: S. J. Battersby,
(address below)
17 Coronation Street,
Blackburn, BB1 6BS.

SOUTH MANCHESTER BREAKERS CLUB
Chairman: R2D2,
'El Patav',
Stretford Arndale Centre,
Stretford, Manchester.

TELFORD CB RADIO CLUB
Chairman: P. McGuinness,
192 Bishoptdale,
Brookside, Telford.

UBA (NE)
Chairman: B. D. Low,
53 Mayfield Avenue,
Lancaster.

KENT 21

EAST KENT BREAKERS ASSC
PRO: A. A. Jammatt,
PO Box 81,
Canterbury,
Kent CT1 2XG.

MID KENT CB CLUB
Chairman: Colin McKay,
18 High Street, Charing,
Ashford, Kent.

SPIRETOWN BREAKERS
Chairman: Dusty Bin,
36 Church Lane,
Calow,
Chesterfield.

UNITED KINGDOM CITIZENS BAND CAMPAIGN

Chairman: Bernie Murray,
32 Downbank Avenue,
Barnehurst, Kent DA7 6RP

WEST MALLING BREAKERS
Secretary: M. Woodward,
c/o The Clubhouse,
the Airfield Club,
Westmalling, Kent.

LEICESTERSHIRE 22

HART OF ENGLAND CB CLUB
Secretary: Mrs S.K. Wilson,
58 Clarendon Road,
Hinckley,
Leicestershire.

HINCKLEY BREAKERS CLUB
Secretary: Miles Richardson,
8 Gladstone Close,
Swallows Green,
Hinckley, Leics.

LEICESTERSHIRE CB's
Chairman: Crapshooter,
c/o Modern Motoring Ltd.,
68 Narborough Road,
Leicester LE3 0BR.

BEDFORDSHIRE 23

LEIGHTON BUZZARD BREAKERS CLUB
Secretary: Sue Ellen,
c/o Red Lion,
Hockliffe,
Nr Leighton Buzzard,
Beds.

WEST MIDLANDS 24

LEA ORE CB RADIO CLUB
Secretary: S.M. Heighton,
c/o Ye Olde Trooper,
Harden Road, Leamora,
Halsall, W. Midlands.

MCBRC
Chairman: R. Hopkins,
85 Allens Lane,
Palasall, Walsall,
West Midlands.

SANDWELL AREA CB CLUB
PRO: Karan Hocknull,
4 Baldwin Close,
Tividale, Wareley,
West Midlands.

SOUTH BIRMINGHAM CB CLUB (SBCBC)
Secretary: R. A. Smith,
14 Delrene Road,
Sollihull,
West Midlands BS90 2HH.

GWYNEDD 25

CB CRUISERS CLUB
Secretary: H. Kendall-Jackson,
Brackenriggo,
Gannock Park, Deganwy,
Llandudno, Gwynedd,
N. Wales.

DRAGON BREAKERS ASSC
Secretary: Barry Townsend,
Gaerwen,
Anglesey,
Gwynedd.

GWYNEDD BREAKERS CLUB
PRO: Ratchet,
8 Trinity Square,
Llandudno LL30 2RA.

FEN LLEYN BREAKERS CLUB
Secretary: J. L. Court,
Llys-Y-Coed,
Abersoch, Pwllheli,
Gwynedd.

TYNE & WEAR 26

CB-NE
Chairman: Ian Morrison,
89 Hareydene,
Newcastle,
Tyne & Wear, NE5 4QH.
(0632-862900)

GLAMORGAN 27

CARDIFF AND DISTRICT BREAKERS CLUB
12 Aberdored Road,
Gabella,
Cardiff.

WEST GLAMORGAN BREAKERS ASSOCIATION

Secretary: G. Bunce,
25 Plas Newydd,
Baglan Moors,
Port Talbot,
West Glamorgan SA12 7DF

CRAIGAVON 28

CRAIGAVON CB CLUB
Chairman: Steve Cairns,
Room 101,
Country Club,
Craigavon.

NORTHAMPSHIRE 29

DAVENTRY BREAKERS CLUB
Chairman: Gavin Foster,
33 The Wye,
Daventry.

NORTHAMPTON BREAKERS CLUB
PRO: Santa,
400 Obellsk Rise,
Northampton,
(0604 36790 daytime)

HANTS 30

POPLEY BREAKERS CLUB
Secretary: Black Widow,
29 Puttenham Road,
Sherfield Park,
Chineham, Nr Basingstoke,
Hants.
(0256 5481)

VICTORY BREAKERS
Chairman: Country Boy,
9 Mayhall Road,
Copnar,
Portsmouth, Hants.

DERBYSHIRE 31

DOVE VALLEY TRUCKERS CBC
Chairman: Captain Beaky,
Sudbury Services,
Sudbury,
Derby DE6 5GX.

SPA TOWN BREAKERS
Chairman: Tom Brewer,
c/o Midland Hotel,
Peak Dale,
Buxton.

WCBC
Secretary: Mrs G. Patrick,
1 Sexton Avenue,
Heanor,
Derby.

SHROPSHIRE 32

SEVERN CITY BREAKERS CLUB
Instigator: Rainbow,
Oakdena,
Shepherds Lane,
Blcton,
Shrewsbury SY3 8BT.

WILTSHIRE 33

SWINDON CB CLUB
Chairman: Dave Broadbridge,
23 Atteck Close,
Toothill, Swindon,
Wilts SN6 8DF.

WORCESTERSHIRE 34

REDDITCH AREA CB CLUB
Secretary: L. Gazely,
c/o Reins Bungalow,
Oak Tree Lane,
Sambourne, Worcs.

WYE FOREST BREAKERS
Chairman: C. Cox,
19 Chowson Pleck,
Chowson Estate, Droitwich.

OXFORDSHIRE 35

QUARRY BREAKERS CLUB
Haddington,
Oxford.
(Oxford 65975)

DEVON 36

MOORLAND RIDERS CB CLUB
Secretary: Match Box
Monts Cafe & CB Centre,
Liverton,
S. Devon.

CORNWALL 37

TRANSWORLD SIDEBANDERS
UK Controller: SID,
PO Box 8,
St Ives PE17 4JF.

DORSET 38

THE WEYMOUTH CB CLUB
Chairman: Ray Howes,
29 St Thomas Street, Flat 1,
Weymouth, Dorset.

NORTH HUMBERSIDE 39

THE WESTPOINT BREAKERS
Secretary: Dave Kemp,
c/o The Ferryboat Inn,
Heasle,
North Humberside.

CO DURHAM 40

DERWENT VALLEY BREAKERS
PRO: Romeo 2,
c/o 10 Prospect Terrace,
New Kyo,
Stanley, Co. Durham.

MIDLOTHIAN 41

EDINBURGH CB RADIO CLUB
Secretary: Jim Martin
22 Ross Gardens,
Edinburgh, EH9 3BR.

ABERDEEN 42

GRAMPIAN BREAKERS CLUB
Secretary: R. T. Strachan,
59 Jasmine Terrace,
Aberdeen.

WIGTOWNSHIRE 43

RED AND BLUE BREAKERS CLUB
Secretary: Stephen Compton,
92 George Street,
Stranraer, Wigtownshire,
Scotland.

ISLE OF MAN 44

ISLE OF MAN CB CLUB
Secretary: J. Dalrymple,
Lower Ballaclucas Farm,
Marown,
Isle of Man.

OVERSEAS 45

BREAKER ONE FOUR CLUB
Secretary: O.K. Corral,
Napier Barracks, BFPO 20.

RHEIN CUPPERS CB CLUB
President: 7-11,
BFPO 40.

Late Addition

TAMESIDE 99 CLUB
PRO: Eric Howard,
c/o 38 Tarbet Road,
Dunkinfield,
Tameside SK16 4BE.

CLASSIFIEDS

RATES

1-3 insertions £5 per scc
 4-11 insertions £4.50 per scc
 12+ insertions £4 per scc
 20p per word (Min. 15 words)
 Box No. £1.50 extra

All advertisements in this section must be pre-paid.
 Closing Date: 3rd Fri. month preceding publication.

Advertisements are accepted subject to the terms and conditions printed on the advertisement rate card (available on request).

SEND TO CB CLASSIFIED 145 CHARING CROSS ROAD, LONDON WC2H 0EE. TEL: 01-437 1002 Ext. 50.

RECHARGEABLE BATTERIES

TRADE ENQUIRIES WELCOME

FULL RANGE AVAILABLE. S.A.E. FOR LISTS. £1.45 for Booklet. "Nickel Cadmium Power" plus Catalogue. "New range of sealed lead now available". Write or call: Sandwell Plant Ltd., 2 Union Drive, BOLDMERE, SUTTON COLDFIELD, WEST MIDLANDS. 021-354 9764.

CB RECEIVERS

Receives all 40 channels plus 64-179 MHz, volume and squelch control, uses 4 HP7 batteries 6V socket for DC use. £16.50 C.O.D. inclusive
 Tel: 041 881 3824.

HERE ARE THE I/C NOS. YOU HAVE BEEN WAITING FOR

TA 7206P £2.35 each.
 MB 3712 £2.35 each.
 Ex-stock same day delivery
 * TA 7310P £2.30
 * TA 7222 £2.85
 * LA 3350 £2.35
 All fully tested and new.
 Terms: Cash with order plus p&p 50p.
 * Available 14-21 days.

Write for quantity discounts of 10 up pieces per line item.

R. Guess Electronics
 13 Crabtree Hse
 Archery Rd
 St Leonard-on-Sea
 East Sussex TN38 0YN.

GUILDFORD C.B.

Helpful advice and some real bargains, comprehensive stock
COBRA 19GTL RIG KITS £66
DV 27 £6.90, SWR meter £6.90
150W BURNER £99
Open 8.0am to 6.30pm
 S.A.E. for list: 34 Aldershot Road, Guildford Tel. (0483) 77550

Also at: **JIM PARK AUDIO**
 High Street, Godalming.

YOUR OWN HANDLE

On a bronze CB belt buckle.
 (3 words max.) £5.95
 1 1/2" belts embossed £2.50
 Plain, black or brown £2.25

Hewlett Bronze
 19 Boythorpe Rd
 Chesterfield.

QUALITY LONDON POSTCARDS by Gordon Fraser. 4" x 6", 10 assorted tourist scenes. £9.00 per 100 including p&p. Money back guarantee. 1 deal DX. Immediate despatch. Cheque or P.O. to S.C. O'Donnell, Keysoe Lodge, Keysoe, Beds. (023-062-641)

CB BELTS Show you support British CB Buy a superb leather belt from us, at only £5.00 with the motto 'CB IN UK OK' printed on it. Make cheque, P.O. payable to: C.S. Owen, send: Barrach Bach, Llangian, Pwllheli, Gwynedd. Support British CB and your Trousers. Allow 28 days for delivery.

C.B. CAR BADGES

Beautifully made in solid brass. Personalised with your engraved handle. Send £3.99 + £1 p&p. Details of Handle/address. Cheques/P.O payable to M.Mason, 5 Kipling Road, The Straits Estate, Lower Gornal, Dudley, West Midlands DY3 3DY. Allow 30 days delivery.

P.C.B.'s FOR "C.B." Projects, SWR, base power supply, antenna pre-amp, etched and pre drilled. Send £1.50 each + SAE to K. Jones, 35 Heaton Close, Poulton-le-Fylde, Blackpool, Lancs. FY6 7TY.

BRISTOL CB STORE LTD

Wholesale Department at
 589 Stapleton Road
 Bristol 5.
 Tel: 0272 512412.

● C.B. AERIAL ● EVERYTHING BUT RIGS ● PLUGS ● SWR METERS ●

MOBILE ANTENNAE



MOBILE STEREO

Dept. CB, 360 York Road, London, SW18
 Telephone 01-870 7362

Free fitting on all units purchased from us

★ This month's Special Offer ★
 Callers Only

**HIGH QUALITY AUTO CB/AM/FM
 MOBILE ANTENNAE
 £20!!!**

BOOST 20RF ●
 IMPEDANCE MATCHER

● BASE ANTENNAE ● RAIN CAPS ● MICROPHONES ● CB SUPPRESSORS

CB SPARES

Japanese original transistors and integrated circuits. Largest selection in Britain at very low prices. Write or phone for free list.

McLaughlin Electronics
44 Carlisle Rd.,
Londonderry,
N.Ireland BT48 6JW.
Tel: (0504) 65002.

FREE! £5 worth of CB gifts! Special Offer on this months CB brochures! radio's, antennas, microphones, base stations etcl send 14p stamp to Falcon CBR, 12 Newington Green Road, London N1.

PERSONALISED CB HANDLE KEY-RINGS "Bring It On Back" to **YOUR HANDLE 90p.** "Lady Breaker" mirror keyrings 90p. CB Memo pad 70p. CB 100 page log books 11" x 8" approx. - £1.75. CB pen & pencil 50p. CB wallet for above items or magazines etc. 50p. Stationery set of all four items 3.20. All prices include post and packing - send to:- J.R.s CB Stationery, 46B, Bath Street, Ilkeston, Derbyshire DE7 8FD. Mail order only.

CITIZENS' BAND (UK) LTD
STAYBRITE HSE
ST. ALBANS, HERTS

Welcome all genuine enquiries.
St. Albans (0727) 55300.



CB clubland's very own
'Club Guide'
For further details ring
Jenny Naraine
on 01-437 1002 Ext 50

NOW!

C.B. HANDLE BADGE

Your handle printed on a top quality, heavy-duty pin-on badge, undoubtedly the best handle badge on the market.

ONLY £1 EACH. Post free from:

T.V.C.

Station Road, Long Eaton, Notts.

Callers welcome

AD INDEX

Ahlers	2
Birmingham CB Accessories	49
The Breakers Yard	36
Bridair Audio Promotions	24
CB City	29
C.B.R.C.	16
The CB Scene	29
CB Services	43
Chelmer CB Accessories	14
Chelsea CB Centre	37
Connexions	25
E.M.C.	40
Fairfield Brokers	36
Feelgood Designs	36
Globe Communications	49
Gt. British T-Shirt Co.	42
Grove House Electronics	22 & 23
The Hira Co. Ltd	14
Knight Security System	4
Kona Publications	53
Mobile Stereo	57
NIC Models	43
Northern Communications	29 & 53
OCT Ltd	30, 31 & 46
021 Radio Electrical	33
Rolling Stock	40
Skywave	53
S.M. Electronics	53
SRU Autos	43
Surrey Sussex Electronics	8
Telecomms Ltd	59
Tempus	21
Wilderman Ltd	49
Wintjoy	60

Rubber Duck calling Logi Baird - "Say Mac where do I get R.F. transistors?"

"Anglia of course!! They've always got what I want, Motorola MRF and Japanese replacement types."

ANGLIA COMPONENTS
BURDETT ROAD, WISBECH
CAMBS PE13 2PS
TEL: 0945 63281
TELEX: 32630

BREAKER BREAKER

CLASSIFIED ADVERTISEMENT

1	2	3
4	5	6
7	8	9
10	11	12
13	14	15

Advertise nationally in Citizens' Band. Simply print your advertisement in the coupon here (left), indicating which magazine you require. Or telephone for more information.

Name

Address

.....

Tel. No. (Day)

Send, together with your cheque to:
Jenny Naraine, CB,
145 Charing Cross Rd., London WC2H 0EE.
Tel: 01-437 1002 Ext. 50.

Please place my advert in: Citizens' Band

TELECOMMS

SOUTH COAST CB SUPERSTORE SAME DAY DESPATCH

Simply ring quoting your Barclaycard / Access number for immediate despatch of items listed below

OUR HOT LINE 0705-62145.



C.B. RECEIVER

Frequency Range: AIR 108-145 MHz. PB 145-176 MHz. WB 162.5 MHz. TV 54-87 MHz. FM 88-108 MHz. CB 1-40 channels.
Very sensitive receiver with squelch control. **£19 (plus £1 p.&p.)**



K40

SIMPLY THE BEST

Mobile Ant. **£32.95**
(£2 p.&p.)



K40

- Clips anywhere without a clip
 - Processes speech with a compressor circuit
 - Sound sensitive 2 inches or 2 feet
 - Two mics with one switch
 - Fresh charge with no batteries
 - Noise cancelling!
- £32.50 (£1 p.&p.)**

'Firestik'

ANTENNAS

2ft	£9.04
3ft	£10.52
4ft	£11.12
5ft	£11.55
Macho-magnetic base	£17.45

(Allow £1.50 p.&p.)



P.A. HORN SPEAKERS

Small speaker	£6.95
Large speaker	£10.79

(Allow £1 p.&p.)

BASE ANTENNAS

T.C. base ant 7ft	£19.95
Starduster	£25.95
Silver rod	£25.95
Firenze II	£59.95
City Star 17ft long	£25.60
Boomerang	£20.53

(Allow £2 p.&p.)

AVANTI 4FT MOONRAKER MOBILE ANT

Magnetic mount
Superb ant.
£29.50 (+ £2 p.&p.)

LOFT/INDOOR ANTS

Mini boomerang (pictured)	£22.95
Mini GPZ27 (loft)	£21.95
Whisky loft ant	£24.95
Stabo loft ant	£29.95

(All plus £1.50 p.&p.)



HTC-2 Twinset®

A super lightweight twin receiver that lets you monitor CB at home without disturbing others. Magnetic receivers give top sound reproduction.
£17.95 (p.&p. £1.50)



C-610 Base Station Headphone

Dual receivers for base station use. Gives clear reception, minimizes distracting noise and provides private CB listing. Rugged construction. Comfortable.
£11.95 (p.&p. £1.50)



COMPACT SWR METER

£9.80 (1 p.&p.)



MODEL 10 SWR METER

Measures power, field strength and SWR.
£16.99 (£1 p.&p.)



MODEL 75 SWR METER AND MATCHER

Measures power, field strength, SWR modulation.
£19.95 (£1 p.&p.)



MODEL 78 DE-LUXE SWR METER AND MATCHER

Measures SWR, power, modulation, field strength.
£26.95 (£1 p.&p.)



TURNER EXPANDER 500

The very best base microphone with built-in compressor.
£43.50 (p.&p. £1.50)



HAM MASTER 4500 VERSATILE BASE STATION MICROPHONE

- compression pre-amplifier built-in
 - volume and tone controls
 - provided with the meter for reading both audio output and battery condition.
- £32.95 (p.&p. £1.50)**



HAM-MASTER 4200

Table microphone with compressor having a rigid stylish finish made of robust ceramic. Very popular base mic.
£29 (p.&p. £1.50)



POWER SUPPLIES

13.8v 3/5 amp	£17.95
13.8v 5/7 amp	£21.50

(Allow £2 p.&p.)



MINI EXTENSION SPEAKER

Designed for communications use in the car small enough not to obstruct driving whilst giving high quality output.
£8.95 (p.&p. £1)

TVI FILTERS

Standard low pass	£5.50
XLP 150 de-luxe low pass	£14.24
Braid break filter (fits in TV lead)	£5.50
Ferrite ring filter (fits in TV lead)	£5.50

(Allow £1 p.&p.)



RETRACTABLE ANTENNAS

De-luxe electric retractable	£37.85
AM/FM/CB	
Standard electric retractable	£27.85
Manual retractable	£14.50
Manual retractable	£19.50

AM/FM/CB

*** HUGE SELECTION *
of transceivers
now available
Ring For Details**

**GUARANTEED
SAME DAY
DESPATCH
on receipt
of your order
with cheque**



★ WHOLESALE DEPT. NOW OPEN ★

Hours:- Mon — Sat
9.30 — 5.30
Closed all day Wednesday.

**189 LONDON ROAD, NORTH END
PORTSMOUTH (0705) 60036**

WHY GAMBLE WITH THE REST?



Sole U.K. agents for
many quality
manufacturers

For 24 hour answering
service ring Teledata
01-200-0200

WINTJOY®

THE 'CB' PEOPLE

• 103 High Street
Shepperton
Middlesex
TW17 9BL
Tel: (09322) 48154