

# CB RADIO

Vol No. 2 ISSUE No 15

SEPTEMBER 81

60p MONTHLY

IRISH REPUBLIC 85p

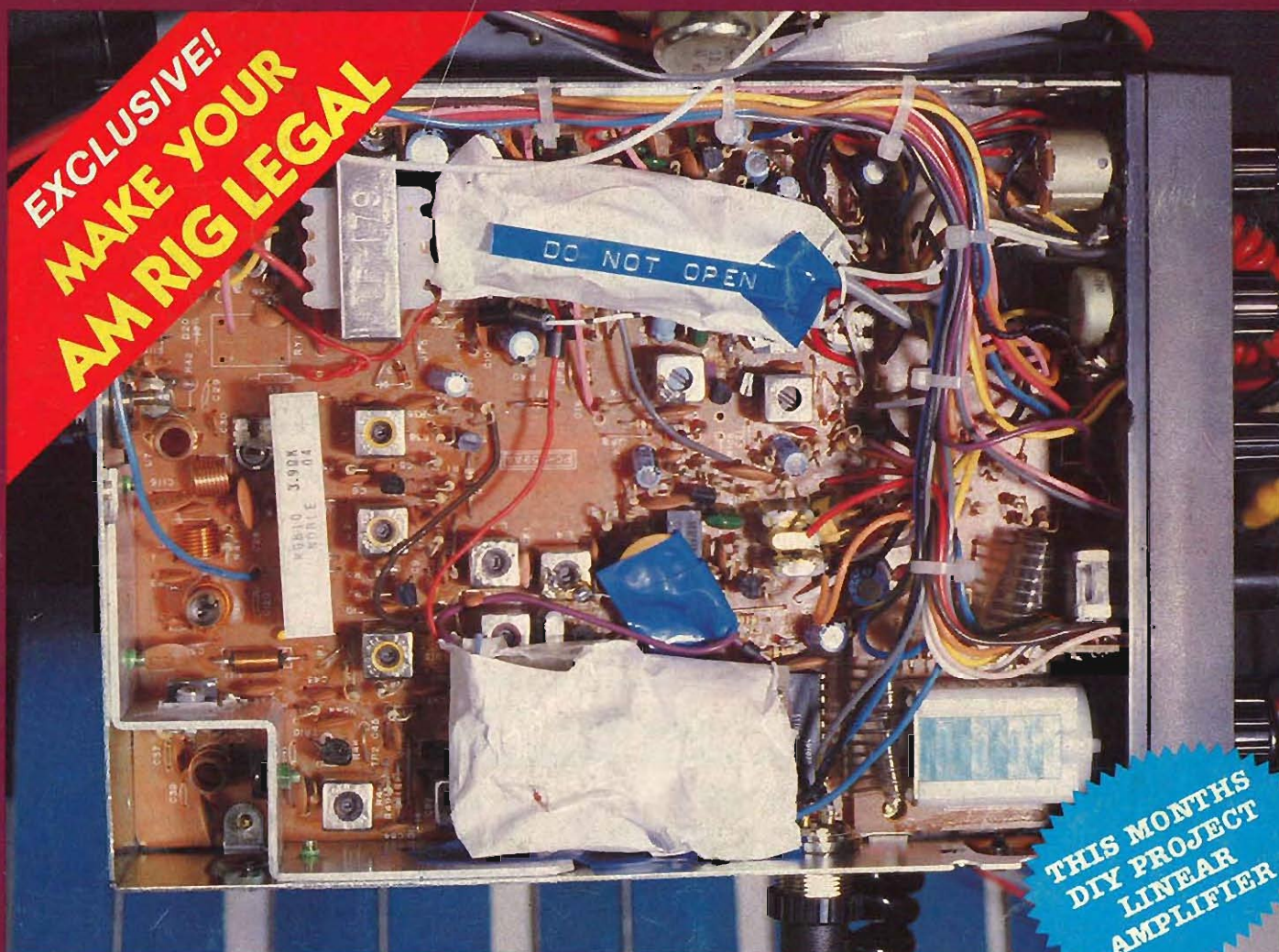

*THE FIRST, THE ORIGINAL, THE MOST INFORMATIVE & THE MOST COPIED..*

## The British Breakers Mag.

*WE LEAD... OTHERS FOLLOW!*

**GET ON YOUR CUSTOMERS WAVELENGTH!**

# **Mura III CB RADIO ACCESSORIES**

**Huge selection of fast-selling  
"Known Brand" Products from MURA  
the largest distributors in the U.K.**

**TUNE IN NOW TO THIS FAST EXPANDING MARKET**

**NEW**  
LARGEST IN THE U.K.

# **Trade**

**STRICTLY  
TRADE  
ONLY**

# **Warehouse**

**Over 6,000sq feet of the BIGGEST & BEST SELECTION of  
CB Radio accessories from all leading manufacturers**

TRADE CENTRES ALSO AT:-

**Chelmer CB**

50 Duke Street, Chelmsford, Essex  
(0245) 351041/87698

**Cee Bee Unlimited**

1 Hamilton Court, Seamoor Rd, Westbourne,  
Dorset (0202) 768787

**Marston Auto Parts**

8 Cherwell Drive, Marston, Oxford (0865) 61668

**Breakout**

102 Main St, Methven, Perth,  
Scotland. (0738) 84345/6

**Carters CB Supplies**

14 Norfolk St, Kings Lynn, Norfolk.  
(0553) 2826

PLEASE NOTE  
OUR NEW  
ADDRESS

**ONLY 5 minutes  
FROM END OF M1**

**CASH  
and  
CARRY**



# **Mura III**

**MURA ELECTRONICS (U.K.) LTD**

**295-297 HIGH ROAD**

**WILLESDEN, LONDON NW10 TEL: 01-451-4141**

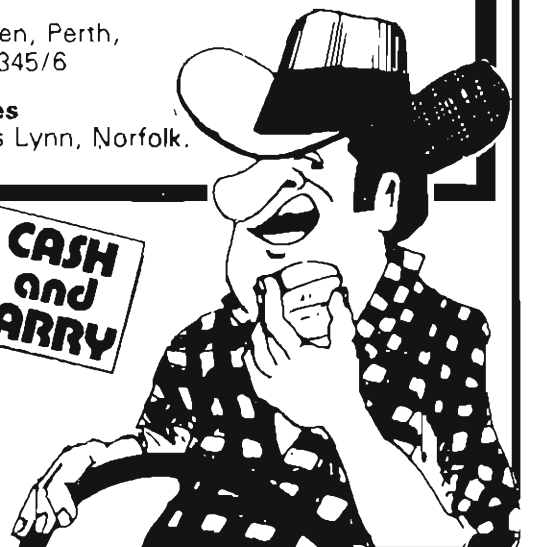

# CB RADIO

# Contents

On a Serious Note	2
Antennas and Transmissions	4
Dealing with Interference Problems	8
Legal Rigs	12
DX QSL International Club Spot	16
Vultures on the Side	20
Readers Write	22
Come Back the Breakers	24
News Review	28
CB Radio - Project Kit	32
Friendly Advice for Emergency Monitors	36
Parliamentary Review	40
CB Round Up	44
The Law and You	51
Wales come to London	52
The Eastbourne AM Rally	53
Club Spot	54
Rig Test	60
Eyeball at the Eyeball	62
Classified Advertisements	64



Play Kits, build a linear amplifier.

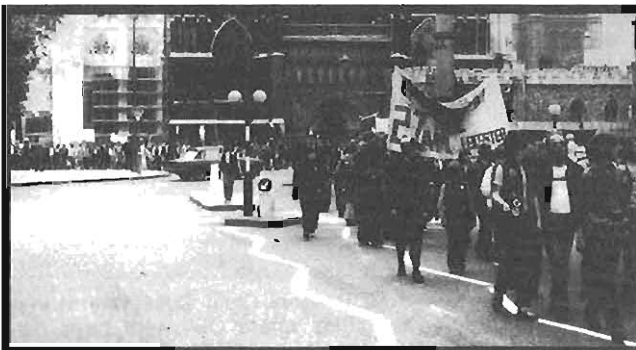

Demonstration coverage, see page 52.

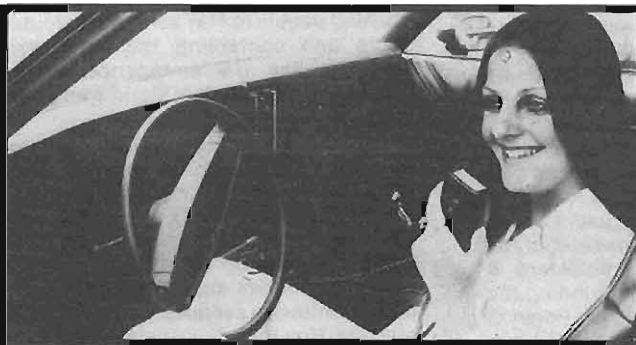

Legal Rigs, see page 12.

## Advertisers

Ace Audio	57	Eyeball Eyeball	59
Acom Trading	16	Ferralline 27	25
Acton CB Centre	59	Froeman and Pardo	63
A.D.S. Electronics	41	Georgio Bulldog	48
Alr Bear	42	Hammernith CB	38
Antenna Specialists	21	Kemow Audio and Sound	43
Auro Lock	26	Kalghat CD Specialists	11
Beech and Son Ltd.	50	Lahar Albrecht	10
Bill Dodger	6	Lucky Numbers	46
Breaker 9	7	Mura Electronics (UK) Ltd.	Inside front cover
Breakers Yard	26	New Force Ltd.	42
Breakers Yard Reading	55	North Hems.	25
Brew Brothers	18	O.C.T.	Rear Cover
CBA	46	Rigs and Twigs	50
CB Centre Croydon	57	Roger Squires	18
CB City	47	Sandhurst Publications	17
CB Radio Magazine	3	Sandwell Plant Ltd.	38
CB World	46	777 Electronics	31
CEM Ltd.	57	Simply CB	46
Chamberbox	55	Skylab CB	43
Chelmer CB	39	Smith and Gasmald	38
Chelsea CB	27	Sound Around	18
Connexions	15 & 23 & 47	Street Legal	55
C.T.E. International	49	T & T Electronics	50
Custom Equip	Inside rear cover	Truck King	19
Dorington Communications	26	Zenith	43
Eurobank	63	ZL Communications	30

## CB Radio Magazine

### British Breaker Productions

Tudor Works, Beaconsfield Road, Hayes, Middx.  
UB4 0FL 01-561 5778

Director	J. O'Hara	Advertising	Sue Sharp
Editor	The Englishman	Features	Paul Carter
Editors Secretary	Carole Robertson	Gopher	Ian Coombs
Photography	Collin Downs	Artwork & Design	The Main Man
Technical Adviser	F.C. Judd, FISTC MJOA Assoc. IPRE.		
Photosetting	Maureen Kelvey		

Printed in Great Britain by Benham & Company Ltd., Sheepen Place, Colchester, Essex. CO3 3UH  
Colour sections by: TRIOVAD Litho Ltd., Chesham, Bucks.  
Distributed by: S.M. Distribution, Trinity Gardens, London. SW9. 01-274 8611

### IMPORTANT

AS A MAGAZINE WE CANNOT CONDONE THE USE OF ILLEGAL 27MHz EQUIPMENT NOR IS THIS PUBLICATION INTENDED TO ENCOURAGE THE USE OF SUCH OR ANY OTHER ILLEGAL EQUIPMENT CAPABLE OF TRANSMITTING OR RECEIVING. WE DO NOT ACCEPT RESPONSIBILITY FOR ANYTHING PUBLISHED WITHIN OUR PAGES NOR ANY DAMAGE HOWEVER CAUSED. - IRRESPONSIBLE AREN'T WE!

COPYRIGHT CB RADIO 1981. ALL RIGHTS RESERVED. REPRODUCTION IN WHOLE OR PART IS FORBIDDEN SAVE WITH THE EXPRESS PERMISSION IN WRITING OF THE PUBLISHERS.

### THIS MONTH'S FRONT COVER

Internal of a rig converted to the legal specification.  
Photograph by C.P. Downs.

# On a serious note

**The End of Speculation?**  
Everybody has spent months guessing at dates for legalisation of C.B. on FM in this country. One manufacturer of 87MHz rigs, Binstone, optimistically expects the 16th October to be that date. On following up Binstones information, a date, which seems more likely has emerged from a very reliable source and that is the 1st of November 1981. Is this the end of speculation? We'll have to wait and see.

## What will be the CB of the future?

In the absence of our highly witty and talented editor it has been left to me a mere mortal to fill this page, commonly entitled Introduction.

Here we are with autumns colourful hues only days away, without a hint, nay not even a whiff of a date for legislation. So what I hear you cry who wants FM anyway, we are going to keep our AM!

Fair enough who are we to deny you your opinion but just take a quick look into the future with three or even four CB systems, some legal some not, all in direct competition with each other for the breakers money.

27MHz AM I'm sure will survive, the breaker who has been using his rig for anything up to 4 years is not going to give up easily. The AM system being the only one currently used widely has served as an enormously beneficial social tool. It has created new friends for otherwise lonely people, broadened the horizons of people housebound by virtue of age or disability and due to the generous nature of many CB Clubs raised thousands of pounds for charity.

Flicking through the pages of this magazine and hopefully reading and digesting them you will have discovered by now the new phenomenon known as Frequency Modulation which by all accounts will be with us fairly soon. Doubtless any new breakers that come onto the air (FM) will derive the same pleasures and benefit as existing AM Breakers for approximately the same outlay.

934 MHz by virtue of its technical complexity will be a fairly expensive system to buy once it becomes available and as such will only fall into the price range of the slightly better off individual. Once again the people that use 934 MHz will have the opportunity to do with it what they will and in essence it will probably end up very much like AM or FM but with different technical capabilities.

So far so good. There is one thing that still puzzles me, why do people bother going out to work to earn money, to in turn spend it on CB when all they are going to use it for is propagating foul language and abuse onto the airwaves. This has been a subject of many readers letters recently and what many of them are saying is true.

Whichever CB radio system eventually wins, be it AM, FM, VHF, whether its users talk like English aristocrats or American truckers, what we do want to be is a Citizens Band Radio system for citizens

not foul mouths.

I want my young daughter (when she gets older) to be able to go on channel and use CB without being propositioned and bad-mouthed. I would like my grandmother to be able to put out a 10-33 after an accident at her home without being badmouthed and her call being treated as a joke.

We can all swear in private when things go wrong or in temper - however hopefully we don't stand up in the local shopping centre and shout abuse at the shoppers. This is precisely the effect you have if you use bad language on channel. CB has too many advantages and uses for the majority for it to be ruined by the minority who see it as another tool for their childish behaviour (thats probably being rude to children as they are usually good breakers).

## Civil Disorder and CB.

Depending on your political point of view the recent spate of rioting could be seen as rebellion by disenfranchised and unemployed youths or as a bunch of hooligans out for a punch up. Whichever view you take the result was the same; a horrific and bloody mess. The toll reads like a script from a war epic rather an example of life in an advanced and so called civilized society. One person dead, buildings burnt, vehicles smashed and set on fire, shops looted, policeman and civilians maimed and it goes on.

One product of our advanced and civilized society is Citizens Band Radio the use of which is illegal and users at the moment are put into the same category as bank robbers and child molesters & criminals. The publicity surrounding the recent riots has also pointed the finger at Citizens Band Radio users as being left-wing agitators or unscrupulous shop looters. Much mileage has been made of the fact that people using CB Radio have been seen in the vicinity of troubled towns by police.

However one aspect of CB Radio that police and journalists alike have overlooked is that, although CB Radio is an excellent means of communication it is by no means private. Anybody with the appropriate monitor can hear exactly what the breakers are talking about. Surely if the police felt that CB was being used in an anti social way they or the post office would have tuned in and got some real evidence.



Mr Gregory Chief Constable of West Yorkshire where CB users have been blamed for riot related offences, may have missed the possibility that CBers could have been helping the situation by warning people to stay away from trouble spots and contacting the emergency services, like the ambulance or fire brigade on the behalf of victims and their property.

The truth of what part CB Radio did play in the riots will probably never emerge. Breakers in the Manchester area are so incensed with the possibility that CB was used as a criminal tool, that they have offered to give up CB altogether if the police claims are substantiated. Responsible monitoring services like REACT may also feel that they could help the police in cases of civil disorder by not only reporting 10-33's but also pinpointing trouble makers. If CBers could somehow become "self policing" it could help to keep the good name of CB alive and prevent bad headlines appearing.

PCC

## Update.

An important announcement has just reached us from the offices of David Allen (Insurance Consultants)Ltd., who you may remember were offering CB insurance in Issue 13 of CB Radio Magazine. Firstly their premium rates have gone down from 12% of the rig value to 10% and also the excess (clause E) has been dropped from £10 to £5.



# ONE YEAR OF CB

NOW YOU CAN KEEP A FULL 12 ISSUES OF  
CB RADIO MAGAZINE IN OUR SMART NEW BINDERS



12 ISSUE  
BINDER  
**£7.50**  
+ £1.00 p&p

A FULL SET  
OF 12 ISSUES  
**£6.50**  
+ £1.50 p&p

SPECIAL OFFER  
BINDER & 12 ISSUES  
**£11.99**  
+ £1.76 p&p

ALL 12 ISSUES ARE AVAILABLE  
single copies 60p + 32p postage (first class)



This smart attractive binder holds 12 copies  
of CB Radio Magazine in a blue binder  
embossed with silver.

Now there is no need to hunt through piles  
of magazines looking for that article on  
interference or that project you wanted to  
build.

Now with this binder you can keep your copy  
of CB Radio safe and clean, not accidentally  
thrown away or borrowed by a friend.

CB RADIO  
Patches Stitched  
GOLD on BLUE



Send your P.O. or Cheque  
with your name address to:

**CB Radio Magazine**  
British Breaker Productions  
Tudor Works, Beaconsfield Road,  
Hayes, Middx. UB4 0FL.

Patches 65p (inc. p&p) Number plates £6.50 (to order only)

# Antennas and Transmissions on CB frequencies

by F.C. Judd, FISTC MIOA. Assoc. IPRE - Part 11

This article is in effect a continuation of part 10 published last month but as is now known the Home Office have limited the physical length of all CB radio antennas for 27MHz to 1.5 metres (approx 5ft.) and also put a limitation on the height above ground at which they may be erected. (HMSO PUBLICATION MPT 1320. Specifications for CB radio). Although both factors play an important part in radio wave propagation at this frequency, the combined effect of reduced length and height limitation is not so serious as might be imagined. Many CB operators have quite wrongly come to the conclusion that the limitation on physical length alone will greatly reduce working range.. This is not so and some explanation of precisely what limited antenna length means may help clarify the reason for this and also why the Home Office, with an obvious lack of knowledge of radio antennas, imposed this limitation in the first place.

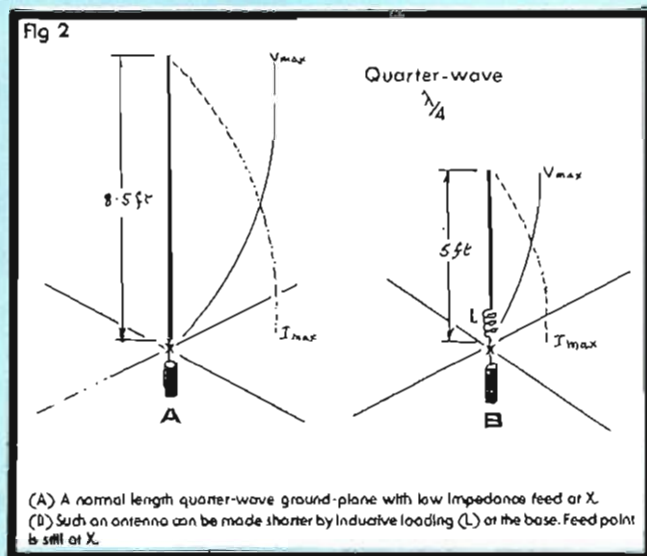
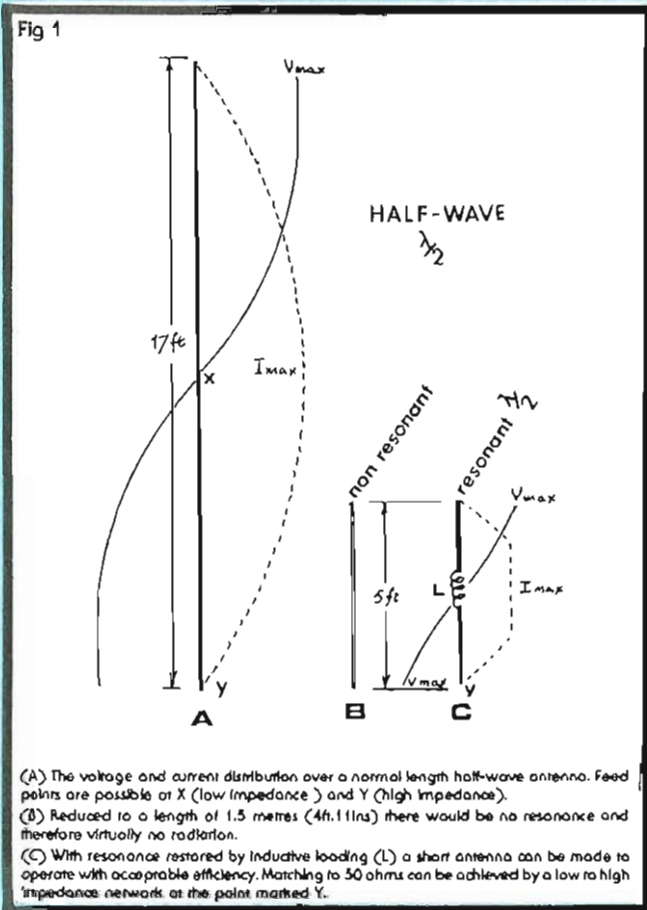

Those who have studied the original HO draft specification for CB radio will undoubtedly have noted that whilst the permitted output power for 27MHz was given as 4 watts (FM) the *effective radiated power* (ERP) from the antenna was to be limited to 2 watts. They apparently lost sight of the fact that a really efficient and properly matched antenna, for example a half-wave dipole, either end or centre fed and physically about 17 feet long, will radiate at least 90% of the power supplied to it. The 10% or so loss is made up of natural resistive losses in the antenna itself (about 8%) and in the transmission (co-axial cable) line for the transmitter. This would mean an effective radiated power of at least 3.5 watts, from a transmitter output of 4 watts. To achieve an ERP of only 2 watts would of course entail attenuation by a resistive network at the output of the transmitter. As most CB rigs are combined transmitter/receivers then any form of resistive attenuation would also reduce the reception of signals by the same amount i.e., by 3dB. NOTE: A reduction of power from 4 watts to 2 watts is  $10\text{Log}_{10} \frac{2}{4} = -3\text{dB}$ .

The wiser beings at the HO must have realised that the use of resistive attenuation to limit ERP was just not practicable and have come up with the equally not so brilliant idea of putting a restriction on the physical length of any antenna for 27MHz CB radio to 1.5 metres (4ft. 11ins.). They obviously assumed that this would automatically reduce antenna efficiency by about 50% and the ERP close to the originally specified 2 watts. Fortunately this is not so.

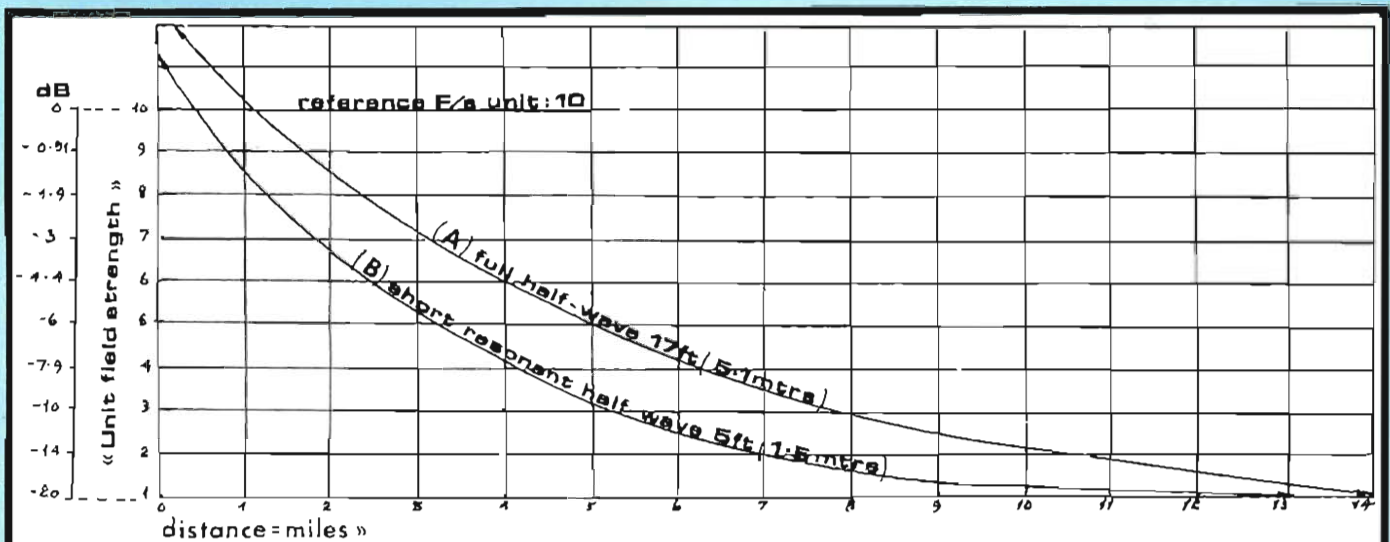

Fig 3

(A) The graph shows field strength v distance with a normal half-wave vertical antenna.  
 (B) With an artificially resonant half-wave 1.5 metres (4ft. 11ins.) long to meet the HO spec for CB radio antennas (see text).

### Antenna Length V Efficiency.

It is of course quite true that if a naturally resonant half-wave antenna as shown in fig. 1A, is made shorter than the normal physical length then the efficiency is greatly reduced. To begin with the antenna would no longer be resonant i.e., not tuned to the frequency of operation as in fig. 1B and it would in fact be virtually impossible to transfer power to it from a transmitter. A shortened antenna can however, be made resonant by inductive loading as in fig. 1C, in which case it will be *electrically* restored to a half-wavelength. Whilst there is still some loss of efficiency by comparison with an antenna of normal resonant length, the amount depends entirely on how small the antenna is actually made. For example, a quarter-wave antenna with its physical length reduced by ten times but otherwise 'tuned' to resonance, would have an efficiency of little more than about 4% and therefore radiate only 1/25th of the power supplied to it.\*

On the other hand shortened quarter-wave antennas with ground-planes are not uncommon anyway. The normal length as shown in fig. 2A would be about 8ft. 6ins. but with artificial (inductive) loading and a physical length of 5 feet as in fig. 2B, the efficiency would still be quite high. However, the problem with *all* ground plane type antennas is that maximum radiation is always at a high angle and

this greatly restricts the distance of operation over a ground path.

Fortunately the loss of radiation efficiency with short but otherwise resonant antennas is not directly proportional to the reduction in physical length. Providing resonance is maintained the overall loss incurred by reducing the length of a 27MHz half-wave base station antenna from 17ft. (5.18 metres) to 5ft. (1.5 metres) is only about 20% as both calculation and measurement have proved. Direct comparison tests between a full length half-wave and a 5ft. long *artificially resonant* half-wave as the graph fig. 3 shows, resulted in a slightly reduced effective working ground path range although the difference in signal levels from British and European stations under good short skip conditions was barely noticeable.

Many antennas for mobile operation at present available will meet the HO specification since the majority are not more than 5ft. long in the interest of safety. Most mobile antennas are however, tuned quarter-wave types relying entirely on the 'ground-plane' effect of the car body to obtain a low impedance match and reasonably efficient operation. The problem of high angle radiation still remains and which limits the working ground range. Field trials with many different mobile antennas of this nature have proved this to be the case.

At 27MHz and frequencies in this region, radio wave

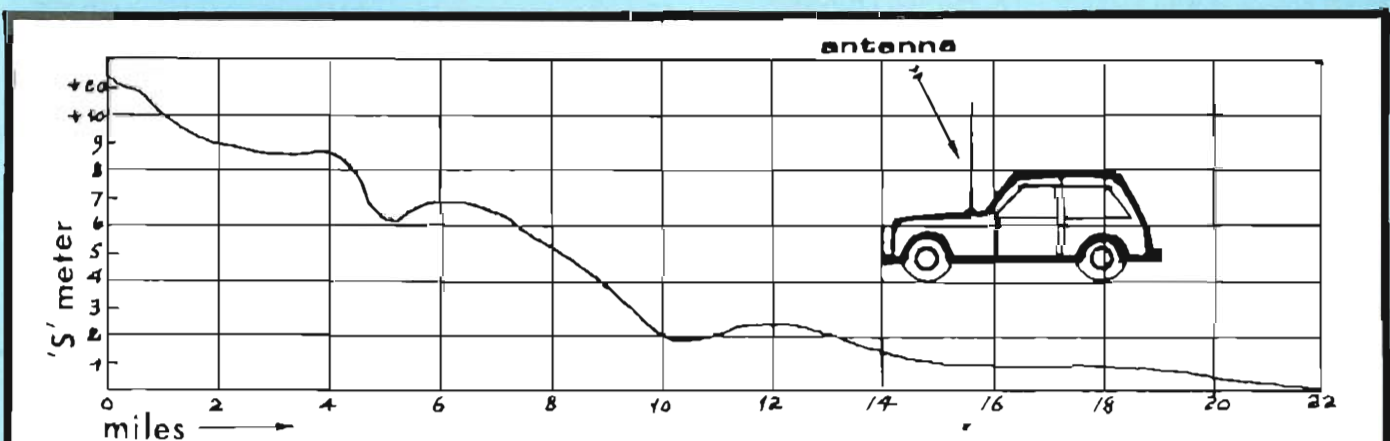

Fig 4

Antenna on car - FERROLINE 27 mobile antenna - BREAKERLINE 27 1.5 metres (4ft. 11ins.) free-space tuned half-wave of height of 15 feet. Countryside - open but undulating. Trial made in normal daylight hours.

# Antennas and Transmissions on CB frequencies

attenuation over a ground path is at its highest. Although increased distances are possible during hours of darkness by reason of very short skip conditions, the average range over ground during daylight hours, as many have no doubt discovered, can be as little as 4 or 5 miles depending also on the nature of the terrain. Thickly wooded country, hilly country and built-up areas also contribute a high degree of attenuation.

## Field Trials with Shortened Antennas.

The writer has been involved recently with the design and trials of three new antennas for CB radio to meet the requirements specified by the Home Office for use on 27MHz. The trials have proved quite conclusively that a fully resonant antenna for operation within the band 27 to 28MHz but with a physical length of 1.5 metres (4ft. 11in.) will compete favourably with its full size counterpart. The trials were conducted over relatively flat open country, over undulating (hilly) but not mountainous country, in built-up areas (large towns) and on the open sea.

The antenna used for the base station was set up at a height of 15 feet above ground at virtually sea level. This was a free-space type 1.5 metres long (to comply with HO spec.) and resonant to a half-wavelength. The graph in fig. 4 is the signal field strength as received using a free space mobile antenna, also to HO spec., positioned on a car as illustrated. The power used for transmitting from base was 4 watts only and with frequency modulation (FM). At a distance of 17 to 18 miles with a level of S1, signals were perfectly readable. *NOTE:* This trial was just one of many and carried out in normal daylight hours.

One of the most interesting trials was carried out from a private vessel located at sea about 14 miles off the coast as in fig. 5. The propagation path was therefore over both sea and land. All contacts were made after dark when short-short skip prevails. The stars indicate the positions of many of the CB stations contacted on land and the figures are the signal meter readings given by them. The transmitting power used on the vessel was 4 watts and the antenna a "FERROLINE 27" at a height of 20 feet above the water.

It is hoped that the results of the trials outlined in this article will dispel any doubts that CB operators must obviously have with regard to the performance of single element antennas with a length not exceeding 1.5 metres (4ft. 11ins.) as now specified by the Home Office. It must finally be emphasised that trials of this nature can only be

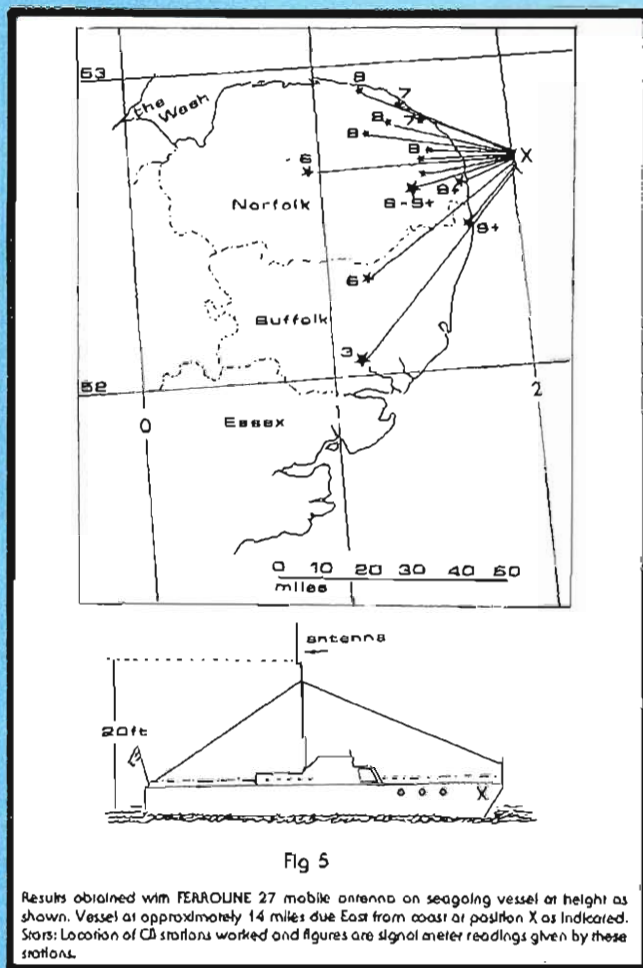

made and the results properly analysed with the aid of very accurate measuring equipment and extremely carefully matched antennas. The majority of so-called "comparison" tests between one antenna and another and the results of field trials on antennas frequently published in other magazines devoted to CB radio and even by dealers, have all too obviously been carried out on an *ad hoc* basis without resource to either laboratory standard measuring equipment and the requisite qualifications, knowledge and experience.

In view of the HO requirement regarding antennas it is suggested that the Editor might like to compile a list of base station and mobile antennas that meet this requirement. Part 12 about antennas continues next month.

\* *Ground-wave propagation with short resonant antennas* by F.C. Judd (Adams prize awarded for this work). Published RSGB Bulletin December, 1960.

## HANDLE BADGE



TOP QUALITY  
HEAVY DUTY  
PIN-ON  
HANDLE BADGE

Your Handle Inserted. Maximum 15 letters or spaces  
Undoubtedly the Best on the Market

**ONLY £1 EACH - POST FREE**

From: **BILL BADGER  
STATION ROAD  
LONG EATON  
NOTTINGHAM**

Callers Welcome

**If you find an ad unacceptable, don't turn the page.**

**The Advertising Standards Authority**

A.S.A. Ltd. Broadwater, Torrington, Devon PL12 8JN



# BREAKER 10

We brought you THE HALF-BREED, THE ROAD HOG, THE ENTERPRISE II (Dial-A-Match) and THE WARRIOR, which have become the best selling Antennas in Great Britain.

As a result of recent deals, we can now offer you a whole new range of other excellent products at unbelievably low prices. Why not discuss your requirements for legalisation with us now, in order to ensure your supplies, and avoid disappointment later? If for any reason you are having difficulty obtaining satisfactory service, please get in touch with us at the address below.

## WE GET YOU OUT FURTHEST

DISTRIBUTORS ARE STILL NEEDED IN SOME AREAS

AERIALS AND A  
WHOLE LOT MORE

For details and prices of our complete new range,  
please write to: Mike or Jeff both at



4-5 The Arcade,  
Hitchin, Herts.  
Tel: 0462 37826

ENTERPRISE II  
(DIAL-A-MATCH)

HALF-BREED®

WARRIOR®

ROAD HOG®

# Dealing with Interference Problems

By E.A. Rule Final Part

This month we are going to deal with the interference problems found in motor vehicles and no excuse is made for the fact that most of the material is reproduced by the kind permission of Lucas Electrical Limited, Parts and Service Division, Birmingham, B18 6AU. This company have had many years of experience in the suppression of interference in motor vehicles and are always willing to help you with particular problems, just write to them and state the type of vehicles involved and type of problem. However it is hoped that most of what you will need to know will be found here. Lucas stockists will have most of the common items mentioned but special parts can be obtained from the address above.

The most common source of interference in a vehicle is of course the ignition system and we will deal with this first. It goes without saying that this should of course be maintained to the manufacturers specification at all times. Indeed it is the Law that all vehicles manufactured in the UK MUST comply with published levels of interference. These regulations are to ensure that only the minimum amount of interference is caused to domestic TV and radios.

## Basic suppression.

First check that the aerial installation is correctly fitted as per the manufacturers instructions. If it is the type that has to be 'earthed' to the vehicle's body, make certain that all paint etc. has been removed so that it makes good contact with the body. Second, take the supply voltage for the rig DIRECTLY from the battery, NOT from some other more convenient point inside the vehicle. Always run a separate power supply lead direct from the battery to the rig, this is to ensure that the low impedance of the battery permits only the minimum of ignition noise to get into the rig via the power supply leads. This is a very important point and the one most commonly ignored. Make sure of course that this supply lead also contains a suitable fuse.

The first check is to remove the aerial connection from the rig and to tune the receiver over all channels with the engine running, this will check for interference via the engine supply. While the aerial is disconnected it is a good time to also check for noise from heater motors, wipers, etc. (when checking the wipers, make sure screen is wet). If interference is found from any of these sources fit a Lucas LS630 choke in the supply lead to the rig. On some rigs it may also be necessary to add an additional filter capacitor between the rig side of the choke and the rig chassis. This capacitor can be a 1000 MFD 16 volt electrolytic which is obtainable from most radio components suppliers. Be sure to observe the polarity of the capacitor when connecting.

Now reconnect the aerial system and recheck all channels as before, noting which items will need extra suppression. First check with just the engine running at various speeds. If interference is present fit an LS627 capacitor between the switch terminal of the ignition coil and earth. It is a very good plan to fit this capacitor as standard in any case, as in areas of weak signal the interference may show up whereas it didn't on the test site.

One point worth mentioning here is to check the earth bonding strap between the engine and vehicle chassis. Check for good contact and possible damaged braiding, replaced if necessary.

The Lucas interference tracing chart is given in fig. 20 and will be found useful in tracking down sources of interference that the basic suppression didn't cure. The other diagrams are also reproduced from the Lucas book (PLT 6338A). Copies of this book are available from Lucas and is recommended very highly as it covers the full range of equipment available from Lucas.

The following diagrams and text are copied directly from this book and are self explanatory.

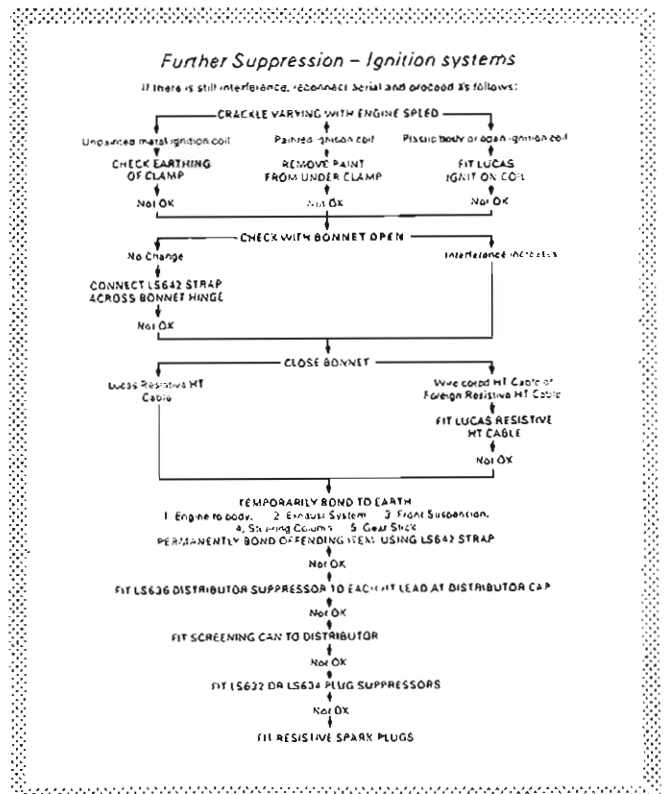

## Additional Suppression

Deal with any remaining interference as follows:

### ELECTRONIC TACHOMETER

Ignition crackle still present after normal suppression – confirmed by disconnecting tach lead.

Connect LS640 choke in series with tach take-off wire at coil/distributor end.

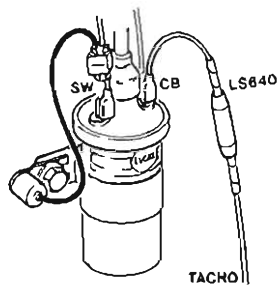

### INSTRUMENT STABILISER

Intermittent burst of crackle – can be provoked by tapping the dashboard.

Fit LS640 choke in the feed to the stabiliser, and if necessary, connect LS827 capacitor across B and E terminals (or B and earth) and LS640 in series with the feed to instruments.

NOTE: When the stabiliser is mounted on a printed circuit board, it will be necessary to make up short flying leads to facilitate suppression. Alternative mounting arrangements may have to be devised. Solder all connections to stabiliser.

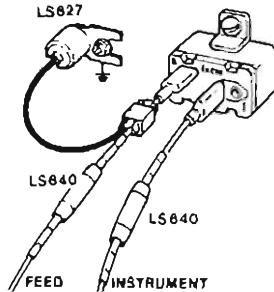

### GENERATOR OUTPUT

Whine varying with engine speed.

Fit capacitor between generator output terminal and earth.

Lucas 16-18-17-18 ACR Alternators	LS829
Lucas 20 ACR Alternators	LS882
Lucas 23-25 ACR Alternators	LS673
Other alternators	LS720
Dynamos	LS628

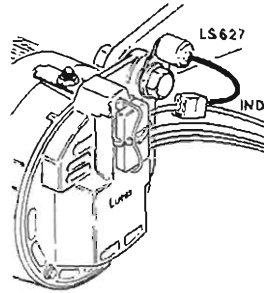
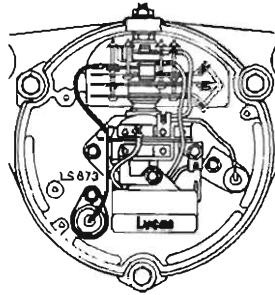

### VOLTAGE REGULATOR

Whine or crackle only apparent some moments after starting; disappears when headlamps and heated rear screen are switched 'on'. Generally not apparent at idling speed.

**Lucas ACR Alternators** (including Delco, Bosch and Fems equivalents). Fit LS627 capacitor between IND terminal and earth.

**Other Alternators**  
Fit LS827 capacitor between regulator positive terminal and earth. Never connect a capacitor to the field terminal.

### DC Charging Systems

Connect LS828 capacitor between control box 0 terminal and earth.

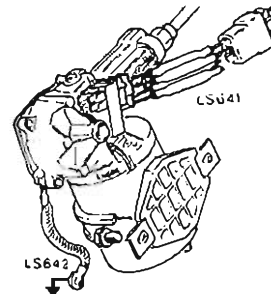
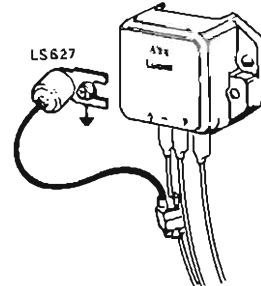

### WIPER MOTOR

Crackling when wipers operated.

Connect wiper body to earth using LS642 bonding strap. If necessary, connect LS83B chokes in each lead to the wiper motor. For Lucas permanent magnet wipers, use LS641 choke assembly.

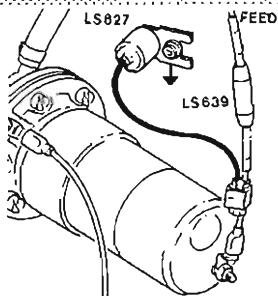

### FUEL PUMP

Whine, crackle or ticking, when ignition is switched 'on'.

Connect LS827 capacitor between feed for fuel pump and earth. If necessary, fit LS639 choke in series with feed.

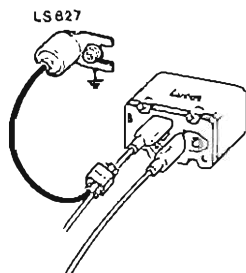

### FLASHERS

Clicking when flashers are operated.

Connect LS827 capacitor between the B terminal on the flasher unit and earth.

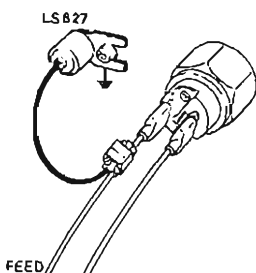

### STOP LAMPS

Clicking when brakes are operated.

Connect LS827 capacitor between feed terminal of stop lamp switch and earth.

### ELECTRIC CLOCK

Regular ticking with ignition 'off'.

Connect LS827 capacitor between clock feed and earth. If necessary, fit LS640 choke in feed lead.

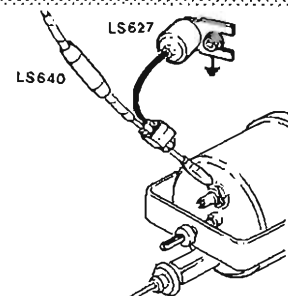

### SCREENWASHER MOTOR

Whine when washers operated.

Connect LS827 capacitor between washer lead terminal and earth.

It is occasionally necessary to fit in addition an LS639 choke in each feed lead.

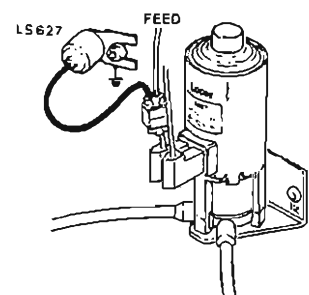

### HEATER MOTOR

Whine or crackle, when heater motor operated.

Connect LS639 choke in series with each feed wire to heater motor. If necessary, fit LS827 capacitor between each feed and earth.

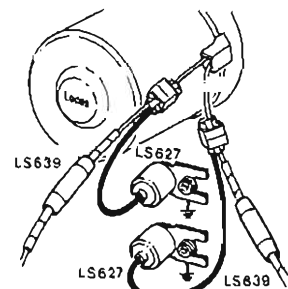



Radios for all frequencies and 400 accessory parts available from the European Specialists:

Albrecht Electronic GmbH  
Lothar Albrecht  
Otto-Mahn-Straße 7A  
D-2077 Trittau GERMANY  
Phone: 04154/3055  
Telex: 218 9406 Agru d

The supplier of RADIO SETS and ACCESSORIES to authorized agents

**SPECIAL OFFER** ALL FIVE BOOKS **£20** INC. P&P.



HOW TO SELECT & INSTALL ANTENNAS  
**£3.95**  
INCL. P&P

CBers SSB HANDBOOK  
**£4.95**  
INCL. P&P

CBers FACT BOOK  
**£3.50**  
INCL. P&P

MODERN CB RADIO SERVICING  
**£5.95**  
INCL. P&P

CB ACCESSORIES YOU CAN BUILD  
**£3.95**  
INCL. P&P

TRADE ENQUIRIES WELCOME ON ALL PRODUCTS-ASK ABOUT OUR FULL RANGE....

**KNIGHT**  
**CB SPECIALISTS**

201 DUNSTABLE ROAD, LUTON BEDS.  
TELEPHONE: (0582) 425722/3

**MIDLAND**<sup>®</sup>  
INTERNATIONAL

**49MHz 2 CHANNEL WALKIE-TALKIE**

COMPLETE WITH WRIST STRAP AND TELESCOPIC ANTENNA- EXCLUSIVE CALL SIGNAL, ALERT TONE, 100MW POWER SUPERHETERODYNE RECEIVER, EASY TO USE. SWITCH ON PUSH BUTTON TO TALK OR SEND SIGNAL. Approx ± 1 1/2 Mile Range- 9 Volt Battery. (not included)

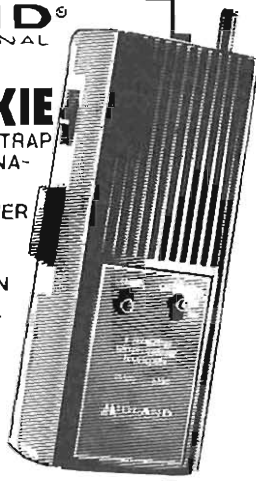

**£29.95** PAIR inc. VAT & P&P

**CB HEAD PHONES**  
Available with blue, red, yellow and black GUMFY-MUFFS Fits all Rigs & Ears!  
**£7.95** INC. VAT & P&P

**APOLLO POWER MIKE** with Switchable ROGER BLEEP  
**£15.95** INC. VAT & P&P

CONVERT YOUR 40ch RIG TO AN **80ch RIG** **£19.95** INC. VAT, P&P  
With the **UFO-40** PIGGYBACK BOARD  
1 1/2" Square Board will fit inside all rigs - Full Instructions. Easy to fit.

DIGALOG TECHNOLOGY INC  
**DIGI-SCAN 400**  
FREQUENCY EXPANDER  
ILLEGAL ALL OVER THE WORLD  
**£89.95** INC. VAT & P&P  
1200 CHANNELS SIDEBAND  
400 CHANNELS AM

**THE TANK**  
MOBILE LINEAR AMPLIFIER  
30 Watts AM-60 Watts SSB COMPLETE with Patch Lead  
**£24.95** INC. VAT & P&P

MAIN AGENTS FOR  
**de**  
ITALY  
TRADE ENQUIRIES WELCOME

THE MOST COMPLETE PRACTICAL GUIDE  
EVERYTHING YOU NEED TO KNOW TO OPERATE A CB RADIO  
Includes with CB Dictionary Glossary and 171 checks and trouble pointers

**C.B.L.P.**  
**£2.95** INC. VAT & P&P

TO: KNIGHT CB SPECIALISTS, 201 DUNSTABLE ROAD, LUTON, BEDS.

Please send me the following items:

1 \_\_\_\_\_ £ \_\_\_\_\_

2 \_\_\_\_\_ £ \_\_\_\_\_

3 \_\_\_\_\_ £ \_\_\_\_\_

Use separate sheet if necessary

Please allow up to 21 days for delivery. TOTAL £ \_\_\_\_\_

NAME \_\_\_\_\_

ADDRESS \_\_\_\_\_

I enclose Cheque/P.O. Payable to **KNIGHT CB SPECIALISTS** for £ \_\_\_\_\_

I wish to pay by BARCLAYCARD  ACCESS  tick.

Card No. \_\_\_\_\_

SIGNATURE \_\_\_\_\_



# LEGAL RIGS!

## AM to FM Conversion

At last a real breakthrough in British CB which is designed in Britain, built in Britain (well Warrington if that counts) by British people. How British can you get.

Finelms Electromec of 50 Parker Street, Warrington have developed circuitry which will convert an existing AM set, straight 40 or side band into a Home Office performance specification rig. This transversion as it's called, takes approximately 40 minutes to fit and will produce a 27 MHz FM Rig with 40 channels from any breakers rig.

As you might well imagine such an innovation has not been arrived at easily. The partners in Finelms, Dave Cross and Pete Ryder, conceived this idea over 9 months ago by almost clairvoyant means. They knew that the government would be making some form of announcement regarding an Open Channel or CB service, and foresaw the eventual demise of AM and the coming of FM. Their commercial sense told them that there would be a lot of redundant AM equipment about come legislation and that a lot of existing breakers, whilst quite happy about CB on

FM would just not be able to afford to buy a new FM set.

At this stage the considerable technical skills of Bill Sparks (what an appropriate name) an experienced radio ham and lecturer on radio communications at Warrington Technical College, were called upon to develop the FM transverter. Bill's considerable technical skills enabled him to predict quite accurately the frequency and channel specifications of the Home Office specifications. Bill, with the assistance of Charles Bushell started gathering together test equipment and components from a whole host of British manufacturers and immediately started work on the laborious task of achieving high FM quality from standard AM sets.

Finelms needed a supply of AM rigs on which to develop and test their transverter and instead of relying on black market suppliers, went to the Home Office Radio Regularity Department and started a lengthy discourse (which is still going on).

One positive result of this conversation is that Finelms were given a test and development licence and permission via C & E to import and use a number of AM sets. The home office have been and are still being highly co-operative which leads me to ask why aren't more people seeking H.O. co-operation and help rather than shouting? Mr. Howarth and Mr. McChlachan of H.O. Excise and Mr. Mouat and Mr. Butcher of C & E along with Mr. C. J. A. Parker (responsible for issuing an FM manufacturing licence to Finelms) have all been extremely helpful individuals whilst dealing with these matters.

The result of months of hard work was shown to me on July 29th (Royal Wedding Day) when on being summoned to Warrington I was given the opportunity of actually using a rig which had been transverted to FM by Finelms. The entire staff of the company had been working all through the previous night making final adjustments to the set and as a result were all biting their fingernails at the time of my arrival.



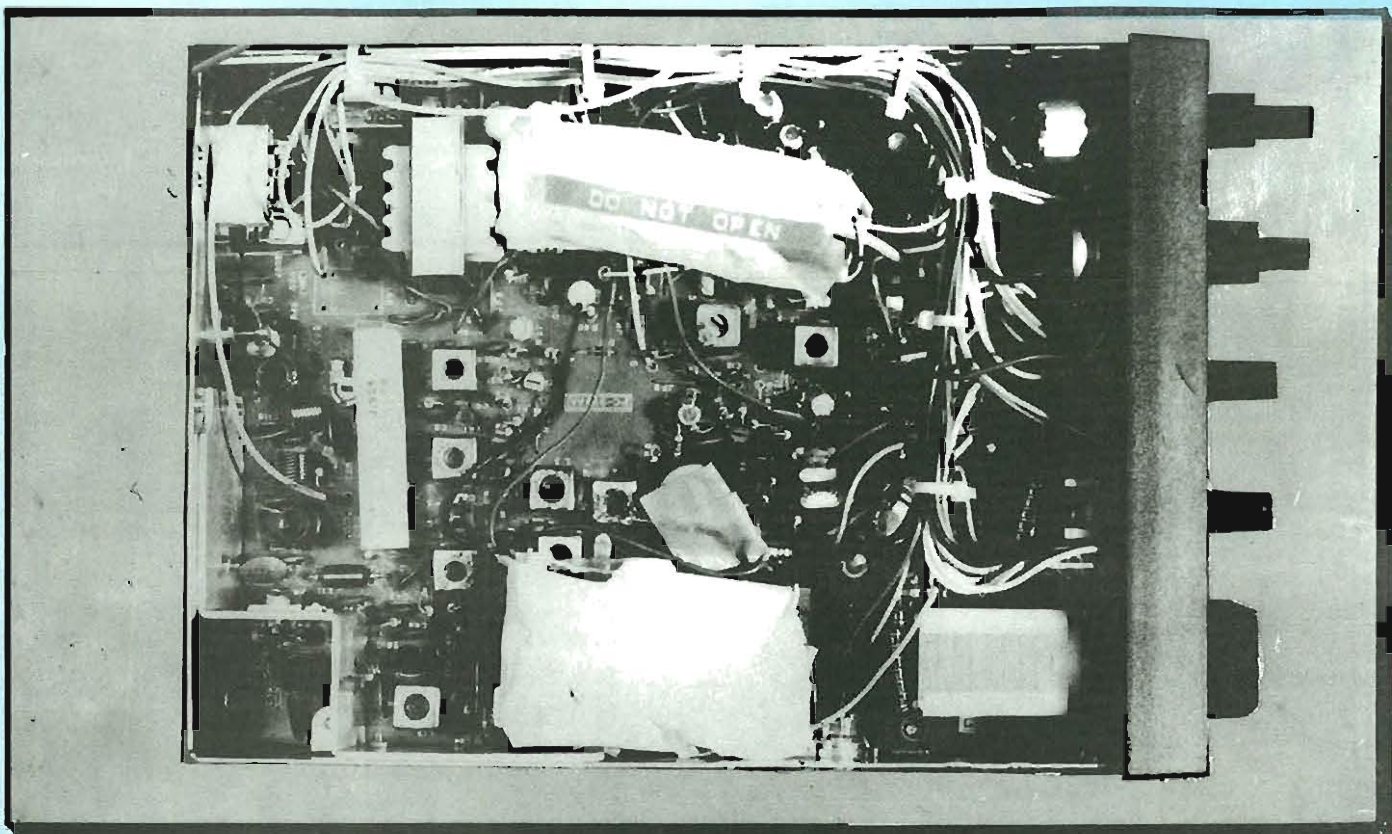

The base station used for the test was a suitably transverted Super Tiger running off a standard power supply using a half wave centre loaded antenna with a small ground plane. The antenna was affixed approximately 5 metres up on the front of Finelms premises. The mobile set was a Midland 150M installed in a Red Chevrolet Monte Carlo using a standard K40 wire type antenna. No amplifiers of any description were used throughout any part of the test. The test was entirely practical and as soon as we are able an independant engineer will take a good look at this system. For reasons of commercial secrecy Finelms are not allowing anybody to inspect or test their invention until it is properly legally protected.

Driven by Dave we set off around Warrington, which incidentally was deserted (caused by the entire population being glued to their TV sets to watch Charles' and Diana's big day). Using the test licence number G95 SU we used the converted rigs under a variety of conditions. We burnt rubber literally up and down dual carriageways, in between tall buildings and got what I consider to be perfect copies up to 7.4 miles away from base. The majority of the test was undertaken with the squelch right up ensuring that we only picked up the strongest of signals. Even surrounded by concrete the signal came in loud and clear. Worth pointing out at this stage is that the Finelms premises are exactly opposite the British railway mains generating plant at Warrington which consists of tons of steel creating all sorts of magnetic fields. This generating plants signal can be picked up happily by the test equipment on the company's property but had little or no effect on the audio quality of the transverted rigs.

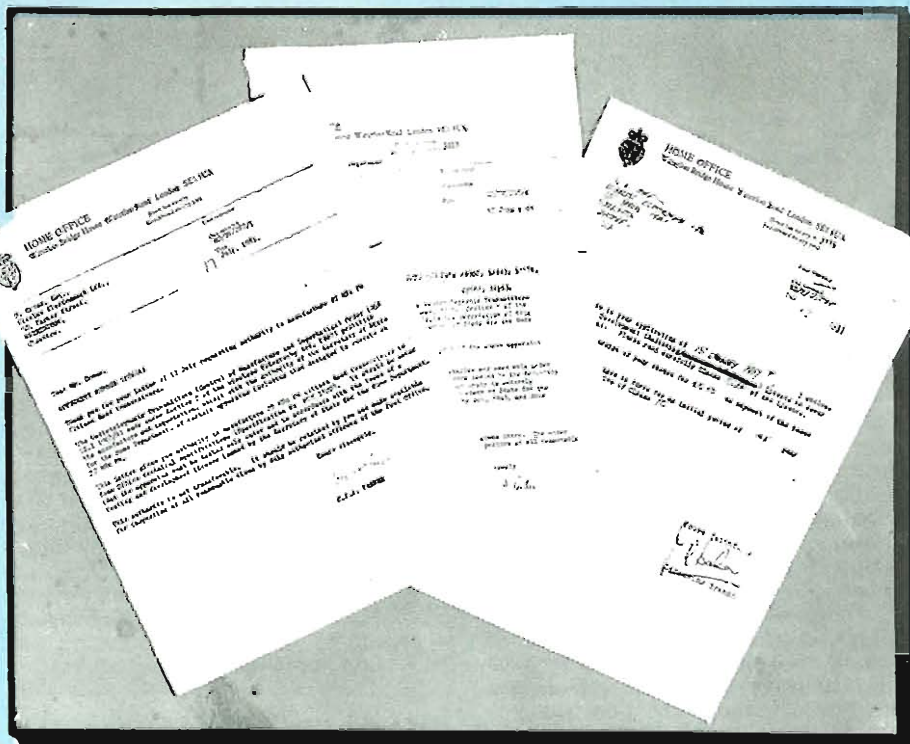

### Speech Processor.

An extra feature on the transverter circuit is a speech processing facility. This works very effectively as proved to me by sitting in the back seat of the Monte Carlo and talking into the Mike while the driver held it. The base station reported back a perfect copy without knowing my position in relationship to the microphone.

Audio quality is one thing that Bill has strived hard to achieve. I think he's got

there, but now he won't be happy until he has achieved BBC FM transmission standards (stereo CB?). Bill was most upset that a components delivery had let him down and BBC type CB wasn't available for me to hear. What I heard was pure undistorted sound at a far range. Perhaps with the use of repeaters if allowed, the range could be bettered, apart from that my verdict is very favourable. The channel spacings were excellent with no pollution emerging through on the channels adjoint to the transmissions.

# LEGAL RIGS!

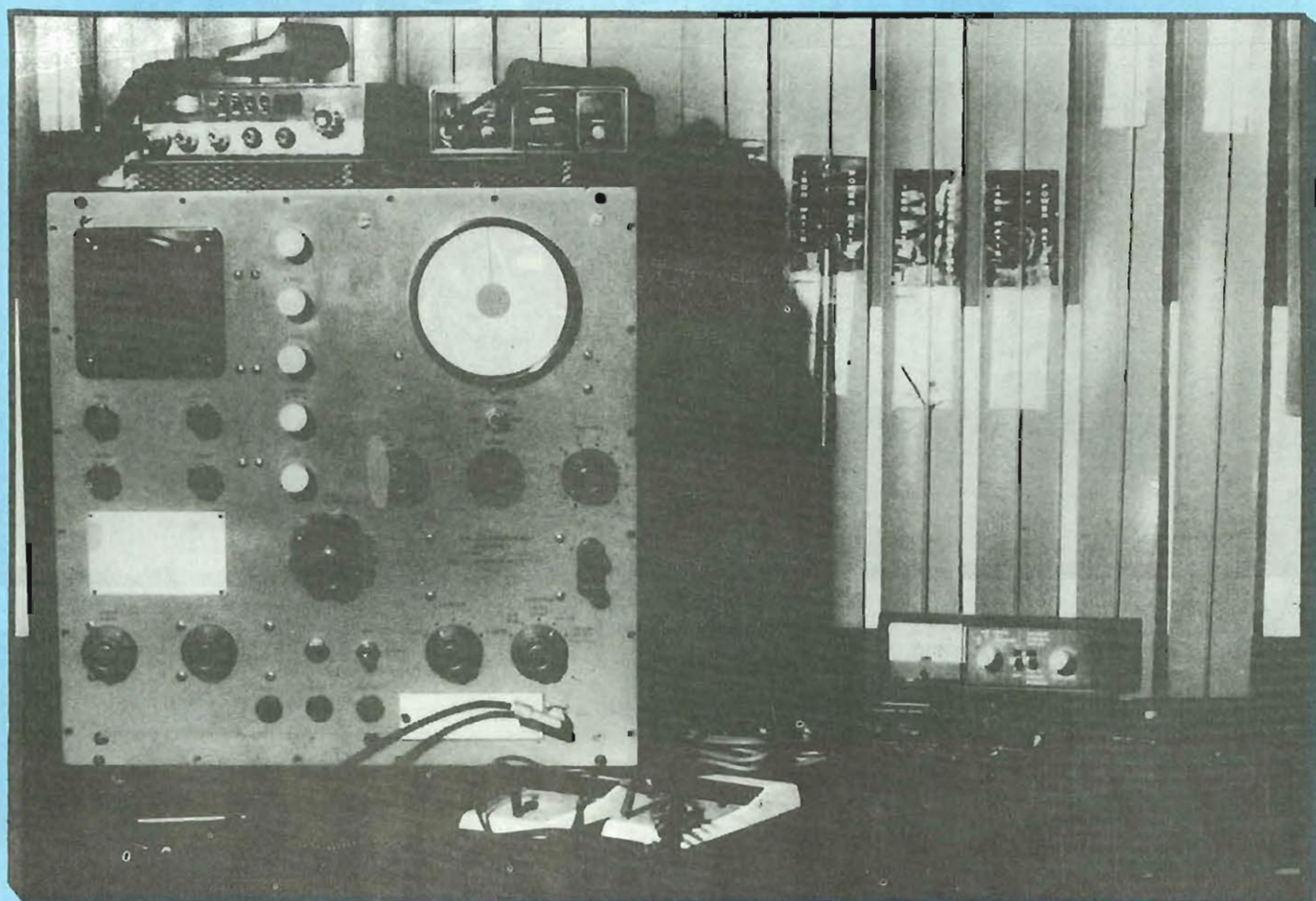

## Make your rig legal.

Well not the type of amnesty you are hoping for i.e. a run in period of time during which AM can be used until full implementation of Government Specification FM. However another part of Finelms discussions with H.O. & Customs and Excise is to sort out an all inclusive price for their transversion circuit to include back duty for the import rig. This gives the breaker the right to take his AM rig in for conversion to FM pay his dues to the Government and obtain a full CB licence as a result. The price and approval for the above mentioned scheme has still to be settled by Finelms who with their so far good relationship with the various official bodies are confident that a sensible price, within the financial capability of most breakers can and probably will emerge.

It's anticipated that the Finelms transverter will be available throughout the country from numerous appointed fitting agents. The official date is all that is now required to enable you the breaker the opportunity to drive in with AM, drive out with FM whilst still airing your original rig.

## New Projects.

Not content with just converting on rigs to FM Finelms are developing a totally new totally British rig. They have already got their manufacturing licence and a factory is currently under negotiation in Warrington. If they are fast enough this will be the first rig with a totally British pedigree. Their factory will be capable of producing 2000 rigs a week and they are confident that price wise their products should be capable of competing with imports from the Far East.

## Sorry Old Bean

"We have been asked to apologise to Modmags Limited, the publishers of **C.B. Citizens Band Magazine** for certain statements contained in an article entitled "**Citizens Band Exclusive**" which appeared in the June 1981 issue of **C B Radio**. We are satisfied from information supplied to us by Modmags that certain statements were incorrect and we have no hesitation in apologising to them.

In particular, we acknowledge that no other magazine carried a report or a similar report on equipment referred to in the

original article entitled "**Rig Review**" which appeared in the May 1981 issue of **C B Citizens Band Magazine** and therefore the article was correctly described as exclusive. We also apologise to Modmags for our failure to obtain their permission to reprint parts of their article and the photographs contained therein, thus infringing their copyright".

## Again?

Our sincere apologies go to Buzzing Bee who in our July edition was referred to as somebody without experience in CB. On further investigation this has been found to be untrue and we are sorry for any misunderstanding which may have arisen as a result of the Legal Rigs article.

**CB  
RADIO**



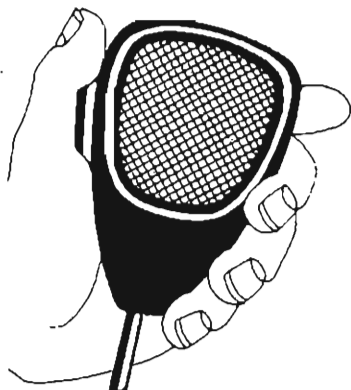

# CONNEXIONS ARE PROUD TO ANNOUNCE

**Sole U.K. Distributorship  
for the Famous.**



Including  
the all New

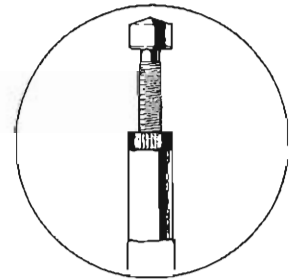

Revolutionary **'DIESEL-STIK'™**

## THE TUNABLE TIP ANTENNA.



Tunable over the full 27<sub>MHZ</sub> Range.



Operates on existing A.M. and the New  
British F.M., as well as SSB.



**NO TOOLS REQUIRED.** Simple hand  
adjustment.



Power Rating: -1000 Watts.

**TRADE ENQUIRIES:**

**Tel (062-882) 4338/9**

Or come and see us at:

- Connexions -  
Furrow Way, Cannon Lane  
Maidenhead, Berks SL6 3NY.  
Telex: 881 3271 GECOMS G

# Connexions

# DX QSL

# INTERNATIONAL

# CLUB SPOT



## Aloha, Kakou from Charlie Hotel.

Aloha Kakou, Pehea oe, Heaha ka mea hou? Well I did warn you that I was going a wee bit exotic this month.

For the benefit of our non-Polynesian readers what's being said is, Greetings to all, how are you, what's new? Now this doesn't mean that I am an expert in foreign languages. All it means is that I have been given a few helpful hints by Bruce Coffman of the Aloha Paradise QSL Club of Hawaii.

### QSL Envelopes.

How are you all finding the QSL scene these days. There's always something new cropping up isn't there? What never fails to delight me are the different styles which people use when posting off their cards.

Some cards are posted in plain envelopes, some in envelopes covered with club stamps and CB style stamps (my own personal favourite style) and some (mostly from Australia) beautiful art work style envelopes. Another method which seems to be popular is envelopes which are specifically designed for CB'ers and QSL'ers.

The nicest part is where you normally put the address. It's already lined up for you with the immortal words;

'To: CB Station' emblazoned across. Sheer magic. I can hardly wait for the day when good old Woolies will be selling them by the 1000's.

Another nice envelope which I've recently received came from Garry Scally, SWAG-MAN 153, of West Australia. On the face of it, his Airmail envelope is 100% normal. It was when it was opened up that it was revealed in all its glory. On the inside of the envelope is a map of Australia plus all the surrounding oceans. Quite an interesting idea that one. It saves checking up in an Atlas to see exactly what's what and where it's at.

### International S.A.E.'s

Speaking of envelopes, do you recall the free club mentioned in the July issue of CB

Radio - The Cheese Eaters Swap Club of Norfolk, Virginia, U.S.A. It was free OK. The only hang up being the Stamped Self Addressed envelope. Well, this puzzled me for a while. Surely in this day and age there must be a way in which you can send a S.A.E. abroad. I know Amateurs have been doing it for years for one reason or another, but how it was done had me stumped. Eventually, my local friendly post office man came to the rescue (again).

'What you need young man is an International reply coupon, form no.C22' and lo and behold, the secret of World Wide stamped addressed communications has been exposed once and for all.

It's quite simple really. It's just a wee slip of paper, costing a mere 30p. Apparently this coupon can be used in any country which is a member of the Universal Postal Union (just about all countries). What happens is, this coupon is exchanged for one or more postage stamps representing the minimum postage for an unregistered letter sent by surface to a foreign country (their wording, not mine). Quite useful if you're sending correspondence somewhere which requires a stamped addressed envelope - and surprise, it actually works!

### QSL Club Survey.

The E.I.D.X.C. has been writing these DX/QSL club articles for quite a while now. I've been pleasantly surprised to occasionally receive correspondence relating to the articles. In fact, more than surprised, delighted is probably the right word. All very nice but something has been niggling me for quite a while. I've yet to receive correspondence which concerns the writers own favourite clubs, as opposed to clubs which have featured in this series of articles. I'm often tempted when I write back to ask 'What are your fave clubs?'

Well I'm now going to take the Bull by the Horns.

'What are your own personal favourite DX/QSL clubs?' In other words, I think it's about time that we ran a popularity poll on DX/QSL clubs. Give the matter some

thought and if you'll be so kind, drop me a card, stating, say your top three clubs in order 1,2,3. Please send this card to me C/O E.I.D.X.C., 225 ARNOLD STREET, BOLDON, TYNE & WEAR NE35 9BA.

### Aloha Paradise QSL Club.

Now then, a temporary change of format. I thought that for the next couple of issues I would leave the basic 100% pure QSL type of club alone and tell you about some very interesting clubs, which although they are not quite QSL clubs in the accepted sense, are nevertheless well worth knowing about.

The Aloha Paradise QSL Club of Hawaii is one such club.

The Aloha Paradise was founded a few years ago by Bruce Coffman, its headquarters being P.O.Box 667, Aiea, Hawaii 96701.

Incidentally, Bruce's full name is Arlen Bruce Coffman, easy to see how his AM Handle of 'The Alphabet Man' came about - A.B.C.

When Bruce founded the club, he had one intention in mind. To spread 'Aloha' to the four corners of the world by means of QSL correspondence and friendship.

Aloha is a word of many meanings depending on the circumstances when used. To briefly define it, Aloha is a greeting of Welcome and also a bid of farewell, generally used when friends arrive or depart. Aloha means Love, Love and respect for all mankind regardless of race, religion or national origin.

Up till the end of May 1981, the Aloha Paradise had 353 members, spread over 17 different countries.

Not a fantastic amount of members you're probably thinking to yourself. True, but there is a reason for this. One of the special attributes of the Aloha Paradise Club is that members can only join via a reference from another member. Quite a unique occurrence in the DX/QSL world.

The full membership package costing 9 U.S.Dollars include club certificate, membership roster, colour postcards of Hawaii,

10 members QSL cards, special Hawaiian pamphlet and a rather special gift 'A little bit of Hawaii' (explained in full further on).

The Aloha Paradise also offers a Money Saver Special costing 4.50 Dollars. This package consists of a club certificate, 10 members QSL cards, some colour post-cards of Hawaii, membership roster and a club rubber stamp. Due to the exorbitant cost of Air Mail (well it is in the middle of nowhere after all) Foreign members have to tack on to these costs, another 2 U.S. Dollars to cover Air Mail.

### A Little Bit of Hawaii!

'A little bit of Hawaii' is rather special. Believe it or not, what Bruce sends out is a small bag of sand taken from Wakiki beach. Run you fingers through it and you can imagine the Beautiful Dusky maidens and the Boyo's out on their surfboards! Wonderful stuff.

Bruce is not only a keen QSL'er but is also a very keen CB'er/DX'er taking an active part in his local CB scene.

Back to Hawaii itself. Since its early beginnings, CB Radio has come a long way in Hawaii. An estimated 1 out of every 75 people, own and operate CB equipment, either in their cars or homes.

Well now, should anybody be interested in knowing more about the Aloha Paradise club or the Hawaiian Islands, Bruce will be

Aloha Paradise DX-QSL					
	Star Rating	Yes First Class	Fair Second Class	Third Rate	No
1	World Recognition		★		
2	Distribution		★		
3	QSL Response Time	★			
4	Club Stamp	★			
5	Club QSL Cards		★\$6.00 per 100		
6	DX Unit Number	★			
7	Wall Chart	★			
8	I.D. Card				★
9	Club Roster	★			
10	Club Patch/Badge				★
11	DX Log Book				★
12	Club Accessories				★
13	Club Information	★			
14	Tourist Information	★			
15	Cassette Swap				★
16	Club Postage	★			
17	Life Membership	★			
18	Discount XYL Membership	★			
19	Value For Money	★			
20	Overall Presentation	★			
<b>Total Star Rating</b>		12	3		5

only to pleased to write and answer your queries, but because of those horrific mailing costs, he would appreciate it if you enclosed a S.A.E.

As is customary, I've done a QSL star rating but strictly speaking its not really applicable here. Although its star rating

does not appear to be too good, don't read too much into it. Take from me, the Aloha Paradise QSL club of Hawaii is a unique organisation and warrants a special mention in the DX/QSL world.

Good DX'ing and nice QSL'ing to you all. Aloha from Charlie Hotel. Echo India 25.

QSL CARDS — QSL CARDS — QSL CARDS — QSL CARDS — QSL CARDS — QSL CA



**CHOOSE FROM OUR RANGE OF 21 PREPRINTED QSL CARDS:**

- ★ PRINTED BLACK WITH CHOICE OF FIVE CARD COLOURS
- ★ FULL RELEVANT INFORMATION ON REVERSE SIDE
- ★ CARD SIZE 5"×3 1/8".

**SEND A STAMPED ADDRESSED ENVELOPE FOR OUR LISTS**

- ★ WE CAN PRODUCE CARDS TO YOUR IDEAS OR DESIGNS:
- ★ OUR ARTISTS CAN ILLUSTRATE YOUR HANDLE OR HOME 20
- ★ SPECIAL DISCOUNTS FOR CLUBS

**ONLY  
£3.40  
per 100**  
(p&p 60p)

**ONLY  
£15.00  
per 250**

Big Dummy's Guide £2.95 (post inc.) Screwdrivers Expert Guide £4.95 (post inc.)  
DX Log Books £1.50 (post inc.) Sample Pack of 20 assorted QSL Cards £1.20 (post inc.) (p&p £1.00)

**SANDHURST  
PUBLICATIONS**

49C YORKTOWN ROAD  
SANDHURST  
CAMBERLEY  
SURREY, GU17 7AG

TELEPHONE  
ENQUIRIES:  
SOUTHAMPTON (0703)  
443008

# A BIG 10-4 FROM ROGER SQUIRE'S

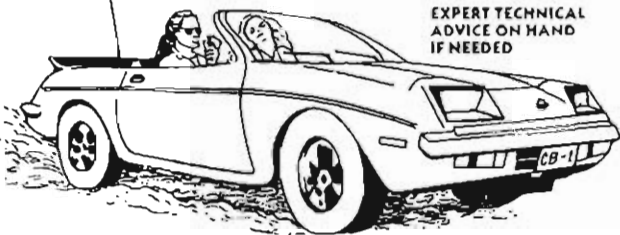

EXPERT TECHNICAL  
ADVICE ON HAND  
IF NEEDED

## CB RADIO DEPARTMENTS

**NOW OPEN**

Featuring the most comprehensive range of Accessories at the keenest possible prices! Our range includes:

Open Mon-Sat. Weekdays until 7p.m.

All types of Antenna — Shakespeare, Firestik, and many others! Linear Amplifiers 25W — 100W, SWR Meters, Antenna Matchers and Trimmers, Dummy Loads, Standard Mics, Power Mics, PSU's, Suppression Kits, TV1 Filters, PA Horns, Ext. Speakers, in fact EVERYTHING YOU'D EVER NEED!

## Roger Squire's

**LONDON** 176 Junction Road, London N19 (50 yds Tufnell Park Tube Station). Tel: 01-272 7474.

**BIRMINGHAM** 220 Broad Street, Nr. City Centre. Tel: 021-643 6767.

**MANCHESTER** 251 Deansgate, M3. Tel: 061-831 7676.

**GLASGOW** 1 Queen Margaret Road (Off Queen Margaret Drive), Kelvinside G20. Tel: 041-946 3303.

# SOUND AROUND

CAR RADIO AND STEREOS  
SUPPLIED, FITTED & REPAIRED

01-575 5030

SOUND AROUND FOR  
ALL YOU REQUIRE IN CB  
OR IN CAR ENTERTAINMENT

**CB ACCESSORIES**  
SOUND AROUND  
114 RUISLIP ROAD  
GREENFORD  
MIDDLESEX

© CB Radio.

Ever been to a  
warehouse and been  
wound up?



wrong stock! no stock!  
wrong prices! no returns!

NOT AT

# ACORN

THE LEADING CITIZENS BAND WAREHOUSE  
WE STOCK THE LOT!

FORGE YOUR  
SIGNATURE  
BELOW

**K40** TRADE ENQUIRIES ONLY

BE A REGISTERED ACORN DEALER BY RETURNING COUPON TODAY  
SPECIAL FREE GIFT OFFER FOR ALL NEW ACCOUNTS

Name \_\_\_\_\_

Company \_\_\_\_\_

Address \_\_\_\_\_

Position \_\_\_\_\_ Tel: \_\_\_\_\_ CBR/9

**ACORN TRADING (CB) LTD.**

UNIT 43, OFF ROMAN WAY, COLESHILL IND. EST. COLESHILL, BIRMINGHAM B46 1JT. TEL: (0675) 64136

## NEW! SEE BREW FOR C.B.

Come September there's going to be a lot of rubber ducks, smokey bears, 10-4's and convoys buzzing about the airwaves so you better find out what they all mean by getting down to the new C.B. Radio centre at Brew Brothers.

Yep, everything you want to know about C.B. Radio can now be found at Brew.

Our new department stocks aerials, handbooks, instruction packs, microphones, in fact everything except the new FM sets, (which don't become legal till September). We'll give you expert advice on fitting, on use and on operation to ensure that you get the most out of this great new craze.

So get yourself down to Brew and learn a thing or two about C.B. Radio now. We open Mon-Sat 8.30-5.30 Sun 9-1.

**BREW for**

C.B. Centre in the Motorist Shop behind the showroom at 133 Old Brompton Road, South Kensington SW7. Tel: 373 3333.





**TRUCK KING**  
**867 ST ALBANS ROAD**  
**GARSTON, WATFORD, HERTS**

**09273-61673** 



A COMPLETE NEW RANGE OF CB TEE-SHIRTS — ALL IN FULL COLOUR. WE CAN ADD YOUR HANDLE TO THESE OR YOUR CLUB NAME — WHATEVER YOU LIKE! ADD 10p PER LETTER FOR THIS.

**NEW**



1. You've Just Eyeballed. The bottom part of this design is for your handle. Add 10p per letter for this.



2. Keep Your Shiley Slide Up.



3. Break. King of the Road.



4. Cobra.



5. British Breaker.



6. CB Station.



7. Have A Nice Day.



8. World's Greatest Skip Talker.



9. Super CB Operator.



10. This is CB Country.



11. Rubber Duck. Keep On Truckin.



12. Licensed CB Operator.



13. UK CB Operator.



14. CBers Are Great Lovers.

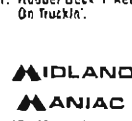

15. Midland Maniac.



16. Firestik.



17. I'm So Happy.

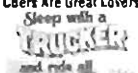

18. Sleep with a Trucker.

## T-SHIRTS - Mail Order Price

Colours - Black, White or Red. Sizes S-M-L-XL. £3.25 inc. Post & Packaging.

USA Sweat Shirts - Colours - Black, Grey, Red or Navy. Sizes S-M-L-XL. £6.75 inc. Post & Packaging.

Children's Tee Shirts - Sizes 20-32. £2.75. (Colours limited on these - give 2 choices - White, Black, Red, Navy).

Don't forget — for lettering, handles etc. add 10p per letter.

If you require a second print on the back add £1.00.

We can quote for club Tees & Sweats — Please enquire for quote.



**USA BREAKERS CAPS — ONE SIZE ADJUSTABLE TO FIT ANY HEAD — COMPLETE WITH YOUR OWN CHOICE OF EMBLEM.**

COLOURS — CHOOSE FROM BLACK, BLUE, RED, GREEN OR YELLOW.

EMBLEMS - CHOOSE FROM Midland, President, Cobra, Turner, Hygain, Lafayette, K40, Avanti, Shakespeare, Firestik, Ham Int., Stalker V. We monitor Ch9/Ch14/Ch16/Ch19, Break 19, 19 Diesel Mobile, My Daddys A CB Trucker, My Daddy is a CBer, My Mammias A CBer, World's Greatest CBer, Worlds Greatest Skip Talker, Don't Be A Channel Hog, Licensed CB Operator, Super CB Operator, British CBER, Have A Nice Day The CB Way, and 73's 88's Forget 10-36s - Buy a Watch, 10-7 Out of Service, Bet Your Sweet Ass I'm A CBER, What's Your 20, What's Your Handle, Modulate With Me, Mercy Sakes, Big Numbers To You, Got The Hammer Down, Beaver Powered, Wanted-Seat Cover Report, Watch For County Mountie, I Run An Alligator Station, Good Buddy, Rubber Duck, New York CB, Breaker That's No Rubber Duck, 10-8, 73's, 3's and 8's, 88's, Keep Smokey Out Of Your Britches, USA-CB Country, CBers Keep The Lipstick Off Your Dipstick, CBers Help The Law, I Operate Barefoot, Rachel Jaw, No 1 Skip Talker, Watch The Bears, Professional Beaver Hunter, Don't Feed The Bears.

**CAP & BADGE £3.95 BADGE ONLY 75p.**

**CAP ONLY £3.20 (ALL PRICES INC. P&P)**

Cheques/PO with order to

**TRUCK KING, 867 St. Albans Road, Garston, Watford, Herts. Access/Visa Orders Tel: 09273-61673**

# CB Accessories

Probably the cheapest in the country. Don't waste your time and money with butchers and bakers, we are a longstanding CB Shop run by breakers for breakers. We have a fitting, SWR and repair service and give free, sensible advice. Some of our accessory prices are listed below, most of them compare with UK WHOLESALE PRICES. We don't run loss leaders to get you to come in - ALL OUR PRICES ARE LOW. (Quoted CB accessory prices are 'over the counter'. Please phone for Mail Order quote).

2-3.5A POWER PACK.....	£8.65
3-5A POWER PACK.....	10.50
5-7A POWER PACK.....	16.25
SIGMA IV.....	49.95
STARMASTER.....	17.50
BIG STICK.....	21.95
GPZ 5/8 WAVE.....	28.00
GPZ 1/2 WAVE.....	21.00
STD 1/2 WAVE DIPOLE.....	9.95
CITY STAR 1/2 WAVE.....	18.95
FIRESTIK UFO BASE ANTENNA.....	25.00
WHISKY 4.....	12.95
ASTRO 8 BASE ANTENNA.....	7.95
LOFT/OUTDOOR ECONOMY ANTENNA.....	5.95
GROUND PLANE KIT.....	5.95
BASIC SWR.....	5.95
SWR/FS/POWER METER.....	9.50
SWR/FS/POWER/DUMMY LOAD/ MODULATION/CRYSTAL METER.....	25.00
60W AM/SSB BURNER.....	45.00
100W SKIPMASTER.....	85.00
150W SKIPMASTER.....	110.00
100W ZETAGI MAINS BURNER.....	95.00
MATCHER.....	3.60
SPLITTER.....	4.20
MOBILE RETRACTABLE.....	6.95
DV27 (SIRTEL).....	4.90
DX 27.....	8.20
K27.....	8.95
T27.....	7.20
K27 TRIBAND AND SPLITTER.....	12.95
K40 ANTENNA.....	26.95
2' FIRESTIK.....	5.95
7' FIRESTIK.....	9.95
TWIN FIRESTIK.....	34.00
ECONOMY MAG MOUNT.....	5.95
DX 5/8.....	13.50
4' HYGAIN GYPSY.....	5.95
RG58 COAX.....	25p YD
RG8 COAX.....	45p YD
PL259.....	0.45p
49 MHz WALKIE TALKIES.....	13.95
GUTTERMOUNT.....	3.95
MIRROR MOUNT.....	3.95
CB/AM/FM MONITOR AND RADIO.....	15.25
REPLACEMENT MIKES.....	3.95
ECONOMY POWER MIKES.....	4.95
TURNER - 2 MIKE.....	22.00
HAM MASTER 4500.....	29.95
K40 SPEECH PROCESSOR.....	26.95
PA HORNS.....	4.95
PA/ALARM HORNS.....	6.95
EXTENSION SPEAKERS FROM.....	3.25

**RIGS £50 - £60 - COBRA, PRESIDENT REALISTIC, KRACO, GEC HYGAIN, MAJOR** (Phone for stock situation)

**Books, Mags, LPs and Cassettes, CB Tee Shirts, Caps Badges, Stickers, Sewons.**

# Vultures on the Side



## Black Baron fights the system.

There is an uneasy feeling amongst breakers at the moment that if you want a quiet life it's easier to accept confiscation and attendant hassles rather than risk further trouble by fighting it.

One breaker who doesn't agree with this point of view is Black Baron from Folkstone in Kent. An active breaker in the area, Black Baron found two Home Office Officials on his doorstep at 10.45 pm on the 11th March. One of the officials, Mr. Marsh, told Black Baron and his wife that they were acting on a complaint of interference of the aircraft directional beacon at Reindeer Wood, affecting the approaches to Manston and Heathrow. Black Baron was naturally alarmed that his hobby could cause such danger, and after being told that he could 'do this the easy way or the hard way' permitted the officials to enter his home. He was worried that the 'hard way' could involve force and police involvement and as he had a 2 year old child and a new baby asleep he did not want any unnecessary disturbance.

## Why not be a Radio Amateur?

After some discussion and disagreement Black Baron presented his boxed Base rig to Mr. Marsh who suggested that if he were so interested in radio he should study to be a Amateur Radio operator, although it was unlikely he would be allowed to operate from his home because of the Reindeer Wood beacon. The base rig was connected up and found to give only 3 watts output although Black Baron had been told that the interference was due to the transmitter power. Black Barons mobile rig was then brought in and both were officially confiscated and two rather dubious looking receipts given. Black Baron was wary of the receipts and asked to see their identification again - he was shown a Home Office identification and a GPO identification card. (No warrant was presented).

After time for calmer consideration Black Baron went to his solicitor for advice. His solicitor sent a letter to the South East Telecommunications office saying that Black Baron had been 'hoodwinked' into permitting Mr. Marsh to confiscate his

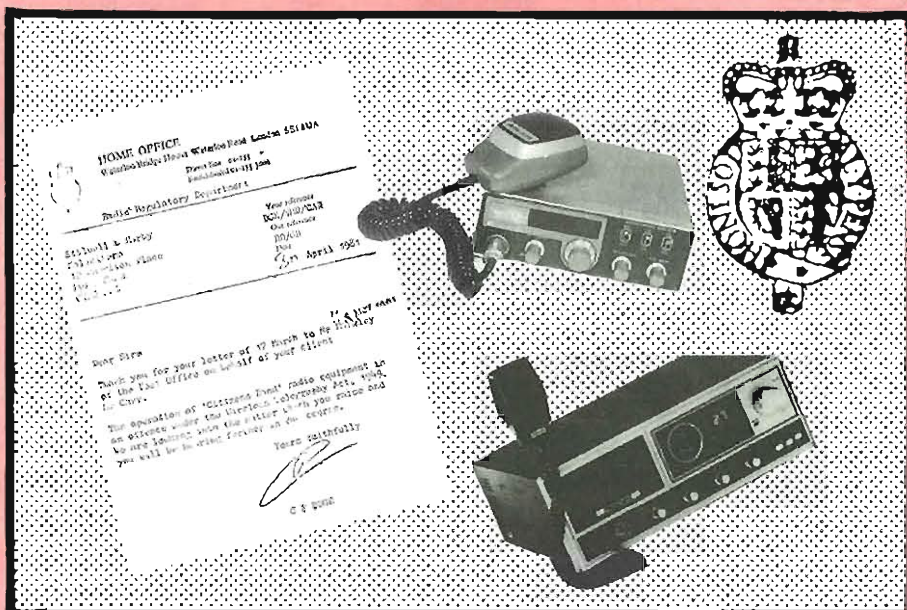

equipment by veiled threats, that the equipment had been confiscated without warrant or authority and that he (the solicitor) considered the impoundment 'unlawful'. No answer was received so 2 months later Black Baron himself wrote asking for his two rigs back as he had never admitted transmitting and no notification of prosecution had been received.

## Repeat performance.

A letter eventually arrived from the Home Office saying they were 'looking into the matter' and that Black Baron and his solicitors would be hearing further in due course. Before they could hear further Black Baron had another night visit. Not one to give in easily he had gone back on channel and had in fact co-ordinated the search by 200 breakers for a missing child the previous week, so the sight of a police car outside the house earlier had not worried him. But at 9.30 pm three Home Office men and two policemen entered his house with warrants and told him they

suspected he was operating illegal CB Radio. Black Baron and his wife were cautioned and the house was searched waking up the two young children in the process. The President Madison and a Midland 3001 were removed and confiscated. Two further Home Office men were positioned at the end of the drive presumably to prevent Black Baron from running away.

Did this further episode happen because Black Baron dared to query the authority of the Home Office or just coincidence? 5 Home Office officials and two policemen is a very obvious demonstration of power (and a very obvious waste of public money). I am sure that if Black Baron had been presented with evidence and proof of his interference to an aircraft beacon he would have gladly stopped transmitting at home but Black Baron believes there could well be a third bust on the way (incidentally he is the only person to be busted at all in his area) and he is beginning to feel as determined as the powers that be! Things are at a stalemate at the moment as both parties wait for the next move.

SS



**IN 25 YEARS...  
WE'VE NEVER BEEN OUTDISTANCED.**

# antenna specialists brand CB antennas...

- Highest quality materials and workmanship • Meets highest performance standards — VSWR 1.5:1 or better, all models • Same professional quality materials, designs and workmanship found in A/S police and professional antennas • Reference for all gain figures — 1/4 wave ground plane



## SUPER SCORPION M2000

### Features

- Precision machine ground tapered whip has less air resistance and less pattern distortion due to whip bending. Highest quality 17-7 PH stainless steel can be bent full circle and still snap back to perfect vertical!
- True static ball tip for continuous dissipation of wind static build up and less noise!
- Full 60-inch radiator surface for maximum range. VSWR 1.5:1 or better from channels 1 to 40 without tuning.
- Antenna Specialists' LEVERLOK™ quick release. Firm, positive electrical and mechanical connection. Instant disconnect, with the twist of a lever.
- Top grade silver mica transmitting capacitor for consistently lower VSWR under extremes of humidity and temperature.
- Stainless steel shock spring absorbs blows from branches and garage doors.
- Silver-plated phosphorous bronze spring contacts. The superior high frequency efficiency of pure silver. Plus spring contacts assure positive continuity for years.
- Guaranteed satisfaction with 5-year limited warranty PLUS lifetime call burnout warranty.

### Specifications

- Model ..... M2000
- Whip ..... Tapered 17-7 PH stainless steel. Full 60" length.
- VSWR ..... 1.5:1 or better. Channels 1 through 40.
- Cable ..... RG-58U, 17' with in-line (1/2" dia.) miniature connector.
- Connector ..... PL-259.
- Mount ..... Trunk lid, no holes or roof mount (3/8" hole).
- Total Height ... 65".



M2000



## CB5000

CB/AM/FM DISGUISE ANTENNA. 5 section locking telescopic. Diplexer pre-tuned. Fine tuning only required. Power rating 50W. (The replacement for the MB10).  
Plus all the other popular models, MS264, M125, MR440, STARBUSTER M400, MIGHT MAGNUM M227 etc.



## 'SKINNY MINNIES' ASC 550, 556

### Features

- Available in 7 colours "Skinny Minnie" fibre glass whip, manufactured only by A/S to professional standards for optimum reliability, long life.
- Solid brass connections imbedded in base. Can't break or shake loose.
- True 3/4 wave professional design for best possible fibre glass performance.

### Specifications

- Models ..... ASC 550 to 556.
- Whip ..... 3', 4' & 5' fibre glass, 3/4 wave.
- VSWR ..... 1.5:1, all 40 channels.
- Connector ..... PL-259.
- Mount ..... Fits any 3/8" - 24 thread.

## ORIGINAL TELEPHONE TYPE M.125

World's most copied CB antenna! Standard of the industry, designed and constructed exactly like our lo-band police antennas.

### Features

- High-efficiency base load design, with waterproof loading coil and mount for maximum reliability.
- 17-7 PH stainless steel (finest grade available) taper ground for resiliency and low wind resistance. Bends full circle without taking a set.
- Static ball tip for less noise.
- Stainless steel shock spring minimizes damage from obstructions.
- Ample 17' coax cable with attached connector.
- Mounts securely and easily on any flat metal surface. Waterproof design. Requires 3/8" hole.

### Specifications

- Model ..... MR126
- Whip ..... 17-7 PH stainless steel taper ground.
- VSWR ..... 1.5:1 or better, channels 1-40.
- Cable ..... 17' RG58U coaxial.
- Connector ..... PL-259.
- Mount ..... 3/8" hole mount.
- Total Height ... 47".



M-125

**IF YOU WANT THE BEST LOOK FOR THE 'STRIPES OF QUALITY'**  
Available from these Main UK Distributors:

- HS & FD Jackson Ltd. 140 Sandy Lane, Camp Hill, Birmingham. (021-772) 1994
- Mura Electronics. 295-297 High Road, Willesden, London NW10. 01 451 4141
- Hobby Communications. 111 West Wycombe Road, High Wycombe, Bucks. (0494) 447093
- Aerial Supplies. Antenna House, Atherton Road, Aintree Industrial Estate, Liverpool. (051-525) 7042
- HB Litherland & Co Ltd. 237 Counce Street, Blackpool. (0253) 32269
- RT Controls. Trident Drive, Britannia Road, Norwich, Norfolk. (0603) 614321
- Open Channel Communications Ltd. Empress Street Works, Empress Street, Manchester, M16 9EN. (061-872) 5438

# Readers Write

I am eagerly awaiting 'legal' day and confine myself to reading the books and listen in at odd times to local breakers. How true Mozart's comments are - this cult CB language!

If only some breakers would tape themselves whilst keying and have a listen afterwards - Mozart was right, it is TRASH e.g. negatory, negatory, na, na is that a Roger (this comprises one typical sentence). It is just meaningless words and why also do so many breakers try for a pseudo transatlantic accent. Let's keep the '10' code by all means but most Americans don't themselves use all that 'Convoy' trash - apart from truckers that is! If you don't believe me, listen in on a good short wave receiver to some 'skip', we get plenty of it.

Sorry that I have carried on at such length but I and many others feel very strongly about this particular point.

Roll on 27MHz FM and keep up your good work.

Ray Warren (Herts.)

*Considering the fact that we imported CB from the States, it's not surprising that some of the language of the trucking fraternity has come with it. Perhaps a specific channel (i.e. 40) should be allocated for 'jargonise'. Bucket mouths should also get their own channel (41).*

I have just read the article on the CB Registration Service in your June issue and I would like to make a suggestion of my own on how to protect your rig. I engraved my good buddies name on the back of his with a simple hand held engraver. This is not as good as registering your rig but if you have access to an engraver it is better than nothing. 10-10.

Bluebottle (Bishop Auckland)

After reading your July issue there are a few points I would like to raise with respect to Mozart's letter.

Herightly points out that pressure from existing breakers has caused the government to introduce a legal CB system. What he omits to say, is that he and HMG know damn well we were campaigning for the adoption of 27MHz AM/FM/SSB to full FCC specification, not Mr. Mozart we have not as you put it "got our own way". OK so they've given us 27MHz but not the 27MHz we, the majority, wanted, not on your life!

I wonder if Mozart is aware of some of the restrictions of 27FM, for instance mobile antennas limited to 1.5m. in length with no helical windings permitted, in other words a very inefficient antenna. If a base antenna is more than 7m. from the ground an attenuator must be fitted, reducing both output and input signals to

1/10th of full power, so who cares if a few 10-33's go unheard!

One final word from one of the "schmucks who couldn't wait", in my experience about 95% of conversation on the air is in plain English with the odd word of slang thrown in just to make it interesting. Now then "Schmuck"? Correct me if I'm wrong but aren't you much more likely to hear that on the other side of the Atlantic? No! Sorry I forgot "We're a bloody long way from Arkansas here lads".

The Oil Burner

*Mr. Mozart certainly managed to raise a bit of oil pressure didn't he?*

Whilst reading through Vol. 2 Issue No. 13 I could not help wondering if the manufacturers of legal FM rigs realise that in GB we use right hand drive cars, if so why do they insist on copying American AM rigs which are made for left hand drive cars by putting the mike socket on the left hand side of the rig. Surely it would be more logical to put the mike socket on the right hand side for use in this country.

N. Hughes (Iron Horse) (Shrewsbury)

*Perhaps the socket could be in the middle of the set allowing easy access for both driver and passenger!*

Whilst being in full agreement with M. Crow (July issue) regarding the use (or rather mis-use) of traffic channel (19), I do not think that the breaking channels should be allocated by any club or CB organisation and that this job should be carried out by the Home Office and written into the licensing conditions. If this was done then no breaker would be in any confusion as regards breaking channels, emergency channels etc. as they are now, also the mis-use of these channels would be in contravention of the license and could be dealt with more effectively.

I would like to add that as the UBA have fully alienated themselves with the new FM system, they should have no part in the organisation of the band should the H.O. wash its hands of the task.

K. DARBYSHIRE (Matt Black)

*Well, I am not sure you will have unanimous backing on your suggestions. But it may be worth considering that the H.O. cannot stop AM use let alone enforce what CB'ers should use.*

I must confess I am glad to see that 27meg FM is to be made legal (one can forget 934!). Although the AM boys are offering stiff resistance it may end up the same way as VHF and UHF television or cassette v cartridge, we will have to wait and see.

I am sure the price of FM equipment will become realistic shortly although I do

hope we get a full 40 channels at 4 watts and not 1/2 watt like the Irish. Its possible that AM will be grudgingly allowed in the fullness of time.

I have made and repaired radios etc. since 1961 and I remember the days of Independent Radio and the hard road travelled by the likes of Radio London, Caroline etc. to get to where we are now. So, I think we must be patient in that respect and keep lobbying officials.

I regret a certain degree of irresponsibility has crept in by a few 'nurds' on the airwaves. I hope the mass responsible CB'ers made them tow the line as they'll do the overall cause no good.

Some of the language and antics used by some people I have heard made me wonder if they are genuine radio enthusiasts or just idiots trying to be like Chips or B.J. and the Bear or Convoy or whatever.

I would just like to conclude by saying to these people if you want AM too - Cool it.

P. Lewis (Devon)

*You've got 40 channels, 2 watts FM but when it will arrive... Well stick a pin in the calendar and you may be right!*

Further to your smouldering difference of opinion with "Citizen's Band" Mag, over what constitutes an "exclusive" and who has the moral right to bring lapses of journalistic accuracy/integrity to the attention of the Public.

It brings to mind the prevailing situation in the world of microcomputing publications, whose UK principals are "Personal Computer World" (pub: Bunch Books) and "Practical Computing" (pub: IPC). "PCW" long ago realised that there's room in the market for more than one mag. serving different interest groups and types of reader. By contrast, the other mag. has always displayed a chauvinism which often goes so far as to pretend rivals don't exist. Listings of computer exhibitions published in "Practical C" never mention one of the biggest of the year, the PCW Show, whereas "PCW" usually gives everyone credit. Result: nobody really trusts "Practical Computing", which comes out of it looking very shabby.

I am afraid there's a moral in that for the CB community. I almost said "for the CB world"; but, actually, if I had to choose two CB mags to take regularly, I'd pick yours and "CB World". This is because, like your good selves at "CB Radio", the staff at "CB World" appear to be knowledgeable enthusiasts. (For once, IPC has done something right!) You and they approach the subjects from different but complementary angles. But "Citizen's Band"? I dunno, I guess they do make me laugh from time to time; and that must be worth something.

Sincerely, Gutenberg

*I'm glad to see that it is not just CB Radio Publications that have their ups and downs. As for your choice of reading material, who am I to argue. Just keep laughing occasionally!*



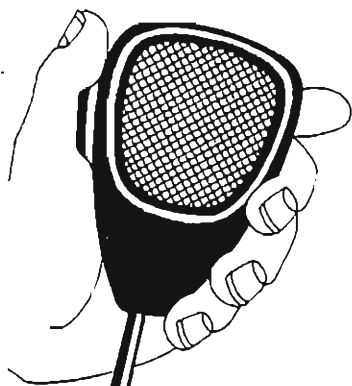

## **CONNEXIONS WORLD-WIDE CB IMPORTERS**

**Buy direct from us  
Save time and money**

 **Huge stocks of all major  
U.S., European and Far East  
brands available now.**

 **24 hour trade delivery  
anywhere in the U.K.**

 **Keenest prices on all items.**

**TRADE ENQUIRIES: Tel (062-882) 4338/9**

**Or come and see us at:**

**- Connexions -  
Furrow Way, Cannon Lane  
Maidenhead, Berks SL6 3NY.  
Telex: 881 3271 GECOMS G**

**Connexions**

# Come Back the Breaker

Get a legal copy on a fellow breaker!

## Breaker Break.

How about ya Big Boy, would you care to talk to a lonely Beaver? This is my usual opening line, and some of the Handles I use are: Bust 40, Hot Pants, Pink Pants, or the Hot Tomato.

The copy is always lighthearted teasing, which can usually be taken two ways. I always sign off with my real Handle 'Night Angel' and explain that it was all in fun, in fact my last words are:- "I say but don't play, I tease but don't please".

The CBers I know and tease, all know me, or know of me, and that I am just a Clown. They always like to be told they have sexy voices, and find they like to joke and kid-around as much as me. I have met a lot of the Guys that I have joked with, and they all have the greatest respect for me, but sometimes their wives get a little jealous, but I say it's only Night Angel doing her thing.

I don't dig talking about housework on the air, I feel CB is to help people in trouble or make them happy so they can forget their troubles, but don't worry girls, I'm not after your man, I just like to tease - I have my own sweet wonderful Man, his name is Bob, and he is the only one I need.

Some people will just sit back and listen or copy the mail as we say, but I just have to remember to be a jolly tease, because when I laugh, my friends laugh with me, but when I cry, I cry alone. I like to be the queen of the buffaloes!

I will be in there from time to time listening for you sexy British Buffaloes, perhaps I can give you a few minutes of happiness by making your blood boil, or make your heart miss a beat by my teasing.

Now when you Big British Boys out there copy skip and hear Unit 31 - KIJ 6271 from Central Pa in the U.S. of A, you will be laughing with the one and only NIGHT ANGEL, QUEEN OF THE BUFFALOES.

Love and more love.

WILMA

## Thanks from Circle City

I should be most grateful if you could print a large 'THANK YOU' to the CB enthusiast who came to the assistance of a three wheeler in dire distress, within five minutes of my calling for help at Grasmont on Sunday 19th July 1981.

Yours faithfully

'Camper'  
from Circle City



## Thank you, Foot sore breakers

I would like to say a big thank you to all the breakers who attended the demonstration held in Blackburn, Lancashire on 20th June. Breakers started arriving as early as 8am. The assembly point we had chosen was a local park which with all the rain was rather soft underfoot to say the least. But the breakers were not deterred, they just kept on coming. Departure time was 2pm and to the tune of Scotland the Brave from our ever faithful Leyland Pipers Band we set off.

The sun came out to cheer us on our way and led by Ian Leslie our National Committee Chairman, Mr K Bowman our Euro MP from Clitheroe, Disco One and Duchess. The march stretched for approximately 5 1/4 miles. In all the day went well, the authorities were excellent and a lot of footsore but happy breakers went home pleased that they had certainly got their message over to the government.

M Gerrard (secretary).  
Central Lancashire Co-Ordinating  
Committee

## North Birmingham CB Club

I would like to state that the North Birmingham Citizens Band Club is in no way whatsoever connected with or associated with South Birmingham CB Club. The South Birmingham CB Club are a pro FM support club and North Birmingham an active fighting club totally for 27AM

and SSB. We are opposed to legal CB on FM. The North Birmingham CB Club are members of Natcolibar and A.M.B.C. As our combined rally in Birmingham organized between the M.C.B.R.C. and N.B.C.B.C. on June 6th proved support is there for 27AM. After all nearly 7,000 Breakers can't be wrong.

10-10 Heron (Chairman N.B.C.B.C.)  
Tom Hargest

## AND ON THE SAME NOTE:

In our report on the Birmingham demonstration held on June 6th we stated that there were no celebrities present, however a Birmingham breaker has informed us that Mr Ian Leslie was present at the demo.

## Foxtrot Charlie SSB DX Group

We are a new group that started early this year. All our members are SSB DXers and are very, very keen. We set a high standard and expect all our members to keep these standards.

We send QSL Certificates instead of cards, the sort you could hang on the wall. To get one all anyone has to do is to QSO with one of our stations (we monitor 27.525) or send a QSL to me and we will swop 1-4-1. We QSL 100%. We have meetings at least twice a month and are always willing to teach new members how to DX.

Yours faithfully,

R Walton.

# 'Ferroline 27'

reaches breakers other antennas fail to reach

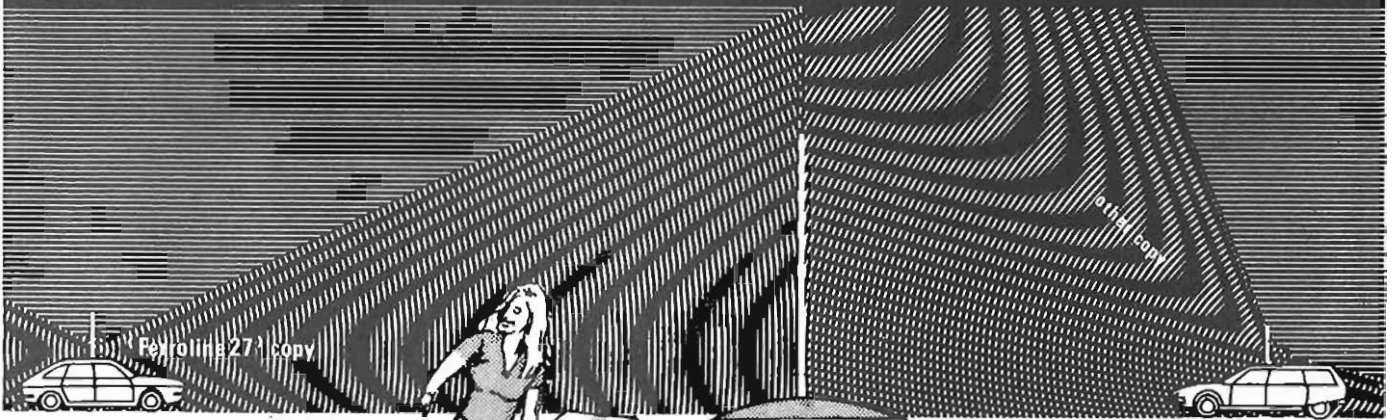

Because 'FERROLINE 27' pushes out power within  $5^\circ$  of the horizontal, you give better copy at greater signal strength - further. Your output isn't wasted skywards as it is with others radiating at  $45^\circ$ . Fit the 'FERROLINE 27' where you want - even on glass fibre, as it needs no ground plane effect and, be sure that it meets Home Office regulations completely. Solidly made in the UK, nationally available and backed with full service facilities.

**SPECIFICATION.** Height - 1.5m. Tunability - 0.5 MHz between 27 and 28 MHz. VSWR - not greater than 1:1.5 at band ends. 1:1.1 at band centre. Impedance - 50 ohm. Power handling - 25w. Ask your dealer for 'FERROLINE 27' the new mobile antenna by F. Judd. Or, write to: C BRIT, Unit 3.4 Wembley Commercial Centre, East Lane, Wembley, Middx. HA9 7XD.

## NORTH HERTS CB CENTRE

8 MELBOURN STREET, ROYSTON, HERTS. TEL: 42295

Are pleased to announce the launch of the Brand New all British 934 MHz UHF CB. These rigs will shortly be available from the Sole Distributor N.H.C.B.C. and will of course conform to British Specification.

Registered dealers who are interested in becoming stockist of this exciting new product, should write to Mick Eldred at address above for further details.

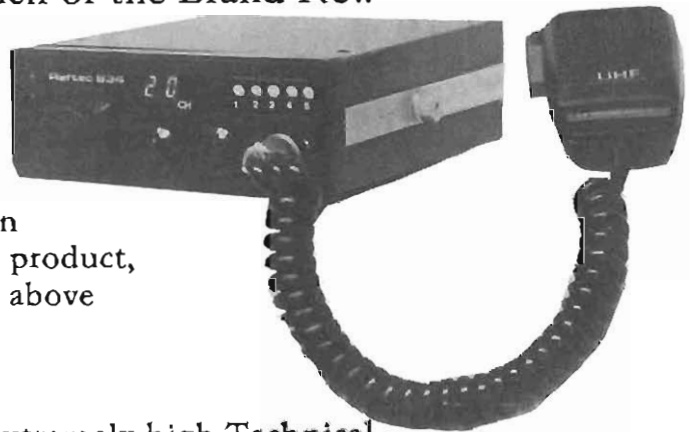

REFTEC 934 Rigs will be made to an extremely high Technical Specification and it is hoped will out perform any existing A.M. equipment.

We are also stockists of a large selection of CB equipment. Registered dealers requiring Wholesale Price List, Please write to Paul Eldred at the above address.

# ASS

**AUTOLOCK SPECIALISED SERVICES LTD.**  
48, Wistaston Road, Crewe, Cheshire. Tel: 0270 661674

**WHOLESALE ★ NORTH WEST ★ WHOLESALE ★ NORTH WALES  
TOP QUALITY PRODUCTS AT VERY COMPETITIVE PRICES**

**BREMI - VALOR - LEMM - SKIPMASTER - SIRTEL - HMP  
TURNER - TELEX - AVANTI - K40 - ALCOM - FIRESTICKS**

And many others

## **DISTRIBUTORS FOR O.C.T. Ltd.**

**IF YOU ALREADY RETAIL OR ARE THINKING OF RETAILING  
C.B. ACCESSORIES (& RIGS WHEN LEGAL) THEN GIVE US A CALL  
FOR FULL DETAILS AND AS MUCH ADVICE AS YOU WANT**

**★ ★ STOP PRESS ★ ★**

**NOW OPEN RETAIL SHOP  
CB (CREWE) LTD. TEL: 663643 ADDRESS AS ABOVE**

## *The "Breakers" Yard*

**CHELTENHAM CB RADIO CENTRE**

**We stock a wide range of CB  
equipment and accessories**

**TRADE ENQUIRIES WELCOME**

**CROFT ST, LECKHAMPTON,  
CHELTENHAM, GLOS.**

**2-8pm MON-FRI  
SHOP OPEN 10am-6pm SAT**

**Telephone (0242) 39783**



### **UNIQUE AMERICAN CB CONVERSIONS**

**EXCLUSIVE TO THE UK**

Send an SAE for details  
of full range

**THE PLL DATA BOOK**

Get more CB Channels!

Conversions,

Truth Charts, Theory,

Tricks of the trade and more!

All in non-technical detail

NORMALLY £4.95  
Special  
OFFER £3.95  
Limited period only.



### **FOR THE SERIOUS DXer**

#### **MICROMONITOR PLL FREQUENCY EXPANDER**

Gives 1200 - channel capability to most AM/FM/SSB  
PLL rigs in 5khz steps. Direct frequency entry, 5  
scanning modes, 5 - channel memory, split channel  
(duplex) operation. America's hottest CB accessory!

Write for specs enclosing S.A.E. stating rig make  
and model. Also suitable for some amateur and  
marine sets. Can be 4 - 6 weeks delivery but worth  
waiting for! **£129.99 plus £1.60 registered post.**

200w rig burner plans £4.50 and other super CB  
construction plans available.

#### **DONNINGTON COMMUNICATIONS SERVICES**

**65, Nuthurst, Crown Wood,  
Bracknell, Berks. RG12 3UW**

© OB Radio.

# CHELSEA CB CENTRE

73-77 BRITANNIA ROAD FULHAM LONDON SW6



**SOLE UK IMPORTERS AND DISTRIBUTORS FOR THE  
COMPLETE INTERCEPTOR RANGE OF TRANSCEIVERS**

FOR FURTHER DETAILS OF THESE "ALL NEW" 27FM SETS  
PHONE 01-731 0027 — ASK FOR STEVE or TONY

# NEWS REVIEW

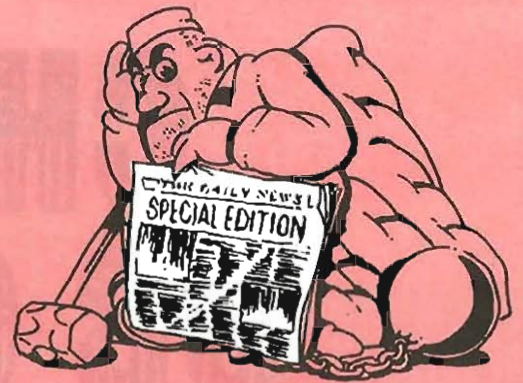

## More what the papers say!

Much of the press coverage on CB this month unfortunately concerns the recent riots that occurred in many of our city centres up and down the country. Claims that CB Radio was used extensively in controlling the looting and pillaging have been made from several quarters. Several counter claims from angry CBers have also been made. Little else of any significance apart from reports of clampdowns in the Midland area, has happened in the CB world this month.

CPD

### Daily Telegraph

#### Police blame CB 'Criminals'.

"It is now clear according to Police that some of the riots in the north of England, certainly in West Yorkshire were stage managed to some extent by criminal agitators using illegal CB Radio to direct mobs," states the Telegraph. "In the Chapeltown riots in Leeds, the West Yorkshire police seized a number of CB Radios and arrested their users and this is thought to be the first definite evidence." Mr Ronald Gregory, chief constable stated that these were not "Simply CB enthusiasts".

The use of CB Radio has been blamed for the "Mobility and Flexibility" of the youths which caused the police so much difficulty. During the riots at Chapeltown, plain clothes police patrolled the streets looking for cars bearing CB antennas and about half a dozen were confiscated. Mr Gregory said that although there is no

evidence of a national campaign. "Some unscrupulous people with CB radios have been taking advantage of the situation."

### East Anglian Daily Times

#### Police praise illegal CB operators after shooting incident.

Outlawed CB Radio operators have been praised by Suffolk police for their help following a shooting incident. 40 operators from the Market Hill area of Sudbury, Suffolk gave chase to two men in a car after a call was made on channel by another breaker who had been hit by air rifle pellets. The car chase, reminiscent of the Dukes of Hazzard, resulted in the arrest of the two men. Inspector Derek Bird, spokesman for the Police said that 'the CB users were of great assistance to us' and that in this instance prosecutions were unlikely.

The tried were bailed pending the consideration of charges being brought at a later date.

### Liverpool Daily Post

#### CB 'Enemy of Criminals'.

Sir - In the middle of the first campaign by Citizens Band Supporters for a Parliamentary seat comes the news over everyones televisions that according to police CB Radio was used by people plotting petrol-bomb riots in Manchester.

What could be at first glance worst news for us? I'd like to say two things.

First if CB had been legal for years as it ought to have been, no criminal would think of using it - for he would know that his every word would be overheard by the police.

Second any medium of communication can be used well or badly, but precisely because of its open nature CB once it is properly established is the one least likely to be used for harmful purposes.

Ian Leslie, Citizens Band Radio, candidate in the Warrington by-election

### The Journal

#### CB Vigilantes scheme illegal.

"Police have criticised a vigilante patrol set up by Wearside CB Radio enthusiasts we are told by the Journal. Breakers in the Sunderland area have organised several weekend patrols in the area using CB Radios from their cars. A spokesman for the Police said that they cannot condone any scheme like this whilst CB Radio is still illegal.

This scheme was started by the CB Club following the recent death of Sarah Simpson and because of concern about vandalism in the area. Patrol organiser "Chief Ironside" said "We knew lots of people who were concerned about rising crime in the area and who would appreciate our Patrol", and that the police are stretched at present and we just want to help."

# Customs crack-down on 'pirate' CB

Mercury Staff Reporter

CUSTOMS men have mounted a crack-down on the Midlands CB radio "pirates" before the start, this autumn, of Britain's new legal CB network.

Customs men have been to the Midland-based British HQ of one of the world's largest electrical chains as well as calling on private individuals.

Sets have been seized at the rate of 100 a month in the West Midlands during the past three months, and I understand that the Customs men now have something

like 1,000 sets in sealed warehouses in Birmingham.

Vehicles used to transport sets have also been impounded, I understand.

Customs officers went to the Walsall HQ of the American Tandy organisation after officers working with Post Office staff intercepted CB sets in transit.

Customs officials would only confirm last night that they had "visited premises in the Walsall

area and taken away three sets," but Tandy's managing director, Mr. John Sayers, told me: "Yes, it was our firm - but it was all a misunderstanding.

"I didn't realise the sets were capable of operating. I'd asked our American parent to send me mock-ups of the new sets they are building for the British system so I could have them photographed for catalogues and advertising work.

"What the Americans did was send us the sets with illegal CB internals.

"The Customs men have accepted the explanation and I have a document from them saying so. I won't get the sets back, though."

The Customs crackdown is forcing black marketers to try to dump their stocks of the illegal 27 MHz sets for just a few pounds. But there are said to be few buyers as enthusiasts prepare to buy the new VHF sets.

"This sort of clampdown was bound to happen," said Birmingham CB campaigner Keith Townsend last night.

## CB vigilantes' scheme illegal

POLICE have criticised a vigilante patrol set up by Wearside CB radio enthusiasts.

Members of Sunderland Breakers Club have organised two weekend patrols involving about 17 members patrolling the area in cars with radio contact.

A spokesman for Northumbria Police said yesterday that they advised anyone setting up such a scheme that CB radio is illegal "and therefore we cannot condone any scheme like this."

The patrol organiser, who is known as Chief Ironside, said yesterday that the death of Silksworth spinster Sarah Simpson and concern about vandalism and

break-ins had sparked off the scheme.

"We know of lots of people in the area who are concerned about rising crime and would appreciate a patrol," he said.

Chief Ironside described the scheme as an assistance to the police and said they were not wanting to take the law into their own hands.

"We realise that the police are stretched at present and we just want to help," he said.

"Everyone is vetted before going on the patrol and they are all responsible individuals so this is not going to get out of hand."

## Eastern Daily Press CB Radio and the Riots.

Sir-Following the publicity in the national Press recently concerning the alleged use of Citizens Band during the riots in our inner cities, we, as a responsible body involved with the image of Citizens Band Radio cannot deplore such action too strongly.

We should also like to point out that if any information is heard on channel this will be passed on to the police immediately.

Let us hope that the action of a very few will not cloud the great deal of good Citizens Band Radio can and already has, achieved—

Yours faithfully

R Gould,  
(Committee chairman  
Aylsham Breakers Club.)  
16, Banningham Road, Aylsham.

prosecuting, said that there was a cardiac arrest in Sheffield last month and that a call had been blocked by CB Radio, the patient died.

A spokesman for the Northern General Hospital said that the incident never took place and that there had been one occasion in which CB Radio had interfered with the paging system but it had been very brief and no-one had died or even suffered as a result of it.

## Daily Mail

### CB Fans help crash victim to speak again.

"Illegal CB Radio enthusiasts are helping a crash victim to speak again after being in a coma for nearly a year."

A CB receiver was donated anonymously to Wheelchair bound John Freeman of Bedfordshire who now receives personal messages using his personal handle "Freewheeler of Fluffy Hill". John received brain damage when he was pillion passenger on a motorcycle nearly two years ago. After 11 months in a coma he returned home paralysed down the left side, speechless and helpless, but with the constant talk of the CB it is hoped that he will be able to speak a few words before Christmas. A spokesman for one of the local breakers club said "It's great to know we can help John to recover just by chatting to him. One day I hope he will be able to call us back."

## Sunday Mercury

### Customs crack down on Pirate CB

Customs men have mounted a crack down on the Midlands CB Radio pirates before the start of Britain's legal systems this autumn. Raids have been made on several private individuals as well as the British HQ of one of the worlds biggest electrical chains. Customs officials confirmed that they had visited premises in the Walsall area and had taken away three sets. A spokesman for Tandy said that it was their firm but it was all a misunderstanding. It appears that they had asked their American parent company to send over some mock ups of the new sets due to be released in the autumn so that photographs could be taken but instead of sending dummies, the American company sent the sets with the existing AM wave bands. The Customs men have accepted this explanation but refuse to return the illegal equipment.

On the private side, it is claimed the 100+ rigs are being confiscated every month in the West Midlands and that these are being stored in secret warehouses in Birmingham.

## Northern Echo

### Take a break say CB men.

"CB breakers in Chocolate City are having a hard time getting on the airwaves", we are told by the Northern Echo, "So many youngsters have taken to the air that the more serious users are unable to make themselves heard above the noise." It's good to hear that us southerners are not alone with this problem as this article only reiterates the complaints we receive day in and day out about "10-1 wallies" and youngsters whose day would not be complete without disrupting the enjoyment of us sensible breakers with their background of constant verbal diarrhoea (but then again its the usual story of the few spoiling it for the many.) The greater majority of sensible breakers are packing away their rigs until the "CB craze" is over and done with so they can go back to modulating in peace. So breakers in the North are pleading with the youngsters to take a break.

## Morning Telegraph

### Hospital denies CB death.

"The Northern General Hospital deny claims that a patient died as a result of interference caused to the internal paging system by CB Radio. Bradford Magistrates heard that CB Radio had delayed the arrival of help to a patient suffering a heart attack. Mr Martin Hewitt

# CB fans help crash victim to speak again

ILLEGAL Citizens' Band radio enthusiasts are helping a crash victim to speak again after being in a coma for nearly a year.

Wheelchair bound John Freeman, 20, was given a radio receiver anonymously and spends hours listening in to the coded chat of the local 'breakers'.

Now they have given John his own call sign — Freewheeler of Fluffy Hill — and send him personal messages.

John's widowed mother, Marie said: 'I can't thank them enough for talking to John. As well as helping him to talk again, they have broadened his outlook on life.'

John, of The Crescent, Amphill, Bedfordshire — Fluffy Hill to CB fans — suffered brain damage when he was a pillion passenger in a motor

cycle crash two years ago. After 11 months in a coma he returned home, paralysed down the left side, speechless and helpless.

But Marie and her five other children spent hours talking to him and by Christmas he was able to mouth a few words.

Marie, 45, said: 'Then he was given the receiver in March and it has helped to provide him with extra stimulation, as he listens to local gossip. He spends hours listening, trying to repeat the words and waiting for the personal messages.'

'Now he is able to hold a conversation, although it takes a little while and he says he enjoys CB very much.'

CB transmission remains illegal until the autumn, when its use will be sanctioned on a new wave band.

One member of the local breakers club said: 'It is great to know we can help John to recover just by chatting to him. One day, I hope he will be able to call us back.'

# NOW THE Ferroline 27 - CB RADIO

## Mobile Antenna

**PROVED!** on land and sea  
**COMPLIES** «.....with  
**Home Office CB Radio  
 antenna specification.**

\* The FERROLINE 27 is a free-space resonant half-wave. Requires no ground-plane effect and will even operate on vehicles with fibreglass tops or bodies and on caravans, boats and motorcycles. Operates indoors eg: In loft space etc.

\* Double adjustment for VSWR and tuneable 27 to 28 MHz.

\* Stainless steel radiating elements and fully weatherproofed.

\* Low angle radiation for maximum operating range.

\* Low self-resistance ensures highest possible efficiency.

\* Standard 50 ohm impedance. Suitable for all CB transceivers FM, AM or SSB. Maximum power handling 25 watts.

-- AND IT'S BRITISH MADE --

NOTE: Only genuine 'FERROLINE 27' mobile antennas carry the registered trade name 'BIG JIM' and are factory tested for performance.

Price (UK only) £29.00.  
 inc vat, postage, packing  
 and insurance.

(Basic retail £27.00 inc VAT)

Still available « « «  
 the 'BIG JIM 27' CB base  
 antenna. £ 55.00 inc vat  
 postage and packing.

SAE FOR DETAILS

TRADE « UK Distributor

CBRIT Unit 3,4 Wembley  
 Commercial Centre, East Lane.  
 Wembley, Middlesex. HA9 7XD.  
 Phone...01 908 2726.



'BIG JIM' is a registered trade name and 'FERROLINE' is the copyright of ZL Communications.

### > the CB bookshop <

Prices include P & P

MODERN CB RADIO SERVICING. Recently published and up to date. For the Serviceman.	£5.30
CB RADIO ANTENNAS. Everything about antennas for base station and mobile operation.	2.75
HOW TO SELECT & INSTALL CB ANTENNAS. Excellent book for the beginner. How to use and choose.	3.55
CB ACCESSORIES YOU CAN BUILD. Many DIY projects for the home constructor	3.50
BIG-DGUIDE TO CB RADIO. Still the most popular book for the beginner	3.25
HOW TO MAKE WALKIE TALKIES. Circuits to build for low power handheld and portable work for CB and amateur use	1.70
CB RADIO CONSTRUCTION PROJECTS. More DIY projects to make at home	3.00
CB'ers HANDY MANUAL OF BASE STATIONS. How to set up and operate home station rigs etc	1.80
CB HANDY DICTIONARY. Dictionary 10 codes and operating etc	1.00
THE ANTENNA CONSTRUCTION HANDBOOK. Includes many designs with how to build diagrams for CB radio antennas	5.60
EAST-GUIDE TO CITIZENS BAND RADIO. Equipment, antennas, installation, procedures and and maintenance	
CB JARGON. First British book written by CB'ers for CB'ers, complete jargon directory	1.13
CB DICTIONARY. The most complete CB guide today. 10 codes, equipment and operation	1.80
O AND A AMATEUR RADIO. All you want to know on how to become a radio amateur	1.95
HOW TO BUILD ADVANCED SHORTWAVE RECEIVERS. Practical constructional details of a number of receivers with high levels of performance	1.30
SOLID STATE SHORTWAVE RECEIVERS FOR BEGINNERS. Very few and relatively inexpensive components for several solid state SW receivers	1.35
PROJECTS IN RADIO AND ELECTRONICS. A variety of projects - all useful, instructive and entertaining	2.70
MASTER IN-CAR ENTERTAINMENT. Everything about mobile audio tape record, broadcast radio and car antennas etc	3.90
GUIDE TO BROADCASTING STATIONS. Guide to listening long and medium-wave stations European stations, short-wave stations of the world	3.25
ELECTRONICS - BUILD AND LEARN. Common components and simple experiments giving confidence to tackle larger projects	3.00

20p stamp for full catalogue and lists.



## ZL COMMUNICATIONS

Cantley, Nr. Norwich, Norfolk NR13 3RT. TEL: GT. YARMOUTH (0493) 700821  
 9-5.30 weekdays - callers only by appointment





# Colt



# Cobra®

# TELEX



# K40



# hy-gain



# Shakespeare

# BREMI



13 Ferry Road  
 Leith  
 Edinburgh  
 Tel: 031 554 9933  
 Telex: 727385  
 Trade Enquiries  
 Tel: 031 554 3733

## 777 ELECTRONICS ARE PROUD TO ANNOUNCE

The opening of wholesale warehouse all trade enquiries are most welcome.

If you are already a CB retailer or if you are thinking about becoming one we at 777 are sure that we can be most helpful to you.

Please feel free to visit our well stocked showroom at Ferry Road you will be made most welcome.

We are sole COLT & COBRA distributors for East Central Scotland, also H.M.P., K40, AVANTI PLUS MANY MANY MORE.

Below are a few examples of our range . . .

### Mobile Range

- COLT 210
- COBRA
- JAWS
- C.B. MASTER
- HAM MAJORS
- TRISTAR 747
- HAM MULTIMODES
- HAM CONCORDES
- SUPERSTAR 2000
- EXPERT 320
- WALKIE TALKIE 40 CH A.M.
- WALKIE TALKIE 80 CH A.M.
- BASE HAM JUMBOS

### Accessories

Our range of accessories is so large that it is very difficult to list the full range, but if you want it then we will probably have it. IF NOT WE WILL GET IT. Because we import direct our prices are good so you can afford to give the customers a better deal. ALL OUR CB RADIOS HAVE BEEN LEGALLY IMPORTED AND CARRY A VAT PAID SERIAL NUMBER.

Our retail department is open to the public where you will be able to purchase your radios and accessories at realistic prices and remember everything we sell is covered by the 777 GUARANTEE.

Mail Order Welcome C.O.D.

Price list Available on Request

# CB Radio Project Kits

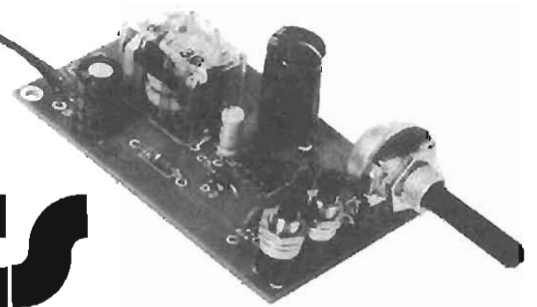

Plug in your soldering irons ready for this month's kits.

Two more kits available this month from our range of DIY Playkits.

The timer is a useful electrical gadget that has many applications and is easy to build. It could be particularly useful in photography or even for putting a time limit on your copies!

KT 420 is a linear amplifier kit and should be intended primarily for licensed amateur use. To assemble or own a linear amplifier is not an offence in itself but if you do intend to build it please show some common sense in its use.

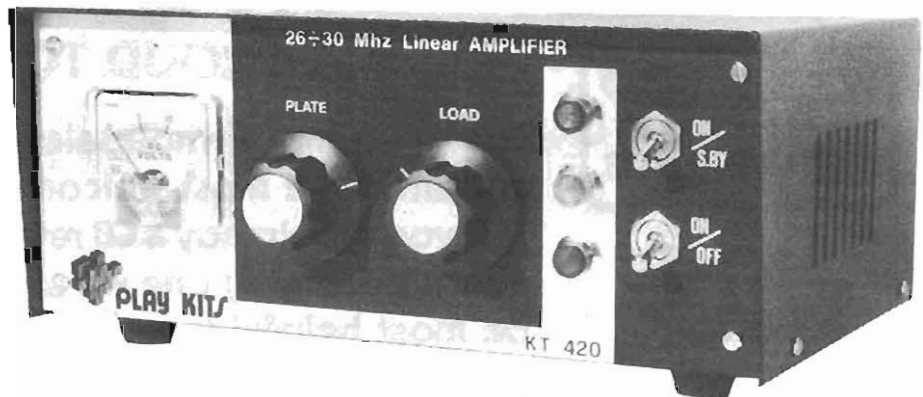

## KT420 Linear Amplifier.

### Technical Characteristics.

Frequency range	26-30 MHz
Modulation	AM, FM, SSB
Antenna impedance	52 ohm
Output power	AM/FM/-70, SSB, -140W
Minimum RF Drive	AM/FM/2W, SSB, 5W
Maximum RF Drive	AM/FM 6W, SSB, 15W
Valves used	6KD6
Semi conductors	4 diodes, 2 rectifiers, 1 transistor
Supply voltage	Mains, 220V 50Hz
Size	230 x 170 x 105
Weight	5.600 kg.

The RF Drive is fed to the KT420 Linear Amplifier via an input SWR tuning network. From there the low level R.F. is applied to the cathode of the 6KD6 valve (VT1). All the grids of VT1 are grounded.

The amplified R.F. appears at the anode top cap and is prevented from backing up the H.T. Line by L3 but passes through the HT blocking capacitor C4 on to the output socket via the Pi Tank tuning circuit.

An electronic switching circuit together with a relay is provided to switch the KT420 into the antenna circuit when R.F. Drive is applied.

### Assembly.

To make sure you put the kit together properly, work in the following order:

1. Fit the four rubber legs at the bottom of the case using the screws with the conical heads 3x12.
2. Fit the 2 S0239 sockets at the back of the case using the four screws 3x8MA;

### Components List.

C1	C2	10KpF	S1	S2	S3	switches	1	socket
C2		10-60pF variable capacitor	L1			see text	1	printed circuit
C3		220pF NPO 6100 120pF parallel	L2			choke 30uH VK 200	1	clip for the valve anode
C4		33KpF 1500V	L3			anode choke	1	anchors for the printed circuit
C5		variable capacitor	L4			see table	25cm	RG58 cable
C6		variable capacitor	LP1			12V bulb	20cm	small screen cable
C7	C8	100uF 500V electrolytic	LP2	LP3		12V bulb	60cm	of silver wire 1mm for L1
C9	C11	10pF capacitor	RL1			Relay 12V	80cm	of silver wire 1.5mm for L4
C10		470uF 35V electrolytic	ST1			meter	40cm	flat wire
C13		220uF 25V electrolytic	T1			transformer	1	aluminum front panel
C14		10uF electrolytic	F1			Fuse 1A	5	screws 3x14MA
C15		100pF capacitor				case - lid	7	screws 3x10MA
R1		10 Kohm trimmer				self tapping screws 3x1/4	10	screws 3x8MA
R2		3.3 Kohm				rubber legs	4	screws 3x5MA
R3		1.5 Kohm				knobs	4	nuts 3MA
R4		3.3 Kohm				coloured sockets red and green	22	washers
VT1		6KD6 valve				S0239 sockets	7	solder tags
D1-D4		2N1711 or 2N1613 or equivalent				fuse holder	4	lengths of solder
D5-D7		EM 513 or equivalent				rubber grommet	2	self adhesive labels
D6-D8		1N4003 or equivalent				feeding cable	4	

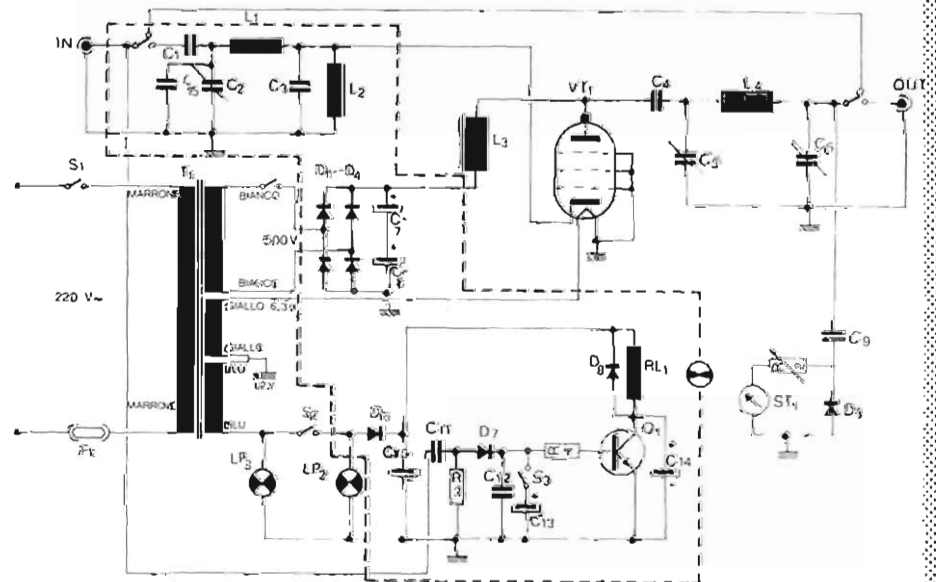

remove the varnish at the points where contact is made for a good electrical contact.

3. Fit the fuse holder.
4. Fit the rubber grommet.
5. Fit the AM/SSB switch at the back on the top right.
6. Wire up the earth straps and fit the valve socket. (remove the varnish from the fixing points).
7. Fit the 3 screws which support the printed circuit as shown.
8. Fit the anode choke.
9. Fit the aluminium front panel using the 4 screws 3x5MA.
10. Fit the meter.
11. Fit the 3 lights in the following order: the green one on top, the orange one in the middle and the red one at the bottom. The orange light is neon and must not be removed from its central position.
12. Fit the two switches on the front: ON/S. BY at the top and ON/OFF at the bottom.
13. Fit the solder tag as shown in the drawing.
14. Fit the variable capacitors.
15. Fit the two knobs.
16. Solder the centre of the 10Kohm trimmer R2 to the of the meter.
17. Solder the 10pF capacitor C9 onto the LOAD variable capacitor.
18. Solder the small screened cable taking care that the central wire is connected between the free end of the 10pF capacitor C9 previously soldered and the free end of the trimmer; solder the free end of the wire next to the capacitor and the end next to the meter should be soldered to the negative of the meter (see drawing).
19. Solder the OA91 diode between the negative of the meter and the middle of the screened cable.
20. Solder the coil L4 between the variables LOAD and PLATE (see drawing).
21. One side of the red and green bulb has to be connected to earth. (See drawing).

How to wind coils L1 and L4		
	L1	L4
Wire mm	1	1.5
Width mm	8	22
Length mm	10	25
No. of spirals	7	9
Spacing mm	1	see note

**Note:**

If the Plate capacitor is completely open, the spacing is narrower and if the LOAD capacitor is completely closed, the spacing is wider.

The ends of C4 should be as short as possible and so should the ends of the RG58 cable.

22. Solder the second end of the red bulb to the ON/S. BY switch (see drawing).
23. Solder the second end of the green bulb to the ON/S. BY switch (see drawing).
24. Solder one end of the centre bulb using a 220Kohm 1/2W resistor R1 (see drawing)
- 25) Fit the transformer by using the 3x10MA screws and the washers.
- 26) Solder the wires of the main part of the transformer; the first one to the fuse holder and the second one to the ON/OFF switch. (See drawing)
- 27) Solder the first wire of the secondary 12V part to the ON/S. BY switch where the second end of the red socket and the second wire of the secondary 12V is attached to the solder tag.

28) Solder the secondary 6.3V; the first end to the solder tag and the second one to the leg N.1 of the valve socket.

- 29) Wind together the two white wires.
- 30) Put the mains cable through the rubber grommet and make a knot in the cable leaving about 30cm of wire free inside the case.

**Note**

**A two wire continental mains lead is supplied with this kit. This lead MUST be discarded and replaced with a three core lead. It is ESSENTIAL that the metal case be properly earthed.**

31) Solder the neutral of the mains lead to the free contact of the fuse holder and the 'live' to the free contact of the ON/OFF switch.

- 32) Solder the electrolytic capacitor 220uF 25V to the first contact of the AM/SSB switch and solder the negative of the capacitor by using the tags fitted to the metal ring on the valve.
- 33) Fit and solder the various components to the printed circuit. (See drawing for details).
- 34) Fit and screw the printed circuit into position.
- 35) Solder the second contact of the ON/S. BY switch (where the green socket is attached) to the contact N8 12V of the base.
- 36) Solder the second end of the small bulb to the appropriate contact N.12 on the base.
- 37) Solder the smaller end of the anode choke to N.11 on the base.
- 38) Solder the free contact of the AM/SSB switch to the appropriate contact on the base.
- 39) Solder the white wires from the transformer to N.9 and 10 of the base. (500V anode H.T.).
- 40) Connect the cathode of the valve (pin 2) to the contact N.5 of the base by using the 1mm silver wire.
- 41) Connect the solder tag on the metal ring of the valve to the contact N.4 of the base by using the 1mm silver wire.
- 42) Connect the centres of the S0239 sockets to the appropriate contacts N.2 and N.3 on the base by using the 1mm silver wire.
- 43) Connect the variable LOAD with the base on contacts N.6 and 7 by using the RG58 cable (See drawing).
- 44) Put the valve into the socket.
- 45) Put the clips onto the valve.
- 46) Connect the valve clip to the variable PLATE by using the 33KpF 1500V capacitor C4 (see drawing)
- 47) Connect the top wire of the anode choke to the valve clip (see drawing).
- 48) Put the 2A fuse into the fuse holder.
- 49) Carry out the tests as per instructions.
- 50) Put the cover on and close by using the 4 3x1 screws.

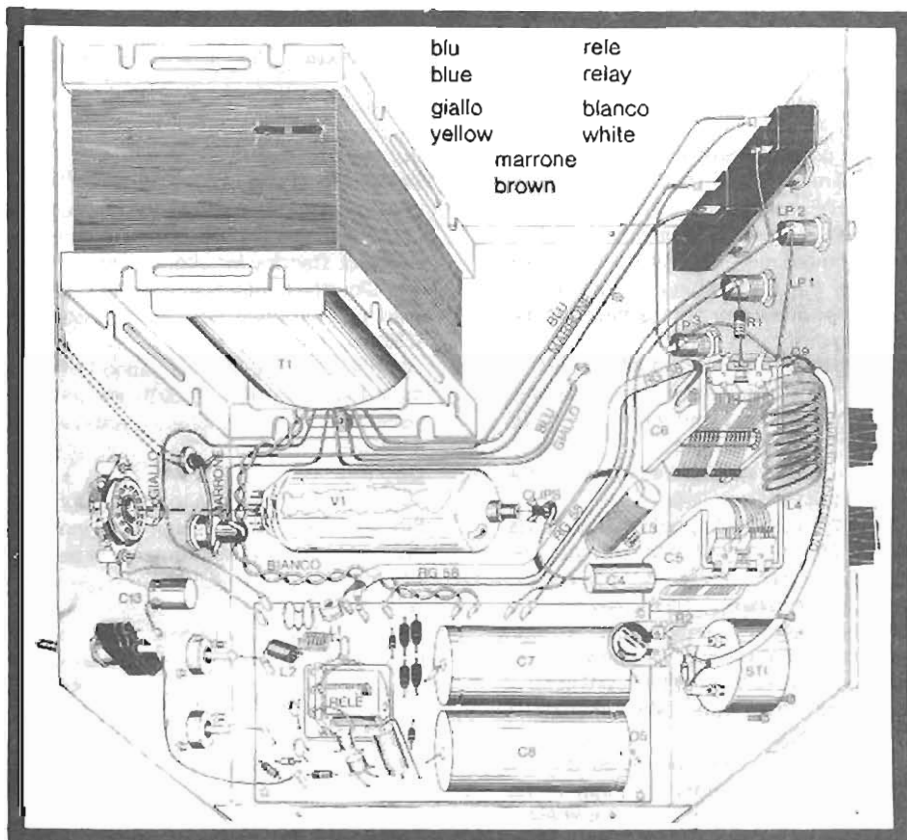

# CB Radio Project Kits

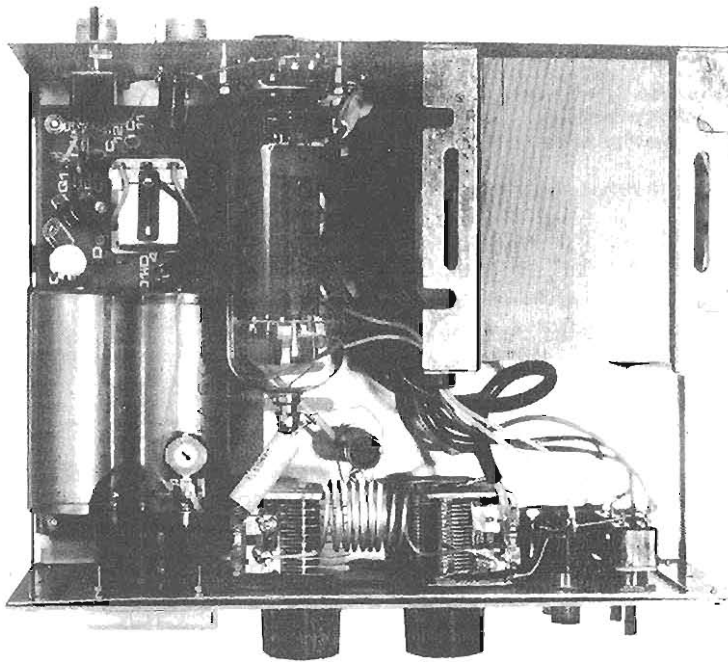

## Transformer Outputs.

- Primary 220V ac brown
- Secondary 12V ac blue
- Secondary 6.3V ac yellow
- Secondary 500V ac white

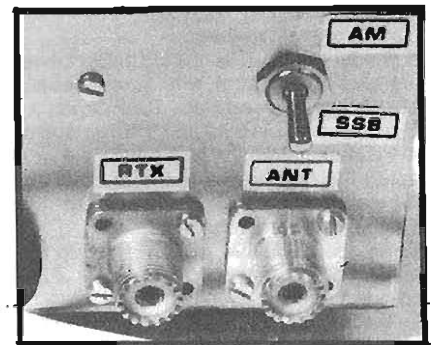
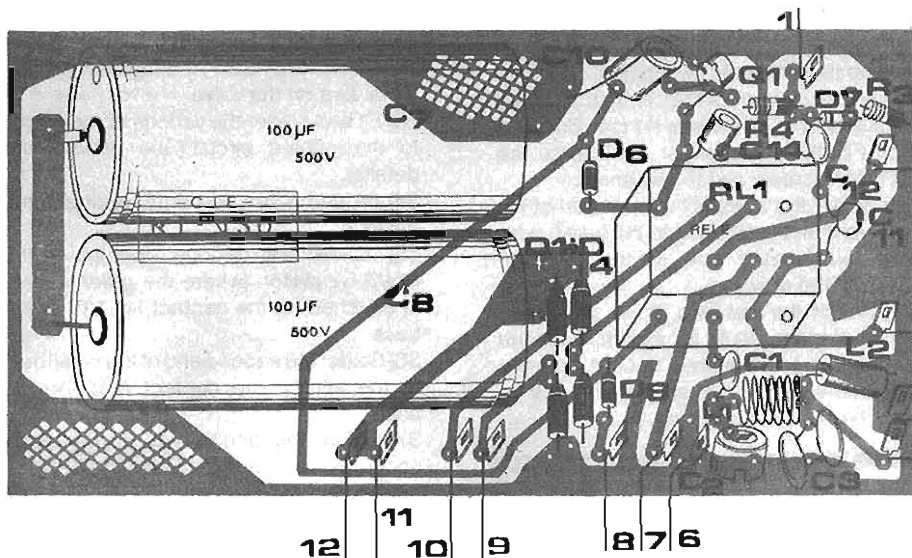

90cm CABLE CAVO 90cm 75Ω

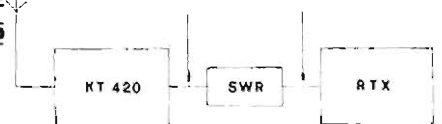

List of terminals on the printed circuit.

1. To the AM/SSB switch
2. To the ANT plate
3. To the RTX plate
4. To chassis 1
5. To the leg on the valve socket
6. To the RG58 cable
7. To the central wire of the RG58 cable.
8. To the ON/ST.BY switch.
9. To the white wires (500V) of the transformer.
10. To the smaller wire of the anode choke.
11. To the 'transmission' bulb.

## Setting Up

**Note:** The voltages produced within this kit are **LETHAL**. Greatest care **MUST** be taken when initially setting up with the cover removed.

1. Make sure that the mains switch and the ON/ST.BY switch are switched off and that the AM/SSB switch is in the AM position. Then connect the RTX and the ANT.
2. Switch on the ON/OFF switch.
3. Make sure that the internal heater of the

valve is on and leave it switched on for about a minute and then switch on the ON/ST.BY switch.

4. Adjust the small trimmer R2 which is placed on the meter to about half way.
5. Press the transmitting button on the transmitter and carry out the tuning in the following order:
  - 5a. Bring the knob of the variable LOAD to half way and then keep looking at the needle of the meter turn the knob PLATF for the maximum reading.
  - 5b. Turn the two knobs alternatively for the highest possible reading.
6. Tune the variable capacitor C2 which is on the printed circuit until you get the highest possible reading. This also corresponds to the minimum SWR between the transceiver and the linear amp.

Insert an SWR meter as shown in the drawing, so as to monitor the SWR input of the linear amp. The SWR should be between 1:3 and 1:7.

7. The meter is used purely to give an indication of power, adjust the trimmer R2 for a reading of about 3/4 of the scale.

## Notes:

### Switching On

When switching on from cold switch the ON/OFF to ON and leave the ON/standby switch at standby for about 1 minute. This is to allow the heater filament in the valve to warm up thoroughly before H.T. is applied. T.V.I.

With a linear amplifier operating T.V.I. can be a major problem. You'll get on a lot better with your neighbours if you only use it outside TV hours.

### Cooling

Quite a lot of heat has to escape through the ventilation slots in the metal case. If they are in any way obstructed overheating will occur.

### AM, FM, SSB

To switch the linear from one mode of transmission to another the switch is located at the back of the case, up for AM/FM, down for SSB.

### Tuning

When switching from one channel to another the linear may need slight re-tuning.

**KT307 Timer.**

Supply Voltage 12v d.c.

Timer 0-15-30-60 minutes (see text)

**Components List.**

Quantity	Description
R1	3.9 Kohm ¼ or ½W
R2	1.5 Kohm ¼ or ½W
R3	2.2 Mohm potentiometer
R4	470 ohm ¼ or ½W
C1	100 u.f. 12V
C2	10 K.p.f.
C3	50 K.p.f.
C4	470 u.f. 10w
C5	4.7 u.f. 16w
P1	Push switch
P2	Push switch
1	Printed circuit board
1	N.E. 555 i.c.
D1	IN 4003
D2	IN 4003
1	12w relay
30cm	Wire
1	length of solder

**Description.**

By using a NE555 i.c an economical and precise timer can be made. The timed interval is controlled by the value of R3/C4.

Maximum value for R3 - 2.2M ohm

Maximum value for C4 - 1000 u.f.  
(timing 1 hour)

Maximum Timing with:-

R3 - 1 M ohm, C4 - 470 u.f. - 15 minutes  
R3 - 2 M ohm, C4 - 470 u.f. - 30 minutes

R3 - 2.2 M ohm, C4 - 470 u.f. - 33.5 minutes

Minimum timing with

R3 - zero Ohms, C4 - 470 u.f. - 1 second

**Assembly.**

To assemble the kit fit and solder the components into the p.c. board as in fig 2.

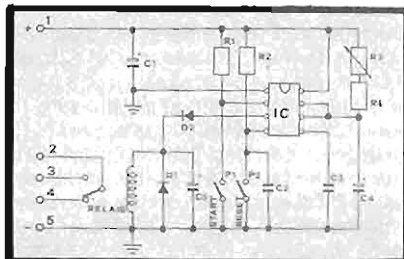

Start with the small components first, fit the big bits last and only use the minimum heat necessary for a good joint on the delicate items -ic1, D1 and D2. When assembled the kit can be fitted into any convenient container, a plastic box (not supplied with kit) is ideal, particularly if the timer is used for switching a mains voltage appliance on/off. The two switched P1/P2 are wired with fly leads to the p.c. board.

Relay contact

- 1 and 5 Relay coil
- 2 and 4 Normally closed
- 2 and 3, Normally open

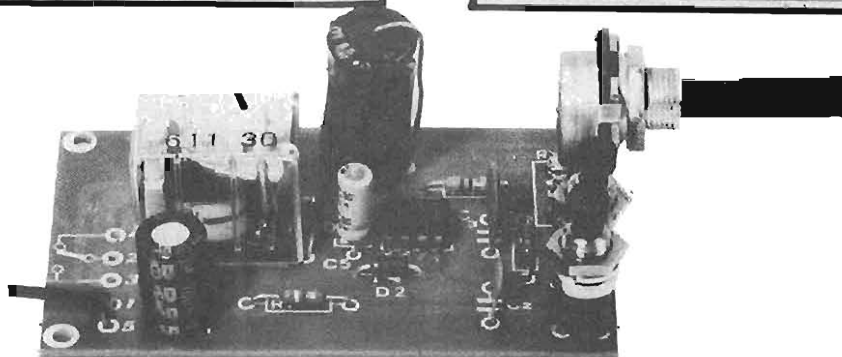
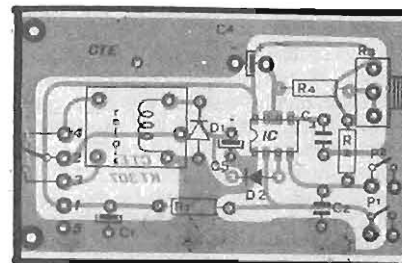

# HOW TO ORDER YOUR CB RADIO PLAY KITS

Please send me.....KT420 (Linear Amplifier) Play Kit at £64.40 each & £2.40 p&p. and.....KT307 (Timer) Play Kits at £6.50 each & 40 p&p

I enclose a Cheque/Postal Order for £.....made payable to CB Radio Play Kits

Send Cheque/Postal Order WITH ORDER FORM to CB Radio Magazine, Tudor Works, Beaconsfield Road, Hayes, Middlesex.  
PLEASE ALLOW 21 DAYS FOR DELIVERY

Name.....  
Address.....  
.....

Also available :

KT419 (Converter) £7.95 each plus 35p p&p. KT421 (Splitter) £5.75 each plus 40p p&p (as in Issue 13)  
KT631 (Walkie Talkies) £5.75 each plus 95p p&p. £9.50 a pair plus £1.40 p&p (as in Issue 14)  
KT414 (Antenna Matcher) £7.95 each plus 95p p&p. KT416 (SWR Meter) £5.75 each plus 95p p&p (as in Issue 14)

# Friendly Advice for Emergency Monitors

Final part of the series by Mike Newbold.

The purpose of this programme is to offer a training syllabus for potential emergency monitor operators (E.M.O.) and give some guidance as to the role of the Emergency monitoring station and the standard of performance to be aimed at. The basic equipment necessary for an E.M.S. has already been covered earlier in this series. It should be emphasised that the following can be taken as practical hints for both present illegal monitoring and future legal monitoring, the latter will undoubtedly include REACT as the forerunner.

The programme given is an adapted version of the National Emergency Aid Radio (Near) and is relevant to any system which might be established in Great Britain. This same programme is being 'anglicised' by REACT U.K. who should have copies available soon. Anyone seriously interested in becoming an EMO/EMS should join REACT as soon as possible. With the date for legalisation drawing closer REACT teams are ready to operate and training films, literature and back up for monitors are now available.



Important: This programme is only a guide as conditions will differ in the U.K. However the basic principles will be the same.

## Introduction

The goal of any emergency aid service must be to develop, upgrade and professionalize the operation of the emergency response system and to achieve a constantly improving system.

This development can be separated into four major sections: Administration, Personnel, Equipment and Communications, the focus of this programme is on the last of this four.

Communications is the means by which the entire system becomes effective and efficient. In the absence of a

'purpose built' road emergency communications system, greater use of Citizens Band Radio will be made as it will be the only convenient method of allowing the public direct and immediate access to the emergency services. The vitally important link in the system is the trained monitor, who will listen for calls on the emergency channel, obtain the facts and then direct them clearly and concisely to the appropriate services.

This manual has been developed to give emergency monitors a thorough understanding of the role of monitor and what standard of performance is required. It outlines the basic rules and techniques used by CB monitors and indicates the five most common kinds of road related calls. These are:

1. Road accidents or medical emergency.
2. Disabled vehicle - not blocking traffic.
3. Disabled vehicle - blocking traffic.
4. Careless, reckless driver.
5. Traveller assistance.

Much of this course is based on a training film and the discussion and questions that follow. Underlying guidelines for all monitor trainees are to adapt professional standards by remaining, as emphasized in part three of this series, calm, courteous, correct and concise and to remember the importance of providing a fast response to anyone in need.

## Qualifications

1. A valid CB licence
2. A strong desire to help your fellow man through dedicated public service. Although not essential a recognised first aid qualification would be useful.

## Purpose of the course

1. To provide an understanding of the role and responsibilities of an emergency monitor.
2. To discuss the various tools and aids used by a monitor.
3. To discuss the government rules that affect the emergency monitor.
4. To discuss the proper attitude and techniques for good monitoring.
5. To discuss the five most common types of road related distress calls.
6. To discuss the need for accurate record keeping and reporting.

## Ground rules for student participation in the course.

1. Ask questions.
2. Be interested in helping others.

## Training approach

On the face of it, being an emergency monitor appears to be a simple job, listen and report. But this is deceptively simple. Its just too important a job not to be done properly.

It is intended that a training film will be shown at this stage. The NEAR film lasts 30 minutes and covers all the essential information needed by the monitor and dramatises the five common types of calls (as listed earlier). A structured discussion period will follow the film to allow ample opportunity to examine, discuss and expand on the material presented.

The main points a monitor should pick up from the films is the facts, rules and communications techniques used. It should be noted how the monitors on the film handle the different types of calls, how they work to immediately establish the location, the urgency of the situation and how to proceed with the rest of the call. Special attention should be given to reporting and logging procedures.

## Discussion of the film

Discussion of the film centres around the following items.

The role of the emergency monitor is to provide a communications link between the NEED and the HELP. To keep that link intact the monitor must:

- \* Get information from the caller as needed.
- \* Pass information to the public safety agency or appropriate response source, and in turn to the responding unit so they can be ready to help in all respects when they arrive on the scene.
- \* Be ready to guide help to the scene.
- \* Act as a relay station among separate stations or mobile units.
- \* Keep records on calls and responses.

Since the overall aim of the monitor programme is to provide a faster response with the most appropriate kind of help, it is essential that calls be channelled into the system in the most efficient way, using the two most valuable tools - the CB set and the telephone.

Make sure you understand the difference between Citizens Band and other two-way radio systems intended for personal communications. CB is like a party line and everyone with a valid CB licence will have equal access to the channels. By contrast, in other types of two-way radio services the frequencies are licensed to an individual company or governmental agency for a specific purpose, CB is the only existing two-way radio service that can provide citizens in

all parts of the country with immediate direct access to the emergency systems.

### Understanding legislation

Although precise details of legislation covering CB in this country are not yet released it is likely the general principles that apply internationally will also apply in Britain. The following recommendations are based on this assumption.

All rules for the use of CB and emergency channels apply equally to everybody, regardless of profession or organisational status.

The American FCC rules state that:

- \* The emergency channel may be used only for emergency communications or for traveller assistance.
  - \* You must, at all times and on all channels give priority to emergency calls.
  - \* You may use any channel for emergency communications or for traveller assistance.
  - \* You must share each channel with other users.
- Also worth bearing in mind;
- \* All stations must identify themselves with their station at the conclusion of each completed message.
  - \* Monitors (like other users) must not use obscene or profane language, make threats or otherwise misuse or try to dominate any channel.
  - \* Singing, whistling, playing music, using sounds other than voice and giving commercial messages are prohibited on all channels.

The objective is to keep the emergency channel for real emergencies (not time checks or radio checks). Use judgement in your approach to each situation, but clear the channel as quickly as possible. It is known that the British Government intend to release a booklet on legal FM operation and no doubt this will consider some of the above aspects.

### Techniques

The emergency monitor should have some knowledge of clear communications techniques to transfer information clearly and accurately. Generally, anything that enhances communication between the caller and the emergency response system is desirable and anything that gets in the way of clear communications is to be avoided.

Plain English, spoken clearly and distinctly at a moderate rate is understood everywhere. CB jargon, 10 codes and slang expressions, on the other hand, are not. For spelling out names and other vital information use the phonetic alphabet (this was covered in part one of this series).

Another important part of monitoring is remaining calm, even though the caller may be excited or abusive. He may be under severe stress — however the monitor is not and should help to relieve the callers stress. A clear, confident plain English speaking style has a professional sound to it and that in itself inspires confidence in the caller. Never argue with a caller, explain any delay as best you can and get back to the caller as soon as possible.

Make sure you identify yourself correctly and establish the kind of emergency and exact location. Report the facts as they have been reported to you. Assume nothing, take nothing for granted. Eliciting the necessary information that has been covered prior previously in this series.

Of course, the actual programme for trainees would include practical exercises and questions to be answered.

When does a monitor order specific types of emergency equipment and crew? .....

What are the two primary tools used by the emergency monitor? .....

What are some of the other tools used by the emergency monitor? .....

What about time checks? .....

What about radio checks? .....

(Hint, are these emergency calls?) .....

What information should the monitor establish first? .....

Examples:

Road traffic accident. ....

"Breaker, channel 9" .....

What should monitor response be? .....

What should the monitor try to establish first .....

What other information? .....

When should the emergency monitor inform the authorities and which authorities .....

"Breaker, channel 9, there's a madman out here on the super slab .....

Comments .....

Summarise action to be taken .....

# BIG BREAKER ONE

LUTON 20006 DUNSTABLE 63371 BEDFORD 213933  
HEMEL HEMPSTEAD 211929 POOLE-DORSET 5566

## CLUB MEMBER DISCOUNTS

ALL LEADING MAKES OF CB ACCESSORIES FROM STOCK.

SELF-SUPPORTING, SWIVEL AND TILT TOWERS ARE SUPPLIED AND FITTED FROM £148.



ALL BASE ANTENNAS CAN BE FITTED AND SWR'ED WITHIN A 60-MILE RADIUS BY OUR ENGINEERS.

63-64 MARKET HALL  
ARNDALE CENTRE  
LUTON  
BEDS

170 BLANDFORD ROAD  
HAMWORTHY  
POOLE  
DORSET

VALOR  
K40  
FIRESTICK  
AVANTI  
MOONRAKER  
SYLVANA  
EX-STOCK

HIRSCHMANN  
ROTATORS,  
SPECIAL  
OFFER  
-TRADE  
ENQUIRIES  
WELCOME

## RECHARGEABLE BATTERIES AND CHARGERS

PRIVATE & TRADE ENQUIRIES WELCOME

Full range available. Pencil, HP7 (AA size) 90p. HP11 (C size) £2.90. HP2 (D size) £3.80. 9 volt PP3 £5.30. Many more and chargers. S.A.E. for full lists.

**EXAMPLE** High power (0.5 Ah) rechargeable pencil (AA size) system and charger. Super power performance.



- ★ Negligible volts drop on load
- ★ Over 500 duty cycles
- ★ Cannot overcharge (our charger)
- ★ Recharge overnight
- ★ Cannot leak
- ★ Running cost 0.1p per recharge

Mains charger shown. Single flying lead output with press-studs. Automatic voltage adjustment for any number of cells between 4 and 12 inclusive. Press studs match holders. 4, 6, 8 and 12 cell holders shown. Charger £7.13. 4 holder 58p. 6 holder 58p. 8 holder £1.47. 12 holder £2.93. Pencells 90p each. All prices include VAT. S.A.E. for full lists.

Send S.A.E. + £1.45 for booklet, "Nickel Cadmium Power".

**MAIL ORDER** (Add 10% Post & Package) to: Dpt. C.B., SANDWELL PLANT LTD, 2 Union Drive, Boldmere, Sutton Coldfield, West Midlands. B73 5TE. Tel: 021 354 9764.

## DON'T BE CONNED

For a Great Selection at the Lowest Prices Come to

HAMMERSMITH

**CB CENTRE**

OR SEND FOR MAIL ORDER LIST.

THIS MONTH'S SPECIAL OFFERS:

FIRESTIKS:		K 27	£8.80
3 ft.	£6.75	SWR METER	£7.50
4 ft.	£7.45	POWER MIKE AND	
5 ft.	£7.95	BATTERY	£12.50
		CB CAR RADIO MONITOR	£8.95.

- ★ WE CAN GET YOU STARTED
- ★ WE CAN KEEP YOU ON THE AIR
- ★ WE'VE GOT THE TEST GEAR FOR THE SPECIALIST
- ★ IF YOU ARE IN THE TRADE, WE'VE GOT ALL YOU NEED TO GET SELLING AT THE BEST TRADE PRICES

**SO C'MON DOWN TO:**  
**HAMMERSMITH CB CENTRE,**  
**HAMMERSMITH CB CENTRE,**  
**216 KING STREET, HAMMERSMITH,**  
**LONDON, W.6. TEL: 01-748 6982**  
**OPEN 7 DAYS A WEEK**

EVERYBALL OUR PRICES

**BUY RIGHT**





# WHITE HORSE COMMUNICATIONS

NOW OPEN AT

349A WHITEHORSE RD. CROYDON  
TEL: 01-684 7861

Wholesale & retail sales  
Distributors for



SIRTEL • VALOR • HAM INTERNATIONAL •

Large stocks of all C.B. accessories  
Price List available on request

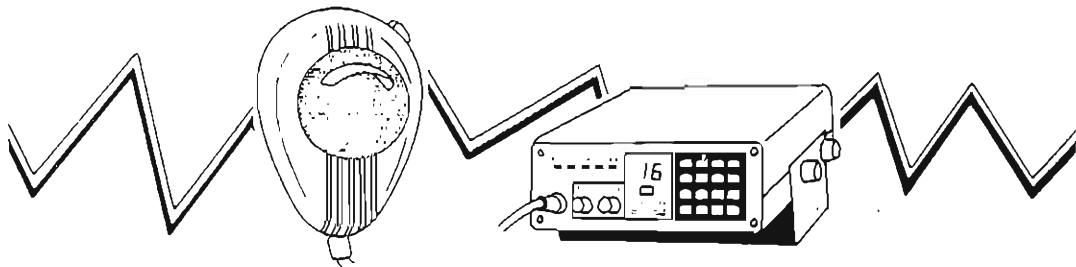

F.M. sets available when legal/with  
complete fitting & repair service.

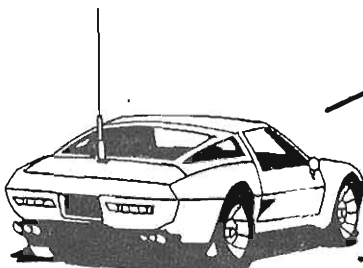

Free technical  
advice given.

# Parliamentary Review



## Our regular look at the House.

Well here we are into the first month of Autumn and still no date has been announced for the introduction of our legal system. Electronics companies throughout the country (and indeed outside the country) are furiously trying to finalise details for the manufacture and marketing of their goods and still the Government refuse to give them and those waiting to use the system an idea of when they are liable to get the go ahead in this country. As far as amnesty for 27AM goes there is still not even the tiniest hint of a change of Policy by Mr Whitelaw or any of his colleagues in the Home Office radio regulatory department, so for those ardent AM breakers determined to stay ardent AM breakers there is still a very long way to go before they become law abiding AM breakers.

CPD

representatives of prospective British manufacturers and importers of citizens band equipment who were members of the Home Office specification committee on citizens band radio are appointed as members of the Advisory Committee on Radio Interference established under section 9 of the Wireless Telegraphy Act 1949 to make regulations under section 10 of the same Act.

**Mr. Raison:** Under section 9(2) of the Wireless Telegraphy Act 1949, my right hon. Friend is required to exercise his powers so as to secure that the committee is sufficiently representative of persons whose interests are likely to be affected. He is satisfied that the panel of persons already nominated by the president of the Institution of Electrical Engineers will enable him to do so.

**Mr. Young** asked the Secretary of State for the Home Department (1) what is the extent of representations that he has received from those supporting AM wavebands for citizens band radio; and what consultations he plans to hold with such bodies;

(2) pursuant to his reply to the hon. Member for Bolton, East, on 1 July, *Official Report*, c.393, whether he intends to have any further consultations on citizens band radio or whether those are now completed.

**Mr. Raison:** A number of organisations and many individuals have pressed us to introduce a 27 MHz citizens band service using AM. However, we cannot ignore the mounting evidence of the interference caused by illicit citizens band AM transmissions and we remain committed to introducing a 27 MHz FM service in the autumn. We will shortly be taking the advice of the advisory committee established under section 9 of the Wireless Telegraphy Act 1949 on the regulations we propose to introduce to control interference from citizens band equipment.

21. **Mr. Campbell-Savours** asked the Secretary of State for the Home Department when he intends to convene a meeting of the advisory committee on radio interference to discuss citizens band radio equipment.

**Mr. Raison:** My right hon. Friend hopes shortly to appoint the advisory committee on radio interference which he will consult before he makes regulations to control undue interference from citizens band radio equipment to other radio services. Once the committee has been appointed, we hope it will be possible to arrange an early meeting.

## Written Answers.

37. **Mr. Freud** asked the Secretary for the Home Department what is his expectation of revenue from licences for citizens band radio over the next three years; and if he will make a statement.

**Mr. Raison:** The licence fee for citizens band radio has yet to be determined and it is not therefore possible to provide an estimate. Our aim will be to ensure that the revenue is adequate to cover the costs of introducing and administering the service.

## Citizens Band Radio.

**Mr. Canavan** asked the Secretary of State for the Home Department what criteria are used in deciding whether to prosecute people making illegal use of citizens band radio equipment.

**Mr. Raison:** All reports of suspected illicit use of citizens band radio submitted to the Home Office are considered with a view to prosecution. Except in the case of juveniles, the only criterion used in deciding on the institution of proceedings is the likelihood of securing a conviction.

**Mr. Nicholas Baker** asked the Secretary of State for the Home Department if he has received any further representations from users of model aeroplanes about the arrangements he has made for allocation of a wave band to citizens band radio operators.

**Mr. Whitelaw:** Since I announced my final conclusions on this matter on 24 June in reply to a question by hon. Friend the Member for Halton (Sir P. Wall) I have received three letters from model aircraft enthusiasts. No authorised service does or will conflict with the 27 MHz sub-band at present allotted to model control; and in addition model aircraft enthusiasts already have two other frequency bands available to them.

**Mr. Campbell-Savours** asked the Secretary of State for the Home Department whether he will ensure that



## Open Channel Radio.

**Mr. Mudd** asked the Secretary of State for the Home Department when he intends to reply to the letter of 9 April from the hon. Member for Falmouth and Cambourne, conveying the observations of Mrs. L. Bevington on citizens band radio.

**Mr. Raison:** I have now written to my hon. Friend. I regret the delay in replying.

**Sir Patrick Wall** asked the Secretary of State for the Home Department if, in the light of the delay in the issue of test and development licences to potential manufacturers and importers of citizens band radio equipment, he will speed up the issuing.

**Mr. Raison:** Applications for licences for testing and development and for more general evaluation of citizens band radio equipment are now being processed as quickly as possible.

We Are Main U.K.  
Distributors for:

**K40**

AMERICAN ANTENNA

**LAKE**

CB RADIO



CB RADIO



CB RADIO

**wipe**

CB RADIO & ACCESSORIES

Dealerships  
Still Available  
in Most Areas

# AM/FM CB RADIOS

THESE ARE ON DISPLAY  
AND CAN BE LEGALLY BOUGHT  
OVER THE COUNTER WITH

**V.A.T. RECEIPTS** AND AVAILABLE FROM ALL OUR DISTRIBUTORS

AVAILABLE  
NOW

**Abingdon**  
Barnes CB  
New Street  
Abingdon  
Oxfordshire  
Tel. 0665 4142

**After Hours**  
Abingdon 0665  
Angley  
John Bandy CB Accessories  
30 Main Street  
Andover  
Angley  
Tel. 047 831634

**Central 15**  
179, 181 Road  
Blyth  
Angley  
Tel. 0427 20520

**11-1200**  
Bar Bar (Garston) Ltd  
120-121 St. Marys Road  
Garston  
Liverpool

**Postfront**  
Post-front CB Accessories  
Malkin College  
Postfront  
Tel. 0977 70444

**Leyland**  
Breaker 27  
5 Clifton Parade  
Bristol Ave  
Leyland  
Nr Preston  
Tel. 0794 2229

**Northwich**  
Channel 40  
CB Specialists  
54 Station Road  
Northwich, Cheshire  
Tel. 1566 236

**Walsingham**  
Robson & Sons  
Larman Road  
Walsingham  
Co. Norfolk  
Tel. 0955 704/7314

**Ramford (Essex)**  
Ramford CB Centre  
2 Basso Corner  
Barnchurch Road  
Tel. 04624 57042/3

**Preston**  
Bottle Opener  
47-48 Taylor Street  
Broadgate  
Preston  
Tel. 3699

**Southport**  
R.L.A. Electronics  
20 Old Park Lane  
Southport  
Tel. 0704 21201

**Bradford**  
R & Pollack & Co  
(Radio & Television) Ltd  
230 Backerwood Road  
Bradford Moor  
Bradford 3  
Tel. 0274 3923

**Leigh**  
Master Electronics  
27 Railway Road  
Leigh  
Lancs  
Tel. 606200

**Newcastle Under Lyme**  
Thistleberry Autoparts  
14 Thistleberry Ave  
Newcastle  
Staffs  
Tel. 0922 46046

**Nucleofield**  
Nucleofield CB Centre  
154 Chester Gate  
Nucleofield  
Tel. 0623 614354

**Quincy**  
Quincy CB Centre  
44 Sogmore Street  
Quincy  
Tel. 6892

**Overmouth**  
Jung Cleland  
89 Main Street  
Overmouth  
Tel. 40785

**J.L. Nelson**  
Chronosound  
14 North Road  
Perryville  
Tel. 0744 51660

**Ryton**  
Orion CB Centre  
101ey Street  
Ryton  
North Yorks  
Tel. 0736 2605

**156 of the**  
John For Bods  
2 Castle Street  
Wavell  
Tel. 0624 21562

**Tunstall**  
Bridgewater CB Barn  
137 Tunstall Road  
Bridgewater  
Barnsley  
Sowerth  
Tel. 01978 40994

**London**  
C.B.A.  
Harrow Hill (Weyhill), Centre  
Hilltown  
London  
Tel. 0907 20704

**Horseshoe**  
Breaker 27  
30 Torkel - Street  
Horseshoe  
Tel. 0574 41236

**Whitnash**  
Chicken Box  
55 Super Street  
Whitnash  
Owleth

## A.D.S. ELECTRONICS.



239 Dickson Road  
Blackpool, Lancs.  
Tel: 0253 21173 /21296  
TELEX: 677583  
SHOP & OFFICE

42, Back Lord Street  
Blackpool Lancs



**STAR BUYS THIS MONTH**  
AVAILABLE FROM ALL  
OUR DISTRIBUTORS

Slide Mounts (Metal Lockable)  
or 2 for £15.00 £2.95  
D.V. 27 Fibreglass (Complete) £4.95

3/5 AMP Power Supply  
(regulated) £12.75

5/7 AMP Power Supply  
(regulated) £16.75

Midland 5/8 Wave Base Antenna  
(approx 900 Gain) £24.95

Electric Retractable £26.95  
(with splitter)

Colt 210 CB Transceiver £69.95  
(with VAT receipt)

7ft Firestik (various colours) £10.50

Basic SWR (complete with Patch  
Lead) £8.95

10ft Tank Aerial (complete) £14.95

5W PA Speaker £4.95

DX 27275/8 (Whip only) £9.95

# Rigs, Repairs, Aerials & Spares

TRY

## NEW FORCE LTD

IN 4001	2 SK 45	2 SC 1945	LA 4400	TA 7130
BC 107	2 SA 715	2 SC 1953	LC 7120	TA 7204
BC 212	2 SC 495	2 SC 1957	LC 7130	TA 7205AP
BC 182	2 SC 496	2 SC 1969	M 515 3L	TA 7222
BF 368	2 SC 1096	2 SC 2028	M 5151 5L	TA 7310
BF 185	2 SC 1172Y	2 SC 2029	MB 3712	TBA 810P
TIP 29	2 SC 1173	2 SC 2078	MRF 450A	UPC 575C2
2N 3819	2 SC 1306	2 SC 2091	MRF 475	UPC 1001H
78L 05	2 SC 1307	AN 2140/124	MRF 477	UPC 1025
3 SK 45	2 SC 1449	AN 240	TA 7120	UPC 1156H
2 SK 33	2 SC 1678	LA 4031P		

### ALL IN STOCK NOW

WE OFFER ATTRACTIVE DISCOUNT TO TRADE & QUANTITY BUYERS  
COMPREHENSIVE RIG REPAIR SERVICE OFFERED THROUGH OUR CHAIN OF ASSOCIATE COMPANIES  
ALL ORDERS ARE SUBJECT TO 15% VAT AND 50p p&p  
PLEASE MAKE CHEQUES & POSTAL ORDERS PAYABLE TO NEW FORCE LTD.

**ORDERS** Tel BENENDEN (058 082) 224 or 201  
Telex 957505 CABLES NEW FORCE BENENDEN



Our range of low priced CB rigs e.g.

40 Channel Standard from £49.20

40 Channel Medium from £54.60

40 Channel Deluxe from £59.20

+ VAT & DELIVERY

150MW Walkie Talkie per pair £21.50

½ Watt Walkie Talkie each £44.13

2 Watt Walkie Talkie each £53.00

available Sept 1st

Send No Money Send for details of our entire range of 27 MHz FM CB Rigs & Walkie Talkies

**AIR BEAR U.K. LTD., Wortley, Sheffield. TEL: Sheffield 886237/885388**



# KERNOW AUDIO + SOUND

WEST COUNTRY  
WHOLESALE AND  
RETAIL CB SPECIALISTS

Large stocks of full range of accessories  
always available.  
Watch out for our special monthly offers  
in local press.

**81 MINA RD,  
ST. WERBURGHS,  
BRISTOL 2**

**Tel: (0272) 541254**

FREE DELIVERY SERVICE IN S. WALES & WEST.

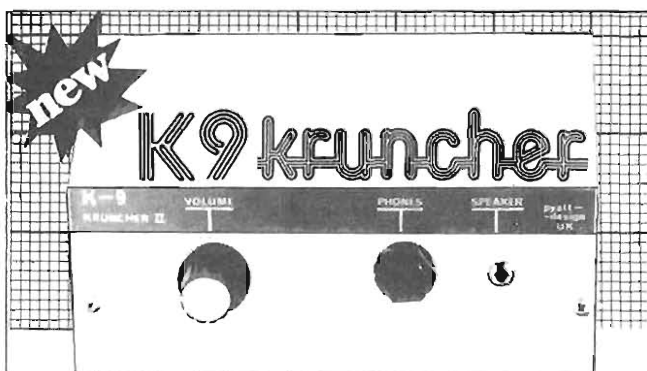

## keeps your hearing and sanity intact

Does the local turkey stamp on you whenever you're listening to a faint DX? Does next door's Model T Dagenham Dustbin interference deafen you? Does Niagara Falls roar thru your shack whenever you break on FM? Does your rig need three hands - one for volume, one for voice lock and one to key your mike when you're trying for your Stateside goodbuddy?

If you have to say Yes to any of these questions, then the K-9 Kruncher is for you.

The British-designed and manufactured K-9 Kruncher levels all output from the audio stage of your rig. It reduces strong signals, strengthens weak ones and maintains whatever level you set. It limits spikes and extraneous noise so that you get all those copies you would normally miss because you daren't turn the volume up to Max. And it fits virtually all rigs.

The K-9 Kruncher also produces many domestic benefits. It reduces household friction and lets your family sleep at night while you break with your ears on - in safety.

Why didn't someone think of it before? All this peace of mind and the best copies you ever had... for only £19.95 plus p&p.

To: Skylab CB, 2c Keighley Road, Crossflatts, Bingley, W. Yorks.

While I still have my hearing and sanity intact, please send me  (write in quantity) K-9 Krunchers. I enclose cheque/P.O. for £21.45 (£19.95 plus £1.50 post & pkg) per unit.

Name .....

Address .....

Full money back guarantee.



A  
PYATT  
DESIGN

H

# NEW

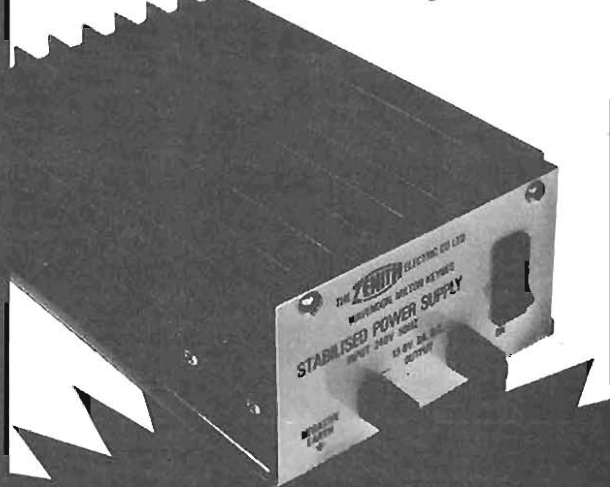

## D.C. STABILISED POWER SUPPLY

Made in UK by ZENITH

- ★ Meets current UK Health & Safety Regulations (BS415)
- ★ Input 240V, 50 cycles, AC mains
- ★ Output 13.8V, DC stabilised at 2 amps continuous
- ★ Fused, electronic current limit, thermal overload protection
- ★ Robust, compact and attractive enclosure
- ★ Carries Zenith's usual 12 months guarantee

Price: Only £16.50 inc. VAT

PLUS £1.75 Postage



The Zenith Electric Company Ltd.,  
Wavendon, Milton Keynes, England  
MK17 8AT. Telex: 825020

Phone: Milton Keynes (0908) 582531

Ask Now  
for full details

ZENITH QUALITY • ZENITH VALUE • YOUR SAFETY

# Round Up

## WINTJOY THE 'CB' PEOPLE

### The End - Wintjoy

Wintjoy Limited the company known for its outrageous advertising and distributing the Firestik range of antennas has ceased trading. This is the first major wholesaler to have been caught by the recession in the CB trade, caused by government inaction over legislation and general economic trends.

Started in 1979 by Glynn Hall, Wintjoy was one of the original CB shops in the south east. Obviously helped by having the sole UK distributorship for Firestik, Wintjoys position was very strong. Cash flow problems unfortunately have put an end to this.

### Not Only vodka in Warrington

As you will have read in all the newspapers Ian Leslie, chairman of NATCOLCIBAR, stood as a by-election candidate of the Citizens Band Legalisation Party in Warrington on 16th July. We were hoping to run a lot more on this milestone in CB history last month but unfortunately all the relevant information didn't arrive from Ian's agent in time. Of course now its old news, but you might not know that he polled 11 votes. Not an enormous amount but Ian has succeeded, in focusing attention on CB and getting exposure for the problems that still face a successful legal system.

James Bryant, also of NATCOLCIBAR, is standing as a candidate for the same party in the Croydon by election. The SDP are likely to grab all the limelight again but congratulations are in order for Ian and James for giving up all appearance of a normal life for the weeks approaching the elections and for standing up publicly for their beliefs.

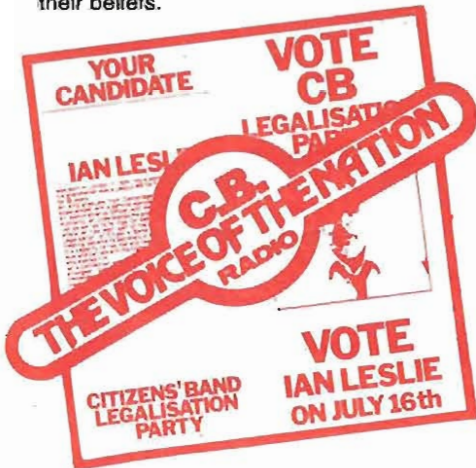

### Breaker Break QRT.

Are Radio Amateurs realising that the enthusiasm and organisation of breakers is to be encouraged? Correspondance and posters from a local technical college arrived on my desk announcing Amateur Radio courses with the heading 'keen Breaker? - CB to Radio Amateurs Conversion Course'. There are lots of indications that the more technical breaker is turning to amateur radio now his attention has been caught by the mysteries of the radio waves. Breakers and hams have a lot to contribute to each other and it would be nice to put a stop to the bad feelings between the two groups. Any one interested should contact Southall Technical College on 01-574-3448 exts. 40, 33 or 67.

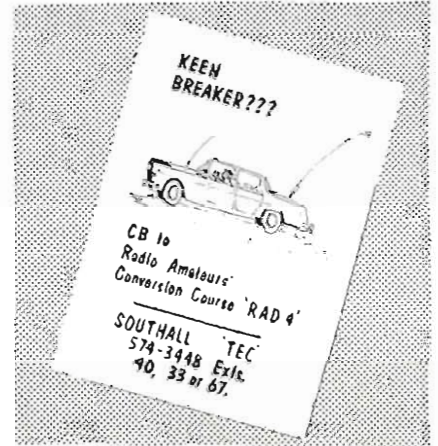

### Best of British

Nice to see two more British companies entering the CB scene.

V-Tronix of Poole in Dorset, already reputable for communication accessories, are applying their expertise to CB equipment. They will be manufacturing and marketing a range of goodies that include power supplies, loudspeakers, cable and connectors and the star of their range, the 'Blue Laser' base station antenna. The specification for this antenna reads very well and the price is very competitive (just under £30). There aren't any distributors selling this range yet so for more information contact V-Tronix at Unit 10D, Dawkins Road, Hamworthy, Poole, Dorset.

That familiar name in car entertainment Radiomobile are intending to bring out a range of CB sets after legalisation - the first such company to announce its intentions to enter the CB market. They intend to market two sets - CB 201 at £90.00 and CB 202 at £120.00. Both rigs have a very high technical specification and are very neat to work at if a touch expensive.

## news from Radiomobile

### Happy Birthday CBIC

Bill Ridgeway celebrated the first anniversary of his Citizens Band Information Centre in July - quite an event in the ever changing world of CB.

We have just received from him his latest collection of information which covers clubs, technical specifications, records, publications etc.etc. Bill will pass on this information plus any other specific information required free to anyone - although a donation, especially from clubs would be gratefully received.

Bill works extremely hard and deserves all the support he can get, contact: CBIC, 7, Sandringham Crescent, Harrow, Middlesex



### Charity begins in Wales.

Another busy club are the Penarth Breakers Club who have sent us a whole pile of newspaper clippings on their activities. They recently gave a turkey meal to over 50 of the areas senior citizens in their club house and produced a 'breakers' cabaret to entertain them. For many of the senior citizens attending it was the first time they had been outside their house this year. One old lady is quoted as saying 'I hear that Citizens Band radio is illegal but if this is an example of the good work they do then long may they reign'.

The club also handed over a cheque to the Llandough Hospital 'Build a Bungalow' scheme. This bungalow will provide accommodation for parents of children in the cancer and leukaemia wards at the hospital.

### October 16th?

Do Binatone know something we don't? Binatone have rigs ready for release onto the British market, and a press release received recently from them states confidently that the British launch will take place on Oct.16th. Further investigation at the Home Office and at Binatone proved this to be wishful thinking. Although we all sincerely hope that it will be sooner rather than later I can't help but think this was a very unsubtle way to put pressure on the government. Not likely to work either!

# Binatone

## Music and CB

There are quite a few records on CB around at the moment, most notable of which the Wall to Wall album by Citizens Banned. Three singles have arrived in the office lately to shake our eardrums (as if the Editors cries of wrath weren't enough!) but due to pressure of other articles we haven't got the space to review them thoroughly.

CB Baby by Rig and Twigs, Breaker Love by Mr. Twister and Breaker 1-4 by Rainbow (or Gypsy - I couldn't quite tell which from the record label), are all by breakers and as such are sincere musical attempts to publicise CB. All three are reasonably well produced (certainly no worse than most singles released today) and have had technical expertise in their production.

CB Baby sounds a bit like a Yorkie advert to me but is quite catchy - I found myself humming along to it. Breaker 1-4 has a strong Country and Western influence which isn't my favourite style but my main criticism of this one is that its too local to mean anything to breakers outside its own area - especially as the singer seems to be determined to cram as many local handles in his three minutes as possible.

My personal favourite is Breaker Love by Mr. Twister as it shows a genuine effort to find a musical style rather than relying on CB to carry it. One worry though is that Mr. Twister seems to be using channel 9 and I can't tell if its an emergency or not! Shame on you, Mr. Twister, if it isn't.

I suspect that these three are the first of a spate of CB records. A word in the ear of anyone considering producing a single (not you three chaps mentioned above) - breakers will want more musically than the odd reference to 'breaker' in the lyrics. A bad single doesn't stop being a bad single because it has some lingo and jargon in it!



### Wheels of Life.

Very few breakers can be unaware of the Gareth Payne appeal on behalf of 2 year old Gareth, suffering from a very rare liver disease. Breakers seem to have adopted this appeal as their own and their efforts to raise £40,000 to send Gareth to America for a life saving operation have featured in many local newspapers.

The Leyland and District Breakers Club in Lancashire have started an ambitious marathon to help raise more funds for Gareth, who has been given only 12 months more to live without the operation. 4 members of the club are cycling from John O'Groats to Lands End, starting on the 2nd of August.

Unfortunately we didn't receive the information in time to feature in last months magazine so we couldn't give any advance publicity but best of luck and God speed to the riders. Any donations should be sent to the Gareth Payne Appeal, P.O. Box 16, Leyland, Lancs.

## The Latest Connexion.

Connexions the up and coming wholesalers in Maidenhead have pulled off their best deal to date by securing the UK sole distributorship for 'Firestik' the famous helically wound fibreglass antennas.

Following the recent demise of Wintjoy, the previously appointed UK distributor, Connexions have persuaded Firestik to appoint them as sole UK importers and distributors. The latest in their Firestik range is the 'Dieselstik' tunable tip heralded as the best helically wound antenna. It is designed to tune over both illegal AM and the new frequency.

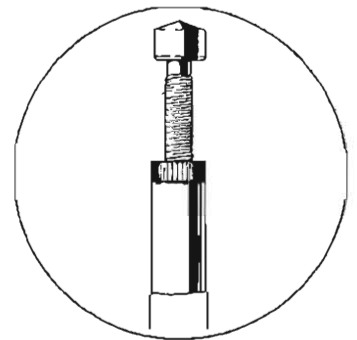

## NEW 'DIESEL-STIK'™

THE ORIGINAL DELUXE  
TUNABLE TIP ANTENNA



### Wedding Present.

Congratulations to Lady Di and Prince Charles who by the time of reading should be successfully hitched. However the prize for the most ingenious wedding present must go to Rigs & Twigs of Westbourne Grove, for their gift of a legally imported (via Isle of Man) Rig suitably wrapped for the occasion.

This was presented on Friday 24th July at the door of Buck House and in return Neil & Brian of Rigs & Twigs received a signed card of acknowledgement.

Should breakers in SW1 watch out for two new handles coming up? Polo Prince & Charlies Angel?

# C. B. A.

26 AYLMEY PARADE  
AYLMEY ROAD  
FINCHLEY  
LONDON, N2  
Tel: 01-341 4161

THE SHOP  
IN THE  
HUB-ANKERS  
FOR  
BREAKERS

PACKAGE DEAL  
40CH RIG  
ANTENNA  
SWR METER  
PATCH LEAD  
£79.95

**CITIZENS BAND ACCESSORIES**

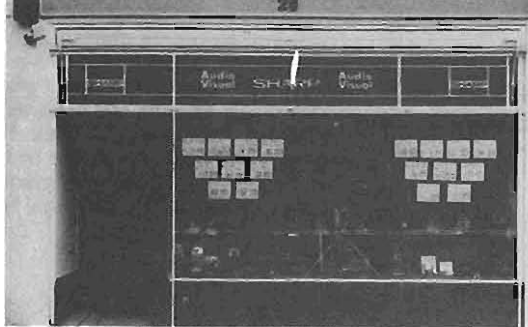

STOCKISTS AND DISTRIBUTORS OF:  
ALL POPULAR BRANDS OF RIGS AND

ALL MAJOR  
CREDIT CARDS  
ACCEPTED

TAGRA  
FINESTIK  
TURNER  
CB MASTER :

ZETAGI  
HAM MASTER  
HARADA  
BREM

Opening Hours  
Tue/Fri 9-7  
Sat 9-6  
Sun 10-5

AVANTI

RETAIL OR TRADE ENQUIRIES WELCOME  
CONTACT: JEFF, TONY OR LEN ON

01-341 4161

**de**  
MAIN AGENT  
FOR C.T.E.



01-573 4848  
Middlesex  
Hayes  
62 East Avenue  
at:

For a comprehensive stock of rigs and accessories  
at very competitive prices, visit our new premises

**RIGS AND ACCESSORIES**

WE TURN PRICES  
UPSIDE DOWN!



**Lucky  
Numbers**

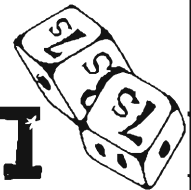

CB Radio.

C.B. World  
BIRMINGHAM



021-784 4523



37 Coleshill Road  
Birmingham B36 8DT.

A SHORT PRICE LIST FROM A BIG SELECTION OF CB GOODIES

<b>ANTENNA</b>		<b>MIKES</b>	
DV27	£4.95	BASE AND MOBILE BY TURNER,	
DSG27	£9.95	K40, LESON, ELECTRA, MIRANDER,	
K27	£9.95	CB MASTER AND HY-GAIN	
VALOR 541SMF	£24.95	POWER SUPPLY (transformers)	
VALOR 531SMF	£23.95	BRS 31 5AMP	£17.50
VALOR 560	£17.95	BRS 26 3AMP	£13.40
VALOR 520	£16.95	BRS 27 3AMP	£14.40
TURNER SIGNAL KICKER	£29.95	BRS 35 10AMP	£39.95
SYLVANIA SOUND STICKS	£7.50	ACCESSORIES	
AVANTI RACER	£21.80	SWR	from £5.50
MOONRAKER (MAG)	£37.50	ANT MATCHER	£5.95
MOONRAKER	£33.53	ANT SWITCHER	£6.95
ROADRUNNERS : ROM	£33.50	PA HORNS	from £3.85
UFO TWIN TRUCKER	£19.95	SLIDE MOUNT	£4.83
BASE ANTENNAE		POWER REDUCER	£18.95
SIGMA 1V	£49.00		
SKY LAB	£18.12	COMPLETE STOCK OF ALL PLUGS,	
DPA2VR	£19.95	CABLE, FUSES, TVI FILTERS AND	
SILVER ROD	£19.95	ANTENNA ACCESSORIES.	
WHISKY	£16.83	<b>new super digital</b>	
SHAKESPEARE 4061	£25.95	<b>u.f.o. scanner</b>	
3 ELEMENT BEAM	£48.00	Transform your 40CH rig to 25.995-	
LINEARS		28.000MHz in 5kHz/steps. 7 SEG LED	
BRL25	£19.43	display. This will give you 400CH	
BRL70	£41.10	for only	£95.40
SKIPMASTER 100	£89.70		
BREM 200	£115.00		
CP100	£85.00		

OPENING TIMES: Mon to Fri 11am-7pm-Sat 9am-6pm-closed Sunday

WE WILL ALSO TAKE ALL REPAIRS. 24-HOUR SERVICE ON MOST ITEMS

Trade Inquiries always welcome. Phone: 021-784 4523

CB Radio.

# Simply C.B.



Limited period only.

## We Know how to turn You On!

WE ARE BACKED BY THE LARGEST  
WAREHOUSES IN THE COUNTRY  
EVERYTHING IN STOCK  
FITTING SERVICE

37 Station Rd, Rickmansworth  
Hertfordshire  
Tel: RICKMANSWORTH 70634

OPEN SEVEN DAYS

8.30am-7.00 pm Mon.-Sat., 10.00 am-4.00 pm Sun.

CB Radio.



**GREAT NEWS  
FOR  
ALL YOU CB'ers**



**GREAT NEWS  
FOR  
CB RETAILERS**

**CB CITY LTD**  
NOW OFFER WHOLESALE FACILITIES TO THE TRADE.  
WHERE SERVICE IS THE KEY WORD

**COMPARE OUR REGULAR LOW LOW PRICES**

K40 ANTENNA	£24.95	SKIPMASTER 150W VARIABLE	£129.95
K40 MICROPHONE	£24.95	<b>BREMI BURNERS</b>	
<b>AVANTI Full Range including:</b>		25 WATT AM	£22.50
AV241 4' MOONRAKER	£18.95	40 WATT AM	£34.95
AV241T BOOT MOUNT	£21.95	70 WATT AM	£45.00
AV241M MAG MOUNT	£22.50	100 WATT AM	£59.95
AV261 6' MOONRAKER	£39.95	SWR 0.6-95	PATCH LEAD £1.25
AV174 SIGMA IV BASE	£61.50	PL259 35p	PL258 50p
<b>VALOR ANTENNAS Full Range:</b>		RG8 58p metre	RG58 20p metre
530 24" DIAL-A-MATCH	£11.25	And many other famous brands at knockdown prices, including HMP, Turner, Shakespeare, Lemm, Firestik	
540 48" DIAL-A-MATCH	£11.75	Send an S.A.E. now for our latest catalogue	
560 WARRIOR 60" CENTRE LOADED	£14.95		
520 HALF BREED 1500W	£11.95		
SKIPMASTER 100W VARIABLE	£115.00		

**LARGE**  
STOCKS AT COMPETITIVE PRICES

**FREE**  
(24-48HRS) DELIVERY ON BIG - ORDERS  
(AND ONLY IS CHARGED ON SMALLER ORDERS)

**NO**  
MINIMUM ORDER VALUE  
(IDEAL FOR TOP UP ORDERS)

**ONLY**  
BONA-FIDE TRADES SERVED

CALL CB CITY NOW ON HIGH WYCOMBE (0494) 20135  
FOR YOUR PRICE LIST OR TO PLACE YOUR ORDER

**ARMSTRONG ANTENNAS NOW IN STOCK**

Super Powerful Magnetic Mount	R.R.P.	OUR	£25.95
Wing or Roof Surface Mount	£35.00	PRICE	£24.50

CHECK US OUT NOW AT ONE OF OUR BRANCHES

- 85 Ash Hill Road, Ash Aldershot, Hants. 0252 318141
- 1. Reading Road, Chineham, Basingstoke, Hants. 0256 53900
- 37 Queens Road, High Wycombe, Bucks. 0494 20135
- 2A Chapel Street, Holsworthy, North Devon. 0409 253504
- c/o A & A Carparts, High Street, Crowthorne, Berks. 03446 77113

<b>CB CITY'S OWN PRODUCTS</b>	★ ★ ★	POWER SUPPLY	£ 13.95
	★ ★ ★	TV FILTER	£ 3.50
	★ ★ ★	ADD ON FM CONVERSION BOARD	£ 12.50
	★ ★ ★	POWER SUPPLY 7A	£ 24.95

© CB CITY... (cbtms)

A NEW RANGE OF PRODUCTS WHICH ARE EXCLUSIVE TO CB CITY LTD  
**POWER SUPPLIES BY 'SURE-POWER'**

A POWER SUPPLY YOU CAN USE WITH CONFIDENCE  
A NEW CONCEPT IN POWER SUPPLIES WHICH ARE SAFE TO USE  
DESIGNED AND MANUFACTURED IN GREAT BRITAIN

**SPECIFICATION:** INPUT 220-240V A.C. @ 50/60HZ. OUTPUT 15 V DC 2.5A CONT/4A SURGE  
**SPECIAL FEATURES**  
● FULLY REGULATED OUTPUT UTILISING SPECIALLY DESIGNED SOLID STATE CIRCUITRY FEATURING INTERNAL FOLDBACK FOR SHORT CIRCUIT AND OVERLOAD PROTECTION  
● GOOD QUALITY AND SAFE CONSTRUCTION. NO POSSIBILITY OF ELECTRIC SHOCK  
● GOOD CABLE CLAMP  
● GUARANTEED FOR 12 MONTHS



A TRUE 7 AMP VERSION ALSO AVAILABLE

**NEW TVI FILTER**  
● CURES PICTURE INTERFERENCE  
● DOES NOT AFFECT PICTURE QUALITY  
● THIS FILTER MEETS AND EXCEEDS THE HOME OFFICE SPECIFICATION NO. 44-7A. BUT HAS BEEN OPTIMISED FOR 21KHz INTERFERENCE

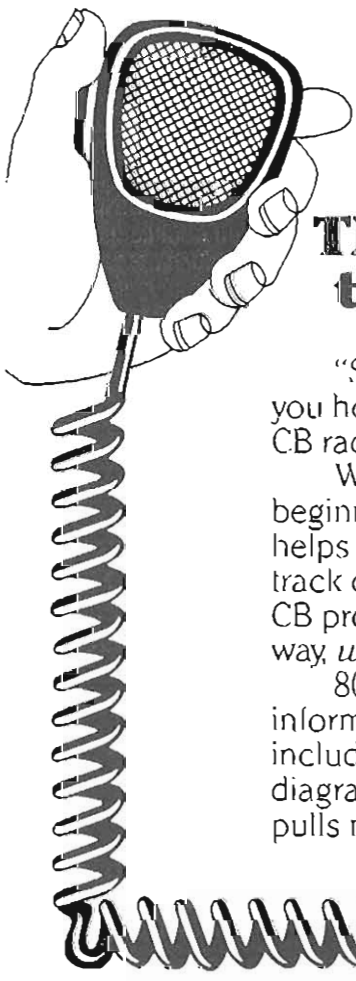

**MUST FOR EVERY CB'er**

**THE SCREWDRIVER EXPERT'S GUIDE to peaking out & repairing CB RADIO**

"Supersparks" Lou Franklin tells you how to get the most out of your CB radio in his US best seller.

Whether you're an expert or a beginner this acclaimed 1981 edition helps you maximise performance, track down faults and solve 95% of all CB problems in a logical, step-by-step way, *without spending a fortune.*

80 pages packed with essential information and practical tips including 20 pages of easy to follow diagrams. It's straightforward and pulls no punches. As Franklin says,

"YOU DO NOT HAVE TO KNOW HOW SOMETHING WORKS TO BE ABLE TO FIX IT"

Read this guide and you'll find he's right. Available from major CB dealers, price £4.95.

Or send direct for your copy to Connexions, sole U.K. distributors, at 8 Furrow Way, Cannon Lane, Maidenhead, Berks. Tel: (062-882) 4338/9.

**TRADE ENQUIRIES WELCOMED**

**Connexions**

CB & TRUCK STOP  
**GEORGIA BULLDOG**



ENGLAND'S LARGEST SUPPLIER

OF C.B. PATCHES, BADGES AND CAPS

Special Summer  
Offer

**FREE CAP**

WITH EVERY SWEATSHIRT ORDERED

ONLY  
**£6.99**  
 FREE POSTAGE



SUPERB QUALITY SWEATSHIRTS - U.S.A. STYLE. MADE OF 50% ACRYLIC, 50% BRUSHED COTTON, WITH EMBROIDERED C.B. LOGO ON THE FRONT AND A FREE CAP WITH EVERY ORDER. IT'S AN OFFER YOU CAN'T REFUSE! WE GUARANTEE TO DESPATCH YOUR ORDER WITHIN 28 DAYS. PLEASE COMPLETE THE ORDER FORM BELOW.

ORDER FORM

LONG OR SHORT SLEEVED	OFF	SIZE	MOTIF 1st CHOICE	MOTIF 2nd CHOICE

SIZE GUIDE

SMALL 34"-36"  
 MEDIUM 36"-38"  
 LARGE 38"-40"  
 X LARGE 40"-42"

COLOUR

AMERICAN  
 SILVER GREY

CHOICE OF EMBROIDERED MOTIFS

- (1) INTERNATIONAL C Bar
- (2) HEART OF ENGLAND
- (3) BRITISH C.B. or
- (4) THIS IS C.B. COUNTRY
- (5) SEDDON ATKINSON
- (6) LEYLAND
- (7) BEDFORD
- (8) FORD
- (9) VOLVO

Includes CB Logo

YOUR NAME ..... TEL. ....

ADDRESS .....

AMOUNT ENCLOSED

ALL CHEQUES & POSTAL ORDERS PAYABLE TO GEORGIA BULLDOG; 56a Milligan Road, Leicester, LE 2 BFA



SEE US AT THE  
SIM HI FI SHOW  
IN  
**MILAN**  
3 - 7th September 1981

**C.T.E. INTERNATIONAL S.r.l**

MANUFACTURERS OF HIGH QUALITY CB ACCESSORIES IN EUROPE FOR OVER 10 YEARS

**QUALITY AT THE RIGHT PRICE**

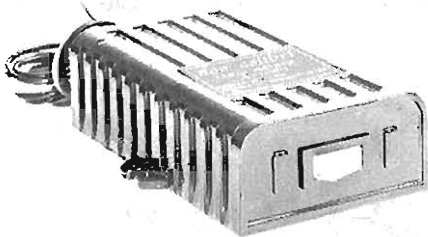
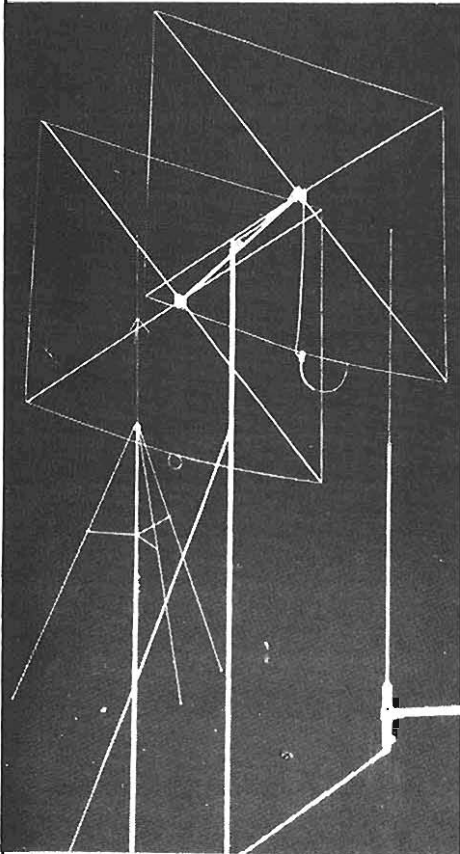

TRADE ENQUIRIES

**01-640 6919/0**

Telex **945414 FORMAN**

***DIGITEK UK***



Unit 3, Mitcham Industrial Estate,  
85 Streatham Road, Mitcham, Surrey, CR4 2AP

# INCREASE YOUR 'TALK POWER'

## THE **PER SUADER** SPEECH PROCESSOR

INCREASE YOUR 'TALK POWER' WITH  
THE T & T ELECTRONICS 'PERSUADER'.



By removing power wasting peaks from the speech waveform and unwanted frequencies the average 'talk power' can be increased by up to THIRTY TWO times.

Simple to install, simply connect between your microphone and transmitter and switch into circuit when the going gets tough. When switched off the microphone connects direct to the transmitter.

Only one control to set the level which is indicated by two light emitting diodes.

Suitable for all standard rigs and microphones in current use. Amateur and CB.

Fully filtered to provide maximum 'talk power' in the speech band of 300 to 3000 Hz. Suitable for all modes: SSB, AM, FM.

Also, British designed TVI filters. Low Pass, type UK33. Cut off freq' 33MHz. Attenuation at UHF 70dB. A three section design with internal screening between sections and also fitted with two harmonic traps. 50 ohms impedance, rated at 250 watts. High Pass, type UK400. Cut off freq' approx

High Pass, type UK400. Cut off freq' approx 400 MHz. Attenuation at 27 MHz 50 dB. A three section filter designed for UHF TV receivers. (not suitable for 405 line sets). 75/80 ohms impedance.

Prices: Persuader speech processor ... £38.18  
Persuader Low Pass UK33 ..... £17.50  
Persuader High Pass UK400 ... £ 5.85

Send 14p stamp for full details.

Order with complete confidence (C.W.O. only please) from:

## **T.&T. ELECTRONICS**

Green Hayes, Surlingham Lane, Rockland St. Mary,  
Norwich, NR14 7HH. Telephone 05088 632

PRICE INCLUSIVE OF V.A.T. & CARRIAGE  
Callers by appointment only

**C.B. ACCESSORIES**



THE FIRST CB RADIO SHOP TO ADVERTISE  
ON CAPITAL RADIO PULLS OFF ANOTHER FIRST

By Presenting..H.R.H. THE PRINCE of WALES  
and his lovely bride....

A 27MHz AM CITIZENS BAND RADIO

Legally imported via the I.A.M.



34 Westbourne Grove W2

On the corner of Newton Rd.



**01-221 4563**

By Appointment

## Calling All Enterprising Breakers

Heres A Great Way To Put Money Into  
Your Pocket, Your Bust Fund And Offer  
A Service To All Breakers Who Are  
Proud To Show Their Handle

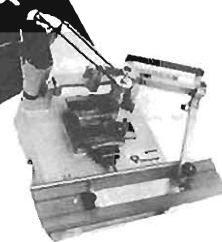

\* With A Gravograph Portable Engraving Machine And Our  
Range Of Coloured Badges You Can Produce Personalised  
Badges For Your Club Members And C.B. Good Buddies Everywhere. \*

You Can Also Personalise Your Rig And Engrave Key Rings,  
Pens, Gear Knobs And A Host Of Other Items.  
No Skill Required—Free Demonstrations

Write Or Telephone Today For Details

BEECH & SON LTD.  
MERIDIAN HOUSE,  
SWANLEY,  
KENT, BR8 8AL.

TEL: (0322) 63211

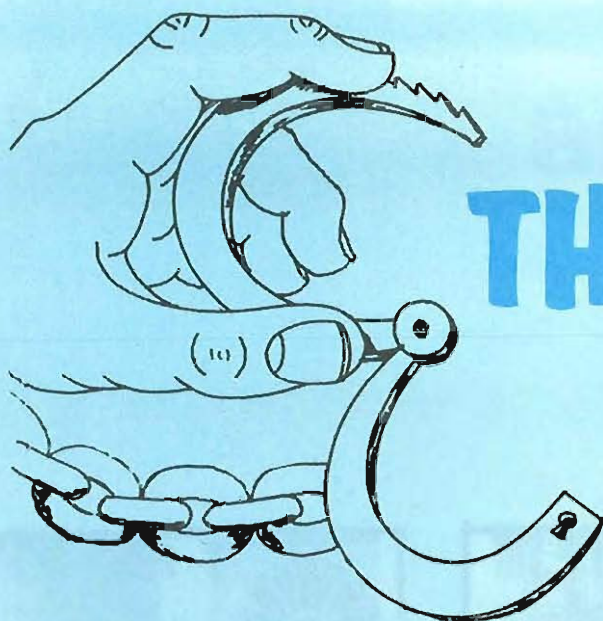

# THE LAW AND YOU

## 6 months of CB Radio Mag. Fact File.

Last March we announced the setting up of a Fact File which would be available free of charge to solicitors to enable them to understand laws and legislation relevant to CB. It was hoped that it would be particularly useful for solicitors who had never had any contact with CB before but had been asked to act on behalf of a breaker.

Although we had teething troubles in getting the information verified by an experienced solicitor and getting the file reproduced, it has proved to be a great success. Nearly 50 files have been sent out, many of them to people in the circumstances we had hoped - ie solicitors who had been asked to act for a breaker but was completely unfamiliar with the law and CB.

### Know the Risks.

Quite a few requests came from solicitors who had been asked to speak to a club meeting about the law. This we were particularly pleased to see as we feel that if someone is going to break the law he should be fully aware of the risks he is taking and how to act if caught.

A lot of the information passed on came from you as we requested that anyone unfortunate enough to get caught and prosecuted send the details on to us. Many of our our readers did this and we were able to research the different laws, statutes and regulations mentioned or concerned.

Although this didn't help the poor breaker who was prosecuted it has meant that other breakers will be able to fight their cases better and with a greater chance of success.

### £100 for First Offence?

One of the most interesting things that came out of the research for the fact file was the vast difference in fines for people found guilty. One breaker in Thornton Heath, London was fined £200 for transmitting without a licence whilst a breaker in Birmingham was fined £25 for a very similar case. This is even though magistrates have been told that 'consistency is desirable in the penalty exacted' and the Magistrates journal has suggested £100 is a 'reasonable starting point for a first offence'. Again many magistrates have given a very light fine because of impending legalisation although the same journal states that 'the fact that the Government may well legalise and

regulate this activity is not a mitigating factor: rather, the reverse'.

### More Prosecutions after legalisation.

The fact file includes a copy of the article in the magistrates journal, a description of the current law prohibiting the importation and use of Citizens Band equipment, examples of typical fines, case histories and reprints of our own articles in 'The Law & You'. Please carry on sending in any useful information as we hope to update the file as more information becomes available. It seems likely that prosecutions could increase after legal FM equipment is available so the Fact File could be as important as ever.

SS



# Wales comes to London

## Where have all the Londoners gone?

Apart from the obvious landmarks in the big city, anybody taking part in the London Demonstration could easily have mistaken his location for Cardiff or Swansea. So large was the Welsh contingent and so minimal the London support that the few London breakers who did bother to turn up made a considerable effort to speak with Welsh accents, for fear of reprisals.

The demonstration was organised by the Thamesdown Transceiver club in support of 27MHz AM and in opposition to FM. When we arrived at Hyde Park Corner designated as kick off for the march we were greeted by the Tiger City breakers, six of them in all who come all the way from Leicester to show their support. The Tiger City chairman, Horizontal (who was vertical when I spoke to him) is an ardent campaigner for AM, was proud that he had only missed one demo all year! However for the first hour of the rally the six TC members, 10 Mosley breakers and a handful of visiting, Welshman, were the only representatives of a demonstration at which over 500 people were expected to attend. With three coachfuls of police, intermittent rain showers and possibly 25 demonstrators it began to look as if AM was dead and buried in UK.

Things eventually perked up with the arrival of several coaches from points west of Bristol and a convoy of some 30 cars and a lorry, the march set off with about 700 people taking part. The usual

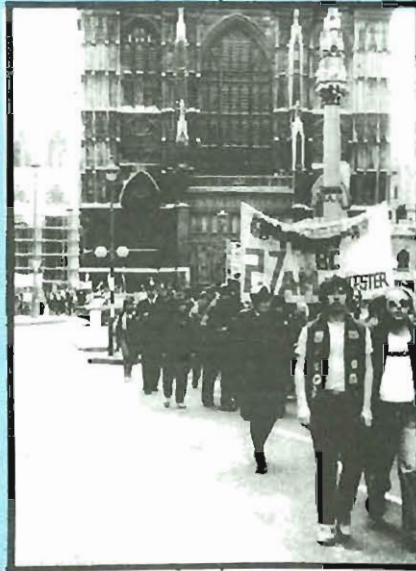

chants of "what do we want . . . AM, when do we want it . . . Now! Failed to impress onlookers at all. The most common comments heard en route were, "whats all that noise about" or "what is AM?" Any non CB onlookers couldn't help being bemused or even frustrated as no literature was handed out to explain the meanings of the series of nonsensical initials FM, SSB, LSB, CB, AM etc. It is no wonder that Joe Normal has no sympathy with



breakers aims because he hasn't got a bloody clue what its all about. Club secretaries please take note, a fair amount of descriptive club literature can maximise the impact of your demo and help to get converts at the same time.

The route of the march was the usual one reserved for London Demonstrations of all kinds: along Park Lane, down Piccadilly to Lower Regent Street through Trafalgar Square to Whitehall where a small delegation of breakers split off from the march to go to Downing Street. Police permission had been granted for 5 members of various clubs to present their pro AM petition to the Prime minister. Gamekeeper, Rollerskater, Mean Machine, Chairman James Bond and Condor were escorted to the door of number 10 where the PM's steward looking rather jovial considering the seriousness of the CBer's plea, received their hastily prepared petition. After passing the Houses of Parliament the demonstration broke up, and the intrepid marchers went home to tea.

Lack of support for this march probably owed alot to the Wimbledon final taking place on the same day. However Exeter CB Biscuit town breakers, South Wales breakers, Tiger City breakers all responded to the call from Thamesdown Transceiver club to demonstrate. Pity there wasn't more local support. Is this an indication that Southern Breakers are resigned to FM and see no future in AM or is it just that apathy is a common complaint in the Home Counties.



# The Eastbourne AM rally

## We were there but where was Willy?

Taking into consideration the average age of the residents of Eastbourne the turnout for the recent pro AM CB Rally wasn't at all bad.

The main focus for attention was the Grand Hotel at which William Whitelaw was supposed to have been attending a conference. These Southern Breakers saw this rally to be an excellent opportunity at which to express their disgust with current legislation proposals. Due to a large amount of civil unrest in other parts of the country the Home Secretary was not in Eastbourne, more likely Toxteth or Brixton.

The absence did not deter our stalwart protesters and with the addition of a well decorated lorry disguised as a rig blurring out Convoy at a couple of hundred watts the noise volume if nothing else was tremendous. East Sussex police who helped immensely with the marshalling and organisation of this event came in for praise from everybody. I was personally surprised to see people openly using CB rigs whilst driving past big burly coppers without a single bust being made. Perhaps East Sussex police realise the benefits of CB and don't want to waste their own time. Whatever the reasons, three CHEERS to East Sussex.

The rally consisted of about 400 breakers, the afore mentioned lorry and a tumult of banners. The only drawback about the whole event was the 'speech', now this rally was originally intended to run for 2½ hours from 7.30-9.30 and to act as a general eyeball as well as a demo. When Penny Black took the stage at about 8pm and immediately promised to keep his speech short a groan of disbelief



circled around the sea. Throughout Penny Blacks speech which for those who didn't stay to listen was pretty good, an exodus of yawning breakers was still in process. Perhaps there is a lesson to be learnt here somewhere? Approximately 10 breakers were left at the end of the event.

After moaning last month about the lack of printed material at the London demonstration, I was very pleased to see an A-4 size printed handout describing what the demonstrators were shouting about.

Not the biggest demo ever seen, not

quite the best organised but I am sure there are a lot of holiday makers and retired civil servants who know all about CB. Whether or not they support us is a matter of pure conjecture.

One disturbing incident that can't pass without a mention is that when the convoys drove off there was a great deal of swearing at passers by, an otherwise sensible event was turned into disgrace by approx. 10 people. Eastbourne breakers please sort out your members.

PCC



# CLUB SPOT



Welcome back to Club Spot.

## Long Eaton Breakers' Club (Castle Breakers)

Just thought that I'd drop you a line about our club which was formed in August last year by two intrepid local breakers Skipper and Rat Bag. We meet every Tuesday night at a local clubroom which is complete with a bar (selling real ale!), pool table and dart board. The club is run in the hope of attracting the more serious CB'er and please note that there is no mind-blowing disco to scramble your brain, no juke box either but merely a place to go for a quiet drink and a chat (as opposed to a shout!) with your CB mates and XYLs.

The Castle Club is run more as a social club than a discotheque; the committee is elected by the members and all club policies and proposals are discussed openly and voted on accordingly by members.

There is a charge of 50p made at the door (XYLs free), which goes to offset the rent and heating charges. It also pays for the free hotdogs and all social events (another open-air barbeque is planned and also day trips will be arranged). All money collected is returned to the member in one form or another, with the exception of raffles held at the club, the proceeds of which go anonymously to local charities. We also have our own membership cards and embroidered badges, plus reasonable discounts from two of the local CB accessory shops.

## Bugs Bunny Give Us A Nine Club

We have been running for several months, and at present have an increasing amount of members. We meet every Tuesday evening at the Hand in Hand, Boxhill Road, Boxhill, Surrey, from 8 p.m. The joining fee is 35 pence, and we make a nominal entrance charge of 10 pence, to go some way towards printing charges and other expenses.

Every week we produce a Newsletter, and an up to date Membership list. We're proud of our raffle, which we believe is one of the best around. We can supply Club posters and QSL cards, and we're awaiting arrival of sew on badges and car stickers.

We're active on the social front, having regular discos and many other functions ranging from barbecues to convoys. We're preparing teams to go Ten Pin Bowling on a regular basis, and we field two darts teams. We're always ready to accept challenges from other Clubs!

At present we're raising money for Leukaemia Research, and would be most

grateful for gifts of stamps and ring pulls (from Coke cans etc) which are sold in aid of this worthy cause.

Our Club membership ranges from Company Directors to school children, from 70 to 7, and we warmly welcome all those 'would be' breakers who want to be ready to go on the air in the Autumn, to come and share the friendship, knowledge and experience of our Members.

Hope to see you soon, Breaker Break.  
Bugs Bunny

## Forfar & District Breakers Club

Our club was formed six weeks ago and to date has between 70 and 80 members. We have, so far, organised and held, a Fox Hunt, Pool Competition and film shows. We are also raising money to purchase and train a Guide Dog for a blind person.

We break on 19 and meet every Monday at 7.30 p.m. at the Stag Hotel, Forfar. Every second Monday is a social gathering. Any Breakers passing through the Bridie Town are welcome and information can be obtained from the Committee: -

Rocket Man, Moonshiner, Star Fighter, Jenny Wren and Iron Fist.

Rocket Man (Chairman)

## The Thorne and District Breakers Club

I am writing to inform you of a new club which has only been opened since Nov. last. We have 165 members, we are called the Thorne and District Breakers Club. We meet every Tuesday evenings at the White Hart in Thorne. We have one O.A.P. 70 years young, named Guinea Pig. We also have about eight disabled members which was a joy to see when they joined us last week. All new breakers are made very welcome to the club, they will find us very friendly breakers. All members of other breakers clubs would be made welcome on our eyeball nights, which are the last three Tuesdays of every month. We are on channel 17.

So 10-10 for now Tea Bags on the side and satisfied.

## Merseyside '27 Club'

The Merseyside '27 Club' was formed 16 months ago when CB was a relatively new thing in the Merseyside area. Our membership grew rapidly as CB activity increased, until such a time was too vast, therefore it became increasingly difficult to please everyone especially those who had to travel long distances to weekly

venues. Consequently groups of members broke away from our club and formed their own clubs in their own area of Merseyside.

Now we cover North Merseyside and our present membership is 145. In North Merseyside the breaking channel is 27 but 19 as you get further towards Liverpool.

We have weekly eyeballs at five different venues where everyone is most welcome, and we have a closed meeting for members only once a month when forthcoming events are arranged and discussed.

Because we use different venues for our eyeballs each week we do not have, as yet, a permanent address for correspondence. We are at present arranging a P.O. Box form our friends the G.P.O. I will personally write and let you know as soon as one has been arranged.

Best 73's to you all.

Golden Eagle

## Southampton Citizen Band Club

Just a few lines to let you know of the existence of the S.C.B.C. (Southampton Citizen Band Club).

We number some 860 members and are growing daily. We hold a general meeting on the last Wednesday of every month, and an information meeting (technical) two weeks after.

A local charity receives our support both financially and practically. It is a home for mentally and physically handicapped children. Disco's, Foxhunts, rally's etc. help with finances.

We are a PRO. 27 megs. A.M. club.

A warm welcome will be given to any out of town breakers passing through the BIG S., just put out a call on 19.

Golden Numbers. To all Good Buddies.  
BAND-AID (PRO)

## South Staffs Breakers Association

We meet every Tuesday night at 8 p.m., our meeting place is the Dolrick, Hednesford Road, Brownhills West, West Midlands.

We are just off the A5, truckers passing through will be made welcome. Our activities include convoys, treasure hunts, disco's, also we are going to form an ankle snappers club to cater for the under 16's.

Membership is £2. Entrance Fee 40p. Visitors 60p. Ankle Snappers membership 25p. Entrance Fee 5p.

We hold a raffle every week with very exciting prizes.

Breaker-Break.

(Secretary)



**CITIZENS BAND . . . THE NEW WAVE . . . CITIZENS BAND**  
**STREET LEGAL CB WHOLESALE**

NOW IMPORTING FROM

**WE'RE MOVING SOON - WAIT FOR  
INFORMATION ON OUR NEW  
PREMISES AND LARGER STOCK**

THE CONTINENT,  
AMERICA AND THE FAR EAST

**FRANCHISE RETAIL OUTLETS REQUIRED ON NATIONAL BASIS**  
**90 STOCKWELL GATE, MANSFIELD, NOTTINGHAMSHIRE**  
**TEL: (0623) 651965**

*Connexions*  
AUTHORISED DEALER

**CHATTER  
BOX**

Every one's talking about us  
because of our Low Prices  
**SADELTA MIC'S, BASE ANT'S**  
PHILIPS ANTENNAS - SUPPRESSION KITS

Everything you'll ever need  
Come and visit us at:-  
**CHATTERBOX**  
48-49 Walsworth Road,  
Hitchin,  
HITCHIN,  
HERTS.

Tel: Hitchin  
(0462) 51692

**BREAKERS YARD  
READING**

WE ARE WELL CONECTED  
WE ONLY SELL THE BEST . . .  
**EVERYTHING**

**CB**

**GOOD PRICES  
GOOD SERVICE**  
**BREAKERS YARD**

Traders Arcade  
Station Road  
READING  
Berks

*Connexions*  
AUTHORISED DEALER

CB Radio.

## Sandwell Area Citizens Band Radio Club

Having written to you on several occasions we find that to date we have not been included in any of your mags on CB.

Could it be that our chairman the Ace of Spades is included in some sort of blacklist as a blackleg. If this is the case we the committee understand, because he came from Jamaica in 1960 dressed in traditional dress (starkers), with a tom tom drum under his arm, manufactured from the tree he perfected his swinging techniques on as a child.

Immediately on arrival to this country he signed on for social security benefits claiming for his 26 brothers and countless sisters, one of which met with a fatal accident whilst swinging from tree to tree on the reservation in Sandwell.

He attended university (Bagdad) and was educated away from cannibalism to becoming our chairman, after realising that CB was a more efficient way to communicate other than the drum which he still uses to indulge in makeshift tribal activities in Sandwell.

Being the only chairman we know who has two-lone hands, a vinyl roof and ivory grill we think we deserve a mention in one of your magazines.

We hold our meetings on alternate Thursdays at the Liberal Club, Nimmings Lane, Blackheath and visitors are more than welcomed if they remember to bring their passports to show the natives on their way through Handsworth and refrain from throwing bananas into the chairmans cage.

Please ignore the red traffic lights in Handsworth as it is only a way devised by the natives to get people to stop there when visiting relatives in the white mans land.

*Apologies for not printing this communique earlier but as we received it over the bush telephone it has taken sometime for our Swahili translator to decipher. Anybody visiting this club does so at the risk of being served up for dinner!*

## Royal 'T' Breakers Club

Hi there! all you breakers in CB land. We are the Royal 'T' Breakers Club who formed on 16/5/81, our present membership stands at approximately 100, but new memberships are being requested daily.

We have official 'eyeballs' on the first Saturday of each month, we discuss a wide range of subjects. We also have sub-committees for our D.X. club and Technical club, of which both are well supported.

We are presently arranging for T shirts, badges etc. to be printed, they will have our club motif and members handles printed on request. Our other main priority at the moment is to arrange indoor/outdoor sports functions with the members, and competing against any other interested club.

Anyone wishing to join our club, just give us a shout on 14, and we'll fix you up.

So we'll give you all the highs and lows just now, 10-10 till we do it again.

The Saint (Secretary)

## Yorkshire's Elite Breakers (Y.E.B.)

We are situated between Steel City, Spiretown and Dukessville, at the present time we have about 80 members. The club is run by myself (2+ 2) and Money - Penny and meets every Wednesday night at 7.45 onwards at the Fairway Inn, Blrley, Sheffield. Visitors are welcome. We have a raffle at every meeting and an assortment of prizes to suit everyone. We are trying to arrange some fund raising activities with other clubs in our area. We are members of the Northern Association of CB clubs and have been in touch with clubs in a radius of 20 miles of our area.

We would like members and visitors to attend clean and green.

10-10 till we write again.

This is 2 + 2 subtracting

## Canal Side Breakers Club

We are the "Canal Side Breakers Club". In addition to being involved in the struggle to get CB legalized on a suitable frequency, we also organise a wide variety of social events for our members and those who attend our 'eyeballs'. At our meetings, we have made special provision for the younger breakers who are not yet old enough to sample the joys of barley pop. We meet every Monday (excluding the first Monday of each month) at the Dingle Hotel (The Woods) in Lymm (The Little Village). Our meetings usually begin at 8.00 p.m. The club welcomes new breakers, and invites breakers from other clubs to pay us a visit if you get lost, break on Channel 14 for more information. We look forward to seeing you soon.

10-10 till we do it again, bye bye we gone.

Plato (Public Relations)

## O.C.B.C. (Orpington C-Ber's Club)

Meeting every Tuesday evening at Ramsden Boys School. Help from Tee-Cee on aerials & D.I.Y. Jimmi Jazz on rigs and Mr. Con mobile installations. No fees Just Fun!

Sold Gold 73's and Keep it clean 10-10 Tee-Cee.

P.S. Mickey Mouse please return old CB Radio Mags to me!

## Wight Breakers Club

The Wight Breakers Club (W.B.C.) is based here on the Isle of Wight.

We meet every fortnight at one of six pubs, this is so that everybody gets the chance to have the eyeball in their local area. If you are down this way we break on one-nine and all information can be obtained on the air.

We hold regular fox and treasure hunts, also discos are planned as well as pub sport events and other activities are in the pipeline.

10-10.

Mr. Flame Sec. W.B.C.

## Severn City Breakers Club

We were formed in September 1980 and we now have a total of 400+ paid-up members. Our Committee consists of: - Chairman, Gander; Vice Chairman, Kibby; Secretary, Brown Owl; Treasurer, Rainbow; Vice Treasurer, Green Duck.

Our local breaking channel is 14. We do not use channels 20, 21 or 22 in the Shropshire area, as these interfere with the hospital systems.

Since our town is on a principal holiday route, it may be of interest to passing breakers that channel 9 is monitored between the hours of midnight and 6 a.m. by Sea Wolf and Mermaid, in case of emergencies.

We meet fortnightly on a Tuesday at Tiffany's in Shrewsbury at 8 p.m. Guests are welcome but should be accompanied by a paid-up member of the club.

Yours faithfully.

C.E. Blumfield, Spitfire (Press Secretary)

## L. A. Breakers

We wish to inform you about a New Club which has started in Bridgetown (Hull). We are the L. A. Breakers, and meet alternate Wednesdays, at the Lockwood Arms in Cannon Street. We also have a fine committee running the club, this committee consists of (Chairman) Midget Man, (Treasurer) Rooster Booster, (Committee Members) Partsman, Swinger, and H.2.O. Also Snowbird, who takes care of all the paper work.

We have got a lot of good ideas in the pipeline some of which have not been done by any other clubs in this area and we are hoping these ideas will be first for our club, as we are a new club we cannot give too much away as yet, but we will keep you informed as to the progress of these ideas.

Yours sincerely.

Midget Man (Chairman)

## Sky Blue City Zen Band Radio Club (Coventry)

We meet at 8.00 p.m. sharp every Monday evening at the Sky Blue F.C. Supporters Club, Highfield Road, Coventry. Visitors are welcome, small admission charge on the door.

We have a limited membership of 200, and we organise various entertainments for our members, including, games, quizzes, discussions etc, our aim being the responsible use of CB radio. Our members range in age from 18 to over 50 and we try to cater for everyone. We are also interested in participating in sports and games with other clubs that may be interested. Any further details, or correspondence should be addressed to either Liberty Bell (Secretary) or myself, Brandybird (P.R.O.) at Sky Blue City Zen Band Radio Club, c/o Skips CB Centre, Wheelwright Lane, Exhall, Coventry, or Phone 1203 362779.

Breaker Break.

Brandybird (Sandra Witter)

CBC \* CBC \* CBC \* CBC \* CBC \* CBC \* CBC



# CB CENTRE



HAVE MOVED THEIR RETAIL & WHOLESALE TO NEW & LARGER PREMISES  
20c SELSDON ROAD. SOUTH CROYDON. SURREY



## 01-680-4503



WE BUY DIRECT FROM ABROAD & CUT OUT THE MIDDLE MEN

DIRECT IMPORTER

AND PASS THE SAVINGS ON TO YOU

DIRECT IMPORTER

We are now K40's Main Distributor for their products throughout the south of England

So to promote this success we are offering for a limited period

K40 Speech Processor Mike	£24.95
K40 Mobile 500W Antenna	£24.95

*These prices include VAT + P&P*

You can order and pay by Access & Barclaycard



FULL RANGE OF C.B. ACCESSORIES AVAILABLE  
FOR FREE CATALOGUE SEND A S.A.E.

HELP & ADVICE GIVEN ON ESTABLISHING NEW CB OUTLETS  
WHOLESALE ENQUIRIES 01-680-4503



CBC \* CBC \* CBC \* CBC \* CBC \* CBC \* CBC

© CB Radio.

**Connexions**  
AUTHORISED DEALER

## ACE AUDIO

For all your CB requirements  
stockists of all major brands  
friendly advice from our  
qualified engineers

### RAPID REPAIR SERVICE

#### SPECIAL OFFERS

KRACO Ext Speaker	£3.99
2 AMP Power Supply	£12.95
Trunk Lipmount Antenna	£5.99
INC VAT	

ACE AUDIO  
126, Dalton Road,  
BARROW IN FURNESS  
Cumbria  
Tel: 0229 35345

## CB ACCESSORIES



**New CB Accessory 20  
now open for all Breakers.**

Twigs	Base Twigs
Mikes	Power Mikes
Slide Mounts	Power Supplies for
PL 259s	Home Base
Magnetic	SWR Meters
Mike Mounts	PA Horns

**DISCOUNTS ON MANY LINES**  
*Fitting and installation  
service available*

SHOWROOM 1st FLOOR

C. E. M. Ltd  
14, Bankswell Road,  
NEWPORT  
(Rear Queens Hotel)

Tel: Newport 841661

**Connexions**  
AUTHORISED DEALER

© CB Radio.

## Wool Ridge Breakers

We meet once a fortnight in a local brown bottle shop; and have a bit of a giggle etc. If any local breakers fancy coming along to see what we get up to, you'll find us in the Skittle alley in the Barnstaple Inn, South Molton, Devon.

Keep up the good work in your excellent magazine.

10-10 Tramp (Treasurer)

## Brewery Town Breakers Club

We are situated in the Shropshire town of Wem but have members from miles around. Our name is taken from the famous Brewery situated here. Our club is a couple of months old and seems to be thriving pretty well. We are in the throes of raising money for a local cause. We extend a warm welcome to any other breakers, we meet every two weeks. Just give us a shout on 19 any time you are passing!

Good numbers.

Treacle Tart - Club secretary

## Bournemouth Independent Breakers Association (B.I.B.A.)

We meet every Tuesday night at the Coach House Motel, at Ferndown, so come along, join and crack a few brown bottles with the other 200 or so members.

For further details contact Wendy C/O "Skywave" 73, Curzon Road, Boscombe, Bournemouth BH1 4PW.

## Beachcombers Breakers Association

Just to inform you that a CB club known as Beachcombers Breakers Association has been formed in the New Milton and Highcliffe district on the borders of Dorset and Hampshire.

At present, membership stands at 150, and anybody requiring further information should write to this address 3, Thursby Road, Highcliffe, Christchurch, Dorset BH23 5PA.

Secretary

## Hucknall Welfare Breakers Club.

The H.W.B.C. was formed due to the demand from local breakers for their own club, and by the second meeting the membership was above 150. We hold our meetings on Tuesday at 7.00 p.m. and invite all breakers actively interested in CB radio to attend.

The club is affiliated to the N.A.C. (Nottingham Area Club), the largest in the area with over 2,000 members, and has the same objective which is to further the cause of CB radio on a local, national and international basis.

Ten Ten Screwdriver

## Weymouth & Dorchester 40 Club

We are a recently formed club in the Weymouth and Dorchester area with 496 members to date. Membership is increasing dramatically at every fortnightly meeting.

We would welcome invitations to participate in any national rally or campaigns and contact can be made through the club at P.O. Box 13, Weymouth, Dorset. For further details please write to Sue Brackley secretary for the W.D.40 Club.

## I.B.C. Ilkeston Breakers Club

I am writing to you on behalf of the Ilkeston Breakers Club (I.B.C.). We have a membership of 900 which is still growing.

The club is non-profit making and most of the funds go to charity. We have recently bought a machine to help crippled children. This machine is a Lightwood Pulsed Radio Generator, and the aim of this machine is to help limbs to grow.

We have the normal raffles and disco, sponsored walks and in the near future we are having a Football Match in drag. It will be the I.B.C. v's Bell Town Breakers.

All breakers are welcome to come and join in our activities. A good time is had by all.

We have also got a P.O. Box for DX'ing, if there are any local clubs that would like to use our P.O. Box for Q.S.L. cards, contact: Venus at the I.B.C. eyeball.

10-10 till we do it again, way down way gone, break a break Venus (Sec).

## Three Counties Breakers Club (3 C.B.C.)

I thought I would write and let you know that we have formed a club here in Gillingham called the Three Counties Breakers Club. We have breakers from Wiltshire, Dorset, and Somerset hence the title.

As of yet we are few in number only 45, but we have also got a junior membership for those under 19 years of age so they don't feel left out.

We meet every 3rd Sunday night at the Kings Arms, East Stour, visitors are welcome, but please come clean.

If anyone would like any information about the club they can contact me at 48, Falrey Crescent, Gillingham, Dorset.

Foxylady (Secretary)

## A.B.C. 25

We have been going for about two months. Our club is called the "A.B.C. 25" and we meet once every two weeks on a Wednesday night.

The main objective of the club is to assist all members in any way possible. In this club we have members which have trades of all descriptions who are available to any member on request, i.e. a 24 hours breakdown service, a car main-

tenance service, an electrical service for repairing rigs, T.V. engineer, fridge engineer, a legal advisor. All these services and many more are available to any member at a very small charge.

We are more of a family than a club all fighting for the same cause. We would also like to have eyeballs with other clubs in other areas, so if any club outside the Birmingham area wishes to have an eyeball with A.B.C. 25 could you telephone Ambassador on: 454-1208, or write to Bushmans 20, Fairy Lights, Broad Street, just off the centre of Birmingham.

10-10 till we do it again. This is the A.B.C. 25 on the side and satisfied.

Break a break we gone.

## Kent & Essex Breakers Association

### 'ODE TO CITIZEN'S BAND'

The word is out, our members shout just you wait and see and us so scared of being found out for using the old CB.

It seems the South has heard our plight down there in Cockney Land we've formed a Club, to prove we're right so why not lend a hand.

We call ourselves Kent Essex Breakers or K.E.B.A. club for short the Government call us mischief makers we're nothing of the sort.

Our club was formed in '79 you might say 'not so long' but in that time we've got on fine nearly 700 strong.

Tuesdays we meet at Orsett Hall where's that? you've got me foxed take the A13 to pay us a call next roundabout from Tilbury Docks.

Up to now we've shown them how we've pushed beds and raced a boat our disco's really are a wow and so is our Carnival Float.

We do these things for charity with sponsors as our backers who pay to see us eat boiled eggs and chomp upon cream crackers.

We may not be your cup of tea its still against the law they say we don't act properly but don't you be so sure.

We don't spray walls with aerosols or vandalise the land this outlaw band has different goals we lend a helping hand.

We've raised a lot of money for those who need it most and you can be sure, we'll raise some more and that's no idle boast.

So if you have a CB set at home or in your car need help or just a little upset a good buddy's never far.

So please print out our bardic verse upon your CB page come buzby's, smokey's do your worse It all helps to pay your wage.

('Angel') Secretary K.E.B.A.

# CB RADIO ACCESSORIES FROM CHELMER CB ACCESSORIES

WHOLESALE AND RETAILERS FOR THE SOUTH EAST



SPECIAL OFFER FOR READERS OF CB RADIO MAGAZINE

- K40 Mike - £24.95 each + £1.65 p & p
- K40 Antenna - £24.95 - Personal callers ONLY
- Kraco Extension Speakers - £3.25 each + £1 p & p
- Multiband Radios - £13.50 each + £1 p & p (Batteries extra)
- 40 Channel CB Radios - £55.00 each + £2.50 p & p



ACCESS AND BARCLAYCARD WELCOMED FOR TELEPHONE ORDERS  
SEND S.A.E. FOR TRADE OR RETAIL PRICE LIST

**CHELMER CB ACCESSORIES, 50 DUKE ST, CHELMSFORD**  
**TEL: 87698 and 351359**

© CB Radio.

*Connexions*  
AUTHORISED DEALER

**West London**

**We've Got You Covered**  
*Everything you'll need to  
get on the air ,  
Yes EVERYTHING!*

SWR'S - BASE ANTENNAS -  
MOBILE ANTENNAS -  
POWER SUPPLIES - P. A.  
HORNS - RECEIVERS ETC.



SADELTA MICROPHONES  
NOW IN STOCK. . . . .

**ACTON CB CENTRE**

17 Old Oak, Common Lane,  
ACTON,  
London W3  
Tel: 01-743 5306

**EYEBALL**

**EYEBALL**



**LOOK AT THESE  
PRICES**

- K40 MIC £25.00 INC.V.A.T.
- 1/2 WAVE DI POLE £9.00 INC.V.A.T.
- STARDUSTER MK 11 £22.50 INC.V.A.T.
- DV 27 £4.95 INC.V.A.T.

WE HAVE RAGGES, PRINT T-SHIRTS ETC.

**CLUB  
DISCOUNTS**

EYEBALL EYEBALL  
20, Salisbury Road,  
CARDIFF,  
South Wales.  
Tel: 0922-371760

*Connexions*  
AUTHORISED DEALER

Open Mon-Sat 10-6  
Late Night Friday 10-7

# Rig Test

# PRESIDENT

## PRESIDENT Thomas J., Deluxe AM Mobile

Unfortunately, the President line of CB transceivers came out just about the time interest in CB had peaked in the States, hence, the President transceivers never truly earned the reputation they deserved.

As you have probably surmised, the marque "President" stems from the fact that each transceiver was named after an American president, though each also has a numeric model number; for example, the Thomas J. is Model 1013001.

A common thread that connected the various President models was (and remains) *quality*. The President transceivers seem to have *just a bit extra* in every characteristic, from finely finished controls and cabinets, to features, to performance. Had the President line been introduced a year earlier, when almost a half million new CBers joined the ranks each month, the President transceivers might well have become standards against which others would be judged.

The President "Thomas J." is a 40 channel AM transceiver for mobile and P.A. (public address) operation requiring a power source of nominally 13.8 VDC.

### Test Results

#### Receiver

Input sensitivity for 10-dB S-N/N.	0.25 uV
Worse-case adjacent channel rejection	60 dB
AGC range for 80 dB input range	5dB
Input level for S9 meter indication	15 uV
S-unit value	Relative (non-calibrated)

#### Transmitter

RF output/50 ohms	4 watts
Modulation capable of 85%	Yes
Relative sensitivity for 85% modulation.	Full off to -28 dB
Modulation limited to 100%	Yes

(Note. Test results are from signals synthesized to be the equivalent of those common to actual CB operations.)

Since there is no direct connection between the power supply and the transceivers cabinet the power source can

have a positive or negative ground (earth). Overall dimensions are 2-13/64" H x 7-5/16" x 8-21/32" D. Weight

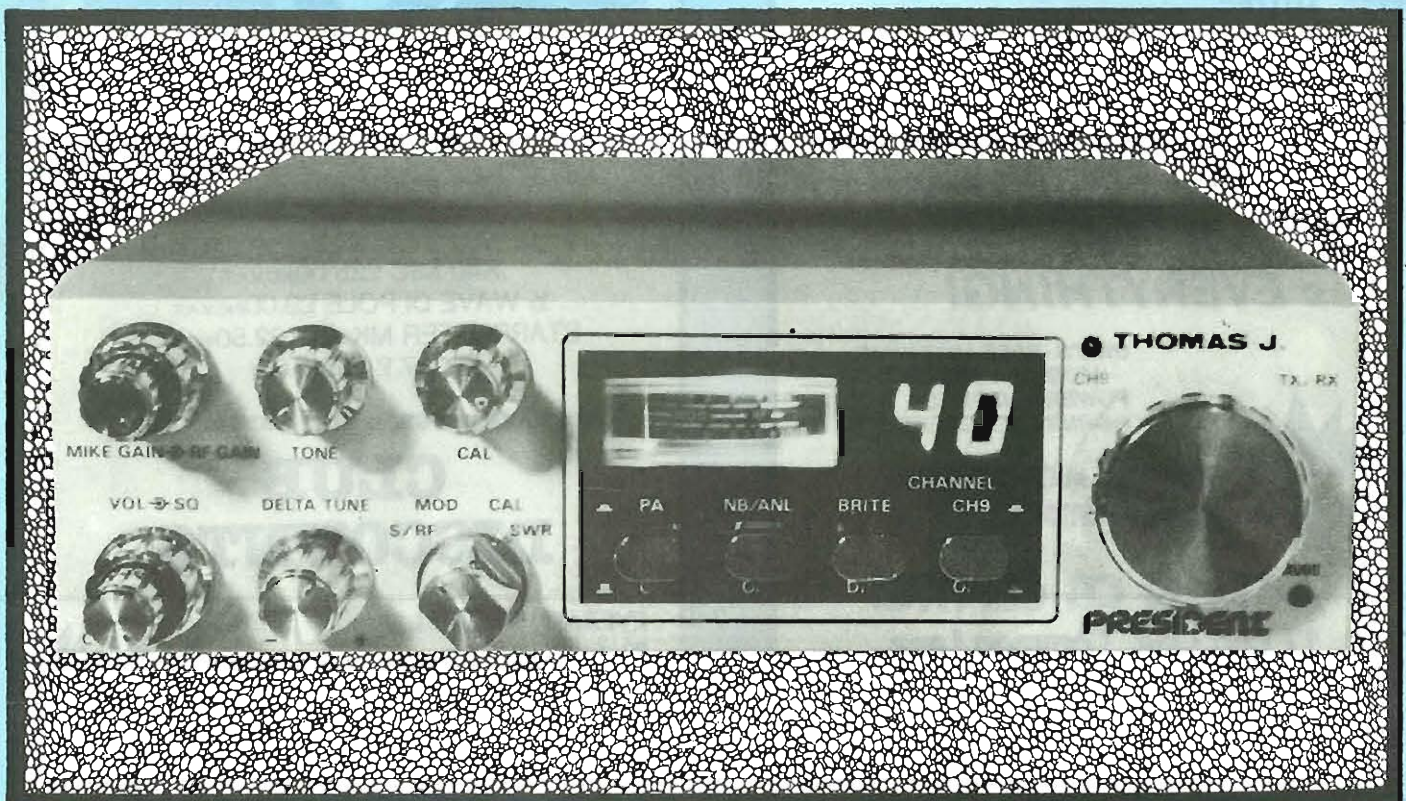

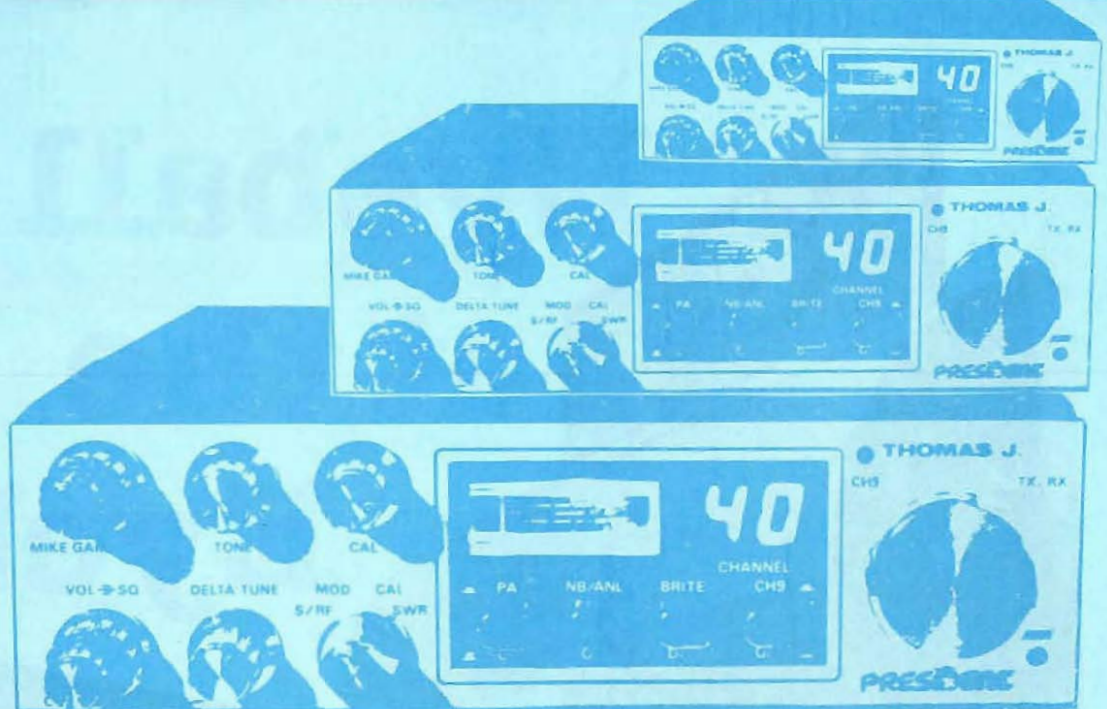

is 4.6 lbs. Standard accessories include a plug-in PTT (Push-To-Talk) microphone, plug-in DC power cable, and a detachable mobile mounting... the familiar U-bracket for under-dash transceiver installation. Each end of the bracket is secured to the transceiver by a cap-screw that permits a moderate degree of up-down tilting of the transceiver.

In addition to the commonly expected features such as a digital channel indicator, noise limiter, squelch, and jacks for a remote speaker and a P.A. speaker, there are: a combination meter that indicates received signal strength, RF output power, the percentage of modulation, and the antenna system SWR; a noise blanker that is particularly effective against

impulse and "shot" noises; a microphone gain control that adjusts the microphone sensitivity from full off to -28 dB; a tone control (actually a high frequency cut); priority (instant) channel 9 selection; panel lamps that indicate channel 9 priority, TX (transmit), and AWI, an Antenna Warning Indicator that indicates visually and instantly that the antenna system SWR is excessive. Finally, there is a *Delta tune*, a control that adjusts the tuned frequency +/- 1500 Hz (continuous tuning). The Delta tune insures that received signals which are slightly off the precise center frequency of a channel can be tuned *dead center* in the I.F. passband to insure optimum rejection of adjacent channel interference.

The front panel is very highly styled. At the extreme left are grouped the frequently used operating controls: a volume control/power switch concentric with the squelch control; the microphone gain control concentric with an RF gain control; the tone control; the Delta tuning control; the meter function selector; and the SWR meter calibration control. In the approximate center, in a "blackout" panel area, are: the combination meter with calibrations for each function; the digital channel indicator; the PA/CB function selector; the Noise Blanker/ANL selector; a panel lamp dimmer; and the instant channel 9 selector. At the extreme right is the normal channel selector and the indicator lamps for channel 9, TX/RX and AWI.

The rear apron has a standard UHF antenna connector, and jacks for the remote and PA speakers. The internal speaker is mounted on the bottom, facing downwards; the most commonly used location.

The microphone plugs into a jack located on the left side, about 1/3 back from the front edge.

Though the test results of the Thomas J. closely resemble those of the *better* or *high quality* transceivers, it is subtle things that make the Thomas J. a *little better*; things like modulation that is crisp yet relatively undistorted, signal reception just a little *cleaner* than one would normally expect - and a little more sensitive, and of course, top quality construction and appearance.

### President Thomas J. Manufacturers Specifications

**Channels:** 40

**Frequency coverage:** 26.965 MHz to 27.405 MHz

**Frequency control:** Phase Locked Loop synthesizer

**Frequency tolerance:** ± 0.005%

**Operating Temperature Range:** -30° C to +50° C

**Microphone:** Plug-in dynamic

**Input Voltage:** 13.8 DC Normal

**Current Drain:** Transmit: Pull AM mod. 1.5A

Receive: Squelched, 0.3A

Full audio output, 1.2A

**Meter:** Illuminated. Individual calibrations

**Semiconductors:** 26 transistors, 4 integrated circuits. 27 diodes, 4 light emitting diodes.

#### TRANSMITTER:

**Power Output** 4 watts

**Modulation:** High and low level Class B AM

**Frequency:** 300 to 3000 Hz.

**Output Impedance:** 52 ohms unbalanced.

#### RECEIVER:

**Sensitivity:** 0.5 uV or less for 10 dB S-N/N

**Selectivity:** 6 dB @ 7k Hz, 60dB @ 10k Hz

**Image Rejection:** 80 dB

**I.F. Frequencies:** 10.695 MHz, 455 Hz

**Noise Blanker:** RF type

**Audio Power Out:** 5 watts

**Frequency Response:** 300 to 3000 Hz

# Eyeball at the Eyeball

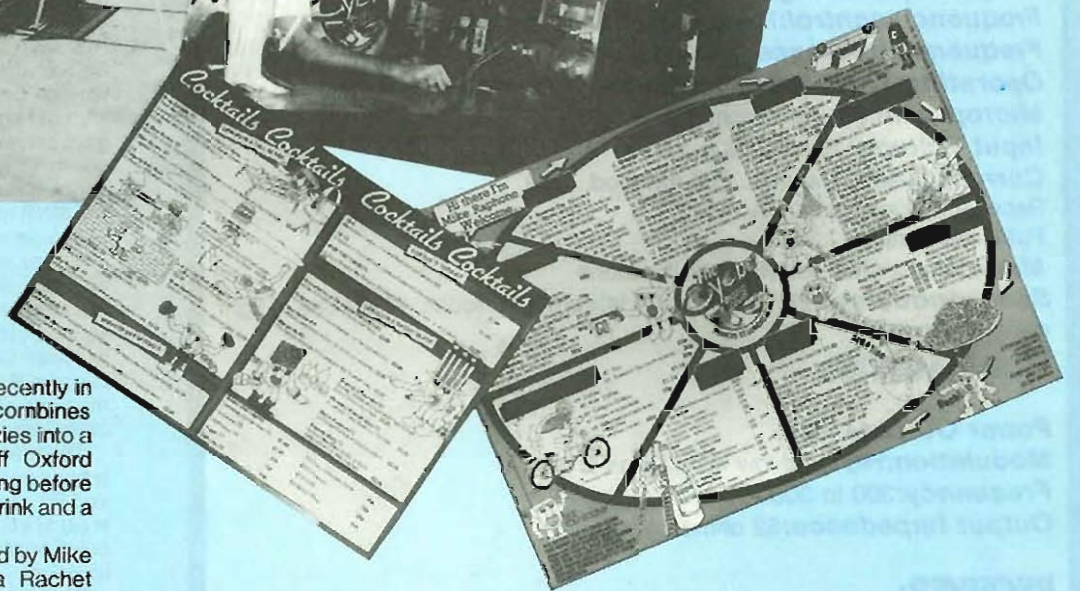

## Enjoy a Home Office prawn special!

A new idea in eating opened recently in London - a CB restaurant that combines two of a breakers favourite activities into a good evening out. Located off Oxford Circus its ideally situated for eating before a film or popping in later on for a drink and a burger.

The Eyeball Bistro Club is hosted by Mike Raphone who presides over a Ratchet Room, Cocktail bar and Eyeball Restaurant. The Ratchet Room is upstairs at the Bistro and offers a selection of salads, sandwiches and Breaker Burgers. Downstairs the Eyeball Restaurant has a selection of good food and wine and includes such delights as Old Smokey and Sea B Sole. The Cocktail Bar is guaranteed to get you very merry in under half an hour with a great selection of weird and wonderful concoctions (try the Pina Coladal).

Things get going at 7am with breakfast in the Ratchet Room, moves onto lunch and

after work appetizers until 2am in the morning. Each table downstairs has an 'eyeball' monitor to either listen to CB or music with a CB slant, and the owners have several ideas for expanding this idea.

Another novel idea is the Eyeball card. A member of staff at the restaurant takes each diners photo and makes up two plastic heat sealed eyeball cards, one for the customer to keep and the other is stuck on the eyeball board. Each card has the owners handle and 20 underneath so you

can identify people you may have copied so beware if you were there with someone you shouldn't have been with!

Congratulations are in order to David Levy and Brad Mills for this novel idea. It should be a great success with the number of breakers and potential breakers on the scene. It's not the cheapest of places but bearing in mind its location the prices are not unreasonable. If you pay a visit have a Pina Colada for me.

SS



# EUROSONIC

# Citizen Band



- ★ DV27 Antennas
- ★ K27 Antennas
- ★ Avanti Moonraker
- ★ Firestik
- ★ Electric Aerial
- ★ Fully retractable CB Aerial
- ★ Walkie Talkie
- ★ K40



## tagra



avanti

## K40

C.B. Centre

Shakespeare

'Firestik'  
ANTENNAS

More CB Accessories than you've ever seen before.

**AND  
LOTS  
MORE!**



C.B. Centre

TRADE ENQUIRIES TO:

# EUROSONIC

Europasonic (U.K.) Ltd  
Britannia Works Buildings,  
Sherbourne Street,  
Manchester M3 1EF.  
Tel.: 061 834 8818  
Telex:- 668652 Eusoni.

Clyde Importers Ltd,  
24/32 Coburg Street,  
Glasgow G5 9JF.  
Tel.: 041 429 2058

We are now the main distributors of the full range of Tagra CB Antennas and accessories and the sole distributor of Star Code 10 Walkie Talkie.

### THE ALL NEW 1/2 WAVE F. & P. ORBITER UK MANUFACTURED BASE STATION ANTENNA

Impedance	80 OHM
Frequency	28-30 MHZ AM, FM, SSB
Gain	+ 4DB
Bandwidth	1.8 MHZ
VSWR	Less than 1.5
Max. Power	800 W
Total Length	19' 0"
Mounting	1-2" mast tube
Connection	8 OR39 Socket
Weight	1.9K

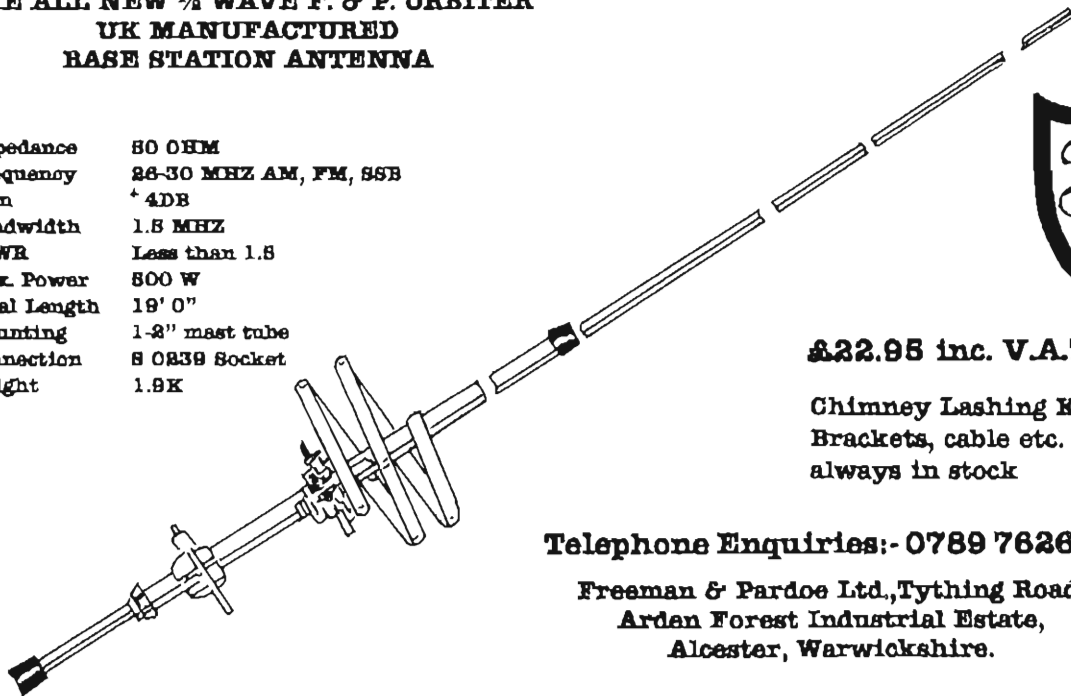

**£22.95 inc. V.A.T.**

Chimney Lashing Kits,  
Brackets, cable etc.  
always in stock

Telephone Enquiries:- 0789 762673

Freeman & Pardoe Ltd., Tything Road,  
Arden Forest Industrial Estate,  
Alcester, Warwickshire.

**TRADE ENQUIRIES WELCOME**

# CLASSIFIED ADVERTS

10 PENCE PER WORD, NO MINIMUM OR MAXIMUM. YOUR NAME & ADDRESS MUST ACCOMPANY ADVERTISEMENT AND IS NOT CONFIDENTIAL.

**CRYSTALS.** Large stocks of 27MHz and 35MHz crystals from £1.65 each (p&p 40p). Also P.S.U. 13.5v 3a from £29. TELERADIO, 325, Fore Street, London.N.9 OPE. 01-807-3719. Closed Thursdays.

**RECORD BOOKS.** INTERNATIONAL DX. NATIONAL D.X. CB LOG. A must for the serious breaker. Including maps Q Codes. 10 Codes Frequencies. Radios. Santiagos. DXing Instructions, etc.etc. Used by Breakers throughout the British Isles. Club recommendations. Excellent value. DX INTERNATIONAL £1.35p. DX NATIONAL £1.30p. CB LOG £1.10p. or pack of three for £3.50p. CLUB DISCOUNTS. By discreet return post from LCR SYSTEM CONTROLS, LYNEAL, SHROPSHIRE.

**BIG BREAKERS:** Made to measure 100% wool double knit jumpers. Also high quality fibrec lined sweatshirts with 'V' or round neck and your handle embroidered. Black, red, navy, dark green, mid blue or white. Any size £14.50 to Hawkesmill Products, 53, Hawkesmill Lane, Coventry. Tel: Coventry 35914.

**ANTI-T.V.I. HALF WAVE DIPOLE AERIALS.** Complete installation £35. Lists S.A.E. Anti T.V.I. Publication £1. G2DYM Aerials, Beerdown, Uplowman, Tiverton, Devon. Tel: 03986-215.

**SOUTH DEVON BREAKERS** - Sundial/Clipper new stock CB Patches, Badges, Keyrings, Quality Sweatshirts, t-shirts, with handles, done in a short short, less greenfields for club members with cards. Samples at CLIPPER, 14, Torbay Road, Paignton, Sundial, Beach Way, Dawlish, Warren, or tel:08047-2987 even.

**Spread your handle around.** Personal cards printed in gold letter on black, red or green card (state preference) - £5.25 for 100 or £8.00 for 200 incl. p&p. (bigger discounts for larger quantities - prices on application). Send wording required (BLOCK LETTERS PLEASE) with your cheque/PO and name and address to John Dexter Ltd., Appleton House, Lancaster Road, Hincley, Leics. LE10 10Q.

**MIDLAND 40 Channel** £57.00. President Sidband £99.00 80 AM/FM, £81.00. President Madson AM/FM/SSB £199.00 C.O.D. SAE for details to: '4 Sure', 7, Pennings Avenue, Guildford.

**Complete CB Handbook.** 490 pages on every aspect including lingo with hundreds of rigs described or illustrated send £3.50. Guildford CB, 34, Aldershot Road, Guildford.

**Components** I.C.'s crystals TA 7205P £2.65. FM Board £12.00. Instant Postal Service. Guildford CB, 34, Aldershot Road, Guildford 0483-77550.

**HEAT SEALED CLUB CARDS HAVE YOUR CLUB CARDS SEALED IN TRANSPARENT PLASTIC, UNBREAKABLE, WATERPROOF, SMART & LONG LASTING.**

10p each (quantity discount available)

SEND YOUR CLUB CARDS & POSTAL ORDERS. o/o THIS MAG. 10 DAYS DELIVERY



Amazing Electronic Plans. Laser - super powered. burning, cutting, rilla, pistol, light shows, ultrasonic force fields, satellite, TV, super giant Tesla, solid state rocket, super fireworks, surveillance, many more. Catalogue 75p. PLANCENTRE, 16, Mill Grove, Bittbrook, Codsall, Wolverhampton.

**BADGES MADE TO ORDER.** Any quantity. Reasonable prices. Quick. Telephone MARC at 01-778-4602 (Monday - Wednesdays) OR 01-340-0473 (Thursdays, Fridays). SAE's: Sunrise Badges, 10, Harold Road, N8 7DE London.

IC's Transistors

Roger D

7, Thyns Court, Nottingham NG3 5GT

**Guildford CB** for larger selection, lower prices & honest advice. 100w Burner with pre-amp C69. 240v Brama 100w £85.50. 40 Channel Rig Kit £56.00. Sirtel DV 27 £5.75. Wholesale enquiries welcome. 0483-77560.

**BADGES 'C.B. Operator'** Metal Brooches 53p each. Ex-Stock. Enamel 'Eyeball' Badges with handles, to order j11.50p each. Ask for details of Club badges made to special order. R.E.V. GOMM (CB) Ltd., 16, FREDERICK STREET, BIRMINGHAM, B1 3HE.

## TELEFONICS

COMPUTER CONTROLLED TELEPHONES

We can supply replacement/extension telephones with built in clock, calculator, automatic redial and digital display for your home & office at competitive rates.

Phone your TELEFONICS agent on

01-573 7276

Engraved Handle Badges are easy to produce and highly profitable with a Gravograph Engraving Machine - Beach & Son Ltd., Meridian House, Swanley, Kent. Tel: 0322-63211.

**Top Quality Handle Badges** in two ply 'Gravoply' Plastic are hard wearing, stain resistant and available in five sizes. Round or Oblong and in over thirty different colour combinations - Ideal for use with Gravograph Engraving Machines and Hot Blocking Machines - Beach & Son Ltd., Meridian House, Swanley, Kent. Tel: 0322-63211.

**PERSONAL QSL/EYEBALL CARDS** from £10.90 per 200 (£21.00 per 1000). DX Log sheets £1.00 per hundred. S.A.E. for price list or send your ideas plus £3.00 for personal design, deductible from first order. Rhedol Books, FREEPOST, Aberystwyth, Dyfed, SY3 1BR.

Caledonian Copiers



For all you will need in photostat copiers Outright purchase from £200.

Phone Colin or Gordon on Uxbridge 54781. 15% discount to all CB shops.

Display Signs

OPENING?  
A SHOP?  
Need a Sign!

call THE SIGN MAN  
01-848 0705



Rapid Service

**Cordless Telephones.** Use anywhere in the house or garden (no wires), 2 year guarantee, £98 inclusive. GPO approved Answering for your home, 1 year guarantee, £65 inclusive. For leaflet ring Texpro on Byfleet 48057.

**Raymac Display** for PVC club cards, club stickers, printed patch badges, PVC club card wallets, T-shirts, club eyeball badges, printed to order, plus standard QSL cards and slogan stickers. Raymac Display, Unit 24, National Works, Bath Road, Hounslow. Tel: 01-570-9118.

## SUBSCRIPTION

1 YEAR INCLUDING FIRST CLASS POSTAGE £9.50

6 MONTHS INCLUDING FIRST CLASS POSTAGE £4.75

USA, AUS & all other countries surface mail same price as above.

AIRMAIL TO EUROPE 1 YEAR £13.80

AIRMAIL TO USA 1 YEAR £18.00 AIRMAIL TO AUS 1 YEAR £20.00

FEE ENCLOSED £ \_\_\_\_\_ PLEASE START FROM ISSUE \_\_\_\_\_

PAYMENT BY CHEQUE OR P.O. TO: CB RADIO

Tudor Works, Beaconsfield Rd., Hayes, Middx. UB4 0FL No 15

NAME \_\_\_\_\_

ADDRESS \_\_\_\_\_

Your name & address will be kept totally confidential.

APPOINTED DISTRIBUTORS FOR  
HMP. ANTENNA SPECIALISTS.  
KHI. ALPINA. EURATRONIKA.  
ALBRECHT EDGEWORTH  
ELECTRONICS.

Dealers in:  
Inverness  
Orkney  
Shetland  
Fraserburgh  
Peterhead  
Old Meldrum  
Aberdeen (3)  
Stonehaven  
Dundee (2)  
Perth  
Kirkcaldy  
Dumfries  
Malling  
Fort William  
Oban  
Edinburgh (2)  
Glasgow  
Wishaw  
Carlucce  
Eyemouth  
Lochgelly  
Panicuk  
Livingston  
Mid Calder  
Ingleston  
Berwick upon Tweed  
Newcastle (3)  
Durham  
Egremont  
Middlesbrough  
Carlisle  
Preston  
Manchester  
Scarborough  
Darlington  
Anglesey  
Ainwick  
Leads  
Bournemouth  
Winchester  
RIngwood  
London  
Northampton  
Callington  
Walsingham  
Liverpool  
Bishop Aukland  
Grimsby  
Gateshead  
Barrow in Furness  
Belfast

DISTRIBUTORS OF TELCO  
PRODUCTS. AVANTI. TURNER.  
MIDLAND. HAM MASTER. GC  
ELECTRONICS. ZETAGI. CTE.  
BREMI. CB MASTER. HAM  
INTERNATIONAL AND MANY  
OTHERS.



# CB RADIO ACCESSORIES

**NEW**

TRADE WAREHOUSE • NOW OPEN •  
over 44,000 square feet packed with  
stock, at :-  
38 GARDNERS CRESENT, EDINBURGH.



**EXPRESS  
DELIVERY BY  
OUR OWN  
FLEET**

"Take a Trip"  
To Custom Equippe

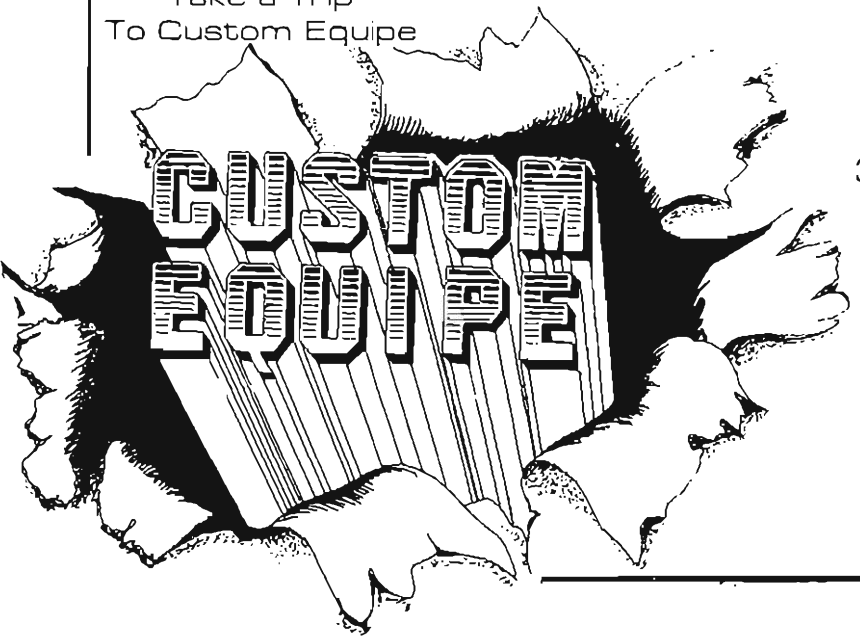

SUPPLIERS TO THE TRADE  
AT THE LOWEST UK PRICES  
TRADE ENQUIRIES  
TO OUR WAREHOUSE AT:-  
38 GARDNERS CRESCENT,  
EDINBURGH.

**Open** OMTECH 133 FOUNTAINBRIDGE EDINBURGH  
EH3 9QG TEL. 031-229-8830  
**Channel** CUSTOM EQUIPE TELEX 727053 OMTECH G TRADE SUPPLIES  
**Communications** 131 FOUNTAINBRIDGE EDINBURGH  
EH3 9QG TEL. 031-229 8830  
CB ONE RETAIL SALES

129 FOUNTAINBRIDGE EDINBURGH  
EH3 9QG TEL. 031-229-8202  
RETAIL - MAIL ORDER

**OMTECH I.O.M. Ltd. + Ass.Co.s**

# BREMI

FOR QUALITY



**DISTRIBUTED BY:**  
**O.C.T. THE TELECOMMUNICATIONS SPECIALISTS**  
407 Lordship Lane, London N. 17 Telex No. 922488 Ref 133  
10 Victoria Street, Newark, Nottingham.  
PLEASE WRITE FOR OUR FREE AUTUMN CATALOGUE TO O.C.T. (London).  
Trade Card or Letterhead, should be included.

**NEW  
SECOND  
WAREHOUSE  
NOW OPEN**  
10 Victoria Street  
Newark Nottingham