

CB

September 1962

40 CENTS
(\$.45 in Canada)

HORIZONS

MUSHROOMING CRISIS IN CB RADIO



1 CB'er EVERY 5.2 SQUARE MILES

WHO HAS A SOLUTION?

TWO-WAY RADIO FOR BUSINESS AND PLEASURE

IN THIS ISSUE

- Business Band Radio Offers Haven From Overcrowded CB Frequencies
- FCC Warns of Part 19 Revision
- CB Saves Lives in Michigan
- Build This Ground Plane Antenna
- HE-15A Conversion Story
- A CB'er And His Audio
- Gigantic Giveaway Returns!



NEW FREQUENCY SYNTHESIZER

With International's new crystal controlled frequency synthesizer you can switch instantly to any one of the 23 CB channels. Each channel uses the same crystal for transmitting and receiving. A 24th position is provided as a spare. Illuminated dial. Self contained power supply. Unit matches Model 100 and Model 50 Executives. Meets FCC requirements for frequency tolerance and spurious radiation.

Complete with interconnecting cables and instructions \$159.50



NEW MODEL 100 A EXECUTIVE TRANSCEIVER

Now International brings you an advanced design Executive transceiver, for more reliable mobile operation, featuring a transistor power supply, new perforated metal cabinet, and equipped with a new rugged dynamic microphone. This is the latest in the famous line of International Executive transceivers. The first commercially available CB unit to make use of a high frequency crystal filter to achieve and permanently guarantee receiver selectivity for the life of the equipment. Twelve crystal controlled channels. Two crystal controlled receive positions. Dual conversion superheterodyne receiver tuning all 23 channels. Built-in calibration circuit. Transistor power supply operates from 6/12 vdc or 115 vac. Push-to-talk operation. Certified tolerance $\pm .005\%$.

Model 100 A, complete with 1 transmit crystal, 1 receive crystal, and microphone.... \$199.50

Check these new features.

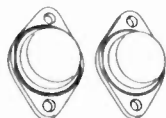

- Transistor Power Supply

- New Dynamic Microphone



for Outstanding Performance

Citizens Band licensees with International equipped stations know the unquestioned superiority and advantages of Executive transceivers and their system engineered accessories.

EXTERNAL SPEAKER S/METER

The perfect companion for the International Executive Model 100. Utilizes a high impedance vacuum tube volt meter circuit. Connects to socket on rear of transceiver. S/meter reads in three ranges Brown cabinet, brown and silver panel matches Model 100 Executive. Dimensions: 5½" H. x 8½" W. x 7" D.

Complete with interconnecting cable... \$49.50



EXECUTIVE SPEECH CLIPPER/FILTER AMPLIFIER

A microphone amplifier designed to increase average modulation... limits modulation peaks... filters audio frequencies above 2500 cycles. Permits arms-length microphone operation. Power requirements: 12 vac or 12 vdc.

Complete with interconnecting cable... \$36.50

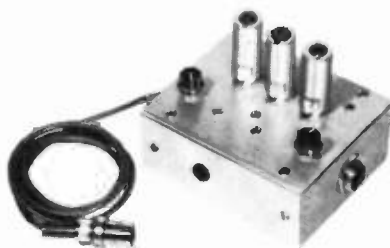

12.6 VAC, 2 AMPERE POWER UNIT

Base station power unit for Speech Clipper/Amplifier. Operates from 115 vac. Provides 12.6 vac at 2 amperes.

Complete with mounting chassis, power cord, fuse, switch..... \$12.50

NEW ILLUMINATED DIAL ASSEMBLY

A new 12-position dial, designed and engineered by International as an accessory for the Model 100 Executive transceiver. Illuminated numerals assist in selecting any one of 12 crystal controlled transmit channels. Simple to install. Dial assembly may also be used with any 12-position, 30 degree switch.

Complete with instructions..... \$11.25



...SELECT INTERNATIONAL!

See International Executive transceivers and accessories today at your authorized International dealer.



18 NORTH LEE • OKLAHOMA CITY, OKLA.

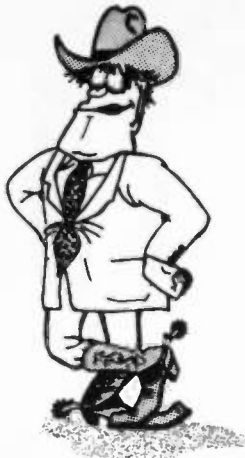

OZZIE'S MAIL- BOX

Dear Ozzie:

On the night of February 8 our family was stuck bumper-deep in the gummy mud of the Mojave Desert, in Southern California. After trying everything imaginable to extricate ourselves we were resigned to spending the night in the car and walking out the next day—no pleasant thought as we had four small children with us. Luckily we were spotted by an engineer on a passing Santa-Fe train who radioed the Sheriff's Department, who in turn called the "CB Desert Rescue Squad." Truly—we think we shall never see a sight more beautiful than the squad's jeeps with merrily waving whips, bouncing through the brush. These CB'ers who donate their time and equipment to help people in that wild and deserted area of California, deserve the highest praise and deepest gratitude of all who receive their assistance. They are a swell bunch of guys, and the people of Borstow (California) can be proud of them!

Tim C. Tingey
Azusa, California

Tim:

Sound's as if the Borstow bunch made a believer in CB out of you! And well that they and hundreds of other volunteer groups like them, might. That's one of the wonderful things about CB—it brings together a group of public spirited citizens eager to help their fellow man by employing the very latest communications marvel—CB Radio!

Ozzie

Senor Ozzie:

In your July issue we read some comments which highly criticize Puerto Rican CB'ers for working on channel 9. It is not our fault that when skip is in, we unintentionally interrupt NATCH-9. There are very many times that State Side CB'ers also interrupt our local communications, and we never complain because we know it is done unintentionally.

Honorato Balzac, 22W0262
San Juan, Puerto Rica

Honoroto:

Mis-interpretation! The letter in our July issue you refer to concerned a high power scotter circuit running from the Philadelphia office of a U.S. concern to their Puerto Rican sub-office. We understand this is the source of irritation to U.S. CB'ers, as this high power scotter circuit operates on NATCH-9. Our apology to the CB'ers of Puerto Rico, as we feel certain they would never intentionally cause interference to any state-side CB'ers.

Ozzie

Ozzie:

Hats off to you on your 1962 "Q" Call-Book! It is the best yet. We operate the only CB station in Augusta and manitor channel 7.

Charles Gelsingar
14W1474

Chaz:

The 1962 "Q" series books are on their last "legs" and just about gone. Anyone who hasn't ordered his copy to date should do so today—using the middle form on card insert page 12, this issue.

Ozzie

Oz:

I have received my 1962 Call-Book and I have a complaint. The print is too small. Many CB'ers have voiced the same thought. Can't you make it bigger?

Ann Zidle, 1Q0239
Haverhill, Mass.

Ann:

Back in the days when International Crystal put out the Call-Book, there was a new book approximately twice a year (at \$3.95 a crack) and 20-30,000 new licenses per book. Now we put out a monthly supplement, and a yearly (annual) Call-Book, which contains 80,000-100,000 new calls. To use the some larger typeface International Crystal used would require a book with 600-750 pages, and the per book cost would run over \$9.00 each. By using smaller type, still plenty big enough to read, we save you an additional \$5.00. However the choice is yours, do you want bigger type? Is it worth \$5.00 or more additional per year for the Annual book alone? You tell me!

Ozzie

Cousin Ozzie:

Hit 'pears likely that they are a couple of artickles here in yare magazine that I think needs some corn crib wisdom. Naw me and Rafe—we bin thinkin. We ain't carin too much 'bout Citizey band in South ameriky or up in Canady cause U na we cain't hoot that fer nahow.

Now that article on workin on HE-20's and thother sets—ther U really gat somethin! Give us marr of 'em.

'Nather feller sed in yore July issu he dan't lik ad-vertizin. Well, hit 'pears likely we wouldn't here af nathin' or nobody ifn we didn't ad-vertize! Keep em comin . . . we jest bought a Brown' complete base rig cause we saw hit ad-vertized in yare magazine.

Wel, Ser, Ozzie, more af everythin' gud to U and yorn, and keep up the gud werk on CB Harizons!

Joseph R. Lankford
Del Paso Heights, Cal,

Joe:

Hit 'pears likely U and Rafe r not alone. A hundrid letters fum fellas like U told we'un to keep the od-vertizin in CBH.

Ozzie

NEW antenna specialists
M-82 "Black Box"

CB Antenna Amplifier

*announcing an entirely new class of
citizens band power accessory
that gives you . . .*

fantastic
new performance
into and out of
your present
CB equipment

Forget everything you know about the "talk and hear power" of your present CB equipment. This remarkable new, self-powered device has changed the standards. HOW? It produces 100% legal power at the antenna, regardless of base station output capability or line loss. (Boosts incoming signal, too.) RESULT: 20 db gain (minimum) received . . . 10 db transmit modulation gain (plus varying carrier gains) from base. THE BENEFIT: Clarity and volume never before possible at both ends. Drastic reduction of inherent mobile noise and interference. It's like having another full turn on your volume controls! P.S. Meets F.C.C. limitations, naturally!

You've got to hear it to believe it. Your nearest citizens band supplier probably is demonstrating the Antenna Specialists brand M-82 "Black Box" right now . . . or write for specifications to

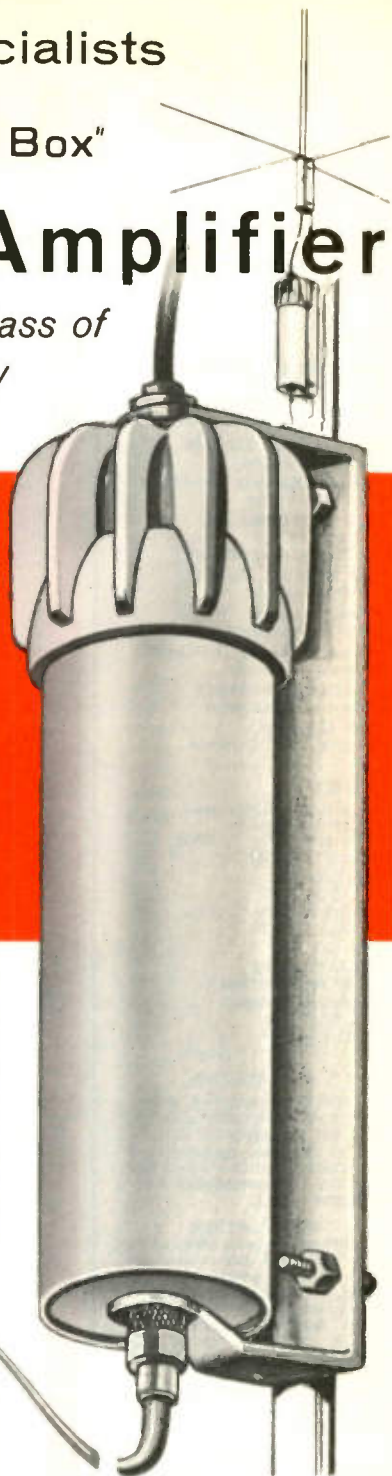

"Stripes of Quality"



Reg. T.M.



the antenna specialists co.

12435 Euclid Avenue • Cleveland 6, Ohio
Export Div., 15 Moore St., New York 4, N. Y.



HORIZONS

PUBLISHED MONTHLY BY HORIZONS PUBLICATIONS, INC.
POST OFFICE BOX 1557 OKLAHOMA CITY 1, OKLA.

STAFF

BOB COOPER, KEG2607
Publisher-Editor

JIM KYLE, 10W0901
Technical Editor

JOHN KREJC, 2W4586
CCM Coordinator

BOB BUCKLAND, XM44168
Canadian Editor

PEDRO SEIDEMANN, YYS-PS279
South American Editor

GAR GREENE, 1W4844
Editor-at-Large

Jamie J. Jones
Editorial Assistant

Patrick T. Pogue, KEG2276
Business Manager

Stan Searle, KEG1062
Advertising Manager

Jean Schaefer
Associate Art Director

OFFICES

Advertising-Editorial—
4 NW 7th Street
Oklahoma City 2, Okla.
Central 2-6290

Circulation—
P.O. Box 1557
Oklahoma City 1, Okla.
Central 2-1109

**Call Collect
for Advertising
Space Reservations**

Canadian Office—
P.O. Box 563
Chatham, Ont.
Tel. 519 ELgin 4-3106

ADVERTISING

CB HORIZONS magazine accepts commercial display advertising from bona fide manufacturers, distributors of electronic equipment and associated apparatus. Advertising rate card and coverage data available upon request.

CIRCULATION

CB Horizons magazine serves more than 74,000 CB radio enthusiasts every month, covering all 50 states, Puerto Rico, Canada, U.S. Possessions and 19 Central and South American countries where 27 mc transceivers are in use. Circulation is through the malls, and "over-the-counter" at more than 500 CB dealers throughout the United States, Canada and South America.

SUBSCRIPTION

Subscription rates in the United States — \$4.00 per year. Single copies 40c each (50c in Canada). Subscriptions outside the U.S.A. — \$5.00 per year. Subscription remittances should be made by bank draft or postal money order. Airmail subscription available at \$7.00 per year, U.S.

TABLE OF CONTENTS

FEATURES

IT ALL STARTS HERE	
A CB'ers Audio.....	8
A GOOD UNIT GETS BETTER	
Add Crystal Receiving to Lofoyette HE-15A.....	10
TO BE OR NOT TO BE	
Homebrew Ground Plane.....	14
POWER BOOSTER TROUBLE?	
Kyle-O-Watt Modifications.....	16
CB RADIO IN ACTION	
CB Dotebook.....	18
"CLASS A" CLASS D RADIO	
Let's Look At Business Bond.....	22
A SPONGE IN YOUR SPEAKER	
Chunnel 13 To The Rescue.....	29
POETRY YET!	
CB Retirement.....	32
HUMMMMM	
Feedback-The Ultimote HE-20.....	34
PART TWO OF A TWO PARTER	
Trouble Shooting Your Transceiver.....	35
MOTHER NEVER TOLD ME ABOUT THIS	
Pre-Mature Antenna.....	37
STEP RIGHT UP LADIES AND GENTS	
CBH Gigantic Giveaway.....	48
PAPER DOLLS AND CHEWING GUM AT THE FCC	
Chunnel 24.....	57

DEPARTMENTS

OZZIE'S MAILBOX.....	4
ORDER YOUR MOBILE HANDBOOK.....	12
CB IN SOUTH AMERICA.....	44
CBL CARD OF THE MONTH.....	45
CB SHOWCASE.....	46
CBH LAB REPORTS.....	47
CITIZENS COMMUNICATION MANAGER REPORTS.....	53
CLASSIFIED ADVERTISING.....	56
EDITORIAL-CHANNEL 24.....	57

CB HORIZONS (title registered U. S. Post Office) entered as Third Class postage in Oklahoma City, Oklahoma. All copyright and editorial rights reserved by Horizons Publications, 1962.

The entire contents of this magazine are copyrighted by Horizons Publications. No article in this magazine may be reproduced in whole or in part without the written permission of the publishers.

COVER: Has CB radio over-propagated itself? Where do we go from here? CBH anticipates the future with a new series starting this month. See page 22.

save most on everything in CB

SEND TODAY FOR YOUR

FREE

ALLIED
1963 CATALOG

464 PAGES
WORLD'S LARGEST
ELECTRONICS CATALOG

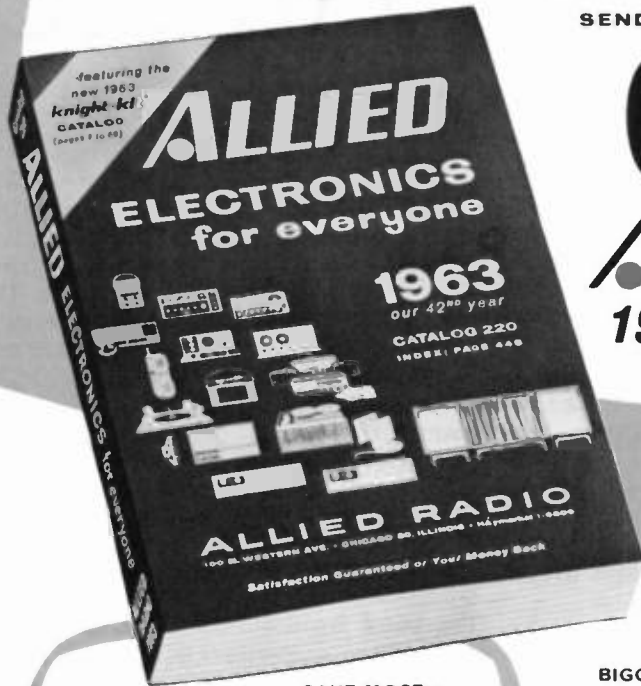

SAVE MOST—
BUILD-YOUR-OWN **CB**
knight-kits[®]

See the exciting new CB KNIGHT-KITS! There's nothing comparable to the all-new C-22 deluxe base/mobile CB transceiver, the exciting KG-4000 walkie-talkie—the only 1-watt walkie-talkie in kit form, the low-cost C-4010 Transceiver for short-range use. Here's quality, dependable CB radio you'll enjoy building and operating—and you'll appreciate the big savings. Fully described in your 1963 ALLIED CATALOG—send for it today!



NO MONEY DOWN: Now! More Buying Power with Your Allied Credit Fund Plan

ALLIED RADIO

America's CB Center

**BIGGEST SELECTION
BIGGEST SAVINGS**

See what's NEW...see the MONEY-SAVING BEST in CB in the 1963 ALLIED Catalog. Send for it today! Largest selection of Walkie-Talkie, portable and fixed-station equipment; everything in CB antennas and accessories—including exclusive products and values available only from ALLIED. For everything in CB, for *everything* in Electronics, get the 464-page ALLIED 1963 Catalog. Send the coupon today!

FREE



ALLIED RADIO, Dept. 53-9-J
100 N. Western Ave., Chicago 80, Ill.

Send FREE 1963 ALLIED 464-Page Catalog

Name _____
PLEASE PRINT

Address _____

City _____ Zone _____ State _____

"Do Ya' Copy NOW!"

A CB'ERS Audio

—STAFF—

Good audio in CB transmitters and the weather (at least, Mark Twain's weather) are pretty much alike: Everybody talks about them but nobody much seems to do anything.

In the case of the weather, the situation is sort of understandable. But in the case of CB audio—where good audio is essential to clear communication—it's a bit harder to grasp the reason.

Possibly one of the main reasons nobody much seems to do anything about his audio is that nobody much seems to know *what* to do—and that's what this article is all about.

If you feel that the audio in your rig could stand improvement, or if you want to increase your *effective* power output as much as 10 times, read on. We'll tell you how.

Before we delve into the interior of your transmitter, though, let's take a look at this whole business of audio and find out just what we need to transmit and receive the voice properly.

The starting place, for anything, is the beginning—so let's start there in our look at audio (if you already are familiar with this, bear with us for a few paragraphs).

Electrically, sound is the same as alternating current in the frequency range from about 30 cycles per second to somewhere above 15,000 CPS. Actually, "sound" is the reaction of the human brain to various variations of air pressure which occur within this same frequency range—but for our purposes, we can call any AC in the frequency range 30-15,000 CPS "audible sound" without much error.

More than 20 years ago, at the 1939 New York World's Fair, something like a million people had their hearing tested at an exhibit sponsored by Bell Telephone. These tests, plus other lab experiments, were evaluated to provide the basis for most of our present knowledge of "sound".

Among other things, the scientists found that most people could hear "sounds" in the range from 30 to 15,000 CPS as we already said—but that almost everyone could understand *speech* (as distinguished from music, singing, or other sounds) clearly even if the frequency range were compressed to the band from 300 to 3,000 CPS.

In other experiments, the scientists discovered that most of the actual *power* in the human voice is concentrated in the lower part of the frequency range. For instance, the average adult male voice has frequencies ranging from about 50 to over 5,000 CPS in it—but most of the actual power is concentrated in the neighborhood of 100-200 cycles. Female voices, as well as those of youngsters, have the power at a higher frequency—but all concentrate the power below 500 CPS.

This is all very interesting, you may comment, but what earthly use is it to CB radio?

The simplest way to answer this question is to compare the radio wave to a bucket. This bucket is a "carrier", and can be used to carry anything—but it has a definite capacity and can carry *just so much* of anything, no matter what it is.

For instance, you can fill the bucket with feathers, or with lead. The bucket-

ful of lead will weigh more than the bucketful of feathers—but the bucket is full in either case.

In similar fashion, the RF carrier of your transmitter can handle just so much audio. If you give it normal untreated speech, those power peaks below 500 cycles will set the upper limit on audio power. This is like the bucketful of feathers; the more important mid-frequency range really isn't getting very much weight on the carrier (a glance at Figure 1 may make this a bit more clear).

On the other hand, if you had some way to boost the lower-power parts of the voice up to the same power as the peaks—or, on the other hand, to remove the low-frequency peaks so that the speech applied to the carrier consisted only of the important parts, then it would be more like the bucket full of lead. Your signal would pack some weight.

Actually, you can do both of these things. "Band-pass" filters which screen out all frequencies *except* the important 300-3000 CPS range are available, and you have a choice of using either a "clipper" or a "compression amplifier" to level off the peaks so that all parts of the voice hit the carrier at equal volume.

When you do this, don't expect the voice to sound natural at the other end. Any time you start "shaping" the audio of a communication system, it won't sound natural again. However, you may find it sounds *better* than natural. In many cases, the "shaped" speech is

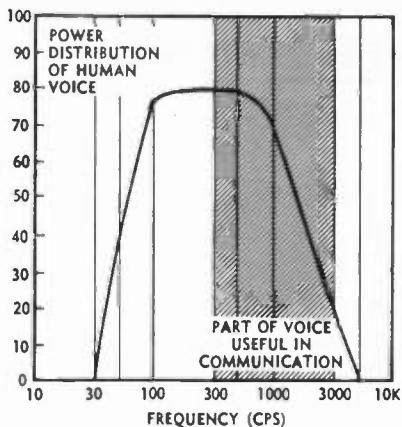

more understandable than the person is in the flesh!

A while back there, we mentioned "clippers" and "compression amplifiers." Although these gadgets both perform about the same function, they go about it in widely different fashion.

The clipper operates by "clipping off" all peaks which go higher than a preset point. If you set this point, by experiment, so that it just barely grazes the top of the voice peaks in the desired range, then the unwanted high-power peaks in the lower range will be clipped off at this same level. This is illustrated pictorially in Figure 2.

Note that, when compared to untreated audio, use of a clipper can increase the average level of the *audio* applied to your signal as much as 10 times. This is the same as running 10 times the power with untreated audio—and this is the basis of such published claims as "make your rig sound like

(Continued—Page 40)

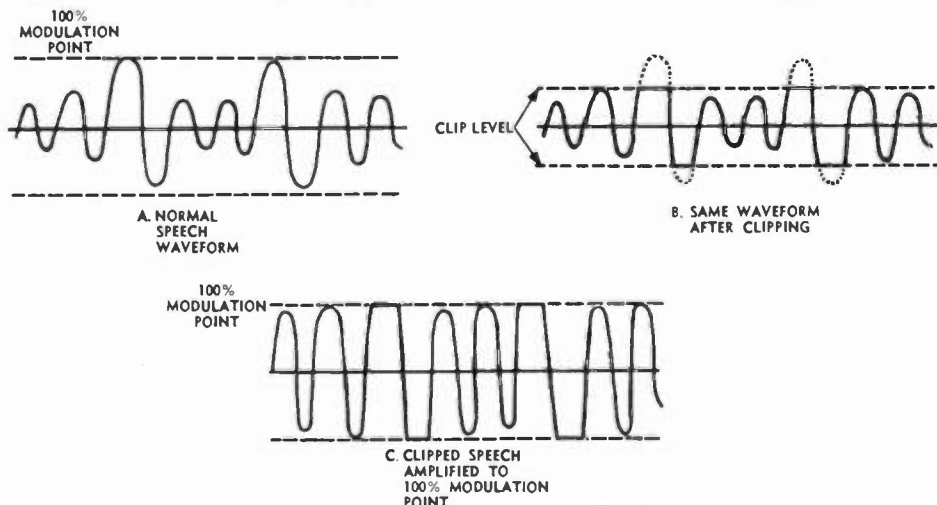

A CBH Conversion



by M. MacKay, 1Q6710

Most inexpensive transceivers of the superheterodyne variety use a variable condenser to tune the oscillator section of the receiver to the channel you wish to listen to.

Variables, by their very electrical specifications, tune rather broadly and often allow interference from adjacent channels where there is a strong "off-channel" signal on the air.

Circuits employing variable condensers are also often subject to thermal drift, so you are never quite sure what channel you are tuned to until the set warms up, regardless of what the dial indication is.

These problems can be corrected very easily by connecting a third harmonic crystal of the correct frequency across the variable condenser, in series with a toggle switch. Closing the toggle switch brings the crystal into the oscillator circuit, locking you on channel in such a way that you are certain you are listening on Natch-9, or whatever. Turning the switch to the off position removes the crystal from the circuit, and bingo—you are back roaming the band with your tunable receiver.

Crystal Frequency

Choosing the correct crystal frequency is no problem. First select the channel you wish to monitor (via crystal control), and consult your equipment manual for the i.f. frequency of your set. Take the frequency of the channel you wish to monitor (ie. channel 11 would be 27.085) and subtract the frequency of your intermediate frequency (i.f.) amplifier. As an example, let's take the channel 11 frequency (27.085) and subtract an actual (HE-15A) i.f. of 1750 kilocycles (1.750 megacycles).

Adding Crystal Receiving To The Lafayette HE-15A

1.750 subtracted from 27.085 leaves us with 25.230 megacycles. This frequency, 25.230 megacycles, is the crystal frequency we would select for our HE-15A example, if we wished to wire a channel 11 monitor crystal into our set (see schematic diagram 1).

The incoming frequency (27.085-channel 11) will now beat (subtract) from the frequency of your 25.230 megacycle monitor crystal, producing a signal of 1750 kc. This will be picked up by your i.f. amplifier stage, and you will hear only channel 11 signals! All other signals (for example channel 9, 27.065 will come out with different beat frequencies (for example channel 9 would come out at 1730 kc, which would not be picked up by the i.f. amplifier stage) and therefore will not be heard.

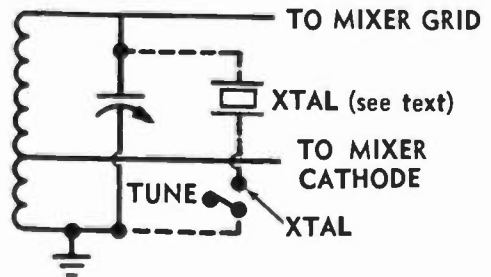

Diagram 1

Construction

The transceiver-receiver modified by the author was a Lafayette model HE-15A, one of the most popular transceivers in use today. It is felt that because of its widespread use, many readers will be able to duplicate my results by following exactly my construction technique and diagram.

(Continued—Page 34)

THE CB RADIO MOBILE HANDBOOK

WILL PREMIERE SEPTEMBER 15

*at a select number of CB
dealers and distributors*

These dealers will be showing this book.

Stop in and order your copy now!

CALIFORNIA—HEMET—Gil Severns, 40400 E. Florida—11W0802, Ch. 16 • INGLEWOOD—Acorn Radio, 4736 W. Century Blvd.—11W7153, Ch. 11 • LOS ANGELES—Radio Product Sales, 1501 S. Hill—11W7159, Ch. 1 • POMONA—Romo Radio, 1090 S. Garey Ave.—11W4075, Ch. 1 • RIVERSIDE—Mission Ham Supplies, 5472 Mission • WHITTIER—T P Electronics, 14104 E. Lambert—11W-5168, Ch. 1
CONNECTICUT—BRIDGEPORT—Lafayette Radio, 2710 Fairfield—1W2580, Ch. 11
FLORIDA—SARASOTA—Citizens Band Radio, 380 Harding Circle—KDHI148, Ch. 9
GEORGIA—LAFAYETTE—Thurman's, Public Square—6Q-6038, Ch. 11
INDIANA—BLOOMINGTON—Lefferson Radio, 405 S. Walnut—18W3627, Ch. 12 • ELKHART—City News Agency, 613 So. Main • FORT WAYNE—CB Two Way Radio, 2801 Broadway—KHA0113, Ch. 11 • GARY—Calumet Camera, 1132 W. 5th—18B1786, Ch. 11 • YORKTOWN—Wilco Electronics, St. Rd #32, 18W4492, Ch. 9
KANSAS—BAKTER SPRINGS—Commercial Electronics, 411 E. 13th—17Q1060, Ch. 9
MASSACHUSETTS—SPRINGFIELD—Lafayette Radio, 527 Belmont—1Q2944, Ch. 9
MICHIGAN—MUSKEGON—Electronic Dist., 1960 Peck St.—19W1721, Ch. 12
MINNESOTA—MINNEAPOLIS—Acme Electronics, 1695 Plymouth Ave. N—16Q0387, Ch. 11
MISSISSIPPI—YAZOO CITY—Appliance Center, 313 S. Main, 8Q1127, Ch. 9
MISSOURI—ST. LOUIS—Warner Communications, 7216 St. Charles Rock Rd. Call pending—channel 9
NEW YORK—EAST QUOGUE—Lewis Dunwell Sales, Vail Ave.—2Q4907, Ch. 9 • RIDGE—Bi-Rite Radio, RFD Box 55A, Old Saddle Rd.—2Q5652, Ch. 9 • ROCHESTER—Alex and Vince, 112 Rexford St.—20W2514
NEW JERSEY—TRENTON—Alray Equipment Co., 139 Ewingville Rd., 2Q5718, Ch. 11

NEW MEXICO—ALBUQUERQUE—Specialty Engineering, 1804 Morris St.—15W0259, Ch. 11
NORTH CAROLINA—FAYETTEVILLE—Southeastern Radio Supply, 325 Rowan St. • GREENSBORO—Southeastern Radio Supply, 404 N. Eugene St. • HICKORY—Southeastern Radio Supply, 907 Second Ave. NW • JACKSONVILLE—Southeastern Radio Supply, 1009 Lefeuve Blvd • KINSTON—Southeastern Radio Supply, 408 N. Heritage St. • RALEIGH—Southeastern Radio Supply, 414 Hillsboro St. • SALISBURY—Southeastern Radio Supply, 316 Depot St. • WILMINGTON—Southeastern Radio Supply, 1815 Dawson St. • WILSON—Southeastern Radio Supply, 321 Goldsboro St.
OHIO—AKRON—Lafayette Radio, 34 N. Main—19Q8500, Ch. 9 • MARION—Electronic Service Co., 187 Carhart St.—19B0497, Ch. 11 • NEWTON FALLS—Johnnie's Radio, 228 Milton Blvd.—19W4673, Ch. 11
OKLAHOMA—OKLAHOMA CITY—CB Two-Way, 4007 N. Penn.—10W3541, Ch. 11 • TULSA—Greer's Teleflex, 528 S. 75 E. Ave.—10W0538, Ch. 9
OREGON—WASCO—Barnett Enterprises, Box 244—13W-1745, Ch. 13
PENNSYLVANIA—PHILADELPHIA—Audiotronics, 3818 Chesnut St.—3Q2172, Ch. 9 • HARRISBURG—Keystone Electronics, 414 S. 13th—3Q0989, Ch. 11 • YORK—Lense's, 201 S. George St.—Channel 1
TEXAS—PT. WORTH—Chas. Horn Radio, 423 South Summit—10W1820, Ch. 11 • HOUSTON—Tele-Comm Electronics, 3820 Almeda—9Q0362, Ch. 11
SOUTH CAROLINA—ANDERSON—B & B Electronics, 203 W. Shockley Ferry Rd.—6W5014, Ch. 9
VIRGINIA—ANNADALE—Arcade Electronics, 9609A Columbia Pike—KCF1232, Ch. 11 • DANVILLE—Southeastern Radio Supply, 215 Craghead St. • ROANOKE—Southeastern Radio Supply, 1330 Courtland Rd., N.E.
WASHINGTON—SPOKANE—Northwest Electronics, East 730 First—14W0333, Ch. 21

OR

Order your Autographed Personal Copy Direct
from Horizons — to be shipped postpaid to
you on September 15th!

(A Limited Number of Dealer Franchises are still open
—Dealers please contact Horizons today!)

Small, Simple, Superb

H OMEBREW G ROUND P LANE

By **CRAIG G. VOGT, 18Q5359**
Milwaukee, Wisconsin

This antenna is a project that can easily be completed in one weekend by an average CB'er with average skills. The entire cost of the antenna should not exceed \$6.00, even if all parts are purchased brand new.

The ground plane is still a top performer, dollar for dollar, when it comes to choosing a CB antenna that will push your signal out and bring the "bacon home." A properly designed ground plane will last through the elements longer than many complex antenna arrays, it is easier to match to your transmitter than some, and it has several distinct performance advantages.

This antenna will not *out perform* most commercial ground planes on the market, but it will give results *equal to most*. If you have need for a second antenna, perhaps for the cottage or home, this ground plane will give performance many times its cost.

FIRST

Round up the parts. The aluminum tubing in my case came from discarded television antennas. You may have to purchase yours at a local "surplus supply house" (the type that sells Army Surplus often sells aircraft tubing too), or from an aluminum supply house. The latter method is by far the most expensive. Many TV service shops have the tubing in abundance, having taken in broken antennas on trade.

The wooden base will prove to be rugged enough to stand up under adverse wind conditions. The wood I used was 1" by 2" pine. As diagram 1 shows, the wood forms our "Quad-Pod" and the length needed will vary as the slope of the roof does.

Nylon or glas-line guy rope is recommended. Never use metal guy wires with ground plane antennas. The antenna "sees" the metal guy wires as additional radials, and this only serves to confuse the poor impedance conscious antenna!

Porcelain insulators (8 in all) are recommended for the guys, as shown in the diagram.

Finally, give the wooden portion of the pine and plywood base a good coat (or two) of outdoor weather protecting paint.

CONSTRUCTION

For the most part the diagram can be followed from start to finish. Note in insert A that a piece of plywood, 8" by 8" by $\frac{3}{4}$ " forms the base for the radials. Tack the radials down to the base with 6-32 metal screws, 2 inches long, or an equivalent. Also note the point marked Feed-Shield on insert A. This is where you tap the Radial element marked and tie in the shield on your RG-8/U coax cable. The center conductor of the coax attaches to the vertical radiator section of the coax exactly two inches up from the bottom of the 8 foot $7\frac{1}{2}$ inch piece of $\frac{3}{8}$ inch diameter tubing. Note that it is optional to include a $\frac{3}{8}$ inch OD piece of tubing at the top of the vertical radiator portion of the ground plane. For the perfectionist, this piece of tubing may be slid in, and out, as a means of fine adjusting the resonate frequency (operating channel) of the antenna.

The "Quad-Pod" is 11 feet high. This makes it inconspicuous against the roofline of your house or building top. At an overall height of 33 feet (ground



COURIER 1-M

NOW!

QUIETEST

MOST POWERFUL

MOBILE

C.B. UNIT!

HEAR IT TO BELIEVE IT!

Write for Free Brochure \$199.50. list, slightly higher west of Rockies.



electronics communications, inc. 325 no. macquesten pkwy, mt. vernon, n. y.

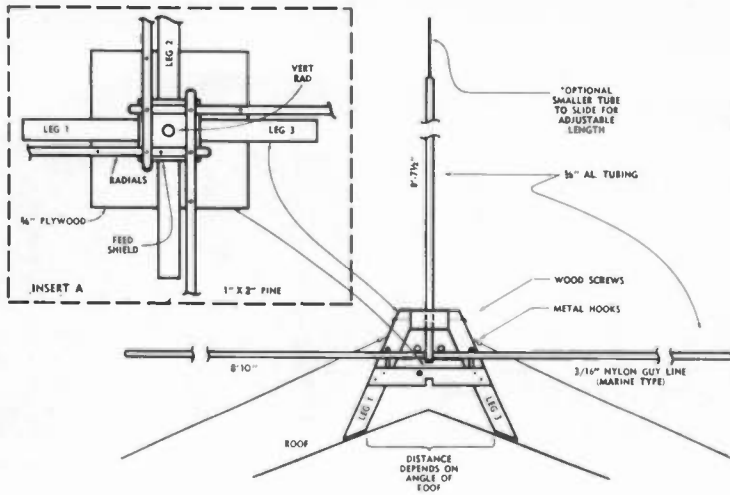

to tip) my base to base range is 30 miles under normal conditions. Base to mobile range is about the same.

The "Quad-Pod" may not win any academy awards for looks or commercial salability, but it does work . . . it is inexpensive to build and it will stack up against just about any other ground plane antenna in use today. Build one yourself . . . and see!

Quad-Pod Parts List

5—9 foot lengths aluminum tubing, 5/8 inch diameter or any diameter from 1/2 inch to 1 inch. This tubing can usually be obtained from local TV

service shops as broken antenna parts.

- 7—feet of 1 by 2 inch pine, or similar wood for the quad-pod. This exact length (see diagram 1) will depend upon the angle of the roof.
- 1—piece of 8 by 8 by 3/4 inch plywood. The radials attach to this base.
- 7—feet of nylon rope, or Glas-Line.
- 4—screw eye guy wire hooks, obtainable at most hardware stores.
- 8—porcelain insulators, 4 for quad-pod and 4 for the roof side of the guys. Two to each guy.

MORE ABOUT POWER BOOSTERS

If you recall the May issue, you'll probably recall the "Kyle-O-Watt" power booster (the one we left the parts list out of).

This article brought us hundreds of letters requesting parts lists—and one king-sized problem from a reader who built it and found it didn't work for him.

This usually happens with any construction article—the reasons are varied, and may be summed up with Murphy's famous law: "If a gadget can possibly fail to work, it will!" But in this case, the reader was speaking for four other people—and all had identical troubles!

After three half-hour telephone calls, and uncounted hours on the bench, the

trouble spot was found—and eliminated. How does it work now? Mr. Roger Scalf, KDB0782, Nashville, Tenn.—the reader referred to above—has this to report: "This combination will cut through skip as if it were a quiet day."

What was the problem? It really wasn't in the booster at all, but in the unit used to drive it. Mr. Scalf found it necessary (in his GW-10) to remove the 12-pf capacitor located inside the old final tank coil, and also to replace the 100-ohm resistor in the 6AU8 plate supply with a James Millen No. 3400 RF choke. Finally, he removed C30, a .002 mf capacitor formerly connected to the junction of the 100-ohm resistor and the final tank coil lead.

On his Eico 770, Mr Scalf grounded the end of the pi-net coil which former-

(Continued—Page 43)



It's
amazing
what a
hat and skirt can do...

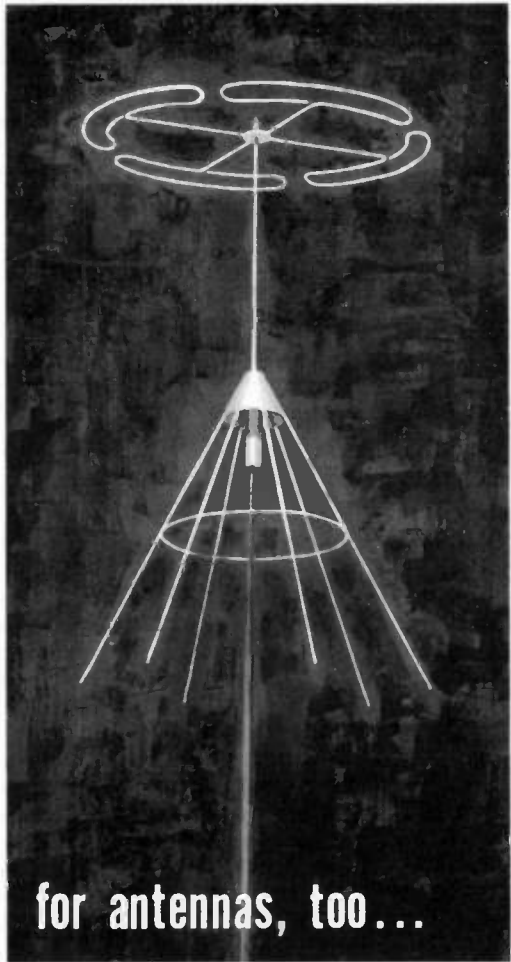

for antennas, too...

Stinger Model DC: guaranteed discone for Class D, 27-mc, fixed-station, commercial and industrial use. A transmitting antenna is only as good as its receiving characteristics — in Stinger's all-new Model DC, both transmitting and receiving characteristics are engineered for optimum performance in the discone design. That means:

- Receiving capability is remarkable because of the large capture area. The weakest of signals are copied loud and clear.
- The prime function of CB is mobile communications; the prime problem of CB is receiving mobile communications; the prime solution is Stinger Model DC, which is characterized by its low-noise reception.
- Model DC is completely electrically isolated, results in minimum ground effect at any elevation. Prevents radiation down the mast and co-

axial cable so that power is concentrated where it should be: 3-db gain at the horizon!

- Broad-band characteristics (receiving and transmitting) permit use on all CB channels without performance deterioration!

Model DC's extremely low angle of radiation eliminates all but the lowest-angle skip; thus, the antenna is highly useful for industrial applications as well as commercial . . . light, sturdy, and not bulky, Model DC is almost entirely free of normal installation problems . . . adapts readily to most existing mast structures . . . pleasing modernistic configuration that fits any roof line. Request Bulletin SF-101, or see your franchised Stinger distributor for a demonstration today! Calibration Standards' Stinger Products, Box 2315, City of Industries, La Puente, California.

Stinger*



CITIZENS BAND DATEBOOK



A SERIES OF IN DEPTH REPORTS ON CB'ERS ACTIVITIES FROM COAST TO COAST.

CB Club and REACT Group Donate Rig For Emergency Use

The 11 Meter Club of Southeastern Michigan and the local REACT Group joined forces in raising funds and buying a complete rig for Monroe County's Sheriff, Bud Harrington, and his department. Following completion of the installation, the Sheriff's department has called for assistance from the marine and mobile units four times.

The first call came three days after the installation was completed. A man was reported overboard off Bolles Harbor in Lake Erie, and boats were needed to aid in the search. Within fifteen minutes there were twelve boats in the immediate area and began searching. Thirty minutes later the man was picked up approximately one mile from where he was thought to have gone overboard. Even though the man had no life jacket, and it was growing dark, the prompt action of REACT

CB'ers in responding to the call undoubtedly saved his life.

The second call came during a severe electrical storm, when a boat went aground on Middle Sister Island in Lake Erie. The boat called for help on 27 mc. and his call relayed to the Coast Guard. The Coast Guard cutter was dispatched and proceeded to go aground trying to rescue the boat. A further distress call was issued and again CB relayed the message to the Coast Guard and a second boat dispatched, which completed the rescue. The CB radios were able to broadcast over the severe static conditions, when the CG frequencies were unable to.

The third call came Wednesday, June 27th. There was a need for boats in the Bolles Harbor channel, as a boy was believed to be drowning. Four boats responded within minutes, but were only able to aid in recovering the body.

The fourth call came Thursday, June 28th. This was to contact a man somewhere on Lake Erie for an emergency message. The CB'ers from Detroit, Flatrock, Newport, Monroe, Erie, Point Place, Toledo, and many other points began calling the boat. Within two and one-half hours the party had been located and the message delivered.

The experiences of the 11 Meter Club and REACT Group of Monroe County have to date, made us feel that a real public service is being offered to the citizens of this area. Approximately one hundred mobile and fifteen marine units are available, through the coordination of the Sheriff's department, to help in any emergency arising that may call for rapid radio communications.

Citizens Banders across the nation are daily engaged in new and unusual ways of putting their short-range communications tool to work. On several occasions, a life has been saved because CB radio was there to provide communications when all other forms of communication failed. CB Horizons invites readers to submit typewritten stories of your "unusual" applications and reports of CB radio saving the day in a time of need.

The Editor

Browning Says...

**You can
improve
your CB
coverage!**

23/S-NINE TRANSMITTER



R-2700-A RECEIVER

Unless you are already using Browning CB equipment, your coverage can be improved. All you need is the R-2700-A Receiver and 23/S-NINE Transmitter as your base station . . . Let us prove it to you!

Send today for new Browning 24-page color catalog. Write Dept. H



browning
Browning Laboratories, Inc.,
100 Union Avenue
Laconia, New Hampshire

AS LOW AS \$15 PER MONTH AFTER SMALL DCWN PAYMENT

We submit this information in the hope that other clubs or groups will see fit to organize emergency units, cooperating with the local governmental agencies, and be able to render similar public services to their communities.

Carl M. Savage
19Q9250

CB IN A CANOE YET!

This is a story of an unusual application of CB radio. The writer doubts it will be duplicated per se, but it may provide you with a few ideas as to how you might make your CB radio more valuable both at work and at play.

Lynn Held, 18Q3637, and myself (18Q5359) became interested in canoeing last fall. As we are also CB'ers, we decided that 27 megacycle communications might be a valuable thing while running the rapids of the Milwaukee river! Our first attempt was with hand held transceivers. Range was poor however and we knew that we needed more range to communicate back home to Milwaukee.

The obvious answer was installing a 5 watt transceiver in the Canoe itself! Right away I can hear the groans and cat-calls. I know . . . this is not only dangerous but also a very good way to lose a CB transceiver. Canoes are not known for their evenness of keel!



Can You Canoe and CB Too?

None the less we set out to accomplish our goal. Lynn's EICO 762 was installed on the bottom of the canoe, and a 42 inch base-loaded whip was mounted on one of the gunnel supports as shown in the photo. This was all fairly simple. The fun began when we decided to locate power for the unit. They just don't make extension cords long enough!

Not wishing to invest any more money than necessary in this pipe dream, we finally located a *loaner* battery which the service station attendant rented to us for the total sum of \$1.00.

To protect the canoe the 12V battery was wrapped first in cardboard, and then installed in a small wooden box. The battery was also tied to the canoe with heavy twine to prevent it from becoming an unguided missile during the trip! Imagine trying to dodge a 30 pound battery in a small canoe!

Once on the river we checked out the rig. The vibrator hummed merrily and the receiver showed background hiss. But the transmitter r.f. output indicating light wouldn't glow, possibly because of a lack of ground connection for the rig.

In motion down the river we found that canoeing and CB'ing don't mix. You tend to navigation or you are suddenly up to your armpits in water. And with a CB rig aboard you don't want this to happen. Our first contact was with Rex Byle, 18B2324. Shocked by our answer and delighted with surprise Lynn and I could hardly keep from laughing and shrieking with delight. And Rex was also a little surprised to hear us singing "canoe-mobile."

After lunch we ran into our first difficulty. We had shot several rapids but some ahead looked more than just a little mean. And, we had probably re-gained some of our senses momentarily lost when we started out on this venture. Now we were concerned with losing the rig in a possible upset. So we decided to portage (hand carry) the canoe and all of its belongings around the next set of rapids. Half way around the rain began!

And the trip ended. A quick call to the home base on the now waterless-canoe mobile brought out a station wagon and shelter.

Once again CB radio saved the day and generally made life a little more fun, and a whole lot easier. True it presented some problems . . . but not without a more than equal share of rewards.

Craig Vogt
18Q5359

MARK *Static Sheath**

Eliminates Noisy Precipitation Static...Improves Signal-to-Noise Ratio
Affords up to 20 db Operating Gain...Increases Receiver Sensitivity
Extends Intelligible Coverage. Easiest to install.*



INCREASE COVERAGE

MARK II SUPER BEACON FIXED STATION ANTENNA *with exclusive Static Sheath**

Design advantages of the new MARK II now make it possible to step up the efficiency of your CB operation, and maintain clearer communication over greater distances. 19 feet overall, the omnidirectional MARK II makes fullest use of the 20-foot legal length limit. Requires no radials or skirts. Provides 1 db gain over ground plane antennas. Employs a full half-wave radiator voltage fed through a special launcher-matcher cable section for excellent impedance match over the entire citizens band. Low angle radiation insures utmost efficiency and maximum contact with mobile units.

Improved mechanical features and extra-rugged base support pipe add to its reliability. Simplified clamp mounting makes installation easy.

Precipitation Static** is caused by charged particles in the air impinging in a continuous stream on metal antenna radiator surfaces. It is revealed by a continuous hissing background noise. The patented **Mark Static Sheath is a tough, durable, dielectric plastic covering that acts as an electrical insulator and eliminates static interference caused by the precipitation effect.

MARK HW HELIWHIP®* MOBILE and MARINE ANTENNAS *Top-Loaded, 50-Ohm Load...with Static Sheath**

Shortened mechanical structure and other Mark features bring new efficiency, new compactness, new convenience to CB communication. Molded Fiberglass, with Static Sheath.* Designed to replace lengthy stainless steel whips. Far superior to whip and loading-coil combinations. Can be located on upper portion of vehicle such as trunk lid, cowl, fender or hood to obtain proper ground plane. Single-hole mounting. 18", 3', 4' and 6' mobile models. Heliwhip Marine Antenna (6' long) eliminates need for metal ground plane.

See Your B & K Distributor or
Write for Catalog HW19-CB

*U.S. Pat. 2,966,679
U.S. Process Pat. 2,938,210



MARK HELIWHIP®*

Another Fine Product Line by

B&K MANUFACTURING CO.
Dept. CB-5, 1801 W. Belle Plaine
Chicago 13, Illinois



LET'S CONSIDER

BUSINESS BAND RADIO

CB Radio is fast reaching a plateau of licensing. More than 300,000 American Citizens now have Class D licenses. An estimated 1,117,000 27 megacycle transceivers have been authorized by the FCC. While no-one believes all or even a substantial part of these are operational, there is no question that

the 23 CB channels (22 for all practical purposes) have reached the saturation point.

This series of articles, prepared exclusively for CB Horizons by our staffs in Washington and Oklahoma City, will suggest two *relief valves* for CB radio. Neither will completely correct

One of the greatest Citizens Band Radio assets is the ease by which we are able to obtain government authorization to operate our stations for personal and business communications. This one factor alone has been responsible for introducing two-way communications to an estimated 1,000,000 Americans in four short years. No other form of radio service could have done 1/10th this job in 10 years! There is simply too much red tape connected with all other forms of two-way radio to make it appealing to the neophyte.

BUT—now that you are actually licensed and operating in the Class D service, it has probably become obvious that for your "ease of licensing" you have relinquished your rights to a number of operational privileges. For example, you share your channel with an unlimited number of stations. If you are a business user of CB, the value of your radio equipment probably decreases daily as new licensees come on the air, further crowding the airwaves. On the other hand, if you are a personal user of CB, the additional channel occupancy probably is nothing more than a minor irritation.

SO—now that you have your feet wet, and know how valuable two-way radio can be, it is very possible that you can qualify as a user of one of the many other forms of low-cost two-way radio authorized by the government.

It is the purpose of this series to explore these 'other' forms of communications. We don't want to lead you away from CB. . . we do want you to realize maximum communications effectiveness for your dollar invested in electronics.

BULLETIN:

Business Radio, Inc.
announces two of the most exciting
new products of the year!

Miniature, fully
transistorized
"S" Meter!

Fully automatic,
voice-operated
Phone Patch!

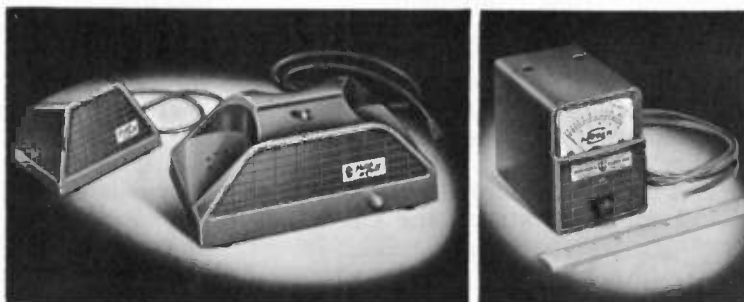

ILLUSTRATED ABOVE—At left is the Model 301 "Patch-a-Call", a fully automatic, voice-operated phone patch—at the right—the Model 601 "S-Master", a miniature, transistorized "S" meter designed for two-wire hook-up to any receiver.

"S-MASTER"—What is it?—The "S-Master" is a highly accurate transistorized printed circuit "S" meter, designed for simplified connection to any receiver. Only 1 7/8" wide by 2 1/2" high and deep, unit is enclosed in a molded, high impact plastic case. Unique, magnetic mounting bracket lets you mount "S-Master" anywhere in seconds! Simplified hook-up requires two connections . . . unit is battery operated, and battery should last 9 months or more with normal usage!

How it works—The "S-Master" utilizes two transistors in a special circuit, for accurate measurement of change in AVC voltage on an incoming signal. This method provides a more faithful reading than provided by more common screen grid current measuring "S" meters. Connects in minutes, one wire to ground—the other to AVC buss. Screwdriver adjustment lets you calibrate "S-Master" to your particular transceiver—and once adjusted need never be set again! To monitor an incoming signal, turn front panel knob "on" and adjust to "zero" meter—you're then ready for an instant, accurate reading. Battery required is a NEDA 1604, and may be inserted or changed in seconds.

Model 601 "S-Master" (less battery)

\$9⁹⁵
NET

NOISTOP

Eliminates Ignition Interference
from Nearby Cars and Trucks . . .

Nothing outperforms it at any price!

Thousands in use all over the country! The original that really works—not an untried imitation! No clipping or distortion of received signal at proper setting—prevents receiver jamming from trucks, cars, or other pulse-type electrical noise. No need to suppress your car—fully guaranteed—with detailed photo instructions for 28 popular CB rigs! Only 1 1/2" x 2 1/2" x 4". **\$16⁹⁵**
Installs in 20 minutes. NET

"Patch-a-Call"—What is it?—The "Patch-a-Call" is an automatic voice-operated telephone patch for use at any base station. Radical voice circuit, designed with in our own laboratory, is superior to other "VOX" circuits in design, performance, and response! Receptacle and speaker are molded of tough, high-impact plastic—transistorized printed circuit is encapsulated. No wires to connect to your telephone—no B+ hook-up required to your set. Designed for fast installation to most transmitters . . . power obtained from any 115 Volt AC outlet.

How it works—When "Patch-a-Call" operation is desired, station operator places telephone handset into "Patch-a-Call", automatically turning unit "on". As party on telephone talks, his voice instantly, automatically actuates base station transmitter—when he pauses, base automatically switches to "receive", and other end of conversation from mobile unit is heard over the telephone. Auxiliary speaker permits monitoring both sides of conversation . . . design permits operator to instantly break "patch" to take over base and mobile control. With easy installation instructions for fast hook-up.

Model 301 "Patch-a-Call"

\$64⁹⁵
NET

See your distributor,
or write today!



BUSINESS RADIO, INC.

P. O. Box 5652, Minneapolis 17, Minn.

Please send full details

NAME _____

ADDRESS _____

CITY _____ STATE _____

all of the interference problems present, but the proper employment of both by progressive CB'ers will help stem the ever growing tide of interference.

"WELL . . . IT'S EASY"

CB radio's popularity can be attributed to (A) the ease in which John Q. Citizen can obtain equipment, and, (B) the ease with which the same John Q. Citizen can obtain a license to operate that equipment.

Unfortunately, its effectiveness can be measured just as easily. It's shown in graph one as a decreasing percentage which heads lower and lower as station occupancy per channel heads higher and higher.

But once acquainted with Citizens Band communications, the CB'er nat-

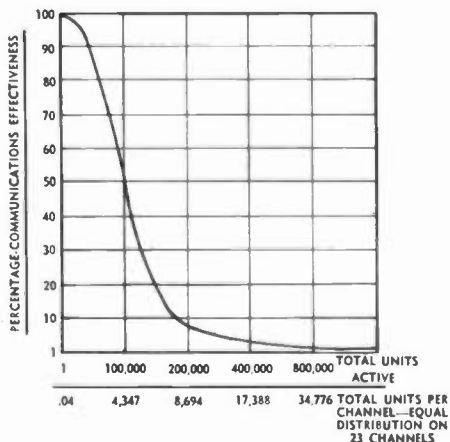

urally looks for better—more powerful—means of getting his message through.

THERE IS A WAY . . .

A little known but still very potent radio service exists just adjacent to the Class D Citizens Band. The *Business Radio Service* is the most liberal form of radio service authorized for two-way communications, with the exception of course of Class D CB. It is also a somewhat more complicated process to obtain licensing in the Business Radio Service. But, a complete investigation of the service, by Horizons, reveals that it is not nearly as complicated as you might believe. And if you can qualify under the requirements, you would find the Business Radio Service several times the radio service Class D is, in many respects.

Before we go into the requirements, let's make it very clear that this is a radio service for business—not personal—communications. If you are not operating a business (and a specified business at that) Class D CB radio is still your best bet for communications.

OK—so you are a business user of CB. And you do need more reliable communications over greater range than you are now getting in Class D operations. What would you get (assuming you could qualify for the Business Band) for your money?

First of all, you would be able to operate with greater power (up to 500 watts in some cases) on frequencies with far less congestion, utilizing antennas up to 170 feet above ground. Let's explore what each of these mean, or could mean, to you.

(A) *Power*—Under section 11.106 the FCC states "The power which may be used by a station (in this service) shall be no more than the minimum required for satisfactory technical operation commensurate with the size of the area to be served and local conditions which affect radio transmission and reception." The maximum allowable is 500 watts, for base operation. Certain Business Band frequencies allow only 180 watts maximum power, as will be noted shortly.

(B) *Frequencies*—After careful investigation of the do's and don'ts of this service, seven (7) 27 megacycle frequencies have been chosen as likely candidates for business radio users. There are actually many more authorized, but only 7 of these offer the fewest problems in getting licensed, while still maintaining the maximum number of operating privileges. They are as follows:

- 27.245 megacycles _____ (a)
- 27.255 megacycles _____ (a)
- 27.265 megacycles _____ (a)
- 27.410 megacycles _____ (b)
- 27.430 megacycles _____ (c)
- 27.450 megacycles _____ (c)
- 27.470 megacycles _____ (c)

The channels noted with an (a) are limited to 30 watts input. The channel marked (b) is authorized

CB EQUIPMENT ORDER BLANK!!!

- | | | | |
|--|---------------|---|---------------|
| <input type="checkbox"/> TRIUMPH 'WALKIE TALKIES'
9-transistor deluxe unit,
leather case, etc. | SALE \$29.99 | <input type="checkbox"/> TOKYO ROSE CRYSTAL
STUDIO MICROPHONES | SALE \$4.89 |
| <input type="checkbox"/> UTICA TRANSCEIVERS
(Town & Country)
+ FREE BONUS!!
Command CB Beam (Reg. \$180) | SALE \$149.95 | <input type="checkbox"/> MICROPHONE STAND
2-pc. adjustable, chrome | SALE \$2.59 |
| <input type="checkbox"/> UTICA TEC 11 TRANSCEIVERS
+ FREE BONUS!!
Command CB Beam (Reg. \$200) | SALE \$159.95 | <input type="checkbox"/> COMMAND XS-12 CRYSTAL
SELECTOR —adds 12-position
to transmit or receive (Reg. \$10) | SALE \$5.95 |
| <input type="checkbox"/> HY-GAIN COLINEAR CLR
ANTENNA + FREE BONUS!
100 ft. RG58 foam coax cable | ONLY \$29.95 | <input type="checkbox"/> BEACON ANTENNA by MARK
+ FREE BONUS!
100 ft.—RG58u foam coax cable | ONLY \$19.95 |
| <input type="checkbox"/> SPEAKEASY (audio comp. amp.)
+ FREE BONUS!
Command channel selector | ONLY \$34.75 | <input type="checkbox"/> SUPER BEACON by MARK
+ FREE BONUS!
50 ft.—RG8u foam coax cable | ONLY \$34.95 |
| <input type="checkbox"/> NOISTOP by Business Radio Co.
+ FREE BONUS!
Command channel selector | ONLY \$16.95 | <input type="checkbox"/> HELIWHIPS by MARK MOBILE
(S-series) (3, 4, 5, or 6 ft.)
+ FREE BONUS!
50 ft. RG58 foam cable | ONLY \$7.20 |
| <input type="checkbox"/> "S" MASTER by Business Radio
+ FREE BONUS!
Tuneable GNS generator filter | ONLY \$9.95 | <input type="checkbox"/> TUNEABLE CITIZEN BAND ANTENNA
(by Antenna Co. of America)
(Little John, Power Dart, Arrow)
+ FREE BONUS!
50 ft. RG58 foam coax cable | ONLY \$9.95 |
| <input type="checkbox"/> "PATCH-A-CALL" by Business Radio
+ FREE BONUS!
"S" MASTER by Business Radio | ONLY \$64.95 | <input type="checkbox"/> MARINE HELIWHIP by MARK
(HW-11-6M)
+ FREE BONUS!
Command channel selector | ONLY \$22.95 |
| <input type="checkbox"/> TRANSICHECK by CESCO
+ FREE BONUS!
Command channel selector | ONLY \$19.95 | <input type="checkbox"/> SIGNAL FILTER by SECO
+ FREE BONUS!
Command channel selector | ONLY \$15.88 |
| <input type="checkbox"/> SECO TRANS. "S" METER (#450)
+ FREE BONUS!
50 ft. RG58 foam coax cable | ONLY \$13.88 | <input type="checkbox"/> ANTENNA TESTER by SECO (#520)
+ FREE BONUS!
Command CB Silencer Kit | ONLY \$42.95 |
| <input type="checkbox"/> NOISQUELCH by COMMAND.
twin squelch eliminates noise
from your car and (Reg. \$16.95)
other cars around you. | SALE \$10.99 | <input type="checkbox"/> CB LOW PASS FILTERS
(Reg. \$5) | ONLY \$2.95 |
| <input type="checkbox"/> COMMAND SUPER III BEAM
rugged-mounts vertically
or horizontally (Reg. \$30) | SALE \$11.99 | <input type="checkbox"/> CERAMIC CRYSTAL SOCKETS
10 for | SALE 89¢ |
| <input type="checkbox"/> COMMAND SUPER V BEAM
mounts vertically or
horizontally (Reg. \$40) | SALE \$18.99 | <input type="checkbox"/> PL-259 COAX CONNECTORS
39c each | 10 for \$3.50 |
| <input type="checkbox"/> COMMAND CONTACT II
stainless steel spring & 102"
whip + chrome body mount (Reg. \$12) | SALE \$6.89 | <input type="checkbox"/> SO-239 COAX CONNECTORS
39c each | 10 for \$3.50 |
| | | <input type="checkbox"/> UG-175 ADAPTORES
14c each | 10 for \$1.19 |

GET THAT SIGNAL OUT WITH
ULTRA-LO-LOSS FOAM COAX CABLE!!!

<input type="checkbox"/> 50 ft.—RG58u Coax Cable	SALE \$2.49
<input type="checkbox"/> 100 ft.—RG58u Coax Cable	SALE \$3.99
<input type="checkbox"/> 50 ft.—RG8u Coax Cable	SALE \$4.95
<input type="checkbox"/> 100 ft.—RG8u Coax Cable	SALE \$8.99

- | | |
|---|-------------|
| <input type="checkbox"/> COMMAND GP-1 GROUND PLANE
ANTENNA solid alum.
radials, heavy duty (Reg. \$16) | SALE \$8.99 |
| <input type="checkbox"/> COMMAND COMET ANTENNA
top-loaded whip +
trunk lid mount (Reg. \$12) | SALE \$7.99 |
| <input type="checkbox"/> COMMAND CORSAIR ANTENNA
bumper mount + spring
+ 102" whip (Reg. \$15) | SALE \$8.99 |
| <input type="checkbox"/> COMMAND CORSAIR II ANTENNA
double bumper mount + spring
+ 102" whip (Reg. \$18) | SALE \$9.99 |
| <input type="checkbox"/> COMMAND COURIER ANTENNA
center-loaded, st. steel,
fits stand, mounts (Reg. \$7) | SALE \$4.69 |
| <input type="checkbox"/> BASE LOADED INDOOR
CB ANTENNA (Reg. \$6) | SALE \$2.49 |
| <input type="checkbox"/> COMMAND CB SILENCER KIT
15-pc. mobile noise suppression kit:
contains GNS tuneable generator
filter, feed-thrus, spk. plug &
dist. suppressors, etc. (Reg. \$10) | SALE \$3.99 |

Closing out our stock of CB kits. Originally advertised at \$39.95 up. Complete with power supply, tubes, crystal, cabinet, wire instructions, etc. Less microphone. Note: transmitter must be tuned and tested by or under supervision of person holding a first or second-class FCC license. All sales final at this price. Thousands now in use. Rush your order in today while the supply lasts.

Check items wanted. Return ad or order with check or money order. Include postage, excess refunded. 50c service charge on orders under \$5.00. Beams and 102" whips shipped Railway Express. 50% deposit on C.O.D.'s

CB DEALERS: Write for Quantity Prices!

GROVE ELECTRONIC SUPPLY COMPANY

4111 W. Belmont Avenue
Chicago 41, Illinois

- Rush items checked
 Send FREE catalog of giant CB Values

Name
(please print)

Address

City Zone State

for up to 500 watts input. The channels marked with a (c) are allowed 180 watts input. In the Business Radio Service you file an application for one (1) frequency. You are not allowed (except under special conditions) authorization to operate on more than one frequency.

(C) *Antenna Height*—Present Class D CB regulations limit the overall height of your antenna structure to 20 feet above any existing objects (except existing radio towers or antennas). Business Band radio installations, like other forms of industrial communications, are limited only by an overall ruling of "170 feet above ground" which is made somewhat more complicated by a 1961 FAA (Federal Aviation Agency) ruling concerning any antenna towers located within three miles of airports of landing strips. Generally, Business Band antennas can be installed up to heights of 80-120 feet without special authority or complicated FCC-FAA filings.

Knowing that these "extras" are available probably whets your appetite to know more. For example, we have been talking about "somewhat more complicated filings" and the other rules of the road prevalent in high power Business Radio operation.

Before we look into the filing procedures, a brief look at who can and cannot use the Business Band frequencies might be of interest.

Subpart L of Part 11 of the FCC Rules and Regulations have this to say, under section 11.551.

"The following persons when engaged in lawful activities are eligible to hold authorizations to operate radio stations in the Business Radio Service:

- (A) Any person engaged in a commercial activity.
- (B) Educational or philanthropic institutions.
- (C) Clergymen or ecclesiastical institutions.
- (D) Hospitals, clinics and medical associations.

Just as interesting as who can and cannot operate in the Business Band

is what you can and cannot do with your license. Section 11.552 notes "The Business Radio Service . . . is intended for use by those eligibles without restriction as to the types of messages transmitted so long as they are necessary to the accomplishment of the business activity concerned."

It is interesting to note that hand held transceivers (or low power transmitters) operating with a final stage power of 200 milliwatts or less are permitted to operate on any of the 7 frequencies listed. They must be licensed however.

BUSINESS BAND FOR FARMS, RANCHES

One of the largest groups of Class D radio users is the ranches and farms of America. They also qualify for the *Special Industrial Radio Service* under Subpart K of Part 11, and with somewhat different privileges than the Business Radio Service. Six (6) frequencies are recommended for farm and ranch utilization, and they are as follows:

27.245	_____	(a)
27.255	_____	(a)
27.265	_____	(a)
27.310	_____	(b)
27.330	_____	(b)
27.350	_____	(b)

Those channels marked with an (a) are limited to 30 watts input, while those channels marked (b) are allowed the full 500 watts input.

All Business Radio comments about antenna height also apply to the Industrial Radio Service.

Specifically, Section 11.501 states the following about who may and may not hold an Industrial Radio Service authorization. "The following persons are eligible to hold authorizations to operate radio stations in the Special Industrial Radio Service:

- (a) Persons regularly engaged in the operation of farms or ranches or similar land installations for the quantity production of crops or plants, vines or trees (excluding forestry operations) or for the keeping, grazing or feeding of livestock for animal products, animal increase or value enhancement."

The Special Industrial Radio Service does have limitations however con-

TR-27B

Citizens Band BASE STATION



MODEL TR-27B \$265
with Turner Mic. 254X

The new TR-27B is designed to meet the increasing demand for better receiver selectivity. The TR-27B with 60 db of adjacent channel rejection allows you to read your mobile right down to "s" 3 with another station booming in at 40 db over "s" 9 just one channel away. This set provides a higher average modulation and greater range. Highest quality components and expert workmanship provide lasting performance and dependability. Minimum R. F. output 3.5 watts, 4 watts of Audio and 100% modulation capability insure superb performance for business or personal use.

- New Low Distortion Keyed Compression Limiting Provides Higher Average Modulation Without Over Modulation
- 15 Hi-Q Permeability Tuned Circuits Provide Maximum Adjacent Channel Rejection
- 5" x 7" 1½ oz. Alnico Magnet Speaker
- Dual Conversion Superheterodyne Receiver
- Fully Adjustable Squelch Control
- 23 Channel Tunable Receive
- 10½" Dial Spread
- Fully Adjustable Limiter Control with Off Switch
- Crystal Access Cover
- S Meter & Relative R. F. Output Indicator
- A. C. On-Off & Volume Control
- Crystal Spotting Switch
- Peak Modulation Indicator
- External Crystal Socket
- Tunable to Crystal Receive Switch
- 8 Channel Transmit & Crystal Control Receive Selector Switch
- Mic Input Jack

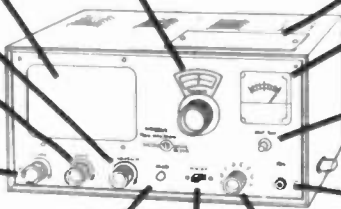

FOR MORE DETAILED INFORMATION
AND SPECIFICATIONS, WRITE TO



TRAM ELECTRONICS

P. O. BOX 187, WINNISQUAM, N. H.

cerning what you may or may not pass over the airwaves. For example, you cannot pass information concerning "sales reports, or the dispatch of salesmen; Payrolls, accounts or inventory control; Any messages relating to the retail delivery of any item or product. . . . ; Any message where the time element is not of immediate importance."

The Commission states, in defining Business Radio versus Industrial Radio, "Persons engaging in activities some of which are eligible under this subpart and some of which are not, and desiring to use radio in connection with both types, should apply for authorization in the Business Radio Service."

TECHNICAL

Actually, there is very little the operator needs to know about the electronics of equipment used in Business Radio Service applications. The operator has no control over the equipment, except to turn it on and off. Equipment in this service does not have channel selectors (you apply for

a single frequency and utilize just that frequency. The transmitter you select is outfitted with the proper receive and transmit crystals.), r.f. gain controls, and the many exotic adjustments now available in Class D sets.

OPERATION

There are two applicable types of operations in the Business Radio Service. *Mobile service* is just what it sounds like, operation from a mobile installation. *Fixed service* is communication between two base stations.

A mobile station may communicate with another mobile station, or with a fixed service station (ie. base station). And base stations may communicate with each other. However the exact type of transmissions expected must be spelled out in the initial FCC application.

In both the Business Radio and Industrial Radio Services certain frequencies have been recommended by this article. To be sure, others are available. However, use of frequencies other than those listed requires what is termed a "frequency search" or coordination of your proposed operating frequency with stations in the same or similar services already licensed.

Actually, this is not as much of a problem as it is red tape. Business Band activity in most areas of the country is all but non-existent. You will probably have the entire channel to yourself . . . just you, your 500 watts and your 170 foot antenna!

BACK DOWN TO EARTH

All equipment which you can use in the Business Band Service must be FCC type accepted. This is equipment which the Commission has approved as meeting its rigid standards for this service.

Form 400 is required from the Commission to make application for a Business Band Radio Service installation. It is suggested that a copy of Part 11 of the Commissions' Rules and Regulations also be requested. This will enable you to view first hand the regulations we have discussed here.

(Continued—Page 34)

MIRATEL CB

1 set of crystals, mounting strap, 2 power cords incl. List \$210.00, Net Price \$152.25.

OUR PRICE 144³⁷

WITH MECHANICAL FILTER List \$230.00, Net \$171.85
Our Price.....163.57

VP-100 100-MW TRANSCEIVER, List \$150.00, Net \$124.17. Our Price.....116.17

UTICA TOWN & COUNTRY MC-27, 1 set Xtals.....129.25

ANTENNA SPECIALISTS M-81 Magnum 27 CB base antenno. Only.....26.87

HYGAIN CLR Colinear Ground Plane CB base antenno. Only.....27.97



Minnesota Radio & Electronic Supply Co.
Rt. 2-Box 153-Wayzata, Minnesota

Enclosed is \$_____ Please send_____

Name_____

Address_____

City & State_____

Man Overboard!

C HANNEL 13 TO THE R ESCUE

By **R. C. DOWNING**
Flotilla Commander, USCGA

The United States Coast Guard *Auxiliary* (USCGA) is a volunteer civilian organization authorized in Section 822, Title 14, U. S. Code to assist the Coast Guard. We have four reasons for existence: 1, promote safety and effect rescues, 2, promote efficiency in operation of motorboats and yachts, 3, foster a wider knowledge of, and better compliance with the laws, rules and regulations governing the operation of motorboats, 4, facilitate other operations of the Coast Guard.

Many people boating inland water do not know that the USCGA operates inland. Feeling that many of our CB readers are also boaters, we think they may want to join us not only to enjoy the fellowship in boating, but to help serve the Public in a dual capacity, BOATING and CB. Membership is easy. First contact your local Flotilla who will be most happy to welcome you and invite you to attend their meetings so that you may see what actually goes on. Then, if you decide that you would like to become a member by first having a sincere interest in boating safety, there are six basic courses to be given by your Flotilla. Upon completion of the courses and passing six basic examinations, you may then become an active member of the Flotilla. Your next step would be to take the course for Inspector Examiner and upon completion of the examination your Coast Guard Headquarters will issue your I/E card showing that you are a qualified examiner.

The USCGA is an ideal organization for the mating and cooperation between boatmen and CB operators. We as Auxiliarist continually work winter

and summer for the promotion of boat safety as a **FREE** service to the Public. Now that many of us are also CB men, we have learned that CB operators also want to be of service to the public. Why don't we get together now, during 1962, all over the country and give to the public a greater sense of Safety? In this way our reason for being is well founded.



Nationwide marine channel is 13. Here training officer Gene Canady (r) mans the EICO 772 while Captain Watt (l) and Commander Downing (center) locate the Emergency on charts.

How can CB be of help to the boatman? Let me tell you about Tulsa Flotilla 1607. Tulsa Flotilla was formed in October of 1960 and Chartered February 20, 1961. Since that time we have tried to become the most active Flotilla in the Second Coast Guard District, which covers 21 States. We have held Public Instructions Courses on Safe boating for the employees of major companies in this area. Were the first in the United States to take 66 Boy Scouts through their boating Merit Badge. We had a very successful year in Examination of boats on our lakes, and participated in local boat shows,

(Continued—Page 32)

A Superb Citizen



METROstar[®] + Monocall =

Here is unique Citizens Band system performance outmoding all squelch operated systems in use today. The Metrostar 8 channel (plus tunable receiver) transceiver and the Monocall selective call signaling unit end forever the annoying static pops and unwanted signals which until now have tripped your unit's squelch and created an annoying background of unwanted noise.

With the Metrostar transceiver and Monocall selective calling system, you have complete system flexibility. Throw a switch on the Monocall and your transceiver remains 100 percent quiet until a similarly equipped base station or mobile, using your special Monocall code, begins transmitting. You do not hear skip signals. Passing autos and "noise" will not activate your squelch. Only your own units open your squelch.

Or, throw the same switch into the neutral position and operate as a normal transceiver—listening for calls from any station.

THE METROSTAR is truly Citizens Band radio supreme. This unit is the ultimate result of years and years of military and commercial communications equipment experience. 8 fixed tuned crystal controlled channels. 23 channel tunable receiver. Dual function S-meter and RF meter indicator. Built-in power supplies for 117 vac and 12 vdc. Detachable heavy-duty ceramic microphone. Externally accessible crystal sockets through handy removable panel. Provision for remote speaker. Convenient external ground and PI network control for proper antenna loading. Visual B+ Indicator. Visual RF indicator. Dual-purpose adjustable mount for mobile or base station installation. 15

CB RADIO SUPERB

The Metrostar 8 channel ultra-sensitive transceiver (0.5 uV sensitivity!) with 100% audio punch, and the Monocall selective tone-sequence calling attachment . . . give you a complete Citizens Band "Communications System".

METROSTAR 149.50
MONOCALL 59.95



is Band Formula!



Most Performance per \$

second removal from mobile installation to base installation. Rigid engineering and quality control assures reliability of performance in every Metrostar transceiver shipped.

THE MONOCALL selective call attachment plugs directly into an accessory plug on the Metrostar. No internal connections or wiring changes necessary. As simple as plugging in an octal holder and pushing the button! Numerous code combinations possible, insuring complete privacy for calls. Virtually foolproof two tone-call system eliminates faulty alerting by skip or unwanted local signals. The Monocall added to your Metrostar means quiet CB operation for home or office use. Ends the annoying "pops" and "whines" of congested channel operation. Single switch-ease of operation. With switch up—your transceiver hears only Monocall-directed signals. Switch neutral—your transceiver operates like any normal transceiver. Switch down—your transceiver is activated with a tone-call sequence from the Monocall, alerting other similarly equipped units in your system and turning on their receivers so they can hear your call. Use one of the many possible tone calling combinations on your base station to direct calls to specific mobile or base stations, or one code for all units, alerting more than 1 base or mobile unit.

Whether you turn to Metrostar plus Monocall, or the Metrostar alone, you can rest assured that you are purchasing the finest communications per dollar in Citizens Band radio today. Superb quality—superb workmanship . . . a superb two-way radio!

Encoder Unit



Low-cost flexibility is yours with the Metrotek Encoder. Add it to your mobiles . . . using Monocall Encoder/Decoder at base. Enables mobile units to "call in" at any time . . . with base station radio quiet except when called by one of your units! **29.95**

CB FLEXIBILITY

Use your METROSTAR TRANCEIVERS in conjunction with MONOCALL or ENCODER units to precisely meet your needs.

Metrostar plus: MONOCALL	209.95	Selective Call & Receive, or normal operation
Metrostar plus: ENCODER	179.45	Tone Call Transmit, plus normal receive

ADD MONOCALL TO YOUR EXISTING CB UNITS

Monocall encoder/decoders and encoder units are readily adaptable to all existing transceivers (transistor units excepted). We will supply complete instructions for adding these Superb Privacy units to your transceivers. Instructions packed with all units.

METROTEK ELECTRONICS, INC.

P.O. Box 9591 • Raleigh, North Carolina

Please send me complete details, including name of nearest supplier for Monocall Metrostar My check or M. O. is enclosed. Please send _____ Metrostar Transceivers, _____ Monocall Encoder/Decoders, and _____ Encoder units.

Name _____

Address _____

City & State _____

Dealers reply to Dept. M. Some Franchises open.



MAN OVERBOARD—From Page 29

stressing safety. We know without a doubt that we have saved several lives as well as loss of property through our work. In addition to the above we patrolled two sail boat races. Upon request of an authorized boat race committee, we will patrol races free of charge. Last year we did not have CB Radios, this year our Flotilla has 19 in operation or on order and the prospect of 8 more by summer. On June 21, 22, & 23rd, we were requested by the Central States District Lightning Class Association to patrol their races on Ft. Gibson Lake, Oklahoma. Here is where the CB sets come into their own. Through them we were able to patrol the race in an orderly manner, dispatch boats to places of emergency without congestion, and have a patrol boat at the right place at the right time.



Coast Guard courtesy boat examination is a regular activity, and it allows marine CB'ers to become acquainted with local marine radio policies.

Another Auxiliary activity is the predicted log contest. This is not a speed race, but a contest where over a given course we apply knowledge of our boats speed at a certain RPM or throttle setting in regard to distance covered. Then from our charts we plot our course and predict to the minute and second the time it will take to pass check points as well as for the whole course. This is where you really learn to know your boat and to navigate your boat under adverse weather conditions. This year the race committee will have much better supervision, and can issue last minute instructions and briefings to contestants by CB radio.

On April 1, 1962, Tulsa Flotilla 1607 had a CB net in operation covering

Lake of the Cherokees (GRAND), and Ft. Gibson Lake and the area from Tulsa to the east where our lakes are located. This gives us net coverage over the area between Tulsa and the Lakes for any emergency that may occur either on the lake or on the highway. In this project we have received the full cooperation of the Tulsa Citizens Band League and other individual CB operators, for which we are most thankful.

We of the USCGA do not want to give the impression that CB is a substitute for regular Marine Radio Equipment, but we do feel that it has a very definite place on our inland waters where distances are shorter, where communications are not usually monitored by the regular Coast Guard.

If you are ever in Northeast Oklahoma, SWL on CB, it may be an Auxiliaryist on the lake enjoying his boat with one ear cocked for an emergency.

CB RETIREMENT

By W. A. O'NEILL, 2Q3196

*Retirement is wondrous, so I've heard it said,
But sometimes I wonder when I crawl into bed.*

With my ears in a drawer and my teeth in a cup,

My eyes on the table until I wake up.

*I get up each morning and dust off my wits,
Pick up my paper and read the "obits".
If my name is missing, I know I'm not dead,
So I turn on my C.B. and get back in bed.*

*Then starts the chatter, laughters and yells,
From guys whose 10-20's must be padded cells.*

*With signals distorted and topics inane,
Sometimes I wonder if it's me who's insane.*

There's an XYL who keeps yelling Maxie

*A dispatcher vainly seeking his taxi.
The clowns who delight in sending dead carriers,
Guys testing their rigs—creating more barriers.*

*When school lets out my day's really made,
For that's when I hear the diaper brigade.
The "hash" is terrific each day without fail,
But still I enjoy "reading the mail".*

ONE UNIT for ALL C-B TESTS



SIGNAL OPTIMIZER 7 in 1 C-B TESTER

Be certain you're getting top performance from your C-B units and installation. Make servicing a snap.

7 pieces of test equipment in one handsome, portable, durable case.

1. **WATT METER**—measures direct transmitter power output to 10 watts, measures relative transmitter power output to 1000 watts.
2. **MODULATOR MONITOR**—tests for power robbing garbled modulation.
3. **FIELD STRENGTH METER**—measures radiated antenna power.
4. **TESTS OSCILLATOR**—to generate RF signals through use of 3rd overtone C-B Crystals.
5. **MEASURES SWR**—full power obtained only with correct standing wave ratio.
6. **TESTS HARMONICS**—fundamental frequency and overtones for correct C-B Crystals.
7. **MEASURES BASE STATION OR MOBILE ANTENNA EFFICIENCY**—adjusts directional antenna—secures optimum radiated power transfer.
Only 8½" x 5" x 1½"—2 pounds.

GC ELECTRONICS Co.

DIVISION OF TETRON ELECTRONICS, INC. · 400 SO. WYMAN ST. · ROCKFORD, ILL. · USA

Model No.
65-518

47⁵⁰

SUGGESTED
NET

FREE
CATALOG

- Send me a FREE copy of the latest Globe Catalog containing the most complete C-B product line available anywhere.
- SPECIAL—C-B Book—the whole C-B story—what you can and can't do—installation and testing information, noise control, tuning up gear—even a C-B lingo dictionary. Compiled by experts—regularly selling for 2.00—NOW FOR A LIMITED TIME ONLY 1.00 (Send Cash or Money Order to:)

GC ELECTRONICS CO., Dept. 16
400 S. Wyman St., Rockford, Illinois, USA

NAME _____

ADDRESS _____

CITY _____ STATE _____

Dept. 16

HE-15A—From Page 10

The r.f. metering jack on the front panel of my HE-15A was removed, and the two wires going to the jack were soldered together and taped. This leaves the circuit intact, and gives us a front panel hole in which to mount the toggle switch. It does take away our metering jack, but we seldom used this anyhow. Should you want to keep this metering jack, it is suggested you mount your toggle switch elsewhere on the front panel. The arm of the toggle switch is connected to ground, while the arm of the toggle switch is connected to one side of the crystal socket. A short lead is then connected from the other side of the crystal socket to the fixed plates (stator) side of the variable tuning condenser in the receiver circuit.

Operation

You will find the tuning dial has little or no effect on tuning when the crystal is in the circuit. On the HE-15A, the i.f. frequency (as has been pointed out) is 1750 kilocycles. The i.f. coils should be tuned exactly to frequency to hear the beat signal produced by the crystal. It may be necessary to "peak" your i.f. coil slugs to attain this accuracy.

It has been suggested that several crystals could be used in a rotary switch to instantly select any one of several crystal controlled receive channels. The HE-15A is already a very compact unit, and it is felt there is no additional room to do this on the existing unit. However a small mini-box could be constructed to hold the necessary switch and crystals. In this case the lead from the switch to the condenser must be as short as possible, or you may introduce variables into the circuit which will affect the final frequency your crystal works on. A piece of RG-58/U is recommended for this jumper wire, grounding the shield to the mini-box on one end and the chassis of the HE-15A (or other transceiver) on the other end.

Note that crystals will not always be stock models available from your dealer's shelves. They are available from crystal manufacturers however, such

as Texas Crystals. In some instances "other" stock crystals will be found to fall on the proper frequency necessary for the proper beat carrier generation. One example of this is standard HE-20 receive crystals for channels 14, 17, 19 which when wired into this circuit will allow you to crystal control your HE-15A receiver on channels 6, 9 and 11 respectively. 10-7

BUSINESS BAND—From Page 28

Lastly, the equipment must be installed and tuned by a first or second class radiotelephone or radiotelegraph licensed operator. *You cannot do it yourself.* There are no adjustments which you are allowed to make yourself, except for squelch control and volume control.

Finally, you will not be allowed to communicate with Class D radio stations. This is mentioned because some have undoubtedly noticed that the Business Band shares CB frequency 27.255 (channel 23) with Class D radio.

Readers desiring additional information on this service, including a local source where you can obtain a first hand look at Business Band Equipment are urged to talk *first* with your local CB dealer (if he has a licensed first or second class operator employed, he can probably work out the installation for you), and, *then* write to "Business Band, CB Horizons, P.O. Box 1557, Oklahoma City 1, Oklahoma." 10-7

FEEDBACK—THE ULTIMATE HE-20

Several readers have written to report unsatisfactory results with the noise-limiter circuit (the Makino circuit) shown in our article "The Ultimate HE-20"—while many more have reported excellent results.

Cause of the bad results for some users appears to be a *reversed* diode. The polarity of the crystal diode is extremely important; if it is accidentally installed backward, you'll have just the reverse of limiting. In addition, the S-meter will *dip* instead of *peak* on strong signals.

The cure, naturally, is to remove the crystal diode from the set, turn it end for end, and re-install it.

PART TWO

TROUBLE SHOOTING YOUR TRANSCEIVER

—Jim Kyle, CBH Tech Editor—

In the July CBH, we covered techniques for preventive maintenance of CB transceivers. But most of us tend to forget preventive maintenance—until something goes wrong. And then it's too late; the problem then isn't "How to keep the set going" but is instead "How to make the set go again!"

While preventive maintenance requires nothing more than a dummy load and access to a tube tester (any drugstore or supermarket seems to have one these days!) *corrective* maintenance requires a little more in the way of tools.

Specifically, you almost *must* have a voltmeter of some sort. A volt-ohm-milliammeter of the kind advertised nationally for less than \$10 will do nicely. A better instrument, though, is a vacuum-tube voltmeter (VTVM)—see page 18 of this issue for details on building one for yourself.

You'll also find that a pair of long-nosed pliers will come in handy, as will an insulated probe (like a plastic drink stirrer) for pushing aside hot leads while making tests.

A CB transceiver, like a TV set or a huge electronic computer, is a pretty complex gadget—but, also like these other modern marvels, is complex only because of the large number of parts. Each basic circuit used is fairly simple. This makes troubleshooting relatively easy—once you locate the basic circuit involved!

But because of the number of circuits, this bit of locating the offending one frequently takes on aspects of a full-sized detective story!

Technicians with long experience—like veteran police officers—carry in their minds a mental file of "modus

operandi" which enables them to check quickly over a dead set, match symptoms with their mental file, and come up with seemingly-impossible answers which usually turn out to be right.

But, just as rookie policemen can solve baffling cases by following a simple technique all the way, the novice troubleshooter can find out what's wrong with his dead transceiver by going through a standard check-off list.

That's what charts 1 and 2 here are—your own version of the veteran's mental "M.O." file.

To use them, first pick the one which applies to your problem. Then perform the action specified in the top box of the chart. Depending on the answer you get to the question in the box, go to either the "YES" or "NO" box immediately below. Et cetera, until you find the trouble.

You'll notice the actions "check tube", "measure voltage", and "check components" are called for most often.

Checking a tube is simplicity itself; just go to the nearest place having a tube tester and plug it in—but this "check" is not always conclusive. For one thing, a few unscrupulous people have gotten into the test-your-own-tubes business and so you'll occasionally find such a tester rigged to show *all* tubes bad. Not often, but it happens now and then.

More important, actually, is the fact that *no* tester duplicates circuit conditions. This means that in some critical circuits, a tube can test *good* but fail to work, while in others, the tube can test *bad* but perform admirably.

The best way to check a tube is to substitute a brand-new tube in its

TROUBLESHOOTING CHART FOR TOTALLY DEAD RECEIVER

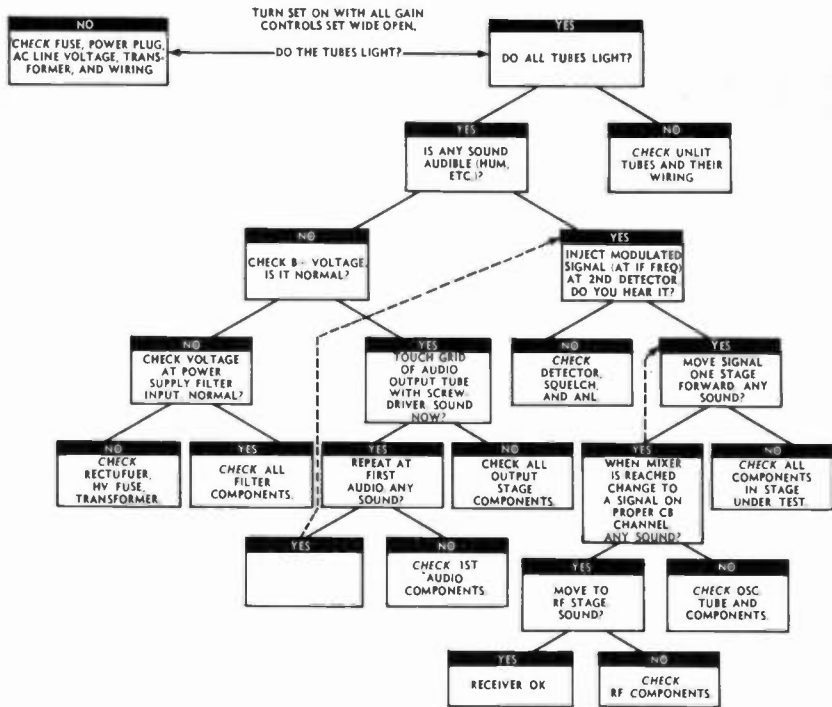

place. The wise operator always keeps at least one spare on hand for every type of tube in his units, and this spare can easily be used for substitution-testing.

When you measure voltage, be careful. We don't want to lose any readers—and the voltage normally found in power supplies *can and will* kill you if you get careless.

Make all connections with the power off if you're using clip-leads on your meter. NEVER touch the high-voltage or even brush against its wires. And *always* be sure someone is with you when you're in this part of troubleshooting, to turn the power off in case you get into the circuit anyway!

Finally, checking components: The "ohmmeter" range of your test meter is used to check both resistors and capacitors. Unsolder *one end* of the component and connect the ohmmeter to it, one lead of the meter to each lead of the component.

A good resistor will measure out at its rated value, or within 10 percent of it. If the measured value is more

than 10 percent different from the value marked, replace the resistor.

A good capacitor of any type except electrolytic will cause the meter to flick *one time* in the direction of low resistance, and will then read "infinite resistance". If you miss the first flick, reverse the leads to the meter. This should produce a larger flick, again with the infinite-resistance reading following.

If you get *any* resistance reading, or cannot get a flick, the capacitor is bad and should be replaced with one of the same type, rating, and value.

Electrolytic capacitors will behave in similar fashion except that they will show a resistance reading even when they're good. So long as this reading is higher than about 30,000 ohms, the capacitor is okay. If it's lower, replace it.

When unsoldering and soldering component connections, be careful not to overheat the components. Many of them will change value *permanently* under too much heat, and some may be completely ruined. If you're not

(Continued—Page 51)

PRE-MATURE ANTENNA

—STAFF—

Lest you think this is to be an article about motherhood and CB, be warned right now it is not.

This is the story of a commercial CB antenna that you cannot buy, although you once could. More than that, this is the story of Leland Reeder, 12W4038 of San Francisco, California.

The 'premature' antenna was just that. Ahead of its time, too early to be recognized for what it was . . . and by admission of the manufacturer, "it had a few design bugs."

On equal interest, perhaps, is the way that this article came about. The March 1962 issue of CB Horizons included a report on a recent (at that time) CB equipment survey. CB Horizons had asked readers what type of transceivers and antennas they were using. From the tabulation came the fact that nearly 100 of our readers were using a "Winegard" CB antenna. Showing our ignorance we noted "this is the first time we knew that Winegard sold a CB antenna." Oh-what a mistake that was! More than 50 letters came in atesting to the fact that Winegard had indeed constructed and sold an antenna for CB.

Typical of the letters arriving and taking us to task was a note from *The Sound Shop*, Grand Rapids, Michigan.

"Come on, Bob boy, you must be slipping in your old age!!! In the March issue you point out that Winegard never made a CB antenna, as far as you know. Fact is Winegard did make a CB antenna and we have sold over 50 of them in this area. They are (we feel) by far the hottest antenna going!"

Well now . . . such praise for a discontinued antenna line must have

some basis in fact. So we picked another letter from the stack and wrote to the owner of the Winegard mystery antenna. 12W4038 replied with the material which makes up this article.

But before we begin, we should note that we also called John Winegard, President of the Winegard Company, Burlington, Iowa (Winegard is a leading manufacturer of television antennas and signal boosters) and got ourselves straightened out!

John told us "we manufactured the MB-27 Colinear antenna in a limited quantity in 1960, although the model has been discontinued. It sold very well, but it also had some problems."

As you will see, the MB-27 sold in three models. The MB-27 (O) was constructed for omni-directional work. The MB-27 (B) was constructed for bi-directional work. And, the MB-27 (U) was constructed for uni-directional operation. The basic antenna (see diagram 1) remained un-changed. But, the antenna was available with anyone of three patterns (see diagram 2) by selecting the proper Winegard phasing matching box.

This made for a very versatile arrangement. If you lived in the center of town, you would probably want the omni-directional pattern (transmitting in all directions) for 360 degree coverage. If you lived way out of town and your mobile to base operation was in a single direction, the uni-directional pattern available in model MB-27 (U) would net you up to 8 db gain, in the desired direction.

Just in case you had even stranger requirements (ie. you lived in the center of a long narrow town, or were

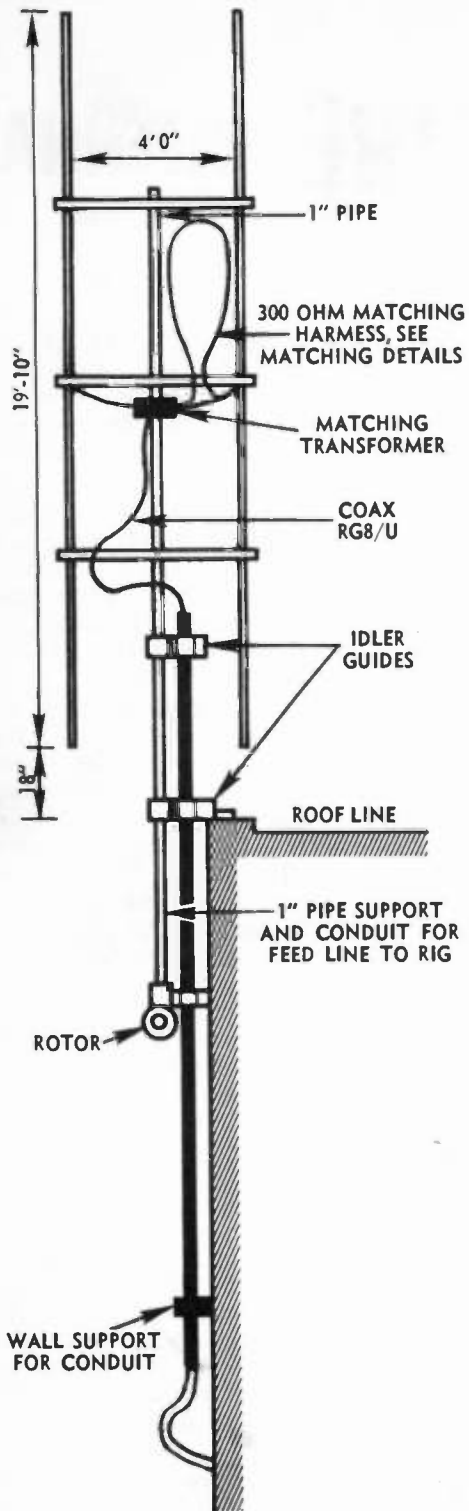
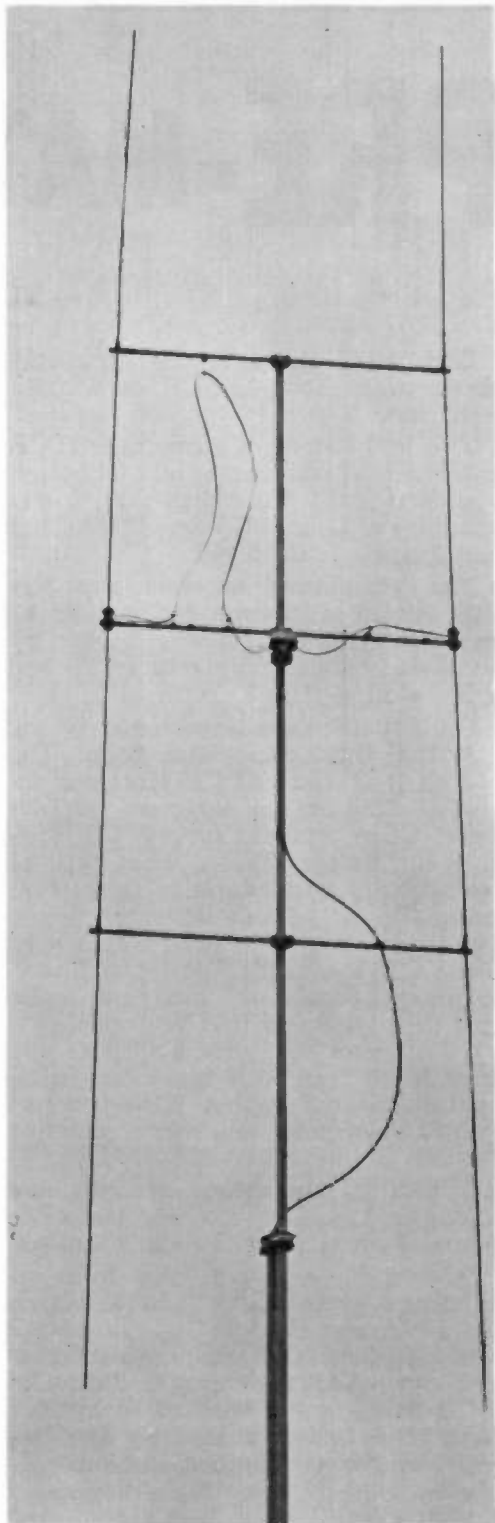

Diagram 1



12W4038's Winegard Array

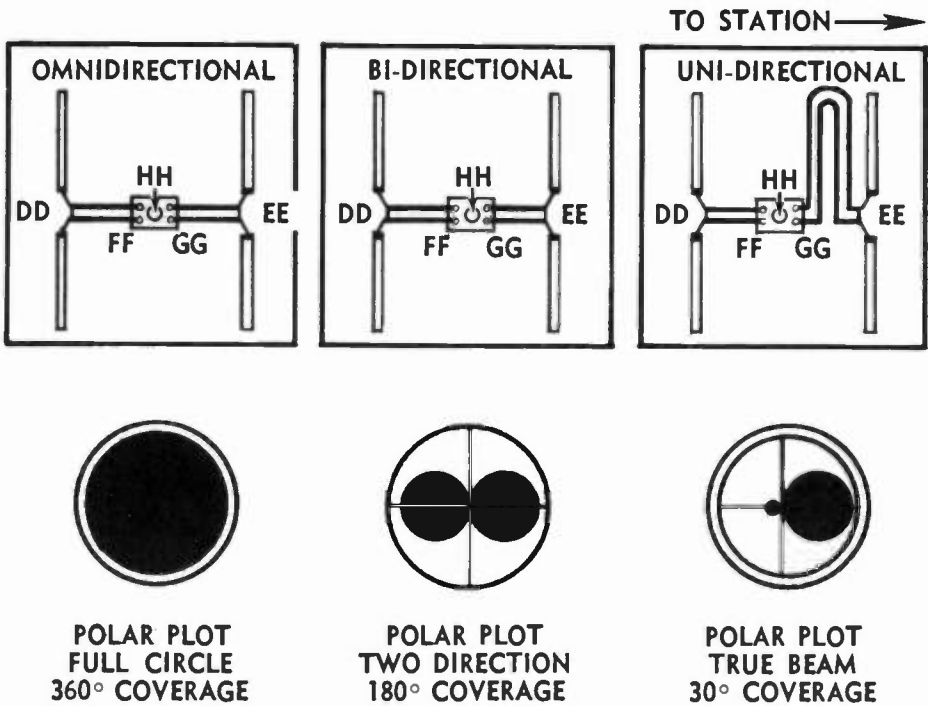

Figure 2

between two towns in opposite directions) the bi-directional (two direction) model of the MB-27 would suit your needs, with up to 6 db gain over a ground plane.

12W4038 was first licensed as 12W1906 in the summer of 1959. At the time Leland Reeder was located high up on the eastern slope of Twin Peaks, a San Francisco landmark famous for its line-of-sight radio transmission to a number of Bay Area towns within a 40 mile radius. 12W1906 utilized a

standard ground plane with dropping radials at this location.

In the summer of 1960 12W1906 became 12W4038 when Leland moved "west" to the other side of the Twin Peaks (see diagram 3). The new location was 200 feet below the summit of the peaks, and the peaks acted as a shadow for almost all of his communications into the main part of South San Francisco proper.

(Continued—Page 41)

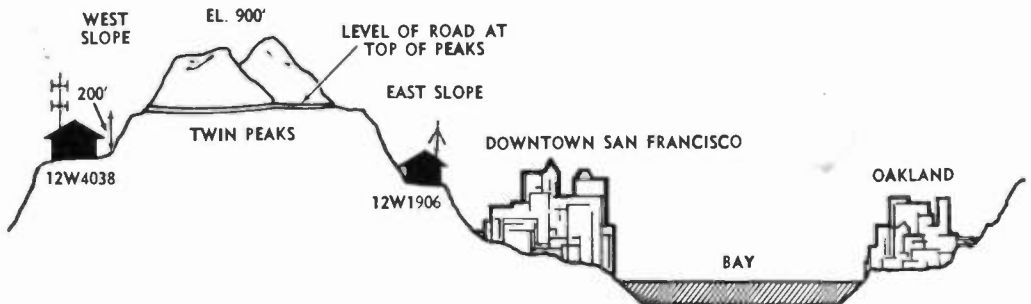

Figure 3

CB AUDIO—From Page 9

50 watts with a Brand Z Gadget". This is the one and only way of legally boosting your effective power on CB.

A compression amplifier, on the other hand, works more like the AVC circuit in your receiver. It is an amplifier with variable gain, whose gain at any instant is determined by the strength of the signal applied to it. A weak signal gets lots of boost, while a strong signal gets little amplification. If the amplifier reacts rapidly enough—and most do — this can also level out the voice peaks, without cutting off any of the voice components themselves. Such amplifiers are widely used by broadcast studios to compensate for variations in mike-performer distances.

Both the clipper and the compression amplifier have certain unique features; some ham operators have gone so far as to include both in their rigs to get all the features of both. However, this drastic step really isn't necessary.

Since the clipper cuts the top of the peak off sharply, its output must be

filtered to keep from "splattering" over adjacent channels (such splatter is frowned upon by the FCC, as well as being most upsetting to other operators). However, when you use a properly adjusted clipper it's not possible to overmodulate your rig, no matter how loud you shout.

A compression amplifier doesn't cut off peaks so sharply, so does not need filtering of its output. The disadvantage of this gadget is two-fold: since it does not make provision for positive clipping, it's possible (though difficult) to over-modulate with a compression amp; also, since the compression amp takes a definite interval to act, even though the time is extremely short, weak peaks following a strong sound won't get full amplification.

Certain designs of compression amplifiers overcome both these disadvantages by making the unit act like a very fast compression amplifier for normal speech, and like a clipper for extremely loud sounds. However, these designs are a bit complex for the average CBer to build at home.

The recommended speech-shaping setup, then, for a do-it-yourself circuit is a clipper combined with proper filters.

When using a clipper, incidentally, the routine band-pass filter doesn't work so well. The reason is this: For proper transmitter action, the audio stages following the clipper must have good low-frequency response. This means that a band-pass filter would have to be placed *ahead* of the clipper. However, as mentioned before, the clipper's output must be filtered to avoid splatter—and this dictates a filter position *after* the clipper.

The remedy, though, is simple. Instead of a commercial band-pass filter (which costs upward of \$20), use built-in do-it-yourself filter circuits. Cut out the bass ahead of the clipper, and the high end after the clipping action.

When adjusting the clipper after you build it, you'll note *two* volume settings instead of one. One of these sets the clipper *output level*; this one is set one time, and need never be touched again. If it is set properly, the rig cannot be overmodulated.

For Maximum Range . . . it's the New MAC-67

"GUT-R MOUNT"

NOW! A Completely Retractable CB Antenna Mount designed for Optimum Gain and Coverage. Mounts at car roof level . . . with No Holes in Car Top!



Attach the GUT-R MOUNT quickly and easily to your car's rain gutter. Any standard $\frac{3}{8}$ -24 thread whip mounts in just seconds! (Requires no drilling in car top!)

RETRACTABLE—at a touch of your hand. LOCKS positively in position—even at high speeds. RUGGED steel and aluminum construction. YEARS of superior service! **ORDER TODAY!**

Postpaid **\$995**

McCULLOUGH-AERO CORP.



5615 Centinella Blvd.
Culver City, Calif.
Ph. EX 8-6293

DEALER INQUIRIES INVITED

The other adjustment sets the amount of clipping. With this one turned all the way down, no audio at all gets through. With it cracked just barely open, transmitter action will be normal (no clipping). As the setting is advanced, the speech will be clipped deeper and deeper, until with the control wide open, it sounds as if you're lost in a huge rain-barrel. This pair of adjustments is common to all clippers, though the names of the adjustments may differ slightly from unit to unit.

Next month, we'll tell you in minute detail just how to build a clipper you can add to your base station; if you're impatient and can't wait, you can find details on various clipper circuits in any of the ham radio handbooks—or you can buy such an instrument from either the Smea Pow-R-Mike people or from the Elenco Power Gainer firm.

PRE-MATURE ANTENNA—From 39

So Leland set out to improve his antenna system, hoping to make up for the signal loss created by the close proximity hills.

Several types of antennas were tried, including mono-pole ground planes, coaxial antennas, beam antennas, end fed "zepps", long wires . . . you name it, Leland tried it!

Next stop was a Ground Plane antenna with top-hat. Leland reports "this was by far the best of the antennas having a ground plane configuration. A gain of about 50% was reported at the spots noted with an "X" on diagram 4 but I was disappointed with signal reports from the Oakland-East Bay region."

Leland had just about given up (and was wishing he had never moved to the west side of the peak) when some of his CB friends suggested he try a homebrew design popular in amateur circles, the "ZL Special." This is a multi-wire antenna roughly comparable to a beam constructed from wire. It has directional characteristics and is similar to a 2 element beam in performance.

The "ZL Special" worked so much better that Leland was hooked! How-

NOTHING, BUT NOTHING, makes these subjects easier to understand than "TEACHING PICTURES" electricity • electronics • gyros TV • radio communications

BASIC ELECTRICITY (5 Vol. Course) by Van Valkenburgh, Nooger & Neville, Inc. ". . . so excellently arranged and so amply illustrated that even the rank beginner can rapidly grasp the full import of any topic under discussion . . ."—POPULAR ELECTRONICS. This is the civilian version of the illustrated course on electricity prepared by the authors for the Common-Core Program of the U. S. Navy and used by them to turn out trained technicians in record time. More than 900 carefully selected illustrations supported by crystal-clear text make electricity completely understandable. #169, 5 vols., soft covers, \$11.25; #169-H all 5 vols. in single cloth bindings, \$12.75.

BASIC ELECTRONICS (5-Volume Standard Course) by Van Valkenburgh, Nooger & Neville, Inc. ". . . a better and quicker way to teach and learn . . ."—FT. GORDON RAMBLER. Available as heretofore, the 5-volume civilian version of the illustrated U. S. Navy course prepared by the authors, covers vacuum tube diodes and power supplies, amplifiers, oscillators, transmitters and receivers. #170, set of vols. I to V in soft covers, \$11.25; #170-H all 5 vols., in single cloth binding, \$12.75.

BASIC ELECTRONIC VOL. VI ONLY, by Van Valkenburgh, Nooger & Neville, Inc. ". . . the section on transistors alone is worth the price of admission . . ."—POPULAR ELECTRONICS. For the many tens of thousands who have completed the 5-volume standard course, the 6th volume on semiconductors, transistors and FM can be bought separately. #170-6, soft, \$2.90; #170-6H, cloth, \$3.95.

BASIC ELECTRONICS (Expanded Course) by Van Valkenburgh, Nooger & Neville, Inc. Consists of 6 volumes including the above 5-volume Standard Course, plus a 6th volume which expands into the areas of semiconductors, transistors and frequency modulation. #170-X, set of vols. I to VI in soft covers, \$13.85; #170-XH, 6 vols. in cloth, \$14.85.

BASIC TELEVISION by Alexander Schure, Ph. D. ". . . the most understandable presentation of the basic theory, operation and circuitry of black and white television ever published . . ."—ELECTRONICS & COMMUNICATIONS. #198, 5 vols., soft covers, \$11.25; #198-H, 5 vols. cloth, \$12.75.

BASIC RADIO by M. Tepper. "Leads the reader step-by-step in plain, every day language to an understanding of radio circuits . . ."—DESIGN NEWS. This 6-volume "pictured-text" course is the best that exists on radio communications. No previous knowledge of electricity is required—the course teaches it. It covers everything from fundamentals of electricity to transmitters at the technical institute level. #197, 6 vols., soft covers, \$13.85; #197-H, 6 vols., cloth, \$14.85.

BASICS OF GYROSCOPES by Carl Machover. "dramatic and forceful, yet extremely lucid approach . . . very useful."—INDIAN & EASTERN ENGINEER.

A wealth of information about the entire field of gyroscopes—so up-to-date much of the material in it has only recently been classified #257, 2 vols., soft cover, \$6.60; #257-H, 2 vols. in one cloth binding—\$7.75.

At electronic distributors, or use convenient coupon.

10-DAY MONEY-BACK GUARANTEE

JOHN F. RIDER PUBLISHER, INC.
a division of the Hayden Publishing Co. Inc. CB-9
116 West 14th Street, New York 11, N. Y.

Enclosed is \$ _____

Please send me postpaid:

- | | | |
|---|--|---|
| <input type="checkbox"/> #169, \$11.25 | <input type="checkbox"/> #170-6, \$2.90 | <input type="checkbox"/> #197, \$13.85 |
| <input type="checkbox"/> #169H, \$12.75 | <input type="checkbox"/> #170-6H, \$3.95 | <input type="checkbox"/> #197H, \$14.85 |
| <input type="checkbox"/> #170, \$11.25 | <input type="checkbox"/> #170X, \$13.85 | <input type="checkbox"/> #257, \$6.60 |
| <input type="checkbox"/> #170H, \$12.75 | <input type="checkbox"/> #170XH, \$14.85 | <input type="checkbox"/> #257H, \$7.75 |
| | | <input type="checkbox"/> #198, \$11.25 |
| | | <input type="checkbox"/> #198H, \$12.75 |

NAME _____

ADDRESS _____

CITY _____ ZONE _____ STATE _____

ever the antenna was a bit unwieldy to mount ("my roof looked like a maze of apartment house clothes lines") and as Leland notes "it has many problems in phasing and matching which I did not feel qualified to really master."

So now Leland had a real problem. He had an antenna that worked . . . but it was more than he could handle.

along the line of his own. So he purchased a Multi-Beam and installed it as is shown in the accompanying photos.

The success of Leland Reeder's Multi-Beam is really the short part of this story. In use nearly 2 years now, the antenna has provided 12W4038 with the constant coverage com-

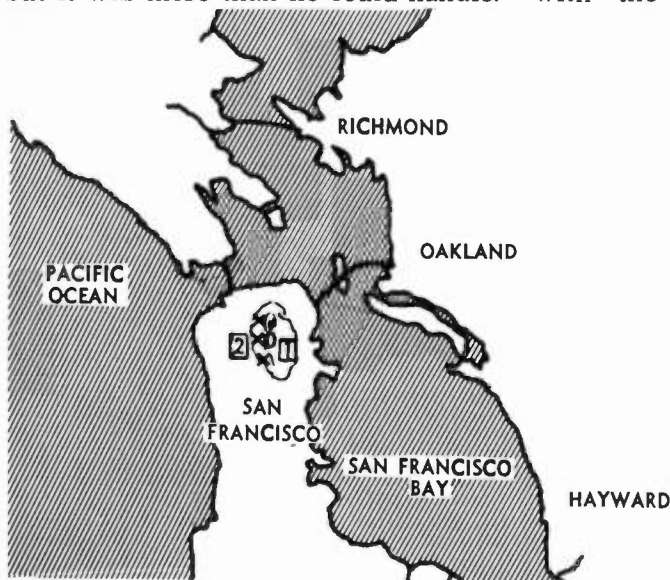

- x CHECK POINTS
- 1 LOCATION 12W1906
- 2 LOCATION 12W4038

MAP OF SAN FRANCISCO AREA

It was at this time that the Winegard Company made its first announcement of the "Multi-Beam" antenna. Leland felt that Winegard's thinking was right

communications he was searching for. And, as should be obvious from his long series of trial by error and tribulations, every generally used Citizens Band antenna system was put through its paces at 12W4038, and all failed — in varying degrees.

THE QUESTION

Why would an antenna that did such a good job in seemingly an impossible location, be removed from the CB'ers grasp?

That's what CB Horizons wanted to know when it called John Winegard, President of the mushrooming Burlington, Iowa antenna manufacturing concern. John blamed the disappearance of the antenna on "engineering problems with the phasing networks." As diagram 2 shows, a series of 3 phasing boxes was used to affect one of three basic patterns with the Multi-Beam antenna. John told CBH that varying weather and humidity patterns was affecting the way in which the phasing boxes affected the patterns. On this basis, according to John Winegard, the antenna was discontinued.

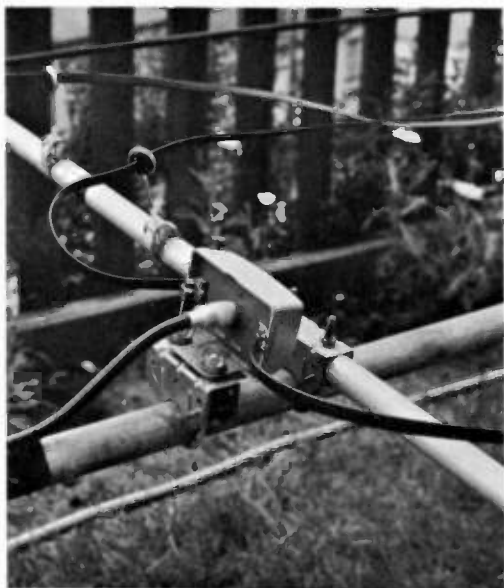

Multi-Beam Phasing Box

Will there ever be another "multi-beam" antenna? Believe it or not, the answer to this question will depend to a great part on the needs of *you*, the CB'er. For the success, failure or even future of the "multi-beam" or *any other* commercial CB product depends very much on the need for such a product, and the demand for that product.



12W4038—A customized Heath transceiver and Sx-71 receiver.

The CB'ers of America can and do dictate the products we eventually put to use in the Class D radio service. And one of the best ways of demonstrating that need is an article in CB Horizons.

Have you written CBH with details of your "unusual approach" or "unusual needs" lately? Leland Reeder, 12W4038 did.

10-7

MORE ABOUT POWER—From Page 16

ly went to the antenna relay, and connected the booster input terminal directly to the 6AU8 plate.

He reports 3.7 watts of RF with the GW-10 and 6.4 watts out with the 770 (into a dummy load, of course).

Schematics of the changes he made are somewhere hereabouts—if you've been having problems with the booster, this might be of help to you.

However, remember that you cannot make any adjustments to the oscillator stage of your rig—or any adjustments at all with the rig tied to an antenna—unless you hold a second-class commercial license. Don't get into trouble with the FCC!

— jk —

BARTLETT NOISE FILTERS

The ULTIMATE in motor noise suppression. For generator, regulator, ignition coil. Eliminates noise at the source. No shielding necessary. Pre-tuned. Sealed against moisture, oil, dust. Complete instruction and installation sheet. Field tested and proven outstanding.



The combination of Bartlett Noise Filters and Beldon IRS Ignition Cable is the ultimate in motor noise suppression. (Self generated.)

Reg. Std. Filter (R/S)	
30 A.	\$ 2.85
Reg. Heavy Duty Filter (R/HD) 50 A.	\$ 3.25
Voltage Reg. Ign. Coil Filter (VR/C)	\$ 2.25
Kit R/S (Contains 2 R/S and 2 VR/C)	\$ 9.95
Kit R/HD (Contains 2 R/HD and 2 VR/C)	\$10.45

Add 15c for mailing. In Calif. add 4% tax.

Beldon IRS Ignition Cable Kits (standard)—Established Prices. Beldon IRS make-up kit for other than standard, send make, year, motor size, and/or model. Prices on request.

If not available at your dealer, write to:

BEN N. BARTLETT CO.

1815 W. 85th St., Los Angeles 47, Calif.

DEALER AND DISTRIBUTOR INQUIRIES ARE INVITED.

WORLD FAMOUS PEARCE-SIMPSON QUALITY

THE
COMPANION

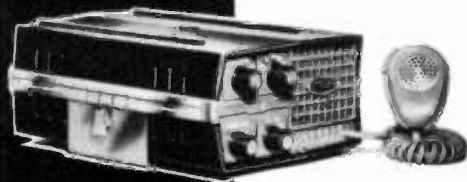

\$189.50

DEALER INQUIRIES
INVITED

- Unique front panel transmitter crystal socket in addition to regular channels
- Pre-set automatic noise limiter

- Superior squelch circuit
- Two antenna connectors to match any standard antenna
- Pre-tuned and crystal controlled for simple operation

PEARCE-SIMPSON



SUPERIOR PRODUCTS

1385 N. W. 27th AVE.
MIAMI 35, FLORIDA

See your authorized **COM-PANION** dealer or write to **PEARCE-SIMPSON** for Full Color Brochure with complete information.

CB in SOUTH AMERICA



by
Pedro Seidemann
YY5-PS279
Corocos, Venezuela

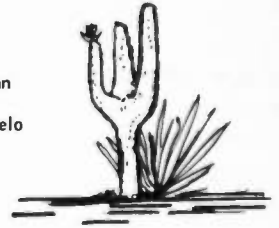

Last month, in my introductory column, I discussed the general use of Comunicaciones Personales (CB, as it is called in South America) here in Caracas. Caracas is the largest center of CB activity currently, in South America. Other large centers are San Jose, Costa Rica and Buenos Aires, Argentina.

Having read of the great 3 month delay U.S. Citizens Banders must go through while awaiting their authorization to operate, I thought I would tell you how we obtain our licenses. For a country that is branded with the typical "manana" attitude of South America, our process is amazingly simple and fast.

In our country it almost always takes a long time to file any type of document for any type of permit, radio or otherwise. Not so with CB. We simply fill out a short form, similar to the U.S. 505, and take it together with the dollar equivalent of \$.11 (11 cents!) to the Ministry of Communications. The \$.11 is used to purchase an official "stamp" and is not necessarily to be confused with an application fee. Licenses are granted to Venezuelan Citizens, although the Ministry will occasionally grant a license to a non-citizen.

Caracas is a city that has grown too fast. In 20 years our population has exploded from under 300,000 to over 1,300,000. The city is bounded on all sides by mountains, and sits in a sort of natural bowl. The residential sections are now creeping into the mountains, which means that telephone lines and communications must follow back into the mountains. It is not un-like Los Angeles in this regard. Unfortunately,

telephone service has not kept up with the exploding home building. Nor has the service of the Department of Public Works.

These are two excellent reasons that the average "compadre in the street" is so enthusiastic about Comunicaciones Personales here. If you don't have telephone service to your new home, 27 megacycle radio serves the same function, at least to your office or to your car.



YY5PS279 at Lond Slide

And if you get caught on a street where a landslide has just occurred, and the Department of Public Works is not there to clear the way for you (or in fact, probably have not even been notified yet!), 27 megacycle radio comes to the rescue again. As the photo shows, your Editor has been on the scene on occasion just after a landslide has blocked a road off (they usually occur after a heavy rainfall). In this case we called for help (we were stranded by a twin fall both ahead of us and behind us!) and in turn alerted the Department of Public Works to "get on the job".

10-7



NEW CB PRODUCTS OF THE MONTH

Allied Radio Corporation, 100 N. Western Avenue, Chicago 80, Illinois, is announcing four additions to the CB line in their brand new 1963 catalogue (see page 5 to order catalogue). Perhaps the most intriguing of the four new CB units is Allied's C-100 hand held transceiver. This 3 transistor kit-set features a crystal controlled super-regenerative receiver, 4 uV receiver sensitivity, 100 milliwatt transmitter input and 50 milliwatts of audio output. The unit comes complete with 2 inch speaker, 45 inch whip, minus only the battery, for a very low \$9.95. At this price everyone should have a pair for emergency communications.



C-100 Hand Held

Allied's Knightkit Division is also announcing a new deluxe transceiver, model KN-2500. The set features a superheterodyne receiver with either 6 crystal controlled positions, or a 23 channel tunable control. It includes a built-in squelch, automatic noise limiter and full AVC. The channel tuning dial is illuminated. 6 transmit channels are available. Other features of the transmitter include a hand held ceramic type microphone, PI-network antenna loading, and built in relative power output meter which

doubles to measure receive signal strength in "S" units. The unit comes ready to operate (factory wired) on 117 vac for \$99.95. 6 or 12 vdc power supplies are available at \$11.95 each.

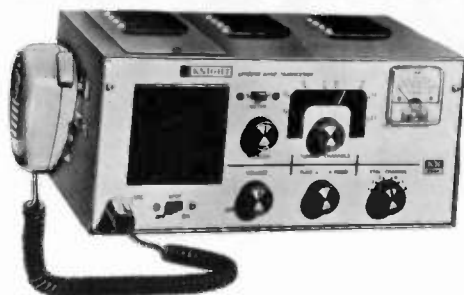

KN-2500 Deluxe Unit

Allied's foursome is rounded out by a 1 watt hand held transceiver (model KG-4000) with 9 transistors and 3 diodes, and Model C-22 5 channel base station or mobile transceiver kit. Model KG-4000 features a range switch for local or distant (up to 5 miles over favorable terrain) contacts, and 50 hours of operation with 8 common "C" cells. Price of the kit is \$60.00. Model C-22 supercedes Model C-27 in Allied's CB transceiver line. It features crystal control on 5 transmit and receive channels, plus a tunable receiver for all 23 channels. ANL and squelch are included. The 12vdc, 117 VAC model will sell for \$69.95.

AMECO, 178 Herricks Road, Mineola, Long Island, New York (they make the Nuvistor CB pre-amplifier) has a pair of new instruments designed to help you keep track of stray signal which may be affecting the efficiency of your CB system. Model SWB standing wave bridge is designed to be inserted in your antenna's coaxial line and left in the line, monitoring the efficiency



of your transmission line. Model BIU Bridge Indicator Unit is used in conjunction with Model SWB to give you a choice of reading (a) forward power from the transceiver to the antenna; (b) reflected power from the antenna back to the transceiver; and (c) relative power output. Price of Model SWB is \$9.95 net. Model BIU is \$15.95. Both units are wired and tested.

Browning Laboratories, Laconia, New Hampshire, has a fine looking new economy version base station transmitter patterned after their well known S-NINE series.

Trade-named the "Compact," this new transmitter features the same tube line-up as the

S-NINE and 23/S-NINE units, and the following features: "Highly efficient PI-network, self-contained audio circuitry, crystal controlled transmitting on 10 channels (plus a crystal socket on the front panel, for 11 channels in all), On-the-Air indicator, and push-to-talk ceramic microphone." The Browning Compact is available, with the R-2700-A receiver (see August Directory issue of CBH) at a combination price of \$230.00. Write Browning for additional information.

Globe Electronics, 400 South Wymon, Rockford, Illinois has an "all new" CB tester. Dubbed the "Globe Signal Optimizer and Universol CB Tester," the new unit will do just about everything except turn hond-springs for you! The seven-in-one unit checks and measures all of the following: antenno power in wotts, modulation, field strength, antenno output, harmonics, standing wave ratio, bose stotion and mobile antenna efficiency. The unit is in an easy to carry cose with outside dimensions of 8½ inches by 5 inches by 1⅞ inches. Price is \$47.50. For full information on this new Globe instrument, write GC Electronics in care of department G-7.

CB LITERATURE YOU NEED TO KNOW ABOUT

Gardiner S. Greene, Sr., President of Browning Laboratories, Loconio, N. H. has announced that his company is now making available, free of any charge, standord stock forms on which Citizens Band Radio Clubs may print their club news.

These newsletter forms ore made available by Browning to give added impetus to the growing nationwide chain of CB clubs and organizations. You can hove free club bulletin printing forms for your group by simply dropping a note to Browning.

A new crystal catalog is in the mails from the folks at **Texas Crystals**, 1000 Crystol Drive, Fort Myers, Florida. The new catalog, number 962, covers all CB crystals as well os crystals for a number of other radio services. Circuit diagrams depicting proper crystal circuits are included in the catalog. Your copy is free for the asking. Just write to **Texas Crystals**.

The annual oll-inclusive catalogs from **Allied Rodio** and **Lofayette Rodio** are both now available. In case you missed the Allied announcement on page 5, or the Lofoyette announcement on page 58, it is suggested that you turn to the respective pages and clip out the coupon now-ordering your catalog. Both are free, and invaluable reference and ordering manuals.

New-Tronics Corporation, 3455 Vega Avenue, Cleveland 13, Ohio, also has a new catalog for you. This one covers the Newtronics CB antenno line, with the usual orray of antenno for other services as well. Complete physical mounting details as well as electrical specifications ore given for each antenna. Write for your copy today. Mention CB Horizons noturully.

RAYTHEON ESTABLISHING NATIONWIDE SERVICE

A nation-wide network of outhorized Citizens Band Radio service stotions has been created by the Raytheon Company. The new system, comprising approximately 250 service shops, are all monned by FCC licensed personnel able to repair or install virtually any CB tranceiver.



CITIZENS BAND SERVICE NETWORK of more than 250 service stations, all manned by F.C.C.-licensed technicians, has been created by Raytheon Company to back up sales of its Ray-Tel citizens band radio. Stations are being signed at the rate of 20 each month. Left to right, Fred B. Simmons, Raytheon's New England district manager, awards the CB Certified Service certificate to Gilbert P. Clark of Gilbert P. Clark Co., Newton, Mass.

New appointments are being mode to the notionwide system at a rote of approximately 20 per month. Roytheon provides a correspondence course to prospective two-way shop personnel on a continuing program, looking towards the day when the man will join the Roytheon service network. Interested service shop owners may contact Fred H. Keswick, Deoler Products Manager, in core of Roytheon's Public Relations Department, Lexington 73, Mossachusetts. Tell them you read about this wonderful oppottunity in CB Horizons.

The CBH Lab Reports . . .

WE TEST

- ★ Hallmark 2-12 Transceiver
- ★ Speakeasy Audio System

The *Hallmark Division* of the *Texas Research and Electronic Corporation*, 6612 Denton Drive, Dallas, Texas recently forwarded a model 2-12 12 channel Class D tranceiver for Horizons' evaluation. We have found the unit to be sensitive, selective and rugged in operation.

Basically, the 2-12 consists of a crystal controlled superheterodyne receiver, and 5 watt plate modulated transmitter, with associated power supplies in a single cabinet housed in a 12 inch by 7 inch by 5½ inch housing. Either 117 vac or 12 vdc operation is possible.

(Continued—Page 52)

HERE WE GO AGAIN!

CB Horizons Gigantic Giveaway is back again!

PRIZES PRIZES PRIZES

Courtesy of CBH and the CB Manufacturers of America!

NO MONEY! NO BOXTOPS! NO RIDDLES! JUST PRIZES!

Simply fill out the Gigantic Giveaway card on page 49 (look to the right men!) and drop it into the nearest postal receptacle before midnight September 10. On September 15 a handful of cards will be drawn from our Gigantic Prize Barrel and the winning CB'ers will receive wonderful free equipment from CBH and the many fine manufacturers who have donated prizes!

FIRST PRIZE—The 12 channel crystal controlled **Hallmark 2-12** transceiver from the Hallmark Division of Texas Research & Electronics Corporation, 6612 Denton Drive, Dallas 35, Texas. Here is a 12 channel beauty you would be proud to own. A handsome S meter, functional 12 vdc and 117 vac operation, and 12 channels to operate on! Receiver sensitivity 0.3 μ V and 30 db of adjacent channel rejection. Yours free (User net \$149.50) if your card is first out of the barrel in September!

SECOND PRIZE—The famous **SPEAKEASY** Audio Compressor from Communications, Inc., 33 Danbury Road, Wilton, Connecticut. Here's the audio compressor unit you've been hearing so much about. Modulation control, accurate modulation meter and "in-out" switch. Complete with handsome meter. Yours free (User net \$34.75) if your card is the second one from the barrel in September!

THIRD PRIZE—The time-tested **NOISTOP** from Business Radio Company, P.O. Box 5652, Minneapolis 17, Minnesota. This is the unit which quiets down your mobile transceiver as if you were operating from the middle of the desert with the motor off! Adapts to your transceiver in 20-25 minutes, gives you unbelievable control over noise from not only your car but all of the cars and noise sources around you! Yours free (User net \$16.95) if your card is the third one from the barrel in September!

FOURTH PRIZE—The popular M-74 cowl-deck mounting base loaded mobile antenna from The **Antenna Specialists Company**, 12435 Euclid Avenue, Cleveland 6, Ohio. This is the 44 inch long tapered steel whip, with completely encapsulated base loading coil that is the talk of 11 meters. Solderless connections and durable construction for a lifetime of mobile communications! Yours free (User net \$19.32) if your card is the fourth card out of the barrel in September!

FIFTH PRIZE—**YOUR CHOICE**—from Horizons Publications, P.O. Box 1557, Oklahoma City 1, Oklahoma! A copy of the brand new CB Mobile Handbook (see page 13), any Call-Book issued to date, or a subscription to CB Horizons for yourself or a friend.

\$225.00 IN PRIZES THIS MONTH!

Fill out the card to your right

RIGHT NOW!

TROUBLESHOOTING TRANSCEIVER

—From Page 36

already skilled in soldering, practice with some plain wire for a half hour or so before tearing into your set.

You will also notice that the "cure" listed in several instances in the charts is "call a licensed technician." It's sad but true that a few things can happen in a set which require an FCC license to repair; in addition, certain parts of the unit are off-limits to unlicensed personnel!

You will, as well, find that the charts are limited only to sets which don't work at all. If the set is partially working, but not as well as you want, you'll be in better shape to take it to the shop. This is because total failure of the unit is usually due to failure of one small part, which you can find and fix without too much difficulty. However, general deterioration of performance is more likely due to a number of causes all working at once—and this is the kind of trouble that gives even an experienced serviceman gray hairs!

TRANSMITTER TROUBLE SHOOTING

TURN ON. CONNECT TO DUMMY LOAD WITH INDICATOR. DO ALL TUBES LIGHT?

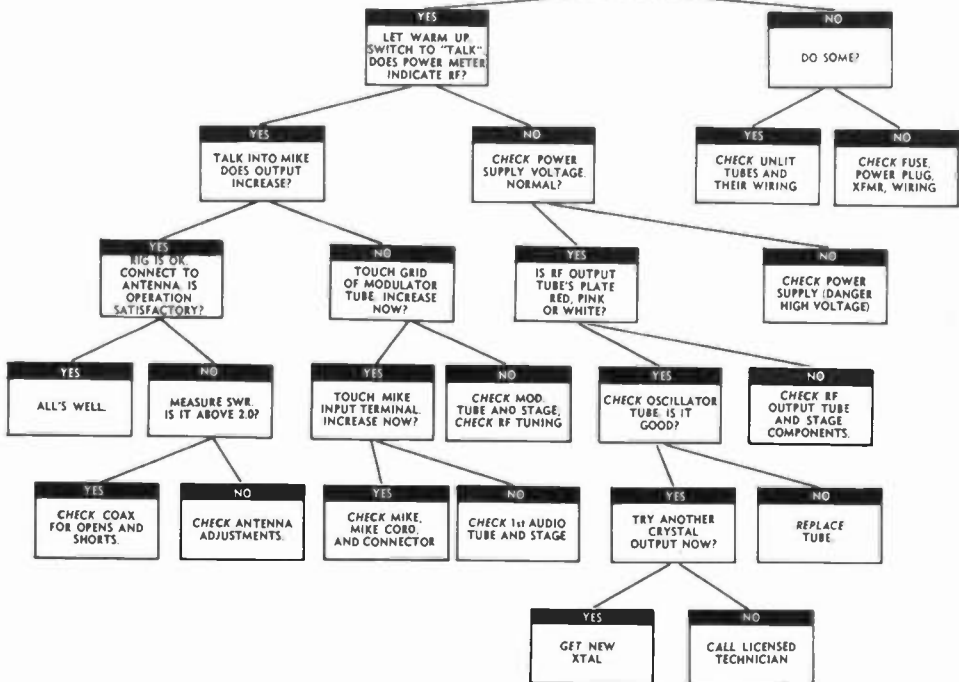

TRANSMITTER BOOST! RECEIVER BOOST!

The ELENCO POWER GAINER Audio Compression Amplifier provides more Talk Power for your CB Transmitter. It also gives you 20 db Audio Gain in the Receiver! Performs as a Volume Compression Amplifier for the CB Receiver . . . ALL IN ONE UNIT! Only 3 connections to rjg; pre-wired quick disconnect plug and socket supplied.

PG-1 for 110 Volt Operation
PG-12 for 12 Volt Operation All Models \$45.00
PG-6 for 6 Volt Operation ONLY

Order Direct from Factory or See Your Local CB Dealer.

ELECTRONIC ENGINEERING CO. - WABASH, IND.



- ★ Simple to Connect
- ★ Instruction Book Included
- ★ For Mobile or Base

Direct Dial
219-563-4536

LAB REPORTS—From Page 47

Two separate power cords are supplied, one for each voltage source.

Hallmark has engineered transmitter stability by utilizing a buffer-amplifier stage between the 12AT7 crystal oscillator and the 6AQ5 final amplifier in the transmitter.

The Hallmark receiver, although single conversion, shows excellent receiver selectivity and freedom from adjacent channel interference. The receiver front end is $\frac{1}{2}$ half (triode connected) of a 6U8A. The amplified signal then works through the pentode section of the 6U8A which operates as a pentode mixer.

Standard Horizons' lab checks were run on the transmitter. We found the channel 11 crystal supplied with the unit to be less than 60 cycles off frequency, well within tolerance specified by Part 19. We liked the hidden although accessible idea incorporated by Hallmark for their crystal sockets. The left hand grill, shown to the left of the S-meter in the photo, is easily removed by popping out four screws. Behind this grill you have access to the crystals.

Transmitter output on a Bird wattmeter, freshly calibrated, was 3.1 watts into a dummy load. The transmitter power supply showed 175 volts at 26 mils, or just 4.6 watts input. Modulation is full and clean.

Price of the 2-12, with one set of crystals supplied, is \$149.50.

SPEAKEASY

Among accessories for transceivers,

Get
Your

First Class Commercial
F.C.C. LICENSE

The key to better jobs and higher pay in electronics is a 1st class commercial (not amateur) F.C.C. license—Federal Gov't evidence of your qualifications as an operator-technician. We train you quickly—by mail or in resident classes. Get your 1st class F.C.C. license in 12 weeks—NO previous training necessary. Our schools are located in Hollywood, Washington, and Seattle. Write to either one of the addresses shown below for our FREE booklet, *Careers in Electronics*, which gives complete details of our training.

GRANTHAM SCHOOL OF ELECTRONICS, 20-P
1505 N. Western Ave. OR 821—19th Street, N.W.
Hollywood 27, Calif. Washington 6, D.C.

one of the most popular types to make the scene this year has been the audio compression amplifier.

One of the more recent such devices is the Speakeasy, a product of Communications, Inc., 33 Danbury Road, Wilton, Conn.

We obtained their most elaborate model for the test; this one features a front-panel modulation meter which tells you at all times what your percentage of modulation is.

The first thing that impressed us about the Speakeasy was its minute size. From photographs, we expected a unit about 4 x 5 x 7 inches—but the gold anodized device we found under all the kimsul packing measured only 2-7/32 inches thick by 5-5/32 wide by 4-1/64 deep at the bottom (the deepest point).

However, the small-sized unit does a large-sized job.

Circuit-wise, it's a single-tube amplifier which goes in series with your present microphone line. This part of it simply supplies any extra gain necessary to obtain 100 percent modulation from even the weakest part of the voice signal.

But one wire in the connecting cable to the set picks off amplified audio from the plate end of the modulation transformer and feeds it back through a rectifier circuit to the grid of the Speakeasy's amplifier. The circuit is set up so that the larger the audio signal at the transformer, the lower is the gain of the amplifier.

The meter is connected in the rectifier circuit and measures the voltage fed back to the grid. Once calibrated as per instructions furnished with the unit, we found it amazingly accurate.

Power for operation of the Speakeasy is taken from the transceiver with which it is used. Full instructions for hooking it up are furnished.

Needless to say, we're happy with the performance of the unit. It's been removed from the HE-20 and transferred to a Hallmark since, and results in both cases proved well worth the investment, time, and trouble. A notable bonus is absence of the "echo-chamber" effect sometimes found with clipper-type circuits.

CITIZENS COMMUNICATIONS



Reports*

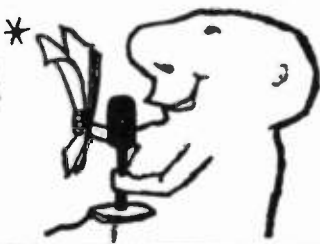

"WHAT'S GOING ON"

The Arfax CB club of Falls Church, Virginia is holding its Jamboree, Aug. 18, at the District of Columbia Armory.

Second Annual Tri-State CB Round-Up on August 26, at the City Park Pavilion, Parkersburg, W. Virginia. Come one and all.

State Convention of the North Carolina CB Radio Association, Sept. 29 and 30 at Kinston, North Carolina.

Listed below are a few new appointments in the CCM program. If your name does not appear, and you are interested in reporting in your call area please contact John F. Krejc, 2W4586, 40 Lanza Ave., Garfield, New Jersey. There are quite a few areas that are not reporting. Let's apply today. This space is for you!

New appointments this month in the CCM program includes, ACCM—Bert Endress, 2W9623, 161 East 4th St., Clifton; ACCM—Mrs. C. J. Easley, 8W2052, 3256 Oak Forest Dr., Jackson 4, Miss.; ACCM—James Cross, KCF0823, 755 S. Potomac St., Hagerstown, Maryland; ACCM—Mrs. W. R. Steele, KCC0625, 418 Linden Ave., Pine Beach, N. J.; ACCM—Val Tareski, 16W1628, 1372—12th Ave. N., Fargo, North Dakota; ACCM—21st Area, Berniece McGraw, KIF0020.

FIRST CALL AREA: CCM—Donald O. MacLeod, 1W8438, 26 Elmview Circle, Dover, N. H.; ACCM's—Muriel Brumage, 1Q2576; Seth B. Paull, 1W1717; William M. Welch, 1Q5640; George Michaels, 1Q1657.

A state charter was presented to the Plymouth County CB'ers of Brockton, Inc. of Mass. at their meeting of June 20 in Brockton. The presentation was made by the Mayor of Brockton, the Honorable F. Milton McGrath. The main speaker for the evening was Mr. Arthur Bellao, Civil Defense Director of Brockton.

The New England CB Council which will represent the entire six state area has been started for the purpose of promoting and protecting CB in the New England area. The organization is headed by Gordon Wilk, 1W8814, of Newton, Mass.

The Bristol County CB Radio Club of R.I., volunteered its services in the recent 4th of July parade in Bristol. The unit was used to keep the parade organized and close together.

The Waterville Area CB'ers, Maine, boast a membership of 74. Pres. of the group is Richard Willette, 1Q5141.

Citizen's Band Association of Conn. with Pres. C. F. Collins, 1W4265.

SECOND CALL AREA: ACCM—John F. Krejc, 2W4586. The Dutchess County Five Watters, Pres. Roland Normandin, 2Q2567.

Bayshore Radio Club meets the first Sunday of each month at the Harris Gardens Fire House, Union Beach, N. J., at 1:30 P.M. Pres. of the unit is Howard P. Wilson, 2Q1596.

Congratulations to the Long Island Chapter of MCEU on their recent assistance at a fire in the Carlstadt, N. J., area and the letter from the Marshal's Association.

State of New Jersey MCEU Headquarters, Gov. Bert Endress, 2W9623, is proud to announce the formation of the Hostings, Florida Chapter of MCEU. Go and present this one Bert!

2W6804, Desire Roefs, President of the CBRL, Citizens Band Radio Relay League. Let's hear more news from you and your many chapters.

CRA, of Rockland County, New York, held its 2nd Annual picnic a few months ago which was a huge success. More news please.

Hats off to the Bergen County Chapter and Marge and Larry Kitz. This couple saved the life of a 9 month old child by rushing him to the hospital at great neck speed and the help of local CB'ers. Job well done MCEU.

THIRD CALL AREA: CCM—Chester Zubrzycki, 3Q1332, 2724 W. 3rd St., Chester, Pa.

The Qui-Co Citizens Radio League of Reading, Pa., of which Bob Hoffman Jr., 3W3906 is president, held their second annual clam bake and election on July 15 at the Maple Grove Park.

Chet Zubrzycki, 3Q1332, Pres. of the South-Eastern Pennsylvania Citizens Radio Club is proud to announce that his club has been appointed to work with the American Red Cross—Chester—Wallingford Chapter as official emergency communications vehicles in times of disaster.

Charlie Amey, 3W2050, Pres. of the TERAC club of Gibbstown, N. J.

Williamstown, N. J. is the home of a new CB club sponsored by the local V.F.W. post. The club meets the 2nd Monday of each month at the VFW Post Hall in Williamstown. Harry Griffith, 3Q1601 is president.

The Bux-Mont club worked on Operation Wet-Sand at Long Beach, N. J. under the direction of the C.A.P. The club is active also with the CD. Thanks to Kay Miller, 3W2563.

The Ocean County Emergency Aid Network recently helped in the clean-up of the ravaged beach and homes along the South Jersey shore line. The group monitors ch. 11 for any distress calls. Pres. is Fred Sharpe, 3Q1055.

FOURTH CALL AREA: CCM—George W. Adkins, 4Q1018, Little Manor Ct., Ocean City, MD. ACCM—James M. Cross, KCF0823.

Members and non-members of the Hub CB Club coordinated by the Hagerstown Unit of REACT assisted the Community Rescue Service by running a telethon on the evening of July 3rd to collect money needed by the unit. A temporary base was installed in the C.R.S. office by 4W2942 and KIC1265. A vote of thanks to these fellows and all others who gave their time and autos for this worthwhile operation.

FIFTH CALL AREA:

The 5 Watt Mountaineers CB Club of Covington, Va. meets the first Friday of each month. They monitor Ch. NATCH 9.

The Rainbow 5 Watt located in Clifton Forge, Va., monitor Ch. 11. Club meets the first Tuesday of each month, Pres. is Allen B. Clarke, 5W2109.

SIXTH CALL AREA:

The Breaker, the club paper of the Volunteer State Citizens Band Radio Club boast a healthy and constructive amount of news. Rudolph Young, Pres.

Cee Banders Radio Phone Club of Birmingham, Alabama, recently elected Lawrence W. Todd, President.

SEVENTH CALL AREA: NO REPORTING CCM

With all the clubs in this area, their column should be bustling with news. We are looking for a CCM or ACCM to report club news to us. If you are interested, please contact JOHN F. KREJC, 2W4586, 40 Lanza Ave., Garfield, New Jersey. This space is for you, so why not take advantage of it. The only club reporting to us is the Central Florida Alliance of Citizen Band Clubs. This includes Cape Canaveral, Greater Orlando, Valusia, Indian River and Brevard 10-4 club.

EIGHTH CALL AREA: CCM—Ralph M. Lord, 8W1494 4834 Crown Ave., Baton Rouge, La.

The Central Arkansas CB Radio club recently published a very good looking membership and business

directory. Very good idea for all clubs to latch on to.

The Teche Valley Radlo Club located in Franklin, La. Pres. of the club is Frank Coli, 8W2224. The club organized in 1961, and includes **CB'ers And Homs.** Ch. 6 is monitored day and night. The group is officially part of the Civil Defense.

TENTH CALL AREA: CCM—Bob Johnson, 10W4389, 4300 Rector Ave., Ft. Worth, Texas. ACCM James Abney, 10Q2516.

Greater Dallas CB club has come up with a new **Brake**, this time it's a Drive-In-Movie and the crowd that turned out for this totaled 42 mobile units. At least 50 of the Greater Dallas CB club members hold First Aid cards and for the other members there is a First Aid class waiting at all times.

Mesquite has their first class of First Aid CB to graduate this month.

9Q0900-6, Charlie Doyle from Corpus Christi on his way through "Big D", said he would be glad to arrange a fishing trip for any CB'ers going to Corpus.

The communications of the Sports Car Races at Green Valley Race Track, were handled by John Pittman, 10Q0245, and his top notch team of 24 CB'ers. The boys are hand picked and have been personally trained by John. This team of 24 CB'ers have been recognized from coast to coast for their work and helping to promote safety. John Pittman is one of the **Very First CB'ers in Fort Worth.**

Every Friday Night the Lancaster CB'ers have a get-together at the Community House.

Recent Coffee break at Low and Dee Haley's home, 77 mobile units showed. Brownwood, Newark, Smithfield, Bridgeport, Decatur, Dallas, Denton, Cleburne, Burleson, Weatherford, Tulsa were represented, approximately 200 people.

ELEVENTH CALL AREA: CCM—R. V. Watson, 11Q1125, 2206 W. Palo Verde Dr., Phoenix, Arizona. ACCM—Jack Kinsey, 11Q5345; Donna Marshall, 11Q5171.

Barry L. Aubrey, the recently appointed public information officer for the newly formed Kern County Citizens Radio Association reports that the organization is now meeting on the first Tuesday of each month. All members monitor Ch. 9 throughout the county, with the exception of the McFarland-Delano unit which monitors Ch. 18. There are 40 members in the group and growing. The club assisted with com-

munications on two mountain-snow rescue operation in the past few months. The McFarland units were responsible for the recovery of a stolen vehicle and the apprehension of the auto theft suspects this past April. The association is planning many summer activities and will be monitoring NATCH (9), 24 hours a day. They are ready and willing to provide necessary assistance and travel information to persons vacationing in Kern County. So in Kern County, its NATCH 9.

Tri-County CB club of Nevada with 26 members, monitor NATCH 9 with their city police on Ch. 12. The club works for the benefit of their community. Pres. Cecile Miller, 11Q3660.

The Citizen Radio Associates of Southern California, Inc. are having a crash program for new members. The group monitors NATCH 9. Pres. is Hal Hasbrouk, 11W3330.

George E. Kremser, 11Q4335, Pres. of the Desert Sands Citizens Radio Club, reports that the newly formed organization in Edwards, Calif., Mojave Desert is very active and successful in desert search, rescue operations and is active in community projects. They handled the communications and conducted field trips for the Mojave Mineralogical Societies 4th Annual "Rock Bonanza". They recently provided communications for the Edwards AFB Kart Club. The group monitors Ch. 9, 10, 11 and 15.

Your CCM is the newly elected Pres. of the Arizona Citizens Radio Assn.

The 10-27 CB club of Ventura/Oxnard meets the first and third Thursday of the month. They monitor Ch. 9 and 11.

The 5 Watt Wizards of San Bernardino meets the third Monday of the month. A hidden Xmitter hunt (Part 15 Type) was held as part of the clubs regular monthly field trip on Sunday, July 22. A family picnic in the Blue Jay, Lake Arrowhead area was the main event.

A new CB club is being formed in the Faunskin area near Big Bear Lake. Members are needed and information may be obtained by calling 11Q3764 on Ch. 11. Meetings will be on Tuesday nights. This club will be of great assistance to CB'ers visiting the mountain areas all year around.

TWELFTH CALL AREA: CCM WANTED

Richmond 11 Meter Radio Club have joined the forces for NATCH 9. Thanks to Barbara Westman, Secretary.

THIRTEENTH CALL AREA: CCM WANTED. HOW ABOUT YOU? THIS AREA MUST HAVE SOMEONE THAT IS INTERESTED IN CB AND REPORT CLUB NEWS. WHAT SAY?

FOURTEENTH CALL AREA: ACCM—Fern Fechner, 14Q1295.

The Apple Capitol 5 Watt Assn., of Wenatchee and Cashmere hosted a state wide picnic at the State Park, Moses Lake, Wash. on June 24th. Clubs that were represented—The CB Minutemen of Seattle, The Sage and Sand of Pasco, The Evergreen Area CB Assn. of Everett, The 7-11 CB Radio Club Of Spokane, The Blue Mountain CB Assn. of Walla Walla, and Mr. and Mrs. E. J. Foster, 15W2938, Denver, Colo.

Bob Drews, pres. of the Washington State CB Assn. introduced the W.S.C.B.A. program to the clubs and also brought them up to date on the REACT program. The area monitors Ch. 9&12. Everyone agreed that the picnic was highly successful and look toward next years affair.

FIFTEENTH CALL AREA: CCM—Spencer Van Noy, 15W1894, 632 E. 3900 South, Salt Lake City 7, Utah.

July 15, The Wasatesh Radio League journeyed to

Ozco 1-10'er

CB-AM Antenna Coupler.

New Ozco coupling network permits Citizens Band operation and AM broadcast reception . . . at the same time with only your CB antenna! No CB signal loss from "2nd antenna bleed-off!" 1-10'er is complete, ready for quick installation. Adjustable fine tuning. **GUARANTEED** to be unsurpassed. Postpaid **\$5.95**



Available from Factory Only. **ORDER NOW!**

OZCO SALES

GRANITE AVE. EXT.
CANAAN, CONN.

EXTRA QUALITY & VALUE!

Sonar CITIZENS BAND RADIO

No where else but at Sonar can you get such performance and quality at this low price! Check these features: Dual conversion • RF output meter • Signal strength meter • Crystal spotting switch • Illuminated panel • 8 channels, crystal-controlled • Receiver tunes 23 channels • Class "B" modulation • 1-year guarantee

SONAR RADIO CORPORATION, 73 Wortman Ave., B'klyn 7, N. Y. Please send me complete information on Model "G" CB Radio.

NAME _____

ADDRESS _____

CITY _____ STATE _____

Complete with 1 pair of crystals and microphone

\$22950

American Fork Canyon for the monthly meeting and picnic. Sherill Powell and Ralph Jacob were in charge. Pete and Helen Hyte vacationed in Canada and Seattle. Look to the skies for Ralph Jacob and his Cessna.

We still would like to hear from some of the other clubs in the 15th Area.

SIXTEENTH CALL AREA: ACCM—Val Tareski, 16W1728, 1372-12th Ave., Fargo, North Dakota.

The Zumbro Valley Citizens Band club comprising of CB'ers from the Southern Minnesota area have been very active under the leadership of Ray Lind, 16W-3514, of Rochester. Regular club meetings are held either on the first or last Tuesday of the month. The official club monitoring channel is NATCH 9, but many can still be found on the former monitoring channel 18, since the transition to 9 has been slow. Other activities of the club at present include a Red Cross training course for members.

SEVENTEENTH CALL AREA: ACCM's Pete Davis 17Q2669, Jim Lloversee 17W3361, Martha J. Lewis 17W4058.

The Mo., Okla., Kans. (M.O.K.) C. B. club celebrated their 2nd. anniversary in Feb. and consists of members from S. W. Mo., Okla. and S.E. Kans. Pres.—Paul Sherman, 17W5042. Meetings are "open" to visitors in Joplin, Mo. area on the 2nd Thurs. of each month, 7:30 P.M. Civil Defense Hdqs., A & Main Sts., Joplin. From this club has come emergency groups in each individual area for through this section is "Tornado Alley". Ch. 22 is the call ch. for Joplin, Carthage and Sarcoxie, but someone is always monitoring Natch-9 and 11 in case some tourists needs directions or help of some sort. A friendlier group you will never find. S.W. of Joplin in Kans. and Okla. they monitor Natch-9.

Springfield, Mo. C. B. Club members monitor Chs. 2 & 9. Pres. is Lloyd Hickman, 17W5146. They hold two meetings a month, 1st Mon.—Social, 3rd Mon.—Technical at 7:30 P.M. Anyone in the area at either times of the month are invited to their meetings. More about this active group in future publications.

Chetopa, Kans. monitors Ch. 22, while Oswego and Parsons, Kans. use Ch. 6.

Independence, Kans. monitors Ch. 11. Nevada, Mo. has an emergency group started and all in that area use Ch. 16.

In the Topeka area, finds the Topeka REACT. The group monitors Ch. 4, 24 hours a day, furnishing road assistance, weather and travel information. The club is composed of 25, with Ron Jones, 2517 Edgewater, Topeka as Pres. Thanks to Marvin Henry.

EIGHTEENTH CALL AREA: CCM—Ralph E. Combs, 18B1711, 202 Bolivar St., Owensboro, Ky., ACCM'S—Robert D. Cooper, 18A7297, Anna Hitchcock, 18W7805, Thomas F. Gillians, 18A1868, D. C. Wolcott, 18A4803.

Good luck to the West Suburban Radio League of Cicero, Ill. President of the new club is Jim Wajtsiack, 18A4096.

The Wells County CB club of Buffton, Ind., held its meeting at the Place City Hall on June 12th and also elected officers. Pres. is Ora Baker, 18Q3612.

Your CCM reported that from Michigan City, Ind., a new club has organized calling themselves the Drifting Sand CB Club. They hold their meetings on the 2nd of each month at the local YMCA. Phil Garrett, 18A4852 is president.

Citizens Band Club of Perry County and Radio Station WTCJ held a six hour show for Kash For Kids. The pledges were phoned to the station and then relayed to the CB units. More than \$2200 was picked up by these units. Nelson Paris, 18B2333, Bill Hill, WTCJ, an-

nouncer and all members should be proud of this feat.

Kentucky and Indiana Citizens Band Radio League has now reached 132 members. Walkie Talkies for club use were bought to be used when needed in the hunt for lost persons and for other projects. The club meets the second Thursday of each month. Club paper is the KICB and will send to any club if you contact CCM.

The Spencer County Civil Defense asked this CCM to attend their meeting at Rockport, Ind. They use CB radio in their work and the Sheriff Dept. stands by on Ch. 16, 24 hours a day.

Members of the Hawkeye CB club of Iowa City, Iowa, patrolled city streets in April-May with not only approval but active support and participation of city police officials. After a fire-bug was found responsible for at least three serious fires, one causing a fatality—police officials determined that regular patrols were inadequate for protection. Within hours, more than 20 CB mobile units were available to supplement law enforcement squads. Success? Like many operations, nobody can really tell whether four additional continuously operating mobile units resulted in an end to the incendiary fires. According to Dr. William Ward, CB prexy, is the fact that the police force and the chief recognized the importance of the contribution of the CB volunteers. This real, not make believe exercise has shown that properly conducted CB activities are needed and accepted by public police officials.

NINETEENTH CALL AREA; CCM—Carl Wesser, 19W-6285, P.O. Box "V", Presque Isle, Mich., CCM—Donald Cuker, 24600 Joy Rd., 75N, Detroit 39, Michigan.

Steel Valley Radio Assn., has been participating in Civil Defense, Highway Patrol, Mahoning County Sheriffs Dept. and the Youngstown Police Dept. President of the group is James Benedict.

The Wayne County Citizens Radio Assn., Covering Wayne and Medina County in Ohio. President this year is Willard H. Dye, 19B0423.

It is with regret that this reporter must resign as CCM of the 19th Call Area, Southern Div., due to leaving the area for reasons of health. My new 10-20 will be in the 11th Call Area. My special thanks go to all those who have given their assistance to me, and for the card during my recent stay in the hospital. Anyone interested in becoming CCM or ACCM in the 19th Call Area, Southern Division please contact the Communications Coordinator, 40 Lanza Ave., Garfield, N. J. Thanks Dan for a job well done.

TWENTIETH CALL AREA: CCM—Jack Marshall, 20W8023, Box 260, RD #1, Conastota, N.Y. ACCM'S—Gary Goss, KIC1572.

Bainbridge CB, Vistal CB, Chenango County CB and the Krystal Crackers are planning a joint picnic.

MCEU, Syracuse, N.Y., Jack Marshall reports, all arrangements are final.

Dan Goss, KIC1572, Hiller, Pa., forming an ALERT CB club. It will consist of CB'ers in Washington, Fayette and Greene Counties. Dan welcomes any literature or aid he can get.

TWENTY-FIRST CALL AREA: Berniece T. McGraw, KIF0020, Quarters 46 D. Naval Station, Ford Island, Honolulu, Hawaii.

The Twenty-One Radio Association moves into its new club house for the July meeting. At present the club has sixty members working together in their spare time to make a "dream come true".

TWENTY-FOUR CALL AREA: CCM WANTED

The Virginia Beach CB Club is the first club in this area to report to us. Their meetings are held every 2nd Tuesday of each month at the Council Chambers, 19th and Arlic Aves., Virginia. President is Roman Harris.

10-7

RUGGED AND POWERFUL!

Sonar CITIZENS BAND RADIO

Sonar Model E's are having phenomenal acceptance by communicators all over the world. Here's why: FCC type accepted • 8 channels, crystal-controlled transmitter/receiver • Tunable receiver for 23 channels • Powerful transmitter 100% Class B modulated • Automatic noise limiter • 1-year guarantee • Lightweight, compact

SONAR RADIO CORPORATION, 73 Wortman Ave., B'klyn 7, N. Y. Please send me complete information on Model "E" CB Radio.

NAME _____
ADDRESS _____
CITY _____ STATE _____



\$17950 Complete with 1 pair of crystals and microphone

CLASSIFIED

Notes for classifieds are 10c per word for advertising which, in our opinion, is obviously of a non-commercial nature. A charge of 25c per word is made to all commercial advertisers or business organizations. We do not bill for advertising in CLASSIFIEDS, nor can we acknowledge receipt of copy sent in. Full remittance MUST accompany all orders. NOTE: The products and services advertised in this section are not guaranteed by the publisher of CB HORIZONS. Closing date for the October issue is Aug. 23rd, in Oklahoma City.

TELEVISION CAMERAS—Build one. Write Spera Electronics, 37-10 33rd Street, Long Island City, New York.

CBH LOG BOOKS—50 pages of spacious entries. 65¢ postpaid, coins acceptable. Elanem Company, 1116 Inwood, Plainfield, New Jersey.

2x3 FCC WARNING DECAL against unauthorized use. 35¢, 4/\$100. CB Box 457, Encino, California.

CB-QSL CARDS—BROWNIE W3CJ1/3W1974 3110C Lehigh—Allentown, Pa. Catalogue with samples 25 cents.

CB's—Colorful Rainba Calls, Space Age, Comic. Samples 25¢ (deductible) C. Fritz, Box 1684, Scottsdale, Arizona.

WOULD YOU LIKE TO MEMORIZE THE MORSE ALPHABET in two hours? Many people have done this with our "Memorizing the Morse Alphabet". You can undoubtedly do as well. Send only \$1.00 to B. G. Munyan, 200 Park Ave., Harrison, New York and get your copy by return mail.

UNIQUE CB SPECIALTY FRANCHISE OPPORTUNITY. Rugged Raytheon TWR-2 two-way CB equipment, engineered for years of trouble-free service. Super-sensitive dual conversion super-heterodyne receiver. No printed circuits, no relays. Complete, ready to use right from the box. Delivers clearer transmission, more stable reception with greatest range. Suggested list price, 189.95. Top-profit TWR-2 specialty franchises now available. For full particulars, spec sheet and schematic drawing, write Raytheon, Box 730, Westwood, Massachusetts.

GW-10; GW-11 Owners! Order SK-3 RF Pre-selector for most preamplification, easiest installations, specific-est instructions, best reception and quickest delivery. Kit \$8.99; wired, \$11.99. Complete, postpaid. HOLSTROM ASSOCIATES, Box 8640-B, Sacramento 22, California. (Dealers, servicemen inquire.)

STREAMLINE YOUR INTERNATIONAL EXECUTIVE 50 or 100 model. Install the new 23 channel switch, completely wired. Takes but five minutes to install. \$19.95 F.O.B. factory, see your dealer or place your order direct to C.B.S. Electronics, P.O. Box 110, Redwood City, California. Dealer inquiries invited.

FREE SAMPLES—CB QSL CARDS. \$2.50 per 100 in 3 colors, POSTPAID. GARTH PRINTING COMPANY, BOX 51, JUTLAND, N. J.

CB WPE QSL CARDS, Finest Quality, Multicolor, 10¢ for Samples. Radio Press, Box 24A, Pitts-town, New Jersey. Price inc. \$4.00

NEED CB QSL CARDS? Fast service, 200 for \$5.00. Postpaid. Send 25¢ for samples and 50¢ coupon. McCartney's, Freedom, Indiana.

ELENCO POWER GAINER new in box, \$30.00. Harold Lucas, P.O. Box 702, Flint, Michigan.

CBL CARDS: Best deal you'll find. 2 colors, \$2 per hundred, postpaid. Cash with order, free sample. 19Q3521, P.O. Box 67, Hartford, Michigan.

RADSON CB, 1 base, 2 mobile. 6 & 12 volts. Best offer takes. Jude Thibault, 74 Farnham Road, South Windsor, Conn.

CB HANDBOOKS! "Your Citizens Radio License" Application information, reprints of FCC rules Parts 15 and 19. Invaluable! "Your Citizens Radio Station" Installation and adjustment of CB equipment! "Antennas for Citizens Radio" Construction and adjustment of CB antennas! Be top signal on the channel! \$1.00 each or all 3 for \$2.75. Also "VHF Handbook" \$2.90. "Better Short-wave Reception" \$2.80. Include 15¢ postage with order to Radio Publications, Box H, Wilton, Conn.

FOR SALE: The original Noistop \$13.95 postpaid. Arnold Kauble, 610 Church Street, Iowa City, Iowa.

MODULATION BOOSTER—It's new! It's terrific. As much as DOUBLES your transmit and receive range with no violation of FCC power requirements. Compact, easy to install, with instructions. New \$14.95. Dealers write: ROKO Products, Inc., Box 3766, Baltimore 17, Maryland.

ANTENNA SWITCH—Operate one CB on two antennas or two CBs on one antenna. Attractive stainless steel. Takes PL-259 plugs. Net \$7.95. ROKO Products, Inc., Box 3766, Baltimore 17, Maryland.

MOBILE POWER BOOSTER for CB auto or marine transceivers. Twice more power than your base unit! 12-VDC only. \$27.95. Robatronics, 3513 MacArthur, Oakland, California.

CITIPATCH—CB 'Phone Patch. Connects any CB rig to telephone without cutting wires. Adjustable preamplification. Modern styled cabinet. \$19.95 Free literature. Lenharv Electronics, 1811 HiPoint St., Los Angeles 35, California.

NEED CB QSL CARDS? Fast service, 200 for \$5.00 postpaid. Send 25¢ for samples and 50¢ **CB QSL Cards** 2 color Glossy 100 for \$2.50. Samples, dime. Ramsbottom Print Shop, Box 237A, Kirksville, Missouri.

QSL CARDS—Many sharp cartoon designs . . . send for FREE brochure. F. B. MATHEWS: PRINTING & ADVERTISING, 1616 Rural Street, Rackford, Illinois.

CB'ers—Sell your used CB Equipment here—only 10 cents per word!

Channel 24

By
BOB COOPER, JR., KEG2607
 Publisher—CB Horizons

It is my rather-unpleasant duty this month to report that indications now are that we will be seeing a completely revised Part 19 proposed by early October, at the latest.

The FCC has been vocal at CB gatherings and active on the telephone of late warning individual CB'ers and manufacturers alike that impending changes are very-very close.

One manufacturer was warned that while he may have gotten away with a certain transceiver attachment in the past, the newly revised Part 19 contains specific wording which states that his unit cannot be used under any circumstances without violating new Part 19 provisions.

Individual CB'ers have been warned in increasing numbers about "idle chit-chat" on the airwaves.

Some form of government imposed clampdown is in the making . . . there can be no question about it now.

But let us not forget for even a single moment that this remains a government *by* the people and *for* the people. The FCC must act in the public interest. In this case, *we are the public* and it is *our interests* which they must, at all costs, keep in mind.

If we don't approve of certain sections of the new Part 19, we will have every opportunity to voice our complaints in the form of formally filed petitions, come October. It behooves everyone of us to take a personal interest in the new proposals for Part 19. This is *not* something "to let George do." Clearly George has not been doing such a good job lately, or the Commission wouldn't feel so compelled to remove the control from the hands of the majority and place it in the hands of the minority.

Talk up the coming changes at your local club meeting and among your local CB'ers.

If you—*personally* don't take an active interest in the new Part 19 . . . well, you may never have another chance.

KEG2607

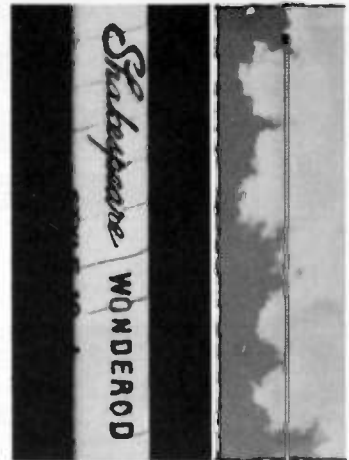

V.I.P.*

Shakespeare construction in a top-loaded CB whip **5.75**

Top-loaded V.I.P. (Style 173) is every inch WONDEROD — a trim, well-proportioned 4' white antenna, with coil embedded in a laminate of thousands of tiny, parallel, rod-length glass fibers. To V.I.P. and all WONDERRODS, Shakespeare construction means less precipitation static, no corrosion; terrific impact strength and flexibility . . . and a *Very Impressive Package



COLUMBIA PRODUCTS COMPANY
 Shakespeare Co. Subsidiary, Columbia, S. C.



CITIZEN BAND CLASS "D" CRYSTALS



3rd Overtone: Hermetically Sealed .005% tolerance—Meet FCC requirements, pin spacing—.050 pin diameters. (.093 pins available, add 15c per crystal.)
\$2.95 EACH
 ALL 23 Frequencies in Stock

(add 5c per crystal for postage and handling)

The following Class "D" Citizen Band frequencies	In stock (frequencies listed in megacycles)
26.975, 26.985, 27.005, 27.015, 27.025, 27.035, 27.055, 27.065, 27.075, 27.085, 27.105, 27.115, 27.125, 27.135, 27.155, 27.165, 27.175, 27.185, 27.205, 27.215, 27.225, 27.255.	26.965, 27.035, 27.115, 27.185, 27.255.

Matched crystal sets for all CB units . . . \$5.90 per set. Specify make and model numbers.

RADIO CONTROL CRYSTALS in HCG/U HOLDERS—SIX FREQUENCIES

In stock for immediate delivery (frequencies listed in megacycles); tolerance .005% 1/8" pin spacing, .050 pin diameter. (.093 pins available, add 15c per crystal.) Specify frequency desired.
\$2.95 EACH
 26.995, 27.045, 27.095, 27.145, 27.195, 27.255
 (add 5c per crystal for postage-handling)

NOW! Engineering samples and small quantities for prototypes now made either at Chicago or at Ft. Myers Plant. 24 Hour Service!
 IN CHICAGO, PHONE Gladstone 3-3555

ASK YOUR PARTS DEALER FOR TEXAS CRYSTALS See big red display . . . If he doesn't stock them, send us his name and order direct from factory.

RUSH YOUR ORDER NOW TO
TEXAS CRYSTALS

1000 Crystal Drive, Fort Myers, Florida
 Dept. H Phone WE 6-2100

FREE for '63

LAFAYETTE RADIO ELECTRONICS

1963 CATALOG NO. 630

388 GIANT-SIZED PAGES

*The Largest Catalog
in Our 42-Year History*

It's New — It's Better Than Ever
It's from America's
Citizens Band Headquarters

The exciting, all-new 1963 Lafayette Catalog features thousands of items for the experimenter, hobbyist, technician, audiophile, engineer, serviceman . . . fully illustrated . . . hundreds of manufacturers.

Check these Outstanding
Lafayette Benefits:

- ✓ LARGEST STOCK SELECTION
- ✓ SATISFACTION GUARANTEED OR MONEY REFUNDED
- ✓ EXCLUSIVE LAFAYETTE PRODUCTS
- ✓ 3-IN-1 EASY-PAY PLAN . . . NO MONEY DOWN
- ✓ LOWEST PRICES



New! LAFAYETTE 10-TRANSISTOR PORTABLE CITIZENS BAND "WALKIE TALKIE"



HE-29B

33.95 ea 2-for-62.90

- 50% More Powerful — Receives and Transmits Up to 2 Miles
- Extra RF Stage
- 10 Transistors plus 1 Diode
- No Licenses, Tests or Age Limits (As per FCC Regulation 15)
- With Carrying Case, Earphone, Antenna, Batteries, Crystals

New! LAFAYETTE HE-20C CITIZENS BAND TRANSCEIVER



HE-20C

Officially Approved for Use in CANADA
Type Approval No. 169361029

109.50

- 8 Crystal Controlled Transmit Positions plus 8 Crystal Controlled Receive Positions
- 14 Tube Performance • Tuneable over all 23 Channels
- Built-in Power Supply for 110V AC or 12V DC
- Complete with Matched Crystals for Channel 9

MAIL THE COUPON FOR YOUR FREE 1963 LAFAYETTE CATALOG

LAFAYETTE LOCATIONS
SYOSSET, N. Y.

JAMAICA, N. Y.	NEWARK, N. J.
NEW YORK, N. Y.	PLAINFIELD, N. J.
BRONX, N. Y.	PARAMUS, N. J.
SCARSDALE, N. Y.	BOSTON, MASS.

LAFAYETTE RADIO, Dept. CB1-2
P.O. Box 10, Syosset, L. I., N. Y.

\$ _____ enclosed for Stock No. _____, shipping charges collect.

Name _____

Address _____

City _____

Zone _____

State _____

Send me the Free 1963 388-Page Lafayette Catalog

FREE



Outperforming everything else in the field!

E. F. Johnson Co. . . . manufacturer of the nation's most popular CB units . . . now first with a completely self-contained selective calling system!



**BRAND NEW!
37 TONE SELECTIVE CALLING SYSTEM!**

The Viking "Tone Alert" is a compact selective calling system which may be easily attached to most two-way radio equipment. Mutes speakers on your units until one calls another—then automatically, your stations receive an audio note and an indicator light flashes "on", remaining lighted until call is answered. Three-position lever switch has "stand-by", "operate" and "call" positions. 37 calling tones permit 37 systems to operate on same channel without overlap. Only 1 1/2" x 4" x 7 3/4". Available **\$59⁹⁵ NET** in 6 VDC/115 VAC or 12 VDC/115 VAC models.

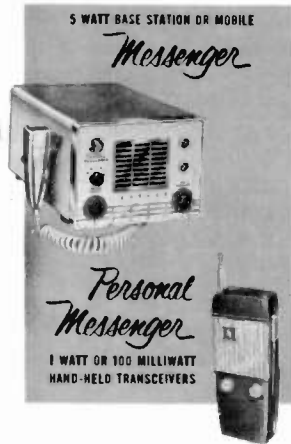

**PRICED FROM \$109.50
BASE STATION, MOBILE, OR HAND-HELD "MESSENGERS"!**

In the field or on the job . . . Viking "Personal Messengers" deliver outstanding performance! Two compact hand-held units . . . 1 watt with excellent range for use on the Citizens Band . . . 100 milliwatt model for unlicensed use over shorter ranges. Operates on penlight cells or rechargeable nickel cadmium batteries. Exclusive tuned RF amplifier gives twice the sensitivity and 40% more range than similar units with conventional circuitry—more output than similar units with same rated input!

FROM \$109⁵⁰ NET

Performance proved Viking "Messenger" is a 5 channel, crystal-controlled Citizens Band transceiver. High efficiency design makes full use of maximum legal power—delivers solid signal unmatched in fidelity and clarity! Excellent receiver selectivity and sensitivity—built-in "squelch"—AVC—and automatic noise limiter circuits. Easy to install, mobile or base. Three units available: 6 VDC/115 VAC, 12 VDC/115 VAC, or 115 VAC only.

FROM \$134⁹⁵ NET

**MESSENGER 202
INDUSTRIAL 2-WAY RADIO
FOR 25 to 50 MEGACYCLES**



Priced at less than \$200.00, the "Messenger 202" delivers all the pep, power and performance needed for solid business communications! F. C. type accepted for use in Industrial, Public Safety and Land Transportation services.

MAIL COUPON TODAY!

for descriptive literature and complete information!



JOHNSON

E. F. JOHNSON COMPANY

1203 Tenth Avenue S.W. • Waseca, Minnesota

Please rush full information on "Messenger" equipment.

NAME _____

ADDRESS _____

CITY _____ STATE _____

Manufacturers of the World's Most Widely Used Personal Communications Transmitters

Announcing **NEW HY-GAIN** **GOLDEN COLINEAR**

Iridite-treated Ground Plane Model GCLR for Citizens Band

**The only C.B. gain antenna
built to rigid commercial specs**

Doubles effective radiated power in all directions!

These new features make a great product... superior in every respect

- Entire antenna, metal tubing and parts are iridite-treated to Mil. Specs. for maximum resistance to rust and corrosion.
- Heavy wall aluminum alloy tubing with injection-molded fibreglas filled styron insulators.
- Stamped steel fittings and heavy duty construction provide an antenna guaranteed to withstand winds of 100 m.p.h.
- DC ground... drains static and reduces noise... adds lightning protection.
- The Golden Colinear consists of a $\frac{5}{8}$ wave length radiator over a ground plane which provides a second $\frac{5}{8}$ wave length mirror image. Because of their extended lengths, these elements develop an omni-directional gain of 3.4db field intensity.
- Up to 20db gain in signal to noise ratio.

Unlike multi-element beam antennas which concentrate energy in one direction at a sacrifice in power in other directions, the Hy-Gain Colinear Ground Plane achieves gain through colinear action which concentrates more power at lowest possible angle to the horizon. It performs equally well receiving or transmitting, greatly increasing the range of consistent C.B. communications. An exclusive Hy-Gain design—precision tuned and matched for 52 ohm coaxial cable. either RG-8/U or RG-58/U. Conforms to legal limitations—overall height only 20 feet.

Send for complete technical information, or see your dealer.

hy-gain antenna products

8402 NE Highway 6, Lincoln, Nebraska

LIST PRICE MODEL GCLR **\$93⁰⁰**

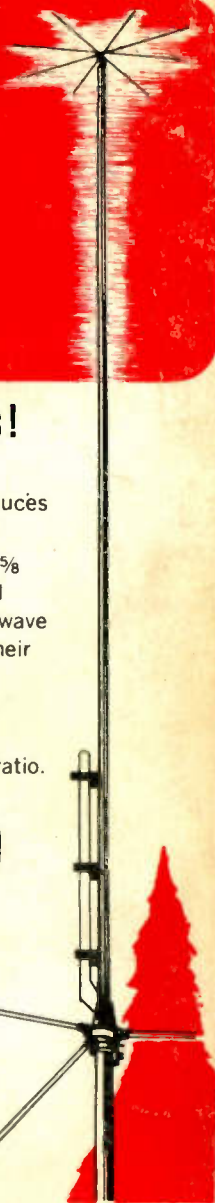

BULK RATE
U. S. POSTAGE
PAID
Permit No. 7
Okla. City, Okla.

CB HORIZONS
P. O. BOX 1557
OKLAHOMA CITY, OKLAHOMA