

CB

HORIZONS

FEBRUARY 1962
40 CENTS

SPECIAL BASE STATION ISSUE ALSO — EXCLUSIVE NEW CB CALL SIGN FACTS!

See Page 21

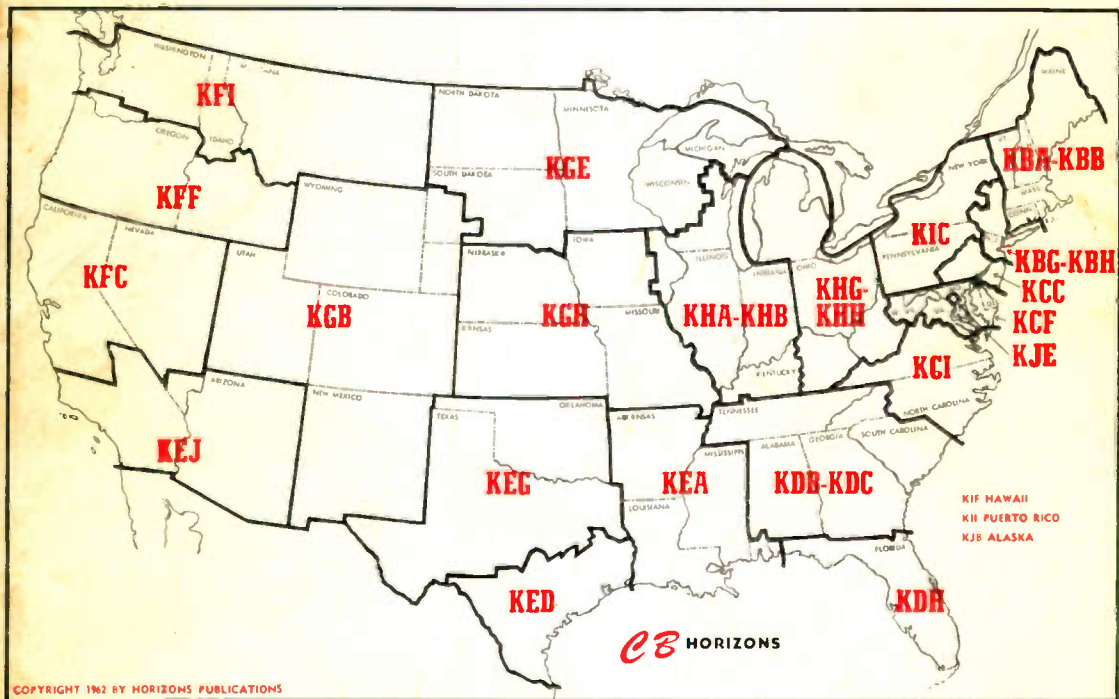

THE CITIZENS BAND RADIO MAGAZINE

IN THIS ISSUE —

Improve your Audio—Crush Mobile Noise—Build your own TVI filters—Build a Simple Converter—CBH Exclusive Report on "Operation Dollhouse"—Phone Patches and CB—FCC News—and Much, Much, More!

INTERNATIONAL'S

Executive

FOR SUPERIOR CITIZENS

The ultimate in Executive Citizens transceivers. New crystal filter which minimizes adjacent channel interference in the receiver. New built-in receiver calibration circuit. New International NR squelch. New 12 position crystal control transmit channel selector. New front panel microphone jack. New provision for connecting external speaker and S/meter. Tunable dual conversion superheterodyne receiver covering all 23 channels. Two crystal control receive positions. Push-to-talk operation. Three way power supply for 6/12 vdc and 115 vac. Full five watts plate input. Certified tolerance $\pm .005\%$. **Complete with 1 transmit crystal, 1 receive crystal, new style ceramic microphone and coil cord.**

\$199.50*

International's exciting New compact transceiver. Field tested full five watt transmitter contained in the higher price Executive transceivers. Certified tolerance $\pm .005\%$. Tunable superheterodyne receiver covering all 23 channels. Three position crystal control transmit channel selector. Manual transmit-receive control. Noise limiter. Available accessories include four separate power supplies — 6 vdc, 12 vdc, 24 vdc, or 115 vac, push-to-talk relay kit, and 12 position transmit channel selector. **Complete with 1 transmit crystal, matching microphone and external speaker, but less power supply.**

\$69.50*

MODEL 100



MODEL 10



See The Executive Series at Your Authorized International Dealer



INTERNATIONAL CRYSTAL MFG. CO., INC.

transceivers

BAND COMMUNICATION

MODEL 50



A precision engineered transceiver featuring push-to-talk operation. Three position crystal control transmit channel selector. Dual conversion superheterodyne receiver tuning all 23 channels. Full five watts plate input. Crisp and clear modulation. Certified tolerance $\pm .005\%$. Two crystal control receive positions. Series Gated automatic noise limiter. New International NR squelch. Three way power supply for 6/12 vdc and 115 vac. Additional features of the Executive Model 100 may be added at any time. The Model 50 is a rugged yet handsome piece of communication gear equally at home in the office, service truck or field. Complete with 1 transmit crystal and matching microphone. **\$149.50***

*Suggested Price

FREE 1962 CATALOG

Your buying guide for precision radio crystals, electronic equipment, and Citizens Band accessories . . . contains suggested oscillator circuits, plus technical information on selecting the proper crystal. Write today for International's 1962 catalog. It's FREE.



18 NORTH LEE
OKLAHOMA CITY, OKLAHOMA

International Crystal Mfg. Co., Inc.
18 North Lee, Oklahoma City, Okla.
Please rush FREE 1962 International Catalog.

NAME.....
Please print
ADDRESS.....
CITY.....ZONE.....STATE.....



OZZIE'S MAIL- BOX

you run, perhaps we would have been able to avoid many of the problems which we have run up against.

Your issue usually turns up at our meetings for reference and discussion.

H. Dewayne Horne, 20W1045
President, Johnstown CB's
Johnstown, Pa.

Our goal, to give our readers, the CB'ers of America, what they want and need. It's very gratifying to receive letters such as yours, Dewayne.

Ozzie

Hey You!

What do you mean, no CB on roller-skates? The enclosed picture was

Dear Ozzie:

My compliments to you on the fine article on Tone Signaling Devices (December CBH, p. 28). We here at General are proud indeed to have been first in presenting a Tone Signal Device to the CB fraternity, however I must give credit where it is really due.

The original tone signal was developed by Mr. Ray Flin, 11W2090, well known motion picture photographer. Mr. Flin was one of the first persons to recognize the need for such a device and set out to do the job in the most practical manner. Hats off to Ray Flin.

Charles Messenger, 11W4165
Chief Engineer
General Radiotelephone Co.
Burbank, Calif.

Thanks for letting us in on this "behind the scenes" glimpse at CB, Charlie. We received a derby full of letters telling us who "really" invented the Tone Signalling Device, and since Ray's name was mentioned in the majority of letters, we'll go along with you on the choice. You know 32 people claimed that they invented the thing themselves.

Ozzie

Dear Ozzie:

We certainly appreciate the article on CB Clubs which ran in your November issue. If your magazine had been in existence last year with this article, and others of its type which



snapped at the Midway Rollerskating Rink here in Marshall, Mich.

Michael G. Peck, 19A6744
Marshall, Mich.

Oh well, anybody tried out a pogo stick yet, or maybe one roller skate?

Ozzie

**Want Wise-Guy
Answers To Your
Letters? Write To
Ozzie.**

first from
**new
tronics**

a new approach
in the design of
CB antennas



Model CB-1

Base has chrome plated split ball to meet severe angle requirements of front fender. Swivels up to 180°.
CB-1 \$1.80

Model CB-2

Mast has same features as that on CB-27. Standard male thread fits any of models shown here.

CB-2 \$8.64

Model C-32

Base has 1½" chrome plated die cast swivel ball, heavy phenolic insulator and cadmium plated hardware.

C-32 \$2.01

Model C-29-32

Base and stainless steel spring. Base is same as C-32. A rugged assembly that provides long life and attractive appearance.

C-29 - 32 \$5.07

For special requirements you can easily combine any of these models

Model CB-27 gives you 23 channel coverage, low SWR and broad banding advantages. You get neat, trim appearance because of its compact size. Expertly engineered and sturdily built. Priced no higher than ordinary antennas. See the Model CB-27 at your electronic distributors or write for details.

The CB-27 series is designed for the individual who is particular about the appearance of his car... and wants performance, too.

MODEL CB-27 (Illustrated below)

Extends to 60", collapses to 27". Four section, chrome plated, heavy duty brass tubing assembly with sealed loading coil. Standard automotive ball-type swivel base. Includes 5' of RG58/U coaxial cable with PL-259. Tuneable top rod has etched tuning scales for field adjustment to 27 MC or 28-30 MC amateur bands.

CB-27 \$10.44

NEW-TRONICS

Manufacturers of Communication Antennas

3455 Vega Avenue • Cleveland 13, Ohio

The Model CB-27 closely resembles an ordinary automobile antenna.
(Pat. Pend.)

If your dealer cannot supply these models, send check or money order direct to New-Tronics.

CB HORIZONS

PUBLISHED MONTHLY BY HORIZONS PUBLICATIONS, INC.
POST OFFICE BOX 1557 OKLAHOMA CITY 1, OKLA.

STAFF

BOB COOPER, 12Q2339
Publisher

TOM KNEITEL
10Q3161/W5KDR
Managing Editor

REX HOLMES, 24W2424
JIM GIBSON, 2W7610
Contributing Editors

GAR GREENE, JR., 1W4844
CLYDE D. MOORE, 9W0219
Editors of Large

H. FRIEDMAN,
2W6045/WZLFL
Eastern Technical Editor

JIM KYLE, 10W0901/K5JKX
Western Technical Editor

DEE CALVI, 10Q2952
Editorial Assistant

JACKIE JOHNSON, 12Q2015
Promotion Manager

STAN SEARLE
Art Director

OFFICES

Business and Western Advertising Offices
1016 14th St.
Modesto, Calif.
Tel. 209 LA 4-7395
(call collect for ad info)

Editorial Offices
9 N.W. 6th St.
Oklahoma City, Okla.
Tel. 405 CE 2-6290
(call collect for ad info)

Eastern Advertising Office
COWAN PUBLISHING CO.
300 West 43rd Street
New York 36, New York
JUdson 2-4460
Dick Cowan
Jack Schneider, 2W5669

ADVERTISING

CB HORIZONS magazine accepts commercial display advertising from bona fide manufacturers, distributors of electronic equipment and associated apparatus. Advertising rate card and coverage data available upon request.

CIRCULATION

CB HORIZONS magazine is circulated through the malls and over the counter to approximately 63,000 readers each month. Readers are operators and licensees of Class D Citizens Band radio equipment in the United States, its territories and possessions. Detailed and sworn circulation statement available upon request from the Publisher.

SUBSCRIPTION

Subscription rates in the United States, Canada—\$4.00 per year. Single copies 40c each. Subscriptions outside the U.S.A. and Canada—\$5.00 per year. Subscription remittances should be made by bank draft or postal money order. Airmail subscription available at \$7.00 per year, U.S. and Canada.

TABLE OF CONTENTS

FEATURES

SOME KNOWLEDGE AND A FEW MODIFICATIONS The P's and Q's of CB Audio	6
BASIC FACTS ON BASE STATIONS February is for Base Stations	10
HASHING OVER MOBILE HASH Flatten Your Mobile Noise	11
KYLE STILL TALKING ABOUT TVI Build Kyle's TVI Filters	16
\$1.50 + LITTLE TIME & EFFORT = CB CONVERTER Build This Cheap and Easy CB Converter	18
COVER STORY—A CBH EXCLUSIVE SCOOP! Full Story on FCC's New 1962 CB Calls	21
DIS VIRE GOES HERE, DAT VUN GOES DERE Modular Equipment: Trend for 1962?	22
BE HAPPY, GET SNEAKY! Suggestions on Clandestine CB'ing	24
OPERATION DOLLHOUSE—A CBH EXCLUSIVE REPORT! CB's Finest Four Hours	32
DON'T WRITE US LETTERS ON THIS! THEY CAN BE LEGAL Phone Patches for CB	36
SOPHISTICATE THAT "LUNCH BOX" The Ultimate Squelch for the CB-1	38
WILL YOU BE IN CHICAGO? Convention Note	44
THEY WERE LUCKY LAST MONTH, WILL YOU BE NEXT? December Giveaway Winners	47
FREE MOVIES ABOUT ELECTRONICS You Asked For It	52
A FREE \$290.00 CB "DREAM STATION" THIS MONTH Our Gigantic Giveaway gets Fancy	53

DEPARTMENTS

OZZIE'S MAILBOX	2
ANTENNA TOPIX	24
CB SHOWCASE	26
LAB REPORTS	27
CBL CARD OF THE MONTH	35
TECH TALK	38
CCM REPORTS	40
GAR'S GABBINGS	46
CLYDE'S CORNER	48
CLASSIFIEDS	51
TK ON CB	52
GIGANTIC GIVEAWAY	53
BEFORE WE SIGN OFF "Late-Late FCC News (to January 6) you can't read in ANY other publication for cons."	55

CB HORIZONS (title registered U. S. Post Office) entered as Third Class postage in Oklahoma City, Oklahoma. All copyright and editorial rights reserved by Horizons Publications, 1962.

The entire contents of this magazine are copyrighted by Horizons Publications. No article in this magazine may be reproduced in whole or in part without the written permission of the publishers.

COVER: New CB coll orens ore shown on this map, the basic design of which is courtesy of International Crystal. Wall size reprints (17"x26") in 2 colors ore available from CBH for 50c each.

FOR POWER OR PORTABILITY . . . UNCOMPROMISING ENGINEERING WITH

EICO® CITIZENS BAND TRANSCEIVERS



Operates 2500 hours on 1 rechargeable leakproof battery

EICO WALKIE-TALKIE MODEL 740: Kit \$54.95. Wired \$79.95.

Carrying Case \$3.95.

Complete with rechargeable battery & charger. No license or permit needed . . . no age limit

**U. S.-made
an original
product of EICO
research**

Size: 7 1/4" x 2 5/8" x 1 5/8", weighs only 19 oz. . . . fits comfortably in hand, slips easily in jacket pocket.

- Finest U. S.-made nickel-cadmium rechargeable battery provides about 8 hours "on" time with 50% duty-cycle operation on a single charge
- Battery can be recharged 300 times, replacing over 1,000 penlight cells (over \$200.00 worth)
- Leakproof nickel-cadmium battery is hermetically sealed in plastic — can never cause corrosion damage
- Full 100mW input to Final, as permitted by FCC for Unlicensed Citizens Band Operation
- Crystal-controlled transmit & receive
- Full modern superhet receiver
- 9 transistors and 1 diode
- Range 1 1/2 miles under average conditions
- High quality circuit board, beginner-tested instructions for complete kitbuilding ease and assurance
- Make a "network" with 2 or more EICO #740's or with EICO 770 series or with EICO 760 series

NEW VERSATILITY WITH NEW DELUXE 770 SERIES

	Kit	Wired
Model 770†: 117 VAC only	\$79.95	\$109.95
Model 771†: 117 VAC and 6 VDC*	89.95	119.95
Model 772†: 117 VAC and 12 VDC*	89.95	119.95

†U. S. Patent #D-190,970 *Including Posi-Lock Mounting Bracket

"A steal . . . Better than manufacturing specs . . . Publisher Cooper reports base-to-mobile contact out to 22 miles consistently, often to 40 miles . . . Thorough manual is almost a handbook for CB radio."—CB HORIZONS

Front panel selection of one of 3 transmit crystals with continuous receiver tuning over all 23 CB channels, or a fourth transmit crystal with appropriate receiving crystal. Press-to-talk button on microphone; transmit-receive switching accomplished by high-quality relay with minimum capacity between contacts to prevent current leakage at RF frequencies. Superhet receiver with RF stage for high sensitivity & proper signal-to-noise ratio. 1750 KC IF strip for unequalled image rejection & freedom from oscillator "pulling" on strong signals. IF strip prealigned so that only "touchup" alignment without instruments is needed. Current metering jack in series in cathode circuit allows checking of input power to transmitter final and adjusting it to FCC limit. 13-tube performance (4 dual function tubes, 4 single function tubes, plus germanium diode). Adjustable squelch control (in addition to automatic noise limiter). Optimum adjustment to any popular CB antenna assured through use of variable pi network in output. AVC. 3" x 5" oval PM speaker. Supplied complete with 8 tubes & 1 transmit crystal (extra crystals \$3.95 each).

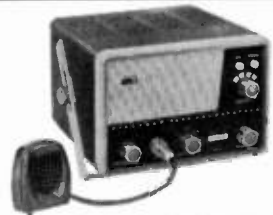

The entire transmitter oscillator circuit and RF final in every EICO transceiver, kit and wired, is pre-mounted prewired, pretuned, and sealed at the factory (about 3 hours of skilled labor, precision adjustments and testing), complying with FCC regulations (section 19.71, part d). This permits you to build the kit and put it on the air without the supervision of a commercial radio-telephone licensee.

STANDARD 760 SERIES



	Kit	Wired	*Including
Model 760: 117 VAC only	\$59.95	\$89.95	Posi-Lock
Model 761: 117 VAC and 6 VDC*	69.95	99.95	Mounting
Model 762: 117 VAC and 12 VDC*	69.95	99.95	Bracket

Same uncompromising engineering, same care and precision, and largely the same circuitry as in 770 series (above), lacking only multiple-channel transmitting, crystal receiving, and push-to-talk microphone.

BEST BUYS IN SERVICE INSTRUMENTS: everything from Scopes to Probes



DC-5 MC 5"
Scope #460.
Kit \$79.95
Wired \$129.50.
Also available—
5" Push-Pull
Scope #425.
Kit \$44.95
Wired \$79.95

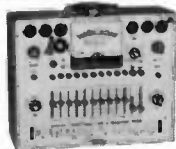

Dynamic
Conductance
Tube & Transistor
Tester #666
Kit \$69.95
Wired \$109.95
Complete with steel
cover & handle

EICO, 3300 N. Blvd., L.I.C. 1, N.Y. CB-2
 Send Free 32-page catalog & Distributor's name.
 Send Free Schematic of Model No. _____
 Send new 36-page GUIDEBOOK TO HI-FI for which I enclose 25¢ for postage & handling.

Peak-To-Peak
VTVM #232
& †Uni-Probe®.
Kit \$29.95
Wired \$49.95
VTVM #221
Kit \$25.95
Wired \$39.95



†Pat. #2,790,051

TV-FM Sweep
Generator & Marker
#368
Kit \$69.95
Wired \$119.95



Name _____
 Address _____
 City _____ Zone _____ State _____

Export Dept., Roburn Agencies Inc.,
431 Greenwich St., New York 13, N. Y.

Add 5% in West

Get The Most From Your CB Audio

A LITTLE KNOWLEDGE AND A FEW SIMPLE MODIFICATIONS

By JIM GIBSON, 2W7610

Perhaps you've heard the expression "audio," and mayhaps you've even gone so far as to actually use the term yourself. But do you fully comprehend the term as it relates to your low RF output CB rig?

Probably to best understand the audio aspects of CB, we'd better first come to a common meeting ground on the "nature of sound."

Sound consists of waves of air particles in motion. When one speaks, the air expelled by the lungs passes through the vocal chords, which set up vibrations of the air particles. These are amplified by resonators in the head and throat and the resultant product emerging from the mouth and nose is called voice. Sound produced by the human voice is usually periodic, or regular in pattern, and thus pleasing to the ear. Sound is perceived through the ear; the physical movement of air particles caused by the sound vibrate the membrane in the ear which then transmits the pattern to the brain where, through various complex nervous processes meaning is given to the perception of sound.

The sound itself has a frequency, which we perceive as pitch, determined by the number of its vibrations — the greater the number per second, the higher the pitch; a regularity or irregularity of vibration — with simple to complex patterns — which we perceive as quality; amplitude of vibrations which we perceive as intensity or loudness; and has an existence in time which we perceive as duration.

The frequency range of the human voice is about 90 cycles per second ("cps") to about 9,500 cps. The frequency response range of the human ear is about 20 cps to 30,000 cps. Optimum CB communications are obtained by proper utilization of the segment of the voice which lies between 500 and 2,500 cps.



The Turner SR-90-R carbon mike.

Microphones

The intermediary device which goes between your vocal cords and the audio section of your transmitter is a translating unit known as a microphone. We are all familiar with the names of the various types of microphones in use, although surprisingly few CB'ers are aware of the actual characteristics

and methods of operation of each. Let us get a general view of each of the basic types you might come across in your excursions through the world of audio.

The Carbon Microphone has a metal diaphragm placed against loosely packed carbon granules called the *microphone button*. As the sound wave strikes the diaphragm, a pressure is built up in the granules. This pressure increases and decreases as the voice pressures vary. The changes in the pressures within the mike button in turn change the electrical resistance of the mike which controls the audio amplifier tubes in a transmitter. This type of mike is excellent for mobile work where there are high background noise levels because it isn't particularly sensitive to sound which are not produced in its immediate area.

The electrical output of a carbon mike is about 0.1 to 0.3 volts into a transformer. The output of the transformer should give peaks ranging between 3 and 10 volts. A battery must be coupled to the button of a carbon mike to provide current which the granules can fluctuate as they vary in pressure.

The Crystal Microphone is centered around piezoelectric properties of Ro-

they do not require batteries and transformers.

The Ceramic Microphone is similar to a crystal mike, although somewhat



The Turner 350C Ceramic mike.

better acclimated to heat and humidity, with slightly lower output as a compromise.

The Dynamic or "Pressure" Microphone receives sound vibrations on a diaphragm and translates them into electrical impulses in a moving coil. The moving coil in the magnetic field, proportional to sound pressures acting on the diaphragm, generates a small electric current. Common characteris-



The Turner Model 80 Crystal mike.

chelle salts crystals. The output level of a crystal mike is generally about 0.03 volts with a 6½ foot mike cord (the length affects the output). Crystal mikes are adversely affected by large amounts of heat and humidity, and



The Turner 57-D Dynamic mike.

tics of these mikes are ruggedness, small size, light weight, broad frequency response and relative freedom from the effects of wind and moisture which makes them excellent for remote pickup broadcasting use, although

their broad frequency response is a bit too "hi-fi" for the best CB communications.

The Velocity or "Ribbon" Microphone is widely used in radio broadcasting studios. It consists essentially of a thin duraluminum ribbon suspended between two magnetic poles. When the



The RCA 44BX Velocity mike.

ribbon is set in motion by sound vibrations, small electric currents are developed. The mike is equally sensitive on the two opposite sides facing the ribbon but is comparatively "dead" on the two edges. The very high fidelity of these mikes (50 to 15,000 cps) makes them poor for CB communications. Made in two versions, high-impedance

it would appear that the better you sound, the better you will be heard.

The fact of the matter is simply that for two-way radio communications purposes, fancy audio is actually more of a hinderance than it is a help.

As mentioned further back in this report, your audio quality need be but from 500 to 2,500 cps for optimum CB communications. If we exceed these limits we must "back down" on the mike gain so as not to modulate over the FCC's permissible 100%.

The trick to getting your audio through the hash is to make every effort to compress your modulation down to these limits — junk the frequencies below 500 cps and above 2,500 cps before they reach the modulator.

Since the major portion of our "speech power" is concentrated below 500 cps, the elimination of these lower frequencies allows us to boost the remaining frequencies to a high level without overstepping the 100% modulation border.

Getting Rid of Low Frequencies

The easiest way to hack off the low frequencies of your voice is by the utilization of a small value coupling capacitor between the resistance coupled stages. When the grid resistor is .47 Megohms, a coupling capacitor of 0.001 ufd. should be inserted as shown in Fig. 2. It will have little effect on your voice at 500 cps, but will have it down

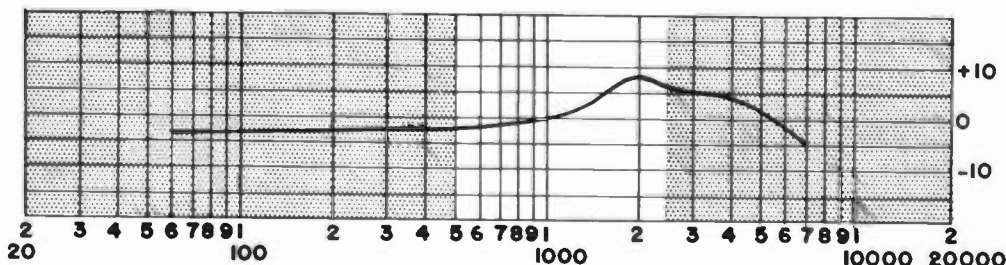

Fig. 1. This graph shows the response curve of a typical CB ceramic microphone. The mike picks up from 60 to 7000 cps. The shaded areas show the portions of the pickup which may be eliminated to produce clearer communications.

(with an output of about 0.03 to 0.05 volts), and low-impedance (for use with long connecting cables).

CB Fidelity

Perhaps you are wondering why the "better" fidelity microphones are not recommended for CB work. Certainly

5 db at 200 cps and 10 db. at 100 cps.

Slicing Off The Highs

High frequencies are simply reduced by the insertion of a 0.01 ufd. capacitor in series with a variable resistor ("pot") as shown in Fig. 2. The pot should be 25,000 ohms. This hook-up

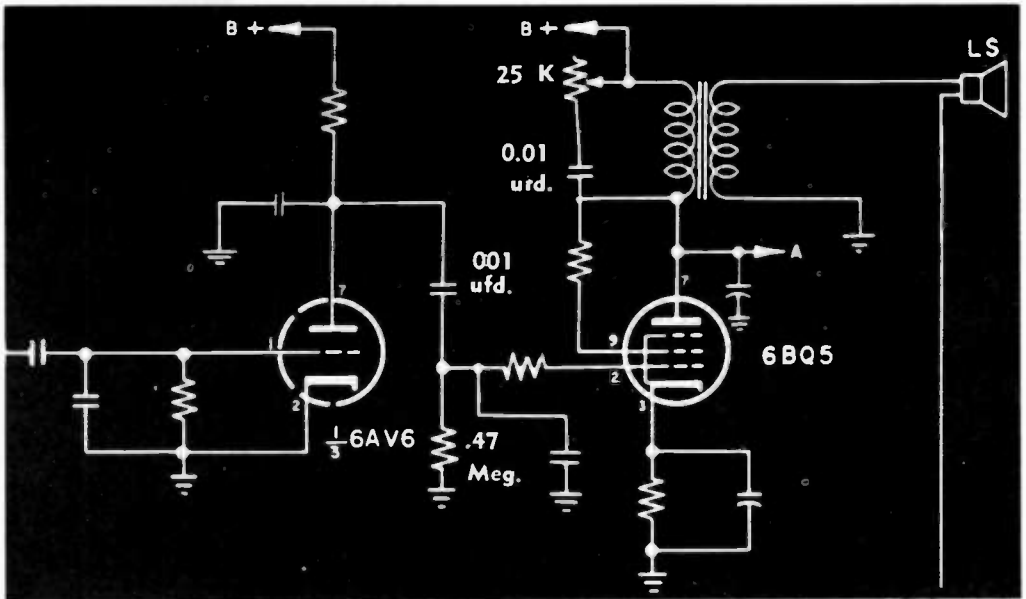

Fig. 2. This schematic shows the audio circuit of a typical CB rig. With the exception of the two tubes, the only component values shown are for the additions and modifications to the existing circuitry. These changes will give your rig "speech clipping."

goes across the primary of the modulation transformer. The pot is adjusted to cut the high frequencies to just above the point where the intelligibility

is hampered. This is done while monitoring the transmitter.

10-7



- Modernistically styled on-the-air Indicator in grey and black.
- Handsome 4"x8" oval casing of high impact styron.
- Mounts easily atop your equipment or on wall brackets.
- Internally illuminated, with bulb included, from standard 110 VAC line.
- Attaches simply; includes six feet of cord with 2-conductor AC plug.

Own the NEW hy-LITE by hy-gain

THAT PROFESSIONAL TOUCH
IN YOUR C. B. STATION

Here is the finest new accessory for Citizens Band use, a practical, handsome "On-the-Air" Indicator that tells when your station is in operation. Designed by Hy-Gain engineers, the Hy-LITE makes an ideal gift for the beginner or advanced operator.

Complete Line of Citizens Band
Antennas and Accessories

JUST

\$8⁹⁵

COMPLETE



antenna
products

DEPT. 262

1135 NO. 22ND • LINCOLN NEBRASKA

Read About The 1962 CB Callbook on Page 4A! 9

FEBRUARY IS FOR BASE STATIONS

By TOM KNEITEL, 10Q3161

Managing Editor

Now's a good a time as any to start taking a long, hard look at your base station. Mobile time won't be upon us for a few months yet so it's worth investing a little effort in improving same.

Presuming that you have selected the equipment which you feel will best suit your needs, the trick is to get the station operating at its maximum capacity.

For one thing, you might consider taking the rig to a licensed technician to have the frequencies checked, the receiver aligned (you'd be surprised how much your reception can be improved after a few months of "component aging,") and transmitter checked out and tuned up.

Examine your antenna, look at the coaxial cable to see if there are any punctures in the jacket, see if the antenna supports are holding-fast in the winter weather.

You might also wish to consider buying a few of the handy accessories on the market. These include audio compression units, vox units (we'll have an article on these in a month or two), multi-crystal switches, modulation and SWR bridges, phone patches, new mikes, extra crystals, dual-conversion units. Don't overlook the possibility of purchasing an entirely new rig (either a "transceiver or a component station) and antenna system. Remember that, unless you purchased your equipment very recently, you are not taking advantage of many developments which have been brought out in the past few months. Not that you should "throw up your hands" and walk away from last year's *dream rig* which you have, but you

might see how it stacks up against the stations currently on the air in your area.

In many instances, your used equipment can bring a healthy price or even be used as a trade-in towards new equipment.

Possibly even more than rigs, antennas have gone through an amazing change. Discones, colinear ground planes, miniaturized beams, miniaturized ground planes, and other exotic innovations will certainly give you improved service over a "standard" base station antenna, especially if it has been battling the elements through a few sleety winters and baking summers.

Winter time at a base station is also *soldering gun time*. When better than now to build yourself a *Q-Bird* (plans in December CBH), an easy-to-build receiver signal booster (plans in September CBH), or some of the projects which have appeared in other publications? Check through recent issues for designs which can be constructed in a minimum of time and without much expense. Best bets here are *ELECTRONICS ILLUSTRATED*, *POPULAR ELECTRONICS*, *ELECTRONICS WORLD*, *RADIO-ELECTRONICS*, and club publications which have technical sections. You might check with CB buddies who have built some of the projects to pick up short-cut pointers.

True, you can unpack almost any CB unit and plug it into 115 volts and an antenna and it will work. It's what you do *after* this which will make your base station better or best!

10-7

Flatten That

MOBILE NOISE

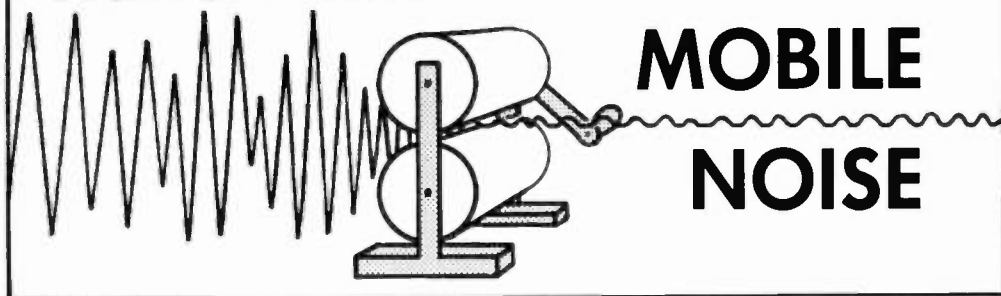

By **BOB COOPER, Jr. 12Q2339**

Publisher, **CB Horizons**

So much of our CB work is done with the mobile. Or to be more exact, as far as the FCC is concerned, *all of our work is done while mobile* as evidenced by the fact that **ONLY** mobile station licenses are granted in the Citizens Class D service.

It would seem, then, that in the annals of CB radio a goodly amount of attention, time and effort would go into the average mobile installation. Since you plan to do so much of your CB'ing while in motion, it follows that you should want to make it as convenient and pleasant as possible.

This, then, is a convenience article. And it is a pleasure article, because it will give you a number of helpful hints for doing away with the most annoying of all mobile irritations (excluding for the moment the wife)—**NOISE!**

Why Noise?

Complete elimination of radio noise coming from the car's mechanical and electrical system is *impossible*. Don't let anyone tell you differently. When some genius brags about eliminating *all* mobile noise, you might candidly ask him how his car is running. It probably isn't . . . or he is stretching the truth a bit. Radio frequency noise, which we hear on our CB sets when the auto motor is switched on, is the direct results of a running motor; A running gasoline motor, which obtains its power from igniting fuel. And fuel is ignited by sparks (appearing in

spark plugs). It is the development of this electricity (ignition coil) in the engine, and the firing of that electricity (spark plug and chamber) in a gasoline vapor that moves your car. The electrical sparking in your car is done at radio frequencies. As a matter of fact, you may have heard of the "spark-gap-transmitters" of old, used by the earliest hams. These transmitters had nothing on your car's ignition system! (Except perhaps an antenna)

So be it resolved . . . if we do completely away with auto noise, we have done away with the auto's power plant. Without the noise . . . (a result of an efficiently running engine) . . . we would be without motion because we would be without power.

Disappointed? *Read on.*

All of this is not to say that mobile noise cannot be curtailed. It can, and in many ways.

Let's look at a few of these.

Generator Hosh

Generator hash appears in the form of a low or high pitched whine tone that varies with the speed of the motor. It may be just as loud at 30 miles per hour in second gear as it is at 50 miles per hour in high gear. The generator will make noise, or it won't work. We don't *really* care if the generator makes this noise, as long as we don't hear it! So to suppress that noise, keeping it out of our receiver, we try to keep it away from the leads on the generator. The generator by itself will not radiate the noise, but the leads

will. So we place a 0.1 ufd. coaxial type condenser (Sprague 80P3) on the dynamotor frame connected directly in series with the armature lead (A lead). Most cars with auto radios already have large paper type condensers in this position. These condensers poop out at 2 megacycles, so replace with the coaxial condenser.

In some cars, this will not be enough to stop generator whine. The next step



MOUNTING NOISE FILTER—with instructions provided by Ben Bortlett (see text), it's a mobile noise cinch as 12Q2339—unit 4 found out. The filter rests on the air cleaner, foreground.

is a special Generator II Meter filter, such as the unit shown during mounting at CBH by 12Q2339, unit 4 (see photo), manufactured by Ben N. Bartlett, 1815 W. 85 St., Los Angeles 47, California. This little gadget is a resonant circuit consisting of a coil and a variable condenser which you place in series with the armature lead on the generator (see figure 1).

Last but not least in the generator department is *shaft hash*. It sounds ugly, and it is! Shaft hash is caused by static electricity building up on the rotating shaft of the generator. It is rare, but it can occur. You eliminate this type of noise by mounting a commonly available (at auto electrical supply stores) grounding brush to ride on the pulley of the generator. The brush will drain off the accumulating charge of electricity.

Regulator Hash

With the generator department well under control, let's investigate the voltage regulator. This is a small box usually mounted on the fire wall of the car in front of the driver's compartment. Its purpose is to provide an even flow of voltage from the generator to the car's electrical system.

Noise in the regulator is caused by sparking at the regulator points. It is an intermittent noise and can appear only when the regulator is working. To eliminate the noise, a 0.1 ufd. coaxial condenser (Sprague 80P3) is placed

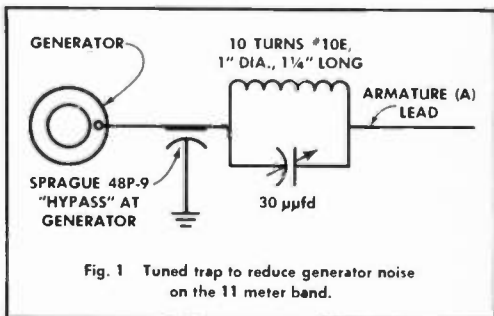

in the battery lead, (B-lead), directly at the regulator. A second 0.1 ufd. coaxial condenser should be placed in the armature lead (A-lead) directly at the regulator. The regulator case must be well grounded. The only remaining lead is the field lead (F). Do not attempt to by-pass this lead or you won't have a voltage regulator! However, you can wire in a 0.002 ufd. mica condenser in series with a 4-ohm, 1 watt, carbon resistor from F lead (Field) to ground. This will suppress the noise in this lead.

Ignition Noise

So much for the so-called primary electrical system of the auto. Now, let's tackle the secondary electrical system. Figure two depicts a typical ignition system complete with suppression. Let's examine the sources of noise in this department.

The ignition coil frequently radiates considerable noise. A 0.1 ufd. coaxial condenser (Sprague 80P3) should be mounted on the car frame and the primary lead from the coil run through the condenser (in series) to the primary ignition circuit.

The distributor is another source of

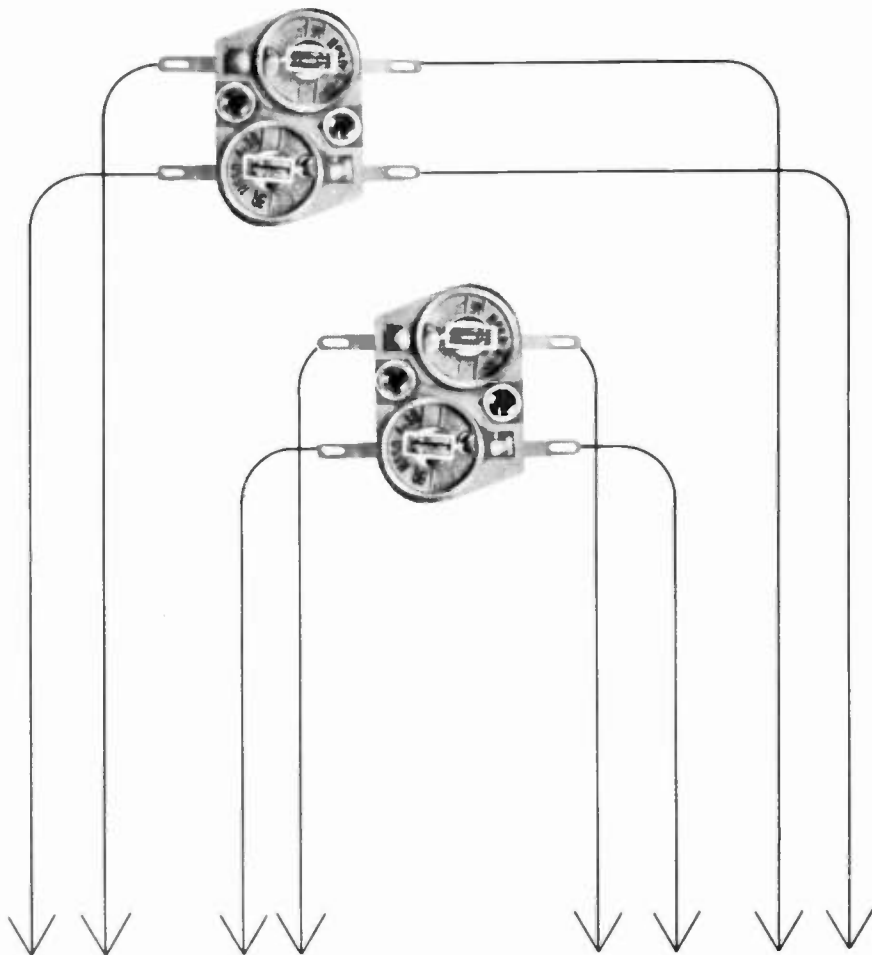

CB RECEIVE CRYSTALS?



write for free brochure

\$189.50

Slightly higher west of Rockies

Never with the Courier 1! Fixed receive is attained via 4 tunable trimmers, each hand-adjustable to any of the 23 channels. While on fixed receive a 5 kc band spread is at your disposal on the tunable dial...a feature not offered by crystal receive units. Courier 1 further provides 23 tunable channels. Think of the money you'll save on crystals! Think of the highly selective tuning, the drift-free receiving, the maximum adjacent channel rejection! Want to know more about the Courier 1? Check these features:

- 12 CHANNEL TRANSMITTING
- TRIPLE CONVERSION
- UNITIZED, HAND-WIRED CHASSIS
- LOWEST NOISE FRONT END (NUVISTOR)
- ELECTRONIC SWITCHING (NO RELAYS)
- BUILT-IN NOISE LIMITER & SQUELCH
- OVER 3 WATTS OUTPUT
- MOBILE OR BASE (117 V AND 12 V)
- BUILT-IN "S" & "RF" METER
- FULLY MODULATED (100%)
- CADMIUM PLATED FOR MARINE USE
- ENTIRE UNIT SLIDES OUT ON TRACKS



electronics communications, inc. 325 no. macquesten pkwy, mt. vernon, n. y.

trouble. Its purpose is to distribute the firing spark to the proper plug in proper firing sequence. Place a 10,000 ohm suppressor (Erie L7VR-10ME) in the center distributor arm lead, and 5000 ohm suppressors (Erie L7VR-5ME) in each spark plug lead, as the lead leaves the distributor cap.

Spark plugs are amazing devices. They can be likened to the final amplifier tube in your transmitter. Picture this. The spark plug potential varies rapidly between 1500 volts when firing and 8000 volts when idling. These rapid changes in potential generate a tremendous amount of radio noise, which sounds not unlike a machine gun firing in rapid succession, increasing in crescendo as the car's engine speeds up. At high speeds the firings come so close together that the noise seems to be almost constant, as one plug firing overlaps the next. There are three methods available for killing spark plug noise.

spark plugs to back up into the spark plug cabling, but because of the shielding in the cable, the noise will not radiate away from the cable to your CB set.

The high voltage-ignition wiring is frequently a source of noise radiation. Remember that in the auto there are a number of noise makers (i.e. generator, voltage regulator, distributor, spark plugs), but these will seldom cause noise that you can hear, until they are connected to some type of radiating surface. The car's wiring is that radiating surface, much like your CB antenna responds to your CB transmitter signal. If you eliminate the noise at the source (generator, etc.) you won't have to worry about the wiring. You should keep the wiring clean, free from oil, and above all, keep all contacts rigid-solid-and clean. Dirty contact points at any spot in the wiring can cause trouble and radiate noise.

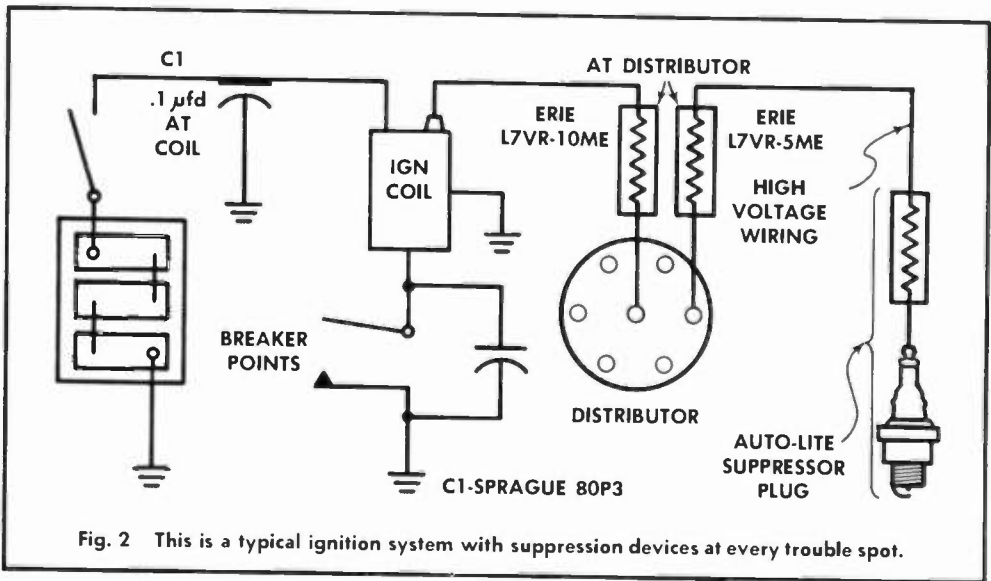

- (1) Use resistor spark plugs which have built-in suppressors.
- (2) Place 10,000 ohm suppressors (Erie L7VR-10ME) at each plug just above the cap on the plug, in the lead from the distributor.
- (3) Resistive ignition cables. This allows the noise generated in the

Flukey Noise Sources

After all is said and done, you may still have auto noise. Remember that without the noise generators (i.e. the generator, voltage regulator, distributor and spark plugs) there would be no possibility of the engine working. You

(Continued on Page 50)

EXCITING NEW CONCEPT IN FIXED LOCATION CB ANTENNA

**insures absolute
control of
radiation range
with
solid coverage
to maximum
range limits . . .**

the amazing



FUTURA I by **Stinger**



Only the **FUTURA I** can have its entire radiating element at maximum F.C.C. Limits



Only the **FUTURA I** exhibits negative horizontal polarization, virtually phasing out auto ignition and man made interference; with a resultant lowering of background noise by 12 DB.

For further information on the amazing **FUTURA I**, or for your nearest **STINGER** Dealer, send this coupon to:

The STINGER CORPORATION
3160 E. Imperial Highway, Lynwood, California

Name _____

Address _____

City _____ Zone _____ State _____

DISTRIBUTION INQUIRIES INVITED

The **FUTURA I** is a vitally new concept in CB Fixed Location Antenna. By Virtue of its disc and cone design, it radiates maximum power in a vertical plane with negative angle of radiation.

The **FUTURA I** is made of durable lifetime material, is compact, easily installed and requires no maintenance or upkeep.

- * **FUTURA I** . . . has extremely low reflected power across the full frequency spectrum.
- * **FUTURA I** . . . can be mounted to full F.C.C. maximum height and complies with both Parts 15 and 19.
- * **FUTURA I** . . . has a negative angle of radiation (positive radiation angle disc is available)
- * **FUTURA I** . . . completely eliminates skip transmission and fringe area signals.
- * **FUTURA I** . . . provides absolute control of radiation range . . . has extremely sharp range cutoff characteristics . . . assures solid coverage to maximum range limits.
- * **FUTURA I** . . . carries a 5 YEAR REGISTERED WARRANTY.

Lifetime weatherproof construction
• Low wind resistance • Designed to enhance the decor of any structure and comes in a variety of decorator colors.

BUILD KYLE'S TVI FILTERS

By JIM KYLE, 10W0901
CBH Western Technical Editor

TVI filters are by nature devices designed to allow one set of signals through while attenuating a second set of signals. In the case of the filter which you place on your transmitter, you want the 27 megacycle CB signal through to the antenna, but at the same time you wish to attenuate or wipe out entirely any harmonics (multiples of your 27 megacycle signal, ie. 54 mc/s, etc.) which may otherwise get to the antenna and radiate. It is most often harmonics which cause the greatest amount of TVI to neighborhood TV receivers. If your transmitter is radiating a second harmonic (near 54 mc/s), this harmonic signal is coming out on TV channel 2. This means that your neighbors are receiving not only the channel 2 television station (if you have on locally) but also your "channel 2" signal. No wonder their TV sets go crazy when you are on the air.

Some of the text to follow, and diagram 1 will show you how to cure this problem.

Another form of TVI is caused by a properly operating transmitter (ie. no harmonics) next to an improperly operating television receiver. This is called over load and nothing you can do at your transmitter will cure the problem, except of course your shutting down operation. This problem must be tackled at the TV receiver, with a filter as shown in figure 2. A true low-pass filter is simple electrically but mechanically complicated; in the interests of economy and ease of construction, what we're describing here will actually be a "harmonic trap" which accomplishes the same purpose. To build and install it, you'll need: 7 feet of coaxial cable of the same type you use for your antenna feedline; one male coaxial fitting which mates with your transmitter's output connector; and one "tee"

coaxial fitting which mates with both the male plug and the transmitter connector.

Attach the male fitting to one end of the 7-foot cable. Disconnect your antenna feedline from the transmitter and put the "tee" fitting on its place. Reconnect the feedline on one outlet of the "tee" and connect the 7-foot cable via the male fitting to the other "tee" outlet. Last, but far from least, stick a common sewing pin through the 7-foot cable at the far end in such a manner as to short the shield and the center conductor of the coax together. With-

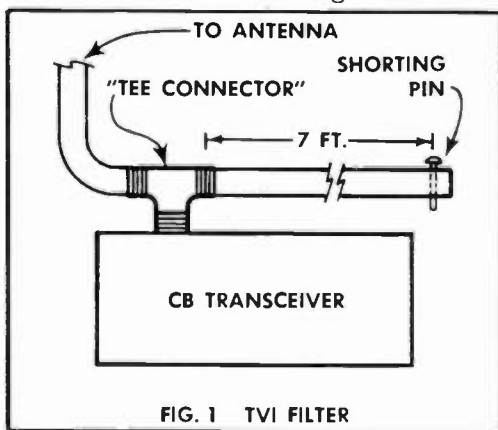

out this shorting pin, the harmonic trap will short-circuit your signal and may easily damage your equipment!

Now, make a series of brief transmissions on the channel you use most frequently. Between transmissions, move the pin down the cable, going only about an inch at a time. At some point in the neighborhood of six feet from the tee, the pin should cause notable reduction of interference. When you get to this area, move it only about $\frac{1}{8}$ inch between transmissions, until you find the point at which moving the pin either way produces less rather than more reduction in interference.

When you find this point, turn off the rig and make a permanent short across the cable where the pin is located. The best way to make a permanent short across the cable, once you have found the best position with the pin, is as follows: Snip the coax off $\frac{1}{8}$ th of an inch down the 7 foot piece between the pin and the open end. Bare the braid on the coax back $\frac{1}{4}$ th inch and the center conductor back $\frac{1}{8}$ th inch. Solder the two together (form a short) at the exact same spot where the pin had previously gone through the coax.

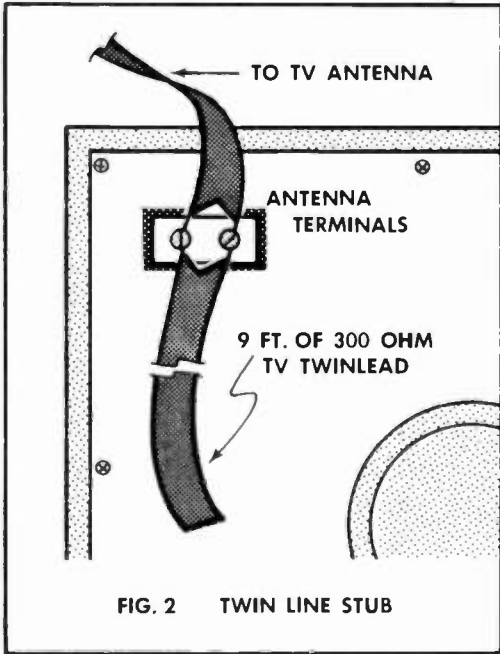

FIG. 2 TWIN LINE STUB

Take nine feet of 300-ohm twinlead, and a pair of wire-cutters. (We use 9 feet here instead of 6 feet because the signal travels faster on the twinlead, and this "velocity factor" changes the physical length of the electrical wave.) Connect the twinlead to the TV set in parallel with the existing antenna lead. Since here, you want to short out *your* signal while leaving the TV channels unaffected, the other end of the twinlead is left open-circuited. Just cut chunks off the open-circuit end, about half an inch at a time, until the interference disappears or begins to get worse again.

10-7

it's **VOCALINE** for advanced design and circuitry—newest features!



**SELF-POWERED
RECHARGEABLE
PORTABLE CB
with
AM RADIO—
up to 8 miles
Model PT-27**

- ✓ Tunable double conversion superhet receiver
- ✓ 4 fixed channels
- ✓ Antenna tuning and meter up-front
- ✓ 18 transistors—5 diodes
- ✓ Plus noise limiter, squelch, built-in battery charger, many other features

Complete with antenna, microphone, charger cord.

**NEW,
IMPROVED
VOCALINE
MODEL ED-27M
4 CHANNEL
BASE UNIT**



- ✓ double conversion superhet receiver
- ✓ improved selectivity—eliminates undesirable adjacent channel interference
- ✓ the most powerful "legal" set on the air today:
- ✓ 6 VDC/115 VAC or 12 VDC/115 VAC

complete with microphone, mounting bracket, AC-DC cords.

— WRITE FOR FREE LITERATURE —

VOCALINE COMPANY OF AMERICA, INC.

24 Coulter St., Old Saybrook, Conn.

Name

Address

City Zone State

Build This "Cheap and Easy" CB Converter!

By ALTON E. GLAZIER, 12W0420/K6ZFV

Asst. Engineer, Sofe-T-Mike Corp.

Have you been looking for a converter with plenty of suds, which is easy and inexpensive to modify? Sounds like a pipe dream, but it's all for real.

If you are tired of receiving only the limited number of channels for which you have crystals, and would like a complete sweep of the 11-meter band so you can keep track of all that is going on, here is your answer.

This Citizens' Band converter is built around the readily available surplus SCR-522 front end, which includes the RF and mixer stage, and was made as a replacement unit for the 522. These units are available from surplus houses* at a cost of \$1.00 to \$1.50 each.

The unit is ruggedly built, and of the highest quality components. As its original frequency was approximately two meters, the conversion of this unit has been kept to a minimum, and if desired, no changes whatever are necessary to the receiver. The first conversion is at approximately 1500 KC, thereby placing the image frequency away by three megacycles. The selectivity will be governed mostly by the quality, including the bandpass of the receiver used.

Step No. 1: Remove all but three plates from the rotary sections of the capacitors. This is easily done by using long-nosed pliers, grasping the plate and twisting. The three remaining plates of each section will cover the Citizens' Band and the 10-meter band. If greater bandspreading is desired, one or two more plates may be removed.

Step No. 2: Remove coils L-1, L-2 and L-3. These are mounted on the piston capacitors, and are readily removed by unsoldering. These coils are

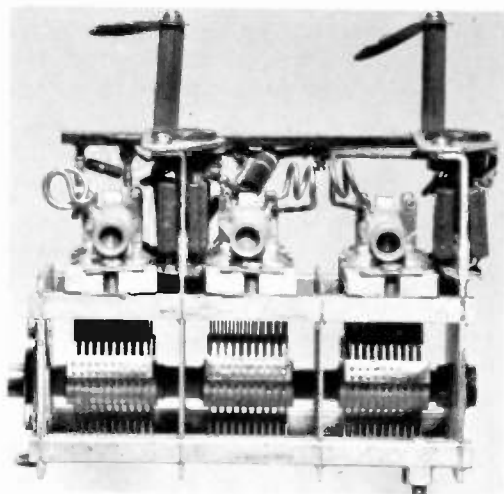

SCR-522 front-end "before."

replaced with coils made of 12 closely wound turns of #18 enamel wire formed on a one-half inch dowel. The leads on these coils should be kept as short as possible. The antenna coil is made of plastic hookup wire, two turns around the grounded side of the coil. The two ends of this coil are brought to a tie point which is soldered on the front end of the unit. One lead goes to the ground post, and the other will go to the coax cable to the 27 MC antenna.

Step No. 3: Remove capacitor from pin #2 of V-2. Replace with a Z-28 choke.

Step No. 4: Remove the 1,000 Ohm resistor from pin #7. Do not discard.

Step No. 5: Remove resistor lead from pin #1 and replace this to pin #7.

Step No. 6: Solder a 22,000 ohm resistor to pin #1 of V-2. Solder the opposite end to ground.

Step No. 7: Solder a 100 MMF capacitor from coil L-2 to pin #7 of V-2. This capacitor shall attach to the same side of L-2 as pin #5 of V-1.

(Continued on Page 20)

*General Surplus Bldg. 735, Oakland Airport, Oakland, Calif. and Encinal Sales Co., Bldg. 647, Oakland Airport, Oakland, Calif.

NOW!

VERIFY SIGNAL LEVELS with FRONT PANEL "S" METER TUNE ALL 23 CHANNELS with FULLY TUNABLE RECEIVER

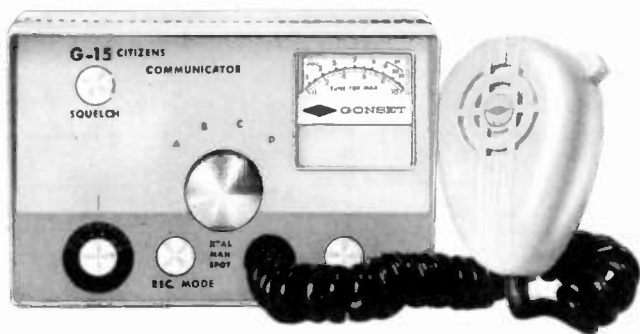

**THE GREAT NEW GONSET G-15 CITIZENS BAND TRANSCEIVER
GIVES YOU THIS EXCLUSIVE COMBINATION
PLUS THESE QUALITY FEATURES!**

- Tunable receiver independent of channel switch position.
- Maximum adjacent channel rejection and interference suppression with dual conversion superheterodyne receiver.
- Maximum talk power (100% modulation).
- Highest audio output.
- Maximum usable receiver sensitivity.
- Compact and rugged construction.
- Universal low-drain power requirement.
- Heat-proof ceramic microphone.
- High efficiency circuitry provides maximum power to antenna.

A quarter century of experience endows Gonset equipment with built-in quality for outstanding performance.

Write to Dept. CB-2 for name of Gonset distributor nearest you.

 **GONSET®**

DIVISION OF YOUNG SPRING & WIRE CORPORATION
801 SOUTH MAIN STREET, BURBANK, CALIFORNIA

Step No. 8: Remove resistor from pin #6 of V-2 and pin #6 of tie bar. Replace this resistor with the 1,000 ohm resistor previously removed in step #4.

Step No. 9: From pin #5 of V-2 install a 1 Mh choke. Connect opposite lead to pin #6 of tie bar.

Step No. 10: Place one end of a 100 mmfd condenser to pin #5 of V-2. The opposite end goes to a two-terminal tie point. This tie point is mounted on the back of the converter by soldering the ground terminal of the tie point.

Step No. 11: Using a short length of shielded cable, connect inside conductor to the 100 mmfd condenser at the tie point, and the shield is soldered to the ground terminal. The opposite end of the cable, the inside lead goes to the antenna post, and the shield is ground-

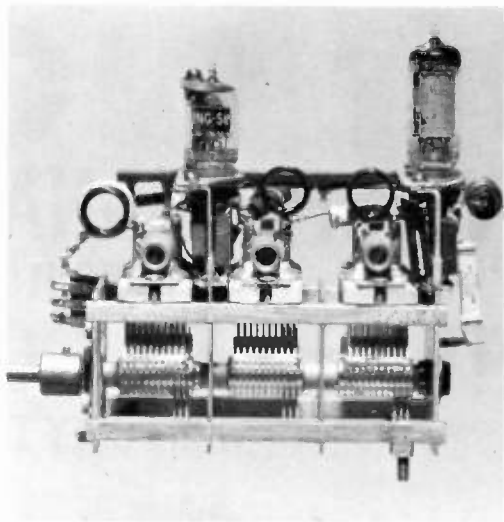

SCR-522 front-end "after," install shaft reducer, reduction dial, place in Minibox and you're in business.

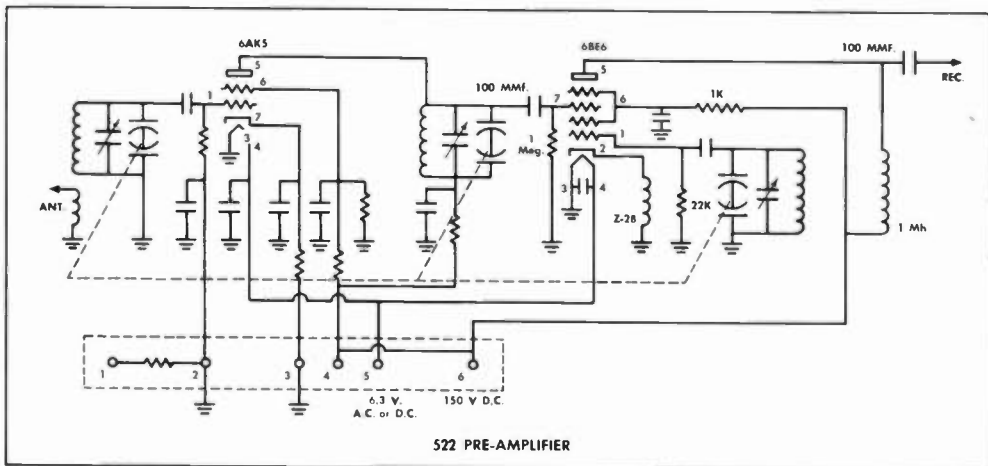

The conversions to the SCR-522 are shown here. All unmarked components are part of the existing circuitry, a listing of the ports needed for the conversion is given below-right.

ed to the receiver.

Step No. 12: Referring to the electrical tie bar, starting from the front of the converter, pin #1 through #6, connect a lead from pin #6 to pin #4. Connect a lead from pin #2 to the ground of the converter.

This completes the conversion.

To put the converter in operation, place a 6AK5 at V-1 and a 6BE6 at V-2. Place 6.3 volts at pin #5 of the electrical tie bar. Place a ground lead from pin #3 to converter. At pin #4, place

(Continued on Page 51)

Parts List

- 1 surplus #522 front end (RF and mixer)
- 3 coils (L-1, L-2 and L-3. 12 turns of #18 enamel wire, closely wound, 1/2" inside diameter)
- 1 ontenu coil (2 turns plastic hookup wire, wound directly on the grounded side of L-1)
- 2 2-terminal tie points
- 1 Z-28 choke
- 1 22,000-ohm 1/2 watt resistor
- 2 100-mmfd copocitors
- 1 1-Mh choke
- 1 short-length shielded cable
- 1 6AK5 tube
- 1 6BE6 tube
- 1 minibox
- 1 shaft reducer
- 1 reduction diol

COVER STORY - -

1962 MEANS NEW CB CALL SIGNS

A CBH SCOOP!

In the Citizens Radio Service, the registered serial number appearing on each station license document is required by the FCC's rules to be used also as the radio station call-sign. In the past these serial numbers have been made up of an arbitrary arrangement of one or two digits, one or two letters, followed by a four digit serial number. Because these serial number-call signs bear no resemblance to call signs issued in accordance with international agreement, it has been decided that all future serial numbers of citizens radio stations will be taken from the international call-sign series available for assignment to stations of the United States. However, currently licensed stations will continue to use the call-serial numbers issued to them from the old series until such time as each license is renewed, modified or superseded. Licenses will NOT be modified solely for the purpose of changing the call sign.

Beginning this past January 1 (1962) for Class B, C and D stations, the call signs (serial numbers) assigned to stations licensed in the Citizens Radio Service will consist of three letters followed by four digits. As before, the digits will be assigned in numerical order from 0001 to 9999 following each three-letter prefix. Examples of such complete call-signs are KCB-4526 and KHR-2345.

The first letter of each prefix in the call sign-serial numbers will be the letter "K" to indicate that the station is licensed by the United States. The two letters which follow will have various uses for record and enforcement purposes of the Commission, and may indicate the class of station involved (Class A, B, C or D), the approximate date of issuance of the license, and the Radio Inspection District in which the licensee has his mailing address. Serial numbers beginning with KAA through KAF will be assigned in sequence to Class A stations and may be reassigned to the same stations, indefinitely, upon proper application for renewal or modification. This call-sign continuity, however, will not be possible in the case of Class B, C or D stations, where the large number of applications and licenses has forced the Commission to adopt streamlined administrative procedures in order to handle the workload. These procedures require that every Class B, C or D license application be treated as a completely new one and that a new call-sign be assigned in every case. This, in turn, means that "modified", "reinstated", or "renewed" Class B, Class C, or Class D licenses will each carry a new call-sign. The former serial number (call sign) is thereby superseded IN EVERY CASE and may no longer be used to identify the station.

During the calendar year 1962, all Class B station license serial numbers will be identified by the prefix KAG; all Class C by the prefix KAH, and Class D station licenses in the various Radio Inspection Districts by prefixes KBA through KJE. The tentative list of such call-sign prefixes is on our cover this month—another CBH first! Who'll be the first to "borrow" it from us?

TREND FOR '62? MODULAR CB STATIONS

By HERB FRIEDMAN, 2W6045

CBH Eastern Technical Editor

If you follow the advertisements in the electronic publications you have probably noticed the slow but steady increase in the makes and type of modular CB equipment.

Modular equipment is usually an individual section of a CB transceiver. Among others, a module can be a complete receiver, a transmitter less power supply or a converter. And because they are coming into common use we will include R.F. preamplifiers and Selective I.F. amplifiers as modular equipment.

Each type of module has its advantages and disadvantages; in a given situation, a module can have above average value for the CBER.

Converters

The converter module probably has the most potential for CB use so we will discuss it first.

A converter is a device which converts a 27 mc. CB signal to a signal with a frequency falling in the standard broadcast spectrum. Therefore, if the output of the converter is fed into, let us say, an auto radio, by tuning the radio you would be tuning the CB band.

The usual converter (and there are exceptions) has an R.F. amplifier, oscillator and mixer, exactly the same line-up as the usual CB receiver.

Essentially, the auto radio provides the IF amplifier and the audio amplifier. The overall result can be equivalent to a high quality receiver since the usual radio has two stages of 455 kc. IF (or maybe even 265 kc. IF). Selectivity can be high enough to reduce adjacent channel interference to virtually zero.

It is the pick-up in selectivity which is one of the converter's greatest ad-

vantages. To illustrate: consider the "fate" of a CBER owning a "Benton Harbor Lunchbox" (Heath CB-1). The transmitter gives good performance but the superregenerative receiver, which suffers from a lack of selectivity, is sort of rough in metropolitan areas. The usual recourse is to purchase a transceiver with a selective receiver section. But since the transmitter and



Philmore's CC-1 Converter.

power supply is good, why spend over a hundred dollars just to get a new receiver? By connecting a converter to a BC radio a high quality receiver can be had for about twenty-five dollars.

There are other advantages to the converter such as "paging." Where one-way communication is needed the converter fills the bill inexpensively.

The converter's disadvantage is primarily its need for a separate noise limiter. Regardless how low an auto's inherent noise is reduced, there is excessive ignition noise due to passing vehicles. To reduce ignition noise to a tolerable level, a noise limiter *must* be wired into the radio.

Converters utilize several types of power sources and you must be sure



Two new modular units on the CB horizon, Browning Labs' 23/S-9 all channel transmitter and the R-2700A deluxe receiver. See page 53 this issue.

the converter you choose will match your power source.

Complete Receivers and Transmitters

Receivers and transmitters are available as separate modules.

The receivers feature high selectivity, S-meters, frequency stability and the other features you would expect in a quality receiver.

The transmitters offer the real extras. For instance, speech limiting and filtering is employed.

A speech limiter clips the high level impulses, permitting the average modulation which is usually about 25% to be raised to nearly 100%. The end result is very high talk-power.

The filter eliminates the harmonic distortion caused by the limiter and as a by-product sharply reduces the frequency response over 3000 cycles. With low frequency attenuation through microphone or amplifier design the total result is an extremely "sharp," high level modulation which is very effective at low signal strength or QRM conditions.

Another feature of the transmitter module is the built-in modulation meter. This meter indicates the percent modulation, enabling you to maintain a consistent high level of modulation.

Another transmitter module is an inexpensive basic unit, containing the familiar third overtone transmitter circuit.

It's chief advantage is that you can build up a station as the budget per-

mits. It's disadvantage is the need for a separate power supply.

RF Preamp

The idea behind the preamp is more receiver gain, since there are times when just a "little bit" more gain means the difference between reading and not reading a station.

While the proper place to add extra



A real CBH Scoop. The new International Crystal MP-1 Nuvistor CB preamp . . . never before seen! Details next month.

gain is, in the IF section (there are also other reasons), this is not easily accomplished. However, it is relatively easy to connect an RF preamp.

For further specs on modular equipment consult the CBH Directory in the August, 1961, issue or the revised one in the 1962 CB Callbook/Handbook.

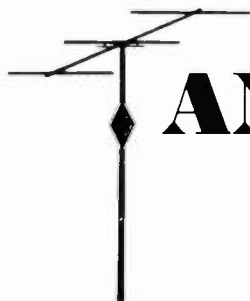

ANTENNA TOPIX



BE HAPPY, GET SNEAKY

By DEE CALVI, 10Q2952

There's no problem in installing a CB antenna on your mobile rig, that is, other than putting the idea across to your XYL. There is a problem often to those who wish to install a base station antenna—whether they own or rent a home or apartment.

If you rent, you have the landlord to contend with; if you own, you have the neighbors. And, of course, a big CB antenna on the roof is like an immense arrow which points to you as being the cause of all the TVI in the city.

To beat the rap, CB'ers have devised several clever ways around the problem, a few of which we will look at here.

The Base Station Whip

The easiest way around the *no antenna buggaboo* is by the simple installation of a ball jointed mount base, a small spring, and a 102" whip on your window sill.

If there is no place handy to hook the shield side of your mount, you might consider trying out some wire "radials" of 102" wire, about 4 of them. They should be hooked to the shield side of the mount and spread out in as large a radius as possible.

Commercial Jobs

If you're lazy but would still like to fake-out the landlord and neighbors you can take advantage of something which Telrex Labs. (Asbury Park, N.J.) has cooked up.

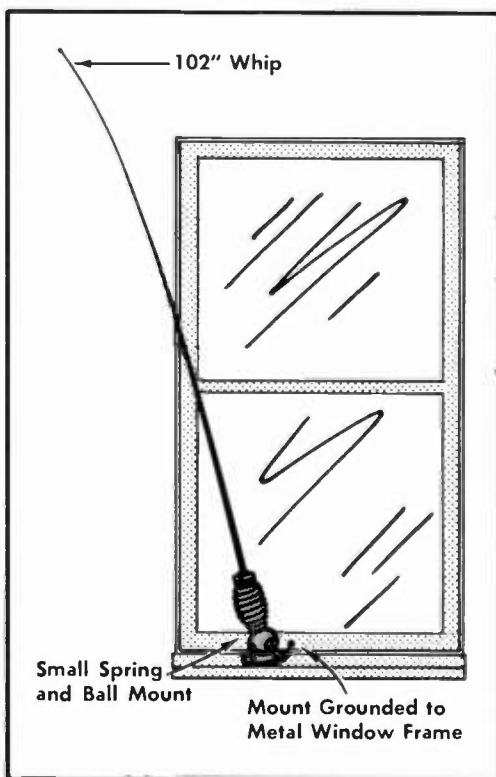

They have two 11 meter antennas specifically designed to look just like TV antennas and you couldn't spot one as a CB antenna in a month of Thursdays.

One antenna, the *Mini-Bowtie* has a bi-directional pattern and the other, the *Mini-Beam* has a regular beam pattern and may be used with a regular TV rotor.

10-7

NEW...
The World's most advanced
11 meter two-way radio...



General is in command with the new MC 5

3.25 watts minimum output. • New phase-reversal modulation transformer for unparalleled talk power. • New Zener Diode shunt noise-clamp and series gated limiter circuit for highest noise limiting ever achieved. • New ultra-low drift oscillators for unsurpassed stability. • New Hi-level Tone-Signal. • 15 watt construction.

Net Price including microphone and crystal... \$199.95.

90 day warranty. F. O. B. Burbank, California

FREE - Write for schematic and complete technical manual

Under present rules part 19.32 the FCC does not provide for more than five (5) watt input in the Citizens Radio Service (26.965-27.225 MC Band).

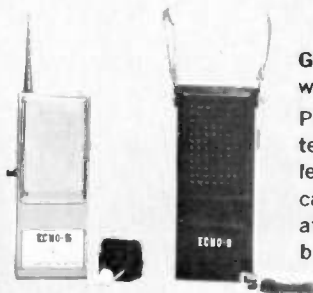

General's new all transistor two-way pocket radio-telephone.

Push to talk communication system, 9 transistors, complete with leather case, earphone in leather case, batteries, "Ready to operate," \$59.95 each, F. O. B. Burbank, California.

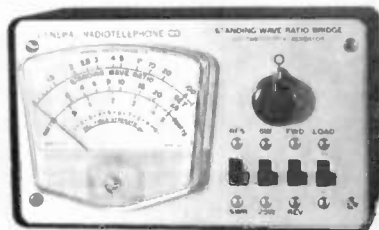

General's Model 615 Multi Function Bridge. The only single precision instrument that measures True Power, Standing Wave Ratio, Relative Field Strength. Net price \$39.95.

F. O. B. Burbank, California

FREE - Write for schematic and complete technical manual.

Your dealer or write:

General Radiotelephone Company. DEPT. E2

2806 West Burbank Boulevard, Burbank, California



NEW CB PRODUCTS OF THE MONTH

The *Antenna Specialists Co.* (12435 Euclid Ave., Cleveland 6, Ohio) has come up with three brand-new mobile antennas for CB'ers.

The first is their M-67 roof-top job which affords omni-directional signals. It comes with 12 feet of coax and a cable. The antenna is base loaded, 39" high and made from stainless steel with a grey base.

The M-73 is the same antenna designed with a different base for trunk-groove mounting. The M-74 is again the same, but for cowl or deck mounting.

By the way, last month we told you about the lab test we made on Antenna Specialists' *Magnum 27* ("Maggie") antenna. We inadvertently referred to the *Maggie* as the "Model M-27." This is incorrect, the official monicker for the *Maggie* is "Model M-81."

While we're re-hashing our old goofs, we've been informed by *K&M Electronics Company*, 4991 Excelsior Blvd., Minneapolis 16, Minn., that their company *Miratel* has purchased all rights to *Morrow Radio Company* products and has, by the time you read this, resumed production in Salem, Oregon. We had previously been informed that the *Morrow* line had been taken up by an outfit in Stockton, Calif.

A new book has arrived upon the CB scene which should bring joy to those who have tried to wander through a CB rig without benefit of a schematic. This publication, called *Citizens Band Radio Manual, Vol. 1*, includes the following information on 46 popular CB

rigs: schematics, chassis photos, parts lists, replacement data, alignment information, plus other time saving data.

The whole deal is 160 pages of 8½" by 11" pleasure and is available for \$2.95 from *Howard W. Sams & Co.*, 1720 East 38th St., Indianapolis 6, Ind., or from many electronic parts distributors and bookstores who stock the *Sams* line.

Rigs covered in the Vol. 1 are: *Apelco AR-9*, *Citi-Fone CD5/6*, *CD5/12*, *Globe CB-100*, *Pocketphone*, *Gonset G-11-3303*, *-3304*, *-3305*, *G-12-3316*, *-3329*, *Hallicrafters CB-1*, *Heath CB-1*, *W-CB-1*, *Lafayette HE-15*, *-16*, *-18*, *Morrow CB-1*, *-2*, *-3*, *5W1-6*, *-12*, *-117*, *5W3-6*, *-12*, *-117*, *Radson RT-70A*, *-75A*, *RP-115*, *-612*, *Raytheon Ray-Tel TWR-1*, *RCA CRM-P2B-5* (ml-555528, -555529), *CRM-P3A-5*, *Realistic TRC-27*, *Regency CB-27*, *CBM-27-6*, *CBM-27-12*, *USL TR-800*, *Johnson Viking 242-126*, *-127*, *-128*, *-129*, *Vocaline ED-27-6*, *-12*, *-M-6*, *-M-12*.

Also included in the book is a 5½ page section on CB servicing.

Here's a new company on the CB horizon, *Euphonics Acoustics, Inc.* of P.O. Box 713, Rio Piedras, P. R. They



The Euphonics C-47

have come up with two new microphones designed for CB service, their Models C-47 and T-46.

The C-47 and C-47D mikes are pressure type ceramic jobs with high-impact polystyrene cases. Comes with

coiled-cord, PTT switch, hang-up button. The C-47D is a noise cancelling differential version. Both mikes have a 50 to 8,000 cps frequency response.

Their T-46 mike is a ceramic unit in a polystyrene case with a pull-out desk stand in back. Has 50 to 8,000 cps response.



General Radiotelephone has given CBH the scoop on their brand new Model MC-5, with the 6BS8 in the final. Rig has 6 transmit channels and an external crystal socket, plus 4 fixed receive channels and tunable. Receiver is superhet with 6 kc selectivity at points 6 db. down. Has built in "Q-Bird," local/distant switch, 7 tubes and 9 semi-conductors. The 6BS8 in the final will allow 13 to 16 watts input for operation on the 10 meter ham band. Has S-meter.

Information on this baby can be obtained from "Chazz" Messenger, 11W4165, Chief Engineer, General Radiotelephone Co., 2806 W. Burbank Blvd., Burbank, Calif. CBH wishes to thank *General* for their ever-lovin' cooperation in giving us this scoop.

Heath (Benton Harbor 15, Mich.) has come out with their new GW-11 transceiver kit. The GW-11 has 3 transmitting channels, single crystal controlled receive channel plus tunable, squelch, ANL, push-to-talk, and S-meter.

If you know of any new CB products why not pass along the information to CBH? Manufacturers are invited to send us their press releases for publication in this column. If it's CB and new, we'll use it.

10-7

The CBH Lab Reports . . .

WE TEST

- ☆ The Poly-Comm "N"
- ☆ The ELENCO Power Gainer
- ☆ The Knight Model 400 Tube Checker
- ☆ The Mork "Super Beacon"
- ☆ The Mobil-Plane MP-1
- ☆ The Utico Town & Country

THE POLY-COMM "N"

By HERB FRIEDMAN, 2W6045
Eastern Technical Editor

Once again we had the pleasure of testing a "high selectivity" transceiver—the Poly-Comm "N" ("N" for the low noise Nuvistor used for the RF amplifier).

The Poly-Comm "N" has four channels and is crystal controlled both transmitting and receiving.

The receiver section is double conversion, with three stages of 455 kc. IF resulting in exceptional gain and selectivity. With a weak channel 7 signal being received, an equivalent S-9 channel 8 signal caused no interference.

The Squelch is particularly good. While it appears that at the critical point the squelch is either all-in or all-out (the sign of a squelch difficult to "break"), it will release on the weakest of signals.



The noise limiter which has an ON-OFF switch is very good. The receive

audio quality is particularly clean.

One receiver feature we liked was not indicated in the schematic. The Volume Control did not turn the volume completely off. A signal, though low in volume, can always "break through." We like this feature and hope it wasn't just our unit.

The transmitter is as good as the receiver. When checked with our SECO 510 the Poly-Comm "N" delivered 3.2 watts. (Our 510 may be inexpensive but it's accurate.)

The modulation hit 100% with very clean quality.

A lamp on the front panel is provided to insure peak tune-up. Maximum brightness denotes peak output.

The Poly-Comm "N" comes with a Universal Mounting Bracket which (for a change) is truly universal. Its amazing how many different ways you can *easily* mount the bracket.

The power supply operates either from 120v. AC or 12v. DC. Both power cords are provided.

Our conclusion: An excellent transceiver which should be considered where dependable communications are necessary under severe noise and QRM conditions. It's as good as any unit we've seen yet.

The ELENCO Power Gainer

Back on page 21 in the December CBH we broke product news on the ELENCO Power Gainer, a device which connects to your CB transceiver between the microphone and the microphone input jack. Some would call the unit a "mike-preamplifier." *They would be wrong.*

The Power Gainer is a *compression* amplifier which makes up for the inadequacies in the human voice by bringing the high's and lows in your voice up to an equal level, and then pushing them at this amplified and equalized level into your transceiver. And just to make sure it is doing a good job, the Power Gainer checks up on itself in the Modulator stage (see diagram) sampling your modulation, and feeding the modulation data back into the Power Gainer where the unit again corrects for any mis-calculation

the first time around! If this sounds complicated, perhaps you will keep this in mind as we tell you how well it works.

The Power Gainer acts as an automatic gain control on your modulation, which permits a high average level of modulation. The control on how high



a level is maintained comes from the modulator tube in the transceiver itself.

Installation is detailed very completely in the instruction sheets provided with the unit. The total installation time will vary from transceiver to transceiver—our's took 30 minutes with the Kaar 327B.

The photo shows the unit mounted on top of the 327B, and the component parts needed for installation (provided by Elenco). First you place the provided 5 prong plug on the end of the mike cable. Next you place your mike plug on one of the two cables coming from the back of the Elenco. Third, you connect a .01 ceramic capacitor (provided of course) to the plate tube on your modulator (usually a 6AQ5 in most sets). Fourth, you mount a pin plug socket in the back of your transceiver, to connect your Elenco into the plate of the modulator tube through a quick disconnect plug.

Lastly, you plug everything together, turn the rig on and determine your proper control settings on the Power Gainer (you have five controls to play with—lots of fun!).

Finally, you go on the air and blast your fellow CB'ers out of their saddles with such tantalizing comments as "yeh—I know I sound stronger . . . course

I'm practically running four times my old power now."

You really aren't, you still have five watts. But now that five watts is work-

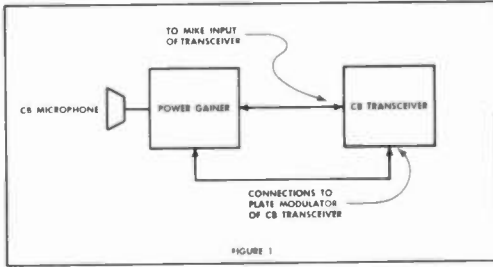

ing as a full 100 percent modulated five a high percentage of the time . . . and you will have *four times* the sock and audio punch you had before.

Write Elenco at *Electronic Engineering Company, Wabash, Indiana* . . . tell them *you* want to be the loudest signal on the band. Enclose \$45.00 and they will help you fill your wish.

P.S.: Yes, it's completely FCC legal.

Knight Model 400 Tube Checker

The express man said "package for you" and within a few minutes I was sorting-out the various nuts, screws, wires, switches, etc.

Checking the parts against the parts list really gave me a pleasant surprise. There were *exactly* 29 6-32x5/16"

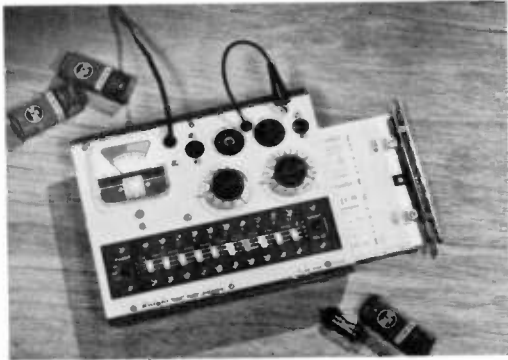

screws, 10 #4 self-tapping screws, 19 pieces red wire 2" long, 18 pieces orange wire 3" long, etc. Everything checked with the parts list—oops! sorry, I measured the solder and there was six feet one and three quarter inches. The parts list says there is

six feet so I must have stretched it when unwinding the roll. Don't worry about the parts, Allied has given enough of everything and you will come out several pieces ahead of the kit, plus some solder.

I followed the instructions step by step and just three hours later had the old bedroom radio out of its case checking the tubes. Three of them tested weak and one bad. Doubt about the testers accuracy started me wondering how to test the tester. Since it was only 10:30 p.m. I took the four weak and bad tubes to the Drug store. It showed the one bad tube to be bad but also one of the others. It tested the other two weak.

As the old radio played good on the two local stations it picked up (we have ten in the area) I decided to wait till morning and have the fellow at our local T.V. station check them out on the station's laboratory tube checker.

Getting the XYL up early (5 a.m.) the next morning so she could take the tubes to the fellow before he left for work wasn't easy. That evening we hurried the "doing-of-the-dishes" to rush over to pick up the tubes. Sure enough, three weak and one bad.

The moral of our little story is that an inexpensive KNIGHT Model 400 Tube Checker Kit should be in every CB'er's home, it would pay for itself in a year's time if the average Joe Citizen checked his own T.V. tubes.

The Mark Super-Beacon

Throughout the midwest and in the eastern U.S., the Mark Mobile Super Beacon Mark II base station antenna has been creating quite a stir. This rather unorthodox design base station antenna comes from a firm with a great deal of knowhow in all phases of communications antennas, from the very lowest frequency arrays right on up into the microwaves.

The antenna is unorthodox because it looks like a ground plane, but it isn't. It has no radials, or in other words, it is minus both the *ground* and the *plane* of the afore mentioned antenna.

But despite these *handicaps* (?) the

antenna performs and performs very well, in a manner which leads us to want to tell you about our lab test results at CBH.

The antenna is a composite of a ground plane, a vertical $\frac{1}{2}$ wave Radi-

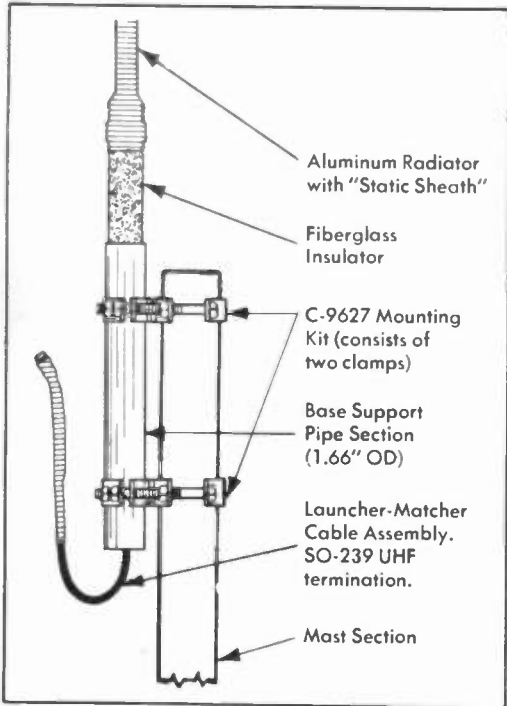

ator and a secret ingredient only Mark Mobile knows about. It "looks like" a ground plane, if you don't happen to notice it doesn't have any radials. The mixture of the " $\frac{1}{2}$ wave Radiator electrical properties" and Mark's "secret ingredient" gives the antenna the lowest angle of radiation we have found in orthodox antennas (this precludes the Stinger Discone, which is an antenna of a different color!). Keep in mind this is *not* a ground plane.

The Mark II goes together in less than five minutes. It consists of two specially treated and coated aluminum radiators, which snap together with a pair of set screws. The base of the antenna is a piece of aluminum pipe (1.66 inch O.D.) molded into a fiberglass insulator (see diagram). We found this to be very strong, and with a simple pipe clamp at the bottom of the antenna, the Mark II stands rigid and straight to its full 19 feet height without any additional support.

Your feedline hooks into the Mark II through an SO-239 connector which is attached at the end of a "launcher assembly." The launcher is purposely provided as part of the antenna's matching system which, incidentally, does an admirable job. Across the band our antenna held to VSWR 1.15 to 1 (didn't dip or peak on any channel or group of channels).

One more important feature of the Mark II deserves special mention. This antenna features a "Static Sheath" device which effectively cuts down on that old bug-a-boo, *precipitation static*. In areas of the country where rain is frequent, noise-build-up from static electricity is a real problem. The Mark people have cured this problem, resulting in lower background noise and higher signal-to-noise ratios (more readable signals) with the Static Sheath.

Finally, the antenna is protected from lightning through a DC ground in the cable assembly.

This is an excellent antenna for base station operations, affording gain equal to the more elaborate ground plane arrays, without the fuss and mess of radials and lengthy installation instructions. Its list price is \$34.95 from distributors around the country.

The Mobil-Plane MP-1

The age-old saying, "build a better mousetrap . . . etc.", is being proven once again with a Southern California firm that specializes in making better mobile communications. The firm is McCullough-Aero of Culver City (5615 Centinela Blvd.) and their product is a new device (in CB circles) called the "Mobil-Plane." The MP-1 and MP-6 models of same mount on your stainless steel, loaded, or whatever mobile antenna much like ground plane radials mount on your fixed station antennas. *Except*, these radials are actually short rods . . . approximately 6 inches long . . . which attach to the whip through a special "hub" at a point only slightly down from the top of the antenna. For example, we ran our tests

(Continued on page 49)

GOOD AUDIO BEGINS HERE

WITH THE TURNER 254C ◆◆◆

No matter how good the rest of your equipment, an improper or worn out microphone means poor audio. If you've been having unsatisfactory audio, try replacing your mike with a Turner model 254C. Here's a dependable base station microphone that's engineered for all amateur communications — the most popular replacement mike on the air. Operates with an on-off push-to-talk or lever lock switch. A 7 foot cable, three conductor shielded (wired for relay operation) is included. Response: 80 to 7,000 cps. Output: -54 db. The 254C ceramic microphone is priced for every CB budget, only \$14.10 net.



◆◆◆ THE TURNER 350C

More Turner 350C microphones are used as original equipment on CB than any other. The 350C is furnished with an 11" retracted (five foot extended) coiled cord. Hanger button and standard dash bracket are included for mobile rig mounting. Response: 80 to 7,000 cps. Output: -54 db. Designed for clear, distinct voice transmission with any CB transceivers. And for all its exceptional qualities, the 350C ceramic microphone is reasonably priced at \$10.08 net.

Write for Turner bulletin No. 1001 and get further information on these fine products.

LEADER IN CITIZENS BAND AUDIO



THE MICROPHONE COMPANY

909 17th Street N.E., Cedar Rapids, Iowa

A CBH EXCLUSIVE . . .

"OPERATION DOLLHOUSE," CB's Finest 4 Hours!

By ROBERT C. DIEFENBACH, 4W2810

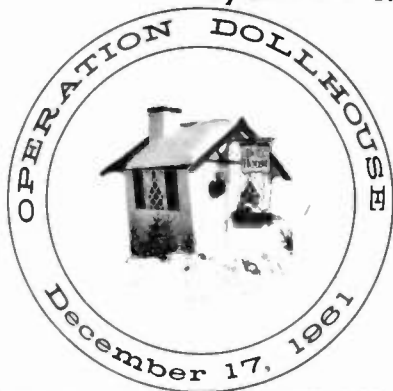

Editor's Note: Mr. Diefenbach is well qualified to report on "Operation Dollhouse", the largest known mobilization of CB enthusiasts and equipment to date. As Coordinator of Press and Public Relations for the National Broadcasting Company's owned-and-operated television station in Washington, D. C., WRC-TV, he was responsible for the creation and execution of the project, and personally directed it to its successful completion. We are pleased that he has agreed to report on this unique and important project in the following exclusive article for CB HORIZONS.

Although space limitations do not allow for a complete summary of the planning, execution and results of "Operation Dollhouse" in Mr. Diefenbach's current article, he has consented to supply these facts to interested communities and CB clubs who address their requests to him, on official letterhead, at WRC-TV, Washington 16, D. C.

If you're operating Mobile around Washington, D. C., and notice other drivers pointing out your antenna or use of a microphone to their passengers, don't feel self-conscious. Chances are they'll be saying something like, "There's one of those 'Operation Dollhouse' cars. Wonder who they're helping out today." Since December 17th, Washingtonians recognize and approve of Citizens' Banders.

CB's public image in Washington and throughout the nation took a huge swing upwards between twelve noon and 4:00 pm of that foggy Sunday, when over 500 Citizens' Band enthusiasts combined their efforts to stage "Operation Dollhouse" . . . the

largest mobilization of CB mobile units ever attempted . . . a massive all-volunteer project that was conceived to prove the value of Citizens' Band radio as an important, flexible, and worthwhile community tool.

Organized by WRC and WRC-TV (NBC's owned-and-operated radio and television stations in Washington), the project brought 213 CB - equipped vehicles into action for the four-hours to pick up Christmas gifts donated to underprivileged children. "Operation Dollhouse" was a new twist to the 26th annual Doll House Campaign of the broadcasting stations, and is considered as a complete success. Within the short four-hour period, the CB units collected over 2,700 gifts and close to \$1,000 in cash and checks. Public enthusiasm created by the project continued for days following "Operation Dollhouse", and accounted for donation of additional thousands of toys and hundreds of dollars as a direct result of the Citizens' Band project.

The unique mobilization made it possible for listeners and viewers of the NBC stations to have their Doll House contributions picked up free, right at their own front doors, by merely calling the "Operation Dollhouse" switchboard to give their name and address. If the donors lived anywhere within 15 miles of the White House (an area of over 700 square miles,) one of the 213 mobile units was at their door within minutes to pick up their contributions.

Better than a month's work went into "Operation Dollhouse" before it was announced to the public. WRC and WRC - TV approached Washington's largest Citizens' Band Club, the 4W-24-CB Club with the idea and were



ONE OF THE TWELVE AREA MEETINGS of "Operation Dollhouse" volunteers was held by Area "F" Base Station Operator Rev. David T. Gleason (24W0858), here seen discussing the location of mobile units with 4W24-CB Club project chairman Robert Avery (4Q0338) (left, pointing) and several of the volunteer mobile operators. Base and mobile operators gave up several evenings before "Operation Dollhouse" to plan the project in detail.

immediately met with the club's full backing on the project. President Sid Butterfield (24W0470) appointed a committee headed by efficient Robert Avery quickly enlisted the cooperation project, already endorsed by better than 80% of the club's membership minutes after presentation as a motion. Avery quickly enlisted the cooperation of the other Washington - Virginia - Maryland area clubs; the Virginia Citizens' Radio Association, the ARFAX (Arlington-Fairfax) CB Club, the Virginia Mobile Radio Search and Rescue Corps and the Potomac and Rappahannock Citizens' Radio Association. Scores of unaffiliated CBers, hearing of "Operation Dollhouse" by excited conversations on every channel, volunteered to help out.

As volunteer units were added to the "Operation Dollhouse" roster, the 700 square mile area was divided into twelve control sectors, with sector boundaries set by major highways, county borders and the famed Potomac River. A strong and well-located fixed CB station was selected to serve as the Area Base Station within each of the twelve sectors. The mobile units were assigned to work in these twelve sectors, with each assignment made ac-

ording to the mobile operator's knowledge of the area and the frequencies on which he was equipped to operate. Each sector, with two exceptions (those separated enough geographically so that interference was minimal), was assigned a separate operating channel. The entire operation covered channels 1, 2, 3, 5, 7, 9, 11, 17, 20, and 22.

The Area Base Station operators, working hard to locate detailed street maps of their assigned areas and sufficient crystals to supply to "rock-bound" mobil units assigned to them, hosted meetings of their fellow-volunteers to lay out detailed plans for the operation. Avery, or the author, or both, attended each of the twelve area meetings to fill the groups in on the overall requirements and regulations of "Operation Dollhouse". Towards the last days before the big Sunday afternoon project, Washington's CB channels fairly crackled with excitement over the operation. Stations identified themselves not only with their FCC-alloted call-numbers, but with their "Operation Dollhouse" area-letter as well. Even the "skip" stations were hearing about the project and offering their best wishes through the mails.

A massive Telephone Message and Dispatching Center was set up at the WRC, WRC-TV studios manned by additional CB volunteers and members of the NBC staff donating their time.



ONE OF THE OVER 2,700 GIFTS FOR UNDER-PRIVILEGED CHILDREN PICKED UP during "Operation Dollhouse" is accepted by driver Robert Loveless (4W2386) from Mrs. Thomas W. McGregor. "Rider" Sid Butterfield (24W0470) is hord-pressed to find room in the gift-crowded cor.

85% INCREASE IN RELATIVE FIELD STRENGTH

(See official Lab Report on page 30, this issue CBH)

"Mobil-Plane" MP-1

Here is a remarkable new attachment for CB mobile antennas, guaranteed by the manufacturer to increase relative field strength by 50-100 percent (model MP-1) or "in excess of 100 percent (model MP-6)." On receive, the Mobil-Plane cuts down noise interference, improving the signal to noise ratio on weak borderline signals, making them more readable.

Easy to install, no cutting or tuning. Use field strength meter to position, and then lock down the holding whip, complete instructions provided. Available to fit all 102 inch whips, top and center loaded whips, or with adapter sleeves for fiberglass and small diameter non-standard whips. Available with blue or black anodized aluminum hub (model MP-1) or nickel plated hub (model MP-6).

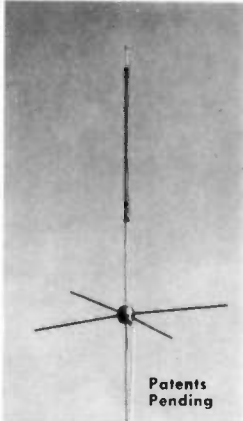

THE ORIGINAL AND ONLY MOBIL-PLANE
"A Better Product for Improved Mobile Communications"

DEALER INQUIRIES INVITED

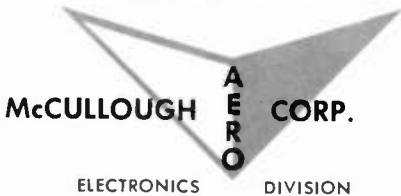

Phone EX 8-6293

McCULLOUGH-AERO CORP.
5615 CENTINELLA BLVD.
CULVER CITY, CALIFORNIA

Please Rush "Mobil-Plane" MP-1 (\$5.95) MP-6 (\$7.95). My antenna is (specify if not 102 inch standard diameter stainless steel whip).....

Check or Money Order Enclosed, Ship Post Paid
 \$2.00 enclosed, balance C.O.D.
(Calif. residents include 4% sales tax.)

NAME.....
ADDRESS.....
CITY..... STATE.....



AREA POLICE DEPARTMENT REPRESENTATIVES, interested in the emergency-condition possibilities of Citizens' Band mobilizations, discuss "Operation Dollhouse" with 4W-24-CB Club President Sid Butterfield (24W0470). Every local police jurisdiction in the 700 square mile area offered their cooperation with the mobilized CBers.

Plans were laid for the broadcast of four special AM-FM radio shows over WRC during the operation.

At high noon on the 17th, with all phones, Base Stations and mobile units manned and ready, the donors' calls started to pour in. As each was received at the Message and Dispatching Center, it was pinpointed as to exact location on the Center's huge dispatching map. Exact information on each caller's name, address and gift were relayed (via telephone) to the operator of the Base Station within whose area the address laid. The Base Station operating, after referring to a map of his area showing the exact location of each waiting mobile unit, contacted the unit closest to the address and ordered the pickup to be made by that unit.

When the "Operation Dollhouse" switchboard was closed down at 4:00 pm, the hundreds of CB enthusiasts returned to the WRC, WRC-TV studios to receive the thanks of Washington's "Christmas Bureau", the organization which distributed the thousands of donated gifts to needy youngsters. A unique automatic form system enabled the Doll House staff to immediately mail letters of explanation to the few "Operation Dollhouse" donors whose contributions were offered too late to be picked up before the cut-off of the project. These letters, received the following

(Continued on Page 45)



Picking the winner this month wasn't easy, we were just flooded with hopefuls. Frankly, there were about 10 cards which were "almost" as good as the one which finally won, and picking that "one" was chosen by our entire staff and the 4 members of the art department at our printer's.

This month's winner: Bob Lee, 10Q2071, P.O. Box 504, Guymon, Okla. Bob's "way out" card is printed in a



stark looking black and white, with an interesting touch of red. Frankly, looking at the card may depart nothing to you at first, however a close examination of the Egyptian-looking design on the left side reveals that it's the brand of Bob's O Cross L Ranch, and the "O" is centered right on Guymon, where the ranch is located.

And don't forget to send a card to CBH at P.O. Box 1557, Oklahoma City, 1, Okla. Get it here by January 22 to try for the next prize of a 6 month subscription to CBH or a year's extension to your present subscription. We hold cards for 2 months, so if you sent in for the December and January contests and didn't win, it's time for another.

10-7

NEW!



Only 1½" x 2½" x 4"

"NOISTOP" ELIMINATES IGNITION INTERFERENCE CAUSED BY NEARBY CARS AND TRUCKS... boosts range and performance by letting you hear signals normally lost due to ignition interference!

Thousands in use by CB'ers throughout the country! Prevents receiver jamming from trucks, cars, out-board motors, or other nearby source of pulse-type electrical noise! No need to suppress your car—ideal for base station use.

\$16⁹⁵
NET

Completely wired, tested and guaranteed. Installs in 20 minutes.

DETAILED INSTRUCTIONS FOR:

EICO 761, 762	KAAR TR-32
ELMAC CD-5	KNIGHT C-27
GENERAL MC-4	LAFAYETTE HE-15A, 20-A
GLOBE CB-100, 200	POLYCOMM PC-2
GONSET G-12, 15	RAYTHEON TWR-1
HALLICRAFTERS CB-2, 3	R. C. A. MARK VII
HEATHKIT GW-10	UTICA MC-27
INTL. CRYSTAL 50, 100	VOCALINE ED-27M
JOHNSON "Messenger"	WEBSTER 4-11

See your distributor, or write to:

BUSINESS RADIO CO. INC.
P. O. Box 5652 • Mpls. 17, Minn.



CHEAP CONVERTER

(Continued from Page 20)

150 to 200 volts DC.

Tuning procedure: Place your receiver at approximately 1500 KC. If a broadcast signal is encountered, tune to either side to clear. Now with a known signal (either a signal generator or a transmitted signal, on channel one, tune the variable capacitor of the converter for maximum capacitance (plates fully meshed). Now tune piston capacitor of L-3 until signal is received. Proceed to coil L-2 and tune for maximum signal strength. The same procedure is followed at the piston capacitor of L-1. Once again, return to L-2 and touch up for maximum signal.

By using an external source of power, one need not disturb the receiver at all, although if desired, power can be taken from the receiver. If AVC action is desired, remove the ground strap from pin #2 of the electrical tie bar, and place a wire from the AVC of the receiver to pin #1 of the tie bar.

10-7

CB AND THE PHONE PATCH

By **HERB FRIEDMAN, 2W6045**

Eastern Technical Editor

As the business CB users have learned, the major advantage of radiotelephone is its speed—a properly used communications system saves time, and to business, time is money. Now that most users have the hang of efficient CB operations the time has come to move another step forward by adding a phone patch.

For those who don't know we'll explain. The phone patch is a device which permits you to feed the received

patch consider the example of a busy service shop. No one waits in the dispatcher's office in case a mobile calls in about a problem; the boss or service manager has other work to do. When a call does come in which requires an "executive opinion", why wait for the proper person to come to to the radio equipment. If a patch is installed at the CB rig, all the dispatcher does is dial the proper party on the interphone, flips the "patch on" switch and the contact is under way—with lots of time and shoe leather saved.

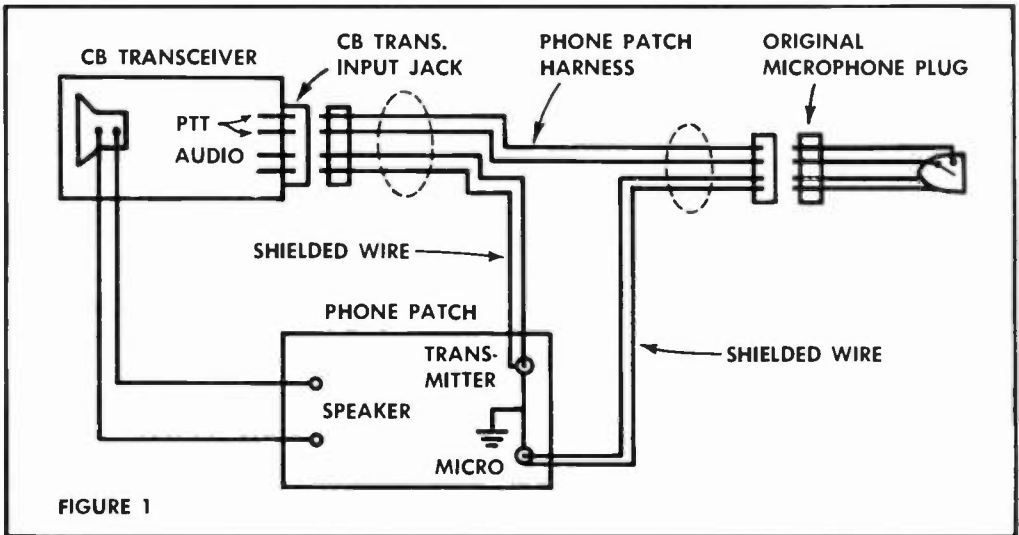

signal into a telephone line. It also permits you to modulate the transmitter with the telephone line signal. There are two types of phone patches, the manual and the automatic. The manual type requires the operator to constantly switch the patch from transmit to receive, this in addition to switching the transceiver. The automatic type requires no attention once the patch-on switch is thrown. For CB use an automatic patch is recommended.

To illustrate the use of the phone

Phone patches can be installed on virtually any rig. If your rig has an external speaker connection and a microphone jack the job can be done in a few minutes. The rigs which do not have jacks will require some minor wiring.

Fig. 1 shows the patch connections. The patch's speaker terminals are connected directly across the transceiver's speaker. If your rig doesn't have an external speaker jack, the patch's leads must be connected across the speaker without either lead touching the chas-



The Lafayette HE-26 phone patch (\$24.50) hooked into an International EXEC.

sis. Some electronically switched rigs have a voltage on the speaker during transmission, and if a speaker lead gets grounded, scratch one speaker.

The microphone input is connected, in most instances, through a special harness which can be made for less than two dollars. Notice that the mi-

crophone lead is broken. The microphone is connected to the patch's input. The patch's output is then connected to the transceiver's input jack. The outer shield is connected to both the patch and the transceiver. The push-to-talk (PTT) wires run straight into the transceiver. (We said it was easy.)

When the patch is in the OFF position the microphone is connected directly to the transceiver's input. When the patch is switched ON, the microphone is disconnected and the interphone is connected to the transceiver.

If yours is a busy organization it will pay to investigate the advantages of a phone patch. Either the small interphone or a large private dial system will work equally well.

10-7

Readers in the New York Metropolitan area who have ideas for CBH articles are invited to discuss them with Herb, our Eastern Technical Editor. Daytime telephone number is ULster 8-3333, at night it's DEwey 2-0963.

SOLD AND HIGHLY RECOMMENDED BY LEADING DEALERS AND DISTRIBUTORS



MC-27

Radio-
Telephone

For 11 Meter
Citizens Radio

UTICA

Tried and proven in the roughest types of commercial and private installations, the **MC-27** by **Utica Communications Corporation** is your kind of 2-Way radio! Try this deluxe six channel CB set at your nearest quality Utica dealer, or write Utica for full details **today**. Exceptional sensitivity and selectivity, "higher than average" output, the very latest in fine styling for base station or mobile installation. Universal operation: 117 vac, 6 or 12 vdc. Fully guaranteed to perform as only an exceptional piece of communications equipment can.

UTICA COMMUNICATIONS CORP.

5055-1 North Kedzie Ave.
Chicago 25, Illinois

can't find a copy of PE to look it up, the circuit described consisted of 1/2 half of a 6AL5. The one thing missing, by my way of thinking, was a true squelch control. And, the way the PE circuit was described, the regenerative detector (1/2 6AN8) ran with only 90-100 volts. This cut down sensitivity on my CB-1, and it may have done the same to yours.

Basically, the PE circuit was a good one. It just didn't go far enough for me.

As shown in the accompanying schematic, the same 6AL5 tube is used. Almost all resistors and by-pass capacitors shown in the original article are also used. I have added one potentiometer and two resistors to my circuit, giving me a true control on the squelch.

R1, the 50 K pot, hooked into the cathode (pin 1 of the 6AL5) produces 15-35 volts DC bias to cut off the tube. Weak skip signals cause a plate drop of only .5 volts. My mobile CB-1 developed 18 volts on the plate of the detector while my base station CB-1 developed 23 volts on the detector plate. If you find, in your CB-1, that more voltage is needed to match the detector plate voltage, the 22K resistor (R2) on the ground side of the squelch control pot (R1) can be increased to 25K or 30K.

The squelch control pot was mounted on the front panel between (and slightly above) the two dial lights (power and output). On the rig chassis, just behind the panel lights, add a terminal strip which will contain B+ voltage and a ground connection for the squelch unit. The 6AL5 was mounted in the only open space on the chassis, near the volume control.

Incidentally, since my original modification to my base station CB-1, I have modified my mobile to a silicon diode which replaces the 6AL5.

In the schematic drawing shown, all wiring inside of the dotted line is new wiring from the original Heath wiring. To further clarify what you will need, resistors and condensers with numbers and values in the schematic are new parts you will need.

10-7

GET THE BEST OUT OF YOUR CB EQUIPMENT

READ

CITIZENS BAND RADIO

by Allan Lytel

Here is the most helpful book for anyone who owns, intends to buy or who wants to service CB equipment.

If you are now operating CB equipment—this book will help you get top flight performance. Design features of different types of transmitting and receiving equipment are described and specific models are analyzed in detail. Particular emphasis is placed on single-channel and multi-channel transceivers and receivers.

Practical problems faced in mobile and base station installations are discussed—selection of a proper antenna; tips on installing CB equipment in boats, cars, trucks and base stations for better performance, ease of operation, elimination of interference.

The actual operation of the equipment is covered along with a discussion of the FCC rules. Power supplies and specific requirements of base station and mobile installations are covered. You also get license information; FCC regulations and historical development of CB.

The portion of the book devoted to repair includes an outline of potential trouble spots to check when trouble does occur. Naturally, CB equipment should be repaired by competent service technicians, and for technicians this book contains information of great value: types of test equipment to be used for alignment and repair of transmitters and receivers; step-by-step alignment procedures; and troubleshooting data.

For the person about to buy CB equipment, this book serves as an excellent guide of what to buy, and how to install it. #278, \$3.90.

Other Rider Books of Interest To Every CB'er:

BASIC RADIO 6-volume "teaching pictures" course enables you to understand the fundamentals of radio communication. No previous knowledge of electricity is required—the course teaches it.

The course will enable you to read schematics, recognize circuits used in radio equipment . . . understand electricity and magnetism, circuit components, vacuum tubes, power supplies, oscillators and amplifiers and their use in radio receivers. You are made thoroughly familiar with semi-conductors and transistors; transmitters, antennas and transmission lines. #197, 6 vols., soft covers, \$13.85; #197-H, 6 vols. in single cloth binding, \$14.85.

HOW TO LOCATE AND ELIMINATE RADIO & TV INTERFERENCE (2nd ed.) by Fred B. Rowe. Covers the latest techniques applicable to the location and elimination of radio and TV interference. Tells the reader what to look for, what to do and how to do it. Discusses the newest FCC rules and regulations. #168, \$2.90.

These are just a few of more than 250 Rider titles. Write for free catalog. Order these books today at bookstores, department stores and electronic distributors, or direct.



JOHN F. RIDER PUBLISHER, INC.
116 West 14th St., New York 11, N. Y.

CITIZENS COMMUNICATIONS



This is the second month of the brand new field reporting news-portion of CB Horizons, *Citizens Communications Reports*.

In the months ahead you will see this portion of CBH blossom out into more than 8 pages in print, with news of CB clubs and individual CB'ers from the first to twenty-fourth CB call districts.

Your CCM is the man responsible for reporting news in your call district. If you are a club official, or an ordinary CB'er, why not drop your call area CCM a note with news of your activities? Club officials will find *CCM Reports* a handy spot to give notice of club meetings, activities and special projects. And you will find *CCM Reports* your best possible source of late-current and up-to-date news of CB activities in your region.

Why not invite your CCM to your next club meeting, and let him tell you about his duties on behalf of CB radio? He donates his services in preparing this column, so you might find him more agreeable to drive 50-100 miles to attend your club function if you offered to take him to dinner before the meeting!

ACCM's, or Assistant CCM's, are special appointment CB'ers who work to report news of their region to the news coordinator for the call district, the CCM. ACCM's are normally appointed to report on news for a specific city or outlying area, within the call district, but outside the normal traveling and listening range of the CCM.

Why not propose at your next club meeting that someone from your club apply to *CB Horizons* for an appointment as a ACCM in your region? And if you notice no CCM reports in print from your call district, why not apply *yourself* for this important ap-

pointment? There's no better way to serve CB radio!

Now this month's reports.

SECOND CALL AREA: CCM Donald R. Lehr, 2W3911, 39 West Blvd. East Rockaway, New York ACCM: JOHN Krejc, 2W4586, 40 Lanzo Ave. Gorfield, New Jersey.

New officers of Nassau C.B. Club for 1962 are Len Pottruck 2W3048, Pres., Ed Weingart Jr. 2W5009, Vice Pres., Don Marsden, recording sect. and Bob Shoppe corres. sect. Ray Adelman 2W6989 was re-elected tres. Congratulations to the Nassau CB L Ladies Aux. for the swell Christmas party they ran for the members kids. Ladies Pres. for next year will be Lee Gorecki; Vice pres. Adele Weingart.

CBRRL Pres. Bob Gardner advises the club now has branches in Bergen, Essex, Hudson, Bronx, Coney



This fine CB station belongs to Harrison Goodman, 2Q2454, of Rego Park, N. Y. (T. K.'s old home town). Via his Hammarlund HQ-105-TR rig he has obtained blood transfusions for 2 children. He's interested in starting a CB'ers Blood Bank.

Island and Queens. Headquarters for the group is in Bklyn. Members receive a hand book listing all members, a bi-monthly club magazine, mobile decal and a membership certificate.

Wayne Chapter, National 11 Meter League Inc. Pres. is Charles Farley. North Jersey CB Club is located at Dumont, N. J. Pres. is Charles Constantine 2W4531. No. Jersey Chapter of MCEU met Dec. 10. Refreshments served were courtesy of Pres. 2W9623 and vice-pres. 2W7574 (an election pay-off???) Club's main project at present is an emergency training program sponsored by the Red Cross.

EIGHTH CALL AREA: CCM Ralph F. Lord 8W1494, 4834 Crown Ave. Baton Rouge, La.

Activity in the area was at a standstill during the last month. This reporter did, however, contact several operators in the area and came up with the following information concerning local monitoring channels: Opelousas, La. Channel 9, Morganza, La. Channels 9 & 14, New Roads, La. Channel 6, Tunica, La. Channel 2, Winnfield, La. Channels 4 & 11, Natchez, Miss. Channels 4, 6, 9, & 11, Shreveport, La. Channel 11.

This CCM rec'd a fine letter from CB'ers Harold & Pauline Olive of the Caddo District CB Club. They included in their letter a complete list of the CB stations in their area and the types of rigs, antennas and operating channels. Thanks, Harold and Polly!

In Baton Rouge, the Emergency Communications Organizations of the East Baton Rouge Parish Sheriffs Office is rapidly forming into a well organized group of Special Deputies, having recently acquired a mobile radio truck with 'phone, 39.5 mc and CB Xmitters. The membership now numbers 23 in this organization.

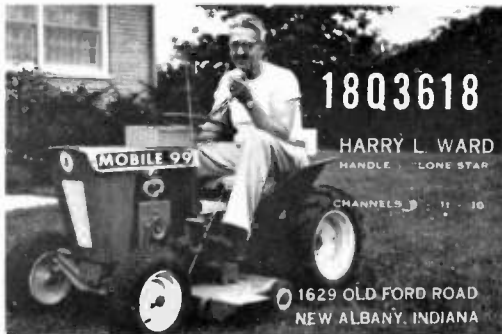

Yet another claimant to the "World's Smallest Mobile" title is Harry Ward, 18Q3618, of New Albany, Ind. From the looks of the installation, we'd say his signal really cuts through the QRM.

ELEVENTH CALL AREA: CCM R. V. Watson, 11Q1125, 2206 W. Polo Verde Drive, Phoenix, Ariz.

The Arizona Citizens Radio Association in Phoenix lost almost all of its top brass to the recently acti-

MONTHLY SPECIALS!

Special introductory offer—Generator noise filters, sell nationally for more than \$3, only \$1.95. RG-8/U coax, new, only 10c a foot. Rigs, antennas, accessories at equal savings. Over-allowances on trades-ins. Order and receive details. Exclusive Oklahoma CBH and CB Callbook distributor. Dealer inquiries invited.

CITIZENS BAND 2-WAY RADIO CO.
4005 N. Penn., Oklahoma City, Okla.

**YOU'LL CALL IT
MAGIC, TOO
See your nearest dealer
for
JAMES KNIGHTS
"GOLDEN LINE"
CITIZENS BAND
CRYSTALS**



Dealer, distributor
and manufacturer
inquiries invited

The James Knights
Company
Sandwich 2, Illinois

TV INTERFERENCE?



A B&W low pass filter will end interference with your neighbors TV reception. B&W Model 424 is a three-section low pass filter which installs in the antenna coaxial line. Reduces all frequencies within the TV band by 60 db (a reduction of 1-million times).

The B&W Model 424 offers negligible filtering to frequencies below 30mc. Made for installation in 52 and 72 ohm coax lines. Ideal for any transmitter (up to 100 watts) operating between 1.5 and 30 mc.

At your dealers for only **\$8.65**



BARKER & WILLIAMSON, Inc.
BRISTOL, PENNSYLVANIA

First with professionals
who know performance

poly-comm "n"

CB TRANSCEIVER



now with
RF NUVISTOR
STAGE for
matchless range

- Dual Conversion Superhet Circuit
- Sensitivity — .1 for 6 db S/N
- Super Sensitive Stable Squelch
- 60 db Adjacent Channel Rejection
- 70 db Image Rejection
- Better than 3W Power to 52-72 Ohm Antenna
- Advanced Design Noise Limiter

You'll see the new Poly-Comm N — or hear it discussed — wherever pros gather. It's been selected alike by stars of the entertainment world and by farmers, by engineers and boat captains, by outdoorsmen and by families out for fun.

The reasons for this wide appeal are simple: The Poly-Comm N — successor to the 11-G, and incorporating an advanced RF Nuvistor stage — has been engineered to provide the best CB performance on the market, regardless of price. It incorporates the most advanced circuitry for optimum performance in continuous duty. Engineered to withstand shock, vibration, high humidity and other rugged use-conditions, it has the range, power, selectivity, low noise, high rejection, and convenience of operation and maintenance that make it demonstrably superior for every CB application.

**Mail Coupon for Important Data
To Guide You in Your CB Investment**

Sirs: Please send complete data on the Poly-Comm N 27 mc transceiver by return mail.

NAME _____
ADDRESS _____
CITY _____ STATE _____
Intended use _____

POLYTRONICS LAB inc. 388 Getty Avenue
CLIFTON, NEW JERSEY

vated 161st fighter squadron which is to be stationed in Hahn, Germany,—President, Ed Lueken, 11W9388, Vice President, Ray Cioppa, 11W7766. The unexpired terms are to be filled by R. V. "Doc" Watson, 11Q1125, and Johnny Miller, 11W9192. Jim Cunningham, 11Q3273 and Art Lampe 11W9779 were appointed to the board of directors. I was happy to meet with John B. Borden, 11Q3228, President of the Tucson CB Club during our recent visit there. Some joint activities with the Phoenix & Tucson clubs are being planned for in the spring.

FIFTEENTH CALL AREA: CCM Spencer Van Noy, 15W1894, 632 E. 3900 So. Salt Lake City, Utah.

The 11 Meter Club Pres. here in Salt Lake City, Niles Squires, tells me that he has worked very hard to promote this club, and I for one am very sorry to hear and know the fellows in S.L. have really let the club down. Many say that they want to belong and take a active part, but when it comes down to the meeting, just a few solid members show up. I know CB clubs are progressing and doing a fine job elsewhere, and there is no reason why it can't be done here as well. We have just learned that Bob Whitman 15Q0721 from Denver, has moved here to S.L. The first thing he asked me was, "How do I get in the club here." I'm sure he will be a fine member. The club has been asked by the county CD to take a active part in their work, so let's back the club to the hilt. Our compliments go to Shosa Ya Sui, who is a engineer for KUTV. Sho spends four days a week on top of a windy, snow covered mountain for this TV station and helps out with relays all over the valley, (where we can't get to he can). His altitude is really high helps his signal really go.

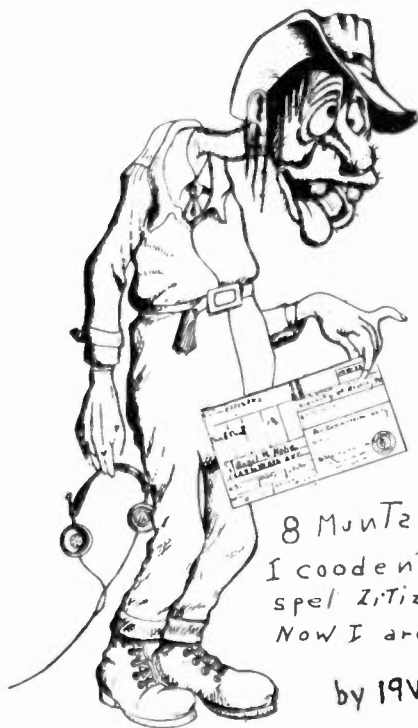

8 Muntz a 90
I coodent even
spel ZiTizen
Now I arc one
by 19W2373

SEVENTEENTH CALL AREA: CCM Lawrence J. Woods 17W5910, 1735 Michigan Dr. Evansdale, Iowa.

On Dec. 14, 1961, The N.E. Iowa CB Club had a potluck turkey supper, had a very good turnout.

I talked to Club Pres.; Jim Leverage, 17W3361, about the emerg. unit he is trying to organize. Pro-

area, I would like to hear from any club in this call area.

NINETEENTH CALL AREA: CCM Carl Wesser, Jr. P.O. Box "V" Presque Isle, Michigan.

In Cheboygan, Michigan, the City Police Depart-



Atlantic City, N. J.
"WORLD'S PLAYGROUND"

3Q1106

73, Wayne



This isn't a paid ad but we certainly advise any CB'er who travels in the Garden State to drop in and see Wayne Hackney, 3Q1106, of HACKNEY'S RESTAURANT in Atlantic City. You haven't lived until you've wrapped your chaps around their world famous sea food.



This jazzy outfit calls itself 2W5679 and is operated by Harry Chase in Schnectady, N. Y. The receiver is a National, the transmitter a home-brew. There's a Hy-Gain 3 element beam and a Magnum-27 on the roof.

gress is a little slow at this time. Jim would like very much to hear from emerg. units of this kind for any kind of advice they can offer. As CCM in this

ment is using a new RCA Mark VII unit on Channel 15 for 24 hour a day monitoring. The unit was donated at completely no cost to the Police Depart-

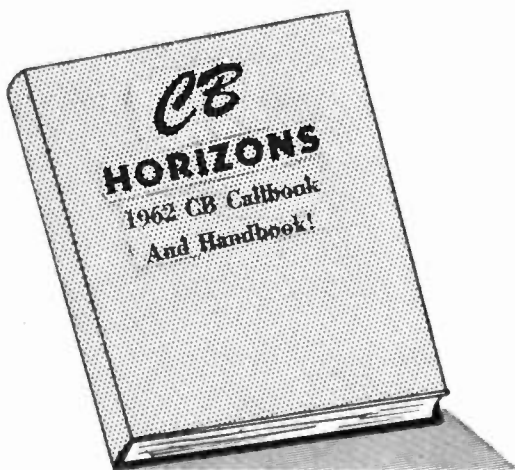

We are accepting
orders for the
1962 CB Callbook
And Handbook!

NOW!

Order now from your local CB dealer or by rushing a check or money order in the amount of \$3.95 to:

CB HORIZONS MAGAZINE, Dept. CB-264

P.O. Box 3150, Modesto, California

ment through the RCA State Distributor and the Two-way communications Service Dealer covering the area. There is a new Johnson CB unit waiting to be installed in the Alpena, Michigan Police Department as soon as approval is received from the City Manager.

Any one traveling in this area will be able to receive assistance from either Department on Channel 15. It has been finalized that Channel 15 will be monitored and used for calling purposes only in this area, which includes the whole N.E. part of Lower Michigan.

The "Top of Michigan Citizens Band Association" will have their first meeting since organization after the first of January to reactivate and to include all CB users in the four to five countries in this part of the State.

Assistance given on the part of 19A8124, David Mintz, was very much appreciated by the members of a Wayne, Michigan family who had the misfortune of overturing their car while trying to miss a group of deer in the road, while visiting in this area. Dave gave a general call for help which was received by 19W6285 who is one of the Township Police Officers, and he was at the scene in less than seven minutes.

On December 15, the following units 19Q4093, 19Q6799, organized a search in the Hillman, Michigan area for two lost Bobcat hunters. Other units from the surrounding counties were called, and within 30 minutes the hunters were safe and sound.

10-7

CONVENTION NOTE

Publisher's Note:

CB Horizons is always willing to extend advance publicity to CB clubs, organizations and groups planning picnics, meetings and conventions. The following is an excellent example of what we can do IF you get the information to us soon enough ahead of the event to meet our press-deadlines. Keep our pages in mind, for free advance publicity, when you plan your events for 1962.

The National Citizens Radio League (NCRL), with headquarters at 6276 West North Avenue, Chicago 39, Illinois, is planning a National CB Convention for the period March 9-11, 1962. The purpose of the meeting, as reported to CB Horizons by NCRL Prexy Charles R. Greene, 18A6256, is "to conduct continuous meetings to outline the NCRL's functions to CB'ers." Among the announced plans of the organization are intentions to aid CB Clubs financially through joint participation in sharing revenue from tickets sold to those CB'ers attending the convention; to serve as lobbyists for CB in Washington and to promote national CB unity through a single organization.

BASE STATION OF THE MONTH

By 5W1203

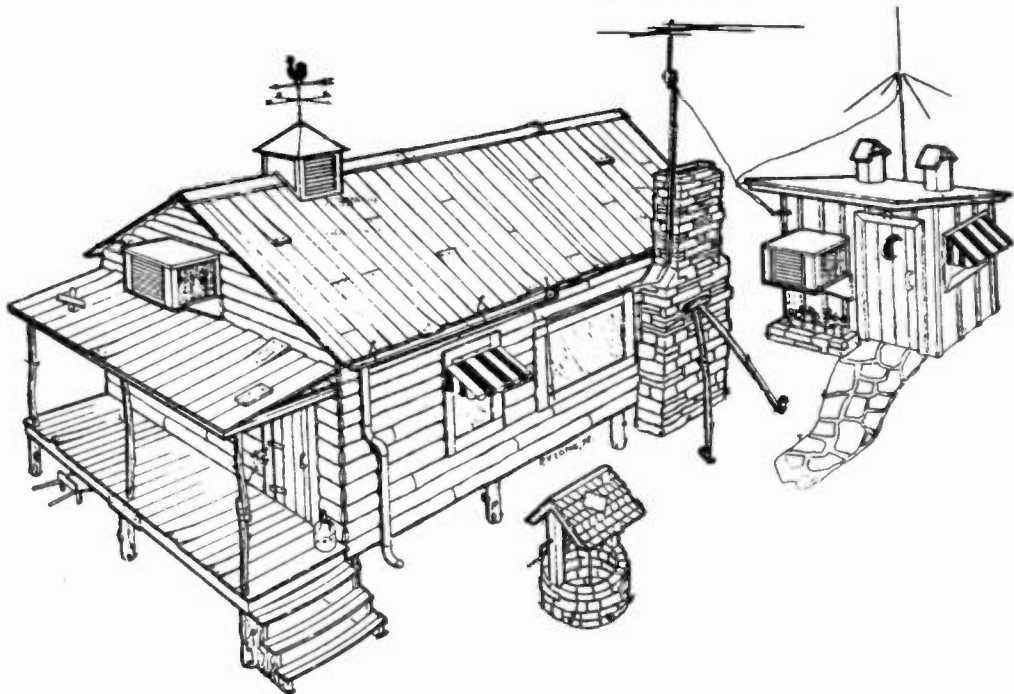

ANNOUNCING NEW BROWNING 23 S-NINE CB TRANSMITTER



23
S-NINE TRANSMITTER \$144.00
(with one crystal)

\$189.00
(with 23 matched crystals installed)

Now with built-in 23 channel selector switch and Standing Wave Indicator!

Browning presents a new concept in Citizen's Band radio communications. It's the 23/S-NINE base station transmitter with built-in all-channel selector that lets you transmit on any of the 23 CB channels at the flick of a switch! Also new is the built-in Standing Wave Indicator for perfect matching of transmitter and antenna system for more powerful, long-range transmissions.

Among other outstanding 23/S-NINE features: special audio circuitry with speech clipper and splatter filter for perfect modulation; advanced design power supply with silicon rectifiers for low operating temperatures and maxi-

mum component life; highly efficient output circuitry using Pi network for maximum transfer of energy to antenna.

Order your Browning 23/S-NINE Transmitter now for home or business use.



browning

Send today for FREE
CB Information Kit: 105 UNION AVENUE, LACONIA, N.H.

FOUR CONVENIENT PURCHASE PLANS

DOLLHOUSE

(Continued from Page 34)

day, requested that the donors bring their contributions to the NBC studios. Most did.

The returning Citizens' Band volunteers were surprised with a drawing for several attractive door-prizes donated in thanks for their efforts by several area electronics companies. Major items of interest were a pair of RCA Personal Communicators (won by Don Jenks, 4Q0299) and an RCA Mark VII (won by Morton Goldberg, 4W1383).

"Operation Dollhouse" was closely observed by the Federal Communications Commission and officials of area Civil Defense and Police organizations invited by WRC and WRC-TV to judge for themselves the potential value of Citizens' Band Radio in community activities and possible emergency conditions. The entire operation was completed with strict compliance to FCC regulations. Curtis B. Plummer (24W-0364), Chief of the FCC's Safety and

Special Radio Bureau, noted his appreciation of being able to "observe the Citizens' Radio Service stations being operated for a beneficial community purpose. I was particularly interested," Plummer said, "to determine the effectiveness of radio communications that can be carried on by a coordinated group of Citizens' stations. The successful operation . . . in this instance . . . serves to indicate the value to the community of such a group of individual licensees, particularly in the case of possible emergency."

George R. Rodericks, Director of Civil Defense for the District of Columbia, echoed Plummer's impressions of "Operation Dollhouse" as a demonstration of the potential of CB radio under emergency conditions. "It offers the mobility and 'blanket coverage' of an effected area that we need in Civil Defense", he said. Depending upon FCC allowance of Citizens' Band cooperation with his organization, Rodericks

(Continued on Page 54)

GAR'S GABBINGS

By GAR GREENE, 1W4844

Let me introduce myself — I am "Gar" Greene, Jr., 1W4844, and I am another addition to the rapidly-growing C.B.H. family. My main function for C.B.H. is somewhat the same as Clyde Moore's, traveling around the good ol' U.S.A., meeting CB'ers.

My travels thus far have taken me through 18 different states (many to which I will return). Leaving New Hampshire, I proceeded south into "radioactive" Connecticut, where I spent my first night. In Bristol, I met John Chauvin (1Q5127) who showed me his fantastic "shack." His walls are papered with CBL cards and his CB equipment and tape recorders cover a good deal of space. I also had an "eyeball" with Don Wallace (1Q-1166) and John Barnett (1Q5707), both from the Bristol area.

My next night was spent in Harrisburg, Pennsylvania with many wonderful CB'ers. About ten of us went down to the local CB "hangout" and talked for hours on CB clubs and other CB topics. The president of the local CB Club, James Warden (3Q1334) was present with his lovely wife, Phyllis. Fred B. Dewey (3Q1614) was also very cordial, leaving me with an open invitation for dinner on my next trip through the area.

The third night was spent sitting in my car at small motel 2 miles west of Steubenville, Ohio. From this location, I worked stations in Wheeling, West Virginia, Pittsburgh, Pennsylvania, and around eastern Ohio. This tri-state area is definitely very active and very friendly. I heartily recommend to all CB'ers traveling through this area to keep their rigs on and enjoy some real hospitable QSO's.

The next afternoon (October 27) found me in Lubbock, Texas, with the band so crowded I couldn't get a word in edgewise. The reason? The next day was the big, Lubbock CB Jamboree!! Being a weary traveler, I checked into a motel, set up a temporary base station, and promptly fell asleep. "Dub" Newsom, 10W0532, and his Lubbock CB'ers were certainly a fine group and their work was heralded by everyone in attendance.

Rushing across Indiana and Missouri without too many contacts, I found myself in beautiful Oklahoma — Tulsa, to be exact. Unfortunately, there was a very bad thunderstorm and the 11-meter band was dead that night. My time being limited, I had to continue driving and by-pass Oklahoma City, which I didn't want to do. I arrived in Amarillo, Texas only to find a relatively quiet CB band, but the next morning, the band was really jumping! My first contact was Harry Wheeler, 10Q2382, and we had an "eyeball" on the sidewalks of Amarillo. Soon we were joined by Allen Shaw, 10W4094, who led me to Southwestern Communications, 10W4316, in which he is a partner. This is a very nice sales and service store devoted entirely to CB. Here I met the co-owner and manager, Don Goforth, 10W3873, and their competent technician, "Woody." We remained there the whole day and I met numerous CB'ers who stopped in on business, pleasure, or just to "chew the rag." Among them was "Onnie" Atkerson, 10Q0203, the acting president of the newly-formed Amarillo CB Club. This club had a meeting that night which I attended. This was their second meeting and the Constitution and by-

laws were voted on and accepted. Incidentally, the Amarillo Auxiliary Police Force is licensed (10W4144) and actively helpful. Amarillo certainly struck me as being a very CB-minded area and should really go places.

The next morning found me leaving the Lone Star State after 8 wonderful days there. I landed in Shreveport, Louisiana, where I had coffee with two members of the newly-formed Shreveport Citizens Band Radio Club. We discussed the formation of CB clubs and their success and failure under various circumstances.

Moving onward, I arrived in Arkansas and made contact with the local monitoring station on Channel 11. I found the Pine Bluff CB Club monitors Channel 11 right to 12 midnight every night. I also discovered, to my delight I might add, that the State of Arkansas has a state-wide organization.

Louisville, Kentucky, is so CB-minded that I could fill a whole issue of CBH just telling about my one night there! Harry "Lone Star" Ward, 18Q3618, of New Albany, Indiana, prints some of the finest, most original CBL cards I have seen! I believe every card I received from Louisville was marked "Lone Star Print." Harry, incidentally, has the only CB mobile garden tractor I have seen to date. It's quite a rig! I can't possibly tell about all the wonderful folks I met in Louisville, but meet them I did and I will say that after hopping from place to place all night, it was good to hit the

(Continued on Page 51)

DECEMBER GIVEAWAY WINNERS

The following lucky CB'ers were dug up from the old oaken barrel by that dauntless winner-picker, Dee (10Q2925):

First Prize—Lafayette HE-35 6-Meter Ham Rig: Linas Beall, 11Q3146, Newbury Park, Calif.

First Prize #2 — Pair of Lafayette HE-29A Walkie-Talkies: Archie Gibson, 18W8089, Indianapolis, Ind.

Second Prize — E. F. Johnson SWR Meter: James Dunham, 11Q0765, Palmdale, Calif.

Third Prize—Turner 350C Microphone: Glen Rhodes, Sr., 17Q3489, Omaha, Nebr.

Third Prize #2—Vanguard RF Amplifier: Thomas Walker, 17Q3590, Maplewood, Mo.

Fourth Prize — OZCO "Snoozer" Squelch: Anthony Armas, 2Q6147, E. Northport, N. Y.

Fourth Prize #2—CESCO Generator Filter: Charles Woolf, 10Q1502, Odesa, Texas.

Fourth Prize #3 to #7—A Texas Crystal for any CB rig: John Holston, 5Q3337, Chincoteague, Va.

Charles Sharpe, 8Q1418, Texarkana, Ark.

Emelio Bruno, 20Q1454, Carbondale, Pa.

Cliff Widdekind, 3W4586, New Castle, Del.

Charles Stevens, 18W4381, Shannon, Ill.

10-7

CB'ers—Increase Your CB Talk Power 4-Times!

- Simple Connections To Any CB Transceiver or Transmitter
- Meets All FCC Requirements —Perfectly Legal!
- Use With Mobile Or Base!
- Many CB'ers Report 50-100 Percent Increased Range!

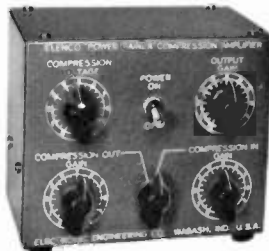

HOW IT WORKS

"The ELENCO Audio Compression Amplifier gives a four times increase in talk power." Like going to 20 watts input! Yet the rig input remains at 5 watts, and modulation at or below 100 percent.

Small, compact—only 5" x 6" x 4"; weighs 3 pounds.

**The ELENCO Power Gainer
Only \$45.00**

Order Direct From Factory or See Your Local CB Equipment Dealer

ELECTRONIC ENGINEERING COMPANY, WABASH, INDIANA

CLYDE'S CORNER...



by Clyde D. Moore, 9W0219

Clyde Moore, CBH Editor at Large, is on an extended motor trip throughout the U.S. His purpose? To meet you and report your CB activities and the activities of your CB club to other CB'ers and clubs throughout the country. Look for his light blue Chevy GREENBRIER with the 2 CB whips. He monitors NATCH-9 and 11.—Ed.

Texans have a habit of doing things in a big way. Back in July the "Lubbock C.B. Radio Club" members decided to hold a general C.B. meeting in Texas. They are proud of their many accomplishments and wanted the C.B. world to recognize them.

Much hard work and many long hours, on the part of all members, were responsible for the wonderful program and guest speakers.

The grand attendance of C.B.ers' from other districts included many representatives of C.B. manufacturers. Among these was Gar Greene, Jr. 1W4844, of Browning laboratories, Laconia, N.H.

Registration began at 1:00 p.m. Saturday, November 28th. At 3:30 p.m. a movie was shown for the children. The banquet was at 7:00 p.m. and a host of speakers were on hand. Lt. Smallwood, of the police dept. congratulated the L.C.B.R.C. for work and cooperation with the police dept. J. O. Lewis, of the fire dept. also expressed his gratitude for the help given to firemen on many occasions. Henry Tower of the CD stated he was new in Lubbock and was not familiar with the club activities, but would try to give them more cooperation than was previously offered by the former CD coordinator. B. V.

Upton, from the local Red Cross, congratulated the group on their receiving of a "disaster preparedness plaque", dated October 10, 1961.

Mr. G. M. Howard, F.C.C. officer from Dallas, delivered a highly informative speech on radio procedure and regulations. Slim Corban, local radio D.J. was master of ceremonies.

Highlighting the banquet was "Bubbles" CB widow (male cb'er) and "Elmer", CB bachelor, on stage with pantomime and jokes.

Things got under way again Sunday about 3:00 p.m. The male members of the club gave a "ladies" style show. Their beauty and fashions closely resembled Paris models. Wigs were up to date in red, pink and blue. "Paulette", (Paul Coker, 10Q0861), sang and played the guitar, while garbed in a flaming red dress and blonde hair piece.

Many gifts and door prizes were given away, along with free subscriptions to CBH. The hall had been gaily decorated with crepe paper and banners. The CBettes worked behind the refreshment counter serving coffee and cold drinks. Great cooperation on behalf of both male and female members was responsible for a fine and successful jamboree.

10-7

If you live in the west or southwest, drop Clyde a note and he'll say hello to your CB club when he's in your area.

LAB REPORTS

(Continued from Page 30)

on 102 inch steel whips, a Topper Hy-Gain loaded whip, and a Fiberglass

the Topper Top-Loaded whip, the "Mobil-Plane" peaked up our relative field strength by 85.1 percent at a point 9 inches down from the top of the antenna.

The "Mobil-Plane" slips down over your whip, and tightens onto the whip. A piece of shielded cable (provided) is run down to your spring mount, or to the body on the car, where it is grounded directly to the car or spring. Next you slide the "Mobil-Plane" up, and then down on the whip, until you find a spot where the relative field strength peaks up.

The capacity provided by the special radials and the anodized hub loading device really does increase your signal, and even results in improved received signals by providing a higher level of radiation on the whip antenna.

Installation time is under five minutes, there is no cutting or tuning. Once it is set, you forget it. Model MP-1 sells for \$5.95 from the manufacturer, while model MP-6 (with a little more gain) sells for \$7.95.

In the CB field, where every last db counts, CBH found this accessory a very worthwhile investment. We predict that in the month's to come CB'ers the nation over will be adding "Mobil-Plane" units to their mobile whips . . . as no rig will be complete without one.

The Utica MC-27 rig incorporates a double conversion crystal controlled superhetrodyne receiver and six transmit (as well as receive) channels into a very attractive and useful package. Dubbed the MC-27, *CB Horizons* ran this rig through the lab over the year-end holidays when on-the-air operating conditions were anything but interference free!

First i.f. in the MC-27 is 1680 kc., while the low second conversion i.f. comes out at 266 kc. Our test unit was outfitted with crystals for channels 7, 9, 11 and 15.

One of our first observations on receive was the noise limiter. It worked so well without distorting the audio we wanted to find out why. It seems



Engineer Lorry Henley positions the MP-1 on the Topper test whip. Unit resembles Sputnik with hub and four spokes!

model whip. On the 102 inch whip, we found the additional capacity provided by the "Mobil-Plane" really took hold about 48 inches up the whip from the spring base. At this point, our relative field strength meter jumped up approximately 60 percent when the "Mobil-Plane" was tightened into place. On

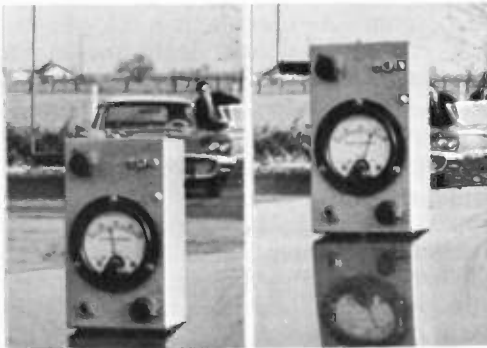

CBH tested the MP-1 on and "off" a Topper top-loaded whip. Field Strength meter at left read '70' with MP-1 off the Topper, and meter on right read '132' with the MP-1 attached to the antenna. Car in background houses new Polycomm "N" rig, the test set

that Utica engineers use a "double gated full wave series noise limiter" which not only clips the noise but also adjusts the amount of limiting so as to not distort weak signals.

Receiver sensitivity is another important feature of the MC-27. The manufacturer claims .6 uV will provide 6 db of signal over the receiver noise.

So here—hand in hand with the double gated full wave series noise limiter—is where the .6 uV receiver sensitivity of the receiver proves its usefulness. We found it capable of copying signals (although we did strain a little) which even straining our ears could not allow us to copy with two other comparable priced receivers in the lab.

The unit is rugged throughout, utilizes more expensive than average "grain oriented silicon steel" for high efficiency, and ceramic disc capacitors throughout for greater reliability. The unit operates from 117vac, 6 or 12 vdc. It is good looking and a very popular buy at \$189.50.

10-7

VERTICAL OR
HORIZONTAL

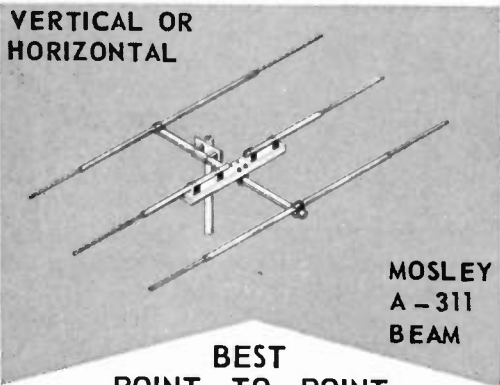

MOSLEY
A-311
BEAM

BEST
POINT-TO-POINT
COMMUNICATION

FCC regulations limit actual power input of Citizens Band transmitters to 5 watts. With the popular Mosley A-311 three element beam you can achieve a legal effective power input of 40 watts. (Note: 9 d.b. signal gain of the A-311 gives you a power gain of approximately 8.) Write Dept. CBH22 for complete specifications.

List \$46.88



Electronics Inc.
BRIDGETON, MISSOURI

(Continued from Page 14)

can't completely eliminate noise . . . but you can completely eliminate noise radiation!

There are occasions when the best tried and true methods of noise suppression fail to eliminate noise radiation. If you have just such a problem, we suggest you look into the following sources of auto noise:

- (A) *Wheel static*—this is usually a popping sound (very loud and annoying) at medium and high speeds on dry pavement. Concrete roadways usually produce the greatest amount of this type of noise. Every auto parts dealer sells inexpensive "wheel static collectors".
- (B) *Tire static*—if you have tubeless tires, forget about this one. If you have inner tubes, beware! This type of noise is difficult to explain, except as a steady drone that increases with speed. A special anti-static powder can be procured at larger auto parts stores, which is injected into the inner tube through the air valve.
- (C) *Instruments*—your dash board instruments are for the most part electrical. The gas gauge, heat gauge, oil gauge and others can cause radio noise. The best way to trace such noise is to disconnect one at a time with the motor running and the CB set on. If you find one or more that reduce the noise level when disconnected, connect a 0.1 ufd. coaxial condenser from the meter contact point to car ground, grounding the condenser case to the auto body.

So there you have the major problem areas in CB mobile. If it makes you feel any better about your own particular problem, 11 meters is one of the worst possible frequencies for mobile operation because many of your car's noise generating devices have maximum noise output near 27 megacycles. But somehow . . . we all seem to live with it.

10-7

CLASSIFIED

Rates for classifieds are 10c per word for advertising which, in our opinion, is obviously of a non-commercial nature. A charge of 25c per word is made to all commercial advertisers or business organizations. We do not bill for advertising in CLASSIFIEDS, nor can we acknowledge receipt of copy sent in. Full remittance MUST accompany all orders. NOTE: The products and services advertised in this section are not guaranteed by the publisher of CB HORIZONS. Closing date for the March issue is January 25th.

AMECO CONVERTER crystal controlled for 11 meters, 12 VDC, no B+, output at 1000 kc, for car radio. New \$15.00 **JONES** VHF-UHF micro-match reads SWR and power up to 400 w. \$22.50. **COLLINS** military 50/100 kc crystal calibrator unit \$9.00. E.V. 915 crystal microphone \$4.50 **DUMONT** 3 inch 'scope \$17.00. R. Wilde, 3671 23rd St., San Francisco 10, Calif.

CB QSL! C. Fritz, Box 1684, Scottsdale, Ariz., for the world famous RAINBO CALLS, many others! Samples 25c (deductable).

CITIZEN BAND! Update old transceivers, improve new ones. OZCO "Snoozer" add-on squelch unit quiets to a hush! Compact, completely wired and guaranteed. Easily installed! Only \$2.00 each, \$3.95 a pair, postpaid (tax included). OZCO Sales, Canaan, Conn.

WANTED; Will purchase your used CB gear. Advise make, model, condition & price. Ready cash. Higley, Box 82, Keyport, N. J.

FREE SAMPLES—CB QSL CARDS. \$2.50 per 100 in 3 COLORS, POSTPAID. Garth Printing Company, Box 51, Jutland, N.J.

WALKIE-TALKIE radiophones, converters, signal boosters at factory prices. Write for free literature. Vanguard Electronic Labs, 190-48 99th Ave., Hollis 23, N.Y.

CB QSL CARDS—100 four-color \$3.70 postpaid. Samples ten cents or send twentyfive cents and receive large selection and free DANGER HIGH VOLTAGE SIGN. Dick Stauffer W8VXK (CB license pending), 1996 N. M-18, Gladwin, Mich.

STOP WASTING THOSE WATTS! Let the SWR-1 help you improve that inefficient antenna system! Read your rf power and SWR directly in watts — no more guessing!. Only \$19.95! Write for details today! Dealer inquiries appreciated. HGL Electronics, P.O. Box 125, Medford, Ore.

GOODBYE CRUEL WORLD! Being drafted and have to part with my 2 "new" Utica Town and

Country rigs. Never used, taken out of packing just once, still in original cartons. Warrantee cards never sent in to factory. I paid \$189.00 each, will sell separately for \$135, or \$250 for the pair. With Ch. 9 crystals. I'll pay shipping. B. Lowe, 1309 1/2 N. Billen, Oklahoma City, Okla.

QRM KILLERS—Sprague "Filterol #2" power line filters—crush incoming power line noise, outgoing CB-TV1. Also attenuates ignition noise when used in mobile rig. Check any catalogue, they're \$8.70—our price only \$1.00 each, two for \$1.50, while they last. McCart Electronics, 2204 Downing, Oklahoma City, Okla.

FOR SALE—Used and demo CB units by Citifane, Morrow, etc. Send for listing. Forman Company, Monmouth, Ill.

AUTOMOTIVE GENERATOR NOISE FILTER — This filter eliminates the noises from the generator at the source; on the generator. It is pretuned to CB frequencies and sealed against moisture, oil and dust. Simple to install (with complete instructions enclosed), efficient in operation. Only \$3.00 postpaid. If your dealer does not stock, write: Ben N. Bartlett, 11W5592, 1815 W. 85th St., Los Angeles 47, Calif.

"SK-3" RF PRESELECTOR kit for Heath GW-10 transceiver. Increases sensitivity at least three "S" units, 18 DB. Wire and install in one evening. Inconspicuously mounts at rear of transceiver; extends only 1 1/2". No original GW-10 wiring cut, only one wire unsoldered. High-GM tube, all parts, complete instructions included. Hundreds of pleased users. Send \$8.99 (postpaid) to HOLSTROM ASSOCIATES, P.O. Box 8640, Sacramento 22, Calif.

GAR'S GABBINGS

(Continued from Page 47)

sack. At this point, I got a "land line" call from John "Foxy" Guttermuth, 18Q3300, of Royal Sales & Service (CB) and we talked CB for about an hour and a half, ending at 3:00 a.m.

Now I found myself heading back toward my native New England with an additional 6,500 miles on the car and my new CB friends behind me. Here endeth my extended trip and, as you can tell by my route, I divided the country in half diagonally. I am now below the Mason-Dixon line, covering the Southeast; this spring, the Northwest. I hope to meet each one of you personally. If you see me, give me a shout!

Be sure to read the next issue of CB Horizons wherein I will be reporting on CB in New England. 73's for now

10-7

7.K. on C.B.

By TOM KNEITEL, 10Q3161

In Response To Requests . . .

Several months ago we mentioned about getting free movies for showings at your CB club meetings. This seemed to stir the interests of many and every day we receive a few more letters asking about the films.

True, some of the free films which are available are strictly for the birds, but you'd be surprised how many are related to radio and land-line communications — and would make for very interesting "member getters" at your meetings.

Free films are produced by a number of sources, the New York Stock Exchange, the big auto manufacturers (Ford, G.M.) and several of the major electronics companies.

Possibly the best and most convenient source of free films on communications is your local telephone company. You'd be surprised at what they have to offer just for the asking—in fact, to show you what we mean we thumbed through their catalogue and extracted a few of the films which would be really great for showing at a CB gathering:

COAXIAL AND MICROWAVE MIRACLES, 11 minutes. The story of coaxial cable and microwave radio relay stations. Shows typical antennas used and also actual operating models to demonstrate the interesting behavior of microwaves.

CRYSTAL CLEAR, 10 minutes, color. This film shows how substitutes for natural quartz crystals are "grown" in laboratory gardens.

HORIZONS BEYOND, 12 minutes, color. A report on the progress of transistor research and new microwave relay systems.

MOBILE TELEPHONES, 11 minutes. The story behind those "other mobiles" you've seen on the road.

THE TRANSISTOR, 10 minutes. The story of the discovery, development, and use of transistors.

VOICE SENTINEL, 16 minutes. A camera tour of Western Electric's amazing crystal cutting workshop. With the aid of animated cartoons, it describes the role of quartz crystals in radio communications.

THE BIG BOUNCE, 14 minutes, color. The story of the ECHO 1 communications satellite and how it can affect your radio communications.

SIMILARITIES IN WAVE BEHAVIOR, 27 minutes. If you've ever wondered about "wave length" or the exact nature of radio waves, this film will clear up the situation.

CRYSTALS—AN INTRODUCTION, 25 minutes, color. The film introduces crystals right from the orderly arrangement of atoms in the crystalline state and the relation of this arrangement to physical properties of radio crystals.

Now these are but a few of the films available from your local telephone company. They will gladly supply you with a catalogue upon your request. And here's another plus — the telephone company will also send a speaker to one of your meetings to demonstrate new developments in the science of electronic communications.

If you live in a large city, look in your yellow pages under *Motion Picture Film Libraries* for companies which distribute the free films produced by American industries, or contact the public relations departments of the larger companies directly.

10-7

THIS MONTH WE'RE GIVING AWAY OUR "DREAM STATION No. 1"

Courtesy of CBH and the CB Manufacturers of America!
NO MONEY! NO BOXTOPS! NO CONTESTS! JUST PRIZES!

All you do is fill out the card between pages 52 and 53 (or reasonable facsimile), paste a stamp on it, mail it to us before February 10th—and you have a chance of all kinds of goodies. Winners' names will be drawn from the old barrel, notified by mail and announced in the April issue. You can enter every month if you like—be sure to watch for our DREAM STATION #2 which consists of a BROWNING LAB 23-S-9 23-channel transmitter (with 23 crystals) and the BROWNING LAB R-2700A super-deluxe receiver, plus a famous signal s-t-r-e-t-c-h-i-n-g antenna and other accessories—SOON IN CBH! (A subscription to CBH is your only assurance of being able to know when this equipment will be given away!)

\$350.46 IN PRIZES THIS MONTH!

Dream Station Prize—(Winner receives A, B, C, & D—worth \$286.88)

(A) **A Poly-Comm II-G Transceiver (\$189.50 Net).** From Polytronics Labs, 388 Getty Ave., Clifton, N.J.

The rig you've heard so much about. Dual conversion receiver, adjustable squelch, AVC, all electronic switching, four channels (with Channel 7 "rock" included). Built like Gibraltar truly a "dream rig" in every sense.

(B) **An ELENCO Power Gainer (\$45.00).** From Electronic Engineering Co., Wobash, Ind.

You've heard about this little gem too. CB'ers report 50 to 100% increased range from this audio compression amplifier which connects simply to any rig. Like having 20 watts! Legal, too!

(C) **A MAGNUM-27 Colinear Ground Plane Antenna (\$27.88 Net).** From The Antenna Specialists, 12435 Euclid Ave., Cleveland 6, Ohio.

You get an effective gain of 6 db due to the exceptional signal-to-noise characteristics of this excellent antenna. It's 18' high, aluminum and steel, grounded for lightning protection. Top notch!

(D) **A Lafayette Hybrid Phone Patch (\$24.50).** From Lafayette Radio 165-08 Liberty Avenue, Jamaica 33, N.Y.

Only four simple connections and your CB system is connected to your inter-office telephone or intercom system.

SECOND PRIZE—A Turner 350C Microphone (\$10.08 Net). From The Turner Microphone Co., 925 17th St., N.E., Cedar Rapids, Ia.

Ceramic hand held mike with 80 to 7000 cps response. Push to talk, hanger button and dash bracket for mobile mounting, high impact case.

THIRD PRIZES—An Antenna Specialists Model M-74 Mobile Antenna (\$19.32 Net). From The Antenna Specialists, 12435 Euclid Ave., Cleveland 6, Ohio.

Brand new antenna far cowl-fender or deck mounting. Includes swivel mount, 12 feet of RG-58U, 2 PL-259 connectors. It's 44" high and the talk of the town.

A Vanguard RF Amplifier (\$10.99 List). From Vanguard Electronics Labs, 190-48 99th Ave., Hollis 23, N.Y.

Receiver signal booster contains high gain pentode tube in a circuit tuned to 27 mc. High image rejection, wired.

and

A Holstrom SK-3 RF Preselector Kit (\$8.99). From Holstrom Associates, P.O. Box 8640, Sacramento 22, Calif.

Designed for Heath GW-10 but will work with any unit. Increases sensitivity at least 3 "S" units. Installs simply, wires up in one evening.

FOURTH PRIZES—An OZCO "Snoozer" Squelch (\$2.00). From OZCO Soles, Canaan, Conn.

Add-on squelch quiets your receiver to a hush!

and

A CESCO Generator Filter (\$2.95). From CESCO, 6151 Dayton Liberty Rd., Dayton, Ohio.

Eliminates generator whine in mobile installations. Tunable.

and

100 4-Color CBL Cards (\$6.00). From Citizens Band Two-Way Radio Co., 4005 N. Penn., Oklahoma City, Okla.

Your own CBL card beautifully personalized from Oklahoma's largest all-CB dealer.

and

5 CB Log Books (\$6.55 each). From Elonem Co., 1116 Inwood Pl., Plainfield, N.J.

Especially designed for CB, this new book contains 50 pages with plenty of space for each entry. Keep track of your station activity. 5 winners here!

DOLLHOUSE

(Continued from Page 45)

stated that "Washington Citizens' Band operators can expect to be called upon in any large-scale emergency operation. They've proved their worth."

Even before the successful completion of "Operation Dollhouse" the official congratulations of the government of the District of Columbia were presented to the Citizens' Band volunteers. A proclamation by the Board of Commissioners of the District, appointed by the President of the United States to head the DC government,



THE F.C.C.'s CURTIS B. PLUMMER (pointing), Chief of the Safety and Special Radio Bureau, and Harold Richmon, member of the Washington Field Staff of the Commission, discuss the application of Citizens' Radio to community projects such as "Operation Dollhouse." A special monitoring station was set up in the Messoge Center for their convenience in listening in on all ten operating channels used in the project.

Mr. Plummer, 24W0364, holds the first "24W" CB license in the call-book.

commended the CBers for their "enthusiastic, able and willing response . . . and their adeptness in organizing this unique full-scale mobilization of a communications system of potential importance to the Washington Metropolitan Area."

"Operation Dollhouse's" primary



A HAPPILY SURPRISED CBer, Morton Goldberg, 4W1383, holds the RCA Mark VII transceiver he won as a door-prize after "Operation Dollhouse." More than 70% of the CBers had already volunteered their help before it was announced that RCA and other companies were donating prizes in thanks for their services.

goal, that of collecting gifts for needy children, was fully and successfully met. So too, by every possible indication, was the secondary goal of proving the tremendous value, current and potential, of organized Citizens' Band radio stations and operators towards the common good. The hard work and enthusiasm of these hundreds of Washington CBers will go a long way towards complete public recognition and acceptance of the great services that CBers can and will perform is called upon.

10-7

DEALERS!

**CB's MOST POPULAR
TUBE, THE**

6AQ5

90% OFF

**NATIONALLY
ADVERTISED
NET PRICES!**

3 FOR

ONLY \$1.20

PREPAID

These are the ruggedized, long-life, missile-age, industrial versions of the 6AQ5 (see p. 23, Sept. '61, CBH) made by 2 famous American manufacturers. One year guarantee.

Pulled from brand new precision electronic equipment, they have never been used. NOT "seconds" or "burnouts." Limited supply at this never-before-offered price!

Order NOW!

**CITIZENS BAND 2 WAY
RADIO CO.**

4005 N. Penn., Okla. City, Okla.



**BEFORE WE
SIGN OFF**

D. C. FLASHES!!

By **REX HOLMES, 24W2424**
"Our Man in Washington"

Knuckle Rappings . . .

William S. Howard, Costa Mesa, Calif., a Class C CB'er, received a "show cause" notice from the FCC because he changed his address without notifying the FCC, for technical violations, and for failure to respond properly to the citation.

Down south, William W. Newman was hit with a "show cause" for allegedly transferring his station "without Commission consent" to another person, and failed to respond properly to his citation.

The stepped-up FCC crackdown on CB also resulted in the revocation of the license of David A. Gentry, 12W3205, of Berkeley, Calif. Gentry was hit for not responding to his "show cause" notice concerning the nature, length, and identification of transmission contrary to the rules.

William Willson, 18Q2940, of Glasgow, Ky., received a "show cause" because he was monitored by the FCC who said that he was using "obscene, indecent or profane language."

Harold V. Schlueb, 19W3768, received his "show cause" for operating his station "with excessive modulation," and for failing to respond to his citation.

There were also allegations that Eugene M. Moody, 7W2223, Vero Beach,

Fla. "had been permitting others, who were operating unlicensed radio equipment, to identify their transmissions" by the use of his call sign. Moody has received a "show cause" notice for failure to respond to a citation received calling his attention to the above violation.

Oscar Hermandy, Jr., doing business as *Main Line Oil Co.*, of Tampa, Fla., had his CB license revoked for not responding to a show cause order concerning "transmissions of communications not permitted by the rules."

Owen L. Tankersley, Pine Bluff, Ark., Class D licensee, has been given an FCC "show cause" order for alleged violation of Part 19 and Section 310 (b) of the Communications Act.

The FCC said that Tankersley "purported to transfer" the authorization for his station to "720 Auto Parts" in Pine Bluff "without the consent" of the FCC. They said that he "sought to conceal such violation by inducing the employees of 720 Auto Parts to claim that the radio apparatus being operated by them under the licensee's call sign was the property of such licensee, whereas such radio apparatus was not the property of such licensee."

It's interesting to note that the majority of the "show cause" notices go to CB'ers who don't properly respond to citations. Presumably there are many CB'ers who receive citations, answer them properly, and go along their merry way.

A "show cause" notice calls for the CB'er to try to talk his way out of the question: "Why shouldn't we revoke your CB license?" In many instances it's a difficult one to answer. If someone asked you that question, what would you say?

New 1962 Call signs

As late as mid-December there was still some question in the mind of the FCC as to whether or not they would give out the "R" letter CB calls as had been planned, or scrap the whole "Q to W" rotation system altogether. Since mid-1961 the Class A CB stations have been receiving calls such as KAA2707, KAA4887, etc.

10-7

LAFAYETTE is America's Citizens Band Headquarters

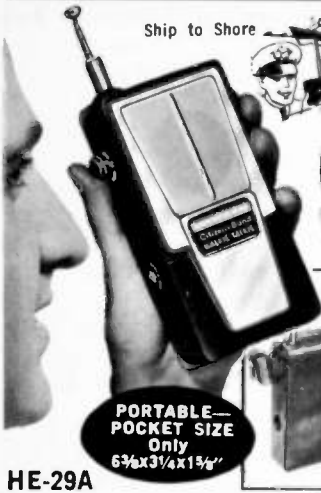

**PORTABLE—
POCKET SIZE**
Only
6 3/4 x 3 1/4 x 1 3/8"

HE-29A

Ship to Shore



On the Farm



Construction Work



**NO LICENSES,
TESTS OR
AGE LIMITS**

**9 LAFAYETTE
TRANSISTOR
CITIZENS BAND
"WALKIE TALKIE"**

39.95
2 for 78.88
NO MONEY DOWN

- Completely Wired—Ready to Operate • Fully Transistorized—9 Transistors plus 1 Diode • Uses Inexpensive Penlight Batteries
- No License, Tests or Age Limits • Comes with Leather Carrying Case, Earphone, Antenna, Batteries and Crystals

As simple and easy to use as the telephone—and twice as handy. Receives and transmits up to 1.5 miles under average conditions. Weighs only 18-oz. and slips into your pocket. Push-to-talk button operates built-in speaker as sensitive microphone.

LAFAYETTE HE-20A

Citizens Band TRANSCEIVER

- Pi-Network for Greater Power Output • Calibrated "S" Meter • Series Gate Noise Limiter • Tuneable Superhet Receiver over all 23 Channels • 4 Crystal-Controlled Transmit Positions • 4 Crystal-Controlled Receive Positions • Dependable Push-To-Talk Ceramic Microphone & Relay • Illuminated Dial • Built-in 12-Volt Power Supply • Complete with Matched Crystals for Channel 9

109⁵⁰
**NO MONEY
DOWN**

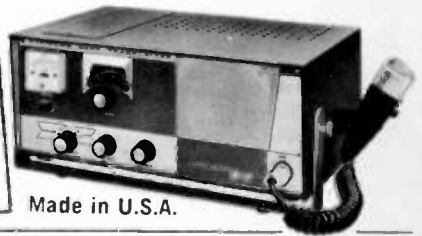

Made in U.S.A.

LAFAYETTE HE-15A Citizens Band TRANSCEIVER

SUPERHET

- Completely Wired—Not A Kit • 5 Crystal-Controlled Transmitting Positions • Tuneable Receiver Over Full 23 Channels • High Output Ceramic Microphone • Complete with Transmitting Crystal for Channel 9

A compact, precision transmitter and receiver covering up to a 20 mile or more radius, depending upon conditions. The HE-15A features an effective full-wave variable noise limiter, planetary vernier tuning. RF and microphone jack on front panel, 12 tube performance from 4 dual-function tubes, 2 single-function tubes, 2 rectifiers.

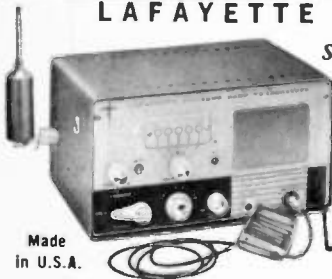

Made
in U.S.A.

**ONLY
59⁵⁰**
**NO MONEY
DOWN**

- | | |
|---------------------------------------|-----------|
| HE-19 Telescoping Whip Antenna | Net 3.95 |
| HE-16 Power Supply for 12 Volts | Net 10.95 |
| HE-18 Power Supply for 6 Volts | Net 10.95 |

LAFAYETTE ALL-IN-ONE CITIZENS BAND MOBILE ANTENNA

*The Scoop Buy for
Citizens Band Mobiles*

6.95

HE-800WX

- Chrome Swivel Base • Stainless Steel Spring • 102 1/2" Stainless Steel Whip for Optimum 11-Meter Performance
- Chrome swivel ball mount base designed for mounting on any surface. Stainless steel spring holds rod in properly adjusted position and prevents rod damage from shocks and blows. Stainless steel whip for maximum reliability and strength.



LAFAYETTE RADIO FREE!

**SEND FOR LAFAYETTE'S
NEW 1962 CATALOG**

Catalog 620
340 Giant
Size Pages

OTHER LOCATIONS:

- JAMAICA, N. Y.
165-08 Liberty Ave.
- NEW YORK, N. Y.
100 - 6th Ave.
- BRONX, N. Y.
542 E. Fordham Rd.
- BOSTON, MASS.
110 Federal St.
- NEWARK, N. J.
24 Central Ave.
- PLAINFIELD, N. J.
139 W. 2nd St.
- PARAMUS, N. J.
182 Route 17

LAFAYETTE RADIO, DEPT.

P.O. BOX 10, CBB-2
SYOSSET, L. I., N. Y.

- Send FREE 1962 Catalog 620 featuring the full line of Lafayette C.B. Equipment
- \$ _____ Enclosed for Stock No. _____

Name _____

Address _____

City _____ Zone _____ State _____

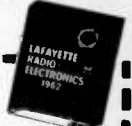



HERE'S THE NEW, 2-WAY
HAND-HELD TRANSCIVER THAT
OUTPERFORMS 'EM ALL!

PERSONAL *Messenger*

- No license required—may be used at once!
- Meets FCC requirements for use with licensed Citizens' Band stations, too!

This is the new "Personal Messenger"—a superbly engineered 2-way crystal-controlled transceiver so compact it fits in your hand—so flexible it can be used in thousands of applications! 11 transistors and 4 diodes—superheterodyne receiver with exclusive tuned R.F. amplifier gives you twice the sensitivity and more than 40% more range than units with conventional circuitry! Powerful two-stage transmitter delivers more power output than similar units with the same rated input! Unmatched audio intelligibility and razor-sharp voice reproduction—automatic noise limiter—automatic volume control—positive squelch control—elastic hand stop—operates on penlight or rechargeable nickel-cadmium batteries.

\$109.50



ILLUSTRATED AT LEFT—The Viking "Messenger"—maximum legal power Citizens' Band crystal-controlled transceiver. Excellent receiver sensitivity and selectivity—highly efficient transmitter punches your signal home! Built-in squelch—AVC—ANL. With tubes, push-to-talk microphone and crystal for 1 channel.

FROM **\$134.95**

<p>Delivery or fleet operation</p>	<p>Your own personal use</p>	<p>Construct on or Business</p>

FREE
Color Brochure

WRITE TODAY



F. JOHNSON COMPANY

10 Tenth Avenue S. W. • Waseca, Minnesota

• Please rush me your full color brochure.

NAME _____

ADDRESS _____

CITY _____ STATE _____

Manufacturers of the world's most widely used personal communications transmitters

**HEAR YE...
HEAR YE!**

**Announcing
The
Horizons Publications
1962
MONTHLY CB Callbook
Supplement Service**



CB Operators have long asked for a monthly listing of new CB licenses as granted by the FCC. NOW—for the first time, and on an exclusive basis, Horizons Publications is able to make such a service available to CB'ers. The new "CB Call-Book Monthly Supplement Service" will provide monthly listings of new CB'ers, broken down by call districts. The first issue will be available February 25 by subscription through Horizons Publications or over the counter at your favorite CB parts store. The February issue will cover all new 1962 licenses granted between January 1 and January 31. Issues will follow on the 25th of each month throughout all of 1962 . . . 12 issues in all. Order your subscription copy now for guaranteed delivery of all 12 issues (\$6.00 per year), or reserve your copy at your local CB center (\$1.00 per copy).

— HOW TO ORDER —

The space below this announcement has your name and address affixed to it. Simply cut off this section of the cover, attach a check or money order for \$6.00 (payable to Horizons Publications) and airmail today to:

**CB SUPPLEMENT
Horizons Publications
P. O. Box 3150
Modesto, California**

BULK RATE
U. S. POSTAGE
PAID
Permit No. 7
Okla. City, Okla.

OKLAHOMA CITY, OKLAHOMA
P. O. BOX 1557
CB HORIZONS