

CB

HORIZONS

THIS IS A FREE SAMPLE COPY
Bonus Subscription Offer Inside

October 1961
40 CENTS

CB's 3rd BIRTHDAY



Hey CB'ers! There's a party going on here.

C'MON IN!

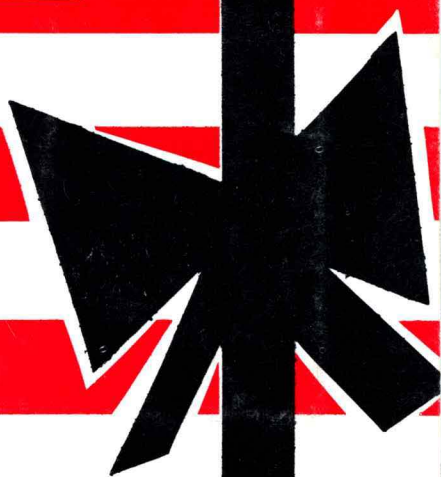

JL

THE CITIZENS BAND RADIO MAGAZINE

IN THIS ISSUE—

A COMPLETE CB STATION—FREE!! • The Full History of CB • A CB Old-Timer Looks Back at Class D in 1958 • Spruce Up Your Operating • Exclusive Report on NEW FCC CRACKDOWN • Tuning Your Mobile Antenna • Build a 2 Element Beam • CB's Future: 250 NEW CHANNELS(?) • FCC Monitoring Map . . and much, much more!

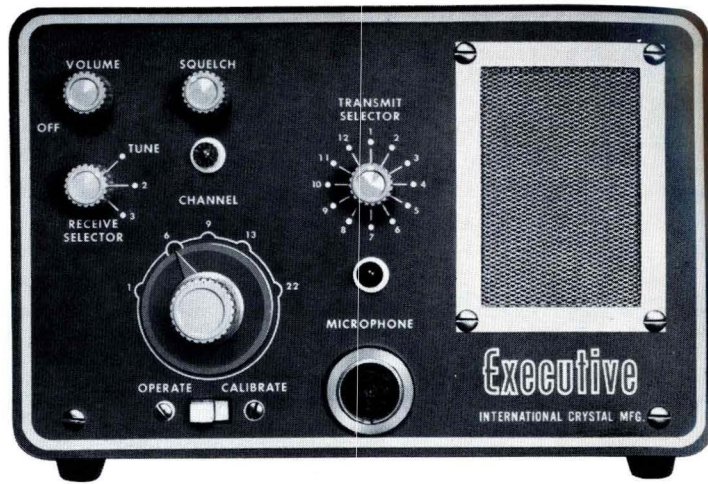

MODEL 100

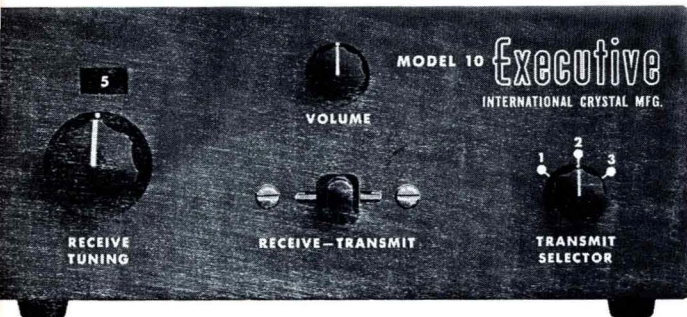

MODEL 10

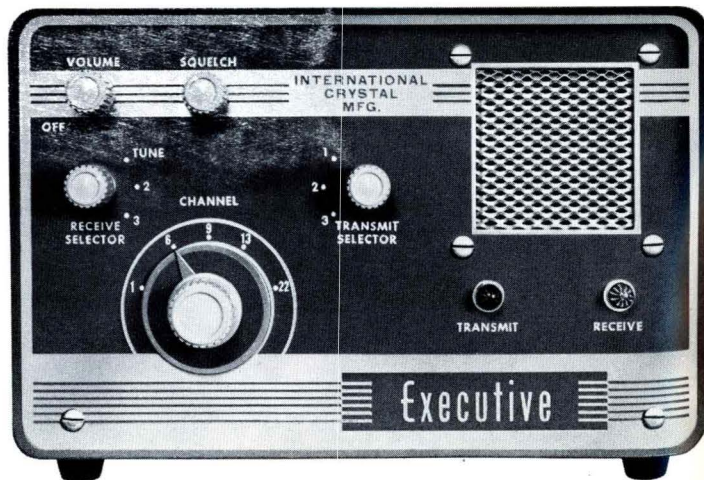

MODEL 50

INTERNATIONAL'S

new series **Executive**

for **SUPERIOR** Citizens band communication

INTRODUCING THREE SYSTEM-ENGINEERED TRANSCEIVERS

MODEL 100

The ultimate in Executive Citizens transceivers. NEW crystal filter which minimizes adjacent channel interference in the receiver. NEW built-in receiver calibration circuit. NEW International NR squelch. NEW 12 position crystal control transmit channel selector. NEW front panel microphone jack. NEW provision for connecting external speaker and S/meter. Dual conversion superheterodyne receiver. Push-to-talk operation. Three way power supply for 6/12 vdc, 115 vac. **Complete with 1 transmit crystal, 1 receive crystal, new style ceramic microphone and coil cord. \$199.50 ***

MODEL 10

International's exciting NEW *Compact* transceiver for the budget minded customer who desires quality workmanship and engineering plus the best possible circuit for the money invested. Field tested full 5 watt transmitter contained in the higher price Executives. Tunable superheterodyne receiver covering all 23 channels. Three position crystal control transmit channel selector. Manual transmit-receive control. Noise limiter. Available accessories include four separate power supplies — 6 vdc, 12 vdc, 24 vdc or 115 vac, push-to-talk relay kit, squelch kit, and 12 position transmit channel selector. **Complete with 1 transmit crystal, matching microphone and external speaker, but less power supply. \$59.50 ***

MODEL 50

A precision engineered transceiver featuring push-to-talk operation. Three position crystal control transmit channel selector. Dual conversion superheterodyne receiver tuning all 23 channels. Series Gated automatic noise limiter. NEW International NR squelch. Three way power supply — 6/12 vdc, 115 vac. Additional features of Model 100 are available as accessories, and may be added at any time. **Complete with 1 transmit crystal, matching microphone \$149.50 ***

**Suggested Price*

SEE THE EXECUTIVE SERIES AT YOUR AUTHORIZED INTERNATIONAL DEALER

 **INTERNATIONAL CRYSTAL MANUFACTURING CO., INC.**
18 NORTH LEE • OKLAHOMA CITY, OKLAHOMA

Modesto Mike's



Mailbox

Dear Mike,

Here I am back again . . . big as life with my 27 megacycle QUAD thanks to your construction article in the August Directory issue of CBH. Each issue gets better than the previous issue, and as far as I was concerned, the first issue was TOPS! What—just what—can you do this month to top the fantastic September issue?

John Guerrero
P. O. Box 788
Lompoc, California

John, we love you! If it's highlights you want, we suggest you read all about the CBH CCM program on page 21 this month. On the other hand, if you want to know what we are really up to, we suggest you relay the following to your unit two:

FLASH!



CB Horizons can now reveal that the popular Warner Brothers television production "77 Sunset

Strip" series will begin regular use of CB radio as a part of the script-action. The use of CB radio in the hands of popular TV stars Edd "Kookie" Byrnes, Roger Smith and Efreim Zimbalist, Jr. as they conduct their "private detective business" will certainly be a boon to the entire field. Certainly the number of Communications-minded Americans who see this program, and later follow through to investigate CB radio as a form of personal communications, will be in the tens of thousands.

The history behind the use of CB radio on this popular adventure show is equally interesting. It seems that an ABC network engineer in Chicago is an avid CB operator. The engineer told the ABC production chief in the windy city of the use of CB radio and the production chief in turn went to bat with ABC Hollywood. After long and careful study "77 Sunset Strip" was picked for the television debut of Citizens Band Communications.

When word of the plans leaked out to the CB manufacturers, interest in CB reached an all time high. The CB manufacturers immediately investigated the possibility of getting further mass public interest in the field by placing an article in a general interest electronics publication. The end result is a scheduled "starting date" of CB radio and "77 Sunset Strip" in mid October, and a follow-up story in the general interest electronics magazine in November. Many of your favorite CB stores will be featuring attractive window display posters tying in the use of CB Radio on "77 Sunset Strip."

CB Horizons congratulates Warner Brothers, the producers of the adventure-packed series, for their insight in making use of "our band" for personal two-way communications.

Gang — take a listen and looksee at the newest 11Q calls on the air — "77 Sunset Strip," in October!

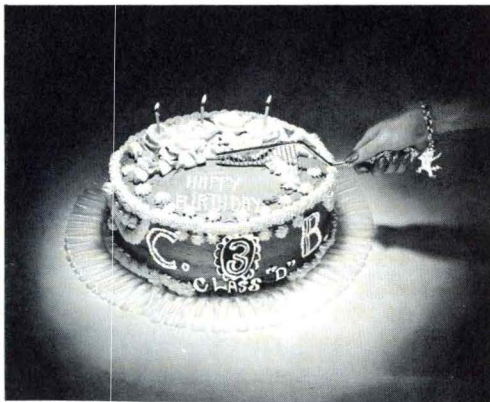

Just thought that you'd like to see the cake that we had at our CB Birthday party here in the CBH offices. The hand wielding the cake cutter is none other than that of our own Jackie Johnson, 12Q2015. Party was attended by members of the local CB gentry who had a good and calorie-filled time. How many other HAPPY BIRTHDAY CB parties are being held this month?

READER DEMAND FORCES CB HORIZONS TO EXTEND OUR BONUS SUBSCRIPTION DRIVE . . .

SO HERE IT IS AGAIN!

As announced last month CB HORIZONS has purchased the rights to publish the "Citizens Band Call-Book" from the International Crystal Company. The next issue of the Call-Book will be available January 20, 1962, listing all of the "Q" calls issued from January 1, 1961 through December 31, 1961.

With the CB Horizons Acquisition of the Call-Book, our Technical Department Announces the Following Additions to the Call-Book Format

- Every CB "Q" Call issued in 1961, more than 80,000 in all!
- ★ **BRAND NEW** — 16 page section all about your station, how to spruce up your antenna, rig, mobile and signal. This is the new HANDBOOK section of the CALL-BOOK.
 - ★ **BRAND NEW** — 16 page section listing with photos and specifications every piece of CB equipment on the market today. A complete buyers guide to CB radio, a handy-ready reference for the year ahead.
 - ★ **BRAND NEW** — CB Logging Section, a specially prepared "Local" directory section where you can jot down the channels, calls, operating times, names and other pertinent data about CB'ers you meet.

These extra-ordinary features will make the 1962 CALL-BOOK the most valuable reference manual you will have in your radio room.

BEST OF ALL — THE PRICE IS STILL \$3.95!

To Save Money—and Reserve Your Copy of the 1962 CB Call-Book Today . . . Turn Over This Card For Very, Very Special Offer

NEXT MONTH — In the NOVEMBER ISSUE of CB HORIZONS

- ★ **THE ADVANTAGES AND DISADVANTAGES OF CB CLUBS**
An IN-DEPTH REPORT all about why CB Clubs are so popular, what they have to offer, and what the pitfalls of club operations are. This will be **must-reading** for every CB'er whether you belong to a club or not.
- ★ The following points will be covered in a series of special articles all about club operation
 - How To Run A Successful Jamboree or Picnic
 - How To Run a Technical Assistance Program
 - Is It Necessary to Incorporate?
 - Methods of Raising Operating Funds for CB Clubs
 - How to Publish a Successful CB Newspaper
 - Operating Crystal Banks, a Club Monitoring Station, a TVI Committee, Establishing a Local Working Channel.
- ★ A Special Exclusive Listing of Every Known CB Club in the Nation, so you can contact those clubs near you for information on joining up!
- ★ **PLUS**—These X-TRA Feature Articles Designed to Make You a More Informed CB'er
 - WHY CB WILL (EVENTUALLY) GET 250 NEW CHANNELS
 - CBH-VMP, PHASE TWO
 - TRI-COUNTY STORY, a complete report on the CB Horizons nomination for the CB CLUB OF THE YEAR AWARD
 - BIG TIME IN ERIE, a report on the Erie, Pa., Jamboree
 - CRYSTALS ARE CRYSTALS ARE CRYSTALS, or, Why They Do What They Do
 - KYLE KILLS TVI, the most comprehensive report on CB TVI to ever appear in print, prepared by famous engineer-writer Jim Kyle, 10W0901.
- ★ **AND**—All of the popular regular columns and features that make CB Horizons the official voice of CB RADIO!

SPECIAL NOVEMBER ISSUE OUT OCTOBER 10th

NOW — TURN THIS FORM OVER FOR SPECIAL BONUS SUBSCRIPTION OFFER

ACT TODAY . . . SEND ONLY \$4.00 FOR . . .

(A) 12 OR MORE ISSUES (see below) OF CB HORIZONS AND
(B) THE 1962 CB CALL-BOOK and HANDBOOK.

Here is How you SAVE more than one dollar by subscribing to CB HORIZONS NOW during our extended-BONUS subscription drive and reserving your copy of the 1962 CALL-BOOK and HANDBOOK.

- (1) Subscribe to CB Horizons using one of the forms below \$4.00
(2) Place your order for the 1962 Call-Book, Handbook using the form below..... \$3.95

TOTAL VALUE \$7.95

(3) NOW—As a special reward for subscribing between September 10 and October 10, you may deduct \$1.00 from the TOTAL VALUE price of \$7.95.

SPECIAL OFFER COMBINATION PRICE \$6.95
(Includes Call-Book and 12 or more months of CBH)

DO NOT SEND THE FULL \$6.95

(4) Return one of the forms below today with \$4.00 and we will sign you up for the number of copies of CBH you have indicated, and reserve your copy of the 1962 CALL-BOOK at the same time! You will be billed for the remaining \$2.95 in December just before the Call-Book comes out!

THIS OFFER EXPIRES OCTOBER 10, 1961

(Tear off and airmail to CB Horizons Magazine, Post Office Box 3150, Modesto, California)

DEAR CBH:

I have checked off the proper line below indicating the BONUS issues of CBH I am eligible for, and reserving my copy of the 1962 Call-Book. Please bill me for the remaining \$2.95 in December. I understand the Call-Book will be mailed on or before January 20, 1962.

- Enclosed \$4 for 15 issues of CB Horizons and reserving my copy of the 1962 Call-Book. I am mailing this form prior to September 22nd.
 Enclosed \$4 for 14 issues of CB Horizons and reserving my copy of the 1962 Call-Book. I am mailing this form prior to September 27th.
 Enclosed \$4 for 13 issues of CB Horizons and reserving my copy of the 1962 Call-Book. I am mailing this form prior to October 5th.
 Enclosed \$4 for 12 issues of CB Horizons and reserving my copy of the 1962 Call-Book. I am mailing this form prior to October 10th.

(NOTE: If you do not wish to order the Call-Book, merely cross out the appropriate line on the subscription form below.)

My Name _____ CB Call _____

Address _____

Town-City _____ Zone _____ State _____

AIRMAIL TODAY to: CB HORIZONS MAGAZINE P. O. BOX 3150, MODESTO, CALIF.

(Tear off and airmail to CB Horizons Magazine, Post Office Box 3150, Modesto, California)

DEAR CBH:

I have checked off the proper line below indicating the BONUS issues of CBH I am eligible for, and reserving my copy of the 1962 Call-Book. Please bill me for the remaining \$2.95 in December. I understand the Call-Book will be mailed on or before January 20, 1962.

- Enclosed \$4 for 15 issues of CB Horizons and reserving by copy of the 1962 Call-Book. I am mailing this form prior to September 22nd.
 Enclosed \$4 for 14 issues of CB Horizons and reserving my copy of the 1962 Call-Book. I am mailing this form prior to September 27th.
 Enclosed \$4 for 13 issues of CB Horizons and reserving my copy of the 1962 Call-Book. I am mailing this form prior to October 5th.
 Enclosed \$4 for 12 issues of CB Horizons and reserving my copy of the 1962 Call-Book. I am mailing this form prior to October 10th.

(NOTE: If you do not wish to order the Call-Book, merely cross out the appropriate line on the subscription form below.)

My Name _____ CB Call _____

Address _____

Town-City _____ Zone _____ State _____

AIRMAIL TODAY to: CB HORIZONS MAGAZINE P. O. BOX 3150, MODESTO, CALIF.

USE THIS FORM

GIVE THIS FORM TO A CB FRIEND

Dear H my cons issu the cern just the

John wan CBI mor kno gest two

FLA

Warner Brothers television production "77 Sunset CB parties are being held this month!

2 ONLY CBH Brings You the CALL-BOOK—a listing of all CB'ers licensed in 1961!

DOUBLE POWER

20 DB GAIN

IN SIGNAL TO NOISE RATIO



Colinear Ground Plane

FOR
Citizens Band



**PROVEN
PERFORMANCE!**

more than
20,000
in use

3.4 DB OMNIDIRECTIONAL GAIN IN FIELD STRENGTH INTENSITY AS MEASURED BY THE NATIONAL BUREAU OF STANDARDS APPROVED METHOD.

The Hy-Gain colinear $\frac{3}{4}$ -wave length colinear ground plane . . . unlike multi-element beam antennas which concentrate energy in one or more directions at a sacrifice in power in other directions, achieves gain through colinear action which concentrates more power at lower angles to the horizon. The Colinear Ground Plane performs equally well receiving or transmitting, greatly increasing the range of Citizens Band communications. An exclusive Hy-Gain design—precision tuned and matched for 52 ohm coaxial cable, either RG-8/U or RG-58/U. Conforms to legal limitations — overall height only 20 feet . . . Built to heavy duty commercial specifications, radiator is $1\frac{1}{4}$ " O.D. to $\frac{3}{4}$ " O.D. heavy wall heat-treated aluminum tubing. Radials are 9 feet long $\frac{5}{8}$ " O.D. heavy wall heat-treated aluminum tubing. Cylolac plastic base insulator and steel bracket assembly accepts all masts up to $1\frac{5}{8}$ " diameter. Complete with matching stub and complete instructions for quick and easy assembly.

Model No. CLR

\$49⁹⁵

List Price

SEE YOUR FAVORITE DISTRIBUTOR OR WRITE TO:

Hy-gain antenna products

1135 NO. 22ND ST.

LINCOLN, NEBRASKA

CB HORIZONS

PUBLISHED MONTHLY BY HORIZONS PUBLICATIONS, INC.
POST OFFICE BOX 3150 • MODESTO, CALIFORNIA

STAFF

BOB COOPER, K6EDX
Publisher
TOM KNEITEL
12Q1747/WA6SYV
Managing Editor
ART BROTHERS
11W0759/W6IQJ
Associate Editor
REX HOLMES
JIM GIBSON, 2W7610
Contributing Editors
CLYDE D. MOORE, 9W0219
Editor at Large
JOHN MARKOVICH
Special Assignments Editor
H. FRIEDMAN, 2W6045/W2ZLF
Eastern Technical Rep.

CARLYNE SILVA, 12Q2207
Editorial Assistant
JACKIE JOHNSON, 12Q2015
Production Coordinator
JOHN R. LANNING
Art Director
SHERRY GREENER
Circulation Manager
JUDY GIBSON
Circulation Assistant

OFFICES

1016 - 14th STREET
MODESTO, CALIFORNIA
Telephone Lambert 4-7395
Eastern-Midwest
Advertising Office
COWAN PUBLISHING CO.
300 West 43rd Street
New York 36, New York
JUdson 2-4460
Dick Cowan
Jack Schneider, 2W5669

ADVERTISING

CB HORIZONS magazine accepts commercial display advertising from bona fide manufacturers, distributors of electronic equipment and associated apparatus. Advertising rate card and coverage data available upon request.

CIRCULATION

This issue of CB HORIZONS is reaching 53,000 plus Citizens Radio Service operators throughout the United States. Detailed circulation breakdown available upon request.

SUBSCRIPTION

Subscription rates in the United States, Canada—\$4.00 per year. Single copies 40¢ each. Subscriptions outside the U.S.A. and Canada—\$5.00 per year. Subscription remittances should be made by bank draft or postal money order. Airmail subscription available at \$7.00 per year, U.S. and Canada.

TABLE OF CONTENTS

FEATURES

AN FCC OFFICIAL SPEAKS The Citizens Band Boom	6
WILD ANTICS OF THE 1958 CITIZENS BAND Random Ramblings of a CB Old Timer.....	10
WITHOUT HIM, WHERE WOULD YOU BE TODAY ? Father of the CB Service.....	12
CBH PUBLISHER GIVES YOU A LOOK AT TOMORROW The Future of Citizens Radio	14
SAY MORE—SPEAK LESS Speak Correctly . . . Briefly!.....	19
HERE'S ONE YOU'VE ASKED FOR Precision Tuning Your Mobile Antenna.....	20
PUT AWAY THE ASPIRIN BOTTLES, BOYS ! FCC Monitoring Stations.....	22
CBH'S NEWEST FEATURE CCM Reports.....	23
FROM A MANUFACTURER'S PRIVATE FILE Understanding Mobile Whip Design.....	26
3 DB'S FOR \$3 Build This Simple CB Beam	28
CBH TESTS	
The Philmore CB Components.....	31
The H & L SWR—I Meter.....	32
Marina Buddy Whip.....	33
WE'RE GIVING AWAY A NEW CB STATION CBH's New Monthly Free Giveaway	42

DEPARTMENTS

MIKE'S MAILBOX (Be Sure to Read this Month)	2
CB TECH TALK	20
ANTENNA TOPIX	28
CB SHOWCASE	30
CBH LAB REPORTS	31
CLASSIFIEDS	34
CLYDE'S CORNER	36
TK ON CB	40
CBH - VMP	41
FREE GIVEAWAY	42
BEFORE WE SIGN OFF "Late-Late FCC News (to September 6) you can't read in ANY other Magazine before December"	38

CB HORIZONS (title registered U.S. Post Office) entered as Third Class postage in Modesto, California May 10, 1961. Second Class postage pending. All copyright and editorial rights reserved by Horizons Publications, 1961.

The entire contents of this magazine are copyrighted by Horizons Publications. No article in this magazine may be reproduced in whole or in part without the written permission of the publishers. Unless we are specifically advised to the contrary by the sender, we regard all material included in CB club papers sent to us as material submitted for publication in CB HORIZONS as a public relations gesture of the club. While CB HORIZONS pays for editorial material which is specifically written for its pages and accepted for publication, it cannot pay for public relations material.

OCTOBER 1961
VOLUME 1 - NUMBER 5

FOR POWER OR PORTABILITY . . . UNCOMPROMISING ENGINEERING WITH EICO® CITIZENS BAND TRANSCEIVERS

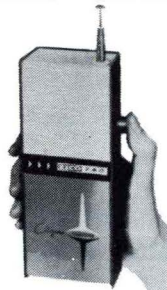

Operates 2500 hours on 1 rechargeable leakproof battery
EICO WALKIE-TALKIE MODEL 740: Kit \$54.95. Wired \$79.95.
Carrying Case \$3.95.

Complete with rechargeable battery & charger. No license or permit needed . . . no age limit

U. S.-made
an original
product of EICO
research.

Size: 7 1/8" x 2 5/8" x 1 5/8", weighs only 19 oz. . . . fits comfortably in hand, slips easily in jacket pocket.

• Finest U.S.-made nickel-cadmium rechargeable battery provides about 8 hours "on" time with 50% duty-cycle operation on a single charge • Battery can be recharged 300 times, replacing over 1,000 penlight cells (over \$200.00 worth) • Leakproof nickel-cadmium battery is hermetically sealed in plastic — can never cause corrosion damage • Full 100mW input to Final, as permitted by FCC for Unlicensed Citizens Band Operation • Crystal-controlled transmit & receive • Full modern superhet receiver • 9 transistors and 1 diode • Range 1 1/2 miles under average conditions • High quality circuit board, beginner-tested instructions for complete kitbuilding ease and assurance • Make a "network" with 2 or more EICO #740's or with EICO 770 series or with EICO 760 series

NEW VERSATILITY WITH NEW DELUXE 770 SERIES

	Kit	Wired
Model 770†: 117 VAC only	\$69.95	\$ 99.95
Model 771†: 117 VAC and 6 VDC*	79.95	109.95
Model 772†: 117 VAC and 12 VDC*	79.95	109.95

†U. S. Patent #D-190,970 *Including Posi-Lock Mounting Bracket

"A steal . . . Better than manufacturing specs . . . Publisher Cooper reports base-to-mobile contact out to 22 miles consistently, often to 40 miles . . . Thorough manual is almost a handbook for CB radio."—CB HORIZONS

Front panel selection of one of 3 transmit crystals with continuous receiver tuning over all 23 CB channels, or a fourth transmit crystal with appropriate receiving crystal. Press-to-talk button on microphone; transmit-receive switching accomplished by high-quality relay with minimum capacity between contacts to prevent current leakage at RF frequencies. Superhet receiver with RF stage for high sensitivity & proper signal-to-noise ratio. 1750 KC IF strip for unequalled image rejection & freedom from oscillator "pulling" on strong signals. IF strip prealigned so that only "touchup" alignment without instruments is needed. Current metering jack in cathode circuit allows checking of input power to transmitter final and adjusting it to FCC limit. 13-tube performance (4 dual function tubes, 4 single function tubes, plus germanium diode). Adjustable squelch control (in addition to automatic noise limiter). Optimum adjustment to any popular CB antenna assured through use of variable pi network in output. AVC. 3" x 5" oval PM speaker. Supplied complete with 8 tubes & 1 transmit crystal (extra crystals \$3.95 each).



The entire transmitter oscillator circuit and RF final in every EICO transceiver, kit and wired, is pre-mounted prewired, pretuned, and sealed at the factory (about 3 hours of skilled labor, precision adjustments and testing), complying with FCC regulations (section 19.71, part d). This permits you to build the kit and put it on the air without the supervision of a commercial radio-telephone licensee.

STANDARD 760 SERIES



	Kit	Wired	*Including
Model 760: 117 VAC only	\$59.95	\$89.95	Posi-Lock
Model 761: 117 VAC and 6 VDC*	69.95	99.95	Mounting
Model 762: 117 VAC and 12 VDC*	69.95	99.95	Bracket

Same uncompromising engineering, same care and precision, and largely the same circuitry as in 770 series (above), lacking only multiple-channel transmitting, crystal receiving, and push-to-talk microphone.

BEST BUYS IN SERVICE INSTRUMENTS: everything from Scopes to Probes



DC-5 MC 5"
Scope #460.
Kit \$79.95
Wired \$129.50.
Also available—
5" Push-Pull
Scope #425.
Kit \$44.95
Wired \$79.95



Dynamic
Conductance
Tube & Transistor
Tester #666
Kit \$69.95
Wired \$109.95
Complete with steel
cover & handle

Peak-To-Peak
VTVM #232
& Uni-Probe®.
Kit \$29.95
Wired \$49.95
VTVM #221
Kit \$25.95
Wired \$39.95



TV-FM Sweep
Generator & Marker
#368
Kit \$69.95
Wired \$119.95



EICO, 3300 N. Blvd., L.I.C. 1, N.Y. CB-10
 Send Free 32-page catalog & Distributor's name.
 Send Free Schematic of Model No. _____
 Send new 36-page GUIDEBOOK TO HI-FI for which I enclose 25¢ for postage & handling.

Name _____
Address _____
City _____ Zone _____ State _____

Export Dept., Roburn Agencies Inc
431 Greenwich St., New York 13, N.Y.

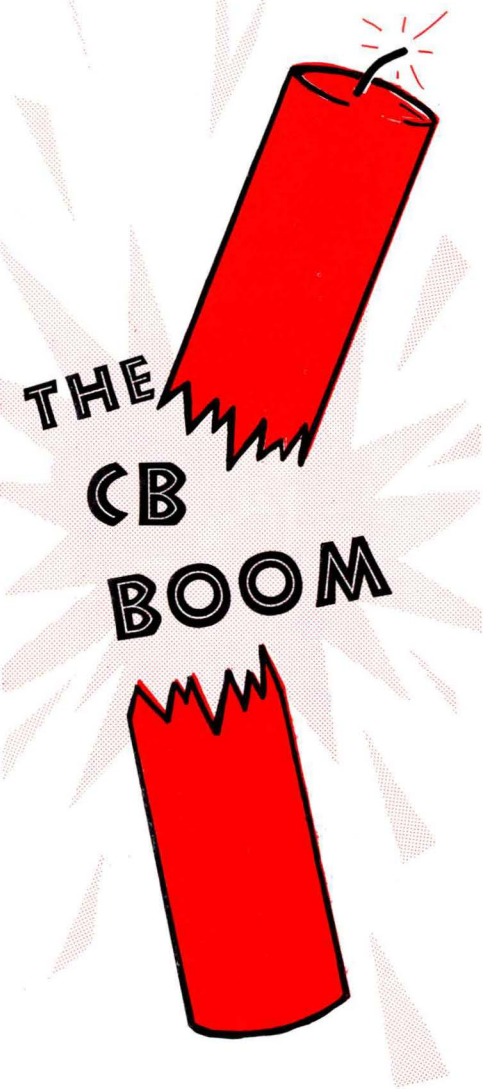

The Citizens Radio Service is defined by the Federal Communications Commission as a radiocommunication service of fixed, land, and mobile stations. Its stated purpose is to provide for the use of radio facilities by any citizen of the United States for private short-distance radiocommunications, radio signalling, or the control of remote objects or devices by means of radio. Let us trace its beginning, its progress, and its present situation.

The Early Days

During the closing months of World War II, the FCC conducted a series of fact-finding inquiries and hearings which culminated in a Report of Proposed Allocations dated January 16, 1945, covering the frequency range from 25 mc. to 30,000 mc., and bearing the designation "Docket No. 6651." In that report the Commission proposed an equitable peacetime allocation of the frequency spectrum above 25 mc., to provide for the reasonable known or estimated needs of all segments of the American public whether local governments, industries, or private individuals. To meet that latter need—to make possible the fullest practicable development of private radiocommunications within the limits set by other demands for assignments in the spectrum—the Commission, on its own motion, proposed to allocate the band 460-470 mc. to a new radio service, to be known as the Citizens Radio Service.

This service was not possible before World War II because sufficient frequencies in the higher portions of the radio spectrum had not been developed to meet the needs of the more-pressing services. That was the situation despite the fact that the usable radio spectrum was already a hundred times larger than in 1925, when for all practical purposes it ended around 3,000 kc. By 1940, the ceiling of formal allocations was 300 mc. (300,000 kc.), but only the frequencies up to possibly 100 mc. were really in effective use.

Because the usable frequency spectrum was rising like a thermometer, the FCC made provisions for the proposed CB service as far down the spectrum as possible to make it more readily available for use. However, owing to such needs as those of

FM Broadcast, TV, police communications, aviation and government agencies, the lowest spot that it could assign for CB was the 460-470 mc. band. This spot was considered well suited for CB for two reasons. First, no "skip" interference would be experienced, and, second, it was felt that because of their experience in making radio equipment for the military services, manufacturers would be able to design and construct sets for these frequencies soon after the end of the war.

On The Air - - At Last

The first developmental (called at that time Class 2 Experimental) authorization for the operation of a station in the CB serv-



The BC-645 U.S. Army transceiver, the first mass produced set used on CB frequencies.

ice was issued to Mr. John M. Mulligan, a radio engineer of Elmira, New York, on February 14, 1947. It was followed in June of that year by proposed technical standards for equipment to be used in the service, which were modified to some extent and adopted by the Commission in October, to become effective on December 1, 1947. These standards made provision for the type-approval of equipment to be used in either of two classes of stations to be operated in the Citizens Radio Service. The first, appropriately called Class "A" was to be subject to fairly strict technical standards, roughly equivalent to those imposed on other services using comparable frequencies, and would be permitted up to 50 watts (input) power when operating on frequencies in the 460-462 or 468-470 mc. portions of the band, but only 10 watts (input) elsewhere. The second, Class B, stations were limited to 10 watts input power but the technical standards were such that nearly any equipment could be used so long as all operation (including tolerance and the occupied bandwidth) was

confined within plus or minus 0.4% of 465 mc. (This was changed to 0.5% in 1950.)

The first CB equipment to be type-approved was for Class A station equipment. It remained, however, for type-approved "B" equipment to become more generally available, within a low-price range attractive to the individual, before the original intent of the Commission with respect to making radio communications available to the average citizen began to be fulfilled.

Equipment Approvals — Finally

The general commercial availability of type-approved Class B station equipment took place in the Autumn of 1955, as a result of the FCC's relaxation of the technical standards for such approval.

Class D On The Air

In 1957, the FCC had to re-arrange the allocations in the high frequency spectrum and as a result, the CB service lost 6.25 mc. of its 10 mc. 460-470 mc. band. At the same time, the frequency band 26.96 to 27.23 mc. (then assigned to the Amateur Radio Service) was reallocated to the Citizens Service, and the rules governing the CB service were extensively revised. The Class D service was added, with official adoption on July 3, 1958. The band was opened for communications on September 11, 1958.

The licensing of stations in the new Class D service began rather modestly with a very few during October and November of 1958, but had reached 600 per month in January 1959. In May of 1959 the number of Class D licenses issued jumped from 600 per month to about 5500 per month.

The total station count in the CB service (all classes of stations) has risen from approximately 28,000 on July 1, 1957, to 36,000 in 1958, to 46,000 in 1959, to 126,000 in 1960, and 206,000 in 1961. The grand total of all station licenses in the CB service on August 1, 1961, was approximately 215,000.

Why The "Boom"

In retrospect, at least, the reasons for the CB "boom" seem fairly obvious. Equipment for CB is cheaper than that available

for use in any of the other services (other than Amateur), it is easy to install and operate, and nearly anyone can be licensed to operate without the requirement of an operator's license or qualifying examination.

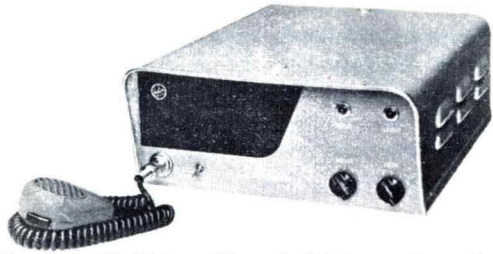

The Kaar TR-500, a Class A CB transceiver. No longer manufactured, but still in wide use.

As noted above, there are presently more than 200,000 outstanding station licenses in the CB service, over 150,000 of which are in the Class D station category, each of which represents an estimated average of more than 3 transmitters. When we consider that there are only 23 available Class D fre-



Vocaline's JRC400 Class B transceiver, the only Class B unit ever to gain any popularity whatsoever.

quencies on which these stations may operate, the question is immediately raised as to how they are able to avoid destructive mutual interference which could easily render the service useless. Yet, it is apparent that full usage or "saturation" of the frequencies has not yet been reached, except during the hours when the hobbyists are operating in force. Applications for new station authorizations are being received by

the Commission at a rate of nearly 15,000 per month, and scores of manufacturers are now engaged in large scale production and sale of sets and kits of Class D station equipment. The continued utility of the Class D stations to their respective licensees and the continued popularity of the service which has led to the "CB Boom", we believe, are due to the fact that there are limitations on both station power and antenna height which hold these stations to the boundaries envisioned by the Commission when it first set up the service.

For many persons, the Citizens Radio Service will serve, or has already served, as an introduction to the economics that can be effected in modern business and industry by the use of vehicular communications; to the time, effort and mileage which



The Stewart-Warner "Portafone" for Class B CB. This set tried, but soon fell by the wayside.

can be saved through instantaneous radio communications with mobile units.

In establishing the Citizens Radio Service, the FCC has succeeded in at least one of many ways in meeting the mandate of the Communications Act of 1934 (as amended), which specifies that it shall "encourage the larger and more effective use of radio in the public interest."

I. L.

first from
**New
Tronics**

a new approach
in the design of
CB antennas



Model CB-1

Base has chrome plated split ball to meet severe angle requirements of front fender. Swivels up to 180°.

Model CB-2

Mast has same features as that on CB-27. Standard male thread fits any of models shown here.



Model C-32

Base has 1½" chrome plated die cast swivel ball, heavy phenolic insulator and cadmium plated hardware.



Model C-29-32

Base and stainless steel spring. Base is same as C-32. A rugged assembly that provides long life and attractive appearance.

For special requirements you can easily combine any of these models

Model CB-27 gives you 23 channel coverage, low SWR and broad banding advantages. You get neat, trim appearance because of its compact size. Expertly engineered and sturdily built. Priced no higher than ordinary antennas. See the Model CB-27 at your electronic distributors or write for details.

The CB-27 series is designed for the individual who is particular about the appearance of his car... and wants performance, too.

MODEL CB-27 (Illustrated below)

Extends to 60", collapses to 27". Four section, chrome plated, heavy duty brass tubing assembly with sealed loading coils. Standard automotive ball-type swivel base. Includes 5' of RG58/U coaxial cable with PL-259. Tuneable top rod has etched tuning scales for field adjustment to 27 MC and 28-30 MC amateur bands.

NEW-TRONICS

Manufacturers of Communication Antennas

3455 Vega Avenue • Cleveland 13, O

The Model CB-27 closely resembles an ordinary automobile antenna. (Pat. Pend.)

RANDOM RAMBLINGS OF A CB OLD TIMER

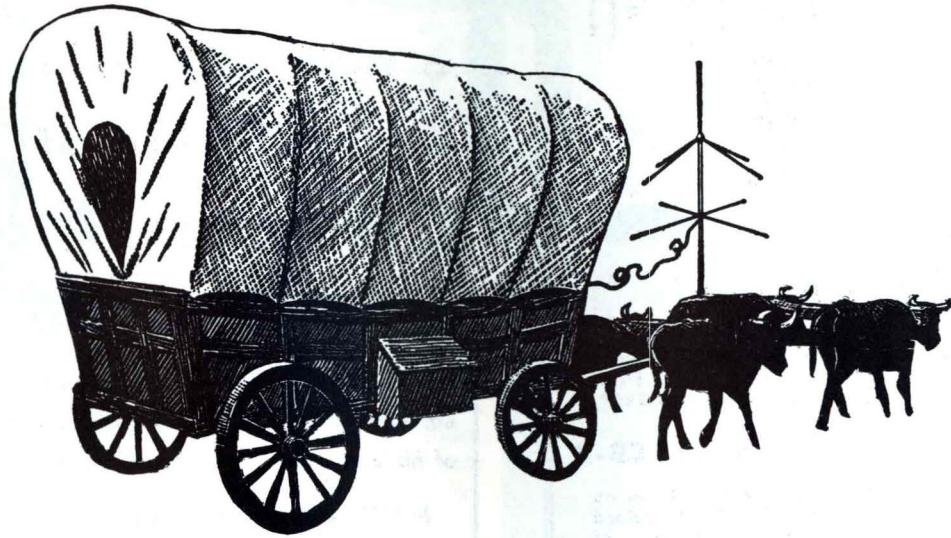

By **TOM KNEITEL**
12Q1747 (ex-2W1965)
Managing Editor

Hello Sonny, you say you just received your CB license? Figure you're really in on the "ground floor" of something big? Well maybe you are—but don't forget that CB has already gone through a lot of growing pains. It wasn't always the sporty, sophisticated young playboy it is today.

Yep, back in the old days, say 1958 and '59, we had it quite a bit different. Oh, there were commercially built rigs, but they were hard to come by in many areas—and they didn't appear until after many of us had "built our own."

Seems like most folks had gone out and wired up the "Stoner" (W6TNS/11W1507) rig from the plans in the May, 1959, issue of RADIO & TV NEWS (now ELECTRONICS WORLD). The rig worked quite well, it had a 6AU8 in the final and a super-regenerative inductor. Many of these sets are still in use and the basic design of the transmitter was used in a number of commercial designs.

I'll never forget the last sentence of the construction article for the Stoner unit. It asked the question; "Who will be the first to issue a certificate for Worked All States—Citizens Band?"

Well, that seemed to blow the cork off the old bottle. Almost everyone started calling CQ, hamming it up like mad, playing music, making up their own call signs from telephone numbers—and like that. I said *everyone*; that might be misleading unless you knew a little more about who *everyone* was.

I lived in the center of New York City at the time and I don't think that there were more than 10 stations to be heard.

As I recall, there was at that time a highly coveted gold trophy awarded to the holder of the area's direct wave ("ground wave") DX champion—and that it was won by the fellow who offered it in the first place. The gang at the New York office of the FCC knows this fellow quite well, as do the boys in Washington.

Towards the summer and fall of 1959 the manufacturers started to bring out their



The Gonset "Gooney Box," tried and proven.

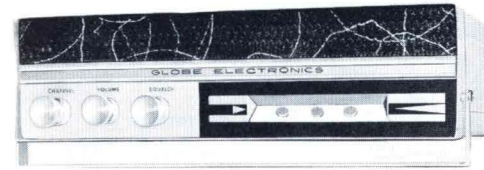

Globe Electronics' popular CB-100 rig.



Breathes there a CB'er who doesn't know International Crystal's "Ice Box"?

units. These were really what you might call the units which "started it all." Pretty soon the market became crowded with more and more units and we had our little band crowded with more and more stations.

But the "real" old timers will never forget the first units out. We even had our own pet names for some of them—not



The CB'ers beloved "Benton Harbor Lunch Box." An old, old friend.



RCA's RADIO-PHONE with the superregen receiver.

names in ridicule, but names of fond endearment. There was the Heath *CB-1* "Benton Harbor Lunch Box," the Gonset *G-11* "Gooney Bird," the International

(Continued on page 35)

FATHER OF THE CB SERVICE



Possibly you have never heard the name "Ewell K. Jett," but without his dynamic foresight you quite possibly might not have a CB service today.

Who is this man, what part did he play in the formation of the CB service, and what does he have to say about the current status of the service?

Mr. Jett, now the Vice President and Director of Television station WMAR-TV in Baltimore, Md., was kind enough to give CBH his cooperation in the preparation of this material.

Before we look into the actual work behind the CB service, let's take a look at the man himself and see the background

events which molded his opinions and helped form his ideas on two-way radio.

Born in Baltimore, Mr. Jett entered the U.S. Naval Service in June, 1911, as a telegraph operator and as a radioman on board the battleships UTAH and MICHIGAN and the destroyer PARKER. From 1916 until World War I he was assigned to the Navy's first remote control station in Washington.

During this period the station conducted the first experimental tests in radio telephony employing a vacuum tube transmitter with stations in Panama, California, Hawaii and the Eiffel Tower in Paris.

When the war broke out he was assigned as Radio Officer on board Vice Admiral Cleaves' flagship SEATTLE and also on the battleship GEORGIA.

After the war he was given a permanent commission in the Navy and served in the following capacities: Radio Officer and Officer-in-Charge of the Navy Department Transatlantic Radio Control Station, Radio Officer of battleship TEXAS, aide on the staff of Admirals Chase and Marvell, Radio Officer of the Fleet Base Force, Officer in Charge of the Registered Publication Section, Assistant Navy Department Communication Officer and Officer-in-Charge of Radio Central.

But it was 1929 when this bright young man began his career as a member of the Federal Radio Commission — the "old" FCC.

Fresh from the Navy, and with an abun-

dance of two-way communications knowledge and experience in his background, Jett was soon appointed Senior Radio Engineer in direct charge of the Commission's engineering work concerning radio services other than broadcasting. He was named Assistant Chief Engineer in 1931, Chief Engineer in 1938 and Commissioner in January of 1944. Later that year, in November, he was requested by President Roosevelt to temporarily serve as Chairman of the Commission.

It was during Mr. Jett's service as FCC Commissioner that he became a very strong advocate for the establishment of a *Citizens Radio Service*.

The now famous "CB Docket" (#6651) was presented in January of 1945 during his term on the Commission.

Mr. Jett now modestly recalls, "While it is true that I played an important part in getting this service organized, I am sure that you realize that it was more than a one-man job! Indeed, as I recall, there was complete agreement on the part of all the Commissioners and members of the staff in setting up the rules and allocations for the Citizens Band. At the time, we were convinced as the result of widespread use of walkie-talkies by the military during World War II, that this type of equipment could be used for Citizens Radio purposes."

"An important part" is a slight understatement on Mr. Jett's part—for in July of 1945 the SATURDAY EVENING POST carried a full-length feature article by Mr. Jett called "PHONE ME BY AIR," in which he outlined his plans and hopes for the CB service.

Mr. Jett states that, "In the lead paragraph of this story I predicted that 'any American Citizen, firm or group or community unit may privately transmit and receive short-range messages over certain wave-lengths. From mere listeners or spectators . . . people in homes and offices throughout the country will become active participants.'

Mr. Jett also predicted numerous specific uses for CB, including the following: Emergency Communications, Civil Defense, on the farms of America, for hunters, sportsmen, physicians, as well as serving

businesses of many kinds, utilities, and municipal agencies.

He suggested that the FCC might urge all licensees in each community to form clubs for voluntary assignment of channels for minimum interference, issuing CB call-books showing the channels and station hours of participating members. The clubs would also adopt such rules and operating procedures for their area as judgment and experience would dictate.

When you consider that all this was predicted more than 16 years ago, you can't help but realize that Mr. Jett's keen intuition and his extensive background in two-way communications was no doubt the main FCC voice in support of our present Citizens Band.

When asked about whether the CB service had developed along the lines he had planned almost 20 years ago, Mr. Jett told CBH, "I can say that I am very well pleased. Indeed, considering the many understandable delays due mostly to technical and economic factors, I was agreeably surprised to read in the FCC's 26th Annual Report to Congress that over 126,000 stations with 441,000 transmitters were licensed at the end of fiscal 1960.

"During the past fourteen years I have devoted my time to the television industry and have not followed the growth of Citizens Radio except to read a trade journal or Public Notice issued by the FCC. However, it is my understanding that the rules have been tightened to re-define permissible communications and to limit the time and length of communications. This, I am sure, is necessary in order to avoid intolerable interference, as well as to prohibit certain unauthorized communications in violation of the law.

"But on the whole, I am sure that the Service is fulfilling most of the needs which were foreseen by the Commission following the end of World War II. It is also gratifying to know that the Service can be authorized with a minimum of regulatory controls."

CB HORIZONS salutes E. K. Jett, without whom, we might not have a Citizens Radio service.

R. B. Cooper

The Future of Citizens Radio

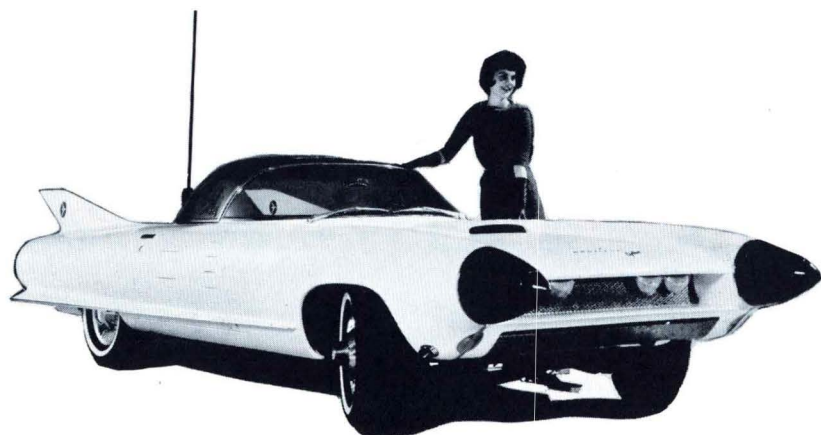

By **ROBERT B. COOPER, JR.**
 Publisher
 Horizons Publications

Elsewhere in this historical issue of CB Horizons you have read of the wild and woolly past of Class D Citizens Radio, and have learned how the service was first conceived.

There are many "experts" in this field who will offer freely and in great quantity any number of prognostications as to "what the band will be like" in one year, three years or ten years. Most of such predictions are based upon the assumption that the presently licensed 825,000 27 megacycle transmitters will continue to be active on the air, and that new transmitters will come on the air at a rate of 20-35,000 each and every month for the years ahead. The possibility that such will be true is enough to send a cold chill down the back of the strongest advocate of "personal two-way communications."

As we go to press the number of United States Citizens licensed to operate in the Citizens Radio Service is nearing 225,000. Each of these licensee encompasses (at least on paper) two stations (as it takes two stations to communicate, and no CB license is issued for "random communications," such as is permissible in the amateur service) and many are authorized to utilize as many as 10 stations. The average number of stations applied for by a licensee

is slightly under 4, or 3.91 to be exact. All of this has taken place in a short 36 months, or three years, span of history. Needless to say this is the fastest growing communications service in the world!

But by our very growth we create problems for ourselves which must be solved by either technical or legal innovations. It is about these problems, and their possible solutions, which we will report on here in this special article, "The Future of Citizens Radio."

Technical

CB Radio has by its very presence on the American Communications scene done more to acquaint the average man in the street with personal two-way communications than anything attempted in the previous 57 year history of two-way dependable communications. CB transceivers have contributed to the technique of mass production in two-way communications equipment in a manner no other service can match. As a result of the fantastic growing demand for Citizens Radio, manufacturers are burning the midnight oil improving existing circuits and discovering new circuits which will cut costs, maintenance and construction time. The end result is usually a better form of two-way communications for you, the user.

Take noise limiters and squelch circuits as two examples of engineering develop-

ment and improvement in communications equipment. Until CB came along the squelch circuit was a novelty, used only in professional high priced FM two-way communications equipment manufactured by such companies as GE and Motorola. Today the squelch circuit has been advanced upon, improved and made simpler merely because of the demand of CB radio. The CB set price range would not allow enough construction money per set for an expensive refined squelch circuit as found in FM two-way equipment. So it was necessary for the early manufacturers of CB equipment to pioneer the development of the squelch all over again, keeping in mind costs, simplicity of design, and most of all, dependability.

Noise limiters were another problem. Again, they had to be simple in design, effective, virtually maintenance free and cost practically nothing! Not a short order for a brand new field . . . but the problem was tackled and licked by firms such as International Crystal and Globe, so today noise limiters are secondary problems in CB set design.

As the channels became more crowded selectivity at the receiver became increasingly important. No longer would a broad receiver fill the needs of the busy CB'er who had to get his message through with a minimum of delay or waiting. Double conversion receivers became common, and even today, one firm (ECI) offers triple conversion in the receiver. With each additional stage of receiver conversion the selectivity of the receiving unit sharpens up so until ultimately you have a receiver too sharp to pass even the channel you are listening to!

Finally the CB'er demanded reliability and quick changeability between a mobile installation and the fixed station. Many CB'ers, after all, use the CB set for business communications during the day while in their vehicle, and personal communications in the evening, while at home. Both are perfectly legal under the law, and the CB'er who operates in this manner is getting the most for his communications dollar. These demands brought about the development of semi-transistorized rigs which

ALLIED saves you money
 on **EVERYTHING** in **CB!**

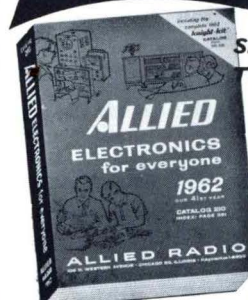

SEE THE BEST BUYS
 THE 444-PAGE 1962

ALLIED
 ELECTRONICS
 CATALOG

free send for it

BUILD YOUR OWN CB
knight-kits[®]
 A PRODUCT OF ALLIED RADIO



C-11 Transceiver Kit; tunable 22-channel super-regen receiver, 5-watt transmitter. Only \$39.95



C-27 Transceiver Kit; dual-conversion receiver, 2-channel crystal-controlled 5-watt transmitter. Only \$79.95

See the biggest money saving selection of transceivers, antennas, crystals, mikes, cable meters and accessories. Get prompt delivery from the world's largest stocks. Save even more with famous build-your-own KNIGHT-KIT CB so easy to assemble, dependable in every way! For everything CB, be sure to get your FREE 1962 ALLIED Catalog—send for it today!

SAVE ON EVERYTHING
 IN ELECTRONICS



Get the most for your money! Stereo hi-fi systems and components • Recorders and tape • Citizens Band radios • Amateur station equipment • TV tubes, antennas, accessories • Electronic parts, tubes, transistor tools, test instruments, books. . . today for your FREE 444-page 1962 ALLIED catalog!

NO MONEY DOWN
 Easiest Terms

FREE CATALOG

ALLIED RADIO

ALLIED RADIO, Dept. 190-K1
 100 N. Western Ave., Chicago 80, Ill.

Rush FREE 1962 ALLIED Catalog

WORLD BIGGEST!

Name _____
 PLEASE PRINT

Address _____

City _____ Zone _____ State _____

of their almost complete lack of tubes, require little if any maintenance.

Seemingly, everything has been done with a Class D radio.

Fortunately, this is not true. In 100% honest appraisal of the situation, the CB manufacturers (all 89 transceiver manufacturers . . . bless their souls) have been hard pressed to keep up with the growth and demands of the service. Noise limiters and squelch circuits came about when channels became a *little crowded*. Double and triple conversion came about when channels became *quite crowded*. Today several manufacturers are working on circuits which will completely squelch out all stations except your own units. These devices will utilize tone signaling much like you find on your standard telephone in your home, with a series of numbers (i.e. 4, 7, 9) in sequence required to reach your own units. Each number dialed will activate a relay within your unit two, and if all three dial sequences fit your particular code number (which you yourself, or your service dealer will pick out) then your unit two will hear your call. Sort of like a wireless telephone, only you will have the *option* of listening to all of the other noise on the channel, at the throw of a switch, if you so choose.

But even this will not solve the problems ahead in the coming 12 months, 24 months or 72 months. Tone sequence dialing will help, but it will postpone only temporarily the inevitable . . . interference, interference and more interference!

One bright light in the channel crowding problem is beginning to make some headway at a pair of laboratories in the east. This development is called Single Side Band, or SSB for short. What it is is this. Take a radio signal. Now slice away the "carrier," and then slice away a "sideband" on that carrier. What you have left is one sideband, no carrier. The carrier is like a tramway but, it carries the voice intelligence to its destination. If you are riding the bus, you depend on its continued existence to get you to your destination. But radio signals do not depend on the "carrier" to get to their destination. In fact, the carrier is

just so much superfluous noise, and could be eliminated entirely and you would still be able to communicate using one or the other of the sidebands which themselves contain all of the voice intelligence (sidebands are something like subcarriers, in that they carry the intelligence of the signal, without actually carrying the signal). The end result of the lab work underway in this field will remain to be seen. Suffice to say that if and when SSB (or single side band) is put to work on Class D CB, we will be able to do away with the annoying heterodynes (these are the whistles you hear when two or more stations are on the same channel at the same time) and at the same time put 3 or more stations on every 10 kc. wide CB channel where previously there was only one!

But even this will only allow us to live with the CB saturation point a little longer. The interference is going to get worse, and our industry may reach the end of its inventive rope before a plan already in the mill at the FCC frees additional channels for CB use. This will be discussed shortly.

In the past four weeks two major developments have come out of communications research labs here in the United States which will materially affect the activities of thousands (even tens of thousands) of CB enthusiasts across the country. One gadget is a new antenna developed for mobile operation and perfected at the Orange County (California) Communications Department under the guidance of Max Elliot, a supervisory genius in the field of 100 percent two-way communications.

The second new development is an accessory unit for your CB transceiver which will cut way-way down on ignition, neon sign, electric motor, lawn mower and what have you interference so that you can bring through the weak CB signal you could not previously hear because of surrounding background noise.

Let's talk about the antenna first. It's called the OMNI-SLOT Boundary Antenna, and has been developed by *General Electromagnetics Corp.*, 11719 East Washington Blvd., Whittier, California.

As the photo shows, the Omni Slot antenna is unlike most anything else you

have ever seen in use for CB. The loop-style antenna mounts on your car top as it is mounted on the board shown in the engineer's hand. It lies flat about 1.5 inches above the roofline. The diameter of the loop is 24 inches for 27 megacycle operation. Now . . . the surprise. This antenna radiate a vertically polarized signal . . . just like a whip! Best of all, the vertical antenna is conspicuous, cumbersome around trees and garages, and makes your family car look like the "Highway Patrol," while the Omni-Slot is low slung, close to the roof, and probably would go un-noticed by all except the most astute observers. Few, if any, would take it to be anything but a luggage rack or transportable basketball hoop.



The OMNI-SLOT, under development by General Electromagnetics, features a radical new design which permits vertical polarization from a small horizontal antenna.

The gain is equal to or better than a 102 inch $\frac{1}{4}$ wave whip. *This antenna promises to revolutionize mobile work.* The price, which we can't announce, is very much in line for the product.

Now the noise eliminating device. Up to now noise suppression gadgets have been available to reduce the noise from your own auto (i.e. resistor spark plugs, filtering of the engine high voltage distributor components, etc.) but little could be done to cut down on noise from *other autos*, power lines, signs and what have you. Today, happily, this may be a thing of the past. *Business Radio Company of P. O. Box 5652, Minneapolis 17, Minnesota* has finished up the final field tests on a unit called *NOISTOP*. *Noistop* is an electronic noise limiting circuit which attaches into your existing CB transceiver to cut way down on the annoying and station covering drone of ignition noise, etc.

GET THE BEST OUT OF YOUR CB EQUIPMENT

READ

CITIZENS BAND RADIO

by Allan Lytel

Here is the most helpful book for anyone who owns, intends to buy or who wants to service CB equipment.

If you are now operating CB equipment—this book will help you get top flight performance. Design features of different types of transmitting and receiving equipment are described and specific models are analyzed in detail. Particular emphasis is placed on single-channel and multi-channel transceivers and receivers.

Practical problems faced in mobile and base station installations are discussed—selection of a proper antenna; tips on installing CB equipment in boats, cars, trucks and base stations for better performance, ease of operation, elimination of interference.

The actual operation of the equipment is covered along with a discussion of the FCC rules. Power supplies and specific requirements of base station and mobile installations are covered. You also get license information; FCC regulations and historical development of CB.

The portion of the book devoted to repair includes an outline of potential trouble spots to check when trouble does occur. Naturally, CB equipment should be repaired by competent service technicians, and for technicians this book contains information of great value: types of test equipment to be used for alignment and repair of transmitters and receivers; step-by-step alignment procedures; and troubleshooting data.

For the person about to buy CB equipment, this book serves as an excellent guide of what to buy, and how to install it. #273, \$3.90.

Other Rider Books of Interest To Every CB'er:

BASIC RADIO 6-volume "teaching pictures" course enables you to understand the fundamentals of radio communication. No previous knowledge of electricity is required—the course teaches it.

The course will enable you to read schematics, recognize circuits used in radio equipment . . . understand electricity and magnetism, circuit components, vacuum tubes, power supplies, oscillators and amplifiers and their use in radio receivers. You are made thoroughly familiar with semi-conductors and transistors; transmitters, antennas and transmission lines. #197, 6 vols., soft covers, \$13.85; #197-H, 6 vols. in single cloth binding, \$14.85.

HOW TO LOCATE AND ELIMINATE RADIO & TV INTERFERENCE (2nd ed.) by Fred B. Rowe. Covers the latest techniques applicable to the location and elimination of radio and TV interference. Tells the reader what to look for, what to do and how to do it. Discusses the newest FCC rules and regulations. #158, \$2.90.

These are just a few of more than 250 Rider titles. Write for free catalog. Order these books today at bookstores, department stores and electronic distributors, or direct.



JOHN F. RIDER PUBLISHER, INC.
116 West 14th St., New York 11, N. Y.

The *Noistop* accessory is approximately 11½ inches tall, 2½ inches wide and 4 inches long. It is designed for universal mounting on either side, top or bottom of your transceiver. The complete installation time should run 20-25 minutes if you follow the complete and easily understood directions.

Now here is what it does. *Noistop* acts like a squelch circuit on noise pulses, cutting down on noise pulses and at the same time bringing up the signals previously buried in the noise. The control on the unit is set at the "threshold point," or where all background noise disappears. Now . . . all you will here are CB signals, and even strong truck ignitions will not trip the unit.

Needless to say the *Noistop* accessory is much needed by mobile and base stations in any and all areas where signals are likely to be buried by outside static and ignition noise. Take a look at CB Showcase, this issue, for purchasing details.

These are some of the problems ahead in our service, from a technical vantage point. Now . . . let's look *briefly* at the future legal developments in the Class D field.

Legal and Moral

The November issue of CB Horizons will carry the first part of a two part special feature entitled "WHY CB WILL (EVENTUALLY) GET 250 NEW CHANNELS." What follows is a brief synopsis of this feature with a few facts you can discuss at the next club meeting with "the uninformed non-reader."

Here are the facts. The FCC's 1953 choice to expand the nation's 12 VHF television channels by an additional 70 UHF channels was an unfortunate one. The FCC felt that UHF and VHF stations could work in the same area. However the commission did not reckon with the whims of a public which already owned VHF receivers, VHF antennas and knew from nothing about this new "ultra high" thing. Nor did the FCC reckon with a public which would be forced to spend an extra \$40-\$100 to receive UHF television signals over VHF.

The end result, after some eight years of combination operation, has been the disap-

pointment that UHF and VHF television stations cannot compete on an equal basis . . . the VHF station simply has too much of an advantage. The UHF station, often without network affiliation because it came on the air after the VHF stations in a region, is forced into bankruptcy because not enough of the viewing public will convert to UHF just to watch movies and whatever else a second rate station can scrape together. No viewers means no advertising, and soon the UHF station is forced from the airwaves.

Now this would be all well and good *except* for one fact. There simply are not sufficient VHF television channels to go around. Cities such as Louisville, Syracuse, Grand Rapids, Rochester, Baton Rouge, and so on do not have three television stations. In other words, each of the three networks *is not shown* in these and other *MAJOR* centers of population.

Because there are not enough VHF channels (12 only) to go around (there must be a certain mileage separation between stations on the same channel, and stations on adjacent channels, to keep them from interfering with one another) the future of free-competitive television in this nation depends on the eventual switchover to an all UHF system. This means that *EVENTUALLY* all television will be on UHF, all competing on an equal basis, with one another. And with 70 UHF channels to work with, there will be sufficient television channel spectrum space so that not only will Syracuse and Rochester (etc.) have their three stations, but they may also have a fourth, and fifth, and town such as Cumberland, Maryland, and Manhattan, Kansas, will be able to have their first!

But most of all, an all UHF television system means the radio spectrum space now occupied by VHF television (i.e. 54-88 megacycles and 174-216 megacycles) will be opened up for the overflowing needs of two-way radio. And this includes CB radiol!

On July 8, 1959, FCC Commissioner Robert E. Lee appeared before the Senate Committee on Interstate and Foreign Commerce. Commissioner Lee pointed out the problems besetting television, and proposed

(Continued on page 35)

SPEAK CORRECTLY . . .

BRIEFLY!

By ART BROTHERS, 11W0759

One of the largest interference generators on the CB channels today is the unnecessary yak, yak, and yuk yuk heard as stations sign off, call or "turn it over" to another station. If CB'ers would use correct procedure with call signs, we would cut our *on the air* time in half. This in turn would mean half the interference and much quieter channels—or twice as many using a given channel—*Heaven forbid!*

After a careful check of the rules and regulations and talking with the FCC as well as commercial operators, the following procedural facts were brought to light and it would behoove us all to take note:

1. All CB licenses are for mobile stations. Even your base station is a mobile as far as the FCC is concerned.

2. All CB units operated under the authority of a given license are mobile. The FCC doesn't care which one is which and in monitoring for violations they don't care who is operating the transmitter—if something happens it is the licensee who is going to get the axe, *not the operator.*

Thus, it is completely unnecessary to use calls which say, "This is 25W2222 base calling 25W2222 mobile." As far as the FCC is concerned, if a station comes on the air and calls 25W2222 and then stands by, the station that called was also 25W2222. There is no such thing, then, as a *mobile unit two*, a *mobile unit one*, or a *base control unit* and etc. ad nauseum. If such numbers are necessary for identification between the users of the system, this is fine. But, keeping in mind the rules and regulations which say all calls should be brief and to the point, the FCC is not going to continue to let calls go by which consist of long drawn out "this is so-and-so base control unit one calling so and so mobile unit five and standing by." Good grief, when you stand by, you don't have to say so. Just stop talking. The person at the other end knows you or you

wouldn't be talking to him. Thus you don't have to identify to each other. And if you are both using the same call or license authority, the FCC doesn't care who is on the microphone or which unit it is either. As mentioned, they are going to fry the owner of the license!

Thus, a simple, short call will do "25W2222 come in, over" is all you have to give when looking for your mobile unit. If he hears you he calls back and can say simply "25W2222." If you hear this, you know he has heard you and is standing by. You then give him the message and do not use any call signs either at the start of the message or the end. He may come back and ask you a question. You may answer. At no time do you mention call signs. At the conclusion of your talk, the last one to talk, or the base will sign by saying, simply, "25W2222 clear".

This is the accepted method recognized by the FCC. Amateur methods, on CB, are not proper, and in fact are considered to be a violation of the regulations pertaining to excess verbage.

The second major gripe from the FCC is a habit which has come from the military, but where it got started will never be known. This procedure of calling a station and receiving no reply—coming back on the air and making the statement "25W2222 no contact". The FCC is clearly on record as being against this practice. In a recent bulletin circulated in the marine field, the FCC stated that such a practice should stop at once. It said that when a called station doesn't answer, if the calling station comes back on the air to make the statement that he didn't have a conversation with the other station, it is just so much cluttering up of the airwaves and it is obvious to those listening that no contact had taken place.

Take pride in being brief. Take pride in your ability to use the bands as a pro-

(Continued on page 35)

CB TECH TALK

PRECISION TUNING THE MOBILE ANTENNA

By **HERBERT FRIEDMAN, 2W6045**
Eastern Technical Representative

An antenna which is not tuned to the CB band will not only cause losses due to a high standing wave ratio (SWR), but it will accept power from the transmitter only with difficulty. Maximum performance from the transceiver is obtained only when the antenna and its feedline are properly tuned.

To start the tuning, the transmission line must be used as a matching transformer.

The standard whip has a radiation resistance considerably less than 50 ohms; if a 50 ohm transmission line of a random length is used, the SWR may prevent proper loading of the transceiver in addition to inefficiency produced by the SWR. However, if the transmission line is cut to an electrical multiple of a half-wavelength, or 12 feet for the CB band, as far as the transmitter is concerned the only load it "sees" is the antenna and not the transmission line. (A continuously loaded whip has an impedance of 50 ohms and in this one case there is no problem with the transmission line, so a random length may be used. However, in the event there are variations which are unknown, use a 12 foot coax cable.)

The SWR meter (SWRM) is the best indicator of antenna system performance; a low SWR indicating that the antenna system is tuned and accepting most of the R.F. output from the transmitter, a high SWR indicating that considerable R. F. output is being lost in the coax transmission line and perhaps preventing the transmitter from loading properly.

If the antenna's transmission line is one half electrical-wavelength, the SWRM and it's connecting cable *must* be part of the 12 feet. As an example, if the SWRM has a spacing of six inches between connectors and a connecting cable 18 inches long, the transmission line must be cut to a length of 10 feet. After you have completed your SWR tests and removed the meter from the line, a section of matching cable two

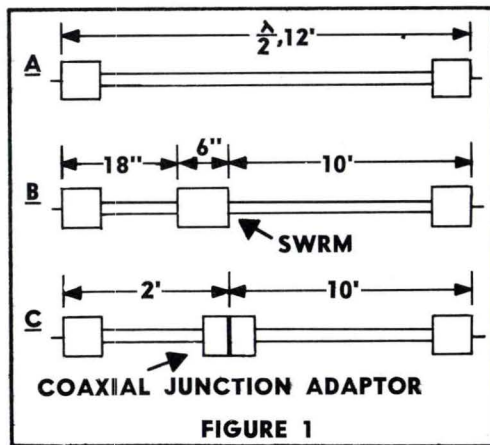

Fig. 1. Proper connection of SWR meter in a mobile installation. A: $\frac{1}{2}$ -wavelength transmission line. B: The same $\frac{1}{2}$ -wavelength with SWRM in the line. C: The $\frac{1}{2}$ -wavelength line after the SWRM is removed.

feet long is added to the line in order to maintain the 12 feet (See Figure #1).

If the SWR indication is low, you know your antenna is working at top efficiency. If the indication is high, you can be certain that the antenna is not tuned to 27 mc., but how much is it off and in which direction, this is where we use a Grid Dip Oscillator (GDO).

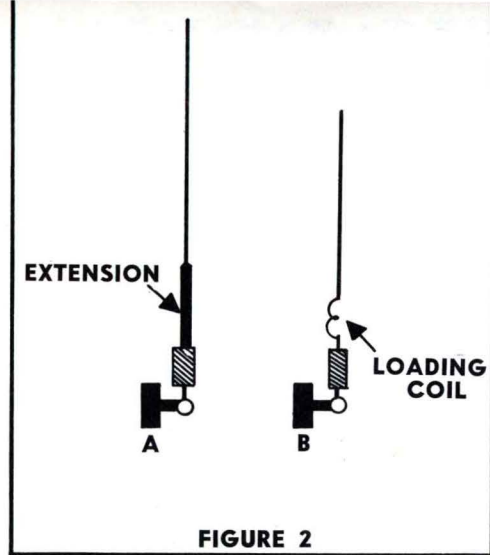

Fig. 2. Antenna can be lengthened by adding an extension, as in A, or by using a loading coil, as in B.

The GDO is a resonance indicator and is an invaluable aid in antenna tuning; the GDO will tell you to what frequency your antenna is tuned.

If you have a standard or coil loaded whip, remove the transmission line at the base of the antenna; connect a two turn loop of wire about three quarters inch in diameter between the base of the whip and ground using the shortest leads possible. Couple the GDO to the loop and tune the GDO for dip (resonance). If the antenna is resonant above the CB band (27 mc.) it can be lengthened either physically or electrically by using a whip extension or a loading coil (See Figure #2). These items are available from any antenna dealer. If the antenna is resonant below 27 mc. it is

best to shorten the antenna electrically by connecting a 150 uufd. variable capacitor between the base of the antenna and the center conductor of the coax transmission line; adjust the capacitor from minimum to maximum until the antenna is resonant at 27 mc. or your exact operating frequency. Remember, the capacitor is part of the antenna and the test loop is formed between

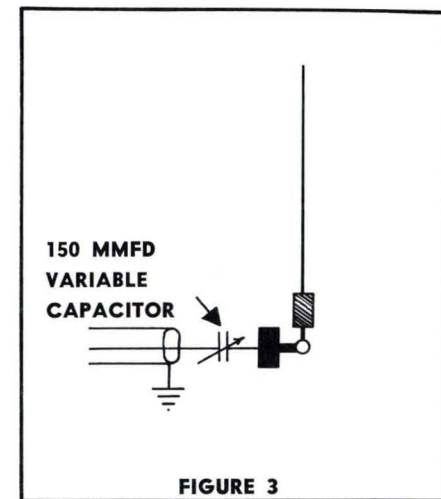

Fig. 3. Antenna is electrically shortened by using a series capacitor.

the capacitor and ground (See Figure #3). The continuously loaded whip is handled somewhat differently. Since the transmission line is "flat" the GDO can be coupled into a test loop formed at the input end of the transmission line (i.e. at the transceiver). Remove the protective tip cap exposing the end of the coil winding and slowly, about $\frac{1}{2}$ turn at a time, remove the top winding until the antenna is resonant at 27 mc.

GETTING STARTED

THERE'S NO BETTER BEGINNING THAN INSTALLING A MOSLEY BASE STATION ANTENNA! FOR EFFECTIVE PERFORMANCE - FOR RUGGED DURABILITY - CHOOSE MOSLEY... LIKE THE EXPERTS DO!

NEW! A low-cost omnidirectional ground plane with features usually found in much more expensive types. This unity gain base station antenna will provide years of dependable, effective and maintenance-free performance!



Model V-11-UGP
Net Price, \$21.95

IN CITIZENS RADIO ?

FEATURES:

- 100% Rust Proof!
- Heavy-Wall, Heat Treated 6061-T6 Aluminum Elements!
- Entire Antenna Grounded for Positive Lightning Protection and Improved Signal to Noise Ratio!
- "Cyclac" Base Supports Vertical Without Guys in Winds Up To 75 mph!
- Low Angle of Radiation for Greater Range!
- 360 degree Radiation Pattern!

Mosley Electronics, Inc.

6410 NORTH LINDBERGH BOULEVARD - BRIDGETON, MISSOURI

FCC MONITORING STATIONS

BY REX HOLMES
CBH Washington Editor

CB'ers have heard all sorts of locations mentioned as being the lurking places of the fabled FCC monitoring stations. Some CB'ers ask if they are hidden in hotel rooms, some ask if they are in this or that city.

Worry not! CBH has come to the rescue with not only the locations of the monitoring stations, but also the call signs and several operating frequencies of their intercommunications radio nets.

The operating frequencies for their intermonitoring station radio transmitters are: 4483 kc., 7790 kc., 10655 kc., 13830 kc., 13990 kc., and 18050 kc.

Find them on the map below by their index numbers, here they are:

PRIMARY MONITORING STATIONS

1. KQA62 Allegan, Mich.
2. KAA60 Grand Island, Nebr.

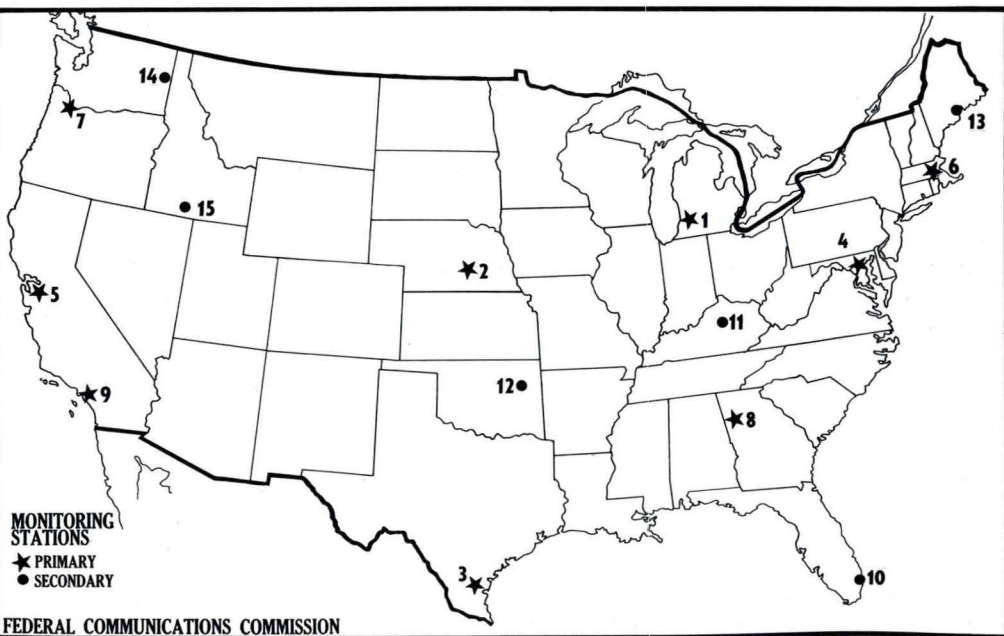

3. KKA60 Kingsville, Tex.
4. KGA91 Laurel, Md.
5. KMB27 Livermore, Calif.
6. KCA38 Millis, Mass.
7. KOA56 Portland, Ore.
8. KIA84 Powder Springs, Ga.
9. KMB26 Santa Ana, Calif.
- KUN70 Lanikai, Hawaii

SECONDARY MONITORING STATIONS

10. KIA85 Ft. Lauderdale, Fla.
11. KIA83 Lexington, Ky.
12. KKA61 Muskogee, Okla.
13. KCA35 Searsport, Me.
14. KOA55 Spokane, Wash.
15. KOA54 Twin Falls, Idaho
- KWC41 Anchorage, Alaska
- KWO66 Fairbanks, Alaska

Coverage for these stations is about 100 miles for direct wave ("ground wave") for local stations. On skip, figure that if you are hearing CB'ers located within 100 miles of any of these stations then chances are the FCC can hear you.

CITIZENS COMMUNICATIONS REPORTS

A Message From The Publisher

Day in and day out CB clubpapers cross my desk from groups all over the continent. Within the pages of these mimeographed and stenciled papers (some are now offset printed . . . a very healthy sign of CB's growth) one reads of the "Personal Communications Activities" of the CB enthusiasts in any given area. Even though we do not personally know "3899-Pete" or "2177-Barney," we find their activities on behalf of the 27 meagcycle Citizens Band interesting reading and we often glean a new use or two of CB from these reports.

Unlike Club papers, CB Horizons caters to the entire nation of CB operators. We must, by nature, skim the cream off the top of the reports we receive, and pass this "cream" along to you—our nationwide readership.

We do note however that many club groups are totally unaware of the activities of clubs 25 miles down the road, or 50 miles up the road. We sincerely believe that if there were a medium of "information contact" between club groups, AND, individuals outside club groups, that a much more cohesive, tightly knit, CB service would result.

I have given a great deal of thought and time to just such a project, whereby CB'ers in different regions could exchange ideas and news through the pages of CB Horizons. I believe that the growth and understanding of the Class D service will progress at a much more orderly rate if we at CB Horizons can provide the proper type of editorial material to keep our readers informed, alert and active.

Here now is your chance to participate in a program to accomplish just this aim. If you feel as we do about the growth of the Citizens Radio Service, I strongly urge you to drop me a note outlining your qualifications to participate with CB Horizons in the "Citizens Communications Manager" program.

What It Is

A Citizens Communications Manager is a reporter. He conducts a *small* monthly reporting section in CB Horizons in which he reports on club activities, and individual activities in his call area. There will be 24 CCM's (Citizens Communications Managers) or one for each call area. In addition to the CCM's, CBH will appoint assistant CCM's for each major metropolitan region within a call area, and it will be the duty of the Assistant CCM to keep his CCM informed of CB doings in his area.

CCM's and Assistant CCM's will be appointed for a one year period, and will be listed regularly in CBH with their columns. Each will receive a handsome wall certificate as a token of thanks from the CB operators in his region for the tireless task he will perform.

CCM's and assistant CCM's will also act as liason between CBH and club groups and CB equipment supply centers in their regions.

As you can see, the position is not one to be taken lightly. The appointed CCM in each of the 24 call districts must be a responsible-mature individual willing to accept the responsibility of gathering news and views about his communications field, and preparing these facts for print in the nation's CB magazine.

The amount of time required, on your part, will be strictly on a voluntary basis. CCM's may be asked by CBH or clubs to attend outlying club meetings and explain their duties to interested CB'ers.

Are you interested enough in the future of CB radio to accept such a responsibility? If you are and are a subscriber to CBH, address a letter to my personal attention today, giving the following basic information, and answering the following questions:

(a) Name, address, call letters.

(b) Your age, and the date your CB call was licensed.

**The TWO-TONE
GETMORE BEAM
Antenna!**

**LOW
BUDGET
BEAM
WITH
BIG
BUDGET
RESULTS!**

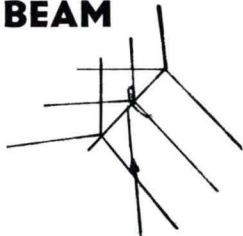

Here is the low-cost way to increase your station power* to nearly 15 watts!

Capacity load gamma match. Constructed from hardened aircraft Dural, seamless and treated. Vert. SWR factory set at 1:1, Horiz. SWR 1.1:1. Up to 8.8 db gain over ground plane, 8 db over horiz. tuned dipole. Only \$47.95 FOB Los Angeles.

* e.r.p. **Dealers invited.**

Two-Tone Electronics

Home of the Famous "Q-Bird" Signaller, and TD-2 Rectifier Tube Replacement.

250 N. Coronado, Los Angeles 26, Calif.

GROVE CB SALE!!

Closing out our stock of CB kits. Nationally advertised at \$39.95 up. Complete with power supply, tubes, crystal, cabinet, coils, etc., less m.k.e. Kit sales final. Rush your order today!!

- 110 VOLT CB TRANSCEIVER KITS... **\$19.95**
- 12 VOLT CB TRANSCEIVER KITS... **\$22.95**
- 6 VOLT CB TRANSCEIVER KITS... **\$22.95**

GET THE GROVE PRICE ON ANTENNAS!

- 3-ELEMENT BEAM ANTENNA (Reg. \$29.95) **\$11.99**
(Mounts horizontally or vertically)
- GROUND PLANE ANTENNA (Reg. \$15.95) **\$11.99**
(Famous Make—solid aluminum rods)
- BUMPER MOUNT + 102" WHIP + SPRING (Reg. \$12.00) SALE PRICE **\$8.99**
- BODY MOUNT + 102" WHIP + SPRING + 25 ft. RGU CABLE—SALE PRICE **\$7.69**
- 11-PC. MOBILE NOISE SUPPRESSION KIT (includes tunable Generator Filter) SALE **\$3.99**
- 100 ft.—RG 58U COAX CABLE... **\$2.99**
- 100 ft. RG 8U COAX CABLE... **\$7.99**
- FAMOUS MAKE CB XMTG CRYSTALS (Reg. \$3.95) (EACH) SALE PRICE **\$1.99**
Lots of 3—\$1.89 each; Lots of 6—\$1.79 each

Check items wanted. Return ad/check or M.O. Include Postage. Excess returned. C.O.D. orders 50% down (Note: Beam Antennas must be shipped railway express)

GROVE ELECTRONIC SUPPLY COMPANY
4107 W. Belmont Ave., Chicago 41, Ill.
 Rush items checked
 Send FREE catalog of giant CB Values

Name
(please print)
Address
City Zone State

(c) Primary use of CB—explain typical operating day at your station.

(d) Your position, interest and activity in any past or present CB organizations.

(e) Your business or occupation.

(f) Include a short paragraph explaining why you believe you would enjoy working for CB radio as a CCM, or Assistant CCM.

(g) A brief description of your station.

We will be announcing our first appointments in the November CBH. A typical CCM column (as we envision it) appears below. This column was prepared with the aid of the Pioneer CB League, Elkhart, Indiana; Citizens Radio League, Northlake, Illinois; and the Racine CB Club, Racine, Wisconsin.

Citizens Communications Reports - 19W & 19Q

CCM—Arnold Schwartz, 19Y0000
Asst. CCM's: **Harry Ballinger, 19Y0001**
Martha Johnson 19Y0002

Racine, Wisconsin was the site as CB'ers formed the Midwest 11 Meter Emergency Association which combines the efforts of 14 Wisconsin and Illinois clubs for CD and emergency work. Bob Smaglik of Manitowoc was elected treasurer, "Happy Jack" Genot of Hebron, Illinois was elected secretary, Phil Kraus of Sheboygan as Vice President, and Alan Fischer of Oshkosh nabbed the top spot. On July 23 Mel, 18B3601 received a "Mayday" call from 16W2224 Marine Mobile who was stranded on Lake Superior. Mel, along with 16W0954 in Duluth, Minn. called the Coast Guard while Texas CB'ers cleared the channel of skip. The CRL Yacht Club held a gala outing August 13th with a host of CB'ers and their boats participating. Boy . . . was channel 13 ever busy! The CB Pioneers, Elkhart, Indiana held a Hot Dog Supper July 22 with lots of fun for all. The same Pioneers have installed a CB-I donated by the Heath Company in their clubhouse on Edwardsburg Road, outside Elkhart. The monitoring station will be manned by Pioneer club members and act as an advising post for CB'ers on the highway passing by Elkhart.

And that is a typical CCM reporting column! Short (no-it won't take you a lot of time to prepare, nor will it make you a Hemingway), to the point and full of current-active news of clubs and individuals in the 19W-19Q region. Of course Racine, Wisconsin and Chicago are 18 land, but for the sake of this sample column, we will overlook this fact!

OK . . . who is first in line to apply for an appointment as CCM or assistant CCM from each call district?

Bob Cooper
Publisher, CBH

introducing
**the most
important
advancement**
in

**CITIZENS
BAND
RADIO**



since the
opening of the
27 MC. band!

THE **ECI.**
Courier 1

- FEATURING:
- TRIPLE CONVERSION
 - 12 CHANNEL TRANSMITTING
 - FIXED AND TUNABLE DRIFT-FREE RECEIVING
 - TWO IF STAGES (262 kc)
 - FULLY MODULATED (100%)
 - OUTPUT EXCEEDING 3 WATTS
 - BUILT-IN "S" AND "RF" METER
 - ELECTRONIC SWITCHING (no relays)
 - UNITIZED CHASSIS
 - MOBILE OR BASE (117 V. and 12 V.)
 - AM RADIO (optional, extra)

The ECI COURIER 1 is truly a product of engineering excellence . . . the ONLY Citizens Band Transceiver to combine TRIPLE CONVERSION with TWO IF STAGES (262 kc) for the ultimate in selectivity and sensitivity!

THE COURIER I also features a built-in dial and crystal spotter, built-in noise limiter, built-in squelch that is triggered by .1 micro volt signal, and front panel adjustable RF gain control. The unit is constructed in five individual hand wired segments — a completely UNITIZED CHASSIS. All metal parts are cadmium plated for marine use. The entire unit slides out easily on tracks, and is housed in a rich chrome cabinet!

The price? **\$189.50.*** For full details, write today!



electronics communications inc.
325 no. macquisten parkway ■ mt. vernon, n. y.

IMPORTANT NOTE TO DEALERS: Make sure to inquire about the E.C.I. exclusive franchise arrangement.
*Prices slightly higher West of Rockies

NEW CBH SERIES

INSIDE DATA

From The Manufacturers' Private Files

WHAT YOU SHOULD KNOW ABOUT . . . MOBILE WHIPS

Editor's Note: Hy-Gain Antenna Products has recently announced a new low wind resistance, stainless steel, top loaded whip. CBH felt that readers would find considerable interest in the "how's and why's" of mobile whip design, a subject which has received more than passing interest in the past. We have, therefore, tapped the engineering files of Hy-Gain (with the permission of Mr. Andy Andros, Hy-Gain President and CB'er 17W1420) for a step-by-step analysis of how a CB antenna is designed, and what the engineer thinks about as the antenna undergoes tests and finally, production.

Design Considerations

The usual 102 inch whip is very efficient; however its length usually requires mounting on the bumper to prevent excessive height above the vehicle. At the same time, bumper mounted antennas are undesirable, for several reasons:

The primary reason bumper mounting is undesirable is that the ground resistance is often equal to the radiation resistance of the antenna, thereby giving poor efficiency and misleading VSWR measurements. The closeness of the auto body to the whip can also detune the antenna. Finally, bumper mounting affects the antenna's pattern, "dislocating it" in the manner shown in figure one.

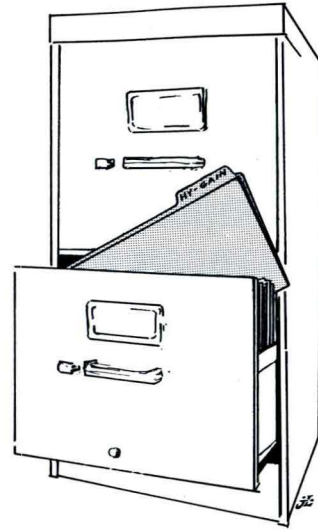

Actual range measurements have shown that trunk or hood mounting gives approximately 1.5 db average gain over bumper mounting, and a less lop-sided pattern, as shown with the dashed line in figure one. Trunk mounted antennas have less ground losses, and radiation resistance is increased, which in turn gives increased radiation efficiency.

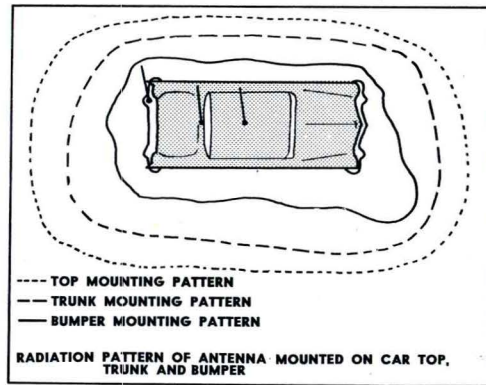

FIGURE 1

Car top mounting, as shown in figure 1, effectively utilizes the largest flat surface of the vehicle and therefore gives the lowest ground losses, best pattern coverage and highest radiation efficiency with an average gain of 3 db over bumper mounting. The better overall pattern of the top mounting position gives as high as 8 db gain over the nulls (i.e. off the right rear bumper side of the car) of the bumper

mount, and this is certainly a point to consider.

Loaded Whips

Top mounting with a 102 inch whip is a safety hazard and generally is not recommended. Not wanting to lose the advantages of top (or even trunk or hood) mounting, the theory of "loaded whips" has been studied. The current distribution curves on the antenna for three different types of shortened antennas are shown in figure 2. The shaded area represents the losses involved due to the inductive loading and shortening of the antenna's surface area. Since 78% of the signal radiation is from the lower $\frac{1}{8}$ wave length of the antenna, it becomes clear that a properly designed top shortened antenna system is much the superior configuration and actually results in a vertical antenna system which is almost as efficient as a full sized whip. The physically shorter loaded whip can therefore be mounted on the car top

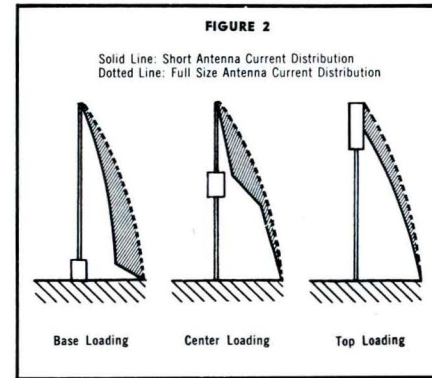

for maximum radiation efficiency, or if more convenient, on the trunk or hood.

Matching

Research has led to the discovery of another important advantage of top loading. The top loaded whip develops a higher radiation resistance than does a center or base loaded antenna, or even a 102 inch whip. Although it is not generally known, the full sized whip actually has a base impedance of only 18 to 20 ohms. On the other hand, the top loaded whip has a base impedance of nearly 50 ohms which results in a more complete transfer of the energy to the antenna from the coaxial feedline cable.

Figure 3 shows a typical SWR curve and the broad banded characteristics of the top loaded whip. The resonant frequency of the antenna can be raised or lowered by shortening or lengthening the top section above the loading coil. However, the antenna is broad banded enough that little would be gained by altering its length.

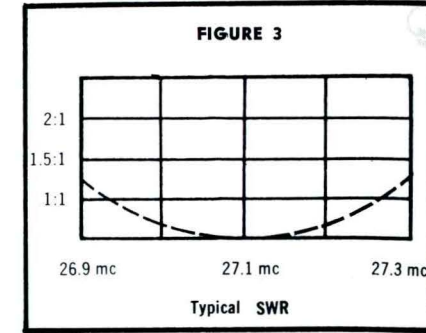

Physical Construction

The TLW series of CB whip antennas utilize an entirely new construction concept for top loading a vehicular whip. For many obvious reasons, the use of stainless steel over fiberglass is decidedly superior for the whip construction. This series of antennas utilizes a fiberglass core, polyethylene coated coil capsule which is approximately the same diameter as the stainless steel section. The coil capsule is permanently fused to the whip section and is completely impervious to any climatic condition or changes. The loading coil is 10 inches long and approximately $\frac{1}{4}$ inch in diameter.

Two basic models were designed into the series so the antenna could be mounted on nearly any vehicle in any convenient location. The model TLW is a 50 inch one piece antenna with a $\frac{3}{8}$ x 24 stud, or a chrome plated diecast single hole mounting base and coaxial cable receptacle (TLW-M) for mounting in a $\frac{7}{8}$ inch hole (or already existing hole used previously by the car radio antenna).

A telescoping model is available with either base (designated TLWT or TLWT-M). It is designed primarily for personal vehicles or for applications where it will be desirable to shorten the antenna for clearing obstacles or for easy garaging.



A Simple Two Element Beam For CB

It is the purpose of this article to discuss the construction of a two element ultra-inexpensive beam antenna for the CB service. All drawings show vertical mounting of the beam, although it may be horizontally mounted if you desire. The total cost for the antenna should be under \$6.00 if you purchase all of the component parts new. If you by chance have some of the twin-lead, coax and bamboo poles on hand, the cost may be as low as \$00.00. For this you will obtain directivity (the ability to place your signal in a given direction towards a given station or region of town) on both receiving and transmitting, and a power gain of approximately 3 db over a dipole, ground plane, coaxial sleeve or what have you.

This is not a beautiful antenna, do not expect raves from your neighbors or CB friends. It is a functional antenna designed to give good-directional performance where directional gain and patterns are required. For example, you live at the far side of a metropolitan region and most of your CB work is done "towards town," the beam would point into the area where you normally reach your "unit two." Another use for the beam . . . you are operating on a crowded channel, and wish to separate several stations coming from different directions. On your ground plane, they all come in well. With the beam you will be able to drop the signal level of stations "outside the antenna's pattern" down as much as 20 db, or more than 3-S units. This is a substantial way to beat interference.

So much for what a simple two element beam will do, now what it won't do. The two element beam will not multiply your power by a fantastic amount. It will not compare to a three, four or five element beam, or twin-three beams. But it will give you a good opportunity to learn why beams work, and how to make improvements to your coverage area without a lot of cost involved.

Best of all, construction is very simple, and there will be lots of time once it is in the air for you to experiment with loading and matching to try to improve its performance.

We call this antenna the "Simple-Two'er," or the start of a more powerful signal from your CB station.

Construction

Construction is strictly Rube Goldberg, using bamboo poles and TV twinlead. The major points are covered in the diagram which shows you how simple a beam can be. The twin lead is taped to the bamboo

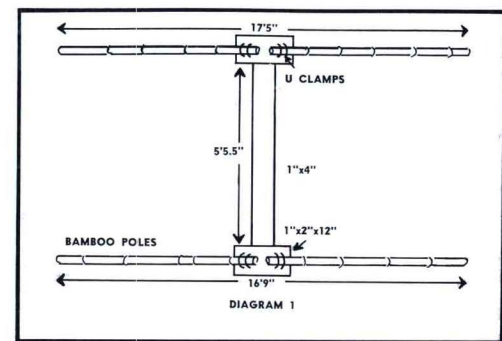

poles to form the conducting and radiating elements. The bamboo serves no useful

purpose except to support the twin lead. The twin-lead replaces standard aluminum tubing found in most beams. The 1x4 wooden boom serves to separate the driven element (top of drawing) from the directive element (bottom of drawing).

Diagram 1A shows the simple method of matching this antenna to your RG58/U (or RG8/U) coaxial cable, and the actual wiring of the antenna. Note the 1/2 twist of the twin lead which connects the directive element with the driven (dipole) element. This is very important.

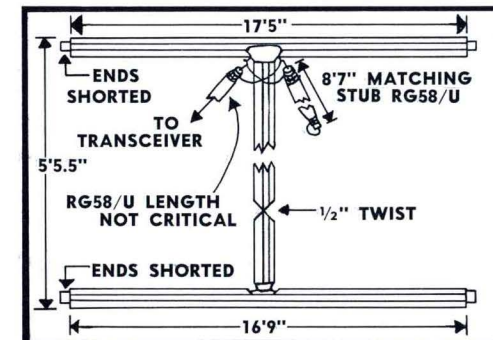

Cut one piece of the 300-ohm TV flat lead-in to a length of 17 1/2" and the other to a length of 16 9/16". Bare the conductors for a half inch at each end and twist and solder together. Cut one conductor of each length at its exact center as shown in diagram 1A and expose 1/4 inch of the conductor on each side of the cut.

Fasten the lengths of 300-ohm line to the bamboo poles with a wrap of black electrical tape every few feet. Join the opened center leads with a 5'5.5" length of 300 ohm twin lead giving it that half twist. Also connect the RG-58/U feed line and the 8 7/8" matching stub to the radiator (longer element) with the center conductor of the feed line and the shield of the matching stub to one terminal, and the shield of the feed line and the inner conductor of the matching stub to the other terminal. Connect the inner conductor and the shield of the matching stub together at the opposite end.

Mount the antenna, aim it in the desired direction, and use it for both transmitting and receiving. My friend . . . you are on the beam!



CITIZEN BAND CLASS "D" CRYSTALS

3rd Overtone: Hermetically Sealed
0.005% tolerance—Meet FCC requirements.
1/2" pin spacing—0.050 pin diameter.
(.093 pins available, add 15c)
ALL 22 FREQUENCIES \$29 EACH
IN STOCK!

The following Class "D" Citizen Band frequencies in stock (frequencies listed in megacycles): 26.965, 26.975, 26.985, 27.005, 27.015, 27.025, 27.035, 27.055, 27.065, 27.075, 27.085, 27.105, 27.115, 27.125, 27.135, 27.155, 27.165, 27.175, 27.185, 27.205, 27.215, 27.225.

Matched crystal sets for Globe, Gonset, Citi-Fone and Halliercraft Units . . . \$5.90 per set. Specify equipment make.

RADIO CONTROL CRYSTALS in HCG/U HOLDERS—SIX FREQUENCIES

In stock for immediate delivery (frequencies listed in megacycles): tolerance .005%, 1/2" pin spacing, .050 pin diameter (.093 pins available, add 15c per crystal). Specify frequency.
26.995, 27.045, 27.095, 27.145, 27.195, 27.255 . . . \$295 EACH
(add 5c per crystal for postage and handling)

ASK YOUR PARTS DEALER FOR TEXAS CRYSTALS
See big red display . . . if he doesn't stock them, send us his name and order direct from factory.

Send for FREE CRYSTAL CATALOG #860 WITH OSCILLATOR CIRCUITS

Now! Engineering samples and small quantities for prototypes now made either at Chicago or at Ft. Myers plant. 24 hour service!
CHICAGO PHONE Gladstone 3-3555

All orders Shipped 1st Class Mail. Rush order to:
TEXAS CRYSTALS
DEPT. H-101, 1000 CRYSTAL DR., FORT MYERS, FLA.
For fastest possible service, Phone WE 6-2100

YOUR BEST CITIZENS BAND BUY!

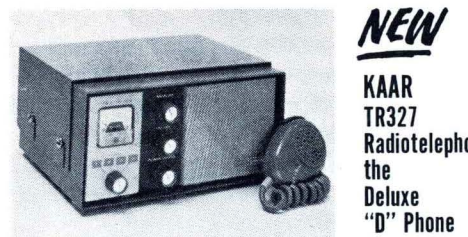

Once again, Kaar's quarter century of progress in 2-way radio communications offers you MORE!

MORE PRACTICAL, USABLE FEATURES
New, Universal Power Supply . . . New, Illuminated Signal Level Meter . . . New, Sealed Relay . . . New, Snap-In, Snap-Out Mounting . . . 4 Crystal-Controlled Channels . . . Front Panel Power Output Peak Control . . . 5-Watt Input . . . Highly Effective Noise Limiter . . . Positive Squelch . . . Lots of Audio . . . Big 4 1/2" Speaker

PLUS...TWO TREMENDOUSLY IMPORTANT OPTIONAL FEATURES
Tunable Citizens Band . . . flexibility and convenience you've never before enjoyed on Citizens Band
Tunable Standard Broadcast Band . . . for music news, and entertainment wherever you go. **179.00**
Always MORE for YOU from KAAR! (BASIC MODEL)

For complete information on the new, KAAR TR327 send coupon to:
KAAR Engineering Corp.
2996 Middlefield Road, Palo Alto, California

NAME _____
ADDRESS _____
CITY _____ STATE _____



NEW CB PRODUCTS OF THE MONTH

Noistop

We heard a fantastic sounding story concerning a Ford dealer in Ft. Worth, Texas, who used CB in conjunction with his business, which, by the way, was located adjacent to a huge turnpike "cloverleaf." The ignition noise was the "living end."

A CB dealer stopped by his shop to let him try a new electronic development which took 20 minutes to wire into the circuit and promised to cut down on ignition noise (not only from the car in which it was installed, *but from any nearby noise-causing cars too*).

When the dealer dropped by to get his eliminator back the Ford dealer absolutely refused to let go the demonstration unit—*and ordered 10 more*.

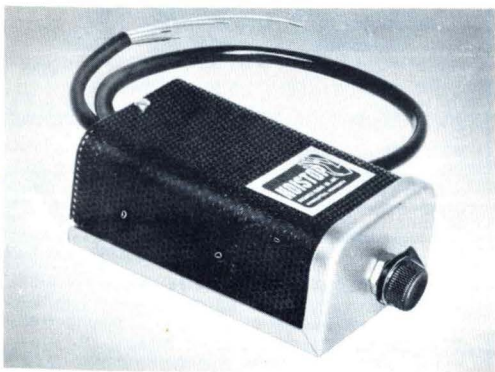

Business Radio's NOISTOP.

We set about tracking down the unit which is involved in this story and here it is: NOISTOP, made by Business Radio Company, Inc., P. O. Box 5652, Minneapolis 17, Minn.

The manufacturer hadn't heard that particular tale about the guy in Ft. Worth, but he related some equally amazing user-reports. Write to them for some truly interesting facts on this new and clever development for CB'ers. Tell 'em we sent you.

C.M.E.

The C.M.E. Manufacturing Company of San Diego, Calif. (3754 Midway Drive) announces a new highly efficient coaxial dipole antenna for marine CB units.

The antenna is 16½" overall and the top half is fiberglass covered (underneath is an all-stainless-steel whip). The bottom half is fully anodized 1½" aluminum tubing.

Separating the two sections of the antenna is a precision machined high-resistance epoxy insulator, covered with a weather-proof plastic boot.

Fitting on standard marine antenna brackets, the installation time is 1 hour. It exhibits an omni-directional azimuth with very low angle of radiation. Write for details.

Lakeland

Here's a transceiver of interest, it's made by Lakeland Electronics, Inc., of P.O. Box 156, Leesburg, Ind. It's called the D-11 and features (non-glare) dial lamps, r.f. and power indicators, tunable receiver with fixed channels, 6 channel transmitter, a.v.c., a.n.l., squelch, crystal spotting. For 115-VAC/12VDC. S-meter kit available too.

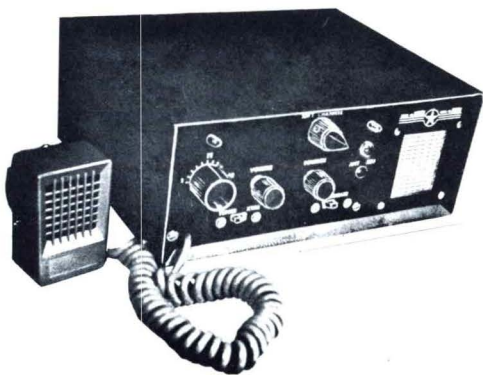

The Lakeland Electronics Model D-11.

This brand new unit, which you are learning about *first* through CBH, will be available by the time you read this.

The Getmore Beam

Remember Two-Tone Electronics, the people who make the "Q-Bird"? They've moved to larger quarters (manufacturers take note: Two-Tone has had a zooming success because of their exclusive CBH ads) at 250 No. Coronado Street, Los Angeles 26, Calif.

To celebrate the move they've come out with a new antenna, the GETMORE BEAM. The GETMORE BEAM is a highly efficient deal utilizing only one feedline for either horizontal or vertical polarization. It's made of hardened aircraft dural, seamless and treated—the whole deal weighs under 8 lbs. Takes less than 5 minutes to put together and requires no tools. Uses capacity load gamma match. Less than \$50. Write.

Rumblings—

The James Knights Company of Sandwich, Ill. is looking for dealers for their CB crystals. They don't require you to be a store or anything like that—just an individual CB'ers or club interested in picking up a few shekles. Ask Jack Craven (18A6811) at the company about this interesting plan of theirs, he's "one of us" and will give you every consideration. They haven't announced it yet, but they're coming out with a real-gone 23-channel switch, complete with crystals *for any rig*.

CESCO has some new products on the way too. Almost ready for sale is their in-line meter which reads SWR and power in watts for some ridiculously low price. Speak to "Doc" Self at CESCO, 6151 Dayton Liberty Road, Dayton, Ohio, about this one.

Next month read about the roof-top antenna which mounts without holes. No, it doesn't have suction cups—just be patient and stop guessing. Read it here. 10-7



We goofed on one listing in last month's Crystal Bawl feature. The crystals were indicated in our chart as being HC17/U for the Regency rig. They are actually type HC6/U. Take a pen and mark the correction in your September issue for future reference.

The CBH Lab Reports . . .

By **HERB FRIEDMAN, 2W6045**
CBH Eastern Technical Representative

WE TEST

- ★ The Philmore Modular Station
- ★ H & L SWR-1 Meter
- ★ Marina "Buddy Whip"

You asked Mike for it and here it is, the Philmore CB components, consisting of the model CC-1 converter, CT-1 transmitter and an a.c. or 12 volt d.c. power supply.

The components can be purchased either in kit form or factory wired. Since the kits are not difficult to wire, they offer extra value for the money.



The CT-1 Transmitter

At first examination you discover two things about the components; one, the rig is well laid out for mobile use particularly in the modern low slung auto—two, someone used a lot of common sense in the tube and control layout. The mounting brackets are so constructed that when the gear is mounted the panels are more or less in line with the dashboard even though the pivots are at *the center of balance*—no extra firewall brackets are necessary. Also, the brackets and cabinets are pre-punched permitting you to stack the units or mount them separately.

The parts are laid out so that all tubes, crystal sockets and receive and transmit tuning controls are accessible through the rear of the cabinets. It is not necessary to disassemble the cabinets for minor servicing.

When installed, the small size of the components precluded interference with the front passenger leg room in a compact car, the same car in which a standard rig restricted the leg room.

Now for the electronics.

Converter

The crystal control converter gives good performance. It changes a 27 mc. signal into a standard broadcast signal and feeds the converted signal into an auto radio (or home receiver). Tuning of CB signals is done with the BC radio. Since the usual auto radio has two stages of 455 kc. i.f., the selectivity is excellent. A pushbutton radio can be preset to your favorite CB channels.

The CB antenna is used for both CB and BC signals with the switching done by the converter.

Wiring of the kit model is very easy since subassemblies are used and the wiring is wide-open.

Transmitter

The transmitter has six switch selected channels utilizing overtone crystals. The output circuit is a pi-network.

The modulation is limited to 100% and is sharp and clean.

Both a plate power input and tune-up meter are built-in. The power meter is calibrated directly in watts—you can load up to an exact "full five". The tune-up meter indicates relative r.f. power and modulation.

While the transmitter kit is more difficult to assemble than the converter, it is relatively easy itself.

Power Supply

The all semi-conductor operated power supply plugs into the cigarette lighter socket and causes no hash. It furnishes the operating voltages, push-to-talk and the antenna switching.

The Philmore component system allows you to build-up your rig within your budget. You can start "reading the mail" with the converter and later add the transmitter and power supply. The converter can be cut into the radio's power supply at the beginning. The Philmore power supply is added with the transmitter.

While not necessarily restricted to mobile use, the Philmore components are well suited to mobile use giving good performance.

H & L SWR-1 Meter

H & L Electronics, P. O. Box 125, Medford, Oregon has come to the salvation of every CB operator who wants to know (a) How much power output he has from his transmitter, and, (b) How much of this precious power is going up to the antenna, and how much is coming back down because of high standing waves?

The SWR-1 meter is about as compact as you could make anything in the CB field, were it any smaller you would probably misplace it under your copy of CBH! The meter is complete, it needs no external power, it does not plug into anything except your transceiver output. It may be used at the fixed station or with the mobile rig, and if you are the type who wants to know exactly how many watts (or fraction thereof) you are putting out while transmitting, the SWR-1 is just the gadget.



The SWR-1

The SWR-1 is designed exclusively for 11 meter CB operation. It indicates power output from the transmitter and reflected power coming back from the antenna on a 0-5 r.f. watts meter. The 50 ua meter gives considerable sensitivity necessary for tuning mobile or fixed antennas, and peaking rigs for maximum output. The meter has two jack inputs, one of which is fed with a short length of transmission line coming from your transmitter, and the other of which feeds directly into your antenna. The meter is left in the line at all times, during both transmit and receive. The SWR-1 is a 50 ohm device, and therefore is used with

50 ohm antennas and feedlines, the former example being a ground plane, the latter being RG58 or RG8.

The meter comes with Philco type female plugs mounted on its chassis. If your rig utilizes Type "N" coaxial connectors or phono antenna plugs, an adaptor kit is available for \$2.50.

The price of the SWR-1 is a paltry \$19.95 which buys a lot of useful meter.

Marina Buddy Whip

California is known for producing the unusual . . . the daring, and the bold. Last month the CBH lab reported on a relatively new two-in-one beam antenna produced by Marina Communications. The beam was the Gizmotchy.

This month the same people who put out the Gizmotchy have provided the CBH lab with a mobile antenna, which in its own way, is just as novel and just as exciting as the Gizmotchy beam. They call it the BUDDY WHIP, named (we suspect) after the inventive genius who designed the antenna, Bud Jones.

Like the Gizmotchy, the Buddy Whip is

unlike anything else you have ever seen. It is not only unusual because of its appearance and physical mounting, it is unusual in performance.

The Buddy Whip is 96 inches tall, overall, and it mounts quickly on the rain gutter of any car or trunk. Installation is simply a matter of two screws, which because they mount through the car's rain gutter base, do not show nor do they in any way detract from the value of the auto.

Because the Buddy Whip mounts on the rain gutter, it is at the roof level just like any antenna mounted squarely in the roof itself. This gives you a few extra feet in height, which is not to be sneezed at.

The Buddy Whip comes complete with all mounting instructions, tools, and coaxial cable (52 ohms) to connect into your transceiver. The actual installation time is less than ten minutes.

One of the many unique features of the Buddy Whip is the special pivot which allows you to swing the antenna forward or back (see diagram) as you go into your garage, a service station, under low trees, etc.

(Continued on page 37)

Save TIME and DOLLARS with
"INSTANT 2-WAY RADIO CONTACT"

TALK and LISTEN to persons "on the job"...at home...at play.
New 2-way radio actually fits into your pocket. Exclusive, rechargeable battery lasts year or more. Range—1/2 to 1 mile. No license required.

GLOBE ELECTRONICS
Pocketphone
THE FINEST 2-WAY RADIO AVAILABLE TODAY

Ideal for office, factory, stores, surveying, construction, sports, recreation, home. Finest quality available. Makes handy paging system. Use with Globe Electronics CB-100A or CB-200 for longer range systems. • Actual size—1 1/4" x 2 3/4" x 6/4" • Weight 13 oz. • High impact cyclac case • All Transistorized. **\$125.00 each**

FOR LONGER RANGE COMMUNICATION



CITIZENS BROADCASTER CB-100-A
Complete 3-channel, 2-way station. Fixed or mobile installation. Easy to install, operate. Range 5-15 miles. **\$139.95 each**



BROADCASTER DELUXE CB-200
A rugged transceiver for commercial use. Transmits on 5 channels. Receives on all 22. Adapts to selective calling system. **\$189.95 each**

CLIP AND MAIL COUPON TODAY

GLOBE ELECTRONICS
A Division of G-C Textron Electronics, Inc.
400 So. Wyman St., Rockford, Illinois

Please send me complete information on the new Globe Electronics

Pocketphone CB-100A CB-200 **CBH-10**

NAME _____

ADDRESS _____

CITY _____ STATE _____

SUPERIOR QUALITY
BETTER PERFORMANCE
OUTSTANDING DEPENDABILITY

CLASSIFIED

Classified rate \$5.00 per five lines (minimum) for non-commercial displays. Commercial displays \$10.00 per five lines (minimum). Payable in advance. Deadline for November issue—October 1st.

A PRECISION FREQUENCY STANDARD

quality manufactured on a printed circuit, our 100 kc. crystal calibrator provides markers every 100 kc. through the entire SW spectrum. Complete and guaranteed, \$10.95 postpaid. Write: Elanem Company, 1116 Inwood Pl., Plainfield, N.J.

STOP WASTING THOSE WATTS!

Let the SWR-I help you improve that inefficient antenna system! Read r.f. power and SWR directly in watts—no guessing! Write for details and free booklet "About CB Testing Equipment." H & L Electronics, P.O. Box 125, Medford, Oregon.

GARAGE SALE of RADIO PARTS and TUBES AT SACRIFICE PRICES.

Trade for U.S. Stamps and F.D.C. at catalog. George L. Beyers (10W0376), 3213 N.W. 22nd St., Oklahoma City 7, Okla.

WANTED—Used CB, Amateur, Test or HiFi equipment.

I buy, sell or trade any new or used equipment you may have or want. What do you have? What do you want? Monthly list of used equipment mailed on request. Bill Tagan, 305 E. 55th St., Kansas City, Mo.

CITIZENS BAND!

Update old transceivers, improve new ones. OZCO "Snoozer" add-on squelch unit quiets beyond belief! Compact, completely wired, guaranteed. Easily installed! Only \$2.00 each, \$3.95 pair, postpaid (tax included). OZCO Sales, Caanan 3, Conn.

CB QSL! For the best, C. FRITZ, Box 1684, Scottsdale, Arizona.

Samples 25¢ (deductible). See our world famous RAINBO CALLS, comic, space age, or regular samples. Be as proud of the cards you send as you are of CB.

RF PRESELECTOR KIT for Heath GW-10 transceiver.

Increases sensitivity and image rejection. Mounts inconspicuously outboard, extending only 1 1/2" rearward. No transceiver wiring is cut, only one joint wire

used. Uses high-gm pentode 6AK5. Wire kit in one evening. Complete instructions. Send \$8.99 ppd to HOLSTROM ASSOCIATES, P.O. Box 8640, Sacramento 22, Calif.

CB - QSL - SWL - WPE CARDS!

Printed in one or more colors from type, line drawings or photographs, QSO 3x5 file card. Send 10¢ for samples. MALGO PRESS, Box 375, Toledo 1, Ohio.

CB OPERATORS - - - 1000 "BUSINESS TYPE" CARDS

All prices postpaid. Flat black \$4.00. Beautifully embossed, blue or black \$4.75. Two color, red with blue or black \$5.50. (Up to 7 horizontal lines on white stock only) Add \$1.00 for three giant CALL SIGNS. Send information, call and layout or words to: CALL SIGNS, P.O. Box 933C, Aurora, Ill.

AUTOMOTIVE GENERATOR NOISE FILTER

— This filter eliminates the noise from the generator at the source; on the generator. It is pre-tuned to CB frequencies and sealed against moisture, oil and dust. Simple to install, efficient in operation. Only \$3.00 postpaid. If your dealer does not stock, write Ben N. Bartlett, 11W5592, 1815 W. 85th St., Los Angeles 47, Calif.

CB QSL CARDS — 100 four-color \$3.70

postpaid. Samples ten cents or send twenty-five cents and receive large selection and free DANGER HIGH VOLTAGE sign. Dick Stauffer W8VXK (CB license pending), 1996 N. M-18, Gladwin, Mich.

CB-BEEPER-TONE SIGNALER FOR CODED CALLING.

This is a transistorized, self powered unit that does a real job. NOT a neon bulb gadget or gimmick, but commercial type design and construction. Deluxe CB-BEEPER is \$7.95, postpaid. Requires one simple connection, works with ANY CB transceiver. Full instructions.

ENGINE NOISE DRIVING YOU NUTS?

Filter-Kit consists of GENERATOR TRAP, DIST. SUPPRESSOR & PLUG SUPPRESSORS. Complete kit with instructions \$6.95 postpaid.

TVI GOT YOU IN TROUBLE WITH FCC?

Power line filter will prevent radiation into a.c. line. \$4.95 postpaid with instruction. Write for catalogue sheets. Martin Development, P. O. Box 82, San Antonio, Texas.

CB'ERS Hear only the channel you tune. Dual conversion adapter kit, all parts, schematic, pictorial for HE-15 & 15A, TR800 & 910, RA395 & 449 etc. \$14.95, with tubes \$16.95 or \$5.00 deposit plus COD. Bainbridge Radio, 2649 Bainbridge Ave., New York 58, N.Y.

CB LICENSES LAMINATED

in heavy gauge plastic. Machine processed to insure permanent seal. Complete with eyelets. Remit \$1.50 with your license. Lots of 4 or more \$1.25 each. Prompt service! Bernard L. Osborn, 18A5344, 16 Woodlawn Street, Bluffton, Ind.

FREE SAMPLES—CB QSL CARDS. \$2.50

per 100 in 3 COLORS, POSTPAID. Garth Printing Company, Box 51, Jutland, N.J.

QUALITYKIT TONE CONTROL

for any receiver—Reduce noise and make the rig easier to live with. Provides variable attenuation of high frequencies. Available as assembled plug-in unit in attractive box for \$4.75 or in kit form for panel mounting for \$3.50, including instructions for easy installation. Postpaid from Qualitykit, P. O. Box 813, Charleston, S.C.

FUTURE OF CB

(Continued from page 18)

that when all television be moved to UHF, that the space be given to two-way communications. Within the Commissioner's proposal was the following listing for the Citizens Radio Service:

54.00-54.26 megacycles — Citizens and ISM
54.26-56.50 megacycles — Citizens

Astute readers will quickly recognize that this spectrum space (54-56.50 mc.) is now utilized by television channel 2. Were this amount of space given to CB radio, there would be room between 54.00 and 56.50 megacycles for an additional 250-10 kc. wide CB channels!

Think of a receiver with 250 channels. Think of a transmitter with 250 channels!

In the meantime, don't put off buying that new rig. 7-10 years is a long way off, and we will get a lot of use out of our equipment in the years ahead. Oh yes . . . FCC sources insist the current 27 mc. band (11 meters) will be retained. The new assignments will strictly be in addition to what we already have. RBC

SPEAK CLEARLY

(Continued from page 19)

fessional. Know that the frustrated desire of most of us, at first, is to grab the mike and talk, talk, regardless of what we say—that our sub-conscious knows that as we do so, the "entire world" can be listening, and that we thereby become important. Take note of the fact that our sub-conscious is dead wrong, that in general we are the same old bore. And if we could hear ourselves on a tape recording we would soon learn.

The mark of a pro is the mark of brevity. Let's be pros. If we do we can be assured the FCC isn't going to bother us about our use of the band, as brevity is the first sign that the frequencies are being used as the FCC wants them to be used. Also, you will all become increasingly aware of your own ability and proud of the fact that you have mastered something that, really, is a difficult thing. Amateur radio operators, as a majority, never do learn how to speak correctly—briefly! *You can.*

10-7

CB OLD TIMER

(Continued from page 11)

Crystal *Citizen Bander* "Ice Box," the *Globe CB-100* and the *RCA Radio-Phone*.

Yes, it sure seems like it was a long time ago. Guess it's the same no matter which call area you hail from.

I'm certain that the Chicago gang will never forget those round-tables on Channel 9 or the *Logan Square* group who used to dish out the latest technical info.

It's all part of our heritage and good or bad, we're proud of it.

10-7

WALKIE-TALKIE RADIOPHONES

Made in U.S.A.

From \$24.98

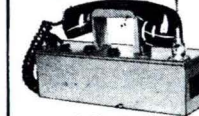

FOR ELECTRONIC CHASSIS

Now you can afford the new fully transistorized portable **SPRINGFIELD TR-28** radiophone kit, or the new **VANGUARD Mark I** factory assembled radiophone. Both high quality industrial types, with a 5 year service guarantee. Available for license free C.B. and Amateur Bands. **Send for free literature.**

VANGUARD ELECTRONICS LABS
190-48 99th Ave. Dept. CH-10 Hollis 23, N. Y.

CLYDE'S CORNER...



by Clyde D. Moore, 9W0219

This month I am reporting to you from the Lone Star State of Texas. I started my trip in Abilene, Texas, at Bill Stevenson's Texaco Station. Bill, 10W1473, monitors Channel 11, and is about the only one that will come back to you in a pinch. CB is new in Abilene and most stations there use it for business.

After leaving Abilene, I attended the club meeting of the "Corpus Christi Citizens Banders," in Corpus Christi, Texas. I was with this group when it organized back in May of this year, while I was flying for an oil company in south Texas. The CB'ers in this area are having a hard time trying to tie in with Civil Defense. They have asked for a CD coordinator to speak at their meetings, but until now no one has shown up. The Corpus Christi group has volunteered its services to the water rescue units of the fire and police departments, but with little or no response. CB'ers from Port Aransas, and Aransas Pass were on hand and they hope to have their club organized soon and will work hand in hand with Corpus. All the Corpus Christi area CB'ers monitor Channel 11 twenty-four hours, and will go to "NATCH" (National Calling Channel) 9 soon. I am happy to report that the Corpus Christi CB'ers subscribe to CB HORIZONS 100%.

After leaving Corpus, I headed north to San Antonio, and stopped in at the CD head-quarters in the city arsenal, to meet with Wesley J. Earls, 9W1919. Wes is the CB/CD coordinator and has helped to make CB big in San Antonio. The CD/

CB'ers there have been active in two floods this year, and have filled in the low and outlying areas of the city where other types of mobile units might lose radio contact. Several of the CD/CB units worked to save a lady from drowning in one of the many creeks that rush over their banks during heavy rains. Her car had stalled in high water washing off the road way when the CB'ers pulled her to safety. Many dollars in property damage, along with many lives were saved by the fast work of CD/CB units relaying messages to the police and fire departments of the city.

After a few days on the ranch, near San Antonio, I drove further north to Fort Worth, to visit the friendliest group of CB'ers you would ever expect to meet. They call themselves the "Citizens Band Radio Club of Fort Worth". Here again is a club that is having trouble tying in with CD. Over 200 mobile and base units are ready to work any type of emergency, BUT they have been told to stay out of all emergency areas until they are called in.

During a hard rain storm in May of this year the CB'ers, acting on their own, helped other rescue units in the Richland Hills area flood. Berman "Heavy" Williams, 10Q0253, along with five others, had their boats and rigs in the high water relaying messages to the fire departments for more than five hours. They carried water and food to their rescue units that were also on the scene. George Fobbs, 10W4650, was there and worked over 24 hours without sleep or rest, helping clean up the homes so owners could move back in.

Yank Bovea, 10W3947, was the net

and fire departments by phone. Two weeks

At Dallas, I attended the "Greater Dallas CB Radio Club" meeting, where I met most of the club members. The GDCBRC monitors Channel 11 and "NATCH" 9, 24 hours.

My next stop was in Lubbock, Texas and I must say they have the most up-to-date club of all. When I arrived in town at 3 in the morning I called for a monitor for some information about a motel. "Dub" Newsom, 10W0532, came back immediately. Later in the day, I called for a coffee call and within ten minutes, there were over twenty CB'ers at "Dubs". They are all members of the Red Cross and carry first aid kits in every car, along with other emergency equipment. They do their own policing of the CB band.

The club is known as the "Lubbock Citizens Band Radio Club" and is sometimes called "The Helping Hand Club". Last winter, during heavy snowstorms, they helped stranded doctors, nurses, firemen, policemen, and national guardsmen get to and from their homes and jobs. They have been active in everything from coyote hunts to locating stolen cars. When they had a "lost child" drill, the local T.V. station filmed it and ran it on the Sunday news final. They monitor Channel 11, 24 hours, and have volunteered their help to anyone that may need them.

The Lubbock CB'ers are holding a big CB Jubilee Jamboree on Oct. 28 and 29. They hope to have representatives from all CB manufacturers, along with over 2,000 visiting CB'ers from all 24 CB lands. For information, write to Lubbock Citizens Band Radio Club, P.O. Box 5341, Lubbock, Texas, or call J. W. "Dub" Newsom, 10W0532, at PO 2-5658.

While driving through Snyder, Texas I met 10W1555, and found out that most of the CB'ers there are ranchers, and monitor Channels 7, 14, and "NATCH" 9.

I'll be in Oklahoma until Sept. 15th, then on to Kansas and Colorado, until about October 25th. I hope to be in Utah and Nevada in November so until I mobile into your CB area, follow my on-the-spot report each month in CB HORIZONS.

THE CB LAB REPORTS

(Continued from page 33)

The antenna itself is fiberglass construction and our test unit withstood a great deal of knocking about without showing signs of wear and tear.

Performance wise . . . you have a big surprise in store! The Buddy Whip works out . . . and works out well. We have seen CB'ers work 20-25 miles mobile to mobile in busy Los Angeles traffic using the Buddy Whip at both ends of the circuit.

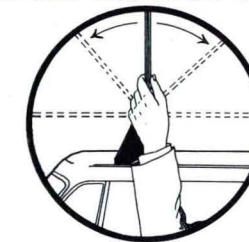

"Buddy Whip Swing Mount"

For the complete poop-sheet including who handles the Marina Line of antennas in your area, contact Marina Communications, 11527 West Washington Blvd., Los Angeles 66, California.

10-7

CITIZENS BAND EQUIPMENT

Check Power Output, Standing Waves Cesco Transichack. Gives meter indication of power output, VSWR. Ideal for transmitter tuning. Specify auto spade or PL-259 type coax connector. **\$19.95**



\$18.95 (auto spade)

Eliminate Generator Whine Cesco Generator Filter. Eliminates generator whine in mobile installations. Tunable for maximum attenuation. Most effective generator noise filter made. Also available for other frequencies. **\$2.95**



Cesco Duopole Base Antenna

Rugged, tuned CB antenna with 1 to 1 VSWR. High gain, non-directional. All elements at DC ground potential for maximum lightning protection. Also available for other frequencies.

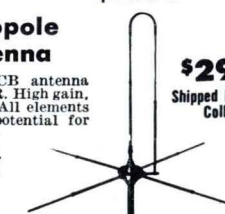

\$29.95

Shipped Express Collect

CONTINENTAL ELECTRONICS
6151 Dayton Liberty Road, Dayton, Ohio

10-7



**BEFORE WE
SIGN OFF**

D. C. FLASHES!!

By **REX HOLMES**
"Our Man in Washington"

FCC Starting Crackdown!

The FCC appears to have more CB license revocation actions on their books this month than at any time since the opening of the Class D service. It looks as if they've finally started the steam roller that they've been cranking up for the past few months, and here are the fellows who have been caught in the current "squeeze."

Randall G. Schaub, (13W0246) of Portland, Oregon, has been ordered by the FCC to "show cause" why his license should not be revoked. He is charged with not maintaining the carrier frequency of his station within the required tolerance. The Commission pointed out that it had brought the alleged violations to the licensee's attention on *nine* different occasions between September, 1959, and May, 1961.

Oscar Hermandy, Jr. (7W3608), doing business as Main Oil Line, Tampa, Fla., has been charged with transmitting communications "not substantive to (his) business or personal activities," and with failing to reply satisfactorily to FCC correspondence concerning the alleged violation.

Heyward J. Gainey, 5Q0036, of Kanasopolis, N.C. has been charged with violating the rules which require "that radio transmissions shall be addressed to specific persons or stations located with the direct ground-wave coverage of the station and

prohibit transmissions which depend primarily upon skywave reflection or which are designed to elicit a response from random or unknown stations, such as by use of the general call sign 'CQ,'" the Commission said. The agency also charged that Mr. Gainey did not make satisfactory reply to its correspondence concerning the matter.

David A. Gentry (12W3205) of Berkeley, Calif., has been hit with a "show cause" because of being charged with non-compliance of section 19.61(a) (non-substantive messages), 19.61(f) overtime talking and 19.62 (failure to identify his station properly).

Robert E. McCarthy, (24W0486) of Washington, D.C., has been asked to "show cause" because of FCC rule violations, as has James Lemon, 11W8008, of Bell Gardens, California.

Warren G. Holleman of Falls Church, Va., has his hearing set too. The FCC is trying to determine whether he has violated permissible communications rules of 19.61, including nature of communications, length of transmissions, transmission of profane language, and other violations. At the same time, the Commission extended his present special temporary authority to operate 3 Class D units until conclusion of the proceeding, without prejudice to any action which may be taken in the proceeding.

So now it looks as if the many months of "threats" have finally ended. A number of readers have written to say that their local CB/FCC grapevines hum with news that the FCC is going to be cracking down on the CB'ers who use the "BREAK, BREAK, BREAK!" routine to initiate contacts with unknown stations as an excuse to talk with someone "new."

One interesting point to note about 'most all of the "show cause" operators mentioned this month — the FCC seems more concerned with the fact that their citations were not *properly* answered by the CB'ers to which they were sent, than the actual Part 19 violation themselves.

CB'ers might pass the word along — the crackdown seems to be underway. You had better pull out your copy of Part 19 and brush up on your operating techniques!

NOW!

VERIFY SIGNAL LEVELS with FRONT PANEL "S" METER TUNE ALL 23 CHANNELS with FULLY TUNABLE RECEIVER

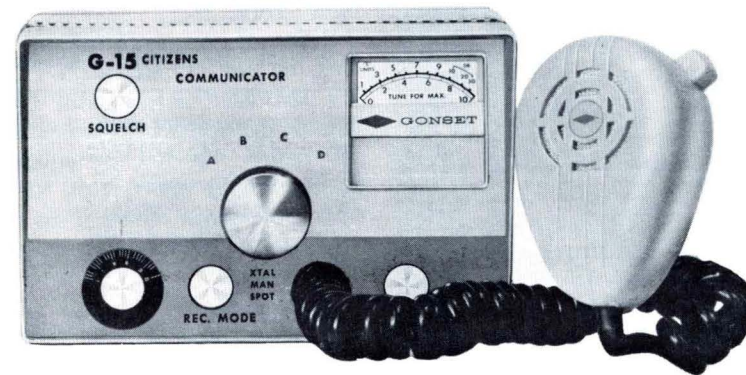

THE GREAT NEW GONSET G 15 CITIZENS BAND TRANSCEIVER GIVES YOU THIS EXCLUSIVE COMBINATION PLUS THESE QUALITY FEATURES!

- Maximum adjacent channel rejection and interference suppression with dual conversion superheterodyne receiver.
- Maximum talk power (100% modulation).
- Highest audio output.
- Maximum usable receiver sensitivity.
- Compact and rugged construction.
- Universal low-drain power requirement.
- Heat-proof ceramic microphone.
- High efficiency circuitry provides maximum power to antenna.

A quarter century of experience endows Gonset equipment with built-in quality for outstanding performance.

Write to Dept. CB-10 for name of Gonset distributor nearest you.

 **GONSET**
DIVISION OF YOUNG SPRING & WIRE CORPORATION
801 SOUTH MAIN STREET, BURBANK, CALIFORNIA

7.K. on C.B.

by TOM KNEITEL, 12Q1747

The Bay State Boys

From "down east" we have received word of the BAY STATE CHANNEL WIZARDS of New Bedford, Mass.

Founded in July, 1960, the CHANNEL WIZARDS have racked up quite a nice reputation in their neck of the band. They have received commendation letters from the New Bedford Civil Defense Director, Police Liason/Safety Officer of the New Bedford Police Dept., The Atlantic Refining Company (commending them for aiding one of their trucks which became stranded), the Red Cross (asking for their services in an emergency), and from a number of citizens who were helped out of jams, courtesy of the BAY STATE gang.

Last Christmas the club gave a kiddies' party.

Their 65 members are ably led by Joseph Duquette, 1W8347, President.

"Giant Eyeball QSO"

I'd hate to think of having a QSO with a "giant eyeball," however, that's just what the Norwalk CB Association has chosen to name its annual Jamboree. The first of these Jamborees will be held from 12 noon to 9 p.m. on Sunday, September 17th. Rain or shine, things will pop at Eagle's Hall and Grounds on Mott Avenue in Norwalk, Connecticut. There'll be prizes, swap shop, refreshments, and general whoopie.

Two Books For CB'ers

John F. Rider has sent us a few books which he feels (and we agree) would be of interest to you. The first is CITIZENS BAND RADIO by Allan Lytel, a 152 page barrel of information which goes interestingly into such things as FCC rules, cir-

cuit designs, portables, kits, antennas, power supplies, installation, servicing and many other points. Sells for \$3.90 from John F. Rider Publisher, Inc., 116 W. 14th Street, New York, N.Y.

Rider also comes to the aid of the CB'ers with HOW TO ELIMINATE RADIO & TV INTERFERENCE by Fred D. Rowe. This is the second revised edition and runs 160 pages. All 160 are chock-full of diagrams, hints, kinks, tips, cures and lists of trouble spots. There is an entire chapter on how to "clean-up" a transmitter. This book is \$2.90.

Smallest???



Lute Watson's miniature mobile station and lovely young daughter.

Last month we ran an item about the smallest CB club. This month its the claimant for the smallest mobile CB unit and it comes from our home state of "Californee."

The rig is that of Lute Watson, 11Q2374, of Oxnard. Lute's cute(y) daughter can be seen in the photo here using the rig, which is installed in a Messerschmitt cycle car. Anybody have a rig in a motorcycle, bicycle, scooter, roller skates??

CBH-VMP REPORT

Here is a breakdown of how VMP monitoring cards were directed this month: Total violation cards sent - 340.

Violation of 19.61(f)—Talking more than 5 minutes without 2 minute break: 215 notices sent.

Violation of 19.61(g)—Calling CQ, testing, etc. to make new contacts: 20 notices sent.

Violation of 19.62—Incomplete callsign: 45 notices sent.

Violation of 19.61 (b)—Transmitting music: 15 notices sent.

Violation of 19.83—False or deceptive signals: 15 notices sent.

Violation of 19.61 (h)—Long dead carrier: 10 notices sent.

The following stations were accepted for participation in CBH-VMP this past month. They are to be commended on their willingness to help clean up some of the bad conditions on the band to give you better communications:

- 1Q3711 Elliot W. Perrin Falmouth, Mass.
- 1W0893 Francis S. Converse Pittsfield, Mass.

- 1W1389 Stanley Zagaski Uncasville, Conn
- 1W2083 Arthur Levy Springfield, Mass
- 2A5174 John R. Rossilli Brooklynn, N.Y
- 2Q0135 Alfred Amendola Grasmere, S.I., N.Y
- 2Q0823 Robert F. True Suffern, N.Y
- 2Q1621 Joseph Fairclough Ken Gardens, N.Y
- 2Q3781 Sam T. Russo Bronx, N.Y
- 2W1711 Sydney B. Martin Bethpage, L.I., N.Y
- 2W5672 Charles F. Pankow New Hyde Park, N.Y
- 2W7382 Martin Wassenburg Elizabeth, N.J
- 2W7831 John A. Sampson Bronx, N.Y
- 2W8397 Roger Howland Bradley Beach, N.J
- 4W0404 Jesse B. Leach, Jr. Linthicum Hgts., Md
- 4W2381 James M. Cross Hagerstown, Md
- 5W3378 Walter R. Dryman, Jr. Danville, Va
- 6Q3944 Donn W. Sanford Northport, Ala
- 6W5551 D. K. Rector Knoxville, Tenn
- 7Q0243 Walter Levi, Jr. Jacksonville, Fla
- 9Q0864 Carl Fitch Corpus Christi, Tex
- 9W1564 Charles Odle Houston, Tex
- 10Q1377 M. L. Cunningham, Sr. Tulsa, Okla
- 10Q1417 E. W. Gee Ft. Worth, Tex
- 10W0538 Don Greer Tulsa, Okla
- 10W3873 Don Goforth Amarillo, Tex
- 10W3989 Harold Collier Marshall, Tex
- 10W4389 Robert J. Johnson Ft. Worth, Tex
- 11Q2201 Stephen E. Goodman Los Angeles, Calif
- 11W4439 Vernon H. McIntyre So. San Gabriel, Calif
- 11W8410 Clarence W. Pare, Jr. Los Angeles, Calif
- 11W8586 Gordon V. West San Pedro, Calif
- 12W5251 Jim White San Francisco, Calif
- 13W1279 Jesse E. English Portland, Ore
- 13W1686 William B. Wilson Bend, Ore
- 15Q0789 David Henville La Junta, Colo
- 16W3375 Dale Preston Caise Harmony, Minn
- 16W3578 Ralph W. Hughes St. Charles, Minn
- 17W5836 W. A. Stalons, Jr. Lincoln, Nebr
- 18A7297 Robert D. Cooper Elkhart, Ind
- 18B2785 Jerry R. Keim Sterling, Ill
- 18Q1996 Leonard W. Higgins Park Ridge, Ill
- 18Q3172 Lawrence A. Haak Madison, Wisc
- 18Q6283 Robert S. Buchman Evansville, Ind
- 18A8157 Terry A. McDonald Toledo, Ohio
- 19A8358 Burt Woodring Akron, Ohio
- 19Q5991 Robert E. Wilcox Dayton, Ohio
- 19W2055 Edward H. Taylor Dearborn, Mich
- 19W5392 Heli J. Malkowski Wayne, Mich
- 19W5392 Heli J. Malkowski, II Wayne, Mich
- 20W3325 Jack R. Auberle, Jr. McKeesport, Pa

FOR SHARPEST, CLEAREST VOICE TRANSMISSION WITH ANY CITIZENS BAND TRANSCEIVERS, SPECIFY

THE TURNER 350C

Even the best citizens band equipment is no better than the microphone it uses. That's why more Turner 350C microphones are used as original equipment in CB than any other. That's why it will pay you to specify the Turner 350C when you buy CB equipment or replace your microphone.

■ The 350C is furnished with an 11" retracted (five foot extended) coiled cord. Hanger button and standard dash bracket are included for mobile rig mounting. Response: 80 to 7000 cps. Output: -54 db. Net price: \$10.08. ■ See Turner microphones at your electronic parts distributor or send coupon for complete information and the name of your nearest Turner distributor.



TURNER 254C FOR BASE STATION

Desk type ceramic mike operates by a touch bar on-off switch and lever lock on-off switch. Response: 80-7000 cps. Output: -54 db. Net price: \$14.10.

THE TURNER MICROPHONE COMPANY
925 17th Street NE,
Cedar Rapids, Iowa

Send me: _____
send me further information on the 350C and 254C CB microphones and the name of my nearest Turner distributor

NAME _____
ADDRESS _____
CITY _____ STATE _____

WE'RE GIVING AWAY A NEW CB STATION EACH MONTH!

Courtesy of CBH and the CB Manufacturers
of America!

NO MONEY! NO BOX-TOPS! NO CONTESTS! JUST PRIZES!

**10 chances to win for each time you enter...and
you may enter as many times as you like!**

HERE ARE THE SIMPLE RULES:

1. Fill out the card provided between pages 42 and 43 (or reasonable facsimile) and return to us immediately (don't forget to put a 3c stamp on the card, or 5c for airmail).
2. Entries must be in Modesto not later than October 10th.
3. Winners will be selected at random from all applicants by our Gal Friday, Carlyne, 12Q2207, on October 10th.
4. Winners will be notified by mail and announced in our December issue (out on November 10th).
5. No cards can be acknowledged, nor can we engage in any correspondence regarding an entry.
6. Staff members of HORIZONS PUBLICATIONS or their families are not eligible.
7. Winners will receive their prizes directly from the manufacturers and not from our offices in Modesto.

Now look at page 43 and see what you can win this month!

Be sure to see what we're giving away next month...
it'll be in our November issue (out on October 10th).

**ENTER NOW!
QUICK!
PRONTO!
USE THIS
CARD!**

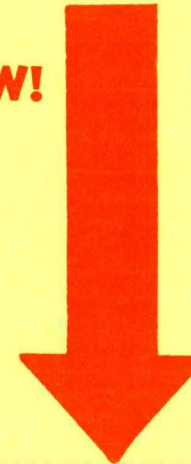

Hey you crazy guys! I can't miss out on a deal like this! Give me a crack at all those free goodies!

Name _____ Call _____
Address _____
City _____ Zone _____ State _____
Local monitoring channel is _____
I would like to see CBH have an article about: _____
Club Affiliation (if any) _____
Club Address: _____

THIS MONTH!

**HE-20A Transceiver
\$50!**

18 Liberty Avenue, Jamaica 33, N.Y.
Set receiver with 4 fixed channels —
input wattage meter! Push to talk!
Keys for "NATCH" (National Calling
win first First Prize!

**al Radiotelephone SWR
Worth \$39.95!**

HONE CO., 2806 W. Burbank Blvd.,

relative field strength, true power
connectors. Unit has bold panel with
you win Second Prize!

**raft Model CSG-11
round Plane
\$6.05!**

rd St., Manchester, N.H.

aluminum construction. Radiator and
treated solid aluminum rod. Built-in
-ohm feed. Yours free if you win a

**729SR Microphone
\$5.90!**

Buchanan, Mich.

response! Unit has pressure diecast zinc
gray and black. Cardioid polar pattern.

**co "Snoozer" Squelch
\$2.00!**

onn.

receiver to a hush! Yours free if you

**From Texas Crystals
\$5 Each!**

Crystal Drive, Ft. Myers, Fla.

Make your choice of a guaranteed .005%
yours free if you win a Fourth Prize!

WE'RE GIVING CB STATION E

Courtesy of CBH and
of A

NO MONEY! NO BOX-TOPS!

**10 chances to win for
you may enter as r**

HERE ARE THE SIMI

1. Fill out the card and 43 (or reason us immediately (d on the card, or 5c
2. Entries must be October 10th.
3. Winners will be se plicants by our Ga on October 10th.
4. Winners will be no in our December is
5. No cards can be a gage in any corres
6. Staff members of TIONS or their fa
7. Winners will recei the manufacturers Modesto.

Now look at page 43 a month!

Be sure to see what we're it'll be in our November

**SO WHAT
ARE YOU WAITING
FOR?
ENTER!**

CB Horizons' Gigantic Giveaway
CB HORIZONS MAGAZINE
P. O. Box 3150
Modesto, Calif.

PLACE
STAMP
HERE

\$198.15 IN PRIZES THIS MONTH!

**FIRST PRIZE—A Lafayette HE-20A Transceiver
Worth \$109.50!**

Donated by LAFAYETTE RADIO, 165-08 Liberty Avenue, Jamaica 33, N.Y.

14 Tube performance! Tunable superhet receiver with 4 fixed channels — transmitter has 4 channels! "S" meter, input wattage meter! Push to talk! Squelch! Comes with matched crystals for "NATCH" (National Calling Channel) Channel 9! Yours free if you win first First Prize!

**SECOND PRIZE—A General Radiotelephone SWR
Bridge—Worth \$39.95!**

Donated by GENERAL RADIOTELEPHONE CO., 2806 W. Burbank Blvd., Burbank, Calif.

The Model 615 which measures SWR, relative field strength, true power output. Complete with silver plated connectors. Unit has bold panel with black wrinkle finish case! Yours free if you win Second Prize!

**THIRD PRIZES—A Cush-Craft Model CSG-11
Deluxe Ground Plane
Worth \$16.05!**

Donated by CUSH-CRAFT, 621 Hayward St., Manchester, N.H.

Self supporting ground plane! All aluminum construction. Radiator and radials drawn aluminum tubing and heat treated solid aluminum rod. Built-in coax fitting takes PL-259 for direct 52-ohm feed. Yours free if you win a Third Prize!

AND

**An Electro-Voice Model 729SR Microphone
Worth \$15.90!**

Donated by ELECTRO-VOICE, INC., Buchanan, Mich.

Ceramic mike with 60 to 8,000 c.p.s. response! Unit has pressure diecast zinc front and plastic back in two-tone gray and black. Cardioid polar pattern. Yours free if you win a Third Prize!

**FOURTH PRIZES—An Ozco "Snoozer" Squelch
Worth \$2.00!**

Donated by OZCO SALES, Canaan, Conn.

Add-on squelch unit which quiets your receiver to a hush! Yours free if you win a Fourth Prize!

AND

**5 Crystals For Any Unit From Texas Crystals
Worth \$2.95 Each!**

Donated by TEXAS CRYSTALS, 1000 Crystal Drive, Ft. Myers, Fla.

Five winners here — if you win you take your choice of a guaranteed .005% crystal for any channel for any unit. Yours free if you win a Fourth Prize!

LAFAYETTE is America's Citizens Band Headquarters

Ship to Shore  On the Farm  Construction Work 

9 LAFAYETTE TRANSISTOR CITIZENS BAND "WALKIE TALKIE"

39.95
2 for 78.88
NO MONEY DOWN

• Completely Wired—Ready to Operate • Fully Transistorized—9 Transistors plus 1 Diode • Uses Inexpensive Penlight Batteries • No License, Tests or Age Limits • Comes with Leather Carrying Case, Earphone, Antenna, Batteries and Crystals

As simple and easy to use as the telephone—and twice as handy. Receives and transmits up to 1.5 miles under average conditions. Weighs only 18-oz. and slips into your pocket. Push-to-talk button operates built-in speaker as sensitive microphone.

PORTABLE—POCKET SIZE
Only 6 3/8 x 3 1/4 x 1 5/8"





LAFAYETTE HE-20A Citizens Band TRANSCEIVER

• Pi-Network for Greater Power Output • Calibrated "S" Meter • Series Gate Noise Limiter • Tuneable Superhet Receiver over all 23 Channels • 4 Crystal-Controlled Transmit Positions • 4 Crystal-Controlled Receive Positions • Dependable Push-To-Talk Ceramic Microphone & Relay • Illuminated Dial • Built-in 12-Volt Power Supply • Complete with Matched Crystals for Channel 9

109⁵⁰
NO MONEY DOWN

Made in U.S.A.

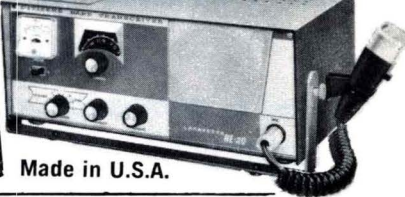

LAFAYETTE HE-15A Citizens Band TRANSCIEVER

SUPERHET

• Completely Wired—Not A Kit • 5 Crystal-Controlled Transmitting Positions • Tuneable Receiver Over Full 23 Channels • High Output Ceramic Microphone • Complete with Transmitting Crystal for Channel 9

A compact, precision transmitter and receiver covering up to a 20 mile or more radius, depending upon conditions. The HE-15A features an effective full-wave variable noise limiter, planetary vernier tuning. RF and microphone jack on front panel, 12 tube performance from 4 dual-function tubes, 2 single-function tubes, 2 rectifiers.

ONLY 59⁵⁰
NO MONEY DOWN

Made in U.S.A.

HE-19 Telescoping Whip Antenna Net 3.95
HE-16 Power Supply for 12 Volts Net 10.95
HE-18 Power Supply for 6 Volts Net 10.95



LAFAYETTE ALL-IN-ONE CITIZENS BAND MOBILE ANTENNA

The Scoop Buy for Citizens Band Mobiles

6.95

HE-800WX

• Chrome Swivel Base • Stainless Steel Spring • 102 1/2" Stainless Steel Whip for Optimum 11-Meter Performance

Chrome swivel ball mount base designed for mounting on any surface. Stainless steel spring holds rod in properly adjusted position and prevents rod damage from shocks and blows. Stainless steel whip for maximum resiliency and strength.



LAFAYETTE RADIO FREE!

SEND FOR LAFAYETTE'S NEW 1962 CATALOG

Catalog 620
340 Giant Size Pages

OTHER LOCATIONS:
JAMAICA, N. Y. 165-08 Liberty Ave.
NEW YORK, N. Y. 100 - 6th Ave.
BRONX, N. Y. 542 E. Fordham Rd.
BOSTON, MASS. 110 Federal St.
NEWARK, N. J. 24 Central Ave.
PLAINFIELD, N. J. 139 W. 2nd St.
PARAMUS, N. J. 182 Route 17

LAFAYETTE RADIO, DEPT. CBJ-1
P.O. BOX 10,
SYOSSET, L. I., N. Y.

Send FREE 1962 Catalog 620 featuring the full line of Lafayette C.B. Equipment

\$ _____ Enclosed for Stock No. _____

Name _____
Address _____
City _____ Zone _____ State _____



HERE'S THE NEW, 2-WAY HAND-HELD TRANSCEIVER THAT OUTPERFORMS 'EM ALL!

PERSONAL Messenger

• No license required—may be used at once! • Meets FCC requirements for use with licensed Citizens' Band stations, too!

This is the new "Personal Messenger"—a superbly engineered 2-way crystal-controlled transceiver so compact it fits in your hand—so flexible it can be used in thousands of applications! 11 transistors and 4 diodes—superheterodyne receiver with exclusive tuned R.F. amplifier gives you twice the sensitivity and more than 40% more range than units with conventional circuitry! Powerful two-stage transmitter delivers more power output than similar units with the same rated input! Unmatched audio intelligibility and razor-sharp voice reproduction—automatic noise limiter—automatic volume control—positive squelch control—elastic hand strap—operates on penlight or rechargeable nickel-cadmium batteries.

\$109⁵⁰

ILLUSTRATED AT LEFT—The Viking "Messenger"—maximum legal power Citizens' Band crystal-controlled transceiver. Excellent receiver sensitivity and selectivity—highly efficient transmitter punches your signal home! Built-in squelch—AVC—ANL. With tubes, push-to-talk microphone and crystals for 1 channel. FROM **\$134⁹⁵**





Delivery or fleet operation



Your own personal use



Construction or Business

FREE Color Brochure

WRITE TODAY

Manufacturers of the world's most widely used personal communications transmitters

E. F. JOHNSON COMPANY
4210 Tenth Avenue S.W. • Waseca, Minn.

• Please rush me your full color brochure.

NAME _____
ADDRESS _____
CITY _____ STATE _____

