

CED

THE MAGAZINE OF BROADBAND TECHNOLOGY / SEPTEMBER 1989

Fiber Optics Application Guide

**A hands-on
reference for
CATV operators**

A special supplement of CED Magazine.



B L I G A T

*Orville And Wilbur Wright
Showed That Commitment To A Goal
Is No Flight Of Fancy...*

Jerrold Cableoptics™ Proves History Repeats Itself!

After nearly a decade of effort and experimentation – including over 200 wind tunnel tests – the Wright Brothers knew the reality of their vision was finally at hand. On a windy day in December, 1903, they seated their biplane on a rail embedded at the foot of Kill Devil Hill. The Wright Flyer was launched and 12 seconds later, the aviation age was born.

Wilbur and Orville knew all along that their plane would fly. But it took five years after Kitty Hawk to convince the skeptics of the practical value of what they had accomplished.

Today, there are scientists and inventors committed to a different kind of flight. The flight of television signals – not through the air or on wire – but as lightwave communication. These "Wilburs" and "Orvilles" are convinced that optical broadband signals will maximize clarity, increase the capacity and appropriately supplement current RF technology.

Jerrold's obligation is clear. Provide our scientists and technicians with substantial R & D investment. Bring products to market that totally integrate and enhance current RF transmission methods. And lead the cable industry into a new age of reliable, improved image quality and economic value.

Jerrold's commitment to the cable industry is over 40 years old. We launched the first successful cable TV system only through our determined effort to develop an amplifier that would deliver a clear signal. And time after time, we've been proven right as we helped bring cable television to homes throughout America.

At Jerrold, our vision of future cable television transmission through Cableoptics™ is as certain as powered flight was to the Wright brothers. And the future is just as bright.

CABLEOPTICS
JERROLD

**GENERAL
INSTRUMENT**



I O N

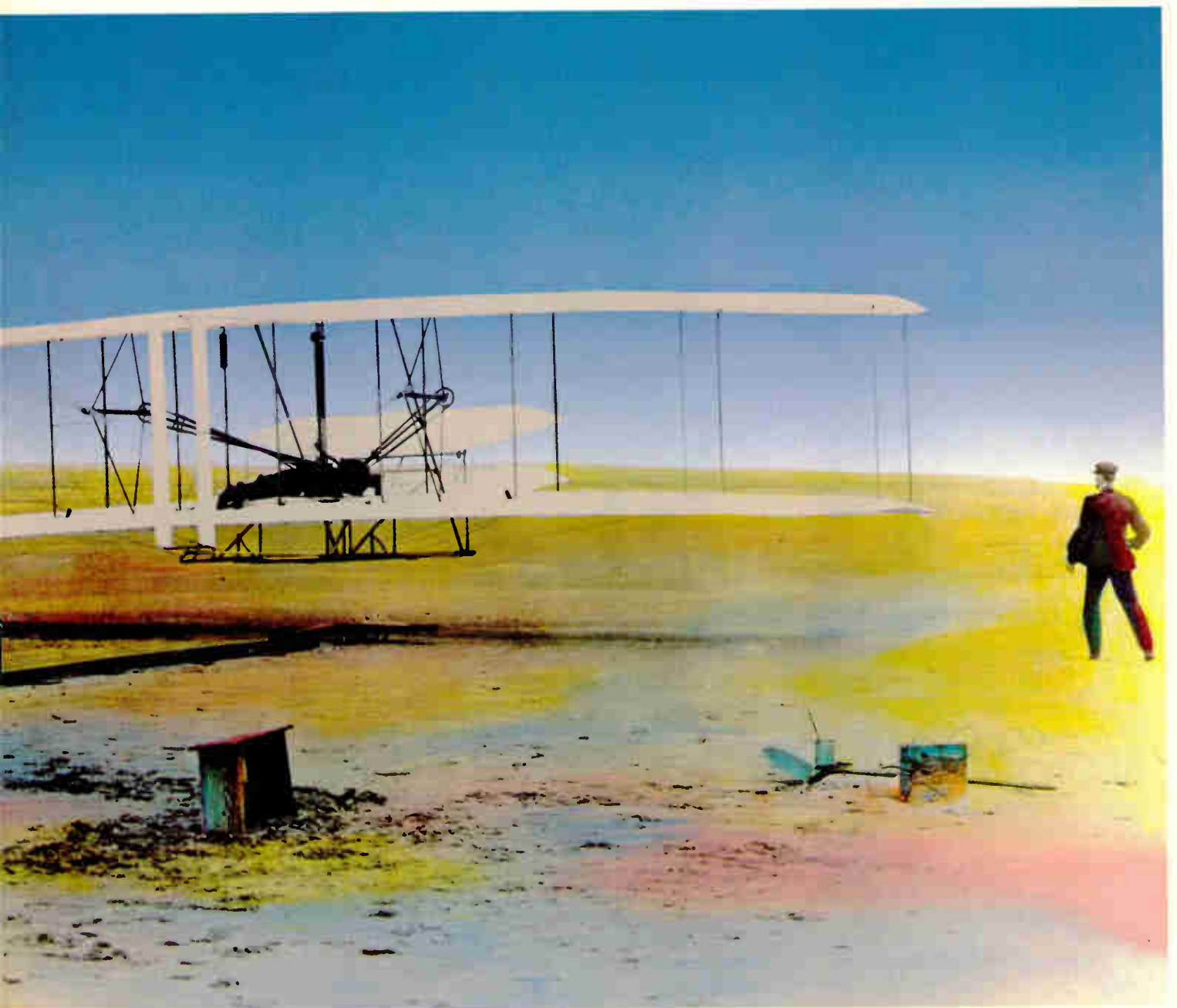

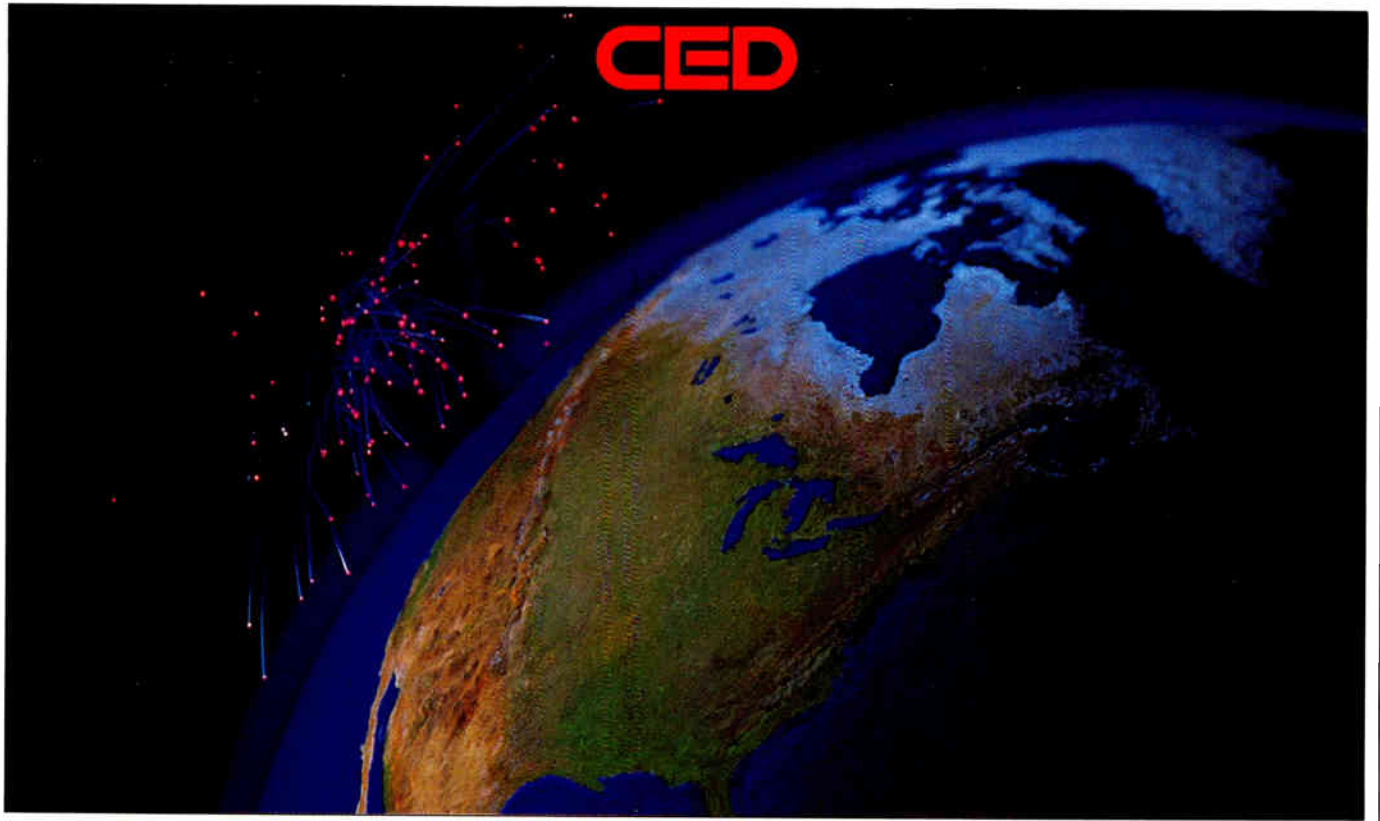

Fiber optics: What are the benefits?	8
James Chiddix and Ron Wolfe of ATC perform a complete technical and economical analysis of a real system to determine whether the installation of a fiber backbone is a viable alternative during rebuild.	
Where has all the fiber gone?	24
Exactly how is fiber optic technology being used in the industry? It depends on who you ask. In this in-depth examination of real systems that use fiber, the answers are as varied as the MSOs they represent.	
Taking that first step	30
Larry Nelson of Comm/Scope Inc. and Ken Carter of Cablevision of Central Florida discuss the first physical step in implementing fiber optics—installation. Similarities and differences between coaxial and optical cables is also examined.	
Fiber to the home: a dream or reality?	38
In this look at delivering fiber to the home, Dean Bogert of Orchard Communications reviews using analog AM technology as a method to get in the door with voice, data and video.	
Integrating CATV and telephone services	42
Setting aside the political concerns, James Hood with Catel Telecommunications analyzes the technology involved with integrating AM video and digital telephony signals on fiber optics.	
AM technology taking the lead	46
There doesn't seem to be much argument lately that AM technology for fiber optics is the way to go. Why this technology is taking the lead is discussed in this paper by John Simons of Times Fiber Communications.	
AML and fiber—no need for competition	50
Dr. Thomas Straus of Hughes Aircraft explores the need for fiber optics and AML microwave to coexist. Both performance and cost advantages are examined along with a review of AM fiber and AML system performance.	
Last but not least, fiber optic training	64
Now that fiber is gaining a foothold, personnel need to work with the technology up close. Dana Eggert of Performance Plus takes a look at the fiber phenomenon and the role training needs to take.	

COVER PHOTO COURTESY OF CORNING GLASS

Do You Know The Difference Between Telephone And CATV Fiber?

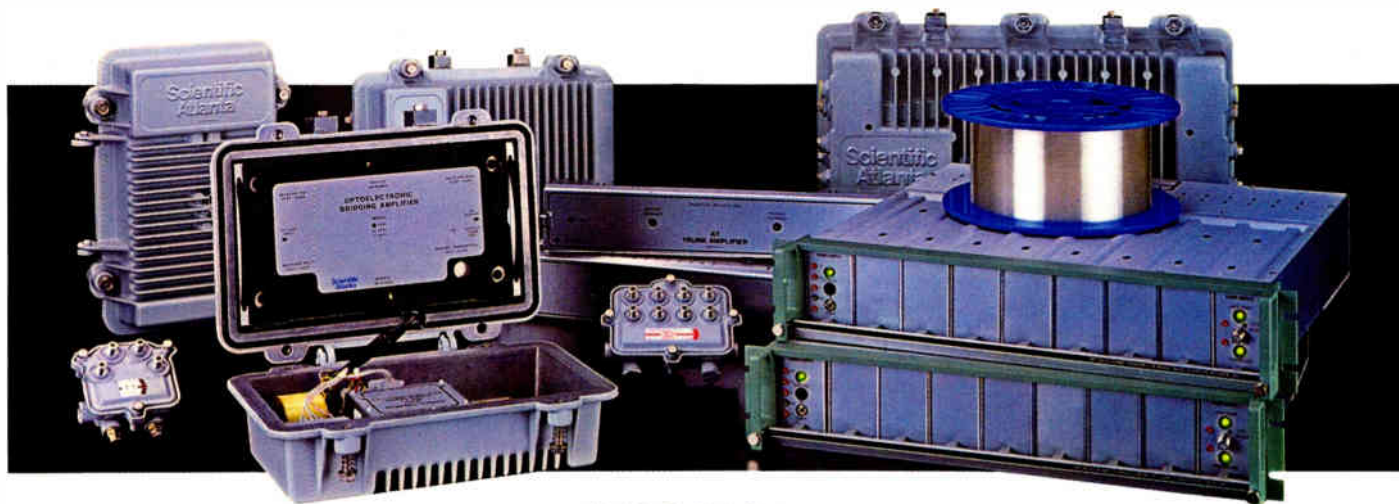

The difference - and it's an important one - lies in our Total Systems Architecture™ approach to CATV. It provides you with the tools to advance your delivery system and protect your investment.

Fiber is fiber. But there the similarity ends. Scientific-Atlanta is the first full line CATV manufacturer to offer it all. Product, system design, service, and support. Introducing the 6450 Optoelectronic Laser Transmitter. Fiber optic cable.

**We
Do.
Scientific
Atlanta**

And, the 6901 Optoelectronic Bridging Amplifier.

Telephone or CATV? Sure the fiber is the same. But everything else about a Scientific-Atlanta fiber optics system is better. These differences are what makes Scientific-Atlanta the company to rely on for CATV fiber optics — we do it right.

Call or write Scientific-Atlanta
Dept. AR, P.O. Box 105027
Atlanta, GA 30348
1-800-722-2009

Our customers are the winners.

Reader Service Number 2

Venturing out into the real world

What a difference 18 months makes. Shortly after Jim Chiddix and Dave Pangrac of ATC "went public" with their notion about an AM fiber optic "backbone" that would reduce amplifier cascade lengths, improve carrier-to-noise ratios, increase bandwidth and open the door to future revenue-generating ideas, I helped organize a roundtable to discuss fiber's future in CATV. The meeting was held in a Denver hotel room and several high-ranking engineers representing some major MSOs were in attendance.

If you contrast the tone of that meeting and the attitudes that exist today, you'd wonder what happened to change the ways of the world. There was almost universal agreement in that room that yes, fiber was the wave of the future, but it was going to take time for the wave to hit the shore. The fiber "mystique" was apparent: there were numerous questions (and doubts) about costs, operating expertise, training needs and even if the "black boxes" would work for video.

Now, of course, the outlook is much different. ATC and other aggressive MSOs have managed to make fiber work for them. First it was FM (there was never really any doubt about point-to-point applications), then some good lasers began to show up that could deliver AM signals and now, digital methods are rivalling FM in cost and beating it in quality.

And that's what this special supplement to CED magazine is all about. We examine how various operators have put fiber to work for them. We avoid most of the theoretical *discussions* about how fiber works and concentrate on the real-world *applications* of the technology.

For example, the lead story (see page 8) is a full-blown technological and economical evaluation of fiber as it relates to a system rebuild that already has a significant investment in microwave (and the findings just may surprise you—it isn't an "either/or" situation). In addition, we picked systems at random to find out why they chose to take the fiber route and discuss their future plans (see page 24).

But perhaps the most provocative portions of this supplement will come from articles written by Catel and Orchard executives. These companies have looked into their crystal balls and anticipate a day when POTS and video will be sent over the same network. Orchard says it has a system that could offer such a combination; Catel is actively working on it now.

This supplement isn't meant to answer everyone's questions about fiber, it is just one attempt to bring some knowledge and information and hopefully open a few eyes to what the future may bring. We hope you enjoy some of the thought-provoking discussions.

Roger Brown
Editor

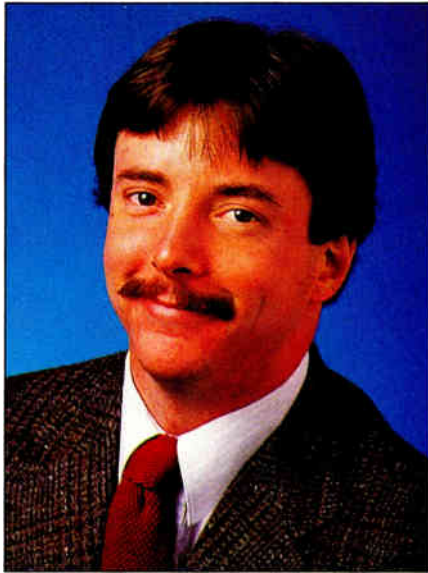

William McGorry, Group Publisher
Robert C. Stuehrk, Associate Publisher

EDITORIAL

Roger Brown
Editor

Kathy Berlin
Managing Editor

George Sell
Contributing Editor

CONSULTING ENGINEERS

Chairman

Wendell H. Bailey, NCTA VP, Science and Technology

Members

Jim Chiddix, Senior VP, Engineering and Technology, ATC

John Dawson, Engineering Consultant

Roy Ehman, Director of Engineering, Jones Intercable

Tom Elliot, Director of Research and Development, Tele-Communications Inc.

Jim Farmer, Principal Engineer, Scientific-Atlanta

Paul Helmbach, VP Engineering, Home Box Office

Fred Kaiser, President, Alpha Technologies

Dave Large, Director, Video Product Planning, Raynet Inc.

Robert Luff, VP Technology, Jones Intercable

Steve Raimondi, VP Engineering, UA Cablesystems Corp.

Joe Van Loan, Engineering Consultant

PRODUCTION

Jeff Knight, Production Director

Don Ruth, Art Director

Elsie Callahan, Production Manager

Dick Benson, Circulation Director

ADVERTISING

Cathy Wilson, National Sales Manager

Judy Medley, Account Executive

Curt Stocker, Classified Sales Manager

MARKETING AND SUPPORT

Michelle Pazar, Author Support and Quality Assurance

Linda Hendrick, SCTE Chapter Support

OFFICE

Denver 600 S. Cherry Street, Suite 400, Denver, CO 80222 (303) 393-7449. Fax (303) 393-6654.

ITCI

INTERNATIONAL THOMSON
COMMUNICATIONS INC.



Your hotline to a full line supplier.

Corporate Office
Charleston, WV
304 343-8874

Central Region
Lafayette, IN 800 382-7526
Outside IN 800 428-7596

Northeastern Region
Pottstown, PA 215 970-0200
Outside PA 800 458-4524

Southwestern Region
Dallas, TX 214 271-8811
Outside TX 800 421-4334

Eastern Region
Clarksburg, WV 304 624-5459
Outside WV 800 532-2288

Southern Region
Ocala, FL 800 433-4720
Outside FL 800 433-3765

Western Region
Denver, CO 303 773-2205
Outside CO 800 232-9378

MIDWEST

CATV

A division of Midwest Corporation

More than supplies. Solutions.

Fiber optic implementation: A case study

Lake City is the center of a metropolitan area of approximately 700,000 residents. For 25 years, Lake City Cablevision has held the franchise for Lake City, as well as a majority of the surrounding communities. Lake City Cablevision (LCC) is a division of ATC, a large MSO, and as such LCC must meet the needs of ATC as well as the communities it serves.

tion is based on the fact that several recent renewals in surrounding, similar communities have resulted in this requirement.

In addition to the regulatory requirement for expansion, LCC anticipates that market pressure would require some degree of expansion if future cash flow goals are to be achieved. At the present time, both LCC and ATC

quality which is not up to the standards of ATC and LCC, and also in numerous outages for those customers who reside at the extremities of the systems' plant.

The layout of the system as it exists today is illustrated in Figure 1.

LCC has made a very large investment in its microwave network, and it is desirable that this investment be preserved during the expansion of the system. There are no significant problems in this area of the country with rain fades, and the equipment has proven to be quite reliable. In addition, there are several crossings of rivers and major highways which would be very costly if some form of cable transportation were used. For these reasons, LCC has chosen to expand the capacity of the microwave system, rather than replace it with some other form of transportation system.

Lake City Schematic

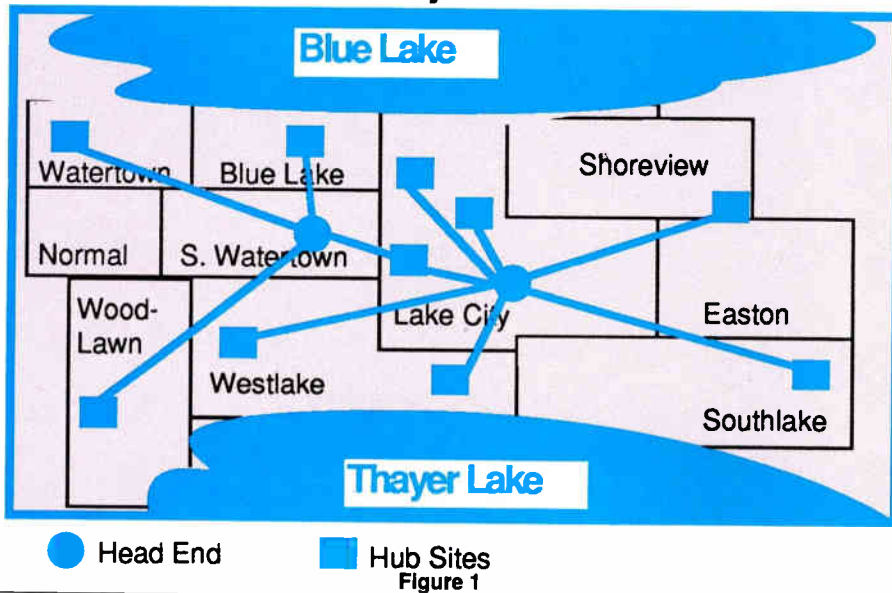

Figure 1

Operating statistics

The LCC system currently operates with the subscriber numbers and statistics shown in Table 1.

Lake City Cablevision Current Operating Statistics

Passings	.285,000
Basic subs	.170,000
Addl. outlets	.35,000
Pay units	.155,000
Plant miles	.3,000

Table 1

System objectives

By reviewing the existing conditions in the LCC system, shown in Table 2, and comparing the results to the goals of LCC and ATC, we can identify several areas where improvements will be necessary.

If we are to offer additional revenue producing services in the future, we will need to expand the bandwidth of the plant. In addition, LCC is quite certain that additional channel capacity will be required as a condition of franchise renewal.

Technical statistics

The existing network of microwave and coaxial plant in the LCC system

In order to determine what course of action is appropriate for Lake City, we must first evaluate the existing situation.

Situation analysis

The franchises for Lake City and a majority of the surrounding systems need to be renewed over the next three years. While LCC has generally enjoyed a favorable relationship with the local franchising and regulatory authorities, it is anticipated that the renewal process will result in a requirement to expand the capacity of the system to 550 MHz, or 77 channels. This assump-

By James Chiddix, Senior Vice President of Engineering and Technology, and Ronald Wolfe, National Training Center Manager, American Television and Communications

believe that expanded bandwidth will be required for carriage of high definition television within the lifetime of the franchise. Several attractive new programming services have also launched recently, and the current system bandwidth will not allow addition of these services to the lineup. For these reasons, ATC and LCC assume that it will be necessary to expand the system to 550 MHz.

Existing system architecture

The system makes use of an extensive AML microwave network to feed signals from its two headends out into the communities. In spite of this network, there are several instances where recent extensions to the plant have resulted in cascades of amplifiers exceeding 30. This results in signal

NO ONE MEASURES MORE.



✓ MORE FIBER. ✓ MORE WAYS. ✓ MORE ACCURATELY.

We're on your wavelength. On the bench or on the line. In the lab or in the field. No one offers more ways to measure fiber than Photon Kinetics.

Single or multimode. Single- or multi-fiber. On board or underwater, the long and short of it is this. The more you measure, the more we measure up.

With more innovations and automated savings. Now cable designers can take greater confidence in their innovations using our SPL-optional 2300 System.

And with an upgrade, fiber and cable manufacturers have the only way of making direct measurements of chromatic dispersion on dispersion-shifted fiber.

They can now accurately measure spectral loss in multimode fibers, too.

Cable crews and manufacturers are locating and assessing hydrogen aging in cable with our 1240nm OTDR plug-in.



And for quick turnaround to meet occasional test requirements or obtain results of the highest accuracy, we've opened a Custom Measurement Service supported by our Applications Engineers and Service Lab.

To save you even more time and money, we've automated long-term environmental testing.

What more can you expect?

Call up a menu of measurements. Ask for our Optical Fiber Measurement Sampler, a PC diskette full of test setups and application information. It's yours free.

Then you'll have even more reasons not to settle for less.

Reader Service Number 4

PK
**PHOTON
KINETICS**

4900 S.W. GRIFFITH DRIVE, 150
BEAVERTON, OR 97005 USA
TELEPHONE 503-644-1960
TELEX: 4992356
FAX: 503/641-5614

COPYRIGHT ©1988 PHOTON KINETICS, INC.

LakeCity Cablevision Existing Plant Specifications

• Longest Cascade	32TR. + 1Br. + 2L.E
• C/N	46 dB
• CTB	- 53 dB
• Cross Mod.	- 53 dB
• 2nd Order	- 60 dB
• Bandwidth	312 MHz*
• # of Headends	2
• # of Hubs	10
• Passive B/W	400
• Age of Plant	5 to 20 Yrs.

*600 Miles of plant is at 400 MHz

NOTES: Approximately 300 miles of plant is built with Dynaflex cable.

The 312 MHz plant was originally built to 270 MHz and has been previously upgraded to 37 channels.

Approximately 10% of the passives are 600 MHz. Some longer extensions do not meet the indicated plant specifications.

These and all other distortion and noise measurements referred to in this case study are made with the equipment fully loaded and with CW, synchronous carriers.

Table 2

results in the technical parameters listed in Table 2, with the noted exceptions.

Some significant amount of capital funding will be necessary to accomplish the goal of expanded bandwidth. However, we must consider that it has always been ATC's policy to investigate all available alternatives, and to determine the most economical and effective means of upgrading system plants. Our objective in this area is to utilize the capital funds which are available in the most cost effective and intelligent manner possible.

The quality of the signal delivered to some areas of the system is in need of improvement. There are several cases where the minimum technical standards established by ATC and LCC are not being met because of the cascade lengths in those areas. This has created customer dissatisfaction in some areas of the plant. In addition to the sub-standard quality of signals in those areas, there is also a high number of complete outages from failure of amplifiers and power outages.

The primary objectives for the Lake City system are listed, in order of priority, in Table 3.

System Objectives

- Increase channel capacity to 550 MHz
- Use capital funds effectively
- Allow for plant expansion
- Improve picture quality
- Increase plant reliability

Table 3

Technical alternatives

In order to effectively evaluate all of the alternatives which might be available to LCC, it is necessary to divide the project into its major parts. We will then consider all alternatives for meeting each of the objectives for each part of the project. By examining all of these alternatives we will try to determine if there is a single alternative, or some combination of solutions which meets all of our objectives in an economical manner.

The first major part of our project is the expansion of the microwave network which links the headends to the hub areas of the complex. There are few options here because of the previously mentioned river and highway crossings. There is no solution, other than expansion of the microwave system, which would not involve extensive capital expenditures.

The coaxial plant itself cannot be expanded beyond its present bandwidth without replacement of all of the active and most passive devices in the system. We can therefore determine that some form of upgrade or rebuild will be necessary to accomplish our objective of expanded bandwidth. It may be possible to expand the bandwidth of the 400 MHz plant which was acquired several years ago to 550 MHz, if feedforward and parallel hybrid technologies are utilized. But the 312 MHz plant, which has already been upgraded from 270 MHz, cannot be pushed any further without finding some way to reduce the cascades.

We also want to increase the reliability of the plant, as perceived by our customers. This can be accomplished in either of two ways, or some combination of both. The first, and most obvious method is to replace components of the system which are prone to failure. Less component failures result in fewer outages. The second method is to reduce the number of devices between the customer and the signal source. This is referred to as "perceived reliability" because components will still fail and cause outages of service, but the area affected will be reduced significantly.

Our existing tree-and-branch architecture is essentially a series circuit, meaning that if a component in the circuit fails, all components beyond that point will also experience an outage. A customer who is serviced by a cascade of 30 amplifiers will experience the same outage if any one of the 30 amplifiers fails. It appears then that we can best meet this objective of

improving reliability by finding some method by which the cascade of amplifiers to any one subscriber is reduced. Some form of trunking is the logical choice for this.

Trunking options

There are many different options by which we could provide trunked signals to small areas of the system, but there are only one of two which accomplish this without using components similar to the ones we are attempting to bypass. The logical alternatives here are the use of either microwave links, or some form of fiber optic system. Because of the high cost of microwave systems which would reduce our cascades to the point we are trying to achieve, as well as the expense of the property which would have to be acquired for each site, this is not a cost effective alternative. We can then concentrate our efforts on determining the best method of meeting our objective using fiber optic trunking.

Fiber optic trunk options

Digital. The use of digitized video over the fiber optic trunks would provide exceptional quality of signals at each of the tie-in locations. However, the bandwidth required for this approach, as well as the cost of the analog-to-digital and corresponding digital-to-analog converters would result in a very costly network. We will eliminate the use of digital fiber optic trunks for these reasons.

Frequency modulation. FM trunks would also provide an acceptable level of signal quality at the output of the trunks. However, this method suffers from the same cost considerations as the digital systems. Each channel would need to be frequency modulated at the front end of the link, then converted to amplitude modulation at the output. Although bandwidth is not a consideration for this application, we have eliminated FM fiber optic trunking as an option based on its cost.

Amplitude modulation. This is undoubtedly the most attractive of the options available because no modulation conversion of the signals is necessary at either end of the link. This significantly reduces the cost of the trunking system. The major obstacle to the use of this technology lies in the fact that it is a new technology, and devices are relatively expensive, and they are generally adaptations of devices designed for some other form of

COMM/SCOPE. THE CHOICE IN CABLE.

Comm/Scope, the company you've come to know as the world's largest supplier of coaxial cable, introduces new Optical Reach fiber optic cable to the CATV industry.

New Optical Reach provides you with the same exceptional quality, reliability and service you expect with other Comm/Scope products.

Physically, Optical Reach uses loose-tube buffer construction. It is available in configurations of up to 72 fibers and custom designs can be developed.

In addition, we've made training and installation available to you and your staff. So you'll be getting a great new product and Comm/Scope know-how. Both of which ensure that technology is employed to your greatest advantage.

For more information on Optical Reach, or our coaxial products, just call 800/982-1708 or 800/222-6808 in NC.

COMM/SCOPE. WITH YOU ALL THE WAY.

Comm/Scope Division, General Instrument Corporation, PO Box 1729, Hickory, NC 28603, 800/982-1708 (800/222-6808 in NC), Telex: 802-166



New
Optical
Reach



GENERAL
INSTRUMENT

Coaxial
Cable

modulation. This limits the distance of our links, as well as the number of amplifiers we can cascade after the link.

Several studies of cascades after the optical link have been performed, and the results have indicated that the optimum cascade lies between four and eight. An analysis of the existing system components, combined with the characteristics of the optical link, indicates that the maximum allowable cascade for Lake City, which still meets our specified performance criteria, is four amplifiers.

This was determined by use of a computerized spreadsheet which analyzes all of the accumulated distortions and noise in a network which contains different types of components. Since we know what the distortion and noise contributions from each of the different portions of the network are, with the exception of the coaxial plant, and since we know the contribution of each station in the coax network, we can simply adjust the cascade of trunk amplifiers until we reach the point where we can no longer meet the required performance criteria. As illustrated in Table 4, we can see that when we exceed four trunk amplifiers in cascade, we fail to meet our minimum performance specifications.

While this limit of four amplifiers in cascade may seem as though it would generate a tremendous investment in

bone architecture is illustrated in Figure 2 and is referred to as Option 1. An alternative approach is also illustrated in Figure 2 and referred to as Option 2. In Option 2, the amplifiers are not reversed, but are left feeding in the original direction of the pre-

backbone systems, as illustrated in Table 4.

An interesting benefit of the fiber optic backbone system is that reliability is also improved as far as any individual customer is concerned because many of the active devices which are subject to failure have been removed from the processing chain. Because each optical link feeds only a small area (about 150 to 200 customers), the catastrophic system outages experienced in the past are virtually eliminated. Consequently we are better able to respond to failures of components because our switchboards are not tied up by hundreds or thousands of customers trying to get through at the same time.

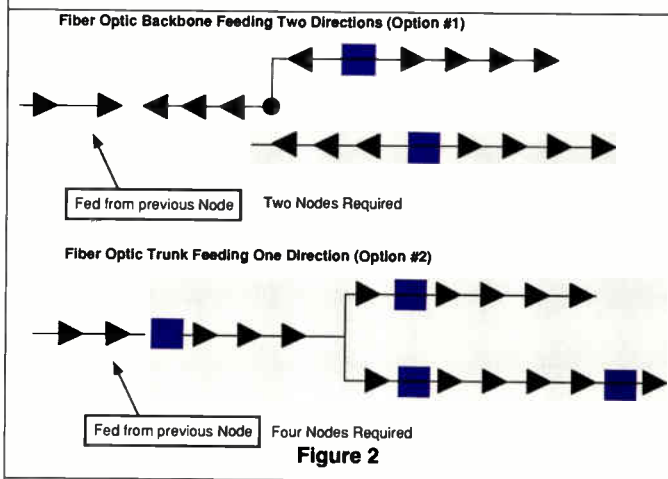

existing system trunk. If we assume that the performance of all nodes is the same, then it is clear that either of the two options provides the same performance to the subscriber because the cascades of trunk amplifiers are the same.

The main difference between these two approaches is that by feeding in both directions, we reduce the number of nodes required to half of that re-

thousands of customers trying to get through at the same time.

Although the fiber backbone does not eliminate the need to expand the capacity of the existing coaxial plant, it does aid in the process in a significant way. Because the cascades of amplifiers are reduced to four from numbers in excess of 30, the inherent accumulation of distortions and noise is also limited. Knowing this, we can push RF amplifiers beyond the operating parameters to which we are accustomed to and still achieve satisfactory performance.

In many cases it is possible to perform a drop-in upgrade whereby only the electronics in the system are replaced to achieve high bandwidth. This is significantly less expensive than replacing every system component, and respacing amplifiers to operate at the new bandwidth, as in the case of a total system rebuild.

The backbone approach also allows relatively easy expansion of the plant to provide service to new growth areas. Extra fibers are placed out to the extremities, and when the growth exceeds the ability of the preceding four-amplifier cascade to feed it, a new node location can be spliced in and a new cascade started.

The only limitation to this approach is that the length of the fiber run cannot exceed the loss budget of the laser and detector without a loss of performance. These loss budgets are improving rapidly, and when demand for optical electronics reaches a point

ATC Minimum Specifications for Fiber Optic Backbone Systems

Parameter	Minimum Specification		Actual Performance		
	With backbone	Without backbone	With 3 amps	With 4 amps	With 5 amps
Carrier to Noise Ratio	49 dB	46 dB	49 dB	49 dB	48 dB*
Composite Triple Beat	-53 dB	-53 dB	-53 dB	-53 dB	-52 dB*
Cross Modulation	-53 dB	-53 dB	-54 dB	-53 dB	-53 dB
Composite Second Order	-55 dB	-55 dB	-61 dB	-60 dB	-60 dB*

*These items do not meet standards

Table 4

NOTE: The above table represents the specifications required at the customer's television receiver, excluding the contributions from any set top converters or other consumer electronics devices. It includes the contributions of the headend, microwave system, the fiber optic link electronics, and any trunk, bridge or line extender amplifiers prior to that point.

optical electronics, it is possible to minimize the capital outlay by using an architecture which has come to be referred to as the fiber optic "backbone." In this configuration, amplifiers are cascaded in both forward and reverse directions from the location of the optical receiver, referred to as the node location.

An example of this fiber optic back-

quired for a fiber optic trunk feeding only one direction. By utilizing an approach such as backbone Option 1, we accomplish several of our initial objectives.

The signal quality is improved because the performance of the fiber optic link is superior to the cascade of amplifiers it is replacing. ATC has set standards for performance of fiber optic

OTDR NO-FAULT INSURANCE

THAT YOU WON'T MIND CARRYING

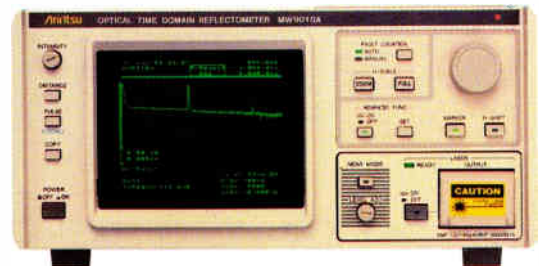

The Anritsu MW9010A gives you fast, automatic fault location, in a compact, light weight, medium range OTDR. Faults can be found automatically on the MW9010A by simply setting the threshold level and depressing one button. This low cost OTDR features 12 advanced functions, 64 internal memory storage, batch averaging, exclusive NEAR mode for 30m dead zone, and a selection of three plug-in modules for 1.3, 1.55 and 1.3/1.55 μm applications. The MW9010A's light weight (under 20 pounds), makes it ideal for on-site field inspections of optical cable.

The Anritsu MW9010A...all the coverage you need for fast, accurate fault location. For details or a demo contact: Anritsu America, Inc., 15 Thornton Road, Oakland, NJ 07436, 201-337-1111 (in NJ) or 800-255-7234. Fax: 201-337-1033.

Anritsu

Reader Service Number 6

in the cable television industry that development of new products is economically feasible, there will undoubtedly be new and better links available which extend the reach of the backbone system. The new links can be put into the system without the need to replace the fiber. This is as simple as making a splice at each end and installing the new electronics.

Selection of alternatives

Now that a decision has been made to proceed with the upgrade of the plant and implementation of a fiber trunking architecture, it is necessary to determine the best possible method by which to proceed with the project. The objective is to achieve the greatest possible degree of improvement with the least amount of capital expenditure, given the budget schedule of the project. There will obviously be some exceptions to this approach as it is easier to do some phases totally once they are started.

The most obvious place where the performance of the system can be improved with a minimal outlay of capital is by running the longer fiber links first. These links provide relief from outages and improved picture quality in those areas of the system where they are most needed. When planning the installation of these links, it is important to accommodate the shorter links which lie between the headend and the extremities. This is particularly important in the process of planning a fiber count for each of the fiber cables.

Powering

Because new amplifiers will be installed in the existing locations, and those new amplifiers will have different power consumption rates than the existing stations, system powering must be carefully examined. Power supplies will most likely need to be relocated and in some cases new supplies installed or existing ones removed to take advantage of the new, higher efficiency supplies. Because the new network will conform more closely to the power grid system, we may want to reconsider the

Project Cost Comparison (\$000's)

	Complete System Rebuild	Backbone and Upgrade Option 1	Backbone and Upgrade Option 2
Plant Upgrade/Rebuild Cost	\$51,120	\$19,320	\$19,320
Fiber Cable Cost		393	707
Construction Cost		792	1,108
Optical Electronics Cost		5,250	10,500
Total Project Cost	\$51,120	\$25,755	\$31,635

Table 4

need for standby powering. If we are serving a small area, and power is lost, the chances are now much higher that any customers in this area will be experiencing a power outage as well, making the need for standby powering questionable. Since we no longer have the long trunk runs which existed previously, we will no longer experience massive outages due to power failures at the front end of the system.

Fiber routing

Often there is a tendency to assume that because we are supplementing the trunk system with the fiber backbone, it is most logical to follow the existing trunk routes with our fiber cables. This is untrue for several reasons.

It is far easier to overlash a new cable over a small bundle which contains one or two feeders than it is to do the same for a main trunk run which may already have four or five cables lashed in. By following feeder routes as opposed to trunk routes, we can work with smaller cable bundles.

In addition to being physically larger bundles, our trunk runs often have a tendency to follow major thoroughfares in the system. This was necessary due to the need to have access to the amplifier stations for periodic maintenance. Because the only portions of our fiber runs which will require this maintenance are at the front and back ends of the run, the routing of the fiber connecting these two points is not critical. It may be possible to find a route which is not only shorter than the trunk run, but is also much less likely to be damaged by automobile accidents.

If we elect to follow feeder cable routes, it is much more likely that the fiber cables will be located in rear easements when they exist. Because there is less pole traffic in these locations we are less likely to incur damage from other utility personnel

climbing and working around the equipment.

The obvious downside to selecting rear easement routing is that repairs are more difficult to perform, although this is probably outweighed by the aforementioned advantages.

Coaxial plant considerations

Knowing that we wish the new coaxial plant to perform to an upper frequency limit of 550 MHz allows us to calculate the new amplifier spacings to determine the approximate gain requirements for the new electronics. By doing this we arrive at a new spacing of 28 dB for the trunk stations. This is probably an overly conservative estimate as most of the trunk spans will contain some type of passive devices which do not have as significant an increase in loss at higher frequencies.

The spacing of the amplifiers at the new frequency is important because we want to preserve the existing trunk station locations if possible. By maintaining the existing locations, we eliminate the need to relocate trunk stations, which in many cases have been situated for easy access, and we also eliminate the need to install undesired splices in our trunk cable.

All line extenders will also need to be replaced, and their new gain requirements have been calculated to be in excess of the rated gain of any currently available. Although this presents an obstacle, it is not one which cannot be overcome.

Because we are now dealing with shorter trunk cascades, we can increase the maximum allowable number of line extenders from the current two to three. By respacing the existing line extenders and adding a third, we calculate that we will be able to reach the ends of even the longest feeder runs. We will be aided in this process by the fact that today's new generations of passive equipment have less loss than their predecessors.

There are some portions of the plant which contain old Dynafoam cable which must be replaced as part of the upgrade. This is confined to the feeder system, and consists of approximately 300 miles of plant. Since we are replacing all of the active and passive equipment, as well as the cable, it would be easy to rebuild this 300 miles.

While we have considered this, the local utility companies have denied any request we have made regarding temporary violations, and there is

WESTEC

Microwave

Manufacturing

Modification

Repair

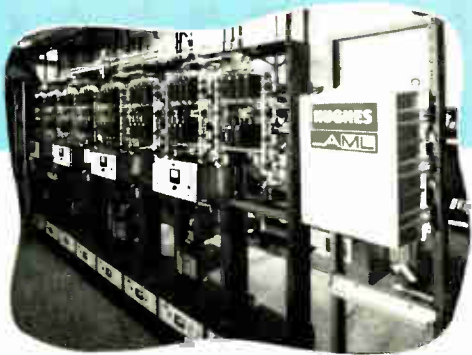

We have enlarged our AML Service operation to include all major AML system requirements at a reasonable cost. Since starting to refurbish solid state sources six years ago, we now provide the services shown below, and then some! Currently we are supplying all the modifications to convert AML systems to 450 MHz Bandwidth. Call Westec for responsive answers to your service problems.

*Bob O'Hara, President
Westec Communications, Inc.*

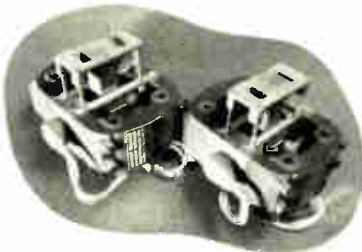

- SOLID STATE SOURCES
- UP CONVERTERS
- TRANSMITTERS
- RECEIVERS
- REBUILT KLYSTRONS
- KLYSTRON & OTHER POWER SUPPLIES



**PHASE LOCK MODS
FOR
INDOOR & OUTDOOR
RECEIVERS**

© Registered Trademark of Hughes Aircraft Co.



WESTEC COMMUNICATIONS, INC.

14405 N. Scottsdale Road, Scottsdale, Arizona 85254
(602) 948-4484 FAX: (602) 998-8701
Microwave Service (800) 666-4441

Be sure to contact us for information on our analog and digital video transport equipment for CATV.

THE PARTNERSHIP THAT WORKS

RELIABILITY Sumitomo Electric, a leader in communication cables for over 90 years, is a recognized manufacturer of quality optical fiber cables.

SERVICE We provide engineering services, contract splicing, training and project supervision. Additionally, we manufacture an integrated line of ancillary equipment including fusion splicing systems.

"Reliability for Today
Creativity for Tomorrow"



Our dedicated people and state-of-the-art facilities assure the latest technological and best quality products.



Our construction group is capable of handling installation in any environment.



Fiber coating provides colors for easy identification.

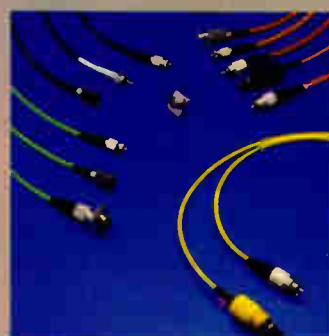

We manufacture a complete line of interconnection cables and connectors.

 **Sumitomo Electric**
Sumitomo Electric Fiber Optics Corp.

SEFOC is a Member of the
Sumitomo Electric Industries, Ltd. Group

Reader Service Number 8

78 Alexander Dr.
P.O. Box 13445
Research Triangle Park, N.C. 27709
(919) 541-8100
800-358-7378

FO IMPLEMENTATION

insufficient space on most of the poles for a second strand. For this reason, we have decided to do what is referred to as an overlash rebuild, where everything except the strand is replaced.

The new cable is lashed over the old, and after the new electronics are spliced in, all loops are cut out of the old cable and it is trimmed back as far as the lashing wire clamps. This allows us to build an acceptable looking new plant without having to remove the old.

New network topology

We have now made most of the critical decisions regarding what our new cable network will look like when we have completed the project. The headends will be preserved, and the microwave system will be expanded to feed 550 MHz of bandwidth to the existing hub sites. From the hub sites we will run fiber, using broadband VSB-AM modulation to the various node points which are located to limit the cascades to four amplifiers in both directions from the node. The feeders will be upgraded by respacing and replacing all of the components except those taps and passives which are already capable of 550 MHz operation. Those components which are 550 MHz capable will be reconfigured by changing the face plates when possible.

What we have built is a star network from the headends to the hubs. This network of hubs is connected to the coaxial plant by another star network consisting of the fiber optic links, which in turn feed the newly upgraded or rebuilt coaxial tree-and-branch network. Although quite different from the networks we are accustomed to, this is not an unmanageable configuration.

Project cost

Obviously, cost is an important factor in the process of selecting an alternative. It has been held out of the discussion until this point to allow for the evaluation the various approaches on their technical merits alone.

Table 5 shows the costs associated with the various options which were considered for Lake City. Those alternatives which were eliminated for technical reasons have not been included. The remaining options include a complete rebuild of the system, and two different configurations of hybrid networks containing microwave, fiber optics and coaxial plant.

Fiber Option 1 is the conventional

The World Communicates Better
Through Reliable Products.SM



Outside Plant Fiber Optic Cabinet

Reliable's new OPFO fiber optic cabinets are the best way to securely store optical fiber splice closures and slack cable.

Because they are above ground cabinets, the large capacity OPFO series can provide easy access to most splice closures on the market today.

OPFO cabinets' hinged front doors use built-in positive action three-point locks to prevent unauthorized entry. And, the OPFO series is available in pole mount and pedestal models to meet various installation requirements.

With 80 years of telecommunications know-how backing every Reliable product, you can be sure that the durable OPFO (which is made using Reliable's unique nine-step finishing process) will store splices while it picks up the slack for years to come!

Call Reliable today at **312-455-8010** for more information on the OPFO enclosures as well as other fiber optic products.

Reliable Electric/Utility Products

Reader Service Number 9

11333 Addison Street, Franklin Park, IL 60131 (312) 455-8010, Telex: 72-8393

**RELIANCE
COMM/TEC**

"Deliver 40 channels with 60dB C/N over 32 kilometers now. No more waiting."

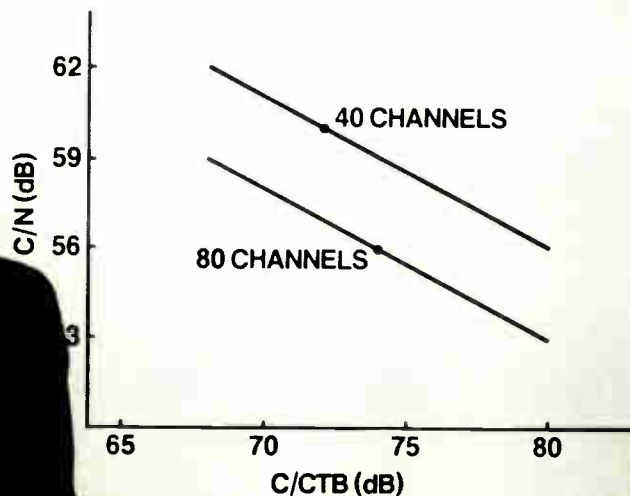

CATV operators can have tomorrow's quality today.

This "new" AML system teams high power solid-state SSTX-145 transmitters with the high performance 550 MHz compact outdoor COR series receiving hubs to deliver the highest signal quality of any AM-modulated transmission system on the market today.

Pass the quality on to your subscribers by locating inexpensive AML receiving hubs throughout the service area, and keep the cascades short. At the same time you gain the system design flexibility, operations dependability and cost-effectiveness you've come to expect from Hughes AML.

Clustering and regional networking have never been easier or more cost-effective. You don't have to sacrifice transmission distance to get a high quality signal. And you can jump immediately to high-density subscriber areas without costly and time consuming construction through marginal revenue areas.

For more information, contact Hughes Aircraft Company, Microwave Communications Products toll free: (800) 227-7359, ext. 6233. In California: (213) 517-6233. In Canada: COMLINK Systems Inc., Pickering, Ontario, (416) 831-8282.

Hughes AML is more than hardware.

HUGHES

FO IMPLEMENTATION

fiber backbone approach originally conceived at ATC, whereby the node locations feed broadband RF signals in both the forward and reverse directions.

Option 2 is the use of a similar approach with the exception that the trunks are fed in only one direction from the node. This allows the existing coaxial plant to provide a backup to the fiber optic system, by utilizing a sensing switch in each node location which switches back to the original coaxial feed if the optical link is lost for some reason.

(The costs above do not include the funds to increase the capacity of the microwave system, nor do they include

Plant costs for this analysis were derived from ATC's prior experience...

new converters or any other unrelated costs. These items were left out of the analysis because they will be essentially constant between all options, just as the plant upgrade cost is constant between Options 1 and 2. There are undoubtedly going to be some minor differences, but they will not be of sufficient magnitude to change the economics of the options dealt with in this case study.)

Plant costs for this analysis were derived from ATC's prior experience with projects of a similar nature, and may vary in other systems based on configurations of plant and slight differences in procedures.

The costs indicated for the total rebuild option assume a cost for the total rebuild of the 2,400 miles of 312 MHz plant at \$20,000 per mile, and an upgrade cost of \$5,200 per mile for the 600 miles of 400 MHz plant.

The plant upgrade costs associated with the fiber optic options 1 and 2 assume 300 miles of overlash rebuild for the Dynafoam cable sections at \$12,000 per mile, 600 miles of upgrade from 400 MHz to 550 MHz at \$5,200 per mile and 2,100 miles of upgrade from 312 MHz to 550 MHz at \$6,000 per mile.

The fiber optic backbone implementation costs are based on a fiber cost of 6 cents per fiber-foot, an overlash construction cost of 50 cents per route foot, and a node cost of \$15,000 for the

The World Communicates Better Through Reliable Products.SM



Central Office Fiber Interconnection Equipment

Reliable's COFO series are new easy-to-access fiber optic interconnect enclosures designed for the central office.

Four entry ports allow cable to be laid in place and retained even when the door (available in clear plexi or metal) is open.

Fitting in any 19" or 23" rack, the compact COFO enclosures accept all standard connector types and have been designed for high connector density.

With 80 years of telecommunications know-how backing every Reliable product, you can be sure that the durable COFO will make fiber connection (or splicing!) a snap in your frame room for years to come.

Call Reliable today at **312-455-8010** for more information on the COFO series of enclosures as well as other fiber optic products.

Reliable Electric/Utility Products

Reader Service Number 11

RELIANCE
COMM/TEC

11333 Addison Street, Franklin Park, IL 60131 (312) 455-8010, Telex: 72-8393

transmitter and receiver pair.

The differences in the cost of the fiber cable between options 1 and 2 are not pure doubles as might be expected. This is because there is a considerable amount of route duplication when running fiber to the various nodes.

This duplication means that even though we are increasing the number of nodes by a factor of two, we can expect that we are already covering most of the routes the fiber would take, resulting in a smaller incremental construction cost than expected.

Fiber cable costs also increase by a factor of less than two since we are able to make slightly more efficient use of spare fibers in this configuration. These differences could vary quite significantly from one system to another. In this case we have determined that the fiber route miles, and consequently construction costs, will increase by 40 percent, and that fiber miles, and consequently fiber cable cost, will increase by 80 percent.

In the case of the fiber optic backbone, the nodes serve an average of 13 miles of plant. In the second option, where we are feeding in the forward direction only, each node serves 6½ miles of plant.

Staff and training considerations

Between the present time and the actual implementation of the project, training needs of the staff relative to fiber optics technology should be evaluated. The existing staff has a limited knowledge of fiber, except at the higher levels of engineering management. This will not be sufficient in the future unless a manager is to be called upon each time there is some problem with one of the links. As there will be approximately 175 links at the end of the project, this is impractical.

The required training is available through several sources, including ATC's National Training Center, which offers two seminars on the topic. In addition, the contracts which are eventually signed with various vendors to provide electronics will contain provisions for on-site training.

Test equipment and spares

When budgeting capital funds for

Lake City Cablevision Capital Cost Comparisons

	Using Two Fibers for 550 MHz	Using Single Fiber for 550 MHz
Complete Rebuild	\$51,120,000	\$51,120,000
Fiber Option 1	\$25,755,000	\$23,016,000
Fiber Option 2	\$31,635,000	\$26,180,000

The above costs reflect plant cost only.

this project we will need to allow a significant amount of capital for acquisition of new test equipment. If we elect to equip all qualified technicians with the necessary equipment to maintain and repair the network, this expenditure could be several hundred thousand dollars.

A more economical option would be to establish one or more emergency repair and maintenance kits which would contain all necessary equipment such as test sets and splicing materials, and to locate those kits at some central locations, such as the headends. The system will also need to acquire at least one OTDR and a fusion splicer, as well as several spare transmit and receive pairs.

Our experience thus far with regard

to reliability of fiber optic components indicates that an inventory of two or three transmitters and the same number of receivers will be adequate to ensure that any component failures can be repaired in a timely manner.

Summary

Lake City Cablevision has decided, with assistance from ATC corporate staff to proceed with the construction of the fiber optic backbone network described in this case study.

This project promises to be interesting for Lake City and ATC for several

reasons. It is the first full implementation of the fiber backbone architecture on a systemwide basis. In addition, it differs from most backbone proposals in that the existing microwave system is being preserved and expanded.

It is hoped that advancements in the area of AM fiber technology will allow for construction of the system using a single fiber to each of the nodes, and in this event, the node costs would be cut in half and the fiber cable cost would reduce by about 40 percent. The reason that cable cost does not experience a 50 percent reduction is that we are able to make more efficient use of spare fibers in the dual-fiber scenario.

Looking at the total project, the cost per mile to complete this project is approximately \$8,585. This is a very promising, particularly when one considers that the rebuild cost for this system is over \$17,000 per mile, even when considering that 20 percent of the plant can be upgraded.

ATC continues to be optimistic about the positive impact that the use of fiber optic technology will have on our operations, not only in the form of capital cost reductions, but in improved quality, extended bandwidth, reduction of outages and network simplification. ■

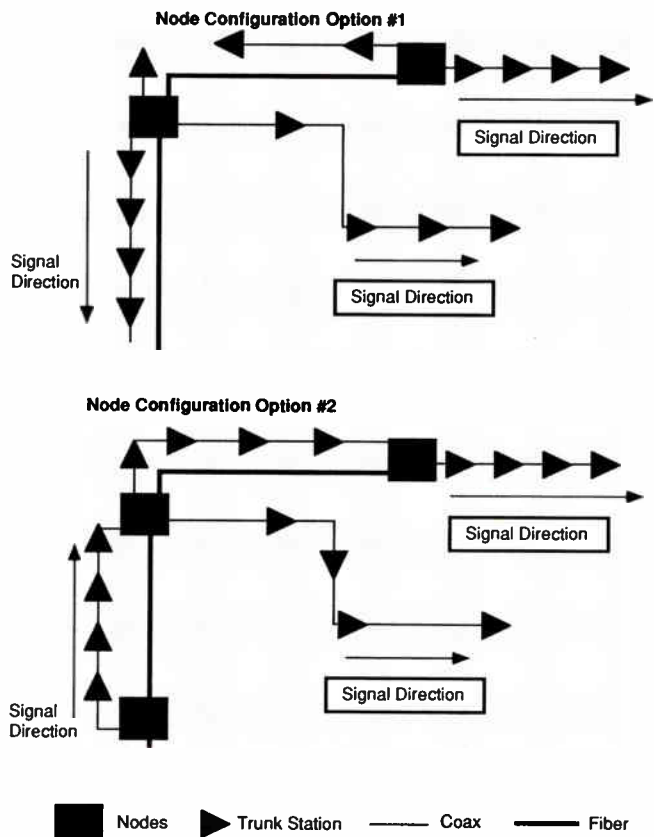

HEADENDS AND FIBER OPTICS: WE'RE TYING IT ALL TOGETHER.

When you think of the headend, think Magnavox. Not only do we supply the best line of components in the industry, but we also supply the headend. Modulators. Demodulators. Even antennas and satellite receivers. We can supply all your headend equipment and even provide professional design assistance to bring it all together.

Our headend commitment doesn't stop there. We're currently designing AM and FM transmissions that incorporate the latest in fiber optic and broadband technology. These are system components that will be found in the cable plants of tomorrow.

To find out more about this marriage of headends and fiber optics, contact your Magnavox representative. We'll show you how it's all tied together.

MAGNAVOX

CATV SYSTEMS CO.

100 Fairgrounds Drive,
Manlius, NY 13104

Call 1-800-448-5171
(In New York 1-800-522-7464)
(315) 682-9105 Fax: (315) 682-9006

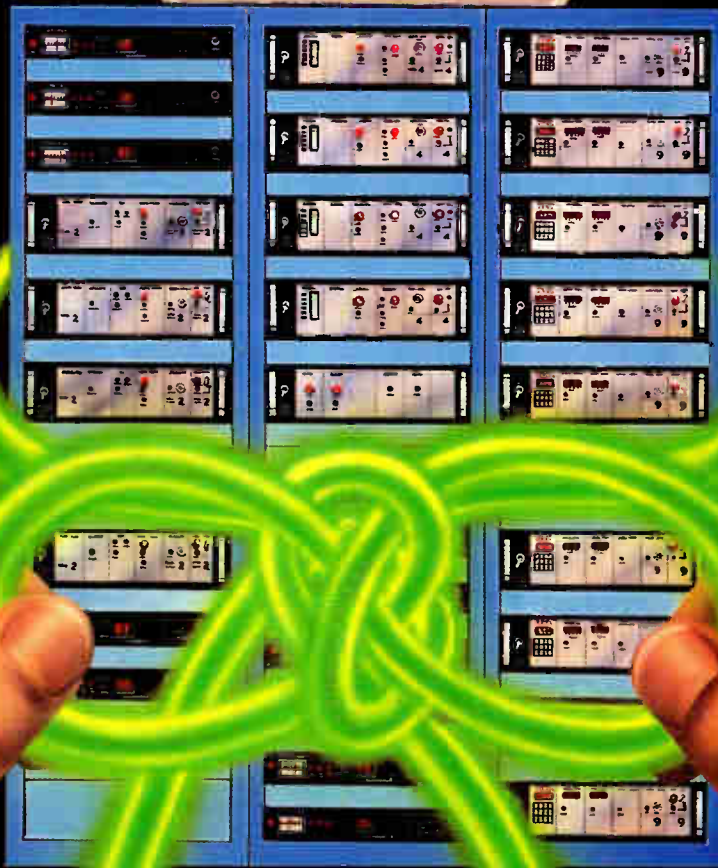

How is fiber optics being used in today's systems?

Years of hope, hype and hard-nosed development have paid off for the fiber optic distribution and transport equipment manufacturers. Fiber is being used increasingly in today's cable television operating systems for various applications, and by all indications its feasibility and profitability has been demonstrated in many ways.

Certain fiber optic applications in operating cable systems have become almost commonplace. Fiber links are operating or are planned for such applications as linking headends, linking headends with remote hubs, transport from satellite earthstation downlinks to headends, replacement of interference-prone microwave paths, not to mention fiber backbone trunks and distribution point-to-multipoint systems to reduce amplifier cascades, improve performance, facilitate future channel additions, and/or eliminate interference.

Fiber optics have been proven to improve carrier-to-noise (C/N) figures and picture quality while reducing maintenance costs. But another benefit is improvement of a system's overall Cumulative Leakage Index (CLI) since there is no egress of lightwave signals.

Comparable costs

The equipment and installation costs of a fiber optic system, when compared to the costs of traditional coaxial solutions, may be about the same or higher. But when overall costs, including maintenance costs over time, are computed, fiber is, more often than not, less expensive. By reducing amplifier cascades, you reduce the costs of maintaining distribution electronics and greatly improve the cumulative failure rates of such equipment. And, with the elimination of interference, improved C/N and composite triple beat (CTB), the system's performance translates to improved picture quality, and that spells improved subscriber satisfaction and perceived value of service.

"The construction costs are going to be very similar (to coax)," advises Robert Lonn, system engineer at Cox

Cable's San Diego system. Fiber takes a little bit more care and fiber optic cable costs a bit more than conventional coaxial cable. But then the fiber optic FM equipment is less costly than the standard coaxial electronics because less is needed. "But realistically, we are talking comparable costs. It's not significant enough to where you should be building coaxial supertrunks and not building fiber optic," concludes Lonn.

Tom Stanniec at the corporate engineering offices of Newchannels, who is working with Magnavox engineers on a design study at the Newchannels system in Syracuse, New York, has come up with a unique analytical approach to determining at what bandwidth figure it makes sense to implement fiber. The result? Fiber builds make sense at a frequency above 500 MHz.

One factor that led to this was the objective of delivering a signal of equal quality to every home in the system. Below 500 MHz, advanced coaxial amplifier technology will meet specs, provided that shortening cascades to reduce maintenance costs on amplifiers is not an overriding consideration. In some locations, such as where lightning strikes can take out amplifiers, shortening amplifier cascades can be very important. According to Stanniec, at above 500 MHz, a cascade of 16 amplifiers out of the headend to the first fiber node is all that is necessary to meet uniform distribution quality specifications.

Another more intangible benefit of a fiber installation is the experience gained by a system's engineers and technicians. Also, system operators can rely upon the wealth of experience with fiber optics that has accumulated within the industry's engineering community, equipment vendors and construction contractors when a fiber optic installation is planned.

Construction and maintenance techniques with fiber optics is constantly improving as industry experience builds up. A case in point is the experience Cox San Diego had with fiber splicing. "When we decided to build our system there was still a lot of controversy in

the industry about enhanced rotary mechanical splices and fusion splices," Lonn says. "It was my decision as system engineer to install seven lines fusion spliced and five lines enhanced rotary mechanical." Lonn took this course because it hasn't been decided which splicing technique is the best choice.

Jury still out

"I think the jury is out on the whole issue of splicing. We want to try a variety of splicing techniques and watch and evaluate these techniques over a period of time. We encourage other systems to do the same. Don't think that you can make a blanket statement that fusion is better than rotary mechanical or vice versa," Lonn asserts.

At the present time, Cox Cable San Diego's AM Laser Link (built by Anixter) is operating through the enhanced rotary mechanically spliced lines. That happens to be the splicing that has had the least loss and the best overall performance.

For Russ Bottjer, technical operations manager for Dimension Cable of Vista, California, a Times Mirror system, fusion splicing is the technique of choice. But he uses rotary mechanical splicing as a repair technique in case of failures or the compromise of the fiber optic system.

"We feel that rotary mechanical splices do work," says Lonn, "and it is probably one of the easiest ways to splice cables back together in the field under some of the worst weather conditions." Cox Cable trained five employees and are in the process of training five more to do this type of splicing.

Lonn's experience with fusion splicers has been good, but he has some reservations. "There's been some concern about fusion splicing in adverse weather conditions. If it gets to be very cold or very hot, or it's very humid out or whatever, fusion splicers can do funny things."

Stanniec at Newchannels is currently working with various manufacturers of fiber optic equipment and each prefers a different approach to splicing or connectorizing. Stanniec

By George Sell, Contributing Editor

Irregularity in the quality of fiber optic connectors means poor performance of your fiber network. Why risk it? You can't afford to use anything but the highest quality connectors: Augat FIBEROPTICS' connectors.

FIBER OPTIC CONNECTORS THAT FIT BETTER. The key to Augat's high performance and low loss in fiber cable assemblies is the unsurpassed quality and repeatability designed into our fiber optic connectors. We consistently make our connectors with precision-machined hole tolerances and concentricity of the highest

caliber for precise connector alignment. And, if you need custom-drilled connectors, look no further. We can supply you with what you need within a reasonable lead time *and* at a reasonable cost.

FIBER OPTIC CONNECTORS THAT FUNCTION BETTER.

Augat manufactures the most popular connectors used in today's network systems to maximize fiber optic performance at minimum expense. Our top-quality SMA (905 and 906 type) and Biconic connectors assure you low signal loss and maximum repeatability. Augat's unique SMT, with its metal ferrule, gives you the design and

performance of an ST[®] connector, with the ease of installation and low cost of an SMA connector. The SMT is also available with a ceramic ferrule.

FIBER OPTIC CONNECTORS THAT GIVE YOU A BETTER NETWORK. You can be assured of a better fiber optic network when you use Augat's quality connectors. For consistently good voice and data transmission over your network, specify Augat FIBEROPTICS connectors. Contact Augat Communications Group, Inc., P.O. Box 1110, Seattle, WA 98111. Call 206-932-8428.

END IRREGULARITY WITH FIBER.

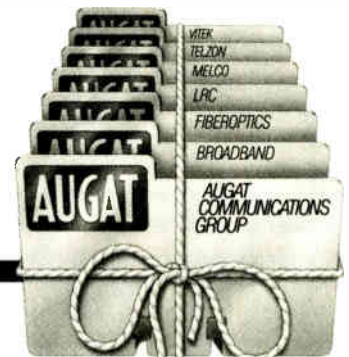
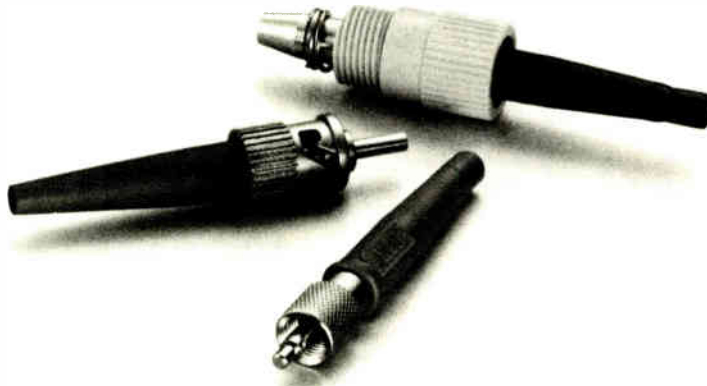

WE'RE AUGAT COMMUNICATIONS GROUP. WE TIE IT ALL TOGETHER WITH EASE.

How Reliable Are Your Repairs?

Scientific
Atlanta

Panasonic

ZENITH

PIONEER

JERROLD

- Qualified repair of Jerrold, Scientific Atlanta, Panasonic, Pioneer and Zenith converters
- Bar coded WIP Tracking
- Line equipment repair
- National repair parts distribution center for Panasonic

Reader Service Number 14

CBA
CABLE BUSINESS ASSOCIATES, INC.

A COMPANY OF THE CBLX GROUP

2446 Palm Drive • Long Beach, CA 90806

213-424-9253

1944 N. Naragansett • Chicago, IL 60639

312-237-2400

CASE STUDIES

sees trade-offs in each approach. He says, "The ones that connectorize have the most attraction for me because if I get a laser or a receiver that dies, I can change it out real easy. The rotary splice appeals to me because all I've got to do is make the connector, and if I've got a connector on there I can at least match them and get the system on line until I can make proper repairs. The fusion splice means that I've got to have some way to break that thing apart if it fails, put a new one in, and re-fuse it and that means I either have to own or lease a fusion splicer. It's not a simple question," Stanniec concludes.

Disaster preparedness

Lonn's experience leads him to make another recommendation. "I would recommend that everybody have a disaster recovery plan." Lonn put together what he feels is a very extensive disaster recovery plan. "This states that if your fiber optic cable is compromised, you have a plan in place that gives everybody specific instructions on not only what to do but how to do it, and where all the equipment is.

"With fusion splicing, one guy can sit down with a fusion splicer and do it all," Lonn adds. "But if you've got a critical situation where your fiber has been compromised and you have your \$30,000 fusion splicer, what happens if you get out there and turn it on and it doesn't work because maybe the battery went bad or a fuse blew? One of the things about rotary mechanical splicing is that it is all mechanical. And you don't have to rely on one single expensive piece of electronic equipment to get your system back on. With fusion splicers you've got all your eggs in one basket; with rotary mechanical splicers you've got the ability to have two or three people doing splicing all at the same time in different locations."

Bottjer would agree with that. In an emergency repair situation, Bottjer prefers the speed with which rotary splicing can be done but has found that there is less optical loss with fusion splicing.

Fiber optics treats a signal (and an operator's budget) kinder and gentler. And systems everywhere are looking for ways to apply it. "The message that I would like to get out to the industry," says Lonn, "is that it is only (limited by) how one uses their imagination on the many things that they can do." Different situations and conditions require different applications. But there are many ways in which fiber

optics can improve upon the results one obtains with traditional coaxial cable.

Fiber optic case studies

In the following sections, snapshots of field applications of fiber optics are shown, along with comparisons of alternative coaxial solutions. Information was supplied by engineers at the systems profiled.

Cable system: Cox Cable, San Diego, Calif.

MSO affiliation: Cox Cable

FO equipment supplier: Turnkey system supplied by Anixter Cable TV, AT&T and Synchronous Communications. Installation construction by AT&T crews.

Objective: Replace three FM supertrunk links from satellite earthstation site to AML microwave mountain top pick-up point due to aging of coaxial cable and electronics, and reliability problems. Also, the existing three supertrunks were at maximum capacity and a planned channel expansion to 450 MHz was required for growth.

Traditional alternatives: Replace existing FM supertrunk links with state-of-the-art coaxial cable and feedforward electronics. The cost for either a rebuild with coaxial or fiber optics is similar but the reduction of maintenance costs and improvement of signal quality and capacity favors the fiber optic approach in this application.

FO application: An FM fiber optic link between the satellite earthstation site and a mountain top pick-up point was installed (see "Other Projects" below). That pick-up point receives a variety of signals, such as the satellite-fed signals, off-air and remote broadcast signals, and microwave reception as well as reinsertion of channels for distribution locally and via microwave to the rest of the system.

FO performance: The FM fiber link was designed to meet RS-250-B medium haul specs. From the day it was installed and activated (December 1988), it has been almost maintenance free. "We just don't worry about it anymore," says Robert Lonn, system engineer.

Unique challenges: During the installation of the FM fiber link, a major brush fire, the second in two years, occurred on the side of the mountain, burning up poles at the site. Poles had to be reset via helicopter. All satellite channels were out for nearly 24 hours for a system of over 300,000 subscribers. This led to rethinking of the

CASE STUDIES

routing up the mountain and realization of the need for redundancy for back-up in case of fire or other disasters.

Other projects: Replaced coaxial distribution system used for subscribers in community near the mountain pick-up point with an AM Laser Link fiber optic system. The 7-kilometer link allowed an elimination of 16 amplifiers from a 40 amplifier cascade and shows (worst case) specs of 54 dB C/N and -68 dB CTB.

Also, a two-way FM fiber link was installed to carry signals from the pick-up point to a studio and office site for commercial insertion and character generator channels, and then return to the pick-up point. All channels are then both inserted for local distribution and for transmission to the rest of the system via microwave.

A short link is also planned to a line-of-sight spot for transmission via microwave to the pick-up point as a redundant back-up for the two-way FM fiber link.

System: Dimension Cable of Vista, Calif.

MSO affiliation: Times Mirror

FO equipment supplier: Synchronous (electronics) and Siecor (fiber cable). Independent contractor but with fusion splicing done by cable system crews.

Objective: Replace 24-channel FM microwave transmission from satellite earthstation site to microwave transmitter. TVRO site had to be moved and there was a desire to explore fiber optic technology.

Traditional alternatives: Reinstall FM microwave transmission system from the new TVRO site with increased channel capacity.

FO application: 15-kilometer run transporting 13 FM channels per fiber on each of two fiber cables. A 16-fiber cable travels the length for future growth with the option of using that run for AM fiber distribution. If all fiber cables were dedicated to carrying signals, the channel capacity would be more than 200 channels. Fiber system activated in January 1989 and has been operating maintenance free except for one laser failure.

FO performance: Objectives have been met with specifications meeting RS-250-B short haul parameters. System's technicians learned splicing but have not had much experience with maintaining the system because it has been relatively maintenance free. "There's not a lot to be learned if it doesn't fail," says Russ Bottjer, techni-

cal operations manager.

Unique challenges: To minimize the number of splices, you try to get the longest runs that you can in the 7,000 to 8,000 foot range, which creates construction challenges, especially at freeway crossings.

Other projects: Splicing has begun on a 20-kilometer FM fiber run using the same equipment carrying the same channels from the TVRO site to the existing headend at the Oceanside main distribution system. Planning an AM fiber distribution application in 1990, but decisions have not been made as to the design or supplier.

System: Rockford Park, Ill.

MSO affiliation: Cablevision

FO equipment supplier: Times Fiber Communications

Objective: Provide a maintenance free link for local government programming transport to the headend for processing and insertion into the distribution system, and to provide training platform and demonstration of new technology within the system.

Traditional alternative: Dedicated coaxial institutional loop.

FO application: Dedicated four-fiber link for remote pickup and transport of two local government programming channels per fiber to the headend. The one-way link was activated in 1983.

FO performance: Rated: 54 dB C/N.

Unique challenges: In the original construction in 1983, fusion splicing was a problem and subsequently several splices have failed.

System: Corvallis, Oregon

MSO affiliation: Tele-Communications Inc.

FO equipment supplier: Anixter Cable TV and AT&T

Objectives: Provide a cost-effective supertrunk run 11.5 miles from headend in Corvallis to Albany. Improve picture quality for subscribers in Albany and facilitate future channel additions. With technical improvement on the supertrunk run, enable the RF system in Albany to be extended into two newbuild areas.

Traditional alternatives: Build using 1.25-inch coaxial supertrunk designs yielding a C/N figure of 46 dB.

FO application: "Laser Link" AM fiber optic link was installed with performance (guaranteed by supplier) of 55 dB C/N and -65 dB CTB based upon modulated carrier input that met or exceeded RS-250-B medium haul specs. TCI engineering determined that specs would enable objectives.

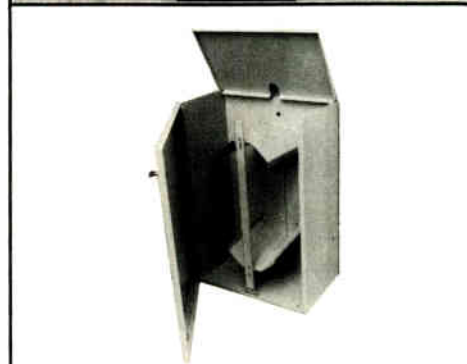
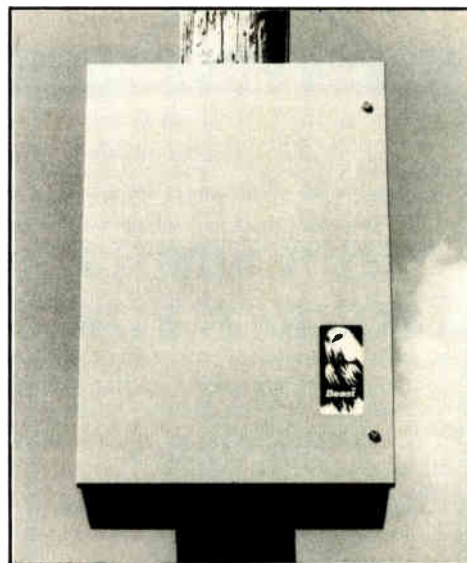

Now, The Fiber Beast

Designed exclusively for CATV use by experts in the cable communications field, The FIBER Beast™ delivers everything you need in a fiber optic cabinet.

- Easy access - Removable slack spool and top; hinged front door.
- Easy to mount.
- Large capacity - Storage for a min. 350 feet of slack fiber.
- Optional add on splice cabinet.
- Secure - Because It's a Beast™!

Call today for more information and ordering at 1-800-288-1506.



Cable Security Systems, Inc.

801 Fox Trail · P.O. Box 2796
Opelika, AL 36801
(205) 742-0050

Reader Service Number 15

Optical cable installation

Comm/Scope, Inc. has supplied optical cable to Cablevision of Central Florida and has worked closely with them during the planning and implementation stages of their fiber project. Ken and I are going to use this project as a basis for discussing ways to make an optical cable installation successful and economical.

Nelson: The system, to give you an overview, is a traditional metro CATV system using a microwave network. This network connects the headend to 12 hubs located around the metro Orlando area. This is being upgraded and replaced with an optical network which will be a routeredundant network interconnecting all the hubs and the headend. When finished later this year, it will include 150 miles of sheathed fiber cable, containing about 4,000 fiber miles. The network will be carrying all the video transport amongst the hubs plus some data and other services.

The decision early on was to overlash the fiber cable over the existing coax plant. Ken, why did you make this decision?

Carter: There are multiple reasons—make-ready costs were a major consideration as limited pole space was available here in Orlando. New construction would have meant purchas-

By Larry Nelson, Comm/Scope, Inc. and Ken Carter, Cablevision of Central Florida

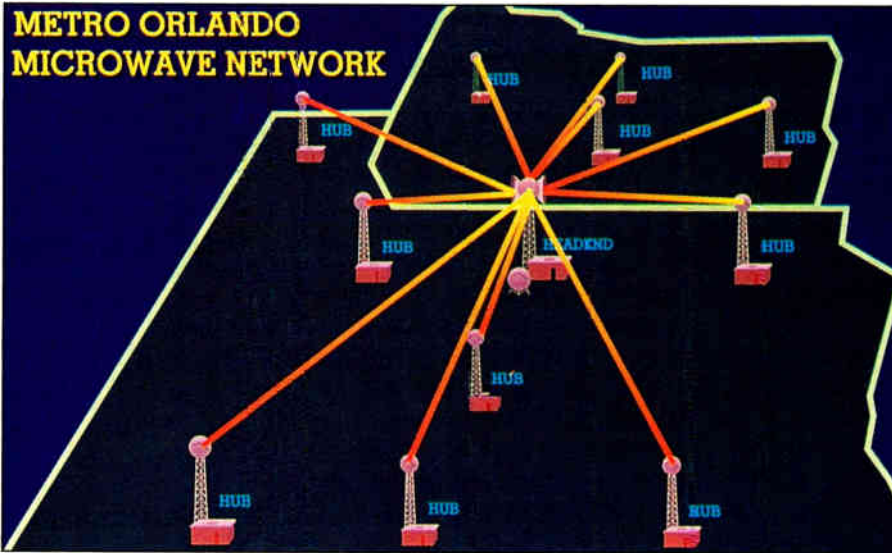

Figure 1

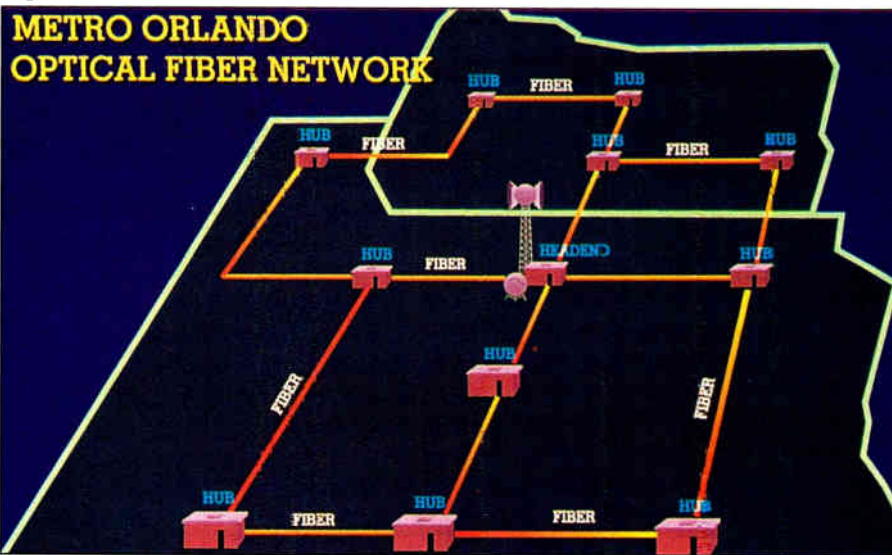

Figure 2

ing a lot of poles and paying for a lot of rearrangements. Also, in most cases separate construction means double pole attachment costs.

When overlashing it is imperative to make sure the coaxial plant is in good condition, rebuilding wherever needed. We always overlash the optical cable separately and last so it can be moved or accessed at a later date without disturbing the coax.

Nelson: Let's talk a little bit about the differences between coaxial cable and optical cable. First of all, optical cable is not semi-rigid like our trunk and distribution coax. It does not take

a set when it's bent and generally speaking optical cables are allowed smaller bend radii. Optical cables typically can be bent to a radius of 5, 6, or 7 inches where coaxial cables are typically 8, 9, 10 or even larger (for the larger sizes).

Optical cables come in long lengths—not 2,500 foot sections as you are used to for coaxial cables. You can order up to numbers like 30,000 feet per reel.

Splicing costs—the reason you want long lengths of cable is to reduce your splicing costs. The actual splice may cost you several hundred dollars per splice plus you add considerably to the loss or attenuation of your system.

When you are ordering your cable from your supplier it does not come as a commodity unit in 2,500 feet per reel. You don't order it as a bulk item. You engineer

your lengths, you engineer your fiber counts and you order your cables specifically for your installation. This impacts the order lead time. It is made to your order—so think about that in your planning.

The reel sizes and weights are quite different (See Figure 3). Optical cable, because you're getting longer lengths, come on larger reels and they weigh more. This impacts how you warehouse it and how you use it in your construction.

Ken, what are some of the things that you had to do to account to these differences?

INSTALLING FIBER OPTIC CABLE

Carter: We had to customize some trailers to facilitate the larger reels, as well as purchase a trailer with hydraulic lifts for reels that sometimes exceed 3,000 pounds.

Nelson: Let's talk about some construction techniques that are different. Ken, would you explain what slack point is?

Carter: What we do during the construction is place extra cable on the strand in a figure 8 and lash it up. The concept behind that is that the slack can be moved at a later date to another location by delashing the cable and moving it (See Figure 4).

Nelson: There are other designs of slack points. A coil of cable is one other design that some people use as opposed to the figure 8 that Ken has used here in Orlando. Ken, what are the pros and cons of these two designs?

Carter: Pulling the slack out of this coil is sometimes difficult and can lead to kinks. With the figure 8 method it falls out straight and you don't have that problem. Also, we considered going down the pole and locating the slack in a pedestal or an enclosure but then you're also increasing your exposure on the pole itself to possible damage by climbers, etc.

Nelson: Another technique that is useful in optical cable installation is figure 8'ing. Why do we need to figure 8? It's because we have to take the cable off the reel occasionally during a run. These cables come in long lengths and we encounter obstacles that we can't pass the reel trailer by, or we exceed the maximum pulling tension. If we are using pull off techniques or we are pulling through ducts or underground, we may have to take the cable off the reel, coil it up and then start over again to avoid excess tension. We do that using a figure 8 method.

Carter: At the origination point, set-up the reel (See Figure 5), pull through the obstacle, pull through your duct, you have another obstacle to go through so you figure 8, pull through that, then another figure 8, and then you have the take up reel or splice point.

In a long run of several thousand feet you may end up figure 8'ing several times. It is time consuming but is probably less time consuming and less costly than splicing.

Nelson: Another construction technique that we found useful for these long lengths of optical cable is what we call a two reel center pull (See Figure 6). This is similar to figure 8'ing. This method is used where you

can do your initial set up at or near the obstruction. We start with a full reel of cable on the left and we pull several thousand feet of cable across the obstruction on to a take-up reel and then you have a normal drive off construction in either direction. Again, the objective of all these construction techniques is to facilitate the use of the drive off construction technique because that's going to make your construction costs minimal and speed up

the job.

Carter: Our costs for fiber are running about two-thirds that of coaxial cable. Labor costs are actually a lot less on fiber than coax.

Nelson: The key to cost and the success of your job is to do your engineering up front. Plan ahead! Let's talk about the things that go into route engineering. First of all, locate all obstructions. Every place where you are going to have to take the cable off

JDS Optics Fiber Optic Test Instruments

New

RM2000A Backreflection Meter

Applications

- Return loss measurements
- Evaluate connectors/components
- Installed system testing

Features

- One step measurement
- -50 dB dynamic range
- Internal reference
- Direct display in dB

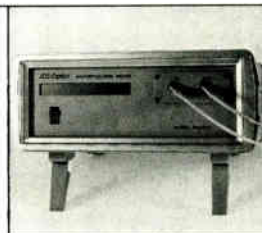

Series 8000/9000 Variable Backreflectors

Applications

- Introduces calibrated reflections
- Evaluate effects of backreflection to laser on BER
- Acceptance testing, transmitter development

Features

- Can introduce reflections of -7 dB to -40 dB
- Backreflection monitor port
- Digital readout of reflection



SW1-NC High Repeatability 1xN Switch

Applications

- Optical signal routing
- Component environmental testing
- Testing of fibers, transmitters, receivers

Features

- High repeatability
- Extremely stable
- Up to 90 outputs
- IEEE 488 compatible



Series 5000/7000 Precision Variable Attenuators

Applications

- Receiver testing
- Link loss simulation
- Power meter linearity checks

Features

- Manual or computer controlled
- Extremely linear
- Low insertion loss
- Low backreflection

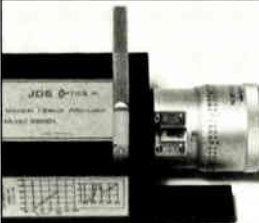

Soon to come

PM1000 Polarization Sensitivity Tester

- Test for component loss variation with polarization
- Will measure to Bellcore requirements

JDS Optics 146 Colonnade Road Nepean, Ontario, Canada K2E 7Y1 Tel. (613) 727-1303 Fax (613) 727-8284

Reader Service Number 18

COAXIAL AND OPTICAL CABLE DIFFERENCES

- Mechanical Flexibility
- Long Lengths
- Splice Costs
- Ordering
- Reel Sizes and Weights

P3 500 302 lbs. 35 x 21 *OR 10K Ft. 920 lbs. 44 x 31
 P3 750 733 lbs. 50 x 28 OR 30K Ft. 2700 lbs. 64 x 45



Figure 3

the reel, places where you can't use drive off installation technique, you need to locate and mark these on your strand maps. Ken, comment on some of the things you ran into.

Carter: Typical examples of obstructions that would prevent you from using drive off techniques are rear

point. You want to maximize drive off whenever you can.

Nelson: Once you have located all of these obstructions during your engineering phase, you will make a decision on how to treat each one—what you are going to do (figure 8, center

easements, railroads (upon occasion), utility laterals (which are attached below your attachment—you may want to work jointly with the telephone company for removing drops that would allow you to drive through), limited access roads (turnpikes/interstates), utility guys, trees and waterways. We have actually taken longer routes in some instances to avoid some of these obstacles and ultimately lowered our costs from a labor stand-

pull, splice) at each of these locations. And all of this information will be noted on your strand maps so your construction crew is going to know exactly what they are going to do at each location.

Nelson: Concerning splice points and the engineering considerations that go into pre-planning your splicing, what are the things we're going to think about? Obviously we want to

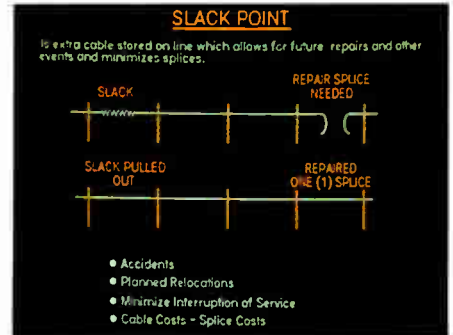

Figure 4

minimize the number of splices for cost reasons, both circuit loss and dollar costs and future maintenance.

Carter: When we have an obstruction it's helpful to put a splice near that obstruction. You would figure 8 much less cable and be much more

Seiko Brings Cables And Connectors Together. So You Don't Have To.

Save assembly time and ensure higher product reliability with Seiko's optical cable and connectors assembled as one unit. These 4 new series add even more diversity to Seiko's full line—and each specifies over 1,000 reliable mating cycles:

SMA-Compatible and Mini-BNC-Compatible Series—feature ceramic capillaries for reliable connectivity. Multi-mode.

SLP Series—is compatible with AT&T's ST™ connector. Low cost, multi-mode.

SDP Series—is compatible with NEC's D4 connector. Easy-assemble 3-part connector for single or multi-mode high performance communications.

PC Series (FC-Compatible)—offers convex surface precision polished cable for long distance transmissions. Use single or multi-mode; jacketed or buffer cable. Connection losses: as low as 0.15dB; return losses: 31dB.

Put all of Seiko's resources to work for you for the most reliable fiber optic components anywhere. Select attenuators. Collimators. Couplers. Polishers. Optical power testers. Bare fiber adaptors. And more. Plus world-wide service and support. Call now: see how Seiko builds connections that last.

Seiko Instruments Inc

Seiko Instruments USA Inc
 Electronic Components Division
 2990 West Lomita Boulevard
 Torrance, California 90505
 Phone: (213) 517-7786
 Fax: (213) 517-7792



Perhaps our most important contribution to CATV powering is restoring meaning to the word reliability.

In the past fifteen years we've made some very significant contributions to the CATV industry. We've developed the most efficient standby power concepts. We've developed the powering technology that delivers the cable signal with unprecedented reliability. In fact, every major standby power innovation has come from Alpha, including complete status monitoring, automatic performance monitoring, uninterrupted power output, and more. But what makes us proudest is to hear people in the industry say we've brought respectability to the standby power business.

Standby power systems were introduced to make CATV signal delivery more reliable.

Ironically, many of the standby systems were notoriously unreliable. They gave the entire industry a black eye.

We've worked very hard to design and build products that keep working under the most demanding environmental conditions. The fact that we're continuing to grow at an increasing pace while others have faded or disappeared shows that our concern for quality is right. And when our customers tell us we've restored confidence in standby power systems, that's the payoff.



Alpha Technologies. We're here to back you up.



3767 Alpha Way, Eellingham, WA 98226 3302
TELEPHONE 206-647-2360 FAX 206-671-4936

5700 Sidley St., Burnaby, B.C. V5J 5E5
TELEPHONE 604-430-1476 FAX 604-430-8908

Reader Service Number 20

efficient and less labor intensive.

Nelson: You have to consider accessibility when you are talking about splices. Splicing is done from an enclosed van for environmental reasons. It is time consuming and tedious work requiring excellent working conditions.

Carter: We leave 100 feet of excess at the splice point during construction. That will probably be trimmed down to 50 feet at completion of the splice. But we want to leave a little bit extra

there just for safety and precaution.

Nelson: In engineering your splice points you want to consider the locations where you are changing fiber counts, branchpoints, and future network requirements. Consider what your plans will be for the next 5 to 10 years. You are dealing with a substantial investment; it's much more difficult to come back and modify than coaxial cable plants. The main point in engineering your splice locations is to end

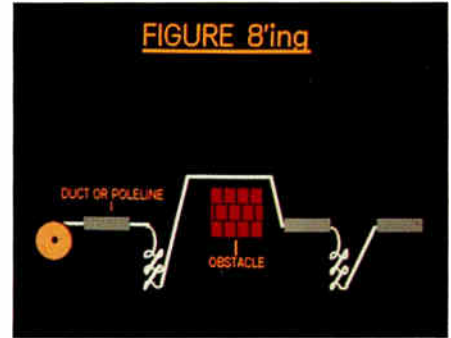

Figure 5

up with a good situation, easy accessibility for doing it the first time and for future maintenance. During a route engineering phase you want to consider anything you can to minimize future relocation problems. What are some of the things you dealt with here in Orlando, Ken?

Carter: Orlando is a very high growth area and consequently we have continual road widenings and road projects. We do extensive research with the counties and municipalities to engineer in advance for them; if we have to engineer through planned projects then we'll add slack points to facilitate future relocations. This is a road widening (See Figure 7) we were aware of but could not go around so we built through it. We placed more slack than normal at this location (about 150 feet of slack). The new pole line in the deceleration lanes being constructed were set back 28 feet from the existing pole lines, which is to be wrecked out.

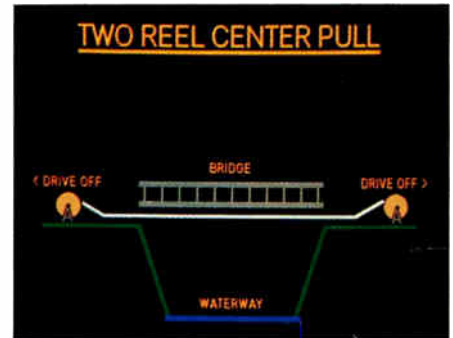
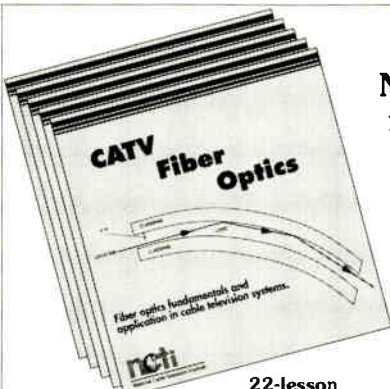

Figure 6

The first span where the slack is located was delashed and on each succeeding span the lashing wire was loosened and the slack pulled through it.

Nelson: Optical cables are ordered to specified lengths. What are the considerations you made when you ordered your cable lengths? We have talked about splice points and adding 50 feet minimum of cable on each side of the splice to reach your splicing van



22-lesson
CATV Fiber Optics covers all aspects
of fiber optics and its use in cable TV.

Now you can learn Fiber Optics
from the industry's broadband
training source!

Introducing NCTI's CATV Fiber Optics

Fiber Optics is undeniably a part of cable television technology. If your system isn't already involved in fiber, chances are it will be in the next three years. And, if you're like most of us, your training and experience is in coaxial cable-based systems, not optics.

CATV Fiber Optics, can bring you into the age of optics. It provides you with a thorough understanding of fiber concepts from transmission and attenuation to bandwidth and dispersion. It will bring you up to speed with the application of fiber from cabling basics and types of lasers, to amplifiers and splicing. Finally, it will complete your knowledge of fiber use in cable television systems with a review of fiber architectures, modulation techniques, RF interfaces, components, testing and monitoring, construction and maintenance.

And best of all, it is an NCTI self-study course. That means you decide when and where to learn about fiber optics. You don't have to travel to an expensive seminar. You can learn in the convenience of your office or home.

For a limited time only!
**Pre-publication
discount...\$295***

* Enrollment must be received before
October 1, 1989. Regular price is \$345.

Please rush me the following:

- More information on CATV Fiber Optics.
- A complete Training Kit with information on all NCTI courses.

Name _____

Title _____

Company _____

MSO affiliation _____

Address _____

City _____ State _____ Zip _____

Daytime phone _____

Mail this form to:

National Cable Television Institute
P.O. Box 27277, Denver, CO 80227
(303) 761-8554



Reader Service Number 21

MAKE THE CLEAR CONNECTION

U S WEST Communications Fiber Optic Technology

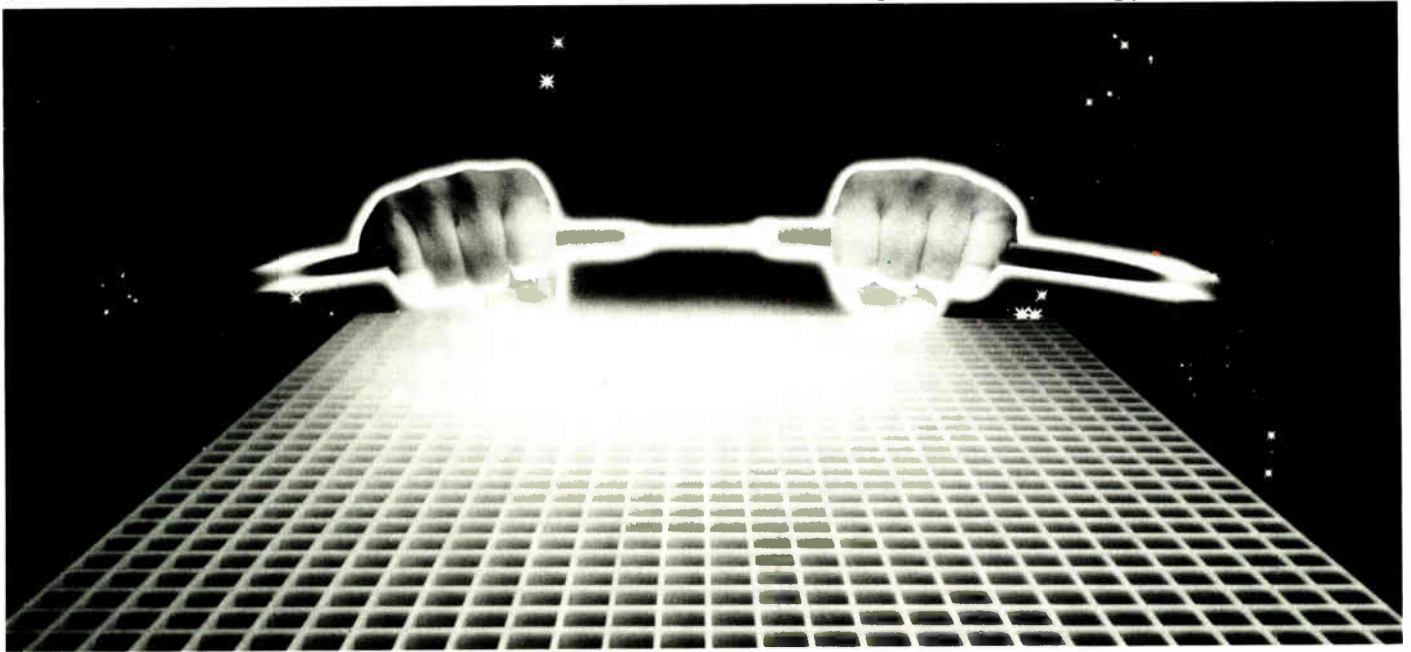

U S WEST Communications is ready to become a player on your team! With our winning combination, you'll keep ahead of the game.

Our experience in fiber optic technology has prepared us to meet the needs of the cable television industry today. Our 14-state region covers one third of the nation, from Canada to Mexico, and includes Arizona, Colorado, Idaho, Iowa, Minnesota, Montana, New Mexico, North Dakota, South Dakota, Nebraska, Oregon, Utah, Washington and Wyoming.

Teaming up with U S WEST Communications offers you:

- A cost-effective solution for your IntraLATA multi-channel video transport needs, allowing you all the advantages of the technology without the large capital required to build your own system.
- Replacement of your AML microwave links with IntraLATA multi-channel video transport, decreasing your system maintenance costs.
- Increased channel capacity and superior signal quality.
- A streamlined ad insertion network, which will lower your costs and improve your advertising income.

U S WEST Communications multi-channel video transport – the clear connection!

Call today! Justin Cislighi, (303) 896-4691.

USWEST[®]
COMMUNICATIONS 

and put back on the strand. Ken, how do you treat sag?

Carter: We are using about a 1.5 percent factor for sag from strand footage. We started out a little bit greater and now through experience we are trimming things down and becoming more confident in what we are doing and where we can trim back on excess.

Nelson: Do you have any significant waste?

Carter: No significant waste as long as you properly engineer everything. We double check all of our strand map footages to make certain they are accurate. If you have a high confidence level in your mapping you can be put at ease about waste.

Nelson: And obviously we have talked about adding a significant amount of footage, up to 10 percent, for slack point installation. Do you add any coverage for future maintenance problems; having a spare length in your warehouse?

Carter: Yes, initially we did. The first reels that we ordered had extra footage placed on it for maintenance purposes and also to allow for future pigtailed that we knew were coming up.

Nelson: You also need to consider that manufacturers typically ship you at least what you ordered plus a little bit. Due to the cost of reordering fiber cable and the cost of splicing, we want to make sure we do not ship you short footage. Due to manufacturing tolerances, we deal with a -0/+10 percent typical shipping length.

The thing you want to remember in dealing with optical cable is that you do not want to be short. The cable does not stretch and if you come up six inches short you are going to end up putting in an extra splice that is going to cost you several thousand dollars and a lot of optical loss.

Does underground construction of optical cable present unusual problems?

Carter: We try to minimize the amount of underground; it is similar to coax construction, but because of all our experiences with damages on coaxial underground plant, we go to addi-

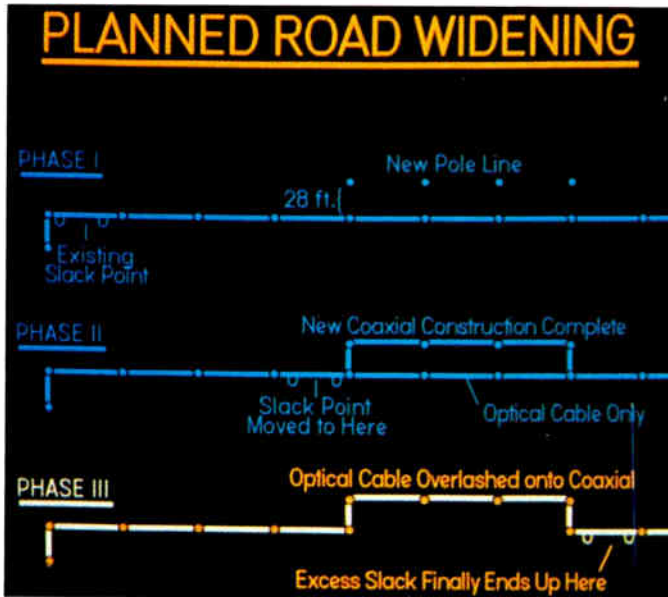

Figure 7

tional steps to try to provide protection. It is very important to monitor tension when pulling underground to make sure you don't exceed your pulling tension.

Nelson: That is the most important thing with underground construction. I can't emphasize it too much, you need to use a tension monitoring device. A dynamometer, tension slip rings, and fusion links are a requirement when you are pulling in ducts so that you do not over-tension the cable. You may need to use some of the techniques that we have talked about previously such as figure 8'ing and center pull. When you reach maximum tension you have got to come out of the duct and do

something to reduce pulling tension.

Nelson: Let's talk about a very important part of the installation. That is the final as-built record. With fiber cable you must have a very accurate record of what you have out in the field for future maintenance/repair and location of problems. Ken, would you comment on some of the things you are doing?

Carter: With an OTR you can pinpoint a place of damage, however, with all your slack points and sags that point is going to be much different than strand footage. As we construct, we write down the sequential footages that are placed on the fiber jackets at each pull and we record those on our maps during the point of construction so we can come back and convert that to a distance in the headend. (See Figure 8.)

Nelson: Do not forget to update all the changes as the years go on so that you have an accurate as-built record. Also, it is important to train your maintenance people that fiber cable is different than your coax.

Nelson: Let's talk about some of the overall experiences that you have had here in Orlando.

Carter: In general we probably average 10-mile runs from point to point with approximately 2 miles average between splices. Maximum drive-off we have about 17,000 feet and we have done pretty well with always having some drive off located in our strand. We have pulled up to approximately 3,000 foot rollers, that was a fairly straight pull without bindings. We are warning here that you will probably end up having to leave a reel overnight.

Make sure you get a guard service or someone who will spend the night with it to prevent vandalism.

Nelson: The installation here in Orlando was highly successful because of the attention paid to those things outlined in this presentation.

Other installations may require some different techniques depending on many factors. We think you will benefit from those ideas presented here. ■

FINAL "AS BUILT" RECORD

- Future Maintenance and Repair
- Minimize Service Interruptions
- Locate Problems
- Record Actual Cable Footage Marker at Each Pole on Strand Map
- Compute and Record Total Footage Between Major Points



Figure 8

INTRODUCING TD-2000...THE ULTIMATE OTDR

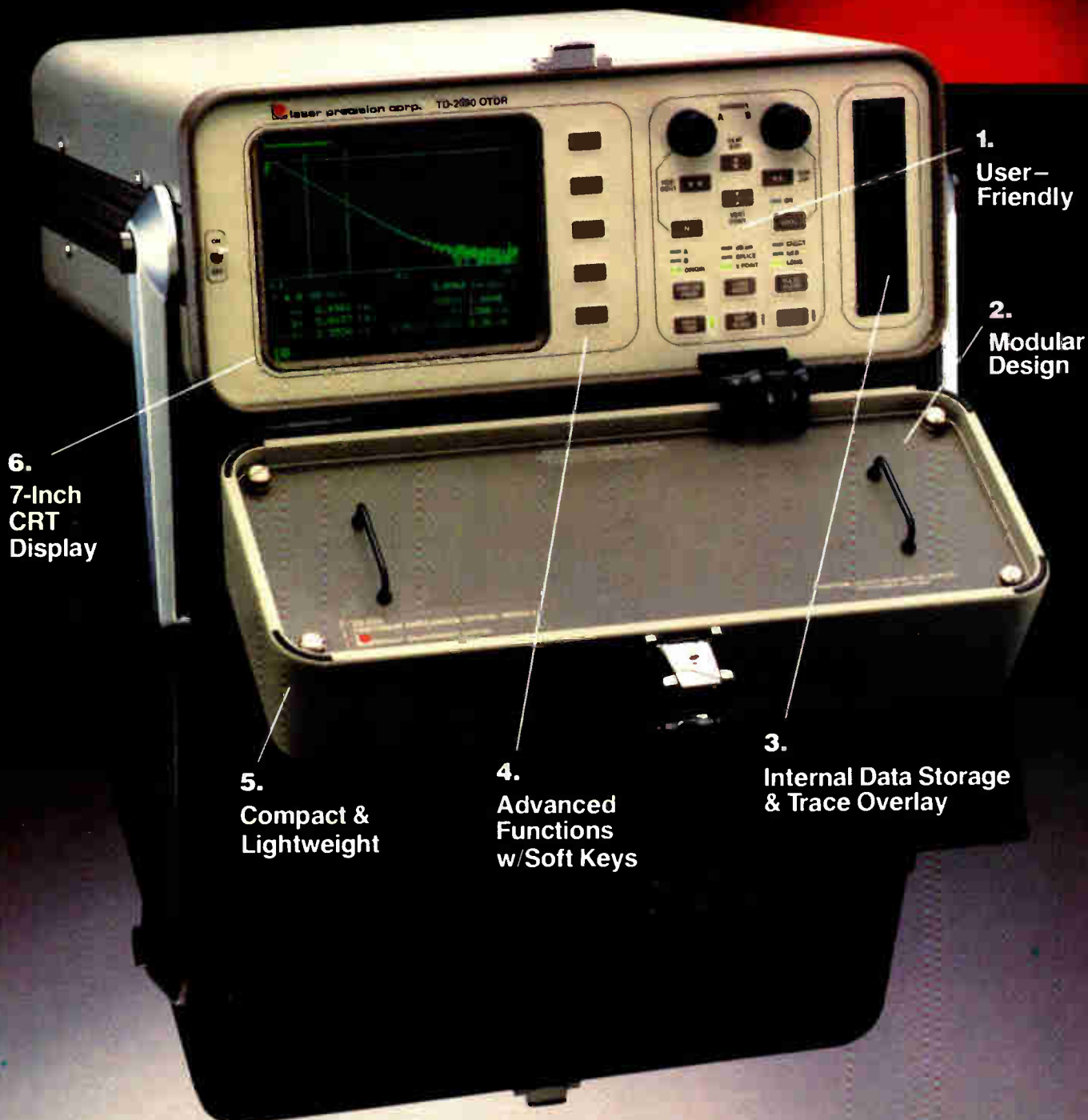

1. User-Friendly

2. Modular Design

3. Internal Data Storage & Trace Overlay

4. Advanced Functions w/Soft Keys

5. Compact & Lightweight

6. 7-Inch CRT Display

SIX GOOD REASONS TO FIND FAULT WITH US

For more information or a demonstration, contact:

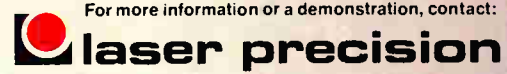

1231 Hart Street • Utica, NY 13502 • (315) 797-4449 • FAX (315) 798-4038

European Office: P.O. Box 81094 • 3009 G. B. Rotterdam, Holland • 31-10-421-6316 • FAX 31-10-455-8019

Brazilian Office: AGC Optosystems • AV. Aclimação, 385-9º • São Paulo. SP-01531 • 55-11-270.2616 • FAX 55-11-279.0725

AM lightwave transmission

The needs of the CATV industry are the impetus for development of AM video transmission over fiber—technology that has been advancing

ity of VCRs, and the emergence of ISDN have worked dramatic changes. In the future, 10 or 12 simultaneous channels of video may become the

norm. Providing that many channels in analog or digital FM format is expensive, and is inherently complex in terms of switching.

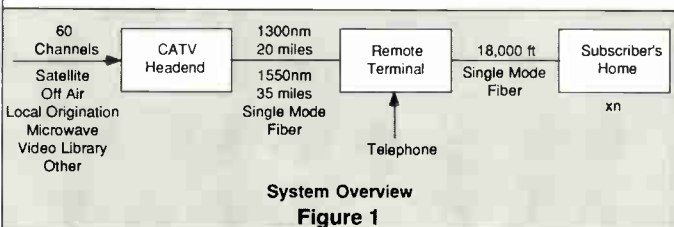

Delivering those same 12 channels

Technology choices

The advantages offered by fiber optic transmission are well known. Optical signals are immune to all types of electrical interference, and direct fiber optic runs to the home do not require the repeaters or amplifiers always needed in coaxial systems.

This proposed fiber-to-the-home sys-

rapidly in the past six months.

Compared to FM systems, AM transmission over fiber offers significant advantages to the CATV industry in the short term. First, AM signals are handled in exactly the same format as coaxial transmission, and second, more AM than FM channels can be transmitted per fiber. Interestingly though, later AM spin-offs may actually hold greater market potential than the original target application.

One of the most obvious of these other applications is fiber to the home. As recently as 1987, a system that

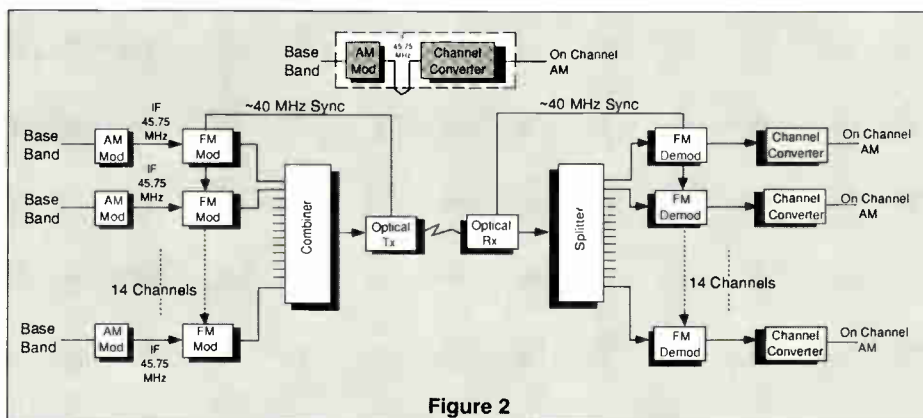

Figure 2

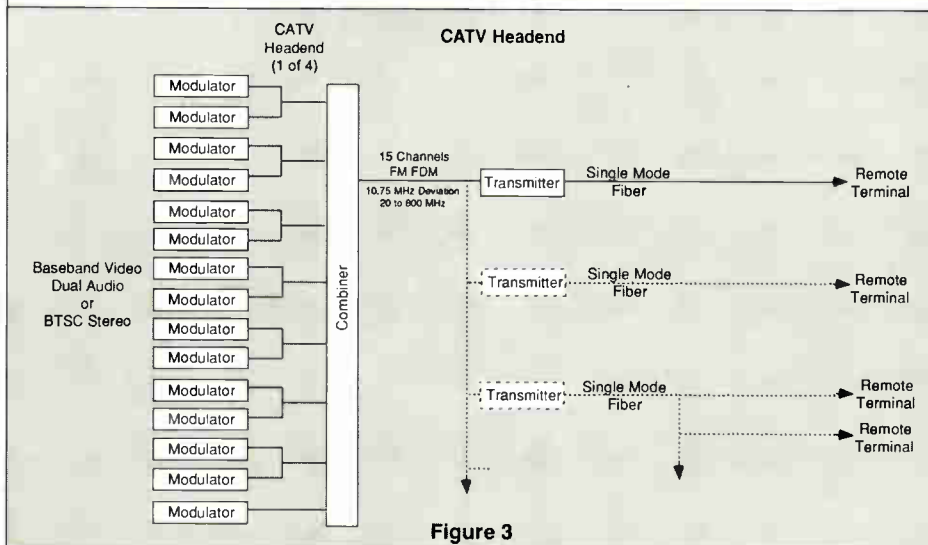

Figure 3

delivered four simultaneous television channels and two POTS (plain old telephone) channels was considered adequate for most American homes. But the advent of multi-picture television sets, the ever-increasing popular-

to the home in analog AM mode should be considerably less expensive. AM technology is relatively simple because the format is compatible with CATV transmission facilities and all current domestic receivers. Compared to the Orchard FM fiber-to-the-home system, which offers four video channels, POTS and data, the Orchard

tem employs analog optical technology for two reasons: picture quality and cost savings. In their natural state, video signals are analog, and digitizing them is an expensive undertaking. Even more compelling, analog transmission makes far better use of fiber bandwidth, so a single optical fiber can carry a great deal more analog than digital information.

Using AM transmission, 60 or more analog full-motion video channels, with associated audio, can be multiplexed onto one fiber, using 600 MHz of bandwidth. On the other hand, one digitized video channel requires 140 Mbits per second without compression. Cost is also a major consideration.

Analog techniques are also better suited to future developments, particularly high definition television.

System overview

This AM system consists of available technology that is simply being repackaged for fiber to the home. Three types of locations constitute the system: headend; remote terminal (RT); and the optical network interface (ONI) at

By Dean Bogert, Orchard Communications Inc.



RESOURCE
RECOVERY
SYSTEMS

NATIONWIDE RECYCLING SPECIALISTS

AN OPEN LETTER TO THE MSO'S

Dear Mr. MSO:

After having recently returned from both the NCTA show in Dallas as well as the SCTE convention in Orlando, I am continually amazed at the number of engineers and construction personnel who are unaware that companies such as ours exist to handle their scrap cable and electronics. This is inexcusable, particularly in light of the number of years we have been advertising, attending the trade shows and, more importantly, corresponding with the corporate and divisional offices of all the major MSO's. Several basic factors contribute to this phenomenon. First, many of you are "decentralized". This usually means that the "buck" for deciding what to do with the scrap gets "passed" down the line to someone at the warehouse level. This brings up the next problem.

Unfortunately, many of the field level personnel who are responsible for the scrap are more likely to be found reading almost anything other than CableVision, CED, or any of the other trade publications. When the need arises to dispose of wreckout, partial reels of cable or other materials, these guys are naturally unfamiliar with whom to contact in this regard.

More often than not they wind up flipping through the Yellow Pages to find someone who is only going to charge the system to have these items removed. If they're smart they'll take bids on the materials. The problem then arises that the company they chose, based upon the highest bid rather than a check of their references, has either left their yard a mess or not paid for the materials they removed (some of which might not be scrap!).

The principal problem behind this entire issue seems to be that of money. As long as the MSO's are making lots and lots of money, who cares about a few tens of thousands of dollars of lost revenue from scrap...it's figured into the budget as "waste factor" anyway. With all the press that has been given to signal theft over the past few years, it's amazing what is continually overlooked in the field at every cable system every day! Until individuals such as yourself, who do read the trade publications, who do attend the cable shows and who should, therefore, know of the services and companies available, make a point of getting the word out to these guys in the field, you will continue to lose money. Until the corporate offices of the major MSO's, such as yours, take issue with the cable manufacturers' recent decision to discontinue handling recycled reels, your people in the field will continue to use their expensive labor to dismantle reels, your people dearly to have them hauled to landfill (those that will still take them). Isn't it time to pay losing money, even if it's only a few thousand out of every million you make!?

Sincerely,

Tom Wood Jr.

Tom Wood, Jr.
Owner/Resource Recovery Systems
Nationwide Purchasers of Scrap Coax & Electronics

8610 Broadway, Suite 220

San Antonio, Texas 78217
Reader Service Number 24

(512) 828-7777

FAX: (512) 828-2944

FIBER-TO-THE-HOME

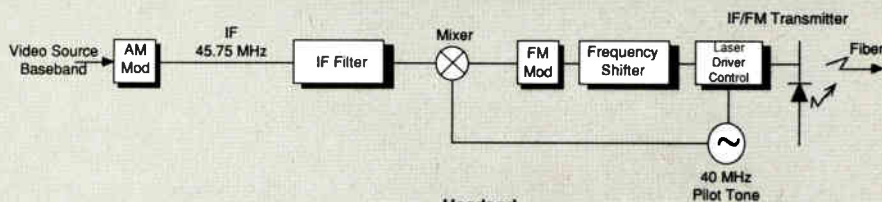

**Headend
Figure 4**

some optical repeaters.

Video signals from the headend can be split electrically and optically to serve multiple RT sites. Electrically, the modulation equipment can drive multiple transmitters, so that the same modulation equipment serves more than one RT. The output signals of the transmitters can also be optically split,

the subscriber's home.

Headend. The CATV headend collects video signals from a variety of sources, such as satellite, off-air local origination, microwave, video library, etc. The baseband audio and video signals are first AM modulated. At the IF level the signals are placed on FM carriers, which are then passively combined. The composite signal is used to intensity modulate the laser diode in an optical transmitter. Typically four laser transmitters, each carrying 15 or more video channels with associated audio, provide a capacity of 60+ video channels with associated audio.

Each of the four transmitters can launch its output onto a separate single mode fiber, or if the signals are wavelength division multiplexed, the 60 channels can be carried on just two single mode fibers. If many more than

60 channels are needed, additional transmitters and receivers can be installed.

FM carriers are used in this part of the system instead of AM in order to increase the transmission distance from the headend and obtain a higher signal-to-noise ratio. The distance from the headend to the RT can be 35 miles or more. For links longer than 20 miles, transmission at the 1550 nm wavelength is ideal because fiber attenuation is only about half of what it is at 1300 nm. Therefore, using the 1550 nm window can eliminate the need for

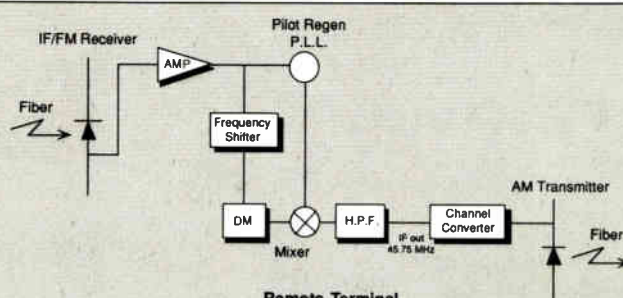

**Remote Terminal
Figure 5**

saving on both modulation and transmission equipment. In both cases, the headend equipment is able to serve many thousands of users, and the cost per subscriber is small.

RT. At the RT, four receivers convert the optical signals into electrical form, and each of the 60 channels is demodulated from the FM carriers. The result-

ATTENTION

CATV

Operators & Installers

Interested in attractively priced and conveniently packaged single and multichannel Analog Video Transmission systems with optional audio and data features?

CCTV

Designers & Contractors

Then consider STC Multiview.

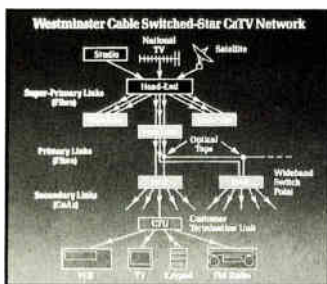

First designed and conceived for Westminster CATV in central London using this philosophy:

Super-primary and primary multichannel links form the tree and branch of a CATV network. Large optical loss budgets allow for optical taps. Switched-star networks provide a combination of shared and dedicated circuits between the head-end source and a wideband video switch located near a group of subscribers. Customer outfeeds can be either coax or single-channel fiber.

Over 6,500 Tx/Rx card-pair systems in service since 1984. with MTBF's in excess of 14 YEARS, via surface-mount technology.

Shortly, we will be offering single-channel coders as well as mult-channel digital video links with similar audio and data add-on features and even better S/N and C/N characteristics.

Call us for an update, or for a tailored quotation to fit your application:

In North America:
K.L. (Ken) Johnsen, Nth. Amer. Mktg. Mgr.
STC Telecomm Inc.
Video Systems Division
11490 Commerce Park Drive
Reston, VA 22091
Phone (703)648-3470 FAX (703)648-3475

In the U.K., Europe and other:
Kevin Marris
STC Telecommunications Ltd.
Video Systems Division
Tintern House, Llantarnam Park
Cwmbran, Gwent. (U.K.)
Phone 0633 838385 FAX 0633 375870

FIBER-TO-THE-HOME

ing IF signals are frequency converted to the standard CATV VSB-AM (vestigial sideband) frequencies. Using WDM (wavelength division multiplexing) or FSK (frequency shift keying), POTS channels and any other digital services are combined with the 60 video and audio channels. The combined signal is used to intensity modulate the transmitter laser, which launches its light onto one single mode fiber running directly to the subscriber's home. The link to the user's home can be as long as 18,000 feet (3.4 miles). The signals from the RT can be split electrically and optically to serve multiple subscribers.

The return signal is generated by a laser transmitter in the ONI at the home. WDM enables signals for both the down link and the return link to be carried in opposite directions on one single mode fiber.

RT equipment description. Four optical receivers detect the incoming optical signals from the four transmitters at the headend. Mounted below the receivers are IF/FM demodulators. One rack contains frequency shifters, amplifiers and combiners. Another rack holds WDM or FSK equipment, and laser transmitters optimized for AM.

Subscriber's home. At the subscriber site, an Optical Network Interface (ONI) converts the incoming optical signals back to electrical form. An amplifier drives standard RG-59 coaxial cable to deliver video information to set-top converters or cable-ready TVs. The data control MUX demodulates the data carrier and provides POTS; POTS information is then distributed on standard telephone house wiring. An eight-hour battery back up provides emergency service in case of an AC power failure. The ONI also generates local ringing for the telephones in the home.

Outgoing voice and E and M signaling for the POTS, and data, are fed into the control MUX for transmission back to the RT.

Diagnostics are also provided on the return line. Information on the status of the battery, transmitter and receiver is sent on the return line to the RT.

Summary

At the headend, baseband video and audio signals are AM modulated. The signals are extracted at the IF level and placed on FM carriers. The composite output intensity modulates a 1300 or 1550 nm laser diode that transmits optical signals over single mode fiber to the RT.

At the RT, a frequency converter changes the frequency of the received signals to the VSB-AM frequencies. The channels are multiplexed with the POTS channels, and any other digital services. The combined signal is used to drive a 1300 nm laser, which launches its light onto single mode fiber running directly to the subscriber's home.

At the subscriber's ONI, the received signal is amplified and the POTS information extracted. Telephone and

other digital signals are sent within the home on standard wiring. Video is distributed on coaxial cable. A laser transmits POTS and channel selection back to the RT.

A major advantage of an AM system for CATV operators is ease of implementation. It is completely compatible with existing equipment in service in the industry—AM modulator/demodulators, scramblers and set-top converters. ■



TAMAQUA
CABLE PRODUCTS CORP.

Presents

**"A Sheep in
Wolf's
Clothing"**



STARRING

TeleCOMM-DUCT

THE DUCT SYSTEM that can be pulled or plowed in long lengths. **PRE-INSTALLED** fiberoptic cable of your choice **WITH** full warranty and testing, yields **SAVINGS** of 25% to 50% in installation costs.

PRODUCED BY Tamaqua Cable Products Corporation,
Schuylkill Haven, PA 17972.

CALL: 717-385-4381

FAX: 717-385-1092

TELEX: 834-573

Reader Service Number 26

Communications Engineering and Design September 1989 41

Integrated CATV and phone services on fiber optics

Integrated CATV and telephone services to the home on a single strand of optical fiber is becoming a reality. In the past, cost and technical complexity relegated this technology to the laboratory and some limited field trials. Today we are solving the technical and cost problems of integrating VSB-AM television signals with digital telephony signals on fiber optics. Although the complex legal and political issues associated with integrated fiber-to-home systems are a critical aspect, our present discussion will be limited to the technology.

No stopping technology

The advent of broadband VSB-AM transmission of CATV signals on fiber optics has greatly simplified the CATV segment of the integrated system. At this writing, costs associated with the CATV portion of fiber to the home or tap currently exceed those of a hybrid fiber optic and coaxial distribution system. However, there are no apparent barriers to significant cost-per-subscriber reductions, provided that the manufacturing volumes inherent in a fiber-to-home system can be achieved.

Current methods for serving CATV and telephone systems are depicted in Figure 1. Existing CATV and digital telephony system architectures for distribution of signals to the home are, in fact, quite different today.

Analyzed from the plan view, the typical distribution system for a CATV franchise uses tree-and-branch architecture, and a telephone system distribution system uses essentially a triple-star architecture, where:

- The central office represents the center of the first star distribution level;

- the remote electronic site represents the center of the second star distribution level; and
- the pedestal represents the center

becomes clear that the logical structure involves making the optical-to-RF conversion points the center of a second-level star, with fiber optic cables radiating to the current tap locations. These locations then become central to the third-level star distribution to the home. Thus, as one looks at the optimum architecture for a fiber-to-home CATV distribution system, the triple-star architecture is similar to that used for a telephone distribution system.

As reported in the July 1989 issue of *CED*, Catel Telecommunications and Reliance Comm/Tec Corporation have announced a working partnership to develop an integrated system for CATV and telephone fiber optics to the home. The fiber optic CATV portion will be developed by Catel, and the digital telephone subscriber loop will be developed by Reliance. Figure 2 depicts the overall system architecture, and shows where each piece of equipment would be located in the currently proposed field trials.

- For the CATV portion, a fiber optic hub would be installed in the telephone central office using an architecture similar to that used for the North Coast CATV system in Cleveland, Ohio.

- For the telephone portion, the central office terminal of the digital loop carrier system would also be installed in the central office.

- The VSB-AM CATV signals would be transported to a controlled environmental vault (CEV) over dedicated single-mode fiber and the digital loop carrier signals would be transported to the same CEV over dedicated single-mode fiber.

The telephone central office thus becomes the center of the first level of the star distribution system.

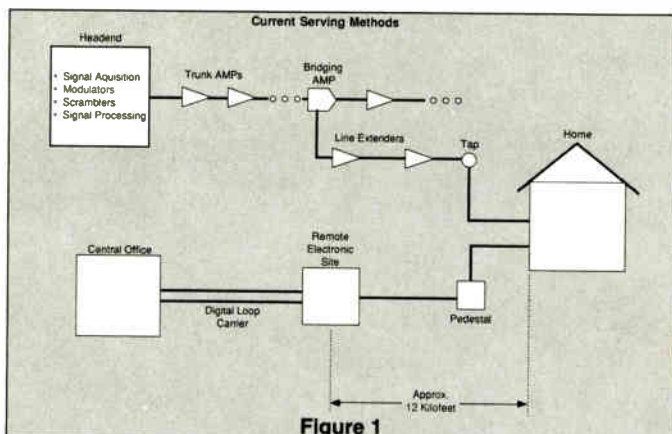

Figure 1

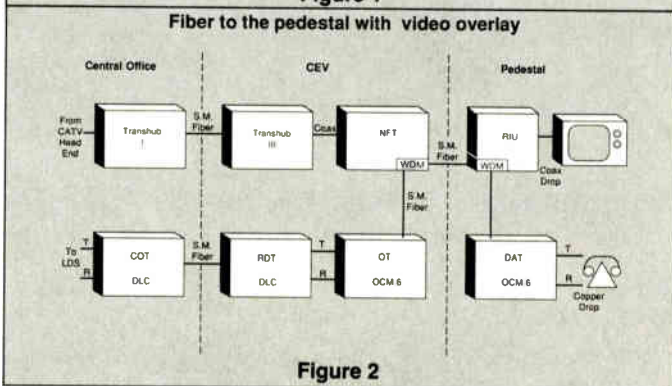

Figure 2

of the third star distribution level.

Although there is little compatibility between triple-star architecture and conventional coax tree-and-branch structure, interestingly, the star architecture emerges as the most economical way to implement a CATV system using fiber optics for the first distribution level. The CATV headend becomes the center of a star fiber optics plan, where the optical fiber radiates from the headend, and terminates in equipment that will convert the optical signals to RF signals suitable for distribution through a coaxial system to the home.

Triple-star is best

In looking at architectures for fiber optics distribution to the home, it

What's a CEV?

A CEV is generally a small, buried

By James D. Hood, Ph.D.,
President and CEO, Catel
Telecommunications Inc.

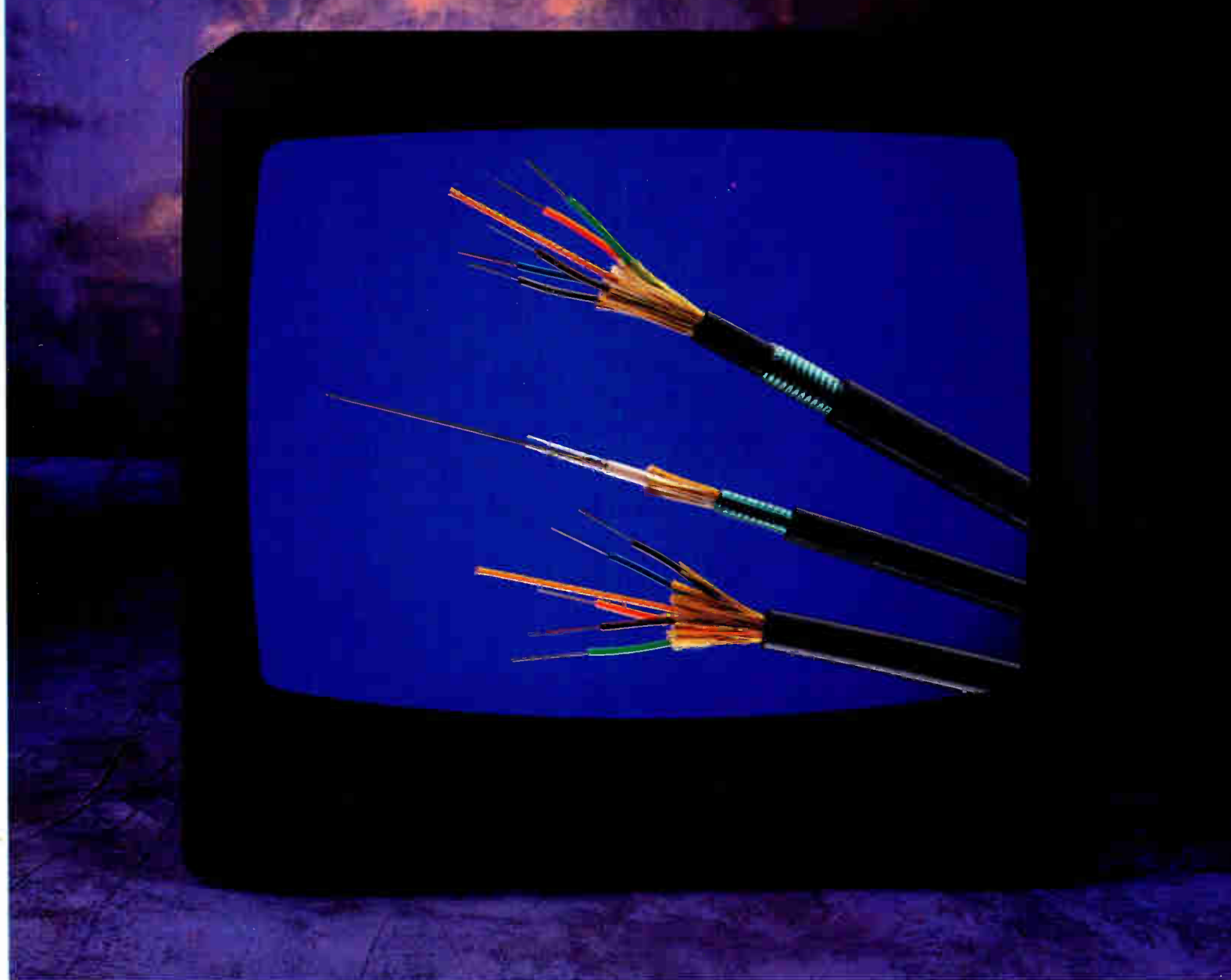

Cable Ready.

If you're ready to integrate fiber optic cable into your cable TV system, Siecor is ready for you. Because we have exactly the products you need from cable and hardware to equipment for splicing and testing. And we offer the precise choices you need, too. For instance, our cable comes in a variety of sheath and core designs to handle aerial, duct and underground applications the best way possible. Furthermore its loose tube design makes installation and maintenance easy. And when it comes to splicing, we offer fusion and mechanical options to suit your specific needs.

What's more, we don't just provide the best-suited products for the job. We're ready to

help with unsurpassed service and support. From our engineering consultation to our installation expertise, we can show you the easiest, most efficient ways to use fiber optic cable every step of the way.

It's this kind of support, together with our many product innovations, that's made us the leader in fiber optics. And it's what makes us so well equipped to serve the cable TV industry.

So call us at 704/327-5819. Or write Siecor Corporation, 489 Siecor Park, Hickory, North Carolina 28603-0489. You'll see that no one's more tuned in to what you need than Siecor.

SIECOR

room accessed through a manhole. It can typically hold 22 racks of equipment and has room for maintenance personnel to work within the vault. Within the CEV the VSB-AM CATV signals will be converted to broadband RF signals suitable for transmission over coaxial cable. These RF signals will be input to several neighborhood feeder terminals and converted back to broadband VSB-AM optical signals. The CEV will also contain the remote terminals for the digital loop carrier system which convert the time-division multiplexed digital telephony signals received from the central office into individual subscriber telephone circuits.

These individual circuits will be input to the originating terminal of the OCM-6 equipment being developed by Reliance as part of this project. Using a wave-division multiplexer, the optical signal generated within the originating OCM-6 terminal will be combined with the optical signal generated by video equipment Catel is developing. The combined signal will be placed on one single-mode fiber for transmission from the CEV to a pedestal.

At the pedestal, the CATV and telephony signals are separated using a wave-division multiplexer. Here the CATV signals are converted from an optical format to the standard VSB-AM RF signal for distribution via drop cable to each home served from the pedestal. The pedestal segment of the OCM-6 digital telephony system converts the time-division multiplexed telephone signals into the standard analog format for interconnection to the home using an ordinary twisted pair.

The pedestal is currently being designed to serve four residences with broadband CATV service and either plain old telephone service (POTS) or ISDN 2B+D telephone service. Clearly, the same complement of equipment could

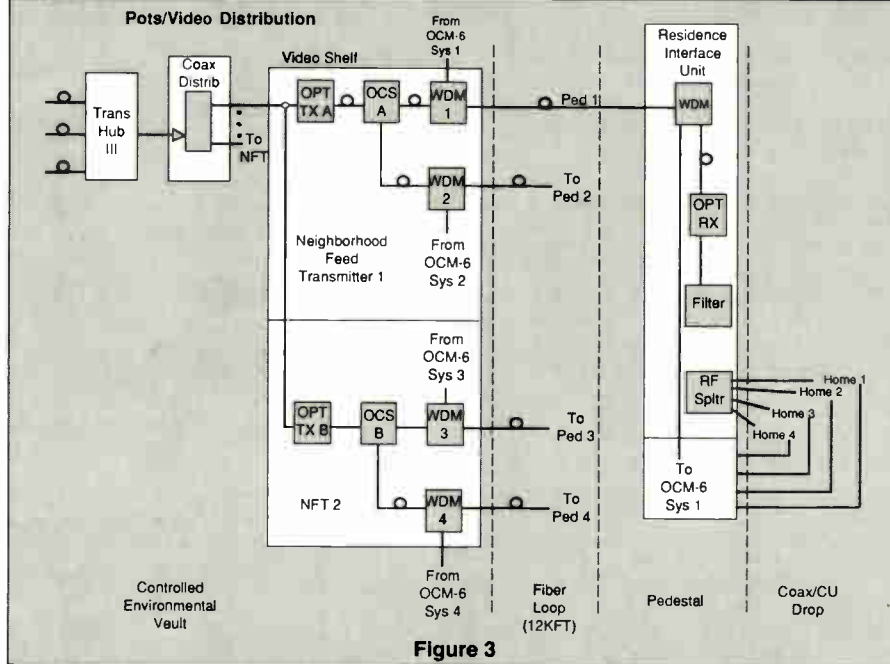

Figure 3

be installed in each home to provide true fiber-to-the-home capabilities. However, current economics strongly favor placing a pedestal in the same location as the tap and feeding multiple residences from that point using a drop cable and twisted pair.

Integrating telephone and video

The integrated telephone and video portion of the system is shown in more detail in Figure 3. The equipment contained in the CEV includes a Catel TransHub III, RF splitters and the neighborhood feed transmitters that convert multifiber VSB-AM television signals into a standard broadband multichannel RF signal. That signal is interconnected to a number of neighborhood feed transmitters. The neighborhood feed transmitter consists of a

broadband optical transmitter plus the passive optical devices necessary to split the signal and combine it with the optical signal generated by the OCM-6 digital telephony equipment. A fiber optic cable runs from the CEV to each pedestal mounted residence interface unit.

Within the residence interface unit, a wave-division multiplexer separates the CATV signals from the digital telephony signals. The CATV signals are converted to a standard RF format and distributed to each home. The pedestal mounted portion of the OCM-6 system demultiplexes the digital telephony signal into the standard POTS format or into a combination of POTS circuits and ISDN 2B+D circuits. The telephone circuits are distributed from the pedestal to the home using a standard twisted pair.

A "brassboard" of the system has been completed that demonstrates the full compatibility of the integrated CATV and telephone approach. Demonstrations of this brassboard to potential customers were started in early August 1989. The mechanical engineering of the CEV portion and the pedestal mounted residential interface unit are nearly completed, and field trials of the units are scheduled for the fourth quarter of calendar year 1989. Limited deployment is projected for calendar year 1990, with volume production starting in early 1991.

Figure 4 shows the projected cost of the CATV portion of the system based on various volume production rates. Our analysis concludes that the CATV portion of the system should ultimately be about \$300 per house in order to be truly cost-competitive with the tree-and-branch cable distribution system. Figure 4 demonstrates that within a given time and adequate manufacturing volume, the cost objective can be achieved. ■

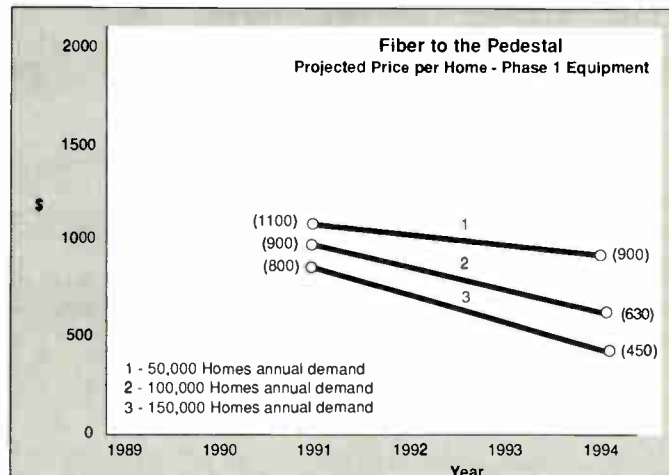
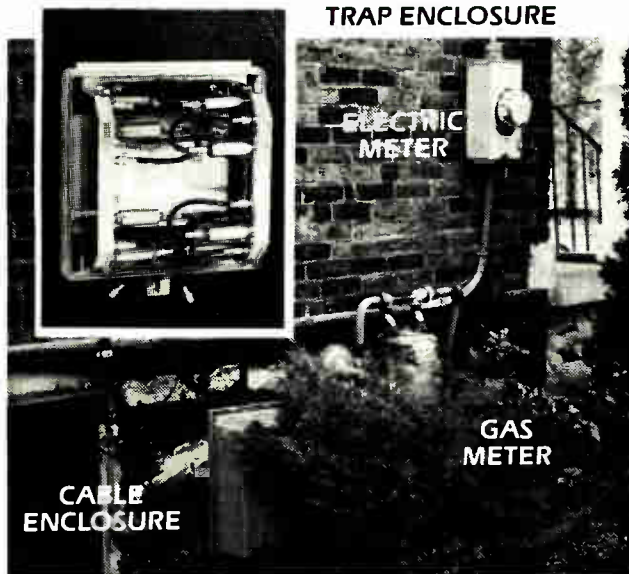
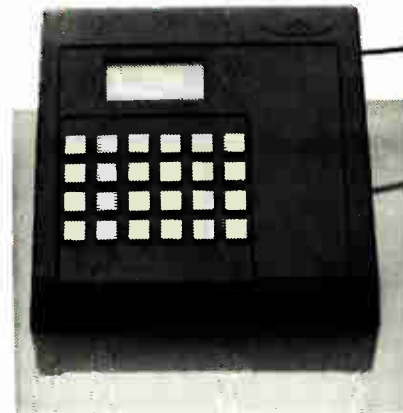

Figure 4

EAGLE'S OUTDOOR ADDRESSABLE TRAP SYSTEM AN ALTERNATIVE TO SET TOP DESCRAMBLERS FINALLY: CONSUMER FRIENDLINESS WITH IMPULSE PPV



TRAP ENCLOSURE



OPTIONAL REMOTE UNIT

TYPICAL INSTALLATION

Addressable Trap System eliminates many of the consumer unfriendly characteristics of present day converter descramblers. **Eagle's Addressable Trap System** provides:

- (A) Ability to record a premium channel while watching a different premium channel.
- (B) A converter descrambler is not required for each TV.
- (C) TV and VCR remote controls can be used.
- (D) Cable ready sets can use their extra channel capacity possibly eliminating a converter.
- (E) Picture and sound distortions are minimized.
- (F) Switch boxes or complicated wirings are not required.

A trapped system is very friendly since all subscribed to channels are present at each TV set simultaneously in an unscrambled mode. Only undesired channels are removed. When addressability and Impulse pay-per-view are added, as with **Eagle's Addressable Trap System**, consumer friendliness, versatility, and economy for today's system operator are the result. The control box in which the traps are located is outside the home similar to electric, gas or water meters, eliminating the need for customer change of service or repair scheduling.

One hundred million traps used in cable systems testify to their reliability, simplicity, and economics for controlling premium channels. Adding **Addressability** and **IPPV** to basic traps, will extend their use many years into the future.

FEATURES

- 4 or 8 tiers of negative, positive or multichannel addressable filters; 256 combinations selectable.
- Consumer friendly with VCRs, cable ready sets, and remote controlled TVs.
- Controls signal delivery to multiple TV sets from one trap switch enclosure.
- Uses your present negative or positive traps.
- Powered from the home; cable system powering changes not required.
- All service disconnect capability; over 80 dB isolation.
- Non-volatile memory protects data during power outages.
- Automatic scheduling of events & previews.
- No need to enter home for audits.
- Automatic shut-down after time out.
- IBM PC or compatible computer control.
- Billing program; compatible with billing systems.
- Transparent to other scrambling technology.
- Compatible with non-attended remote headends.
- Ground block.
- Non-interrupted test points.

OPTIONAL REMOTE UNITS

- Subscribe to premium programming without need to call the cable system; order IPPV by event number.
- Auto-dialer transmits customer usage back to the system operator, using store and forward techniques.
- Pre-authorize customers for limited amounts of pre-paid programming.
- Parental Control of premiums or all service.

EAGLE

COMTRONICS INC.

MADE
IN
U.S.A.

AM fiber: The new tool

It seems that every time you read an industry trade journal today, there is something being written about AM fiber optic technology. Many of the CATV operators are looking hard at integrating this technology into their plans and, for the most part, each plan is an offshoot in some form of the following, most talked about architectures:

- ATC Fiber Backbone System;
- Jones—Cable Area Network;
- Rogers Cablesystems of Canada—Urban Transmission Topology.

Each of these architectures ultimately provides the following benefits in varying degrees to both the operator and the subscriber:

- Improved signal quality;
- Improved system reliability;
- Accommodates channel expansion;
- Adaptable for future services.

Along with reducing a total franchised service area into multiple mini-service areas through the use of AM fiber node technology, operators will soon come to realize the following additional advantages of this networking approach:

- Local and remote system diagnostics.
- Real time system performance analysis.
- System fault isolation.
- Very fast - meantime to repair.
- Status monitoring.
- System inventory control.

These features will invariably lower maintenance costs, consequently reducing operating expenses. Additionally, the customer will experience better service, which reduces the likelihood of a disconnect.

All this sounds well and good, but how does the CATV engineer make some basic decisions when looking at AM fiber optics? Fiber is not new to the CATV industry but is now coming of age where it can possibly make good economic sense on a widespread basis. On the average, AM systems are about a 6:1 reduction in initial first cost as compared to FM fiber transport systems. Fiber optic FM video transmission systems have been the workhorse of the industry for the long haul (40

km), high quality, headend-to-hub links for the past 10 years.

FM's downfall

FM requires frequency conversion, which requires many racks of equipment in a controlled environment. Therefore, FM hub sites require real estate—which is expensive. AM transmission is the preferred method of transmission because no signal format changes are required. AM can be integrated anywhere in the trunk system up to a maximum of 12 miles from the headend. At the receive sites, light is converted back to RF and continues with standard trunk amplifiers. The AM fiber optic receive site node location can be either a strand mounted housing or a pole/pedestal enclosure.

In order to evaluate if AM fiber is a technology that can be utilized in your system, some basic questions should

- What limits the transmission distance of AM fiber systems?
- What is the overall system performance when AM fiber electronics is added to the trunk amplifier cascade?

The application of AM systems is limited by distance, by the CNR (carrier-to-noise ratio) and distortion performance. The maximum link margin for AM transmission is about 9 dB. For example, a 12-mile (20-km) link has the following link losses:

- Attenuation of the fiber: 0.35 dB X 1.61 km/mile X 12 miles = 6.76 dB
- Fusion splices @ 0.1 dB per splice (1 splice per 4 km) X 4 = 0.40 dB
- Optical connectors (one at each end of the system) @ 0.35 dB ea. = 0.70 dB

Total optical loss: 7.86 dB.

Based on a 9 dB loss budget, there is 1.14 dB of safety margin to protect against future system aging, fiber cable breaks and other unanticipated future cable losses. To add safety margin or travel further, you can eliminate the end point terminal connectors and fusion

splice directly to the transmitter and receiver. Also, in the field, 0.05 dB fusion splices should be the desirable target to improve the safety margin.

Based on the best performance available for short distance links today (9 dB of loss or less) an AM fiber system with 36 channels can deliver a CNR of approximately 51 to 52 dB, depending upon manufacture and transmission schemes selected today over a maximum distance of approximately 12 miles with some safety margin.

Ideally, an AM system is desired since it can take a broadband input and deliver a broadband output with no need for separate VSB-AM modulators

Typical AM Optoelectronic Specifications

• Number of channels fiber	42
• CNR	52 dB
• Composite Second Order—(CSO)	65 dB
• Composite Triple Beat—(CTB)	65 dB

Typical CATV Amplifier Specifications

550 MHz—77 Channels

		Trunk Station	Bridger Station	Line Extender
Noise figure	(dB)	9.5	10	10.5
Output	(dBmV)	30	46	46
CTB Rating	(dB)	102	86	76
CSO Rating	(dB)	84	74	69
Gain	(dB)	22	34	27

Table 1

Eventually, when the AM nodal design becomes an industry standard, the pole and pedestal designs will probably emerge as a popular hub concept for the following reasons:

- Accessibility—Ground level access for immediate site access for servicing, troubleshooting and maintenance.
- System powering—Small 110/60 volt power supplies can be incorporated to feed the short cascades and hub electronics.
- Future services—This is easily accomplished in an enclosure that provides initial mainframe space expansion.
- Reliability—An enclosure offers a potentially less hostile environment.

By John Simons, Eastern National Accounts Manager, Times Fiber Communications, Inc.

CATEL

Ready with the next step into your fiber optics future.

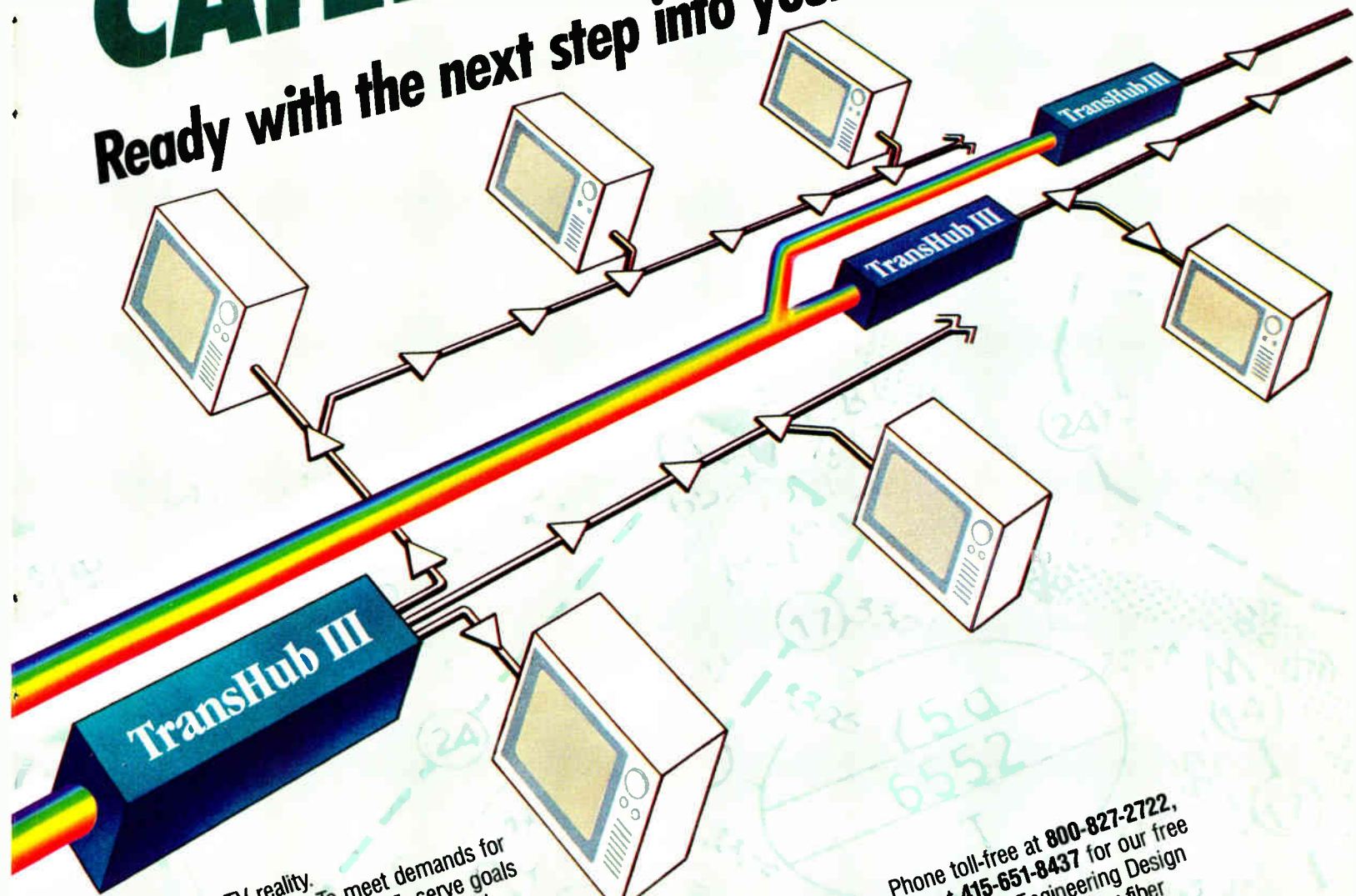

It's a CATV reality. Rebuilding. Upgrading. To meet demands for better signals, more channels. To serve goals of lower costs, reduced maintenance and higher revenues. Catel's family of FM and AM fiber optics equipment lets you do all that, while ensuring smooth response to future needs.

Take our TransHub™ III. Stand-mounted and driven by your headend equipment or a TransHub I, it converts AM-on-fiber to VSB-AM for coax. So you can take quality signals "deeper." With a fiber loss budget under 7.5 dB. SNR of at least 52 dB. Second-order products under 70 dBc and composite thirds less than 65 dBc. You also gain bandwidth needed for migration to new standards—HDTV, for example—and for higher revenue potential. And you do it at the cost of traditional coax. With no repeaters and none of the accompanying noise and maintenance.

Exemplifying decades of CATV technology leadership, TransHub III—like our entire fiber optics product family—can be delivered in standard configurations within 45 days.

Phone toll-free at **800-827-2722**, or FAX us at **415-651-8437** for our free CATV Fiber Optics Engineering Design Kit. Get a clear look into your fiber optics future—from your best guide into that future.



CATEL
THE CLEAR CHOICE IN FIBER

Reader Service Number 29

at the receive site. AM is readily adaptable to about any receive site location without the purchase of real estate.

The total system

To evaluate total system performance, the overall performance of the CATV amplifier cascade is power added to the performance of the AM link. Some of the typical performances are stated in Table 1.

An AM fiber system can transport 77 channels (550 MHz) through the use of multiple laser/receivers at the current state of technology to achieve the aforementioned performance levels. The best way to determine the effect of this technology in a particular plant is to look at a comparative example of a system designed with and without AM fiber. The following example analyzes the requirements to service a 15-mile run from the headend using both AM fiber electronics and power doubling amplifiers:

Bill-of-materials

AM fiber plus power doubling amplifiers:

- one 10-mile AM system;
- 10 trunk stations, one bridge, two line extenders (10-1-2).

Power doubling amplifiers:

- 34 trunk stations, one bridge, two line extenders. (34-1-2).

Other amplifier types are available with different operating parameters and associated distortion specifications that yield completely different end-of-line performance.

From the above example, it is evident that power doubling technology at 22 dB spacing may not be desirable for long cascades, but is very suitable when implemented in conjunction with AM fiber optics. This cascade without fiber would probably lend itself to feedforward technology, but there is still a trade-off between CNR and distortion.

The performance parameters that will be evaluated in this example are: CNR, CSO and CTB. The formulas used in this evaluation are approximations. These have been obtained from the various manufacturer handbooks and some are stated below. The formulas apply to the specifications published at the rated output for that number of channels.

Through the use of AM fiber optics,

Formulas

$$\text{CNR (dB) (single)} = \text{input level} + 59 - \text{Noise Figure (NF)}$$

$$\text{CNR (dB) (cascade)} = \text{CNR (single)} - 10 \log(n); n = \# \text{ of like amplifiers}$$

$$\text{CNR (dB) (total)} = 10 \log \left[\frac{\left(\frac{\text{CNR}}{10}\right) \text{AM} + \left(\frac{\text{CNR}}{10}\right) \text{CATV}}{10} \right]$$

$$\text{CSO (dB) (cascade)} = \text{CSO (single)} - 10 \log(n); n = \# \text{ of like amplifiers}$$

$$\text{CSO (dB) (total)} = 10 \log \left[\frac{\left(\frac{\text{CSO}}{10}\right) \text{AM} + \left(\frac{\text{CSO}}{10}\right) \text{CATV}}{10} \right]$$

$$\text{CTB (dB) (cascade)} = \text{CTB (single)} - 20 \log(n); n = \# \text{ of like amplifiers}$$

$$\text{CTB (dB) (Total)} = 20 \log \left[\frac{\left(\frac{\text{CTB}}{20}\right) \text{AM} + \left(\frac{\text{CTB}}{20}\right) \text{CATV}}{10} \right]$$

Overall Performance

	AM Fiber + 10-1-2	34-1-2
CNR (dB)	46	42
CSO (dB)	62	64
CTB (dB)	60	64

the cascade has been reduced greater than 3:1. Peak-to-valley of this reduced cascade provides better bandwidth performance. Distortions have been kept

60 dB down, which is desirable. The greatest improvement is in the quality of the delivered picture to the subscriber. The subscriber now has a picture that rivals the performance of Super-VHS. If the CATV picture is as good as other forms of media entertainment subscribers can receive, picture quality can be eliminated as a reason to disconnect.

To improve performance further, one can look at reducing the number of channels carried per laser or evaluating the affect of varying operating levels on the amplifier stations and derating line extender outputs.

This example was meant to demonstrate the use of the new AM fiber optic transmission system when considering that rebuild or extension. Significant improvements have been made in the last year on AM performance and that trend is continuing.

Ten years ago, when FM transmission over fiber was introduced into the CATV industry by Times Fiber Communications Inc., the system carried three channels per laser over 2 miles. Today's new FM architectures carry 18 channels/laser over distances of 28 miles without repeaters. AM technology is here to stay as an integral system element to provide the higher quality picture that the subscriber will ultimately demand. ■



FREE! FIBER OPTIC PRODUCT GUIDE.



ATI Supply provides fiber optic cables, assemblies, test equipment, and lightguide systems to fit your special requirements small or large. For your free catalog call any of the ATI locations below.

Western District (602) 894-1606	Corporate Headquarters Inside CA (800) 468-6278 Outside CA (800) 826-4821	Southern District (404) 233-7082
Eastern District (516) 293-1772	Northern California (916) 344-8080	Pacific Northwest (206) 395-0122
Atlantic Region (703) 817-0959	Central Region (312) 537-0520	Southwest District (409) 874-2308

ATI Supply is a Certified Women Owned Minority Corporation

Work Smarter with ADC Computerized Maps

Capture your entire operation at a glance. Plan for expansions and new territories. Generate maps for installation and service crews to follow. You can do it all – using your own computer and digitized maps from ADC.

No matter where you are in the continental U.S., ADC has digitized maps for you. All you need is a PC and one of the common CAD programs like AutoCAD.[®] We'll provide your map data on either 5 1/4" or 3 1/2" disks matched to your exact mapping requirements.

ADC offers you a variety of map options. Like Basic Maps, indicating major and secondary roads, trails, waterways, railways and other transportation routes. Double-Line Maps, ideal when road widths are needed. Or, Digital Elevation Maps, that can show terrain as either contour lines or as three dimensional grids.

Using your CAD program, you can modify, change or enhance your map to fit your exact needs. Add your revisions as overlays and plot them out in any scale or format.

Start mapping your course to future growth today. Call or write for more information and a free map sample.

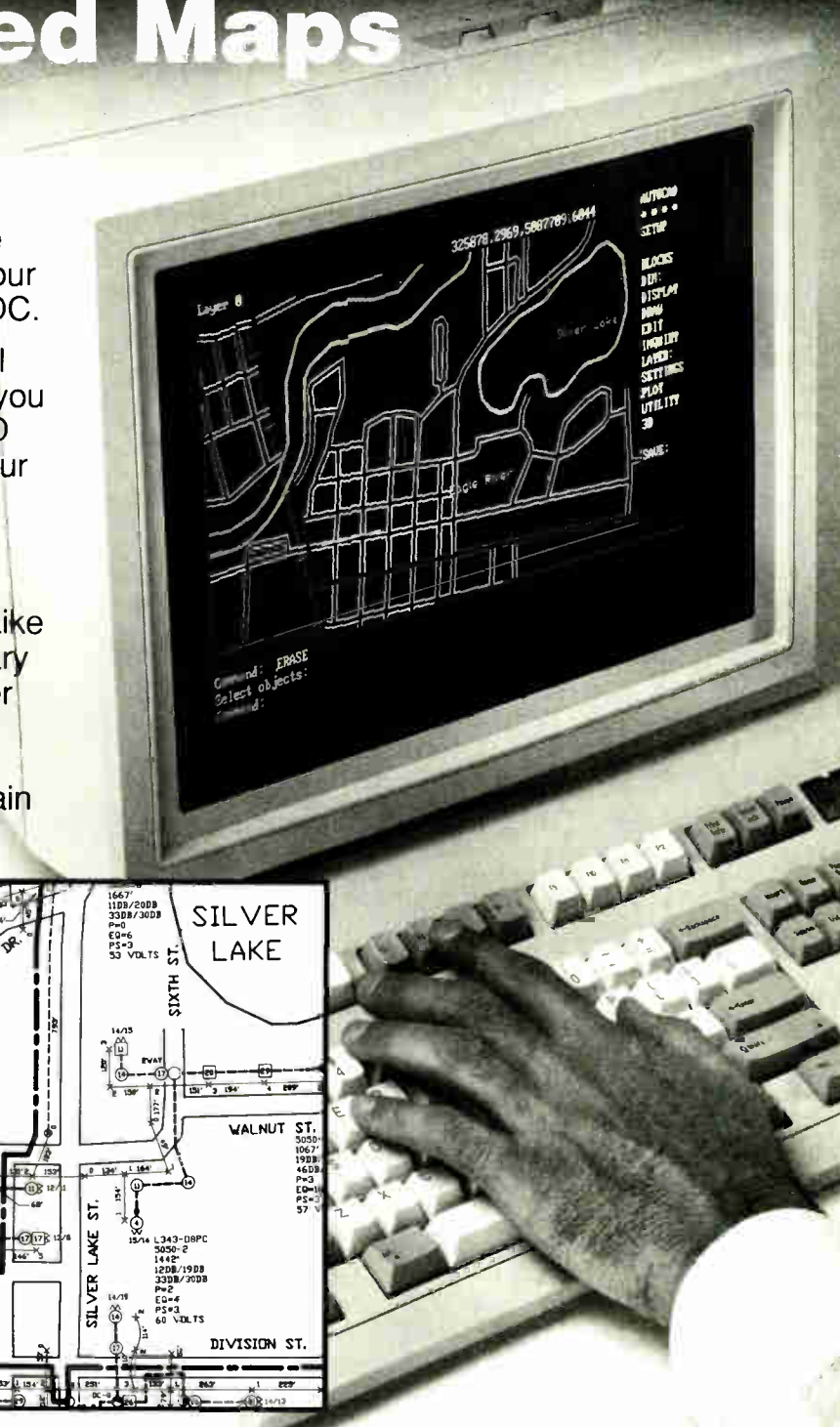
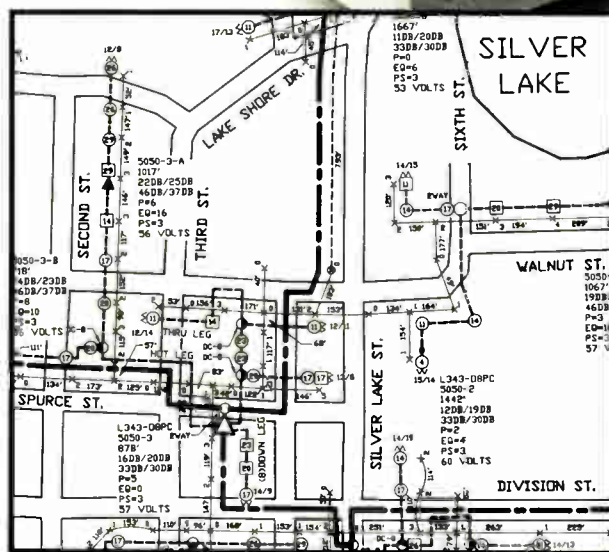

Sample map above shows ADC Double-Line Map with user enhancements indicating utility poles, cable and strand routing, location of splices, anchors, line amplifiers and power supplies, electronic specs and distances between points. Your CAD program will allow you to color code different elements and capture information on separate overlays.

AutoCAD[®] is a registered trademark of Autodesk, Inc.

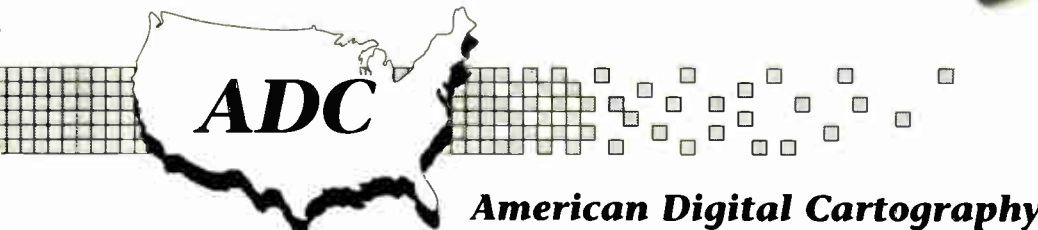

715 West Parkway • Suite A • Appleton, WI 54914 414/733-6678

Reader Service Number 31

Integrated AML/Fiber backbone system

A fiber optic backbone system fed by AML is a cable system architecture that provides both performance and cost advantages. Although both AML and a fiber backbone have been separately proposed as means of improving the overall cable system carrier-to-noise ratio, the attributes of AML and AM fiber are, in this case, complementary rather than competitive.

By combining the two technologies, one can overcome the drawbacks of each. Line-of-sight and zoning restrictions sometimes limit the location of AML receive sites. Shot and thermal noise sharply limit the carrier-to-noise ratios achievable with multiple-carrier AM fiber on long paths. When the latest AML technology is used to reduce the average length of the fiber backbone, the overall system C/N can be improved. At the same time, the savings in the cost of the glass can more than offset the cost of the microwave.

Introduction

The fiber backbone system concept was described in a series of papers presented at the 1988 NCTA convention.¹⁻³ The performance goals of this system were stated to be a 10-dB optical loss budget, 42 channels, and 55 dB C/N with 65 dB C/CTB and C/CSO. By cutting the trunk amplifier cascade length to two to four amplifiers, the fiber backbone concept should provide the advantages of improved reliability, quality and maintainability for the overall cable system.

Back in 1976, similar advantages were found to apply when AML microwave was used to cut trunk cascades to a maximum of 10 amplifiers.⁴ However, it is not always feasible to use microwaves for these purposes. A clear line of sight with adequate path clearance is required. Zoning restrictions may ban the installation of receive

sites, particularly in residential neighborhoods. In addition, if the trunk cascade is to be cut to two to four amplifiers, the number of receive sites in major cable systems would imply a broadcast type of transmit antenna. With existing power limitations, the microwave system would be restricted to very short range even if such a broadcast antenna pattern were permissible under CARS band rules. Currently, the largest point-to-point AML system utilizes only 32 receive sites.

On the other hand, it must also be acknowledged that today's AM fiber systems still fall short of the above-stipulated performance goals, particularly at larger distances. Moreover, with a large number of fiber hubs, and multiple glass fibers to each hub, the overall cost of glass is not an insignificant item. For these reasons, it is useful to consider a system architecture using AML microwave to sharply reduce the length of the fiber runs.

Each microwave receive site, aside from taking the place of one fiber hub, then becomes the source for feeding a dozen or more fiber backbone hubs. With modern AML equipment, it is possible to achieve high-quality performance at distances in excess of 20 miles. This reach should not be confused with 32 kilometers of fiber. Whereas microwave is "as the crow flies" distance, fiber must follow routings dictated by local conditions.

Even when there are no natural barriers, such as river crossings, involved, a reasonable expectation might be that the required fiber distance exceeds the microwave distance by 30 percent. Thus, the equivalent reach is 41 km of fiber. To this, one can add up to 10 km of AM fiber backbone for a total equivalent reach of over 50 km.

The general characteristics of the C/N performance of an AM fiber system have been clearly described.⁵ The three contributions to overall C/N are

$$C/N_{SOURCE} = \frac{m^2/2}{RIN \cdot B} \quad (1)$$

$$C/N_{QUANTUM} = \frac{m^2 R P_R / 2}{2qB} = \frac{m^2 \eta P_R / 2}{2h\nu B} \quad (2)$$

$$C/N_{RECEIVER} = \frac{m^2 R^2 P_R R_{eq} / 2}{4kTB \cdot F} = \frac{m^2 R^2 P_R^2 / 2}{< i_N >^2 B} \quad (3)$$

where m is here taken as the modulation index for each individual TV channel, which is often assumed to relate to a total modulation index $M = m\sqrt{N}$, with N being the number of channels. RIN stands for "relative intensity noise" and normally describes the intensity noise of the laser. However, multiple reflections on the fiber system, aside from possibly directly degrading laser RIN, can also give rise to additional RIN through conversion of phase noise to intensity noise.⁶

A typical linewidth for a DFB laser is 50 MHz. With this linewidth, a better than 40 dB return loss must be required of all fiber system components to keep the additional RIN at channel 2 (54 MHz) under -160 dBc/Hz. This is important when, with the use of optical isolators, the laser RIN is maintained at -153 dBc/Hz or better.

In equation (2), η is the quantum efficiency, a measure of the probability that an incoming photon of energy, $h\nu$ (h = Planck's constant and ν = optical frequency) will generate a hole-electron pair that is collected across the junction of a PIN photodetector. Although quantum noise is identified with receiver shot noise, it is based on a fundamental limit intrinsic to the electromagnetic field, wherein the background noise radiation at optical frequencies is approximated by $H\nu B$, rather than kTB as in microwave satellite receive terminals.

A factor of two arises because direct detection is less sensitive than heterodyne detection. Since η is already quite high (a 1.3 μ detector responsivity, R of 0.85 amps/watt implies an 81 percent quantum efficiency) the only available means of significantly increasing the C/N when quantum noise is dominant is to raise either m or the average optical received power P_R . Note that with electron charge, $q = 1.6 \times 10^{-19}$, P_R is in watts. With the NCTA definition of C/N, $B = 4 \times 10^6$.

A great deal of effort has been expended within the last decade in optimizing optical receiver sensitivity. This continuing effort⁷ has focused on transimpedance amplifier designs suitable for high speed data communications. Standard receivers of this type

By Dr. Thomas Straus, Chief Scientist, Hughes Aircraft Co., Microwave Communications Products

©NCTA. Reprinted with permission from 1989 NCTA Technical Papers

At Integral, Fiber Optics is "Old Hat"!

Hard



When you're ready for fiber optic cable-in-conduit, look no further than Integral. While Fiber Optics may be new to the CATV industry, it's "Old Hat" to us. We've been manufacturing Cablecon[®] Fiber Optic Cable-in-Conduit for more than 3 years now, and it's already in use in CATV "backbone" and transportation trunk line applications.

Integral has been in business for nearly three decades. Our involvement in the CATV industry began in 1980 and for the last four years, we have been considered the leader in the industry. Our Cablecon Cable-in-Conduit and empty duct are used in

more CATV underground plant installations than any other polyethylene duct. We are one of the largest commercial purchasers of underground coaxial cable in the United States.

Integral's Cablecon Fiber Optic Cable-in-Conduit provides the optimum solution for your underground plant installation needs. Our tough polyethylene duct provides unmatched protection from the elements, rough terrain, aggressive environments, and

people. And, Cablecon allows easy replacement of coax or fiber optic cables in the event

that it should become damaged and need repair or replacement.

Integral can provide Cablecon pre-assembled fiber optic cable in duct with cable purchased by you or Integral. It's readily available on standard 2KM or 3KM reels, and can even be purchased on reels up to 18,000'. Or, install Integral's empty duct with pre-installed pulling member and simplify your future cable installation. Either way, you'll save money, time, and tempers.

If you're ready for fiber optics, you're ready for Integral.

CALL 1-800-527-2168 TODAY

Now from Integral...

LUBADUK[®]

A slick solution
for cable pulling!

Marketed to the CATV industry
exclusively by
Channell Commercial Corporation
(818) 963-1694
(800) 423-1863
(except CA)
(800) 345-3624
(in CA)

 **Integral
Corporation**

P.O. Box 11269, Dallas, TX 75223-0269
(214) 826-0590

can respond out to 550 MHz with an equivalent transimpedance, R_{eq} , of 2 k Ω and beyond 330 MHz with $R_{eq} = 5$ k Ω . Unfortunately, at the high P_R required by equation (2), standard receiver designs suitable for data communications are not sufficiently linear for 40-channel CATV applications.

In particular, second-order distortion limits the transimpedance to on the order of 500 ohms for high-level input. Equivalently, one can ascribe an equivalent input noise current density, i_N , whose square is proportional to a noise factor, F , divided by R_{eq} . Receiver designs based on improved impedance matching of the photodiode to a CATV-type amplifier may also be characterized by an i_N .

Table I summarizes the assumed contributions to C/N for a hypothetical 42-channel link. It is obvious that all three contributions to system C/N must be improved to meet the original fiber backbone requirements. A 6 dB increase in laser power output would result in a 6 dB improvement of $C/N_{QUANTUM}$. Raising transmitter output by 6 dB also increases $C/N_{RECEIVER}$ by 12 dB, but the receiver distortion limit must be raised with higher P_R . Raising transmitter output by 3 dB

Table I
Assumed Fiber Optic Link Parameters

Optical Loss (dB)	C/N_{SOURCE}	$C/N_{QUANTUM}$	$C/N_{RECEIVER}$	C/N_{LINK}
2	56	58.3	71.6	53.9
4	56	56.3	67.6	53.0
6	56	54.3	63.6	51.8
8	56	52.3	59.6	50.2
10	56	50.3	55.6	48.3

$m = 4\%$ ($N = 42$)
 $RIN = -153$ dBc/Hz
 $P_{LASER} = 2$ mW (into fiber after isolator)
 $R = 0.85$ A/W
 $i_N = 4$ nA/ \sqrt{Hz}

also increases $C/N_{QUANTUM}$ by 3 dB. At this point, C/N_{SOURCE} would become the dominant term and RIN would have to improve.

The only factor that enters into all three terms is the modulation index, m . Improved laser linearity would be required but "crash point" saturation limit cannot be very far removed since even with 4 percent per-channel modulation, the 42-channel instantaneous current can, however briefly, drive the laser to below its threshold current. It

has been pointed out⁸ that phase fiddling in HRC systems could be useful in this regard.

The optical loss is normally assumed to be 0.5 dB/km at 1.3 μ . This includes an allowance for splice loss, but connector losses at transmitter and receiver ends and residual link margin are not included. The CATV operator will have to decide whether the planned fiber link distance can be based directly on the optical loss required for given C/N or whether 1 or 2 dB should first be subtracted before applying the 2 km/dB formula. Figure 1 plots the Table I C/N vs. distance assuming a 1 dB loss holdback for connectors.

Recent AML developments

Figure 2 summarizes the relative output capability of AML transmitters. The point to be made is not only the wide range in output capability but also the wide diversity of choice. The day when AML transmitters were available in only two varieties is long gone.

Two transmitters are of particular recent significance. The SSTX-145 is a solid-state high-power channelized transmitter⁹ that is almost comparable in power with traditional high-power AML but uses half the floor space and one-fifth of the primary power. At the



CABLE TELEVISION SERVICES

OFFERING EXTENSIVE TECHNICAL SUPPORT SERVICES INCLUDING:

- ★ SYSTEM DESIGN (D3 PROGRAM)
- ★ ON SITE PROJECT MANAGEMENT
- ★ TURNKEY INSTALLATION SERVICES
- ★ CLI SURVEYS (INCLUDING MTCE SERVICES)
- ★ FIBER OPTIC AND COAXIAL SYSTEM DESIGNS
- ★ MAPPING SERVICES (BASE, STRAND, AS BUILT) LINEX CAD SYSTEM

FOR ADDITIONAL INFORMATION, CALL

1-800-443-0738

1-800-782-1202 (MO Only)

"Providing Practical, Affordable Solutions to Real Problems"

Reader Service Number 33

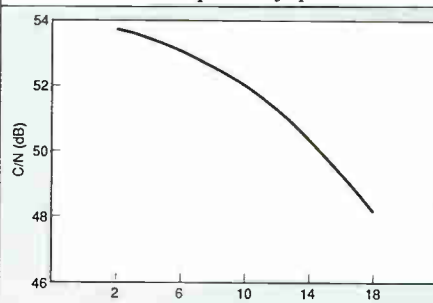

Figure 1

AML/FIBER BACKBONE

1988 Western Cable Show, this transmitter was teamed with a new Compact Outdoor Receiver¹⁰ for a live demonstration of a simulated eight-output 40-channel 32-km microwave link with 60 dB S/N. The AML demonstration equipment is depicted in Figure 3.

overall system costs for AML microwave will be far less than for the corresponding fiber system (disregarding for now the performance differences). Cost will of course vary greatly depending upon site availability, type of fiber construction, etc., but in gen-

eral, microwave will be more economical except for applications involving multiple paths under two to three miles in length or where the total of all path lengths add up to less than 10 miles. Thus, if cost and performance are the criteria, AML microwave will be preferred in most supertrunk applications. However, in the fiber backbone application, the one technology complements the other.

Combined AML and fiber backbone

Consider a rather idealized fiber backbone system in which the fiber nodes are uniformly spaced on an 8-by-8 grid. Assume further that the central headend is located at the point "X" shown in Figure 4a. If the streets run north-south and east-west, the fiber routes might exit the headend as shown. In total, there are 63 fiber hubs with the four directions connecting respectively to 17, 16, 15 and 15 hubs. If the spacing between hubs is conceived to be unity distance, the maximum length fiber run is eight units long, and the average distances is four units.

Contrast this with the situation in Figure 4b, in which four AML receive

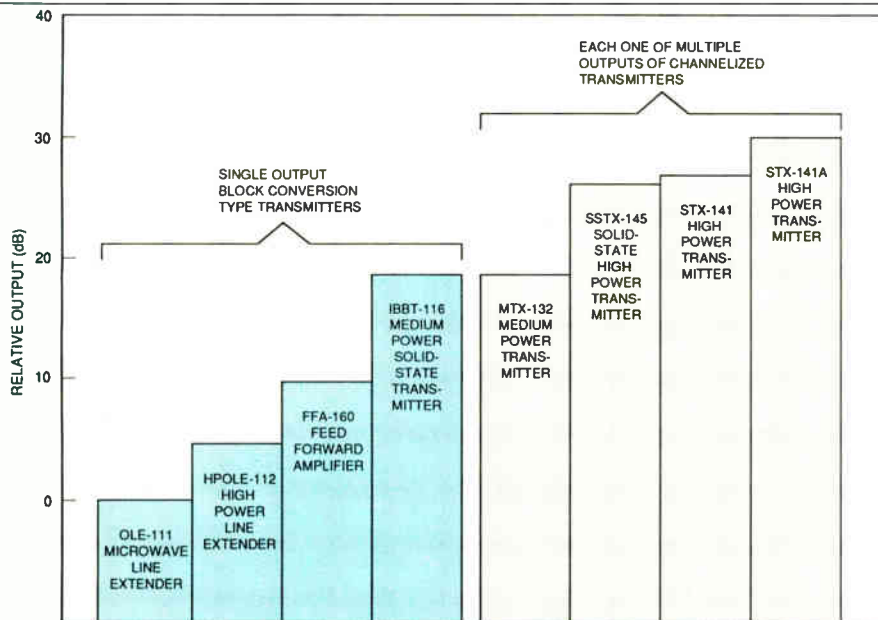

Figure 2

By measuring baseband characteristics including differential gain and phase, it was shown that the signal was indeed of a high quality. The S/N was largely determined by the higher than normal receiver microwave AGC threshold setting. This level setting trades off C/N against C/CTB and C/CSO. At the normal factory setting of -46 dBm for the COR-299 6 dB noise-figure receiver, C/N is 56 dB, C/CTB is 75 dB, and C/CSO is 70 dB for 40-channel loading.

Another recent AML development is the block upconverting IBBT-116 transmitter.¹¹ Table II summarizes its performance capabilities. This transmitter with a two-tone 3-IM intercept point of +57 dBm has 8 dB greater output capability than any previous CARS-band block-conversion type of transmitter. It is capable of full 80-channel loading, but when loaded with only 42 channels, its output is +9 dBm with 60 dB C/N, 65 dB C/CTB, and 65 dB C/CSO. Including a four-way split to 16-km microwave paths, the received signal level would be -42 dBm.

It is clear from the above that for supertrunk applications, AML microwave performance far outpaces what AM fiber systems can deliver. Moreover, for the two examples given,

SOLID STRENGTH AND PERFORMANCE

The tools of choice by Cable Prep

- Hand-crafted from precision parts
- Proven in the field for durability
- Made in the U.S.A. • Competitively priced
- Today's CATV toolmaker, CABLE PREP

We make your job easier!

GP cable prep
BEN HUGHES COMMUNICATION PRODUCTS CO.
207 Middlesex Avenue, P.O. Box 373
Chester, Connecticut 06412-0373
(203) 526-4337 FAX: (203) 526-2291

Copyright 1989 Ben Hughes Communication Products Co.

AN OPEN DOOR TO SUCCESS

CONVERTER REPAIR DEPT.

RIFKIN'S
 STORER CABLEVISION
 MULTIVISION UNIT
 CA... NT
 CE... EL
 PA... LE
 CC... ENTIAL CO
 CAST GROUP W M
 RETROVISION MULT
 TICHANNEL NYT C
 CABLE ATC TCI JC
 RIFKIN STORER CA
 CABLEVISION MU
 LTVISION UNITED
 D CABLE JONES I
 INTERCABLE CENT
 COM CENTEL PAR
 AGON CABLE CO
 TINENTAL COMCA



Authorized Parts Company
 has the quality repair parts need-
 ed to keep repair departments
 within budget and on schedule.
 APC has redesigned many new
 parts to be better than original, so
 operators can reduce service calls
 and save money.

Call for a catalog.

(312)658-6900

Authorized



Parts
Company

208 Berg Street Algonquin, IL 60102

Reader Service Number 35

AML/FIBER BACKBONE

sites, indicated by the cir-
 cles, have been added. The
 maximum length of fiber
 run is now reduced to
 three units, and the aver-
 age length is 1.85 units.
 The number of fiber hubs
 has also been reduced
 down to 59, because the
 AML receivers replace the
 fiber hubs at their loca-
 tions. The total cable dis-
 tance is likewise reduced
 from 63 to 59 units.

The central headend
 services 11 fiber sites, while each of the
 AML receivers connects to 12 fiber
 hubs. Table III summarizes the situ-
 ation. The cost savings that can be

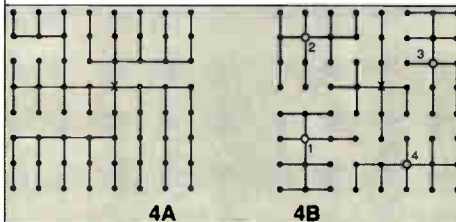

realized in the fiber plant will, of
 course, depend critically on the actual
 unit distance. Typically, the "unit"
 will be in the range of one to two miles
 or even greater if the length of the
 trunk cascade is allowed to grow above
 four.

A second critical parameter is the
 number of fibers that will be dedicated
 to each hub. An estimate of four
 (including spares) may not be unrea-
 sonable, but in some cases there may
 be even more. One reason for using
 multiple fibers is to reduce the channel

Table II

IBBT Power Output And C/N For 65 dB C/CTB and 65 dB C/CSO

No. of Channels	P _o (dBm)	C/N (dB)
12	15	66
21	13	64
35	10	61
60	7	58
80	5	56

loading on the individual fiber link. In
 particular, if the loading is reduced to
 18 channels, a frequency plan that
 avoids in-band second-order distortions
 can be constructed.

Aside from being able to increase the
 per-channel modulation index, *m*,
 roughly in proportion to the inverse
 square root of the number of channels,
 a further increase in *m* may be possible
 if filtering is applied to remove the
 out-of-band second-order products at
 the photo receiver output prior to
 recombining the channels. In all, the
 C/N shown in Figure 1 might then be
 increased by about 4 dB, assuming all
 other DFB laser and receiver param-
 eters were held the same. The exception
 would be the cross-over channels since
 the broadband noise would leak through
 and degrade C/N at the filter band
 edge.

When the signal source is also broad-
 band, as is the case with the AML
 receiver, it is probable that a guard-
 band channel would have, in any case,
 to be set aside to prevent undesired
 signal phasing effects due to inad-
 equate overall filtering at the source

Table III

Comparison of Idealized Fiber Backbone Systems

System Parameters	Without AML	With AML IBBT-116
Number of fiber hubs	63	59
Maximum fiber-run distance (unit)	8	3
Average fiber-run distance (unit)	4	1.85
Total fiber distance for one fiber/hub (unit)	252	109
Total fiber distance for four fiber/hub (unit)	1008	436
Total fiber cable distance (unit)	63	59
Max. distance from head-end to AML receive site (unit)		3.6
If unit distance = 2-1/4 Km		
C/N of longest 42-channel fiber link (dB)	49.2	52.8
C/CTB of fiber link (dB)	63	65
Combined C/N with AML (dB)	49.2	50.3
Combined C/CTB with AML (dB)	63	63.2
Installed cable cost savings @ \$6.8K/mile		\$38K
Glass cost savings @ 7 cents/foot and four fibers/hub		\$297K
Fiber hub savings @ \$20K/Tx-Rc pair		\$80K
AML IBBT-116 System Cost		<\$267K>
NET SAVINGS		\$148K

and fiber receiver ends. In any case, multiple fiber links to each fiber hub, although increasing complexity and cost of the electronics (assuming the same quality laser and receiver), is another option which presents itself to the CATV system designer.

To make a numerical comparison between the fiber backbone systems with and without AML, it is necessary to assign a definite length to the unit distance in Table III. With 2¼ km, the maximum fiber run length without AML is 18 km. It is assumed that increased C/N can be traded 1:2 for C/CTB without "crashing" the fiber system. Adding 1 dB to Figure 1, one then achieves a more respectable 49.2 dB. For the shorter 6¾ km maximum fiber distance with AML, normal 65-dB CTB operation is assumed.

The AML system consists of an IBBT-116 transmitter backed off to +7 dBm/channel output to improve C/CTB from a chain of dissimilar devices will add randomly, i.e., on a power-addition basis. The AML system cost includes the transmitter, four receivers, antennas, waveguide, typical installation costs, and a \$30K allowance for a transmit tower. The advantage in both cost and performance is evident even at these small distances. As the unit distance increases, the advantages of incorporating AML will tend to increase further.

It is of interest to compare this idealized system with a real CATV system layout. For this purpose, an enlarged cable system trunk route map corresponding to the fiber backbone system described in references 2 and 3 was obtained. The originally proposed

61-node fiber plant was redrawn with four AML receive locations superimposed. With fiber rerouting, the receiver sites service 7, 11, 12 and 14 fiber hubs, respectively, while the central point is connected to only 13 hubs. Although the fiber maximum distance was, without AML, only 9 miles (14.4 km), the ratio of average fiber route distance with and without AML worked out to be 0.50, which compares fairly well with the 0.46 ratio in Table III. The ratio of maximum fiber length correlated less well: 0.44 in the real system vs. 0.37 in the idealized case.

Although there are many similarities between the idealized and real systems, two factors diminish the AML advantage. One is the aforementioned smaller distance. The second factor stems from the Florida location where the rainfall environment is particularly severe. Nevertheless, another possible option in this case serves to illustrate a general point. The central hub site is itself fed from an existing channelized 7.6-mile distant AML transmitter with parallel 47 dB C/N AM fiber being used to provide a fail safe type of route redundancy to protect against rain fades.

With presently unused AML transmitter outputs, additional paths could potentially be implemented to provide signals to one or more of the AML receive sites. Although the cost of possibly upgrading the transmitter must be considered, in many cases the only real cost would be the addition of the receive path(s). In such a case, the economic advantage with AML would be overwhelming.

To achieve the goals¹ of the fiber

backbone system with present-day systems, one could construct a system

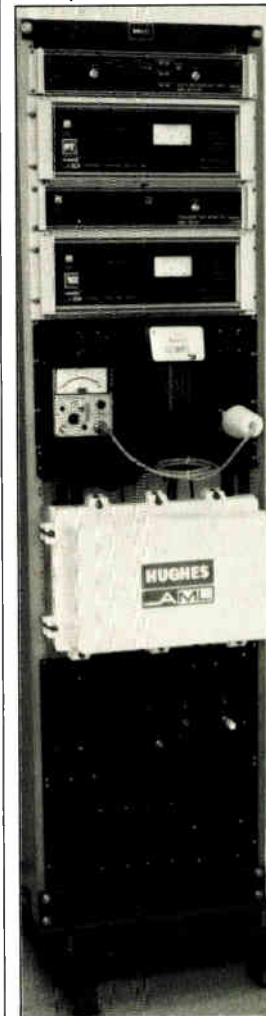

Figure 3

based upon either the AML MTX-132 transmitter of the SSTX-145 fiber plant. The channelized AML transmitters lend themselves to fiber backbone systems with many more fiber hubs than considered in Figure 3. The geographic coverage of such systems would extend over large urban and suburban areas. The principal drawback to such systems would be the complexity and cost associated with filtering and multiple laser sources to service each fiber hub.

One could, however, achieve the 50-dB distribution-system

Continued on page 62

C-COR & COMLUX

Working Together In Digital Fiber Optics

C-COR and COMLUX have joined forces to develop and produce all-digital fiber optic systems with price, features and performance for a perfect fit in your cable television plant.

Watch for the next generation of digital fiber products in the near future.

WE'RE OUT TO GIVE YOU THE BEST RECEPTION IN THE INDUSTRY.

C-COR[®]
ELECTRONICS INC.

60 Decibel Road / State College, PA 16801
814-238-2461 / 800-233-2267 / 800-356-5090 (in PA)

FIBER OPTIC CALLBOOK

The following companies have paid a fee to have their listing appear in the Fiber Optic Callbook.

Fiber Optic Cable

ANIXTER CABLE TV

Anixter Cable TV(312) 677-2600
WATS (National)(800) FIBER ME
4711 Golf Rd.

Skokie, IL 60076

PERSONNEL: Mike Sparkman, Wendell Woody

DESCRIPTION: A full line of AT&T single mode LXE fiber optic cable, in three designs: Standard LXE, with two steel strength members and an armor jacket; LXE-RL, with a copper coated stainless steel jacket for maximum rodent and lightning protection; LXE-DE, with an all dielectric design, eliminating steel jacketing and strength members for sensitive lightning and grounding areas. All LXE cables are available with fiber counts from 4 to 96.

C-COR[®] ELECTRONICS INC

C-COR Electronics, Inc.(814) 238-2461
WATS (National)(800) 233-2267
WATS (State)(800) 356-5090
FAX(814) 238-4065

60 Decibel Rd.

State College, PA 16801

PERSONNEL: John Hastings, National Market Manager, CATV; David Jordan, Product Manager

DESCRIPTION: C-COR designs and manufactures high quality electronic equipment for cable television and data communication systems worldwide. Together with COMLUX, C-COR is currently developing the first all-digital fiber optic system for the transmission of television signals.

Comm/Scope, Inc. THE Cable in Cable TV.

Comm/Scope, Inc.(704) 324-2200
WATS (National)(800) 982-1708
WATS (State)(800) 222-6808
FAX(704) 328-3400

1375 Lenoir Rhyne Blvd.
P.O. Box 1729

Hickory, NC 28603

PERSONNEL: Paul Wilson, Lynn Sigmon
DESCRIPTION: Supplier of high quality Optical Reach™ fiber optic cables employing depressed clad fibers in buffered tubes. Optical Reach is available in many constructions and fiber counts.

SIECOR

Siecor Corporation(704) 327-5554
FAX(704) 327-5973

489 Siecor Park

Hickory, NC 28603-0489

PERSONNEL: Sandy Lyons (704-327-

5806), David Johnson (704-327-5895)

DESCRIPTION: Siecor manufactures fiber optic cables for aerial, direct buried, duct installations. Loose tube design is easy to handle and provides superior protection from lightning, water penetration, stress fatigue. Modular buffer tube design simplifies fiber drop-off and mid-span access. Many cable design available to meet variety of customer needs.

SUMITOMO ELECTRIC Fiber Optics Corp.

Sumitomo Electric(919) 541-8100
Fiber Optics Corp.

WATS (State)(800) 358-7378
P.O. Box 13445

78 Alexander Drive

Research Triangle Pk, NC 27709

PERSONNEL: Larry Corsello, VP-Sales & Marketing; Fred McDuffee, Product Manager, Optical Cables

DESCRIPTION: Manufacturer of fiber optic cable, fiber optic analog and digital systems, fusion splicing machines, ancillary equipment, optical data links and provider of engineering/installation services.

TFC TIMES FIBER COMMUNICATIONS, INC. an J.P.J. company

Times Fiber Comm.(203) 265-8510
FAX(203) 265-8422
358 Hall Ave.

Wallingford, CT 06492

PERSONNEL: John Simons, Jack Forde

DESCRIPTION: Times Fiber offers a complete line of fiber optic systems, including high quality FM links for your studio needs, microwave replacement systems, FM super trunking to HUB networks as well as the latest fiber technology being applied to AM

CATV trunk systems.

Electronics

ANIXTER[®] CABLE TV

Anixter Cable TV(312) 677-2600
WATS (National)(800) FIBER ME
4711 Golf Rd.

Skokie, IL 60076

PERSONNEL: Mike Sparkman, Wendell Woody

DESCRIPTION: Anixter Cable TV supplies a full line of both FM and AM electronics for fiber optic systems. FM electronics by Synchronous Communications offer BTSC stereo and scrambling compatibility; The SAFOL system transports quality signals from a remote satellite receiver to the headend. Anixter's own AM Laser Link: LLT Headend Transmitter (utilizing AT&T DFB lasers for high power and superior linearity), and an LLR Hub Site Receiver (rack-mounted) or an LLR Remote Node Receiver (stand or pedestal mounted). The LLR's offer modular 1GHz platforms with feed forward or power doubling, and are available in multiple configurations to fit any fiber architecture. Anixter Cable TV also carries a full line of AT&T digital transmission electronics for voice and data applications.

C-COR[®] ELECTRONICS INC

C-COR Electronics, Inc.(814) 238-2461
WATS (National)(800) 233-2267
WATS (State)(800) 356-5090
FAX(814) 238-4065

60 Decibel Rd.

State College, PA 16801

PERSONNEL: John Hastings, National Market Manager, CATV; Dick Taylor, National Sales Manager, CATV

DESCRIPTION: C-COR designs and manufactures high quality electronic equipment for cable television and data communication systems worldwide. C-COR offers a complete line of amplifiers with status monitoring, modems, a camera control system, passives, and power supplies.

CableBUS[®] SYSTEMS CORPORATION

CableBus System Corp.(503) 228-6761
FAX(503) 228-6831
3489 N.W. Yeon
Portland, OR 97210

FIBER OPTIC CALLBOOK

PERSONNEL: Cliff Schrock, President; Byron Johnson, Customer Service
DESCRIPTION: Provides broadband and optical fiber telemetry products including security systems, camera control, and industrial control. CableBus also provides short haul optical fiber extentions to broadband for traffic light and water control applications.

JERROLD

Jerrold (215) 674-4800
General Instrument
WATS (National) (800) 523-6678
WATS (State) (800) 562-6965
FAX (215) 672-5130
 2200 Byberry Road
 Hatboro, PA 19040
PERSONNEL: David Robinson, Director of Cableoptics; Geoff Roman, V.P. of Marketing
DESCRIPTION: Designer/Manufacturer of the industry's most comprehensive line of electronic and fiber optic broadband communications equipment. Jerrold Starlite Cableoptics™ equipment supports both FM supertrunk and AM backbone distribution applications. The company's RF distribution and headend gear provide a complete optoelectronic product line for cable TV and LAN systems.

MAGNAVOX

CATV SYSTEMS CO.

Magnavox CATV Systems . (800) 448-5171
WATS (State) (800) 522-7464
FAX (315) 682-9006
 100 Fairgrounds Drive
 Manlius, NY 13104
PERSONNEL: John Caezza, Product Manager; Rick Haube, Fiber Optic Product Specialist
DESCRIPTION: Manufacturer of video and data transmission systems, FM video transmission systems to include FM modulators/demodulators, laser diode transmitters, and optical receivers. AM fiber optic transmission systems to include rack mounted transmitters and rack or strand mounted receivers. Also a supplier of Amplitude modulated headend equipment.



Ortel Corp. (818) 281-3636
FAX (818) 281-8231
 2015 W. Chestnut Street
 Alhambra, CA 91803

PERSONNEL: Larry Stark, Director of Marketing; Bill Moore, Director of Sales
DESCRIPTION: Ortel manufactures fiber optic components for AM CATV transmission and for satellite TVRO antenna remoting.

Scientific Atlanta

Scientific-Atlanta (800) 722-2009
FAX (404) 925-5445
 P.O. Box 105027
 Atlanta, GA 30348
PERSONNEL: John Mattson, Godfrey Pinto
DESCRIPTION: Scientific-Atlanta's FOCUS AM Fiber Optic System provides unmatched performance combined with maximum reliability. The system consists of the model 6450 Optoelectronic Transmitter and the model 6901 Optoelectronic Bridging Amplifier, each of which can be custom-configured for optimal performance in a variety of applications.

SUMITOMO ELECTRIC

Fiber Optics Corp.

Sumitomo Electric (919) 541-8100
Fiber Optics Corp.
WATS (State) (800) 358-7378
 P.O. Box 13445
 78 Alexander Drive
 Research Triangle Pk, NC 27709
PERSONNEL: Larry Corsello, VP-Sales & Marketing; Fred McDuffee, Product Manager, Optical Cables
DESCRIPTION: Manufacturer of fiber optic cable, fiber optic analog and digital systems, fusion splicing machines, ancillary equipment, optical data links and provider of engineering/installation services.

Test Equipment

fotec

fotec incorporated

Fotec (617) 241-7810
WATS (National) (800) 537-8254
FAX (617) 241-8616
 529 Main Street
 Boston, MA 02129
PERSONNEL: Kevin Collins, Bill Pierce, Louise Downing, Sales Dept.
DESCRIPTION: Products: Fotec manufactures test equipment for fiber optic telecom, datacom and CATV systems and provides training programs in fiber optics.

Fotec has been involved with fiber optics since 1981 and has helped develop testing technology, products and training to support the installation, testing and maintenance of fiber optic systems. Low cost field equipment is a specialty.

Laser Precision Corp. . . . (315) 797-4449
FAX (315) 798-4038
 1231 Hart Street
 Utica, NY 13502
PERSONNEL: Dave Stehlin, Wes Simpson
DESCRIPTION: Established in 1969, Laser Precision Corporation is a manufacturer of fiber optic test equipment. Products include Optical Time Domain Reflectometer (OTDR's), loss test sets, reflectometers, power meters and light sources for short or long haul applications.

SIECOR

Siecor Corporation (704) 327-5503
FAX (704) 327-5042
 489 Siecor Park
 Hickory, NC 28603-0489
PERSONNEL: Judith Lavin (704-327-5503), Todd Jennings (704-327-5051)
DESCRIPTION: Siecor's optical test equipment includes attenuation, bandwidth and dispersion testers; OTDRs, hand-held optical testers, power meters and light sources; and accessories, for troubleshooting, maintaining and testing CATV and related applications, as well as fiberoptic testing programs at training schools, colleges, lab and production facilities.

Accessories

Amphenol

an LPP company

Amphenol Fiber Optics . . (312) 960-1010
FAX (312) 810-5640
 1925A Ohio Street
 Lisle, IL 60532
PERSONNEL: Phillip Schofield, Paul Kopera
DESCRIPTION: Manufactures fiberoptic interconnection systems including: SMA, ST, & FC connectors and termination tooling, patchcord, pigtailed, singlemode & multimode passive couplers and wavelength division multiplexers.

FIBER OPTIC CALLBOOK

ANIXTER CABLE TV

Anixter Cable TV(312) 677-2600
WATS (National)(800) FIBER ME
 4711 Golf Rd.
 Skokie, IL 60076
PERSONNEL: Mike Sparkman, Wendell Woody

DESCRIPTION: A complete line of apparatus, test equipment and accessories for fiber optic system deployment, including: AT&T LGX enclosures and cabinets for accessible termination points in headend or hubsite locations. The AT&T UCB1 fiber optic enclosure accommodates both fusion and rotary splices in remote node sites, offering express through capabilities for both aerial and underground applications. Multiple splicing options, featuring the Anixter Rotary Splice (ARS) with performance comparable to fusion splicing. All associated tools and test equipment, and complete training on proper use by Anixter Cable TV Fiber Optic Engineers.

AUGAT AUGAT COMMUNICATIONS GROUP INC.

Augat Comm. Group . . .(206) 932-8428
FAX(206) 938-8850
 2414 SW Andover Street
 Seattle, WA 98106

PERSONNEL: Randy Noland, Group Dir. of Marketing; Amy Amrhein, Fiberoptic Product Manager
DESCRIPTION: The fiberoptics product line of the Augat Communications Group offers the following: SMT, SMA and biconic connectors; SMT, SMA and termination kits. Gauging tools; heat curing ovens; tools and accessories; modems and mux interfaces; cable assemblies; fiberoptic patch panels; Augat/Cinch fiber optic wiring system.

C-COR[®] ELECTRONICS INC

C-COR Electronics, Inc. . .(814) 238-2461
WATS (National)(800) 233-2267
WATS (State)(800) 356-5090
FAX(814) 238-4065
 60 Decibel Rd.
 State College, PA 16801

PERSONNEL: John Hastings, National Market Manager, CATV; Dick Taylor, National Sales Manager, CATV
DESCRIPTION: C-COR designs and manufactures high quality electronic equipment for cable television and data

communication systems worldwide. C-COR's power supplies include the PS-900A, a single module Standby Power Supply featuring: 900 watts @ 60 volts; transfer time 16 ms; surge protection; pole or pedestal mounting; and a 3-year warranty. Non-standby power supplies are also available.



Cable Security Systems, Inc.

Cable Security/(800) 288-1506
Power Guard
FAX(205) 742-0058

506 Walker Street
 P.O. Box 2796
 Opelika, AL 36801
PERSONNEL: Mike Springer, V.P. CSSI; D.J. Bos, V.P. Power Guard
DESCRIPTION: CSSI's new pole mount fiber optic slack boxes with add-on splice cabinets were designed specifically for CATV by CATV experts. Power Guard's fully modular power supplies are perfect for fiber backbone applications. They are available in 5, 8, 10, 15, and 18 amp models to meet all cascade depths.

Integral Corporation

Integral Corp.(214) 826-0590
FAX(214) 823-4845

P.O. Box 11269
 Dallas, TX 75208
PERSONNEL: Dean Taylor, VP Sales; David Massaglia, Sales Manager
DESCRIPTION: CABLECON®: HDPE conduit with fiber cables or pull rope pre-installed. Lengths, up to 31,000 feet are available. LUBADUK®: Cable pulling lubricant with microspheres.

RELIANCE COMM/TEC

Reliable Electric(312) 455-8010
FAX(312) 451-5516

11333 Addison
 Franklin Park, IL 60131
PERSONNEL: Rick Huggins, Product Manager, Fiber Optics; Rick Siemens, Product Manager, CATV Products
DESCRIPTION: Fiber optic accessory items, connectors, cables splice organizers, distribution enclosures for indoor and outdoor applications, buried and aerial terminal and splice enclosures, headend distribution

equipment, fiber optic pedestals.



Tamaqua Cable(717) 385-4381
Products Corp.

FAX(717) 385-1092
 300 Willow Street
 Schuylkill Haven, PA 17972
PERSONNEL: Joe Helms, Wendy Gehrig
DESCRIPTION: Fiber optic cable pre-installed in high density polyethylene "Ducted Systems". Sizes from 1 inch to 3 inch, in continuous lengths up to 30,500 feet. Tensile strength of some systems to 5,000 pounds.

Construction Services

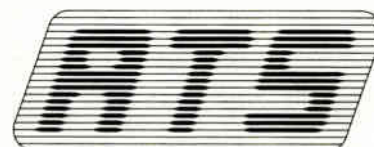

American Telecom(800) 537-2440
Services, Inc.

FAX(215) 538-3229
 P.O. Box 479
 Quakertown, PA 18951
PERSONNEL: Maqbool A. Qurashi, John T. Kurpinski, Sr.
DESCRIPTION: Complete turnkey or labor only construction of fiber optic systems services include routing, field survey, planning, design, supply and installation of lightguide communications. Systems both aerial and underground.

Burnup & Sims Cable Com, Inc.

Burnup & Sims(404) 482-7612
Cable Com, Inc.

FAX(404) 482-5914
 6440 Hillandale Drive
 Lithonia, GA 30058
PERSONNEL: Larry E. Wallace, John (Mike) Gepford
DESCRIPTION: Burnup and Sims pioneered in the installation of fiber and is capable of quality aerial and buried installation. Our service area is the Continental U.S.



Kennedy Cable(912) 557-4751
Construction Inc.

FAX(912) 557-6545
 P.O. Box 760
 Highway 280 West
 Reidsville, GA 30453

FIBER OPTIC CALLBOOK

PERSONNEL: Frank Walker, Roger Kennedy Jr.
DESCRIPTION: Kennedy Cable Construction, Inc. provides field work, computer-aided design, engineering and drafting of different hybrid fiber optic—coaxial cable architectures. Systems can be constructed on a labor only cost or full/modified turnkey basis. Construction services include aerial, underground and submarine.



RESOURCE RECOVERY SYSTEMS

Resource Recovery(512) 828-7777
Systems
FAX(512) 828-2944
 8610 Broadway, Suite 220
 San Antonio, TX 78217
PERSONNEL: Tom Wood, Mary Wood, Tom Wood, Jr.
DESCRIPTION: Nationwide buyers of scrap material from system new and rebuild construction across the country. We also buy scrap electronics such as taps and amp housings. Also working to develop effective methods of separating and marketing scrap drop wire. Give us a call and let us show you how you can generate revenue from those items you might otherwise have to pay to have hauled to landfill.



Schenck Construction . . .(206) 867-9694
 15042 NE 95th
 P.O. Box 3159
 Redmond, WA 98073-3159
PERSONNEL: Edward A. Schenck, President; Bud Longnecker, VP/Aerial
DESCRIPTION: Aerial and underground cable TV construction; turnkey, and fiber optic installation.

Suppliers/Dist./Reps



Anixter Cable TV(312) 677-2600
WATS (National)(800) FIBER ME
 4711 Golf Rd.
 Skokie, IL 60076
PERSONNEL: Mike Sparkman, Wendell Woody
DESCRIPTION: Anixter Cable TV is a complete fiber optic systems integrator, with a dedicated group of Fiber Optic Engineers to assist customers with deployment of the technology in the field. In addition to Anixter's own AM Laser

Link™ product line of optical electronics, Anixter Cable TV carries FM electronics by Synchronous Communications, LXE single mode fiber optic cable by AT&T, splicing and accessories by AT&T, and apparatus and test equipment by AT&T and other leading manufacturers.



Cable Services Company Inc.

2113 Marydale Ave., Williamsport, PA 17701 • 717/323-8518
 1-800-233-8452 Nationwide

Cable Services Co., Inc.(800) 233-8452
WATS (State)(800) 332-8545
FAX(717) 322-5373
 2113 Marydale Ave.
 Williamsport, PA 17701
PERSONNEL: Sales Department
DESCRIPTION: Suppliers of cable, distribution, splicing, tools and hardware for CATV fiber optic systems.



Your Link with Fiberoptics

Fibertron Corp.(213) 690-0670
FAX(213) 697-5360
 450 E. Commercial Way
 La Habra, CA 90631
PERSONNEL: Marlene Spiegel, Melisa Walker
DESCRIPTION: Fibertron offers the one place where customers can learn about fiber optics and buy all of the products they need. In many ways, the company fills the role of rep firm, a value-added reseller and a specialty distributor. Fibertron's authorized product lines include 3M, AT&T, AMP, Augat, Belden, Chromatic Technology, ITT Cannon, Ixian, Reliance Electric, Amphenol, American Fibertek, BICC, Codenoll Technology, Lee Data Communication, PSI Lightlinker, Siecor, Arnco, Bausch & Lomb, Buehler, Clauss Cutlery, Lunzer, Paladin and Tra-Con. In addition, Fibertron markets its own Multi-Cure Fiber Optic Connector oven that provides uniform, controlled curing of epoxy used in the termination of fiber optic cables to connectors.



Jerry Conn Assoc. Inc.(717) 263-8258
WATS (National)(800) 233-7600
WATS (State)(800) 692-7370
FAX(717) 263-1547
 P.O. Box 444
 Chambersburg, PA 17201
PERSONNEL: Bob Sollenberger, John Miller, Mike Harpster
DESCRIPTION: Manufacturers' representatives for Siecor, manufacturer of

various styles of fiber optic cable; and for Catel, manufacturer of FM and AM fiber optic transmission equipment including transhub FM VSB/AM and the new high performance transhub III VSB/AM fiber optic systems.



MICROJAT

Microsat Inc.(404) 971-1021
WATS (National)(800) 438-0812
WATS (State)(800) 334-1558
FAX(404) 977-7128
 1519 Johnson Ferry Road
 Suite 250
 Marietta, GA 30062
PERSONNEL: Butch Roberson, Rick Jubeck
DESCRIPTION: Manufacturer's representative for a complete line of fiber optic equipment and connectors by Augat. Fiber optics, AM and FM headend equipment by Catel, and cable by Siecor.



A Division of Midwest Corporation

More than supplies. Solutions.

Midwest CATV(304) 343-8874
WATS (National)(800) 532-2288
FAX(304) 346-0624
 P.O. Box 271
 Charleston, WV 25321
PERSONNEL: Christopher Sophinos, Vice President/Chief Operating Officer; Scott Henry, Sales Engineer
DESCRIPTION: Midwest CATV is a full-line fiber optics supplier. Fiber is available to your needs from Belden, Comm/Scope or Times Fiber. Electronics are available from Olson Electronics and the Jerrold Division of General Instrument. Accessories for installation are also available from numerous manufacturers, including our own fiber optic splice pedestal. Call our offices for fast service.



Midwest Comm. Corp.(606) 331-8990
WATS (National)(800) 543-1584
 One Sperti Drive
 Edgewood, KY 41017
PERSONNEL: Paul R. Nickless
DESCRIPTION: Midwest Communications Corp. is a leading supplier of video, audio and transmission equipment and systems to the television industry. Midwest offers design, engineering equipment selection and procurement, installation, testing and maintenance services for RF and fiber transmission systems.

CATV fiber training

The evolution of new technology in the cable industry is truly an ongoing phenomenon. Where would the industry be without significant technical advancements and innovations? So, the introduction of fiber into the cable plant was not totally unexpected. In fact, it seemed the next logical step to keep the telephone companies at bay and improve the image of cable companies as highly technical, even aggressive contenders in the telecommunications race to the subscriber's home.

True to form, the introduction of fiber into the industry has followed the same process as all new technologies: we talk about it a lot in technical sessions at conventions, the trades provide information on what we talked about in the technical sessions, we talk about it some more, someone bites the bullet and tries it in a single system (holding the vendor for ransom if it doesn't work), it does work, others try it and like it. Then we discover we need training. It happens every time!

But this time, we seem to be a little more prepared. Fiber training is not far behind the introduction of the technology, giving the cable operator the advantage of hitting the ground running.

Where does new training come from?

The development of training for new technologies follows an equally regular pattern as the introduction of the technology itself. The first easily available information is provided by the technical trades. This information gives a sometimes in-depth look at current research, different theories, potential configurations and applications, economic impact, and some of the nitty gritty technical information surrounding the birth of a new technology.

By the time cable operators are ready to use the technology, the vendors become the next source of training. Because they are now experts in the technology, they provide initial, often on-site training to users. But fre-

quently, vendors are accused of providing only product-specific training rather than a general training course. So, to provide that overall training program, consultants and training vendors begin to fill in the blanks.

With the introduction of fiber, the cable industry has experienced this same cycle, but at a much faster pace. The players in the cycle seem to have anticipated the need for training, and have planned much further in advance of the critical need.

The need for fiber training

The introduction of fiber into cable TV has manifested some rather typical

disadvantage is the staff, particularly the technical staff at the system level, are left waiting for information to begin to migrate out into the field. If the information is passed along at all, it is usually in an abbreviated form. And so it is with fiber.

There is a tendency to assume technical staff at all levels of a cable operation are equally informed about fiber when, in fact, communication from the corporate office to the field site can leave many gaps.

What we tend to forget is if we were all in a race for information on fiber, not only are we not neck-and-neck, we didn't even begin at the same starting point. Training is an effective means to fill in the gaps as well as provide a consistent starting point.

Third, now that fiber has been embraced by the industry, there is almost too much information to digest and assimilate. Information overload can occur when an organized plan of information transfer, or learning, is not established. A well-planned training program on fiber is a simple cure for overload. Once the basics of fiber are understood, residual information is easily filtered for its usefulness or applicability.

Through training that provides a foundation in fiber basics, and specifically how the use of fiber will impact day-to-day operations, most false assumptions will be addressed and fears alleviated.

reactions, all of which training can effectively address. First, there is a hesitancy or fear of the unknown. Fiber is so completely different in its construction than coax, there is a tendency to make somewhat inaccurate assumptions about it that foster a negative reaction or fear. Through training that provides a foundation in fiber basics, and specifically how the use of fiber will impact day-to-day operations, most of those false assumptions will be directly addressed and fears alleviated. The best time to provide such training to system personnel is before the fiber project begins.

Second, with most new technologies, the preliminary testing, evaluation, meetings with vendors, initial design, and sometimes even final purchase decisions are made at the corporate office. The advantage of this process is the cost-effectiveness and contributions of the small collective group. The

What you should know about fiber

If you are evaluating a fiber training program or wishing to develop a training program, some of the basic information that will be necessary in order to implement a fiber project are as follows:

Fiber theory. Important to a fundamental understanding of fiber optics is light theory and how it compares to other transmission media including digital, AM and FM. Equally important is an overview of fiber structure, lasers and electronic components of a fiber system.

Design. Because system design varies dramatically, a basic understanding of basic fiber architectures, "backbone," CAN (Cable Area Network), back-to-back AM, is necessary before considering the design of a fiber project. Also key to designing CATV fiber applications is the loss budget concept

By Dana Eggert, President, Performance Plus

No ad could possibly demonstrate the world's easiest fiber optic splicer. So demo our video.



10:01

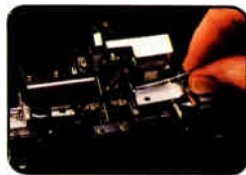

10:02



10:02

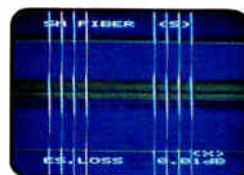

10:03



10:06

If you've ever cursed at a fiber optic splicer, we have something that will make you smile: the new Type-35 Fusion Splicer demonstration video.

You'll see that fiber optic splicing is a lot simpler and faster than you ever imagined. The portable Type-35 lets you whip out flawless fusion splices in the field just as you would at the workbench.

Flawless, because fusion splicing gives you permanent, environmentally stable connections with extremely low reflection.

And not just the easy splices either. The Type-35 lets you



choose 16 independent fusion programs to handle practically any field application.

But even with a ton of standard features, it weighs just 22 lbs. And it's strong, built to be knocked around under the worst field conditions and still stay in calibration. Because tough conditions are the norm, and a finicky splicer can turn a bad day into a long, bad day.

Watch our video and see how a smart, flexible, tough fusion splicer can change all of that.

Call 1-800-358-7378 (in North Carolina, 919-541-8200) or send/fax the coupon for your free copy.

Yes, I want to see it for myself. Send me your demo video on the Type-35 Optical Fiber Fusion Splicer.

Sumitomo Electric
Fiber Optics Corporation
78 Alexander Drive
P.O. Box 13445
Research Triangle Park, NC 27709
Fax: 919-541-8265

Please enclose your business card.

Name _____

Company _____

Address _____

City _____

State _____ Zip _____

Phone (____) _____

Limit one video per facility.
Offer expires May 1, 1990.

© 1989 Sumitomo Electric Fiber Optics Corp.

 **SUMITOMO ELECTRIC**
Fiber Optics Corp.

FIBER TRAINING

and field design considerations.

Construction/equipment. While fiber construction is performed primarily by contractors, it is nevertheless, beneficial to have a general knowledge of the installation process, aerial and underground placement, fiber splicing techniques as well as the equipment installation, rack mounting, power requirements, input and output levels, and a thorough knowledge of the operation of the equipment.

Operation and long-term maintenance. Finally, in order to maintain and operate the fiber plant, testing procedures, preventive maintenance and troubleshooting techniques are essential.

Available fiber training sources

Although it may seem like there are a limited number of resources available for CATV fiber training, there are nonetheless, a number of programs that will be introduced before the end of the year. There is an abundance of documentation on CATV fiber applications through the trades and technical papers, SCTE chapters have and continue to provide special fiber meetings. In addition, NCTI plans to release a stand alone course, CATV Fiber Optics,

by October of this year.

Vendor sponsored training programs also provide an in-depth approach to fiber. Not only are they providing

**...the outlook for
fiber training looks
positive...**

product-specific training, but some of the basic fiber concepts as well. For example, AT&T National Product Training Center provides a number of separate courses ranging in length from two to five days and focus on cable placing and distribution and outside plant fundamentals.

In an effort to address the ever-present issues of time and cost involved in training, other vendors are currently considering delivering fiber training in a computer-based, interactive format in addition to initial on-site sessions.

The advantages to the cable operator of this delivery system are numerous;

technical staff is provided the opportunity to go through the training program according to their schedules; since the training remains with the cable operator, training can be repeated frequently; the training is divided into stand alone modules so that staff members can complete as much of a single module or multiple modules as time allows. In fact, the operator can control the training function in-house through this vendor-sponsored computer-based training.

Training the technical workforce

As more and more fiber projects are implemented, more of the CATV technical workforce will be required to have first-hand knowledge of the technology. Although it is not an organized process, each time a technology is introduced and expands, the industry, in essence, trains the entire technical workforce. However, as unplanned a process as it may be, the outlook for fiber training looks positive, in part, due to the rapid implementation of the transmission medium. Fiber training will become even more abundant and readily available as the industry adopts the fiber phenomenon. ■

Ad Index

Reader Service #	Page #	Reader Service #	Page #
AT&T33 52	Kennedy Cable Const.16 28
ATI Supply30 48	Laser Precision23 37
American Digital Cartography31 49	Magnavox CATV12 23
Alpha Technologies20 33	Midwest CATV3 7
Anixter Cable TV41 68	Midwest Cable Services37 63
Anritsu American Inc.6 15	National Cable Television Institute .2134
Augat Communications13 25	Photon Kinetics4 11
Authorized Parts35 54	Power Guard15 27
C-COR Electronics36 55	Reliable Electric9, 11 19, 21
Cable Exchange14 26	Resource Recovery24 39
Cable Prep/Ben Hughes Comm.34 53	STC Telecomm. Inc.25 40
Catel Communications29 47	Scientific-Atlanta2 5
Commscope5 13	Seiko Instruments USA19 32
Eagle Comtronics28 45	Siecor Corp.27 43
General Instrument/Jerrold1 2-3	Sumitomo Elec. Fiber Optics8, 39 18, 65
Hughes Microwave10 20	Tamaqua Cable26 41
Integral32 51	Times Fiber40 67
JDS Optics17, 18 29, 31	U.S. West Comm.22 35
Jackson Tools38 62	Westec7 17

The Future Is Here!

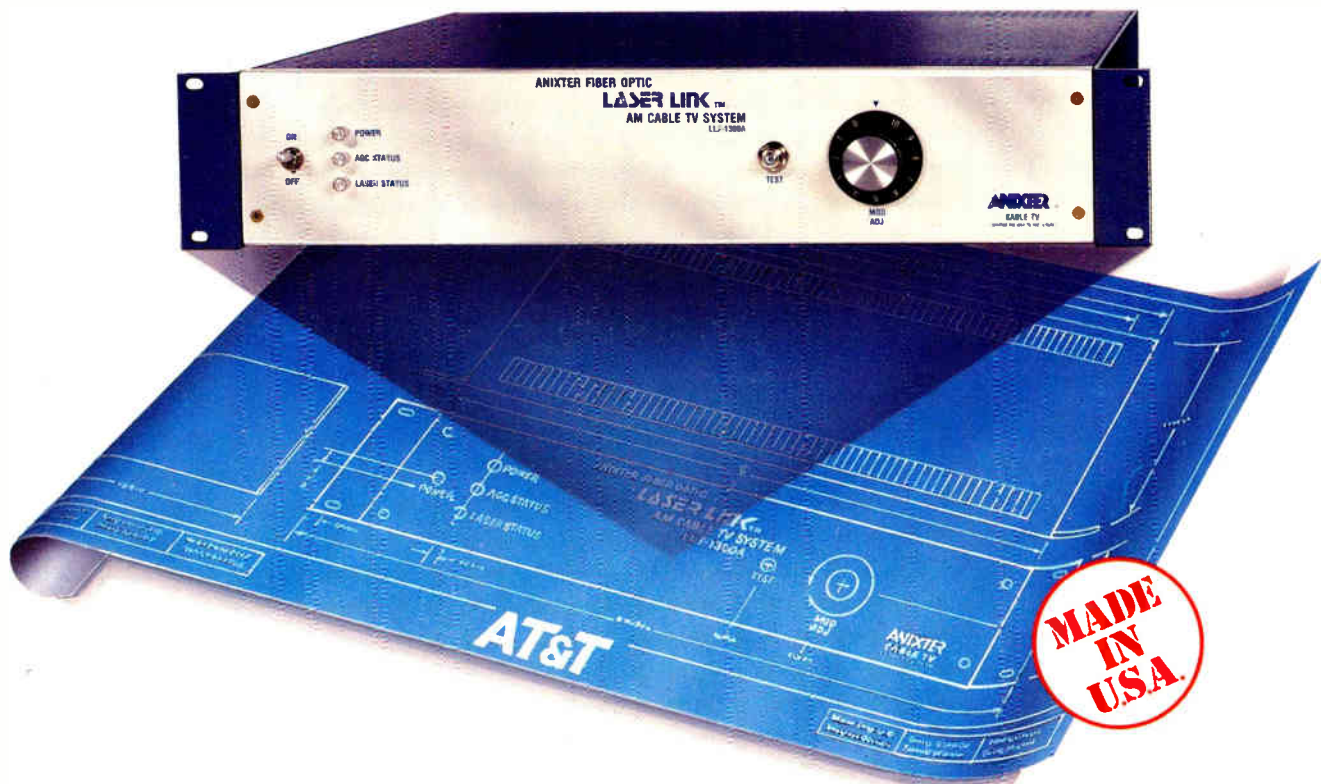

The ANIXTER Fiber Optic Laser Link AM CATV System

AT&T and Anixter Cable-TV have joined forces to bring you — *today* — the most exciting technological advancement in the cable-TV industry. And, we're proud to say it's the *only* system that is truly "Made in U.S.A."

It's Anixter's Fiber Optic Laser Link AM CATV System — a major breakthrough for cable TV in the transmission of multiple AM analog television channels over long distances. Following extensive, highly successful field tests, initial installations of the Laser Link System will be made

this year by many MSO's. Major features and benefits include:

- Easy installation and maintenance
- Compatible with existing CATV networks
- Low start-up costs
- Reduced maintenance costs
- Easy network upgrades
- Improved signal quality and reliability



Call our Fiber Optic Information Center at: 1-800-FIBER-ME. (1-800-342-3763)

ANIXTER CABLE TV