

SEPTEMBER 1987

COMMUNICATIONS ENGINEERING AND DESIGN  
THE MAGAZINE OF BROADBAND TECHNOLOGY

Inside:  
The status of  
SMATV and MDS

# CEED

**Converter testing:  
What's important?**

**Why Europeans  
dislike American  
television**



\*\*\*\*\*ALL FOR STATE  
#6295 880331 CEDF 11941-S  
Fred Mc Connack  
Box 5221 St Univ  
Fargo ND 58105

**Which came first?  
At last, we have an answer**



# We're all under a Lot of Pressure!

## YOU'RE UNDER A LOT OF PRESSURE.

Operating a cable TV system places you under a lot of pressure... the pressure to perform and to grow profitably. Especially since a minor equipment failure can cause a signal outage for many subscribers who remember only your mistakes.

## WE'RE UNDER A LOT OF PRESSURE TOO.

We have to perform under pressure too, in order to make sure that our products will perform for you year in and year out.

So we design for performance and endurance, use heavy-duty parts, manufacture with care, and test our equipment every step of the way. This means that nobody makes longer-lasting equipment than Magnavox!

## SERVICE WHEN YOU NEED IT.

When you purchase equipment from Magnavox, you also receive the best warranty and repair service available... from Magnavox Factory Service.

And when you need field service, troubleshooting, and technician training, our Field Engineering Team and Mobile Training Center will be there to help you.

## A TRADITION OF RESEARCH & DEVELOPMENT.

As a subsidiary of North American Philips, we carry its strong tradition of R&D into cable TV systems, with Powerdoubling™, Feedforward, and DSS Status Monitoring Systems.

And our advanced modular design gives existing systems the cost-effective flexibility to upgrade and add features.

## WE HELP RELIEVE THE PRESSURE.

An unhappy subscriber never forgets. So don't lose profits and customers to unnecessary service calls. Install Magnavox equipment. Your system will operate smoothly and profitably, year after year!



A NORTH AMERICAN PHILIPS COMPANY  
100 FAIRGROUNDS DR., MANLIUS, N.Y. 13104

FOR MORE INFORMATION CALL:  
(800) 448-5171 In N.Y. State (800) 522-7464  
Telex 937-329 Fax (315) 682-9006

# FOLLOW THE LEADER

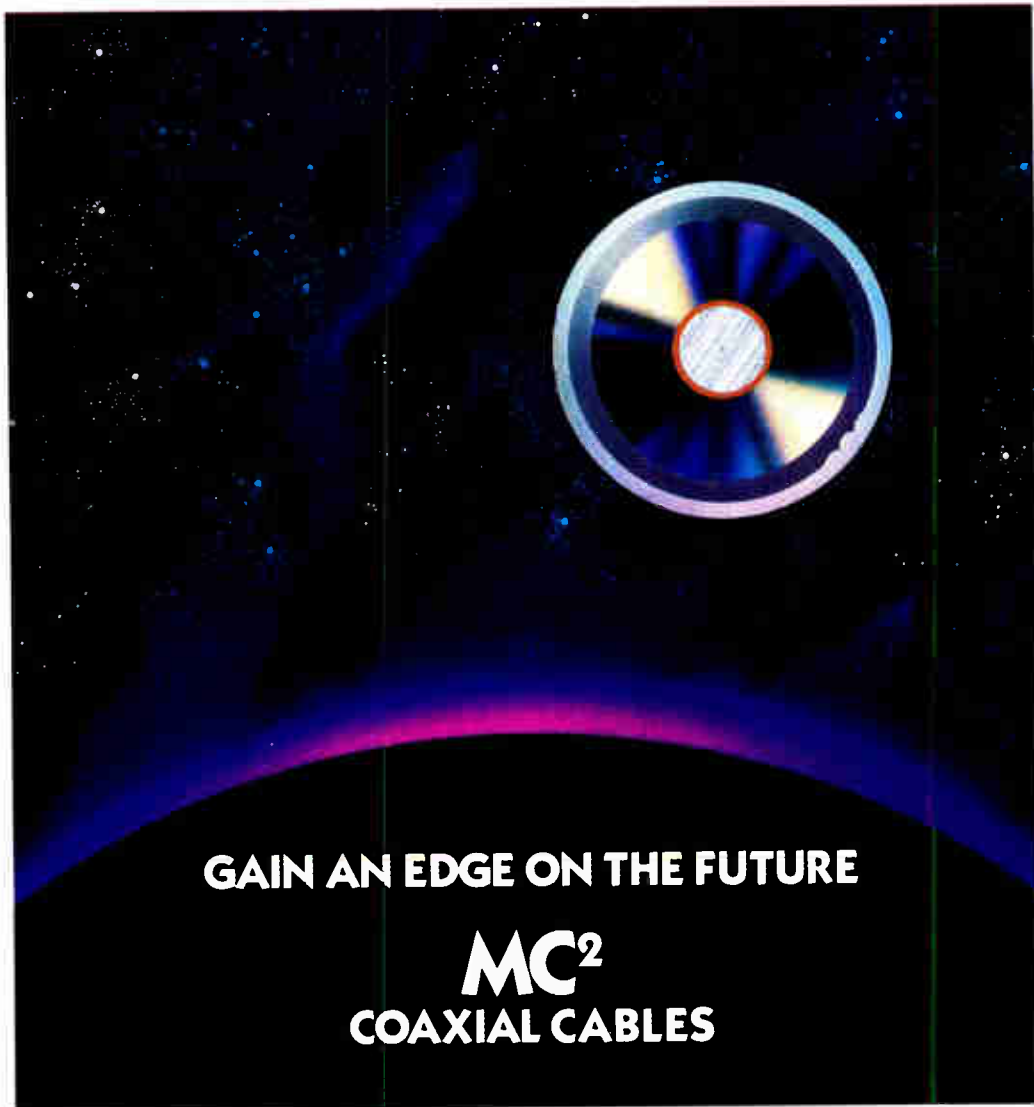

**GAIN AN EDGE ON THE FUTURE**

**MC<sup>2</sup>  
COAXIAL CABLES**

Follow the leader, that's what our competitors are trying to do in order to approach the superior attenuation characteristics of MC<sup>2</sup> coaxial trunk

CABLE SIZE .500"						
@550 MHz	<b>MC<sup>2</sup></b>	[Longest bar]				
GAS INJECTED	I	[Shorter bar]				
	II	[Shorter bar]				
	III	[Shortest bar]				
25 dB SPACING (x 100 ft.)		12	13	14	15	16

and feeder cable. But they succeed only by increasing the standard diameters of MC<sup>2</sup> — our familiar .500" must become .565" or .625"; and our .750" must become .840" or .860" or .875". The space-saving benefit of MC<sup>2</sup> is now even greater than before.

The competition is also making a lot of noise about their new medium density jacketing. The MC<sup>2</sup> jacket has always been medium density. Trilogy leadership is clear.

**TRILOGY LEADS IN TECHNOLOGY**



**Trilogy** 

COMMUNICATIONS INC.

Call or write for a free sample and brochure:

TRILOGY COMMUNICATIONS INC., 2910 Highway 80 East, Pearl, Mississippi 39208

800-874-5649

601-932-4461

Reader Service Number 2

**EDITORIAL**

**Gary Y. Kim**  
 Publisher/Editor  
**Kathy Berlin**  
 Associate Publisher  
**Roger Brown**  
 Managing Editor  
**Linda J. Johnson**  
 Production Editor

**CONSULTING ENGINEERS**

**Chairman**  
**Wendell H. Balley**, NCTA VP, Science and Technology

**Members**  
**Jim Chiddix**, VP, Engineering and Technology, ATC  
**Ron Coffen**, VP of Engineering, Daniels & Associates  
**Bob Dattner**, Consulting Engineer  
**John Dawson**, VP of Engineering, Mile Hi Cablevision  
**Roy Ehman**, VP of Engineering, Storer Cable Communications  
**Mark Elden**, Consulting Engineer  
**Robert Lutt**, VP Technology, Jones Intercable  
**Steve Raimondi**, Director of Engineering, US Cable Corp.  
**Graham Stubbs**, Consulting Engineer  
**Sruki Switzer**, Consulting Engineer  
**Joe Van Loan**, Eng. VP, Viacom Cablevision

**PRODUCTION**

**Jeff Knight**, Production Director  
**Don Ruth**, Art Director  
**Debra Rensel**, Assistant Production Director  
**Debbie Van Dyke**, Production Assistant  
**Dottie Slevers**, Circulation Director

**ADVERTISING**

**Cathy Wilson**, Sales Manager  
**Judy J. Medley**, Classified Sales Manager, Display Sales

**Patrick Keleher**, President/CEO  
**Janice L. Benesch**, Controller

**OFFICE**

Denver 600 Grant Street, Suite 600,  
 Denver, CO 80203 -or- P.O. Box 5208  
 T.A., Denver, CO 80217, (303) 860-0111. Fax (303) 837-8625.



INTERNATIONAL THOMSON  
 COMMUNICATIONS INC.

© 1987 by International Thomson Communications Inc. All rights reserved.  
 CED (USPS 300-510) (ISSN 0191-5428) is published monthly by International Thomson Communications Inc., 600 Grant St., Denver, CO 80203. © September 1987. Volume 13, Number 9. Subscriptions free to qualified industry readers. All other one-year subscriptions are \$26, prepaid in U.S. funds only. Second-class postage paid at Denver, CO, and additional mailing offices. CED is published on behalf of the cable television and broadband communications industries. POSTMASTER: Please send address changes to P.O. Box 5208 T.A., Denver, Colorado 80217. MEMBERS OF THE BPA.

**CLASSICS**

**Delay distortions: their importance and effects**

**24**

Part I of this 16-year-old paper, written by Fred Schulz (then with Sterling Communications in New York City), introduces the reader to basic concepts of delay distortions and describes their effects and importance. Part II follows next month.

**Which came first?**

**32**

Since its development, implementation of the IS-15 decoder interface standard has been plagued by the chicken-or-egg question. At long last, it seems we finally have an answer.

**BROADBAND LAN**

**450 MHz mainstations**

**36**

After explaining the difference between amplifiers used for LAN and CATV environments, this roundup looks at who offers mainstations for LAN use and describes their features.

**Stand-alone modems**

**44**

Very quietly, a number of vendors have stepped out of the general purpose, stand-alone modem arena. This piece looks at who's still in the ring and the products they offer.

**SMATV back on track?**

**50**

Our annual look at the state of the SMATV industry finds it healthy and robust in many areas while struggling for recognition in others. In fact, some SMATV operators are beginning to feel the squeeze from competing cable concerns.

**Multi-channel makes its move**

**56**

Don't look now, but MMDS is where the heat is and operators of single-channel systems who are planning on adding channels need to know there are a number of new technical considerations to keep in mind.

**When choosing converters...**

**60**

... don't overlook a number of important testing parameters. This piece by Jesse Still and Emory McGinty of Scientific-Atlanta discusses crosstalk, backtalk, parasitic FM and other parameters often overlooked in spec sheets.

**PRODUCT PROFILE**

**Plain vanilla converters 70**

**DEPARTMENTS**

<b>Return Path</b>	<b>20</b>
<b>Spotlight</b>	<b>8</b>
<b>Looking Ahead</b>	<b>22</b>
<b>My Turn</b>	<b>12</b>
<b>LAN Watch</b>	<b>46</b>
<b>Frontline</b>	<b>16</b>
<b>Classifieds</b>	<b>66</b>
<b>From The Headend</b>	<b>18</b>
<b>In The News</b>	<b>73</b>

**About the cover**

*Could there be any better way to illustrate the quandry the cable industry found itself in over IS-15 deployment? Photo courtesy of FPG International Corp.*



# HOW TO AVOID SPLITTING HEADACHES.



## OUR NEW MULTIPURPOSE AMP TAKES THE HEADACHES OUT OF DISTRIBUTION.

Scientific-Atlanta introduces quick relief for a whole host of distribution aches and pains. Our new multipurpose distribution amplifier features built-in splitters and couplers that make installation a breeze. And where can you install it? Just about anywhere. When we say multipurpose, we mean it.

## THREE WAYS TO WORK BETTER.

We gave our new distribution amplifier four ports for multiple outputs. And they're not there for looks. This versatile product performs. It can be configured as a line extender, but it also makes an ideal terminating bridger amp because it's small, simple and more reliable. Additionally, when used with optional AGC, it costs less than a trunk station of similar configuration

yet offers equivalent performance, quality and features, such as a switching regulated power supply.

## EASY ON YOUR SYSTEM.

Forget the hassle of splicing in splitters and couplers. We've redesigned them to plug into the inside of the amp housing. That means fewer external connections, easier installation and less maintenance. Not to mention fewer chances of cable suck out, signal leakage and level adjustment error. So you save on installation and repair costs.

## FAST RELIEF ANYTIME.

Our multipurpose distribution amplifiers are as perfect for upgrades as they are for new builds because they easily integrate into your current system. In low-density applications, they have the flexibility to let you start small and then grow with the population. Snap-in modular components provide push/pull, feedforward or parallel hybrid capability at two different gain levels and in bandwidths from 300 to 550 MHz.

We know you could use a few less headaches. So call us toll-free at **1-800-722-2009** or write to Scientific-Atlanta, P.O. Box 105027, Atlanta, GA 30348 for more information.



## Scientific Atlanta

**Double your  
productivity  
without leaving  
your seat.**



It's hard to be productive when you're constantly changing seats.

That's why Case makes trenchers that offer something you won't find anywhere else — single seat operation. A feature that helps you work faster and more effectively.

Case's low maintenance, hydrostatic ground drive gives you still another edge. With the single move of a lever, it lets you go from forward to reverse — without clutching — for unmatched productivity in either direction. What's more, you can vary ground speed to accommodate soil conditions. The result: you trench, backfill and plow at peak capacity. All the time.

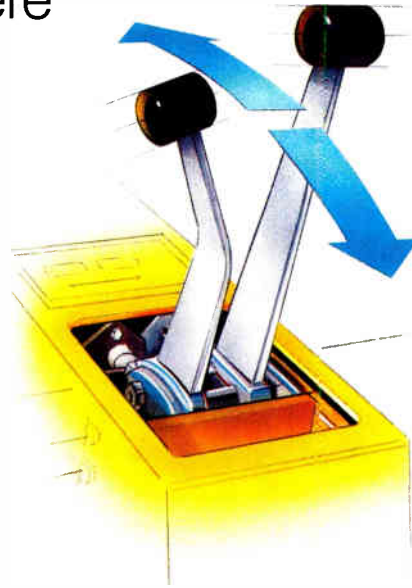

To learn more about the trenchers that help you do more, visit your Case dealer today.

**JI Case**  
A Tenneco Company



700 State Street Racine, WI 53404 U.S.A.

**Building On Quality™**



Maxi-Sneaker B



360



DH4B





Andy Devereaux

## Quality means success to Devereaux

Meet Will Rogers of the cable industry. Rogers was perhaps best known for his statement, "I've never met a man I didn't like." Although its doubtful he'd go that far, W.A. "Andy" Devereaux, executive vice president of engineering at American Cablesystems, counts his people relationships as the one thing he's most proud of.

"The thing I feel best about is the people I've worked with and the growth those people have achieved through working with me," says Devereaux. Indeed, both Devereaux and his colleagues at American have grown a lot—both in ways that can be counted and ways that can't.

Devereaux began his career in the Canadian telephone industry (yes, he's a native Canadian and yes, he's probably going to become an American citizen—perhaps next year), where he worked for three years. While there he held positions in both engineering and

supervisory management. One of his projects during that time was a two-way broadband system that carried TV signals—essentially a cable TV system.

He later helped start a cable company in St. John, New Brunswick, that slowly but surely grew into a small MSO, with systems all over Eastern Canada and northern Maine. But then the industry went flat as all of the viable areas of Canada became built out.

Eight years ago, Devereaux hooked up with Steve Dodge, who had just left the First Bank of Boston, and started the process all over again—this time calling themselves American Cablesystems. Starting with just 20,000 subscribers in 1979, American is now the 24th-largest MSO with just under half a million subs. Growth of that magnitude is impressive, but it wasn't necessarily planned.

"Growth has never been a number one priority for American, quality was," says Devereaux. "Our problem has been growing a management team fast enough to stay ahead of our growth. We've had to check and balance ourselves carefully to ensure we've had quality all along. We (American) have punted on some very attractive situations because we didn't have the management to handle the new growth. But that's been to our advantage—we've had no failures."

In fact, in conversations with Devereaux, one realizes that quality is what this man lives for. He counts his priorities as (1) health (he runs a couple miles five days a week and enjoys skiing, golfing and sailing), (2) family and (3) job. "But (2) and (3) are constantly in conflict and continually getting reversed," he says. "I guess that's the challenge of being busy."

In many ways Devereaux is different than many of his colleagues in the industry. He's more interested in the operations side of engineering than trying to invent a new piece of equipment. "I'm a well-informed technologist who takes existing technology and tries to use it in innovative ways," he says. "I'm certainly not a bench engineer or someone who could sit down and design a radio receiver. My interest is more in building systems."

Devereaux has built his systems so they're poised to take advantage of coming technologies and programming services. Most American subscribers are addressable, half of the systems are two-way interactive and the rest are two-way capable and the systems are clustered in five geographical areas. Consequently, American averages \$30 in revenue from every subscriber. "We've put most of our money in the plant, the bandwidth and good, reliable equipment, then tried to keep the costs in line in the subscriber's home."

Overall, Devereaux is "very bullish" about the industry long-term. But cable has a crying need for better trained personnel. "There's a whole pile of technical issues, but the biggest is a lack of trained, quality personnel. We have well-motivated people, but they're not necessarily well-trained." That's one reason why he's been so supportive of the SCTE (he's been on its board almost since entering the country and a member of the executive board for the last three or four years) and its BCT/E certification program. With a well-trained corps of personnel, any of the most competitive forces can be beaten back, Devereaux says.

"If you've got good strong people who are well educated, smart and can absorb new technologies, then none of these issues, whether it's stereo, DBS, Ku-band or anything else, present an overwhelming problem," he says. "I think cable owns the residential market right now, from a marketing point of view—and that's a strong position to be in." Why? Because cable can be the retailer of interactive services like pay-per-view, data information services, shopping services and the like.

After graduating from college in Canada with a BEE, Devereaux has added to his education with a BA, majoring in psychology and later attended the Harvard Business School, where he studied advanced management. All of that has given him a true understanding of the operations side of business and made his relationships with other people more rewarding.

So, even though he hasn't necessarily ever met a man he didn't like, there's a good chance that when you meet Andy, you'll like him.

—Roger Brown





## Broadband: For the best in distribution amplifiers

Broadband Engineering offers a distribution amplifier for every application from the lowest cost to the highest performance CATV, MATV and SMATV installation.

Flexibility to meet demanding system requirements is our goal with:

- Bandwidths up to 550 MHz
- Gains from 14 to 50 dB
- One and two-way operation
- Sub, mid and high-split options
- Standard or power doubler hybrids

Extruded aluminum housings insure

excellent heat transfer from active devices for long life and reliable service.

And we don't forget maintenance either. Our hybrids are installed in sockets so that replacement is quick and easy and down time short.

We don't cut corners in design, we engineer the best.

For more information, call Broadband Engineering at 800-327-6690 (305-747-5000 in Florida) or write us at 1311 Commerce Lane, Jupiter, Florida 33458.

**For quality, performance and service, call Broadband**

**AUGAT<sup>®</sup> BROADBAND**  
*Quality and Innovation*

## The technical quality of the video signals produced in American television studios is generally excellent.

sion is likely to be judged mainly by the quality of technical performance.

The national television facilities in Europe typically broadcast on only one to three program channels (four in England). Although regional and cross-border programs are also receivable in some locations, television receivers in Europe that are not connected to a cable network are seldom required to select more than three to six channels, none of which are adjacent. European countries use a combination of high powered, mostly UHF, transmitters and a great many low and medium powered relay transmitters and repeaters to cover the population with negligible white areas.

In several ways, the conditions existing in Europe tend to favor better TV reception than is available in the U.S. Phase errors in receiver IF traps are avoided because, until recently, the adjacent channel selectivity requirement has been so low. High gain

receiving antennas are feasible because, in many cases, the transmitting antennas for the few receivable signals are co-located. The high density of repeaters suggests higher field strength at the fringes.

In addition to favorable reception conditions and the arguable inherent superiority of PAL over NTSC color, there does appear to be evidence of superior workmanship in Europe in the design, construction and day-to-day operation of television transmission facilities, both broadcast and cable. Although many factors probably contribute to this result, it seems that perhaps the most important are (1) the lack of "bottom line" profit criteria, and (2) completely divorcing the responsibility for transmission from programming or revenue generation. Technical staff and budgets in the U.S. are controlled by management that is predisposed to maximize revenue and minimize expense. Revenue generation

correlates much better with the cost of a vigorous marketing campaign or new programming, that with the cost in salaries and equipment required to fine tune transmission facilities.

Money is certainly not the only factor. The technical quality of the video signals produced in American television studios is generally excellent. Commercial and program tapes and films may not uniformly meet the same standards of excellence, however. Do we make too many compromises with respect to cost and "practicality" when it comes to transmission and reception? Are transmitters and antennas maintained continuously at optimum performance? We know there are compromises in receiver technology with respect to I and Q bandwidth, IF filter shaping and envelope delay distortion. Receiving antennas are rarely designed and installed with engineering skill appropriate to the best possible performance.

# PACKAGED TO PERFORM

At Triple Crown we specialize in pre-packaged head ends. Each unit is custom designed to suit your specific application.

- factory assembled, balanced & burned in
- easy to service, cool open frame racks
- layout & wiring diagrams included
- complete with all accessories needed for simple on-site installation
- most international TV formats available

We provide dependable cost-effective equipment to satisfy your requirements. With over 1000 Triple Crown pre-packaged head ends in use world wide, you can trust us to perform.



## TRIPLE CROWN ELECTRONICS

4560 Fieldgate Drive,  
Mississauga, Ontario L4W 3W6  
(416) 629-1111  
800-387-3205 (U.S. Only)

601 Fairway Drive,  
Deerfield Beach, Florida 33442  
(305) 429-0870  
Inwats 800-824-4332

Reader Service Number 7

# Harris Quality Midwest Pricing and Delivery



## \$1,295.<sup>00</sup>

*Model 5115-AZ includes AZ/EL mount and dual polarity feed.*

The Harris 3-meter C-Band Delta Gain™ Antenna gives you more than an impressive 41 dB gain. It's also rugged enough to withstand 120 MPH winds. Plus, it's easy to install and available with either an Az-El Mount or a Polar Mount with optional motorization.

The Harris 6529-2 Frequency Agile Receiver is the updated version of the popular 6529. It is a 4 GHz input receiver, so if you have an older system you can get the excellent picture quality of the 6529-2 without the added cost of installing an external down converter or new plumbing. Plus you get one of the best warranties in the industry – two years on parts, labor and workmanship.

As one of the world's largest stocking distributors of Harris equipment, Midwest has these, and other Harris products, on hand and ready to ship – instantly. Midwest provides complete systems or individual components for either C or Ku-Band, fixed or mobile, Up-link or TVRO.

For the best prices and fastest delivery in the industry, contact Midwest at 800-543-1584.

## \$695.<sup>00</sup>

*Model 6529-2*



**MIDWEST**  
Communications Corp.

One Sperti Drive  
Edgewood, KY 41017

**800-543-1584**  
(In KY 606-331-8990)



## A case study in customer service

In the articles I've written to date, I may have given some the impression that providing good, reliable service, is hard going. I didn't mean to indicate that it's too hard to attempt or too expensive to expect a decent cable operator to put up the effort and expense necessary to do the job right. On the other hand, anything worth doing is worth doing well and doing anything well frequently takes effort and resources.

In the case of providing service to telecommunications customers other than residential subscribers, we come smack up against customers who know the difference. I recently received a letter from John Rivenburgh, corporate product manager at Rogers Cable in Portland, Ore., who detailed for me a case history along with some thoughts on lessons learned in their attempts to provide quality, highly reliable service to their customers, both existing and potential. To quote Rivenburgh, "Our industry must take a more active role in defining appropriate levels of service for the delivery of CATV's two-way services. If not, we will never achieve more than a bit player role for servicing

the local loop." Rogers' system in Portland offers an array of data and video communications services to its customer base, which includes both commercial and institutional entities. I was greatly impressed by the thoroughness of the preparation which Rogers made to attack this market.

First, they had to make a determination that they could be competitive in the provision of end-to-end service to the business community. Having made that determination, they had to ask themselves whether or not they could meet the expectations of the customers whose business they expected to win. Rivenburgh said, "Once our service offering was defined, we surveyed customer requirements for service and reliability. Three basic themes emerged: network availability, response time and bit error rate (BER) specifications. For comparison," he goes on, "the phone company would contractually agree to two- to four-hour maximum response time, 99.95 percent network availability and a  $10^{-6}$  BER."

I can almost see some of you readers shake your heads, thinking this could be tough. You'd be surprised to find out what was discovered when the cable technology was reviewed along with the operational history of this company. The conclusions were straightforward and potentially pleasing. First, the cable environment is more efficient, for a variety of reasons, for the transmission of data and, consequently, the BERs could be expected to be  $10^{-9}$  or better.

Second, judging that commercial customers would not tolerate busy signals, long unanswered phone rings and the other problems which so many people blame the cable industry for, it was decided better and more efficient incoming communication should be established for commercial customers only. More importantly, it wasn't done just by adding a bunch of phone lines. It was done by putting in a single dedicated phone line directly through to the dispatch office. In other words, communication between the customer most affected and people who could do something about a problem was established in a straightforward and no-nonsense way. This simple but well thought out act led Rogers to discover

that a one-hour response time was, to quote Rivenburgh, "easily obtainable."

Finally, network availability was checked. Experience and calculation showed that they could achieve a network availability of 99.98 percent. Well, the good news is that this is a successful story. The bad news is that even a company with this amount of forethought and professional attitude can slip up and, by their own admission, fall below the network availability target. The result of this was a mounting number of maintenance calls from their commercial customer base.

But, to their credit, Rogers learned its lesson and mounted an aggressive attack on the problem. They did not attempt to fix just the problems that were reported, but instead, they attacked the root of the problem by putting preventive maintenance back into the system. An effort to find out what needed to be done found several chronic problems. When these things were fixed, once again network availability met or exceeded expectations, customer complaints declined, and satisfaction and service were once again up to the high standards established by Rogers.

Another pleasing note in the letter was how the system dealt with the issue of staffing for a commercial, customer-based service effort of this type. Rivenburgh found, much to his delight, that they were able to recruit all of the necessary personnel from in-house and when these people were put before the challenge, they found satisfaction in providing top quality service to discriminating customers.

Rivenburgh sums up his report to me with the most telling and compelling statement that I could leave you with. They have been serving data customers since 1982. They have learned a lot and their customers have learned a lot, and while customers' needs and customers' understandings change, you can keep your customers by providing quality service, meeting the specifications you contract for and keeping reliability high. Clearly, the professional approach, the application of service, use of preventive maintenance and offering the proper challenge to motivated people will lead you, just as it led Rogers, to be an effective competitor in the telecommunications business.

*By Wendell H. Bailey, Vice President, Science and Technology, NCTA*

SEND FOR  
FREE SAMPLE!

# Cablecon® Cable-in-Conduit...



## Has Flexibility!

Cablecon Cable-in-Conduit (CIC) provides you with flexibility when installing trunk, feeder, or drop cables in underground CATV applications.

CIC is a low-cost method of protecting coaxial cables and can be universally used in trench, vibratory plow, and street cut applications.

Cablecon's polyethylene conduit is formed by continually extruding it as a pipe over the cable assembly ... permitting it to be manufactured to almost any desired length. Crush resistant, yet flexible, it is much easier to handle than PVC during installation ... greatly

3/4" with  
RG service wire

1" with  
500 jacketed,  
flooded coax.

1 1/4" with  
750 jacketed,  
flooded coax.

reducing installation time and overall labor costs.

Why direct-bury coax when you have Cablecon's added

benefit of long-term protection, *plus* a lifetime "hole-in-the-ground" for future upgrading?

For complete information on CIC, drop-in-conduit, empty duct with pull-string pre-installed, or prelubricated conduit, contact Integral Corporation or Channell. Direct sales representatives and distribution facilities are located throughout North America.

- Dallas • Baltimore
- Tampa • Los Angeles
- Toronto

Marketed exclusively by  
Channell Commercial Corporation  
(818) 963-1694  
(800) 423-1863  
Except CA



## Integral Corporation

1424 Barry Avenue, Dallas, TX 75223  
(214) 826-0590 • (800) 527-2168 Except TX

from the headend



## Noise figure vs. carrier-to-noise ratio

The NCTA Handbook of Recommended Practices calls for the headend's output carrier-to-noise (C/N) ratio for any channel to be greater than 58 dB in a 4 MHz bandwidth. In our example last month, we saw how the simple addition of a channel preamp on a remotely located off-air antenna tower improved the noise figure of that channel from 17 dB to 4.8 dB; an improvement of 12.2 dB. Does this mean that the output C/N ratio has also improved by 12.2 dB? Well, unfortunately, the answer is an unequivocal maybe. Theoretically, an improvement in the noise figure of a transmission system could improve that system's output C/N ratio by an equal amount, but only if the noise accompanying the input signal were equal to the theoretical  $kT_0B$  or so-called "thermal noise." Therefore, in reality, a system's output C/N ratio is a complex function of its Standard Noise Figure (noise figure with  $kT_0B$  input noise only) and the signal's actual input C/N ratio.

The C/N ratio out of any amplifier can be shown to be dependent upon three major contributors. These include the signal's carrier level ( $S_i$ ) at the input to the amplifier, the Standard

Noise Figure (SNF) of the amplifier ( $NF_{amp}$ ), and the actual C/N ratio at the input to the amplifier ( $C/N_{in}$ ). The relationship shown in the graph in Figure 1 indicates that there is only one instance of input C/N ratio where there is a direct 1:1 relationship between improvements in SNF and a corresponding improvement in the output C/N ratio of the headend. This instance occurs only when the noise accompanying the input signal is equal to the so-called  $kT_0B$  or thermal noise due to the random motion of charge carriers in any conducting medium at 290 Kelvin.

In 75-ohm systems, the value of  $kT_0B$  is commonly accepted as -59 dBmV. Thus, for a +10 dBmV input signal carrier level, the maximum input C/N ratio is 69 dB (at 290 Kelvin). It is only in this case that an improvement in the system's SNF of 12.2 dB will in fact result in an equal improvement in output C/N ratio. As the C/N ratio of the input signal increases or decreases from this theoretical mark, however, improvements in the SNF of the headend will not provide a corresponding 1:1 improvement in the C/N ratio of the signal at the output of the headend.

If, for example, the C/N ratio of the signal at the input to the headend were only 55 dB, a 12.2 dB improvement in the headend's SNF, through the installation of the preamp, would only improve the output C/N of that channel by 4.7 dB. On the other hand, if the input noise power accompanying the signal were lower than the value for  $kT_0B$ , such as may be the case at the output of certain off-air antennas, then improving the SNF of the headend by 12.2 dB would im-

prove the output C/N ratio of the headend by an even larger amount. Therefore, as the input C/N continues to improve beyond 69 dB, the two curves of Figure 1 will separate even further.

The problem with simply adding the SNF of the channel to its input C/N ratio in order to calculate the system's output C/N ratio is due to the classic definition of noise figure. This definition of noise figure is only valid when the input noise is nothing but  $kT_0B$  noise (-59 dBmV for 75-ohm systems). If the noise accompanying the signal is something other than  $kT_0B$  noise, then you can no longer make such a simple calculation.

Improvements in SNF can, in many cases, go a long way toward improving the output C/N ratio of your headend; but not in all cases. The actual output C/N ratio of the headend is dependent, not only upon the SNF of the headend equipment, but also upon the input signal's C/N ratio if the noise accompanying the signal is something other than  $kT_0B$ . After all, an amplifier simply cannot remove the noise which has already contaminated the signal present at its input.

FIGURE 1

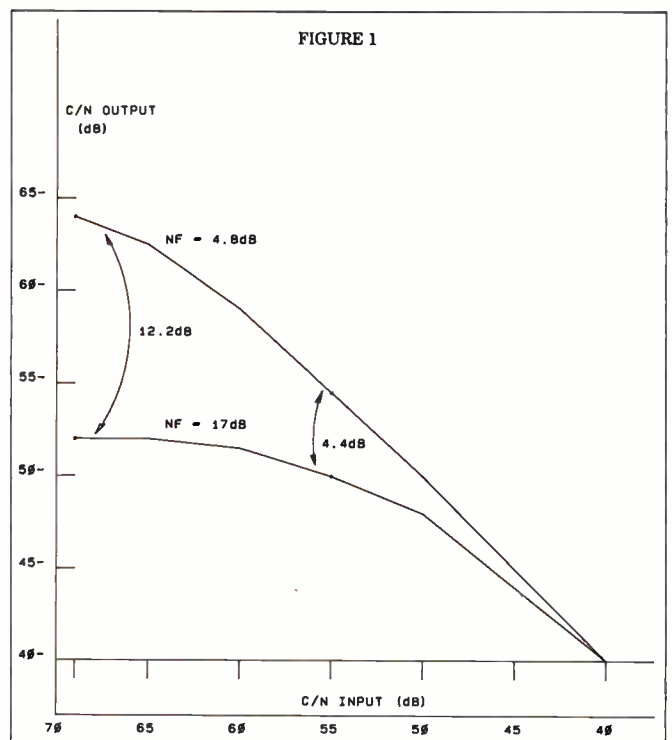

By Chris Bowick, Engineering Dept. Manager, Scientific-Atlanta

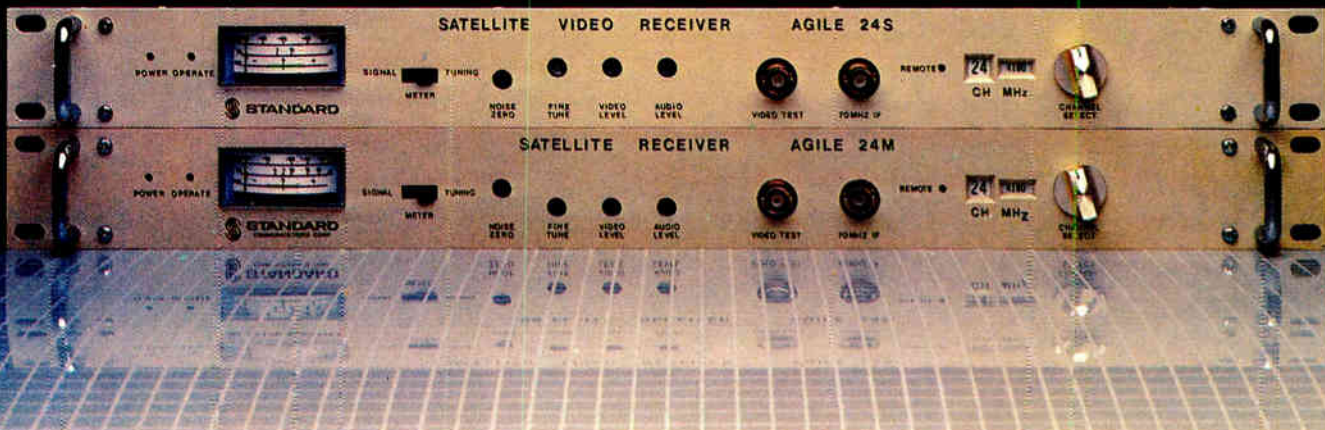

# GROWING BIGGER SHOULDN'T MAKE YOUR SIGNAL GROW WEAKER

With Standard's Agile 24 receivers' loop-thru IF circuitry, upgrading your system doesn't have to mean degrading your signal, blowing your budget, or accumulating lots of downtime.

Instead of replacing your present 4-way splitter with an 8-way splitter, thus attenuating your 4 GHz signal output by half, Standard's loop-thru feature allows you to maintain full power as your system expands.

All you need is a one-port jumper from your splitter to our Agile 24M master receiver.

Our loop-thru feature lets you drive up to 12 Agile 24SB slave units from the master **without expensive power dividers, and without losing signal strength.**

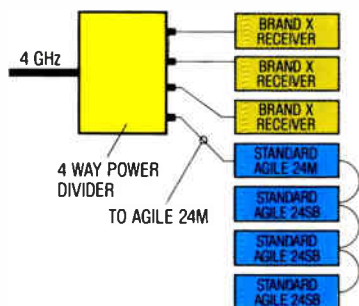

## Our most relied-upon receiver

Known industry-wide for dependable operation, the Agile 24M is a dual-conversion 4 GHz receiver that

block downconverts to 760-1260 MHz.

Its active loop-thru design supplies the entire 500 MHz wide block of frequencies to Agile 24SBs.

The Agile 24M's phase-locked loop synthesizer and effective AFC circuit combines with a temperature-stabilized dielectric resonator oscillator (DRO) to ensure rock stable operation. In areas where microwave interference is a problem, optional 60 MHz and 80 MHz filters can be easily installed.

## Simple installation, testing and maintenance

The Agile 24 M/SB Series features a low-profile 1 $\frac{3}{4}$ " chassis that occupies a single rack space. The front panel includes a three function meter that displays signal strength, C/N, and center tune; as well as convenient test connections and performance adjustment controls. It is Video-Cipher II™ tested and approved for all programs being scrambled.

## Backed with the industry's strongest warranty/replacement program

Our satellite receivers are built to last, and our warranty program shows it.

If a unit fails, call us and an immediate replacement will be shipped within 24 hours.

If it's within our one-year warranty, the replacement is free. Within years two through five, the replacement is only \$100.

For more information on improving your system, and on the full line of Standard Communications TVRO products, call us toll free at 800/243-1357 (in Calif. call direct, 213/532-5300, ext. 275), or mail in the coupon below.



**Standard**  
Communications

SATCOM Division  
P.O. Box 92151  
Los Angeles, CA 90009-2151

**Engineered to a new standard**

**I'm planning to add satellite channels**

Please send me a detailed brochure

Have a sales representative call

Name \_\_\_\_\_

Title \_\_\_\_\_

Company \_\_\_\_\_

Phone \_\_\_\_\_

Street \_\_\_\_\_

City \_\_\_\_\_

State \_\_\_\_\_

Zip \_\_\_\_\_

## return path

### More numbers

In my store, it was hard to sell a fuse when the customer wanted a 1 amp, 125 volts and all I had was a 1 amp 250 volts. How many of us know that the voltage is just the point at which the fuse may explode and damage things if operated in a circuit with voltage over and above the number stamped on the fuse?

On why 50-ohm coax: Archer Taylor failed to mention the largest user of radio in the early days—the military. The only antenna they used was the  $\frac{1}{4}$  wavelength vertical ground plane. No matter what you did, it was always approximately 50 ohms at the feed. The government even came up with a lot of different values of coax to make  $\frac{1}{4}$  wavelength matching sections to get from one impedance to another. They even called all these numbers the Radio Government Universal Standard. Somehow, it was RG 11/U and then just RG 11.

When you ask almost anyone in the field what RGU means, most will say they don't know. I think the communications people got stuck with 50 ohms because a  $\frac{1}{4}$  wavelength vertical was just that: 50 ohms.

*Bob Layton*

*Editor's note: Because of space limitations in that issue, the portion of Archer Taylor's column dealing with the military was cut from the story.*

The communications from Ben Dawson of Hatfield and Dawson consulting engineers in Seattle, and Bill Ruck, engineering manager for KFOG (FM), San Francisco, (*CED*, August 1987) were gratefully received. A former engineer at Communications Products provided the information in my column that the 51.5-ohm impedance was related to the size of the ceramic steatite discs that happened to be available at the time. After the publisher's deadline, I learned from two former RCA engineers that standard copper pipe and tubing sizes actually dictated 51.5 ohms, as Dawson and Ruck stated.

RCA was apparently the prime mover in the change to 50 ohms, triggered to some extent by the development of UHF television. Since they would have

to use special-order tubing for the large sizes needed for UHF anyway, they decided to take the big step and change all rigid lines to the simpler 50.0 ohm characteristic that is now standard. Moreover, at the same time, they would be able to specify tighter dimensional tolerances than normally required for water pipe or tubing.

As Jim Hatfield well knows, radio broadcasters did not (and probably still do not) always ask for, nor follow, prudent installation recommendations. I can only guess where it was that the farmer knocked down an AM transmission line installed in a trough two feet above ground.

Mechanical installation of coaxial lines involves a variety of risks. Underground installation is the least desirable, because of inaccessibility for maintenance and vulnerability to corrosion and possible moisture penetration at the flanges. Any above ground installation is subject to damage if agricultural uses of the land are permitted. At six or eight feet above ground, there would be an even more serious risk of injury to the farmer riding a tractor under the line. Installation close to the ground is less likely to distort the RF radiation pattern of the antenna.

If I did, in fact, acquiesce in the particular installation cited, it would have been either because it was an accomplished fact without my prior involvement, or because the broadcaster client insisted the land would not be used for other purposes. The real issue is whether the broadcaster in the case was merely a tenant who had agreed to use the land in such a way as not to interfere with the farmer-owner's normal uses; or had actually purchased (or leased) the land, agreeing to let the farmer continue to use it in such a way as not to interfere with or damage the radio facilities. I have seen both situations, as well as combinations of the worst aspects of each. The consultant may offer caveats and cite risks, but is seldom in a position to enforce detailed mechanical installation specifications not directly related to the performance of the antenna system.

Nevertheless, I appreciate receiving the comments from Dawson and Ruck.

*Archer S. Taylor*  
*Malarkey-Taylor Associates*

### Kudos to Karr

I wish to compliment Randy Karr for his article entitled "Headend noise and multiple agile modulators" (*CED*, July 1987). We confirm that his findings were correct for most older generation designed agile modulators which had poor C/N ratios to begin with. At ISS we have been shipping agile modulators with C/N ratios in-band of at least 63 dB being typical.

We have a number of cable systems of 30 channels and up using ISS modulators with good results. However, we recommend on the larger systems the use of an inexpensive bandpass filter which we supply. If used, it gives out-of-band C/N's that are immeasurable. Once again, for cost and performance the agile modulator wins out, with the additional benefit that spurs are also 80 dB down or greater.

*Norman Gillaspie*  
*President, ISS Engineering*

### New bands

FYI for the next CATV Frequency Chart, there are two new amateur radio bands. These are 10.100 to 10.150 MHz and 24.890 to 24.990 MHz. I realize that the 1987 chart just came out, but I thought you might want to be aware of these new band so they can be included in the next chart.

*Steven C. Johnson*  
*Senior CATV Project Engineer, ATC*

## We're Listening!

Send in your letters to the editor of *CED*. Attention Roger Brown, managing editor, 600 Grant St., Suite 600, Denver, CO 80203.



# MOST FOLLOW STANDARDS...

## ...A VERY FEW SET THEM.



In every industry there are leaders who are innovative and dedicated to producing the highest quality product. The vision of these leaders fuels progress; they forge ahead and bring new solutions to the marketplace. Most of all, these leaders listen to their customers and translate their needs into products and services of the highest standard.

In CATV, Alpha has set the standard in Standby Power technology. This leadership is based on a long list of 'firsts' in powering concepts and product capabilities. Implementation

of Alpha's single ferro-resonant power supply design revolutionized the industry and gave new meaning to cable system reliability and customer satisfaction.

Direct cost reductions through improved battery performance and

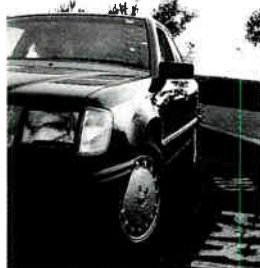

simplified system maintenance were brought about by Alpha's temperature compensating and performance monitor-

ing circuit designs. In addition to these technological contributions, Alpha has

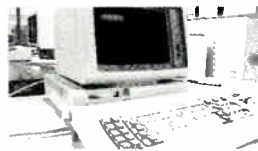

established the highest quality and safety standards. To date Alpha remains the only Standby Power manufacturer offering UL, CSA and SEV listed products to the CATV industry.

The unique *Lifeline* status monitoring system provides

diagnostic information and remote control facilities on *one-way* and two-way cable systems. This pioneering development now enables operators to optimize service strategies and reduce overall system maintenance costs. *Lifeline* is Alpha's latest in a series of

historic status monitoring milestones: the first and only stand-alone power-supply monitoring system, hardware interfaces

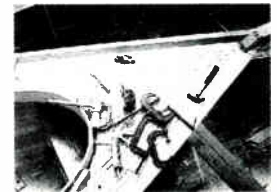

for the major amplifier monitoring systems, and complete monitoring software have all preceded the *Lifeline* introduction.

Alpha Technologies set the standards in Standby Power for one reason: Alpha's customers won't settle for second best.

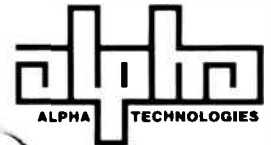

**We're Here to Back You Up.**

3767 Alpha Way  
Bellingham, WA 98225  
TELEPHONE:  
206-647-2360

7033 Antrim Ave.  
Burnaby, B.C. V5J 4M5  
TELEPHONE:  
604-430-1476  
TELEX: 04-356760

Reader Service Number 11

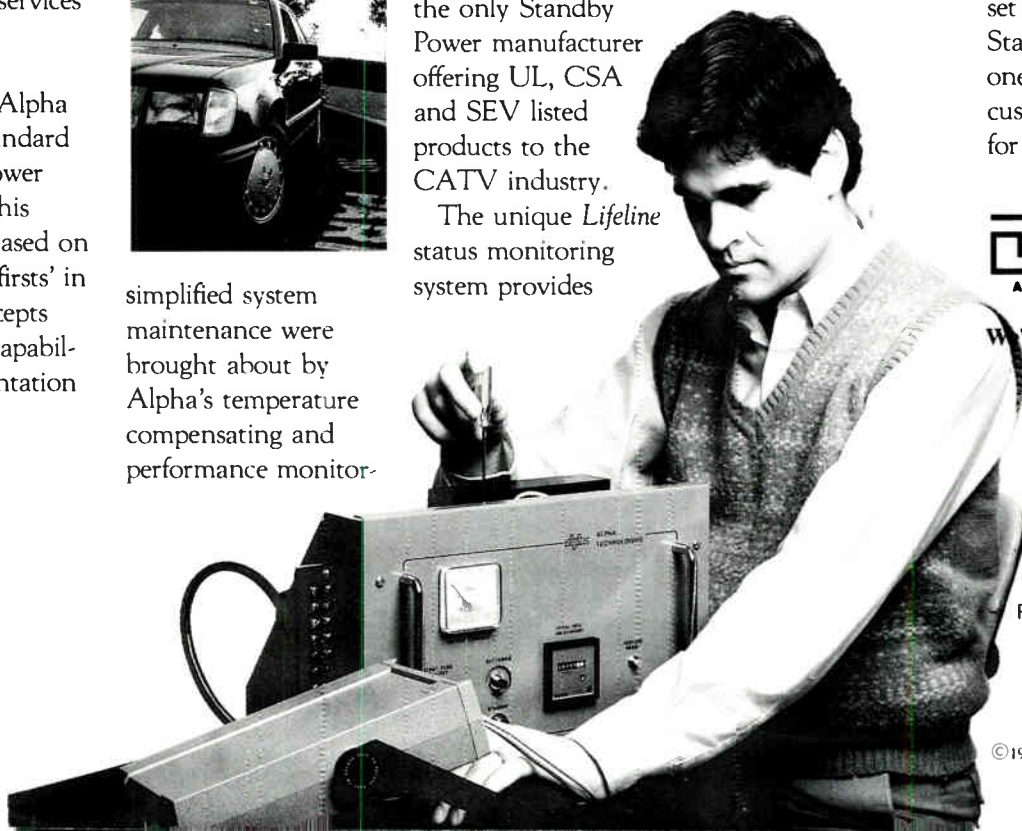



## Whither addressability?

Over the last several years the cable industry has been undergoing an agonizing reappraisal of the role which addressability should play in its operating systems. While there is not yet industry consensus, the outcome of this debate will be a major factor in determining cable's future. On the one hand, some operators are moving aggressively away from addressability, finding refuge in the simple negative and positive trap technology which initially built the pay TV business. Other operators are moving more aggressively into addressability because of their belief in the future of pay-per-view services.

The original dream of addressability encompassed delivery of multi-pay and pay-per-view, operating savings from reduced truck rolls, reduced box losses and the ability to market more flexibly. In retrospect, we see a number of unanticipated problems. Addressability introduced additional layers of complexity to virtually all operational aspects of our systems, and there were varying degrees of success in coping with this. Some vintage addressable converters were unreliable, wiping out

*By Jim Chiddix, Vice President,  
Technology and Engineering, ATC*

potential operating savings and angering subscribers to boot. While most addressable set-top units being delivered today have achieved acceptable reliability, these problems will be with us for some years in our universe of older converters.

Additionally, the multi-pay environment does not require the number of channels once expected. Three or four services appear to meet the needs of most markets and trapping is often a viable delivery option. Problems with consumer friendliness which resulted from our introduction of scrambled signals at the same time that "cable-ready" consumer equipment was being introduced were largely unforeseen, but have growing significance. Today, over 40 percent of our subscribers own cable-ready equipment and over 60 percent have VCRs. As an industry, we have not been particularly successful in addressing these issues, even to the extent that technical solutions are available to us.

These factors, in combination with the significant additional capital investment required by addressable converters, have resulted in a natural urge to seek simpler delivery solutions. We cannot, however, afford to discard the investment we have already made in addressability, and I believe that it is important for our future that we continue to try to realize its potential.

First, pay-per-view appears to be a business for the cable industry. The experience of a number of operators indicates that there is additional revenue available to us from pay-per-view, although the magnitude remains unclear. In addition, our most likely long-term competitors who employ direct broadcast satellites and switched telco delivery systems will be capable of pay-per-view delivery to all their subscribers. Thus, to the extent that pay-per-view offers things that consumers want, our moving away from addressable technology puts us at a competitive disadvantage.

Secondly, the operating economies which are an unrealized part of addressability's potential are more important than ever. This is true in improving present-day margins, as well as in positioning for future price competition. Third, we need to capitalize on the

proliferation of cable-ready equipment, with its potential to decrease the need for capital investment inside the home. Further, the consumer expects us to be compatible with the equipment he purchases. While traps can satisfy the need for broadband unscrambled delivery to the home, in the long term it is important that we explore ways to combine this feature with addressability.

It stands to reason that we must take advantage of the MultiPort consumer interface standard and other interface solutions in systems which already use scrambling with addressability for the delivery of pay services. In many markets, however, I believe that we should aggressively pursue the technology of unscrambled off-premise addressable signal delivery which a number of vendors are beginning to offer. This would allow us to separate addressability from scrambling. The benefits of these "addressable tap" technologies include the potential of substantial operating savings by eliminating the need for truck rolls, connects, disconnects and changes in service level. Audits and converter retrieval would need to remain part of our operations, but converter retrieval lends itself to a variety of creative solutions. This approach also opens the door to a gradually decreasing investment in set-top converters as cable-ready equipment proliferates. It maximizes consumer friendliness by delivering broadband unscrambled services to all outlets of the subscriber's home. Off-premises addressability also provides the mechanism for universal pay-per-view delivery, with a variety of ordering options.

These benefits accrue only if a high degree of reliability can be maintained, and if operational savings, subscriber satisfaction and pay-per-view delivery can justify the significant capital investment required. Nevertheless, the potential for a combination of happier subscribers and more efficient operations dictates that the industry actively pursue this type of delivery system. With industry encouragement, it is hoped that vendors will overcome the problems which have plagued addressable tap efforts in the past. It may be deeply important for our future that they do.

**“The Tracer™ has been  
the chief ingredient  
in our leakage  
prevention program.”**

Nick Worth  
Vice President  
Engineering  
TeleCable

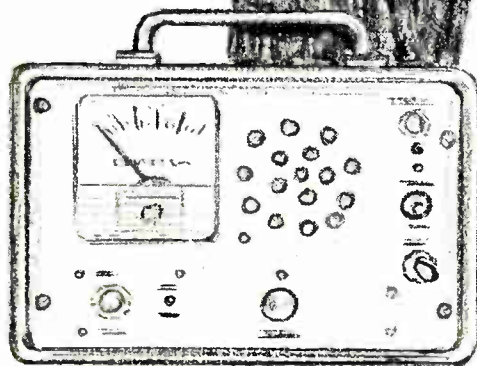

“Because it features a near field probe and an FCC-calibrated scale, The Tracer enhances productivity of our leakage detection personnel.

We also appreciate its reliability, its sensitivity and its lightweight packaging.

And because The Tracer operates with one of our existing video carriers, we don't need a special frequency or transmitter.

Augat/LRC has designed a reliable, easy-to-use RF leakage detection receiver to fit our needs.”

**AUGAT LRC**

*A part of the growing Augat Communications Group*

901 South Avenue  
Post Office Box 111  
Horseheads, NY 14845  
(607)-739-3844  
TELEX: 5101-011:251  
FAX: 607-739-0106

# Envelope, phase, group and chroma delay...

The CATV industry is still growing, and in its path to maturity it is becoming more sophisticated technically. While in the early days of CATV it was sufficient to get a picture to the subscribers' TV set one is now confronted with meeting federal specifications. A number of new terms have crept into the CATV engineers vocabulary, some of which may be familiar, some of which may, however, have been misunderstood. The following presentation focuses on giving simple (and in some instances simplified) explanations of terms such as "envelope delay," "chroma delay," etc. An attempt will be made to explain the effects on picture quality. Appropriate test equipment, test methods and costs are explained. The explanations will be held in simple form so hopefully the average CATV engineer can follow; mathematics will be avoided.

The first part is devoted to the introduction of some necessary fundamental know-how, and may be looked upon as a refresher for those already familiar with it.

The function of a CATV system is to bring high quality undistorted pictures to a subscriber's TV set. The CATV engineer is usually familiar with distortions such as: noise, cross-modulation, second order distortion, echoes, amplitude distortion, etc. Cross-modulation and second order distortion are so-called non-linear distortions. Amplitude distortion usually does not depend on signal levels; it is called a linear distortion.

Amplifiers and filters may also exhibit phase distortion, another linear distortion. Phase distortion is of prime concern in single channel and studio equipment, and will be explained here, since the CATV engineer seems to be least familiar with it.

## Phase shift and phase delay

Phase shift is most readily explained with an experiment; let's feed a CW signal into a low pass filter and observe

©1971, with permission from the NCTA Convention Record, 1971.

By Fred Schulz, formerly with Sterling Communications of New York.

...what does it mean, how is it measured?

the input and output wave forms on a dual channel oscilloscope. See Figure 1.

We find that the output waveform is not in phase with the input (the crests of the waves are shifted with respect to each other). We say there is phase shift. In this case the output lags the input waves. Phase shift is measured in degrees. One full cycle of a wave is 360°.

Phase shift occurs in any network containing capacitors and/or coils.

To be more specific, we should label the sweep response amplitude response; after all the familiar sweep generator setup measures the amplitude vs. frequency characteristic. The phase characteristic is seldom measured, but we believe this will become more commonplace in the future, particularly for single channel devices.

## The make-up of TV waveforms

A square wave is a familiar waveform to all of us. If fed into a modulator, a series of black and white bars will appear on the screen.

The square wave can be understood

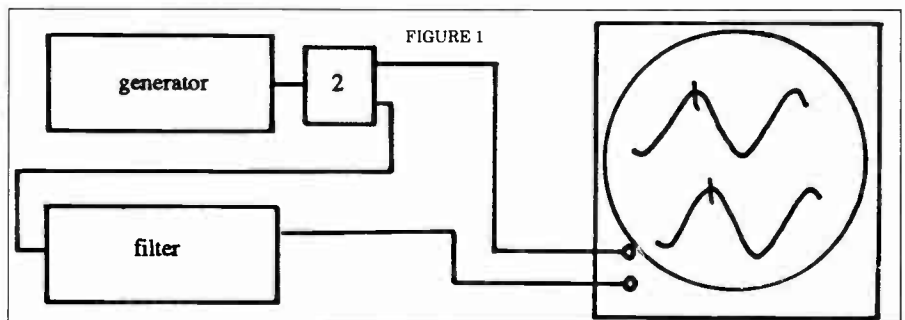

Another way of interpreting this effect is to say that the output is delayed compared to the input signal. Physically this makes sense, since it obviously does take a finite time for the signal to pass through the filter. If we express the phase shift as delay time we speak of phase delay.

$$\text{Phase delay} = \frac{\text{phase shift in degrees}}{360 \times \text{frequency}}$$

TV waveforms are not as simple as the foregoing sinewave signal, but the

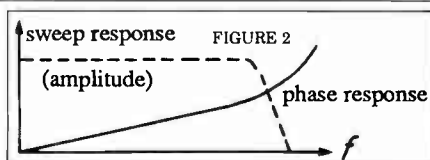

basic principle still holds. We should be aware that the phase shift of a wave through a filter is usually not constant as the input frequency is moved through the range of the filter and particularly as the frequencies pass through the cut-off region. If we plot the phase shift vs. frequency we may get a curve like that shown in Figure 2.

## Cable Classics

How comfortable are you with the definition of the terms "envelope delay," "phase delay," "ground delay," and "chroma delay?" Can you distinguish between the terms as they are applied to cable technology? Do you recognize the difference between "non-linear" distortions and "linear" distortions?

This paper, written in 1971 by Fred Schulz (then with Sterling Communication in New York City), introduced the reader to the basic concepts of delay distortions and describes their effects and importance in cable systems.

Note, that when reading the paper, it was written 16 years ago—equipment costs and references to prepared standards may be dated—but the basic concepts described are just as important for the cable engineer to understand and apply today as they were then!

Graham S. Stubbs  
Consulting Engineer

**The fundamental is the highest amplitude component, higher harmonics are of decreasingly lower amplitude.**

better if it is broken down into its components. This is called Fourier Analysis, but let the words not frighten you, the basic principles can be well understood without the rather advanced mathematics usually associated with it.

Let us feed a square wave through a bandpass filter, one which will just pass the signal equivalent to the funda-

made up of a fundamental and all odd harmonics. If the square wave has truly "sharp" corners and vertical sides, we will get harmonics at all odd multiples of the fundamental up to infinity. The fundamental is the highest amplitude component, higher harmonics are of decreasingly lower amplitude.

We just "disassembled" a square

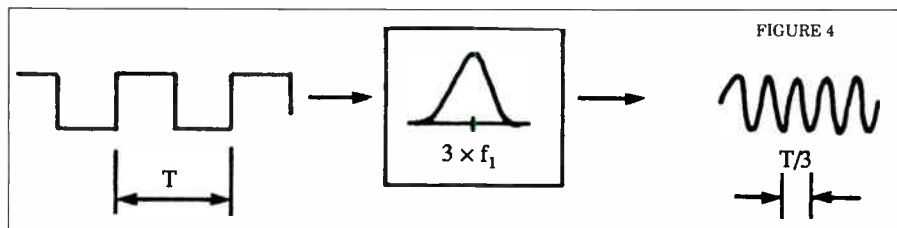
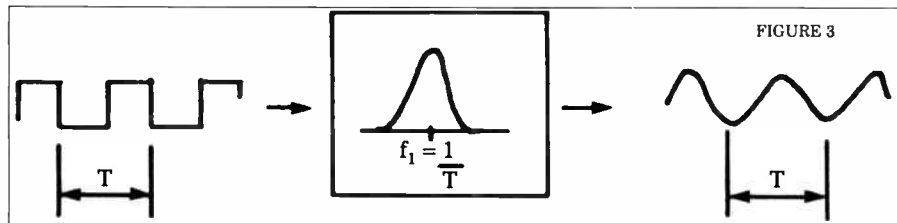

mental frequency. The resulting output is a sinewave.

We also get a sinewave output if we feed the square wave through a filter with a bandpass frequency for three times the fundamental frequency. The same will happen if we use a filter for five times the fundamental, also for seven times, nine times, etc.

We can say that the square wave is

wave into its sinewave components. Conversely, we can reassemble the wave from its sinewave components. See Figure 5.

Figure 6 shows the fundamental and the first three harmonics of a square wave.

The result is not a very good square wave since one should also add the 9th, 11th and all other odd harmonics to

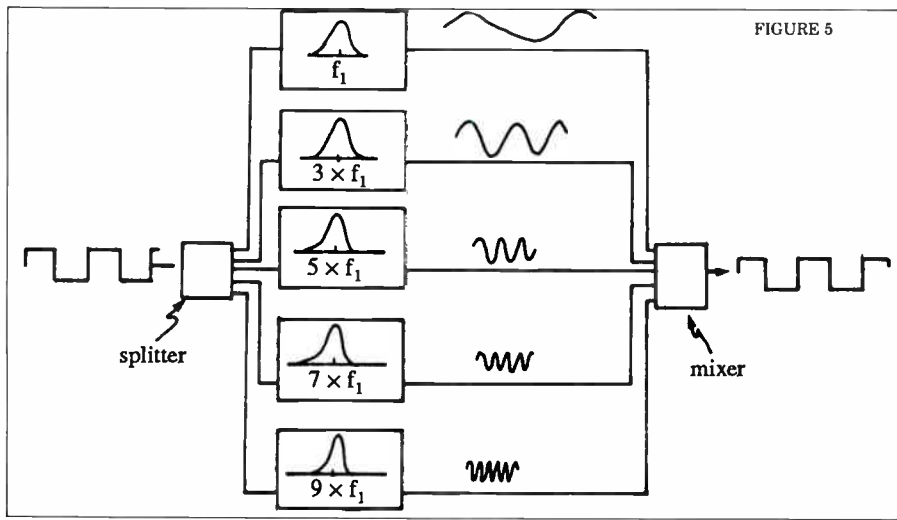

# MODULATORS YOU CAN SLEEP WITH.

We've heard horror stories about engineers who can't sleep at night because of constant equipment trouble. Well, they're probably not using CATEL equipment—because our products enjoy an industry-wide reputation for excellent performance and reliability.

Let's take our CTM20 Modulator, for example. Originally RCA's top of the line equipment, the CTM20 offers enhanced reliability, self diagnostics, additional solid state automatic switching, local and remote monitoring capabilities, as well as a built in character generator. And, because all functions can be controlled from a PC, it eliminates the time consuming hand and foot work required by other modulators.

CATEL has been providing innovative solutions to the telecommunications industry for almost 20 years. Solutions that span video, audio, and data transmission over fiber optic or coaxial cable, and microwave, satellite, or IR links.

Whether you're a small or large systems operator, you can now enjoy more capabilities and better signal quality, with less manpower and less downtime. Get a good night's sleep—contact us today to receive our new catalog, and find out more about CATEL and our new products.



## CATEL

Catel Telecommunications  
4050 Technology Place  
Fremont, CA 94537-5122  
(415) 659-8988

Call Toll Free 1/800/225-4046

# E-Z TRENCH

OUR NAME  
SAYS IT ALL



**J-1000**  
cuts: 1-2" wide/7" deep

Can it pay for its self in only one day?! E-Z Trench makes trenching a very quick and easy one man operation, while saving valuable time and money. Cuts approximately 100 feet in five minutes. Giving the most professional look possible with virtually no damage to the turf. Its rugged construction and dual belt drive produces long and dependable service, with a very small investment.

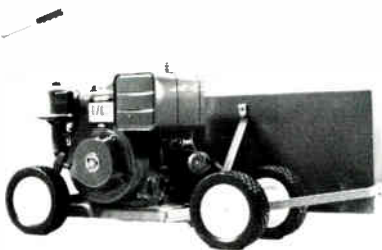

**J-2000**  
cuts: 2¾" wide/8" - 13½" deep

Shouldn't you consider an E-Z Trench?  
Call for: Nearest Distributor or order direct.

**E-Z TRENCH**  
Rt. 3 Box 78-B  
Loris, S.C. 29569  
803-756-6444

Reader Service Number 14

## So far we have concerned ourselves with changes in amplitude of the various frequency components only.

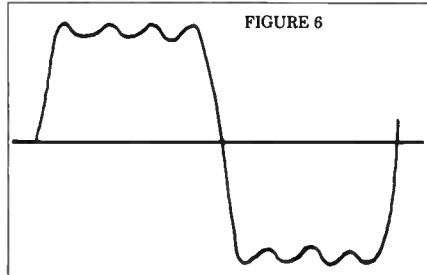

make a true square wave. It should also be noted that a square wave does not contain any even, such as 2nd harmonics. The principle, however, holds.

Any waveform can be made up of harmonically related sinewaves. Another rule worth remembering is: "A waveform with very abrupt amplitude changes contains significant components up to many times its fundamental frequency."

### Waveforms through filters

Let us look at the previous example again, but let us feed the signal through a low pass filter which passes

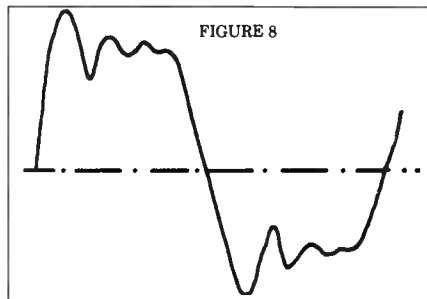
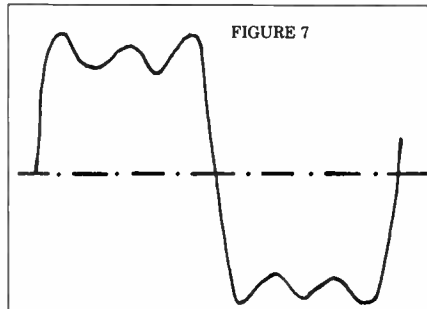

only the fundamental, the 3rd and 5th harmonics, but cuts off the 7th harmonic. See Figure 7.

We see that to faithfully reproduce the input waveform one must pass all

significant frequencies. As the next experiment, let us pass the signal through a filter which attenuates the 5th harmonic, such a trap is represented in Figure 8.

So far we have concerned ourselves with changes in amplitude of the various frequency components only. We indicated earlier that signals passing through a filter also get a change in phase or a delay, and further that not all frequencies may suffer the same delay. Let us pass the sample wave through a filter which shifts the 5th harmonic by 15° and the 7th by 30°, with respect to the fundamental. See Figure 9.

The output is non-symmetrical with a very pronounced ringing. As a further example let us shift the 3rd harmonic by 30°, the 5th by 60° and the 7th by 90°, as in Figure 10.

From these examples it is obvious that we must retain the relative positions of the signal components or distortions will result. The delay of the various frequency components, also called a group of frequencies, must be

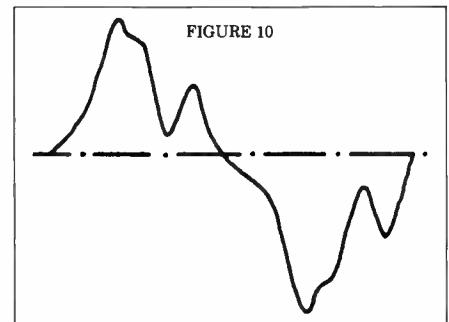
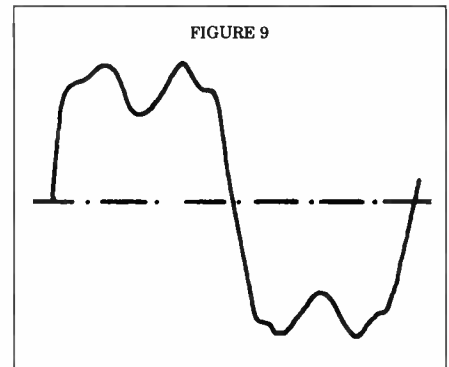

equal for distortion-free transmission. If this is not the case, we speak of group

# Micro-Beam™ The Cable Expansion Problem Solver

## Innovation in Cost-Effective CARS-Band Microwave Technology



Turn your cable expansion goals into a working reality with MICRO-BEAM™, the Channel Master® CARS-band microwave relay system designed for cost-efficiency and flexibility...two important bottom line considerations in any cable expansion plan.

Both of our 1 and 5 watt systems offer you more for your investment. With MICRO-BEAM™ there are no "hidden costs" for the equipment or services you need to make your system operational. Our standard system package includes feasibility studies, equipment installation, on-site service, warranties and much more, all at no extra charge. And because MICRO-BEAM™ is basically option free, the system you order is in stock, giving you the fastest lead time of any microwave product on the market.

In addition, our new microwave repeater and microwave multiplier offer extra versatility and cost-savings to your MICRO-BEAM™ system by consolidating transmitter and receiver equipment, as well as allowing you to add microwave paths as needed without utilizing expensive and often excessive, tube type equipment.

### Standard Equipment & Services

- 450 MHz Transmitter
- 300-450 MHz Microwave Receiver
- LNA/Image Rejection Filter/AGC
- Mounts, Waveguides, Connectors
- Feasibility Study
- Installation of MICRO-BEAM™ Electronics
- F.C.C. Application Assistance
- Alignment of Microwave Paths
- 1-Year Warranty on Parts & On-Site Service
- 24 Hour, 7-days a week, Technical and Warranty Service (In Continental U.S. Only)

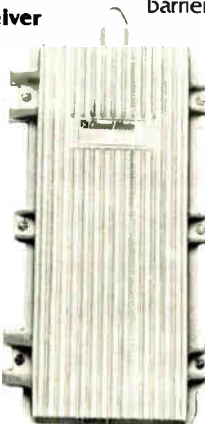

That's why small cable operators, as well as some of the top MSO's like United Cable, Centel Cable, Cable Entertainment, Sonic Communications and Telescripts, use MICRO-BEAM™

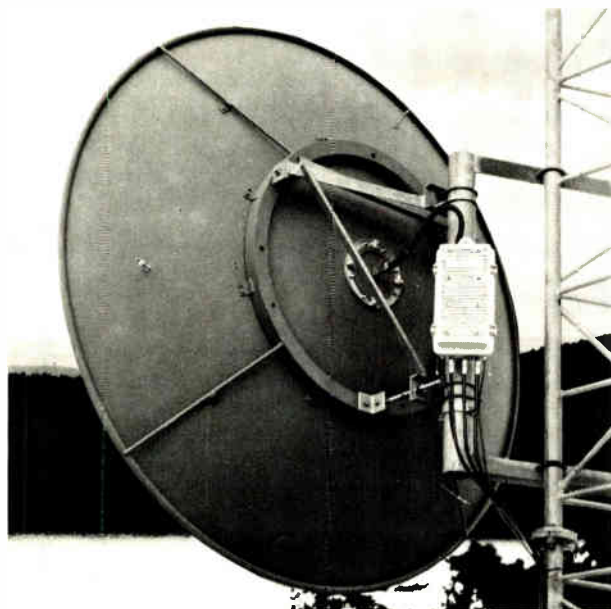

as an alternative to the more expensive systems on the market today. They know that a MICRO-BEAM™ CARS-band system will put their money to work profitably.

### Eliminates Additional Headends

MICRO-BEAM™ reaches isolated subscriber pockets and spans natural barriers without additional remote headends, adapting to your entire service including audio, video, data and addressability signals and commercial insertion capabilities. MICRO-BEAM™ also saves you that \$500 per-channel descrambling cost by allowing you to descramble each channel at the main headend. In fact, MICRO-BEAM™ is so compact, it allows you to transmit from a weatherproof unit that mounts behind the antenna. It can even be mounted on water towers, and can be placed anywhere in your system, not just at the headend!

### Two New Microwave Products

Channel Master® has added a new microwave repeater and microwave multiplier to its line of CATV equipment products for even greater CARS-band system expansion.

The new **Repeater**, available in 1 and 5 watts, is a low noise amplifier designed to consolidate transmitter and receiver functions, allowing microwave links to be cascaded or hopped without down-converting and then up-converting the signal.

The new **Multiplier** allows the systematic addition of microwave paths to a single transmitter location without utilizing tube type equipment. Also available in 1 or 5 watts, the new multiplier is designed with adequate gain to allow full output power over a wide range of input power, allowing microwave paths to be added as needed.

### Versatility In Signal Delivery

#### 36-Channel 300 MHz System

1-Watt: Transmits a fully loaded signal up to 9 miles in four directions.  
5-Watt: Transmits a fully loaded signal up to 15 miles in four directions.

### Sample Applications:

#### 60-Channel 450 MHz System

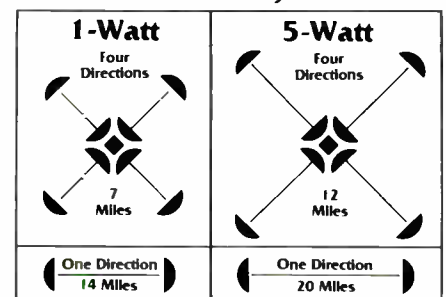

Contact us today and let our staff of qualified specialists show you how flexible and cost-efficient your cable system expansion can be, now and in the future with MICRO-BEAM™.

Contact: Jim Crossover

**Channel Master®**

Division of Avnet, Inc.  
Industrial Park Drive, Smithfield, N.C. 27577  
(919) 934-9711

# Eagle TAPS



*RFI Exceeds  
FCC Specs!*

Independent testing laboratories confirm only Eagle's tap far exceeds FCC specifications. Look closely and you'll find there is no substitute for Eagle quality.

- Double Corrosion Protection. Iridite undercoating, polyurethane surface coat
- 100% pressure tested to 15 p.s.i.
- 2-4-8 way available
- Brass F Ports Standard
- Designed to allow either aerial or pedestal installation
- Mylar bypass capacitors
- Double tongue & groove construction with matex gasket
- Sand-bond finish hardware

**(800)  
448-7474**



4562 Waterhouse Road  
Clay, NY 13041  
(315) 622-3402

## Delays are usually so small that they are expressed in microseconds or nano seconds.

delay distortion or simply group delay. The group of frequencies, if applied to a modulator, will result in a carrier and associated sideband envelopes. The envelope which contains the modulation must be passed distortion-free or we speak of envelope delay distortion. The terms envelope delay and group delay are generally used interchangeably.

For the sake of completeness, let us also state the accepted definition of envelope delay: "Envelope delay is the rate of change of the phase vs. frequency curve." Mathematically expressed:

$$\text{Envelope delay} = \frac{d\theta}{d\omega}$$

misregistration, will be treated later.

### Measuring envelope delay

Envelope delay measuring equipment is built to measure the change in phase a sample signal suffers when passed through a device under test. Figure 11 indicates a block diagram of such an instrument.

Delay measurements also require very good impedance matching all around, because mismatch causes reflections with resulting ghosts, and ghosts are a delay phenomena also.

To measure delay at RF frequencies one needs a modulator and a demodu-

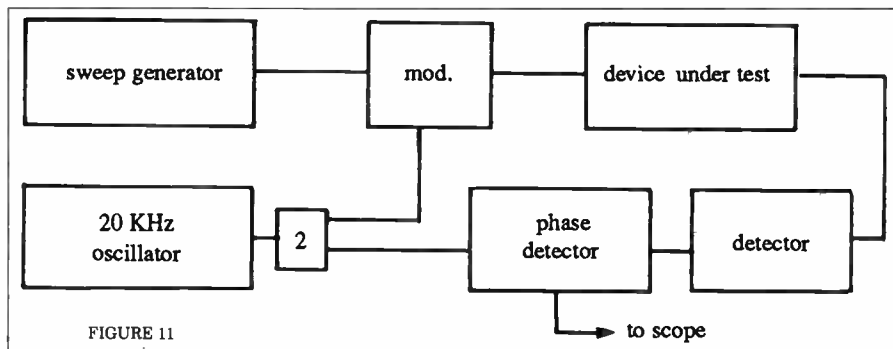

FIGURE 11

Delays are usually so small that they are expressed in microseconds (millionth of a second) or nano seconds (billionth of a second).

The effects of envelope delay result generally in ringing (preshoot, overshoot) producing closely spaced ghosts particularly visible on vertical black/white transitions. Another effect, color

lator, which by themselves already exhibit some delay. The best modulator demodulator combinations available today have a residual delay of  $\pm 20$  nsec. over a 4 MHz video bandpass.

### Chroma delay

A standard color TV picture consists

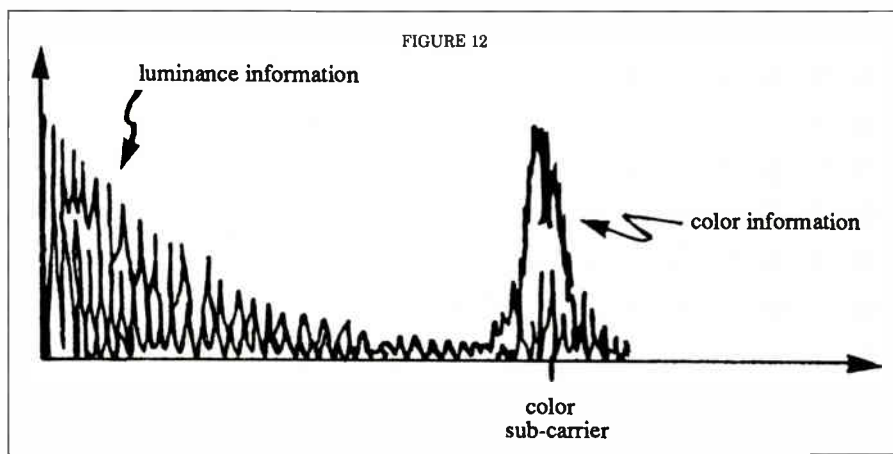

FIGURE 12



## Chroma delay is one of the most visible effects of envelope delay and methods to measure it rapidly have been developed.

of a high definition black and white picture with a low definition color picture added to it. The color information is carried at the upper end of the video spectrum around a 3.58 MHz color subcarrier. The frequency distribution can be seen in Figure 13.

It is important that the color information arrives at the picture tube at the same time as the black and white picture or the color will be out of registration. This error can be called chroma delay. In reality it is simply the envelope delay between the low frequency black and white picture components and the delay of the color information around 3.58 MHz, as shown in Figure 14.

Chroma delay is one of the most visible effects of envelope delay and methods to measure it rapidly have been developed.

The 20T pulse has gained wide acceptance for measuring chroma delay; it is a low frequency pulse modulated

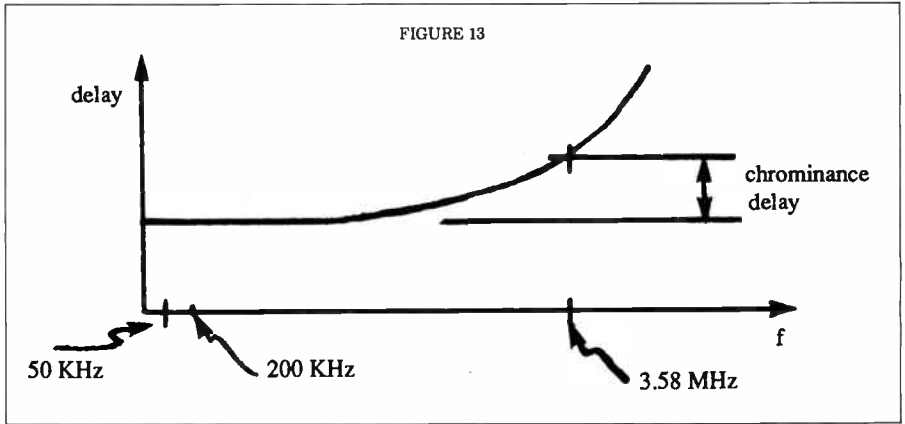

with 3.58 MHz color subcarrier signal. Its shape and frequency components are pictured in Figures 15 through 17.

The base line of this pulse gets distorted when the signal is passed through a device with chroma delay. It is possible to determine the delay by measuring pulse height (as referenced

to the bar signal level) and the base line excursion using graphs or formulas.

Several manufacturers offer instruments that allow the introduction of delay of opposite polarity and of 3.58 MHz gain/loss to straighten the base line; the introduced delay is then a

# R.T.G.\* VERSALIFTS - Ready for You - Right Now!

When you need a lift in a hurry, call your **Versalift** Distributor. He has fast access to our R.T.G.\* pool of complete, mounted **Versalifts**. No waiting because of long delivery on vehicles, manufacturing delays, or freight problems. Best of all, they're **Versalifts**, with job-proven reliability and industry-wide acceptance. And, since we're mounting them in quantity, the

prices are right, too. Truck or van mounted, telescopic or "elbow" models, with working heights up to 55 feet, all ready to go to work — Now!



**\*Ready To Go**  
Mounted on current model chassis.

For the name of your **Versalift** Distributor, call:



P.O. Box 20368  
Waco, TX 76702-0368  
(817) 776-0900

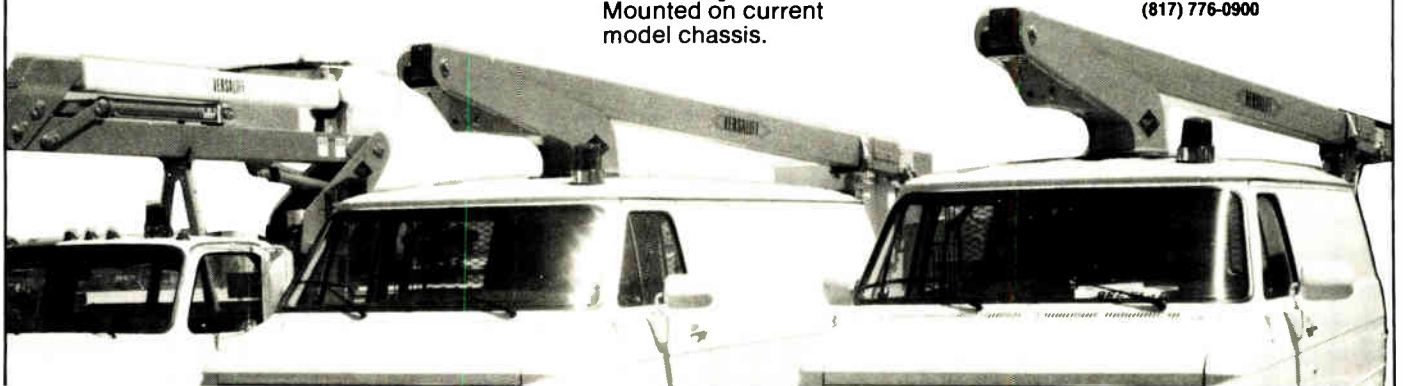

**Tektronix is now featuring a 12-½T pulse which yields a wider frequency spectrum around the color subcarrier.**

direct measure of the chroma delay. Instruments to generate 20T pulses cost around \$1,500—usually coupled with generation of other test pulses. The cost of the special receiver described above is approximately \$1,500. The 20T pulse was originated in Europe and is in wide use there; U.S. networks are not using it yet for transmission

over the air.

Tektronix is now featuring a 12-½T pulse which yields a wider frequency spectrum around the color subcarrier to be more representative of the actual color information bandwidth and to yield easier computation of the chroma delay from the measured base line excursion.

Tektronix has introduced a way to measure chroma delay using the color bar test pattern.

*Part II of this article by Fred Schulz, including Tektronix's test pattern, will appear in the October issue of CED.*

FIGURE 14

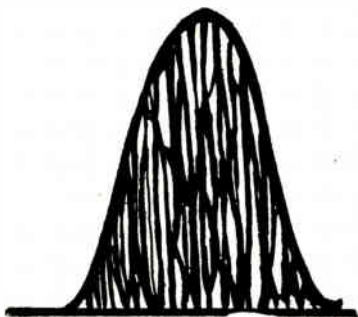

FIGURE 15

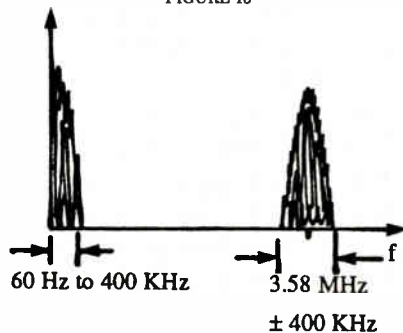
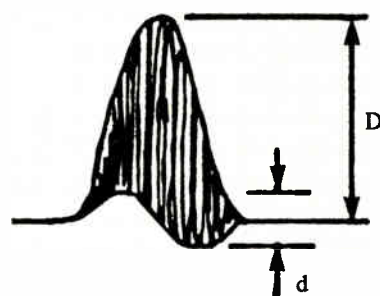

FIGURE 16



**RMS GUARANTEES**  
**-120 dB RFI!**



Only RMS guarantees -120 dB RFI in its CA-1090/M and CA-2090/M directional couplers, and CA-2002/SM silver plated two-way hybrid splitter. No one else comes close. These products are especially useful at the headend of systems in metropolitan areas, and in LAN systems where RF integrity is essential.

*RMS—"Built with the technician in mind"*

**RMS ELECTRONICS, INC.**  
50 Antin Place, Bronx, N.Y., 10462 CALL COLLECT: (212) 892-1000 (New York State)  
TOLL FREE: (800) 222-8312 (Continental U.S.A., Puerto Rico, U.S. Virgin Islands)



# Your best training isn't across the country. It's across the hall.

You shouldn't have to send your people on a four-day trip to get the training they need.

Now you don't.

Announcing Wavetek's Field Seminars for cable TV engineers and technicians. Definitive. Practical. Customized to your operation's needs.

And taught by Wavetek experts at a site you choose.

You deserve the best hands-on training in the business. Now, get it down the hall. From Wavetek.

To receive a complete Wavetek Field Training Menu, mail the attached reply coupon to Wavetek RF Products, Inc., 5808 Churchman Bypass, Indianapolis, Indiana 46203-6109. Or call 317-788-5965.

  Send a training menu.  
 Have a technician call.

Name \_\_\_\_\_  
 Title \_\_\_\_\_  
 Company \_\_\_\_\_  
 Address \_\_\_\_\_  
 City, State, Zip \_\_\_\_\_  
 Type of operation CATV  LAN

# Which came first? The chicken

It's an age-old question, but it appears we may finally have the answer. Early on, after IS-15 was developed and accepted as an interim standard, people started using the "chicken or the egg?" analogy to describe the predicament they were in. Television and VCR manufacturers didn't want to spend the money necessary to add the plug if nobody built decoder boxes; operators couldn't buy decoder boxes because they weren't available; and decoder suppliers weren't building decoders because TVs with plugs weren't being offered yet. Sound like a mess? You bet it was.

But within the past six months, the gridlock was loosened by announcements from Panasonic and RCA that selected, high-end models would be equipped with IS-15 plugs commencing with the 1988 model year. Those sets are presently being produced and on their way to dealers. Additionally, there are reports that JC Penney and Bang & Olufsen will be offering IS-15 equipped sets next year.

The announcements took many in the cable industry by surprise. In the past, cooperation between the two industries was non-existent and relations were strained, at best. Now, however, TV manufacturers have come to realize that their customers are the cable industry's subscribers and vice versa. Consequently, a new spirit of cooperation has emerged.

"The plain, unadulterated fact is that those guys (TV vendors) have bet on something with real serious downside risks for them, in the sense they have no guarantees that anything is going to happen except they're going to make a bunch of TVs with a strange protuberance on the back," said Wendell Bailey, vice president of science and technology at the National Cable Television Association. "This was a chicken and egg problem and they said, 'We're just going to be the chicken, let's go' and they did it."

So now that the question of who came first has been answered, it's up to the cable industry—both the operators and manufacturers of decoder boxes—to keep the development momentum going, says Walt Ciciora, vice president of strategy and planning at American Television and Communications, because the TV makers will

## The next step in IS-15 is up to the cable industry.

probably only include the plug for two or three model cycles without positive response. "It's up to the cable industry to respond favorably and keep this thing happening," he said.

For those not in the know, the IS-15 is a baseband decoder standard consisting of a 20-pin plug designed to be located on the back of TV receivers or VCRs. The plug accepts descrambling units and other add-ons, thereby allowing descramblers to be placed after the TV or VCR tuner. This will allow consumers to use all the programming and remote control features built into the electronic equipment.

An additional benefit is that by removing redundant parts (tuners, remote controls, channel number indicators and remodulators) and eliminating one level of processing, the descrambling units will be reduced in price anywhere from 40 percent to 60 percent and signals will be delivered to the receiver in a cleaner fashion. In these days where signal quality is becoming ever more important, that will be a critical feature.

According to a survey sent to the top 50 MSOs, support for IS-15 (which has for marketing purposes been given the title of EIA MultiPort) does exist. Joe Van Loan, vice president of engineering at Viacom and chairman of the subcommittee formed to drum up support for the plug, said 21 MSOs representing 9 million subscribers responded to the survey and results were "encouraging," he said.

For example, to the question of would they buy a decoder if it was priced between \$30 and \$45, 10 said definitely and nine said probably. If it cost between \$45 and \$60, one said definitely and 12 said probably. And if it were available, six said it would definitely influence their descrambler purchase plans, eight said probably and five said it might influence their decision.

"If 60 percent of the probables and 80 percent of the definites actually buy one, you can draw some conclusions

about purchase intent," said Van Loan. "That may be our next step." In fact, Bailey said a second survey, with more well-defined questions, is being considered so the committee can get a better feel about the MSOs' purchasing plans. More evidence of operator interest



is the purchase orders being sent down by Viacom, ATC, American Cablesystems and Jones, to name a few. Granted, the order are not for thousands of boxes, but it is clear there is interest and a desire to test the concept.

"I'm very supportive of IS-15," said Andy Devereaux, vice president of engineering at American. "We have ordered IS-15 decoders for our Illinois

## Later this year, the IS-15 name long used for the baseband decoder standard may disappear altogether.

system" which uses Zenith Z-TAC converters, he said. Although he is in favor of the technology, he notes it will take a period of several years before a majority of TV receivers carry the plug. And he feels something else needs to be done, too. "Currently, IS-15 doesn't



deal with impulse pay-per-view and that is forcing us to do other things" like offer a multi-function remote control to many subscribers, Devereaux said. (In fact, however, there has been a decision made to set aside two of the pins for PPV and other uses.)

Speaking of Zenith, the Chicago-based manufacturer is being seen as the most aggressive builder of deco-

ders, having announced its intention to have a Z-TAC module, IS-15 compatible, in production by the fourth quarter of this year. Other vendors have shown prototypes or at least gone into the engineering lab at ATC in Denver (which has been offered as a neutral testing facility for interested parties). But some in the industry get the impression this is where the bottleneck is occurring.

While he admits he has no specific target date, Andy Meyer, market specialist at Scientific-Atlanta, said the company has a working prototype that is compatible with the existing S-A scrambling scheme and will make a product announcement when a demand is perceived.

"I don't think we're dragging our feet," said Meyer. "It's in our best interest to offer the product but I think we have to see a little more demand first. Right now, it's not a practical way to spend our R&D dollars by mass producing a product that isn't in full demand."

The lack of product announcements from this segment of the industry doesn't bother Van Loan, though. "Our manufacturers know that when they have it (decoder box), we'll buy some," he said. And the story is the same for other MSOs who are keenly interested in eliminating the consumer interconnect headaches. Other operators may not yet be issuing purchase orders, Van Loan said, but "when the boxes are available, they'll buy some."

Then, once everyone gets on the same page of the script, the challenge of logistics has to be met, according to Bailey. With RCA and some others selling a few MultiPort sets and decoder vendors selling a few decoders, the challenge early on will be matching those sets with the decoders.

"For the time being, we have to do this manually as best we can," said Bailey. We need to make sure these things come together. We have to be prepared to midwife this baby." One idea that has been proposed is a nationwide hotline number where operators who need decoders can find out where to find one that's available. In the meantime, the industry may need to work with the TV makers directly to help get sets matched with decoders in the markets for which they have

been purchased.

But before that occurs, Van Loan wants to test MultiPort, using RCA TVs and Zenith decoders (since those two manufacturers will have product available), later this year. "To put out 100,000 sets all over the United States and marry them to 20,000 boxes in 5,000 homes would be a hard way to gauge their success," said Van Loan. "But if we can get a microscopic view by putting 200 or 300 of them out there in one place and then go talk to the people who use them, I think that will be helpful." Van Loan is already trying to get a feel for how the whole idea works by testing reaction to Zenith's Redi-Plug and Base-TAC, a device that has been installed on all Zenith TVs and VCRs for several years, in Viacom's Pittsburgh system. And, indeed, Van Loan has been in contact with officials from Rogers in Canada, where Base-TAC units and the Redi-Plug have been in use for a few years.

What's next for MultiPort? Tests and, perhaps, refinements. Already, with advances being made in VCR and TV receiver technology, there was a meeting held in Denver to discuss the need to accommodate for separate Y/C inputs. After some discussion, the subcommittee decided it would have little or no effect on MultiPort and voted to take no action, said Van Loan. By not making provisions for the Y/C connection, an opportunity to keep the interconnection as simple as possible was missed, admits Ciciora. But, he added, it's not an issue of great significance.

Later this year, the IS-15 name long used for the baseband decoder standard may disappear altogether as the interim standard becomes a full-fledged standard. "The intent there is to have the Japanese TV manufacturers jump on board" and include the plug on the back of the sets they build, said Van Loan. "We want to give a clear message to them that this is something that's needed and that all development work has been completed."

When it's all said and done, it's obvious the past 12 months were a busy time for MultiPort proponents, dotted with several small success stories. Those same people are hoping the trend continues through next year.

—Roger Brown

# In 1962, AT&T brought television into the space age.

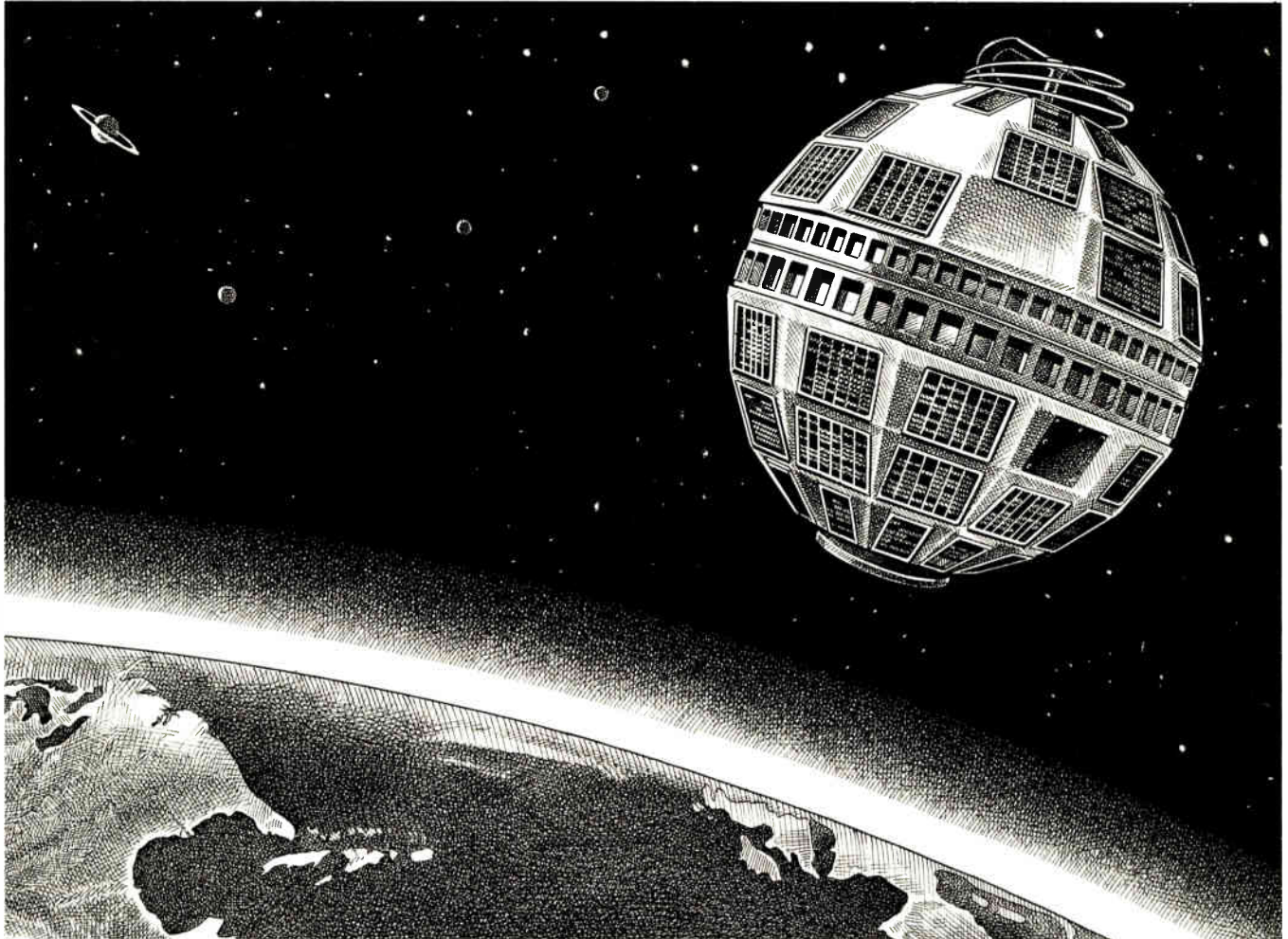

## **AT&T comes through with 25 years of satellite service.**

It was twenty-five years ago that AT&T first ventured into space.

Our mission was to rocket Telstar 1, the world's first active communications satellite, into orbit.

The launch thrust technology into a whole new dimen-

sion. Telstar 1 proved that a satellite could be used to successfully relay television, data and voice transmission overseas.

And today AT&T continues to uphold their commitment to technical excellence by offering a variety of satellite services under the AT&T SKYNET® family name.

From equipment to networking, from computers to communications, AT&T is the right choice.



**AT&T**

The right choice.

# BroadbandLAN

Modems: Who's in, who's out?

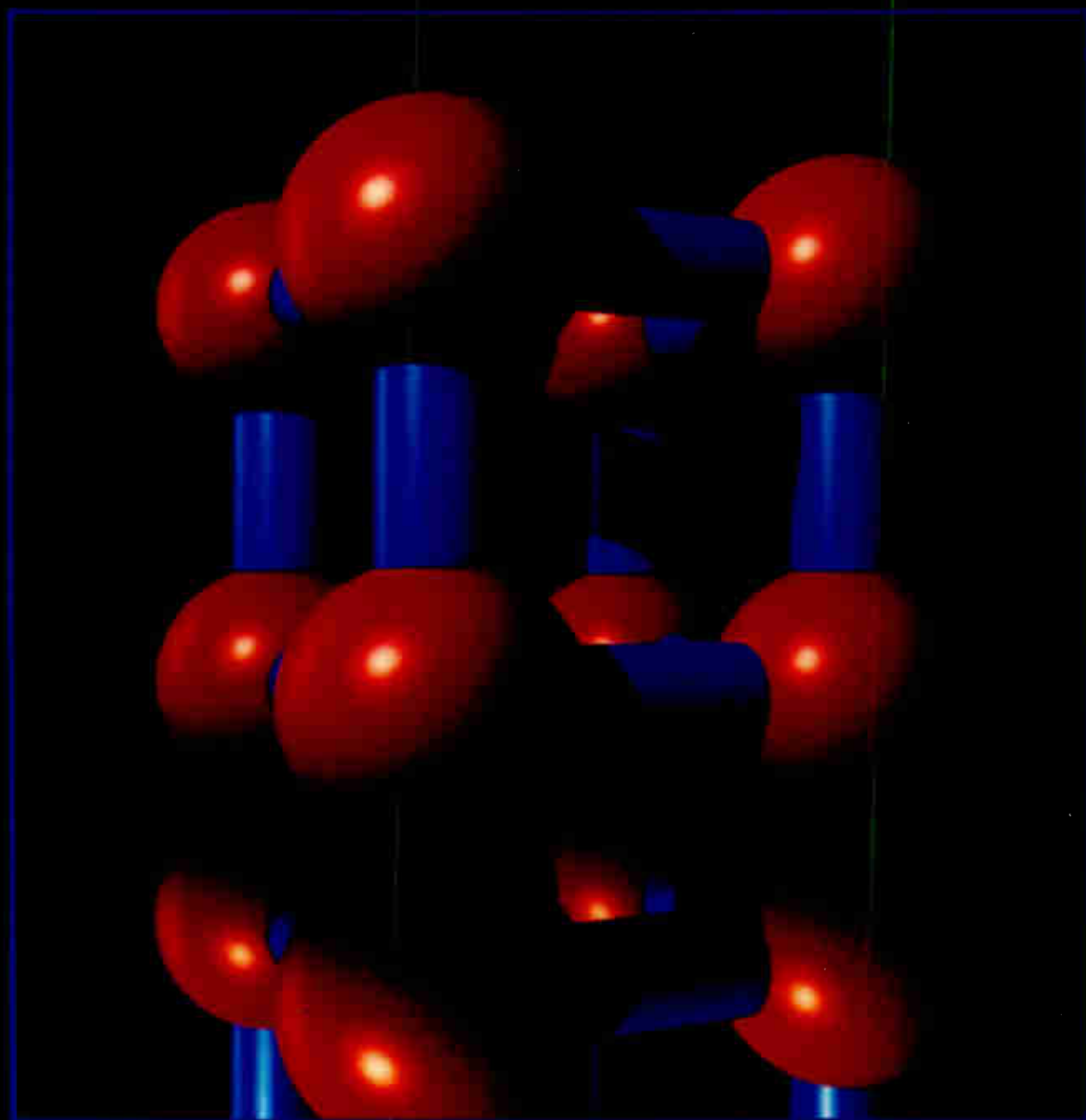

# Amplifiers for the LAN environment

CATV systems routinely use sub-split amplifiers which allocate nearly all their bandwidth to carry video signals to subscribers, (54 to 400 or 450 MHz out, 5 to 30 MHz return). In a LAN environment, it is necessary to have much more bandwidth on the return path. This can be alleviated by using a dual cable system with an amplifier for each cable, inbound and outbound, or a LAN system can be configured with amplifiers using mid-split (typically 168 to 400 MHz forward, 5 to 116 MHz return) or high-split (232 to 400 MHz out, 5 to 174 MHz return) frequencies.

Redundancy and status monitoring are important in a cable system, but play a bigger role in a LAN configuration. With a cable system, the delivery is entertainment. Unless the system is two-way and status monitoring is present, operators are unaware of a failure until the phones start ringing. In a LAN system, reliability and time to repair a failure is critical. A few minutes down-time in a LAN can result in a loss of thousands of dollars. Being able to remotely control and monitor the performance of an amplifier is essential.

Since there are not as many amplifiers operating in a LAN cascade, distortion specifications are not as important as frequency response and reverse gain. Because there can be a lot of flat loss, the reverse gain needs to be the same as the forward gain.

## **Augat/Broadband Engineering Inc.**

Broadband Engineering offers several LAN amplifiers. Available are the DATA-450 LAN amplifier, DATA-200 LAN amplifier, Bi-Directional Data Network Amplifier (BDA), VFA-450 LAN amplifier, VRA-200 LAN amplifier and the DAX-450-2W outdoor distribution amplifier (available in September). Broadband's Bi-Directional amplifier is for indoor distribution of data. The BDA is designed for operation on a single cable, two-way system with a mid-split frequency allocation. The mid-split carries bandwidths of 5 to 112 MHz/150 to 450 MHz and high-split carries 5 to 186 MHz/222 to 450 MHz. Features include 30 or 60 volt cable-powered, 120 or 240 VAC

## **LAN amplifier requirements differ from CATV, but are no less critical.**

mains powering, gain and slope controls in forward and reverse amplifiers and plug-in equalizers. Broadband's DAX-450-2W is also designed for operation on a single cable, two-way system but with a mid- or high-split frequency allocation. It is cable powered from 25 to 60 volt square wave source.

The VFA-450 and VRA-200 are both rack mounted amplifiers. The VFA-450 has outbound capabilities of 40 to 450 MHz whereas the VRA-200 is inbound out to 200 MHz. The VFA-450 may be used by itself in two-cable networks and with the VRA-200 and duplex filters in single cable two-way systems. Sub-, mid- and high-split capabilities are possible through the use of plug-in duplex filters at the output of the VFA-450. The VFA-450 also accepts plug-in pads and equalizers, has gain and slope controls, -20 dB test points at input and output, response equalization for flatness adjustment and a 12 dB directional coupler available to insert sweep or other signals prior to the output of the amplifier.

The VRA-200 is designed primarily for use with Broadband's VFA-450 forward amplifier. It may also be used in conjunction with the VFA-450 and the DPRM duplex filter set as the reverse amplifier in a two-way amplifier pair.

Broadband's DATA-450 is a DC powered rack mountable amplifier. DC powering provides the capability for standby powering from a 24 volt battery float charge system. The DATA-450 is a wide band amplifier with a nominal bandwidth of 40 to 450 MHz.

Broadband offers the BLX-2 series line extenders. The BLX-2 is two-way and comes in 330 and 450 MHz bandwidths, with gains ranging from 26 dB to 44 dB. Reverse bandwidth is 5 to 30 MHz with gains of 16, 20 and 30 dB. Also available from Broadband is the NE-4 LAN expander, which, when designed for two-way cable, allows for expansion from 1 drop to 4 outputs.

## **Blonder-Tongue**

Although not specifically designed for LAN application, Blonder-Tongue provides several amplifiers which have been used in the LAN marketplace. However, all splitting needs to be done externally, unless it is a low-split. The DA 400-33 is a high-output, 53 channel CATV distribution amplifier. The unit uses push-pull hybrid IC amplifiers and has cable slope compensation from 40 MHz to 400 MHz. The DA-33 features wide bandwidths, 0.5 MHz to 300 MHz, wide range continuous gain control and surge protected amplifier and power supply sections. It may be employed as a sub-channel return amplifier but requires external multiplexers to bypass VHF in the forward direction.

The DA 450-45 and DA 450-30 are push-pull, high output level amplifiers. The 40 MHz to 450 MHz amplifiers employ plug-in pads and external accessible slope and gain controls. The DA 450-45 has a flat operating gain of 45 dB minimum which can be reduced to 28 dB with the variable attenuator. The DA 450-30 has a gain range of 30 to 13 dB.

## **C-Cor Electronics Inc.**

C-Cor Electronics Inc. currently has four trunk amplifiers for different applications. The LAN-3XXX and LAN-4XXX are for dual cable (the LAN-4XXX also is used for inbound only), the LAN-5XXX for single cable midsplit (5 to 112 MHz/150 to 450 MHz) and the LAN-6XXX for use with single cable high split (5 to 186 MHz/222 to 450 MHz). Both the LAN-5XXX/6XXX series split-band amplifiers have high frequency automatic level control (ALC), bridger capability, status monitor capability, active failsafe capability, manual/TLC low frequency amplifiers, ALC low frequency amplifiers, external test points and bridger disconnect capability.

The LAN-4XXX series amps are designed specifically for use in the inbound portion of dual cable distribution systems. Normally, they are used in conjunction with the LAN-3XXX. The LAN-4XXX can be configured to operate in either a one-way or two-way mode. In the one-way mode, the LAN-4XXX carries inbound signals from 42



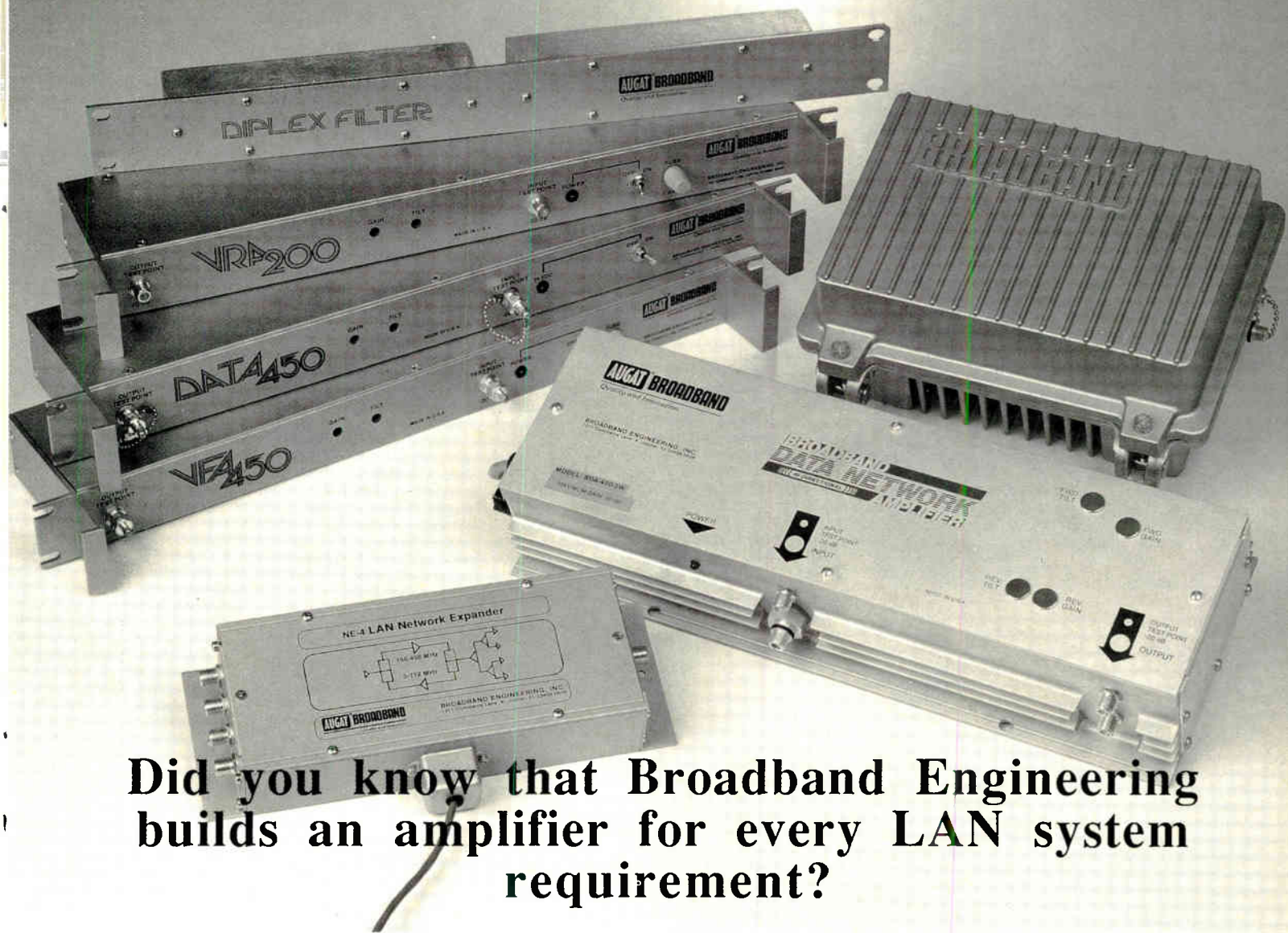

## Did you know that Broadband Engineering builds an amplifier for every LAN system requirement?

It might surprise you to learn that we are the most innovative supplier of LAN amplifiers. That comes from listening to our customers and designing amplifiers that meet their requirements.

To meet our customers needs, we build rack mounted amplifiers for single and dual cable networks, a mid-split amplifier with a weatherproof housing and a highly efficient switchmode power supply. We also have mid-and high-split indoor distribution amplifiers.

Our rack mounted amplifiers are AC or DC powered. DC powered units are built for use with communications battery powering systems.

Another unique LAN product is our network expander for expansion from a single port to four ports. The network expander allows more terminals on an existing network without adding taps.

To find out about our full line of LAN products or for LAN application assistance, give us a call.

Call toll free at 800-327-6690. In Florida, call 305-747-5000 or write us at 1311 Commerce Lane, Jupiter FL 33458.

**AUGAT<sup>®</sup> BROADBAND**  
Quality and Innovation

*A part of the growing Augat Communications Group*

Reader Service Number 21

# WE KEEP YOU

A new National Electric Code is going into effect which will be adapted by many cities and states.

Comm/Scope manufactures several dropwires that already meet or exceed the new VW-1 Flame Test which doesn't even go into effect until July, 1988.

There's a reason.

At Comm/Scope, we believe that if you can make a better dropwire you should do it today.



# U CURRENT.

And we also believe that if you can install a safer dropwire you shouldn't wait until tomorrow.

If you'd like to get started right now, contact your nearest Comm/Scope representative or call us direct at 800/982-1708 (800/222-6808 in NC).

## **COMM/SCOPE. WITH YOU ALL THE WAY.**

Comm/Scope Division, General Instrument Corporation, PO Box 1729, Hickory, NC 28603, 800/982-1708 (800/222-6808 in NC), Telex: 802-166

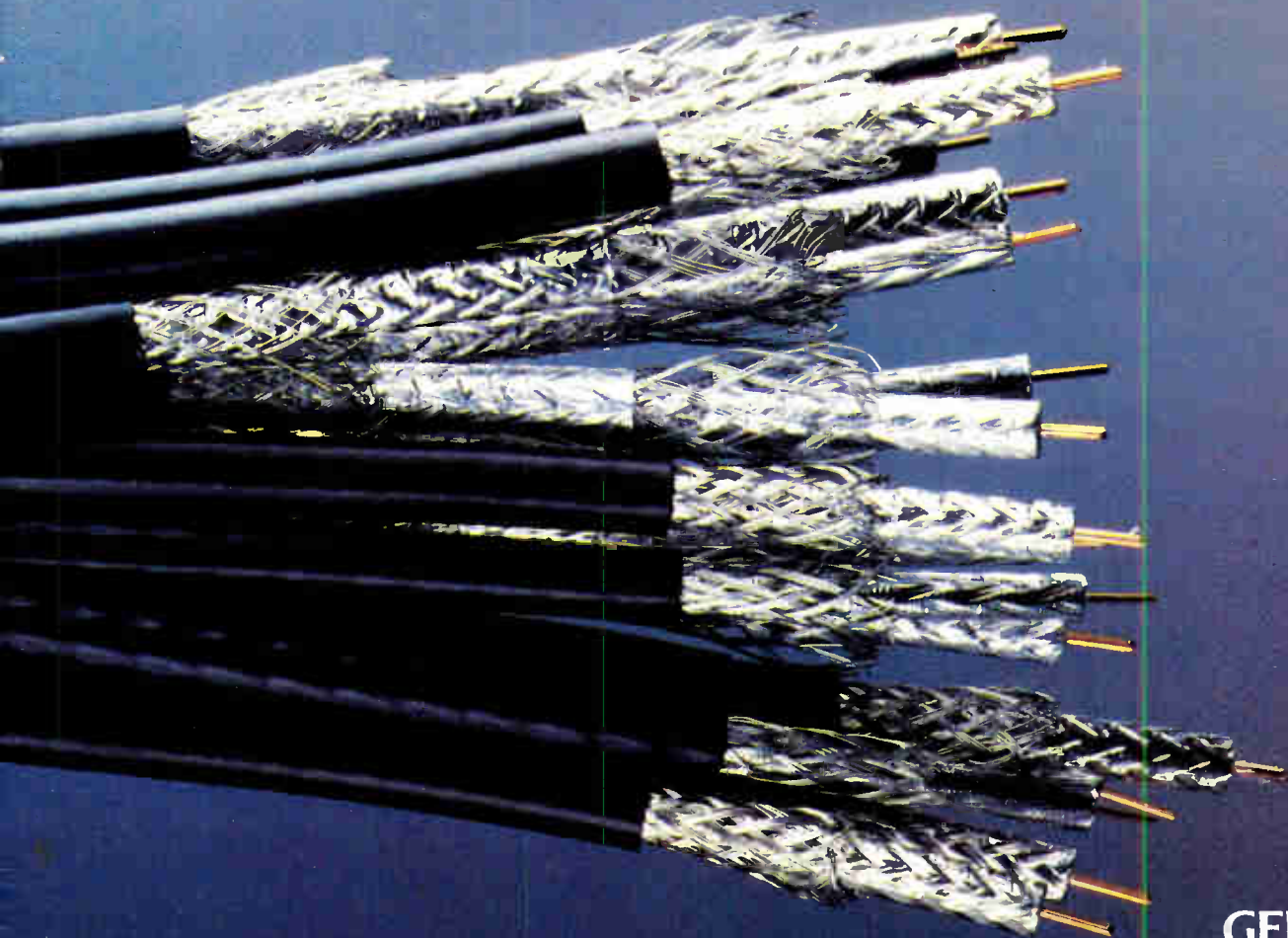

**GENERAL  
INSTRUMENT**

Reader Service Number 22

## The Starline 'SJ' Series from Jerrold is a mainstation amplifier for mid-split and dual cable applications.

to 450 MHz. In the two-way mode, the amplifiers carry low frequency signals from 5 to 25 MHz in the opposite direction of the inbound high frequency signals (42 MHz to 450 MHz). The two-way mode requires the use of a low frequency amplifier.

The LAN-3XXX is designed for use in the outbound portion of a system. This series also can be configured for a one- or two-way mode. In the one-way mode, the LAN-3XXX carries outbound signals from 42 MHz to 400 or 450 MHz. In the two-way mode, the amplifiers carry low frequency signal from 5 to 25 MHz in the opposite direction of the outbound high frequency signals (42 to 450 MHz). Both the dual cable amplifier's low frequency band is used for Quick Alert status monitor communications. Features of the LAN-4XXX and the LAN-3XXX include pad and equalizer locations, removable plug-in modules and accessories such as low frequency mod-

ules, bridger modules, splitters, directional couplers and striplines.

Available for single or dual cable networks, C-Cor offers the Active Fail-Safe Amplifier (AFA) which provides active amplification in the event of a failure of any trunk amplifiers.

### Jerrold

General Instrument's Jerrold division has a complete line of amplifiers for LAN applications. The X-2000 allows for upgrading from mid- to high-split or dual cable in the same housing and chassis. The housing is designed to accept two cables, thus allowing for two-way dual cable amplifier stations with all the same features of single cable amplifiers. The X-2000 can be configured with active redundancy for failsafe operation. The mid-split stations operate from 5 to 116 MHz inbound and from 156 to 450 MHz outbound, while the high-split stations

operate from 5 to 180 MHz inbound and 222 to 450 MHz outbound. These frequencies conform to current MAP/TOP standards and specifications being considered by IEEE 802. Configuration of the X-2000 amplifier is by user selection of features by functions.

The Starline "SJ" Series from Jerrold is a mainstation amplifier for mid-split and dual cable applications. The Starline Series utilizes quad technology and is capable of 450 MHz performance and amplifying 60 standard forward video channels. Features include a seven-port aluminum housing, RFI weather gaskets and input and output test points. Power supply features include the SJSW "Super Switcher" and heavy duty surge arrester standard (SJS-145). Accessories for the Starline Series are feeder-makers for a choice of which feederline ports will be active, plug-in pads and circuit breakers.

Line extenders from Jerrold include

# Avoid Costly LAN Delays.

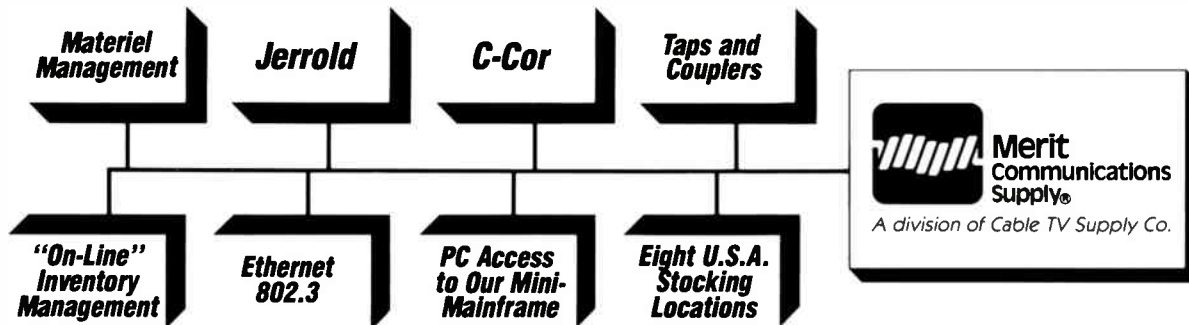

B R O A D  
B A S E  
F I B E R

**YES! Send me info on:** (Specify) \_\_\_\_\_

Name: \_\_\_\_\_ Mail to: Merit  
Title: \_\_\_\_\_ Communications Supply  
Company: \_\_\_\_\_ 5922 Bowcroft St.  
Address: \_\_\_\_\_ Los Angeles, CA 90016  
City, State, Zip: \_\_\_\_\_ **Or CALL 800-443-8615**  
Phone: ( ) \_\_\_\_\_ **Nationwide.**

Reader Service Number 23

# Heads Above the Rest!

## Viewsonics CATV/LAN Headend Products

• All 19" Rack Mount • All Brushed Aluminum Finish

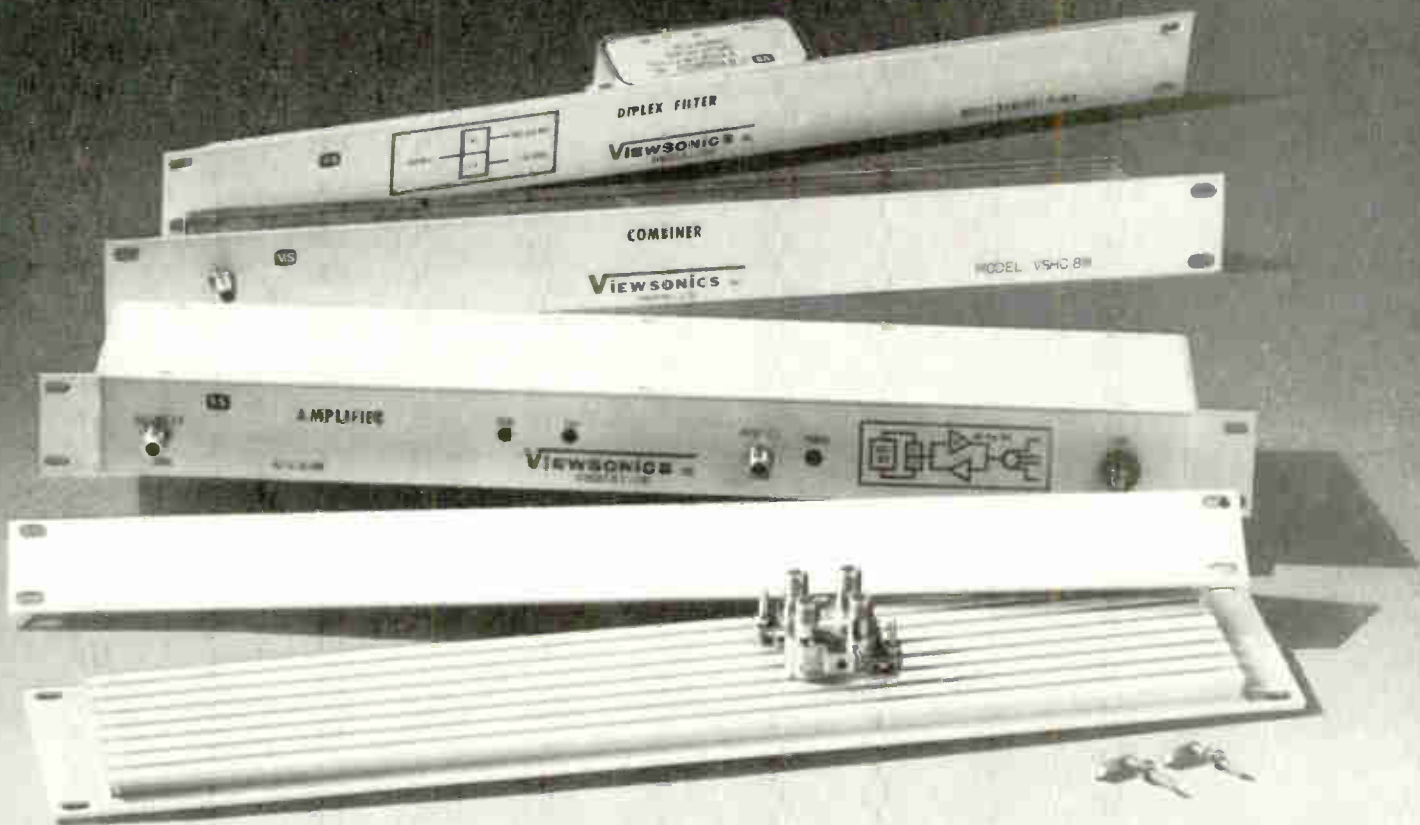

### **RACK MOUNT DIPLEXERS:**

Model #VSREDP (\*) RM

- Low/Mid/High Split Options
- High Isolation/Guard Band Attenuation
- High RFI Integrity

### **HEADEND COMBINER:**

Model #VSCH-8W

- Excellent Port-To-Port Tolerances
- High RFI Integrity
- Front Panel Test Point

### **RACK MOUNT AMPLIFIERS:**

Model #VS-FA-20-40D

Model #VS-RA-20-40D

- Forward/Reverse Models
- Full Bandwidth/Superior Flatness Response
- 20db to 40db Gain Options
- External, UL Approved 120 VAC Powering
- Slope and Gain Controls
- Plug in Pads and Equalizers

### **RACK MOUNTING PANELS:**

Model #VSMP1.75"

Model #VSMP3.50"

- Simplifies Rear Mounting Problems (Mounting Hardware Included)
- Eliminates Drilling
- Improves Heat Sink Characteristics
- Front Panel Customizing Available on Special Order



**Viewsonics** INC.  
"PRODUCTS WITH INTEGRITY"

Reader Service Number 24

170 Eileen Way, Syosset, NY 11791  
Call Toll Free: 800-645-7600  
In New York Call: 516-921-7080  
FAX: 516-921-2084

## Also available from Magnavox is the Digital System Sentry (DSS/A) status monitoring system.

the models JLE-MS-450-HG (high gain), JLE-MS-450 (standard gain), the JLE-7-451-HS for high-split and the SLX-450-1W for dual cable. The JLE-MS-450 and JLE-MS-450-HG are designed for use in single cable two-way mid-split broadband LANs. The return amplifier section features post equalization to reduce return noise accumulation. The JLE-MS-450-HG has a high gain capability in the forward direction (36 dB) and in the return (28 dB). The JLE-MS-450 has 28 dB gain capability in the forward direction and 28 dB return gain. Both line extenders feature a bandwidth of 5 to 116 MHz/156 to 460 MHz, low noise figures and accept a variety of pads and equalizers.

The JLE-7-451-HS is the newest line extender from Jerrold. It carries many of the same features as the JLE high and standard gain models but employs a bandwidth of 5 to 180 MHz/222 to 450 MHz. The SLX-450-1W was developed to meet the needs of dual cable networks. It can be used in conjunction with the X-2000 dual amplifier for larger networks.

Also available is the model IDA-450 indoor broadband push-pull amplifier. The IDA-450 is two-way capable with three return bandwidth options (5 to 32 MHz, 5 to 116 MHz, and 5 to 174 MHz).

### Magnavox CATV Systems Inc.

Magnavox CATV System's modular design allows for selection of product groupings for housing, chassis, trunk amplifier, equalizer, attenuator, response equalizer, AGC/ASC status monitoring, bridger, bridger splitter, return amplifier, terminators and power supply. Depending on the bandwidth desired, 450 MHz or 550 MHz, the configuration is up to the system planner.

Magnavox offers two band-splits for 450 MHz; a 108 mid-split system carries return signals in the 5 to 108 MHz bandwidth and forward signals in the 174 to 450 MHz bandwidth; a 174 high-split system carries return signals in the 5 to 174 MHz bandwidth and forward signals in the 225 to 450 MHz bandwidth. Mid-split versions of interconnection chassis, forward trunk and bridger amplifiers, and return

amplifiers perform the same basic functions as the corresponding sub-split versions but act upon different sets of frequencies.

Also available from Magnavox is the Digital System Sentry (DSS/A) status monitoring system. The DSS/A continuously checks operation of forward and return amplifiers, controls and monitors remotely-located disconnect switches in the return trunk and feeder lines and monitors the status of the stand-by AC line power supply. The DSS/A is compatible with its predecessor, the DSS system.

### Scientific-Atlanta

Featuring line or 110V AC powering and selection of three reverse splits, Scientific-Atlanta offers several amplifiers for the LAN marketplace. Available for mid-split systems is the Series 6560 with a range of 5 to 112 MHz in the reverse direction and 150 MHz upper frequency for forward direction. For the 450 and 550 MHz range, the series 6570 for high-split offers a reverse bandwidth of 5 to 174 MHz and a forward bandwidth of 235 MHz up to 550 MHz. The modular design allows for user configuration. For use with the 6560 and the 6570 is the 6585 Status Monitoring/Reverse Switching system. The 6585 utilizes an IBM personal computer, a color graphics monitor, printer, RF subsystems located at the headend or central control location and drop-in modules for the series 6500 trunk station amplifiers.

Line extenders from S-A applicable for a LAN application are the models 6501, 6502 and 6810. The distribution amplifiers are available in either the standard hybrid configuration (Models 6501 and 6502), or in a feedforward gain block configuration (Model 6810). Frequency bandwidth ranges from 330 to 450 MHz/550 MHz and may be used in sub-, mid-, and high-split applications.

### Texscan, Communications Products Division

Texscan Corp. has slightly adapted its present CATV amplifiers for LAN application. The T-Series trunk amplifiers have a low-, mid- and high-split

with the mid-split range carrying 5 to 110 MHz/165 to 454 MHz and the high-split carrying 5 to 174 MHz/220 to 450 MHz. Also designed for the T-Series amplifiers is Vital Signs, a status monitoring system.

The 2000 series from Texscan are trunk bridger stations which carry a mid-split of 5 to 108 MHz/165 to 454 MHz and a high-split of 5 to 174 MHz/220 to 450 MHz. Configured for redundancy, the 2000 series supports two parallel amplifiers in case of failure. As a line extender companion, the 1000 series offers the same splits as the 2000 series.

### Viewsonics Inc.

Three amplifiers are currently available from Viewsonics Inc. Designed for headend applications, the LAN/CATV RF amplifiers and data-net bi-directional modular amplifier may also be used for station amplification or line extenders anywhere in the network. The Viewsonics rack-mount LAN/CATV RF amplifiers, VS-FA-20-40D, flat pack forward amplifier and VS-RA-20-40D, flat pack reverse amplifier are suitable for a wide range of CATV and data network applications. Utilized in combination, the VS-FA-20-40D and the VS-RA-20-40D, along with the appropriate frequency diplexing, provide an amplification package to serve the bi-directional requirements of a LAN.

The LAN/CATV RF amplifiers feature 20 dB or 40 dB gain availability, gain and slope controls, plug-in pads and equalizers, -20 dB input and output test points and 120 VAC, U.L. approved external transformer powering.

Applications for the VSBDA-20-40D Bi-Directional amplifier include distribution networks requiring high signal levels (+50 dBmV), line extenders for LANs, compensator for "high loss" pathways or filter/passive losses into or out of translators and as a driver for high loss complex combining circuits. The Viewsonics Bi-Directional amplifier offers push-pull hybrid and transient suppressing circuitry, various gain level and duplex filtering options, front panel adjustment controls and a chassis for high density packaging.

—Kathy Berlin

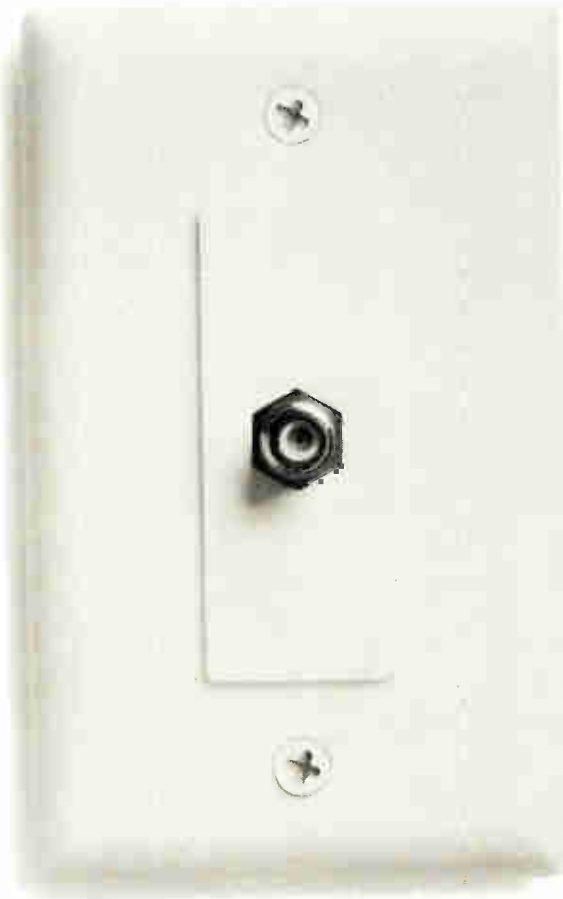

# From this point, only one instrument can tell you so much about your broadband LAN system.

Whether for peak performance or trouble shooting, the Wavetek LAN 450D gives you a versatile, portable solution to verifying RF output levels of modem signals or the amount of loop loss. From virtually any point on the system.

In addition to signal level and loop loss measurement, the meter provides a means of testing Carrier-to-Noise, Hum, path loss and system frequency response, return loss, and tap isolation.

Push-button direct access to



frequencies, unparalleled accuracy, light weight and battery power allow you to check many drop locations fast.

Point for point, there's no better way to check out your LAN system.

Ask your LAN equipment supplier or installer about the new Wavetek LAN 450D Network Analysis Meter. Or contact Wavetek Indiana, Inc., 5808 Churchman, Beech Grove, IN 46107, 317-788-5965.

Reader Service Number 25

**WAVETEK®**

# General purpose broadband modems

**B**roadband modems can be bought as stand-alone items, in pairs, for simple point-to-point or multidrop applications. They also come bundled with complete broadband local area networks and are commonly referred to in those applications as network interface units (NIUs). This month, *CED* looks at stand-alone modems. Next month we'll take a look at NIUs.

Broadband modems can conveniently be divided into voice and data products and run at low (19.2 Kbps or below), medium (56 or 64 Kbps) or high speeds (1.544 Mbps and above). Some are fully frequency agile while others operate at pre-determined frequencies. Point-to-point applications still are common but multidrop applications, where a single transmitting device addresses multiple receiving devices, are growing. Asynchronous transmission techniques are used for low speed applications. Higher speeds increasingly use synchronous techniques. Traditionally broadband modems have been used for data transmission, although newer voice products also are available.

## Halley Systems

There's been a flurry of new product activity recently as well as a reshuffling of suppliers. Halley Systems, formerly Zeta Laboratories, holds by reliable estimates 60 percent of the U.S. market share for stand-alone broadband modems. It has recently introduced three new modems: the Z19A, the Z19V and the Z64. The Z19A operates at 19.2 Kbps and offers improved clock recovery and jitter performance than the Z19. In addition, the Z19A allows local or remote loopback testing. Both Z19A and Z19V use 50 kHz spacing.

The Z19V operates in switchable digitized voice or data modes. In voice mode, tones from 300 Hz to 3,000 Hz are encoded using delta modulation. The Z64 runs at 64 Kbps and runs 100 kHz data channels spaced at 150 kHz (switch selectable at 150 kHz steps). Circle Reader Service number 75 for details.

## ISC Datacom

ISC Datacom, a company led by former Zeta Laboratories (now Halley

## Who makes them and where to get them.

Systems) principals, has two products: the Model 1019 and the Model 1056. About 10 of the units are in the field for evaluation and the firm currently is building its first 100 units. The Model 1019 runs to 19.2 Kbps and uses QPSK modulation to pack in 2,650 data channels spaced at 25 kHz. Remote and local control of power levels, frequency and data format is standard. The Model 1056 runs at 56 Kbps and runs 662 data channels spaced at 100 kHz. It has the other features of the 1019 model as well. Circle Reader Service number 76 for details.

Buyers should soon see an interesting contrast of business philosophies from ISC Datacom and Halley Systems. Halley will lean much more heavily toward larger orders; ISC leans toward lots of custom work and smaller orders, at least initially. ISC may want to develop its own RF bridge products; Halley will look to bundle other existing RF products to offer a larger system integration role and more software support. Halley's going big on marketing and wants volume; ISC still says the business is "artsy" and wants to be known for its ability to handle "specials." Halley will offer higher speeds and more channels, but wants to stay away from complex, "pie-in-the-sky" bandwidths. ISC believes in the value of tinkering as an approach to product development. Halley will tend to keep boxes on the shelves and ready for shipping; ISC typically prefers to build after an order is received.

There are some similarities, though. Both companies will be active in new product development. Neither will offer the cheapest modem on the market because both companies emphasize quality, not price. Halley already has a reputation for quality and ISC will try to engineer further improvements on the Halley designs. Watch them both. It will be interesting.

## EF Data

EF Data specializes in products that transmit data at RF and makes broad-

band, satellite, microwave and troposcatter modems. The company's strength is high-speed transmission. At 9600 bps or 19.2 Kbps, EF's modems aren't really cost-effective. Its BCM-64 modem operates at 56 and 64 Kbps rates over



## EF Data's BCM-101 modem

the 5 MHz to 400 MHz frequency bands. Frequency agile in 50 kHz steps, the BCM-64 spaces data carriers at 100 kHz. One of EF Data's fastest moving products is the BCM-101/T-1 modem which transmits at 1.544 Mbps using QAM-4 modulation. It also operates over the 5 MHz to 400 MHz range and is agile in 50 kHz steps. The BCM-101/SDR transmits at rates from 200 Kbps to 6.3 Mbps using QAM-4 modulation. It's frequency agile in 50 kHz steps. The highest data rate supported is T-3 (45 Mbps).

All the company's products use a proprietary processing technique to reduce noise effects and the firm's modems are approved for use in vacant spectrum on Wangnet, Ungermann-Bass and Sytek LANs. The SDR modem is particularly useful for IBM CAD/CAM systems, which transmit at 2 Mbps, and for specialty military and government data rates. The bypass market really is sparking the company's growth. In fact, a bit less than 93 percent of current business now comes from sales of modems to private firms that want to bypass the local telco network and connect directly with a long-distance carrier. That's being done over CATV plant more places than you might think. Cost is the driver. About 50 percent of the total revenues earned by some long-distance companies goes directly to the local Bell companies for access charges. So you can imagine the savings if big circuit users can avoid those local access charges. Circle Reader Service number 77 for details.

## Radyne Corp.

Radyne Corp. sells the CMS-1200 modem which uses QPSK modulation and is frequency agile in 50 kHz steps between 5.75 MHz and 300 MHz. It



**C-Cor still sells the model 7140 synchronous and model 7130 asynchronous modems.**

runs at data rates between 56 Kbps and 5 Mbps with carriers spaced at 0.6 times the bit rate. Three loopback test modes are available. In IF test mode, the signal is looped through the modem as far as the IF and with the transmitter disabled.

In the local test mode, the data signal is looped back at the data interface for retransmission. Circle reader service number 78 for details.

**Fairchild Data Corp.**

Fairchild Data Corp. is active in the Manufacturing Automation Protocol market as well as the high and medium-speed point-to-point markets. Fairchild is one of four companies offering MAP modems and the only supplier focusing on OEM boards rather than stand-alone boxes. The M505 modem runs from 56 Kbps to 10 Mbps and although the market for this product had been somewhat sluggish over the past few years, it seems to be picking up now because of renewed interest on the part of large companies in bypass of local telephone company circuits. Essentially, what users want is a high-speed link directly to a long-distance carrier. Fairchild also has products in the lower speed arena as well. Its 520 series of modems operate at 9600 and 19.2 Kbps. For details circle Reader Service number 78.

**LanTel**

LanTel, based in Norcross, Ga., offers a line of lower-speed data and voice modems. The 900 series comes in sub-split, mid-split and high-split versions using a 192.25 MHz translation offset while the 500 series uses a 156.25 MHz offset. Async and synchronous versions are available, operating to 9600 bps and 19.2 Kbps. For details circle Reader Service number 79.

Although ISC Datacom is a new entrant, there's been some recent consolidation of broadband modem capacity. Scientific-Atlanta had developed a model 6404 modem operating at T-1 (1.544 Mbps) rates and, as far as we know, will custom build them if a quantity order is received. Other than that, however, S-A isn't pushing them.

Jerrold, which had been selling modems OEMed from Phasecom, has

gotten out of the modem business entirely, choosing to concentrate on distribution system sales.

C-Cor still sells the model 7140 synchronous and model 7130 asynchronous modems operating over the

30 MHz to 250 MHz frequency range at 2400 and 9600 bps standard with an optional to run at 19.2 Kbps. For details circle Reader Service number 80.

—Gary Kim

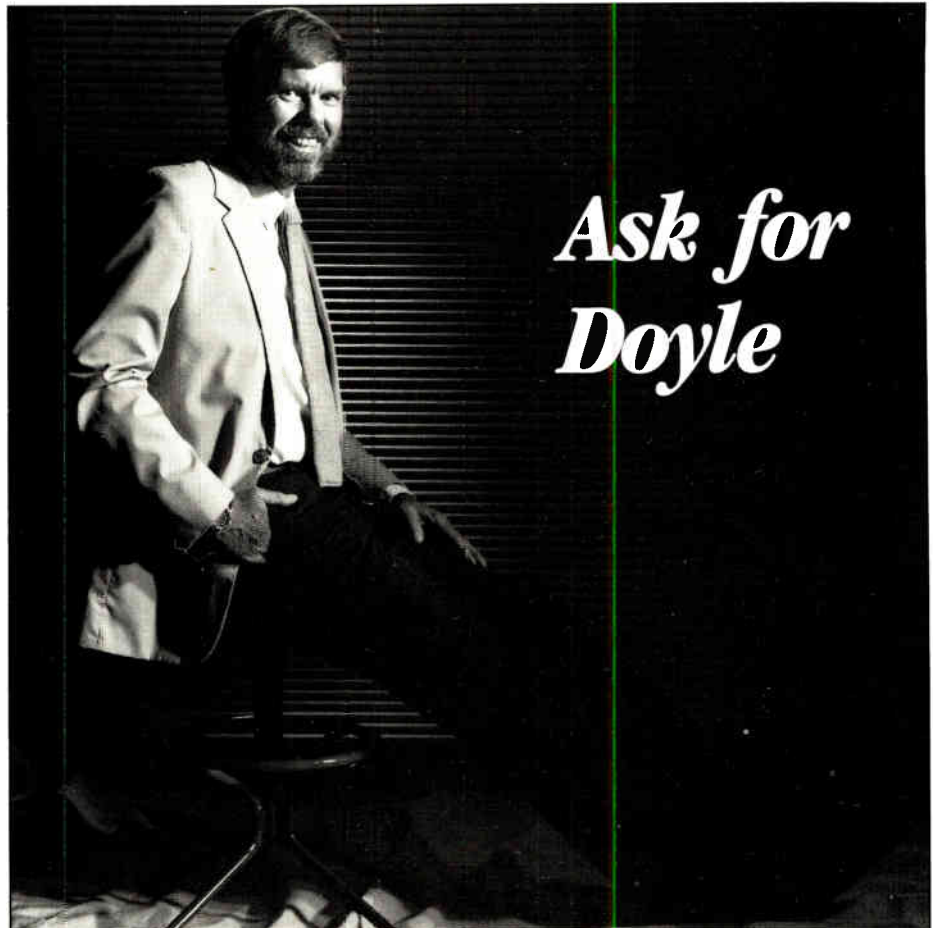

Meet Doyle Haywood. President and founder of Applied Instruments, Inc. Not your typical corporate executive. In fact, when Doyle's not on the phone reviewing a unique application of an Applied Instruments product, he's most likely camped out in the engineering department working on a new design. You won't find a more enthusiastic and knowledgeable person when it comes to solving your broadband test equipment needs. Under Doyle's direction, Applied Instruments has developed many innovative test products for the CATV and LAN industries. So, next time you've got a unique RF instrumentation problem, pick up the phone, call Applied Instruments, and...ask for Doyle.

**317-782-4331**

Applied Instruments, Inc.  
51 South 16th Avenue  
Beech Grove, IN 46107

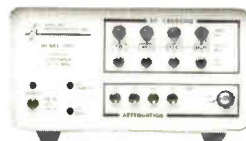

## LANwatch

### New connectivity solutions from Sytek, Bridge

Sytek Inc. has a new family of products for its LocalNet 4000 and LocalNet 8000 systems. The LocalNet 4000 products support Ethernet, Transmission Control Protocol/Internet Protocol (TCP/IP) and Novell networks. The LocalNet 8000 products allow linking of Ethernet, broadband token bus and TCP/IP networks. The 6120 Broadband Network Adapter Card attaches IBM PCs and compatibles to a broadband network. The 8050 Broadband PC/Ethernet Bridge links LocalNet 4000 Ethernet networks to LocalNet 6000 broadband PC nets. The 8080 Bridge links two Ethernet subnetworks into one larger network. As many as four 8080s can be linked serially. The 8200 Bridge connects Ethernet subnetworks (standard or thin) to an IEEE 802.4 standard token bus broadband network. The 8290 remodulator is the headend of Sytek's LocalNet 8000 broadband backbone network compliant with the IEEE 802.4 token bus specification.

Also new: software supporting TCP/IP protocols on LocalNet 4000 and 6000



Texscan's RAB-1 remote A/B switch

systems and Novell Netware on LocalNet systems.

The 4000 and 4001 transceivers provide connections to Sytek's 4000 series Ethernet systems. The 4010 and 4020 are board level firmware products allowing VAX series computers (4010) and MicroVAX-II computers to communicate over Ethernet LANs. Both support TCP/IP.

The 4080 Transceiver connects clusters of up to eight devices to an



Bridge Communications' IB/3 Internetwork Bridge

Ethernet network. The 4130 Adapter Card is a board level product attaching IBM PCs and compatibles to Ethernet LANs. The 4300 Repeater connects two Ethernets over thin or standard cable. As many as four repeaters can be daisy-chained. The 4310 Repeater connects two Ethernet LANs over a fiber optic link up to two kilometers in length.

The 4390 DDN/EtherGateway links an Ethernet TCP/IP network to the Defense Data Network, ARPAnet,

Bridge Communications, which announced it will merge with Novell competitor 3COM, has a new NCS/2 Network Control Server that monitors and controls TCP/IP-based Ethernet or broadband LANs. The NCS/2 supports as many as 16,000 ports. Available 60 days ARO, the NCS/2-140 (supporting 2,000 Bridge servers) costs \$35,000. The software license fee costs \$10,000. The NCS/2-260 (supporting 4,000 Bridge servers) is available 90 days ARO and costs \$75,000 plus the \$10,000 software license fee.

Bridge's new Internetwork Bridge/3 connects remote Ethernet LANs over point-to-point links, including T-1 lines. The IB/3 is protocol independent and will run TCP/IP, ISO standards and DECnet, for example. The T-1 version costs \$10,500 and is available 60 days ARO. For details circle Reader Service number 82.

Bridge also has named Terry Gray director of software engineering and Stephen Rizzone vice president, sales.

Zeta Laboratories now is called Halley Systems and will focus not just on making modems but on supplying multi-vendor networking solutions compliant with the Open System Interconnect (OSI) standards. The marketing group is led by Ed Moura, formerly with Sytek, David Systems and Excelsan. The sales group is lead by Ralph Jacobi, who has been with Zeta for three years. The broadband products engineering group is headed by Nathan

MILNET or other compatible LANs. The 4430 Network Server is a Novell Netware controller working on Sytek 4000 and 6000 series LANs. The 4520 and 4580 are two-port and eight-port attachment units for devices on an Ethernet LAN. The 4920 Remodulator is the headend for an Ethernet-on-Broadband LAN. The 4910 is a manual switch for moving to a backup remodulator. For details circle Reader Service number 81.

## Augat LRC Electronics has been granted a patent for its self-terminating connector.

**Silberman**, who also was with Zeta. The network products engineering group is led by **Vasant Acharya**. **Vince DeLellis** heads the new operations group.

**C-COR Electronics** now is selling its new line of PowerVision standby power and uninterruptible power systems. The standby units, designed for computers and peripherals, come in 300, 500 and 1,000 watt versions. The UPS devices come in 1-, 2- and 3-KVA versions. For details circle Reader Service number 83.

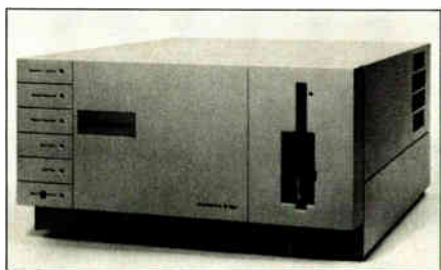

Allen-Bradley's IB/1 bridge

**Allen-Bradley** has a new IB/1 inter-network bridge connecting Ethernet LANs to a VistaLAN/3 broadband LAN. Texscan Instruments has released the RAB-1 remote A-B switch, designed for use with the firm's Vital Signs status monitoring system. The RAB-1 allows automatic or manual switching of signal sources between two outputs.

The company also has a new Spectrum 600 signal level meter and pilot carrier generator. For details circle Reader Service number 84.

**Dale Kirkland** has joined RFI Enterprises as president and CEO. RFI is the parent of RFI Communications, the value added reseller of broadband and other turnkey networks.

**Augat LRC Electronics** has been granted a patent for its self-terminating connector, designed for automatic termination of a broadband transmission line. The connectors can be ordered separately or pre-assembled with wall plates. For details circle Reader Service number 85.

**William Selmeier** is vice president, marketing for LanTel Corp. Selmeier formerly worked with Sytek and Telecom Consortium, a consulting group.

**Riser-Bond Instruments** has a new Model 921E negative pulse time domain

reflectometer used to find cable faults on Ethernet and other LANs. For details circle Reader Service number 86.

**Microwave Filter Co.** has a new notch filter with a forward passband

of 150 MHz to 400 MHz and a reverse passband of 5 MHz to 112 MHz. Delivery is 30 days ARO and price is \$5,890. For details circle Reader Service number 87.

—Gary Kim



# Our ground crew is now UL LISTED

## 100% GROUND SACHS HAS THE ONLY ALTERNATIVE

Now you can be sure of your grounding. The UL listing reaffirms our quality. Here are our special unique features:

### SC-13

#### Series Ground Strap:

- Easy one tool installation
- Positive contact (all copper)
- Preformed to fit any size pipe
- One piece construction.
- No welding

### SC-12

#### Ground Block/Bracket:

- Exceeds 280 hrs anti-corrosion Salt test per ASTM B117
- Accepts single or dual F81 fittings.
- Easy and positive attachment of grounding wire.
- Additional subscriber lines can be accommodated using splitters without removing block/bracket
- Accepts 2 way, 3-way, 4-way 5-way, etc... splitters.
- Very low contact resistance; less than 1 ohm

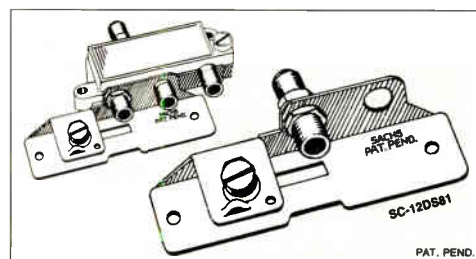

FREE SAMPLES SENT WITH EVERY INQUIRY



**SACHS** Communications Inc.,  
30 West Service Road, Champlain, N.Y. 12919-9703  
In Canada: 745 Avoca Avenue, Dorval, Qué. H9P 1G4

FOR MORE INFORMATION  
CALL TOLL FREE  
**800-361-3685**  
In Canada: Call (514) 636-6560

Reader Service Number 27

**ISS ENGINEERING, COMMITTED TO EXCELLENCE . . .**



### **GL-5000A SATELLITE RECEIVER**

The ISS Engineering model GL-5000A offers a complete choice of downconversion formats to the user. Available in the popular 950-1450MHz format, this receiver can also be ordered to interface with non-standard downconversions. Each unit comes with an integral Terrestrial Interference Filter, and for extreme T1 Environments can further be ordered with special filtering to provide the maximum of unwanted signal rejection. Extended threshold provides for "Studio Quality" pictures even in the most marginal areas.

Thousands of these units are currently in use in CATV, Broadcast, Weather and Commercial use, providing an enviable record of reliability and customer acceptance. From the initial introduction, this unit has provided complete reliability, often replacing many "old line" units which were not VideoCipher compatible.

For special applications, this receiver is also available in the "M" model for Morales or Intelsat use, the "S" version offers Half Transponder format for subcarrier use, with or without using an external "Frame." (If you are currently using a system utilizing a "Frame," ISS can supply a

Translator card to allow you an economical expansion option to your existing system.)

**MANUFACTURERS LIST PRICE: \$650.00**

### **GL-2610 SERIES AGILE MODULATOR**

This series of modulators, in both +60 and +45 dB versions, has proven to provide an uncompromised level of quality and proven performance with thousands in use. In fact, ISS has more Agile modulators in use than all other manufacturers combined. ISS has achieved the levels of performance in Agile Modulators which was previously unattainable. Spurious Beats < 60dB, low Carrier to Noise, and total agility, channels 2-WW. This level of quality and reliability can only come from one manufacturer: ISS.

In CATV and Commercial applications this family of modulators has provided the foundation for many to integrate agility into their Head Ends and still meet FCC specifications. Each unit includes automatic offsets on those channels designed by the FCC,  $\pm 5\text{KHz}$  stability,  $\pm 1\text{KHz}$  Aural Intercarrier stability.

Each Modulator utilizes an easy, "Numeric"



channel selection format from the front panel. This eliminates confusing "Code" setting for a simple channel selection. The Non-Volatile Memory will always come up on the last channel selected in the event of a power failure. The extensive use of this Non-Volatile Memory is throughout the entire ISS family of products. All adjustments are strictly "Front Panel." The addition of BTSC Stereo is no problem and can be ordered for added band width from the factory, or added by a simple field change.

**MANUFACTURERS LIST PRICE:**

- GL-2610 (+45DB)      \$450.00**
- GL-2610XT (+60DB)   \$706.00**

**GL-1000A AGILE DEMODULATOR**

One of the most powerful and flexible units in any Head End today. With this agile demodulator and a GL-2610 series modulator, you can have one of the cleanest Signal Processors available. Filtering unattainable with a simple heterodyne unit, no forbidden conversions, and complete "Any channel in, Any channel out" selection for those unanticipated channel realignments. When used as a

standby with a GL-2610 modulator you can back up an entire headend or processors, demodulators, and modulators with only two pieces of equipment! This is the promise of agility which ISS makes a reality for you.

All selections are made via front panel switching. Signal Source can be selected, channel selection and even programming alternate channel input into the Non-Volatile Memory can be rapidly accomplished in minutes. The features and flexibility of this unit have often been copied in units costing much more, but you can only get the real GL-1000A from ISS or our authorized distributors.

Special options such as composite video and 4.5MHz sound, or I.F. Outputs are available on order.

**MANUFACTURERS LIST PRICE:    \$500.00**

**ISS ENGINEERING, INC.**

104 CONSTITUTION DRIVE #4 • MENLO PARK, CA 94025  
 (415) 853-0833 TELEX: 383524 ISS • FAX 415-853-0908  
 800-227-6288 WEST    800-351-4477 EAST

# SMATV—the future's looking bright

**T**hey may still be playing on a rocky field, and the competition is tough, but the SMATV industry players are here to stay. Unlike a few years ago when predictions ran high that SMATV wouldn't be around for long, or at least wouldn't amount to much, SMATV operators are voicing confidence in themselves, the latest products and the services they offer.

Insiders in the business admit problems with CATV operators haven't all been worked out yet, but most are confident that coexistence is possible. SMATV operators cite the lack of a level playing field, little chance for access to capital, restricted programming access, price disparities and mandatory access questions as the areas that still have to be dealt with between the SMATV and CATV industries.

"We really are coexisting today except where forced access is concerned," said Bob Vogelsang, president of the Houston-based National Satellite Programming Network. In that arena, there are states, he said, that are "really trying to legislate us out of business," specifically in Florida where they seem to be overbuilding each other. "It's kind of a range war there."

Those problems and others do exist, but SMATV operators aren't giving up in the face of adversity. They are finding new ways to bring in capital; through consolidation, expansion into new services such as security, providing SMATV to new areas including hospitals and prisons, and generally looking for ways to make a go of it.

"It's a market that I think the CATV business thought was going to go away," said Leslie Hill, vice president of the National Satellite Programming Network. "The market is here to stay, it's a legitimate business."

There also were those who worried that SMATV would become too much competition for the CATV industry and out of that nervousness arose some of the discrepancies cited by SMATV players, especially the prices charged SMATV operators for premium programming and the access battles.

"SMATV was not a threat (to cable) in the sense of being a threat to the viability of the cable people," said Jim Theroux, president of MetSat Cable, an SMATV company in Cleveland.

## Competition and consolidation is the wave of the future.

"All the SMATV people have done is made some extremely rich businessmen slightly less rich," he said. Theroux's company specializes in apartment buildings and condominiums within the Cleveland area.

### New territory

It's not a matter of invading CATV's territory, he and others maintain, especially because in the beginning CATV operators didn't really want to be bothered by such small-potatoes wiring as apartment units, condominiums, the hotel/motel market and other multi-dwelling units. But now that most of

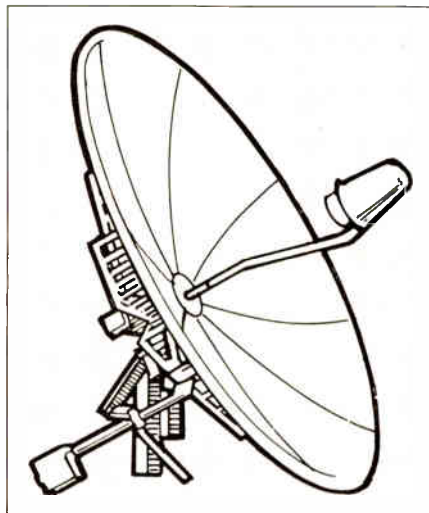

*SMATV beams ahead.*

the country has been built out, CATV operators are looking for new avenues of growth. The avenue of choice has been areas traditionally dominated by SMATV operators, in part because it's all that's left. Many CATV operators are buying up SMATV and small cable systems when they have built their areas. It's turning into the place to be, said a number of SMATV operators.

It's ironic, Hill said, that in a few short years, "A lot of the CATV operators have built out their franchises

and now they're going in and trying to buy private cable operations and bidding head-to-head for property along with private cable operators," which is something they wouldn't have dreamed of only a few years ago, she said.

"Today the trend is that a lot of cable operators are purchasing private cable systems and they're paying pretty good prices," anywhere from \$800 to \$1,200 a subscriber in some markets, said Hill.

"I think there's been a definite interest all of a sudden, I'm getting more feedback from my people about cable companies coming in and bidding on systems," she said. The National Satellite Programming Network is a member organization that is a distributor of sorts. They arrange for programming and distribute it to their member companies. They then receive payment from the companies and pass that on to the programmers.

According to Bob Swander, head of TeleMedia Associates and chairman of the National Satellite Cable Association, the SMATV industry's trade group, CATV's refusal to "treat multi-dwelling unit properties any differently or uniquely in their franchised area" is what has allowed private cable to exist. "Private cable has had difficulty over time out of the sheer market power of CATV and the industry is very fragmented," he said. But he does think private cable is a viable business.

"I believe there are still significant opportunities that exist for serving markets that are either under-served or not served at all by CATV," Swander said. "Certainly the lack of capital has been a severe retardant on the industry today. But if that capital is attracted, it's one alternative to CATV for the future and its obviously one I'm targeting toward," he said.

### Opportunities still exist

"Whether I will still be there five to 10 years from now doing the same thing is yet to be determined. If those opportunities continue, which I think they may well, I think the business can continue to grow." But, he noted, one of SMATV's top priorities is to attract capital.

MetSat's Theroux also believes the business is growing and will continue



## OUR INDUSTRY IS GOING THROUGH A PERIOD OF RAPID TECHNOLOGICAL EVOLUTION!

You can either take advantage of the new technologies or go the way of the dinosaur. Construction and maintenance costs are skyrocketing. Competition for TV delivery to hotels, motels, apartments, small communities and unwired urban areas is increasing.

Fortunately, headend costs are dropping.



12 Channel Headend

Your answer? Large numbers of innovatively applied headends. Call it cherry picking, bundling, restricted access or SMATV . . . the result is more profit and a stronger competitive position.

Profit from the evolution.

Call NEXUS for the know-how and the best low-cost headend equipment.

### Nexus - Definitely Ahead of Our Time

TEL: (206) 644-2371  
BELLEVUE, WA.  
(604) 420-5322  
BURNABY, B.C.  
FAX: (604) 420-5941

OR WRITE: NEXUS ENGINEERING CORP.  
7000 LOUGHEED HWY.  
BURNABY, B.C., V5A 4K4  
TELEX: 961000  
MAILBOX: \*XPI8348

Reader Service Number 29

**NEXUS**  
ENGINEERING CORP.  
PERFORMANCE  
YOU CAN SEE.

*profit from*

## As systems meet more stringent technological standards, SMATV becomes a good strong market for the cable industry to buy into.

to grow. "There is a consolidation going on," he speculated. "I know the industry is bigger just in absolute terms."

Theroux said the industry will get more stabilized, more experienced and

offer better quality. "I think that in most cases, in the long run, the competition is here to stay," and within the next four or five years, we'll see more CATV operators purchasing SMATV businesses but at cable industry prices.

"The next couple of years are going to be a determinant of how (SMATV) develops over the long run," Swander added. "What will occur is that professional managers will be coming into this particular market segment." People "who have access to capital and know how to plan and develop strategy for the business will be able to carve out particular market niches in the cable business. That will either be an ongoing and long running business or essentially we will have more of the same" small systems operating as today.

"Alternative two," Swander added, "says that private cable will not be able to attract sufficient capital and people and it will essentially continue to diminish in size and those opportunities will be taken up by CATV operators."

Vogelsang sees subscriber numbers growing each year in the SMATV market. "A few years ago, things were growing tremendously, but now it's toned down somewhat to a more steady growth," he said. Vogelsang said his largest percentage of growth right now is in the hospital market.

As systems meet more stringent technological standards, SMATV becomes a good strong market for the cable industry to buy into, he said, adding that systems are going for \$800 to \$1,200 a subscriber, depending on the market area and technical quality.

"To me that's a very healthy sign, it means SMATV is surviving as an industry," Vogelsang added. "We still have some problems in price disparity between franchised cable and SMATV, and higher programming rates: it's really an unlevel playing field. Some programmers are denying us the right to show their programming in SMATV, which we don't understand."

SMATV operators still purchase the premium channels through the cable franchise in their area. Since there is no regulation on pricing, the cable franchise can charge any amount it wants for that programming. That often means higher prices.

"We still have an untenable situation where we have to buy HBO through franchised cable operators," he said, adding that it's "very unpleasant when an SMATV operator has to buy from a cable operator."

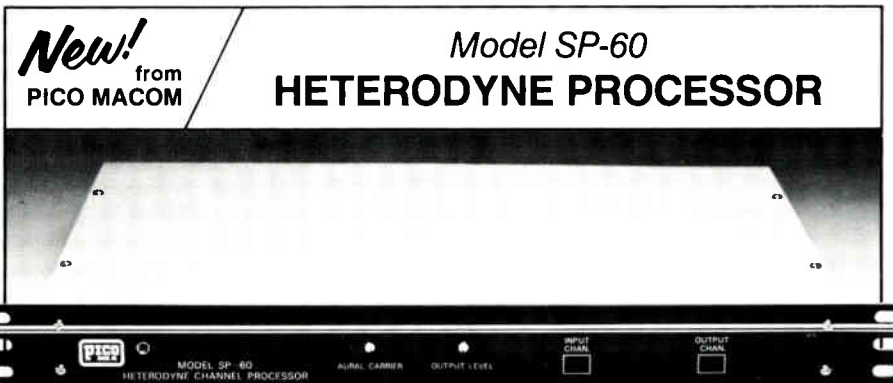

### Features

- Low cost
- High gain: 70 dB
- High output: 62 dB
- SAW filtered
- Spurious outputs down 60 dB
- High adjacent channel rejection 60 dB
- Superior low noise circuitry (6 dB NF)
- Sync tip AGC for precise signal regulation
- Stereo signal compatible
- 45 MHz IF loop-thru
- Assured reliability with 100% burn-in of all processors

### Step Up to Guaranteed Quality at Attractive Low Prices.

*The Pico Macom SP-60 uses the latest low noise, PLL, SAW filter and AGC techniques to provide superior processor quality and performance.*

Frequency Range	Low, mid, high, super bands
Max. Output	62 dB
Min. Output (for 46 dB C/N)	- 7 dBmv
Output Adjust Range	46 - 62 dB
Gain	70 dB
AGC Range	- 10 dBmv to + 25 dBmv input
AGC Type	Keyed sync tip
AGC Stability	0.5 dB
Frequency Response	± 1 dB
Noise Figure	8 dB
Selectivity	60 dB (adjacent channel)
Spurious Outputs	- 60 dB (at 62 dB output)
Aural Carrier Adjust Range	- 15 dB

**Two Year Warranty—Guaranteed!**



**PICO MACOM, INC.**

A Subsidiary of Pico Products, Inc.  
12500 Foothill Blvd., Lakeview Terrace, CA 91342  
(800) 421-6511 / (818) 897-0028

Reader Service Number 30



## One area that has improved over the last few years is the technology available to SMATV operators.

### Technological improvements

One area that has improved over the last few years, as most in the industry will attest to, is the technology available to SMATV operators. Not only is the technology better, but for the most part, prices have come down to a level where they are more accessible to the smaller system operators.

"The industry has matured now," said Steve Havey, headend earth station marketing manager at Scientific-Atlanta. "People realize it takes quality products" especially with increased competition from the CATV industry.

"They have to improve their quality, said Havey. "You're also seeing a lot of consolidation, systems are being bought up by larger operators who have a feel for what quality is required. They're there for the long run and they do proper system design."

Glenn Tongue, vice president of marketing and sales at Blonder-Tongue, agreed. "The selling to that group of end users is more a sophisticated type of sale, yet if you do have the full line and the high quality product line and a good reputation, it leaves someone like B-T in a good position.

"Sure it's better to work with a large organization that has the financial stability to weather the tougher times," he said. "I think that the consolidation is generally good and as long as we can convince them to buy our products, it's great."

"The SMATV industry is starting to get pretty sophisticated," added Mike Holland, president of Pico Macom, "basically because there's a lot of people from cable who've crossed over and a lot of cable companies who are now doing SMATV." He estimated that 50 percent of cable companies are involved in SMATV.

"That causes manufacturers to upgrade their products a little bit," because people used to a \$1,500 device somehow find it difficult to purchase a similar piece of equipment for \$150, he said, adding "they will settle for a \$350 one."

For the most part, though, SMATV operators still tend to have smaller operations, and for them, cost is a critical factor. If the product is out of reach financially, it doesn't matter how

good it is. A vendor has to offer a well performing product at a reasonable cost.

"SMATV operators have a smaller subscriber base and cost is critical for them. If you can offer a basic product with good performance at a fair price it

gets snapped up," said Dave Robinson, Jerrold's SMATV product manager.

Tongue said the largest reduction in cost has come in earth station equipment and satellite receivers, mostly because of economies of scale, where

**PRODUCT: CABLESTAR™**

**DEFINITION: CATV BILLING AND MANAGEMENT SYSTEM**

**FOR: IBM PC, XT or AT**

**STARTING AT: \$2,750.00**

**Cablestar** is a comprehensive CATV Billing and Management System which is now available on the IBM personal computers. **Cablestar** provides a cable office with automated statement, postcard, or coupon billing, computer generated work orders, late notices, mailing labels, and financial reports for multiple pay services and franchises. Many reports are available to assist in marketing and subscriber management.

Complete turnkey in-office systems are available on IBM computers for cable systems with up to 30,000 subscribers.

**CABLESTAR offers the most performance per dollar of any system available. Join the 150 companies who have already invested in KMP's CABLESTAR system.**

**KMP COMPUTER SYSTEMS ARE READY-TO-RUN WORK SAVERS!**

**IMPROVE CASH FLOW AND INCREASE PROFITS!**

**THE ONE COMPLETE SYSTEM!**



**KMP COMPUTER SYSTEMS**  
A DIVISION OF FIRST DATA RESOURCES, INC.  
2075 Trinity, Suite 100  
Los Alamos, New Mexico 87544  
(505) 662-7700

## And while the early rush for products may have slowed, Jerrold's Robinson says product sales are anything but at a standstill.

the large volume of products has caused prices to drop. With heterodyne processors and modulators, however, Tongue said the prices haven't changed that much. For the most part, though, because the marketplace has grown, there are more total units so per-unit cost is lower, Tongue said.

Although the costs, in some cases, have dropped, Tongue said the smaller suppliers aren't having as much luck as some of the larger ones. "For the smaller suppliers, business is not very good these days," he said. "In my perception, end users are looking for a full line manufacturer, one that can supply all their products and all their needs." He added that, in his opinion, the credibility of smaller manufacturers has been damaged in the last few years because of poor product quality and problems in reaching some of the claims they've made.

"But for the bigger guys," he added, "business is great."

One company that provides a full line of products for the SMATV industry is Pico Macom. Holland said his company is one of the lower priced companies for the SMATV operators. "We're big volume in the cable industry and we're able to pass along those things to SMATV."

Due to the lower cost of many SMATV products today, there is less of a discrepancy in the quality of the products used by the SMATV industry as compared to the CATV industry. The majority of the products made for SMATV can be used by both operators. But the majority of lower-priced equipment, most vendors state, is still being purchased by the SMATV operator.

And while the early rush for products may have slowed, Jerrold's Robinson says product sales are anything but at a standstill. "The price dynamics we've seen in the last five years have slowed recently," in part due to the Japanese yen, and the lower-priced

products on the market, Robinson said. "Do I see it stopped? No, Jerrold will have product with improved price performance ratios going forward. That's the name of the game."

Scientific-Atlanta is also in the game for the full four quarters, according to Havey. The company's latest products for the SMATV industry include the Model 9640 receiver, the 9220 modulator and the new 9260 frequency agile modulator.

"The 9260 gives more flexibility and frequency agility up to 300 MHz. That's important as a back-up unit in either CATV or SMATV application and for SMATV operators who may be in a hurry to get a system installed," Havey said. Also sold in the SMATV industry are model 6330 modulators and model 6680 receivers. "All of those are CATV as well as SMATV quality products but those are our lower priced products which is what we primarily sell to the SMATV indus-

## Qintar's New

### Channel Elimination Filter



#### Model CEF

The Qintar Channel Elimination Filter (CEF-\*) is a single channel bandstop filter designed specifically for the attenuation of all information contained within a 6 MHz wide television channel.

- CEF-\* is Available in Lowband (2-6)
- CEF-R is Available in Highband (7-13)
- High Q Helical Resonator Construction
- Non-Interactive Alignment Enhances Stability
- -55 dB Attenuation, Typical

## QINTAR PRIVATE CABLE HEADEND PRODUCTS

Example: **COMPLETE** 12 channel VHF Headend for only **\$5966** would include the following:

- 4 Commercial satellite receivers
- 4 Commercial modulators
- 4 VHF channels
- 4 UHF channels converted to VHF
- Bandpass filters
- All combiners, splitters and cabling included
- Post amplifier, +55 dBmV output
- Assembled, burned-in & ready to install



**Proven Reliability**  
in Hundreds of Systems Across the Country

**QINTAR INC**  
QUALITY SYSTEMS FOR TODAY'S TECHNOLOGY

P.O. BOX 6579

Westlake Village, CA 91359

**(800) 252-7889**

In CA **(800) 572-6262**

or **(818) 706-1940**

## Recent enhancements to products include BTSC stereo compatibility and Ku-band capabilities.

try," he added.

### Moving to Ku-band

Recent enhancements to products include BTSC stereo compatibility and Ku-band capabilities. And while those enhancements apply primarily to the CATV side, it also gives the SMATV operators a higher quality product, and that's what it's all about, he said.

Havey said that S-A has also made several improvements in the Model 9640 in preparation for the possible move of programming to Ku-band. Other vendors agreed that the Ku-band capability is something they are moving toward.

"I think Ku-band is a pretty critical element in this whole portfolio, because Ku-band would make it more economically feasible to deliver satellite programming to the smaller complexes. So the switchover of some of the major services to Ku-band would be a shot in the arm of the industry," added Tongue.

In the early days of SMATV, people used home receivers because of its low cost for their systems. According to Havey, the problem with home receivers for commercial application is that they tend to drift. Drift isn't a problem in a home environment where channels are being changed often. But, he noted, in a commercial setting, drift can cause problems and the picture loses quality.

Overall quality of SMATV signals hasn't always been praised by industry leaders. But, SMATV people will say that it's not always greener on the other side. "What is carrying on is the stereotype of private cable which has come forward for several years," said TeleMedia's Swander. He said there were a number of technically oriented entrepreneurs and hotel owners who built systems or had them installed who "basically did it on a shoestring and they didn't do a particularly good job of it."

On the other hand, he said, there are an equal number of CATV systems with poor quality systems. "There's good and average and bad in everything and that includes CATV. It's just that somehow the bad of private is deemed to be worse for some reason. It's ironic that it's the same people who have restricted our access to programming, capital and limited street cross-

ings. They do those things and then point to the poor quality and limited capacity of the (SMATV) systems."

The quality today, added Holland, is much improved. "It's come pretty much close to cable quality, but the

main difference... is that cable systems have to go through multiple amplifiers," and therefore, the quality has to be better to start with.

The equipment hasn't always been

*Continued on page 57*

# Panasonic Excellence...

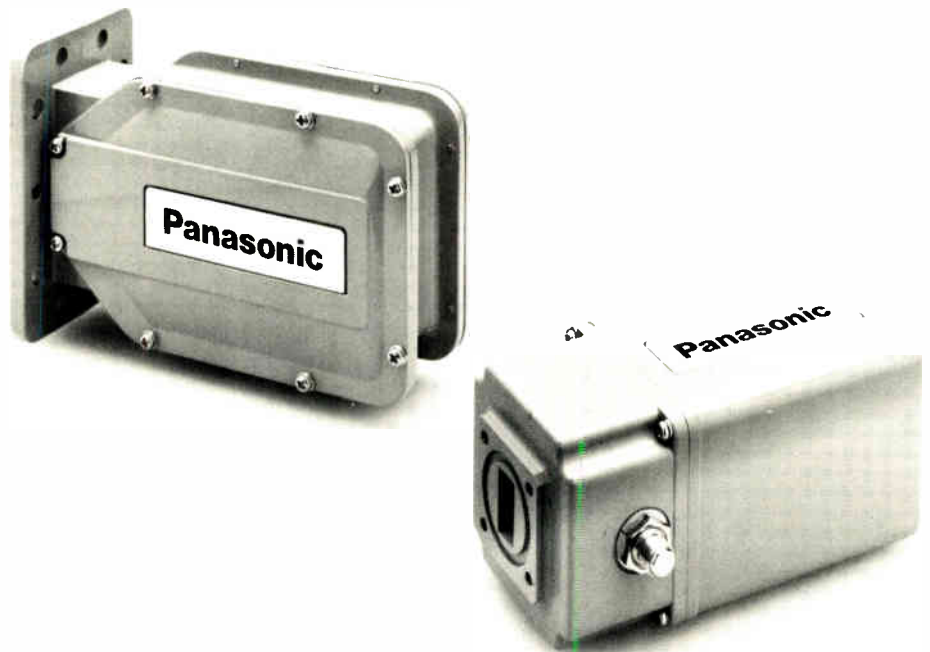

## The proof is in the performance.

When you're looking for low-noise, high-performance LNBs at affordable prices, Panasonic® is the supplier to look for. With features like selected FETs and built-in isolators for C-Band use, Panasonic offers you a variety of reliable Ku-Band and C-Band LNBs to choose from.

**C-Band**  
LNB-65cp 65°K  
LNB-70cp 70°K  
LNB-75cp 75°K

**Ku-Band**  
LNB-150pw 150°K  
LNB-170pw 170°K  
LNB-200pw 200°K

Put Panasonic LNBs to a test. You'll find excellent performance—at an excellent price.

**Panasonic**  
Industrial Company

Video Communications Division  
(201) 392-4108/4804

# MMDS technology supercedes MDS

Although the Federal Communications Commission has only licensed about 15 Multichannel Multipoint Distribution Systems (MMDS) and awarded about 50 construction permits so far, multi-channel technology already is displacing the older single-channel Multipoint Distribution Service (MDS) equipment. In fact, industry suppliers Texscan Corp. and General Electric Comband predict that many MDS operators will convert to MMDS over the next few years, fueling the trend to multi-channel gear. A case in point: Texscan's new TMI down converter receiver, which block converts the older 2150 MHz to 2162 MHz MDS band (two channels) and the new 2500 MHz to 2686 MHz MMDS band (31 channels). Using a compression system such as GE's Comband, users can squeeze out 62 channels.

End-users of relatively simple single-channel MDS technology may be surprised at the new issues raised by multichannel microwave systems. MMDS users will face intermodulation, loss, transmitter linearity, sideband filtering and antenna co-location issues that MDS operators never did. In addition, urban and rural systems will present distinct technical challenges.

Rural areas generally will have longer transmission paths but less terrestrial interference (TI). So down converter noise figure will be important because received signals will tend to be weaker than in an urban setting. Urban systems, on the other hand, will have shorter path lengths, greater TI and direct pickup (DPU) concerns. In addition, there's likely to be greater channel capacity available over-the-air and from CATV, thus requiring MMDS operators to offer competitive channel capacity. So greater down converter dynamic range and image rejection is important in the urban setting.

The new technical demands created by MMDS include intermodulation, cross modulation and distortion performance. As Texscan Corp. sees it, downconverter performance is key. Low dynamic range products begin to generate beat products at four channel loading and can't process 32 channels without lowering signal levels toward the noise floor. Good adjacent channel

## Multi-channel is where the market is now

rejection and image rejection of -50 dB is recommended.

Transmitters should be highly linear and have enough filtering that unwanted sideband energy and spurious signals will fall at least 60 dB below the visual carrier in the passband of the adjacent channels. Assuming 6 MHz channel spacing, aural carrier levels should be set 15 to 17 dB below visual carrier levels.

Receive equipment, which includes an antenna and down converter, should be connected by the shortest possible length of cable (loss is extremely high at microwave frequencies). Common antenna gains are 18, 21 and 24 dBi. Two methods are commonly used to down convert signals. Down converters with integral antennas eliminate the 0.5 dB per foot of cable loss that occurs between a stand-alone antenna and input of a down converter. A connector loss of 0.3 dB also is avoided. An integral design also makes switching antenna gain a simple matter of changing reflector size. But separate components are used when a larger parabolic antenna is needed (for example in high theft areas where, for security reasons, it's necessary to mount the down converter inside a building).

In either case, long drop cables should be avoided because output frequencies from down converters will approach 400 MHz (attenuation is higher at higher frequencies). Also, loop resistance reduces voltage between the down converter power supply and the converter. Long drops increase the chance that the converter input voltage won't be sufficient.

MMDS technology has some advantages over MDS. MMDS transmitters can be either horizontally or vertically polarized, allowing closer spacing. Two methods, each producing loss somewhat greater than 3 dB, are commonly used. One method uses two receive antennas, one set for vertical polarization, the other set for horizontal. A combiner has to be used, resulting in 3 dB insertion loss. Cable jumpers will add an extra 1 to 3 dB of loss. Another

method uses a single antenna rotated 45 degrees. Both horizontally polarized and vertically polarized signals can be received, but both experience 3 dB loss as well.

MMDS also avoids certain types of common MDS interference, such as "sporadic E." Smaller, lower power transmitters now are available. So are low cost, light weight receive antennas not requiring high pointing accuracy.

And at current costs of about \$250 to \$450 per subscriber, MMDS seems a reasonable technology even for CATV operators looking to serve subscribers in low density areas on the edges of urban franchises. Texscan estimates that a typical unscrambled MMDS system with 10,000 subscribers will run \$250 per sub. Capital costs should range from one-fourth to one-third that of an equivalent CATV plant, industry suppliers say. A 10-watt transmitter with good line-of-site can reach up to 35 miles while a 100-watt transmitter can reach as far as 50 miles or so.

Stand-alone MMDS operators still haven't gotten the kinds of programming support they want, however, and like many SMATV system operators, are very price sensitive. Many program suppliers still remember the theft rates prevalent among early MDS operations so signal encryption probably will be mandatory for MMDS operations. Still, equipment suppliers are optimistic about prospects for the MMDS industry over the next several years.

Turnkey systems may be a bit hard to find, however. No single supplier makes all the required equipment, although contractors like Communications-Link Inc. in Missouri City, Texas, will put all the pieces together.

General Electric's Comband division also will provide everything from engineering services and surveys, electricity and air conditioning, the addressable system, a billing system interface (but not the actual billing computer), the transmitters, waveguide and encoders, receive antennas, set-top converters and block down converters. GE offers the Comband 2-for-1 compression system as well as the Proband scrambled baseband system. "When we turn it on, it works," says Comband's Ron Polomsky.

—Gary Kim

## As for today, one area of emphasis for product vendors seems to be in the headend equipment they offer.

*Continued from page 55*

built as well as CATV systems, he added, but even that has improved substantially in the last couple of years because of breakthroughs in technology. "Like anything else, as the volume goes up, the price of integrated circuit chips," for example, "available early on can now be had for approximately one-third the cost of a few years ago," Holland said.

"That's where the changes have occurred, it's not because someone said 'we're going to get better at it, we didn't know what we were doing,' it's just all the parts have gotten cheaper," he said.

As for today, one area of emphasis for product vendors seems to be in the headend equipment they offer. Some are moving toward pre-packaged headends and others are simply trying to improve the lower-priced headend equipment that's available.

Triple Crown is one company that

has had good luck with the pre-packaged headends, especially in Canada. "We've now manufactured over 1,000 pre-wrapped headends, designed them, assembled them, tested them and installed the applicable decoders in them," said Brian Ward, director of marketing at Triple Crown.

The advantages of a pre-packaged headend, especially for a small private operator, are that most operators do not have the technological background to handle installing the system themselves. With the pre-wrapped headend, Triple Crown does everything for the operator, from design to installation.

"It's a great thing for a private cable (operator)," Ward said. "It's really started to take off in this past year."

Another important aspect of the pre-packaged system is its appearance, Ward added. "When (the operator) has to go and collect his bill and somebody comes up to look at the system, it's very professionally put together." Also, he

said, because of the schematic that goes with the headend, adding channels is a simple matter of calling the company and saying they want channel 16.

For larger systems, they offer stereo generators for introducing BTSC stereo into a cable system. They also make interactive addressable hotel pay-per-view systems and low powered TV broadcast equipment, in addition to their line of amplifiers, modulators and processors.

"Our business is going quite well, we're pleased with it," he said. "When people are doing rebuilds and upgrades of systems our products fit in really well because we have so many different models we can offer that we can give them the best performance they need without spending any more money than they have to," he said.

"It is a changing market, because there aren't many big cities being wired," Ward continued. "Now it's going to upgrade or rebuild situations,

# SATELLITE EQUIPMENT

## SATELLITE TEST EQUIPMENT



The PSA-35A Portable Spectrum Analyzer accurately measures wideband signals commonly used in the United States and European satellite communications industry. The PSA-35A frequency coverage is from less than 10 to over 1750 MHz, and from 3.7 to 4.2 GHz. The PSA-35A features switch selectable sensitivity of either 2 dB/div or 10 dB/div. The portable, battery or line operated PSA-35A Spectrum Analyzer is the perfect instrument for the critical dish alignment and tracking requirements necessary for maximum signal reception. Price \$1965

### MICROWAVE FREQUENCY CONVERTERS

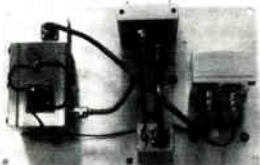

AVCOM's line of Microwave Frequency Converters, MFC, can increase the capability of any spectrum analyzer including the AVCOM PSA-35A.

The MFC series of converters is available in a wide variety of frequency conversion schemes and stabilities to meet specific customers requirements. AVCOM MFC's cover MDS, CARS, MMDS, Industrial Microwave Heating frequencies, Satellite Communication (3.7 - 4.2 GHz), and other frequency bands up to 6 GHz. Prices start at \$695.

### TYPICAL MFC MODELS

MFC-300 General purpose MFC with LO at 3 GHz Designed to enable surveillance of frequencies from 1.5 to 4.5 GHz with a spectrum analyzer that tunes to 1.5 GHz. Great for Electronic Counter Measure (EMC) applications.

MFC-2000 with LO at 2 GHz. The MFC-2000 allows the spectrum from 2 - 3 GHz to be translated to 0-1000 MHz. Ideal for MMDS (Educational TV) application.



The AVCOM STA-70D Test Analyzer displays SCPC and FM signals and their frequency from 50 MHz to 110 MHz and allows the user to monitor wide and narrow band carriers. A built in audio demodulator allows the STA-70D to operate as a fixed tuned receiver at zero span. This feature allows SCPC and other FM signals to be listened to as well as viewed on the CRT. The ability to identify carriers and verify total system operation has never been simpler, easier or more enjoyable. Rack mount adapter available. Price \$1960

NEW!! Now available!! - - The AVCOM STA-10D Test Analyzer with a frequency coverage of 0 to 50 MHz is designed for observation of audio and data subcarriers such as SCS and SCPC. Call for more information. Price \$1965



The AVCOM MSG-1750A Microwave Sweep Generator provides an economical means of producing accurate signals over the 950 to 1750 MHz frequency range. The MSG-1750A led FREQUENCY READOUT IS ACCURATE TO ±1 MHz. The MSG-1750A has been developed for International use with the

wider block frequency band from 950 to 1750 MHz. Operation from 110 VAC is standard, 220 or 240 VAC available. The MSG-1750A can be used as a marker generator for the PSA-35A Spectrum Analyzer to accurately specify TI filters or to establish performance criteria for satellite communications installations contracts. Price \$1275

## SATELLITE AUDIO RECEIVERS



AVCOM's Single Channel Per Carrier Receiver, model SCPC-2000E, has been developed for the reception of FM SCPC signals from satellites operating in the 3.7 to 4.2 GHz band. The SCPC-2000E is a complete receiver that can tune up to 4 specific crystal controlled audio or data channels from a given transponder and available in either wide band or narrow band models. Optional circuitry is available to allow up to 8 crystals for channel selection. The SCPC-2000E may be used with the SS-1000 Slave for simultaneous reception of additional channels.

At the heart of AVCOM's SCPC-2000E is a sophisticated phase locked microwave oscillator and multiplier system that enables the SCPC-2000E to exhibit exceptional stability. You can obtain very high audio or data signal to noise ratios with the AVCOM SCPC-2000E. No other equipment at a comparable price can offer the performance of the SCPC-2000E receiver.

Included in the SCPC-2000E Receiver is the AEM-123, AVCOM's Audio Expander Module. The AEM-123 is a cost effective means of obtaining 1-to-2 or 1-to-3 expansion with a choice of 0, 25, 50, or 75 microsecond deemphasis. Other features included selectable low pass 15, 7.5, or 5 KHz audio filters and an on-board output driver stage for low impedance earphones. The SCPC-2000E is designed for mounting in a standard 19 inch equipment rack or cabinet. The unit requires a panel space of 3 1/2 inches. Price \$1875

# AVCOM®

**500 SOUTHLAKE BOULEVARD  
RICHMOND, VIRGINIA 23236  
TELEPHONE (804) 794-2500  
FAX: 804-794-8284  
TELEX: 701-545**

## If looks as though the SMATV industry has carved its own spot in the cable business.

and our products lend themselves very well to that."

Jerrold is also big in the headend business, according to Robinson. "Our emphasis in SMATV is on active electronics particularly as related to the headend products," he said. "You're actives are concentrated in the headend because the distribution systems are much smaller, that's where our product emphasis is at this time and it's where we see the future of the market."

Jerrold's headend products, "which is where the bulk of the dynamics are occurring," he said, include the model S412R C- and Ku-band switchable satellite receiver, which was introduced about two years ago. They are selling predominantly for C-band applications now, but two-way capability is "really becoming a standard," he added.

"It's geared toward SMATV but it's catching on in CATV," Robinson stated. It is lower in price, he added, than some

of the older satellite receivers with fewer features.

The growing demand for receivers is very similar in both the cable TV and SMATV marketplace, he added, noting the CATV industry might look a little more closely at the technical specifications, but the end result is the same: "If the picture looks good and it's generally an acceptable product, SMATV and CATV are really looking for the same thing, low cost cable TV."

Robinson recently completed a proprietary study on the SMATV market, and while he wouldn't disclose what the study said, he indicated Jerrold's pleasure with the findings. "We're quite pleased with the results and are bullish on the market," he said.

"SMATV operators are becoming more and more like cable TV operators," Robinson continued. "They're all looking for a well-performing product at a good price, and price performance is what we see people buying

on, not just price."

Pico Macom's Holland compared the growth of the SMATV industry to that of the sale of VCRs. It skyrocketed for a few years and then tapered off. "I think it's going to grow, but it's going to grow slow," he said.

Differences in technology between the two industries aside, it looks as though the SMATV industry has carved its own spot in the cable business. Operators have every intention of growing and expanding into new areas. The only thing still left to be determined over the next few years is how the two groups will settle their differences.

"The overall industry is positive. It's a completely legitimized industry now, it can coexist with the cable people," said Tongue. "The future is positive and consolidation will continue as it proves to be viable, but I don't see any major fundamental changes."

—Linda J. Johnson

### Our Microwave Reception Systems Cover Every Angle!

#### MMDS MICROWAVE SUBSCRIBER RECEIVE SYSTEMS

- Complete 31 Channel ITFS MMDS/OFS frequency band coverage
- High Signal Handling Capability / Low Distortion
- Large Out-of-Band Signal Rejection

Just a few reasons why Texscan microwave receive systems look their best from all angles!

# Texscan

OUR TIME HAS COME

COMMUNICATION PRODUCTS DIVISION  
EL PASO, TEXAS 79935 (800) 351-2345  
Reader Service Number 35

### Introducing CG-PLUS

A high-resolution, broadcast-standard, full-featured character generator/titler. Optional gen-lock, graphics and digitizer.



Look at the detail you can get with our optional, low-cost color digitizer!

Just **\$3695 u.s.**  
**\$4795 Cdn.**

Dealer inquiries welcome.

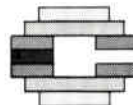

D.E.L.  
**Compu-Cable Systems, Inc.**

#6 - 301 45th Street West  
Saskatoon, Saskatchewan  
Canada S7L 5Z9  
Call collect: (306) 934-6884

# Now MMDS Operators Don't Have To Go Through Channels To Double Their Channels.



## The Comband® System.

Forget about red tape. Because now you can take channel expansion into your own hands.

All it takes is the Comband® system from General Electric.

The Comband system is a necessity for all Multi-channel Multipoint Distribution Service operators and Instructional Television Fixed Service operators. Because its unique two-for-one technology lets you quickly double the channels within your allotted bandwidth.

The system also offers other features that will enable your operation to reap greater profits. It's flexible, stereo-ready and contains an unsurpassed one-way addressable baseband system. Plus the

Comband bandwidth compression process makes signal theft virtually impossible. Unauthorized programs cannot be seen or heard.

The modular design of the Comband system allows you to control when, and to what extent, you upgrade your operation. So whether you're planning to enter a market or planning to capture a larger share of one, you can do so with minimum time and expense with a Comband system.

Before you make any further plans, see the Comband system in action. Call Ron Polomsky at 1-800-432-2253 to arrange a Comband demonstration.

Because when it comes to doubling the capabilities of your operation, we're the authority.



# Often overlooked cable converter parameters...

**H**ow can a cable operator select a cable converter from a list of published specifications by a manufacturer? The selection is made more difficult because many parameters are listed differently or not at all. Cable operators need to be aware of the many parameters which must be tested to insure good performance of cable converters. This article covers RF performance parameters that are often overlooked but can adversely affect converter performance. These parameters include: input-to-output isolation; bleedback; crosstalk; backtalk; electromagnetic conduction at the input of the converter; and parasitic FM. Many of these parameters may be unfamiliar to the reader. Each parameter is defined, adverse effects are listed and acceptable performance levels are given, along with a possible test method to quantify the parameter.

Internal to a cable converter, signals can be combined, rerouted, distorted or coupled to other points in the converter, causing poor RF performance. The cause can be anything from inherent circuit design to mechanical integrity and packaging. The terminology can be confusing and even misleading if you are unfamiliar with the parameters. The RF parameters to be discussed in this paper are only those considered to be less well publicized in the cable industry. This article assumes a channel 3 output converter, but the same parameters and procedures can be applied to any output channel converter.

## Input-to-output isolation

Input-to-output isolation may be familiar to many cable operators, however, this parameter is seldom specified and often overlooked in RF performance of cable converters. Isolation of a converter is measured differently than the isolation measurement of an A/B switch or tap because input channels are down converted to a different channel. Input-to-output isolation refers to signal leakage of the input carrier transmitted to the RF output as illustrated in Figure 1. Consider a converter that is

...and how to measure them.

tuned to channel 2. Some of the channel 3 input signal will leak to the channel 3 output. However, channel 2 is the desired output channel and the channel 3 leakage carrier can cause interference to it. Input-to-output isolation is

measured as the difference between the desired output carrier level and the channel 3 carrier that leaked from the input to the output. This level can be different for each channel tuned. This leakage affects the desired video carrier only when the leakage carrier falls within the 6 MHz output channel.

The leakage may occur from a variety of causes. If the RF electrical circuit was not shielded properly, signal leakage could occur. Often, when the coax ground fails, the center conductor acts

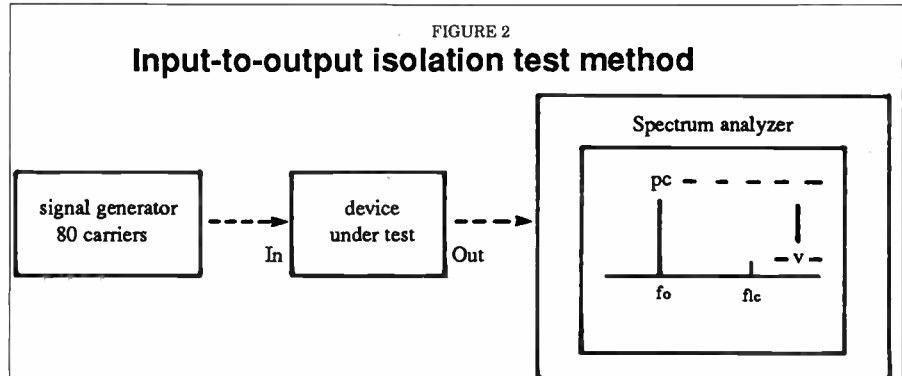
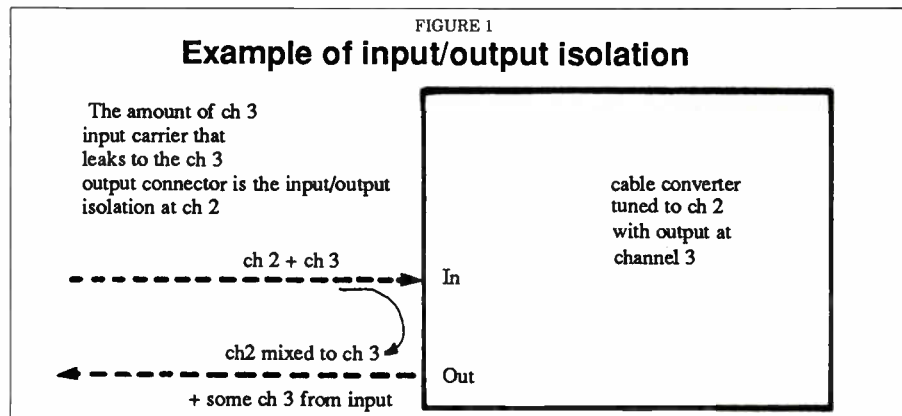

$$\text{Isolation (dB)} = \text{amplitude of picture carrier in dBmV} - \text{amplitude of leakage carrier in dBmV}$$

$f_{lc}$  = frequency of leakage carrier  
= channel 3 (61.25 MHz)

$f_o$  = frequency of picture carrier at output

$$= f_{in} + (f_{2LO} - f_{1LO})$$

$f_{in}$  = frequency of input carrier

$f_{1LO}$  = frequency of 1st L.O.

$f_{2LO}$  = frequency of 2nd L.O.

### Procedure:

1. Adjust output of signal generator on all carriers to +15 dBmV
2. Tune device under test to channel 2
3. Measure amplitude of carrier at the output of the device under test
4. Measure amplitude of carrier leakage at output of device under test
5. Difference in the amplitude of the carriers should be at least 57dB
6. Repeat steps 2 through 5 above for remaining channels

By Jesse Still and Emory McGinty,  
Scientific-Atlanta



# CATV services marketplace



## CONTRACT INSTALLERS, INC.

UHF Radio Equipped Trucks • Uniformed Installers

### HOUSE INSTALLATIONS

*Aerial - Underground - Pre-wire*

### APARTMENT INSTALLATIONS

*Post wire - Pre-wire - Commercial Building*

Tap Audits

Install or Remove Traps and/or Converters  
Drop change over for System Rebuilds

LENNY FISCHER  
(414) 582-7087

P.O. Box 1564  
Appleton, Wisconsin 54913-1564

Reader Service Number 38

## Beta Tech Engineering

### Equipment Repairs

4112 N. 27th Avenue  
Phoenix, AZ 85017  
(602) 266-9389

**MDS  
CATV  
MATV  
METERS  
HEADEND  
CONVERTERS  
TEST EQUIPMENT**

James A. Monroe  
President

Reader Service Number 39



## INTRASTELLAR ELECTRONICS

*"Quality Converter Repair  
and Brokerage"*

MIKE PLATACIS

(312) 658-0300  
200 Berg St.  
Algonquin, IL 60102

See us at Great Lakes Show, Booth #461

Reader Service Number 40

## DLM ENTERPRISES

*Design engineering software  
and LAN construction*

DAVID MARSHALL  
President

P.O. Box 1207  
Marietta, GA 30061  
(404) 924-8948

Reader Service Number 41



(915) 595-6740

Don Priem  
Dave Shurts

## CATV

- Repairs
- Transmission Equipment
- Converters
- Refurb
- Pathmaker Transmission Equipment

Reader Service Number 42



## NaCom LAN Division

### CABLING INSTALLATION SERVICES

- industrial
- commercial
- broadband
- ethernet
- nationwide

LARRY BROWN

1-800-848-3998

1900 E. Dublin-Granville Rd. • Columbus, Ohio 43229  
614-895-1313 • 1-800-848-3998

Reader Service Number 43

Harold Bigham  
President

*Bigham*

**Cable Construction, Inc.**  
Complete CATV Construction

(904) 932-6869

P.O. Box 903  
Gulf Breeze, FL 32561

Reader Service Number 44



## CABLE CONSTRUCTORS INC.

IRON MOUNTAIN, MICHIGAN

- PLANNING
- STRAND MAPPING
- SYSTEM DESIGN
- MAKE-READY
- OVERHEAD/UNDERGROUND
- TESTING
- TURNKEY HEADEND
- MATERIAL SUPPORT
- FCC PROOF OF PERFORMANCE
- MICROWAVE/ITFS SYSTEM PLANNING

If you are seeking a single source with the experience and resources to build a top caliber cable system accurately and on schedule. Contact: Cable Constructors, Inc., 105 Kent St., P.O. Box 190, Iron Mountain, MI. 49801, telephone (906) 774-6621.

Reader Service Number 45

## It is generally believed that any undesired signals must be at least 57 dB below the desired video carrier.

like an antenna and the undesired signal is radiated to the converter's output. RF shielding within the cable converter may not be sufficient and signals can radiate to sensitive areas within the converter. Poor mechanical construction can be the cause of the poor grounding or shielding and aggravate the situation. It is generally believed that any undesired signals must be at least 57 dB below the desired video carrier to avoid a beat within the picture. Poor input-to-output isolation causes the cable operator to avoid using the converter's output channel frequency for an active video channel.

Often the input-to-output isolation is measured only when the converter is tuned to the same channel as the output channel. However, there are several factors which can cause the isolation to vary from channel to channel. The isolation in the up/down electrical circuitry can vary from channel to channel. The converter's gain often varies as a function of the channel tuned. The FCC allows video carriers to vary by as much as 12 dB on a given cable system. Because of these fluctuations, it is important that the isolation specification allow for such level changes. In order to guarantee that the unwanted leakage signal is 57 dB below the desired video carrier on all channels, measurements should be made on every channel. A sample test procedure for testing input-to-output isolation is shown in Figure 2. If the desired output signal happens to be on frequency (61.25 MHz), then the input-to-output isolation signal cannot be measured at the output of the converter. It will be necessary to mis-tune the converter or the input carrier if the unit has automatic fine tuning (AFT).

### Bleedback

Bleedback is similar to isolation, and is illustrated in Figure 3. Bleedback occurs when the desired output signal finds an electrical path to the input port of the converter. If the converter is tuned to the same channel as the output, the bleedback signal is translated to the output channel, causing a beat. Bleedback only occurs when the converter is tuned to the same channel as the output channel. It is caused by

inadequate RF shielding, often a result of poor mechanical construction of the shield or poor electrical connection of the shield to ground. An acceptable performance level is considered to exist when the bleedback signal is at least 57 dB below the desired output signal. Poor bleedback causes the cable operator to avoid using the converter's output channel frequency for an active video channel.

A procedure for testing bleedback is shown in Figure 4. When measuring

for bleedback, it is important not to measure the input carrier leakage signal discussed above. If the desired output signal happens to be on frequency (61.25 MHz), then the bleedback signal cannot be measured at the output of the converter. It will be necessary to mis-tune the converter or the input carrier if the unit has AFT.

### Crosstalk

Crosstalk, once referred to as "injec-

### Example of bleedback

FIGURE 3

Bleedback is the amount of ch 3 output that leaks to the input connector at ch 3. This leakage will again be converted to ch 3 causing interference.

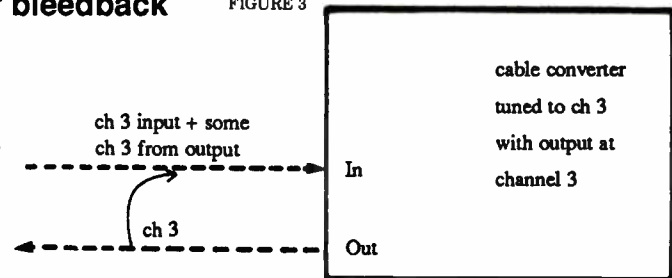
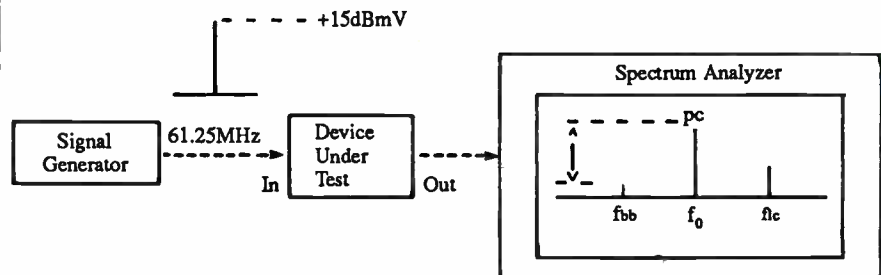

FIGURE 4

### Bleedback test method



Bleedback (dB) = amplitude of picture carrier in dBmV—amplitude of bleedback carrier in dBmV

$$f_0 = \text{frequency of picture carrier at output} \\ = f_{IN} + (f_{2LO} - f_{1LO})$$

$$f_{1LO} = \text{frequency of 1st L.O.}$$

$$f_{2LO} = \text{frequency of 2nd L.O.}$$

$$f_{IN} = \text{frequency of input carrier} \\ = \text{channel 3 (61.25 MHz)}$$

$$f_{bb} = \text{frequency of bleedback signal} \\ = 2 * f_0 - f_{IN}$$

$$f_{lc} = \text{frequency of leakage carrier (see text)}$$

#### Procedure:

1. Tune the Device Under Test to channel 3 (or other output channel)
2. Adjust the output from the signal generator to +15 dBmV at 61.25MHz
3. Measure the amplitude of the desired carrier
4. Measure the amplitude of the undesired bleedback signal.  
Be sure carrier measured is not the isolation leakage carrier which may also be present.
5. Difference should be at least 57 dB.

## Backtalk is a relatively new parameter which may be unfamiliar to many cable operators.

FIGURE 5  
**Crosstalk test method**

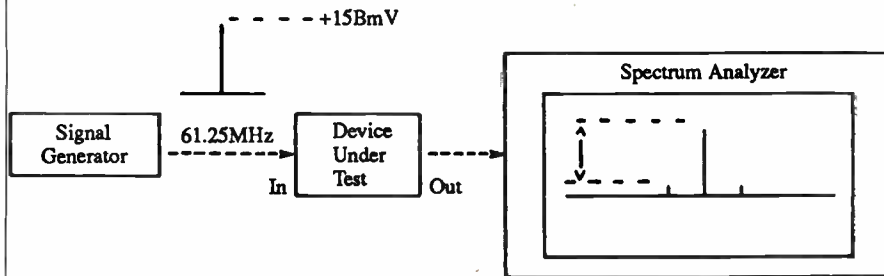

**Procedure:**

1. Tune the Device Under Test to channel 3
2. Adjust the signal generator for 61.25MHz at +15dBmV
3. Measure the input carrier frequency and the output carrier frequency with a frequency counter.
4. Calculate the difference between the two carriers.
5. Measure the desired video carrier level.
6. Measure the first sideband level at the frequency difference of the two carriers.

tion locking," has been a concern for cable operators for many years. It is caused by the two local oscillators (LO) beating against each other and producing undesirable effects on the video signal at the converter's output. When the two LOs are close in frequency, the energy of one of the LOs causes the other LO to shift in frequency. The AFT, PLL or oscillator circuitry causes the shifted frequency to try to return to its nominal frequency. The process continues, causing the affected LO to become frequency modulated. The two LOs are closest in frequency when the converter is tuned to the same channel

as its input. The unwanted FM'ing is transferred to the desired video carrier at the output of the converter. The effect on the picture quality depends on the frequency difference between the LOs and the amplitude of the deviation.

Every converter performs differently because of the different amount of coupling between the two LOs. The cause of crosstalk is usually a result of poor mechanical and/or electrical construction of the shielding in the up/down converter.

A method of testing crosstalk is shown in Figure 5. To begin the test,

the difference between the first and second LO frequencies must be determined. The difference between the first and second LO frequencies is equal to the difference between the input and output carriers. Once the LO difference frequency is determined, the first sideband level is measured at that difference frequency. The difference in amplitude between the desired video carrier and the sideband energy is the crosstalk level. If the residual FM on the video carrier is greater than the frequency difference of the two LOs, then it will not be possible to measure the first sideband level. If the converter has an AFC, then it may be possible to mis-tune the LOs by adjusting the input carrier frequency in order to measure crosstalk.

### Backtalk

Backtalk, sometimes specified as inband spurious at the input, is a relatively new parameter which may be unfamiliar to many cable operators. Backtalk refers to the unwanted signals caused by the mixing of the first LO with the input carriers which then return out the RF input of the converter. This is illustrated in Figure 6. These spurious signals may appear on the input of another converter, producing a beat. Until CATV systems went to extended bandwidths, this problem could be avoided by proper choice of an IF frequency. However, when frequencies above 330 MHz came into use, selection of an IF frequency to avoid this problem became impractical. Whether the backtalk will interfere with a channel depends on the frequency range of the input signals and the channels tuned. For example, in Figure 6, we have a converter tuned to channel 2, at 55.25 MHz. Among other incoming signals is channel 53, at 397.25 MHz. Because the converter is tuned to channel 2, the first LO is at 668 MHz (668-55.25 = 612.75 MHz IF). Channel 53's energy is also converted by the LO, to 270.75 MHz. This energy should be dissipated in losses in the mixer, but some of the energy appears at the input connector. This signal is 500 kHz below channel 32's picture carrier.

On a 550-MHz system with the first converter tuned to channel 2, the first LO would be 668 MHz, assuming an

FIGURE 6  
**Example of backtalk**

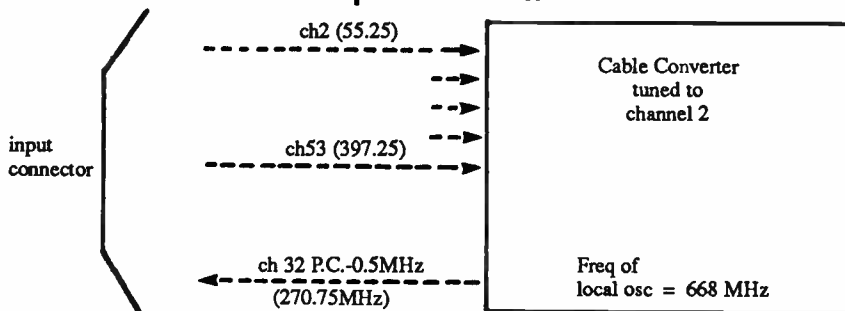

**Calculation:**

$$688-55.25 = 612.75 \text{ desired IF frequency}$$

$$688-397.25 = 270.75 \text{ Backtalk}$$

## The effects of electromagnetic conduction (EMC) are different for three frequency ranges.

IF frequency of 612 MHz. The lowest backtalk carrier is calculated by subtracting the highest input carrier, channel 78 (547.25 MHz), from the first LO (668 MHz), which equals 120.75 MHz (channel 14 - 500 kHz). Only the unwanted carriers below 550 MHz could interfere with a second converter. If a TV or VCR is tuned to a channel from 14 to 78, then an unwanted signal would appear within the 6 MHz bandwidth output. The spurious signal may appear within a desired cable channel causing a beat to appear on a television when the second device is tuned to the same channel as the unwanted signal.

To determine an acceptable backtalk level for a converter, the path from the input of one converter to the input of the other device must be taken into account. Typically, a splitter or a directional tap is used with some length of drop cable between the two converters or between the converter and a VCR. The backtalk is generated by the converter tuned to channel 2 and propagates back toward the splitter. Due to imperfection in the isolation of the splitter, a portion of the backtalk arrives at the second set, tuned to channel 32. Here the backtalk signal shows up as a 500-kHz beat. This signal must be at least -57 dB below the desired video carrier in order to eliminate any effect on the picture quality. Assuming worst case, the splitter port-to-port isolation is 20 dB and the cable loss is 0 dB. This suggests a minimum backtalk specification of 57 dB minus 20 dB, or 37 dB down from the input carrier. Backtalk can be minimized by using a special tracking filter or a buffer amplifier at the input of the converter.

To measure backtalk, it is necessary to calculate where all backtalk signals appear at the input of the converter as the converter is tuned to different channels, see Figure 7. The unwanted signals will fall inband at the input of the converter. On a standard-channel system, except for channels 5 and 6, the backtalk signals are located 500 kHz below an incoming carrier. Many converters have a 1 MHz step resolution for the phase-lock-loop on the first LO; therefore, the first LO cannot tune accurately for an HRC system. For these converters, except for channels 5 and 6, the backtalk signals are located

250 kHz below an incoming carrier. It is necessary to measure all backtalk signals to determine the worse case spurious for a given tuned channel. Be sure not to mistake an input carrier on the spectrum analyzer as a backtalk signal.

### Electromagnetic conduction

Electromagnetic conduction at the input refers to spurious signals which appear at the input of the converter with no input signals present. It was once referred to as LO leakage. When the converter causes unwanted signals to be present at its RF input, these signals can travel down the coax drop cable and interfere with other devices connected to the coax drop cable, such as a VCR or second cable converter. These signals can also travel through the tap on the pole, causing interference with other cable signals. This converter parameter is of special importance to two-way systems when unwanted signals must be kept to a minimum. Examples of typical unwanted signals from a converter might include leakage from the LOs, crystal

oscillators, harmonics of the crystal oscillators and mixing products of the two LOs.

The effects of electromagnetic conduction (EMC) are different for three frequency ranges. The 0 to 50 MHz range is reserved for two-way communication on some cable systems. Any signals within this frequency range are combined as they are amplified and passed on to the cable headend. A typical converter may have a couple of lower frequency crystal oscillators which may couple to the input of the converter. EMC levels within this range would add with other converters on the cable system and could adversely affect RF performance of equipment designed to operate below 50 MHz. It is difficult to calculate acceptable EMC levels below 50 MHz because performance depends on the type of equipment being used in this frequency range and the physical size and layout of the cable system.

The Electronic Industries Association publication entitled "CATV RF Interface Specification for Television Receiving Devices" is a proposed industry standard (IS-23) and contains a

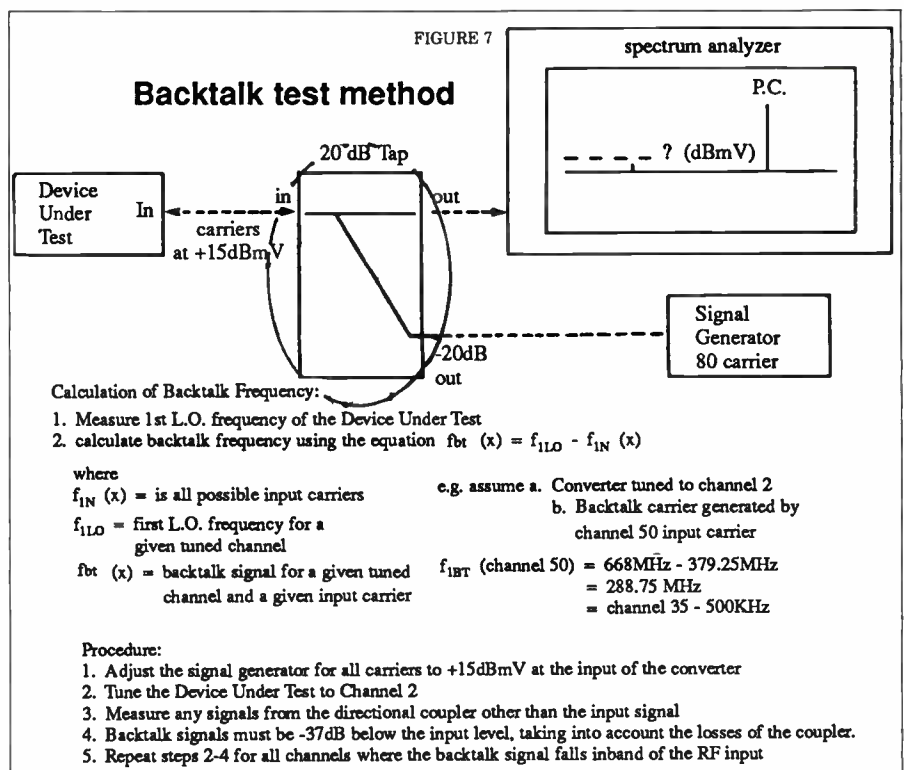

## The RF parameters discussed here affect converter RF performance, but often get little attention in the cable industry.

specification for EMC. Within the 50 to 550 MHz input tuning range, Scientific-Atlanta believes the minimum EMC level should be derived from the maximum acceptable spur of -57 dB below the video carrier level. If the minimum input carrier level is 0 dBmV, the spur must be below -57 dBmV. EMC interference assumes that another RF receiver is also connected to the converter's input through a splitter or tap. Since the worst case port-to-port isolation of a splitter or tap is 20 dB, the maximum EMC should be -37 dBmV (-57 dBmV + 20 dB),

which differs from IS-23.

The first LO leakage will range from 668 to 1,160 MHz for a typical 550 MHz converter and these frequencies are too high to interfere with the converter's input carriers. Depending on the output frequency, the second LO will typically be greater than 600 MHz, which is too high to interfere with the converter's input carriers. However, the difference between the first and second LO frequencies will be within the 50 to 550 MHz frequency range and can interfere with converter RF performance.

A method for testing EMC is shown in Figure 8. It is important that this test be performed in a room that has RF shielding to guarantee no external signals are being measured.

### Parasitic FM

Parasitic or residual FM refers to the amount of FM'ing present on the video carrier, generated by the converter. This excess FM'ing interferes with the picture and sound quality in two ways. Some FM to AM conversion takes place in the TV due to the Nyquist slope of the IF filter causing noise in the picture. Depending on how the TV receiver circuitry recovers the audio information, some phase noise is introduced, which may be heard at the audio output. By testing many old and new TV receivers, it was found that 10 kHz peak-to-peak of parasitic FM at a modulation frequency of 15 kHz is an acceptable performance level causing no audio or video degradation. Parasitic FM is caused by any ripple voltage present on either the power supply to the LO amplifier circuit or the varactor diode in the LO circuit.

It is important that the signal generator have very little FM'ing, as shown in Figure 9. The amount of parasitic FM'ing is channel dependent because of the ripple on the varactor diodes used for the LOs; therefore, the parasitic FM'ing should be measured on all channels.

FIGURE 8

### Electromagnetic conduction at the input test method

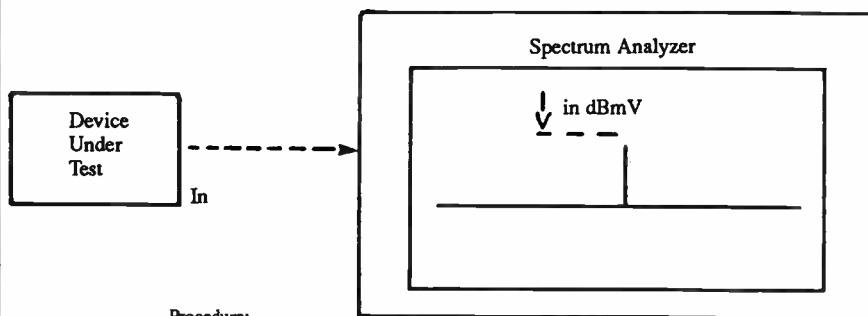

#### Procedure:

1. Connect the input of the Device Under Test to the spectrum analyzer
2. Tune the Device Under Test to channel 2.
3. Measure all spurs from 0 to 1200 MHz
4. Repeat step 3 above as the Device Under Test is tuned to all channels

FIGURE 9

### Parasitic FM test method

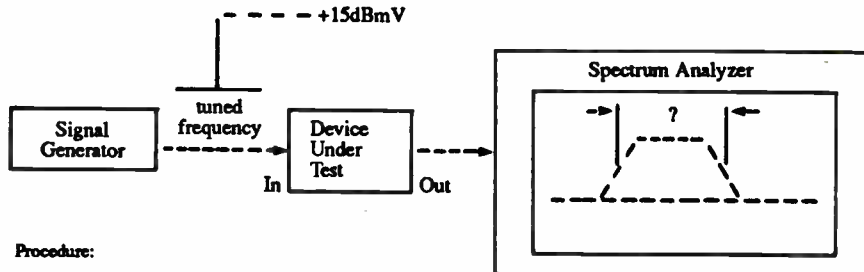

#### Procedure:

1. Tune the Device Under Test to channel 2
2. Adjust the output of the signal generator for channel 2 at +15dBmV
3. Measure the peak-to-peak FM'ing on the video carrier at the 3db points with a resolution bandwidth of 1KHz
4. Adjust the output of the signal generator for next channel to +15dBmV
5. Repeat step 3 & 4 above for all channels

### Conclusion

The RF parameters discussed here affect converter RF performance, but often get little attention in the cable industry. With an understanding of these parameters and how to measure them, you can be better equipped to evaluate converters and select those that have the best RF performance. Occasionally published specifications are vague and some parameters are missing altogether.

Don't be afraid to ask the converter manufacturer about parameters that are unclear or missing. If the answer is still unclear, ask for a description of how those parameters are tested. A good understanding of CATV converter test parameters will insure that you get exactly the product you want. ■

## HELP WANTED

### "Leader in the Placement of Cable Television Professionals"

Nationwide Service

**JIM YOUNG &  
ASSOCIATES**

One Young Plaza  
1235 Ranger Highway  
Weatherford, TX 76086

(800) 433-2160

(817) 599-7623

### MANAGER ENGINEERING/SERVICE

Unusual opportunity to take charge of a national multimillion dollar expansion plan in hotel pay-per-view (satellite received/two-way addressible). Headquartered in Austin, Texas. Technically expert, entrepreneur, manager, business-oriented and highly qualified. Experience with cable/SMATV essential. Resume, references and compensation requirements please.

**Hospitality Network**

Attn: Linda Yell

5000 Plaza on the Lake  
Suite 300

Austin, Texas 78746

### CATV SERVICE TECHNICIAN

National Cable TV MSO looking for a highly motivated individual with a basic knowledge of electronics. One to two years experience in cable trouble shooting preferred. Outdoor work. Excellent benefits with opportunity for advancement. \$6-\$8/hr. Resume required. Applications accepted at:

Paragon Cable

Attn: C. Feathers

11500 9th Street North

St. Petersburg, FL 33716

### LINE/SERVICE TECHNICIANS

Positions available immediately. 2 years experience preferred. \$7-12 per hour. Send resume to:

**Brad Shoemaker**

Cable TV Montgomery

250 Hungerford Drive

Rockville, MD 20850

## CONSTRUCTION MANAGER Based in Haverhill, Massachusetts

Times Mirror Cable Television is one of the country's leading cable companies. We have an immediate opening for a seasoned Construction Manager to manage one or more cable television construction projects, their associate activities and offices, with a single or multi-system environment, from inception to completion. The position does involve some travel.

The ideal candidate will have 8-10 years operations and construction experience, preferably in the cable television industry. Must have a thorough knowledge of the technical aspects of cable television construction and engineering techniques, plus the knowledge and ability to understand budget management. An Engineering or Business degree or equivalent experience is required.

As part of The Times Mirror Company, we offer an exceptional benefits package and our salaries are competitive. For immediate consideration, please mail your resume with salary history and requirements to our corporate offices: Attn: Human Resources, Dept. 7231, Times Mirror Cable Television, P.O. Box 19398, Irvine, CA 92713. We are an equal opportunity employer.



**Times Mirror  
Cable Television**

### TECHNICIAN

Preventive maintenance technicians. Earn up to \$15/hr; service technicians earn up to \$11/hr. High school diploma and prior cable television technical experience required. Desirable east coast location. Generous relocation assistance. Call collect on our "hot lines": 1-301-294-7651, 7665 or 7611.

**EOE**

### POSITION WANTED

Eight years of CATV Engineering Management experience has made me a real problem solver. Fluency with personnel, operations, planning, budgets, headends, microwave, fiberoptics, data, video, and distribution plant rounds out my credentials. I will turn your organization's engineering challenges into pleasant memories. Reply to:

**CED: 0901-01**

**HELP WANTED**

**WE PLACE ENGINEERS,  
SALES, MGMT. & FINANCIAL  
PEOPLE**  
*(all levels for the CATV Industry)*  
**Nationwide Service — All Locations**  
*America's Leading Source for a Decade*  
For information phone or write Mark Kornish



**key SYSTEMS**  
479 Northampton Street  
Kingston, PA 18704  
(717) 283-1041

*Employer  
Paid Fees*

**EQUIPMENT FOR SALE**

**MAILING LISTS  
AVAILABLE**  
For more information, call Judy Medley at  
(303) 860-0111.

**WANTED:  
SURPLUS CABLE EQUIPMENT**  
Jerrold, Oak, Hamlin & Scientific  
Atlanta equipment.  
**Highest Prices Paid**  
Cable Equipment Brokerage Co.  
**(818) 709-3724**

**BUSINESS DIRECTORY**

Why buy new? Save that budget!

**CHARACTER  
GENERATOR  
REPAIR**

★ **METRODATA** ★  
system 110, 120

★ **BEI** ★  
CG 800, CG 800R

- Single and Multi-Channel used systems available
- Software Reconfigurations

C.A.B. Digital Service  
(516) 286-5822

**HOW TO RESPOND TO A BLIND  
BOX AD: CV (Blind Box Number)**  
c/o *CableVision* magazine, 600  
Grant St., Suite 600, Denver,  
CO 80203.



**If you're not on our  
MONTHLY PARTS  
MAILING LIST  
you should be!**  
**Here's why . . .**

JRX RF Case	\$2.19
DRX Bezel	1.58
Piggyback AC Cord	3.25
TEA 1009	1.95

Minimum Quantity 100 Pieces

**Call  
1-800-382-BRAD**  
In NY 518-382-8000  
Ask For Parts Sales

CLEARLY BETTER



**BUSINESS DIRECTORY**

**NETCON**  
A Division of C & S Construction, INC.

**TURNKEY LAN SYSTEMS**

Richard Piltz  
Projects Coordinator  
412-935-1277

P.O. Box 260  
Northgate Drive  
Warrendale, PA 15086

**SIGNAL LEVEL METER REPAIR**  
Prompt, Professional Service  
at Reasonable Prices



**JGL**  
**ELECTRONICS, INC.**

4425 BLACKSTONE DRIVE  
INDIANAPOLIS, INDIANA 46237  
317/783-6130

Licensed

**AUTOMATION TECHNIQUES INC.**

Modification for commercial receivers to work with descramblers

**PDC new tunable processor, demodulator, converter \$329<sup>00</sup>**  
**GLR 500 CH new crystal commercial satellite receiver \$329<sup>00</sup>**

1839 North 105th East Avenue • Tulsa, OK 74116 • (918) 836-2584/(918) 836-8284 (Service Center)

## Plain vanilla converters

As the morning of Jan. 1, 1987, dawned, the cable industry officially started a new era of deregulation. Among the myriad other benefits it brought to the industry, deregulation was, and still is, chiefly responsible for creating a new boom in hardware sales.

Operators have wasted little time in gearing up their newbuild, rebuild and upgrade machinery and, consequently, orders for everything from headend equipment to set-top converters went through the roof. And, as more subscribers purchase cable-compatible electronic equipment (the latest estimates say more than 40 percent now have this type of gear) an increasingly popular item is the plain vanilla converter. They're popular because only those subscribers without cable-compatible TVs or VCRs need them (in a non-addressable environment), they're inexpensive and reliable and they're so small they're unassuming.



Hamlin's CR-6800 converter

### Hamlin

The Hamlin CR 6800, distributed by Anixter, is equipped for 550 MHz capacity (83 channels). It is a full-featured, digital converter with a 30 percent smaller footprint than other models. It comes with an infrared remote control that can be used in the traditional hand-held mode or placed in a cradle located on top of the

converter for use as an on-board control keypad. Other features include last channel recall, parental guidance, channel elimination, barker channels, auxiliary AC socket, channel scan, eight memory locations and self-test diagnostics. The CR 6800 is about \$50. Circle Reader Service number 88.



Jerrold's Starcom VI converter

### Jerrold

The Starcom VI model DQN is a 550-MHz, 82-channel digital plain converter from Jerrold, a division of General Instrument. It is designed for subscribers of basic services in addressable or pay systems and all subscribers in plain or trapped systems. Features of interest to operators include parental control without operator intervention, a non-volatile memory, custom channel assignment and remote unit enable/disable. These features can be programmed by the operator through use of an infrared remote programmer.

Subscriber features include automatic fine tuning, accelerated channel scan, favorite channel programming, last channel recall, parental control, a convenience outlet and an auxiliary port for stereo adapters. The model DQN is available immediately for a list price of \$56. Circle Reader Service number 89.

### NSC Electronics

NSC (formerly Standard Components) offers plain converters in 36 (300 MHz), 60 (450 MHz), 70 (500 MHz) or 78 (550 MHz) channel capacities, all of which are microcomputer controlled. NSC's total redesign of the units culminated recently with the addition of the following group of features: full parental control on all channels, unlimited pro-



NSC's micro converter

gram memory, A/B capability, fine tuning, SAW resonator, SAW filter and inverted carrier capability. With the hand-held remote unit (included), a subscriber has full random program access, can fine tune the converter and can control the TV power through the on/off switch. The sleek, black units have just three keys on the front of the units. Circle Reader Service number 90.

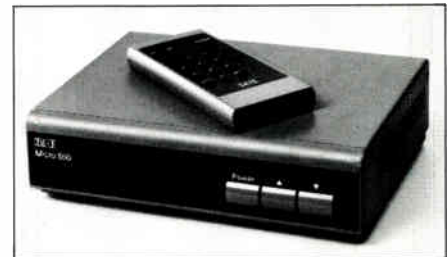

Oak's Micro 550 converter

### Oak Communications

Three different plain models are offered by Oak: the L35, Sigma 500 and the Micro 550. The L35 has a mechanically selected varactor tuner and is geared toward systems searching for a low-priced, reliable basic box. Part of the old "Econo-Line," the L35, which has a 35-channel capacity, sells for about \$25 each.

The Sigma-style model offers 500 MHz, 75-channel capacity and comes with a remote control that works over a wide angle and long distance. Available for NTSC, HRC or IRC configurations, the Sigma 500 offers favorite channel memory, channel scan, last channel recall and direct channel entry. This unit sells for about \$45.

Oak's latest product is the Micro 550. Featuring a sleek, compact design with just three buttons on the set-top, the 83-channel capacity unit also comes with a hand-held, 17-button remote.



# DELIVER MORE RELIABILITY.



## With the Panasonic TZ-PC130 and TZ-PC160 Series Converters.

Over the years, you've come to expect quality performance and reliability from Panasonic CATV converters. And now, we're making it possible for you to deliver even more of this reliability to your subscribers—with our TZ-PC130 and TZ-PC160 series converters. They're a full 40% smaller than previous models, which means your installers will be able to carry more converters and stack them more efficiently in service vehicles. Not to mention, all the room you'll be saving in your warehouse.

We've decreased the size of our converters, but we certainly haven't cut down on performance. Our TZ-PC130 and TZ-PC160 series offer a host of

quality features designed for ease of operation and convenience. Like 68-channel capacity with direct access selection, up/down channel scan, channel recall, and an optional non-volatile parental guidance control.

In addition, each converter comes equipped with a full-function, wireless infrared remote control. The top of each converter incorporates a special docking bay for the remote, which permits convenient set-top use, and serves as a handy storage place to help prevent lost remotes.

For your subscribers who have stereo ready TVs, both the TZ-PC130 and TZ-PC160 have the ability to pass

BTSC stereo signals without adaptors or add-on units. And for your subscribers who want volume control, the TZ-PC160 offers up/down keys as well as a mute key.

The Panasonic TZ-PC130 and TZ-PC160 series converters. Small in size—but big on reliability.

For more information call:  
East Coast: (201) 392-4109  
West Coast: (415) 672-2592

## Panasonic Industrial Company

Reader Service Number 46



**Ten years ago  
we set some  
standards for  
our company...**

- High Quality
- Competitive Prices
- Good Customer Service

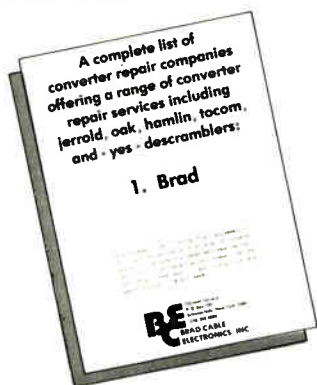

**Today...we're  
still using  
those same  
standards.**

**Corporate Headquarters.**  
1023 State Street. Schenectady, NY 12301.  
518-382-8000

5906 Breckridge Pkwy., Suite 1.  
Tampa, FL 33610. 813-623-1721  
4630 Pacific Hwy. East, Suite B-7.  
Fife, WA 98424. 206-922-9011

Highway 19, Old Socco Road.  
Cherokee, NC 28719. 704-497-5314

CLEARLY BETTER



Reader Service Number 47

PRODUCT PROFILE

**Two standard models are  
available from Pioneer, one  
with remote and one without.**

Features include channel scan, favorite channel memory and last channel recall. It sells for about \$47, including the remote. Oak is presently building inventory of all three converters. Circle Reader Service number 91.



*Panasonic's TZ-PC160 converter*

**Panasonic**

Panasonic offers two non-addressable models, the TZ-PC130 and the TZ-PC160 (includes volume control), both of which offer a 450 MHz, 68-channel capacity. (A 550 MHz version is slated for introduction later this year.) Both boxes have just three buttons on the front, but come standard with full-featured remotes that can be used either as on-board keypads or as hand-held devices. Both feature channel scan, favorite channel memory, last channel recall and parental control. BTSC stereo signals are passed cleanly through the TZ-PC130. The TZ-PC160 series also passes stereo signals, provided the unit's volume control is set at maximum. The 130 series sells in the low-\$50s, while the 160 series sells in the upper-\$60s. Both are available now. Circle Reader Service number 92.

**Call for  
information on  
Business Card  
space  
(303) 860-0111**



— The magazine of broadband technology —



*Pioneer's BC-4500 converter*

**Pioneer Communications**

Two standard models are available from Pioneer, one with remote and one without. The BC-2000 tunable converter has a rotary tuner and a fine tuning dial located on the front. It has a 50 MHz to 300 MHz frequency range, AC convenience outlet and can be configured for standard, HRC or IRC alignments. It sells for about \$35, depending on quantities. The BC-4500 series offers a full-featured wireless remote control and 550 MHz capacity. Through the use of the Options Selector, operators can program converters for such options as parental control, IR remote and barker channels. Other standard features include favorite channel memory with 10 programmable channels, last channel recall, TV on/off relay and surge protection. The BC-4500 sells in the mid-\$50s, depending upon quantity. Availability on both units is immediate to 90 days. Circle Reader Service number 93.

**Scientific-Atlanta**

Two plain set-tops are being offered by Scientific-Atlanta. Model 8505 has two large keys on the front to allow tuning and power on/off functions. A two-speed channel scan is featured. A manual fine tuning wheel has been included on the side of the unit and a convenience AC outlet is located in back. It is designed for use in 330 MHz systems. The 8510 is an enhanced unit containing all the features listed above plus automatic fine-tuning, a switched AC outlet and infrared remote control for direct channel entry. The remote unit offers last channel recall and favorite channel memory. The 8510 is meant for use in 450 MHz systems. Circle Reader Service number 94.

—Roger Brown

## Addressable universe continues growth

Is addressability seeing a resurgence of interest? Perhaps so, as evidenced by the fete thrown by **Jerrold** in honor of Sammons Communications' Southern New Jersey system becoming the 500th addressable system installed by the division of General Instrument. In fact, addressability is growing fast enough that at the luncheon announcing the benchmark, Hal Krisbergh, vice president and general manager of the subscriber systems division said 549 systems have actually been installed. More on this in an upcoming issue of *CED*.

A signal processor with complete heterodyne circuitry is offered by **Pico Macom**. The Model SP-60 features SAW filtering for guaranteed 60 dB out-of-band signal rejection, spurious outputs down 60 dB, high adjacent channel rejection of 60 dB, low input signal capability, sync tip AGC, stereo compatibility, 45 MHz IF loop-through and 100 percent burn-in. Price is \$490. Model SP60-\* is pre-tuned to a specific channel and priced at \$440. Reader Service number 95.

**Channell Commercial Corp.** has developed the KTH series of trap holders which permit all types of traps to be mounted in existing Channell pedestals. The halo-shaped assemblies have openings on one side to allow installation into the base of existing pedestals without disconnecting equipment. Attachment of traps to passives is done by using locking terminators and jumpering the traps with RG coax. The traps are contained in trap shield protectors which are installed in the KTH holders. Also, a new low-profile enclosure, the CPH-1230, has been developed. It is designed to house actives like line extenders, tap/splitter combos and trunk amps. Price is \$96.20 each. Reader Service number 96.

A series of new products has been announced by **Texscan Instruments**. The 5301 scrambler scrambles video by suppressing a composite of the channel's synchronization pulses, burying them in the video brightness, to

create diagonal lines and video tearing. It is designed to operate in conjunction with 6 dB sync suppression decoders.

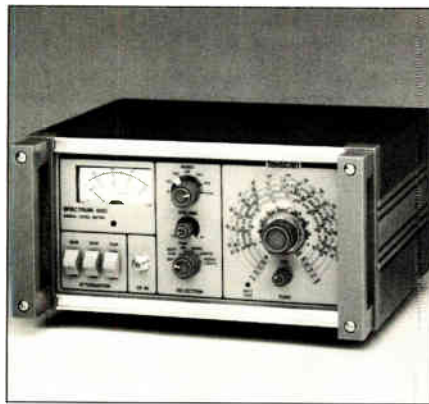

*Texscan's Spectrum 600 SLM.*

The TPCG pilot carrier generator can be used for reference signals or controlling gain and slope in AGC amps. It uses crystals with 0.005 percent frequency tolerance and narrow bandwidth characteristics. A redesigned Spectrum 600 signal level meter offers a reinforced case, color-coded frequency dial and operates from 5 MHz to 600 MHz. Price is \$895. Finally, the RAB-1 remote A/B switch has been announced. Designed to augment the Vital Signs product line, the rackmountable unit monitors A and B inputs from 5 MHz to 550 MHz and permits auto switching manual control or remote control. Circle Reader Service number 97.



*Wavetek's 1882 sweepless sweep.*

A sweepless sweep has been introduced by **Wavetek**. After connection to a reference point, the Model 1882 scans the system and measures selected carrier levels, storing them in a non-volatile memory. The unit is then connected to test points elsewhere and comparisons are made to the stored reference levels. Other measurement features include C/N, 2nd and 3rd order distortion, cross mod, FM deviation, percent hum modulation and leakage detection. Circle Reader Service number 98.

**Trilithic** has developed a family of programmable attenuators using surface mount technology. The units mount on the ground plane or circuit side of the printed circuit board and attach by solder pins. Circle Reader Service number 99.

**Hewlett-Packard** has introduced a portable analyzer to detect sources of excessive radiation in prototype products. The HP 8590A Option H51 is designed for use with a set of hand-held close-field probes. Circle Reader Service number 100.

A high-power, low noise continuous coverage amplifier has been introduced by **Multiplex Technology**. The DA-1000 distribution amp provides max output of 55 dBmV for all frequencies from 50 MHz to 1000 MHz. Circle Reader Service number 101.

**Dr. James Hood** has been named president of **Catel Communications**. Hood was formerly senior vice president of Granger Associates.

**Ronald Ruppe** was promoted to vice president of sales and marketing at **SelectTV**. Ruppe will oversee all sales and marketing programs including direct response, wholesale and retail sales. He was previously director of sales and service for Willamette Subscription Television and served as director of sales for ONTV before joining SelectTV.

**Hospital Satellite Network** has elected **Jack Weiblen** as its chairman. He was formerly president and CEO of Memorial Health Services in Long Beach, Calif.

**Mike Balsom** has been appointed assistant sales manager for the **R.L. Drake Co.** He will oversee distributor relations in the western half of the United States and handle administrative, sales and marketing functions.

## The SCTE has developed a product-specific satellite teleseminar program series.

He was previously employed by Quasar and Radio Shack.

**Van Walbridge** has been named vice president and general manager of the General Cable Co./Apparatus Division of **Penn Central Telecommunications Corp.** in Westminster, Colo. **Dan King** was named sales manager of Telsta aerial lifts.

**Jennifer Lambert** has joined **Jerrold's "World of Impulse"** as director of affiliate relations for new business development. She will work to sell and market impulse technology for a variety of uses. She comes to Jerrold from Request and Rogers Cablesystems.

**Lance Belcher** has been appointed as manager of national accounts at **Pioneer Communications.** He will be responsible for managing a select group of cable converter accounts and will be stationed in Irving, Texas. He comes to Pioneer from Burnup and Sims.

**Abe Sonnenschein**, AML program

manager at **Hughes Aircraft**, has been inducted as a member of the Cable TV Pioneers group for his work in applying microwave transmission techniques in the cable industry. **Sonnenschein** has been with Hughes since 1967 and is a recipient of the NCTA Science and Technology Award. He has also served on the the boards of both the NCTA and SCTE.

**David Green** has been appointed account executive of **Intercept Communications Products.** Formerly with RMS Electronics and EM Electronics, Green will service MSO accounts nationwide.

The SCTE has developed a product-specific satellite teleseminar program series which will allow companies to pitch their products directly to system engineers and technicians. The series will cover a broad range of products. For information, call Mike Aloisi, (404) 396-1333, or Bill Riker, (215) 363-6888.

In other SCTE news, three new

meeting groups have been formed, including the Southeast Texas group, in Houston; the North Country group, in Minneapolis/St. Paul; and the Tennessee group, from Nashville. The **Heart of America** meeting group, in cooperation with the **Gateway** group, will meet Thursday, Sept. 3, at the Lodge of the Four Seasons to present topics on fiber technology. Call Charlie Broomfield, (816) 453-3392. The **Rocky Mountain Chapter** will meet Wednesday, Sept. 9, at Jones Intercable's headquarters and present "Interface with Local Broadcasters" as its program. Issues like BTSC stereo, HDTV and future consumer add-ons will be covered. Call Joe Thomas, (303) 978-9770. The **Great Lakes** meeting group will meet Wednesday, Sept. 30, to discuss subscriber/terminal interfaces. Call (313) 336-7031 for more information.

—Roger Brown



# BUYS NEW & USED SURPLUS EQUIPMENT

(CONVERTERS, LINE GEAR, HEADEND, PASSIVES, TRAPS, ETC.)

<b>OHIO</b> Corporate Office 280 Cozzins St. Columbus, OH 43215 (614) 221-3131	<b>MICHIGAN</b> Sales Office 2482 Tucson Drive - 2C Drayton Plains, MI 48020 (313) 673-0818	<b>TEXAS</b> Sales Office 2439 NE Loop 410 - #1404 San Antonio, TX 78217 (512) 650-3132
---	--	--

Sales and Repair of CATV Equipment  
Reader Service Number 48

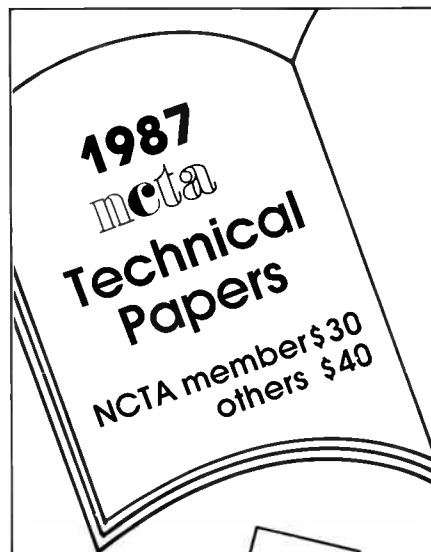

Pre-paid mail orders only.  
Price includes shipping.  
Send check with request to:  
NCTA  
Science & Technology Department  
1724 Massachusetts Ave., N.W.  
Washington, D.C. 20036

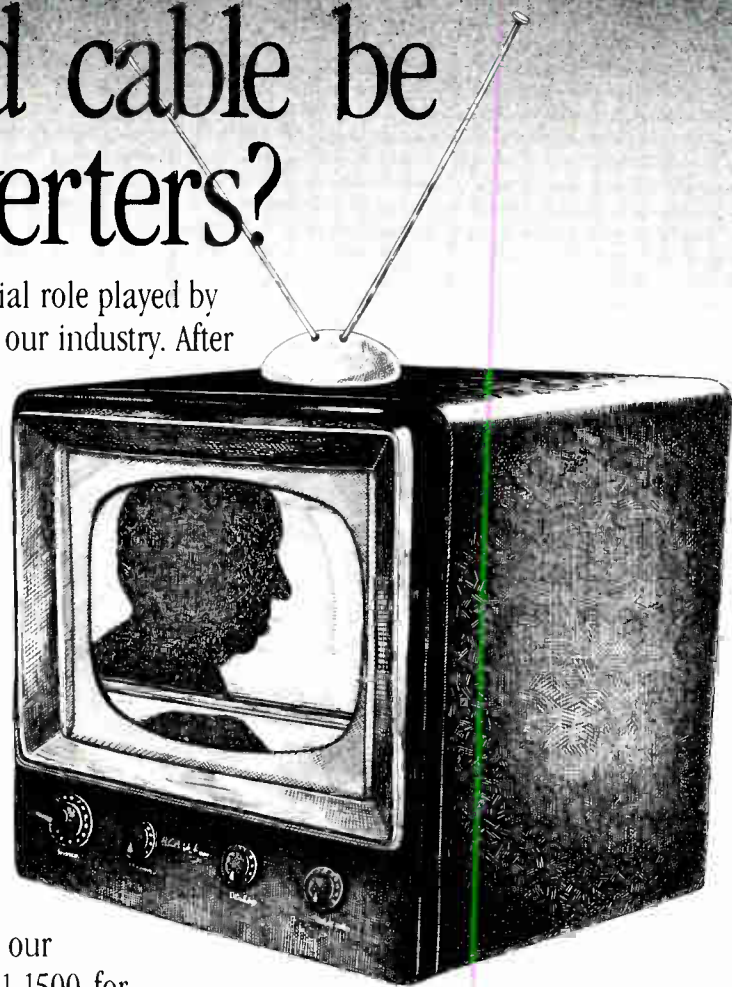

# Where would cable be without converters?

Nobody knows better than Oak the crucial role played by the humble converter in the growth of our industry. After all, we introduced cable's first mass-produced converter product almost 20 years ago. Today we continue to supply a high-performance line of non-addressable settop units to meet any system need and have just introduced two new advanced converter units. Some are available for *immediate shipment* and you'll soon be able to order all of them *right off the shelf*. With a reputation for reliability backed by millions of field-proven units, Oak is still the first name in CATV converters.

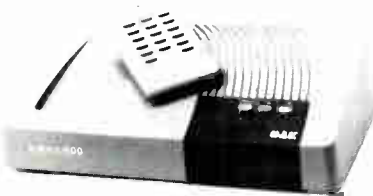

## Want More Details?

Call your nearest Oak sales representative or our division headquarters in San Diego (619) 451-1500 for complete spec sheets, pricing, and firm delivery schedules.

MICRO 550 REMOTE CONTROL CONVERTER	SIGMA™ 500 REMOTE CONTROL CONVERTER	L35 Econoline® CONVERTER
		
<ul style="list-style-type: none"> <li>• Our newest product</li> <li>• 550-MHz, 83-channel tuner</li> <li>• Compact, high-tech styling</li> <li>• Unlimited favorite channel memory</li> <li>• Last-channel recall</li> <li>• Full 2-year warranty</li> </ul>	<ul style="list-style-type: none"> <li>• 500-MHz, 75-channel tuner</li> <li>• Wide-angle IR remote</li> <li>• Stylish "Sigma" design</li> <li>• Unlimited favorite channel memory</li> <li>• Last-channel recall</li> <li>• Full 2-year warranty</li> <li>• <i>Immediate shipment</i></li> </ul>	<ul style="list-style-type: none"> <li>• 54-270 MHz tuner, 35 channels</li> <li>• Varactor Tuning</li> <li>• Low-profile design</li> <li>• Rugged ABS cabinet</li> <li>• Highest reliability</li> <li>• Incredibly low price</li> <li>• <i>Immediate shipment</i></li> </ul>

**OAK Communications Inc.**  
16516 Via Esprillo, Rancho Bernardo, CA 92127

P.S. For addressable systems, our Sigma™ line is the most advanced system available (Oak invented addressability, too), with cable's most secure signal and friendliest IPPV capability, all-channel digital stereo, standard VCR timer and lots, lots more.

# Hamlin Has It All!

## Full 550 MHz (83) channel capacity digital convertor



The Hamlin CR-6800 full feature set top digital convertor provides a long list of subscriber features designed for ease of operation and customer satisfaction. Traditional Hamlin quality is designed and built into each convertor for long lasting service and reliability. And, the Hamlin CR-6800 is available only through Anixter!

- Full 550 MHz-83 channels
- Reduced size
- 8 Memory locations
- Last channel recall
- Parental guidance feature
- Channel allocation tables
- Channel elimination
- Auxiliary A.C. socket
- Self-test diagnostic
- Convertor configuration routine
- Barker channels



A unique feature of the CR-6800 is a cradle for the hand held transmitter that provides a storage area for the remote control, and also allows the transmitter to function as an on board keypad to control the convertor.

# ANIXTER

## Wiring Systems Specialists

Voice • Video • Data • Power

CORPORATE HEADQUARTERS:

ANIXTER BROS., INC., 4711 Golf Road, Skokie, IL 60076 (312) 677-2600 — Telex 289464

©1987 ANIXTER BROS., INC.

# ANIXTER

DEPT. HAMLIN  
4711 Golf Rd., Skokie, IL 60076

Please send me more information on Hamlin Convertors.

Name \_\_\_\_\_

Title \_\_\_\_\_

Company \_\_\_\_\_

Address \_\_\_\_\_

City \_\_\_\_\_ State \_\_\_\_\_ Zip \_\_\_\_\_

Telephone \_\_\_\_\_

CED91