

BYTE

THE SMALL SYSTEMS JOURNAL®

DECEMBER 1986 VOL. 11, NO. 13

\$3.50 IN UNITED STATES
\$4.25 IN CANADA / £1.75 IN U.K.
A MCGRAW-HILL PUBLICATION
0360-5280

Graphics
Algorithms

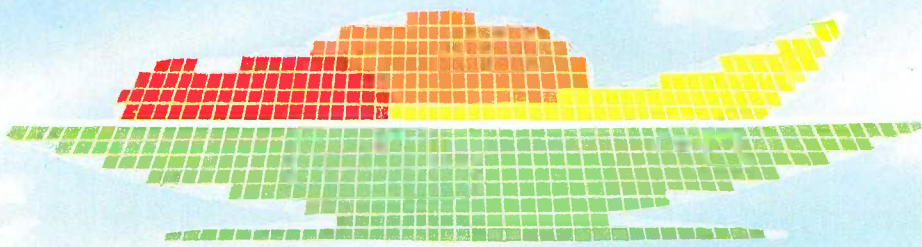
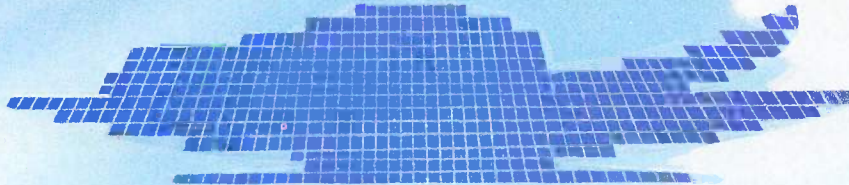
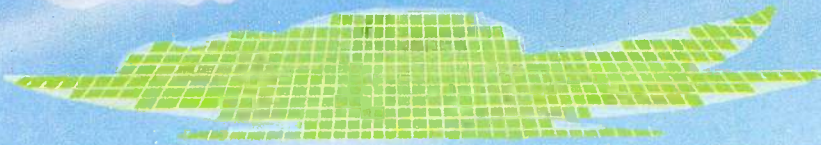
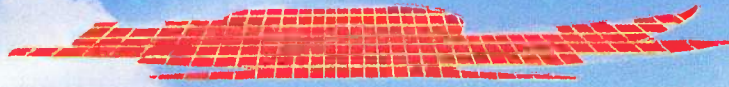
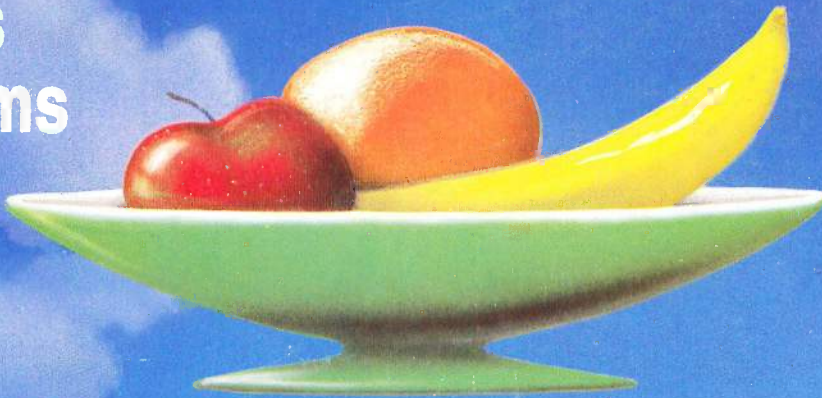

ROBERT
TINNEY

Turbo Pascal Programming

Learn Secrets, Strategies,
Game Theory!



\$10.00 Scratch 'n Win Rebate!

Turbo GameWorks®

Also recently released, Turbo GameWorks is what you think it is: "Games" and "Works." Games you can play right away (like Chess, Bridge and Go-Moku), plus the Works—which is how computer games work. All the secrets and strategies of game theory are there for you to learn. You can play the games "as is" or modify

them any which way you want. Source code is included to let you do that, and whether you want to write your own games or simply play the off-the-shelf games, Turbo GameWorks will give hours of diversion, education, and intrigue. George Koltanowski, Dean of American Chess, and former President, United States Chess Federation, reacted to Turbo GameWorks like this: "With Turbo GameWorks, you're on your way to becoming a master chess player." And Kit Woolsey, writer, author, and twice Champion of the Blue Ribbon Pairs, wrote, "Now play the world's most popular card game—Bridge... even program your own bidding and scoring conventions." Suggested retail: \$69.95. Use a \$10.00 Scratch 'n Win Rebate and you're talking an incredible \$59.95! Minimum memory: 192K.



Turbo GameWorks' Chessboard

Create Your Own
High-Res Graphics!



\$10.00 Scratch 'n Win Rebate!

Turbo Graphix Toolbox®

It includes a library of graphics routines for Turbo Pascal programs. Lets even beginning programmers create high-resolution graphics with an IBM, Hercules,™ or compatible graphics adapter. Our Turbo Graphix Toolbox includes all the tools you'll ever need for complex business graphics, easy windowing, and storing screen images to memory. It comes complete with source code, ready to compile. Suggested retail: \$69.95, but with a \$10.00 Scratch 'n Win Rebate, only \$59.95! Minimum memory: 192K.

The Ultimate
Learning Experience!



\$10.00 Scratch 'n Win Rebate!

Turbo Tutor® 2.0

COMPLETELY
NEW VERSION!

The new Turbo Tutor can take you from "What's a computer?" through complex data structures, assembly languages, trees, tips on writing long programs in Turbo Pascal, and a high level of expertise. Source code for everything is included. New split screens allow you to put source text in the bottom half

of the screen and run the examples in the top half. There are quizzes that ask you, show you, tell you, teach you. You get a 400-page manual—which is not as daunting as it sounds, because unlike many software manuals, it was not written by orangutans. Suggested retail: \$39.95. Use a \$10.00 Scratch 'n Win Rebate and you're down to an unheard of \$29.95! Minimum memory: 192K.



Recognition for Borland International has come from business, trade, and media, and includes both product awards and awards for technical excellence and marketing.

America's Cup. Coming Soon!

How to use Scratch 'n Win Rebates

It's really simple. You purchase the product between 9/5/86 and 3/31/87, and return the license agreement along with dated proof of purchase and your rebate card. We'll mail you a check for \$10.00 on single product purchases or a check for \$15.00 when you buy an advertised "bundle"—which means our Turbo Pascal Jumbo Pack, or Turbo Lightning and Lightning Word Wizard, or Reflex: The Analyst and Reflex Workshop, or SideKick and Traveling SideKick. (Restrictions do apply. See Official Rules on back of Instant Winner card).

Sail designs generated
from Shore Sails' Turbo
Pascal programs.

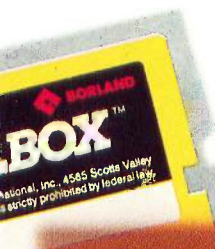

© Copyright 1983 Licensed Material Program property of BORLAND International, Inc., 1685 Scots Valley Drive, Scots Valley, CA 95068. Unauthorized use, duplication or distribution is strictly prohibited by Federal Law.

Turbo Pascal Programming

New! Artificial Intelligence!

5th-Generation Language!

\$10.00 Scratch 'n Win Rebate!

Turbo Prolog™

"Borland International, Inc. is gunning onto the fast track in the artificial intelligence and engineering-language-software race, riding aboard a new \$99 Turbo Prolog," says Tom Schwartz in *Electronic Engineering Times*.

And so we are. Our new Turbo Prolog has drawn rave reviews—which we think are

well deserved—because Turbo Prolog brings 5th-generation language and supercomputer power to your IBM PC and compatibles. Turbo Prolog is a high-speed compiler for the artificial intelligence language, Prolog, which is probably one of the most powerful programming languages ever conceived. We made a worldwide impact with Turbo Pascal and you can expect the same results and revolution from Turbo Prolog, the natural language of artificial intelligence. Darryl Rubin, writing in *AI Expert* said, "Turbo Prolog offers generally the fastest and most approachable implementation of Prolog." Suggested retail, \$99.95. Use a \$10.00 Scratch 'n Win Rebate and that goes down to only \$89.95! Minimum memory: 384K.

"If you're at all interested in artificial intelligence, databases, expert systems, or new ways of thinking about programming, by all means plunk down your \$100 and buy a copy of Turbo Prolog."

Bruce Webster, BYTE

Technical Specifications:

TURBO PASCAL 3.0 Minimum memory 128K, includes 8087 and BCD features for 16-bit MS-DOS and CP/M-86 systems. CP/M-80 version minimum memory 48K, 8087 and BCD features not available. **TURBO DATABASE TOOLBOX** Minimum memory 128K. CP/M-80 minimum memory 48K. Requires Turbo Pascal 2.0 or later. **TURBO GRAPHIX TOOLBOX** Minimum memory 192K. Requires PC/MS-DOS 2.0 or later, Turbo Pascal 3.0, and IBM CGA, Hercules Monochrome Card or equivalent. **TURBO TUTOR 2.0** Minimum memory 192K. CP/M-80 version minimum memory 48K. Requires PC/MS-DOS 2.0 or later and Turbo Pascal 3.0. **TURBO EDITOR TOOLBOX** Minimum memory 192K. Requires PC/MS-DOS 2.0 or later and Turbo Pascal 3.0. **TURBO GAMEWORKS** Minimum memory 192K. Requires PC/MS-DOS 2.0 or later and Turbo Pascal 3.0. **TURBO PROLOG** Minimum memory 384K. **REFLEX: THE ANALYST** Minimum memory 384K. Requires IBM CGA, Hercules Monochrome Card or equivalent. Works with Intel's AboveBoard-PC and -AT, AST's RAMpage! and RAMpage! AI, Quadram's Liberty-PC and -AT, Tecmar's 640 Plus, IBM's EGA and 3270/PC, AT&T's 6300 and many others. **REFLEX WORKSHOP** Minimum memory 384K. Requires Reflex. **TURBO LIGHTNING** Minimum memory 256K. Two disk drives required. Hard disk recommended. **LIGHTNING WORD WIZARD** Minimum memory 256K. Requires Turbo Lightning. Turbo Pascal 3.0 required to edit source code. **SIDEKICK** Minimum memory 128K. **TRAVELING SIDEKICK** Minimum memory 256K. **SUPERKEY** Minimum memory 128K. *For IBM PC, AT, XT, PCjr and true compatibles only, running PC/MS-DOS 2.0 or later.

Build Your Own Word Processor!



\$10.00 Scratch 'n Win Rebate!

Turbo Editor Toolbox™

Recently released, we called our new Turbo Editor Toolbox a "construction set to write your own word processor." Peter Feldmann of *PC Magazine* covered it pretty well with, "A 'write your own word processor' program for intermediate level programmers, with lots of help in the form of prewritten

procedures covering everything from word wrap to pull-down windows." Source code is included, and we also include MicroStar, a full-blown text editor with pull-down menus and windowing. It interfaces directly with Turbo Lightning to let you spell-check your MicroStar files. Jerry Pournelle of *BYTE* magazine said, "The new Turbo Editor Toolbox is the Turbo Pascal source code to just about anything you ever wanted a PC-compatible text editor to do." Suggested retail: \$69.95. Use a \$10.00 Scratch 'n Win Rebate and you'll get all this for only \$59.95! Minimum memory: 192K.



MicroStar file directory accessed by pull-down menu

Borland's Business Productivity Programs:

- Reflex: The Analyst** Analytical database manager. Provides complete, new look at data normally hidden by programs like 1-2-3* and dBASE.* Best report generator for, and complement to, 1-2-3.
- Reflex Workshop** Important new addition to Reflex: The Analyst. Gives you 22 different templates to run your business right.
- SideKick** Complete RAM-resident desktop management includes notepad, dialer, calculator and more.
- Traveling SideKick** Electronic version of business/personal diaries, daytime organizers; works with your SideKick files; important professional tool.
- SuperKey** Keyboard enhancer. Simple macros turn 1000 keystrokes into 1. Also encrypts your files to keep confidential files confidential.

Borland's Electronic Reference Programs:

- Turbo Lightning** Works with all your programs and checks your spelling *while you type!* Includes 80,000-word Random House® Concise Word List and 50,000-word Random House Thesaurus. Forerunner of Turbo Lightning Library.™
- Lightning Word Wizard** Includes ingenious crossword solver and six other word challenges. If you're into programming, Lightning Word Wizard is also a development toolbox and the technical reference manual for Turbo Lightning.

All Borland products are registered trademarks or trademarks of Borland International, Inc. or Borland Analytica, Inc. Turbo Lightning Library is a trademark of Borland International Inc. AST TurboLaser, RAMpage! AI, AdvantagePremium, SixPakPremium, 3G Pak and RAMpage! are trademarks of AST Research, Inc. Lotus 1-2-3 is a registered trademark of Lotus Development Corp. dBASE is a registered trademark of Ashton-Tate. IBM is a registered trademark of International Business Machines Corp. Random House is a registered trademark of Random House, Inc. Hercules is a trademark of Hercules Computer Technology. CP/M is a registered trademark of Digital Research, Inc. Traveling SideKick is not in any way associated with Traveling Software, Inc. of Seattle, Washington. Copyright 1986 Borland International. BI-1075C



Borland's award-winning software is the best Holiday present you can give yourself or anyone else

Any one of these Holiday presents could save your marriage, career, reputation and quite a few bucks.

When you give or get any one of these Holiday presents, every day's a Holiday, because you're giving or getting long-lasting software that's a lot more welcome to the Woman in your Life than vacuum cleaners, egg-beaters and ugly earrings. And the Man in your Life would rather have Turbo Prolog,[®] Reflex,[®] Reflex Workshop,[®] Turbo Pascal,[®] Turbo Lightning[®] or SideKick[®] than socks, ties and wrong-size shirts.

Turbo Prolog takes you by the hand into the brave new world of Artificial Intelligence

Artificial Intelligence is no substitute for the human brain (well, most human brains; you make your own list), but it is a fascinating new field, and we're leading it with our 5th-Generation Turbo Prolog. In fact, people are telling us that Turbo Prolog is "The most exciting product they've seen this year." So see it for yourself. Give it. Get it. You deserve it.

Turbo Pascal wins PC World's 1986 World Class PC Award for 'Programming Language!'

Give someone our Turbo Pascal "Jumbo Pack," but keep some of the precious pieces for yourself

There's so much in there—Turbo Pascal, Turbo Tutor,[®] Turbo Database,[®] Turbo Graphix,[®] Turbo GameWorks,[®] Turbo Editor[®]—you can probably give someone else one or two of them. (Just keep the ones you don't have already and make the rest thoughtful, really inexpensive presents for someone's Turbo Pascal library.)

Give them one, maybe two kinds of Holiday Reflex action!

Adam B. Green, InfoWorld's highly respected columnist, says "Everyone agrees Reflex is the best-looking database they've ever seen." Peter Norton of PC WEEK says, "The next generation of software has officially arrived." And now, with our brand-new Reflex Workshop, which includes 22 instant ways to run your business well, you can give someone both programs and just about guarantee them a Happy well-run New Year!

Turbo Lightning wins the 1986 World Class PC Award for "Most Promising Newcomer"!

Solve your gift-giving and spelling problems now with Turbo Lightning

While you use SideKick, Reflex, Lotus 1-2-3[®] and most popular programs, Turbo Lightning proofreads as you write! If you misspell a word, Turbo Lightning will beep at you instantly, and suggest a correction for the word you just misspelled. Press one key, and the misspelled word is immediately replaced by the correct word. And if you're ever stuck for a word, Turbo Lightning's thesaurus is there with instant alternatives. Perfect gift for everyone who reads and writes!

Attention SideKick users! Your SideKick now has a sidekick!

If you're going anywhere for the Holidays, you'll need a Traveling SideKick!

It's the electronic organizer for this electronic age—a professional binder, a software program and a report generator—a modern business tool that prints your ever-changing appointments in daily/weekly/monthly/yearly form. Your appointments, phone list, address list, meeting schedule, travel itinerary—even your mailing list—can be kept up-to-the-minute correct and with you! (SideKick Owners: All your files translate instantly to Traveling SideKick.) Traveling SideKick is electronic, so it's good for this year, next year and all the next years after that—it's not a dusty old diary that dies Dec. 31!

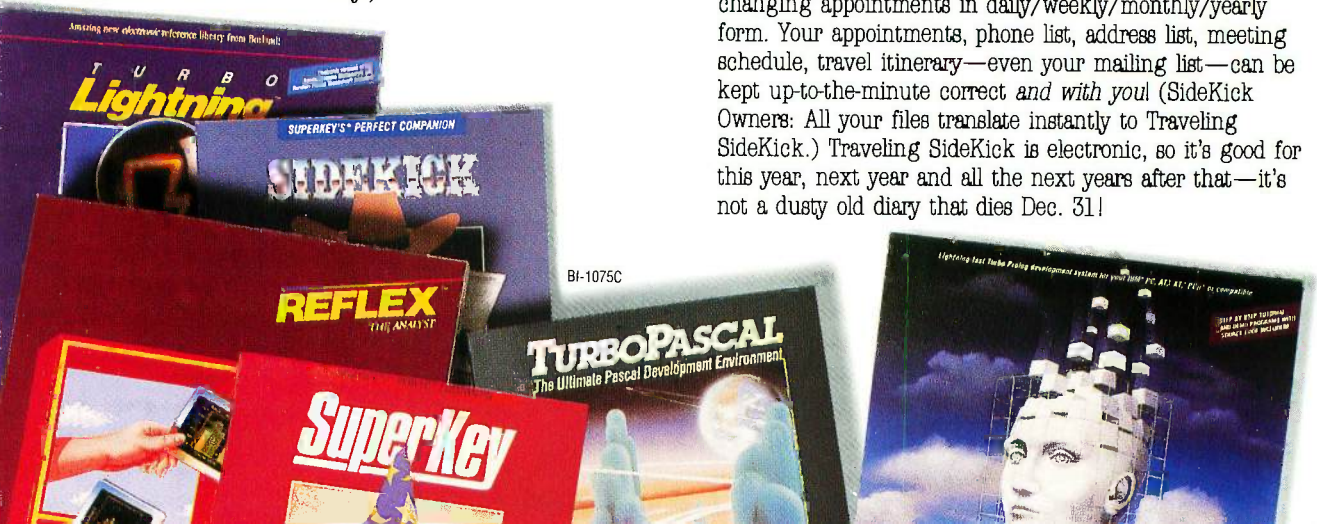

BI-1075C

Borland's Instant Winner Game

Scratch this card now and you could *instantly* win 2 free round-trip airline tickets to Australia for the America's Cup Race!



\$10,000

First Prize (\$10,000 value!) includes accommodations for two in Perth, Australia during the final America's Cup races, which start January 31, 1987. See America win it back after our *only* loss in 134 years! There's more than one *instant winner* in Borland's

Instant Winner Game, because you could win one of two new \$6,895 4-WD Suzuki Samurai convertibles,



\$6,895

printer, or a \$4,499



or a \$4,995 AST TurboLaser™

\$2,399 Toshiba T1100™

Toshiba T3100,™ or a

AST SixPakPremium™, or a \$69.95 Traveling SideKick,® or



\$4,499

any one of hundreds of other Borland products—and at



\$69.95

the very least a Borland Rebate Coupon, good for \$10 off any single product or \$15 off any bundled product offer!

See Official Rules on the back of this card for details.

Don't delay! There will be a second-chance drawing for the trip if not claimed by 12/30/86. There's also a second-chance drawing for the two Suzukis if not claimed by 2/28/87. All rebate coupons are good for products purchased 9/6/86-3/31/87. Product prices above are suggested list prices.

Rub the silver box to reveal whether you win a prize or get a rebate coupon. Then fill in the second-chance entry blank to the right.

SCRATCH 'N WIN!

Second-Chance Sweepstakes Entry!

We're running two Second-Chance Sweepstakes drawings to award the trip and cars. They *will be won* by someone—it *could be you!* Fill in the entry coupon and mail it now. Winners will be notified immediately, because the final America's Cup races start in Australia on January 31, 1987, and you'll have to pack in a hurry.

(You will need a valid passport and the ability to comprehend Australian versions of the English language.)

Name _____

Address _____

City _____

State _____ Zip _____



OFFICIAL RULES - BORLAND INSTANT WINNER GAME

1. NO PURCHASE NECESSARY: To participate, you may obtain a game card inserted into the October, November, December, or January issue of the following magazines: PC World; Byte; PC Tech Journal; PC Magazine. You may also obtain a game card by mailing a self-addressed, stamped envelope to: Borland International Game Card, P.O. Box 870, Wilton, CT 06897. (Washington State residents send self-addressed envelope.) Limit one game card per stamped request. All requests must be received by January 15, 1987.

2. TO PLAY: Remove the rub-off area on the game card to reveal what prize or rebate offer you have obtained.

3. PRIZES/ REBATES: Beneath the rub-off area one of the following prizes may be revealed: Trip for Two to America's Cup Races or \$10,000; 1986 Suzuki 4W Samurai Convertible or \$6,895; AST Turbo Laser; Toshiba 1100 Portable Computer; Toshiba 3100 Portable Computer; AST Sixpak premium; AST Advantage premium; AST 3G Pak; AST Rampage; AST Rampage AT; Free Borland Product, or you may obtain the following rebate offer: \$10 rebate offer on any individual product or \$15 rebate offer on any single advertised Borland bundle (See rule # 11 for prize details).

4. PRIZE CLAIMS: If you obtain one of the prizes stated in Rule # 3, sign your full legal signature on the game card and send via certified mail (copy should be made for your records) along with your name and address to: Borland International Prize Claim, 196 Danbury Road, Wilton, CT 06897. All prize claims must be received or postmarked by February 15, 1987. (See Rule # 12 for Trip for Two to America's Cup exception.)

5. REBATE CLAIMS: Rebates are good for products purchased from September 5, 1986 through March 31, 1987. The \$10 rebate is good for any individual Borland product and the \$15 rebate is good for any advertised Borland software bundle. To receive your rebate you must return your completed license agreement from the manual, this game card and dated proof of purchase to: Borland International, Game Card Rebate, 4585 Scotts Valley Drive, Scotts Valley, CA 95066. Upon receipt of the license agreement, game card and proof of purchase, Borland will send your check. Rebate is not valid with any other rebate or promotion offered directly from Borland.

6. VERIFICATION: All game materials are subject to verification. Game materials are void and will be rejected if not obtained through authorized, legitimate channels, and may be rejected if any part is reproduced, counterfeited, torn or altered in any way, or if materials contain printing, typographical, or mechanical errors. Decisions of the Redemption Center are final. Game pieces from any game other than the Borland Instant Winner Game may not be used in this game.

7. CONDITIONS OF PARTICIPATION: Material submitted becomes the property of Borland International. The submission of game pieces is the sole responsibility of the individual seeking verification, who is solely responsible for lost, late, or misdirected mail. All taxes, registration and inspection fees are the sole responsibility of the verified winner. Winners may be required to execute an affidavit of eligibility and name and likeness publicity release. By participating in the game you accept and agree to be bound by these rules and the decision of the Official Redemption Center which will be final.

8. ELIGIBILITY: Participation is open solely to residents of the United States 18 years of age and over, except employees and agents of Borland International, service agencies, and individuals engaged in the development, production, or distribution of game materials. The Merritt Group, Inc. and their immediate family or members of their households. Void in Vermont and where prohibited by law.

9. GAME SCHEDULE AND AWARD OF PRIZES: The Borland Instant Winner Game will commence on or about September 5, 1986 and end on January 30, 1987. It will officially end, however, when all game pieces are distributed. Verified game prizes will be awarded within thirty (30) days from the date of their receipt for verification at the Official Redemption Center. A major prize winners' list can be obtained by sending a stamped, self-addressed envelope to: Borland Instant Winner Game Winners' List, P.O. Box 7089, Wilton, CT 06897.

10. ODDS CHART: The odds of winning prizes are based upon obtaining the one rare game piece among the applicable number of game pieces.

PRIZE	Qty.	Total Value	Odds of Winning
Trip for Two to America's Cup or \$10,000	1	\$ 10,000.00	1 in 6,458,000
Suzuki 4W Samurai Convertible JA or \$6,895	2	\$ 13,790.00	1 in 3,229,000
AST Turbo Laser	1	\$ 4,995.00	1 in 6,458,000
Toshiba Portable Computer	2	\$ 6,898.00	1 in 3,229,000
AST Memory Boards	25	\$ 15,025.00	1 in 258,320
Borland Products	1,000	\$149,000.00	1 in 6,458
OVERALL TOTAL	1,031	\$199,708.00	1 in 6,264

All remaining game cards will contain a \$10 rebate good on any individual Borland product or a \$15 rebate good toward any advertised Borland software bundle.

11. PRIZE DETAILS: Trip for two to America's Cup Races (or \$10,000) will include coach seating round trip airfare on regularly scheduled commercial airline from San Francisco, California to Perth, Australia and up to two weeks hotel accommodations in Perth, Australia plus \$4,500 spending cash. Winners will be responsible for obtaining visa, passport, and all other travel documents. Trip does not include meals, taxes, excess baggage charges and other hotel charges. Minor must be accompanied by parent or legal guardian.

Suzuki 4W Samurai Convertible JA Standard Equipment Package (or \$6,895), verified winner will be responsible for all registration, insurance, and licensing fees. AST Turbo Laser; Toshiba Portable Computer Model # T1100; Toshiba Portable Computer Model # T3100; AST Memory Boards and Free Borland Products are non-substitutional except by sponsor due to product availability and all warranties and guarantees are subject to manufacturers terms. All prizes are non-transferable. Winning consumer is responsible for all local, state and federal taxes.

12. SECOND CHANCE SWEEPSTAKES: There are two Second Chance Sweepstakes drawings scheduled to be conducted on December 31, 1986 and February 28, 1987. Random drawing from all entries received by December 30, 1986 will award trip for two to America's Cup Races (or \$10,000). Random drawing from all entries received by February 26, 1987 will award two (2) Suzuki 4W Samurai (or \$6,895). All remaining prizes that are unclaimed after February 15, 1987 will remain unclaimed. Send entry to: Second Chance Entry P.O. Box 870 Wilton, CT 06897.

If you have any questions concerning the Borland Instant Winner Game, call: 1-800-451-4471.

The Worldwide Programming Standard

Turbo Pascal Programming!



\$10.00 Scratch 'n Win Rebate!

Turbo Pascal® 3.0

"For the IBM® PC, the benchmark Pascal compiler is undoubtedly Borland International's Turbo Pascal," says Gary Ray of PC Week. We and

more than 500,000 other people around the world think Mr. Ray got that right. Since launch, Turbo Pascal has become the *de facto* worldwide standard in high-speed Pascal compilers. Described by Jeff Duntemann of PC Magazine as the "Language deal of the century," Turbo Pascal is now an even better deal than that—because we've included the most popular options (BCD reals and 8087 support). What used

Turbo Pascal now includes free 8087 support and BCD!

to cost \$124.95 is now only \$99.95! You now get a lot more for a lot less: the compiler, a completely integrated programming environment, and BCD reals and 8087 support—all for a suggested retail of only \$99.95. And with a Scratch 'n Win \$10.00 Rebate, you pay only \$89.95—which really is the "language deal of the century"! Minimum memory: 128K.

\$10.00 Scratch 'n Win Rebate!

Turbo Database Toolbox™

A perfect complement to Turbo Pascal, because it contains a complete library of Pascal procedures that allows you to

search and sort data and build powerful database applications. Having Turbo Database Toolbox means you don't have to re-invent the wheel each time you write a Turbo Pascal program. It comes with source code for a free sample database—right on disk. The database can be searched by key words or numbers. Update, add, or delete records as needed. Just compile it and it's ready to go to work for you. (Shore Sails has



Build Your Own Database Applications!

more than 700 boat designs and rigs in their Database Toolbox. See front page story.) Suggested retail: \$69.95. With a \$10.00 Scratch 'n Win Rebate check back from us, only \$59.95! Minimum memory: 128K.



SPECIAL PRICES! AMAZING VALUE! ACT NOW!



It's the Works! Everything! The whole electronic enchilada! It's the Jumbo Pack... Turbo Pascal 3.0, Turbo Tutor 2.0, Turbo Editor, Turbo GameWorks, Turbo Graphix and Turbo Database. All 6 Turbo Pascal programs for only \$299.95—or only \$284.95 with a \$15.00 Scratch 'n Win Rebate! That's about \$47.00 each and that's a deal!

Save a bundle! on our bundles!

SideKick and Traveling SideKick for only \$125.00 but only \$110.00 after a \$15.00 Scratch 'n Win Rebate!



Reflex: The Analyst and the new Reflex Workshop for only \$199.95! And a \$15.00 Scratch 'n Win Rebate cuts that down to only \$184.95!



\$15.00 Scratch 'n Win Rebate on all Xmas packs!



Turbo Lightning and Lightning Word Wizard for only \$149.95! and an amazing \$134.95 after a \$15.00 Scratch 'n Win Rebate!

YES!

I want the best!

For credit card orders or the dealer nearest you
call (800) 255-8008
in CA call (800) 742-1133
in Canada call (800) 237-1136

Copies	Product	Price	Totals
—	Turbo Pascal 3.0 w/8087 & BCD	\$99.95	\$ _____
—	Turbo Pascal for CP/M-80	69.95	\$ _____
—	Turbo Pascal & Turbo Tutor	125.00	\$ _____
—	Reflex: The Analyst	149.95*	\$ _____
—	Reflex Workshop	69.95*	\$ _____
—	Reflex & Reflex Workshop	199.95*	\$ _____
—	Turbo Prolog	99.95	\$ _____
—	Turbo Database Toolbox	69.95	\$ _____
—	Turbo Graphix Toolbox	69.95	\$ _____
—	Turbo Tutor 2.0	39.95	\$ _____
—	Turbo Editor Toolbox	69.95	\$ _____
—	Turbo GameWorks	69.95	\$ _____
—	Turbo Lightning	99.95	\$ _____
—	Lightning Word Wizard	69.95	\$ _____
—	Turbo Lightning & Lightning Word Wizard	149.95	\$ _____
—	SideKick	84.95	\$ _____
—	Traveling SideKick	69.95*	\$ _____
—	SideKick & Traveling SideKick	125.00*	\$ _____
—	SuperKey	69.95	\$ _____
—	Turbo Jumbo Pack	299.95	\$ _____
—	Outside USA add \$10 per copy CA and MA res. add sales tax		\$ _____
—	Amount enclosed		\$ _____

Prices include shipping to all US cities.
Carefully describe your computer system:
Mine is: 8-bit 16-bit
I use: PC-DOS CP/M-80
 MS-DOS CP/M-86
My computer's name and model is: _____

The disk size I use is: 3 1/2" 5 1/4" 8"
Payment: VISA MC Money order Check
Credit card expiration date ____/____
Card # _____

Name: _____
Shipping Address: _____
City: _____
State: _____ Zip: _____
Telephone: _____

CGDs and purchase orders WILL NOT be accepted by Borland. Outside USA make payment by bank draft, payable in US dollars drawn on a US bank. **GF15**

NOT COPY PROTECTED 60-DAY MONEY-BACK GUARANTEE
If within 60 days of purchase you find that this product does not perform in accordance with our claims, call our customer service department and we will gladly arrange a refund.
All prices are suggested list prices and are subject to change without notice.



Vive la différence

4585 SCOTTS VALLEY DRIVE
SCOTTS VALLEY, CA 95066
(408) 438-8400 TELEX: 172373

For Canadian credit card orders or the Canadian dealer nearest you, call (800) 237-1136

NEW!

Inquiry 54 for End-Users. Inquiry 55 for DEALERS ONLY.



C·O·N·T·E·N·T·S



84



158

FEATURES

- INTRODUCTION** 84
- CIARCIA'S CIRCUIT CELLAR: BUILD THE GT180 COLOR GRAPHICS BOARD, PART 2: HARDWARE** *by Steve Ciarcia* 87
Steve provides a description of the major VLSI components and includes the hardware schematic.
- PROGRAMMING PROJECT: USING DOS FUNCTIONS FROM TURBO PASCAL** *by Douglas F. Yriart* 102
You may never need to write another line of assembly language code.
- PROGRAMMING INSIGHT: A PROGRAM FOR APPROXIMATING INTEGRALS** *by David M. Smith* 113
By using Aitken extrapolation, you can approximate integrals with increased precision.
- DEBUGGING MACINTOSH APPLICATIONS** *by Joel West* 127
The standard principles of debugging apply, but the Mac's toolbox routines present some unique problems.
- LOCAL EFFECTS OF NUCLEAR WEAPONS** *by John R. Fanchi* 143
Two programs calculate the effects of an atomic blast on your surroundings.

THEME: GRAPHICS ALGORITHMS

- INTRODUCTION** 158
- HENON MAPPING WITH PASCAL** *by Gordon Hughes* 161
Use iterative simulations to study the behavior of physical systems.
- ABSTRACT MATHEMATICAL ART** *by Kenneth E. Perry* 181
The author's BASIC program explains how to find the hidden structures known as "one-dimensional cellular automata."
- THE TMS34010 GRAPHICS SYSTEM PROCESSOR** *by Carrell R. Killebrew Jr.* 193
A bit-addressable graphics engine with an on-chip instruction cache.
- PLOTTING THE MANDELBROT SET** *by Peter B. Schroeder* 207
Fractals used for modeling can create intriguing displays.
- GRAPHING QUADRIC SURFACES** *by George Haroney* 215
Some techniques that allow you to simulate 3-D graphics in color.
- FREE-FORM CURVES ON YOUR MICRO** *by Steve Enns* 225
Implement Bézier and B-spline curves for interactive graphics.

REVIEWS

- INTRODUCTION** 234
- REVIEWER'S NOTEBOOK** *by Jon Edwards* 237
- FOUR IBM PC AT CLONES** *by Wayne Rash Jr.* 239
Offerings from Epson, Western, and Zenith.
- THE HERCULES GRAPHICS CARD PLUS** *by Rich Malloy* 249
An inexpensive general-purpose display card for the IBM PC.

BYTE (ISSN 0360-5280) is published monthly with one extra issue per year by McGraw-Hill Inc. Founder: James H. McGraw (1860-1948). Executive, editorial, circulation, and advertising offices: One Phoenix Mill Lane, Peterborough, NH 03458, phone (603) 924-9281. Office hours: Monday through Thursday 8:30 AM - 4:30 PM, Friday 8:30 AM - 1:00 PM, Eastern Time. Address subscriptions to BYTE Subscriptions, P.O. Box 590, Martinsville, NJ 08836. Postmaster: send address changes, USPS Form 3579, undeliverable copies, and fulfillment questions to BYTE Subscriptions, P.O. Box 596, Martinsville, NJ 08836. Second-class postage paid at Peterborough, NH 03458 and additional mailing offices. Postage paid at Winnipeg, Manitoba. Registration number 9321. Subscriptions are \$21 for one year, \$38 for two years, and \$55 for three years in the U.S. and its possessions. In Canada and Mexico, \$23 for one year, \$42 for two years, \$61 for three years. \$69 for one year air delivery to Europe, 31,000 yen for one year air delivery to Japan, 15,600 yen for one year surface delivery to Japan, \$37 surface delivery elsewhere. Air delivery to selected areas at additional rates upon request. Single copy price is \$3.50 in the U.S. and its possessions, \$4.25 in Canada and Mexico, \$4.30 in Europe, and \$5 elsewhere. Foreign subscriptions and sales should be remitted in U.S. funds drawn on a U.S. bank. Please allow six to eight weeks for delivery of first issue. Printed in the United States of America.

BYTE December

VOLUME 11, NUMBER 13, 1986

23 MODEMS by Stephen Satchell	255
An evaluation of devices from several companies and their ability to handle impairments.	
PASCAL FOR THE IBM PC by Namir Clement Shammas	265
Four compilers with various features.	
STELLA by Stephen B. Robinson	277
Modeling and simulation software for the Macintosh.	
FLASH-COM by Brock N. Meeks	281
Electronic mail and communications software.	
REVIEW FEEDBACK	285
Readers respond to previous reviews.	

KERNEL

INTRODUCTION	288
COMPUTING AT CHAOS MANOR: THE FINAL FRONTIER by Jerry Pournelle	291
Jerry uses BIX to help plan an academy for space cadets.	
ACCORDING TO WEBSTER: SEASON'S GREETINGS by Bruce Webster	305
Bruce's particular focus this month is the Amiga.	
APPLICATIONS ONLY: STOCKING STUFFERS by Ezra Shapiro	321
A collection of programs that would make terrific gifts.	
BYTE U.K.: THE U-MAN POTENTIAL by Dick Pountain	329
Dick looks at a computer for scientific users and a molecular modeling system.	

BEST OF BIX

AMIGA	349	MACINTOSH/APPLE II	370
ATARI	356	APPLE IIGS	376
IBM PC AND COMPATIBLES	362	GRAPHICS	385

DEPARTMENTS

EDITORIAL:		CIRCUIT CELLAR FEEDBACK	58
BYTE GETS FASTER	6	BOOK REVIEWS	65
MICROBYTES	9	EVENTS AND CLUBS	81
LETTERS	16	CHAOS MANOR MAIL	337
WHAT'S NEW	29	BOMB RESULTS	437
ASK BYTE	52	READER SERVICE	439

LISTINGS	
FROM BIX	320
FROM BYTENET .(617) 861-9764	
ON DISK	see card after 320
IN PRINT	see card after 320



234



288

Address editorial correspondence to: Editor, BYTE, One Phoenix Mill Lane, Peterborough, NH 03458. Unacceptable manuscripts will be returned if accompanied by sufficient postage. Not responsible for lost manuscripts or photos. Opinions expressed by the authors are not necessarily those of BYTE.
 Copyright © 1986 by McGraw-Hill Inc. All rights reserved. Trademark registered in the United States Patent and Trademark Office. Where necessary, permission is granted by the copyright owner for libraries and others registered with the Copyright Clearance Center (CCC) to photocopy any article herein for the flat fee of \$1.50 per copy of the article or any part thereof. Correspondence and payment should be sent directly to the CCC, 29 Congress St., Salem, MA 01970. Specify ISSN 0360-5280/83. \$1.50. Copying done for other than personal or internal reference use without the permission of McGraw-Hill Inc. is prohibited. Requests for special permission or bulk orders should be addressed to the publisher. BYTE is available in microform from University Microfilms International, 300 North Zeeb Rd., Dept. PR, Ann Arbor, MI 48106 or 18 Bedford Row, Dept. PR, London WC1R 4EJ, England.
 Subscription questions or problems should be addressed to: BYTE Subscriber Service, P.O. Box 328, Hancock, NH 03449



BYTE

SENIOR VICE PRESIDENT/PUBLISHER

HARRY L. BROWN
EDITOR IN CHIEF
PHILIP LEMMONS

BIX

MANAGING EDITOR, BYTE
FREDERIC S. LANGA

EXECUTIVE EDITOR, BIX
GEORGE BOND

ASSISTANT MANAGING EDITOR

GLENN HARTWIG

CONSULTING EDITORS

STEVE CIARCIA
JERRY POURNELLE
EZRA SHAPIRO
BRUCE WEBSTER

SENIOR TECHNICAL EDITORS

JON R. EDWARDS, *Reviews*
G. MICHAEL VOSE, *Themes*
GREGG WILLIAMS, *Features*

TECHNICAL EDITORS

DENNIS ALLEN
RICHARD GREHAN
KEN SHELDON
GEORGE A. STEWART
JANE MORRILL TAZELAAR
TOM THOMPSON
CHARLES D. WESTON
EVA WHITE

STANLEY WSZOLA

ASSOCIATE TECHNICAL EDITORS

CURTIS FRANKLIN JR., *Best of BIX*
MARGARET COOK GURNEY, *Book Reviews*
BRENDA McLAUGHLIN, *Applications Software Reviews*,
San Francisco

COPY EDITORS

BUD SADLER, *Chief*
JEFF EDMONDS
FAITH HANSON
NANCY HAYES
CATHY KINGERY
PAULA NOONAN
WARREN WILLIAMSON
JUDY WINKLER

ASSISTANTS

PEGGY DUNHAM, *Office Manager*
MARTHA HICKS
L. RYAN McCOMBS
JUNE N. SHELDON

NEWS AND TECHNOLOGY

GENE SMARTE, *Bureau Chief, Costa Mesa*
JONATHAN ERICKSON, *Senior Technical Editor, San Francisco*
RICH MALLOY, *Senior Technical Editor, New York*
CINDY KIDDOO, *Editorial Assistant, San Francisco*

ASSOCIATE NEWS EDITORS

DENNIS BARKER, *Microbytes*
CATHRYN BASKIN, *What's New*
ANNE FISCHER LENT, *What's New*

CONTRIBUTING EDITORS

JONATHAN AMSTERDAM, *programming projects*
MARK DAHMKE, *video, operating systems*
MARK HAAS, *at large*
RIK JADRNICKEK, *CAD, graphics, spreadsheets*
ROBERT T. KUROSAKA, *mathematical recreations*
PHIL LOPICCOLO, *computers in medicine*
ALASTAIR J. W. MAYER, *software*
ALAN R. MILLER, *languages and engineering*
DICK POUNTAIN, *U.K.*
ROGER POWELL, *computers and music*
PHILLIP ROBINSON, *semiconductors*

ART

NANCY RICE, *Art Director*
JOSEPH A. GALLAGHER, *Assistant Art Director*
JAN MULLER, *Art Assistant*
ALAN EASTON, *Drafting*

PRODUCTION

DAVID R. ANDERSON, *Production Director*
DENISE CHARTRAND
MICHAEL J. LONSKY
VIRGINIA REARDON

TYPOGRAPHY

SHERRY MCCARTHY, *Chief Typographer*
LEN LORETTE
DONNA SWEENEY

PLANNING AND PUBLIC RELATIONS (603-924-7255)

MICHELE PERRON, *Director*
FAITH KLUNTZ, *Copyrights Coordinator*

FINANCIAL SERVICES

PHILIP L. PENNY, *Director of Finance and Services*
KENNETH A. KING, *Business Director*
CHRISTINE LEE, *Assistant*
VICKI WESTON, *Accounting Manager*
LINDA SHORT, *D/P Manager*
MARILYN HAIGH
DIANE HENRY
VERN ROCKWELL
LISA TEATES
JOANN WALTER

PUBLISHER'S ASSISTANT

BEVERLY JACKSON

SENIOR EDITOR

DAVID BETZ

ASSOCIATE EDITORS

TONY LOCKWOOD
DONNA OSGOOD, *San Francisco*
MICROBYTES DAILY
DENNIS BARKER, *Coordinator, Peterborough*
GENE SMARTE, *Bureau Chief, Costa Mesa*
CATHRYN BASKIN, *Peterborough*
RICK COOK, *Phoenix*

JONATHAN ERICKSON, *San Francisco*

MARTHA HICKS, *Peterborough*

CINDY KIDDOO, *San Francisco*

ANNE FISCHER LENT, *Peterborough*

RICH MALLOY, *New York*

STAN MIASKOWSKI, *Peterborough*

LYNNE NADEAU, *Peterborough*

DAVID NEEDLE, *San Francisco*

WAYNE RASH, *Washington, DC*

LAMONT WOOD, *San Antonio*

GROUP MODERATORS

DAVID ALLEN, *Applications*
FRANK BOOSMAN, *Artificial Intelligence*
LEROY CASTERLINE, *Other*
MARC GREENFIELD, *Programming Languages*
JIM HOWARD, *Graphics*
GARY KENDALL, *Operating Systems*
STEVE KRENEK, *Computers*
BROCK MEEKS, *Telecommunications*
BARRY NANCE, *New Technology*
DONALD OSGOOD, *Computers*
SUE ROSENBERG, *Other*
JON SWANSON, *Ctips*

BUSINESS AND MARKETING

DOUG WEBSTER, *Director (603-924-9027)*
PATRICIA BAUSUM, *Secretary*
DENISE A. GREENE, *Customer Service*
BRIAN WARNOCK, *Customer Service*
TAMMY BURGESS, *Customer Credit and Billing*
TECHNOLOGY
CLAYTON LISLE, *Director, Business Systems Technology, MHIS*
BILL GARRISON, *Business Systems Analyst*
JACK REILLY, *Business Systems Analyst*
LINDA WOLFF, *Senior Business Systems Analyst*

ADVERTISING SALES

DENNIS J. RILEY, *Director of Sales and Marketing*
SANDRA FOSTER, *Administrative Assistant*

ADVERTISING/PRODUCTION (603-924-6448)

LISA WOZMAK, *Supervisor*
LYDA CLARK, *Senior Account Coordinator*
MARION CARLSON
VIRGINIA CARPENTER
KAREN CILLEY
BRIAN HIGGINS
WAI CHIU LI, *Quality Control Manager*
JULIE MURPHREE, *Advertising/Production Coordinator*

MARKETING COMMUNICATIONS

HORACE T. HOWLAND, *Director (603-924-3424)*
VICKI REYNOLDS, *Promotion Manager*
LISA JO STEINER, *Marketing Assistant*
STEPHANIE WARNESKY, *Marketing Art Director*
SHARON PRICE, *Associate Art Director*
WILBUR S. WATSON, *Operations Manager, Exhibits*

RESEARCH

JULIE PERRON, *Market Research Analyst*
CYNTHIA DAMATO SANDS, *Reader Service Coordinator*

CIRCULATION (800-258-5485)

LAURIE SEAMANS, *Assistant Manager*
SUSAN BOYD
LOUISE MENEGUS
AGNES E. PERRY
JENNIFER PRICE
JAMES BINGHAM, *Single-Copy Sales Manager*
CATHY A. RUTHERFORD, *Assistant Manager*
CLAUDETTE CARSWELL
KAREN DESROCHES

PERSONNEL

CHERYL HURD, *Office Manager*
PATRICIA BURKE, *Personnel Coordinator*

BUILDING SERVICES/TRAFFIC

ANTHONY BENNETT, *Building Services Manager*
MARK MONKTON

RECEPTIONIST

DONNA HEALY

 Officers of McGraw-Hill Information Systems Company: President: Richard B. Miller. Executive Vice Presidents: Frederick P. Jannott, Construction Information Group; Russell C. White, Computers and Communications Information Group; J. Thomas Ryan, Marketing and International. Senior Vice Presidents: Francis A. Shinal, Controller; Robert C. Violette, Manufacturing and Technology. Senior Vice Presidents and Publishers: Laurence Altman, Electronics Week; Harry L. Brown, BYTE; David J. McGrath, Construction Publications. Group Vice President: Peter B. McCuen, Communications Information. Vice President: Fred O. Jensen, Planning and Development.

Officers of McGraw-Hill, Inc.: Harold W. McGraw, Jr., Chairman; Joseph L. Dionne, President and Chief Executive Officer; Robert N. Landes, Executive Vice President and Secretary; Walter D. Serwatka, Executive Vice President and Chief Financial Officer; Shel F. Asen, Senior Vice President, Manufacturing; Robert I. Bahash, Senior Vice President, Finance and Manufacturing; Ralph R. Schulz, Senior Vice President, Editorial; George R. Elsinger, Vice President, Circulation; Ralph J. Webb, Vice President and Treasurer.

BYTE, **BYTE**, and The Small Systems Journal are registered trademarks of McGraw-Hill Inc.

EDITORIAL AND BUSINESS OFFICE: One Phoenix Mill Lane, Peterborough, New Hampshire 03458, (603) 924-9281.

West Coast Offices: 425 Battery St., San Francisco, CA 94111, (415) 954-9718; 3001 Red Hill Ave., Building #1, Suite 222, Costa Mesa, CA 92626, (714) 557-6292. **New York Editorial Office:** 1221 Avenue of the Americas, New York, NY 10020, (212) 512-2000.

BYTEnet: (617) 861-9764 (set modem at 8-I-N or 7-I-E; 300 or 1200 baud).

HiWIRE™ Starts the Job that smARTWORK® Finishes

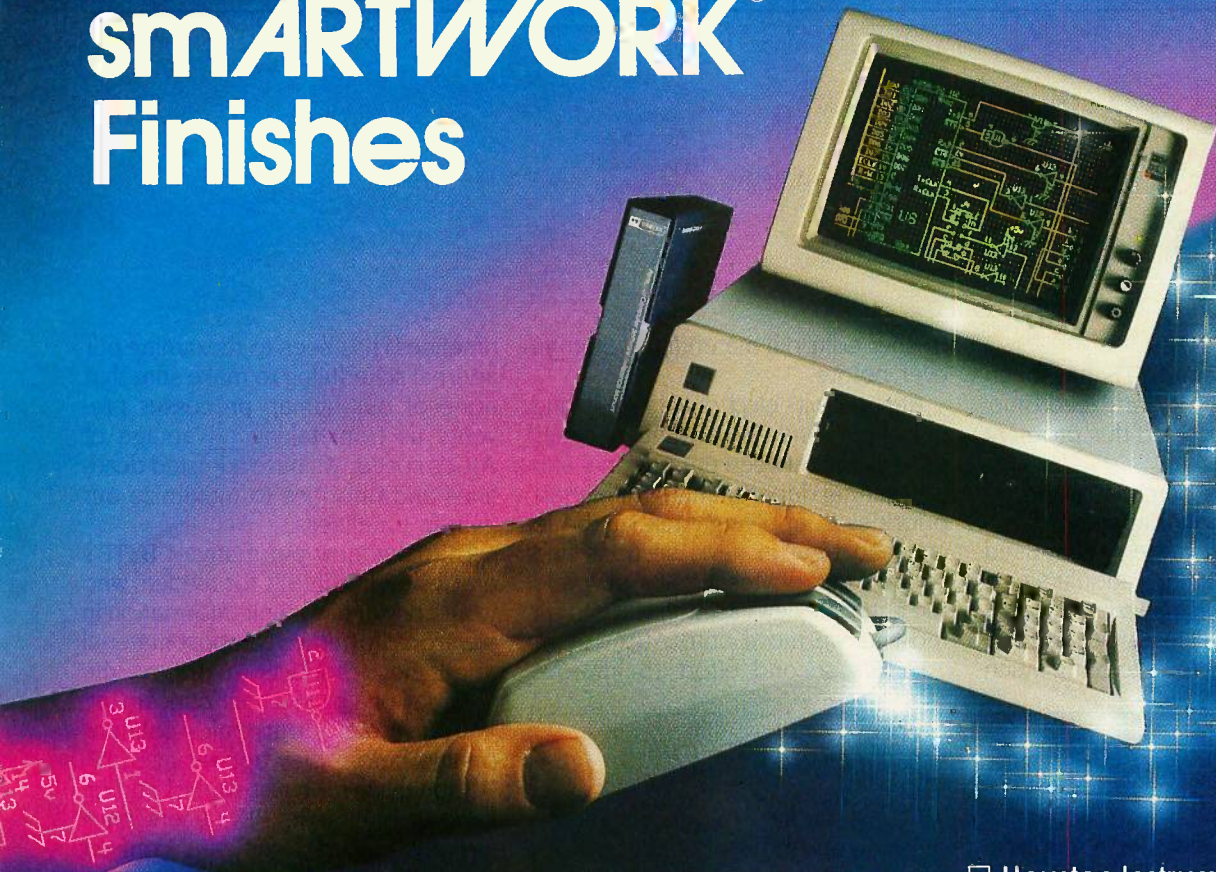

Introducing HiWIRE™

Wintek's smARTWORK® is used by thousands of engineers to design printed-circuit boards. Now Wintek introduces HiWIRE, an electronic-schematic program that is easy to learn and use.

With a click of the mouse button, you can extract symbols from our library of over 700 common components and connect them with wires and buses. You can also easily modify the library's symbols or create your own by combining labels, lines, and arcs.

HiWIRE Advantages

- Easy-to-learn mouse/menu-driven operation
- Complete documentation and tutorial
- Extensive TTL, CMOS, micro-processor, and discrete-component libraries
- Rubberbanding

- Moving, copying, mirroring, and rotating of symbols
- Text-string searching
- Multiple display windows
- High-quality schematics from printers and plotters
- Hierarchical-design support; netlist and bill-of-materials utilities
- Schematic/layout cross checking
- 800 number for free technical support

System Requirements

- IBM Personal Computer, PC XT, or PC AT with 320K RAM, parallel printer port, 2 disk drives, and DOS V2.0 or later
- IBM Color/Graphics Adapter or EGA with RGB color monitor
- Microsoft Mouse
- IBM Graphics Printer or Epson FX/MX/RX-series dot-matrix printer, and/or:

- Houston Instrument DMP-40, 41, 42, 51, 52 or Hewlett-Packard 7470, 7475, 7550, 7580, 7585, 7586 plotter

High Performance at Low Cost

At \$895, HiWIRE delivers quality schematics quickly and easily. You don't need to guess whether or not HiWIRE is right for you. Our money-back guarantee lets you try it for 30 days at absolutely no risk. Call (800) 742-6809 toll free today and put HiWIRE to work tomorrow.

Wintek Corporation
1801 South Street
Lafayette, IN 47904-2993
Telephone: (800) 742-6809
or in Indiana (317) 742-8428
Telex: 70-9079 WINTEK CORP UD



"HiWIRE" is a trademark, and "smARTWORK", "Wintek", and the Wintek logo are registered trademarks of Wintek Corporation.

BYTE GETS FASTER

Through the years, BYTE has been justly criticized for its long lead time. We have now corrected this problem in four ways.

First, BYTE has purchased and installed an Atex editorial and production system. Atex is the system used by most of the major national weeklies, including *BusinessWeek*, *Newsweek*, and *Time*. BYTE will remain a monthly, but Atex will enable us to bring much

fresher editorial material to you than ever before.

Atex permits electronic makeup and copy-fitting and saves countless cycles of revision between the editorial and typesetting departments. Our highest priorities in applying Atex will be to cut lead time in news sections and reviews. Microbytes, What's New, and the entire Reviews section will benefit most as we move onto Atex.

BYTE's second effort to improve

timeliness has been to reexamine our internal scheduling to make sure that none of our human processes prevents us from taking advantage of Atex's speed. We have adjusted deadlines and priorities to maximize our gain in timeliness.

Third, we now put many of BYTE's articles on-line in BIX for readers who would rather have their information in electronic form. We can post material about new products in BIX on the very day of a product announcement. We put most of our major columns on-line before they appear in BYTE. Although we have just started putting reviews on-line in BIX, users have already logged significant connect time in the BYTE reviews conference.

Our fourth means of improving timeliness is the news service available on-line in BIX. Since I have previously described this service, I will be brief in describing it here. It has three main components now: microbytes, microbytes.hw, and microbytes.sw. The latter two sections consist of hardware and software product announcements, respectively. The "microbytes" section contains news of technological developments as well as preannouncement and other very early product news.

Our new editorial and production system will let us make BYTE as timely as any monthly. Our on-line publications make us more timely than any weekly. But this new emphasis on timeliness will in no way diminish BYTE's efforts to cover computers and related topics comprehensively and in depth. We will continue to publish our traditional generous selection of in-depth technical articles in our Theme and Features sections. By adding timeliness to comprehensiveness and depth, we hope to do a better job of meeting your needs.

—Phil Lemmons
Editor in Chief

BIX HAPPENINGS FOR DECEMBER

The end of the year is becoming a busy time for the BYTE Information Exchange, with a number of special events and conferences underway or soon to begin.

Conferences concerning the Intel 80386 are ongoing. Visiting experts from Phoenix, AT&T, Softguard, Phar Lap, and other software vendors are joining the BIX regulars in the systems software conference (os386), and early users of 80386 systems are sharing their experiences in the user386 conference.

The issue of benchmarks for graphics boards and processors is being addressed with a conference event in the grafic.pgms conference. Visiting experts from chip and board manufacturers, together with programmers and users on BIX, are trying to reach a consensus on two issues: important criteria for graphics benchmarks and nonpreferential methods of testing.

A new conference on software publishing has begun, focusing on the marketing, financial, and legal aspects of the computer software business. BIX subscribers who write and/or publish their own soft-

ware are sharing expertise and addressing questions of common interest in this new forum.

Conference events scheduled to begin in December include an event for owners and users of Hewlett-Packard computers, from the Integral to the HP 3000, focusing on successful integrated systems implementations; a discussion of the ISO seven-layer OSI communications protocol, with an emphasis on its practical implications for those working in microcomputer data communications; a special event on UNIX as a microcomputer operating system; and a look at central file servers and remote file systems in local area networking.

Finally, selected BYTE reviews of hardware and software are available on-line in the byte.reviews conference on BIX. These include the earliest possible looks at reviews to be published in BYTE as well as special reviews selected for publication only on BIX.

Check the system.news conference for exact starting dates and details of these events and information on other upcoming specials.

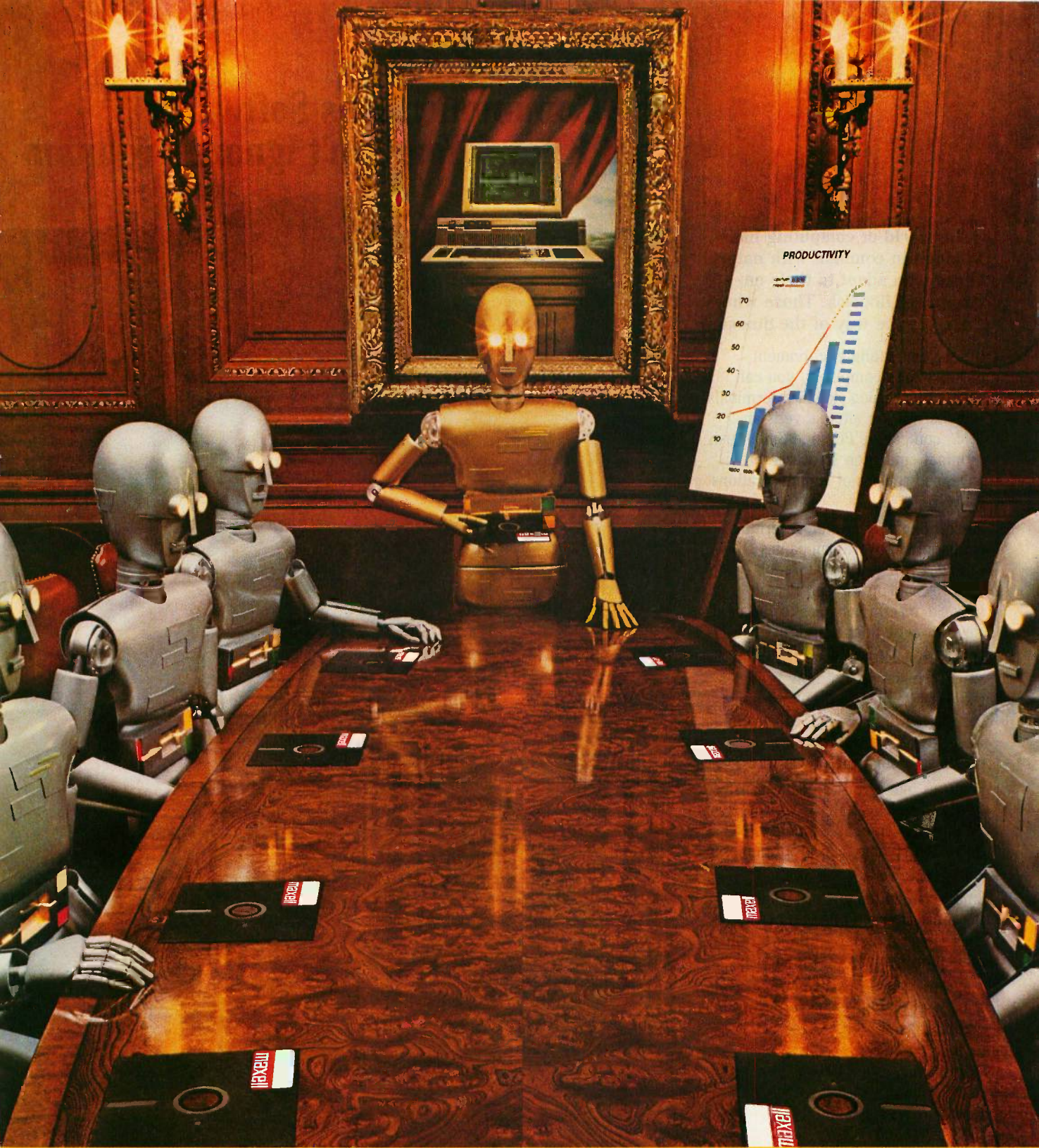

When computers get down to business, they move up to Maxell.

Maxell was first to provide you with a 5¼" high density floppy disk. Just another example of how we keep you a step ahead.



maxell
THE GOLD STANDARD

smarterm®

The Communications Software That Knows You Can't Ignore Evolution

The world of computing has much in common with nature: Those who adapt to their environment flourish. Those who can't—go the way of the dinosaur.

If your computing environment includes mini computers, you can access them using standard terminals. But the smarter alternative is an IBM* compatible PC* and SmarTerm terminal emulation software—an advanced species of communications software.

Persoft began where most terminal emulation software companies strive to end—with exact, feature-for-feature emulation. Then Persoft took SmarTerm software to the next stage of evolution: superiority.

SmarTerm 240, the latest in the SmarTerm series, not only provides the ReGIS* and Tektronix* graphics capabilities of a DEC* VT240* terminal, but adds capabilities that are only possible through the power of a PC.

Features like error-free data transfer (using Kermit or XMODEM protocols), on-line help screens, remappable keyboard layouts, and programmable softkeys.

SmarTerm 240 is just one example of the most advanced line-up of DEC, Data General and Tektronix terminal emulation software in the industry.

Make the "natural selection." Ask your local dealer about SmarTerm terminal emulation software. Or contact:

Persoft, Inc.
465 Science Drive
Madison, WI U.S.A. 53711
(608) 273-6000
Telex 759491

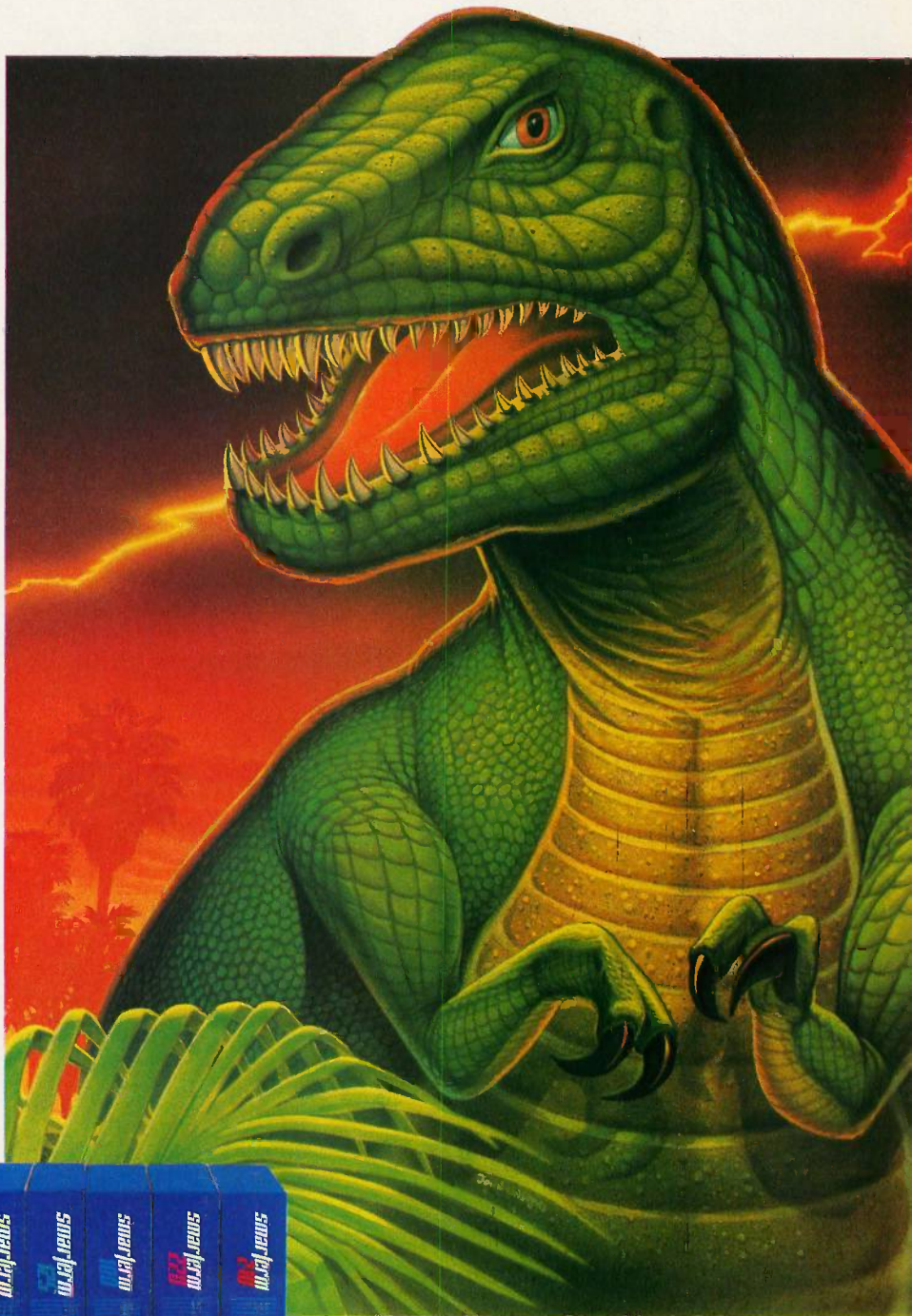

persoft

Inquiry 271

**SmarTerm Terminal Emulation Software
... The Natural Selection**

GTE Develops High-Speed GaAs Multiplexer Combining Four Data Channels

In an effort to achieve data communication rates of several gigabits per second, GTE Labs (Waltham, MA) is combining the high capacity of fiber optics with the high speed of gallium arsenide circuits. The research arm of GTE has designed a GaAs multiplexer that can combine four data channels, each with a communication rate of 1 gigabit per second, into one channel. GTE has also recently developed a technique called MOVPE (metal-organic vapor-phase epitaxy) for efficiently growing thin-film GaAs crystals.

The new devices should play an important role in future communication systems, which will involve high-capacity fiber-optic cables connecting houses and offices through telephone switching centers. Data rates on these cables could be as high as 20 gigabits per second. In addition to standard computer data, numerous video channels could be supported, each with a data rate of almost 100 megabits per second. The GaAs multiplexers will probably be the only devices fast enough to interface houses and offices with this fiber-optic grid.

In future supercomputers, these multiplexers will also be used for high-speed fiber-optic transmissions between various boards in the computer, replacing copper wires. Because of the high-speed nature of the fiber-optic link, such techniques may even be used for chip-to-chip communication.

GTE said it has completed a prototype of the GaAs multiplexer and a final version should be ready in less than a year.

Use of Surface-Mounted Technology Growing: Expected to Be Seen in Half of All Components Soon

If any single theme was repeated at the IEEE International Electronic Manufacturing Technology Symposium, it was expressed succinctly by a speaker who said that "surface-mounted technology is going to be the way of doing business in the U.S."

Surface-mounted technology (SMT), or the attachment of electronic components and circuits to the face of a circuit board instead of connecting circuitry layers and components via holes drilled through the board, is one of the strongest trends in electronic packaging. SMT offers manufacturers two distinct advantages over conventional through-hole (TH) technology: Circuits can be built on both sides of the board, and SMT is ideal for automated assembly, thereby reducing costs and improving efficiency and quality.

Virtually every manufacturer at the symposium, including Intel, Texas Instruments, Hewlett-Packard, IBM (which uses SMT in its PC Convertible), Fujitsu, NEC, and Motorola, indicated that they are currently manufacturing products using high-density SMT processes. Estimates are that 20 percent of all electronic components now being made are surface-mounted and that within two years it will be 50 percent.

Many manufacturing engineers still express concern about some problems, particularly those that deal with thermal expansion and inspection.

"Charge Ratio" Could Be Alternative to Electromagnetic Technology in Graphics Tablets

Summagraphics (Fairfield, CT) has developed a graphics tablet technology that uses ratios of sensed areas to generate the coordinates of the stylus or cursor position. The company says that because its technique uses ratios instead of absolute signal values, variations caused by distance or dielectric constant changes between the electrode surface and the stylus don't affect tablet operation.

(continued)

The "charge ratio" tablet has three main elements: an electrode, or digitizing surface; an anode, or transducer (the stylus or cursor); and the processing electronics. The digitizing surface consists of a pattern of three differently shaped electrodes: wedges, stripes, and the area not covered by those electrodes. Summagraphics says its three-electrode approach results in stable and accurate coordinate output over the tablet's active area and eliminates problems caused by environmental noise.

The 12- by 12-inch tablet is currently undergoing tests by "major OEMs" in the CAD/CAM and workstation markets, according to a spokesperson. Look for a final product next year.

Perpendicular Technique Puts 100 Megabytes on 5¼-inch Disk

Maxell (Moonachie, NJ) has developed a disk it says can handle 100 megabytes of storage using a perpendicular recording technique. The new disk provides more magnetic surface than conventional media by standing the magnetic particles so they're perpendicular to the substrate plane instead of putting them flat on the surface. The disks have a recording density of 100 kilobits per inch, the company said.

The 5¼-inch disks won't work in current drives but, according to a spokesperson for the company, current drives can be retrofitted to handle the 100-megabyte disks. Hitachi Ltd. has designed drives for the new disks; those drives are now in prototype form. The drives will show up in machines next year, the spokesperson said.

Researchers Claim Working Part-Time at a VDT Poses No Threat to Pregnancy

Two researchers have concluded that pregnant women who work at VDTs less than 20 hours a week don't appear to be at higher-than-normal risk of having a miscarriage. However, they cautioned that more study is needed to determine if women who work at VDTs more than 20 hours a week run a higher risk.

According to William Butler at the University of Michigan, who teamed with colleague Kelley Ann Brix to study the 817 pregnancies of 728 women, "Pregnant women who worked 1 to 20 hours a week at VDTs had the same miscarriage rates as women who did not work at the machines." Of 697 pregnancies among women working 1 to 20 hours a week at a VDT, there were 145 miscarriages, which Butler and Brix said were about as many as expected. But of the 120 pregnancies reported by a group working more than 20 hours a week, 26 ended in miscarriage, "about four more" than expected.

The study was funded by the March of Dimes, which is still examining possible effects of VDTs on birth defects. Brix said more work is needed to find out if using a VDT full-time is hazardous to pregnant women. The National Institute for Occupational Safety and Health is conducting a study that will focus only on full-time VDT workers.

At "32-Bit Shootout," Speakers Take Shots at DOS, Benchmarks

Besides Motorola's new 68030, NEC's new V60/V70 chips, and everyone picking on Intel's 80386, three topics dominated the one-day symposium billed as "The 32-Bit Shootout": the future of MS-DOS in the 32-bit world, the value of benchmark results, and compilers.

From Intel's perspective, compatibility with existing 8086-family software will be the driving force in establishing the 386 as the leading 32-bit CPU in the microcomputer market. As one speaker said, "Six million PCs are the lowest common denominator and software will continue to be written for them." Motorola's Jeff Nutt countered by stating that the influence of MS-DOS will lessen and UNIX will gain prominence. However, he also said that the 68020 will eventually run DOS 5.0.

Of the six chip makers participating, only Motorola refused to release benchmark statistics. "We'll run whatever applications our customer base wants and give them the results," Nutt explained. Manufacturers and panelists agreed that benchmarks aren't meaningful to the user unless they are uniform and repeatable; instead, what is really needed is a series of market-specific evaluations, and the buyer had better run those tests. Just about everyone agreed that "benchmarks don't lie, but liars do benchmarking." George Morrow, former chairman of Morrow Designs, concluded that "magazines that support the industry should act as watchdogs" and do benchmarking for their readers.

(continued)

We invented the modem that makes fewer demands on your PC.

The Ven-Tel Half Card™ modem. All the power and speed of our regular modems, but with some major advantages for people who demand versatility from their PC.

Regular modems plug into one of your computer's full-size slots. Just like expansion boards—color boards, graphics cards and memory expanders.

The Ven-Tel Half Card modem is different. It plugs into a short slot, freeing up a long slot so your PC can handle an additional function. And while other modems have about 300 components, ours has 70.

So it not only demands less space from your computer—it also demands less power and generates less heat. Your PC stays cool and stress-free.

Competitively priced, the Half Card modem is available in both 1200 baud and 2400 baud speeds. And it's backed by Ven-Tel's free *five-year* warranty. No other major manufacturer even comes close.

If you make a lot of demands on your PC... demand the less-demanding modem: The Ven-Tel PC Modem Half Card.

Ven-Tel
Modems

Our free 24-page booklet, "How To Select The Correct Modem," contains specific information about our full line of modems. To request your copy, call 800-538-5121. In California, call 408-727-5721.
Inquiry 372

Panelists agreed that compiler portability is more important in the micro market, while compiler performance is more important in the workstation and minicomputer markets.

Hardness Tester Helps Build Better Integrated Circuits

Electrical engineers know that the thin-film, multilayered structures that make up integrated circuits are subject to high degrees of failure, particularly at interconnection points. Researchers at Stanford University (Palo Alto, CA) are using new techniques to understand why relatively straightforward interconnections that appear to be solid when made, inexplicably break later on. One technique devised by William Nix, a professor at the Stanford School of Engineering, uses a new submicron hardness tester (nicknamed the "nano indenter") to determine the hardness of thin-film material by indenting the metal to a minimum depth of 500 angstroms.

"The nano indenter allows us for the first time to probe mechanically on a very small scale," Nix explained. The degree of hardness as determined by the indentation is then compared to the known microstructure of the material being studied, which helps determine why the material might fail.

Hewlett-Packard Defends Its Choice of DDL

After taking its licks at the Seybold Desktop Publishing Seminar for picking Imagen's DDL as a document-description language, Hewlett-Packard held its own symposium on desktop publishing and defended its choice. Apparently the company was still smarting somewhat from Steve Jobs's comment at the Seybold seminar that HP must have been "brain-damaged" when it decided to support DDL instead of Adobe Systems' PostScript. In her talk, Jan Bell of HP's Peripherals Group (Boise, ID) specifically compared DDL to PostScript and Interpress, a document language from Xerox. HP chose DDL over PostScript, she said, because DDL supports both binary and ASCII representation (PostScript supports only ASCII, she said), intelligent scaling of bit-map characters (PostScript does not), composite objects (again, she said, PostScript does not), full object caching (PostScript supports font object caching only), and document layout (PostScript does not). Interpress, she pointed out, supports only limited programmability, binary representation, font-only object caching, and limited document layout. She also said Interpress doesn't support intelligent scaling of bit-map characters and composite objects.

NANOBYTES

VLSI Technology (San Jose, CA) brought out a series of 1.5-micron CMOS gate arrays based on its Continuous Gate technology. Arrays in the VGT100 series contain from 10,000 to 50,000 usable gates. The series gives designers a choice between gate array or cell-based implementations. . . . The **IEEE** has formed a group to address the work of the **Personal Computer Extended Technology Standards Committee**, which has released a technical spec for its proposal for a 16-bit PC AT-compatible bus with a 32-bit bus extension. According to Gary Lyons of the IEEE's microprocessor standards committee, the society's involvement with PCET will lead to an AT-compatible bus specification that's officially recognized by the IEEE. The final document could be used by manufacturers basing systems on 32-bit processors, including Motorola's 680x0 series, National Semiconductor's 32xxx series, and Intel's 80386. . . . **Symbolics Inc.** (Concord, MA) is selling the source code for its New Flavors object-oriented programming system, written in Symbolics Common LISP. Full source code on a DOS-compatible disk costs \$25; documentation costs \$50. . . . **Corvus Systems Inc.** (San Jose, CA) has acquired the laser printer technology developed by BDS Computer Corp. (Mountain View, CA). . . . **OEM Marketing** (Canoga Park, CA) is selling a device that monitors a computer's temperature. Heat Alarm bleats a high-pitched warning when the temperature hits 123 degrees. It costs \$49.95 and, according to the company, it's easily installed between the speaker and the motherboard. The firm's next product? The Cool Card.

TECHNOLOGY NEWS WANTED. *The news staff at BYTE is always interested in hearing about new technological and scientific developments that might have an impact on microcomputers and the people who use them. We also want to keep track of innovative uses of that technology. If you know of advances or projects that involve research relevant to microcomputing and want to share that information, please contact us. Call the Microbytes staff at (603) 924-9281, send mail on BIX to Microbytes, or write to us at One Phoenix Mill Lane, Peterborough, NH 03458.*



INTRODUCING THE A★STAR II™

We're having a party! It's a going away party. And, it's for IBM. But, shhhhh! Don't tell them. We want it to be a surprise!

Why a party? Well, it's because we've been told that more than a few of IBM's customers have been "going away" ever since we introduced our A★Star™ PC/AT compatible micro-computer. Now that we've announced our new A★Star II, we figure a lot more of their customers will be going away. That's because the A★Star II is the *only* "network ready" PC/AT compatible that can operate at 6, 8, 10 and 12 MHz. And because it's available in a super selection of models starting at only \$995!

The A★Star II is not just another clone, it's better...*much* better! Not only is it faster and more powerful

than IBM's model, it's also incredibly less expensive. Better yet, the A★Star II is built and backed by Wells American - a company that's been making micro-computers *longer* than IBM. (We bet that surprises even you!) Plus, the A★Star II is serviced nationwide by RCA Corporation - one of the world's largest and most respected consumer electronics firms. And if that's not enough, every unit includes free schematics and a money back guarantee!

If you'd like to be a part of our IBM going away party, clip and return the coupon or call us at the number below. But don't tell IBM! If they find out how many of their customers are going away, they might just go away themselves! Of course, that would be okay with us. We never *really* invited them anyway!

A PC/AT FOR ONLY \$995? WHAT A REASON TO CELEBRATE!

Special Introductory Offer: Order now and receive a \$395 option - absolutely FREE! Limit one per customer. Hurry! This offer and quantities are limited.

Name: _____
 Company: _____
 Phone: _____
 Address: _____

 City: _____
 State: _____ Zip: _____

 **Wells American**

803/796-7800 • TWX 510-601-2645
 Sunset Boulevard • West Columbia, SC 29169



Corporate Headquarters: 3243 Sunset Boulevard • West Columbia, South Carolina 29169 • 803/796-7800 • TWX 510-601-2645

IBM, Personal Computer AT and AT are trademarks of International Business Machines.

PRINCETON. The in



And much more:

Full EGA and CGA support. Princeton EGA monitors bring you 64 brilliant colors and bright sharp images in enhanced graphics mode, with 640 x 350 resolution. Your EGA software never looked better. Plus our HX-12E and HX-9E automatically switch from EGA to CGA mode, when needed.

Compatibility. Princeton monitors are 100% compatible with leading personal computers like IBM®, Compaq®, and more. No matter what system you have, there's a Princeton monitor that's right for you.

Quality Image. A .28mm dot pitch (the finest dot pitch of all leading EGA displays), bright colors, and sharp resolution give Princeton monitors a quality image that cannot be beat.

Easy Viewing and Ergonomic Design. Princeton monitors are designed for easy use, too. You get easy viewing with the HX-12E's black matrix tube and etched

nonglare screen. The lines are crisp, the characters sharp, and the colors even, so you're more productive. Controls are located on the front, where you can reach them.

Reliability. Princeton monitors are designed and manufactured to meet your most demanding needs. Only the finest components are used. The result: dependable performance day in and day out.

Value. No other monitor gives you more for the money than Princeton. Compare for yourself. Feature for feature there's not a better value around.

Availability. Princeton monitors are as easy to get your hands on as they are easy to use. You can find them at computer stores around the world.

Reputation. More and more, people are making Princeton Graphic Systems their number one choice in personal computer displays. Because people know Princeton delivers the ultimate in compatibility, reliability, and performance.

IBM is a trademark of International Business Machine, Inc. Compaq is a trademark of Compaq Computer Corp. Wall Street Journal is a registered trademark of Dow Jones, Inc.

best dot pitch EGA monitors.

For the no-compromise enhanced graphics monitors, look for the Princeton Graphic Systems name. Princeton delivers everything you need in a quality EGA display, from crisp, clear, full EGA support to rugged reliability. When you choose Princeton you choose the best.

HX-9E. The first IBM compatible 9" high resolution color monitor to support EGA. Has a .28mm dot pitch black matrix tube and etched nonglare screen for sharp, crisp displays and features a built-in tilt/swivel stand and green/amber switch.

HX-12E. The first IBM compatible high resolution color monitor to support EGA with a .28mm dot pitch. The HX-12E builds on the award winning features of the HX-12 and features 640 x 350 resolution for sharp, crisp text and colorful graphics.

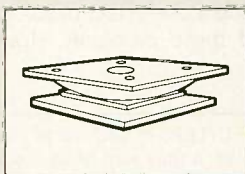
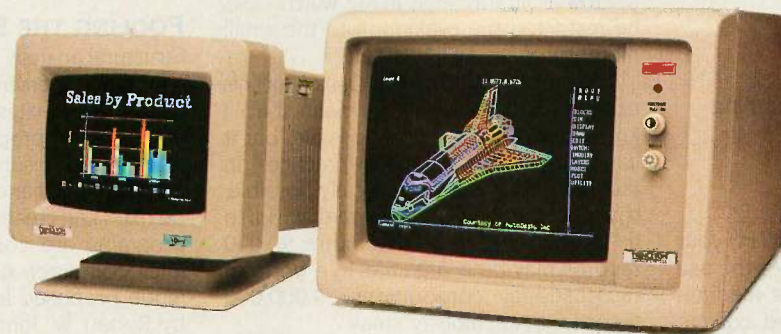

FREE TILT AND SWIVEL STAND

With every purchase of an HX-12E Monitor between November 1 and January 31, 1987. To receive a free monitor stand, simply send us your completed warranty card with your original invoice (no photocopies accepted) by February 15, 1987. All requests will be filled within 6-8 weeks after receipt.

PRINCETON®

GRAPHIC SYSTEMS
AN INTELLIGENT SYSTEMS COMPANY

601 Ewing Street, Bldg. A Princeton, NJ 08540, Telex: 821402 PGSPRIN, (609) 683-1660, (800) 221-1490, Ext. 1804

COMPUTER-BASED COURSES

The following institutions have responded to our September editorial with information on their courses via computer:

Polytechnic Institute of New York
Dept. of Humanities & Communications
333 Jay St.
Brooklyn, NY 11201

Mary Washington College
Office of Graduate and Extended Studies
1301 College Ave.
Fredericksburg, VA 22401-5358

University of Cincinnati
Dept. of Chemical & Nuclear Engineering
Mail Location #171
Cincinnati, OH 45221

Thomas A. Edison State College
101 West State St.
CN 545
Trenton, NJ 08625

Connected Education Inc.
92 Van Cortlandt Park South, #6F
Bronx, NY 10463

Nova University
Information Sciences
Center for Computer-Based Learning
3301 College Ave.
Fort Lauderdale, FL 33314

CORRECTION

I wish to point out an error in your September editorial, which urges the use of computer conferencing as a medium for educational instruction and college credits. When mentioning the EIES conferencing system, you give credit to the correct person (Murray Tuross), but to the wrong school. EIES was in fact developed at New Jersey Institute of Technology, not in New York as you claimed.

MARK SAVASTANO
Bloomfield, NJ

SORT RUN TIMES

In every generation there is someone who has trisected the angle with compass and straightedge, squared the circle, repealed the second law of thermodynamics, or written a sort with run time linear in the number of records. Alas, they are always mistaken! The letter from John W. Ward (September, page 373) is in this category

and illustrates the danger of generalizing from a single datum.

Mr. Ward claims to have found a sort that runs in $O(n)$ time. In fact, the sort he presents runs in $O(n^{1.5})$, that is, $O(n\sqrt{n})$, considerably worse than the $O(n \log n)$ that the better sorts offer.

The timing for Mr. Ward's algorithm has a component that is $O(n)$ and I/O-bound, and a second component that is $O(n^{1.5})$ and CPU-bound. Since his memory was too small to handle more than 90,000 records, his timing was dominated by the slow disk drives he was using. Had he tried the same algorithm with 9,000,000 records, the CPU time would have been more noticeable. Had he tried it with semiconductor auxiliary memory instead of disks, that is, with "RAM disks," the I/O time would have been less noticeable. In either case, his error would have been obvious.

The description of algorithm timing as $O(f(n))$ is only meaningful when n is allowed to grow arbitrarily large. In Mr. Ward's case, he restricted the evaluation to the small memory of his DEC PDP-11/73.

Whether Mr. Ward meant $O(n)$ or $o(n)$, his example fails to justify his claim that "I know it's theoretically impossible, but it can sometimes be done in practice." In fact, what he did is theoretically possible, trivial, and irrelevant to the real world. In a "Mom and Pop" grocery store, 90,000 records may be a large file. In a world of multinational corporations, 9,000,000 records is ridiculously small.

SEYMOUR J. METZ
Annandale, VA

CD-ROM SOFTWARE DEVELOPMENT

Editor's note: Hein ten Bosch of Kluwer Technical Publishing in Deventer, The Netherlands, called to say he had spotted a bug in our May article "CD-ROM Software Development." Says he, "The author compares the number of bytes but forgets to calculate inner sectors," so that the final counts represented in table 2 (page 184) are off. Author Bill Zoellick's response:

The reader is correct; table 2 is in error. I do not understand what the reader means by "inner sectors," but he is right about my not adding up the maximums

in the table. The figures in the columns for two levels and three levels are in fact the number of records just at that level, rather than in the whole tree. An entire three-level tree, of course, contains records at the first and second levels as well as those at the third level. So we need to accumulate the records as we move from left to right, resulting in the following, corrected table:

Block size	One level	Two levels	Three levels
2K	64	4,224	274,624
4K	128	16,640	2,146,688
8K	256	66,048	16,974,592

I am sorry about this error and am pleased that someone read the article closely enough to notice it. I also notice that we left out the "K" in the field that should read "Block size = 2K" in table 2.

BILL ZOELICK
Stillwater, OK

FOOLING THE SYSTEM

Structural analysis programs developed in a mainframe environment frequently use a large array that is partitioned for various purposes. Appropriate subelements are then passed to subroutines. The Microsoft requirement that dimensions of an array be fixed can create problems when these programs are converted for use on a microcomputer. At first glance, the technique proposed in "Structural Analysis" by Robert W. Johnson and Fernando G. Loygorri for "Fooling the [operating] System" (July, page 210) appears to provide a useful technique to alleviate some of these problems. However, there are

(continued)

LETTERS POLICY: To be considered for publication, a letter must be typed double-spaced on one side of the paper and must include your name and address. Comments and ideas should be expressed as clearly and concisely as possible. Listings and tables may be printed along with a letter if they are short and legible.

Because BYTE receives hundreds of letters each month, not all of them can be published. Letters will not be returned to authors. Generally, it takes four months from the time BYTE receives a letter until it is published.

If You Just Look At The Screen, You're Missing The Picture.

AST-3G Plus™ and AST-3G I/O™

lots of companies bundle EGA, CGA, MDA, and Hercules™ graphics card capabilities on one board.

AST gives you this and a lot more starting with a choice.

AST-3G Plus or AST-3G I/O.

Choose the AST-3G Plus and get high-resolution 640 x 350 graphics, brilliant 16 color displays created from a full-spectrum palette of 64 colors and high-quality text. Giving you across-the-board IBM® PC/XT/AT® applications software compatibility.

So, you'll have all the power you need for business and presentation graphics, CAD/CAM, graphic arts and desktop publishing.

You can even expand the AST-3G Plus

AST-3G I/O

All the graphics and memory of the AST-3G Plus, combined with a Serial Port, Parallel Port, Clock/Calendar, and available Game Port.

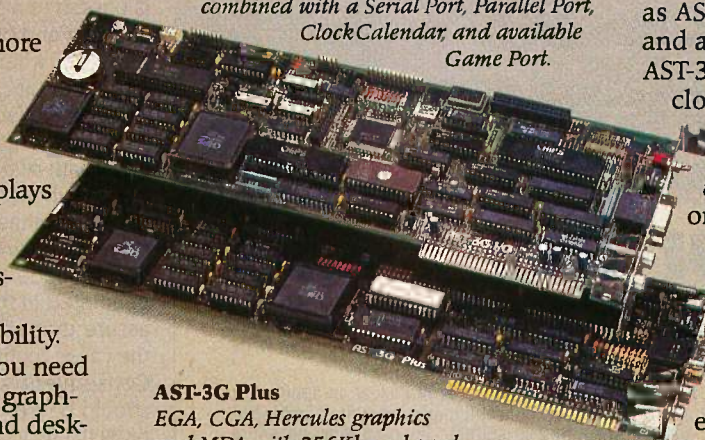

AST-3G Plus

EGA, CGA, Hercules graphics and MDA with 256Kb on-board video memory and available Parallel Port.

with an optional parallel port.

Or, pick the AST-3G I/O (formerly known as AST-3G Pak) and get the parallel port and all the graphics capability of the AST-3G Plus, as well as a serial port and clock/calendar with battery back-up.

You can also order an optional game port. Both the AST-3G Plus and AST-3G I/O give you 256Kb of on-board video memory.

So whether you need more powerful graphics, or powerful graphics and more, AST has an EGA solution.

More, An AST Tradition. AST pioneered compatible multifunction expansion boards. For more power. Now we're doing the same with graphic display adapters.

And all AST products are built with front-line components, then burned-in and tested. Again and again. For more reliability.

Get The Whole Picture. Find out more about unleashing the graphics power of your PC, XT, or AT by visiting your local dealer, calling our Product Information Center at 714/863-1480, or mailing the coupon below to AST Research, 2121 Alton Avenue, Irvine, California 92714-4992.

AST-3G Plus and AST-3G I/O trademarks of AST Research, Inc. IBM and AT registered trademarks of International Business Machines. Hercules trademark of Hercules Graphic Products, Inc. Copyright © 1986 AST Research, Inc. All rights reserved.

AST
RESEARCH INC.



Yes, Please send me more information about AST-3G Plus and AST-3G I/O.

Name _____

Title _____

Company _____

Address _____

City _____ State _____ Zip _____

Phone () _____

Send to: AST Research, Inc., 2121 Alton Ave., Irvine, CA 92714-4992. 01 BC068 A 01GI 12/86



A Hero For Our Time

We live in an age of efficiency. People want the best possible performance, the highest return on investment, that extra ounce of speed. **Modula-2** is the language that embodies that philosophy. Pecan's **Modula-2** is the implementation that best expresses that philosophy. With Pecan's professional **Modula-2** you can write fast, efficient, reliable and maintainable code.

STATE OF THE ART: This elegant language incorporates the best features of Pascal. In addition, it includes standard extensions for real-time programming, the module concept, improved syntax and facilities for multiprocessing and low-level machine access. **Modula-2** is suitable for programming entire computer systems, from high-level machine independent application programs to machine-specific software such as device drivers.

COMPLETE: Pecan includes the **Power System**, a complete, integrated development environment, along with every **Modula-2** compiler. You get a text editor, file handling utilities, library, print and file transfer utilities, in every package. And a wide variety of additional integrated program development aids are available. These include the languages **UCSD Pascal**, **FORTRAN-77**, **BASIC** and **Assembler**, so you can construct your application using modules written in your choice of languages.

POWERFUL: The Power System utilizes a system of fast on-screen menus so you need not learn cumbersome command structures. The sophisticated compiler/editor interface permits you to automatically correct errors as they are detected or log errors for unattended compilation. The editor itself supports editing of multiple files, dynamic function keys and virtual memory editing.

A standard set of utility modules form an integral part of Pecan's **Modula-2** implementation. These powerful modules provide facilities for input and output, random access files, disk directory operations, console I/O, storage management, program execution and process scheduling. A utility library contains modules for mathematical functions, decimal arithmetic, strings and data conversion. And the language itself supports opaque types, procedure variables, a transparent **WORD** type, an address function and interrupt-driven multitasking.

PORTABLE: Portability is the hallmark of the Power System and **Modula-2**. The Power System is available on more machines than any other environment. This means that programmer teams working on diverse machines will not have to learn multiple development environments. Moreover, applications developed under the Power System are themselves portable to the same wide variety of machines.

PECAN'S MODULA-2 FEATURES:

- Fast compilation • Native code • Separate compilation of modules • Comprehensive module library
- Integratability with UCSD Pascal, FORTRAN-77, BASIC and Assembler • Extended precision arithmetic
- Dynamic memory management • Multitasking • 8087 and BCD support (PC's and compatibles) • I/O redirection

Modula-2 with the Power System environment Only \$99.95

For PC-DOS, MS-DOS, Amiga, Atari ST, Macintosh, Apple II (including new Apple II gsl), Rainbow, Tandy, Stride, as well as most popular 8/16/32 bit systems. Also available for VAX, UNIX, PDP-11 OS's and others.

Order additional languages! Your choice of UCSD Pascal, FORTRAN-77, BASIC or Assembler for only \$79.95 with your purchase of Modula-2.

BUY TWO ADDITIONAL LANGUAGES AND GET ANOTHER LANGUAGE FREE!

To custom-tailor software, PECAN offers such programming tools as:

SYMBOLIC DEBUGGER	\$59.95	CONFIGURATION TOOLS	\$39.95
PROGRAM ANALYSIS TOOL KIT	\$59.95	DISK RECOVERY TOOL KIT	\$39.95
APPLICATION SERVICES INTERFACE	\$59.95	PRINT SPOOLER	\$39.95

ORDER MODULA-2 AND ALL SIX UTILITIES AND PAY ONLY \$199.95 FOR A TOTAL SAVINGS OF \$100.

Write for a complete list of our other development aids.

ATTENTION CORPORATIONS: Ask about our training seminars:

SCHOOLS: Special educational discounts.

NOT COPY PROTECTED

Mail your check or money order to:

Pecan Software Systems, Inc.

1410 39th Street

Brooklyn, New York 11218

(718) 851-3100

ITT TELEX NUMBER: 494-8910

CompuServe ID: 76703, 500

Inquiry 269

PECANTM
The UCSD Pascal Company

Credit Card Orders **1-800-63-PECAN**
Call Toll Free (NYS) 1-800-45-PECAN

Please add \$4.50 for shipping within the US. Foreign orders add \$15.00 and make payment by bank draft payable in US dollars on a US bank. New York State residents add appropriate sales tax.

UCSD Pascal is a trademark of the Regents of the University of California

important qualifications that should have been mentioned.

First, many mainframe programs will mix double-precision numbers, integers, and characters in the same array. If so, the programmer must assure that no scalar crosses a segment boundary. Otherwise, incorrect results are likely when that item is passed to a subroutine (since only one segment and offset will be associated with that item when it is passed).

In addition, the proposed approach relies on the fact that the array spans more than one segment to create code that deals with both segment and offset. However, a subelement of a large array passed to a subroutine often does not itself span more than one segment. The fact that proper code for an actual argument is generated in the calling routine does not assure that proper code is generated in the called routine for the formal argument. Consequently, the formal argument should be explicitly declared as \$LARGE or \$HUGE to assure that both segment and offset are used within the subroutine. (The \$LARGE metaccommand could be applied to all code in a program.)

Finally, and most importantly, the memory model was changed for version 3.3 of the Microsoft FORTRAN compiler and linker. At run time, common blocks and large variables are now loaded below segments such as the stack and heap. We compiled and linked a short program, first using MS-FORTRAN 3.2 and then MS-FORTRAN 3.31. The result: Memory organization is substantially changed and a number of segments now occur above the common blocks. Using the recommended "tricks" will now result in "clobbering" the program unmercifully.

Ten years ago the prevalent view seemed to be that good programming meant getting the most out of a specific machine. That notion is outdated because it ignores issues such as code maintenance, portability, and assurance that the results are accurate. In our view, a "very sloppy approach" is writing code using shortcuts that significantly increase the probability of incorrect results, as opposed to writing code that "will not use all the memory available in computers that have plenty of it."

This is not strictly a philosophical exercise. Recognize that the standard of care required of a programmer or an engineer using an analysis program is still developing. Many lawyers would argue that "strict liability" is appropriate for areas, such as structural analysis, that are "inherently dangerous." In other words, if analysis results are incorrect because of some

(continued)

VIDEOTRAX DATA BACK-UP. WE JUST INTRODUCED IT. AND ALREADY 40 MILLION PEOPLE OWN HALF OF IT.

Every human in the hemisphere who owns a standard VCR has half of what's needed to back up data. The rest of what you need is neatly contained on the new Videotrax™ controller board by Alpha Micro.

Slip the Videotrax board into the expansion slot of any PC. (Meaning any IBM® PC, XT, AT, or true compat-

available. More dependable, even, than the hard disk you're covering for.

QUICK STUDY

Videotrax has been designed to extremely demanding standards. So that it won't put a lot of demands on you. Anyone who can run a VCR knows most of the drill.

The rest is covered by our menu-driven software. By clear, concise documentation. And by a range of backup modes that keep it simple:

Insert a blank video cassette tape and follow the directions which appear on screen. These guide you through the painless steps for copying or restoring an entire hard disk, specific files, or only files modified since the last backup.

Meanwhile, Videotrax rigorously monitors itself for proper functioning.

WE MAKE THE VCR PART OF IT, TOO.

If you like, opt for our enhanced Videotrax VCR and experience the extra joy of its automatic,

unattended backup capabilities.

It will be a most prudent investment. Because,



Your basic video cassettes. Reliable, cheap, easy to find.

for the price of taping Dallas you can preserve your most precious data. Up to 80MB on a single cassette, at less than a third of the cost of streamer tape.

And of course, if you ever require service, your authorized Alpha Micro dealer and our worldwide network of factory service centers will provide all the support you need.

For the name of your nearest Videotrax dealer, call Alpha Micro at 1-800-992-9779. In California, call 1-800-821-0612.

The Videotrax System. It's a great leap forward in backing up.

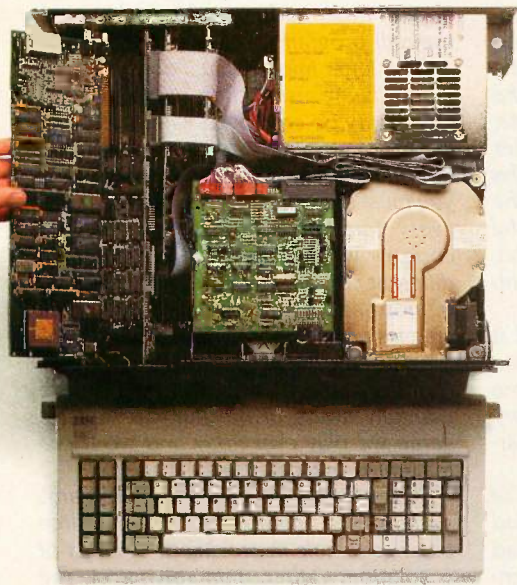

High-tech. Open your PC and slide the controller board into any expansion slot. Low-tech. Hook up VCR to computer with standard connector cables.



ible.) Connect the computer to a VCR with standard connector cables. And, as of that moment, you are under the protection of a highly sophisticated, stringently reliable, data backup system.

In fact, exhaustive testing and the long term experience of over 19,000 Alpha Micro users have proven Videotrax technology to be more reliable than any other backup option

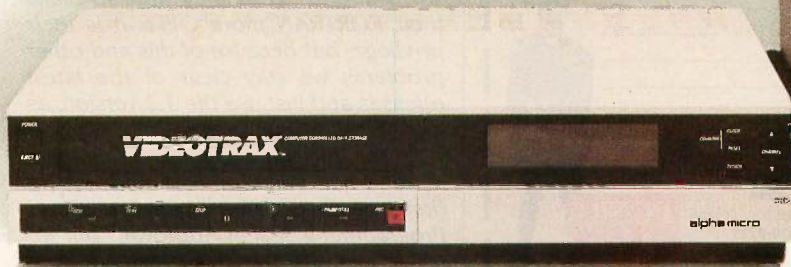

Inquiry 18

Finally, software you don't have to be rich to own.



We're PC-SIG. We have the world's largest library of user-supported programs (where authors ask that you send a donation) and free public domain programs. For only \$6, you buy software that has been selected from leading authors, thoroughly analyzed, and technically supported. Perhaps that's why we've been referred to as the Robin Hood of software publishers.

- #499 **PROCOMM** Professional communications program written in compiled MicroSoft C and assembly code.
- #523 **SIDE WRITER** Perfect for spreadsheets, this application prints text files sideways.
- #528, 529 **NEW YORK WORD** Powerful word processing with split-screen editing, mail merge, auto hyphen, and more.
- #574 **FREECALC** Word processing and spreadsheet application for forecasting and budgeting.
- #78 **PC WRITE** Our most popular word processor. "I'm more at ease with PC WRITE than WordStar."
- #521 **FREE FILE** Easy-to-use and learn relational data base manager.
- #522 **INSTANT RECALL** Memory-resident program for storing and retrieving a wealth of information.
- #405 **DESKMATE** Desk organizational tool with phone dialer, notepad, calendar, and calculator.
- #478 **HARD DISK UTILITIES** The best and most useful utilities for the hard disk user.
- #133 **ULTRA UTILITIES** A must for every PC owner. For recovering lost or accidentally erased files.
- #558 **PC-PROMPT** A memory-resident help utility that provides formatting for DOS commands online.
- #429 **ELEMENTARY C** Application for learning C language.
- #424 **PASCAL COMPILER** Popular compiler written in Turbo Pascal.
- #423 **PROJECT MANAGEMENT** PC management system capable of handling 1000 tasks.
- #237 **PC-GENERAL LEDGER** For the serious bookkeeper. All the controls needed for balancing the books. Plus an audit trail.
- #404 **EZ-FORMS** Program for generating tailor-made forms. "Compared to \$80 packages, this is super."
- 1-year **PC-SIG Membership**. Includes printed directory, supplement, bi-monthly magazine.... \$20. (\$35 foreign.)

The PC-SIG introductory Special

Any 5 diskettes plus 1-year membership...\$39

All diskettes are \$6 each. Add \$4 postage and handling (\$10 foreign) CA residents add state sales tax.

Total Enclosed \$_____ by Check VISA MC

Card No. _____

Exp. date _____ Phone # _____

Name _____

Address _____

City _____

State _____ Zip _____

Dealer Inquiries Invited

To order, call: 800-245-6717

In CA: 800-222-2996

For technical questions or local orders: (408) 730-9291

1030-D East Duane Avenue, Sunnyvale, CA 94086



Software in the public interest.

LETTERS

obscure bug, and the incorrect results cause damage, the responsible programmer and/or engineer may be liable for that damage, regardless of the care taken to ensure accuracy. If there is any question about the degree of care, the case will be even stronger.

KENNETH S. HERRING
VICKI R. HARDING
Rockville, MD

The authors' reply:
We fail to see how it is possible to "mix double-precision numbers, integers, and characters in the same array" in FORTRAN 77. Perhaps the writers meant to say "in the same common block," in which case Microsoft FORTRAN's inability to cope with segment boundaries is already well documented in the manuals. Anybody using MS-FORTRAN should be aware of it by now.

We also fail to see why a subroutine should have code to handle common-block variables that is different from the equivalent main program code when the compiler has the explicit definition of the common block in both cases. Of course, there could be an error in the compiler itself, but our experience tells us that this is not the case. Furthermore, since the article was written we have finished the graphics module for the 3-D models and, as before, memory expansion gave us no trouble.

Now, if a subarray is passed and it crosses a segment boundary, then you have a problem, but again, it is a more general problem not due to the memory expansion method presented in the article.

We found that the declaration of \$LARGE for big arrays was not as good as using common blocks because it had the nasty side effect of including the entire array in the .EXE file! As a result, the program submitted by the writers compiles into an executable file 260K bytes long, instead of 20K.

After MS-FORTRAN 3.3 was released we became aware of the memory model change, but it was too late. As you can imagine, we cannot predict what Microsoft will do next. If they want to make their FORTRAN more C-like, it is their privilege, but because of this and other problems we stay clear of the latest releases and just use the 3.2 version, as was stated in our article.

As for the philosophical arguments about what should and should not be done, we are not after anybody's "Good Programming Seal of Approval," but we try to get the job done instead. And when there is only one way of accom-

plishing a task with the available tools; the "programming style" is a moot point anyway.

Regarding maintenance, it is our opinion that it would be much more complex to maintain, update, and keep track of multiple versions of the programs for different computer memory sizes. Portability is a nonissue for us, as we are dedicated to designing software for the IBM PC family.

From the writers' comments about reliability, it seems that they think we dreamt up the memory expansion mechanism one afternoon, then implemented it hastily and never tested it. Nothing could be further from reality.

We know that the mechanism works well because we have used it extensively in different types of models with total success. Of course, it is always possible to make errors, so the results should always be checked out, not only in the case of tricky code but also with run-of-the-mill programs.

Their letter implies that if only standard methods are used, then different compilers may be employed with no fear of incorrect results. We wish such a naive notion would hold true. In the real world you must thoroughly check out programs every time any change is made to your code, or when a different compiler or a different computer is used. The existence of nonstandard techniques neither increases nor decreases this responsibility.

As for the legal ramifications of performing any activity in the U.S., we are painfully aware of the Russian roulette game we play every day and we try to maximize our chances.

That is why our Microsoft-safe programs generate a complete model force balance to help in proving the validity of a solution, rather than relying on the philosophy that if the steps are correct, the results must be correct too.

Not many other Finite Element Analysis programs conduct a force balance at all nodes as a second, independent method to ensure the validity of the solution. We believe that such an approach is much better than blind faith in the correctness of code just because it follows simplistic rules and trusts compilers explicitly. After all, compilers are not perfect either, especially MS-FORTRAN.

The use of software, as well as the rest of the activities conducted by engineers, requires the use of checks and balances, together with methods that are sound and proven by experience, to provide a defense that reasonable and appropriate

(continued)

**SATELLITE
MODULES
NOW \$99**



The Most Powerful LAN Fits on a Disk.

Network Power. You knew that someday there would be a powerful LAN that didn't need old-technology network boards. It would be fast, easy to install, and run 99% of PC-DOS software. It would be expandable, provide remote access, password-protection, and enable you to use inexpensive terminals as workstations in a PC-DOS environment.

Dream no more, because the power is here.

Its name is LANLink™

A Software-Driven LAN Powerful Enough To Use RS-232 Ports for Network Communications. In development for over three years, LANLink™ represents the next generation of local area networks. All of the logic which has traditionally resided on network boards is on LANLink's Satellite and Server Diskettes.

No additional hardware is required. Inexpensive serial ports replace "Kilobuck" Network Interface Boards making installation costs one-third that of a board-driven network.

How To Configure a Smart Network...With Dumb Terminals, But Without Dedicated Servers. Boasting a wide variety of configurations, LANLink™ is most often set up as a "Star" having up to eight satellites connected to a central, nondedicated server. Larger networks can have multiple servers, supporting a total of 73 or more network users.

R-LAN™ (Remote-LAN) gives users the ability to interact with a LANLink™ network in real time via modem. Plus, if MultiLink Advanced™ is run on a Satellite, inexpensive dumb terminals can be used to access network disks, files, and programs.

99% of PC-DOS Applications Run in a Totally-Transparent Network Environment. If you know DOS, you already know how to use LANLink™ COPY transfers files among users, and a 2-drive PC Satellite boots 1-2-3 from the Server's hard disk with the entry c:\lotus. Each satellite's access can be limited to specific disks, printers, and sub-directories. A wide variety of software including Lotus 1-2-3, dBASE III, and WordStar 2000 is fully compatible. LANLink™ has a collision-free data transfer rate which exceeds 115,000 BPS.

Power Up Your PCs Today. For complete details and the authorized dealer nearest you, call The Software Link TODAY. The LANLink™ Starter Kit is \$495 and includes modules for both a Server and a Satellite. For a limited time, 50 feet of shielded RS-232 cable will be included free of charge. Additional Satellite Modules are only \$195, each.

LANLink™ is immediately available and comes with a money-back guarantee. VISA, MC, AMEX accepted.

LANLink™



THE SOFTWARE LINK, INC.
Developers of LANLink™ and MultiLink Advanced™

8601 Dunwoody Place, Suite 632, Atlanta, GA 30338 Telex 4996147 SWLINK

CALL: 404/998-0700

Dealer Inquiries Invited

THE SOFTWARE LINK, INC./CANADA 250 Cochrane Drive, Suite 12
Markham, Ontario L3R 6B7 CALL: 416/477-5480

LANLink™ MultiLink Advanced™ & R-LAN™ are trademarks of
The Software Link, Inc.

IBM, PC, & PC-DOS are trademarks of IBM Corp. WordStar 2000,
dBASE III, and Lotus 1-2-3 are trademarks of MicroPro, Ashton-
Tate, and Lotus Development Corp., respectively.

Inquiry 331 for End-Users.

Inquiry 332 for DEALERS ONLY.

care was used in the design process. It is not a justification to allow bad solutions to be used because of the "It's not my fault" philosophy.

ROBERT W. JOHNSON
FERNANDO G. LOYGORRI
Microstress Corp.
Seattle, WA

EASY C

The company I work for was in a situation very similar to what Pete Orlin and John

Heath described ("Easy C." May): converting to C from other languages with no experience in C. We also used the #define macro features of C to make a version of Easy C. I was very relieved to read the May article and learn that we were not alone in the world. Having worked in the meantime with two C "expert" consultants, I was not surprised at the letter from John A. Rupley in the September issue (page 22). I can understand Mr. Rupley's dislike of Easy C; beauty is in the eye of the

beholder. But some of his other comments are, well, staggering.

Mr. Rupley's first objection relates to communication by accepted rules of style. There is certainly a great deal of merit in writing books and magazine articles in a commonly accepted standard form of C. Articles written for law magazines need to be written in legalese, medical journals have their own style, and so on. I find it hard to believe, however, that learning local variations of C will freeze the brain and make programmers illiterate. I don't have any trouble converting an article in any FORTRAN/ALGOL-style language to standard C, and Easy C to standard C is no exception.

There is a comment in the letter that asks "... should not the ANSI Standardization Committee, rather than individual dissenters, be enjoined to wrestle with the problem [of confusing operator characters]?" Is that a joke? Or should I make a comment about how that hooligan Galileo should leave the motion of heavenly bodies to the experts? Naw, he can't be serious.

Mr. Rupley's "moral" of hiding one's light under a barrel (preferably with the barrel in the dumpster out back) is puzzling. What is the point of suppressing new ideas and innovation? Whether the idea is good or bad is beside the point in the case of the Easy C article. You are not being asked to like Easy C; you are not being asked to use it. If you encounter it and find it intolerable then by all means remove the irritation, but please, no more calls for the Thought Police.

If you work in an environment that requires programmers to move from one language to another rather frequently, there are advantages to having the source code as similar as is practical and Easy C is worth looking at. I am not trying to belittle Mr. Rupley's opinion. If I were forced to work only with C all day long, year after year, I would think Easy C is a waste of time. I have just gotten very tired in the last year of "experts" telling me that God speaks in The One True C.

NEAL S. PENDLETON
San Dimas, CA

The September BYTE contained a letter from John A. Rupley that was quite critical, to the point of being sarcastic, of "Easy C" by Pete Orlin and John Heath. He claimed that Easy C would lead to C illiteracy and that it masks the clarity and beauty of C programs. As a consequence, he asserts, an ANSI Standardization Committee is the proper forum for considering "new species" and that individual

(continued)

FoxBASE wins the dBASE race!

6.43 times faster than dBASE III PLUS

New FoxBASE+ sweeps the field: runs 2.26 times faster than Clipper, 6.69 times faster than dBCOMPILER, and 10.86 times faster than dBMAN! And FoxBASE compiles programs up to 60 times faster than other compilers.

The others aren't even close!

New FoxBASE+ is totally compatible with dBASE III PLUS as is original FoxBASE with dBASE II. No changes in your present programs, databases, screens, or reports!

Though FoxBASE is a super-fast compiler, it offers the familiar, user-friendly interactive features of dBASE and the full power of "dot prompt" mode plus many significant enhancements.

FoxBASE is available in single and multi-user versions for MS-DOS, XENIX, UNIX, many networks, and other environments.

Best of all, FoxBASE is economical. Single-user FoxBASE costs just \$395, multi-user FoxBASE \$995**—no matter how many workstations you have.

So call (419) 874-0162 now, and ask for a copy of our detailed benchmarks. After all . . .

Nothing Runs Like a Fox.

FOXBASE 

Fox Software
27475 Holiday Lane, Perrysburg, OH 43551
(419) 874-0162 Telex: 6503040827



*Compiled and tested on a 486 PC for 1984. All programs are multi-user XENIX compatible. Multi-user XENIX version available at \$795. FoxBASE and FoxBASE+ trademarks of Fox Software. dBASE II and dBASE III PLUS are trademarks of Ashton-Tate. Clipper is a trademark of Borland. dBCOMPILER is a trademark of WorldTech Systems Inc. dBMAN is a trademark of Versa-Soft Corporation. UNIX is a trademark of AT&T Bell Laboratories. XENIX and MS are registered trademarks of Microsoft Corporation.

AMAZING



Ten Good Reasons to Buy an Amazing Things™ Model "A" Series™ Modem

1. Amazing Things Modems Provide Access to a Wealth of Information through Databases.

You can access over 2,500 informational databases with an Amazing Things Modem. Research topics from astrology to zoology, stock quotes, news, weather, sports, legal references, medical information and more.

2. Amazing Things Modems Network.

Connect your personal computer to any other personal computer in your office or in the world.

3. You can Telecommute with Amazing Things Modems.

Work at home and send your data to the office via telephone. Observers believe that 15-20 percent of the office work force will be telecommuting by 1990.

4. Amazing Things Modems are Direct Links to any Mainframe.

Access your company's mainframe from your office, from your home or on the road with an Amazing Things Modem.

5. Amazing Things Modems Overcome Incompatibility Problems.

Send documents from one personal computer to another, even if the systems are incompatible.

6. Amazing Things Modems Bring You Electronic Banking and Shopping.

Many banks now offer banking and investment services over the telephone. And you can shop for thousands of products — from cameras to clothing — with electronic catalogues.

7. You Can Send and Receive Electronic Mail with Amazing Things Modems.

Send letters and memos instantly. Mass mail them automatically, across the office or across the country.

8. Amazing Things Modems are Inexpensive Alternatives to the Telex.

Send and receive volumes of information overseas at a fraction of the cost of a Telex.

9. Amazing Things Modems are Fun.

Through various bulletin boards, you can join clubs, exchange software, advertise, meet people, find jobs and much more.

10. Amazing Things Modems are Inexpensive.

The Amazing Things Model "A" Series 1200B Modem is priced at **\$149.95** — about one third the price of an equivalent Hayes Modem. And the 2400B is priced at only **\$289**.

● 300-1200 Baud \$149.95

● 300-2400 Baud \$289.

● Half-Card

● Auto-Answer, Auto-Dial

● Hayes®-Compatible

● Full or Half-Duplex

● Two-Year Warranty

● For Leading Edge® Personal Computers, IBM and Compatibles

For a dealer near you or to order direct, call 1-800-835-0139, (617) 551-0880 in MA.
MasterCard and Visa accepted.



**Amazing Things Inc.
57 Providence Highway
Norwood, MA 02062**

Amazing Things and Logo and Model "A" Series are trademarks of Amazing Things, Inc. Hayes is a registered trademark of Hayes Microcomputer Products, Inc. IBM is a registered trademark of International Business Machines Corp. Apple is a registered trademark of Apple Computer Inc. Leading Edge is a registered trademark of Leading Edge Products, Inc.



dissenters should keep such "mutants" to themselves.

Personally, I take issue with virtually every point Mr. Rupley made. First, he suggested that Orlin and Heath have made "changes in an established language." Exactly how they changed it evades me, since they followed not only the rules but also the intent of the #define construction (see Kernighan and Ritchie, page 12) precisely! Moreover, they have conformed to the C convention of writing symbolic names in uppercase (Ibid., page 13)—a practice Mr. Rupley condemns in a cleverly written, intentionally confusing paragraph in which he transformed all punctuation to uppercase words. (For those of you who have heard it, there is a close and very interesting parallel between that paragraph and Victor Borge's comic monologue, "Phonetic Punctuation." I see little parallel, however, between that paragraph and Orlin and Heath's work.) Why would an ANSI committee want to become involved in someone's following the rules, except, perhaps, to applaud it? Perhaps Mr. Rupley's complaints should really be pointed at Kernighan and Ritchie, not Orlin and Heath!

I think Mr. Rupley's real concern is that, if Easy C is used, it alters the appearance of C source code from its pristine state, which he seems to prefer. From my perspective, the alteration is for the better, too, for the Easy C coding example in figure 6 of Orlin and Heath's article is (Mr. Rupley's claim to the contrary) much more readable than its straight C equivalent in figure 5. It even incorporates Kernighan and Ritchie's own suggestion on improving the appearance of C code (Ibid., page 87)! Is this an alteration of the language? I think not. If it is, then vive la mutant!

The truth is that *all* languages are living things, the use of which changes with time. I abhor the inclusion of the word "ain't" in the English language, but it is certainly found in my dictionary. George Bernard Shaw correctly claimed that "Americans haven't spoken English for years!" In this sense, I can understand Mr. Rupley's objection, but I hope we see a lot of Easy C.

D. MARTIN HARRELL
Severna Park, MD

CALCULATING CRCs

I don't have a 6809 reference manual handy and Greg Morse ("Programming

Project: Calculating CRCs by Bits and Bytes," September) did not include any listings of his byte-wise CRC generator, but 86 cycles seems too high. When I implemented it a couple of years ago, the operation was about 8 instructions: two 1-byte table lookups and two XORs (no shifting at all). The contents of the two 256-byte tables depended on the polynomial, but I used a macro assembler to generate them from a couple of formula lines. The algorithm in Modula-2 is

```
/* Variable declarations, just so you can see
   what is involved . . . */
```

```
VAR T0T7, R0R7, R8R15, D0D7: BYTE;
    Table1, Table2: ARRAY BYTE OF BYTE;
```

```
/* Temporary T0-T7: XOR of Data and high
   byte of R */
```

```
T0T7 := R8R15 / D0D7;
```

```
/* Index into Table 1 and XOR to low byte of
   R to form new high byte */
```

```
R8R15 := R0R7 / Table1 [T0T7];
```

```
/* Index into Table 2 for new low byte */
```

```
R0R7 := Table2 [T0T7];
```

TOM PITTMAN
Manhattan, KS ■

WiseTEK INT'L, INC.

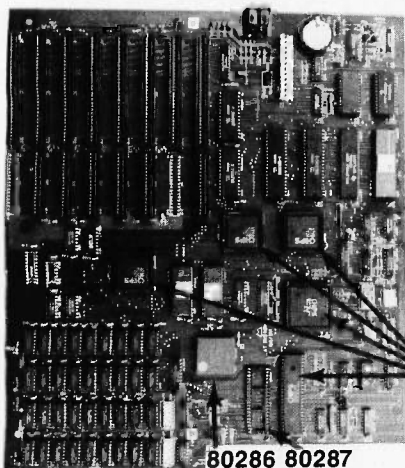

80286 80287

← **TURBO AT**

- 80286 IBM Compatible
- 6 MHz, 8 MHz, or 10 MHz Keyboard Switch
- 5 CHIPS SET—(Lower Heat. Higher Quality)
- 0 or 1 Wait State
- 1 MB Memory
- On Board Battery
- 80287 Socket Ready
- 3MB with serial/parallel port on board
- XT size AT JR motherboard available

5VLS1 **TURBO XT** →

- 8088-2 IBM-XT Compatible
- 4.77 MHz or 8 MHz Keyboard Switch
- 4 Layer PC Board
- 640K Memory
- 8087 Socket Ready

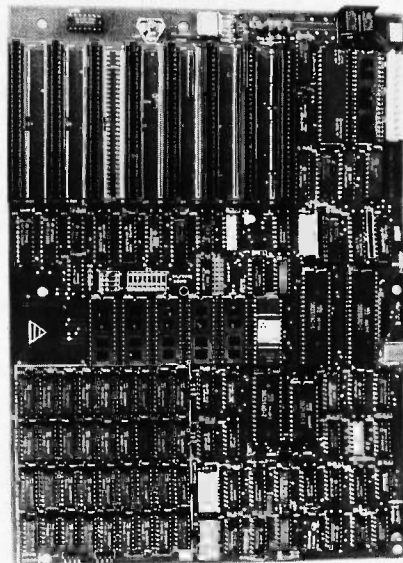

WiseTEK International, Inc.
513 Valley Way
Milpitas, CA 95035
TEL: (408) 263-1237
FAX: (408) 263-1870

**Distributors, Dealers, OEMs,
VARs, Corporations,
Educational Welcome.**

Micronic Corp.
108 East 16th Street
New York, NY 10003
TEL: (212) 529-4699
FAX: (212) 529-9926

LANGUAGES THAT ARE CAUSING THE BIGGEST PROGRAMMING BACKLOG IN HISTORY ARE ALSO EATING NICE BIG HOLES IN OUR POCKETS.

Whether it's BASIC, COBOL, Pascal, "C", or a data base manager, you're being held back.

Held back because the language has frustrating limitations, and the programming environment isn't intuitive enough to keep track of what you're working on.

In the real world, there's pressure to do more impressive work, in less time, and for more clients.

We've been given some incredibly powerful hardware in recent times, but the languages aren't a whole lot better than they were 20 years ago.

So, whatever language you have chosen, by now you feel it's out to get you — because it is.

Sure, no language is perfect, but you have to wonder, "Am I getting all I deserve?"

And, like money, you'll never have enough.

Pretty dismal, huh?

We thought so, too.

So we did something about it.

We call it CLARION™.

You'll call it "incredible."

Distributed on 7 diskettes, CLARION consists of over 200,000 lines of code, taking 3+ years to hone to "world-class" performance.

With CLARION you can write, compile, run and debug complex applications in a New York afternoon.

Even if you're in Savannah.

It gives you the power and speed to create screens, windows and reports of such richness and clarity you would never attempt them with any other language.

Because *you* would have to write the code.

With CLARION you simply design the screens using our SCREENER utility and then CLARION writes the source code AND compiles it for you in seconds.

Likewise, you can use REPORTER to create reports.

Remember, only CLARION can recompile and display a screen or report layout for modification.

And with no time wasted.

All the power and facilities you need to write great programs, faster than you ever dreamed of.

Programs that are easy to use.

Programs that are a pleasure to write.

And to you that means true satisfaction.

You've coveted those nifty pop-up help windows some major applications feature. But you can't afford the time and energy it takes to write them into your programs.

That's the way it used to be.

So we fixed that, too.

CLARION's HELPER is an interactive utility that let's you design the most effective pop-up help screens that you can imagine. And they're "context sensitive," meaning you can have help for every field in your application.

Unlike the other micro languages, CLARION provides declarations, procedures, and functions to process dates, strings,

screens, reports, indexed files, DOS files and memory tables.

Imagine making source program changes with the CLARION EDITOR. A single keystroke terminates the EDITOR, loads the COMPILER, compiles the program, loads the PROCESSOR and executes the program. It's that easy!

Our data management capabilities are phenomenal. CLARION files permit any number of composite keys which are updated dynamically.

A file may have as many keys as it needs. Each key may be composed of any fields in any order. And key files are updated whenever the value of the key changes.

Like SCREENER and REPORTER, CLARION's FILER utility also has a piece of the CLARION COMPILER. To create a new file, you name the Source Module. Then you name the Statement Label of a file structure within it.

FILER will also automatically rebuild existing files to match a changed file structure. It creates a new record for every existing record, copying the existing fields and initializing new ones.

Sounds pretty complicated, huh?

Not with CLARION's documentation and on-line help screens. If you are currently competent in BASIC, Pascal or "C" you can be writing CLARION applications in a day. In two days you won't believe the eloquence of your CLARION programs.

Okay, now for the best part of all. You can say it in CLARION for \$295.00—plus shipping and

handling. All you need is an IBM® PC, XT, AT or true compatible, with 320 KB of memory, a hard disk drive, and a parallel port.

And we'll allow a full 30 day evaluation period. If you're not satisfied with CLARION, simply return it in its original condition for a full refund.

If you're not quite ready to take advantage of this no-risk opportunity, ask for our detailed 16 page color brochure. It vividly illustrates the elegance of CLARION. Consider it a preview of programming in the fast lane.

Either way, the 800 call's a freebie.



SAY IT IN

CLARION™

DEPT. A4BY/8

1-800-354-5444



BARRINGTON SYSTEMS, INC. 150 EAST SAMPLE ROAD POMPANO BEACH, FLORIDA 33064 305/785-4555

IBM is a registered trademark of International Business Machines Corporation. CLARION™ is a trademark of Barrington Systems, Inc. ©1986 Barrington Systems

PORTABLES: MOBILE ACCESS

Tech PC Portable Computers come in four different base models to match your computing needs. Our entry level Tech PC/XT portable computer is designed to provide a non-obstructive profile, and has a capacity to hold two thirty megabyte hard disks, a high resolution monochrome monitor with a Hercules compatible graphics card to drive it with

800 by 400 lines resolution, and never before heard of 6 expansion slots in a portable computer. If 4.77 MHz of Intel 8088 power isn't fast enough, try our Turbo 4.77 to 8 MHz 8088-2 or optional NEC V-2 microprocessor based portable machine.

Designed to increase speed up to 170 percent of a standard PC/XT, this turbo gives you the edge.



Tech Personal Computer Systems are designed and manufactured by Tech Personal Computers . . . The leader in quality, performance and state of the art computer system engineering. . . each of our portable, desktop, multiuser, and minicomputer systems are unparalleled in the

industry for quality construction, dependable operation, complete software compatibility, and an unbeatable combination of product satisfaction guarantees, long warranty periods, and comprehensive third party maintenance. At Tech PC we're out to

capture your micro-computer business. No one matches our diverse line of high performance products, or our comprehensive system of support, warranty, and third party maintenance service options.



TECH PC PORTABLE COMPUTERS are available now in 4 different base models:

TECH PC/XT PORTABLE.....\$ 899

Options:

Tech Turbo PC/XT Portable with 20 MB Hard Disk . \$1349
Tech Turbo PC/XT Portable with 1200 Baud Internal Hayes Compatible Modem and 20 MB Hard Disk . \$1549

TECH TURBO PC/XT PORTABLE.....\$ 999

Options:

Tech Turbo PC/XT Portable with 20 MB Hard Disk \$1449
Tech Turbo PC/XT Portable with 1200 Baud Internal Hayes Compatible Modem and 20 MB Hard Disk . \$1649

TECH PC/AT PORTABLE.....\$1799

Options:

Tech PC/XT Portable with 20 MB Hard Disk\$2199
Tech PC/XT Portable with 1200 Baud Internal Hayes Compatible Modem and 20 MB Hard Disk\$2399

TECH TURBO PC/AT PORTABLE.....\$1999

Options:

Tech PC/XT Portable with 20 MB Hard Disk\$2399
Tech PC/XT Portable with 1200 Baud Internal Hayes Compatible Modem and 20 MB Hard Disk\$2599

All TECH PC PORTABLES available with tape backups, hard disks up to 1 gigabyte, networking systems, and hundreds of other hardware and software accessories.

The Tech PC/AT and Tech Turbo PC/AT portable units are state of the art in portable performance. The 80286 microprocessor based units can be fitted with up to 240 megabytes of

high speed voice coil hard disk technology, and with the Turbo AT's 10 MHz math co-processor socket and 10 MHz 80286 microprocessor the unit can manipulate large spreadsheets

with unparalleled performance.

(714) 385-1711

1911 Betmor Lane,
 Anaheim, California 92805

Telex 272006 Answer Back
 - TECH FAX: 7143851523

TECH PC

Inquiry 352 for End-Users. Inquiry 353 for DEALERS ONLY.

**Upgrade
Your Lotus 1-2-3,
Framework, Symphony,
Enable Or Smart Software
For Only \$155! Call For Details.
Act Now! Offer Expires Nov. 30, 1986.**

Available in English Language Version Only

INTRODUCING OPEN ACCESS® II™

THE FULLY INTEGRATED BUSINESS SYSTEM
WITH THE WORLD AT YOUR FINGERTIPS

Open Access II Comparison Chart

	Database	Form Query	Report Generator	Query Processor	Relational Database	Graphics	3-D Graphics	Spreadsheet	Goal Seeking	Word Processor	Communications	Time Management	Price
Open Access II	✓	✓	✓	✓	✓	✓	✓	✓	✓	✓	✓	✓	595⁰⁰
Lotus 1•2•3	✓					✓		✓					495 ⁰⁰
Symphony	✓	✓	✓			✓		✓		✓	✓		695 ⁰⁰
Framework	✓		✓	✓		✓		✓		✓	✓		695 ⁰⁰
Enable	✓		✓			✓	✓	✓		✓	✓		695 ⁰⁰
Smart	✓	✓				✓	✓	✓		✓	✓	✓	895 ⁰⁰

**NETWORK VERSION
AVAILABLE**



Open Access II is a new, super-program which can perform virtually every managerial and business task you'll ever need with performance and ease-of-use unheard of in the industry.

Open Access II combines an extremely powerful relational database and superior spreadsheet with data communications, word processing, 3-dimensional graphics, and time management. Information is conveniently changed from module to module.

Open Access II's Database features an effective and flexible report generator and user definable screens. "Programmer," our new Database language, features simple interacting English-like commands to produce your customized applications.

Open Access II's Spreadsheet offers a unique combination of business problem solving capabilities; including goal-seeking, and an advanced table look-up command. Professional business presentations are easily produced by the enhanced graphic capabilities.

Open Access II's improved Word Processor can merge data from Spreadsheet or Database easily to produce reports, mail merge and graphic presentations.

Open Access II's data communications provides you with the capabilities to handle any of your micro computer communications needs. All of Open Access II's modules work together and data is easily communicated to the rest of the world.

**BEST OF ALL,
THE PRICE**

\$595. U.S. Version Only

Open Access II's super program is also available in the network version. Ask for details. Call (619) 450-1526 in California, or (800) 521-3511 if outside California for your nearest authorized dealer or distributor and expand your business base with Open Access II, the fully integrated business system.

SPI

SOFTWARE PRODUCTS INTERNATIONAL

10240 Sorrento Valley Road
San Diego, California 92121
(619) 450-1526

For Your Authorized Dealer
In California

(800) 621-7490

Outside California

(800) 521-3511

© 1986 Software Products International, Inc. All rights reserved.
Open Access II is a registered trademark of Software Products International, Inc.
Open Access II is a trademark of Software Products International, Inc.
Lotus 1-2-3 and Symphony are registered trademarks of Lotus Development Corp.
Framework is a registered trademark of Ashton-Tate.
Enable is a trademark of The Software Group.
Smart is a trademark of Innovative Software, Inc.

Inquiry 333 for End-Users.
Inquiry 334 for DEALERS ONLY.

*Price: U.S. Version Only

NEC Introduces Fast IBM-compatible Portable

NEC Home Electronics has released the MultiSpeed, its first IBM-compatible laptop computer. The computer has a 16-bit NEC V30 (8088-compatible) microprocessor running at either of two clock speeds: 4.77 MHz or 9.54 MHz.

The MultiSpeed features two 3½-inch 720K-byte floppy disk drives, a detachable LCD screen, and a built-in keyboard with a separate numeric keypad. The computer's memory is composed of 640K bytes of RAM and 512K of ROM. Included in the ROM are a number of desktop utility programs with windowing capabilities.

The MultiSpeed also includes a parallel port, serial port, and RGB display connector. The 80-character by 25-line LCD uses high-contrast "super-twisted pair" technology and features a resolution of 640 by 200 pixels. Battery life is said to be 6 to 10 hours.

The 11-pound laptop computer, which supports MS-DOS 3.2, has a retail price of \$1995. Options include an internal 300/1200-bps Hayes-compatible modem, two external 5¼-inch floppy disk drives, and a PC-compatible file transfer package. For more information, contact NEC Home Electronics (U.S.A.) Inc., Computer Products Division, 1255 Michael Dr., Wood Dale, IL 60191, (312) 860-9500. Inquiry **550**.

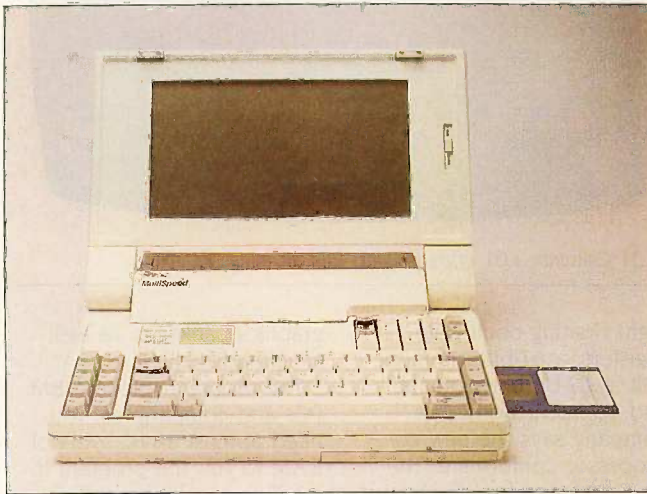

NEC's MultiSpeed runs at 4.77 and 9.54 MHz.

Hand-Printed Character Recognition

Incorporate your own hand-printed characters into your applications with Handprints, a program that includes C and assembly language callable routines for character entry and recognition. The routines take up about 12K bytes of RAM, according to Skylight Software, the manufacturer.

Handprints runs on IBM PCs and compatibles and costs \$1200. Contact Skylight Software Inc., 2 Charles St., Bedford, MA 01730, (617) 275-2999. Inquiry **551**.

Convergent's S/50 Workstation

Convergent Technologies introduced several 68000-based workstations, including the S/50, a 68010 machine that has an op-

tional IBM PC XT-compatible coprocessor.

The S/50, which has a base price of \$5500, supports five users under AT&T's UNIX System V release 5.2. Its system board, which operates at 10 MHz, is available with 1 or 2 megabytes of RAM, and its memory management system supports demand paging with 4 megabytes of virtual address space. Also included on the main processor board is a 300/1200-bps modem and circuitry to control two data lines and a voice line. Two tip/ring line jacks and one telephone jack are standard, as well as one RS-232C serial port and one parallel port. The board provides controllers for the machine's 5¼-inch floppy disk and hard disks, available in capacities from 24 to 85 megabytes.

An additional 2 megabytes of RAM, for a system total of 4 megabytes, can be added via the expansion

slots. The three available slots can accommodate a variety of options, including a coprocessor board (\$1000) that runs standard IBM PC XT software, a two-port RS-232C board, a combination RS-232C board with 1 megabyte of RAM, an Ethernet interface, and a controller for an external ¼-inch streaming tape drive.

The S/50 workstation comes with a keyboard, mouse, and 12-inch diagonal monitor that displays 80 columns by 29 rows and offers a resolution of 720 by 348 pixels. The system's software costs \$795, which includes UNIX and the firm's WGS/Office software, an integrated package that provides access to UNIX-based applications. The package includes a word processor, spreadsheet, calendar, and electronic mail system.

Among the other workstations in the series are the 68020-based S/120 and S/220, which support 12 and 22 users, respectively, at 12.5 MHz; the S/320 and S/640, which handle 32 and 64 users; and the S/1280, which can support up to 128 users at 8.8-MIPS performance levels. Contact Convergent Technologies, 2700 North First St., San Jose, CA 95150, (408) 434-2848. Inquiry **552**.

Accounting on the Atari ST

The PayDay payroll program for the Atari ST is the first in a set of account-

(continued)

ing software announced by Crystal Software. According to Crystal, the program can handle a \$21 million payroll with up to 255 employees and is capable of printing monthly, quarterly, or yearly tax information. You can also print W-2 tax forms, employee lists, personnel information, mailing labels, and continuous checks.

A configuration utility enables you to adapt the program according to your state's tax and small-business laws. The program is menu-driven and offers context-sensitive help.

PayDay sells for \$69.95 and runs on the Atari 520ST and 1040ST with at least one 360K floppy disk drive. For more information, contact Crystal Software, P.O. Box 803, Merlin, OR 97532, (503) 479-9516. Inquiry 553.

Motorola Develops Successor to 68020

Motorola's Microprocessor Group announced the MC68030, a 32-bit processor that the company claims is twice as fast as the 68020 and is fully code-compatible with its existing 16-/32-bit chips.

The chip, about $\frac{3}{8}$ -inch square, uses 300,000 transistors. According to Motorola, the 68030 is the first single-chip microprocessor to use the "Harvard-style" parallel architecture incorporated in some mainframes and supercomputers. The company claims the new device is the first 32-bit microprocessor to have on-chip instruction and data caches. The chip supports a synchronous bus interface with two-clock-cycle access and an asynchronous interface with one-clock-cycle burst access.

At the same time, the firm announced the MC68882, a 32-bit floating-point co-processor. This chip features

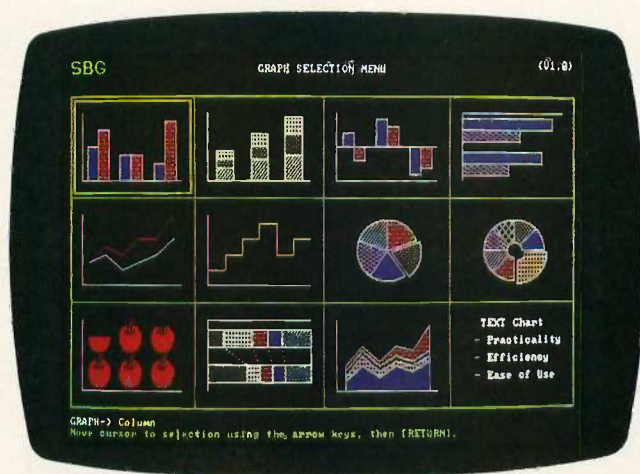

VCN Concorde 1.01 offers graphics and an image database.

eight floating-point data registers, a 67-bit arithmetic unit, a 67-bit barrel shifter, and 46 instructions. The company says the new co-processor conforms to the IEEE-754 standard for binary floating-point math.

Sampling and production for both chips are scheduled to begin in 1987. Final prices were not yet set at press time; the company estimates the chips will cost \$150 to \$200 in lots of 5000. For more information, contact Motorola Inc., Microprocessor Products Group, P.O. Box 52073, Phoenix, AZ 85072, (512) 440-2839 (in Austin, TX). Inquiry 554.

Business Graphics with Image Database

VCN Concorde version 1.01 offers business graphics, freehand painting, slide show and animation capabilities, and text generation. The package includes 16 fonts, 15 of which are proportionally spaced. Also included is Image Database, which contains over 2000 bit-mapped pictures. VCN Concorde works with word-processing and

graphics packages, as well as spreadsheets.

The program runs on IBM PCs and compatibles. You need at least 384K bytes of RAM to run the program in medium resolution and 640K for high resolution. VCN Concorde sells for \$695. For more information, contact Visual Communications Network Inc., 238 Main St., Cambridge, MA 02142, (617) 497-4000. Inquiry 555.

Software Library for Series 151 Image Processor

ITEX 151 is a subroutine library of over 200 image-processing and graphics routines designed for use with Imaging Technology's Series 151 Image Processor. The program includes board-level access and control routines, look-up table operations, image filtering and convolutions, graphics, image geometry, and statistical analysis.

The program is distributed as object code for MS-DOS systems and costs \$995. Contact Imaging Technology Inc., 600 West Cummings Park, Woburn, MA 01801, (617) 938-8444. Inquiry 556.

Paradise EGA Chip Has Higher Resolution

Paradise Systems has developed a single-chip Enhanced Graphics Adapter compatible with IBM's EGA that provides an extended EGA mode when used with continuous frequency monitors, like NEC's MultiSync. The chip, called the PEGA 2, offers a resolution of 640 by 480 pixels, in contrast to the maximum 640 by 350 resolution provided by IBM's EGA.

The 84-pin chip enables EGA software to run on standard monochrome and color monitors and enhanced monitors. It also permits EGA software to be emulated on monitors with 640 by 480 resolution (the same as that supported by the IBM Professional Graphics Controller) or 640 by 400 resolution (compatible with the AT&T PC 6300). The chip also supports the IBM CGA, MDA, and Hercules monochrome graphics standards.

The firm will provide software developers with drivers for Microsoft Windows, GEM, and a variety of applications programs, including CAD, graphics, and desktop publishing packages.

Production quantities are slated to be available this year; the price is set at \$55 each in OEM quantities. For more information, contact Paradise Systems Inc., 217 East Grand Ave., South San Francisco, CA 94080, (415) 588-6000. Inquiry 557.

IBM Adds RAM, Storage to RT PC

IBM has introduced a new desktop model of its 32-bit RISC-based RT PC, called the RT PC 6151

(continued)

Orchid's TurboEGA™

The world's fastest EGA



**FREE
MS WINDOWS™**



Introducing the only Enhanced Graphics Adapter with PcTurbo™ speed.

The experts agree: the EGA is the breathtaking new graphics standard, but the sophisticated software written for it places a big burden on the PC's processing speed. Beautiful graphics, crisp text, but too slow.

Everyone else rushed their EGAs to the market, but Orchid Technology took the time to do it right. Orchid's TurboEGA™, from the inventors of PC TurboProcessing, packs a high-speed Turbo and an EGA into one slot, for the world's fastest EGA.

Graphics with Speed

TurboEGA makes IBM PCs and XT's run faster than an AT. It brings dazzling speed to sluggish graphics programs. All types of software run faster, so you finish more quickly. Transparent to the user, you won't know it's there until you see its speed.

We are so confident that our TurboEGA is the ultimate graphics card that we decided to give away a free copy of Microsoft's Windows™ with each TurboEGA*. Even Microsoft recommends that you run Windows on an AT. Now Orchid's TurboEGA gives you AT speed so XT users can use this number one windowing software at the speed they demand.

The Complete Solution

Only Orchid puts this much performance into one slot and comes fully loaded with 256K of RAM, so there's no hidden cost. TurboEGA is the complete graphics solution.

Pick up the phone and find out how you can have the EGA the competition wishes they had: Orchid's TurboEGA, the world's fastest.

If you have an AT or a system with 80286 speed, ask about the Orchid EGA™—four graphic-card compatibility in one slot.

Features:

- Powered by 7.2MHz 80286
- Optional 5 or 8MHz 80287
- 256K of on-board RAM
- Four graphics modes: EGA, CGA, MDA, Hercules
- Supports the long list of EGA software:
 - Microsoft Windows & Word
 - Lotus 1-2-3 & Symphony
 - Topview
 - Framework
 - Chart-Master
 - AutoCAD
 - PC Paint Plus
 - and more...

47790 Westinghouse Dr.
Fremont, CA 94536
415/490-8586
Tx: 709289



The Innovative Leaders

* Offer good on TurboEGA while supplies last. Please allow two weeks for delivery.

TurboEGA, OrchidEGA, and PcTurbo and trademarks of Orchid Technology. Microsoft Windows is a trademark of the Microsoft Corporation. All other product names are trademarks of their manufacturers. CGA screen by PC Paint Plus.

Inquiry 427 for End-Users. Inquiry 428 for DEALERS ONLY.

DECEMBER 1986 • BYTE 31

model 15. Priced at \$10,050, the unit comes with 2 megabytes of internal memory and a disk capacity of 70 megabytes. The firm also introduced a 4-megabyte memory expansion card (\$4300) that can bring the RT's memory to a total of 8 megabytes, double the computer's previous maximum.

IBM said it will release a revised version of the RT's UNIX-based operating system next year. AIX 2.1 will handle 16 users concurrently (double the capacity of the original version) and provide the RT with Systems Network Architecture capabilities. Also sometime next year, IBM will bring out an SCSI adapter card (\$1080), a System/370 host interface adapter (\$1795), and a plug-in board called the Advanced Floating-Point Accelerator (\$1995) that the company claims will nearly triple the speed of floating-point calculations. For more information, contact IBM Corp., Information Systems Group, 900 King St., Rye Brook, NY 10573. Inquiry 558.

Presentation Charts and Graphs on the IBM PC

With Stella Business Graphics, you can produce graphs and charts by supplying data and labels through the Stella Data Spreadsheet. Stella also works with your spreadsheet, word-processing, and numerical database programs to create graphic presentations. Stella offers you a choice of 12 graphic formats, and you can import data from ASCII or DIF files to create pie, donut, area, column, deviation, bar, pictograph, and text charts.

Stella Business Graphics costs \$199 and runs on IBM

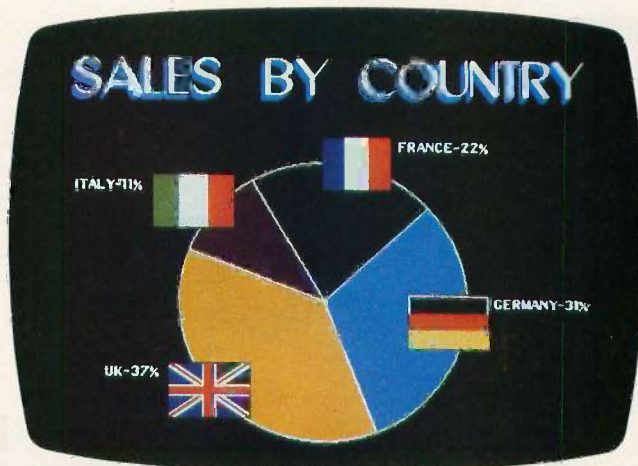

Stella Business Graphics for IBM PCs and compatibles.

PCs, XT's, AT's, or compatibles with 320K bytes of RAM and an Enhanced Graphics Adapter, Color Graphics Adapter, or a Hercules-compatible graphics board. Stella Systems recommends using a hard disk drive. The program works with dot-matrix and laser printers, plotters, and film recorders.

For more information, contact Stella Systems Inc., 10430 South De Anza Blvd., Cupertino, CA 95014, (408) 257-6644. Inquiry 559.

Chip Replaces Seven in PC AT

Chips and Technologies introduced an IBM PC AT-compatible chip that replaces seven VLSI chips on the AT system board. The 82C206 Integrated Peripheral Controller (IPC) performs the functions of two 8237 DMA controllers, two 8259 interrupt controllers, an 8254 timer/counter, a 146818 real-time clock, and a 74LS612 memory mapper.

The 84-pin CMOS chip consumes one-tenth the power of and operates 60 percent faster (8-MHz versus 5-MHz DMA clock) than the

seven chips it replaces, the company claims. The IPC is designed to be used with the firm's AT-compatible CS8220 CHIPSet, five chips on a board that replace 63 logic devices on the AT board; the current CHIPSet system board has a socket to accept the 82C206. The CHIPSet board is about half the size of the AT board, operates 25 percent faster (10 MHz versus 8 MHz), and consumes one-third the power (15 W versus 42 W).

Chips and Technologies will sell the DK8220 development kit for the 82C206; it includes data sheets, schematics, and an evaluation board to be used in design environments. The DK8220 board has a diagnostic LED display, test points, programmable wait states, AT BIOS, and sockets for expansion.

The 82C206 costs \$49 each in quantities of 100; the CHIPSet remains \$51 each in the same quantities. The development kits are \$1495 each. For more information, contact Chips and Technologies, 521 Cottonwood Dr., Milpitas, CA 95035, (408) 434-0600. Inquiry 560.

32-bit Floating-Point Processing for PCs

Data Translation's MACH Series for the IBM PC, XT, and AT is designed to provide floating-point capabilities for the company's data-acquisition and image-processing boards.

The series includes the DT7010 Floating-Point Array Processor, a plug-in board based on Advanced Micro Devices' Am29325. The chip incorporates a 32-bit floating-point ALU and multiplier with a 32-bit data path. The \$4995 board, the company reports, performs floating-point operations in a single clock cycle at a rate of 6.5 MFLOPS, using the IEEE-754 standard. The board's microcode memory (2K by 56 bits) provides storage for microcoded routines that can be called from the accompanying software and for user-written microcoded routines. Its data memory (8K by 32 bits) is mapped into the host computer's memory space.

The series' software consists of three modules. The Vector Subroutine Library, which is priced at \$1495, incorporates 115 subroutines that can be called from user-written programs in C or FORTRAN. The Microcode Assembler, designed for developing microcoded algorithms, provides access to the individual systems on the processor board and lets you write routines for specific applications. The Simulator enables you to write, run, and analyze custom-written microcoded routines without using a DT7010 board. The Assembler and Simulator sell for \$1495; all three programs cost \$2495 when purchased together. Contact Data Translation Inc., 100 Locke Dr., Marlborough, MA 01752, (617) 481-3700. Inquiry 561.

(continued)

RAM-Resident Program Users...

IT'S EASY TO WIN WHEN YOU BUY THE REFEREE™

**With Referee,
you make
the rules.**

If you use desktop organizers, spell checkers, keyboard enhancers or other RAM-resident programs, you may have already discovered the horror of "RAM Cram."

RAM Cram occurs when memory-resident programs compete with each other (and with applications programs) for control of your keyboard or other computer resources. It's a fierce competition that can cause your computer to lock up completely. Then you pay the penalty—in lost time and lost data.

Referee, by Persoft, is a new type of software that puts you in total control of your RAM-resident programs.

And that puts Referee in a league all its own. You can create your own RAM Teams™ for specific applications programs. Team Superkey™ and Sidekick™ with Lotus 1-2-3™. Or call in Prokey™ and bench the others when you switch to dBASE III™.



Load all the programs you need at the beginning of your workday. Referee automatically activates and deactivates the ones you need according to *your* set of rules. Instantly. Invisibly. You can also use Referee to unload programs from memory—even those with no unload option of their own.

Referee's Sideline™ menu enables you to control RAM-resident programs from within an applications program!

It's ideal for integrated packages like Symphony™. You can use a keyboard enhancer with the spreadsheet module. Or deactivate it, enter the word processing module and activate your favorite spell checker. It's easy. And you never have to back all the way out of the program!

Referee puts an end to RAM-resident program conflicts. At \$69.95, it solves a very big problem for a very small price.

It's easier to win with the Referee on your side. For more information, and for the dealer nearest you, contact: Persoft, Inc., 465 Science Drive, Madison, WI 53711, (608) 273-6000—Telex 759491.

Referee™

persoft

© Copyright 1986 Persoft, Inc. All rights reserved.
Referee, Sideline, and RAM Teams are trademarks of Persoft, Inc.
Sidekick and Superkey are registered trademarks of Borland International, Inc.
Lotus 1-2-3 and Symphony are registered trademarks of Lotus Development Corp.
Prokey is a trademark of RoseSoft, Inc.
dBASE III is a registered trademark of Ashton-Tate.

Perspective in 3-D

Three D Graphics announced a three-dimensional business graphics program. Perspective enables you to choose from 33 three-dimensional and 16 two-dimensional preprogrammed graph types. You can customize the graph by modifying the viewing angle, picture size and placement, primary and background shades and patterns, and title designs. Also included are a data manager and a label manager.

Perspective runs on IBM PCs and compatibles with a medium- or high-resolution display, a graphics card, a monochrome graphics controller, and MS-DOS or PC-DOS 2.0 or higher. The program costs \$295. For information, contact Three D Graphics, 860 Via de la Paz, Pacific Palisades, CA 90272, (213) 459-7949. Inquiry 562.

Slide Maker Based on PC

General Parametrics, manufacturer of presentation graphics products including VideoShow, has come out with a film recorder that connects to an IBM PC or compatible for the production of 35mm slides. Slides produced with the device can use up to 1000 colors with 2048 by 2048 resolution.

The PhotoMetric 200 PC system includes a desktop box containing a 35mm camera, an interface board that's inserted in the computer, and menu-driven software. Images produced with any PC graphics program (Lotus 1-2-3, ChartMaster, Microsoft Chart, Harvard Presentation Graphics, Freelance, PictureIt, and so forth) can be previewed in full



The PhotoMetric 200 PC, a slide-making system.

color and at high resolution before the slide is made. No adjustments need to be made before the slide is produced; the unit incorporates automatic exposure calibration, which adjusts brightness and exposure times.

The 200 PC contains an on-board 8086 microprocessor and 1 megabyte of RAM. The high resolution and large number of available colors are generated by video circuitry, called MacroVision, developed by General Parametrics. The system, which includes the film recorder, board, 35mm camera, and software, has a retail price of \$5995. For more information, contact General Parametrics Corp., 1250 Ninth St., Berkeley, CA 94710, (415) 524-3950. Inquiry 563.

PC Clock Card Shares Slot

The SideClock, designed for IBM PCs, XTs, and compatibles, is able to share an expansion slot with any other expansion card. Measuring about 1 inch by 4 inches, the card has a rectangular hole in its center and is horizontally mounted

on any of the expansion slots in the computer's motherboard. A second expansion card can be inserted through the SideClock's center hole into the same slot.

The SideClock costs \$59.95 and includes clock/calendar functions, a 5-year lithium battery, and control software. For more information, contact Innoventions Inc., 1669 South Voss, Suite 880, Houston, TX 77057, (713) 728-0938. Inquiry 564.

Stereo Sound for Apple's IIGS

MDIdeas' SuperSonic board enables the Apple IIGS to produce stereo sound. The board incorporates high-speed analog demultiplexing circuitry to separate audio into two separate channels. Its fourth-order digital filters allow only selected frequencies to pass through, and its buffer amplifiers isolate the audio for clean line-level output.

The board comes with two 0.5-watt amplifiers that can drive 8-ohm speakers and has an edge connector for future enhancements, such as a sound digitizer. You can also select power output levels for speakers or headphones. According to the company, the SuperSonic

supports Apple's routines for the IIGS's Ensoniq sound chip and is compatible with software that can address the chip, like Electronic Arts' Music Construction Set.

Suggested retail price is \$59.95. For more information, contact MDIdeas Inc., 1111 Triton Dr., Suite 205, Foster City, CA 94404, (415) 573-0580. Inquiry 565.

Tektronix 4115 Graphics Terminal Emulator

TGRAF-15 emulates a Tektronix 4115 graphics terminal. It enables you to run minicomputer and mainframe graphics programs using your personal computer as a terminal. TGRAF-15 can display images of up to 1280- by 1024-bit resolution with 256 colors out of a palette of up to 16 million colors.

The program supports applications that require 32-bit coordinates, which enables you to store detailed graphics data and examine it by zooming in on the screen image. There are functions for generating circles, arcs, rectangles, points, vectors, and filled panels. You can use the extended graphics input mode, which includes user-definable and multiple cursors. You can also establish up to 64 graphics windows, providing multiple views of a complex graphical model.

TGRAF-15 runs on IBM PCs, XTs, ATs, and compatibles. It costs \$1995. For more information, contact Grafpoint, 4340 Stevens Creek Blvd., San Jose, CA 95129-1102, (408) 249-7951. Inquiry 566.

(continued)

YOU ARE ABOUT TO BE SEDUCED BY POWER AND MONEY.

Admit it. You're intrigued with the idea of C programming. You may be working in BASIC, Pascal or Assembler now. But you're drawn to the power, portability and flexibility of C. And if money is what motivates you, imagine having it all for just \$75 with Mark Williams Let's C.®

EVERYTHING YOU COULD ASK FOR IN A C COMPILER.

Let's C is no mere training tool. It's a complete, high quality C compiler. With the speed and code density to run your programs fast and lean. It won't get you side-tracked on some quirky aberration of C; Let's C supports the complete Kernighan & Ritchie C language—to the letter. And it comes from the family of Mark Williams C compilers, the name chosen by DEC, Intel, Wang and thousands of professional programmers.

POWERFUL UTILITIES ARE A REAL BONUS

Let's C doesn't stop with being a high performance C compiler. It includes utilities you'd expect to pay extra for—like a linker and assembler plus the MicroEMACS full screen editor with source code included. Having the source code not only allows you to customize the editor, it offers a close up, fully commented view of C programming at its best.

REVIEWERS ARE SOLD ON LET'S C, TOO.

"Let's C is an inexpensive, high-quality programming package...with all the tools you will need to

Features

- For the IBM-PC and Compatibles
- Fast compact code plus register variables
- Full Kernighan & Ritchie C and extensions
- Full UNIX compatibility and complete libraries
- Small memory model
- Many powerful utilities including linker, assembler, archiver, cc one-step compiling, egrep, pr, tail, wc
- MicroEMACS full screen editor with source

- Supported by dozens of third party libraries
- Upgradeable to C Programming System for large scale applications development
- Not copy protected

Let's C Benchmark Done on an IBM-PC/XT, no 8087.
Program: Floating Point from BYTE, August, 1983.

Exec Time in Seconds	
Let's C	134
MS 4.0	147

MARK WILLIAMS LET'S C
\$75
60 DAY MONEY BACK GUARANTEE

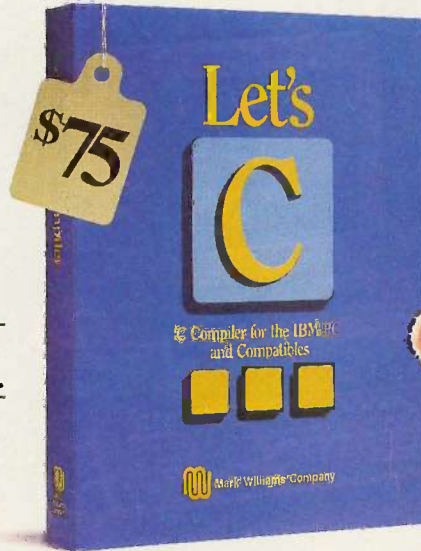

create applications."

—William G. Wong, *BYTE*, August 1986.

"Let's C is a thoroughly professional C environment loaded with tools and programming utilities...another fine Mark Williams product."

—Christopher Skelly, *COMPUTER LANGUAGE*, February 1986

"The performance and documentation of the \$75 Let's C compiler rival those of C compilers for the PC currently being sold for \$500... highly recommended..."

—Marty Franz, *PC TECH JOURNAL*, August 1986

ADD THE *csd* DEBUGGER AND CUT DEVELOPMENT TIME IN HALF.

Invest another \$75 and you've got Mark Williams revolutionary source level debugger. *csd* lets you bypass clunky assembler and actually debug in C. That's a big help when you're learning C and indispensable when you're programming. *csd* combines the interactive advantages of an interpreter with the speed of a compiler, slicing development time in half. This is how Byte Magazine summed it up: "*csd* is close to the ideal debugging environment." William G. Wong, *BYTE*, August 1986



ARE YOU STILL RESISTING?

If there's any doubt that now's the time to get your hands on the power of C, consider Mark Williams 60-day money back guarantee. You can't lose. But with Let's C and *csd*, imagine what you could gain.

Ask for Let's C and *csd* at your software dealer's, in the software department of your favorite bookstore, through the Express Program at over 5500 Tandy stores or order now by calling 1-800-MWC-1700.*

*In Illinois call 312-472-6659



1430 West Wrightwood, Chicago, Illinois 60614

Inquiry 212

© 1986, Mark Williams Company
Let's C is a registered trademark of the Mark Williams Company
UNIX is a trademark of Bell Labs.

MARK WILLIAMS LET'S C. ONLY \$75.

SYSTEMS

**Wyse Announces
XT Compatible**

Wyse Technology has added the WYSEpc+, an IBM PC XT compatible, to its line of PC-compatible computers. The WYSEpc+ is based on the Intel 8088-1, a dual-speed processor that runs at 4.77 or 9.54 MHz, selectable from the keyboard. The computer includes a built-in display adapter on the motherboard that supports Hercules monochrome as well as IBM monochrome and color graphics adapter modes, 16 shades of gray, and the ability to display 132 columns by 44 lines.

Three models are available. The 1400-01 is a single floppy disk drive system with 256K bytes of RAM for \$1265; the 1400-02 comes with two floppy disk drives and 640K for \$1445; and the 1400-20 includes a single 360K floppy disk drive, a 20-megabyte hard disk, and 640K for \$1995.

All three systems are equipped with two serial ports, one parallel port, a real-time clock with battery backup, two available XT-compatible slots, and a standard AT-style keyboard or the enhanced version with function keys across the top row. All come with MS-DOS 3.1. Contact Wyse Technology, 3571 North First St., San Jose, CA 95134, (408) 433-1000. Inquiry 567.

**SB180FX Single-
Board Computer**

The SB180FX, a follow-up to the 8-bit SB180 single-board computer, is available from Micromint. The new version, like the first, is based on a Hitachi HD64180 processor running at 6.144 MHz; the new version's processor, though, can



The WYSEpc+, a dual-speed PC XT-compatible computer.

be upgraded to run at 9.216 MHz or 12.288 MHz. The company reports that the SB180FX is software- and hardware-compatible with the SB180 (see September 1985 BYTE, Ciarcia's Circuit Cellar), with the exception of additional connectors that support extra features.

With a base price of \$409, the SB180FX is equipped with 256K bytes of on-board dynamic RAM and can accommodate 512K bytes (compared to the 256K in the SB180). The memory can be expanded to 4 megabytes. The system also has an 8K, 16K, or 32K EPROM socket with an 8K ROM monitor. In addition to two serial ports and one parallel printer port, the SB180FX has a 4-bit memory extension address and 8255 PIA with 24 bits of parallel I/O. The board's SMC 9266 disk controller supports four floppy disk drives, and its NCR 53C80 SCSI controller can handle a 32-megabyte hard disk. Thirty-two ports from a total of 256 are available on a 40-pin

header, and the system can support 64 additional ports.

With software, the SB180FX sells for \$499. Contact The Micromint Inc., 25 Terrace Dr., Vernon, CT 06066, (800) 635-3355; in Connecticut, (203) 871-6170. Inquiry 568.

ITT's XTRA/286

ITT's Information Systems Division announced an IBM PC AT compatible, called the XTRA/286 Advanced Technology Workstation (ATW), that comes with a display adapter compatible with IBM's Enhanced Graphics Adapter, Color Graphics Adapter, and Monochrome Display Adapter, as well as the Hercules Graphics Card. The machine features a 10-MHz, one-wait-state 80286 processor (which can be switched from the keyboard to run at 6 MHz) and 640K bytes of memory. The ATW includes eight full-length expansion slots (six 16-bit and two 8-bit), plus five half-height drive slots. A serial and parallel port, clock/

calendar, and detachable keyboard are standard.

The base model, with a 1.2-megabyte floppy disk drive and the multimode graphics adapter, costs \$2499. A model with a 30-megabyte hard disk costs \$4299. Contact ITT Information Systems, 2350 Oume Dr., San Jose, CA 95131, (408) 945-8950. Inquiry 569.

**Portable
AT Compatible**

AMO Computer is selling a portable computer that's compatible with the IBM PC AT. Called the AMO 286 Model II, the computer runs on an 8- or 10-MHz 80286 and supports four graphics modes.

About the same size as the Compaq Portable II, the \$5995 computer is equipped with a 1.2-megabyte floppy disk drive, a 40-megabyte hard disk drive, and an AT-style keyboard. It comes with 1 megabyte of RAM that can be expanded to 4.1 megabytes on the motherboard. Three full-size expansion slots are available, and a built-in 9-inch dual-mode monitor is standard. Display modes supported include IBM monochrome, color, and enhanced graphics and Hercules monochrome graphics. An interface for external RGB, EGA, and monochrome monitors is standard; a composite-video port is optional.

Other standard features include a serial and parallel port, a real-time clock, a socket for an 80287 math coprocessor, and a 160-watt power supply. Contact AMO Computer Corp., 655 North Pastoria Ave., Sunnyvale, CA 94086, (408) 720-8055. Inquiry 570.

(continued)

MARK WILLIAMS C. AN ENLIGHTENING DEVELOPMENT FOR ATARI ST USERS.

If you've tried your hand at developing applications on the Atari ST, you know the problem. Programming tools aren't only hard to come by, they're hard to use. One might even say primitive. But now for some enlightening news: you can have all the power, portability and versatility of the C language from a leader in professional C programming tools, Mark Williams.

BRING YOUR PROGRAMMING UP TO SPEED.

The Mark Williams C compiler produces fast, dense code and supports the complete Kernighan & Ritchie industry standard C. You'll have access to GEM's AES and VDI libraries for programs using graphics, icons and the Atari mouse. And Mark Williams C lets you take advantage of the full 16 megabytes in Atari's 68000 microprocessor.

STREAMLINE DEVELOPMENT WITH POWER UTILITIES.

Mark Williams C is loaded with everything you'll need for professional development. Bring the power of the UNIX environment to your Atari ST with our

Features

C compiler

- Complete Kernighan & Ritchie C plus extensions
- Up to eight register variables
- Full access to AES and VDI libraries for programs using graphics, icons and mouse
- Complete UNIX-compatible libraries allow easy portability to and from UNIX development environment.
- Over 300 Atari-specific routines
- One-step compiling, linking with cc command
- English error messages
- Lint-like error checking

Microshell Command Processor, powerful UNIX style shell includes I/O redirection, pipes, command substitutions

MicroEMACS Full Screen Editor with commented source code included

Make Program Building Discipline Complete symbolic debugger with single-step, breakpoints and stack traceback

Assembler, linker and archiver Powerful Utilities Package: egrep, sort, diff, cmp, pr, tail, uniq, wc and more

Over 600 pages of documentation including 120 sample C programs Not copy protected

MARK WILLIAMS C FOR THE ATARI ST
\$179.95
60 DAY MONEY BACK GUARANTEE



Microshell Command Processor including pipes, I/O redirection and more. Edit your program with the highly acclaimed MicroEMACS full screen editor. Accelerate and simplify compiling with *make* which finds and recompiles only those modules affected by your changes. Then, when you're ready for debugging, call on our db Symbolic Debugger with single step, breakpoint and stack traceback functions. Over 40 commands, including a linker and assembler, provide a total development package for your Atari ST.

DEPEND ON A NAME WITH A HISTORY OF PERFORMANCE.

Mark Williams C for the Atari ST is part of our growing line of C compilers. A line that includes the C compiler chosen by DEC, Intel, Wang and thousands of professional programmers. Now our Atari C compiler is earning its own reputation:

"Finally a great C compiler that exploits the power of the ST"—Sigmund Hartmann, President, Atari Software Group

"The all-around best choice for serious software development on the ST."—Douglas Weir of *ANALOG COMPUTING*

GET WHAT YOUR ATARI ST HAS BEEN WAITING FOR.

Mark Williams C is just what your Atari ST was made for: powerful, professional programming. So now that you can have Mark Williams C for just \$179.95, what are you waiting for?

Ask your Atari dealer about Mark Williams C or order today by calling **1-800-MWC-1700.***

*In Illinois call: 312-472-6659

 **Mark
Williams
Company**

1430 West Wrightwood, Chicago, Illinois 60614

© 1986, Mark Williams Company
UNIX is a trademark of Bell Labs.

Inquiry 213

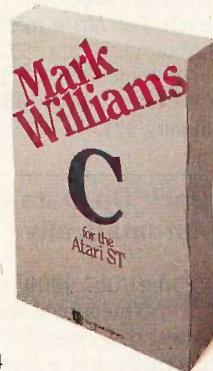

PERIPHERALS

Okidata's Laserline 6

Okidata has announced its first laser printer, the Laserline 6, that prints 6 pages per minute and features several plug-in modules, one of which enables up to three users to share a single printer.

Fifteen fonts are resident in the Laserline, and additional fonts are available on cartridges. The printer is equipped with a 128K-byte page-image buffer; an optional 384K expansion cartridge provides extra memory for loading additional fonts and macro commands. The company offers three plug-in personality modules. The basic module provides one port and compatibility with the Hewlett-Packard LaserJet, and the advanced module offers one port and compatibility with the HP LaserJet Plus. The third module, also compatible with the HP LaserJet Plus, provides three ports. The advanced and multiuser modules have extended graphics, downloadable fonts, and forms overlay capabilities. All three modules come with a parallel or serial interface.

Suggested retail price for the printer is \$1995, plus \$200 for the basic plug-in module. The advanced module sells for \$400, and the multiuser costs \$600. The memory expansion board costs \$399; additional font cartridges are \$149 each. For more information, contact Okidata, 532 Fellowship Rd., Mt. Laurel, NJ 08054, (609) 235-2600. Inquiry 571.

Back Up Data Automatically

The ARC 9000, a 60-megabyte streaming tape drive, operates continuously and automatically

to back up data as it's written to disk. Designed to work with IBM PCs, XTs, ATs, and compatibles, the unit provides a mirror image of all files and stamps each with the time and date. Files can be restored by time, date, filename, and directory, and by the entire disk. The unit also provides a real-time clock/calendar, a 128K-byte print spooler, battery-operated RAM, and diagnostic routines.

The drive, which sells for \$2600, comes with software and a half-slot adapter board with an SCSI interface and processor. An optional half-height hard disk that fits in the unit offers an added 10 to 80 megabytes of storage. For more information, contact Digital Storage Systems Inc., 1234 Sherman Dr., Longmont, CO 80501, (303) 651-6312. Inquiry 572.

Analyze IEEE-488 Bus Signals

The GBA 1500, an IEEE-488 bus analyzer, enables computers or terminals with an RS-232C port to capture and display up to 16,384 bus transactions. The unit can acquire, store, and display each byte as it's transmitted and then store the data for analysis. It can single-step the bus and display the data in IEEE-488 mnemonics and in hexadecimal format. The unit displays the status of control lines and the current location of its buffer pointer as well.

The GBA 1500 sells for \$795. For more information, contact Connecticut micro-Computer Inc., 568 Danbury Rd., New Milford, CT 06776, (203) 354-9395. Inquiry 573.

Microsoft Adds Menus to Mouse

Microsoft has added extra capabilities to its mouse, including menu support for Lotus 1-2-3, DisplayWrite 3, and MultiMate. In addition, the Microsoft Mouse version 6.0 is bundled with Microsoft Paintbrush and Show Partner, a presentation graphics package.

A serial version of the mouse sells for \$195; a bus version, \$175; and an InPort version, \$125. A programmer's reference kit for writing custom menus costs \$25. Contact Microsoft Corp., 16011 Northeast 36th Way, Box 97017, Redmond, WA 98073-9717, (206) 882-8080. Inquiry 574.

High-Speed Printers from Epson, C. Itoh

Epson's LQ-2500, a 24-pin dot-matrix printer, prints draft-quality text at 324 characters per second and near-letter-quality text at 108 cps with a density of 12 characters per inch. At 10 characters per inch, the printer's speed is 270 cps in draft mode and 90 cps in near-letter-quality mode.

The \$1595 printer has an LCD panel on the front for entering and storing printer setup commands. You can store four combinations of command sets and change them at any time.

The 136-column printer comes with serial and parallel interfaces and an 8K-byte buffer. Five typefaces are standard. The printer is compatible with software that works with the Epson LQ-800, LQ-1000, and LQ-1500. Contact Epson America Inc., 2780 Lomita Blvd., Torrance, CA 90505,

(800) 421-5426; in California, (213) 539-9140. Inquiry 575.

C. Itoh's ProWriter C-715 Reliant, a 24-pin dot-matrix printer, prints at 300 cps in draft mode and 100 cps in near-letter-quality mode. The Reliant also offers seven-color printing and credit-card-size plug-in personality cards.

The printer, which sells for \$1295, comes with a serial and parallel interface and a 32K-byte buffer. The plug-in cards, which cost \$49.95 each, emulate the Epson LQ-1000, IBM Proprinter XL, Toshiba P351, and Diablo 630 printers; the Epson card is standard. The printer also provides a hex-dump mode for debugging that prints hexadecimal and ASCII characters of each byte the printer receives. Contact C. Itoh Digital Products Inc., 19750 South Vermont Ave., Suite 220, Torrance, CA 90502, (213) 327-2110. Inquiry 576.

Test Dynamic RAMs

Adynamic RAM tester from Bugtrap Instrumentation is capable of testing a variety of dynamic RAMs, including 16K, 64K, 128K, 256K, 1 megabit, and others. The unit tests the DRAM using data patterns loaded into and read from all cells. Access time can be selected from a range of 100 to 300 nanoseconds; a refresh test is also available.

The unit can test a DRAM with a single test sequence or a series of test cycles for identifying intermittent or thermal failures. The Model 8000 Dynamic RAM Tester sells for \$1495. Contact Bugtrap Instrumentation, 1209 Alderwood Ave., Sunnyvale, CA 94089, (408) 734-1118. Inquiry 577.

(continued)



Clipper is the fastest dBase III and dBase III Plus™ compiler available. Nothing else comes close. When performance counts, experts rely on Clipper for more speed, more power, and more creative freedom. You can, too. Call for details.

- Clipper compiled programs run 2 to 20 times faster.
- No royalties...no runtime fees.
- Source code security.
- User defined functions.
- Arrays.
- Simple menu commands.
- Context sensitive help can be included with programs.
- More fields; more memory variables.
- Call C and Assembly programs.
- Complete debugging facilities.
- Multiple file relationships.
- IBM PC, XT, AT, 3270 compatible™.
- Multi-user capability.

Clipper™

CLIPPER. THE dBASE COMPILER.
A WINNING PERFORMANCE EVERY TIME.



Nantucket™

Nantucket Corporation
5995 South Sepulveda Boulevard
Culver City, California 90230
(213) 390-7923
Outside California call toll-free:
1-800-251-8438

dBase, dBase III, and dBase III Plus are trademarks of Ashton-Tate, Inc.
IBM PC, XT, AT, and 3270 are trademarks of International Business Machines Corporation.
Clipper and Nantucket are trademarks of Nantucket Corporation.

LOOK FOR CLIPPER™

Autumn '86

IT MAKES NETWORKING EASY.

Lotus HAL Lets You Do More With (And Get More From) 1-2-3 Than Ever Before.

Lotus HAL™ is a memory resident companion product for Lotus 1-2-3® that enhances the full range of 1-2-3's capabilities—and adds new ones.

It increases 1-2-3's power and flexibility, so you can work more efficiently and become more productive than ever before.

Benefits For All 1-2-3 Users

Lotus HAL works by giving you easier access to all of 1-2-3's numerous capabilities. And it's extremely useful for 1-2-3 users of all levels.

If you're new to 1-2-3, Lotus HAL will let you use it with greater confidence and speed.

If you're familiar with 1-2-3, Lotus HAL will make it easier for you to access additional power and capabilities.

And if you're an advanced 1-2-3 user, Lotus HAL will show you new features and functions that will add extra flexibility to the power of 1-2-3 you've already tapped.

How does Lotus HAL do all this—for all users?

Easier Commands

Lotus HAL makes executing 1-2-3 procedures even easier than before. Because it accepts phrases like "total sales," "graph Jan to Mar," or "copy this to A10," etc. In fact, Lotus HAL's vocabulary includes English words and phrases. So you can customize a command dictionary of your own—with the words and operations you're most used to and most comfortable using.

Since Lotus HAL makes 1-2-3 more accessible for all users, you'll learn more—in less time—about all the capabilities of 1-2-3.

For instance, if you're presently using only the spreadsheet, Lotus HAL will show you how to create graphs and do database functions—far more simply than ever before.

Time-Saving Shortcuts, Easy-To-Creatе Macros

With Lotus HAL, you'll take shortcuts and accomplish multi-step tasks quickly and easily. So you'll greatly reduce errors—and save time.

And, with a simple "undo" command, Lotus HAL even lets you recover from errors you've already made. So if you're a novice user, you'll learn faster and with greater confidence. And if you're an experienced user, you can experiment more freely and do "what ifs"—without fear of having a mistake destroy hours of work.

Lotus HAL also makes developing macros simpler than ever—so simple, in fact, that even novice users can create 1-2-3 macros with Lotus HAL. And no matter how familiar with 1-2-3 you are, you'll benefit from being able to write and test macros to make sure they do what you had in mind.

New Power

Lotus HAL will let you take 1-2-3 as far as you need. And if you've been taking it far already, Lotus HAL offers you new commands that will further enhance your productivity.

For example, Lotus HAL lets you replace items anywhere in the worksheet (even within formulas), and create a dynamic link between cells in multiple worksheets. It also lets you audit your worksheet—so you can find mistakes without having to review the entire sheet "manually."

Best of all, while Lotus HAL greatly enhances 1-2-3's commands, it doesn't change either 1-2-3 or the worksheet. It's always available, but it never gets in your way. And you can share data as freely when you're using Lotus HAL as you did when you were using 1-2-3 alone.

In fact, you can do everything you've ever done with 1-2-3 even better... plus a great deal more.

And since Lotus HAL is part of the 1-2-3 system—and the Lotus family—you get an unparalleled commitment to customer service and support that will keep you up and running.

© 1986 Lotus Development Corporation.

Lotus and 1-2-3 are registered trademarks of Lotus Development Corporation. Lotus HAL and 1-2-3 Companion are trademarks of Lotus Development Corporation.

Lotus HAL is distinguished from HAL which is a trademark of Qantel for its Hotel and Leisure software.

System Requirements.

Lotus HAL requires 1-2-3 Release 1A, Release 2 or Release 2.01 for personal computers from IBM, COMPAQ, and AT&T, plus 1-2-3 Certified Compatibles; DOS 2.0 or higher. Please refer to your 1-2-3 package or 1-2-3 documentation for appropriate hardware configurations and DOS requirements or consult your dealer.

Lotus HAL resides in memory with 1-2-3 and operates with it; a minimum system configuration of 512K is required.

*Lotus HAL does not operate with 1-2-3 for the IBM PCjr (ROM version), IBM PC Convertible or Release 1A for the IBM 3270 PC.

THE
1-2-3



1-2-3
GREAT

STAIRWAY TO HEAVEN

1-2-3

EVEN BETTER

↑
LOTUS HAL



Try Lotus HAL Without Obligation For 30 Days.

For a limited time*, when you purchase Lotus HAL for only \$150, you'll get a 30 day money back guarantee from Lotus.

It's an unconditional guarantee that will allow you to put Lotus HAL through its paces on your own work—and see how it can make you more productive.

If, for any reason at all, you're not satisfied with the performance of Lotus HAL, simply send your Lotus HAL package back to Lotus. We'll send you a full refund. No questions asked.

It's a totally risk-free way to try one of the most remarkable productivity tools available today for 1-2-3 users.

But order today. Because there are two million 1-2-3 users who are going to be as impressed with Lotus HAL as you are. And quantities are limited.

To get Lotus HAL, visit your local authorized Lotus dealer, or just complete the coupon below, enclose it with your check, money order or credit card information and mail it to the address provided.

Or, for even faster service, order Lotus HAL (Product No. YD-1377), by calling Lotus, toll free, at

1-800-345-1043.

Lotus HAL

A 1-2-3 Companion™ that makes 1-2-3 a more powerful and accessible productivity tool.

Complete and return to: Lotus Development Corporation, 90 Annex, Atlanta, Georgia, 30390-0370 or call 1-800-345-1043.

- Yes, I'd like to try Lotus HAL for 30 days without obligation. (YD-1377)
- Please send more information about Lotus HAL. (YD-1385)

Send me _____ unit(s) of HAL @ \$150 each _____

Sales Tax** _____

Total _____

I've enclosed my check or money order made payable to: Lotus Development Corporation.

Please charge my: VISA MasterCard

Card No. _____

Expiration Date _____

Signature _____

Name _____

Company _____

Address _____

City _____ State _____ Zip _____

Telephone (____) _____

*Offer expires February 28, 1987.
**Residents of the following states apply applicable sales tax: CA, DE, FL, GA, MA, MD, MI, MN, MO, NJ, NY, OH, TX, VA, WA. Offer good in U.S.A. and Canada only. In Canada make payment by credit card or International Postal Money Order. CODs and purchase orders will not be accepted.

A D D - I N S

PC Convertible Modem

Megahertz has introduced a Hayes-compatible modem for use with the IBM PC Convertible. Built to the same physical specifications as IBM's modem, the EasyTalk 1200 operates at 300/1200 bps. It comes with two phone jack connectors and features a low power requirement (250 milliwatts when operating) as well as a utility that can turn the modem off to prevent draining the computer's battery.

The modem is capable of full- and half-duplex communication, has auto-answer and auto-dial capabilities, supports rotary and pulse dialing, and is compatible with Bell 103 and 212A and CCITT V.22 standards. Without software, the modem sells for \$400; with a full-function communications program, the cost is \$450. For more information, contact Megahertz Corp., 2681 Parleys Way, Suite 2-102, Salt Lake City, UT 84109, (800) 338-8726; in Utah, (801) 485-8857. Inquiry 578.

Up to 54 Megabytes on a 3½-inch Hard Disk

Rodime announced the RO 3000 Series of 3½-inch hard disk drives that provide 45.4 or 54.5 megabytes (unformatted) of storage capacity. The drives use a voice-coil actuator and offer an average access time of 28 milliseconds. Their power consumption is 11 watts.

The company says that the drives can be used with most controllers and multiple drives can be daisy-chained from a single controller. The single-unit OEM price for the 45-megabyte

drive is \$895; for the 55-megabyte drive, \$995. Contact Rodime, 901 Broken Sound Parkway NW, Boca Raton, FL 33431, (305) 994-6200. Inquiry 579.

Extra Memory for Apple IIGS

Orange Micro's RamPak 4GS memory board for the Apple IIGS provides 512K bytes of RAM that can be expanded to 4 megabytes in 256K-byte increments. The board's memory is automatically configured, and its diagnostics utility can detect RAM problems.

Also bundled with the board are utilities for RAM caching and dynamic allocation of memory. With 512K bytes of RAM, the board costs \$259. For more information, contact Orange Micro Inc., 1400 North Lakeview Ave., Anaheim, CA 92807, (714) 779-2772. Inquiry 580.

Two memory boards for the Apple IIGS are available from Applied Engineering. The GS-RAM offers up to 1.5 megabytes on one card; an optional piggyback card, expandable to 2 megabytes, brings the total to 3.5 megabytes. The GS-RAM Plus card can be expanded to 6 megabytes. With an optional piggyback board, a total of 8 megabytes is available.

The GS-RAM with 256K bytes of RAM is priced at \$169; with 512K, \$219; with 1 megabyte, \$299; and with 1.5 megabytes, \$379. With 1 megabyte of RAM, the GS-RAM Plus costs \$599. For more information, contact Applied Engineering, P.O. Box 798, Carrollton, TX 75006, (214) 241-6060. Inquiry 581.

AST's RamStakPlus board provides up to 1 megabyte of memory for the Apple IIGS. The board plugs into the IIGS's extended memory slot and uses the computer's built-in RAM disk capability. The board costs \$129. For more information, contact AST Research Inc., 2121 Alton Ave., Irvine, CA 92714, (714) 553-0340. Inquiry 582.

Hi-Res Graphics Controller

Modgraph has announced the Prism high-resolution graphics controller. The board offers a resolution of 1024 by 780 pixels with a choice of 16 colors from a palette of 4096. It supports 16 gray levels for monochrome graphics.

The board's NEC 7220 chip provides primitives for lines, arcs, circles, and rectangles, as well as hardware zoom and pan functions. It features a drawing speed of 1 million pixels per second and dual-ported 4-megabit memory. An RS-232C port is standard, as is an RS-343A RGB video output that's jumper selectable for a variety of displays.

The Prism (Model 3152) sells for \$1695. Contact Modgraph Inc., 56 Winthrop St., Concord, MA 01742, (617) 371-2000. Inquiry 583.

Plug-in Adapter for Serial Printers

The Missing Link, a serial adapter board, enables you to connect serial printers to an IBM PC or compatible without using a serial port. The board occupies a short slot in the computer and is addressed as a parallel printer (LPT1, LPT2, or LPT3). Because the

computer addresses the board as a printer device, there's no need for mode commands for initializing COM1 or COM2 and re-directing printer output. The adapter will work with any software, the company says, and any RS-232C printer using the XON/XOFF or ETX/ACK protocols.

The \$189.95 board connects to the printer with an existing printer cable or a modem cable. It has a standard RS-232C connector; according to the company, no pin swapping is necessary. Contact Henson Scientific Inc., 870 Seventh Ave., 27th Floor, New York, NY 10019, (212) 245-4180. Inquiry 584.

Memory for Laser Printers

The JLaser Plus from Tall Tree Systems combines 2 megabytes of RAM with an interface to laser printers based on a Canon engine and the Canon IX-12 scanner. The company says the board triples the speed at which a page is scanned, can increase printing speed by as much as 50 times, and provides a full-page resolution of 300 dots per inch.

Available in versions for the IBM PC XT and AT, the unit stores images in memory that conforms to the Lotus/Intel/Microsoft standard. The memory can function as conventional memory, expanded memory, extended memory in ATs, or as a RAM disk or print spooler. The XT and AT versions are priced at \$599 and \$699, respectively. Contact Tall Tree Systems, 1120 San Antonio Rd., Palo Alto, CA 94303, (415) 964-1980. Inquiry 585.

(continued)

CRITIC'S CHOICE AWARD
 Family Computing, 1986

HERE ARE THE
 ADDITIONAL FONTS
 YOU ORDERED FOR
 USE WITH
FONTASY
 Thank you for ordering from

OVERHEAD FOILS

- Quick and easy to prepare
- Centering, tabbing, indenting
- Large variety of typefaces
- Great for report covers, too

Sample Reports



NEWSLETTERS on the PC

Personal Publishing

Highlights

- On-screen fonts & drawing
- Microfilm Samples
- Read text from disk and keyboard
- Select and position City Art

\$69.95

Request the
 Your Company
 at the Wedding of
 their daughter

We build good ships here.
 At a profit, if we can.
 At a loss, if we must.
 always, good ships.

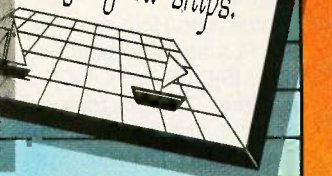

NEW **FONTASY ART FOLDERS™**

Each folder contains about 100 professionally drawn pictures, converted by camera to computer images and ready for use with **FONTASY VERSION 2**. Now available in six popular categories: Holiday; Sports-Recreation-Music; Attention-Getters; Food; Animals-and-Plants; Home-and-Office. \$29.95 per disk.



Imports

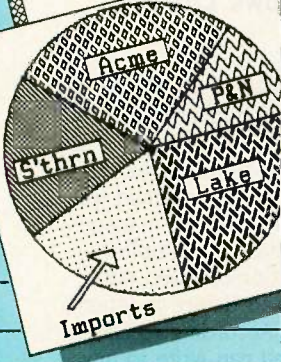

Fontasy printed all of these.

See What You Can Do With



Presentations! Newsletters! Flyers! Signs! Overhead foils! Invitations! Menus! Logos! Announcements! Banners! Layouts! When you need a good-looking visual quickly, you need **FONTASY** — superb typefaces, drawing, and pictures in one easy-to-use package.

FONTASY gives you a "what-you-see-is-what-you-get" picture, as you type and draw on the graphics screen of your IBM-PC. You can create a page at a time, see a mini-picture of it, print it, and save it on disk. Page size is limited only by memory, not by screen size.

Highlights

Proportional space, justify, kern, boldface, re-position, magnify and shrink, black/white reversal, rotate, mirror image, lines, rectangles, ovals, draw, fill-in, undo (and un-undo), on-line help, 200-page book, and easy control from keyboard or mouse.

Fonts, fonts, and more fonts! We have over 275 Add-On typefaces in our growing library. Each disk of about 10 fonts costs \$24.95 and we will be happy to send you free print samples on request.

Picture Library! Each of the six **FONTASY ART FOLDERS™** contains about 100 large (full-screen), high-quality add-on pictures and costs \$29.95 per disk. Please see back issues of this magazine for examples, or ask us for free print samples.

Equipment Needed

IBM-PC, XT, AT, or true compatible (Compaq, etc.) with IBM or Hercules graphics adapter and graphics monitor. 256K memory needed for partial pages, 448-640K recommended for full pages on most printers. Mouse optional. MS-DOS 2.10 or above. **FONTASY** supports: IBM Graphics Printer, Proprinter; Epson FX, JX, LX, MX, RX, and LQ; C.Itoh 8510, 1550, 1570, Prowriter-Jr; H-P LaserJet, LaserJet-Plus, ThinkJet; Microline 92-293 (native or IBM-compatible); Gemini 10X, 15X; Radio Shack DMP 105-430, 2100; Toshiba 351, 1340-1351; Star; and most IBM / Epson-compatible printers.

Money-Back Guarantee

FONTASY is not copy-protected and has a 30-day money-back guarantee. If you order now, we will include 28 fonts (a \$50 value) at no extra charge. So, call today.

\$69.95

Includes 28 Fonts & 60 small pictures

(818) 765-4444

PROSOFT
 7248 Bellaire Ave., Box 560
 No. Hollywood, CA 91603-0560

FONTASY \$69.95
 Tax _____
 Shipping _____
 Total _____

Name _____ Company _____
 Address _____ Telephone _____
 City, State, ZIP _____
 Visa/MC _____ Exp. Date _____
 Computer _____ Memory _____ Printer _____
 Terms: M/C, Visa, checks. Please add \$3.00 shipping and handling in U.S. or Canada, \$15.00 overseas, \$2.00 for C.O.D., and sales tax in Calif.

Help Screen Utility

Create context-sensitive on-line help screens with SoftScreen/Help. A screen processor enables you to draw help screens without programming; a screen linker ties the help screens together so that users can select additional help topics at run time; and a run-time manager enables you to integrate the help system with the application program.

SoftScreen/Help runs on IBM PCs and compatibles with MS-DOS or PC-DOS 2.0 or higher. The program sells for \$195. For more information, contact Dialectic Systems, 1930 East Marlton Pike, Cherry Hill, NJ 08003-2148, (609) 424-0140. Inquiry 586.

Researcher's Expert System

EXPERIMENTAL DESIGN is an expert system that determines the statistical requirements of projects and suggests the most appropriate

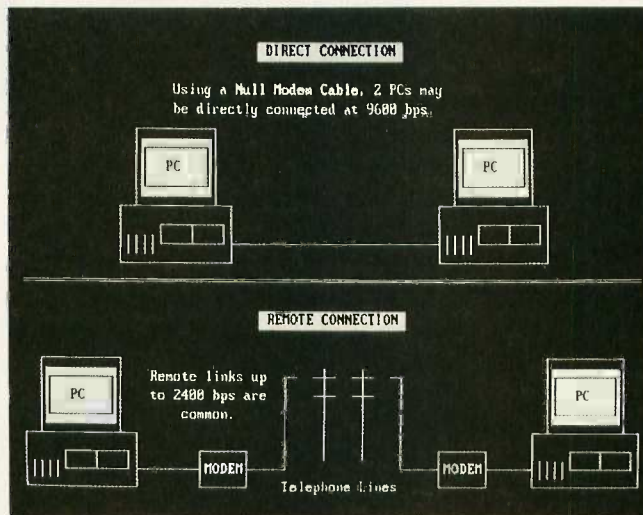

SoftScreen/Help, a utility for creating help screens.

ate of 13 experimental designs.

The program costs \$295 and is written in Turbo Pascal. It runs on IBM PCs, XTs, ATs, and compatibles with 256K bytes of RAM and MS-DOS or PC-DOS 2.1 or higher. For more information, contact Statistical Programs, 9941 Rowlett, Suite 6, Houston, TX 77075, (713) 947-1551. Inquiry 587.

C++ for MS-DOS Systems

Lifeboat Associates introduced Advantage C++, a software development tool that enables you to design your own data types using object-oriented programming methods. Versions of Advantage C++ are available for use with Lattice and Microsoft C compilers and cost \$495.

For more information, contact Lifeboat Associates Inc, 55 South Broadway, Tarrytown, NY 10591, (914) 332-1875. Inquiry 588.

Windows Library for C

DataWindows, a window and data-entry library for C programmers, was announced by Greenleaf Software. It offers overlaid windows with screen management, program simplicity, transaction-oriented data entry, and device independence. According to Greenleaf, you can write to any window whether it is showing on the screen or not. DataWindows supports many popular C compilers and sells for \$225. The source code is also available for DataWindows in C or assembly language and costs an additional \$225. Contact Greenleaf Software, 1411 LeMay Dr., Suite 101, Carrollton, TX 75007, (214) 631-0811. Inquiry 589.

Graphics and Mathematical Toolbox

Math Toolbox enables you to use graphics and mathematical tools for engineering and scientific applications on your IBM PC, XT, or AT. Matrix operations, complex arithmetic, and vector operations in cartesian, polar, cylindrical, and spherical coordinates are included. You can also create two-dimensional screen and printer graphics and histograms of numerical data. And you can store custom-plotting parameters

in template files.

Math Toolbox costs \$249 and requires 256K bytes of RAM, one 360K floppy disk drive, a Color Graphics Adapter, and PC-DOS or MS-DOS 2.0 or higher. For more information, contact Alpha Applied Research, 2355 McLean Blvd., Eugene, OR 97405, (503) 485-6841. Inquiry 590.

Site Planning and Landscape Design

LANDCADD is a set of three programs that make use of AutoCAD 2.18 and 2.5 for producing site

plans, cost estimates, and irrigation designs.

The program includes a library of symbols and site amenities and lets you view your plans in three dimensions, from any viewpoint. Each drawing is linked to a database that estimates costs at each phase of design. A zoom feature enables you to view any part of the drawing in detail, and you can input changes through a mouse or digitizer. Hard copy is output through a pen plotter.

The three programs include Site Planning and Landscape Design (\$595), Cost Estimating (\$395), and Irrigation Design (\$395). You can purchase the three packages as a whole for \$1095. To run LANDCADD you need an MS-DOS system with 640K bytes of RAM, a math coprocessor, a hard disk drive, a digitizing tablet, and a high-resolution graphics adapter and monitor.

For more information, contact LANDCADD Inc., 10418 East Tanglewood Rd., Franktown, CO 80116, (303) 688-8160. Inquiry 591.

Give Your Business A Merry Christmas and Have a Happy New Year!



1987 will be a very good year when you streamline your business with Dac-Easy Accounting. Now is the perfect time to give your business the gift it deserves and start the New Year right. Don't put off any longer the advantages of computerized accounting. At \$69.95, Dac-Easy Accounting is a superb value even Scrooge would love.

We've combined seven full-featured accounting modules in a single package including General Ledger, Accounts Payable, Accounts Receivable, Inventory, Purchasing, Billing and Forecasting. This is the software that the readers of PC World have voted as their favorite accounting package in the 1986 World Class Awards. Dac-Easy Accounting received more than five times as many votes as the second place finisher BPI — costing thousands of dollars more.

VALUE

Price plus tremendous performance means value, and the experts agree. *InfoWorld* has recognized Dac-Easy Accounting as 1985's "BEST SOFTWARE VALUE."

No other accounting package can match the explosive consumer base or the unanimous acclaim from industry experts. Dac-Easy Accounting is the perfect choice for your first accounting system or for upgrading from a single module system. Either way compare, and you will join over 150,000 people who are already having a happy New Year!

PERFORMANCE

Accurate information when you need it is what performance is all about. Fast, flexible reports

Holiday Savings of Over 40%

Give your business something it really needs this Christmas. Once you have automated your complete accounting and payroll process with the Dac-Easy Bonus

Pack, you will always have the information you need at your fingertips. Just think, instant access to General Ledger, Accounts Payable, Accounts Receivable, Inventory, Purchasing, Billing, Forecasting, and Payroll. This is one gift that will keep on giving year after year.

Dac-Easy Bonus Pack includes five great software packages for a low \$149.95. That means a savings of over \$130. You receive Dac-Easy Accounting, Dac-Easy Payroll, Dac-Easy Accounting Tutor, and Dac-Easy Payroll Tutor. Also included is Pop-Up DeskSet Plus, a \$129.95 retail value, selected Editor's Choice in a recent PC Magazine review on desktop programs. Don't delay. Order our Bonus Pack today and get the accounting system everyone is talking about!

give you what you need to know to manage cash-flow, turn inventory and increase profits. Dac-Easy Accounting's seven modules work together perfectly. Enter data once and it's posted to the other modules automatically. Most modules can also be used stand-alone.

No matter what type of business you have, Dac-Easy Accounting can make 1987 a better year. It offers the rare ability to handle either service or product-oriented companies without sacrificing features.

Dac-Easy Payroll for 1987 is here just in time to help you get a handle on the new tax laws. Dac-Easy Payroll is the fastest selling payroll package on the market. It not only processes your payroll, but helps you with

personnel functions as well. Dac-Easy Payroll automatically calculates payroll taxes for all 50 states, prints checks, W-2's, and allows you to review your departmental payroll taxes hundreds of different ways. Priced at only \$49.95, it is another example of the price/performance value of the Dac-Easy Series.

Find out for yourself why Dac-Easy Accounting is the fastest selling accounting package in history. Call us today!

Minimum hardware requirements
All Dac-Easy products run on IBM or other compatibles. 256K memory, two disk drives, MS-DOS, PC-DOS 2.0 or later, 132-column printer in compressed mode, color or monochrome monitor. MS-DOS is a trademark of MicroSoft Corp. IBM and PC-DOS 2.0 are registered trademarks of International Business Machines Corp.



**TO ORDER
CALL TOLL FREE
1-800-992-7779
IN TEXAS CALL
1-214-458-0038
or mail the
order form below.**

Mail to:

dac software, inc.
4801 Spring Valley Rd.
Bldg. 110-B
Dallas, TX 75244

**Yes, please rush me
the following Dac
products:**

Product	Qty.	Price	Total
Dac-Easy Bonus Pack	—	149.95	—
Dac-Easy Accounting	—	69.95	—
Dac-Easy Payroll	—	49.95	—
Dac Accounting Tutor	—	19.95	—
Dac Payroll Tutor	—	19.95	—
Add Shipping Charge			7.50
Texas Residents			
Add Sales Tax (6 7/8%)			
After 12/31/86 Add Sales Tax (7 1/4%)			
			TOTAL

Check Money Order
 AMEX VISA MASTERCARD
 Account # _____
 Expires _____
 Signature _____
 Name _____
 Company _____
 Address _____
 City _____
 St. _____ Zip _____
 Phone _____
 Computer Brand _____
 Type of Business _____
 No. of Employees _____

30 Day Money-Back Guarantee
Dac Software offers an unconditional guarantee on all Dac-Easy products (less shipping charges). There is a \$10 restocking fee if the disk seal is broken. This guarantee is available on all products bought directly from Dac Software.

#830

Printed Circuit Board Design

Tango-PCB is a \$495 IBM PC program that enables you to design printed circuit boards up to 32 by 19 inches. Expanding and contracting the layout allows you to place components precisely. Five zoom levels are available from 1.6 by 0.95 inches, expandable to the full 32- by 19-inch workspace capacity.

You have a choice of nine grid sizes for placement of component shapes such as DB-25 connectors and edge connectors with odd spacings. It also offers an eight-layer capability, including power and ground planes, plus text and component overlay. You can create precise microstrip designs with an area-fill command. A library of common components is supplied, and you can add to it by creating your own entries for

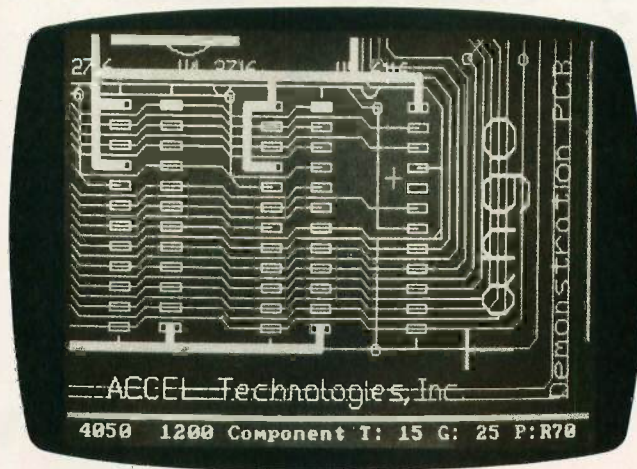

Tango-PCB, a program for designing printed circuit boards.

specialized components. In the Enhanced Graphics Adapter 640- by 350-pixel mode, 16 colors are supported. Four colors are supported in the Color Graphics Adapter 320 by 200 mode.

The program runs on IBM PCs and compatibles with 256K bytes of RAM and MS-

DOS or PC-DOS 2.0 or higher. A CGA or EGA with an RGB monitor is also required.

Contact Accel Technologies Inc., 7358 Trade St., San Diego, CA 92121, (800) 433-7801; in California, (800) 433-7802 or (619) 695-2000. Inquiry 592.

Computer-aided Testing

A computer-aided test program that calibrates, measures, and manages vector network analyzer data was announced by EEsof. ANACAT has a built-in database, DOS interface, full-

screen editor, and color graphics capability.

The database stores and manipulates data retrieved from the network analyzer, and you can use it to store any number of S-parameter measurements, according to EEsof. The database manager enables you to

create, delete, and revise test data, and you can present the data in graphs and tables. The database files are also compatible with spreadsheet and database programs.

ANACAT runs on IBM PCs, XT's, AT's, and compatibles and is priced between \$5000 and \$7500. For more information, contact EEsof Inc., 31194 La Baya Dr., Westlake Village, CA 91362, (818) 991-7530. Inquiry 593.

Graphics and Statistics

You can use Engineering Tool Kit to record numerical engineering data and translate it into graphic forms and statistical analysis reports. You can generate scatter plots, trend charts, and histograms. The pro-

gram includes a polynomial regression routine for graphics and statistics for first- to fifth-order polynomials.

Engineering Tool Kit runs on IBM PCs, XT's, AT's, and compatibles and requires a graphics card and two floppy disk drives or a hard disk drive. The IBM version sells for \$129. A version for the Apple II family sells for \$59, and the 512K Macintosh and the Macintosh Plus version sells for \$99.

For more information, contact SofWare Tools, P.O. Box 8751, Boise, ID 83707, (208) 343-1437.

Inquiry 594.

Design Tool for Electrical and Control Engineers

Using control theory, SASP aids in the analysis of feedback control systems for circuit design, digital filter design, servo design, and aerospace autopilot design.

SASP, which stands for Stability Analysis and Simulation Program, runs on IBM PCs and compatibles with 512K bytes of RAM (640K for high resolution), MS-DOS or PC-DOS 3.1 or higher, a hard disk drive, a math coprocessor, and a graphics board. The program works in S-plane, Z-plane, and W-plane plots and can convert transfer functions from one form to another. It enables you to draw a variety of plots, and you can enter transfer functions in polynomial or pole/zero format.

SASP sells for \$750. For more information, contact Lewis Engineering Software 21722 Roscoe Blvd., #24, Canoga Park, CA 91304, (818) 883-2786.

Inquiry 595.

(continued)

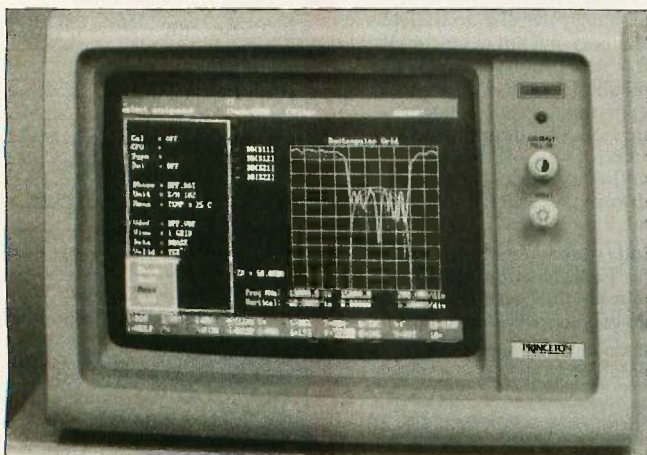

ANACAT handles network analyzer data.

Btrieve®

The Programmer's Choice.

Whether you're a programming pro or just beginning, there's one thing to remember when developing applications: Btrieve.

The Btrieve file manager is an alternative to all those DBMSs that promise ease of use—but deliver something far different. Like languages that take weeks to master. Performance that fizzles instead of sizzles. Programs that won't network. Of course you can write applications with these "revolutionary" packages. But someday you'll wish you hadn't.

If you know a programming language, you already have what it takes to build better applications. All you need is Btrieve.

Btrieve is the programmer's choice for file management. But you don't have to be a professional programmer to use it. With Btrieve loaded in your PC, your programs can use simple subroutine calls to retrieve, store and update records.

Btrieve has built-in security features and the ability to handle four billion byte files. And there are no royalties on Btrieve applications.



SoftCraft

P.O. Box 9802 #917
Austin, Texas 78766
(512) 346-8380 Telex 358 200

Suggested retail prices: Btrieve, \$245; multi-user Btrieve, \$595; Xtrieve, \$245; multi-user Xtrieve, \$595 (for report generation, add \$145 single-user and \$345 multi-user). Available from SoftCraft and selected distributors. Requires PC-DOS or MS-DOS 2.X, 3.X, Xenix. Btrieve is a registered trademark and Xtrieve is a trademark of SoftCraft Inc.

Inquiry 325

B-tree based for high performance. Performance is all-important, especially as your database grows. That's why Btrieve implements the b-tree file structure—the most efficient data access method known. With Btrieve your applications run fast.

Database queries, report writing. Add Xtrieve™ to your Btrieve applications for a fully-relational DBMS. Xtrieve's menu-driven interface lets you look up information easily—without programming. Add our report writer option to produce custom reports and forms.



Interfaces to C, BASIC, Pascal, COBOL. Don't waste time learning a proprietary language! With Btrieve you can use the language you know best—and immediately begin programming the right way. Over 15 language interfaces are available.

Fault tolerant. Btrieve insures against database disasters. Two levels of fault tolerance guarantee data integrity during accidents or power failures—no extra programming required.

Multi-user versions for LANs and Xenix.

When your applications need to network, Btrieve's multi-user versions connect you to the industry's most popular LANs: IBM PC Network, Novell Advanced Netware, or any DOS 3 network. Btrieve is also available for Xenix and multitasking operating systems such as MultiLink Advanced, Microsoft Windows and IBM Topview.

Help is just a phone call away. Need technical support? You've got it! Btrieve users receive 30 days of unlimited phone support at no charge. This "Direct Connect" policy is renewable for a full year at low cost. And try SoftCraft's free bulletin board for technical tips, seven days a week.



Thorough documentation, easy implementation. Getting started with Btrieve is easy: the manual is packed with step-by-step instructions and examples of every Btrieve function in BASIC, Pascal, COBOL and C.



Desktop Publishing on the Mac

LetraPage and The Laser Quill are Macintosh desktop publishing programs with word-processing capabilities.

LetraPage features a toolbox with 12 mouse-driven icons that enable you to edit text and create page layouts on screen. Automatic hyphenation, line and depth justification, and a library of 137 kerned letter pairs are offered. You can import files from other Macintosh programs to LetraPage. Documents created can be up to 1024 pages in length in 20 page sizes, with as many as 48 columns.

LetraPage sells for \$599. For more information, contact Letraset USA, 40 Eisenhower Dr., Paramus, NJ 07653, (201) 845-6100. Inquiry 596.

The Laser Quill offers seven levels of superscripts and subscripts, headers and footers, windowing, and search and replace capability. You can output documents to digital typesetting computers that support PostScript or to the Imagewriter, LaserWriter, or other printers.

The Laser Quill enables you to create documents of up to 698 pages. The program sells for \$199. For more information, contact Firebird Licensees Inc., 71 North Franklin Turnpike, Waldwick, NJ 07463, (201) 444-5700. Inquiry 597.

Communications for the 128

A terminal software package for the Commodore 128 was announced by Abacus. SpeedTerm 128 performs VT52 terminal emulation and works with

most of the low-cost modems for the 128, according to Abacus.

SpeedTerm costs \$39.95 and includes more than 30 commands. The program supports the XMODEM and Punter file transfer protocols and manages a 45K-byte capture buffer. For more information, contact Abacus Software, P.O. Box 7211, Grand Rapids, MI 49510, (616) 241-5510. Inquiry 598.

Screen Reading for the Visually Impaired

Computer Aids introduced Screen-Talk Pro, a program that uses macros to add audio capability to your applications programs. To run the program you need an IBM PC or compatible with at least 128K bytes of RAM and a voice synthesizer.

Screen-Talk Pro comes with ProKey for macro processing. Other features include the ability to recognize monochrome and color video attributes and a Find command that locates video attributes and other strings of characters on the screen. The program also lets you review text by word, letter, or screen, or you can create up to 10 windows for review.

Screen-Talk Pro costs \$395. For more information, contact Computer Aids Corp., 124 West Washington, Lower Arcade, Fort Wayne, IN

46802, (800) 647-8255. Inquiry 599.

Thinking Cap Outlines on a Commodore

You can create outlines for reports, speeches, resumes, or memos with Thinking Cap. The program sells for \$49.95 and handles up to seven levels of information, with 16 subtopics within each level. Once you've established the levels, you can enter details randomly under the appropriate headings, and the program creates the numbering format for an outline up to six pages long. You have a choice of formats, including roman numerals, prose, technical, or numeric. You can also use underlining or boldface. The program has templates for five outlines.

Thinking Cap runs on a Commodore 64 or 128 with a printer. For more information, contact Brøderbund Software Inc., 17 Paul Dr., San Rafael, CA 94903-2101, (415) 479-1700. Inquiry 600.

PC-to-VAX Communications

Polygon announced poly-STAR, PC-to-VAX communication software. The program emulates Digital Equipment Corp.'s text terminals. It has seamless file transfer capabilities, pop-up

window menus, hot-key switching, international keyboard support, and enhanced remote-control features. The program supports modems and has a user-programmable communication language. The phone book feature enables you to automatically dial, connect, and log on.

The program runs on IBM PCs, XTs, ATs, and compatibles with at least 512K bytes of RAM and PC-DOS or MS-DOS 2.0 or higher. Poly-STAR prices start at \$200. For more information, contact Polygone Associates Inc., 1024 Executive Parkway, St. Louis, MO 63141, (314) 576-7709. Inquiry 601.

Term Paper Writer

Personal Choice Software announced Term Paper Writer. The program includes The Notetaker, The Outliner, The Writer, and The Footnoter and Bibliography Compiler.

The Notetaker is an electronic card file that enables you to collect information by source and by topic. The Outliner lets you organize lists of ideas into topical groups or a formal outline. The Writer is a word processor that includes margin-setting, line-spacing, and page-break functions. It also allows you to specify styles such as boldface, underlining, and centering. The Footnoter and Bibliography Compiler will insert footnotes on appropriate pages and compile information for the bibliography from The Notetaker.

Term Paper Writer runs on IBM PCs and Apple IIs and sells for \$59.95. For more information, contact Personal Choice Software, P.O. Box 7286, Mountain View, CA 94039, (415) 960-0410. Inquiry 602.

WHERE DO NEW PRODUCT ITEMS COME FROM?

The new products listed in this section of BYTE are chosen from the thousands of press releases, letters, and telephone calls we receive each month from manufacturers, distributors, designers, and readers. The basic criteria for selection for publication are: (a) does a product match our readers' interests? and (b) is it new or is it simply a reintroduction of an old item? Because of the volume of submissions we must sort through every month, the items we publish are based on vendors' statements and are not individually verified. If you want your product to be considered for publication (at no charge), send full information about it, including its price and an address and telephone number where a reader can get further information, to New Products Editor, BYTE, One Phoenix Mill Lane, Peterborough, NH 03458.

A Computer Work of Art ...the Advanced 286.™



Everything You Ever Wanted in an IBM AT Compatible System, Including Price.

The Advanced 286 offers all the features of the IBM PC/AT® at a fraction of the cost. The Advanced 286 is available for \$1395.

Add \$85.00 for MS-DOS® 3.2 and \$95.00 for GW Basic®.

All systems are FCC Class B/UL approved and come with Phoenix BIOS assuring you of far reaching compatibility.

Features:

- 6/8 MHz Software Switchable
- 640K upgradable to 1 MB on board • Floppy Disk Controller • 1.2 MB Floppy Disk • Patented easy mount mechanism for installing disk drives and streamer tapes
- On board real time clock
- Runs all major software written for IBM PC/AT • Phoenix BIOS

Options:

- Up to 4 MB RAM • 20 to 40 MB Hard Disk • 360K Floppy Disk Drive
- AT Hard Disk Controller • RLL Hard Disk Controller • 3-1/2" Floppy Disk • Streamer Tape



Testimonials:

"If compatibility, aesthetic design and price are key considerations in your computer selection decision, you will be delighted with the Advanced 286 ..."

— Steve Zelencik, Vice President
Advanced Micro Devices

"We have evaluated over 35 clones and compatibles and the Advanced 286 proved superior to all units tested including the IBM AT product. The easy mount disk drive design and providing easy access to three half height devices makes upgrading a snap ..."

— Jim Lizzio, President
Concept Development Corp.

Everything You Ever Wanted in AT Compatible Boards Including Price.

- 2 MB Multi I/O Card w/Serial (optional 2nd serial) Parallel, game ports/OK \$179.00
- 3 MB Ram-Card/
- I/O Card w/serial, parallel (optional 2nd serial) \$ 89.00
- EGA/256K (Half-Card) \$249.00
 - EGA Monitor ... \$499.00
 - EGA Mouse \$119.00
 - Color/Mono-chrome Graphics Card \$169.00

Advanced 286™

**CALL NOW
FOR
DEALER
PRICING**

**BUY NOW
GET MS-DOS
GW BASIC
FREE!**

Since 1976 ...

INTERNATIONAL, INC.
 1310 E. Edinger Street, Santa Ana, CA 92705
 (714) 558-8813 (800) 854-8230

• IBM PC/AT is a registered trademark of International Business Machines, Inc. • GW Basic is a registered trademark of Microsoft Corporation®
 • MS-DOS 3.2 is a registered trademark of Microsoft Corporation • The Advanced 286 is a registered trademark of ACP International, Inc.

IT'S COMING JANUARY

re:Source—Powerful software that will rewrite the rules of online computing forever.

If you own an IBM PC or compatible, now there's a way to turn The SourceSM into a powerful business productivity tool.

New re:Source software.

Other communications software only controls your PC's ability to respond to an online service.

re:Source telecomputing software controls both your PC and the online service itself.

It speeds up file transfers, integrates extensive database information and performs multiple tasks

simultaneously by tearing down the language barriers that separate your PC from The Source's main computer. The net result: A new definition of "user friendly". A new concept in computing power.

Online, Offline and back again, in a flash.

re:Source automates frequent command sequences. It logs on and off so quickly you can almost begin to measure your connect time in seconds instead of minutes. And with powerful offline editing features, you make fewer mistakes for more effective control of the connect time you do use.

You paid a lot for your PC. It shouldn't act like a dumb terminal.

re:Source takes a fresh new approach to the organization and presentation of The Source's powerful information and communication capabilities. So you can capitalize on the time and money you've spent developing your PC skills to master online communications like never before. Comfortably and productively.

re:Source gets its power from a high-level script language that lets you develop and customize your own scripts.

RY 1ST

BYE BYE

Illustration by Brad Holland

Updates and upgrades directly from The Source.

We're supporting re:Source with its own online Special Interest Group. Get quick responses to questions about script development, exchange scripts with other users or share ideas and suggestions on re:Source applications. It's software that can grow with you as your needs expand.

We've even developed a unique way to deliver re:Source updates and new software to you. As new versions become available, you can download them to your PC, along with comprehensive technical information, directly from The Source.

re:Source. Guaranteed by The Source.

Our guarantee: if you think you've seen everything online services can offer, you haven't seen re:Source. There is no obligation. If you don't agree that re:Source is the most powerful online computing software you've ever seen, return it for a full refund.*

The cost? Only \$89.00. And this price includes a free membership to The Source,** America's most powerful online information network featuring communications, investor services, news, travel guides, personal computing information, education,

Special Interest Groups and more.

Order re:Source today while this ad is still in front of you. And be one of the first to enter the age of power online computing. Call the toll-free number below now.

1-800-336-3366

re:Source

from The Source
1616 Anderson Road, McLean, VA 22102

*If returned within 30 days. Guarantee in effect until March 31, 1987.

**Source members subject to a \$10 minimum usage fee each month.

Conducted by Steve Ciarcia

FROM TYPEWRITER TO PRINTER

Dear Steve:

I have an Olivetti TES 401 Electronic Typewriter that I would like to convert into a printer. Do you know of a company that has the plans or parts that will allow the typewriter to interface with a computer's serial or parallel port? Also, the TES 401 has an 8080 microprocessor in it and the motherboard has an unused edge connector. I have been unable to acquire a circuit diagram or pin-out information for the typewriter. Do you know of a source for these?

LARRY PAIVA
Colleyville, TX

In the early days of personal computers—a mere ten years or so ago—there were many conversion kits and instructions being sold for a large number of popular typewriters. Today, I see an occasional conversion kit for IBM Selectrics offered, but little else.

I have been unable to locate a source for schematics or a conversion kit for the Olivetti TES 401 typewriter. Many companies deliberately restrict distribution of parts and circuit diagrams.

Try writing letters to the editors of electronics magazines such as Modern Electronics. The publication of such letters might yield productive responses and useful information. Some magazines, such as Electronics Test, have regular columns specifically for the publication of requests for circuit diagrams and technical manuals. These magazines, unfortunately, are not usually "general circulation" publications, so the best source for them might be the electronics department at a nearby college or university. You might also try a classified ad in magazines such as Computer Shopper.

While it is possible to convert some electric typewriters for use as printers, they aren't usually designed for the kind of high-volume, high-speed work that a computer generates. Some typewriters are unlikely to endure such usage for a long period of time. If your application involves heavy usage, you should consider getting either a typewriter/printer designed for such purposes or a letter-quality or daisy-wheel printer. At the

prices currently advertised, that approach might be less expensive than attempting to convert your Olivetti.—Steve

FLOPPY JUMPERS

Dear Steve:

A friend and I are putting together IBM PC XT clones using Teac 55BV floppy drives. I know how to set up the drive-select lines and the resistor pack on the Teacs, but the rest of the jumpers are a mystery to me. Do you have any suggestions for the proper setup of these jumpers?

EDWIN J. MULLICAN
Gulfport, MS

The jumpers you mention are related to maintenance and format functions and are preset at the factory to accommodate normal applications such as yours.

If you would like to order a service manual describing these jumpers, along with other use and maintenance information, you can contact Teac Corporation of America at 7733 Telegraph Rd., Montebello, CA 90640, (213) 726-0303. They will give you price and ordering information. I find it to be a good practice to have the maintenance manuals for any drives I own, if only for the replacement parts and servicing information.—Steve

MANAGING WORDSTAR THROUGH SUBDIRECTORIES

Dear Steve,

After spending far too much time searching the directory of my hard disk, I finally sat down and arranged the files into subdirectories. Word processing is not the most important task I do, so I copied WordStar (version 2.1) onto a third-level directory. Unfortunately, now I cannot run the program. Is there a way I can run WordStar within a subdirectory?

CINDY SHELTON
Great Falls, MT

The early versions of WordStar were not designed to handle directory names as part of the filename, nor search subdirectories for overlays. There are, however, two or three ways you should be able to run the program from a subdirectory.

The simplest is to use the CD (change directory) command to the WordStar subdirectory to make it the default. You should then be able to run the program and save your files in that subdirectory. The obvious problem with this is that you don't have the freedom to put your word-processing files in other subdirectories.

Alternatively, you could save your files on a floppy disk in drive A or B.

Another way is to copy the WordStar program and overlay files into a RAM disk (say, drive D), switch the C drive default to the directory where you want to save your files, and then switch to the D drive (RAM disk) and load WordStar. This way you can either configure WordStar to look on the C drive for files or simply change the logged drive to C after the program loads.

A final method is to change to the WordStar directory (using CD) and temporarily save your data files to RAM disk while editing. This is the fastest possible way to run WordStar but entails some risk of losing your work due to power failure or forgetting to copy your work off the RAM disk before shutting off the computer. I recommend that you use a batch file to do the directory switching, load the program, and copy the files back to the designated directory when you exit WordStar. For example, assume you have a directory \word with a subdirectory \WS containing the WordStar program files and a batch file named WST.BAT. You

(continued)

IN ASK BYTE, Steve Ciarcia answers questions on any area of microcomputing. The most representative questions received each month will be answered and published. Do you have a nagging problem? Send your inquiry to

ASK BYTE
c/o Steve Ciarcia
P.O. Box 582
Glastonbury, CT 06033

Due to the high volume of inquiries, personal replies cannot be given. All letters and photographs become the property of Steve Ciarcia and cannot be returned. Be sure to include "ASK BYTE" in the address.

The Ask BYTE staff includes manager Harv Weiner and researchers Eric Albert, Bill Curlew, Ken Davidson, Jeannette Dojan, Jon Elson, Roger James, Frank Kuechmann, Dave Lundberg, Edward Nisley, Dick Sawyer, Andy Siska, and Robert Stek.

News about the Microsoft Language Family

Debugging with Two Monitors Simultaneously Using the Microsoft® CodeView™ Debugger.

The Microsoft CodeView, the revolutionary window-oriented symbolic debugger in Microsoft C Compiler Version 4.0, is a powerful tool. One of its numerous capabilities is the versatile way it enables programmers to view their code's output on the default monitor and video adapter while debugging on another monitor and video adapter. This is especially helpful for graphical applications. For example, if you have both a Color Graphics Adapter (CGA) and a Monochrome Adapter in the same system, you might want to set up the CGA as the default adapter. You could then debug a graphics program with the graphics display appearing on the graphics monitor and the debugging display appearing on the monochrome monitor. This feature is evoked by typing:

CV/2 program name

If you only have one graphic adapter and monitor in your system, you may use the screen swapping (/S) or flipping (/F) options to view your output while debugging with CodeView.

Finding Null Pointer Assignments with Microsoft CodeView.

When a value is assigned to an uninitialized pointer in C, the Microsoft C runtime code displays:
error 2001: Null pointer assignment

This is because it is impossible to tell at runtime that such an operation has occurred (the runtime routine “__nullcheck()” checks the first 54 bytes of the data segment to see if they have been changed when the program terminates). With Microsoft CodeView, this problem can be easily discovered. Debug your program with Microsoft CodeView and execute the program up to “main()” to set the DS register to the program's data segment. Now set a tracepoint on the first byte of the data segment using the command “TPB 0” (the pull-down menu can also be used). Now execute the program using the “go” command. When the program attempts to use an uninitialized pointer, thus writing to location 0, Microsoft CodeView will halt execution of the program just after the offending instruction. This operation can be made even faster using debugging hardware compatible with the Microsoft CodeView debugger.

Debugging Assembly Language Programs with Microsoft CodeView.

Microsoft CodeView has special features for the assembly language programmer. The radix command allows the user to set the default input and output radix so that assembly language programmers can use hex numbers just like the popular Microsoft SYMDEB debugger and DEBUG. To switch to hex simply type:

n16

In addition, the assembly and register displays allow viewing of code at the machine level. If you're debugging Microsoft C code, the assembly display will also show local symbols in the disassembly listing, so “MOV SI, [BP-4]” might be displayed as “MOV i, [count].” A unique backward-scroll mechanism allows you to quickly scroll backward through disassembled code.

For more information on the products and features discussed in the Newsletter,
write to: Microsoft Languages Newsletter
16011 NE 36th Way, Box 97017, Redmond, WA 98073-9717.
Or phone:
(800) 426-9400. In Washington State and Alaska,
call (206) 882-8088. In Canada, call (416) 673-7638.

Latest DOS Versions:

Microsoft C Compiler	4.00
Microsoft COBOL	2.10
Microsoft FORTRAN	3.31
Microsoft Macro Assembler	4.00
Microsoft Pascal	3.31
Microsoft QuickBASIC	2.00

also need a path to that directory in the CONFIG.SYS file, for example, path=c:\word\ws. Assume also that you have some subdirectories set up in \word for saving word-processing files, and that one of these subdirectories is called \myword. The batch file would look something like

```
cd \word\ws
ws
copy d:*. * c:%!
```

Now, to start word processing from any place in the system with the intent of saving the files in the C:\myword directory, simply enter the command WST \word\myword. DOS will find the batch file and execute the first two commands. When WordStar loads, it takes control while it is running. Change the logged drive to D and do your work.

When you exit to DOS, it will resume execution of the WST batch file and copy all files from D: to C:\word\myword. —Steve

CHANGING CHANNELS

Dear Steve:

I have a microcomputer that uses an RF

modulator with either channel 3 or channel 4 output. Are you aware of any circuitry or commercial unit that can convert channel 3 (or 4) into channel 7 (or a higher VHF channel)?

Although my problem sounds unique (it has something to do with a foreign TV system), I think the circuit could help people whose RF modulator has only channel 3 output and who receive annoying TV broadcast interference.

FAHFU HO
Wappingers Falls, NY

The only RF modulation modules I have seen on the market are the type that provide VHF channels 3 and 4 selectable outputs. I have not seen adjacent channel interference when the modulator was properly installed with an antenna switch. The output signal level from the modulator is usually higher than the signal received by the television set from a broadcast station when no antenna is connected; the RF modulator's signal wins out.

If you are receiving interference from an adjacent VHF broadcast station, I would suggest shielding your modulator

and antenna switch in a metal enclosure that is grounded to the television chassis or a common electrical ground point. In some instances, changing the position of the television receiver will eliminate interference problems.

If you want to experiment with the modulator, you have to raise the carrier frequency in the modulator to that of channel 7. Channel 2 has a video frequency of 55.25 MHz, Channel 3 is at 61.25 MHz, but channel 7 is at 175.25 MHz. You must modify the oscillator-tuned circuit to achieve the higher frequency. Without proper test equipment, this would be a trial-and-error procedure. Also, recognize that the device must be FCC-approved to minimize spurious radiation.—Steve

A TALENTED CONTROLLER BOARD?

Dear Steve:

I am the proud owner of a Percom RFD-40SI disk drive for use with Atari 400/800 computers. I have heard rumors that the controller board in the drive can support 5¼-inch double-sided double-

(continued)

FORTRAN PROGRAMMERS

Looking for the right PC FORTRAN language system? If you're serious about your FORTRAN programming then you should be using F77L - LAHEY FORTRAN.

"Lahey's F77L FORTRAN is the compiler of choice. It's definitely a 'Programmers FORTRAN,' with features to aid both the casual and the professional programmer. . . F77L compiled the five files in a total of 12 minutes, which was 4 times as fast as MS FORTRAN and an astounding 6 times as fast as Pro FORTRAN." - PC Magazine

Compare the features and performance of other PC FORTRANs with F77L and you will find that F77L is clearly the superior product.

- Full Fortran 77 Standard (F77L is not a subset)
- Popular Extensions for easy porting of mini and mainframe applications
- COMPLEX*16, LOGICAL*1 and INTEGER*2
- Recursion - allocates local variables on the stack
- IEEE - Standard Floating Point
- Long variable names - 31 characters
- IMPLICIT NONE
- Fast Compile - Increases productivity
- Source On Line Debugger (Advanced features without recompiling)
- Arrays and Commons greater than 64 K
- Clear and Precise English Diagnostics
- Compatibility with Popular 3rd Party Software (i.e. Lattice C)
- Easy to use manual
- Technical Support from LCS

• NEW FEATURE - NAMELIST

F77L - THE PROGRAMMER'S FORTRAN

\$477.00 U.S.

System Requirements: MS-DOS or PC-DOS, 256K, math coprocessor (8087/80287)

FOR MORE INFORMATION: (702) 831-2500



Lahey Computer Systems, Inc.
P.O.Box 6091
Incline Village, NV 89450
U.S.A.

International Dealers:

England: Grey Matter Ltd., Tel: (0364) 53499
Denmark: Ravenholm Computing, Tel: (02) 887249
Australia: Computer Transitions, Tel: (03) 537-2786
Japan: Microsoftware, Inc., Tel: (03) 813-8222

SERVING THE FORTRAN COMMUNITY SINCE 1967

MS-DOS & MS FORTRAN are trademarks of Microsoft Corporation. Pro FORTRAN refers to Professional FORTRAN a trademark of International Business Machines.



Editor's Choice
- PC Magazine

**It used to take up to \$15,000
and a video technician to
project real-time PC images.
Now anybody can do it
in five minutes for \$1270*.**

- 1.**
Plug the unit into your PC.
- 2.**
Place it on your overhead projector.
- 3.**
Begin your real-time presentation.

New KODAK DATASHOW System

Just think of all the applications.
Call for details:

1 800 44KODAK, Ext 865
(1 800 445-6325, Ext 865)



The DATASHOW System is used with an IBM PC or 100% compatible computer.
*Price shown is Kodak's suggested price only. Actual selling price is determined by dealer.



Eastman Kodak Company
Motion Picture and
Audiovisual Products Division
Inquiry 119

AT COMPATIBLE

IMMEDIATE DELIVERY

\$1125

MADE IN U.S.A.
NOT A FOREIGN COPY
SERVICED IN U.S.A.

Extended Warranty Available

10 MHz CPU Option \$1150



**AUTO CAD
RUNS Xenix™
NOVELL NETWORK
MULTI TASKING**

- Free Set-Up utility
- 48 Hours Burn-in
- 1.2MB Floppy Drive
- 195W Power Supply
- Touch-type Keyboard
- 33% faster than IBM AT
- 512K RAM, expands to 1 MB
- 8/6 MHz, 8MHz CPU Chip
- Full Documentation and Manual
- Clock/Calendar with Battery Backup
- W.D. Hard Disk/Floppy Disk controller
- Fully Compatible BIOS, written in U.S.A.

FREE
Fully configured and tested
for your system requirements



- With 20MB Seagate 65MS 1/2 Ht. \$355
- With 20MB Seagate 39MS Full Ht. \$549
- DOS 3.1 \$85
- G.W. Basic \$95
- 80287-8 8MHZ \$225
- 80287-5 5MHZ \$195

* One Year Limited Warranty
* Dealers and Corporate qty.
Discounts available

CLUB CT Mono AT compatible system
• Basic system as described above plus Monochrome Display card and IBM quality Monochrome monitor **\$1335**

CLUB CT Color AT compatible system
• High quality
• Basic System as above
• Plus color Display card and color monitor
• Fully Assembly and tested, no installation required **\$1539**

CLUB EGA Color AT system **\$1803**

<p>MONO MONITOR</p> <ul style="list-style-type: none"> • Nonglare • 12" screen • 800 x 350 resolution • FCC class 'B' approval • IBM Color <p>\$138 \$345</p>	<p>EGA MONITOR</p> <ul style="list-style-type: none"> • 640 x 350 • 640 x 200 • EGA and CGA • FCC class 'B' approval <p>\$480</p>	<p>NEC MULTISYNC</p> <ul style="list-style-type: none"> • 800H x 560V • Test Mode Switch • No Installation required • EGA, VGA, CGA compatible <p>CALL</p>	<p>CLUB EGA GRAPHIC CARD</p> <p>\$228</p> <ul style="list-style-type: none"> • Parallel Port • Fully IBM compatible • 256K video memory • Runs color/mono display • 16 colors 640 x 350 resolution <p>Quantity discounts available Made in U.S.A. Complies with FCC</p>	
<p>UNIVERSAL DISPLAY</p> <ul style="list-style-type: none"> • Parallel Port • FCC class 'B' approval • One Year Limited Warranty • 132 columns text, color or mono • Mono Display Hercules Compatible <p>\$248</p>	<p>HERCULES COMPATIBLE</p> <p>132 Columns</p> <ul style="list-style-type: none"> • Printer Port • Software Switchable • Monochrome Graphics • Runs Lotus 123 Graphics • Run 132 x 44 column display • Comply with FCC class 'B' <p>\$99</p>	<p>6-PAC COMPATIBLE</p> <p>CLUB 384 (for PC)</p> <ul style="list-style-type: none"> • Serial Port • Parallel Port • 0-384K Memory • Clock/Calendar • FCC class 'B' approved • Game Port and software <p>\$88</p>	<p>CLUB TURBO</p> <ul style="list-style-type: none"> • w/128K RAM • Runs 80287 math-processor in 5 MHz or 8 MHz speed • Runs 7 times faster than PC or 33% faster than the IBM AT <p>\$399</p>	<p>HIGH CAPACITY</p> <p>80MB 28 ms Access time</p> <ul style="list-style-type: none"> • Manual • With software <p>\$1295 CALL</p>
<p>MEMORY CARD</p> <p>\$55</p> <p>CLUB 576 (for PC, Portable)</p> <ul style="list-style-type: none"> • Software • Short Card • 0-576K Memory • Supports 64K/256K DRAM • Made in U.S.A. 	<p>MINI I/O FOR XT/AT</p> <ul style="list-style-type: none"> • Software • Parallel Port • Half size card • Real time clock/calendar • 2 serial Port (2nd optional) • Made in U.S.A. <p>\$75</p>	<p>AT MEMORY CARD</p> <ul style="list-style-type: none"> • No Piggy back • 0-3 MB capacity • 64k/256K RAM chips • One Year Limited Warranty • FCC class 'B' approved • Made in U.S.A. <p>CLUB 3000 \$155</p>	<p>AT-MULTIFUNCTION CARD</p> <p>Manager's Choice</p> <p>\$179</p> <ul style="list-style-type: none"> • Game port • 0-2MB Memory • Runs at 12 MHZ • 128K Increment range • 2 Serial port (1 option) • Self Installing software <p>12MHZ AT-Multifunction Made in U.S.A.</p>	
<p>FLOPPY DISK DRIVE</p> <ul style="list-style-type: none"> • 360K • Half height • TEAC/FUJITSU • Double density • IBM grey color extra <p>\$89</p>	<p>XT POWER SUPPLY</p> <ul style="list-style-type: none"> • 135W • Reliable • Complies with FCC • Direct replacement • One Year Limited Warranty <p>\$83</p>	<p>MOUSE</p> <p>Microsoft Compatible</p> <ul style="list-style-type: none"> • 200 Dots/inch • Work with Auto-Cad • 3 Buttons/built in Microprocessor <p>\$75</p> <p>Mouse with DR. HALO \$109</p>	<p>PRO KEYBOARD</p> <p>5151</p> <p>\$88</p> <ul style="list-style-type: none"> • Separate Numeric & Cursor keypad • AT Style Keyboard w/LED 	<p>SWITCH MASTER</p> <ul style="list-style-type: none"> • Cable included • Printer Spooler for IBM • Share one printer by 4 computer or 1 computer to 4 printer <p>\$88</p>

FAST HARD DISK FOR PC/XT AND COMPATIBLE

**Upgrade Your PC/XT
Power Your XT**

39 ms Access time

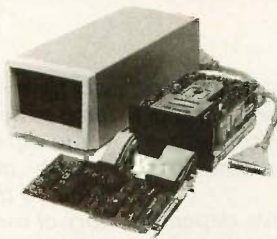

- * Auto Head Park
- * Boot from Hard disk
- * Quality Seagate drive
- * 39 ms average access time
- * Software and Manual included
- * Special Western Digital controller

- 20MB Hard Disk Subsystem Seagate 4026
- 30MB Hard Disk Subsystem Seagate 4038
- 40MB Hard Disk Subsystem Seagate (available now)

	INTERNAL	EXTERNAL
20MB	\$659	\$759
30MB	\$759	\$859
40MB	\$859	\$959

FAST AT HARD DISK DRIVE



39 ms Access time

- * 39 ms access time
- * Auto Head Parking
- * Linear Voice Coil Activator
- * One Year Limited Warranty
- * Cables, AT sliding rail and Software included

20MB 4026	\$528
30MB 4038	\$628
40MB 4051	\$699
72MB (23 ms)	\$1195
80MB 4096 (28 ms)	\$1295

EVEREX MODEM—HAYES COMPATIBLE

Made in U.S.A. *FCC class 'B' approval

- * 300/1200 Baud
- * Half size/Half power
- * One Year Limited Warranty
- * Excellent for Long Distance calls
- * Free Bitcom Communication Software
- * **2400 Baud CALL**



\$128

20/30 HARD DISK SUBSYSTEM

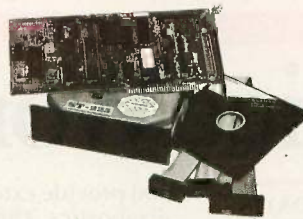

For PC Upgrade to XT

CLUB XT TURBO 4.77/8.0 MHZ

- * 360K Floppy Drive
- * 135W Power supply
- * Color: PC/XT Color
- * Electrical: 115V220V
- * 8088 CPU, 4.77 MHZ
- * Legal Compatible BIOS
- * Floppy Disk Controller
- * 8087 Math Co-processor (option)
- * Dimension: 17.5 x 19 x 6.1
- * 640K Memory 765K Standard
- * 640K Memory 765K Standard
- * One Year Limited Warranty
- * Quantity discounts available



\$505

INTERNAL EXTERNAL

20MB	\$375	\$567
30MB	\$475	

- * 65MS access time
- * Boots from Hard Disk
- * Western Digital Controller
- * Manual, Cables, Hardware and Software included
- * 20/30MB Seagate Hard Disk

With Floppy Controller Add \$50

EXPANSION CHASSIS



- * 8 expansion slots
- * No wait state design
- * Round shielded cable
- * 4 half height drive space
- * Most compatible chassis on the market

\$428

WEEKLY SPECIALS

Qty. of 2

Toshiba 72MB	\$1099
Seagate 4051	\$638
Teac Floppy 360K	\$85

64K DRAM

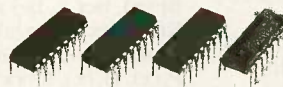

150 ns (9 pcs.)

\$9

256K RAM

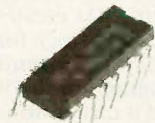

150 ns (9 pcs.)
120 ns (add \$9.00)

\$27

OTHERS

HARD DISK CONTROLLERS

* Data Switch Box	\$68
* PC/XT controller	\$90
* Floppy controller	\$49
* 25 Pin Serial Cable	\$18
* Split Power Y-cable	\$8
* IBM Type Printer Cable	\$15
* IBM AT Bus Extended Card (good for test & debug)	\$30
* AT HD/Floppy Controller	\$170
* Compaq 286 Hard Disk Controller	\$188
* PC/XT HD/Floppy Controller	\$140

CHIPS

* EPROM 2764	\$6
* EPROM 27128	\$8
TAPE	
INTERNAL	EXTERNAL
* Teac	\$580
* Wangtek	\$827

SOFTWARE

Graphics DR. HALO	
Communications BIT-COM	
ADD ON	
* Kits for Mini I/O, 2nd Serial Port	\$25
* Kits for C117B 2000, 2nd Serial Port	\$25

FREE MEMBERSHIP

CLUB AT INC.

46707 Fremont Boulevard, Fremont CA 94539

Quality and volumes is Our Business

All Sales CALL (415) 490-2201

FAX No. 415-490-2687

**Now Open 7:30 to 6:30 PST
for your convenient**

University P.O.'s are welcome

Corporate Buyer call for Neil Mehta

Quantity Discounts are Available

Dealers are Welcome

ORDER BY MAIL: Check or Money Order, California add 6.5% Sales Tax

ORDER BY PHONE: C.O.D., Cashier Check, Visa, MasterCard, American Express (3% Extra) or Approved Company P.O.

TERMS: Due to our Low Prices, all sales are final. All prices are subject to changes and quantity may be limited. We reserve the Right to Substitute Equivalent Items. Unauthorized Returns are subject to 10% Restocking Fee. Call for RMA Number for Returns and Repairs. *All Prices are subject to change without notice.

IBM, Hercules, Bitcom, Xerox, are Trade Marks of the Respective Companies. Limited Warranty, 1 Year parts and 6 months Labor

DEALERS SPECIAL

* Mini I/O	\$45
* AT keyboard	\$50
* Math Co-processor	CALL
* Two Drive Chassis	\$85
* Memory Short card	\$40
* AT Power supply 192 watt	\$95
* 6/8 MHZ AT-compatible computer	CALL
* AT HD/Floppy Controller (XT size)	\$160
* XT HD/Floppy Controller (XT size)	CALL

CHASSIS

\$99

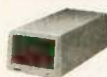

- * W/Power supply
- * Good for 2 drives

AT HARD DISK/FLOPPY



* AT-compatible
* Western Digital Chipset
\$170

density drives, 8-inch drives, and even a hard disk with some modifications. However, I have been unable to obtain a definitive answer from anyone that it can support all those drives. Could you tell me if the rumors are true, and if so, what modifications would be necessary?

STEPHEN ARMSTRONG
Norfolk, VA

While I am not specifically familiar with the controller board for the Percom drive

you speak of, it is unlikely that the board would support both hard drives and floppies. Controllers for hard disk drives are quite different in design from controllers of floppy drives.

Using a double-sided drive depends not only on the floppy controller chip used but also on the software (DOS). It is likely that the board could support 8-inch drives as well, but again, it depends on what the designers chose to put on the card in the first place. If they

did have such expansion in mind at the time of design, it might be an easy matter to expand the system as you indicate.

Such modifications are often distributed through users groups. A directory of users groups that I have lists the following entry:

Tidewater Atari Users' Group
c/o Buck Maddrey
5245 Shenstone Circle
Virginia Beach, VA 23455

Perhaps someone associated with this group near you can provide information on your system.—Steve

Lattice[®]Works

SCREEN DESIGN AID (SDA) IS NOW AVAILABLE FOR RPG II PROGRAMMERS

The Lattice Screen Design Aid (SDA) utility helps Lattice RPG II programmers create and modify display screen formats during the development and testing of application programs. Instead of coding S and D specifications for the SFGR, SDA allows you to build displays directly on your PC. When the displays on the screen are as you want them, SDA creates the SFGR source file, the screen format file for the RPG program and the skeleton RPG program for the WORKSTN file; and it can optionally print out a source listing. This product now joins Lattice Sort/Merge (LSM[™]) and Source Entry Utility (SEU) in supporting the Lattice RPG II compiler. \$350.00

LATTICE ANNOUNCES NEW SCIENTIFIC SUBROUTINE PACKAGE

SSP/PC is a library of mathematical subroutines essential to scientific, engineering and statistical computations. Comprised of more than 145 subroutines callable from FORTRAN, Pascal, BASIC and C, SSP/PC is as extensive as similar packages generally used on mainframe computers. The routines are very fast and extremely accurate

and provide extensive error diagnostics. The Error Messages save the user from inadvertent mistakes. Using SSP/PC, scientists and engineers can save time by freeing themselves from tedious and difficult programming.

SSP/PC functions include:
34 Elementary Fcns, 18 Probability and Statistical Fcns, 15 Random Number Generators, $Ei(x)$, $E_n(x)$, $li(x)$, $Si(x)$, $Ci(x)$, $\Gamma(x)$, $\psi(x)$, $B(x, \omega)$, $I_r(a, b)$, $erf\ x$, $S(x)$, $C(x)$, $J_r(z)$, $Y_r(x)$, $I_r(z)$, $K_r(x)$, $Ai(x)$, $Bi(x)$, $Ai'(x)$, $Bi'(x)$, $ber\ x$, $bei\ x$, $ker_1\ x$, $kei_1' x$, $K(x)$, $E(x)$, $F(\rho|a)$, $E(\rho|a)$, $\Pi(\rho|a, b)$, $\Lambda(a, b, \rho)$, $\mathcal{P}(z)$, $\mathcal{P}'(z)$, $P_n(x)$, $H_n(x)$, $L_n^{(\alpha)}(x)$, $J_n^{(\alpha, \beta)}(x)$, $G_n(p, q, x)$, $C_n^{(\alpha)}(x)$ and many more. \$350.00

LATTICE NOW OFFERS CODE SIFTER

Code Sifter is a software development tool that enables programmers to write faster executing software. It produces CPU usage statistics that indicate which code sections are the heavy CPU users. Using this information you can concentrate your optimization efforts on the areas that are really the bottlenecks and ignore the routines that are light CPU users.

A major advantage of Code Sifter over other products of this type is that it does not require that the user have knowledge of the machine architecture or assembly language. Link map listings are optional. In most cases Code Sifter can set up the ranges and repeatedly subdivide them automatically, freeing the programmer from a lot of drudgery. \$119.95



Lattice

(312)858-7950 TWX 910-291-2190

INTERNATIONAL SALES OFFICES: Benelux: Ines Datacom (32) 2-720-51-61
Japan: Lifeboat, Inc. (03)293-4711 England: Roundhill (0672)54675
France: SFL (1)46-66-11-55 Germany: Pfothenaur (49)7841/5058
Hong Kong: Prima 85258442525 A.I. Soft Korea, Inc. (02)7836372

CIRCUIT CELLAR FEEDBACK

SPEECH-RECOGNITION SYSTEM

Dear Steve:

I am a member of a group of students designing a speech-recognition system for a class project. We intend for the system to eventually control a mobile robot that recognizes commands such as "stop," "forward," "right," etc. We have decided to restrict the system to speaker-dependent, discrete-utterance recognition. We plan to use an 8085 as the host processor.

Having seen your Lis'ner 1000 project in the November 1984 BYTE, we decided to use General Instrument's SPI000 as the front end of the recognition system. We are now searching for literature to explain the software needed for such a system and we are hoping you can recommend some books or articles.

STEPHEN LEE
Clemson, SC

The problem in searching for references on speech recognition is not in finding articles but in finding the ones that apply to your specific needs. There are hundreds of magazine articles that concern speech recognition. However, many are about specific hardware devices or dedicated systems.

I have listed a few books and articles that may have information you will find useful. Some of these items will have bibliographies that can lead to more sources of information.

BOOKS:

Verbal Control with Microcomputers by Mike Rigsby (TAB Books, 1982).
Digital Pattern Recognition edited by K. S. Fu (Springer-Verlag, 1980).

Trends in Speech Recognition by W.

(continued)

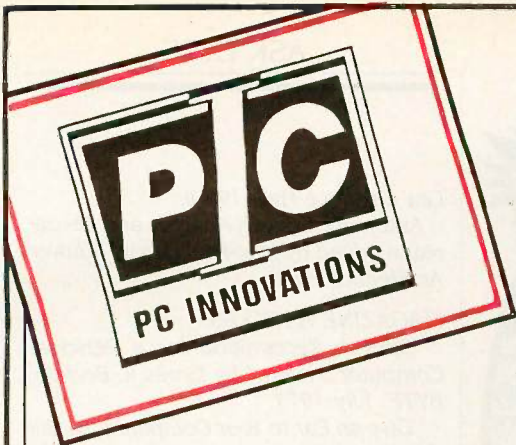

— PIC — THE BEST!!!

ALL ITEMS IN STOCK AVAILABLE FOR IMMEDIATE DELIVERY

PIC A COMPLETE BUSINESS SYSTEM AND SAVE

PIC AT 1800+

- 512K RAM Expands To 1MB
 - 33% Faster Than IBM AT
 - 1.2 MB Floppy Drive
 - 8/6 MHZ CPU 80286-8
 - USA BIOS Fully Compatible
 - Clock/Calendar W/Battery
 - Hard Disk/Floppy Controller
 - AT Style Keyboard
 - 195 Watt Power Supply
 - 48 Hour Burn In
 - Full Documentation
 - Includes Setup Software
 - One Year Limited Warranty
- Made In U.S.A.

PIC AT 1800+ \$1125

10MHZ, Zero Wait State
\$1495

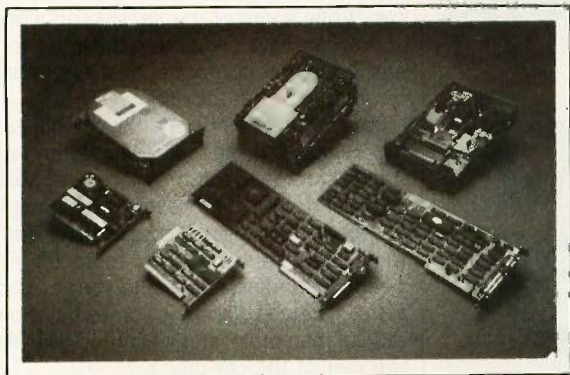

PIC YOUR DRIVES

Seagate ST225	\$310
Seagate 20MB	\$529
Seagate 30MB	\$595
Seagate 40MB	\$699
Seagate 80MB	\$1395
Toshiba 72MB	\$1395

PIC YOUR MONITORS

NEC Multisync	\$569
PIC EGA	\$439
PIC CGA	\$259
Samsung TTL	\$99

PIC YOUR BOARDS

PIC EGA	\$209
Everex EGA	\$229
PIC CGA	\$99
PIC Monographics	\$99
AT Multifunction	
Up To 2MB	\$169

PIC YOUR PRINTERS

Epson FX 85	\$379
Epson FX 286	\$539
Epson LQ 800	\$579
Epson LQ 1000	\$739
Epson EX 800 (NEW!)	\$579
Toshiba 321	\$525
Toshiba 341	\$757

PIC SPECIALS

PIC 1200 Baud Modem	\$109
Toshiba 1100 + Laptop	\$1995
Toshiba 3100 Laptop	\$3395

PIC XT TURBO SYSTEM

1 Floppy, 640K, And Choice Of:

20MB Mono	\$1195
30MB Mono	\$1295
20MB Color	\$1295
30MB Color	\$1395

FCC Approved

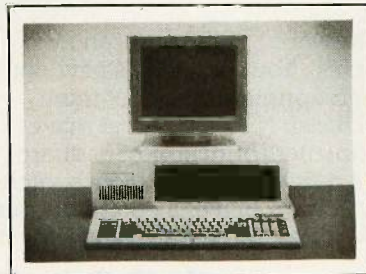

VISA & MC WELCOME
QUANTITY DISCOUNTS AVAILABLE

ALL PRICES SUBJECT TO CHANGE.
CORPORATE AND UNIVERSITY P.O.'s ACCEPTED.

PIC INNOVATIONS

10 Hughes St., Suite A-200
Irvine, California 92718
(714) 768-8130

631 S. Main Street
Plymouth, Michigan 48170
(313) 451-0664

ESTABLISHED SINCE 1980

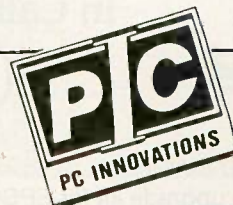

SUNDAY 10-5 **PROMPT DELIVERY**

LAP TOP COMP. COMPAQ PORTABLE 286-2 640K 286-3 1.2 MB Flop. In Stock	COMPUTERS APPLE Macintosh Plus \$1675.00 ATARI 520 w/Color Moni. Call 1040 w/Color Moni. \$949.99 AT&T 6300 640K 10 Meg. \$1999.00 Dual Drive. \$1449.99 256K 30 Meg. Call	PRINTERS BROTHER HR15-XL Call HR-20 Dual 310.00 HR-35 675.00 Twinwriter 5 In Stock M-1109 In Stock M-1409 350.00 M-1509 449.00 M-1709
MONITORS Amdek 310-A 144.99 Amdek 600 Color In Stock Amdek 722 Color 279.00 Commo. 1902 639.99 IBM Color Moni. Call IBM Multi-Sync 399.99 NEC Color Moni. 469.99 PGX HX 12 149.99 PGX HX 12E 409.95 PGS MAX 12 469.95 Taxan 630 Taxan 640	COMMODORE Amiga w/Col. Moni. Call C-128-1571 D/D. Call COMPAQ DESKPRO 286-1 1.2 Meg. Flop. \$2399.99 286-2 640K 30 Meg. Call 286-3 1.2 Meg. Flop. In Stock	EPSON Homewriter 10 Call EX-800 In Stock EX-1000 New 345.00 FX-85 450.00 FX-285 450.00 LG-400 700.00 LG-1000
LASER JET PTR. Canon 1850.00 HP Laser Jet 2175.00 HP Laser Jet Plus Call HP Laser Plus-500 Call	IBM PC Dual Drive \$899.99 640K 2 Floppies \$1049.00 256K 10 Meg. Dr. \$1299.00 IBM XT-278 Dual Flop. \$1549.99 IBM XT-089 256K 20 Meg. Dr. \$1999.99	IBM Pro Printer Call Pro Printer XL 475.00 Quietwriter II

GUARANTEED LOWEST PRICES
COMPUTER: 1-800-874-1235
VIDEO: 1-800-223-6779
HOURS: Mon-Thurs. 9-6
Fri. 9-2, Sun. 10-5, Sat. Closed

TOLL FREE OUT OF N.Y.
IN N.Y. CALL (718) 237-2828
S'nW ELECTRONICS & APPLIANCES
633 Bedford Ave, Bklyn, NY 11211

C.O.D. Accepted
Credit Card Accounts charged on time of order
Add shipping, handling, insurance
Qty limited
Prices subject to change without notice
Not responsible for typographical errors

Lea (Prentice-Hall, 1980).

Automatic Speech Analysis and Recognition edited by Jean-Paul Haton. (Kluwer Academic, 1982).

MAGAZINE ARTICLES:

"Speech Recognition for a Personal Computer System" by James R. Boddie, BYTE, July 1977.

"Give an Ear to Your Computer" by Bill Georgiou, BYTE, June 1978.

"How Computers Recognize Speech" by Maryann P. Walsh and Josef Bernard, Computers and Electronics, July 1984.

"The Many Sounds of Voice Digitization" by Jacques Saint-Remi, Data Communications, January 1984.

"Exploring Practical Speech I/O" by Tom Brighton and Sharon Cooke, Mini-Micro Systems, May 1982.

—Steve

8-BIT BUGGY

Dear Steve:

Back in the December 1979 Circuit Cellar you gave an introduction to electrically alterable ROMs and mentioned plans of putting a small computer in your car. While some of the latest production sports cars have computers, these sensors and computer components are not easily obtained by hobbyists.

Some of my friends and I have built racing buggies using somewhat standard frame, block, and transmission parts. Most of them do not even have simple gauges for speed, tach, oil pressure, etc. (We don't race these cars, we build them for appearance and enter them in various contests.) Our latest frame is somewhat more radical than most, and we intend to make the rest of the car match.

I need information on what is available for electronically monitoring the different aspects of a car's operation. Originally, I intended to use a single microprocessor module—say, a 6502 with peripheral interface adapter, ROM, and scratchpad RAM. Is it feasible to have the 6502 measure RPM, MPH, fuel level, and others? Or would it be better to have dedicated circuits do the counting and have the results available to the 6502? I also want to use a simple keypad to make requests to the controller for specific results or to activate various accessories. I would like to display the output on seven-segment LEDs and possibly LED bar graphs. Perhaps I could also add a speech synthesizer.

JAMES DUMESNIL
Port Arthur, TX

It is definitely feasible to use a micro-processor such as a 6502 to monitor such

(continued)

Attention all FX80, FX100, JX, RX, & MX owners:
You already own half of a great printer

Dealer inquiries welcome.

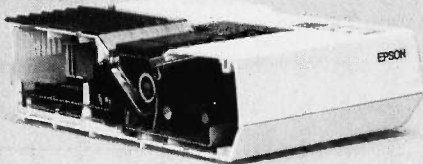

Now Only \$79.95

Now for \$79.95 you can own the rest. You see, today's new dot matrix printers offer a lot more.

Like an NLQ mode that makes their letters print almost as sharp as a daisy wheel. And font switching at the touch of a button in over 160 styles. But now, a Dots-Perfect

upgrade kit will make your printer work like the new models in minutes— at a fraction of their cost.

And FX, JX and MX models will print the IBM character set, too.

So, call now and use your Visa, MasterCard, or AmerEx. Don't replace your printer, upgrade it!

1-800-368-7737
In California: 1-800-831-9772

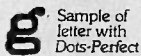

Dots-Perfect™
Dresselhaus

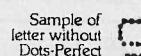

837 E. Alosta Ave., Glendora, CA 91740 Tel: (818) 914-5831
An upgrade kit for EPSON FX, JX, RX, & MX printers



EPSON is a trademark of EPSON America, Inc.

The faster you move The sooner you'll succeed

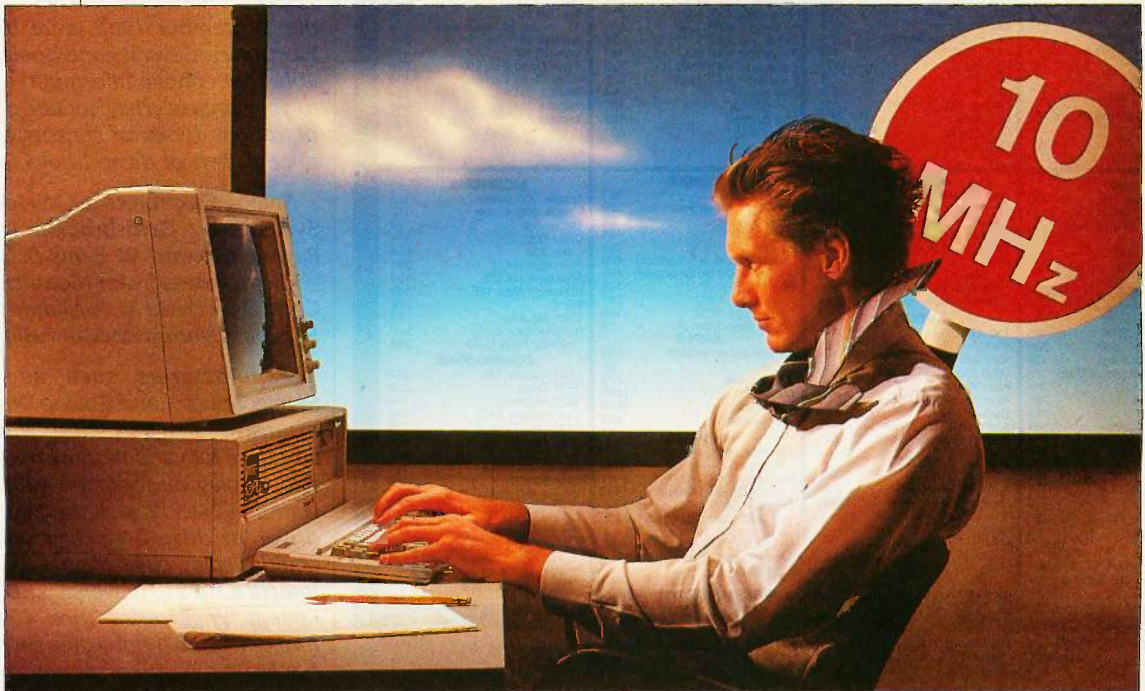

The 900 puts real power in your hands

At 10MHz, the Multitech 900 is considerably faster than the industry standard. And, with one easy touch you switch back to 6MHz.

Add to that, a front-panel restart button and you have hassle-free booting.

How's that for greater business efficiency-time for more useful tasks.

What's more, eight expansion slots make peripheral add-ons a cinch. Not to mention true-blue IBM compatibility.

As a company, we've been in the business ten years, have a proven 'famous-name' OEM track record and are committed to computer technology, 32 bit development, VLSI design, even artificial intelligence.

And because our policy is not to risk what we can't afford, we intend to be around for a long, long time.

Which is not the only good news, because best of all, the Multitech 900 is priced to go.

Check it out today. And put yourself in the fast lane.

12-month, TRW Nationwide Service Warranty on the Multitech 900.

Feel free to write for independent third party evaluation and further information.

TECHNICAL SPECIFICATIONS

Multitech 900B
CPU 80286, 6/10 MHz
switchable socket for
80287 Math Coprocessor
RAM 512 KB expandable to
1MB, 1FDD, 1.2MB.
MS-DOS 3.2

**Multitech 900E
(Enhanced)**
As 900B plus 1WDD,
30MB or 40MB-40ms
Also available:
Plus 700.

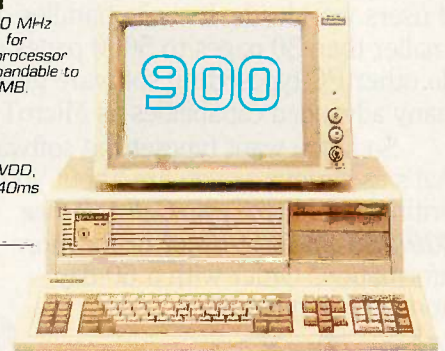

We're going to work for you.

Multitech Electronics Inc., 1012 Stewart Drive, Sunnyvale,
CA 94086. Tel: [408]-773-8400. Fax: [408]-749-8032

Call (800)-538-1542, toll-free for the name of the dealer nearest you.

Multitech

HARMONY COMPUTERS

2357 CONEY ISLAND AVE. (Bet. Aves T & U) BKLYN NY 11223
800-VIDEO84 or 800-441-1144 or 718-627-1000



Commodore 128
\$259.95
STAR NX-10
\$214.00

PANASONIC 1091
\$206.95
IBM PC (256K)
\$799.00

"PRINTER SPECIALS"

Brother HR 15XL	289	Epson FX 85	345	OkiData 193 Plus	494	Star SD 10	289
Brother 1509	359	Epson 286	459	OkiData 292 w/INTFC	468	Star SD 15	386
Brother HR 35 (Comrex C4)	449	Epson EX800	469	OkiData 293 w/INTFC	599	Star SR 10	419
Comrex 420 IBM	849	Epson LQ2500	1029	Panasonic KXP 1091	207	Star SR 15	539
Citizen 120D	169	IBM Proprietary	359	Panasonic KXP 1092	289	SR 10, SR 15 Sheetfeed	49
Citizen MSP 10	269	IBM Proprietary XL	519	Panasonic KXP 3131	234	Star SB 10	369
Citizen MSP 15	369	NEC 3550	719	Panasonic KXP 3151	369	Star NB 15	949
Citizen MSP 20	319	NEC 8850	1039	Panasonic KXP 1592	389	Silver Reed Exp 550	279
Citizen MSP 25	459	NEC P6	449	Panasonic KXP 1595	529	Silver Reed Exp 800	619
Citizen Premier 35	409	NEC P7	519	Star NX-10	214	Toshiba 341 E	634
Epson LX80 (Homewriter 10)	169	OkiData 182	209	Star SG-10C	189	Toshiba 351	949
Epson LX86	219	OkiData 93	289	Star LV 1210	169	Toshiba 321	429
Epson LQ800	509	OkiData 192	284	Star SG 15	331		
Epson LQ 1000	699	OkiData 192 +	329				

IBM	SEAGATE	MODEMS	MONITORS
AT Unenhanced	Hard Drives	Hayes 1200	Amdak 300 Green
AT Enhanced IBM 20 Meg.	20 Meg. No Controller	Hayes 1200B w/Smartcom	Amdak 300 Amber
AT Enhanced IBM 30 Meg.	10 Meg. w/controller	No Smartcom	310 Amber
IBM PC 256K	20 Meg. w/controller	Hayes 300	Color 600
IBM PC XT # 286	30 Meg. w/controller	Hayes 2400	Color 722
IBM PC XT 286#	30 Meg. AT	Hayes 2400B w/Smartcom	Princeton HX12
6 MHz, 640K	40 Meg. AT	Hayes 2400B No Smartcom	Princeton HX12E
1.2 MB, 20 MB	Tandem 20 Meg. Hard Card	Micromodem 2E	Princeton Max 12E
PC XT Turbo Clone 8mhz		Promethias 1200	SR12
IBM Monitor	ATARI	Hayes Smartcom 2	Scan Doubler
AST Slx. Pack 384K	130 XE	2E Enhanced w/128K	NEC Multisync
AST Advantage 128K	65 XE	Drive	Goldstar RGB Color
Hercules Color Card	Atan 801 Printer	Apple Drive	COMMODORE
Hercules Monochrome Card	1050 Drive	Mac 512K	Commodore 128
Quad EGA +	Atan Writer +	Mac Plus	1571 Drive
Video 7 EGA +	Atari Modem 301	Imagewriter 2	1670 Modem
STB EGA +	Comrex Printer	COMPAQ	Commodore 64C
Multifunction Card	520 ST Color System	Portable 256K 2-380K	1541 Disk Drive C
IBM Disk Drive	520 ST B & W System	Compaq Drives	1802 Monitor
8087 Chip	AT&T	256K 1-360K	1902A Monitor
Everex EGA +	256K 2-360K	1-20MB Hard Seagate	MSP 1000 Printer
Everex Graphics Edge	640K 1-360K 1-20MB	Deskpro 640K 1-360K	Star SG10C
Everex Edge	Seagate Hard Drive	1-20MB Hard Seagate	Kaypro PC 256K
Everex Graphics Pacer			2 - Drives Monitor
Joystick for IBM			

Leading Edge Model D 256K
2 Dr. Monitor **\$1199**

Leading Edge Model D 30MB
w/monitor **\$1895**

Commodore Amiga 256K, DOS
Mouse, Amiga color monitor
\$1095

800-441-1144

Items reflect 4% cash or check discount. For your protection we check for stolen credit cards.
m.c. visa welcome. Personal checks cause 4 week delay. Shipping & Handling charge extra.
All Sales Final - Price and availability subject to change without notice.

variables as RPM, MPH, fuel level, etc. A brief discussion of shaft encoding to measure speed can be found in Don Lancaster's "Hardware Hacker" column in the September 1985 issue of Modern Electronics. Several good books are available that contain information pertinent to your project. They contain discussions of various types of sensors and transducers. Two of these books are

Analog Electronics for Microcomputer Systems by Goldsbrough, Lund, and Rayner (Howard W. Sams & Co., 1983).
Microprocessors for Measurement and Control by David M. Auslander and Paul Sagues (Osborne/McGraw-Hill, 1981).

Manufacturers such as National Semiconductor and Analog Devices have extensive manuals and applications literature for various converters, sensors, and display devices. You could use the National 74C917 seven-segment display driver to drive a six-digit display. You could display eight digits if you use the Intersil ICM7218 universal LED driver IC. Omega Engineering (Box 4047, Stamford, CT 06907) publishes several handbooks on measurement and control that contain data and information you would find useful.

Finally, several Circuit Cellar projects are relevant to your application. Among them:

- "Build a Keyboard Function Decoder," July 1978.
 - "Build a Low-Cost, Remote Data-Entry Terminal," September 1980.
 - "Analog Interfacing in the Real World," January 1982.
 - "Build a Third-Generation Phonetic Speech Synthesizer," March 1984.
- Steve

OUTGROWING THE MODEL 100

Dear Steve,

I am a neophyte computer owner, testing the waters with a Radio Shack Model 100 laptop computer. I bought it with 32K for well under \$300. It has worked well, it is certainly cost-effective, and I am having fun figuring out how things work. But 32K isn't enough. "Upgrades for the TRS-80 Model 100" by Terry Kepner in the December 1985 BYTE tells me I can buy an expansion memory bank that gives me 96K bytes for \$425. I'm afraid that's too much for my budget.

Any suggestions on making a low-cost RAM module that leaves the Model 100's ROM and expansion sockets vacant?

STEVEN F. TROTTER
Bel Air, MD

(continued)

How to tackle a 300 page monster.

Turn your PC into a typesetter.

If you're writing a long, serious document on your IBM PC, you want it to look professional. You want MicroTEX. Designed especially for desktop publishers who require heavy duty typesetting, MicroTEX is based on the T_EX standard, with tens of thousands of users worldwide. It easily handles documents from smaller than 30 pages to 5000 pages or more. No other PC typesetting software gives you as many advanced capabilities as MicroTEX.

So if you want typesetting software that's as serious as you are about your writing, get MicroTEX. Call toll free 800-255-2550 to order or for more information.* Order with a 60-day money back guarantee.

MicroTEX™ from Addison-Wesley

Serious typesetting for serious desktop publishers.

*Dealers, call our Dealer Hot Line: 800-447-2226
(In MA, 800-446-3399), ext. 2643.

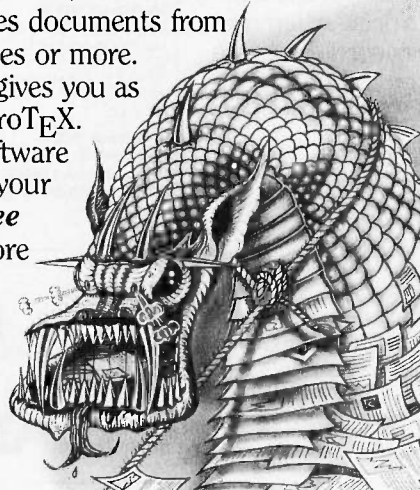

It had to happen.

After years of building high-quality, low cost terminals and monitors to American specs, Samsung has gone American all the way.

We've established a stateside group to handle your needs. Samsung Electron Devices.

Besides providing liaison with Korea, we have an American design team on staff. So you can get terminals and monitors designed right to your specs. With ease. Because there's always somebody on your side of the Pacific to talk to.

What's more, we can deliver 12" and 14" terminals that emulate America's most popular models. Plus we offer a variety of monitors, including color, in several cabinet styles, that also emulate America's most popular models. (In many cases, they already *are* the most popular models in the states.)

Our perfected manufacturing techniques keep the costs down. And our automated, robotic assembly lines turn out everything from CRTs to terminals to computers that meet U.S. standards, no problem. No inscrutable delivery delays, either.

In short, we have what it takes to do business your way. The American Way.

Join up with Uncle Samsung.

Call 213/404-1835.

It's a great way to serve your company.



SAMSUNG
Electron Devices

Inquiry 314 for End-Users.
Inquiry 315 for DEALERS ONLY.

UNCLE SAMSUNG WANTS YOU.

LOS ANGELES OFFICE
16031 S. CARMENITA ROAD
CERRITOS, CA 90701
TEL: 213/404-1835
TELEX: 183423 SEDLA
FAX: 213/926-7748

SEOUL HEAD OFFICE
TEL: (02) 755-2333 (511 ~ 513)
TELEX: K22596
FAX: (02) 756-9111

TOKYO OFFICE
TEL: (03) 581-5804, 581-9521/4
TELEX: 2228009 SANSEI
FAX: (03) 581-4835

LONDON OFFICE
TEL: (01) 831-6951/5
TELEX: 264606 STARS LG
FAX: (01) 430-0096

8 YEARS OF GUARANTEED QUALITY & SERVICE

PC HARD
DISK KITS
20 MEGABYTES
IS20 \$429
30 MEGABYTES
IS30 \$525



PC/AT
HARD DISK KIT
80 MEG HARD DISK
FREE SCSI PORT
IS80-S \$1995



PC, AT &
TANDY 1000
HARD DISK CARD
30 MEG HARD CARD
PCWD-30 \$795
TWD-30 \$795



HIGH CAPACITY
AT/XT
HARD DISK KIT
250 MEGABYTES
WITH SCSI PORT
IS250S \$4995



PC, AT &
TANDY 1000
HARD DISK CARD
21 MEG HARD DISK
FREE SCSI PORT
THC-21 \$675
PCHC-21 \$675



PORTABLE
FLOPPY DRIVE
CAPACITY: 720K
MF720P \$295



PC, AT &
TANDY 1000
HARD DISK CARD
20 MEG HARD DISK
PCWD-20 \$479
TWD-20 \$479



SCSI HOST
ADAPTER CARD
CONNECTS YOUR
PC TO 7 OTHER
DEVICES
SCSI-1 \$190



TAPE BACKUP
40 MEG INTERNAL
MT40 \$595
40 MEG PORTABLE
MT40P \$695



TANDY 1000
MULTI-FUNCTION
CARD
SERIAL PORT
DMA CONTRL
CLOCK 512K
TMF-1 \$269



TAPE BACKUP
60 MEG INTERNAL
MT60 \$795
60 MEG EXTERNAL
MT60E \$895



CALL FOR OUR
FULL LINE OF
HALF CARDS
COLOR GRAPHICS
MEMORY CARD
FLOPPY
CONTROLLER
CALL

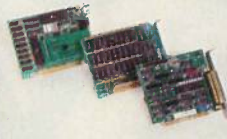

LASERBANK
2000
2 GIGABYTE
LASER DRIVE
CALL



WITH ALL HARD DRIVES
DIRECT/ASSIST \$49.95
R/ASSIST \$49.95
LIGHT SPEED \$79.95
CACHE/ASSIST \$49.95

FREE

LASERBANK
400
200 MEGABYTES
LASER DRIVE
CALL



DATA TOWER
1 GIGABYTE
HARD DISK SYSTEM
CALL



The TRS-80 Model 100 laptop computer is a very versatile unit. It does, however, have some limitations in its hardware and software—one of them being the difficulty you encounter when you try to add RAM to the system.

The 80C85 microprocessor is designed to address 64K bytes of memory. The Model 100 uses 32K of ROM for its operating system, BASIC, and other software. This leaves only 32K of room available for RAM. The device mentioned in the December BYTE uses the technique of bank switching to control the additional RAM. You cannot, however, have a program larger than 32K, since a program cannot cross a bank boundary.

The high cost involved in this method is due not only to the cost of the memory chips but to address decoding and support ICs. It seems, therefore, that your applications will be quite limited with this machine. Depending on your needs, you might want to consider a larger portable with bigger RAM capacities.—Steve

PERFBOARD

Dear Steve:

I have been looking for a large prototyping board. I had given up hope of finding such a board until I read your article "Build an Audio-and-Video Multiplexer" in the February BYTE. In it, you depicted what appeared to be an 8-by 16-inch prototyping board. Where can I get such a board?

THOMAS J. MILLER
St. Louis, MO

One source for prototyping boards (called perfboards) in the size range you require is

Jameco Electronics
1355 Shoreway Rd.
Belmont, CA 94002
(415) 592-8097

Jameco's catalog number 169P84WE is a sheet of 1/16-inch epoxy-glass perfboard that is 8 1/2 by 17 inches in size.—Steve ■

Over the years I have presented many different projects in BYTE. I know many of you have built them and are making use of them in many ways.

I am interested in hearing from any of you telling me what you've done with these projects or how you may have been influenced by the basic ideas. Write me at Circuit Cellar Feedback, P.O. Box 582, Glastonbury, CT 06033, and fill me in on your applications. All letters and photographs become the property of Steve Ciarcia and cannot be returned.

ORDER LINE 800 228-0891
0986 **305 677-8333**

Inquiry 223



1 YEAR WARRANTY, 30 DAY MONEY BACK GUARANTEE

Micro Design International, Inc.

6985 University Boulevard, Winter Park, Florida 32792



PROJECTIVE GEOMETRY AND ITS APPLICATIONS TO COMPUTER GRAPHICS
 Michael A. Penna and Richard R. Patterson
 Prentice-Hall
 Englewood Cliffs, NJ: 1986
 403 pages, \$41

PROGRAMMING PRINCIPLES IN COMPUTER GRAPHICS
 Leendert Ammeraal
 John Wiley & Sons
 New York: 1986
 168 pages, \$19.95

A MODEL IMPLEMENTATION OF STANDARD PASCAL
 Jim Welsh and Atholl Hay
 Prentice-Hall
 Englewood Cliffs, NJ: 1986
 483 pages, \$49.95

PROJECTIVE GEOMETRY AND ITS APPLICATIONS TO COMPUTER GRAPHICS
 Reviewed by
 John D. Unger

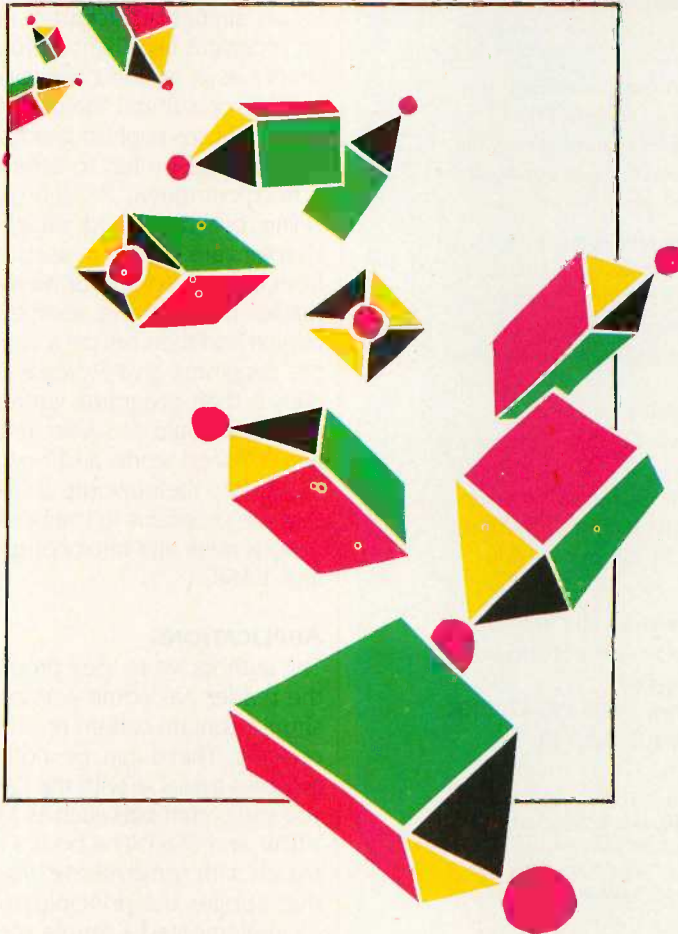

familiarity with matrix notation and simple matrix operations.

FOCUS ON DIMENSION
Projective Geometry and Its Applications to Computer Graphics is liberally sprinkled with helpful examples and illustrations. Chapters are divided into sections, each with its own set of exercises. It would be more convenient for a nonclassroom situation if the book also contained an answer section for at least some of the exercises. Most of the book is devoted to teaching the mathematics of projective geometry; only 145 of the book's 400 pages deal with applying the mathematical principles to computer graphics.

The first of two chapters devoted to computer graphics gives an overview of how projective geometry is applied to writing computer graphics applications and centers on a two-dimensional graphics program.

Imagine writing graphics programs that can show a three-dimensional perspective drawing of a specific object, or designing programs that let you zoom in on a circuit board layout to see progressively finer details. *Projective Geometry and Its Applications to Computer Graphics* by Michael A. Penna and Richard R. Patterson explains how to manipulate such graphical concepts and teaches the fundamental principles of projective geometry. The book will be most useful to experienced programmers who need to write sophisticated graphics applications that use two- or three-dimensional perspective and projections.

Penna and Patterson's book is not for those not mathematically inclined. It is a math/analytic geometry book, and as such, the prerequisites for using it include analytic geometry and calculus, a computer background, and

The second chapter covers the more complex subjects of three-dimensional graphics, perspective views, hidden-line techniques, rotational graphics, and the like.

These two chapters also introduce several key concepts concerning how to transform an object's coordinate system to the natural coordinate space of the graphics device. A good example involves mapping the x,y coordinates of an office building's floor plan onto the row and column coordinates of your screen. The authors pay special attention to coping with computer-related problems that arise in displaying two-dimensional graphics. The finite size of the pixels on a screen and their aspect ratio must be taken into consideration, as must their relationship to the actual screen size in inches. Because the size of a display area

(continued)

ARTEK™ ADA (R)

TAKE THE NEXT STEP FOR ONLY \$495!

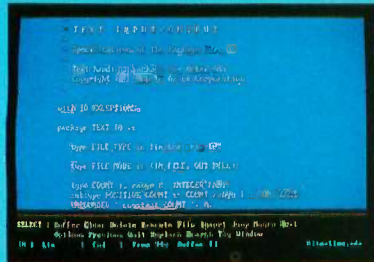

Ada's powerful features make it the programming language of choice for today's complex software. Artek Ada is the most advanced Ada compiler for PCs.

Artek Ada is a new approach to personal computing. Our fast and efficient Ada compiler runs on a vanilla PC, XT or AT with 384 Kb RAM, giving you unprecedented power and ease of use. But don't take our words for it. Take Artek Ada out for a test drive yourself. Order a Demo diskette today!

Artek Ada is an extensive, totally upwards-compatible implementation of the 1983 ANSI Ada military standard. It compiles amazingly fast and includes an Ada Programming Support Environment to greatly enhance productivity. In the APSE we have integrated the compiler with a powerful editor and a high-level debugger.

True to Artek's PC heritage the compiler is not copy-protected, and the complete source code for the Ada library is included free of charge.

We are now working on a new, validated version of Artek Ada, expected to be available in the first half of 1987. You will be able to trade in your compiler at full price, if you decide to upgrade.

Artek Ada is ideally suited for universities and in-house training. Our new, low price and aggressive educational and volume discounts won't stretch your budget.

For orders or information call toll-free **1-800-PC-ARTEK**, in New Jersey or outside the continental U.S.A. call **201-867-2900**, or write to our address.

A free brochure is available on request. Our Demo kit, including the real compiler with a 40-line maximum program length costs \$ 29.95, including p&p anywhere in the world. The compiler costs \$ 495.00. VISA, MC and AMEX accepted. In New Jersey add 6% sales tax. Outside the U.S.A. add \$20.00. Please pay with credit card or a bank draft, payable in U.S. Dollars, drawn on a U.S. bank.

Dealer and distributor inquiries welcome.

CALL: 1-800-PC-ARTEK

Artek Corporation, 100 Seaview Drive, Secaucus, NJ 07094



Artek is a trademark of Artek Corporation. Ada is a registered trademark of the U.S. Government, AJPO.

Inquiry 37

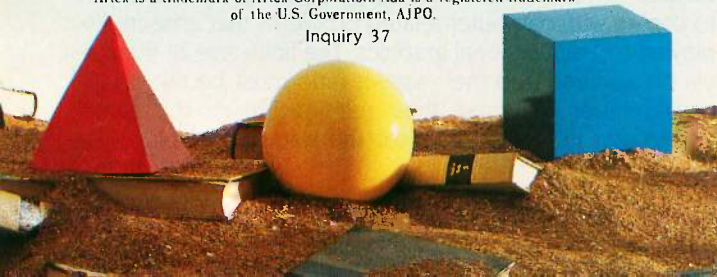

BOOK REVIEWS

on a CRT is difficult to measure accurately, the authors recommend drawing squares on the screen while varying the value of the aspect ratio until the best possible results are obtained. They also point out that the aspect ratio of the plotter or printer used with a given microcomputer frequently differs from that calculated for the CRT.

A SIMULATION

The chapter on three-dimensional graphics includes an intriguing section on writing a program that simulates an enhanced attitude indicator or artificial horizon indicator for an aircraft. It produces an image similar to that seen on programs like Flight Simulator, but the ground is shown simply as a gridded network of lines without any topographic or cultural features. This program is rather complex and uses sophisticated projection techniques. It looks like it would be fun to attempt to write this program for a microcomputer, though quite a challenge as well.

The programs and program fragments in these two chapters are written in pseudocode, which keeps the book from being software- or hardware-specific but prevents the reader from having source code that could simply be copied and then run on a computer. The pseudocode sample programs give *Projective Geometry* a much broader audience than programs written for a specific computer or language would. However, readers have to know something about pseudocode and how to translate this generic language into their favorite source code. The authors indicate that the programs in the book have been implemented on various mini- and microcomputers using Pascal, FORTRAN, and BASIC.

APPLICATIONS

The authors wrote their programs with the assumption that the reader has some sort of graphics library. This library should contain certain primitive graphics functions or procedures. These can be nothing more complex than the graphics available with the GW-BASIC interpreter, which lets you use commands such as MODE, LINE, PRINT, WINDOW, VIEW, and PSET. The book's role is to combine these commands with some matrix operations to produce a program that applies the principles of projective geometry.

I implemented a simple version of the authors' Graph2D program for my AT&T PC 6300 using a C compiler and some graphics library functions I wrote. The only procedure in the program that I couldn't duplicate was one to write character strings on the screen at different scales and rotated at various angles to the horizontal. This simple yet powerful program lets you view any part of a two-dimensional picture at an arbitrary scale and translated or rotated any amount. It is the type of program that has applications for floor plans of buildings, electronic micro circuits, or maps.

Unfortunately, the book does not discuss the details of how to write specific graphics procedures, such as the best (fastest) way to draw a line between two points. The pseudocode examples simply call a function such as Draw-LineFrom(U0,V0)To(U1,V1). It is up to the user to figure out

(continued)

Softline

PRICE BUSTERS



Lotus 1-2-3 \$319

Paradox \$469

dBase III Plus \$389

FrameWork II \$389

Multimate Advantage \$279

Word Perfect 4.1 \$209

Software

Word Processing

Table listing word processing software such as FANCY FONT, FINAL WORD II, MICROSOFT WORD 3.0, MULTIMATE, and WORD PERFECT 4.1 with their respective prices.

Database Systems

Table listing database systems such as CLIPPER, CONDOR III, DBASE III PLUS, and PARADOX with their respective prices.

Spreadsheets/Integrated Packages

Table listing spreadsheet and integrated packages such as ENABLE, FRAMEWORK II, JAVELIN, and MULTIMATE with their respective prices.

*CALL FOR SHIPPING COSTS

Graphics

Table listing graphics software such as CHARTMASTER, DIAGRAM, DIAGRAM MASTER, and ENERGRAPHICS 2.0 with their respective prices.

Project Management

Table listing project management software such as HARVARD TOTAL, PROJECT MANAGER, and MICROSOFT PROJECT with their respective prices.

Communications/Productivity Tools

Table listing communications and productivity tools such as CARBON COPY, CROSSTALK, PROKEY, and RELAY GOLD with their respective prices.

Statistics

Table listing statistics software such as SPSS/PC+, STATGRAPHICS, and STATPAC GOLD with their respective prices.

Accounting

Table listing accounting software such as BPI, GREAT PLAINS, IUS EASYBUSINESS, and ONE WRITE PLUS with their respective prices.

Network Applications

Table listing network applications such as DBASE III LAN PAK, KMAN 2, MULTIMATE, and ADVANTAGE with their respective prices.

Languages/Utilities

Table listing languages and utilities such as C86 C COMPILER, COPYWRITE, FASTBACK, and LATTICE C with their respective prices.

Desktop Environments

Table listing desktop environments such as DESQVIEW, GEM DESKTOP, MS WINDOWS, and SIDEKICK with their respective prices.

Hardware*

Multifunction Boards

Table listing multifunction boards such as AST ADVANTAGE (128K), AST 6 PAK PLUS (64K), and AST I/O MINI with their respective prices.

Display Boards

Table listing display boards such as HERCULES GRAPHICS CARD, HERCULES COLOR CARD, and PARADISE MODULAR GRAPHICS with their respective prices.

Emulation Boards

Table listing emulation boards such as AST 5211-11+, AST 5251-12, and AST BSC with their respective prices.

Modems

Table listing modems such as AST REACH 1200, HAYES 1200, HAYES 1200B, and HAYES 2400 with their respective prices.

Mass Storage/Backup

Table listing mass storage and backup devices such as IOMEGA 10+10, W/INTFC, and IOMEGA 20+20 with their respective prices.

Monitors

Table listing monitors such as AMDEK 310A, AMDEK 600/722, NEC MULTISYNC, and PRINCETON HX-12 with their respective prices.

Networks

Table listing networks such as AST PC NET, NOVELL, and ORCHID PC NET with their respective prices.

Printers/Plotters

Table listing printers and plotters such as BROTHER TWINWRITER, DATA PRODUCTS DIABLO 635, EPSON FX-85, and EPSON FX-286 with their respective prices.

Input Devices

Table listing input devices such as KEYTRONICS 5151, KEYTRONICS 5153, MICROSOFT MOUSE, and PC MOUSE W PAINT+ with their respective prices.

Accessories

Table listing accessories such as CURTIS SURGE PROTECTORS, DATASHIELD BACKUP POWER, DATASHIELD SURGE PROTECTORS, GILTRONIX SWITCHES, and MASTERPIECE PLUS MICROFAZER INLINE with their respective prices.

NEC Multisync \$619

Mountain Drivecard 20 \$719

Quadram EGA+ \$369

Hayes 1200B Halfcard \$349

JRAM AT-3 \$239

IRMA Board \$725

FREE SHIPPING

on all orders over \$1000.00, credit card orders, and prepaid orders.



1-800

221-1260

In New York State call (718) 438-6057

Softline P.O. Box 729, Brooklyn, NY 11230 TELE: 421047 ATLN U! FAX: 718-972-8346

Our Policy: * Visa or MasterCard... * Cash, M.O. or bank check only... * No sales tax... * Prices subject to change... * All returns require prior authorization.

SIX MODES OF MULTIPLEXING IN ONE SMART UNIT

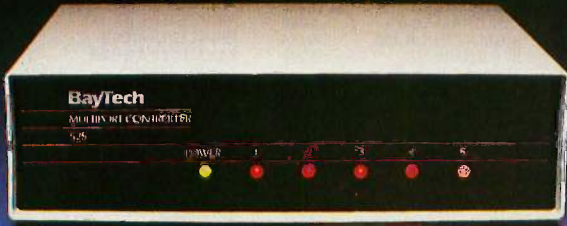

THE 525H

Multiplex data from multiple devices to one port on a computer with an H-series multiplexer from BayTech. Its versatility makes it the ideal choice for data collection and control applications. You tailor this multi-function device to your own environment by selecting one of six modes of operation: time-division multiplexing, port expansion/sharing, or four types of buffered message multiplexing.

The Model-H is a stand-alone RS-232C multiplexer that connects between one host computer and up to 17 peripheral devices. It provides full duplex transmission of asynchronous data at speeds up to 19,200 bps. Selecting the mode of multiplexing (and also the baud rates, control character, data block size, message terminating character, etc.) is as easy as answering questions from a menu. All parameters are saved permanently in non-volatile memory.

In a size to fit large and small applications:

The 525H with four peripheral ports, \$395.

The 528H with eight peripheral ports, \$649.

The 5212H with eleven peripheral ports, \$1,095.

The 5218H with seventeen peripheral ports, \$1,495.

**CALL FOR YOUR FREE BROCHURE
800 523-2702**

Bay Technical Associates, Inc.
Highway 603, PO Box 387
Bay St. Louis, MS 39520
Telephone 601 467-8231
Telex 910-333-1618 BAYTECH

Inquiry 48

BayTech

DATA
COMMUNICATIONS
PRODUCTS

BOOK REVIEWS

how best to write or implement this function using his or her particular software and hardware.

CRISP STYLE

Given the textbook nature of *Projective Geometry*, Penna and Patterson have adopted a lucid and fairly easy-to-read writing style. Make no bones about it, though, the book uses a quantitative approach to the subject; there is very little descriptive material. The organization of the book is straightforward and logical. First the math is presented and then the applications with examples. Fortunately for computer types, the two chapters on computer graphics applications are among the easiest to read. There is about as much jargon as you might expect from a math-oriented textbook; you won't be coddled.

John D. Unger (P.O. Box 95, Hamilton, VA 22068) is a geophysicist for the U.S. government who uses computers to help study the geologic structure in earthquake-prone regions of the eastern U.S.

PROGRAMMING PRINCIPLES IN COMPUTER GRAPHICS

Reviewed by Steve Cunningham

Of his book *Programming Principles in Computer Graphics*, Leendert Ammeraal states that "for anyone who teaches computer graphics, at least some parts of the book will be useful." I'll go beyond that. The book is among the best starting points I've seen for people who need to learn computer graphics, be they students, teachers, or programmers. This slim volume offers a concise, concrete introduction to graphics that prepares the way for additional graphics work. It assumes only that you have previous programming experience.

GENERAL APPROACH WORKS

Some books cover a lot of material but skimp on the details. This one, however, picks its topics carefully and describes each one fully. What Ammeraal covers is line graphics, and he does so in a very thorough, device-independent fashion. All the topics he discusses have complete program listings. His vehicle is C, which could well be the best modern graphics language. Though he uses UNIX C and some of his programs are filters that preprocess scene data for later graphic programs to use, his programs are readily adaptable to other systems or even other languages. The reader needs to provide only the most elementary move and draw routines to make the programs work on essentially any system and provide output to a wide variety of devices. I have written my own graphics package, and I was able to adapt programs readily, even in a raster graphics environment.

The approach of this text is far superior to that of most microcomputer graphics books. By treating the topic in a device-independent way, Ammeraal covers a great deal of material very clearly. Most graphics books, on the other hand, tend to spend so much time discussing machine-

(continued)

Get a new handle on your business with SBT.

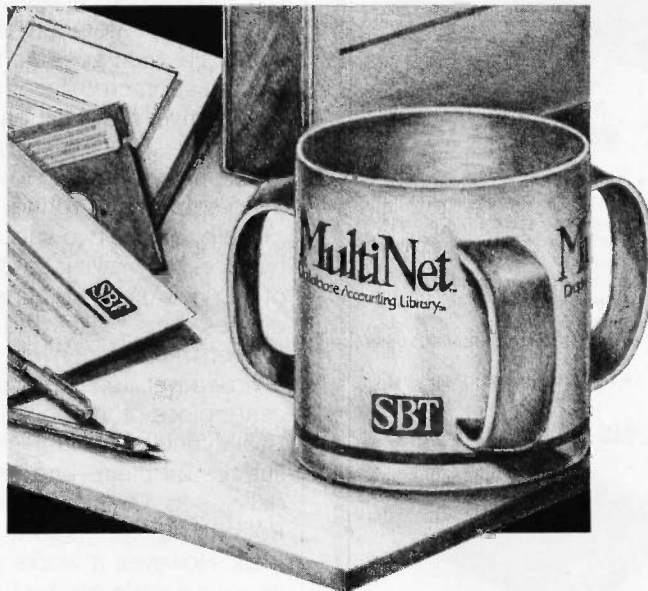

Now you can handle up to 254 users, all working in the same data files, with the SBT MultiNet Database Accounting Library. The accounting software written in dBASE III PLUS.

So whether your business is large or small, you can grow to the limits of the most advanced PC networks available.

When you want that special report, or your business needs something we didn't think of, you can quickly and easily modify our programs to meet your needs exactly (because our dBASE source code is included).

And if you don't have time to make the changes yourself, there's a nearby consultant who can make them for you.

So if your company has two users or two hundred and fifty, you can add customers, update records, and have as many people enter orders as it takes to keep your business growing.

Isn't it nice to know there's software you can't outgrow? The SBT MultiNet Database Accounting Library.

Now you can get a new handle on your business.

Three Harbor Drive Sausalito, CA 94965
(415) 331-9900

Call today for our demo disk and brochure.
(415) 331-9900.

THE SBT DATABASE ACCOUNTING LIBRARY.

dProfessional	Time & Billing	\$395
dOrder	Sales Order processing	\$195
dInvoice	Billing/Inventory Control	\$195
dStatement	Accounts Receivable	\$ 95
dPurchase	Purchase Order	\$195
dPayable	Accounts Payable	\$295
dPayroll	Payroll/Labor	\$395
dLedger	General Ledger/Finance	\$395
dAssets	Asset/Depreciation	\$295
dProject	Project/Job Accounting	\$395
dProperty	Tenant/Unit Management	\$395
dBackup	Menu/Backup	\$ 65

MultiNet versions \$200 additional per module

Call today for the name of the SBT consultant
in your area.



*Compiled versions also available. dBASE III and dBASE II are registered trademarks of Ashton-Tate, Inc. Copyright 1986, SBT Corporation.

SCSI ENGINES

Little Board/186™ \$495

High Performance, Low Cost PC-DOS Engine

**Boots IBM PC-DOS
(not included)**

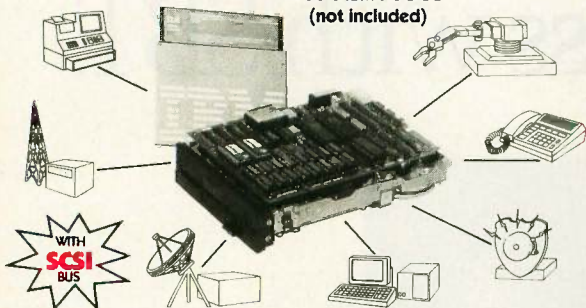

- Three times the COMPUTING POWER of a PC
- Data and File Compatible with IBM PC, runs "MS-DOS generic" programs
- 8 MHz 80186 CPU, DMA, Counter/Timers, 128/512K RAM zero wait states, 16-128K EPROM
- Mini/Micro Floppy Controller (1-4 Drives, Single/Double Density, 1-2 sided, 40/80 track)
- 2 RS232C Serial Ports (50 -38,400 baud), 1 Centronics Printer Port
- Only 5.75 x 7.75 inches, mounts directly to a 5-1/4" disk drive
- Power Requirement: +5VDC at 1.25A; +12VDC at .05A; On board -12V converter
- SCSI/PLUS™ multi-master I/O expansion bus
- Software Included:
 - PC-DOS compatible ROM-BIOS boots DOS 2.x and 3.x
 - Hard Disk support

OPTIONS

PROJECT BOARD/186™ - adds 25 square inches of wire wrap prototype area with buffered and pre-decoded 80186 bus interface for Little Board/186

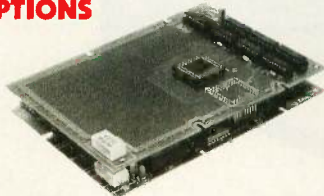

EXPANSION/186™ - adds five key options to Little Board/186

- 512K RAM
- 8087 co-processor
- Battery-backed Real Time Clock
- 2 RS232/422 sync/async serial ports
- I/O expansion bus

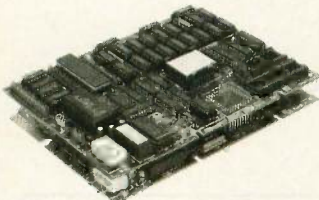

VIDEO RAM EMULATOR™ - allows use of software that writes to display controller "VIDEO RAM"

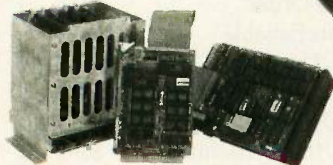
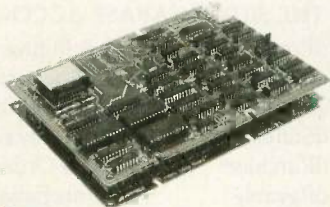

SCSI/IOP™ - permits connection of off-the-shelf STD bus industrial I/O interfaces (analog, digital, serial, display, power control, etc.)

DISTRIBUTORS

ARGENTINA: FACTORIAL, S.A., 41-0018
TLX 22408 AUSTRALIA: ASP
MICROCOMPUTERS, (613) 500-0628,
TLX 36587 BELGIUM: CENTRE ELECTRONIQUE
LEMPEREUR, (041) 23-45-41, TLX 42621
BRAZIL: COMPULEADER COMPUTADORES
LTD.A., (41) 262-1939, TLX 416132 **CANADA:**
TRI-M, (604) 438-9012 **DENMARK:** DANBIT,

(03) 66 20 20, TLX 43558 **UK:** AMBAR
SYSTEMS LTD., 0296 35511, TLX 837427
FINLAND: SYMMETRIC OY, 358-0-585-322,
TLX 121394 FRANCE: EGAL PLUS,
(1) 4502-1800, TLX 620893 ISRAEL: ALPHA
TERMINALS, LTD., (03) 49-16-95, TLX 341667
SWEDEN: AB AKTA, (08) 54-20-20, TLX 13702
USA: CONTACT AMPRO COMPUTERS INC.,

IBM®, IBM Corp., 80186®, Intel, Corp.,

AMPRO

COMPUTERS, INCORPORATED

67 East Evelyn Ave., • Mountain View, CA 94041 • (415) 962-0230
 TELEX 4940302 • FAX (415) 962-1042

BOOK REVIEWS

dependent questions that good general questions are slighted. Moreover, the general approach can be implemented easily on any computer.

GRAPHICS TOPICS DISCUSSED

Ammeraal starts with two-dimensional graphics and covers transformations, windowing and clipping, recursive drawing, and B-spline curves—all in 30 pages. He conveys more useful information here than most books do in twice the space. He then goes on to three-dimensional topics, including geometry, decomposing polygons into triangles, perspective drawing, backface removal, a hidden-line algorithm, and some applications. He includes all the mathematics required for his techniques, but readers will need some background in math and trigonometry.

The book has two special technical features. First, it introduces the viewing transformation, the fundamental part of 3-D viewing, by locating the eye point in spherical coordinates. This makes the transformation's matrix much clearer than the conventional Cartesian approach but is almost never done in standard texts. Second, the technical centerpiece of the book is its hidden-line algorithm. This is a difficult problem—more difficult than the hidden-surface problem—and its solution is carefully and fully developed. The algorithm is a special case of the classical Roberts algorithm, so it is not as unique as the author feels. However, it works well, is of reasonable length so its source code can be fully included in the book, and is used to produce some very nice illustrations. For a more technical discussion, see David F. Rogers's *Procedural Elements for Computer Graphics* (McGraw-Hill, 1985).

PROVIDES BASIC TOOLS

As good as it is, *Programming Principles in Computer Graphics* is far from a complete source of graphics information. It makes no attempt to cover such topics as raster graphics, surfaces, color, lighting models, fractals, or ray tracing. After working through Ammeraal's book, you will have the tools you need to go on to these areas and work through more advanced texts such as James D. Foley and Andries van Dam's *Fundamentals of Interactive Computer Graphics* (Addison-Wesley, 1982) or D. Donald Hearn and M. Pauline Baker's *Computer Graphics* (Prentice-Hall, 1986).

Steve Cunningham teaches computer science at California State University, Stanislaus (Computer Science Department, Turlock, CA 95380). He is chairman of ACM-SIGGRAPH's Education Committee and the author of SIGGRAPH's Computer Graphics Education Directory.

A MODEL IMPLEMENTATION OF STANDARD PASCAL

Reviewed by Paul E. Hoffman

A *Model Implementation of Standard Pascal* by Jim Welsh and Atholl Hay has many goals: to put the source code for a complete implementation of ISO Standard Pascal into

(continued)

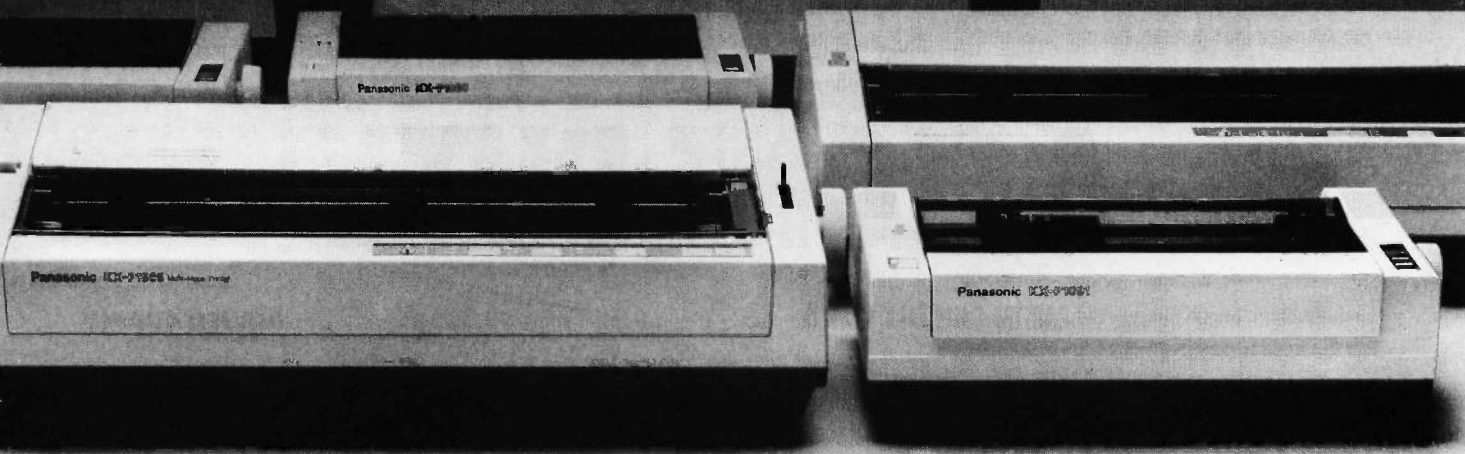

PANASONIC® PRINTERS. THEY'RE GENERATING A LOT OF GOOD PRINT.

The good reviews keep rolling in. And, as you can see, the critics agree: Panasonic printers are real winners!

But that shouldn't come as too big of a surprise. After all, Panasonic printers offer the advanced features and ease-of-use you've come to expect from Panasonic.

So, whether your business is big, small or in-between, you'll find a printer with features to love every bit as much as the critics. Like—as one

...y had. Like their competition, the Panasonic machines are well made, sturdy printers that should serve well in the various applications for which they were designed. They are letter-quality text. About the

PC WEEK—JUNE 17, 1986

with this little printer.

As far as I'm concerned, the KX-P1091 produces not near letter quality but rather true letter quality in this mode. You'd really have to strain to distinguish it from typewriter quality. Knowing that the text output was printed by the company produced fast, courteous, and knowledgeable answers.

PC—SEPT. 17, 1985

reviewer observed—extraordinary near-letter-quality on our dot matrix models. They also come standard with impressive high-resolution graphics capability. So you can add graphs, charts, illustrations—even your company's logo.

Not to be outdone, all our daisy wheel printers give you sophisticated advances like boldface, shadow and underline.

Of course, we've put just as much care into the human side of our printers, too. You'll find

switches and buttons that let you change print sizes and styles right on the printer rather than through the computer. And, with our continuous, self re-inking ribbons, you'll find yourself changing ribbons less often. When you do, our snap-in cartridge makes it a snap.

...and performance of the KX-P3151. It is a well-built product that promises to deliver many hours of trouble-free operation. The print quality is clear and well-defined. The alignment of characters on adjacent lines is also excellent, a sign of a well-designed paper and printwheel transport system.

PC PRODUCTS—APRIL, 1985

Finally, just when you thought all this would be hard to top, there's more: all our printers are backed with an unprecedented two-year limited warranty.

Now that you've reviewed all of this for yourself, call toll-free 1 (800) PIC-8086 for the name

...ed. This 30.1 pounds. Like all the Panasonics we tested at, the 1592 comes with the company's exceptional two-year warranty. And like all of them, it definitely rates a look.

of the dealer nearest you. Or you can write to: Panasonic Industrial Company,

PRINTERS BUYERS GUIDE & HANDBOOK #3
Computer Products Division, Two Panasonic Way, Secaucus, NJ 07094. You'll see how easily Panasonic printers generate good print for you.

And you'll agree: **THE EASIER, THE BETTER.**

Panasonic
Office Automation 

Inquiry 260

ANYONE CAN BUILD A CLONE, BUT...

MAIN CIRCUIT CARD

POWER SUPPLY

CONTROLLER CARDS

ROM/BIOS
CHIP

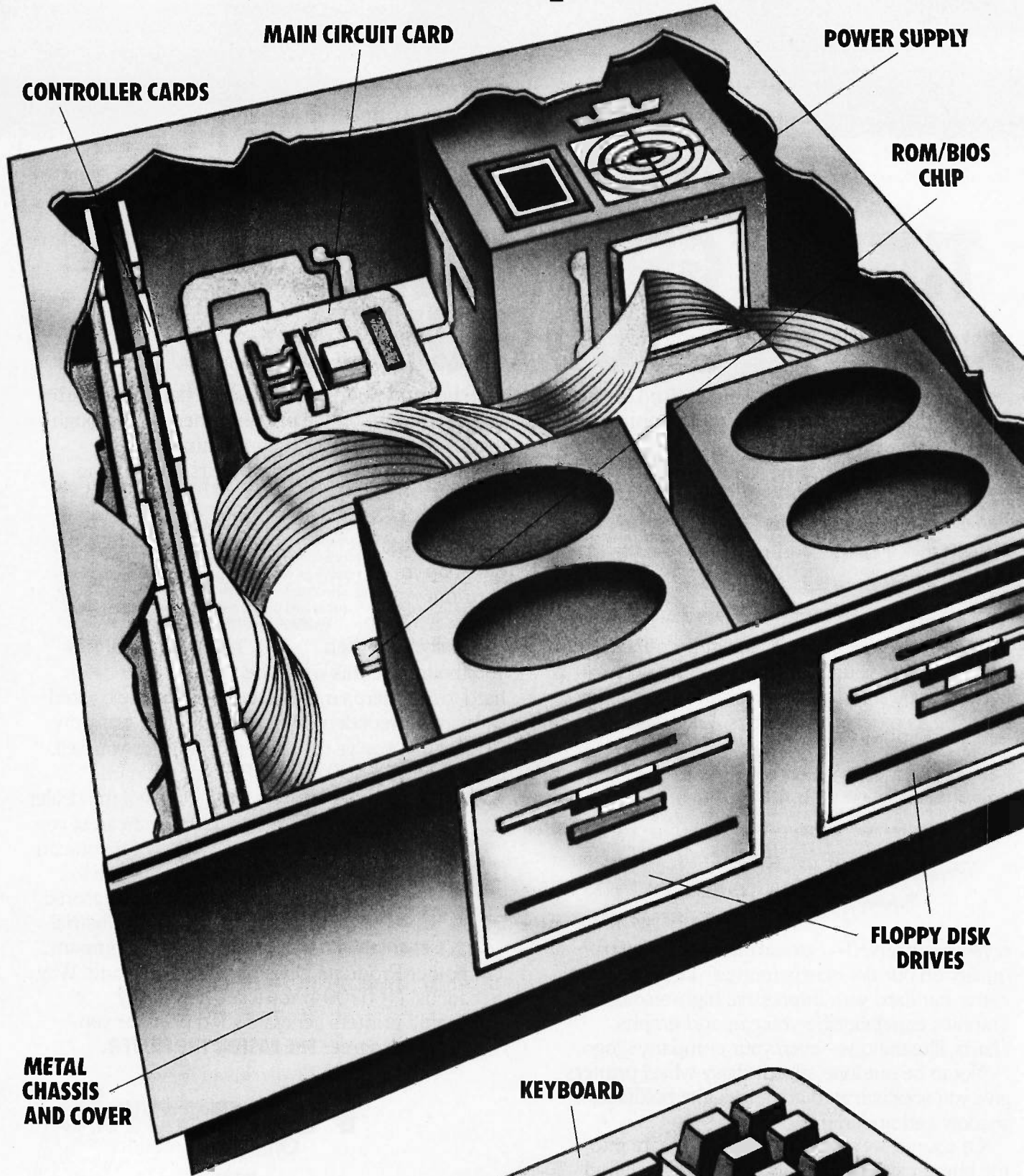

METAL
CHASSIS
AND COVER

KEYBOARD

FLOPPY DISK
DRIVES

ONLY PANASONIC® GIVES YOU A BUSINESS PARTNER.™

Everyone seems to be jumping on the bandwagon. Today, companies that weren't there yesterday, and may not be there tomorrow, are building computers from easily assembled components.

The result is a sea of computer clones with little to distinguish one from another.

THE PANASONIC DIFFERENCE—A POWERFUL BUSINESS ALLY. Our approach to offering you a computer was entirely different. We looked at what would work best for you and your business.

The result is the Panasonic Business Partner and Panasonic Business Partner 286. Two powerful business allies, designed to answer your most demanding computer requirements.

YOU CAN SEE THE DIFFERENCE

PANASONIC MAKES. With our long, unparalleled heritage in video technology, you get high-quality, high resolution monitors. An optional Panasonic CGA PLUS board is switchable to let you use a color or monochrome display for both graphics and text.

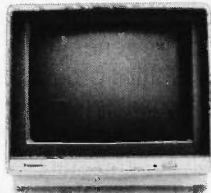

BUILT-IN FLEXIBILITY. No two businesses run exactly the same way. So you can configure the Business Partners to your own individual needs. In addition to their built-in floppy disk drives, you can add a hard disk drive, additional half-height drives—even a magnetic tape drive.

SPEED AND PERFORMANCE. The Business Partner 286 is built with maximum power and speed. Its 80286 processor runs at 6 MHz or 8 MHz, with the ability of addressing up to 15Mb RAM.

The Business Partner, with its 8086-2 processor, runs at 4.77 MHz, and for projects that need added acceleration, it will run up to 7.16 MHz.

FUTURE GROWTH. Both Business Partners have been designed to grow as your business grows. Extra slots are built in to offer you the flexibility—now and in the future—to add on cards for high resolution graphics, communications accessories and other peripherals.

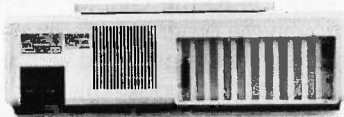

POWER TO SPARE. As your business grows, you'll put greater demands on your Business Partner. Don't worry, it can handle it. With 130 watts on the Business Partner and 220 watts on the Business Partner 286, you'll be able to drive additional peripherals and expansion boards.

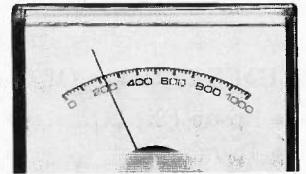

IMPORTANT DESIGN CONSIDERATIONS. The deluxe, detachable keyboards on both models have been designed for comfort and ease of use. We've separated the cursor keys and numeric keys for quick, convenient



access. Swivel monitors adjust for each operator. On the Business Partner 286, you can lock the cabinet with a key to help prevent tampering and prying.

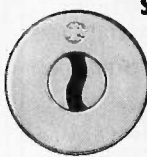

SOME REASSURING LAST WORDS. You'll find the Business Partner compatible with the IBM® PC/XT. And the Business Partner 286, with the PC/AT. So you'll be able to run the most popular software. You'll also get compatibility with Panasonic's wide range of quality peripherals, for the complete Panasonic office.

And more importantly, both Business Partners are from Panasonic, the company firmly committed to building a high-quality and dependable reputation in computer products. So both are backed with a full-year limited warranty.

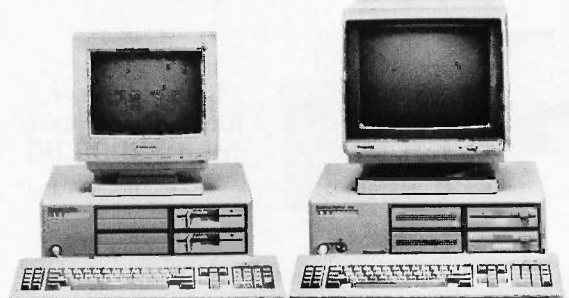

For more information, and the location of the dealer nearest you, call **1-800-PIC-8086**. Or write: Panasonic Industrial Company, Computer Products Division, Two Panasonic Way, Secaucus, NJ 07094. And discover how the right Business Partner can make running your business easier. You'll see: **THE EASIER, THE BETTER.**

Panasonic
Office Automation 

Inquiry 261

*IBM is a registered trademark of the International Business Machines Corp.

AT LAST: Professional Typesetting Capability For PC Users

With **PC T_EX™** — the best-selling full implementation of Professor Don Knuth's revolutionary typesetting program T_EX.

FINEST Typeset Quality Printing From:
 dot matrix laser phototypesetter

$$\sum_{i=1}^{\infty} \frac{1}{i} \begin{pmatrix} a_{11} & \dots & a_{1n} \\ a_{21} & \dots & a_{2n} \\ \vdots & \ddots & \vdots \\ a_{m1} & \dots & a_{mn} \end{pmatrix} \int_{-\infty}^{\infty} e^{-x^2} dx$$

WIDEST Range Of Output Device Drivers:

- Epson FX, LQ
- Toshiba
- Corona LP-300*
- Screen preview, with EGA or Hercules card
- HP LaserJet*
- Apple LaserWriter
- APS-5 phototypesetter

MOST COMPLETE Product Offering:

PC T_EX (not copy protected) includes the following:

- Our specially written *PC T_EX Manual*, which enables you to start using T_EX right away.
- Custom "macro packages" that provide formats for letters, manuals, technical documents, etc.
- The *L^AT_EX* document preparation system, a full-featured macro package for preparing articles, books, reports, etc., and *L^AT_EX User's Manual*.
- *A_MS-T_EX*, developed by the *Amer. Math. Society* for professional mathematical typesetting.

Site licenses, volume discounts, and interfaces to PC Paintbrush, PC Palette, FancyFont and Fontrix are also available.

PRICED FROM ONLY \$249.00!

(Printer drivers and interfaces additional.)

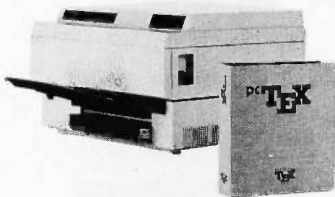

**Laser printer,
 fonts & software
 from \$2995.00**

For IBM PC/XT, AT or compatible, DOS 2.0 or higher, and 512K RAM. Hard disk required for printer drivers and fonts.
 *HP LaserJet and Corona require additional interface boards.

For more information call or write:

Personal T_EX, Inc.

20 Sunnyside, Suite H, Mill Valley, CA 94941 (415) 388-8853

This ad, with space for the photograph, produced by PC T_EX. Typeset on the Epson FX80, the Corona LP-300 laser printer, and the Autologic APS-5 phototypesetter.

T_EX is a trademark of the American Mathematical Society. Manufacturers' product names are trademarks of individual manufacturers.

BOOK REVIEWS

the public domain, to show good Pascal programming style by example, to explain how to implement a complete p-code system efficiently and coherently, and to detail the considerations needed to implement a robust compiler.

The book is quite successful in these goals. Because it is highly technical, it will be of little interest to beginning Pascal programmers. However, if you are a mid- to high-level Pascal programmer or you are interested in how compilers are constructed, you will probably find this book fascinating.

THREE SUBSTANTIVE PROGRAMS

The book presents three complete and lengthy programs. The first and longest program is the Pascal compiler. A complete implementation of ISO Standard Pascal (ISO #7185), it takes up about 70 percent of the book. The compiler produces object programs in p-code.

The second program is the P-machine that interprets the p-code from the compiler and executes it on the target machine. The P-machine is designed to run on almost any computer and has no CPU-specific instructions in it. The P-machine program has an interesting feature: If a p-code program terminates abnormally, the P-machine saves a file with run-time information. This is processed by the "post-mortem generator."

This third program reads the "corpse" file that is left by the P-machine and gives the programmer valuable information on exactly what went wrong in the program. It analyzes the state of the "dead" program by comparing its values to those of the files generated by the p-code compiler.

A SOUND STRUCTURE

A *Model Implementation of Standard Pascal* consists of a bit of front matter and these three heavily commented programs. All of the text that you would normally find in a book is program comments here. This novel approach has forced the authors to present their material in the same order as it appears in the programs. Of course, this means that the programs must be very well structured or the book wouldn't make much sense. Fortunately, the programs are put together very well and the book is quite readable.

The chapters consist of the functional parts of the programs. For example, the chapters in the postmortem generator section include an overview, global definitions, diagnostic file-reader procedures, error message output procedures, a symbolic variable lister, and a driver program. Each chapter begins with a discussion of the code and an explanation of some of the variables used by the functions and procedures in the chapter.

In addition to the chapter opening, each routine and function in the programs is commented in two ways. Most program units are prefaced with the kind of material you would expect in a book. This consists of a few paragraphs explaining the purpose of the unit, its input and output, and notes on implementation. Some statements in the routines and functions are also commented. The variable

(continued)

Technical & Other
Info. (602) 246-2222



SPECIAL
WORD PERFECT
\$195



Call for programs
not listed

TOLL-FREE ORDER LINE 1-800-421-3135

Call us for your Microsoft needs.

For your Holiday Shopping, we have extended our hours to: Monday, Wednesday & Thursday — 7 am-9 pm; Tuesday & Friday — 7 am-5:30 pm; Saturday 9 am-5 pm; Sunday 10 am-2 pm. MST.



DATA BASE MANAGERS		EDUCATIONAL		KEYBOARDS		Quad EGA Plus \$349	
Clipper..... \$329		Flight Simulator..... \$28		Keytronics 5151 \$155		STB EGA Plus Call	
Clout 2..... 117		Turbo Tutor II 25		Keytronics 5153 255		Vega Video 299	
Condor III 310		Typing Tutor III Call		PRINTERS			
Knowlegeman II Package 365		LANGUAGES		CANON LASER 1939			
Powerbase 2.2 212		Lattice C Compiler 242		CITIZEN		RAM	
Q&A Call		Microsoft C Compiler 249		MSP-10 279		64K 150NS (set of 9) 11.50	
Quickcode 138		Microsoft Fortran 195		MSP-15 379		256K 150NS (set of 9) 30	
Quickreport 138		Microsoft Macro Assembler 84		MSP-20 315		256K 120NS (set of 9) 39	
Revelation 445		Microsoft Pascal Compiler 166		Premiere 35 Daisywheel 469		MODEMS	
R: Base System V 365		Microsoft Quick Basic 55		EPSON SPECTACULAR		Everex 300/1200 120	
WORD-PROCESSING		Ryan McFarlan Fortran 305		Hurry — Call us now for special		Hayes 1200 Call	
Easy 88		Ryan McFarlan Cobol 479		low, low pricing on the following		Hayes 1200B Call	
Microsoft Word 252		Turbo Pascal w/8087 + BCD 55		Epson printers:		U.S. Robotics Courier 2400 359	
Multimate Advantage Call		UTILITIES		FX86 FX286		U.S. Robotics Passwd. 1200 .. 180	
Peachtext 5000 145		Copy II PC 19		LQ800 LQ1000		BOARDS	
Volkswriter 3 139		Copywrite 39		EX800 EX1000		AST Advantage Premium Call	
Webster Spellicheck 37		Desqview 55		EX86 LQ2500		AST Premium 359	
Wordstar 162		Double Dos 27		Pricing good through December		AST Sixpac (384K) Call	
Wordstar Propac 233		Fastback 85		31, 1986.		Hercules Color Card 145	
Wordstar 2000 233		Microsoft Windows 55		FUJITSU		Hercules Graphics + 182	
Wordstar 2000+ 278		Norton Utilities 3.1 48		DX2100 Parallel Call		Intel Above Boards Call	
SPREADSHEET		Prokey 4.0 70		DL2400 Ser/Par Call		J Lazer (Tall Tree) Call	
Microsoft Multiplan 108		Sidekick (unprotected) 47		LASER IMAGE 2000		J Ram III (Tall Tree) 179	
Spreadsheet Auditor 3.0 82		Sideaway 3.1 36		NEC		J Ram III AT (Tall Tree) Call	
Supercalc 4 Call		Superkey 39		NEC P5XLP 1126		COMPUTERS	
VP Planner 49		Traveling Sidekick 39		NEC P7 Parallel 635		ABBOTT TURBO PC	
ACCOUNTING		XTree 27		NEC 8850 1098		IBM Compatible Computer,	
BPI AP, AR, PR, GA 299 ea.		ACCESSORIES		NEC P6 Parallel 455		4,77 or 7.47 key selectable,	
Cyma Call		Copy II PC Board 75		OKIDATA - Call on all models		AT style keyboard, 640K,	
Dac Easy Accounting 39		IBM 135 watt power supply 59		PANASONIC		dual drive, 135 watt power	
Dollars & Sense 94		Mini Micro Parallel		1091 235		supply Call	
Managing Your Money 3.0 Call		Print Buffer 69		1092 299		or with 20 MB Seagate	
INTEGRATIVE		Masterpiece 88		1592 425		Harddrive Call	
Ability 59		Masterpiece Plus 113		KXP3151 399		6 month limited warranty	
Enable 312		INCREDIBLE VALUE		STAR MICRONICS		Corona PC Call	
Smart Software Call		Nationally advertised boards for		LV1210 179		Multitech 900 Accel	
COMMUNICATION		IBM PC and most compatibles		NB15 975		IBM AT Compatible, 512K,	
PROGRAMS		at give away prices.		NX10 232		expandable to 1 MB on the	
Carbon Copy 415		Keyboards (similar		SG15 365		mother board, one 1.2 MB drive,	
Crosstalk 89		to 5151) \$79		SR15 585		195 watt power supply, MS/DOS	
Remote 89		Monochrome Board w/printer		TOSHIBA		3.1, clock, 6 or 10 MHz key	
Smartcom II 83		port (similar to Hercules		P351 969		selectable, soft white monitor,	
GRAPHICS		Graphics) \$79		P341 768		AT style keyboard, 1 year	
Chartmaster 199		Expansion Board		P321 Call		TRW warranty Call	
Energraphics 2.0 269		0 to 576K \$42		MONITORS		Multitech Turbo	
In-A-Vision 249		Multifunction Board w/game		AMDEK 310A 142		IBM Compatible Computer,	
Microsoft Bus Mouse 106		port (similar to AST		AMDEK 600 395		256K, dual drives, 8 MHz, ports-	
Microsoft Chart 164		six pack) \$79		Magnovox Color RGB Call		parallel-serial-clock, 5151 type	
Microsoft Serial Mouse 119		Four Drive Floppy		Multitech Color RGB 259		keyboard, graphics board (simi-	
Newsroom 31		Controller \$39		Princeton Max 12 159		lar to Hercules), mono monitor	
PC Mouse W/DR Halo II 106		Color Card w/o printer		Samsung TTL Amber 72		DOS 3.1, 6 month national	
Printshop 33		port \$69		Samsung TTL Green 70		warranty Call	
Signmaster 132		Color card w/printer		EGA MONITORS		Sharp Portable 1120	
PROJECT MANAGER		port \$79		AMDEK 722 502		TERMS: Add 3% for C.O.D. orders. Shipping	
Harvard Total Project 262		HARD DRIVES		NEC Multisync Call		on most software is \$5.00. AZ orders +6.7%	
Microsoft Project 219		Bernoulli 20 MB w/cont. 2077		Packard Bell EGA Call		sales tax. Personal check - allow fourteen	
Super Project Plus Call		Filecard 20 MB 555		EGA BOARDS		(14) days to clear. We accept purchase	
Timeline 2.0 209		Maynard 20 MB Hard Card Call		Everex Enhancer EGA 235		orders from authorized institutions for	
		Plus Hardcard 20MB 665		Paradise Auto Switch		1.5%. All returns are subject to our ap-	
		Seagate 20 MB Int. w/cont. 385		EGA Card 359		proval. There will be a 20% restock fee.	
		Seagate 30 MB Int. w/cont. 479				Minimum phone order \$50.	
		Seagate 30 AT Int. Call					

No Charge for Master Card or Visa

TOLL-FREE ORDER LINE 1-800-421-3135

WAREHOUSE DATA PRODUCTS

2701 West Glendale Ave. • Phoenix, AZ 85051



PC/XT SYSTEM 800

- Slide Off case
- 640K Expandable Mother Board
- 256K Installed
- K-136 AT/XT Keyboard
- Floppy Control Card
- Monitor
- Mono or Color Graphic Adapter
- Assembled and Fully Tested

Mono **\$569.00**
Color **\$759.00**

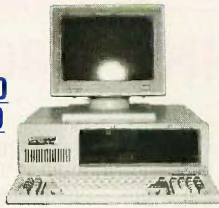

XT TURBO SYSTEM 900

Mono **\$599.00**
Color **\$789.00**

PC/AT SYSTEM 1000

Mono **\$1549.00**
Color **\$1739.00**



- 200W Power Supply/Case
- K-136 AT/XT Keyboard
- 1024K Memory On 80286 Mother Board
- 1.2M High Capacity Floppy Drive
- AT HDC/FDC Controller
- Mono or Color Graphic Adapter
- Monitor
- Assembled and Fully Tested



SAMSUNG MONITORS

- MD-1252G Amber or Green \$79
- 12" Monochrome Monitor TTL, Swivel Base, 720 x 350 Dot Resolution, 80 character x 25 Rows
- CD-1464W RGB \$269
- 16 color, 640 x 200 Dot Resolution, 80 Character x 25 Rows
- CD-1452M EGA—Hi Resolution RGB CALL
- 640 x 350 Dot Resolution

KEYBOARDS

- K-139 AT/XT Keyboard \$75
- Large Return Key, 12 Function Key, Enhanced Keyboard
- K-136 AT/XT Keyboard \$65
- Software Switchable, Large Return Key
- K-135 XT Keyboard \$70
- Features Separate Num. & Cursor Pads/LED Cap Lock & Num. Lock w/Large Return

MODEMS

Hayes Compatible

- Smarteam External 1200 \$165
- Lynkers External 1200 \$110
- Discovery External 2400 \$299
- Easy DATA Internal 1200 \$119

POWER SUPPLY

- P-150 Switching Power Supply \$65
- P-200W Switching Power Supply \$99
- Mini Power Center \$40

CHASSIS

- C-600 XT Case Slide Off/Open top \$29
- C-600-A XT Case AT, Jr style, XT size \$39
- C-700 AT Case \$99

DRIVES

- 360K Teac 1/2 Disk Drive \$90
- 360K Fujitsu 1/2 Drive \$85
- 1.2M High Capacity AT Drive \$135
- 20 MB Seagate Hard Disk \$300
- 20 MB Seagate Hard Disk w/Western Digital \$399
- 30 MB Seagate Hard Disk CALL

ADD-ON BOARDS

PC/XT

- MGB-101 XT Mother Board \$105
- MGB-102 Multifunction Card \$78
- MGB-103 Monochrome Graphic \$65
- MGB-103-1 Monographic Printer \$75
- MGB-104 Color Graphic \$55
- MGB-105 Floppy Disk Card 1 port \$29
- MGB-105-1 Floppy Disk Card 2 port \$38
- MGB-106 RS 232 Card 1 port \$25
- MGB-106-1 RS 232 Card 2 port \$30
- MGB-107 Game I/O Card \$20
- MGB-108 XT512K RAM Card \$44
- MGB-109 XT Parallel Printer Card \$21
- MGB-110 6220 XT HD & FD Controller \$125
- MGB-111 XT Color Graphic Printer Card \$66
- MGB-112 Monochrome Card \$50
- MGB-113 XT 640K RAM Card \$46
- MGB-128 XT 640K Turbo Board \$130
- MGB-129 Clock Card \$29
- MGB-131 XT I/O Plus Card \$49
- MGB-132 XT Multi I/O \$79
- MGB-133 6210 XT HDC \$105

PC/AT

- MGB-201 AT Mother Board Bios \$575
- MGB-202 AT 3M Multi Card \$179
- MGB-205 AT 1.2 M Floppy Disk Card \$82
- MGB-205-1 AT 1.2M 360K Controller \$119
- MGB-208 AT 2.5M RAM Card \$109
- MGB-210 AT HDC/FDC Controller w Cable \$225
- MGB-231 AT I/O Card \$80
- MGB-109-1 AT/XT Parallel Serial \$55
- MGB-135 EGA Card \$285

CABLES

- 8510 Computer To Printer
- 6 ft \$7 10 ft \$7.50
- 15 ft \$8
- 8511 RS 232 Serial Cable DB25 f/f
- 6 ft \$7
- 8512 Computer To Printer Centronic 36 pin c/c
- 6 ft \$8.50 10 ft \$9.50
- 25 pin c/c
- 6 ft \$7.50 10 ft \$8.50
- 8513 RS 232 Serial DB25 m/f
- 6 ft \$7 10 ft \$8
- 8514 RS232 Serial DB25 m/m
- 6 ft \$7
- 8515 Computer To Modem
- 6 ft \$4.50 10 ft \$5.50
- 8519 Computer To Modem DB 25 m/DB 9f
- 6 ft \$7
- 8524 Gender Changer DB25 m/m \$4
- 8525 Gender Changer DB25 f/f \$4
- 4 Ways Switch Box-Serial \$35
- 4 Ways Switch Box-Parallel \$37
- A/B Switch-Serial \$25
- A/B Switch-Parallel \$25
- Power Outlet Strip UL \$9.99
- Monitor Cable \$7.50

ACCESSORIES

- DX-45 Diskette Box \$7
- OX-100 Diskette Box \$8
- Bar Code Reader \$300
- Keyboard Cover COM \$4.50
- Keyboard Cover IBM \$3.75
- Keyboard Drawer (Wood) \$35
- 256K RAM Chip \$3.00
- 64K RAM Chip \$1.25
- 2nd Serial Port Kit \$17.99

names throughout the book are very well chosen and help to document the program in sections that are un-commented.

One stumbling block in *A Model Implementation of Standard Pascal* is that there is no bookwide index. Each program has a fairly complete index of procedures and functions, but there is no easy way to find where a general topic is covered unless it is mentioned in the table of contents. This makes the book much less useful for the person who wants to find out how small parts of the implementation work. Fortunately, it shouldn't get in the way of most readers.

The Pascal code throughout the book is formatted beautifully. The indentation is flawless even on multistatement lines. In addition, the authors have used the accepted Pascal character formatting throughout, so that all Pascal keywords are in bold, and variable and constant names have initial capitals. A nice touch added by the authors is that all string constants are displayed in a monospaced typewriter font.

AN ADMIRABLE JOB

Writing a compiler is never an easy task. The authors have done an admirable job not only of making the code correct but also of making it easy to follow in the book. This is achieved by organizing the compiler in such a fashion as to hide minor details until after the larger picture is explained.

For example, the first few chapters deal with global definitions and the source input and output. This is followed by a chapter on object code generation, which covers the structure of the p-code file in great detail. The syntactical analysis is covered after this. The authors assume that you already know the rules for writing Pascal programs since these are shown only by following the source code and are not discussed in the comments.

Welsh and Hay don't bother detailing most of the basic concepts that they discuss. Instead, they show how a particular data structure is set up or how a certain procedure converts its arguments. It seems to me that one of the most educational parts of the book is the authors' use of complex data structures to hold the program state and contents of variables.

Although the authors' assumptions of the reader's previous knowledge may seem cavalier, it leaves them more room to discuss the important issue: how to write a compiler well. They do this in a subtle and effective way. Rather than giving "rules" for good compiler construction, they simply show how they did it for ISO Standard Pascal. They let you make your own judgments on how to do it for other languages. Although the book does not address any other languages, the data structures and parsing procedures are appropriate for other programming languages such as BASIC or Ada.

The authors have a few intrinsic features of ISO Standard Pascal working in their favor. It is easier to implement a p-code compiler than a machine language compiler. Also, the highly structured nature of Pascal makes

(continued)

MAGITRONIC TECHNOLOGY INC.

9-02 43 Road, Long Island City, NY 11101

ORDERS ONLY: 1-800-227-5454

NY & West Coast Information: 718-706-7670

PLEASE CALL FOR QUANTITY PRICES
Orders Can Be Shipped from West Coast

All Orders are Shipped UPS COD Cash, Certified Check or Money Order Within 24 Hours.
IBM® PC/XT and Hayes are registered trademarks of their respective companies.

ARC — the No-Problem Computer Company

Compatibility — The most compatible machines on the market.
Reliability — Ask about ARC. Our reputation in the industry is built on it.
Performance — We introduced the first *turbo* machine in 1984, and haven't stopped since!

The ARC 286 Turbo

Fully IBM AT™ compatible, the ARC 286 turbo has been reviewed by InfoWorld and by PC Magazine.

InfoWorld, May 12, 1986: "The ARC 286 Turbo ... topped the list ... scored better than the IBM PC AT, the Tandy 3000, Zenith Data Systems Z-200, and Epson Equity III."

If you use a 286 based machine, ARC is your company. Our compatibility with IBM™ is the best in the industry. You can use all of your software, expansion cards, network systems. Our chassis looks great, yet is built to stand up to abuse. The 200 watt power supply will support the largest drives and peripherals you might want to add.



But don't take our 286 for itself alone. When you buy ARC products, you get a whole company behind you—warranty, service, and our Technical Support Hot Line—the kind of support you need, and the kind you expect from "The No-Problem Computer Company".

The ARC 3278 PC

Full function 3278 terminal. Coax connector attaches to your IBM or compatible 327x cluster controller. File transfer software that is the fastest in the industry is also available at a low per-mainframe charge. Beats IRMA™, P.J.™, PCOX™ and IBM™.

System comes complete with 640K RAM, 4.77 / 8 MHz *turbo* mode, Hercules™ compatible monochrome graphics, amber monitor, and one 360KB floppy disk drive.

All ARC systems include full one year manufacturer's warranty. Independent service contracts by TRW and 3M are available optionally.

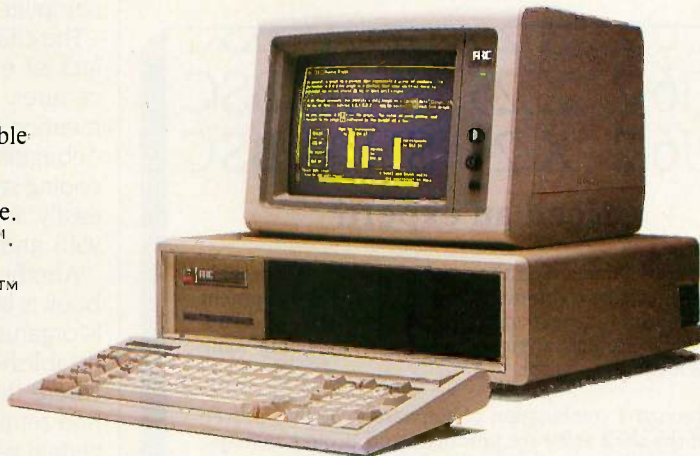

Let us introduce you to the complete line of ARC Turbo products — including the ARC Turbo, Jet Turbo, Model 10, and The World computer. For a complete catalog of ARC products, including a list of ARC Authorized Dealers, please write: ARC Consumer Services, 1101 Monterey Pass Road, Monterey Park, CA 91754.

For a list of ARC Authorized Dealers, please write: ARC Consumer Services, 1101 Monterey Pass Road, Monterey Park, CA 91754.

If you are interested in volume purchases, please call an ARC Major Accounts representative at (213) 264-6531.

If you are interested in becoming an ARC Authorized Dealer, please call ARC Dealer Relations at (800) 654-6151.

ARC

American Research Corporation

1101 Monterey Pass Road, Monterey Park, CA 91754 In California: (213) 265-0835. Technical Support: (213) 265-2861

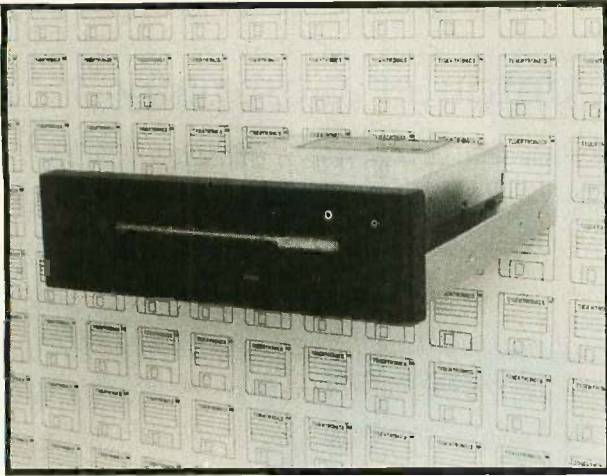

3.5 " Drive Replaces 5.25"!

Step up to the future with a 1 MEGABYTE 3.5" disk drive that is directly interchangeable with the 5.25" drive in your PC. It's the ideal solution for exchanging data with the new generation of laptop computers. Disk format is compatible with IBM and Toshiba portables. The Model 853W Drive Kit includes a high performance DSDD drive, front bezel, mounting brackets, and interface adapters. Available in your choice of gray or black. Disk drive is available separately. Requires DOS 3.2 for maximum performance. Ask about our special prices on diskettes and supplies! \$159.95 + Freight. & Tax M/C, VISA, COD.

Tigertronics, Incorporated
 2734-C Johnson Drive P.O. Box 3717
 Ventura, California 93006

IMMEDIATE DELIVERY! (805) 658-7466 or 67

LU0.2 X.25 SNA BSC
 LU6.2 X.25 SNA BSC
 LU6.2 X.25 SNA BSC

Need an expert?

Systems Strategies is the expert's expert. We provide systems and communications software development consulting to the experts, including IBM, DEC and AT&T. Our project team approach emphasizes planning, management and control.

Through a combination of software expertise, proven off-the-shelf software products, and project management skills our consultants can solve any data communications or systems software problem in minimal time.

Let our consultants put it together for you.

- UNIX • Bridges/Gateways • Networks • LANs
- Device Drivers • Multibus, VME, AT and Q Buses
- Transaction Processing • Process Control

Connect with us to get results.



Systems Strategies Inc.
 An AGS Company

225 West 34th Street New York, N.Y. 10001

(212) 279-8400 ext. 400

Telex: 380226

it easier to determine when the programmer has messed up a program by forming an incorrect structure.

COVERAGE

The book covers a great deal of ground in less than 500 pages. It shows how a compiler and P-machine are constructed and how to write a large and well-structured Pascal program. Although the authors do not belabor the point, any compiler should be well structured in order to assure the programmer that it is complete and correct.

The learn-by-example method has its shortcomings. For instance, the authors do not spend much time discussing the connection between the p-code generator and the P-machine. Readers may want to refer to sections of the P-machine program while reading about the compiler in order to understand why a certain construct is used. This is also true in the section on files used by the postmortem generator. Unfortunately, without an index, this task is not easy.

Since most compilers generate machine or assembly language, books on compiler writing rarely cover p-code in depth. The chapters on the P-machine are a very good introduction on how to implement P-machines while remaining CPU-independent. The authors cover the construction of the P-machine that has to handle memory management, multiple-precision math and strings, file manipulation, and error recovery. The memory-management scheme shown in the book is a good model for any compiler, not only p-code generators.

The chapters on the postmortem generator suffer from lack of explanation of the purpose of many of the procedures. This is unfortunate since very few books even mention methods for handling aborted exits and symbolic debugging of aborted programs. Still, the authors' clear coding style lets you follow the code for the program fairly easily and determine what data the program is working with and what the output will look like.

Another weakness is the authors' assumption that the book is being read from beginning to end. Since the book is organized like the program, various details rely on facts established earlier in the book. There were many places where the book would have been clearer if the authors had reminded the reader about the range of values for certain variables or the purpose of certain procedures that were covered hundreds of pages earlier.

OVERALL

As a program and as a guide, *A Model Implementation of Standard Pascal* makes a very interesting book. The clear structure of the program makes the book understandable and enjoyable. The book goes further to show how a compiler and P-machine are implemented. Many of the often-overlooked aspects of compiler design are covered here in a way that makes them seem natural. This volume will make a good addition to many programmers' libraries. ■

Paul E. Hoffman (2000 Center St., Suite 1024, Berkeley, CA 94704) writes and edits books. He is the editor of Text In Computers, a new scholarly journal.



The C for Microcomputers

PC-DOS, MS-DOS, CP/M-86, Macintosh, Amiga, Apple II, CP/M-80, Radio Shack, Commodore, XENIX, ROM, and Cross Development systems

MS-DOS, PC-DOS, CP/M-86, XENIX, 8086/80x86 ROM

Manx Aztec C86

"A compiler that has many strengths ... quite valuable for serious work"

Computer Language review, February 1985

Great Code: Manx Aztec C86 generates fast executing compact code. The benchmark results below are from a study conducted by Manx. The Dhrystone benchmark (CACM 10/84 27:10 p1018) measures performance for a systems software instruction mix. The results are without register variables. With register variables, Manx, Microsoft, and Mark Williams run proportionately faster, Lattice and Computer Innovations show no improvement.

	Execution Time	Code Size	Compile/Link Time
Dhrystone Benchmark			
Manx Aztec C86 3.3	34 secs	5,760	93 secs
Microsoft C 3.0	34 secs	7,146	119 secs
Optimized C86 2.20J	53 secs	11,009	172 secs
Mark Williams 2.0	56 secs	12,980	113 secs
Lattice 2.14	89 secs	20,404	117 secs

Great Features: Manx Aztec C86 is bundled with a powerful array of well documented productivity tools, library routines and features.

Optimized C compiler	Symbolic Debugger
AS86 Macro Assembler	LN86 Overlay Linker
80186/80286 Support	Librarian
8087/80287 Sensing Lib	Profiler
Extensive UNIX Library	DOS, Screen, & Graphics Lib
Large Memory Model	Intel Object Option
Z (vi) Source Editor -c	CP/M-86 Library -c
ROM Support Package -c	INTEL HEX Utility -c
Library Source Code -c	Mixed memory models -c
MAKE, DIFF, and GREP -c	Source Debugger -c
One year of updates -c	CP/M-86 Library -c

Manx offers two commercial development systems, Aztec C86-c and Aztec C86-d. Items marked -c are special features of the Aztec C86-c system.

Aztec C86-c Commercial System	\$499
Aztec C86-d Developer's System	\$299
Aztec C86-p Personal System	\$199
Aztec C86-a Apprentice System	\$49

All systems are upgradable by paying the difference in price plus \$10.

Third Party Software: There are a number of high quality support packages for Manx Aztec C86 for screen management, graphics, database management, and software development.

C-tree \$395	Greenleaf \$185
PHACT \$250	PC-lint \$98
HALO \$250	Amber Windows \$59
PRE-C \$395	Windows for C \$195
WindScreen \$149	FirstTime \$295
SunScreen \$99	C Util Lib \$185
PANEL \$295	Plink-86 \$395

MACINTOSH, AMIGA, XENIX, CP/M-68k, 68k ROM

Manx Aztec C68k

"Library handling is very flexible ... documentation is excellent ... the shell a pleasure to work in ... blows away the competition for pure compile speed ... an excellent effort!"

Computer Language review, April 1985

Aztec C68k is the most widely used commercial C compiler for the Macintosh. Its quality, performance, and completeness place Manx Aztec C68k in a position beyond comparison. It is available in several upgradable versions.

Optimized C Macro Assembler	Creates Clickable Applications
Overlay Linker	Mouse Enhanced SHELL
Resource Compiler	Easy Access to Mac Toolbox
Debuggers	UNIX Library Functions
Librarian	Terminal Emulator (Source)
Source Editor	Clear Detailed Documentation
MacRam Disk -c	C-Stuff Library
Library Source -c	UniTools (vi,make,diff,grep) -c
	One Year of Updates -c

Items marked -c are available only in the Manx Aztec C86-c system. Other features are in both the Aztec C86-d and Aztec C86-c systems.

Aztec C68k-c Commercial System	\$499
Aztec C68d-d Developer's System	\$299
Aztec C68k-p Personal System	\$199
C-tree database (source)	\$399

AMIGA, CP/M-68k, 68k UNIX call

Apple II, Commodore, 65xx, 65C02 ROM

Manx Aztec C65

"The AZTEC C system is one of the finest software packages I have seen"

NIBBLE review, July 1984

A vast amount of business, consumer, and educational software is implemented in Manx Aztec C65. The quality and comprehensiveness of this system is competitive with 16 bit C systems. The system includes a full optimized C compiler, 6502 assembler, linkage editor, UNIX library, screen and graphics libraries, shell, and much more. The Apple II version runs under DOS 3.3, and ProDOS, Cross versions are available.

The Aztec C65-c/128 Commodore system runs under the C128 CP/M environment and generates programs for the C64, C128, and CP/M environments. Call for prices and availability of Apprentice, Personal and Developer versions for the Commodore 64 and 128 machines.

Aztec C65-c ProDOS & DOS 3.3	\$399
Aztec C65-d Apple DOS 3.3	\$199
Aztec C65-p Apple Personal system	\$99
Aztec C65-a for learning C	\$49
Aztec C65-c/128 C64, C128, CP/M	\$399

Distribution of Manx Aztec C

In the USA, Manx Software Systems is the sole and exclusive distributor of Aztec C. Any telephone or mail order sales other than through Manx are unauthorized.

Manx Cross Development Systems

Cross developed programs are edited, compiled, assembled, and linked on one machine (the HOST) and transferred to another machine (the TARGET) for execution. This method is useful where the target machine is slower or more limited than the HOST, Manx cross compilers are used heavily to develop software for business, consumer, scientific, industrial, research, and educational applications.

HOSTS: VAX UNIX (\$3000), PDP-11 UNIX (\$2000), MS-DOS (\$750), CP/M (\$750), MACINTOSH (\$750), CP/M-68k (\$750), XENIX (\$750).

TARGETS: MS-DOS, CP/M-86, Macintosh, CP/M-68k, CP/M-80, TRS-80 3 & 4, Apple II, Commodore C64, 8086/80x86 ROM, 68xxx ROM, 8080/8085/Z80 ROM, 65xx ROM.

The first TARGET is included in the price of the HOST system. Additional TARGETS are \$300 to \$500 (non VAX) or \$1000 (VAX).

Call Manx for information on cross development to the 68000, 65816, Amiga, C128, CP/M-68k, VRTX, and others.

CP/M, Radio Shack, 8080/8085/Z80 ROM

Manx Aztec CII

"I've had a lot of experience with different C compilers, but the Aztec C80 Compiler and Professional Development System is the best I've seen."

80-Micro, December, 1984, John B. Harrell III

Aztec C II-c (CP/M & ROM)	\$349
Aztec C II-d (CP/M)	\$199
C-tree database (source)	\$399
Aztec C80-c (TRS-80 3 & 4)	\$299
Aztec C80-d (TRS-80 3 & 4)	\$199

How To Become an Aztec C User

To become an Aztec C user call 1-800-221-0440 or call 1-800-832-9273 (800-TEC WARE). In NJ or outside the USA call 201-530-7997. Orders can also be telexed to 4995812.

Payment can be by check, COD, American Express, VISA, Master Card, or Net 30 to qualified customers.

Orders can also be mailed to Manx Software Systems, Box 55, Shrewsbury, NJ 07701.

How To Get More Information

To get more information on Manx Aztec C and related products, call 1-800-221-0440, or 201-530-7997, or write to Manx Software Systems.

30 Day Guarantee

Any Manx Aztec C development system can be returned within 30 days for a refund if it fails to meet your needs. The only restrictions are that the original purchase must be directly from Manx, shipped within the USA, and the package must be in resalable condition. Returned items must be received by Manx within 30 days. A small restocking fee may be required.

Discounts

There are special discounts available to professors, students, and consultants. A discount is also available on a "trade in" basis for users of competing systems. Call for information.

Inquiry 210



To order or for information call:

800-221-0440

A LASER PRINTER SHARING UNIT WITH 256K BUFFER AND 8 USER INPUTS FOR UNDER \$800?

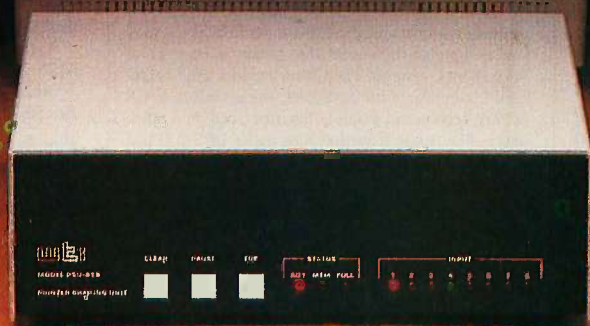

That's right! Now up to eight PCs, word processors, CAD systems, or whatever can share two printers automatically.

In addition to eight serial input ports, the PSU-81B gives you two output ports — one serial, one parallel — that can operate simultaneously.

You also get lots of other convenient features, including a pause button, clear button, memory test, TOF, and of course, a 256K dynamically allocated buffer.

So for under \$800, make your laser printer eight times more cost effective.

Check into our new PSU-81B, and other low-cost automatic printer sharing units, from the leaders in data communications technology.

Call or write WTI today for a complete catalog. In California, call (714) 979-0363. Telex 467741.

800-854-7226

wte **western telematic inc.**
2435 South Anne St., Santa Ana, California 92704

E·V·E·N·T·S A·N·D C·L·U·B·S

December 1986

EVENTS

SECOND INTERNATIONAL CONFERENCE ON ARTIFICIAL INTELLIGENCE, Marseilles, France. Viviane Bernadac, Institut International de Robotique et d'Intelligence Artificielle de Marseille, 2 rue Henri-Barbusse, 13241 Marseille cedex 1, France tel: 91.91.36.72, telex: 440 860.

December 2-5

ELECTRONIC MESSAGING '86: THE ERA OF INTERCONNECTION BEGINS, Washington, DC. Electronic Mail Association, 1919 Pennsylvania Ave. NW, Suite 300, Washington, DC 20006, (202) 293-7808. December 3-4

SEVENTH ANNUAL COMPUTER LAW INSTITUTE, Chicago, IL. Law & Business, 855 Valley Rd., Clifton, NJ 07013, (800) 223-0231; in New Jersey, (201) 472-7400. December 4-5

FIFTH SOUTH JERSEY MICRO SHOW, Parsippany, NJ. Ken Gordon Productions Inc., P.O. Box 13, Franklin Park, NJ 08823, (800) 631-0062; in New Jersey, (201) 297-2526. December 7

MICRO COMPUTER FAIR, Oak Lawn, IL. Thomas J. Zarecki, T.J. Enterprises, P.O. Box 255, Chicago Ridge, IL 60415, (312) 839-2611. December 7

COMPUTER GRAPHIC ARTS 86/87, New York, NY. Pratt Center for Computer Graphics in Design, 9 Skyline Dr., Hawthorne, NY 10532, (914) 592-1155. December 7-10

1986 FALL INDUSTRIAL ENGINEERING CONFERENCE, Boston, MA. Registrar, Institute of Industrial Engineers, 25 Technology Park/Atlanta, Norcross, GA 30092, (404) 449-0460. December 7-10

1986 ASME WINTER ANNUAL MEETING: ELECTRONIC PACKAGING—A MULTIDISCIPLINARY CHALLENGE, Anaheim, CA. American Society of Mechanical Engineers, 345 East 47th St., New York, NY 10017, (212) 705-7053. December 7-12

DIGITAL ELECTRONICS AND INTEGRATED CIRCUITS FOR NON-ELECTRICAL ENGINEERS, Washington, DC. Continuing Engineering Education, The George Washington University, Washington, DC 20052, (800) 424-9773; in DC, (202) 676-6106; in Canada, (800) 535-4567. December 8-11

NATIONAL DATA COMMUNICATIONS SYMPOSIUM ON LOCAL AREA NETWORKS AND MICRO-MAINFRAME LINKS, Washington, DC. Digital Consulting Associates Inc., 6 Windsor St., Andover, MA 01810, (617) 470-3870. December 8-11

ARIZONA ELECTRONICS EXPOSITION CONFERENCE PROGRAM, Phoenix, AZ. MG Expositions Group, 1050 Commonwealth Ave., Boston, MA 02215, (800) 223-7126; in Massachusetts, (617) 232-5470. December 9-11

OPTICAL INFORMATION SYSTEMS '86, Arlington, VA. Conference Management Corp., 200 Connecticut Ave., Norwalk, CT 06854, (203) 852-0500. December 9-11

INTERNATIONAL OEM DESIGN '86 AND IMEX '86, New York, NY. Penton Expositions, Suite 900, 122 East 42nd St., New York, NY 10168, (800) 634-4639; in New York, (212) 867-9191. December 9-11

HI TECH UPDATE '86: SMART BUILDINGS, Ottawa, Ontario. Conference Coll Inc., 1138 Sherman Dr., Ottawa, Ontario, Canada K2C 2M4, (613) 224-1741. December 10-11

SECOND ANNUAL INTERFACE IN JAPAN CONFERENCE AND EXPOSITION, Tokyo, Japan. The Interface Group Inc., 300 First Ave., Needham, MA 02194, (617) 449-6600. December 11-13

TENTH BOSTON AREA MICRO SHOW, Boxborough, MA. Ken Gordon Productions Inc., P.O. Box 13, Franklin Park, NJ 08823, (800) 631-0062; in New Jersey, (201) 297-2526. December 14

DEXPO EAST 86, New York, NY. Expoconsul International Inc., 3 Independence Way, Princeton, NJ 08540, (609) 987-9400. December 17-19

MICROCOMPUTER GRAPHICS SHOW AND CONFERENCE, New York, NY. Expoconsul International Inc., 3 Independence Way, Princeton, NJ 08540, (609) 987-9400. December 17-19

If you send notice of your organization's public activities at least four months in advance, we will publish them as space permits. Please send them to BYTE (Events and Clubs), One Phoenix Mill Lane, Peterborough, NH 03458.

CLUBS

METRO TANDY COMPUTER USERS GROUP (TRS-80), George Mueden, 310 West 106th St.—15D, New York, NY 10025, (212) 222-8751.

NORTH SEATTLE AMIGA USERS' GROUP, 17050 2nd Ave. NW, Seattle, WA 98177, (206) 546-3482. Special emphasis on AI and astronomy.

KERN INDEPENDENT PC USER GROUP, P.O. Box 2780, Bakersfield, CA 93303.

OBJECT ORIENTED PROGRAMMING SOCIETY (OOPS), Box 3516, Phoenix, AZ 85030.

COMMODORE COMPUTER CLUB, P.O. Box 23396, Vancouver, B.C., Canada V7B 1W1, (604) 738-3311.

ASSOCIATION OF SMALL COMPUTER USERS (ASCU), P.O. Box 14151, Atlanta, GA 30324, (404) 321-5400.

ALOHA COMPUTER CLUB OF HAWAII, P.O. Box 4470, Honolulu, HI 96813.

ONX USERS GROUP, c/o DA Systems, Inc., 1503 East Campbell Ave., Campbell, CA 95008, Anna Lange, (408) 559-7434 or Dave Merchant, (205) 688-2827.

COMPULINK USER GROUP, 67 Woodbridge Rd., Guildford, Surrey GU1 4RD, U.K.

EUGENE PC/R CLUB, 1011 Valley River Way, Suite 220, Eugene, OR 97401.

NEW YORK TIMEX/SINCLAIR ENTHUSIASTS (NYTSE), Stoney McMurray, Editor, 473 Westminster Rd., Brooklyn, NY 11218-6307, (718) 469-5948.

GATEWAY CP/M USERS GROUP, P.O. Box 37022, St. Louis, MO 63141-1522, (314) 569-4399 or 991-4399.

A-PEELING ADS, Apple II users magazine, PD Software, P.O. Box 13256-A, Houston, TX 77219.

THE MACHONOR BULLETIN, CE Software, 801 73rd St., Des Moines, IA 50312-1051, (515) 224-1995.

JAYRAY'S CONNECTION BBS AND THE BOARD NEWSLETTER, Ray Anderson, 3309 Rose Lane, Falls Church, VA 22042-4012. ■

Before you consider the new Hercules Graphics Card Plus, consider the technology behind it.

A short while ago, Hercules™ introduced a product that will forever change the way information is displayed on a PC.

The product is called the Hercules Graphics Card Plus.

We gave it that name because it gives you the same hi-resolution text and 720x348 graphics that made the original Hercules Graphics Card famous.

Plus it gives you RamFont™.

RamFont is a radical new hardware mode that combines the speed of text mode with the flexibility of graphics mode.

And opens up a whole new world for software.

The world according to RamFont.

In the old days (before the Graphics Card Plus), programs like Lotus® 1-2-3®, Symphony™, Framework™ and Microsoft® Word had to use graphics mode to display multiple fonts and variable text sizes, or to mix text with graphics.

But graphics mode is a whole lot slower than text mode. Up to eight times slower.

Enter RamFont.

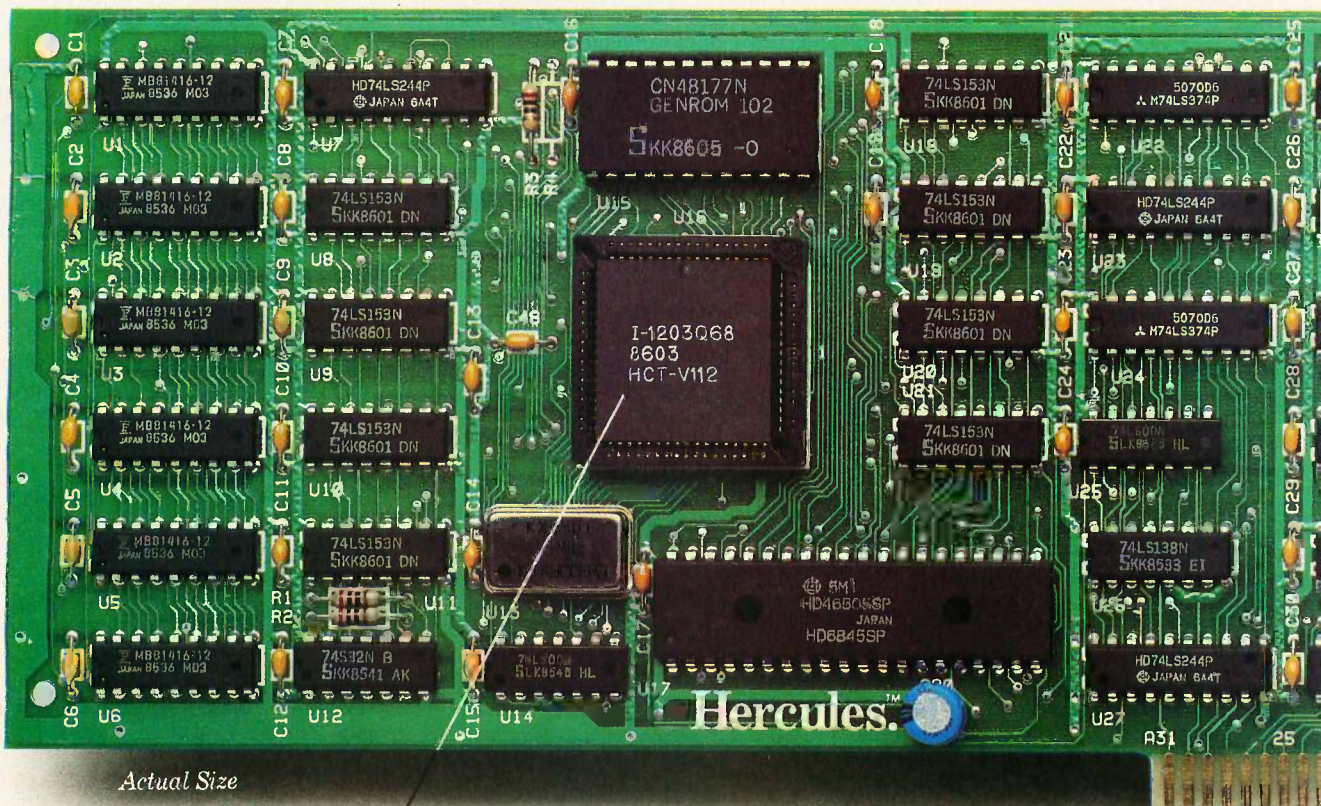

Actual Size

The heart of the Graphics Card Plus: the V112 microchip, Hercules' next generation video processor that makes the RamFont mode possible.

It lets all the programs we just mentioned (and plenty more in the future) do all the things we just described, all on one screen.

At precisely the same speed as text mode.

How RamFont works.

Like text mode, RamFont uses a 16-bit word to represent a character on the display.

Unlike text mode, however, the 48K RamFont mode uses a 12-bit character code instead of an 8-bit code.

Which allows you to choose from an astonishing 3072 different characters.

While setting the size of your screen cells from eight to nine pixels wide and

from four to 16 scan lines tall.

To help you design your own RamFont characters and symbols, we've included a font editor called FontMan.™

Along with a set of 25 sample fonts to start your library.

And since the 4K RamFont mode can accept 8-bit character codes, running your text mode software with your favorite font is as simple as loading it into RAM.

Just for the record, RamFont supports the standard character attributes of reverse, high-intensity, blink and underline.

Plus two new RamFont attributes: boldface and strike-through.

What price success?

While we're on the subject of technological breakthroughs, let's not forget the suggested retail price.

Think of it. You get everything the original card gave you.

Plus RamFont.
Plus FontMan.

Plus a parallel printer port that you can now disable if there's a conflict with another port in your system.

All for just \$299—about half the price of the original Graphics Card.

If you haven't gone into shock, call 1-800-532-0600 ext. 212 (in Canada call 1-800-323-0601 ext. 212) for the name of an Authorized Hercules Dealer near you and we'll rush you our free info kit.

\$299.
Suggested retail price.

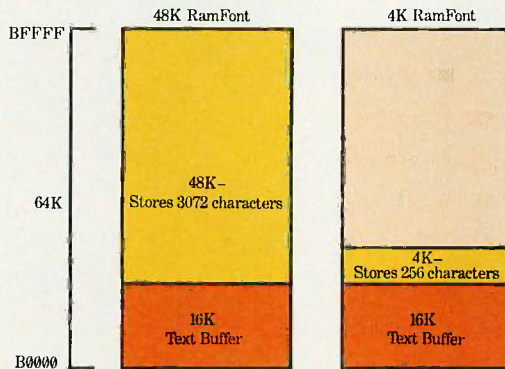

The new RamFont mode displays 3072 programmable characters at the speed of text mode, or replaces the standard character set with one of your choice in 4K RamFont mode.

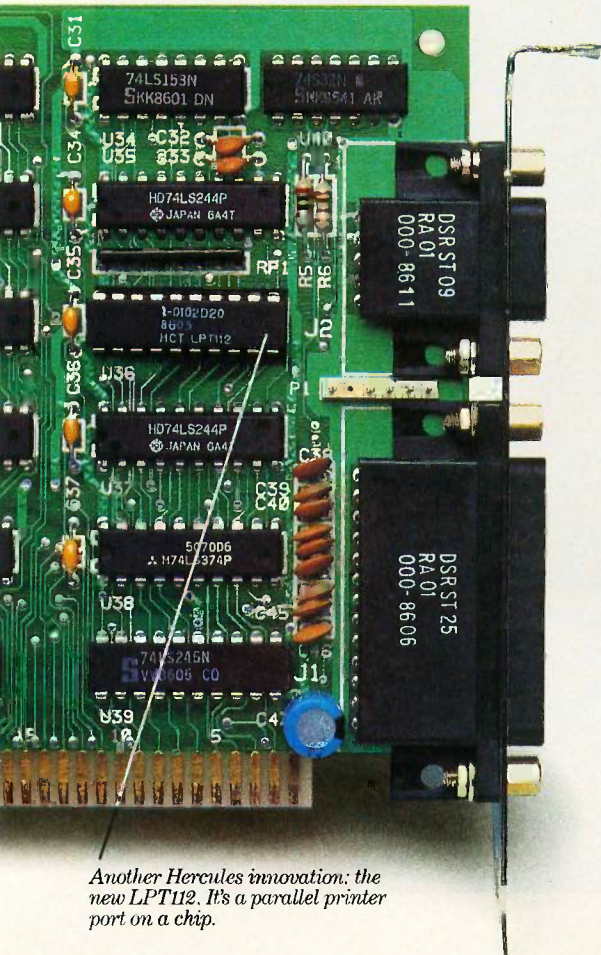

Another Hercules innovation: the new LPT12. It's a parallel printer port on a chip.

Hercules.™ We're strong on graphics.

Address: 2550 Ninth Street, Berkeley, California 94710 Ph: 415 540-6000
Telex: 754063

Trademarks/Owners: Lotus, 1-2-3, Symphony/Lotus; Framework/Ashton-Tate; Microsoft/Microsoft; Hercules, RamFont, FontMan/Hercules

Inquiry 156 for End-Users. Inquiry 157 for DEALERS ONLY.



Features

**CIARCIA'S CIRCUIT CELLAR:
BUILD THE GT180
COLOR GRAPHICS BOARD,
PART 2: THE HARDWARE**
by Steve Ciarcia 87

**PROGRAMMING PROJECT:
USING DOS FUNCTIONS
FROM TURBO PASCAL**
by Douglas F. Yriart 102

**PROGRAMMING INSIGHT:
A PROGRAM
FOR APPROXIMATING INTEGRALS**
by David M. Smith 113

DEBUGGING MACINTOSH APPLICATIONS
by Joel West 127

LOCAL EFFECTS OF NUCLEAR WEAPONS
by John R. Fanchi 143

IN THE CIRCUIT CELLAR this month, Steve Ciarcia continues with his GT180 project, which is designed to provide Professional Graphics Adapter-like resolution on the SB180 single-board computer. In this second of three parts, Steve focuses on the hardware. He gives a description of the major VLSI components and also includes the hardware schematic of the GT180 itself. While presented as an SB180 XBUS peripheral device, the GT180 can also be used in many other "ported" graphics applications.

In "Using DOS Functions from Turbo Pascal," our Programming Project for December, Douglas F. Yriart explains how to call on operating system functions from programs written in Turbo Pascal running under PC-DOS or MS-DOS. You may never need to write another line of assembly language code.

David M. Smith's "A Program for Approximating Integrals," this month's Programming Insight, explores Aitken extrapolation. By using this technique, you can approximate integrals with a minimum of function evaluations.

Next, Joel West looks at the trips and traps you're liable to encounter in "Debugging Macintosh Applications." Having wrangled with the Mac himself as well as having gleaned advice from commercial developers, West has developed a checklist on how to get an application up and running on the Macintosh.

This month's features end on a sobering note. "Local Effects of Nuclear Weapons" by John R. Fanchi presents two BASIC programs: One lets you determine the immediate thermal, percussive, and radiative effects of nuclear detonations on yourself and your immediate surroundings; the other examines longer-term effects, including fallout distribution.

12MHz SPEED plus A MEGABYTE FOR DOS!



THEY ALL NEED NUMBER SMASHER/ECM™

Turn your PC or XT into the machine it should have been! The 12 MHz Number Smasher/ECM is the fastest accelerator on the market. It is also the most powerful, providing a true megabyte for DOS!

To break the 640K DOS barrier MicroWay designed a Memory Management Unit (MMU) that is tailored to DOS plus a 2000 byte resident driver - MegaDOS™. MicroWay calls this breakthrough Extended Conventional Memory. When you type CHKDSK with the board installed, your system will report 1,036,288 bytes total memory and 1,010,016 bytes free! Any conventional DOS program can utilize a full megabyte for data or code without changing a byte.

Downloading a mainframe application? ECM memory runs with any program that uses DOS for screen services including RM and MS FORTRAN and MS and LATTICE C! This means you have an additional 384K available for oversized applications. Programs which write directly to the screen require a simple patch to adhere to the new standard. MicroWay has already developed patches for the Lotus, WORDSTAR and AUTOCAD screen drivers. Release 1A of 1-2-3 jumps from 535,516 to 916,444 bytes available and runs faster than Release 2 for most worksheets.

Number Smasher/ECM is 100% compatible with all hardware and software including EMS and EGA boards. The compatibility is a result of control: its speed is switch, keyboard or software selectable from 4.77 MHz to 12.0 MHz. Applications which have not been upgraded to ECM can still be run by setting DOS to 640K or 704K and using the memory above DOS for I/O enhancers.

Number Smasher/ECM runs floating point bound programs faster than an AT or any other 80286 based machine. In fact, Number Smasher's 12 MHz 8087 runs a factor of three faster than the standard 80287 on the AT, delivering up to 125 kflops. Software is included for RAM Disk, print spooler, and disk caching, which speeds up floppy and hard disks by a factor of 2 to 10!

Number Smasher/ECM is the most cost effective productivity tool you can buy. The base board which runs at 9.54 MHz comes with 512K and costs only \$599! The complete system which includes a motherboard accelerator, one megabyte of memory and a 12 MHz 8087 is just \$1199. Call today to discuss your particular configuration. Remember: "The advantage of buying from MicroWay is outstanding personal service." (PC Magazine, 6/10/86 - p. 162)

See our product ad on page 191.

The World Leader in 8087 Support

P.O. Box 79, Kingston, Mass. 02364 USA (617) 746-7341
Tempo House, London, U.K. call 01-223-7662

Number Smasher, ECM and MegaDOS are trademarks of MicroWay, Inc. MicroWay is a registered trademark of MicroWay, Inc.

Micro Way

BUILD THE GT180 COLOR GRAPHICS BOARD

PART 2: HARDWARE

BY STEVE CIARCIA

*A description of the components and
the hardware schematic*



Last month I introduced my new Professional Graphics Adapter (PGA)-like GT180 graphics adapter for the SB180 and SB180FX computers and discussed the basics of CRT controllers. This month I'll continue with a description of the major VLSI components. I'll also include the hardware schematic of the GT180 itself. While presented as an SB180 XBUS peripheral device, the GT180's combination of high-level integrated circuitry, parallel port interfacing, and Borland International's Graphix Toolbox standard software facilitates its use in many other "ported" graphics applications (see photo 1).

FEW CHIPS ARE USED

The key to the GT180's design is a recently announced CMOS VLSI graphics processor, the Hitachi HD63484 ACRTC (advanced CRT controller), and two companion chips: HD63485 GMIC (graphic memory interface controller) and HD63486 GVAC (graphic video attributes controller). These are supplemented by a highly integrated CMOS palette D/A converter—the Brooktree BT450.

The block diagram in figure 1 shows that these chips, in combination with a 512K-byte frame buffer (sixteen 64K by 4-bit

dynamic RAM chips), need little extra support to achieve an entire graphics drawing and display subsystem. The 512K-byte frame buffer can hold three or four screens as well as a library of graphics objects like windows, fonts, and icons. A standard shift register allows input from an IBM PC-compatible keyboard. Finally, a few TTL chips and a PAL (programmable array logic) generate the control signals to interface the ACRTC, keyboard shift register, and palette D/A converter to the SB180's XBUS. The GT180 can directly connect to a number of standard CRTs—both TTL and analog—like the Princeton Graphics SR-12 and SR-12P.

THE HD63484 ACRTC

The ACRTC, an incredibly powerful CMOS chip containing more than 100,000 transistors, needs to perform a number of tasks. First, it must generate the CRT timing signals, including HSYNC and VSYNC. Next, it must perform display-control tasks like scanning the frame buffer while keeping track of cursors, split screens, and windows. Finally, it must assist the application pro-

(continued)

Steve Ciarcia (pronounced "see-ARE-see-ah") is an electronics engineer and computer consultant with experience in process control, digital design, nuclear instrumentation, and product development. The author of several books on electronics, he can be reached at P.O. Box 582, Glastonbury, CT 06033.

grammer by providing built-in drawing algorithms and commands. The ACRTC integrates all these functions on a single device.

Examining the ACRTC block diagram (see figure 2) reveals that it con-

tains three separate microprocessors (16-bit CPUs)—one CPU for each of the primary tasks: CRT timing generation, display control, and drawing. The ACRTC contains more than 200 bytes of command and control registers

used in conjunction with 38 high-level drawing commands (see figure 3). The registers and commands will be explained and put to good use in next month's software description.

GMIC AND GVAC

It is possible to use the ACRTC by itself in a graphics design. However, for a design exploiting all the ACRTC features, the amount of TTL support logic required is large. Furthermore, due to the complexity and high speed required of the support logic, such a circuit would be difficult to design and debug.

For example, during a drawing operation, the ACRTC treats the frame buffer as a simple linear sequence of 16-bit words, just like a regular 16-bit CPU. However, during a display refresh, the frame buffer needs to read 64 bits at one time to keep up with the high speed requirements of a fast CRT. Thus, the frame buffer's address-decode and data-buffer circuits must be dynamically reconfigured for 16- and 64-bit operations. On the display-controller side, ACRTC features (like windows, horizontal smooth scroll, and zooming) require circuits to interact with and control the 64-bit high-speed video shift registers.

To help the designer eliminate much of the TTL support logic and lessen the design complexity, I have used the HD63485 GMIC and HD63486 GVAC support ICs. The GMIC manages the multiplexed addressing of the frame buffer's DRAMs and generates the required control signals like RAS, CAS, and WE. Each GVAC includes two 16-bit shifters, so two GVACs provide a 64-bit shift register. The GVACs also map ACRTC 16-bit drawing accesses to the 64-bit frame-buffer bus. The GMIC and GVAC are manufactured using a special process called Hi-BiCMOS, which combines the speed and drive of bipolar (64 megahertz, IOL=24 milliamperes) with the low power operation of MOS (less than 1 watt).

This subsystem (ACRTC, GMIC, GVAC, and frame buffer) can directly interface to a digital RGBI (red-green-blue-intensity) monitor. The addition of the BT450 palette D/A converter allows the connection of an analog

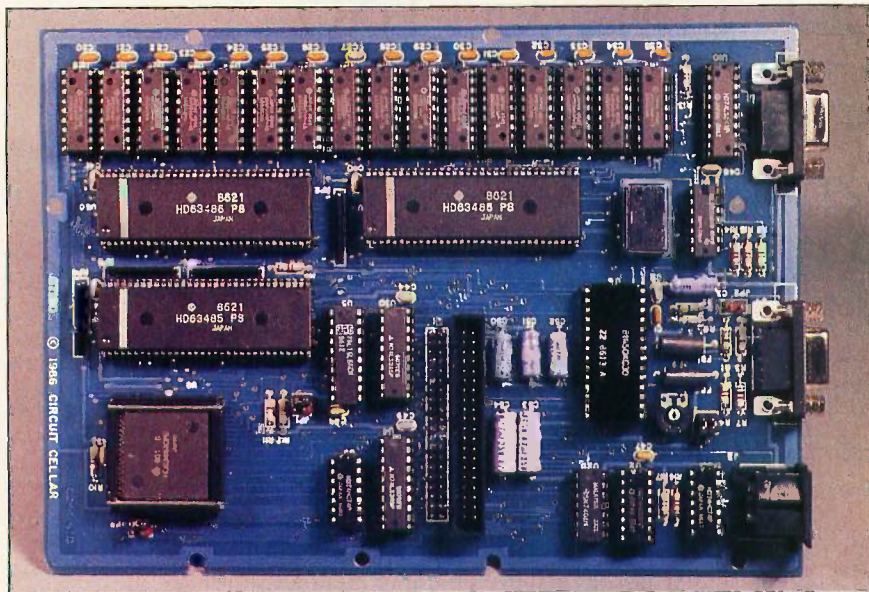

Photo 1: The GT180 graphics adapter. The various connectors along the right-hand side are (from top to bottom): a DB-9 connector for analog RGB output, another DB-9 connector for RGBI TTL output, and a DIN connector for an IBM PC-compatible keyboard.

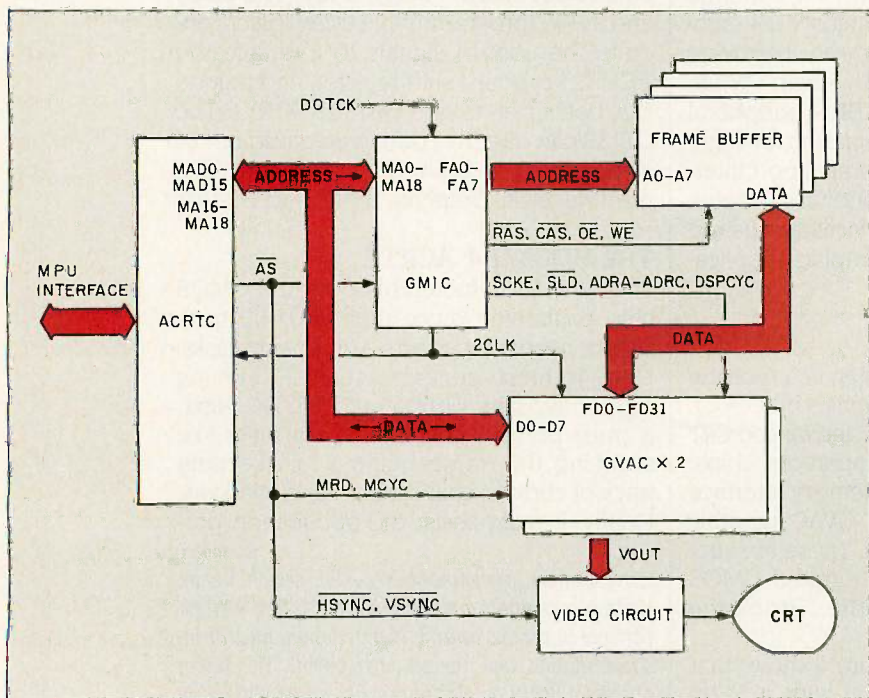

Figure 1: A block diagram of the GT180.

CRT for finer color selection. In the past, the designer would have to build a palette D/A converter by combining a static RAM palette with three separate video D/A converters—a difficult and expensive task. Now, the BT450 combines the 16- by 12-bit palette RAM and three separate 4-bit 30-MHz to 70-MHz D/A converters.

Watch for the availability of new palette D/A converter chips like the BT450 to cause a trend to analog displays, even for low-cost computers.

THE GT180 HARDWARE

The GT180 board consists of a number of distinct sections: the graphics display and control section

(the ACRTC, GMIC, and GVACs), monitor interface (the palette D/A converter and TTL buffers), SB180 XBUS interface circuitry, and the IBM PC keyboard adapter. The complete GT180 schematic is shown in figure 4.

The interface between the ACRTC, PC keyboard register, palette D/A con-
(continued)

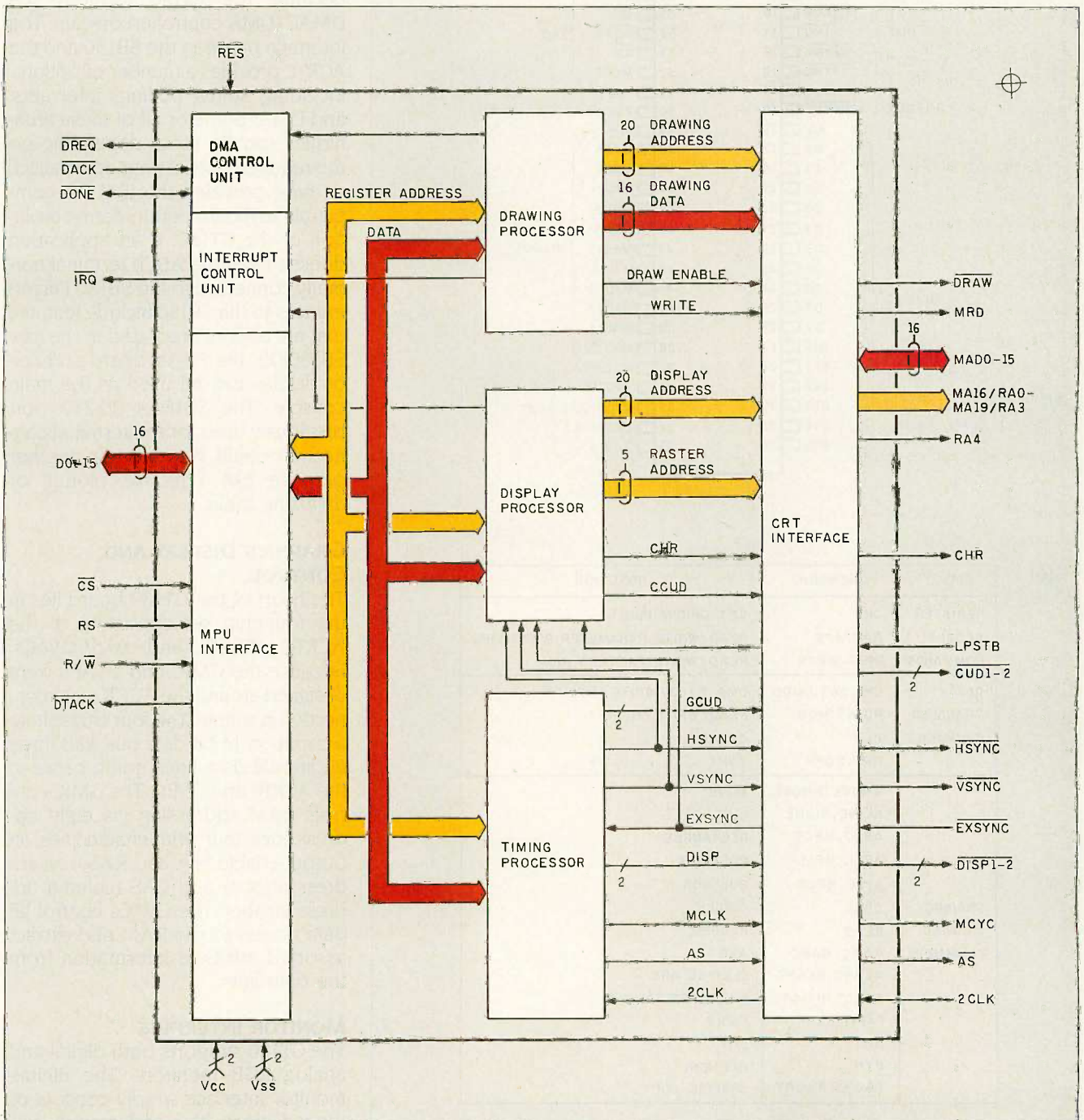

Figure 2: A block diagram of the ACRTC chip.

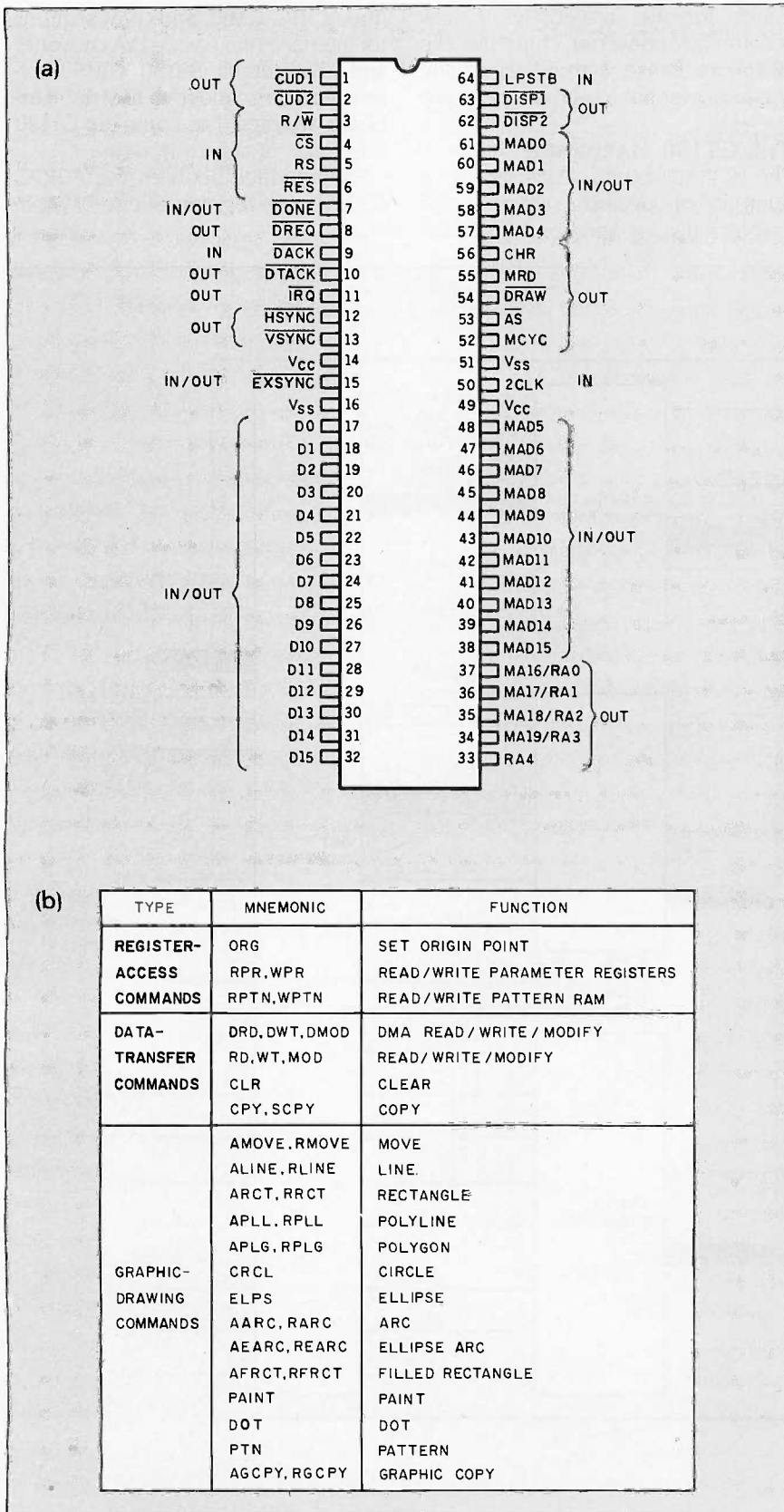

Figure 3: (a) A pin-out diagram of the ACRTC; (b) the ACRTC's command list.

verter, and the SB180 (or SB180FX) XBUS expansion bus requires some "glue" logic. Fortunately, a PAL is easily used for a major portion of this circuitry. Besides decoding port addresses for the ACRTC, D/A converter, and keyboard port, the PAL inverts the polarity of the R/W signal during direct memory access. This is required because the 64180 includes the DMAC (DMA controller) on-chip. The interface between the SB180 and the ACRTC provides a number of options, including status polling, interrupts, and DMA. Some or all of these techniques can be used, depending on the requirements of your application.

I have provided the IBM PC-compatible keyboard port to permit evolution of the GT180. If an application doesn't need the ASCII terminal normally connected to the SB180 (all references to the SB180 include features that are also incorporated in the new SB180FX), the PC keyboard and color display can be used as the main console. The SB180's RS-232 port previously used for the terminal connection could be used for another purpose, like a mouse, plotter, or digitizing tablet.

GRAPHICS DISPLAY AND CONTROL

The heart of the GT180 board lies in the four-chip set consisting of the ACRTC, GMIC, and two GVACs. Because the GMIC and GVACs were designed around the ACRTC, interconnection is simple. The four chips share a common 16-bit data bus with three additional data lines going between the ACRTC and GMIC. The GMIC controls RAM addressing via eight address lines, four write-enable lines, an output-enable line, and RAS (row address strobe) and CAS (column address strobe). The GVACs control all data access to the RAM and extract assorted attribute information from the data lines.

MONITOR INTERFACE

The GT180 supports both digital and analog RGB monitors. The digital-monitor interface simply consists of the red, green, blue, and intensity outputs of the GVACs plus HSYNC and VSYNC from the ACRTC buffered

through a 74S241 (IC10). Jumper JP3 allows selectable inversion of both the HSYNC and VSYNC signals. If the jumpers are installed, IC1 inverts the signals.

The analog RGB section is a bit more involved. The RGB signals coming from the GVACs are fed into the palette D/A converter (IC6). These signals are used to reference the color look-up table, which provides the color information to the D/A converters. The RGB outputs of IC6 are capable of driving the monitor directly with 75-ohm termination (R1, R2, and R3). The SYNC signal is made up of HSYNC combined with VSYNC via an exclusive-NOR operation and buffered through IC10. Finally, the MODE signal controls whether the Princeton SR-12P monitor runs in 400-line or 480-line mode. You should remove JP2 for 480-line operation.

Noise is a critical factor to consider in the design of video circuitry. To minimize the noise imposed on the palette D/A converter through the power supply, ferrite beads are used to isolate power for IC6 from the rest of the board. The beads filter out any high-frequency noise created elsewhere on the board that could result in garbage in the final picture.

INTERFACE CIRCUITRY

The GT180 is designed to be plugged into the 40-pin XBUS on either an SB180 or the SB180FX. The SB180 doesn't provide any output buffers, so line loading is an important consideration when producing a peripheral (the 180 XBUS is buffered). The GT180 uses the data, address, and bus-control lines in numerous places on the board, so two 74LS245s (IC4 and IC30) have been added to buffer the majority of interface lines. The direction of data flow through the data-bus buffer (IC4) is controlled by an \overline{RD} line from the SB180 and an enable output from the PAL (IC5).

We need some additional circuitry to decode I/O ports for the devices on the board. The ACRTC needs two ports, the palette D/A converter needs two ports, and the keyboard needs at least one port. It would also be nice to use jumpers to change the location of the GT180 I/O ports within the ex-

pansion space to avoid conflicts with other peripherals plugged into the same system. Ordinarily, such decode circuitry would require many TTL gates occupying a good deal of board space. Instead, this is a perfect application for a PAL.

PAL DECREASES INTERFACE COMPLEXITY

A PAL is a device similar to a PROM in that it can be custom-programmed for an application by the designer. The GT180 uses a 16L8. The "16" means the device has 16 possible inputs, the "8" means it has 8 possible outputs, and the "L" in the middle indicates that the outputs are active-low.

A PAL gains more flexibility from the fact that most of the outputs can also be defined as inputs. However, since there are only 18 pins on the chip for I/O, the sum of inputs plus outputs cannot exceed 18. You can, for example, have 14 inputs and 4 outputs. The GT180's PAL uses 11 inputs and 7 outputs.

Inside the chip is a series of AND and OR gates. The inputs to the chip are directed to the inputs of the AND gates, and the outputs of the AND gates are directed to the inputs of the OR gates. The OR gates' outputs are sent to a buffered inverter and then to the chip's outputs. This arrangement of gates makes implementing standard sum-of-products logic equations easy.

The programmable array comes into play when you decide how the inputs to the chip are to be connected to the inputs of the gates within the chip. An array of fuse links is used for this. The chip's input pins are connected to the columns of the array, and the inputs to the gates are connected to the rows. At each row-column intersection is a fuse connecting the row to the column. On an unprogrammed chip, all the fuses are intact, so all the chip's inputs are connected to all the logic inputs. In the process of programming the chip, all unwanted fuse links are literally blown out by the PAL programmer, leaving just the links that connect the desired chip input to a particular gate input.

Most of the PAL inputs are standard

bus signals necessary for I/O port decoding. Two select lines are also defined that let you select one of four base locations for the GT180 I/O ports. JP1 is used to set these select lines.

The \overline{DMA} input is not a standard bus signal. When the ACRTC generates a DMA request, it is latched by IC3 and sent to the \overline{DMA} input on the PAL (as well as to the \overline{DREQ} input on the SB180). The ACRTC requires that R/W be inverted during a DMA transfer, so this is taken care of within the PAL.

There are also seven outputs defined on the PAL. The \overline{BDSEL} line goes active anytime the board is referenced and is used to enable the data-bus buffer (IC4). \overline{ACRCS} provides chip select to the ACRTC, and $\overline{ACR\overline{W}}$ provides the R/W signal to the ACRTC. \overline{ACDACK} is the DMA acknowledge signal to the ACRTC. \overline{DACCS} is the chip select for the palette D/A converter, while \overline{KEYCS} is the chip select for the keyboard adapter.

The last PAL output is labeled \overline{EXSEL} . A little history is necessary to explain this signal. When I designed the COMM180 board (see the December 1985 Circuit Cellar), I hadn't considered that I would be designing something like the GT180. Consequently, I made the assumption that only one expansion board would ever be plugged into the SB180 at any one time. Therefore, the data-bus buffer is enabled whenever $\overline{EXSEL2}$ from the SB180 goes active, even though there are gaps in the expansion space that the board uses. When I sat down to look at doing a graphics board, I realized that if someone wanted to use the GT180 with a hard disk on an SB180, I had to make some allowance for plugging both a COMM180 and a GT180 into an SB180. (The SB180FX incorporates both the floppy disk and SCSI controllers on the same board and therefore does not require the COMM180 to add a hard disk. Refer to the What's New section in this issue for further details.)

The GT180 uses eight I/O ports. The base address for the ports is jumper-selectable and can be set for either E0, E8, F0, or F8 hexadecimal. (For the remainder of the article, all port

(continued)

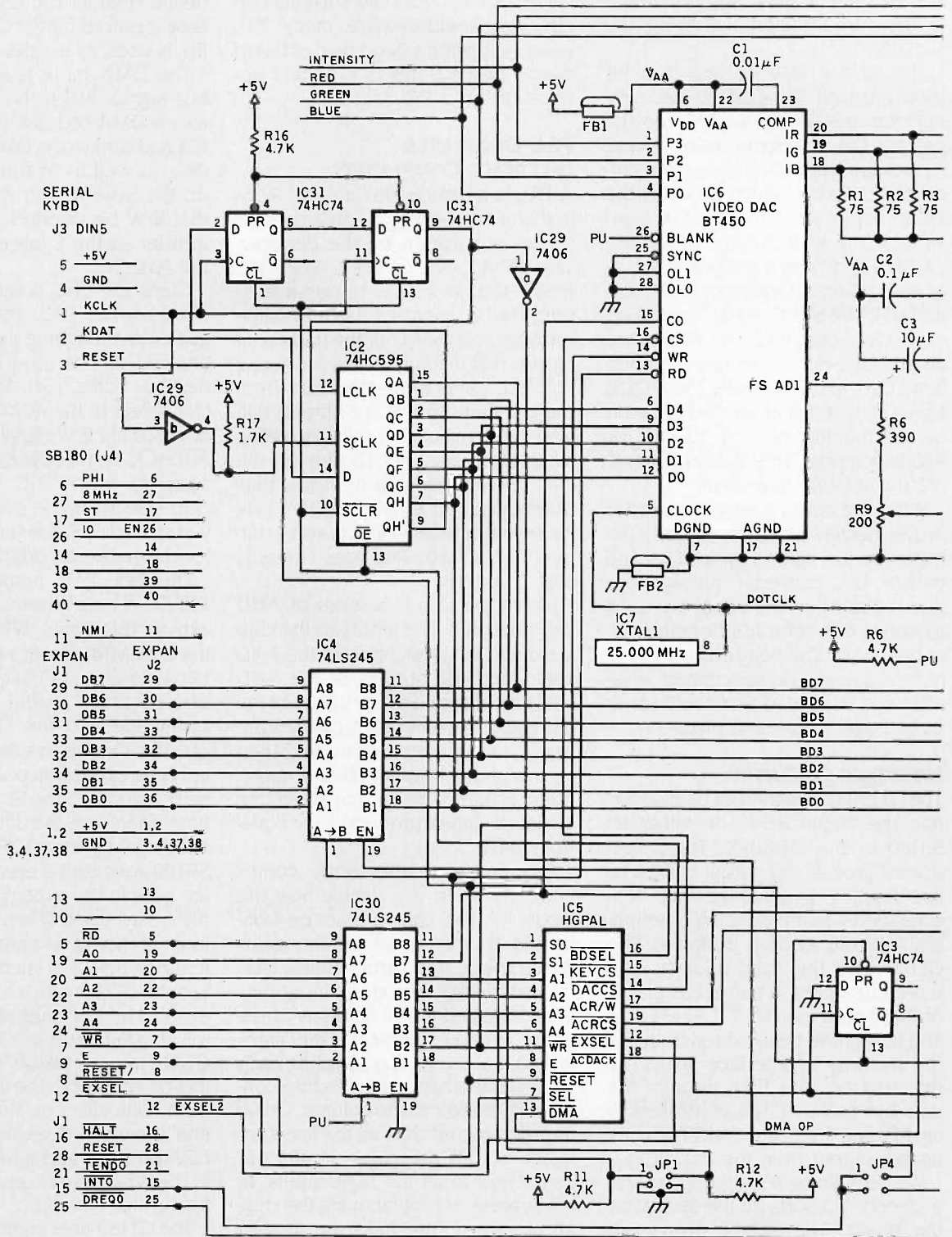
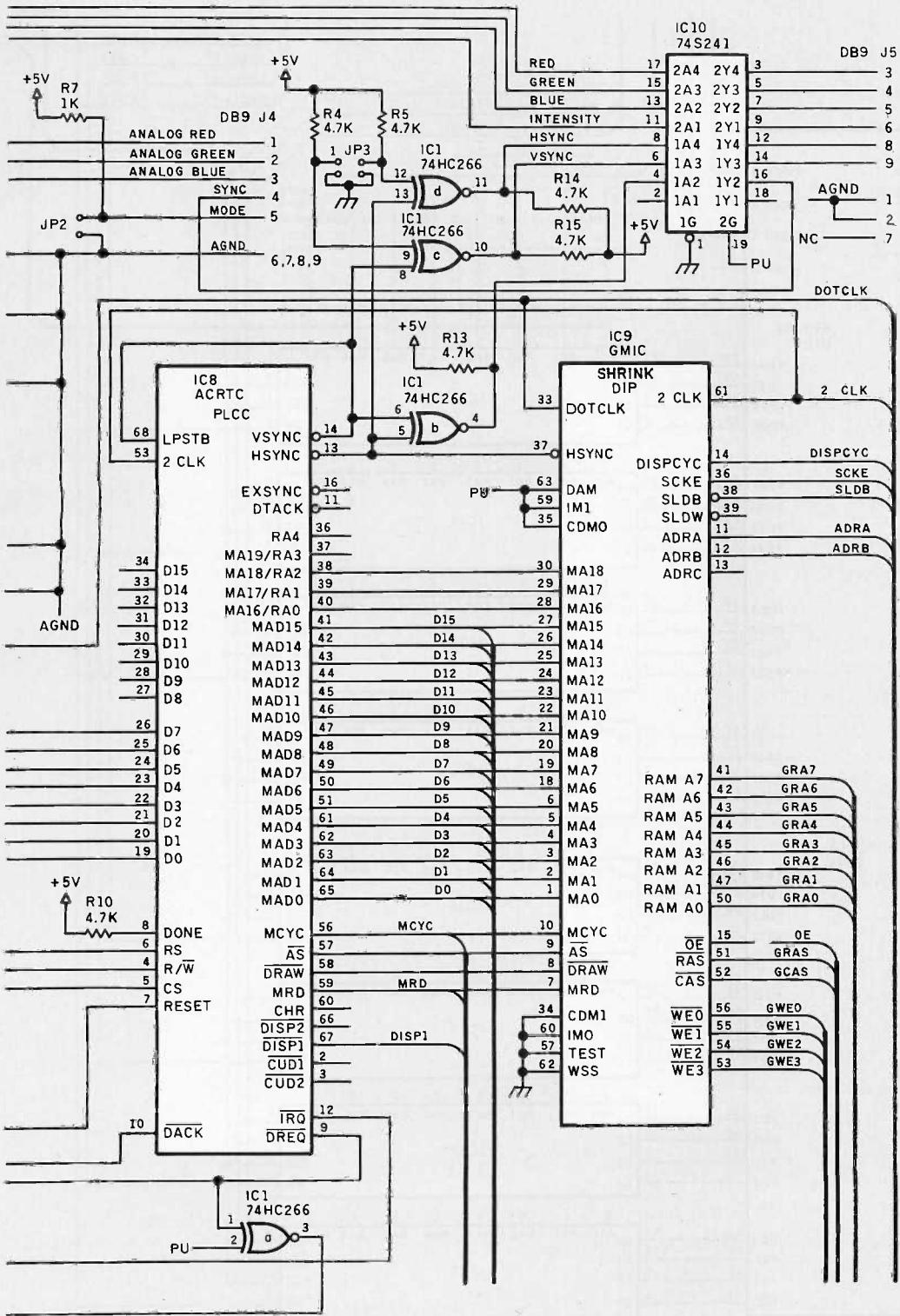

Figure 4: The schematic of the GT180.

CIRCUIT CELLAR



CIRCUIT CELLAR

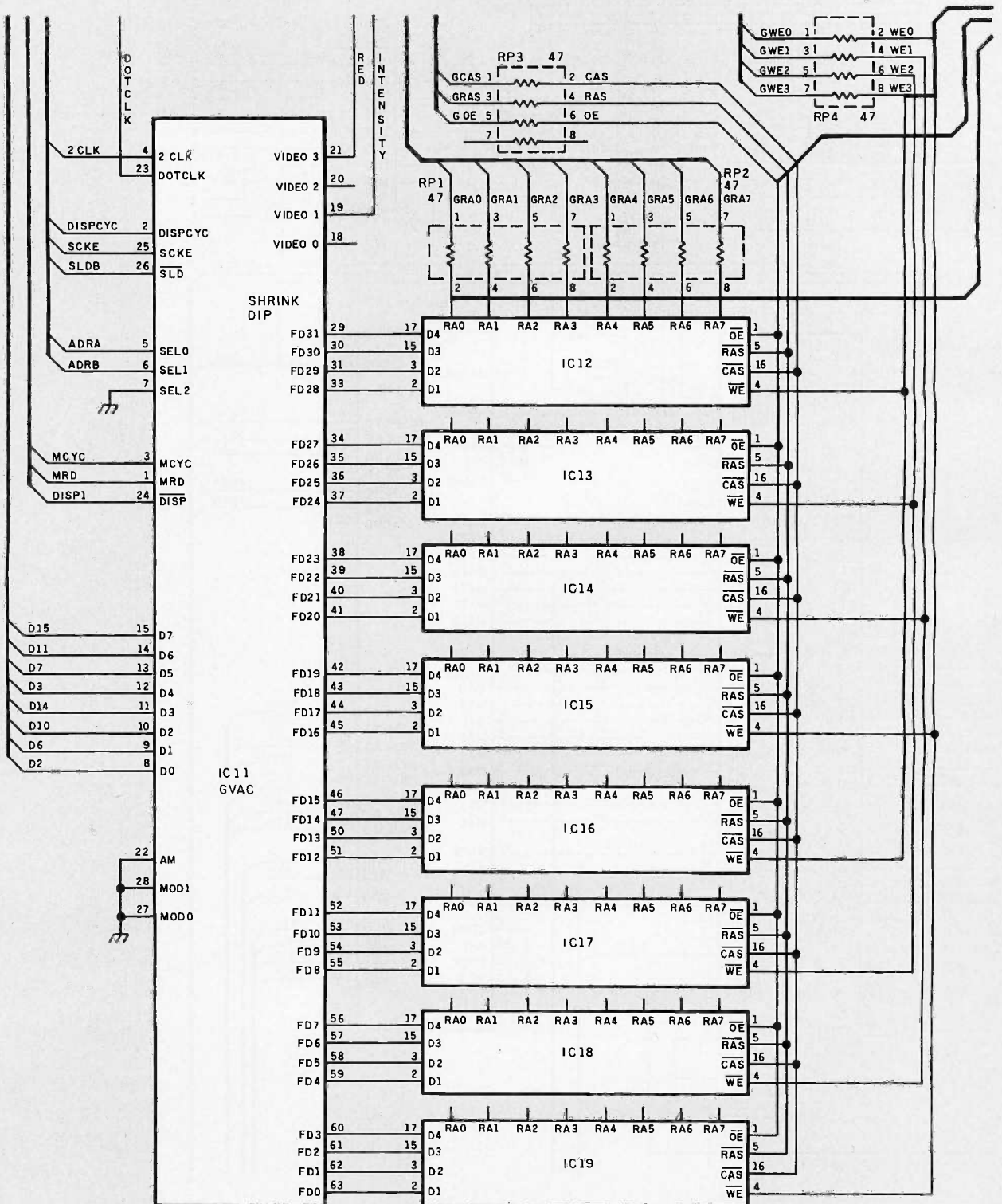
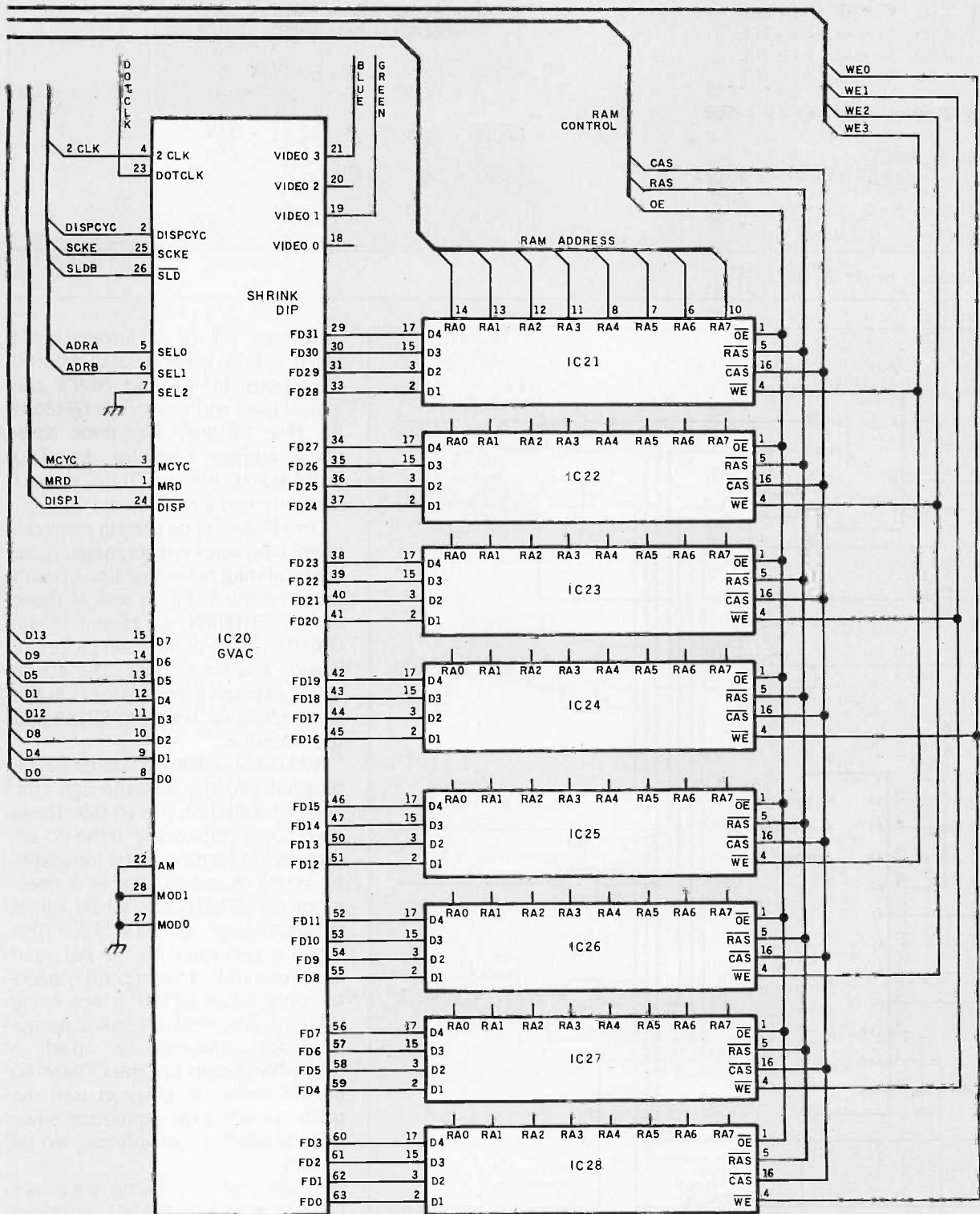

Figure 4 continued.

CIRCUIT CELLAR



$$\begin{aligned} \overline{\text{BDSEL}} &= \overline{\text{S0}} \cdot \overline{\text{S1}} \cdot \overline{\text{A3}} \cdot \overline{\text{A4}} \cdot \text{SEL} \\ &+ \text{S0} \cdot \overline{\text{S1}} \cdot \overline{\text{A3}} \cdot \overline{\text{A4}} \cdot \text{SEL} \\ &+ \text{S0} \cdot \text{S1} \cdot \overline{\text{A3}} \cdot \overline{\text{A4}} \cdot \text{SEL} \\ &+ \text{S0} \cdot \text{S1} \cdot \overline{\text{A3}} \cdot \overline{\text{A4}} \cdot \text{SEL} \end{aligned}$$

$$\overline{\text{ACRCS}} = \overline{\text{BDSEL}} \cdot \overline{\text{A1}} \cdot \overline{\text{A2}} \cdot \text{E} \cdot \overline{\text{DMA}}$$

$$\begin{aligned} \overline{\text{ACDACK}} &= \text{RESET} \\ &+ \overline{\text{BDSEL}} \cdot \overline{\text{A1}} \cdot \overline{\text{A1}} \cdot \text{E} \cdot \overline{\text{DMA}} \end{aligned}$$

$$\begin{aligned} \overline{\text{ACR}\overline{\text{W}}} &= \overline{\text{BDSEL}} \cdot \overline{\text{DMA}} \cdot \overline{\text{WR}} \\ &+ \overline{\text{BDSEL}} \cdot \text{DMA} \cdot \overline{\text{WR}} \end{aligned}$$

$$\begin{aligned} \overline{\text{KEYCS}} &= \overline{\text{BDSEL}} \cdot \overline{\text{A2}} \cdot \text{E} \cdot \overline{\text{DMA}} \\ &+ \text{RESET} \end{aligned}$$

$$\overline{\text{DACCS}} = \overline{\text{BDSEL}} \cdot \overline{\text{A1}} \cdot \overline{\text{A2}} \cdot \text{E} \cdot \overline{\text{DMA}}$$

$$\overline{\text{EXSEL}} = \text{SEL} \cdot \overline{\text{BDSEL}}$$

Figure 5: Equations for the GT180's PAL.

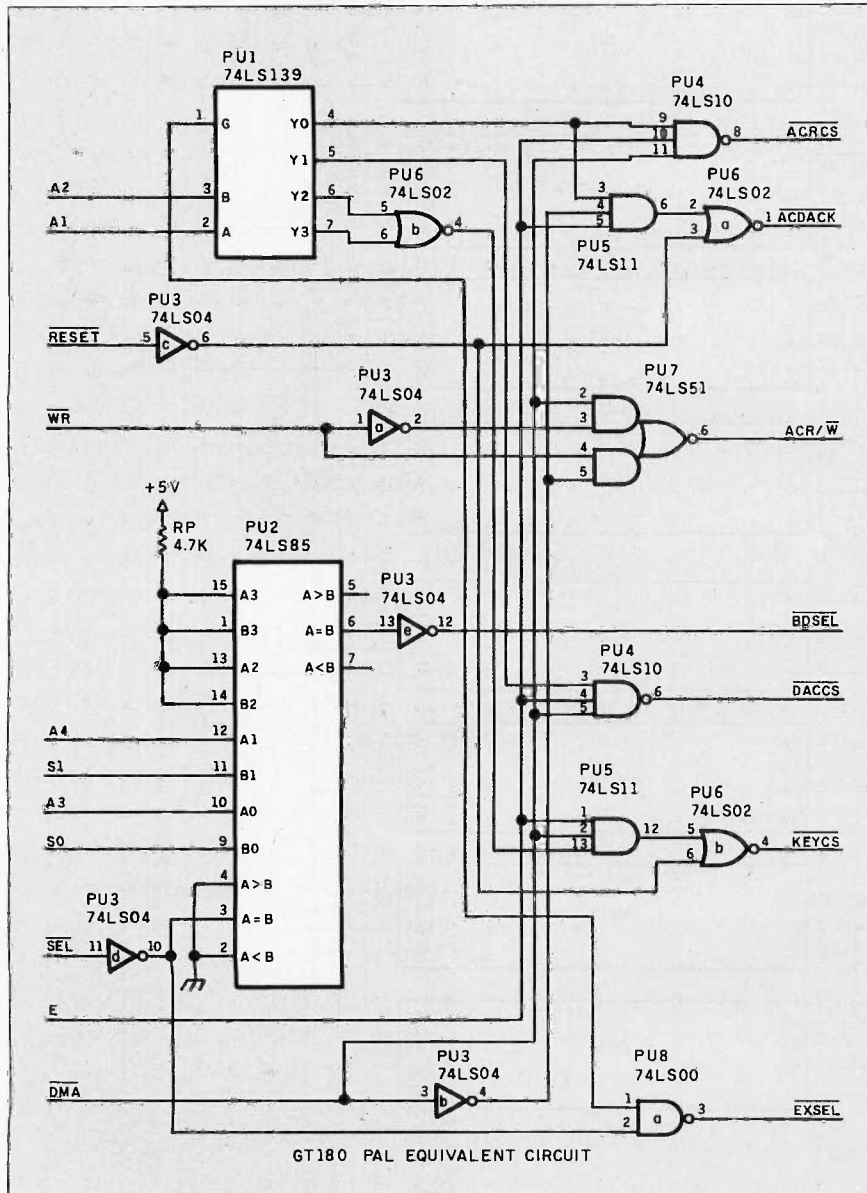

Figure 6: The schematic of a discrete logic equivalent to the GT180's PAL.

addresses will be in hexadecimal.) Since a fully populated COMM180 uses ports E0-E7 and F0-FF, the logical base address for the GT180 is E8. (The SB180FX has three additional address lines for decoding ports 40-7F, but the GT180 doesn't currently use any of them.)

The GT180 can be used in many different hardware configurations. There are mounting holes that line up with those on the SB180 as well as those on the SB180FX, so mounting the GT180 to either of the main processor boards is a simple task. The 40-pin XBUS expansion connector is in the same place on both the SB180 and the SB180FX.

Additional expansion boards can be plugged into the pass-through connector located on the GT180. These boards can employ any of the I/O addresses not being used by the graphics board. A second 40-pin connector on the GT180 passes all the signals straight through, except EXSEL2. This signal is generated by the PAL, and it is presented on the second connector only if the GT180 is not being selected. Consequently, this is the appropriate connector to attach a COMM180 board to. (The COMM180 should never be plugged into the main pass-through connector since bus-contention problems would occur.)

To aid you in building your own GT180, I have listed the PAL equations for IC5 in figure 5. Also, figure 6 shows the schematic of a discrete component equivalent to the PAL if you want to build the GT180 but do not have the facility to program a PAL. When

you are done, you are welcome to download utilities and other graphics software that I will post on BYTEnet, BIX, and the Circuit Cellar BBS to aid in checking out your handiwork.

THE KEYBOARD ADAPTER

The IBM PC keyboard uses a synchronous serial interface to talk to the host computer. While the typical IBM connection allows data flow to and from the keyboard, the circuit used on the GT180 only reads from the keyboard. This greatly simplifies the circuit.

Five lines connect the keyboard to the computer. Two are for +5 volts and ground, one is a power-on reset signal that initializes the keyboard, and the last two carry the data signal and clock signal. Data is sent from the keyboard using a 9-bit serial stream. You can think of the first bit as a start bit. The remaining 8 bits contain the code for the key being pressed (or released), with the low-order bit arriving first. The falling edge of the clock signal is used to indicate valid data is present on the data line. (Note: IBM PC keyboards are not ASCII-compatible.)

The core of the keyboard adapter is a 74HC595 (IC2) 8-bit shift register with a built-in three-state latch. It also has an unbuffered output, QH', that reflects the state of the last bit in the shift register. This is normally used to cascade multiple registers. Data is fed into the D input directly from the keyboard. The clock is inverted since the chip assumes valid data on the rising edge of the clock pulse.

When the register is read or a reset is performed, IC2 and IC31 are cleared. Data arriving from the keyboard is shifted into IC2, and the data presently in the register is shifted up one bit (A to B, B to C, etc.). When all the data has been received from the keyboard, the shift register will contain the 8-bit keycode. The problem now is how to latch the data into the register's output buffers and tell the computer that a key was pressed.

Remember that an extra start bit was sent by the keyboard. This high bit will appear on the QH' output as the seventh data bit being clocked into the shift register. Data from the

QH' output is clocked into IC31a one-half clock period after it appears on QH'. Half a clock period later, the last bit of the keycode is shifted into the shift register. Half a clock period after that, the data from IC31a is clocked into IC31b. The output of IC31b immediately strobes LCLK on IC2, causing the current state of the shift register to be latched into the output buffers. The output of IC31b is also connected to an open-collector inverter (IC29) and can be used as an interrupt to the SB180.

A subsequent read to the keyboard port will place the byte in the output buffers onto the data bus and will clear the shift register and IC31 so they are ready for the next keystroke. The data in the output buffers is not cleared and is available until the next byte is received from the keyboard.

SELECTING A COLOR MONITOR

Whether or not a particular monitor is suitable for use with the GT180 depends on two factors: the monitor's bandwidth and its physical interface.

The analog RGB interface has three analog signal lines—one each for red, green, and blue—with a peak voltage of +0.6 V for maximum brightness. There is also a negative composite

sync at TTL levels that consists of the HSYNC and VSYNC signals combined. This type of interface is compatible with the SR-12P monitor mentioned before.

The digital TTL interface includes four TTL-level lines for the red, green, blue, and intensity lines. There are also two more TTL-level lines for separate HSYNC and VSYNC signals. This type of interface is compatible with most monitors designed for IBM's CGA board. Unfortunately, some monitors on the market don't fit the format of either of the two interfaces described above. You will probably have problems with such monitors, so it's best to avoid them altogether.

The GT180 is designed and presented as a 640- by 480-pixel resolution display controller. However, you can configure it by software to resolutions of 640 by 400, 640 by 350, 640 by 200, 320 by 200, etc. (all with 16 colors). Ultimately, the frequency of the crystal oscillator you use on your GT180 board controls the resolution you can expect and the monitor you can use. A 25-MHz oscillator will give you a PGA-like 640 by 480 or 640 by 400 resolution but requires a high-

(continued)

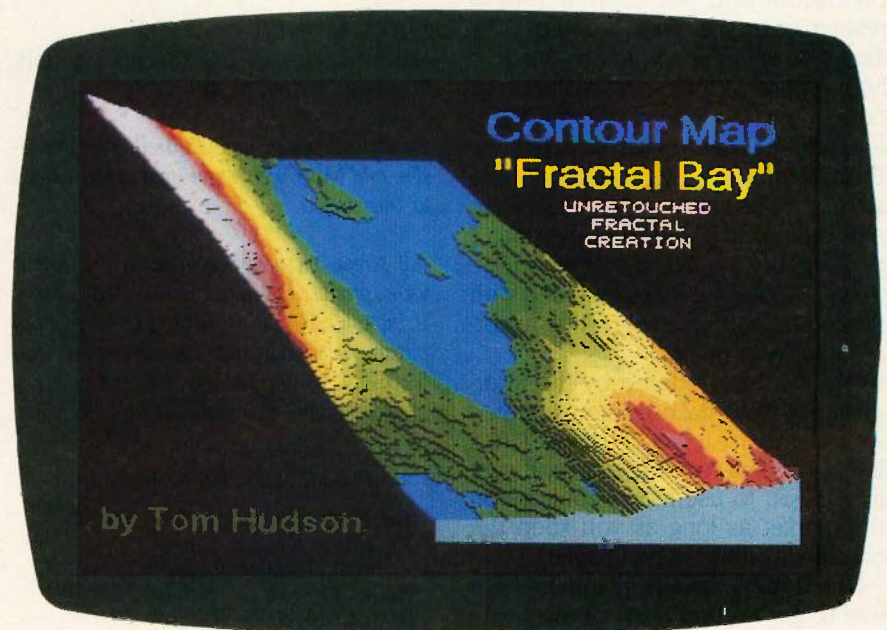

Photo 2: This screen picture was produced using the GT180 and a Princeton SR-12P monitor.

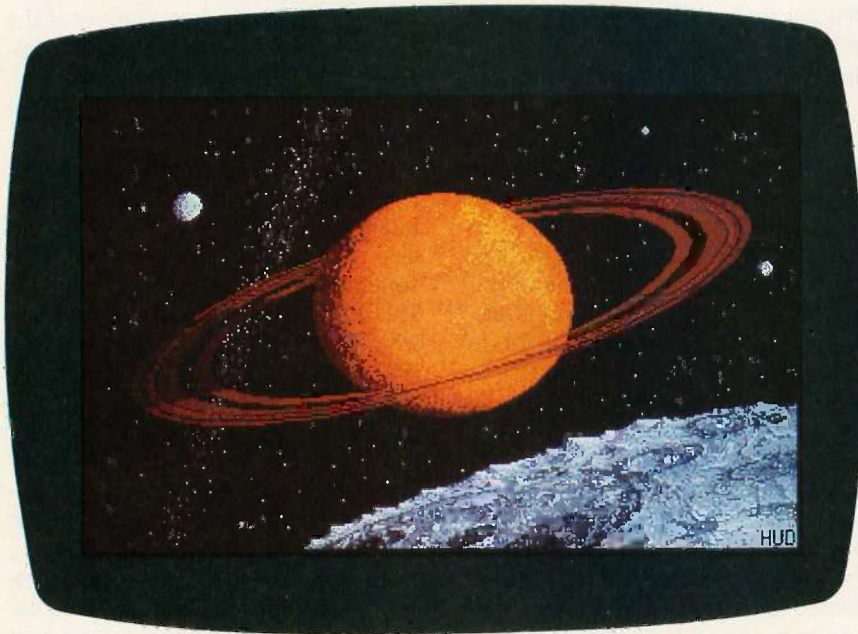

Photo 3: Another screen picture using the GT180 and SR-12P.

quality 30-MHz monitor like the SR-12P (see photos 2 and 3).

In order to use a less expensive EGA- or CGA-compatible color monitor intended for the IBM PC, you must use a lower oscillator frequency and give up some resolution. A CGA monitor, for example, has a 15-MHz bandwidth and will support only a resolution on the order of 640 by 200. The newer EGA monitors have a higher bandwidth and a resolution of 640 by 350 (an EGA monitor is RGBI and not analog). You will have to slow the GT180 down by a proportionate amount to use a slower scan rate. Use a crystal oscillator in the range of 12 to 13 MHz for a 640 by 200 monitor. (Note: Software utilities included with the GT180 allow use of the lower-resolution monitors.)

The flexibility offered by the interchangeable crystal oscillators coupled with the ability to set up the ACRTC's internal timing registers from software allows you to use most monitors on the market as long as you keep the bandwidth limitations in mind.

One tidy and relatively inexpensive way to get around most of the problems listed above is to use a monitor that can support a range of scan rates and either of the interfaces mentioned. No such animal? Well, NEC

makes a MultiSync monitor that will adapt to whatever scan rate you are using and accepts either analog or digital RGB inputs.

CIRCUIT CELLAR FEEDBACK

This month's feedback begins on page 58.

NEXT MONTH

Part 3 looks at the GT180 Graphix Toolbox software. ■

Special thanks to Tom Cantrell, Ken Davidson, and Mike Weisert for their contributions to this project.

All screen pictures presented in this article were produced using the GT180 with a Princeton SR-12P monitor. The bit-mapped pictures were originally composed on an Atari 520ST using DEGAS by Tom Hudson. They are reproduced and used here by permission.

The following items are available from

The Micromint Inc.
25 Terrace Dr.
Vernon, CT 06066
(800) 635-3355
(203) 871-6170
Telex: 643331

1. GT180 graphics board: RGBI version less palette D/A converter. Comes with demo disk and user's manual.

- board alone.....\$395
- board with Modula-2 and GT180
Graphix Toolbox.....\$449
- 2. GT180 graphics board: RGBI and analog version with palette D/A converter. Comes with demo disk and user's manual.
board alone.....\$449
- board with Modula-2 and GT180
Graphix Toolbox.....\$499
- 3. Borland International's Turbo Modula-2 GT180 Graphix Toolbox software for the SBI80 and SBI80FX computers, optimized for the 64180 processor. Supplied on 5¼-inch DS/DD SBI80 format disks with 300-page manual.
SBI80 Modula-2 alone.....\$69
- SBI80 Modula-2 with Graphix
Toolbox alone.....\$89
- 4. SBI80FX 5.75- by 8-inch single-board computer, accommodates 512K bytes of memory, two serial ports, three parallel ports, parallel printer port, floppy disk controller, SCSI controller, ROM monitor, 6-MHz 64180. Comes with ZRDOS, ZCPR3, hard disk BIOS, and user's manuals. Populated with 256K-byte memory, less 53C80 SCSI controller chip.
SBI80FX board alone.....\$409
- SBI80FX board with software....\$499
- SBI80FX board fully populated with
512K bytes, SCSI chip, and
software.....\$599
- 9.216-MHz 64180 processor upgrade
(SBI80FX only).....\$50

GMIC, GVAC, ACRTC, and palette D/A converter chip sets are available for experimenters who wish to hand-assemble the GT180. Call for price and availability information. Borland's Turbo Modula-2 is also available for most CP/M Z80 machines. Contact Echelon Inc., 885 North San Antonio Rd., Los Altos, CA 94022, (415) 948-3820. The SBI80FX is hardware- and software-compatible with the SBI80.

Surface delivery (U.S. and Canada only): add \$5 for U.S., \$10 for Canada. For delivery to Europe via U.S. airmail, add \$20. Three-day air freight delivery: add \$8 for U.S. (UPS Blue), \$25 for Canada (Purolator overnight), \$45 for Europe (Federal Express), or \$60 (Federal Express) for Asia and elsewhere in the world. Connecticut residents please add 7.5 percent sales tax.

There is an on-line Circuit Cellar bulletin board system that supports past and present projects. You are invited to call and exchange ideas and comments with other Circuit Cellar supporters. The 300/1200/2400-bps BBS is on-line 24 hours a day at (203) 871-1988.

To be included on the Circuit Cellar mailing list and receive periodic project updates and support materials, please circle 100 on the Reader Service inquiry card at the back of the magazine.

MIX C COMPILER



C FEVER *catch it!*

It's becoming an epidemic... everyone is switching to C! First there were a few hackers, then came the college students, next the major software houses, and now the rest of the programming world. Programmers everywhere are infected with the desire for SPEED, POWER, and PORTABILITY.

It's time to face the inevitable. You're going to catch the fever too! When you do, give us a call. We've got the best cure — an illustrated guide to the C language, plus a complete program development system. Everything you need to master the C programming language... all at a price that's less than the cost of a book!

But don't let this price fool you. Our system is powerful; it compiles twice as fast as the others, is completely standard, and it's very easy to use. Most C compilers are designed for wizards. We have designed ours for you!

- **What do you get for a mere \$39.95?**
- **A 370 Page book filled with sample programs, plus...**
- **A fast, standard full featured C compiler** that supports all data types and the latest features like bit fields, enumerations, structure assignment, and passing/returning structures.
- **A fast linker** that loads separately compiled files, searches libraries, and builds an executable program.
- **An extensive library of more than 175 functions** (including the standard C functions and the computer specific functions that provide direct access to the operating system and BIOS).
- **Tools that allow you to optimize** your programs for minimal space or maximum speed.

Works on all MSDOS/PCDOS and all CP/M Z80 COMPUTERS! (Not Copy Protected!)

The Powerful MIX
C COMPILER
Harness the Power of the C Language with this full featured Compiler
MIX SOFTWARE

Incredible Value
\$39.95 **With 30 Day**
AT ONLY
Money-Back Guarantee

Operators are standing by... Please use this Number for ORDERS ONLY!
CALL TOLL FREE FOR RUSH ORDER DELIVERY!

1-800-523-9520 **IN TEXAS, PLEASE CALL TOLL FREE 1-800-622-4070**

For Technical Support Please call 1-214-783-6001
MIX Software, Inc. / 2116 E. Arapaho / Suite 363 / Richardson, Texas 75081
Or contact our Worldwide Distributors direct in:
Canada: Saraguay Software 1-416-923-1500 Switzerland: DMB Communication CH-1-825-53-29
Australia: Techlow 047-586924 France: Info/Tech 1-43-44-06-48

Split Screen Text Editor

an Incredible Value AT ONLY \$29.95 (Not Copy Protected!)
Works on all MSDOS/PCDOS and CP/M Z80 Computers

Our high powered editor is great for editing high level languages. **It works just like Micropro's Wordstar[®]** but macros allow you to create your own custom editor, and the split-screen feature lets you edit two files at the same time.



The MSDOS/PCDOS version is loaded with special features:

- Execute any DOS command or RUN other programs from the editor.
- Quickly edit files as large as 300,000 characters.
- Compile MIX C programs directly from memory. The editor automatically positions the cursor to the first error in your program.

ASM UTILITY \$10

an Incredible Value AT ONLY \$10
Call assembly language routines from your C programs. The ASM utility works with Microsoft's MASM or M80 assembler. Macros make it easy! Works just as if you were calling a C function, and you can even call C functions from assembly language. Lots of useful assembly language functions are included as examples.



RUSH REPLY ORDER FORM!

SPECIAL OFFER!

Buy both for an even greater value!

SAVE \$14.95 Off Our Regular List Price!

Limited Time Only \$54.95
C Compiler & Text Editor

Please check method of payment:
 Check Money Order MasterCard/VISA
Your Card # _____
Expires _____
Shipping Charges: (No charge for ASM Utility)
In the U.S.A.: Add \$5.00 per Order.
In CANADA: Add \$10.00 per Order.
OVERSEAS: Add \$10.00 per Text Editor. Add \$20.00 per C Compiler. Add \$30.00 for combined C Compiler and Text Editor.
Operating System: (Check one)
 CP/M Z80 MSDOS/PCDOS

Description	Quantity	PRICE	Total Order
Split-Screen Text Editor	_____	\$29.95	\$_____
C Compiler	_____	\$39.95	\$_____
C and Text Editor (Special)	_____	\$54.95	\$_____
ASM Utility	_____	\$10.00	\$_____
Texas Residents Add 6.125% Sales TAX			\$_____
Shipping Charges (See at Right)			\$_____
TOTAL OF YOUR ORDER:			\$_____

Specify Your Computer Name _____
Specify Disk Format _____
NAME _____
Telephone A/C (_____) _____
Street _____
City _____
State _____
Country _____ ZIP _____

MIX software 2116 East Arapaho Suite 363 Richardson, Texas, 75081
Ask about our Volume Discounts!
Call 1-214-783-6001

Finally, a language worth

For years BASIC has been everyone's first language. And for almost as long, they've been tempted by other languages. Lured by promises of more speed, more power.

We have a solution. A new language that's a substantial improvement over BASICA. Faster. More structured. Finally, a compelling reason to leave BASIC.

Introducing Microsoft's QuickBASIC Compiler, Version 2.0.

At last, you can have the latest programming techniques, combined with the solid foundation of BASIC. Our new compiler is as compatible with BASICA as you can get. At the same time it offers the extra speed and power you've been looking for.

Run faster with compiled code.

If there's one thing you've asked for, it's speed. And Microsoft® QuickBASIC simply blazes. Old BASICA programs will run up to ten times quicker once they've been compiled. Sometimes even faster.

Everything you need. Built-in.

Making programs run faster is only part of the story, though. The new Microsoft QuickBASIC Compiler includes a full-screen editor, built-in. So now you can make the jump from writing to RUNning in no time flat. Edit your program, compile it, and run it. Faster than any other BASIC compiler around. All without leaving our on-line help and prompts.

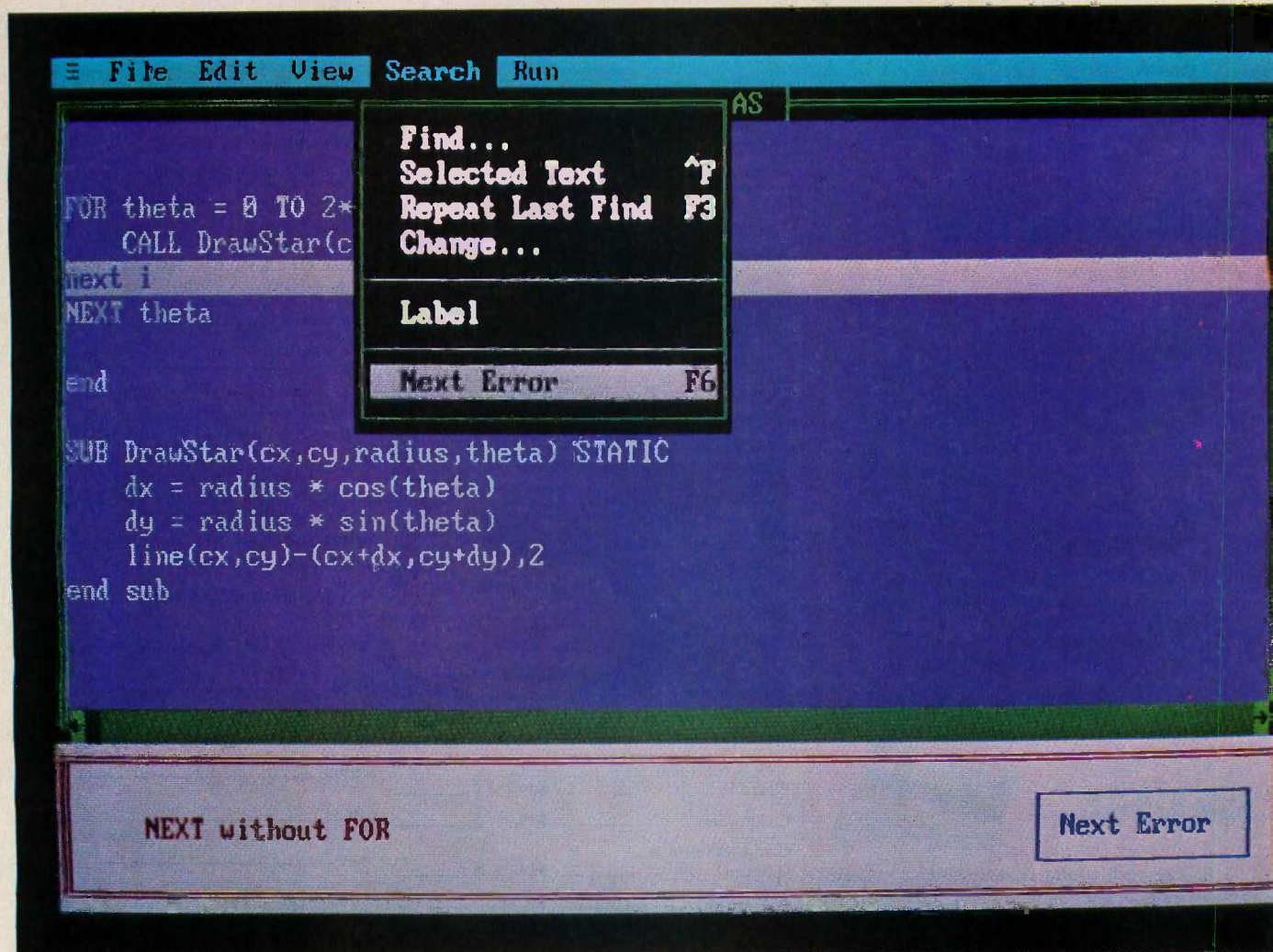

leaving BASIC for.

On the rare chance your program doesn't run 100% the first time out, we've got another surprise for you. The Microsoft QuickBASIC debugger. Our full-screen tracing lets you debug your programs while watching the source code execute. A line at a time, or with breakpoints. As easy as can be.

Our compiler is also smart enough to save you time. First, by finding any errors in one pass. Second, by putting your editor's cursor on the problem. Automatically. So you don't have to get lost in a maze of error codes and line-numbers.

The BASIC virtues. And more.

Speaking of line numbers, let's not. Because line numbers are strictly optional. And Microsoft QuickBASIC lets you use alphanumeric labels as well. Now you can GOTO *ErrorCheck* instead of line number 6815.

Or you could stop using GOTOs altogether. There are a variety of options that could make the GOTO an endangered species. Features like multi-line IF-THEN blocks. And named sub-programs. Now your BASIC programs can be as structured and organized as you want.

We've only just begun to talk about the virtues of Microsoft QuickBASIC. There are dozens of enhancements to your favorite language. Things like larger arrays. Local and global variables. Reusable modules that let you create libraries of your most often-used routines. All explained in a revised manual that includes a complete language reference.

Making your quick escape.

If all these features follow your BASIC instincts, then zip on down to your nearest Microsoft dealer. That's where you'll discover the best surprise of all. The price. Only \$99 for the best reason to leave BASIC.

For the name of your nearest Microsoft dealer, call (800) 426-9400. In Washington State and Alaska, (206) 882-8088. In Canada, call (416) 673-7638.

Microsoft® QuickBASIC
The High Performance Software™

Microsoft QuickBASIC Compiler Version 2.0 for IBM® PC and Compatible Computers.

BASICA Compatibility

- Sound statements including SOUND and PLAY.
- Graphics statements including WINDOW, VIEW, DRAW, GET, PUT, LINE, CIRCLE, LOCATE and SCREEN.
- Support of EGA extended graphics modes. NEW!
- BASICA structures are supported including WHILE/WEND, IF/THEN/ELSE, FOR/NEXT, GOSUB/RETURN, and event handling.

Results of Sieve Benchmark	BASICA 3.1	Microsoft QuickBASIC 2.0
Seconds per iteration	78	0.52

Complete Programming Environment

- Built-in Editor that places the cursor on found errors automatically. NEW!
- Compile entirely in memory at speeds up to 6000 lines per minute. NEW!
- Link routines once when starting a programming session and no need to link again when changing programs. NEW!
- Built-in debugger with single-step, animate, and trace modes. NEW!
- Create stand-alone programs.

Alphanumeric Labels

- Can be used to make your programs more readable. Line numbers are not required but are supported for BASICA compatibility.

Structured Programming Support

- Block IF/THEN/ELSE/END IF eliminates the need for GOTO statements. NEW!
- Subprograms can be called by name and passed parameters. Both local and global variables are supported.

Modular Programming Support

- Separate compilation allows you to create compiled BASIC libraries to use and re-use your programs.
- A library of routines to access DOS and BIOS interrupts is supplied. NEW!

Large Program Support

- Code can use up to available memory.
- Numeric arrays, each up to 64K bytes, can use up to available memory. NEW!

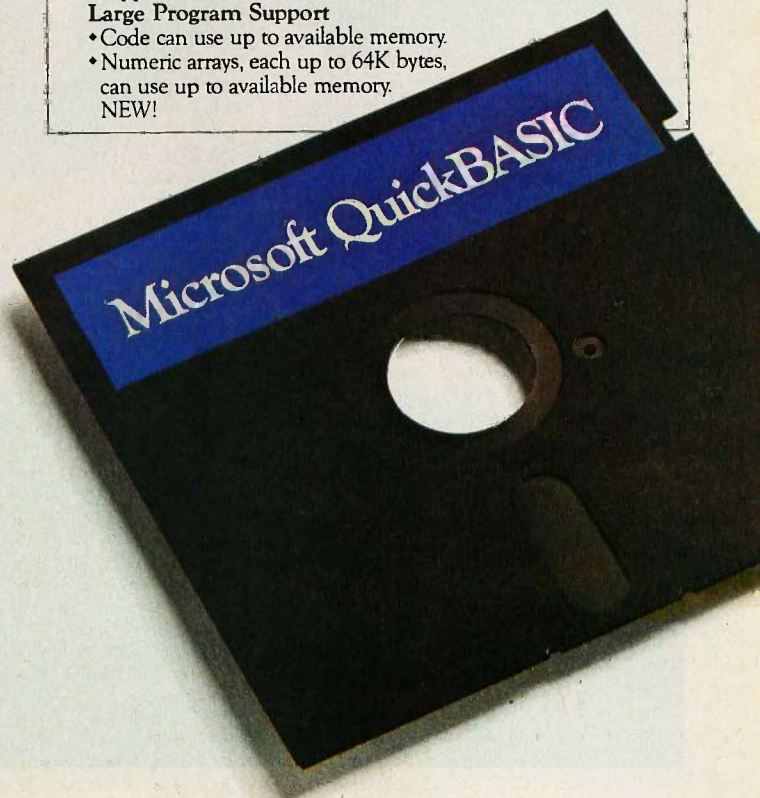

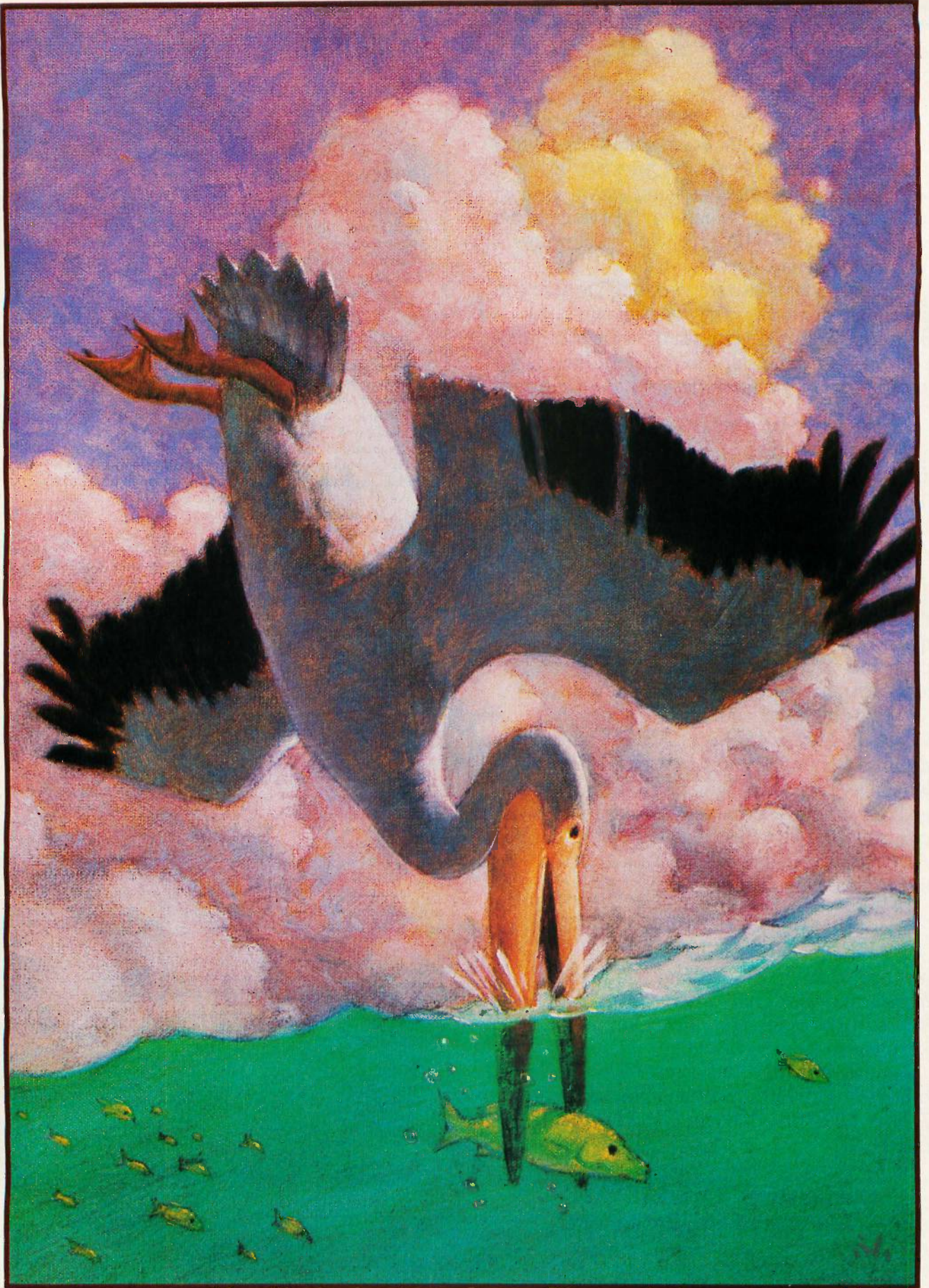

USING DOS FUNCTIONS FROM TURBO PASCAL

BY DOUGLAS F. YRIART

*You need never write a line
of assembly language code*



When you decide whether to use a high-level language or assembly language to write an application program, you must weigh several trade-offs. One element

to consider is which operating system services the high-level language provides access to versus the services available directly to an assembly language program. This article demonstrates how to call on operating system functions from programs written in Turbo Pascal running under PC-DOS or MS-DOS. You can apply the techniques described to other implementations of Pascal or to other high-level languages as long as the language in question provides facilities for making calls to the operating system and the ability to examine the values returned in the CPU registers.

The program DirectoryDemo (listings 1 through 6 inclusive) returns a disk directory with filenames and sizes by searching for matches to the specified input pattern, much as the DIR command does. In addition to demonstrating how to use DOS function calls, the procedures and functions that make up the program can be used within other programs to automatically process a group of files or show you a list of available files and information about them. [Editor's note: The program DIRDEMO.PAS is available on

disk, in print, and on BIX. See the insert card following page 320 for details. It is also available on BYTEnet. See page 4.]

DOS AND HIGH-LEVEL LANGUAGE SERVICES

DOS provides a number of functions for handling I/O from the console, mass storage, and other devices so that assembly language programmers have a standard means of dealing with these devices. Higher-level languages use some of these functions as well. To open a file in Turbo Pascal, you need only assign a filename to a file variable. In an assembly language program, you must take care of numerous details, such as setting up a file control block (FCB), before you can ask DOS to open the file.

An operating system as rich as MS-DOS or PC-DOS provides many more I/O and memory management functions than are available in a higher-level language. There are two reasons for this. First, different operating systems provide different functions; to let you write portable programs, languages provide for only those functions

(continued)

Douglas F. Yriart (6805 Melrose Dr., McLean, VA 22101) is a commander in the U.S. Naval Reserve and the chief of the computer user center for the U.S. Office of Personnel Management in Washington, DC. He has a B.A. in international relations from Johns Hopkins University.

that are reasonably standard across operating systems. Second, some limit must be set on the facilities provided by a language so that it does not become unwieldy. However, in exchange for portability and simplicity, you lose access to some useful capabilities.

Implementations of some high-level languages provide a back door through which you can access functions or perform tasks they do not provide. Usually, the method used is either to allow the inclusion of in-line assembly language code or to provide a means of linking assembly language modules with compiled programs. To take advantage of these facilities, you must write assembly language code.

Turbo Pascal lets you include in-line assembly language code in your programs. However, this facility is not generally needed because the language contains the facilities to make calls to the operating system and to

load and examine the CPU registers. Thus, you can build procedures and functions to perform tasks not built into the language without resorting to assembly language. The price of using this capability is that your programs are not portable to other operating systems.

DOS provides two sets of functions for file management. The traditional set is FCB-oriented. To use these calls, the application program must build the FCB and pass it to DOS. The new, extended set of functions was introduced with DOS 2.0 and is easier to use. For a detailed explanation of DOS functions, see references 1 and 2.

MEMORY ORGANIZATION

To understand the operation of DOS functions, you need to know how memory is organized in computers using the Intel 8088/8086 family of CPUs. The CPU registers are 16 bits wide and can contain unsigned in-

tegers in the range from 0 to 65,535. To address more than 64K bytes of memory, these CPUs use a scheme of 20-bit segmented addresses made up of a base segment address, which is a multiple of 16, and a relative offset from that base. With this technique, you can access any byte in the CPU's 1-megabyte address space. The CPU divides this area into four segments that you can use concurrently—the code, data, stack, and extra segments. A pair of registers is provided for referencing each of these areas—one contains the segment address; the other, the current offset.

DOS manages memory dynamically. The actual address at which a program resides is not established until the program is executed. DOS loads the CPU code-segment register with the appropriate segment address when it loads the program into memory.

As part of the load process, DOS also sets up a number of work areas for its own use. Their positions are variable, depending on a number of factors outside program control. To use some of the DOS function calls, programs need to be able to access these work areas. The data transfer area (DTA) in particular is needed when you use the extended file and directory services.

The DTA is where the directory search functions return information on the files they find. DOS establishes a default DTA in the program-segment prefix (PSP), another area it sets up while initializing a program. Programs can also establish and change their own DTAs once they begin running. DOS provides a function for setting the address of the current DTA. More important for our purposes, DOS also provides a function that reports the address of the currently active DTA.

CALLING DOS FUNCTIONS

Reference 1 describes two preferred ways to invoke DOS functions. Both methods require that you place the number of the function to be called in the CPU's AH register. In addition, you may need to place values in other CPU registers, depending on the call. After making a call, the function often returns information in the CPU regis-

Listing 1: The type, constant, and variable declarations for the program *DirectoryDemo*.

```

program DirectoryDemo;
{ Copyright June 1985 by D. F. Yriart. }

type
  UserSpec   = string[64];
  Registers  = record
    AX, BX, CX, DX, BP, SI, DI, DS, ES, Flags : Integer;
  end;
  FileName   = string[13];
  DTAPointer = ^DTARecord;
  DTARecord  = record
    DOSReserved : array[1..21] of byte;
    Attribute    : byte;
    FileTime,    : special format }
    FileDate,    : " " }
    SizeLow,
    SizeHigh    : integer;
    FoundName   : array[1..13] of char;
  end;

const
  NUL          = ^@;      { character 0 }
  SeekAttrib  = $10;     { files & sub-directories }

var
  TransferRec : DTAPointer;
  MatchPtrn   : UserSpec;
  RetName     : FileName;
  FilSize     : Real;
  Count       : Integer;
  NoFind, LastFile,
  SubDir     : Boolean;
  
```

ters. For example, if an error occurs, many of the functions turn on the carry flag in the flags register and return an error code in the AX register.

Calling a DOS function is a three-step process.

1. Set up the call:
 - A. Place the desired function number in the AH register, and
 - B. Place any other data in other registers as appropriate.
2. Make the call.
3. Check the carry flag in the CPU's flags register.
 - A. If it is on, an error has occurred; handle it as necessary.
 - B. If it is off, there is no error; examine the appropriate registers for returned information.

In a Turbo Pascal program, you call DOS functions by using the pre-defined procedure `MsDos`, which requires a `Registers` record as its parameter. That record contains integer fields corresponding to most of the CPU registers. To set up the call, you assign values to the appropriate fields. Each register is 16 bits, or 2 bytes, wide. The AH register is the high-order byte of the AX register. To get the function number into AH, you must multiply it by hexadecimal 100 (\$100 in Turbo Pascal notation, which will be used throughout this article) and assign the result to the AX field of the `Registers` record. When the DOS function has completed its operation, the corresponding fields in the record will contain any values that were returned in the CPU registers.

Several DOS functions, including the one that makes an initial directory search, need information that does not fit in the CPU registers. This information is stored in an ASCIIZ string—a string of ASCII characters without an initial length byte that is terminated by a byte of binary zeros. The binary zeros are supplied by terminating the string with the NUL character, which is the ASCII character zero. When you set up the call, you use a pair of registers containing the ASCIIZ string's segment and offset addresses to reference the string.

To demonstrate how to implement

Listing 2: Procedure `PointDTA`, which finds the location of the program's DTA.

```

procedure PointDTA(Var DTARec : DTAPointer);
Const   GetDTA = $2F00;   { function number }

var
  Regs : Registers;

Begin
  Regs.AX := GetDTA;
  MsDos(Regs);
  DTARec := Ptr(Regs.ES, Regs.BX);
End;
    
```

Listing 3: Function `SizeOfFile`, which is used to calculate file size.

```

function SizeOfFile(HiWord, LoWord : Integer) : Real;

Var
  BigNo, Size : Real;

Begin
  BigNo := (MaxInt * 2.0) + 2;
  if HiWord < 0 then Size := (BigNo + HiWord) * BigNo
    else Size := HiWord * BigNo;
  if LoWord >= 0 then Size := Size + LoWord
    else Size := Size + (BigNo + LoWord);
  SizeOfFile := Size
End;
    
```

DOS function calls in a Turbo Pascal program, let's use functions \$4E (`FindFirst`) and \$4F (`FindNext`). Function \$4E locates the first file that matches the input specification. Function \$4F finds additional matches. You also need to use function \$2F (`GetDTA`) to determine the location of the current DTA, because directory search functions return information about the files they find in the DTA.

THE DEMONSTRATION PROGRAM

`DirectoryDemo` is the name of the demonstration program. It includes a function, `SizeOfFile`, and three procedures, `PointDTA`, `FindFirst`, and `FindNext`. As input, the program accepts a standard DOS file specification, which may include drive name, path name, and filenames. The file specification may include the global characters * and ?. The program output consists of a three-column screen listing of filenames (along with file sizes) and subdirectories that match the input specification. Subdirectories

are displayed in low intensity with a file size of 0 bytes since they are not regular files. The display concludes with a count of the files and subdirectories found.

`DirectoryDemo` compiles correctly with versions 2 and 3 of Turbo Pascal for the IBM PC. The program has run and functioned correctly on systems running PC-DOS versions 2.0 and 2.10 and also under Compaq's MS-DOS 2.11. It will run on PC-DOS version 3.0 but under certain conditions may fail. Apparently, DOS 3.0 returns additional error codes beyond those used by DOS 2.x. `DirectoryDemo` uses several of the "new" DOS functions and therefore does not work on DOS 1.0 or 1.1.

DATA TYPES, CONSTANTS, AND VARIABLES

Three defined data types are important to the program `DirectoryDemo` (listing 1), and two procedures actually do the directory search. The `Registers`

(continued)

Listing 4: Procedure FindFirst, which finds the first directory entry.

```

procedure FindFirst(Pattern : UserSpec;
  Var Found : FileName; Var Size : Real;
  Var NoMatch : Boolean; Var LastOne : Boolean;
  Var SubDir : Boolean);

Const  FindFirst  = $4E00; { function number }

Type
  ASCIIIZ      = array[1..64] of char;

var
  FileSpec : ASCIIIZ;
  Regs      : Registers;
  PosInStr,
  Count     : Integer;
  FoundLen  : Byte absolute Found;

Begin
  for PosInStr := 1 to length(Pattern) do
    FileSpec[PosInStr] := Pattern[PosInStr];
  FileSpec[length(Pattern) + 1] := NUL;
  With Regs do
    begin
      DS := Seg(FileSpec);
      DX := Ofs(FileSpec);
      CX := SeekAttrib;
      AX := FindFirst;
      MsDos(Regs);
      if (Flags and 1) > 0 then
        begin
          Case AX of
            2 : begin { No match }
                  NoMatch := True;
                  LastOne := True;
                end;
            18 : begin { No more files }
                  NoMatch := False;
                  LastOne := True;
                end;
          else
            writeln('^G'Can't interpret error return code');
            Halt;
          end; { Case }
        end
      else
        begin { No error return code }
          NoMatch := False;
          LastOne := False;
        end;
      end; { with Regs }

    if (not NoMatch) then
      with TransferRec^ do
        begin
          Found := FoundName;
          Count := 0;
          While Found[Count] <> NUL do Count := Count + 1;
          FoundLen := Count;
          For Count := length(Found) + 1 to 13
            do Found := Found + ' ';
          if (Attribute and SeekAttrib) > 0
            then SubDir := True
            else SubDir := False;
          if not SubDir
            then Size := SizeOfFile(SizeHigh,SizeLow)
            else Size := 0.0;
          end; { with TransferRec }
        end;
      End;

```

data type is a record containing integer fields that represent the CPU registers. This type of variable is passed as a parameter to the pre-defined procedure MsDos whenever a DOS function is called. The fields in this record contain the values to be loaded into the CPU registers. When the call returns, those fields contain the values that the DOS function call is returning. Both MsDos and its parameter record are described in the Turbo Pascal manual (reference 3).

The other two data types, DTARecord and DTAPointer, work together. DOS returns the information for each file found in the DTA in a specific format. DTARecord is a record whose fields correspond to the layout of that data. DTAPointer defines a pointer to DTARecord. When you set the pointer to point to the DTA, you can directly access the information returned by the directory search calls in the fields of DTARecord.

For convenience, two global constants have been defined. NUL has the value of ASCII character zero and is used as a terminator in constructing the ASCIIIZ string that is passed to the function that begins the directory search. The other constant, SeekAttrib, has a value of \$10. When you conduct a directory search, you can specify the attribute of the files you want to find. The subdirectory attribute is \$10, and it tells the search to return subdirectories as well as files that match the input search criterion.

The three Boolean variables NoFind, LastFile, and SubDirec are used to report the progress of the search after each call and whether the name being returned is a subdirectory name, so that it can be displayed in low intensity.

GETTING THE DTA ADDRESS

The program's first procedure, PointDTA (listing 2), is used to find the location of the current DTA and to set its pointer, TransferRec. The program calls DOS function \$2F to get the address of the DTA. In writing procedures or functions that use DOS function calls, I restrict each to a single DOS function. In addition, I declare the DOS function number as a con-

(continued)

How to use 137% of your Multisync™ monitor.

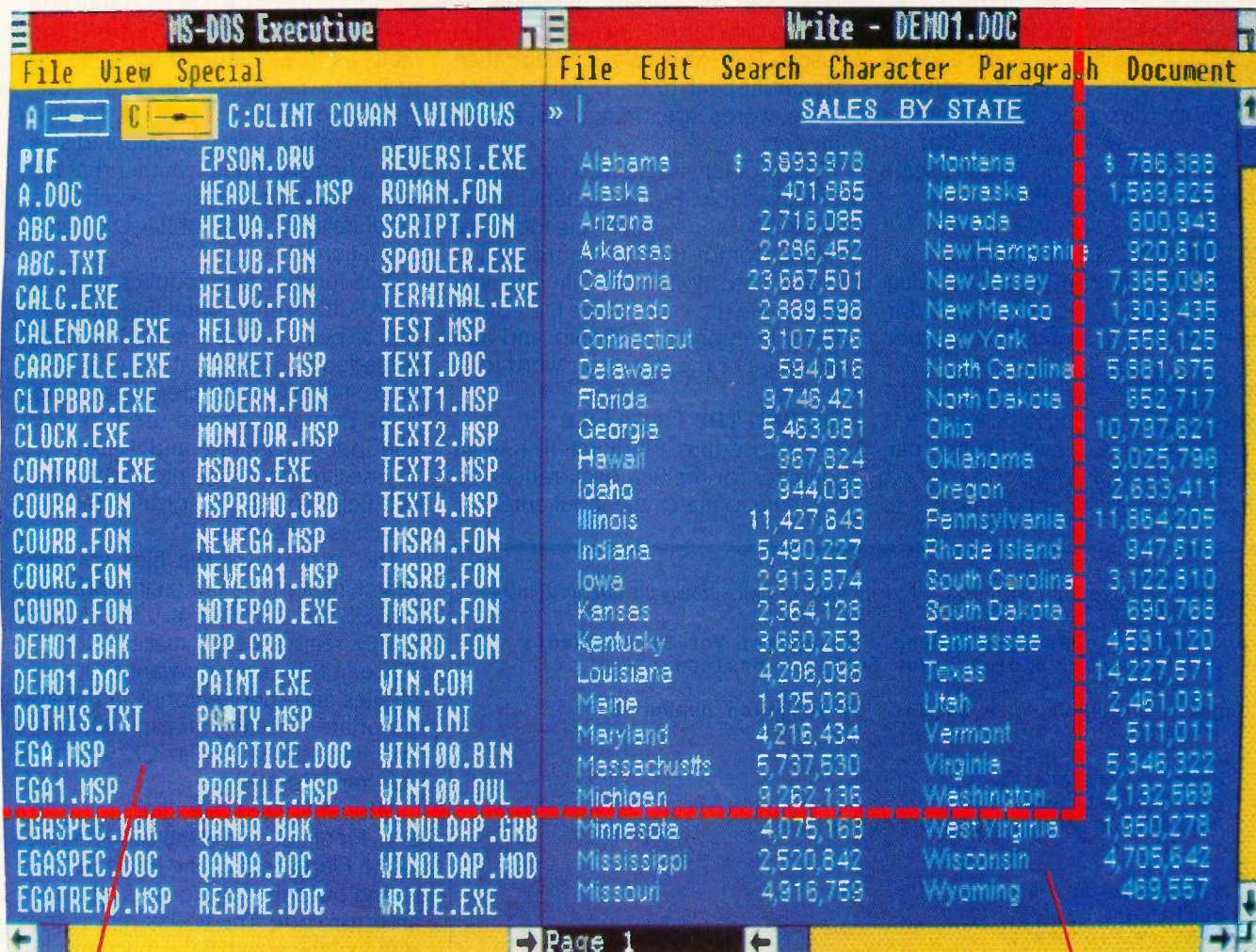

With a standard EGA, you can only display this much data.

QuadEGA ProSync™

With QuadEGA ProSync, you can display this much data in EGA mode.

QuadEGA ProSync takes full advantage of your Multisync monitor by delivering two additional enhanced graphics modes: 640 x 480 and 752 x 410. The ultra sharp resolution lets you comfortably fit up to 37% more data on your screen in 16 bright, solid colors with crisp detail.

That means you get more text and more graphics. The end result is increased productivity. Because, not only can you work with more data, it's easier to read, too.

Featuring AutoSelect™

It's easy to run your favorite programs with QuadEGA ProSync. Our AutoSelect feature automatically selects the correct display mode for most software.

Together with your Multisync, QuadEGA ProSync delivers the leading edge technology that lets you make the most of desktop publishing, presentation graphics, and software that works best in the ultra high resolution mode.*

Now you have a choice - QuadEGA+ and QuadEGA ProSync

Quadram makes the world's best-selling EGA boards. QuadEGA+ gives you compatibility with the four PC display standards. And to take advantage of Multisync-type monitors, QuadEGA ProSync gives you two additional high resolution modes.

To find out more about our complete line of EGA products, contact us at One Quad Way, Norcross, Georgia 30093. Or call 404-564-5566.

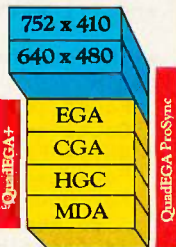

QuadEGA ProSync delivers a total of six graphics modes!

QUADRAM
An Intelligent Systems Company

Microsoft Windows is a trademark of Microsoft Corp. QuadEGA+ and QuadEGA ProSync are trademarks of Quadram Corp. Multisync is a trademark of NEC Home Electronics.

70% Savings Coupon on WINDOWS by MICROSOFT.

*QuadEGA ProSync includes drivers to run Microsoft Windows and software that runs under Windows in 752 x 410 and 640 x 480 modes, and a coupon good for 70% off the Windows package.

stant already multiplied by \$100 (in this case \$2F00) so that you can load it into the AH register simply by assigning the value to the AX register. DOS function \$2F returns the address of the DTA in the ES and BX registers. The ES register contains the segment address, and BX, the offset. You set the pointer value using Turbo Pascal's predefined function `Ptr`.

CALCULATING THE FILE SIZE

Function `SizeOfFile` (listing 3) calculates the size of each file found during the directory search. The function returns a value of type `Real`, since DOS file sizes can exceed 32,767 bytes (`MaxInt` for Turbo Pascal). DOS delivers the size of each file in a pair of 2-byte words, `HiWord` and `LoWord`, which are passed as parameters to

`SizeOfFile`. This presents a minor problem. The value of each word is expressed as a 16-bit unsigned integer, a data format unknown to Turbo Pascal. Therefore, values greater than `MaxInt` appear to be negative when these words are treated as signed integers.

The problem is resolved by creating a real variable, `BigNo`, containing the value 2^{16} , and subtracting negative values from it to find the true value of the word. To find the file size, you determine the value of the high-order word, multiply it by `BigNo`, and add the value of the low-order word to it.

FINDING THE FIRST FILE

The procedure `FindFirst` (listing 4) searches for the first occurrence of a filename to match the input criterion.

It invokes DOS function \$4E to begin the search and lays the groundwork for subsequent calls to DOS function \$4F, which returns additional matches, if any. `FindFirst` loads the appropriate registers, makes the call, checks for errors, and, if it finds a match, returns the filename and size and a flag signifying whether that file is a subdirectory. If the search fails, `FindFirst` uses a pair of flags to signal the failure.

DOS function \$4E requires as input an ASCII string containing the pattern to be matched. The ASCII string is loaded into the local variable `FileSpec`. Turbo Pascal's predefined functions `Seg` and `Ofs` are used to load `FileSpec`'s segment and offset addresses, respectively, into the DS and DX fields of the `Registers` record, which is called `Regs`.

The attribute of the files you are searching for is an optional parameter of DOS function \$4E. You load it into the CX register before making the call. Since in this case you want to locate all files and subdirectories in the appropriate directory that match your specification, you load CX with the constant `SeekAttrib`.

After making the call to function \$4E, `FindFirst` checks the carry-flag bit in the `Flags` field of the `Regs` record to find out if the function has returned an error code. The codes report the status of the search if the function fails to find a match. DOS 2.x reports one of two possible conditions: error 2, indicating that no match was found, or error 18, indicating that the last file that matches the input specification has been found. (`FindFirst` is coded so that if any error code other than 2 or 18 is returned, the program halts with the message "Can't interpret error return code." In a production system, you would want to provide a more graceful way of handling this. Procedure `FindNext` works the same way.)

If the carry-flag bit is not turned on, there is no error code to check, and a file matching the input specification has been found. `FindFirst` transfers the information about the file from the fields of the DTA record to variables for return to the main program. For this example, three pieces of in-

(continued)

Listing 5: Procedure `FindNext`, which is used to find subsequent directory entries.

```

procedure FindNext(Var Found : FileName; Var Size : Real;
  Var LastOne : Boolean; Var SubDir : Boolean);

Const  FindNext    = $4F00;  { function number }

var
  Regs : Registers;
  Count : Integer;
  FoundLen : Byte absolute Found;

Begin
  With Regs do
    begin
      AX := FindNext;
      MsDos(Regs);
      if (Flags and 1) > 0 then
        if AX = 18 then LastOne := True
        else
          begin
            writeln('^G'Can't interpret error return code');
            Halt;
          end
        else LastOne := False;
    end; { with Regs }

  with TransferRec^ do
    begin
      Found := FoundName;
      Count := 0;
      While Found[Count] <> NUL do Count := Count + 1;
      FoundLen := Count;
      For Count := length(Found) + 1 to 13
        do Found := Found + ' ';
      if (Attribute and SeekAttrib) > 0 then SubDir := True
      else SubDir := False;
      if not SubDir then
        Size := SizeOfFile(SizeHigh,SizeLow)
      else Size := 0.0;
    end; { with TransferRec }
End;

```

Unforgettable.



Disc drives should never forget one thing:
your important information.

At Seagate, we build our drives to protect
your data against all mishaps. And we put
each drive through a series of grueling tests
to make sure it doesn't forget.

That's why quality-conscious customers
have bought more than 3 million of our
5 1/4" hard disc drives.

So the next time you're looking for a new
computer, disc memory upgrade or add-on,
ask for Seagate by name.

It's all you need to remember.

Seagate Technology, 920 Disc Drive,
Scotts Valley, CA 95066. 800-468-DISC.
In California, 800-468-DISK.

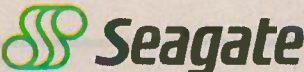

Inquiry 319 for End-Users. Inquiry 320 for DEALERS ONLY.

formation about each file are returned: its name and extension, its attribute (whether it is a subdirectory or a normal file), and its size.

Function \$4E returns the filename and extension in a single field, separated by a period and terminated by a NUL. There may be garbage characters in the remainder of the field if the name and extension do not fill the entire field. The Boolean variable SubDir is set to True and the file size is set to zero if it is a subdirectory. If not, the file size is calculated by function SizeOfFile. The date and time of the file's last update are also available in the DTA; however, for the sake of simplicity, decoding these fields has been left out of the demonstration program. Both the date and the time are stored in special packed formats (see reference 1).

FINDING ADDITIONAL FILES

The procedure FindNext (listing 5) searches for additional files that meet

the specification set up by FindFirst. All you need to do is load the AX field of the Regs record with the function number \$4F and make the call. As in FindFirst, the procedure checks the carry flag for an error condition. DOS function \$4F returns only a single error code, 18, when the last matching file has been found. If no error is reported, the process of capturing and returning the information from the DTA is the same as in FindFirst.

THE MAIN PROGRAM

The main program (listing 6) has three basic sections: a setup phase, a loop that searches for files matching the input specification, and a closeout phase.

In the setup phase, you are asked to enter a specification, procedure PointDTA sets the pointer to the DTA, and the program invokes procedure FindFirst to look for the first match. Since this is merely a demonstration program, there is no check to ensure

that your input is valid. (Note that in DOS function calls, you may delimit path names with slashes as well as the backslashes we are used to.)

If FindFirst is successful, the main program enters a loop that displays information about each file found and invokes procedure FindNext to search for another match until no more are found. Subdirectories are displayed in low intensity; all other files are shown in regular intensity. When the main program has found the last matching file, it closes out the display with a summary message and exits.

CONCLUSIONS

The program DirectoryDemo serves two purposes: It illustrates how to use DOS functions from within a Turbo Pascal program, and it shows how to invoke the directory search services provided by DOS to locate and process a group of files whose names match a given specification.

The techniques in this article also apply to invoking DOS and BIOS services through interrupts using Turbo Pascal's predefined procedure Intr. In this case, in addition to loading the appropriate fields in the Registers record, the program must specify the desired interrupt number.

With the procedures MsDos and Intr and similar "hooks" to the operating system that other high-level languages may provide, you can have full access to the rich variety of services provided by DOS functions and interrupts without ever having to write a line of assembly language code. Programs can perform almost any task the hardware is capable of. The price is that programs that make use of these services through function calls and interrupts are not portable to other operating systems without extensive modification. ■

REFERENCES

1. *Disk Operating System Technical Reference*, Microsoft Corp. and International Business Machines Corp., first edition, version 2.10, September 1983.
2. Norton, Peter. *The Peter Norton Programmer's Guide to the IBM PC*. Bellevue, WA: Microsoft Press, 1985.
3. *Turbo Pascal Reference Manual*, version 3.0, Scotts Valley, CA: Borland International Inc., 1985.

Listing 6: The main body of the program DirectoryDemo.

```
BEGIN
  ClrScr;
  writeln(' -- Demonstration of Directory Search Calls --');
  write(' Find? ');
  readln(MatchPtrn);
  writeln;
  Count := 0;
  PointDTA(TransferRec);
  FindFirst(MatchPtrn,RetName,FileSize,NoFind,LastFile,
    SubDir);
  if NoFind or LastFile then writeln('File not found.')
  else
    begin
      While (not LastFile) do
        begin
          if SubDir then LowVideo;
          write(RetName,' ',FileSize:8:0,' ');
          NormVideo;
          Count := Count + 1;
          if (Count mod 3) = 0 then Writeln;
          FindNext(RetName,FileSize,LastFile,SubDir);
        end;
      end;

  If (Count mod 3) <> 0 then writeln;
  writeln;
  write('*** ',Count,' Files or ');
  LowVideo;
  write('Sub-Directories');
  NormVideo;
  writeln(' found ***');
END.
```

PERFORMANCE

THAT IS OUT OF THIS WORLD...



\$389⁰⁰

**MODEL 2000 20MHz
DUAL TRACE**

\$549⁰⁰

**MODEL 3500 35MHz
DUAL TRACE DELAYED SWEEP**

...AT A DOWN TO EARTH PRICE

At last! Truly affordable test equipment with no compromise in design, and features you would expect to find only on oscilloscopes costing hundreds of dollars more! JDR Instruments presents two, new, high-performance models backed by a two year warranty and technical support which is only a phone call away. Perfect for the technician or advanced hobbyist, both models feature Dual Trace capability and a variety of operating and triggering modes, including CH-B Subtract and X-Y operation.

MODEL 2000 has a 20 MHz bandwidth and 20 calibrated sweeps ranging from .2s to .2 μ s. A convenient built-in component tester provides additional diagnostic power.

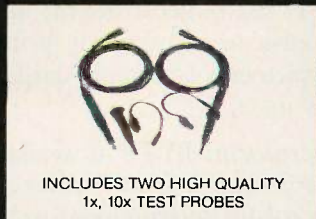

INCLUDES TWO HIGH QUALITY
1x, 10x TEST PROBES

MODEL 3500 features a 35 MHz bandwidth and exceptional 1mV/DIV sensitivity. Delayed sweep and variable holdoff allow stable viewing of complex waveforms.

ORDER TOLL FREE
800-538-5000
800-662-6279 (CA)

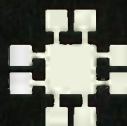

JDR INSTRUMENTS
1224 South Bascom Avenue
San Jose, California 95128 (408) 995-5430

Announcing BYTE's New Subscriber Benefits Program

Your BYTE subscription brings you a complete diet of the latest in microcomputer technology every 30 days. The kind of broad-based objective coverage you've read in this issue. *In addition*, your subscription carries a wealth of other benefits. Check the check list:

DISCOUNTS

- 13 issues instead of 12 if you send payment with subscription order.
- One-year subscription at \$21 (50% off cover price).
- Two-year subscription at \$38.
- Three-year subscription at \$55.
- One-year GROUP subscription for ten or more at \$17.50 each. (Call or write for details.)

SERVICES

- BIX:** BYTE's Information Exchange puts you on-line 24 hours a day with your peers via computer conferencing and electronic mail. All you need to sign up is a microcomputer, a modem and telecomm software.
- Reader Service:** For information on products advertised in BYTE, circle the numbers on the Reader Service Card enclosed in each issue that correspond to the numbers for the advertisers you select. Drop it in the mail and we'll get your inquiries to the advertisers.
- TIPS:** BYTE's Telephone Inquiry System is available to subscribers who need *fast response*. After obtaining your



Subscriber I.D. Card (see TIPS information adjacent to Reader Service cards), dial TIPS and enter your inquiries. You'll save as much as ten days over the response to Reader Service Cards.

- Disks and Downloads:** Listings of programs that accompany BYTE articles are now available free on the BYTEnet bulletin board; and on disk or in quarterly printed supplements (see reply cards in this issue).
- Microform:** BYTE is available in microform from University Microfilm International in the U.S. and Europe.
- BYTE's BOMB:** BYTE's Ongoing Monitor Box is your direct line to the editor's desk. Each month, you can rate the articles via the Reader Service

Card. Your feedback helps us keep up to date on your information needs.

- Customer Service:** If you have a problem with, or a question about, your subscription, you may phone us during regular business hours (Eastern time) at our toll-free number: 800-258-5485. You can also use Customer Service to obtain back issues and editorial indices.

BONUSES

- Annual Separate Issues:** In addition to BYTE's 12 monthly issues, subscribers also receive our annual IBM PC issue free of charge, as well as any other annual issues BYTE may produce.
- BYTE Deck:** Subscribers receive five BYTE postcard deck mailings each year—a direct response system for you to obtain information on advertised products through return mail.

To be on the leading edge of microcomputer technology *and* receive all the aforementioned benefits, make a career decision today—complete and mail in a subscription card or, call toll-free weekdays, 8:30am to 4:30pm E.S.T.: 800-258-5485.

*And... welcome to
BYTE country!*

BYTE
THE SMALL SYSTEMS JOURNAL



A PROGRAM FOR APPROXIMATING INTEGRALS

BY DAVID M. SMITH

Gauss approximation with Aitken extrapolation yields increased precision

THE PROBLEM OF computing the value of a definite integral arises often in scientific, engineering, and other technical applications. Most of these integrals cannot be found exactly using techniques of calculus. Instead,

they must be approximated using numerical methods, which work by evaluating the function at a finite number of points and doing a weighted sum of the function values. As more and more function values are

computed, the sequence of approximations converges to the correct value of the integral.

However, the rate of convergence can differ widely for various functions. For one function, 30 evaluation points might produce an approximation correct to five significant digits (SD), while 1000 points might be needed to get the same degree of accuracy in the approximation of another function. Because of the need for many function evaluations, numeric approximation of an integral tends to be time-intensive and thus expensive.

This article presents a method for approximating integrals with a minimum of function evaluations. The technique, called Aitken extrapolation, is incorporated into the program in listing 1. A more accurate version of the program, written in FORTRAN, is available separately. [Editor's note: Both programs are available on disk, in print, and on BIX. See the insert card following page 320 for details. Listings are also available on BYTEnet. See page 4.] I'll review some

(continued)

David M. Smith teaches numerical analysis and computer-related mathematics at Loyola Marymount University. He can be reached at the Mathematics Department, LMU, Loyola Blvd. at West 80th St., Los Angeles, CA 90045.

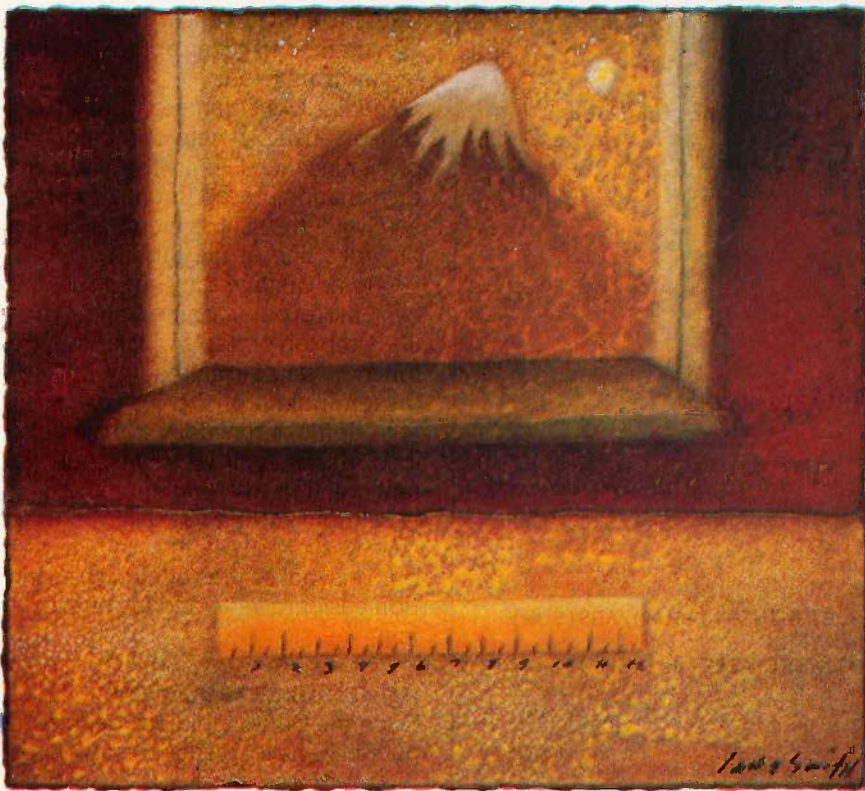

Listing 1: A BASIC program to approximate the integral of a function (defined in lines 170 and 180). The program uses Gauss approximation and Aitken extrapolation.

```

100 DEFDBL A-H,L,O-Z
110 REM Use EPS=1E-6 if functions are single precision.
120 EPS=1E-10
130 SQT3=SQR(3)
140 DIM TABLE(20)
150 LG10=LOG(10)
160 DEF FNL10(X)=LOG(X)/LG10
170 F$="f(x)=SQR(EXP(x)-1)/SIN(x)"
180 DEF FNF(X)=SQR(EXP(X)-1)/SIN(X)
190 T1$="#####.#####   ###   ----"
200 T2$="#####.#####   ###   ###"
210 T3$="#####.#####   ----"
220 T4$="#####.#####   ###"
230 PRINT "Approximating the integral of the function:"
240 PRINT " "; F$
250 INPUT "Number of lines in Gauss column (>1)";KL
260 INPUT "Lower limit for integral";A
270 INPUT "Upper limit for integral";B
280 IF B<=A THEN PRINT "Error. Lower limit <= upper
    limit.": STOP
290 PRINT
300 GOSUB 410
310 PRINT
320 FOR J=1 TO 20
330 INPUT "Enter 1 for next Aitken column, 0 to quit";CQ
340 IF CQ=0 THEN J=20: GOTO 390
350 GOSUB 760
360 PRINT
370 KL=KL-2
380 IF KL<3 THEN J=20
390 NEXT J
400 END
410 IF KL<1 THEN PRINT "Error in Gauss subroutine: KL<1.":
    STOP
420 NLINES=KL
430 NSUBS=1
440 NFNCT=0
450 PRINT "Gaussian integration table for the function"
460 PRINT F$; ", for x=";A; " to ";B; "."
470 PRINT "Table contains ";NLINES; " lines."
480 PRINT
490 FOR JLINE=1 TO NLINES
500 XH=(B-A)/NSUBS
510 XH2=XH/2
520 XR=XH2/SQT3
530 START1=A-XH2-XR
540 START2=A-XH2+XR
550 SUM=0
560 FOR K=1 TO NSUBS
570 SUM=SUM+FNF(START1+K*XH)+FNF(START2+K*XH)
580 NEXT K
590 SUM=SUM*XH2
600 NFNCT=NFNCT+2*NSUBS
610 IF JLINE>1 THEN 650
620 PRINT "      N      Gauss      NF Est.S.D."
630 PRINT USING T1$; NSUBS,SUM,NFNCT
640 GOTO 720
650 RELERR=EPS
660 IF SUM<>0 THEN RELERR=ABS(TABLE(JLINE-1)-SUM)/ABS(SUM)
670 IF SUM=0 AND TABLE(JLINE-1)<>0 THEN
    RELERR=ABS(TABLE(JLINE-1)-SUM)/ABS(TABLE(JLINE-1))
680 IF RELERR<=0 THEN RELERR=EPS
690 NUMSD=-FNL10(RELERR)
700 IF NUMSD<0 THEN NUMSD=0
    
```

(continued)

analytic techniques for simplifying integrals to obtain increased precision.

FIRST APPROXIMATIONS

To use Aitken extrapolation, we need a set of approximations to the integral of $f(x)$ from a to b . Table 1 gives such a table for the function $f(x)=\sqrt{e^x-1}/\sin x$ from 0 to 1. The table was generated using the Gauss formula.

The Gauss formula approximates the area under a function from x_{i-1} to x_i as follows:

$$\int_{x_{i-1}}^{x_i} f(x) dx \approx \frac{x_i - x_{i-1}}{2} \times \left(f\left(\frac{x_i + x_{i-1}}{2} - \frac{x_i - x_{i-1}}{2\sqrt{3}}\right) + f\left(\frac{x_i + x_{i-1}}{2} + \frac{x_i - x_{i-1}}{2\sqrt{3}}\right) \right)$$

In line 1 of the table, the Gauss formula is applied to the entire interval (0,1). In the second line, the interval is divided into two subintervals and the Gauss formula is applied to each subinterval; the two approximations are totaled to produce the value shown in the Gauss column. In general, for each n th line in the table, the program divides the interval into 2^{n-1} subintervals and applies the Gauss formula to each. These values are summed to get an approximate integral from a to b .

The Est. SD column of table 1 is a conservative estimate of the number of significant digits in the latest approximation, based upon a comparison with the Gauss number in the previous line of the table.

One advantage the Gauss rule has over more popular integration rules like Simpson or trapezoidal is that the function is not evaluated at either of the endpoints of the interval of integration. For functions with singularities, this means you can code the function into the program more easily, without having to make a special case to avoid division by zero, and so on. This makes the code for the function easier to write and faster executing.

AITKEN EXTRAPOLATION

Once the Gauss table has been computed, we have a sequence of approx-

(continued)

Explore AI on your PC

Smalltalk/V transforms your PC into a versatile AI workstation

Only Smalltalk/V lets you experience the thrill of a responsive AI workstation while learning artificial intelligence techniques and using them to create practical applications.

"Smalltalk/V gives me the feel of an AI workstation on my PC."

—Darryl Rubin,
Technical Editor,
AI Expert
Magazine



"Smalltalk/V is the highest performance object-oriented programming system available for PCs."

—Dr. Piero Scaruffi
Chief Scientist
Olivetti Artificial Intelligence Center

\$99.00

Smalltalk/V Features

- High-performance object-oriented programming
- Integrates object-based and rule-based programming with object-oriented Prolog
- A user-extensible, open-ended environment
- A responsive graphical user interface
- Supports exploratory programming and prototyping
- Class hierarchy with inheritance creates highly re-useable code
- Smalltalk source code included, with browser windows for easy access and modification
- A huge toolkit of classes and objects for building a variety of applications
- Object-swapping creates virtual memory on hard or RAM disk
- Bit-mapped graphics with bit and form editors
- A sophisticated source-level debugger
- Automatic change log for easy recovery from errors
- Powerful directory/file browser system for organizing DOS files
- Optional communications interface to Unix™ and other systems
- Access to other languages and DOS functions
- DOS command shell
- Detailed owner's manual designed for both beginners and advanced programmers

"We found Smalltalk/V excellent for developing advanced decision-support tools based on decision analysis and AI techniques."

—Dr. Samuel Holtzman,
Professor, Stanford University

Smalltalk/V is pure object-oriented programming — a powerful tool for designing frame/script-based knowledge representations, inference engines, expert systems, simulation environments, intelligent interfaces, network control software, communications interfaces, and much more.

Methods, our character-based Smalltalk, is now available for \$79. It has all of the features of Smalltalk/V except graphics, rules, source-level debugger, and object-swapping. However, it supports color, includes the communication package, and does not require a mouse.

BYTE and BIX are trademarks of McGraw-Hill, Inc. IBM, IBM-PC, and IBM PC-AT are trademarks of International Business Machines Corporation. Unix is a trademark of Bell Laboratories.

Inquiry 111

Watching someone use an AI workstation is a vision of what the computer was meant to be. Fingers dance across the keys as windows dilate, shift, overlap, and disappear on the bit-mapped display. Ideas spring to life as program fragments execute, are modified, expanded, combined and tried again in a creative arabesque of text and graphics. The interface vanishes, man and machine are one. Smalltalk/V brings that experience to your IBM-PC.

"We use Smalltalk as our primary language for teaching artificial intelligence."

—Dr. John Pugh
Director, School of Computer Science
Carleton University

Of the three main AI languages, Smalltalk, LISP, and Prolog, only Smalltalk was intended for individual use on a personal computer. Only Smalltalk was designed to provide a match between human and computer models of reality. Only Smalltalk is easy to learn, easy to read, and easy to use.

YES! I want to turn my PC into an AI workstation. Send me . . .

Smalltalk/V \$99

Communications for Smalltalk/V . . . \$49

Methods (including Communications) \$79

Shipping and Handling \$ _____

CA residents add applicable sales tax \$ _____

TOTAL \$ _____

Shipping and Handling
U.S., Canada, and Mexico \$ 5.00
Elsewhere \$15.00

I enclose Check Money Order

Credit card information MC VISA

Number: _____ Expiration: _____

Signature: _____

Name: _____

Street Address: _____

City/State/Zip: _____

Phone: _____

NOT COPY PROTECTED. 60-DAY MONEY-BACK GUARANTEE ON-LINE USER-SUPPORT CONFERENCE ON BYTE'S BIX™

Smalltalk/V requires DOS and 512K RAM on IBM PCs (including AT) or "compatibles," a Microsoft or compatible mouse, and a CGA, EGA, Hercules, or AT&T Hi-Res graphic controller.



5200 West Century Boulevard
Los Angeles, CA 90045 (213) 645-1082

```

710 PRINT USING T2$;NSUBS,SUM,NFUNCT,NUMSD
720 NSUBS=2*NSUBS
730 TABLE(JLINE)=SUM
740 NEXT JLINE
750 RETURN
760 IF KL<3 THEN PRINT "Error in Aitken: KL<3." STOP
770 KLM2=KL-2
780 PRINT: PRINT "Aitken column. ";KLM2;" entries."
790 PRINT: PRINT "   Line   Aitken           Est.S.D."
800 KLM1=KL-1
810 FOR JLINE=2 TO KLM1
820 TOP=(TABLE(JLINE+1)-TABLE(JLINE))^2
830 BOT=TABLE(JLINE+1)-2*TABLE(JLINE)+TABLE(JLINE-1)
840 IF BOT=0 THEN TABLE(JLINE-1)=TABLE(JLINE+1) ELSE
TABLE(JLINE-1)=TABLE(JLINE+1)-TOP/BOT
850 JLM1=JLINE-1
860 IF JLINE<=2 THEN PRINT USING T3$;JLM1,TABLE(JLM1):
GOTO 940
870 RELERR=EPS
880 IF TABLE(JLM1)<>0 THEN RELERR=ABS(TABLE(JLM1-1)-
TABLE(JLM1))/ABS(TABLE(JLM1))
890 IF TABLE(JLM1)=0 AND TABLE(JLM1-1)<>0 THEN
RELERR=ABS(TABLE(JLM1-1)-TABLE(JLM1))/ABS(TABLE(JLM1-
1))
900 IF RELERR<=0 THEN RELERR=EPS
910 NUMSD=-FNL10(RELERR)
920 IF NUMSD<0 THEN NUMSD=0
930 PRINT USING T4$;JLM1;TABLE(JLM1);NUMSD
940 NEXT JLINE
950 RETURN
    
```

Table 1: Gaussian integration table for the function

$$f(x) = \sqrt{e^x-1}/\sin x, \text{ for } x=0 \text{ to } 1.$$

The BASIC program in listing 1 produced the data for the table. Each successive line of the table corresponds to a finer approximation. The number of subintervals used is "n," "Gauss" is the resulting approximation, "NF" is the number of function evaluations used to produce the current estimate, and "Est. SD" is a conservative estimate of the number of significant digits in the approximation.

n	Gauss	NF	Est. SD
1	1.9285506935	2	—
2	2.0298952302	6	1
4	2.1019189001	14	1
8	2.1529799461	30	2
16	2.1891343294	62	2
32	2.2147171070	126	2
64	2.2328132539	254	2
128	2.2456114423	510	2
256	2.2546619381	1022	2
512	2.2610618921	2046	3
1024	2.2655874445	4094	3

imations T_1, T_2, T_3, \dots , which converges to the correct value of the integral. The number of subintervals used increases geometrically (1, 2, 4, 8, ...). Numerical analysis tells us that such a sequence is linearly convergent, or nearly so.

Aitken extrapolation uses this linear-convergence property to derive additional accuracy from the Gauss table results without the need for further function evaluations. If we let T represent the exact value of the integral, and e_i the error in the Gauss approximation on line i , then $T_i - T = e_i$. By the definition of linear convergence, there exists a constant c for which $e_i = ce_{i-1}$ for every i . Assuming this gives us three equations in three unknowns, T , e_i , and c : $T_i - T = e_i$, $T_{i+1} - T = ce_i$, and $T_{i+2} - T = c^2e_i$. Solving for T yields

$$T = T_{i+2} - \frac{(T_{i+2} - T_{i+1})^2}{T_{i+2} - 2T_{i+1} + T_i}$$

This is the formula for Aitken extrapolation. In practice, the convergence is not precisely linear, so this computed T is still not the exact result, but

it is often more accurate than any of the three values used to generate it. Unlike the Gauss values, which are each the sum of n terms, the Aitken values derive from only a few arithmetic operations. The time needed to compute the values in the Aitken column is negligible when compared to the time taken for the Gauss column.

Table 2 gives the Aitken extrapolations to the integral of the function using the data in table 1. Each Aitken value is found using three successive numbers in the previous column (either Gauss or Aitken) and extrapolating to the limit under the assumption that the numbers are part of a linearly convergent sequence. Thus line 1 in the Aitken column with nine entries was computed using the Gauss approximations with $n=1, 2$, and 4. Line 2 in that column used the Gauss approximations with $n=2, 4$, and 8, and so forth. Then line 1 of the Aitken column with seven entries used the same formula with the approximations on lines 1, 2, and 3 from the previous Aitken column.

Notice that each new Aitken column has two fewer entries than the previous one.

The Aitken table gives a final approximation accurate to at least nine SD, even though the Gauss approximation was accurate to only two SD. The singularity is what makes the approximations so bad in the Gauss column. For a well-behaved function, the Gauss accuracy would be ten or twelve SD, so the Aitken extrapolations would not be necessary.

On the other hand, computing the Aitken columns takes almost no time when compared to the time required to calculate the Gauss column. A compiled version of the Aitken program (listing 1) took 2 minutes, 15 seconds to produce the results of tables 1 and 2, running on an IBM PC without floating-point hardware. Since the running time increases with the total number of function computations, it would take about twice as long to add one more line to the Gauss table with $n=2048$.

HANDLING SINGULARITIES

Before applying the program to an integral, you should locate all singular-

(continued)



Enlarged Shift keys

Two Ctrl and Alt keys for ambidextrous access.

Positive-tactile, firm-feel keys.

12 Function keys for increased automatic operation.

Extra-wide, easy-to-find Return key. IBM changed sizes again by shrinking their Return key.

Dedicated Function Control keys.

Caps, Num and Scroll Lock indicator lights. IBM has no lights on their XT.

Separate dedicated Numeric Pad with enlarged Enter key, four Arithmetic Function-keys.

Switch-selectable compatibility with IBM, PC, XT, AT, PCjr, AT&T and all compatibles. IBM's new Enhanced Keyboard runs only on their new XT's, AT's and ignores their installed base which probably includes you.

Isolated Escape key.

Switch allows you to swap position of Ctrl and Caps lock. IBM moved Ctrl to bottom row, you have no choice!

Separate Cursor and Screen Control keys.

Here it is... DATADESK'S TURBO-101 ENHANCED KEYBOARD for the 10 million PC users IBM just ignored!

IBM just announced their new redesigned "standard" keyboard for personal computers. There's only one problem: it won't work on your IBM computer if it was purchased prior to June 1986 or on any PC compatible purchased at any time!

Not to worry. Our new Turbo-101 Enhanced Keyboard gives you the layout and enhancements of the IBM with some logical improvements (see above photo). And it works on your existing PC, XT, AT, PCjr, AT&T, Epson and virtually all compatibles!

Get Borland's Turbo Lightning™ For FREE!

To really turbocharge your productivity, we are including, free-of-charge, Borland's red-hot Turbo Lightning software with each keyboard. Now, when using SideKick, WordPerfect, Microsoft Word, 1-2-3 or most popular programs, our Turbo-101 Keyboard will check your spelling as you type, gives you instant access to Random House's 80,000-word Concise Dictionary and 60,000-word Thesaurus and much, much more!



"Lightning's good enough to make programmers and users cheer, executives of other software companies weep," says Jim Seymour of PC Week. Sold separately, Turbo Lightning retails for \$99.95!

The Only Alternative
datadesk™
INTERNATIONAL

7650 Haskell Avenue
Van Nuys, California 91406 (818) 780-1673

Turbo-101 is a trademark of DataDesk International. Turbo Lightning is a trademark of Borland International. IBM and IBM AT are registered trademarks of International Business Machines, Inc.

Inquiry 105 for End-Users.
Inquiry 106 for DEALERS ONLY.

The Turbo-101 is the best data entry tool since the pencil!

For users of spreadsheets like 1-2-3, the Turbo-101's separate cursor controls and numeric keypad makes entering numeric data into cells and moving from cell to cell as natural as moving your fingers. And for word-processing, the 'Selectric' typewriter layout makes the Turbo-101 as easy to use as a pencil; and with the extra large Enter, Shift & Control Keys, you'll make so few mistakes, you won't even need an eraser!

Up to now, DataDesk International may be one of the best kept secrets, but here's what's being said about our first end-user Keyboard/Borland software bundle:

- "Who Can Pass Up a Deal? Department. Talk about an aggressive product!"
John C. Dvorak, InfoWorld Mar 86
- "It solves all of the problems exhibited by their regular PC/XT keyboard...it's a great bargain!"
PC Productivity Digest May 86
- "DataDesk Int. has designed a sturdy and handsome keyboard that has tactile response...is the hardware bargain of the year" says Charles Humble, Oregonian Jan 86
- "The best part of the keyboard is the way it feels. It's ideal! And fast. I've never worked on a keyboard with a nicer touch."
Business Computer Digest Aug 86
- "It's a good keyboard. Good feel: the keys have tactile feedback. No mush at all. This is about as good a keyboard deal as you're likely to find...I have absolutely no hesitation in recommending the Model PC8700."
Jerry Pournelle, Byte Magazine Sept. 86
- "This keyboard is neat to type on and feels solid. It has tactile feedback keys...I can type much faster on it."
Test Drive Scorecard: DataDesk-10 Key Tronics-9 Teleconnect Magazine May 86

SPECIAL OFFER! ONLY \$149.95* FOR BOTH KEYBOARD & SOFTWARE

Includes 30-day money back guarantee and 2 year full warranty. To prove that we don't ignore you or your pocketbook, you get our Turbo-101 Enhanced Keyboard and Borland's Turbo Lightning for an astounding \$149.95.* No, you didn't read it wrong. During this amazing Introductory Offer you get both keyboard and software for less than most software programs by themselves! Now, if you're still feeling ignored, you can always do what you-know-who wants you to do...and buy a new computer to get their keyboard!

credit card orders call
(800) 826-5398
in CA call
(800) 592-9602

*Price does not include adaptor cables required by certain compatibles. * A limited offer—price subject to change without notification.



BOTH TURBO-101 ENHANCED™ KEYBOARD AND BORLAND'S TURBO LIGHTNING™ SOFTWARE FOR ONLY:

\$149.95* LIMITED OFFER

*Plus \$10 Shipping & Handling. California Residents Add \$3.75 Per Unit Sales Tax

NO. UNITS: _____

PAYMENT: VISA MC CHECK

AMOUNT ENCLOSED: \$ _____

Enter ←

NAME: _____

ADDRESS: _____

CITY: _____ STATE: _____ ZIP: _____

PHONE: _____ COMPUTER TYPE: _____

CC NO.: _____ EXP: _____

Table 2: Successive Aitken extrapolations based on the data in table 1. The BASIC program in listing 1 produced the data.

Aitken column. 9 entries.		
Line	Aitken	Est. SD
1	2.2788375790	—
2	2.2773551404	3
3	2.2768225975	4
4	2.2766261985	4
5	2.2765539625	4
6	2.2765278095	5
7	2.2765184458	5
8	2.2765151139	6
9	2.2765139321	6

Aitken column. 7 entries.		
Line	Aitken	Est. SD
1	2.2765240364	—
2	2.2765114484	5
3	2.2765119368	7
4	2.2765129672	6
5	2.2765132235	7
6	2.2765132734	8
7	2.2765132825	8

Aitken column. 5 entries.		
Line	Aitken	Est. SD
1	2.2765119185	—
2	2.2765110082	6
3	2.2765133084	6
4	2.2765132854	8
5	2.2765132845	9

Aitken column. 3 entries.		
Line	Aitken	Est. SD
1	2.2765116604	—
2	2.2765132856	6
3	2.2765132844	9

Aitken column. 1 entry.		
Line	Aitken	Est. SD
1	2.2765132844	—

ities of the function that lie inside the interval of integration. Break the integral up into subintervals bounded by these singularity points; Aitken extrapolation works best when the points where $f(x)$ is computed approach the singularity in a regular manner. This is true if the singularity is an endpoint but is not usually true otherwise.

For example, consider the integral

$$\int_0^1 |x - 0.3|^{0.33333} dx$$

The function has a mild singularity at

Table 3: This table summarizes the results of applying Aitken extrapolation to a function over a specified interval. The "Aitken columns" show the number of significant digits obtained in each step. In this case, we see that dividing an integral at its singularity point before starting numeric approximation greatly improves the significant digit yield (compare run 1 and runs 2A and 2B).

Run	Function	Interval	Aitken columns
1	$ x - 0.3 ^{0.33333}$	(0,1)	2 2 3 3 3 3 3 3 4 5 4 4 5 5 5 5 5
2A	$ x - 0.3 ^{0.33333}$	(0,0.3)	5 6 8 7 10 9 8 9 9 9 9 9 9 9 9 9 8 9 10 10
2B	$ x - 0.3 ^{0.33333}$	(0.3,1)	5 6 8 7 9 9 8 10 10 10 10 10 10 11 10 9 9 10 9 10

$x=0.3$, since even though it is continuous, its derivative is undefined there. Table 3 compares the results of integrating the entire interval as opposed to integrating the two subintervals (0,0.3) and (0.3,1).

In run 1, Aitken extrapolation is not able to gain much accuracy over the initial results in the Gauss column, finishing with about five SD correct. In runs 2A and 2B the partial results can be added to get about nine SD correct.

The function

$$f(x) = \frac{1}{x^4 + x^2 + 1}$$

is nice and smooth on the interval (0,3). Gauss integration does not really need much help from Aitken (see table 4, run 1). But the same function on the larger interval (0,300) doesn't yield so easily to Gauss approximation, and even Aitken extrapolation is ineffective through 1024

subintervals (table 4, run 2).

A person might formulate such an integral in an attempt to approximate the integral of $f(x)$ from 0 to infinity. The reasoning would go something like this: Since $f(x)$ is less than x^{-4} for all x , the error made in stopping at $x=b$ is less than

$$\int_b^\infty x^{-4} dx = \frac{1}{3} b^{-3}$$

Setting this to 10^{-8} (a reasonably small error tolerance) and solving for b yields about 300.

However, as the results of table 4, run 2 suggest, chopping the integral off at some large value is seldom a good way to handle an integral to infinity.

Here again, the techniques of calculus can improve the situation. The idea is to find a change of variables that reduces the problem to a mathematically equivalent one on a finite

(continued)

CAD — THE BEST IS EVEN BETTER!

ProDesign II — The Easy-to-Use CAD System. It's the NUMBER ONE CAD PACKAGE for under \$1000. And it costs only \$299. With over 25,000 satisfied users, ProDesign II outshines anything in its class. It outshines many packages costing \$2000 and more! ProDesign II offers more features, more compatibility, and superior ease-of-use.

But now, THE BEST IS EVEN BETTER!

Version 2.5 of ProDesign II is now available. More than 50 additional features have been added to ProDesign II. Features such as Pattern Hatching, On-Screen Menus, Geometric Calculations, Macros, Parallel Lines, Parallel Curves, enhanced Auto-Dimensioning, Block Arrays and Circular Arrays, to name a few. Features that make ProDesign II even more powerful. Features that make ProDesign II even easier to use.

How much more does version 2.5 cost? None! The new ProDesign II is still \$299! Where can you get it? See your local dealer, or contact us:

**AMERICAN SMALL BUSINESS COMPUTERS
118 SOUTH MILL STREET
PRYOR, OK 74361
(918) 825-4844**

Telex 9102400302

Inquiry 32

PRODESIGN II — ONLY \$299!

F-18 HORNET

DRAWN USING PRODESIGN II

1. RADOME
2. 20MM ROTARY CANNON
3. AMMUNITION MAGAZINE
4. WINDSCREEN
5. INSTRUMENT PANEL
6. HEADS-UP DISPLAY
7. CANOPY
8. EJECTION SEAT
9. AVIONICS EQUIPMENT
10. SECOND SEAT SPACE
11. LEADING EDGE ROOT EXTENSION
13. FUSELAGE TANKS
14. LEADING EDGE FLAP
15. WING TANK
16. SIDEWINDER AIR-AIR MISSILE
17. MISSILE LAUNCH RAIL
19. NAVIGATION LIGHT
19. WING FOLD WING JOINT
20. AILERON
21. FLAP VANE
22. FLAP
23. HYDRAULIC RESERVOIRS
24. STROBE LIGHT
26. RUDDER HYDRAULIC ACTUATOR
27. NAVIGATION LIGHT
28. RADAR WARNING ANTENNA
29. FUEL JETTISON
30. MOVING TRAILPLANE
31. ECH ANTENNA
32. RADAR WARNING ANTENNA
34. FORWARD LIGHTING STRIP
35. AFTERBURNER NOZZLE
36. AFTERBURNER NOZZLE ACTUATORS
37. MOVING TRAILPLANE
38. TRAILPLANE PIVOT MOUNTING
39. TRAILPLANE HYDRAULIC ACTUATOR
41. TURBOFAN ENGINE
42. AILERON HYDRAULIC ACTUATOR
43. WING FOLD ACTUATOR
44. SIDEWINDER AIR-AIR MISSILE
45. LEADING FLAP ACTUATOR
46. WING TANK
47. LEADING FLAP DRIVE SHAFT
48. EQUIPMENT CERAMIC
49. AUXILIARY POWER TURBINE
50. REAR LANDING GEAR
51. SPARROW AIR-AIR MISSILE
52. LEADING FLAP DRIVE MOTOR
53. MAIN RETRACT ACTUATOR
54. FORWARD RETRACT ACTUATOR
57. LIQUID OXYGEN CONVERTER
58. BOMBING LADDER
59. FORWARD LANDING GEAR
60. CATAPULT LAUNCH STRAP
61. CONTROL COLUMN
62. RUDDER PEDALS
63. AMMUNITION FEED CHUTE
64. ANGLE OF ATTACK SENSOR
65. PITOT HEAD
66. FORMATION LIGHTING STRIP
67. RADAR EQUIPMENT BAY
68. FORWARD ECH ANTENNA
69. RADAR PIVOT MECHANISM
70. RADAR SCANNER

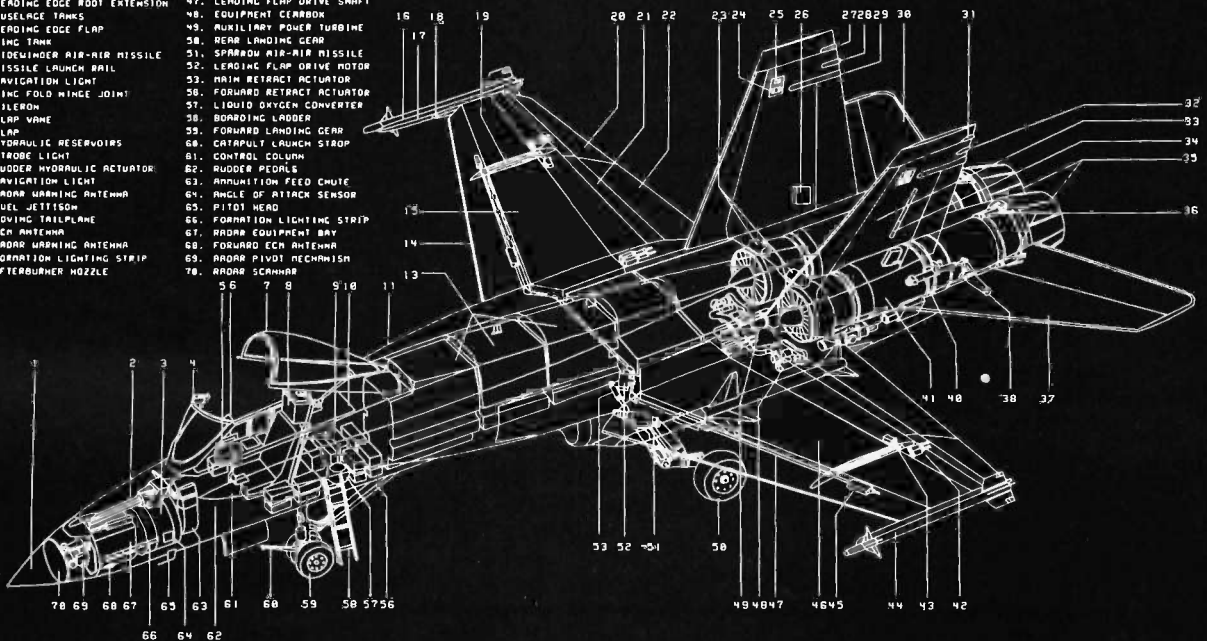

Some integrals require preliminary analysis and more than one run of the program.

interval. This avoids the necessity of truncating the interval and gives a shorter interval that can be expected to converge more rapidly. Note, however, that the substitution variable must be continuous on the original interval. For example, the substitution $u=1/x$ could not be used if the original interval contained zero, since $1/x$ is not continuous there. For the problem at hand, $1/x$ makes a good substitution (zero winds up as the endpoint of the reconstituted integral).

We split the interval in two and change variables in the second part:

$$\begin{aligned} & \int_0^1 \frac{1}{x^4+x^2+1} dx + \int_1^\infty \frac{1}{x^4+x^2+1} dx \\ &= \int_0^1 \frac{1}{x^4+x^2+1} dx + \int_1^0 \frac{-u^{-2}}{u^{-4}+u^{-2}+1} du \\ &= \int_0^1 \frac{1}{x^4+x^2+1} dx + \int_0^1 \frac{u^2}{u^4+u^2+1} du \\ &= \int_0^1 \frac{x^2+1}{x^4+x^2+1} dx \end{aligned}$$

Here the two parts happen to combine nicely into one integral at the end, but even if the two parts are integrated separately they are both now well-behaved functions on small intervals. Table 4, run 3 shows that the Aitken program has no trouble with the reformulated integral, quickly surpassing the BASIC compiler's intrinsic precision.

This function can be integrated analytically to get the exact value of $\sqrt{3}\pi/6$, but most people could get the approximate result faster using the

program than doing it by hand.

The last problem is slightly harder:

$$\int_0^1 \frac{\sqrt{x}}{x-1} - \frac{1}{\log x} dx.$$

For this function, the only possible singularities are at $x=0$ and $x=1$, but table 5, run 1 shows that Aitken extrapolation does not help much. After inspecting the singularity, an expert might make the substitution $u=x^2$ to get an equivalent integral that is well behaved, but let's try a more straightforward attack.

When functions like this one give the Aitken program trouble, it is important to realize that most of the error comes from the one or two subintervals containing singularities. To get much accuracy we need to use very small subintervals near singularities, but much larger subintervals will suffice elsewhere. Therefore, we split the interval into three parts, with small intervals around the endpoints.

Running the program three times for the intervals (0, 0.01), (0.01, 0.99), and (0.99, 1), we are able to get seven or eight SD for the first interval, nine or ten for the middle interval, and even more (the compiler's precision becomes the limiting factor) for the last interval (see table 5, runs 2A-2C).

Because of the different magnitudes of the integrals, their sum should be accurate to seven or eight SD. Most of the error is coming from the first interval, where there is a singularity. The immediate high accuracy of the output for the third interval indicates no such problem there. If we wanted to try for still more accuracy, a reasonable set of intervals would be (0, 0.001), (0.001, 0.1), and (0.1, 1).

As shown, these output tables contain a lot of information. In addition to an approximation of the integral, we get a good idea of how accurate the Aitken method is and an indication of the presence and severity of any singularities in the intervals used.

CONCLUSION

We have seen several examples of techniques for using the Aitken program to solve fairly difficult integrals. We were able to evaluate each integral to high precision, although some re-

(continued)

Table 4: Aitken extrapolation is effective for this function on a small interval (run 1), but not when the interval is extended toward its singularity point. However, converting to an equivalent integral using calculus eliminates the problem (run 3). Note that values above 10 or 11 are suspect; in such cases we have probably exceeded the precision of the BASIC compiler.

Run	Function	Interval	Aitken columns
1	$1/(x^4 + x^2 + 1)$	(0,3)	2 5 7 8 9 11 9 11 12 14 13 14 15 14 14 15 15 15 15 15
2	$1/(x^4 + x^2 + 1)$	(0,300)	0 0 0 0 0 0 0 0 0 0 1 1 2 2 2 4
3	$\frac{x^2 + 1}{x^4 + x^2 + 1}$	(0,1)	6 7 8 10 12 12 12 13 13 13 13 14 15 17 13 16 17 14 17 15

Your first color monitor should be good enough to be your last.

NEC introduces the only color monitor you need. Superb resolution plus MultiSync for across-the-board compatibility with all three PC graphics boards made by IBM[®] for business graphics, CAD/CAM, computer art, and text.



Now there's one high resolution color monitor that does things your way. The MultiSync™ monitor from NEC. It gives you the best color resolution available at the price.

- Compatibility with the IBM Professional Graphics Adapter, the IBM Enhanced Graphics Adapter, and the IBM Color Graphics Adapter.

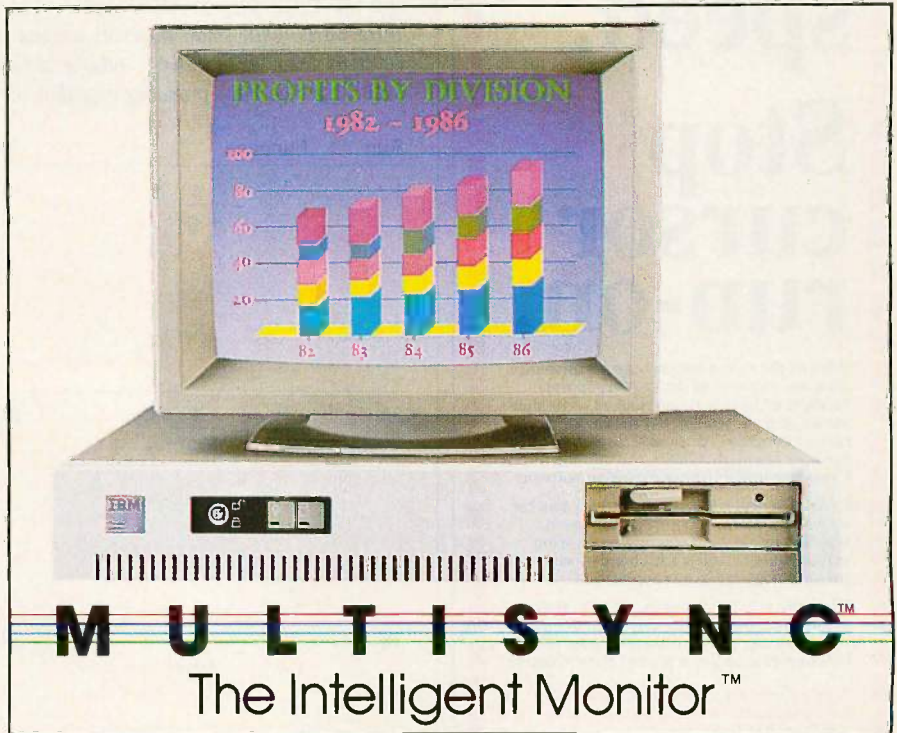

Compatibility with the IBM[®] Enhanced Graphics Adapter Board



- MultiSync, the NEC feature that automatically adjusts to color adapter board scanning frequencies from 15.75 KHz to 35 KHz — suggesting the possibility that the MultiSync monitor might be compatible with *all* color graphics boards that are fully compatible with the IBM PC, PC/XT, and PC/AT, now and in the future.

compatibility with all three PC color graphics boards made by IBM. With so many board and monitor configurations, folks didn't know which way to look.

The new MultiSync color monitor gives you unique compatibility. As well as TTL and analog color. With 7 switchable text colors. And resolution up to maximum 800 horizontal dots and maximum 560 vertical lines, on a large, 13" diagonal viewing area.



All from NEC, a name respected around the world for advanced, reliable products backed by nationwide service.

- Full implementation of high resolution graphics software for business and other applications, now and in the future.

- And color capability limited only by the board being used.

Compatibility with the IBM[®] Professional Graphics Adapter Board

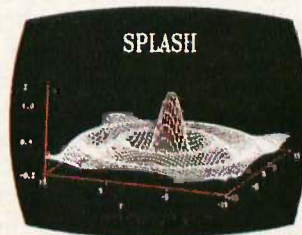

It's the one color monitor that does everything your way.

Compatibility with the IBM[®] Color Graphics Adapter Board

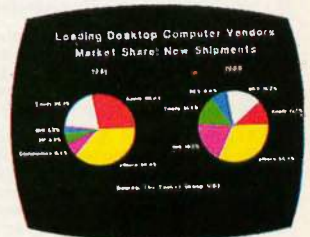

But why talk more about it? Visit your nearest dealer and see a graphic demonstration of the new NEC MultiSync monitor's capabilities. Then draw your own conclusions.

For information dial **1-800-447-4700**

NEC HOME ELECTRONICS (U.S.A.) Inc.
Computer Products Division
1255 Michael Drive
Wood Dale, IL 60191-1094



See Things Our Way
Until now, you had to choose different color monitors for

Boost cursor speed. Stop cursor run-on.

With all the recent hoopla over performance, it's ironic that two of the PC's ergonomic deficiencies have been overlooked — its slow cursor, and the tendency of the cursor to remain in motion (run-on) after a cursor key has been released. Finally, the solution — Cruise Control™ from Revolution Software.

Cruise Control is a new productivity tool for serious PC users. It boosts cursor speed, typically by 3-5 X. It eliminates annoying cursor run-on. And it adds hands-free cursor navigation to any application.

If you use 1-2-3, Symphony, dBASE, Reflex, or Paradox, you need Cruise Control's Anti-Skid Braking. Here's what the leader of one Lotus users group said about Cruise Control:

"Once I used it, I wanted it! Excellent idea. Very practical. One of the best programs ever sent to us for review!"

If you use Word Perfect, MS-Word, Q&A, DisplayWrite, MultiMate, WordStar 2000, Framework, PC-Write, or SideKick, you need Cruise Control's Screen Runner, the high-performance, adjustable-speed cursor.

Cruise Control's namesake feature takes the drudgery out of paging through data base records, long documents, and large spreadsheets. It lets you repeat any key, hands-free — at the speed of your choice.

And there's more. A Chronometer "types" the time or date into your application at the current cursor position. The keyboard-controlled Screen Dimmer protects your privacy. The programmable Auto-Dimmer extends the life of your display screen.

Compatible with thousands of today's popular programs, including Lightning, SuperKey, and Ready!. Uses only 3K RAM. For DOS 2.0 or later. Not copy-protected. No risk, 60-day money-back guarantee.

Cruise Control™

From now until 12/31/86:

Only \$29.95.

Call now to order by credit card (VISA/MC/AX):

201-366-4445

Or, mail \$29.95 plus \$3.50 shipping and handling to:

Revolution Software, Inc.

715 Route 10 East • Randolph, NJ 07869

Dept. 200

Table 5: In this case, the function integrates nicely except when it approaches the two singularity points 0 and 1. The solution is to break up the interval into three parts, with small intervals around the two singularities and a large interval covering the "well-behaved" middle section. Values above 10 or 11 are suspect; in such cases we have probably exceeded the precision of the BASIC compiler.

Run	Function	Interval	Aitken columns
1	$\frac{\sqrt{x}}{x-1} - \frac{1}{\log x}$	(0,1)	3 3 4 5 5 5 3 3 3 3 3 4 4 5 4 5 6 5 6 6
2A	$\frac{\sqrt{x}}{x-1} - \frac{1}{\log x}$	(0,0.01)	4 4 6 5 7 8 5 8 8 8 6 8 7 7 6 8 8 7 8 8
2B	$\frac{\sqrt{x}}{x-1} - \frac{1}{\log x}$	(0.01,0.99)	3 4 5 5 4 5 5 4 5 5 5 6 7 10 7 9 10 8 10 10
2C	$\frac{\sqrt{x}}{x-1} - \frac{1}{\log x}$	(0.99,1)	12 11 11 12 12 13 13 13 13 14 11 12 13 13 11 10 10 11 10 10

quired preliminary analysis and more than one run of the program.

However, a theorem says that given any program to approximate integrals by sampling function values at a finite number of points, functions exist for which that program fails. The program will get the wrong answer, and any estimate of the error it computes will be wrong as well.

On the other hand, almost all the problems found in applications in science and engineering can be handled in ways similar to the examples we have seen. And in dealing with very tough functions where the program does not get much accuracy, the lack of accuracy is almost always obvious from looking at the Est. SD

columns.

Thus the Aitken extrapolation technique illustrated in listing 1 provides a powerful tool so that someone who is not an expert in numerical analysis can quickly do applications requiring the evaluation of definite integrals. ■

BIBLIOGRAPHY

- Acton, Forman S. *Numerical Methods That Work*. New York: Harper & Row, 1970. A classic applied numerical methods book with lots of advanced techniques for handling hard integrals.
- Gerald, Curtis F., and Patrick O. Wheatly. *Applied Numerical Analysis*. Reading, MA: Addison-Wesley, 1984. A more recent standard numerical analysis text that gives derivations of the Gauss and Aitken formulas.

Still the only integrated scientific analysis, graphics, and data acquisition software.

ASYST™



Macmillan's widely-acclaimed ASYST™ Scientific Software still offers more built-in capabilities than any other PC software. Its unique interactive programming environment includes such functions as FFT, smoothing, integration, differentiation, curve fitting, statistics, differential equations, and matrix and polynomial operations. And all functions are supported by sophisticated graphics, such as error bars, scatter plots, and axonometric plotting.

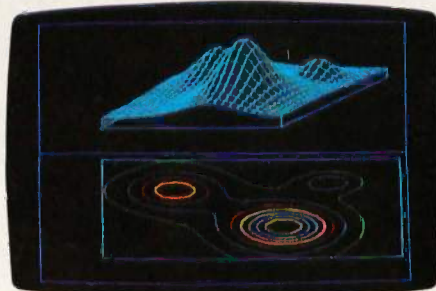
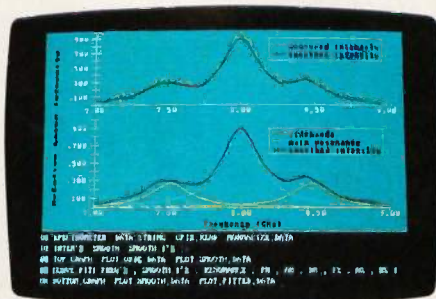

ASYST's extensive function set provides the building-blocks that let you assemble scientific applications—fast. RS-232 and optional A/D and

GPIB/IEEE-488 support offer interface versatility you just can't get from other products. And all hardware support integrates seamlessly with the full range of ASYST capabilities.

Free technical support. 60 days of free technical support help you design, set up, and fine-tune the perfect system. Ongoing support is available at a nominal cost.

**30-Day No-Risk Offer.
CALL 1-800-348-0033.**

In New York state, (212) 702-3241.
Ask for technical literature, including performance benchmarks.

Macmillan Software Co.

An affiliate of Macmillan Publishing Company
630 Third Avenue, New York, NY 10017

CONSTANT COMMITMENT

THE ENGINE

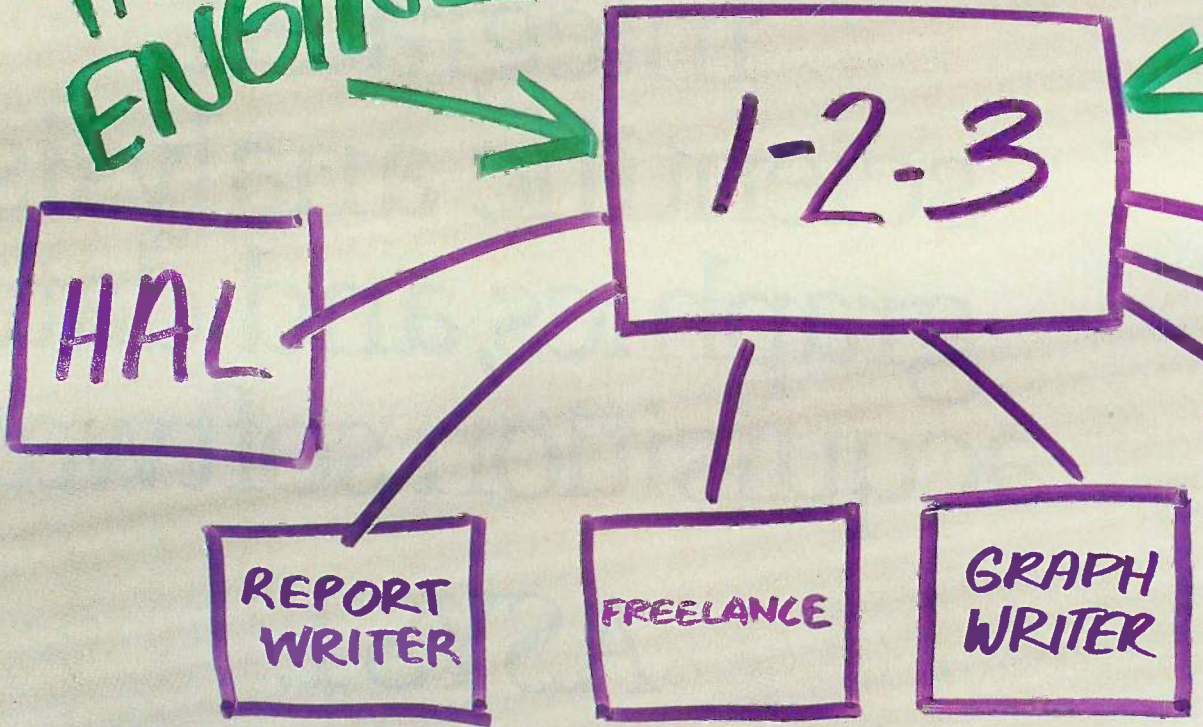

THE 1-2-3 SYSTEM



STANDARD EQUIPMENT

CONTINUOUS INNOVATION

INDEPENDENT SOFTWARE DEVELOPERS

ETC.

ETC.

When 1-2-3® was first introduced it quickly became the best-selling, best-working software in the industry. Today it's practically an industry all by itself.

An example: there are more than 1000 independent software developers who have created and continue to create specialized applications for 1-2-3. . . steadily adding value to the product for people in all areas of business. Today 1-2-3 is the engine that drives an industry full of software tools designed for such specialized jobs as construction management, tax planning, business modeling and more.

Add to this Lotus supported companion products such as 1-2-3 Report Writer™, Freelance®, Graphwriter®—and soon-to-be available products such as Lotus HAL™ and others—and it's clear that you're looking at an entire *system* of products to help you work more productively with 1-2-3.

All of which makes 1-2-3 better than it ever was.

About a *thousand* times better, in fact.

Learn about the 1-2-3 system and how it can work for you. Talk to an authorized Lotus dealer.

Lotus 1-2-3

The business software integrating spreadsheet, graphics and database.

© 1986 Lotus Development Corporation. Lotus, 1-2-3, Freelance and Graphwriter are registered trademarks of Lotus Development Corporation. 1-2-3 Report Writer and Lotus HAL are trademarks of Lotus Development Corporation. **Lotus HAL is distinguished from HAL, which is a trademark of Qantel for its Hotel and Leisure Software.

THE STRONG, SILENT TYPE.



Standard Model



Portable Sound Manager



On MicroManager
System Assembly

THE SOUNDMANAGER PRINTER ENCLOSURE

Printer enclosures should be seen and not heard. So we'll keep it short.

Performance? In independent tests* the Sound Manager reduced noise pressure intensity by an amazing 92%. Price? An equally amazing \$129.95. Those two figures together make the Sound Manager an unbeatable bargain.

Looks? Compare the Sound Manager's compact, elegant profile to the clunky competition. Enough said—a picture's worth a thousand words.

The Sound Manager's low-cut sides allow easy access to printer controls, so it can handle most wide-platen (132 column) printers, while staying compact enough for narrow-platen (80 column) printers.

The Sound Manager is high-pressure molded, so it's not only more silent, it's stronger. In fact, it's so sturdy, yet lightweight and compact, that a portable version is available (for \$149.95). Have printer, will travel!

An optional super-quiet fan is available which installs easily inside the Sound Manager.

And the Sound Manager is designed to integrate with our MicroManager System of modular computer furniture! The strong, silent, *organized* type!

Inquiry 226 for End-Users.
Inquiry 227 for DEALERS ONLY.

* Performed in accordance with
ANSI S12.10-1985.

DEBUGGING MACINTOSH APPLICATIONS

*A look at the trips
and traps you're
liable to encounter*

Debugging on an advanced windowing micro-computer like the Macintosh is more difficult than debugging in a "traditional" line-oriented environment for at least two reasons. First, the extensive use of

pointers to data structures (and the Mac's double-indirected handle) means that only a small error in a pointer variable can lead to a fatal error. Second, a single-tasking micro-computer is often only one step away from fatal crashes, with little recourse once the program fails. Unlike on a multitasking mainframe, there's no memory management unit to assure that the system keeps running in the event of a program failure.

Having wrangled with the Mac myself as well as gleaned advice from commercial developers, I have developed a sort of checklist on how to get an application up and running on the Macintosh (the principles are applicable to other windowing 68000-based systems). I have also added advice on the psychology of debugging, based on several years' experience with a mainframe programming language. I assume that you are an accomplished programmer working on a complete stand-alone application with a compiled language, such as Pascal or C. I'll use C for examples, although analogs are available in Pascal. I'll also assume you've read at least the introductory chapters of *Inside Macintosh*.

THE BLACK ART OF DEBUGGING

It came as a shock the first time I realized that I hadn't really written a program until the last bug was out of it. While occasionally a small program

(continued)

Prior to joining Western Software Technology (P.O. Box 2733, Vista, CA 92083), Joel West helped users debug programs as a compiler writer for CACI Inc. He is now working on a forthcoming Bantam book on Macintosh programming.

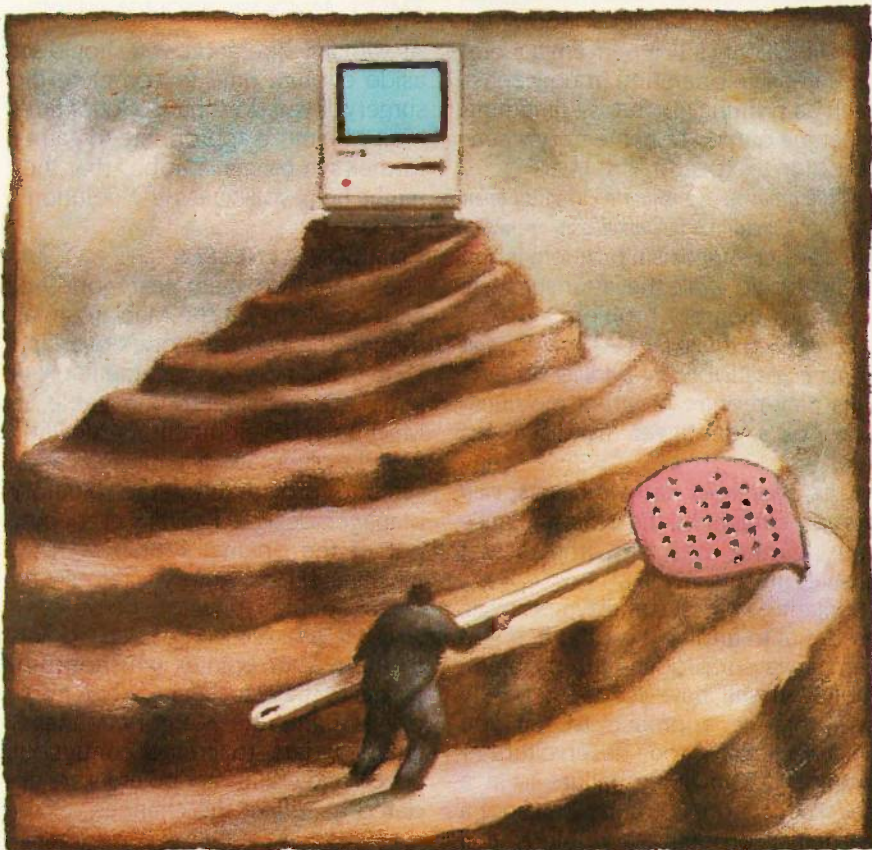

worked properly (or nearly so) the first time, usually extensive debugging was required.

Although debugging a complex piece of systems code may be as much fun as cleaning bedpans, it requires the surgeon's patience and insight. In fact, I've found it actually ends up resembling the well-known scientific method:

- Analyze the symptoms
- Hypothesize a possible explanation.
- Predict effect of hypothesis
- Look for predicted results

In both the scientific and debugging laboratories, you don't know what the answer is, and if you make too many assumptions you will never know the answer. Instead, you systematically test hypotheses until you find one that appears valid; the proof comes in the correcting and retesting.

Great contributions to science come through genius, and the genius of debugging is an intuitive understanding of what's going wrong, even with inadequate evidence. In short, you need the ability to make an educated guess. A good hunch can pay off on the probabilities, much as a blackjack player knows that it's a good bet to double on an ace.

For example, suppose you've just added 50 lines of new code and your program crashes. But only three of those lines use new routines or data structures, and only one routine call includes a null pointer. Without attempting to propose other hypotheses, you could investigate whether that null pointer (NIL to Pascal users) is causing the problem.

When it comes time to investigate a failing program, there are really two ways to approach it. If you wrote the program, you can work from the source code to improve your understanding of the program. Eventually, you will understand exactly what the program is doing and see where it's going wrong. I'll call this the analytic approach.

I call the other approach symptomatic—you work backward from the point of failure. This technique is necessary when there are interactions with code you didn't write (such as the Macintosh Toolbox or a desk acces-

sory). However, in my years of customer support, I discovered that many programmers get lost chasing symptoms. The frustrated cry of "I changed A and B broke" often indicates an undue reliance on symptoms to provide the magic answer.

In general, I've found a hybrid method to be the most successful: Gather information on as many symptoms as possible, then closely examine the code that seems suspect. It helps, of course, to pay close attention to Macintosh-specific interactions and to keep an eye out for their common problems.

DIAGNOSING THE SYMPTOMS

To illustrate the symptomatic approach, I'll use an actual problem. In this case, starting a certain desk accessory (DA) within a particular application worked, but starting the DA a second time crashed the computer. I devised a number of questions to test alternate hypotheses that explained the DA's failure.

Are there other interactions at work? Does it fail only when the selection involves an update event, because the DA was covered by some other window? Or does it fail only if you perform a memory-intensive operation in between—such as printing? Perhaps something is getting purged from memory where you didn't expect it.

Is the problem "Opening a currently open DA" or "Opening a DA previously opened"? The former suggests a problem in the reentry logic, while the latter suggests a purged memory problem.

Did it make it into the DA, or does it fail in the application before reaching the DA? This may require program modifications or a debugger, as discussed later.

Does it fail under other programs, or only this one? It might be the program that's causing the problem (the actual answer, in this case).

Isolating at least some symptoms is essential to finding a problem. If you can't always reproduce the problem, then you will have to use a purely symptomatic approach to tell you what sections of code deserve further attention. Knowing a failure is in a specific section, you can often spot a particular problem—a dubious null

pointer—through pure analysis.

The article "Debugging Techniques" by Gregg Williams in BYTE's June 1985 issue describes general approaches to debugging. As he notes, you must follow what every good programmer has learned: Don't assume anything. Experienced hands advise that a "paranoid style" of Macintosh debugging is the key to success.

PREPARING FOR SURGERY

It helps to come prepared to the operating room. I've found the following to be extremely helpful to have within reach while I'm working on the Macintosh:

- The source listing, soon to be copiously annotated.
- Operating system documentation—*Inside Macintosh*.
- Hardware documentation, such as a good 68000 manual.
- Quick-reference documentation posted within sight. I personally keep "Inside Macintosh Quick Reference" clipped to the curtains of my office.
- A hex-to-decimal calculator.
- Specialized tools, such as MacsBug, TMON, MacNosy, resource editors.

As with any operation, you should set aside enough time to complete the surgery. If you don't have a lot of time, it may be more appropriate to gather further symptoms in hopes that they might help you guess the solution.

COMMON ILLNESSES

There are two major categories of fatal problems on the Macintosh, although the two categories overlap.

First, memory management problems are considered inevitable in Macintosh development, particularly with the elaborate dynamic relocation scheme provided by the Memory Manager, designed to milk every byte out of the original 128K-byte RAM machine. Most memory is referenced via a double-indirected pointer, referred to as a *handle*. The handle points to the master pointer, which in turn points to the actual data. When memory is tight, the Memory Manager shuffles data to create contiguous space, and the master pointers are updated to reflect the changes.

(continued)

THE DIRECT APPROACH ALWAYS PAYS OFF.

CD/286™ \$1195

- Runs at 6/10MHz
- 512K RAM
- Includes 1.2 Meg floppy drive
- AT-style keyboard

- Combined floppy/hard disk controller card
- 192 Watt power supply
- 80287 math coprocessor socket
- Complete operations manual



Add a Hercules-compatible monochrome graphics card, a top-quality monochrome monitor, and a 20 meg hard disk—all for \$1,695! This 10 MHz power-user package replaces the monochrome display with superb high-resolution EGA-style monitor and a high-resolution EGA compatible video card (complete with 256K of video RAM)—the ultimate power-user parlay for just \$2,195, complete!

HARD DISK KITS

For COMPAQ Portable

- Cables
- Instruction Manual
- Software
- 3½" Shuck Mounted Winchester Hard Disk
- Hard Disk Controller
- 20 Meg

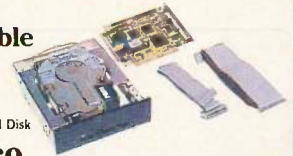

\$469

For IBM PC™

- Half height hard disk
- Western Digital controller
- Cables and instruction manual
- Boots from hard disk
- 20 Meg

\$389

For IBM AT™

- 40ms access time
- Full height hard disk
- Cables, mounting rails, and manual
- Boots from hard disk
- Uses AT controller (not included)

20 Meg Seagate for AT— **\$529**

→ Half height hard disk
→ 30 Meg w/RLC controller **\$459**

30 Meg Seagate for AT— **\$629**

20 MB Hard Disk Drive on a Card



- Low power consumption
- 3½" hard disk
- Western Digital controller
- Easily installs in minutes

\$395

EGA Card



- 640x350, 16 colors
- 100% compatible with IBM EGA™ Card

\$229

MonoGraphics Card



- 720 x 348 resolution
- Hercules compatible
- Parallel port
- Serial port available as an option

\$89

Multifunction Card



- OK expandable to 384K
- Parallel port
- Serial port
- Clock/calendar

\$99

I/O Card



- Game port
- Parallel port
- Serial port (2nd optional)
- Clock/calendar

\$75

Internal Modem



- 300/1200 Baud
- Fully Hayes compatible
- Built-in speaker

\$119

External Modem \$139

Floppy Disk Drive



- Half Height
- DS/DD
- Beige or AT™ gray.

\$95

AT Multifunction Card



- OK expandable to 1.5 MB
- Parallel port
- Serial port (2nd optional)

\$159

EPSON®

Printers

LQ-800	\$609
LQ-1000	\$759
FX-286	\$575
FX-85	\$395



- 5160 AT Style Keyboard
- Made in USA

\$59

AST RESEARCH INC.

AST AdVantage™ w/128K	\$395
AST RAMPage!™ w/256K	\$259
AST SixPak™ w/384K	\$189

intel®

Math Co-Processors

8087-3	\$119
8087-2	\$149
80287-6	\$195

IBM®

IBM PC-XT	IBM PC-AT	COMPAQ Portable
→ 256K RAM	→ 256K RAM	→ 20 Meg Hard Disk
→ 1/350K Floppy drive	→ One 1.2 Meg floppy drive	→ Dual floppy/hard drive controller

\$1695

\$2789

\$1995

HERCULES®

Color Graphics Card w/parallel port	\$155
Monochrome Graphics Card	\$195

MITSUBISHI ELECTRONICS®

EGA Monitor **\$449**

Hayes®

Smartmodem

1200	\$379
1200B	\$339
2400	\$695

Computer Direct is committed to maintaining a very high level of customer satisfaction. Our sales representatives are available to answer any questions, provide advice or technical information, and arrange to deliver your computer equipment in a timely fashion.

No minimum order, we accept VISA and MasterCard (no surcharge). Multi-money orders, certified checks, and personal checks (allow 10 days to clear), wire transfers, approved company/institutional purchase orders (not Upon Receipt, C.O.D.), \$5.00 surcharge on cash/credit checks. All Continental U.S. orders are shipped UPS ground at no charge. Shipments are fully insured. Next Day Air is available, Texas residents must add 6.125% sales tax.

All products carry a One Year Limited Warranty on parts and labor. All returned merchandise must have a return authorization number. Prices are subject to change without notice. Call for latest price. A copy of our limited warranty is available upon request.

One year limited warranty. Visa and MasterCard accepted. UPS ground shipment prepaid in USA only. All brands are registered trademarks of their respective companies.



COMPUTER DIRECT

Inquiry 86

7801 North Lamar, Suite E-216, Austin, Texas 78752

(512) 459-4199

TOLL-FREE SALES CALLS, 1-800-225-5655

FAX (512) 454-0986

Second, the Macintosh ROM is optimized for speed, not user-friendly development. Thus, most routines do not validate all their arguments. Passing a bad argument can cause a delayed crash, or no crash at all. Needless to say, a large subset of bad argument-induced failures includes memory management problems.

In some ways, the tendency for catastrophic failure can be made into an advantage. A crash close to the problem area places you that much closer to the solution.

MEMORY LAPSES

Common memory management problems include

- Zero pointer (also includes null and empty handles)—Although some routines (yours or the toolbox) may check for zero pointers, in most cases you're asking for trouble. Figure 1 diagrams the various null and empty alternatives for pointers and handles, shown in increasing order of reliability.
- Wild pointer—This is probably the most common, or at least most noticeable, point of failure. Accessing any wild pointer gives your program a 50/50 chance of addressing an odd

memory location. This causes the 68000 to generate an interrupt, prompting the familiar "Sorry, a system error occurred" dialog box to appear with ID=02. Even if the pointer is even, writing to a high memory address will cause another common failure—random screen display and sound leading to the dreaded "bomb box."

- Relocated memory block—The symptoms of this will be garbage data values, sometimes including a null or wild pointer. Memory blocks allocated by NewHandle will be dynamically relocated when more memory is needed. This is done in a process known as "heap compaction," the goal of which is to create large areas of contiguous free memory by combining the scattered fragments of unused memory that develop as programs acquire and release memory blocks in the course of their execution. Unless you know otherwise, you should assume that any procedure called may request memory allocation, thus risking heap compaction. Alternately, memory blocks can be locked against relocation.
- Purged block—If there is not enough free memory for the Macin-

tosh to allocate a requested block even after compaction, the Memory Manager will try to create free space by purging some blocks from the heap. Newly allocated memory blocks cannot normally be purged, but many user and system resources are. A purged block looks like any other empty handle, and the same null pointer symptoms apply.

- Clobbered block—The symptoms are similar to those of a relocated block. A possible reason is an underestimate of the amount of memory needed when another block was allocated or the failure to limit use of that block to its actual size. A call to ReAllocHandle can be used to expand the block when its space is used up.
- Out of memory—Any time you try to allocate memory, the attempt can fail for lack of memory. If your program doesn't check for failure, Murphy's law suggests it will fail at the least opportune time—such as in the middle of updating a large file.

Since memory management problems are so common, you may want to force them to become more conspicuous:

- You can force relocated and purged block problems to the surface by making frequent calls to CompactMem and PurgeMem.
- Allocate a large memory block, or use Switcher or a RAM disk to use up the available memory, thus forcing out-of-memory conditions.
- Set location 0000 to an odd value, then a zero handle will cause an address error. If you choose an unusual value—such as 5A65426F hexadecimal or ASCII "ZeRo"—you will be able to recognize an attempt to dereference location zero.

Also, most Mac debuggers have a "heap scramble" option that forces frequent purging relocation of blocks. The TMON debugger also marks deallocated memory with odd values to force additional wild pointer errors.

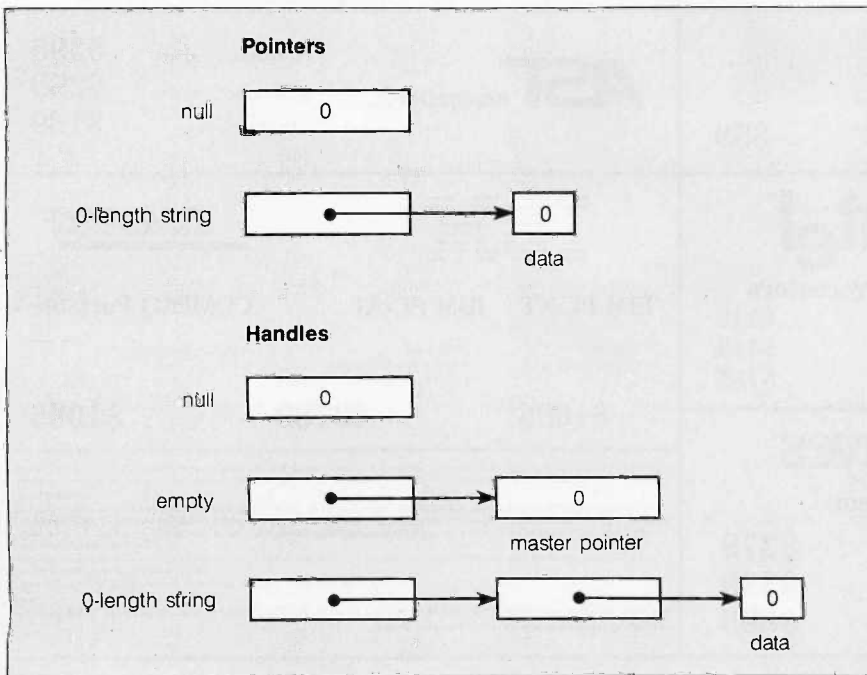

Figure 1: Null pointers and null and empty handles can get unsuspecting routines into trouble.

DUBIOUS ARGUMENTS

Many of the argument-related problems are, in fact, memory manage-

(continued)

NewViews™ Accounting

The Visual Approach at Last

Your Search is Over

Finally, you have accounting created more for the sensibilities of business than the requirements of systems designers. Drive windows over your books, editing as you go. NewViews is "WYSIWYG" at its best.

It's Like a Multi-Dimensional Spreadsheet

NewViews documents expand and contract for more detail. To add reports, accounts and transactions just add lines to documents. The rules of double entry accounting are strictly enforced with complete security and audit trails. But for the first time, you can see what you're doing.

Forget About Menus

Issue commands from easy pull-downs with full context sensitive help. Your hand is held every step of the way.

Forget About Modules

NewViews unifies all accounting functions in a single consistent approach. It completely redefines integration because there is no such thing as a separate "module". With one program, one manual, at one price, you can manage:

- General Ledger
- Financial Statements
- Accounts Receivable
- Accounts Payable
- ATF Payroll
- Time & Billing
- Sales & Order Entry
- Client Write-Up
- Financial Inventory
- Manufacturing
- Job Costing
- Consolidations
- Departments & Branches
- and so on...

Forget About Batches

All documents are related in real-time. Your accounts and reports change on a transaction by transaction basis.

System Requirements

NewViews runs on IBM and compatible personal computers and local area networks. You need a hard disk, 256K RAM, any monitor, and DOS 2.0 or later. Information can be imported and exported to other popular software packages. Companies, reports, accounts, transactions, branches, departments, etc., are limited only by your disk. NewViews is not copy-protected.

Order NewViews

C.O.D., MasterCard, American Express, check or money order are accepted. Phone support is provided at no charge. Training workshops are available.

Free Seminars

See NewViews in action at a seminar in your city. They are ideal for evaluation, orientation and training. CALL (416) 487-3424 FOR RESERVATIONS.

Atlanta GA	Jan 07, Jan 26	Fresno CA	Dec 08, Jan 26	Nassau NY	Dec 12	Sacramento CA	Nov 26, Jan 13
Baltimore MD	Dec 03, Jan 21	Hartford CT	Nov 21, Jan 28	New Orleans LA	Jan 12	San Antonio TX	Jan 16
Birmingham AL	Jan 09	Houston TX	Jan 14	New York NY	Dec 10, Jan 13	San Diego CA	Dec 01, Jan 23
Boston MA	Nov 17, Dec 16	Indianapolis IN	Dec 08, Jan 22	Newark NJ	Jan 26	San Francisco CA	Nov 25, Dec 11
Buffalo NY	Jan 06, Jan 29	Jacksonville FL	Jan 28		Dec 08, Jan 14		Jan 15, Jan 29
Chicago IL	Dec 19, Jan 30	Kansas City MO	Dec 01, Jan 15		Jan 23	San Jose CA	Nov 24, Dec 10
Cincinnati OH	Dec 05, Jan 08	Los Angeles CA	Nov 18, Dec 05	Ottawa ON	Dec 11, Jan 22		Jan 16, Jan 28
Cleveland OH	Dec 10, Jan 23		Jan 20, Jan 21	Philadelphia PA	Dec 05, Jan 16	Seattle WA	Dec 17, Jan 07
Columbus OH	Dec 12	Memphis TN	Jan 23	Phoenix AZ	Dec 03	St. Louis MO	Dec 03, Jan 20
Dallas TX	Jan 21	Miami FL	Jan 30	Pittsburgh PA	Dec 15, Jan 26	Tampa FL	Feb 02
Detroit MI	Nov 18, Jan 06	Milwaukee WI	Nov 24	Portland OR	Dec 15, Jan 09	Toronto ON	Nov 27, Dec 18
Fort Worth TX	Jan 20	Minneapolis MN	Nov 26, Jan 12	Providence RI	Nov 19, Dec 15	Vancouver BC	Dec 19, Jan 05
		Montreal PQ	Dec 09, Jan 20		Jan 08	Washington DC	Dec 02, Jan 20

IBM is a registered trade mark of International Business Machines Corp. NewViews is a trade mark of Q.W. Page Associates Inc. Copyright 1986 Q.W. Page Associates Inc.

NewViews Complete Financial Accounting for \$695.00
Q.W. Page Associates Inc.
(416) 487-3424

HOW



EASY:

The AT&T Card is so fast and simple to use, you're going to get spoiled.

To use it, just dial the number you want to call, and enter your AT&T Card number. That's it. It's the easiest way to plug into the AT&T Long Distance Network from virtually any phone.

In fact, you can make calls even without carrying your AT&T Card. Just remember your AT&T Card number.

So, if you travel frequently, spoil yourself and get the AT&T Card. It's as simple as dialing

1 800 CALL ATT, Ext. 229



AT&T

The right choice.

MAC DEBUGGING

ment problems. For example, very few ROM routines are designed to manage null handles; instead, they usually expect empty handles or handles pointing to zero-length strings.

Many incorrect argument references can be validated by carefully examining the documentation and sample code. If worse comes to worst, you can use MacNosy (a smart disassembler) to reverse-engineer the routine to find out what arguments it is expecting.

Finally, owners of TMON have the best argument-checking option of all. TMON includes user extensibility, as demonstrated by Extended User Area (EUA), a 5000-line enhancement to TMON placed in the public domain by its author, Darin Adler.

Among other features, EUA includes "discipline," a dynamic validation of toolbox arguments based on an earlier implementation by Steve Capps. For example, a pointer, handle, or the master pointer of a handle is checked for zero, an odd value, or other unreasonable values. It also looks at Rectangles, GrafPorts, WindowRecords, and so on, to make sure the fields have reasonable values.

If for no other use, the discipline of EUA is recommended as a final pass through a finished program to catch subtle or obscure bugs. The validation is good enough to find lingering bugs in a number of commercially released products.

PRINT STATEMENTS REVISITED

There are two practical approaches to track down such problems: compiling debugging traces into the source code or using some form of debugger. Which approach you should take depends on the particular problem and your own personal skills.

If you're used to debugging without getting down to the machine level, I'm sure that print statements are by now a familiar fixture.

The debugging print statement is a standard approach and the best one available without special tools. Simply place an identifying print statement within your code somewhere in the likely vicinity of the bug. Then execute the code and note whether or not the

program "makes it" to the print statement. Continue this process, using a binary search to converge on the routine, or even statement, causing the failure.

The debugging print statement approach requires some translation into the Mac's window environment. A number of options are available:

- Debugging window—This is the best approach to port existing programs with debugging traces, or for developing large systems that will require permanent debugging code. It's really the same as the line-oriented print statements, but with a dedicated window. When debugging a screen-oriented program, the windowing metaphor is an advantage—the added complexity provides added capabilities. The additional window introduces new window-related events, however, making it a bad choice for low-level debugging.
- Serial port—You can send debugging information out of either of the Mac's serial ports to a printer or another computer. Although this introduces the complications of serial I/O to your application, for most programs this adds the fewest interactions.
- Reserved screen area—If you bypass the Window Manager entirely, you can avoid the interactions associated with windows becoming active and inactive. Instead, you can write directly to a particular location on the screen by using the SetPort routine to set the drawing area to the desktop. You should either choose an area of the screen not used for any other purpose—such as the upper right corner—or do as the debuggers do and save and restore the previous screen contents using CopyBits.
- Dialog box—In this approach every print statement gets a temporary window. It is one of the easiest to implement, as shown in listing 1 and figure 2. It has the disadvantage of being very distracting for large amounts of debugging information and also causes a large number of additional interactions. These can be minimized by choosing a small window in an unused corner of the screen.

(continued)

WHY



BECAUSE:

The AT&T Card is your key to the dependable AT&T Long Distance Network. As you travel around the country, it'll help you keep in touch with everyone who really matters—from your boss to your best friend. And because every call you make is important, it's reassuring to know the AT&T Long Distance Network is carrying your message.

To put the key to the high quality AT&T Long Distance Network in your pocket, order your AT&T Card today. Simply call

1 800 CALL ATT, Ext. 229



AT&T

The right choice.

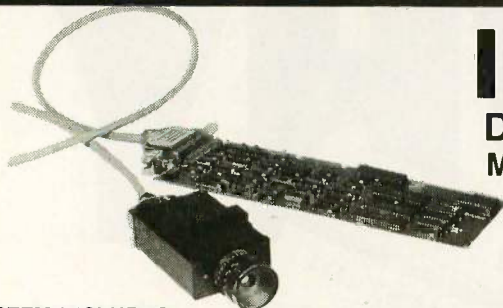

IDETIX™

DIGITAL CAMERA

MOS Imaging System

SYSTEM INCLUDES:

MOS sensor based, IBM PC compatible camera with C-Mount lens. High speed controller board. Demonstration software and subroutine library.

Adjustable frame size and resolution to 1024 x 512 pixels using the MOS digital image sensors, IS32A and IS256 OpticRAM™.

Rugged and reliable camera head for industrial environments. The high speed differential driver/receiver camera head measures 4.3"L x 1.5"H x 3"W.

MACHINE VISION APPLICATIONS INCLUDE:

- FACTORY INSPECTION
- ROBOTICS
- REPROGRAPHICS

- PROCESS CONTROL
- MANUFACTURING AUTOMATION
- SIGNATURE VERIFICATION

UNDER \$500 IN OEM QUANTITIES.

Micron Technology, Inc., a world leader in semiconductor development and manufacturing, presents the IDETIX™ Imaging System, a low cost alternative for machine vision applications.

For more information contact:



Systems Group
2805 E. Columbia Road
Boise, Idaho 83706
(208) 386-3800

UNPRECEDENTED

INTRODUCING BOXCARD! HI - RES! LOW PRICE!

Illuminated Technologies has been providing high resolution graphics solutions to supermicro users worldwide for four years. Our Boxcard brings proven graphics controller technology to PC/AT and compatible users. Boxcard provides up to 1024 by 1024 pixel 8 color images at an unprecedented \$1195 list. AUTOCAD™ users will find that Boxcard provides the performance and productivity they need at half the price of other controllers. Boxcard's short slot adapter even includes a serial port. The Boxcard can be mounted on your 25—35Khz monitor, where short cables ensure crisp images.

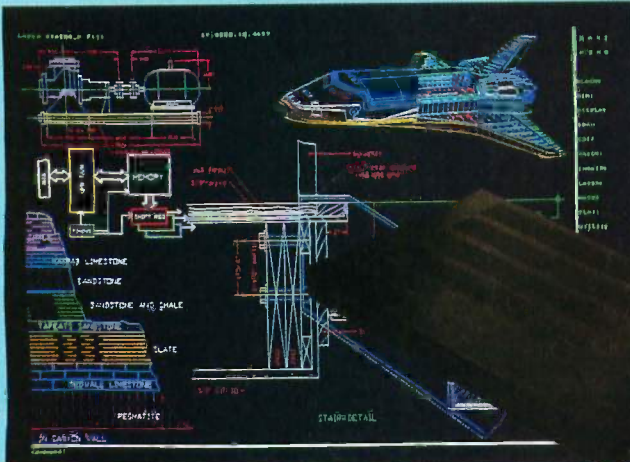

Call us to discuss your application!

- 7220 Graphics Controller
- 50 Mhz video rate
- C drivers included
- \$1195 list price
- DEALER / OEM Discounts



ILLUMINATED TECHNOLOGIES, INC.
1-800-262-8086 toll free or (405)943-8086 in OK
3005 N. May • Oklahoma City, Oklahoma 73107

When adding debugging code, you also need selectivity. If you display intricately detailed debugging information, the output will be overwhelming. You need a way to turn it on and off, or to select levels or areas of debugging.

One approach is a separate debugging menu that disappears from the finished product. An even easier method is to use a particular combination of keys—for example, command-Option-space—as an on/off toggle.

CHOOSING YOUR INSTRUMENTS

Where print statements fail, or are unlikely to produce results, assembly-level debuggers will be the only way to get answers. They also allow you to track a problem without modifying your program.

There are a number of debuggers available. The most commonly used is MacsBug, Apple's family of line-oriented single-Mac debuggers. The MacsBug variants trade off features in exchange for memory usage.

The MacsBug debuggers are part of the new Macintosh Programmer's Workshop (MPW), the older Macintosh 68000 Development System (MDS), as well as Apple's periodic Software Supplement. They are also included with many third-party compilers and MacNosy. A very limited version is included in the 128K ROM of the Macintosh Plus and the enhanced 512K.

Most systems also include Apple's MacDB, which is the least intrusive and uses the least amount of memory of any debugger. It achieves this by requiring a second Macintosh as a windowing control terminal connected via serial port to the Mac you are debugging on.

Finally, TMON from ICOM Simulations (formerly sold by TMO Software) is an advanced, single-Mac debugger that supports multiple windows. It includes user extensibility, as well as improved formatting and a number of extensions over MacsBug.

The basic features of all debuggers include displaying and modifying registers, disassembling code, single-stepping, setting breakpoints, and displaying the heap. All allow you to use

(continued)

Work, work, work.

If your visa stamps from across the Pacific are starting to look less like souvenirs and more like battle scars, try flying the friendly skies next time.

United can't make the distances less. But we can make them easier.

Our Royal Pacific Service

will look after you all the way to Tokyo, Osaka, Hong Kong, Bangkok, Taipei, Singapore, Manila, Sydney, Melbourne, Seoul, Shanghai, Beijing, and Auckland. With convenient service from over 150 U.S. cities.

In fact, United flies to more cities over there from more cities

over here than any other airline.

And all the while, you can rack up big Mileage Plus points on your account.

Who says you can't mix business with pleasure?



United

Listing 1: A windowed analog to debugging print statements; (a) shows the source code of the program to be debugged, and (b) is the input for the RMaker (resource compiler) utility program that generates the program's associated resource file.

```
(a)
#ifdef DEBUG
#define MADEIT(string) madealert(string);
#define ALRT_madeit 9001
#else
#define MADEIT(x)
#endif

...
madealert(msg)
char *msg;
{ ParamText(msg,NULL,NULL,NULL);
  NoteAlert(ALRT_madeit,NULL);
}

...
MADEIT("out of SetUp")

...
MADEIT("Into print initialization routine")

(b)
Type ALRT          ;;Alert template
,9001              ;;Resource ID
45 125 200 345    ;;top left bottom right
9001
444

Type DITL          ;;Dialog item list
,9001              ;;Resource ID
2                  ;;2 items in list
button            ;;button item
120 80 140 140    ;;top left bottom right
OK
staticText Disabled
Made it ^O, Kemosabe! ;;message
```

the interrupt button (the button to the rear on the programmer's switch attachment) to transfer control to the debugger for further commands.

In addition, many have found MacNosy essential for understanding how the Mac toolbox and operating system work, beyond the level described in the documentation. In the end, as any systems programmer will tell you, the code is the documentation.

OPENING UP THE PATIENT

When it comes time to break out a machine language debugger, you'll need to have handy an assembly code listing of the failing routine or program. For the purposes of illustration, I'll assume that you are using the MacsBug debugger, whose major commands are summarized in table 1.

Start first at the point where the Macintosh crashes. You can examine the registers (the TD command in MacsBug), memory (DM), and disassemble instructions (IL) to find out where the program failed.

Many compilers allow you to make your routine names available to the debugger. If the compiler you are working with doesn't, the ordering of trap names around the failure should correspond to the same clustering in your source listing. Or you can trace traps (AT) to find the specific ones called immediately prior to failure. For brevity, you can limit the trace to only a numerical range of traps, such as those in the File Manager.

Once you have found the failure point—or if it can't be isolated—you usually want to place a breakpoint just before it. The approaches include

- Using the debugger, set breakpoint (BR) at the entry to particular routines.
- The debugger can be set to stop upon reaching a particular trap (AB).
- If your compiler includes an in-line assembler, you can compile in F-series traps (op codes in the range F000 to FFFF hexadecimal) at key locations in your program to immediately invoke the debugger, as in

```
#ifdef DEBUG
#define USERBRK(i)
```

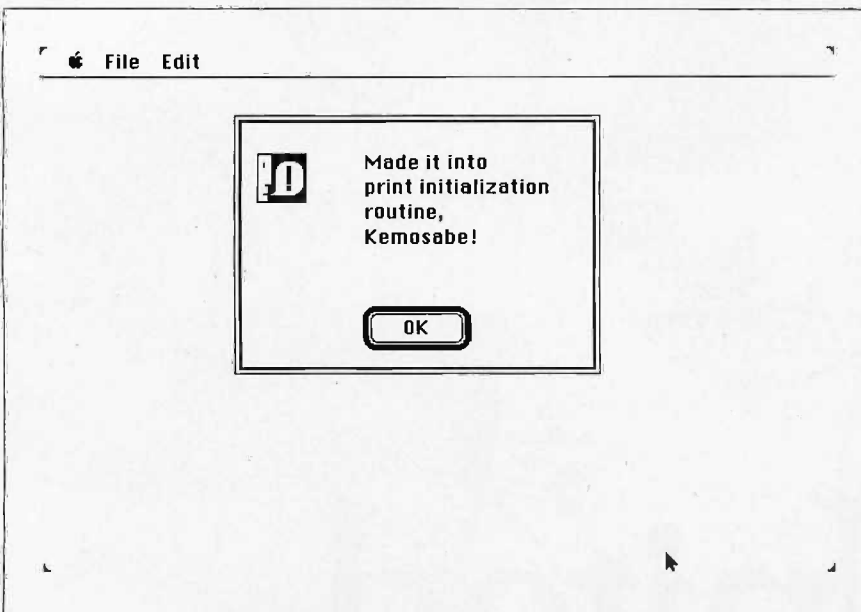

Figure 2: A debugging dialog box, generated by the program shown in listing 1.

(continued)

Verbatim Ensures Your Data Won't Meet a Shocking End



Introducing DataLife with DataHold for Unsurpassed Data Protection

Static Danger is Everywhere—Your data is vulnerable to loss from an unseen enemy—static electricity! Even small static charges could cause sudden data loss from your diskette.

And static lurks everywhere. Just walk across a carpeted floor and you build up a static charge of up to 1,500 volts—enough to ZAP your data.

DataHold Protects Your Data—DataHold is our ingenious diskette liner that disperses damaging static charges instantly. Compare DataLife to other popular brands which retain static charges up to four minutes and *your choice should be obvious.*

DataHold, available exclusively from Verbatim DataLife for unsurpassed data protection.



Verbatim[®]
A Kodak Company
Inquiry 373

323 Soquel Way
Sunnyvale, CA 94086
800-538-1793

**DATAHOLD
INTRODUCTORY
OFFER**
Two free disks inside specially
marked 10-packs of
Verbatim DataLife
miniDiskettes.

```
asm { dc.w 0xF000+i }
```

USERBRK(0x20)

The availability of 4096 distinct traps allows you to use each breakpoint as an unambiguous sentinel indicating progress within your program. However, on a future 68020-based Macintosh, these op codes will be reserved for 68881 coprocessor instructions, so you would use the `__Debugger` trap (A9FF hexadecimal).

Once in the general vicinity of the problem, you can use single-stepping (S) to monitor the value of key registers or arguments up to the point of failure. Most of the time you'll want to use the single-step command that steps through traps as one instruction (T). If there are compiled breakpoints in the program, the go command (G) will continue execution until the program reaches the next breakpoint.

Finally, if you want to save your RAM disk, or just avoid rebooting, the

`ExitToShell` trap (ES) will normally place you safely back in the Finder.

Machine language debugging is made much more difficult by those development systems that use "glue routines" to bind your program to ROM traps. In such code, a direct reference to a particular trap won't be in your routine; instead you'll find that your program calls a subroutine that references the trap. Based on experience, I would make this a major consideration in choosing development software for the Macintosh.

Table 1: The most often used subset of MacsBug commands. The commands with an asterisk are included in the built-in debugger on the Macintosh Plus.

*DM addr nbytes	Display memory
*SM addr val1 val2	Set memory values
IL addr num	Disassemble num lines at addr
*SM PC 4E71	No-op at current PC location
*An or Dn	Show address or data register n
*{An,Dn} value	Set address or data register n
TD	Display all registers
PC addr	Set program counter
BR addr count	Breakpoint at addr after count
S num	Step number of instructions
T	Single-step past trap
ST addr	Step until PC reaches addr
ES	Exit to shell (Finder)
HD	Formatted heap dump
*G addr	Branch to specified address
*G 40F6D8	Exit to shell (128K ROM)
AB trap1 trap2†	Breakpoint at specified traps
AT trap1 trap2†	Trace specified traps

† If trap1, trap2 omitted, for all traps

PREVENTIVE MEDICINE

As you may have concluded by now, it is cost-effective to avoid or reduce actual debugging on a system such as the Mac. The previous sections, plus some hands-on debugging of your own, will offer some clues as to what maladies to guard against.

A brief list of remedies includes

- **Compiler checking**—A high-level language provides tremendous productivity advantages over assembly or low-level languages, customarily at the expense of speed and size. All languages are not created equal and, in particular, compile-time verification of argument parameters is extremely valuable. A compiler that detects a pointer where you should be using a handle can save you hours of hair-pulling. In this regard, Pascal (or Modula-2) with its data-type checking has a marked advantage over C. To remedy this problem for devoted C users, at least one version of the lint interface-checking utility is under development for the Mac.

- **Desk checking**—This may sound obvious, but if you're treading in a new area of the toolbox, you should verify the interfaces manually by checking that they correspond to definitions in *Inside Macintosh*. (For more information refer to *Macintosh Technical Note #43*.)

- **Prototyping**—If you're really not sure how a particular manager or routine works, make a simple test. In particular, if you want to pass a null pointer as an argument, and the documentation doesn't explicitly endorse it, test it first. Assuming it works will likely cost you more time in the long run. Also, it's easier to isolate prob-

ITEMS DISCUSSED

MACINTOSH 68000 DEVELOPMENT SYSTEM\$195
 Apple Computer Inc.
 205025 Mariani Ave.
 Cupertino, CA 95014
 (408) 996-1010
 Includes editor, assembler, linker, MacsBug, and MacDB debuggers.

MACINTOSH SOFTWARE SUPPLEMENT price varies
 Apple Computer Mailing Facility
 467 Saratoga Ave., Suite 621
 San Jose, CA 95129
 (408) 988-6009
 Each update can include revisions to development tools (MacsBug, ResEdit) and new or revised chapters of *Inside Macintosh*.

MACNOSY\$75
 Jasik Designs
 343 Trenton Way
 Menlo Park, CA 94025
 (415) 322-1386
 Includes MacsBug. Be sure to specify version for 64K or 128K ROM.

TMON\$100
 ICOM Simulations Inc.
 626 Wheeling Rd.
 Wheeling, IL 60090
 (312) 520-4443
 You can also request information on the public domain Extended User Area, which includes "Discipline," an extension of TMON that validates arguments on trap calls.

lems in small test cases than if you add the code directly to your program.

- **Modular libraries**—As Bruce Webster noted in his article "Subroutine Libraries in Pascal" in BYTE's June 1985 Programming Techniques theme issue, "Libraries can be a real lifesaver." Smart programmers always plagiarize themselves: Once you've developed an interface or library you like, use it over and over again.

A library is particularly useful if you are, for example, moving a number of programs from another system to the Mac, or if you wish to maintain a common programming style across several systems. But if your goal is a quality product rather than a hack job, don't attempt to "kludge up" untranslatable idioms.

For example, many file systems use a character style of indicating a directory's file path, such as the "/foo/bar/bas" style of UNIX. However, the Macintosh uses a file definition of

```
struct filedef {
    int vrefnum;
    char fname[255];
}
```

Some programs bypassed this approved approach and appended the filename to the volume name. These programs broke under Apple's Hierarchical File System (HFS); vrefnum was

extended to become a directory identifier, not just a volume identifier.

- **Following specifications**—If you follow the standardized, documented interfaces provided by large corporations—such as Apple or Microsoft—you will benefit from the company's promises of upward compatibility. However, there are no guarantees what a team of programmers will do with undocumented behavior of the old code, particularly "features" they didn't even know about. The problem with HFS above is one example.

- **Anticipating errors**—It is tempting when hacking out early code to ignore many error conditions. However, this only guarantees loss of sleep at some later date when an unchecked error condition causes a delayed-failure crash. Certain error conditions—lack of memory or disk space—must always be allowed for, while others—a missing code segment from your program—may be safe to ignore, if you're feeling brave.

SUMMARY

The standard principles of debugging on other systems generally apply to the Mac. Isolating problems through binary searches, collecting symptoms, print statements, desk checking, and good coding practices are all standard techniques that can also be applied

within a complex windowing environment. Some approaches require some translation, however, and the intricate suite of toolbox routines presents its own set of unique problems.

Finally, as with other systems, there's no substitute for adequate preparation and painstaking, methodical analysis. While debugging Macintosh programs requires a great deal of skill, once you master the high learning curve, you will be able to recognize common patterns of failure and their solutions. ■

FURTHER READING

Rose, Caroline, ed. *Inside Macintosh*. 3 vols. Reading, MA: Addison-Wesley, 1985.

(This is supplemented by *Macintosh Technical Notes*, published bimonthly by Apple.)

Snively, Paul. "Debugging with TMON." *MacTutor*, September 1985.

Snively, Paul. "TMON Revisited." *MacTutor*, July 1986.

Taylor, Tom. "MacBug Debugs Modular Code." *MacTutor*, December 1985.

Webster, Bruce. "Subroutine Libraries in Pascal." *BYTE*, June 1985.

Williams, Gregg. "The Apple Macintosh Computer." *BYTE*, February 1984.

ACKNOWLEDGMENTS

I'd like to thank Eric Zocher of Silicon Beach Software and Darin Adler of ICOM Simulations for sharing their experiences in Macintosh development.

DataSaver® Standby UPS

90 Watt. The original micro-UPS that brought standby AC power to Apple users in 1980. Still the POWER SOLUTION for serious applications of the MAC, small micros, and portables. Model 9012060 \$350. FCC(15A&B).

400 Watt. Now, POWER PROTECTION and MASTER CONTROL for full-size micros. Filters electrical noise/spikes and provides up to 10 minutes of AC power for the AT and supermicros. Model 40012060 \$695. UL-E101268.

200 Watt. This DataSaver standby UPS offers compact, cool and quiet line conditioning and backup power to PC, XT, and COMPAQ markets. Data and hardware are protected. Model 20012060 \$495. CSA-LR51253.



Cuesta Systems Corporation
3440 Roberto Court
San Luis Obispo, California 93401

© 1986. Made with pride in the U.S.A.
805/541-4160 TLX:4949381 CUESTA
Dealer, VAR, & OEM inquiries invited.

IBM's new 2,400 bps PC Modems
give you an easy choice:

Either

Stand-alone.
The IBM 5842
2,400 bps Modem.



Either way, you can't go wrong.

With IBM's new modems and a personal computer you can tap into information at a very impressive 2,400 bits per second (bps).

That translates into a binary file transfer speed of nearly 13 K characters per minute—or over six pages worth. Now imagine the impact that can have on your long distance telephone bill.

But these new modems aren't just fast, they're also versatile. They can both send and receive data asynchronously at speeds ranging from 2,400 bps down to 75 bps.

Both modems are compatible with the popular "AT" command set, as well as the IBM command set. And they have been tested for compatibility with leading PC communications software such as Crosstalk™ XVI, Microsoft® Access, Kermit, Smartcom® and Smartcom II®.

Or

The Automatic Modems

These modems feature Automatic Adaptive Equalization at 2,400 and 1,200 bps—

which means they will continuously fine-tune themselves to compensate for changes and noises on the telephone line. The result is, you can receive data over a wider range of telephone line conditions.

Both modems also feature automatic or manual answering and dialing. They'll automatically switch to pulse dialing if tone dialing doesn't work. They have automatic redialing. And once a connection is made, automatic speed detection. They also have automatic detection of a voice or a failed call.

A Modem with a Memory of Its Own

The stand-alone IBM 5842 2,400 bps Modem offers some additional features. It can also send and receive data synchronously at speeds of 2,400 bps or 1,200 bps. You'll find extensive "Help" menus. A dial directory for 20 phone numbers. A log-on directory for five log-on sequences. A built-in pattern generator for self testing. Diagnostics implemented from the front panel as well as from the computer keyboard. And a complete array of LED Status Indicators to give you a quick visual check on what's happening.

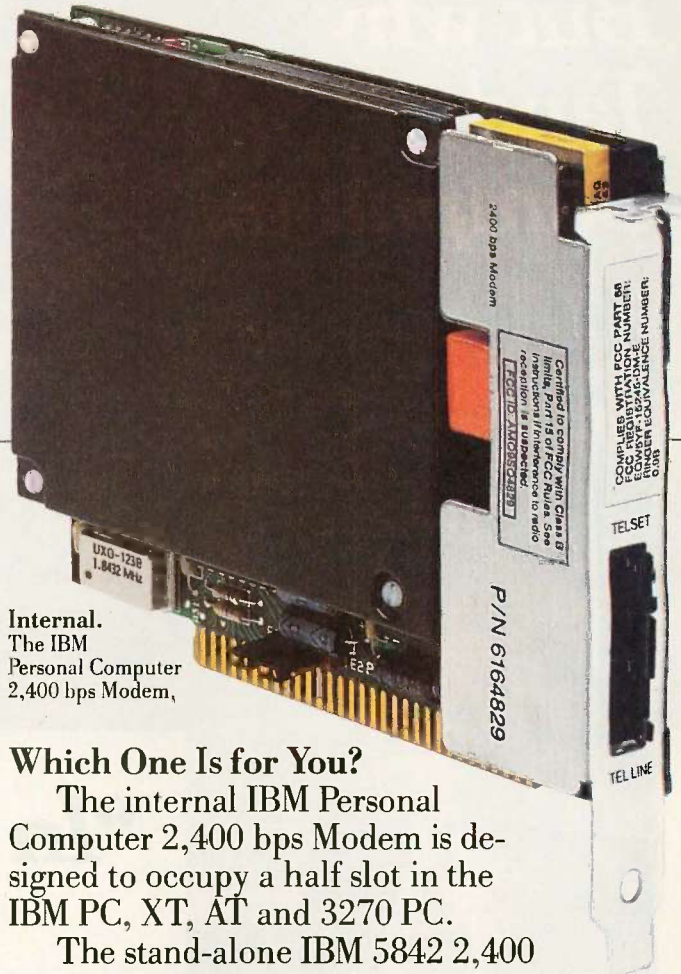

Internal.
The IBM
Personal Computer
2,400 bps Modem,

Which One Is for You?

The internal IBM Personal Computer 2,400 bps Modem is designed to occupy a half slot in the IBM PC, XT, AT and 3270 PC.

The stand-alone IBM 5842 2,400 bps Modem is compatible with all models of IBM Personal Computers. And, in addition to the features mentioned above and its internal power supply, the significant difference is that a stand-alone modem can be moved from PC to PC more easily than an internal modem.

If you feel that 2,400 bps is more modem than you need, we also offer the stand-alone IBM 5841 1,200 bps Modem, and the internal IBM Personal Computer 1,200 bps Modem.

For the Authorized IBM PC Dealer nearest you—or for free literature on the IBM family of PC Modems—call 1 800 IBM-2468, Ext. 104/EM. Or you can contact your IBM marketing representative.



Crosstalk is a trademark of Microstuff, Inc. Microsoft is a registered trademark of Microsoft Corp. Smartcom and Smartcom II are registered trademarks of Hayes Microcomputer Products, Inc.

**“Ok...
But why
Tandy
Computers?”**



“In a word...quality.”



Tandy 3000 HD

Tandy® computers are designed, built, supported and serviced by Radio Shack.

Our total commitment assures a high degree of product quality and, just as important, customer satisfaction long after the sale.

Quality-built in the USA. Our MS-DOS® personal computer line is made in America in our own

manufacturing plants. We control quality, from initial assembly to completed and tested product.

Nationwide Support. Over 1200 Radio Shack Computer Centers are ready to help you choose the latest in computer technology, backed by quality support.



Tandy 3000 HL

Training and specialized software instruction is available at your



Tandy 1000 SX

place of business or ours, in 60 major market areas.

We've got what it takes. Like commercial leasing plans. And service performed

by technicians who work for the same company that manufactured and sold you your computer.

You expect quality . . . and you get it from Radio Shack.

TANDY COMPUTERS:

In Business...for Business™

MS-DOS/Reg. TM Microsoft Corp.

**Radio Shack®
COMPUTER CENTERS**

A DIVISION OF TANDY CORPORATION

Inquiry 304

LOCAL EFFECTS OF NUCLEAR WEAPONS

*Calculate the impact
of atomic blasts
on your surroundings*

The prospect of nuclear war is and will continue to be a major source of international concern. Yet, despite the daily discussion of nuclear issues, few people have a working knowledge of the effects of nuclear weapons. For-

tunately, acquiring a working knowledge does not require specialized skills. Models are a particularly valuable tool for understanding this complex subject. References 1 through 5 describe the effects of nuclear weapons in a fairly nontechnical manner.

We'll look at three major topics: the basic effects of nuclear detonations, the distribution of nuclear fallout, and the climatic effects of pollutants dispersed in the atmosphere after a nuclear exchange. The models used to describe the latter two effects are relatively simple, yet they highlight important physical effects while providing reasonable quantitative estimates.

Each model is presented from the perspective of an observer at a specified location in relation to a nuclear detonation. This perspective emphasizes the local aspects of the effects.

I have provided references for readers interested in historical reviews of the nuclear age (references 3, 7, and 8); current policy concerns (references 9 and 10); and advice on how to survive a nuclear confrontation from a governmental (reference 11) or an individual (reference 12) perspective. The references represent the most prominent views expressed publicly today.

SUMMARY OF NUCLEAR DETONATION EFFECTS

As noted earlier, I will discuss the effects of nuclear detonations from the

(continued)

John R. Fanchi (1078 East Otero Ave., Littleton, CO 80122) is a research scientist in the oil industry. He has a Ph.D. in physics from the University of Houston.



Electromagnetic pulse can short-circuit electrical equipment.

perspective of an observer at a given distance D from a blast with a yield Y . Yield is the total effective energy released by a nuclear explosion. The observer's distance from the blast is known as the *slant range* and will be expressed in units of miles in subsequent calculations. The yield Y is expressed in units of megatons. Yield raised to the $\frac{2}{3}$ power gives equivalent megatons (EMT). EMT is useful because it is directly proportional to the area of blast damage caused by a nuclear detonation (references 1 and 2). It is worth noting here that 400 EMT of retaliatory yield is considered sufficient to achieve "mutual assured destruction." As of 1982 the U.S. and the U.S.S.R. had warheads capable of delivering approximately 4000 and 6000 EMT. Typical intercontinental ballistic missiles have yields of 9 and 20 megatons for the Titan II (U.S.) and the SS-18 (U.S.S.R.). Submarine-launched ballistic missiles have yields on the order of 0.05 to 1 megaton (reference 2).

Four important effects of a nuclear

detonation are dependent on D and Y . They are overpressure, thermal flux, electromagnetic pulse (EMP), and radiation dosage. *Overpressure* is the increase in ambient pressure caused by the detonation. *Thermal flux* is the total thermal energy propagating outward from the detonation point per unit cross-sectional area transverse to the direction of propagation. The *EMP* calculation estimates the magnitude of a very strong but short-duration electrical field generated by atmospheric relativistic electrons. The electrons attain relativistic energies as a result of Compton scattering with gamma rays. Gamma rays are emitted by decaying excited states of fission fragments following an airburst. Perhaps the most important effect of the EMP is its ability to short-circuit electrical equipment, especially solid-state devices. Subsequent estimates of these effects require the height h at which the detonation occurs, the fraction f of explosive energy appearing as thermal (heat) energy in the nuclear fireball, and an atmospheric transmission factor T_A that accounts for the absorption of thermal energy in the atmosphere.

Airbursts, such as the detonations over Japan in World War II, can be hundreds or thousands of feet in the air. An airburst is defined as a burst

below 100,000 feet (sections 1.31 through 1.38 of reference 13) but high enough that the fireball at maximum luminosity does not touch the earth's surface. One important difference between groundbursts and airbursts is the relative fallout generated by each. Groundbursts generate the most fallout, or radioactive dust. As the height of the blast increases above the surface of the earth, the suction of dust and debris from the ground into the atmosphere is reduced with a corresponding decline in fallout. Once h is specified, a thermal energy fraction f is estimated. The variable f ranges from 0.15 (groundburst) to 0.35 (airburst). The fractional atmospheric transmission factor T_A depends on the wide variability of weather conditions. It is a value between 0 and 1, though it is usually on the order of 0.5.

Four important blast characteristics are now computed (references 1 and 5).

Thermal flux (calories/sq cm):

$$Q = 3000 f Y T_A / D^2 \quad (1)$$

Blast overpressure (psia):

$$P = 22.4 Z^3 + 15.8 Z^{1.5} \quad (2)$$

where

$$Z = Y^{1/3} / D. \quad (3)$$

Electromagnetic pulse range (miles):

$$EMP = (2Rh/5280)^{0.5} \quad (4)$$

(continued)

March 24, 1986
 Project CNS Associates
 45 Andover Road
 Andover, MA 01820
 Mr. Allen W. Weyer
 United City Development Department
 1000 Main Street
 Concord, MA 03301

We are pleased to submit the following proposal for design, engineering, procurement, and construction management services for the **United City Project**.
 For this project, CNS has a number of years of experience in the areas of design, civil and process engineering, construction management, and plant design. Our staff has a wide range of professional and technical expertise. We have a strong track record in the design and construction of industrial facilities. We have a strong working relationship with the United City Project. The CNS staff is confident in its ability to provide a high quality of service to the United City Project.
 The CNS staff is confident in its ability to provide a high quality of service to the United City Project. We have a strong track record in the design and construction of industrial facilities. We have a strong working relationship with the United City Project. The CNS staff is confident in its ability to provide a high quality of service to the United City Project.
 We look forward to discussing this project in detail with you. Should you have any questions regarding this proposal, please contact our office.

Respectfully,
 Allen W. Weyer
 Project Manager
 Project CNS Associates

CNS Associates 45 Andover Road, Andover (MA) 01820 (617) 931-0881

Table of Contents

- 1 Project Basis and Approach
 - 1.1 Site Use and Development Issues
 - 1.2 Site Characteristics
 - 1.3 Site Constraints
 - 1.4 Site Objectives
 - 1.5 Site Location
 - 1.6 Site Access
 - 1.7 Site Easements
 - 1.8 Site Zoning
 - 1.9 Site Environmental
 - 1.10 Site Historical
 - 1.11 Site Cultural
 - 1.12 Site Archaeological
 - 1.13 Site Paleontological
 - 1.14 Site Paleontological
 - 1.15 Site Paleontological
 - 1.16 Site Paleontological
 - 1.17 Site Paleontological
 - 1.18 Site Paleontological
 - 1.19 Site Paleontological
 - 1.20 Site Paleontological
 - 1.21 Site Paleontological
 - 1.22 Site Paleontological
 - 1.23 Site Paleontological
 - 1.24 Site Paleontological
 - 1.25 Site Paleontological
 - 1.26 Site Paleontological
 - 1.27 Site Paleontological
 - 1.28 Site Paleontological
 - 1.29 Site Paleontological
 - 1.30 Site Paleontological
 - 1.31 Site Paleontological
 - 1.32 Site Paleontological
 - 1.33 Site Paleontological
 - 1.34 Site Paleontological
 - 1.35 Site Paleontological
 - 1.36 Site Paleontological
 - 1.37 Site Paleontological
 - 1.38 Site Paleontological
 - 1.39 Site Paleontological
 - 1.40 Site Paleontological
 - 1.41 Site Paleontological
 - 1.42 Site Paleontological
 - 1.43 Site Paleontological
 - 1.44 Site Paleontological
 - 1.45 Site Paleontological
 - 1.46 Site Paleontological
 - 1.47 Site Paleontological
 - 1.48 Site Paleontological
 - 1.49 Site Paleontological
 - 1.50 Site Paleontological
 - 1.51 Site Paleontological
 - 1.52 Site Paleontological
 - 1.53 Site Paleontological
 - 1.54 Site Paleontological
 - 1.55 Site Paleontological
 - 1.56 Site Paleontological
 - 1.57 Site Paleontological
 - 1.58 Site Paleontological
 - 1.59 Site Paleontological
 - 1.60 Site Paleontological
 - 1.61 Site Paleontological
 - 1.62 Site Paleontological
 - 1.63 Site Paleontological
 - 1.64 Site Paleontological
 - 1.65 Site Paleontological
 - 1.66 Site Paleontological
 - 1.67 Site Paleontological
 - 1.68 Site Paleontological
 - 1.69 Site Paleontological
 - 1.70 Site Paleontological
 - 1.71 Site Paleontological
 - 1.72 Site Paleontological
 - 1.73 Site Paleontological
 - 1.74 Site Paleontological
 - 1.75 Site Paleontological
 - 1.76 Site Paleontological
 - 1.77 Site Paleontological
 - 1.78 Site Paleontological
 - 1.79 Site Paleontological
 - 1.80 Site Paleontological
 - 1.81 Site Paleontological
 - 1.82 Site Paleontological
 - 1.83 Site Paleontological
 - 1.84 Site Paleontological
 - 1.85 Site Paleontological
 - 1.86 Site Paleontological
 - 1.87 Site Paleontological
 - 1.88 Site Paleontological
 - 1.89 Site Paleontological
 - 1.90 Site Paleontological
 - 1.91 Site Paleontological
 - 1.92 Site Paleontological
 - 1.93 Site Paleontological
 - 1.94 Site Paleontological
 - 1.95 Site Paleontological
 - 1.96 Site Paleontological
 - 1.97 Site Paleontological
 - 1.98 Site Paleontological
 - 1.99 Site Paleontological
 - 2.00 Site Paleontological

1 Project Issues and Approach



Listing 1: The program BLAST.BAS.

```

10 REM
20 REM
30 REM NUCLEAR BLAST CALCULATION
40 REM (C) JOHN R. FANCHI, JUNE 1985
50 REM MICROSOFT BASIC FOR CP/M-80 OPERATING SYSTEM
60 REM PART OF THIS CODE IS EXCERPTED FROM J.R. FANCHI'S
70 REM ADVENTURE SIMULATION GAME "NUCLEAR SURVIVAL"
80 REM CHR$(26) CLEARS THE SCREEN
90 DIM ANSER$(2)
100 PRINT CHR$(26)
110 PRINT TAB(20); "*** NUCLEAR BLAST CALCULATION ***"
120 PRINT
130 PRINT TAB(21); "(C) John R. Fanchi, JUNE 1985"
140 PRINT
150 PRINT "The calculations performed here are based on information published"
160 PRINT "by the American Institute of Physics."
170 PRINT
180 INPUT "HIT CARRIAGE RETURN WHEN YOU ARE READY TO PROCEED";ICAR$
190 PRINT CHR$(26)
200 PRINT
210 INPUT "Specify your slant range (distance) from the blast in miles";D
220 PRINT
230 REM .....DETERMINE WEAPON YIELD (Y)
240 PRINT "Specify the yield of the blast in megatons. Typical values range"
250 INPUT "from 0.8 to 20 megatons";Y
260 REM .....DETERMINE BLAST HEIGHT
270 PRINT
280 INPUT "Specify the height of the blast in feet";H
290 PRINT
300 PRINT "Specify the thermal energy fraction. This is the fraction of heatn"
310 PRINT "energy in the nuclear fireball. It should be between 0 and 1. A"
320 INPUT "typical value is 0.35";TEF
330 PRINT
340 REM .....DETERMINE TRANSMISSION FACTOR
350 PRINT "Specify the atmospheric transmission factor. It should be between"
360 INPUT "0 (very cloudy day) and 1 (perfectly clear day)";TAU
370 PRINT
380 REM .....CALC BLAST EFFECTS
    
```

(continued)

Was your word processor designed to write like this?

...to be addressed to ensure that the project is properly developed.

CNS Associates

Because of the many facets of the project, CNS has selected experienced geologists, hydrologists, landscape architects, and civil engineers from its Governmental, Engineering, and Planning and Design, respectively, divisions to provide all services. This project team is well equipped to provide all services to the project. The project team is well equipped to provide all services to the project. The project team is well equipped to provide all services to the project.

1.1 Site Use and Development Issues

One site investigation reveals that the presence of dunes, boulder rubble, terraces, and other geological features in various areas need to be addressed. Soil chemistry evaluation and testing of potentially hazardous materials will also be done.

1.1.1 Soil Conditions

The purpose of the site visit by the city for sampling rubble from seven excavation sites, and the results of the soil sampling are shown in Table 1.1.1. The information will be used to determine the soil conditions and to provide recommendations for site development. A settlement monitoring program will be initiated for rubble and other large debris. The information will be used to determine the location of any settlement. This information is shown in Table 1.1.2.

Layer	Depth	Site A	Site B	Site C	Site D
1	0-11	0.208	0.329	0.278	0.158
2	11-23	0.123	0.104	0.104	0.079
3	23-35	0.104	0.104	0.104	0.079

Settlement rates were calculated using the following formula:

$$S = \frac{C \cdot W \cdot L}{E \cdot A}$$
 where:
 S = settlement (inches)
 C = compression index
 W = vertical stress (lb/ft²)
 L = thickness of layer (ft)
 E = modulus of elasticity (lb/ft²)
 A = cross-sectional area (ft²)

CNS Associates

CNS Associates

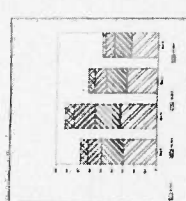

The graph illustrates the settlement rates for the different layers and sites. The information will be used to determine the soil conditions and to provide recommendations for site development. A settlement monitoring program will be initiated for rubble and other large debris. The information will be used to determine the location of any settlement. This information is shown in Table 1.1.2.

1.1.3 Groundwater

The RFP indicates that there is concern about the conditions of the ground water. The information will be used to determine the soil conditions and to provide recommendations for site development. A settlement monitoring program will be initiated for rubble and other large debris. The information will be used to determine the location of any settlement. This information is shown in Table 1.1.2.

1.1.4 Surface Drainage

Area of the site adjacent to the surface water. The information will be used to determine the soil conditions and to provide recommendations for site development. A settlement monitoring program will be initiated for rubble and other large debris. The information will be used to determine the location of any settlement. This information is shown in Table 1.1.2.

CNS Associates

```

390 REM THERMAL FLUX Q
400 Q=3000*TEF*TAU*Y/(D*D)
410 REM BLAST OVERPRESSURE P
420 Z=(Y^(.333))/D
430 P=22.4*(Z^3) + 15.8*(Z^(1.5))
440 REM EMP RANGE
450 EMP=SQR(2*H*3963/5280)
460 REM RADIATION DOSAGE REM
470 REMS=250*1000*Y/(16*3.1416*D*D)
480 PRINT
490 PRINT "The NUCLEAR BLAST had the following effects:"
500 PRINT
510 PRINT TAB(10);"THERMAL FLUX (cal/sq cm)";TAB(50);Q
520 PRINT TAB(10);"OVERPRESSURE (lb/sq in)";TAB(50);P
530 PRINT TAB(10);"EMP RANGE (miles)";TAB(50);EMP
540 PRINT TAB(10);"RADIATION DOSAGE (rems)";TAB(50);REMS
550 PRINT
560 INPUT "HIT CARRIAGE RETURN WHEN YOU ARE READY TO PROCEED";ICAR$
570 PRINT CHR$(26)
580 PRINT
590 REM .....OVERPRESSURE EFFECTS
600 IF P<20 THEN 640
610 PRINT "Overpressure has caused winds in excess of 500 miles per hour."
620 PRINT "Even multi-story reinforced concrete buildings are leveled. "
630 GOTO 820
640 REM
650 IF P<10 THEN 700
660 PRINT "Overpressure has caused winds in excess of 300 miles per hour."
670 PRINT "Most factories and commercial buildings are leveled, as are small"
680 PRINT "wood and brick residences."
690 GOTO 820
700 REM
710 IF P<5 THEN 750
720 PRINT "Overpressure has caused winds in excess of 160 miles per hour."
730 PRINT "Unreinforced brick and wood houses are leveled. "
740 GOTO 820
750 REM
760 IF P<2 THEN 790
770 PRINT "Overpressure has caused winds in excess of 70 miles per hour."
780 GOTO 820
790 REM
    
```

Was it designed to write a very long, very complex,

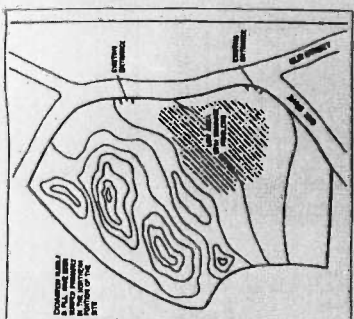

CIV. America

CIV. America

1.2.1 Community Issues

1.2.1.1 Neighborhood Support

This section of the report discusses the needs of the neighborhood in the area of the Oak Park Hill site. It identifies the needs of the community and provides recommendations for addressing these needs. The needs identified include: (1) improved access to public transportation, (2) improved access to parks and recreational facilities, (3) improved access to shopping and services, and (4) improved access to education and training opportunities. The recommendations include: (1) providing for improved access to public transportation, (2) providing for improved access to parks and recreational facilities, (3) providing for improved access to shopping and services, and (4) providing for improved access to education and training opportunities.

Table 2: Neighborhood Use Projections

Activity/Category	Percentage of Population	
	Necessary	Unnecessary
Playing Fields	70%	10%
Ballfields Courts	70%	10%
Swimming Pools	51%	12%
Recreation Buildings	60%	10%
Shopping Mall	57%	6%
Food Store	60%	6%

1.2.2 Park Security

This section discusses the security of the park area. It identifies the security risks and provides recommendations for addressing these risks. The risks identified include: (1) inadequate lighting, (2) inadequate fencing, and (3) inadequate security personnel. The recommendations include: (1) providing for adequate lighting, (2) providing for adequate fencing, and (3) providing for adequate security personnel.

CIV. America

CIV. America

1.2.3 Parking and Traffic

This section discusses the parking and traffic issues in the area. It identifies the parking and traffic problems and provides recommendations for addressing these problems. The problems identified include: (1) inadequate parking spaces, (2) inadequate traffic flow, and (3) inadequate traffic control. The recommendations include: (1) providing for adequate parking spaces, (2) providing for adequate traffic flow, and (3) providing for adequate traffic control.

CIV. America

Table 3: Parking and Traffic Summary

Item	04-20	05-12	12-15	14-20	20-25
Car Spaces	12	215	611	66	41
Car Spaces	12	215	611	66	41

NUCLEAR WEAPONS

```

800 PRINT "Overpressure has not had a significant effect on wind conditions"
810 PRINT "or the structures of buildings."
820 REM
830 PRINT
840 REM ..... THERMAL EFFECT
850 IF Q<10 THEN 880
860 PRINT "Thermal flux has burned you to a crisp."
870 GOTO 980
880 REM
890 IF Q<5 THEN 920
900 PRINT "You have suffered third degree burns because of THERMAL FLUX."
910 GOTO 980
920 REM
930 IF Q<1 THEN 960
940 PRINT "You have suffered second degree burns because of THERMAL FLUX."
950 GOTO 980
960 REM
970 PRINT "THERMAL FLUX has added to your tan. "
980 PRINT
990 REM ..... RADIATION EFFECTS PRINT
1000 PRINT
1010 IF REMS<5000 THEN 1050
1020 PRINT "You are experiencing convulsions, tremors and ataxia because"
1030 PRINT "of RADIATION exposure. No treatment will help you."
1040 GOTO 1330
1050 REM
1060 IF REMS<1000 THEN 1120
1070 PRINT "You have diarrhea, fever and a disturbance of your body "
1080 PRINT "chemistry because of RADIATION exposure. Treatment may"
1090 PRINT "alleviate pain, but it will not save your life. You have"
1100 PRINT "less than 2 weeks to live. "
1110 GOTO 1330
1120 REM
1130 IF REMS<600 THEN 1190
1140 PRINT "You have very severe leukopenia and internal bleeding."
1150 PRINT "You have also developed ulcers and infection is likely because"
1160 PRINT "of RADIATION exposure. You need hospitalization but none is"
1170 PRINT "available, therefore you have less than a month to live."
1180 GOTO 1330
1190 REM

```

(continued)

very technical document, mixing text and graphics?



1.3 Administrative Issues
 Major issues include the feasibility of the project and identifying the permits and approvals that will be necessary.

1.3.1 Permits and Approval
 The project will require a significant number of permits and approvals at the city, state, and federal levels. The exact number and type of permits and approvals will vary depending on the design of the park and the type of funding that is used.

At the city level, permits or approval from the Zoning Board, the City Council, the Planning Commission, and the Department of Public Works are required. The Department of Public Works will also be responsible for reviewing the design for safety and quality and will also be responsible for reviewing the design for safety and quality and will also be responsible for reviewing the design for safety and quality.

CNS recommends that County City apply for a building permit (under Title 16.01, Section 16.01.01) and to the building permit for that funding would be required. The building permit is the first step in the process of obtaining the necessary permits and approvals for the development of the park.

1.3.2 Costs and Funding
 Working from the information that the Commercial Park design will include, CNS has developed a sample funding plan, which is presented in Table 4b. The funding plan is based on the assumption that the park will be funded by a combination of state and local corporate foundations should be considered to make up the difference.

Because all funds are not definite, the preliminary design of the park will be based on the assumption that the park will be funded by a combination of state and local corporate foundations should be considered to make up the difference.

Estimate of Costs	\$101,000
Design	
Environmental Consulting	60,000
Architectural and Civil Plan	3,700
Land Survey	12,300
Public Works	106,800
Permits and Approvals	12,900
Construction	15,000
Earth Moving	11,000
Site Preparation	179,300
Utilities	30,000
Lighting	11,800
Other	90,000
Construction Materials	10%
Contingency	5%
Total Estimated Cost	1,110,000
State Funding	642,000
Local Funding	468,000
Commercial Park Revenue	140,000
State Funds (Other 2002-23)	250,000
State and Local Bonds	800,000
Total Available	1,290,000
Residual	180,000

```

1200 IF REMS<200 THEN 1250
1210 PRINT "Your symptoms range from leukopenia to hair loss because of"
1220 PRINT "RADIATION exposure. Hospitalization is required and is"
1230 PRINT "available to you because you have a reasonable chance to live."
1240 GOTO 1330
1250 REM
1260 IF REMS<100 THEN 1310
1270 PRINT "RADIATION exposure has made you sick--vomiting, headache, some"
1280 PRINT "loss of white blood cells and dizziness. This is good. You"
1290 PRINT "will completely recover."
1300 GOTO 1330
1310 REM
1320 PRINT "You have survived RADIATION exposure with NO effects."
1330 PRINT
1340 REM .....EMP EFFECT
1350 IF D>EMP THEN 1410
1360 PRINT "Your distance from the blast is within the range of the "
1370 PRINT "electromagnetic pulse (EMP). The EMP is capable of burning"
1380 PRINT "out electrical instruments."
1390 PRINT
1400 GOTO 1440
1410 REM
1420 PRINT "You are outside the range of the electromagnetic pulse (EMP)."

```

where R is the radius of the earth in miles.

Radiation dosage (rems):
 $REMS = 250 (1000Y)/(16\pi D^2)$, (5)

where I have assumed that a 1-kiloton

fission bomb has delivered about 250 rads of neutrons at a distance of 0.5 mile and that 1 rad is approximately equal to 1 rem. The latter assumption implies a relative biological effectiveness of unity (reference 1).

A few comments should be made about the limitations of equations 1

through 5. Thermal flux is most deadly if you are in direct view of the detonation. Virtually any shelter can effectively shield a person from thermal flux. Equation 1 does not take into account firestorms resulting from the thermal flux, which can also be lethal. The overpressure estimate in

Was it designed to write a highly-structured document,

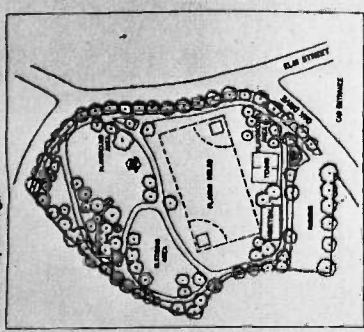

Continued from Project 8

Continued from Project 8

2. Scope of Work

The following scope of work and sub-assignment information demonstrates our approach to the design and development of the plant.

2.1 Phase 1: Data Collection and Analysis

- Field and photographic survey and preparation of appropriate maps
- Detailed survey of the site for final property lines, verification of utility locations, and existing utility lines, structures, and existing drainage channels
- Soil chemistry evaluation and testing for potentially hazardous materials
- Site plan review of adjacent lots to determine required easements or other plant growth
- Selection of construction program materials to determine workpiece type
- Evaluation of surface water and potential drainage patterns, including:
 - Analysis of dependence of water stream in the area
 - Analysis of drainage patterns
 - Analysis of drainage channels

Summary reports on these and any other initial investigations and analyses will be prepared for the city.

2.2 Phase 2: Site Use Analysis

To be successful, the development of Chemical Plant uses to include:

- Site plan review of adjacent lots to determine required easements or other plant growth
- Selection of construction program materials to determine workpiece type
- Evaluation of surface water and potential drainage patterns, including:
 - Analysis of dependence of water stream in the area
 - Analysis of drainage patterns
 - Analysis of drainage channels

Summary reports on these and any other initial investigations and analyses will be prepared for the city.

11-200 with 1 column revision

3 Proposed plant data will also be evaluated

11-200 with 1 column revision

Continued from Project 8

2.3 Phase 3: Preliminary Design

The following scope of work and sub-assignment information demonstrates our approach to the design and development of the plant.

- Public meetings to determine both local neighborhood concerns and needs as well as city-wide needs
- Meetings with city officials to determine special financial requirements
- Analysis of existing and proposed circulation patterns and adjacent lots
- Site plan review of adjacent lots to determine required easements or other plant growth
- Soil chemistry evaluation and testing for potentially hazardous materials
- Site plan review of adjacent lots to determine required easements or other plant growth
- Selection of construction program materials to determine workpiece type
- Evaluation of surface water and potential drainage patterns, including:
 - Analysis of dependence of water stream in the area
 - Analysis of drainage patterns
 - Analysis of drainage channels

Summary reports on these and any other initial investigations and analyses will be prepared for the city.

11-200 with 1 column revision

equation 2 is reasonable for surface bursts but will underestimate airburst overpressures. It is sufficient for conveying the concepts of shock wave and atmospheric pressure changes (wind) as a result of a nuclear detonation. Detailed airburst overpressure calculations are discussed in sections 3.64 through 3.78 of reference 13. The EMP range estimated in equation 4 is the maximum distance that the EMP can reach. Electrical equipment damage is greatest near the detonation point and declines as you approach the edge of the EMP range. A detailed discussion of the destructive potential of the EMP effect is given in sections 11.27 through 11.59 of reference 13. Estimating radiation dosage, particularly biologically damaging radiation dosage, is the most complicated and uncertain of the nuclear detonation estimates. Equation 5 is a simple estimate. It does not include air-secondary gamma radiation or gamma radiation from fission fragments. The basic concept—that radiation is released in lethal amounts—is adequately represented.

Listing 1, BLAST.BAS, is a short program that calculates Q, P, and REMS for a nuclear detonation. It is written in Microsoft BASIC for the CP/M-80 operating system. [Editor's note: These programs will run on most machines that use the Microsoft BASIC interpreter.] Once Q,

Table 1: Example outputs from program BLAST.BAS.

Input Values			Calculated Values			
Height (ft)	Yield (Mt)	Slant range (mi)	Thermal flux (cal/cm ²)	Over-pressure (psia)	EMP range (mi)	Radiation dosage (rems)
0	1	1	525.0	38.0	0	4974
0	1	10	5.3	0.5	0	50
0	1	20	1.3	0.2	0	12
0	20	1	10500.0	517.0	0	99472
0	20	10	105.0	2.7	0	995
0	20	20	26.0	0.8	0	249
1000	1	1	525.0	38.0	39	4974
1000	20	20	26.0	0.8	39	249

For all examples $f = 0.35$ and $T_A = 0.5$.

P, and REMS are known, an interpretation of their effect on physical and biological systems is made using the tables provided by Sartori in reference 1. Several numerical examples are presented in table 1.

NUCLEAR FALLOUT

Nuclear fallout is the deposition of radioactive dust and debris carried into the atmosphere as a result of a nuclear detonation. The point of deposition of the fallout depends on climatic conditions such as ambient air temperature and pressure and wind conditions.

Let's look at a simple model of the

spatiotemporal distribution of fallout. The model assumes that the distribution of fallout proceeds as a random walk (or Brownian motion) distribution (reference 14). Although many other factors play a role in determining fallout distribution (reference 15), the random walk model is a reasonable method for estimating the time it takes fallout to reach a particular location. A Gaussian distribution is the solution of the convection-diffusion equation representing the random walk problem. I make the additional assumption that gravity minimizes vertical movement of radioactive par-

(continued)

with many revisions, as easily as it knocks out a memo?

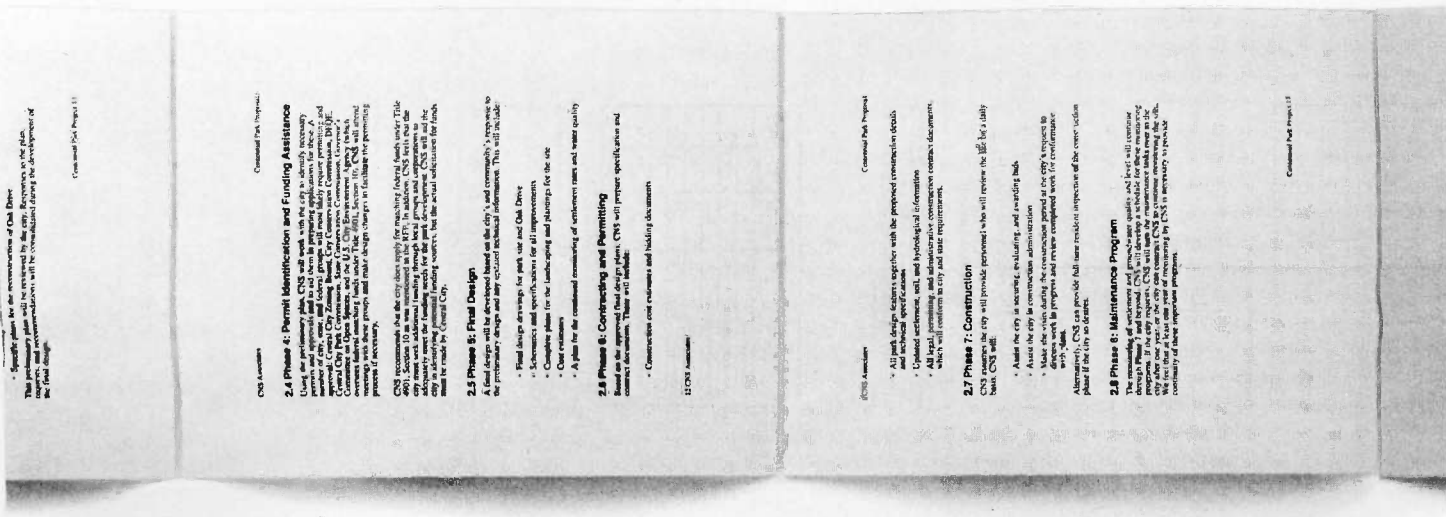

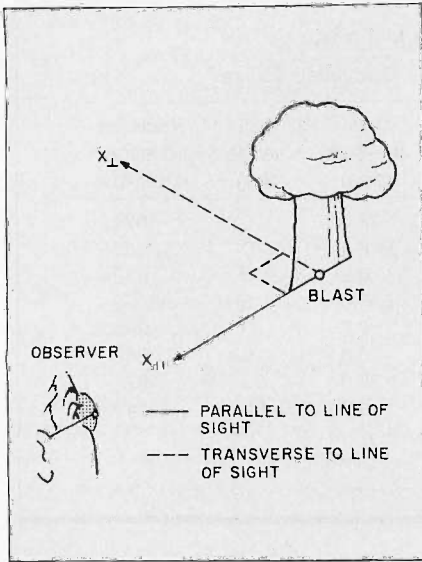

Figure 1: Coordinate system for fallout calculation.

ticulates so that fallout is distributed primarily in the horizontal plane. With these assumptions, and separating the wind velocity into two components aligned parallel and transverse to the observer's line of sight (figure 1), I obtain a fallout distribution of the form seen in figure 2, where v_{\parallel} , v_{\perp} and D_{\parallel} , D_{\perp} are the velocity and dispersion of the radioactive particulates, respectively. The velocity is typically wind velocity, and the constant U_0 is defined as the maximum

$$U(x_{\parallel}, x_{\perp}, t) = \frac{U_0 x'_{\parallel} x'_{\perp}}{\sqrt{D_{\parallel} D_{\perp}} t^2} e \left[-\frac{(x_{\parallel} - v_{\parallel} t)^2}{4D_{\parallel} t} - \frac{(x_{\perp} - v_{\perp} t)^2}{4D_{\perp} t} \right]$$

Figure 2: Fallout distribution equation.

$$U(D, O, t) = U_0 \frac{t_{max}}{t} \left\{ e \left[\frac{(D - v_{\parallel} t_{max})^2}{4D_{\parallel} t_{max}} - \frac{(D - v_{\perp} t_{max})^2}{4D_{\perp} t} \right] \times e^{[(v_{\perp}^2 t_{max} - v_{\perp}^2 t) / 4D_{\perp}]} \right\}$$

Figure 3: Fallout distribution equation as a function of time.

value of the fallout at the observer's location. A value of the constant x'_{\parallel} is fixed by the condition

$$U(x_{\parallel}^{obs}, x_{\perp}^{obs}, t_{max}) = U_0 \quad (6)$$

The coordinates $(x_{\parallel}^{obs}, x_{\perp}^{obs})$ are the observer's coordinates (D, O) , and t_{max} is the time when $U(x_{\parallel}^{obs}, x_{\perp}^{obs}, t)$ is a maximum. The maximum is determined by setting the first time derivative of U to 0 and solving for t . The result is

$$t_{max} = (1 / 2\gamma) \{ 1 + [1 + 4(D^2 / 4D_{\parallel}) \gamma]^2 \}^{1/2} \quad (7)$$

where γ is given by

$$\gamma = (v_{\parallel}^2 / 4D_{\parallel}) + (v_{\perp}^2 / 4D_{\perp}) \quad (8)$$

Collecting the above results yields the *(continued)*

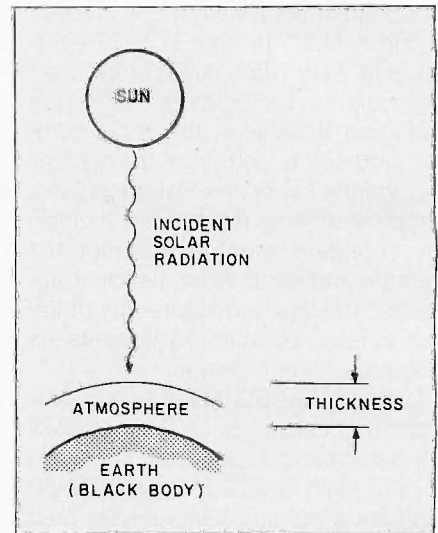

Figure 4: A simple temperature model.

Sure it's not impossible, but it could be a lot easier.

4 Project Management

CNS has assigned a project team of environmental professionals from its staff, as well as consultants, to assist with all facets of the project from site to final design and construction. The project team includes the following individuals for the Central City project:

Project Management	CNS	Woodward and Clyde	Central City
Project Management	X	O	X
Environmental Engineering	O	X	X
Environmental Architecture	X	X	O
Urban Design	X	X	O
Community Participation	O	O	X
Construction Administration	O	O	X

5 Project Team

CNS has chosen experienced architectural, landscape, landscape architects, and environmental engineers to assist with the project. The project team includes the following individuals for the Central City project:

```

graph TD
    CNS[Central City] --- PM[Project Manager: S. McGuire]
    CNS --- Design[Design: R. O'Neil]
    CNS --- Landscape[Landscape: C. Skermer]
    CNS --- Urban[Urban Eng: M. Miller]
    CNS --- Env[Env. Eng: S. Blum]
    CNS --- Const[Construction: W & F]
    
```

Yes, Lotus Manuscript™ is a very different kind of word processor. Because when you're processing long, technical documents such as proposals, specifications and reports, you have very different kinds of needs.

Needs like mixing text and graphics on the same page. Or, creating complex equations. Or, working with columns and tables. Or, making wholesale revisions.

Very often technical documents require the mixing of text and graphics on the same page. Graphics from Lotus® 1-2-3®, Symphony® and Freelance® Plus. With Manuscript you can import diagrams, and scanned images, as well as spreadsheets and charts.

Another feature designed specifically for the writer of technical documents is Manuscript's integrated Outliner. When you collapse the document you're able to navigate the outline much easier than wading through

Manuscript allows you to mix text and graphics on the same page.

You can throw away your scissors and glue, cut and paste are a thing of the past.

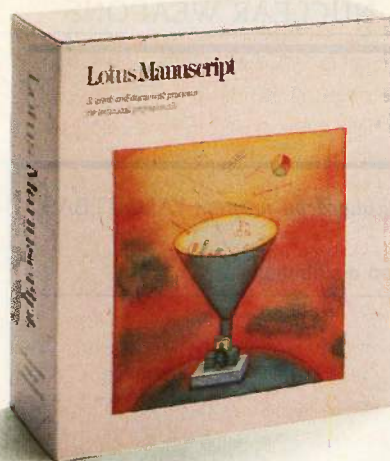

the entire piece. You can move a page, or even an entire chapter with just a few keystrokes.

Also, because Manuscript is structured, you can globally format an entire document or format by individual sections. Imagine changing all headlines from 14 point plain text to 16 point bold, all with just one command.

How about the age-old dilemma of proof reading revisions? Manuscript's Document Compare feature highlights changes between revisions. You might call it fool-proofreading.

Also, Manuscript automatically sizes and generates math equations as well as upper and lower case Greek symbols, diacritical marks and brackets. No longer do

you need to literally cut and paste to create complex equations.

With our powerful Print Formatter you can control the look of your document with the creation and editing of tables. You can choose fonts and point sizes from a built-in typeface list. You can even save format information as a template for regular use.

As for the quality of output, Manuscript takes full advantage of today's printing technology, from dot-matrix to laser, including PostScript® printers.

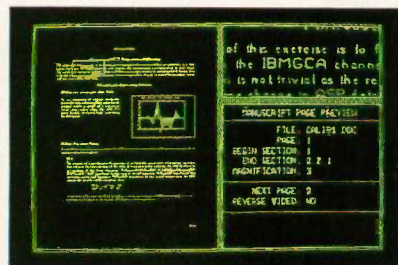

With our Document Preview feature you can see exactly how any page will look before it's printed.

Manuscript is designed to work on most IBM PCs and compatibles. Its familiar 1-2-3 interface makes it easy to use. And our Manuscript evaluation kit makes it easy to try. For \$10.00, you'll get a presentation disk, working software, and a tutorial manual. To get your evaluation kit, call 1-800-345-1043, ask for lot #YD-1450. Or, for more information, see your authorized Lotus dealer, or write Lotus Development Corp., 55 Cambridge Parkway, Cambridge, MA 02142.

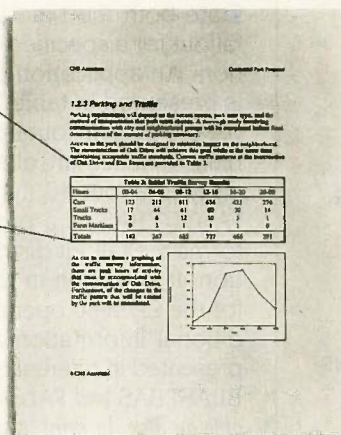

May we suggest Lotus Manuscript.

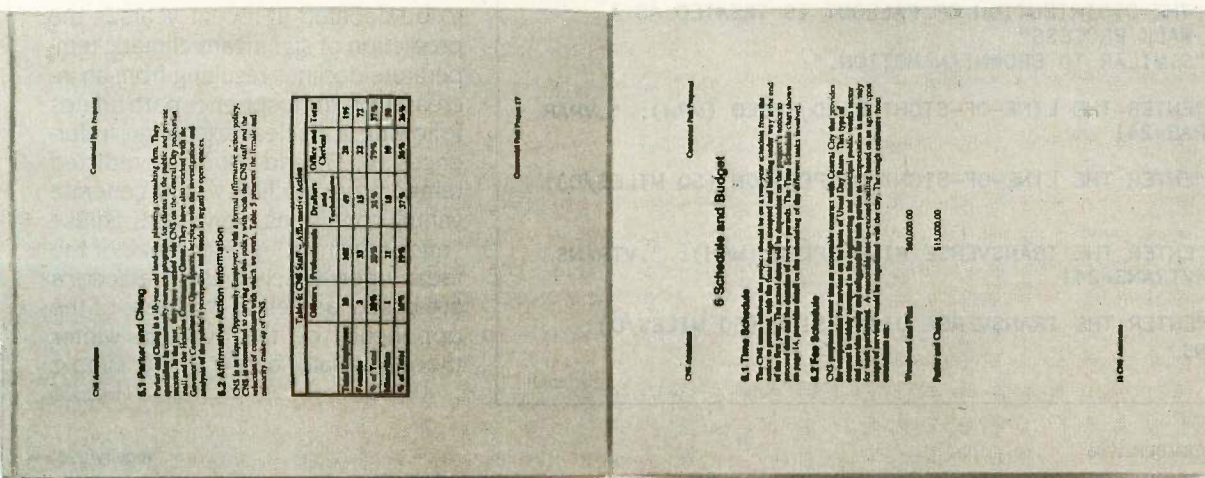

© 1986 Lotus Development Corporation
 Lotus, 1-2-3, Symphony and Freelance are registered trademarks and Lotus Manuscript is a trademark of Lotus Development Corporation. PostScript is a registered trademark of Adobe Systems, Inc. IBM is a registered trademark of International Business Machines.

Table 2: Temporal dependence of fallout as calculated by program FALOUT.BAS.

Hours	Normalized distribution
0.623	0.001
0.637	0.011
0.651	0.062
0.665	0.223
0.680	0.535
0.694	0.876
0.708	1.000
0.722	0.814
0.736	0.481
0.750	0.211
0.765	0.069
0.779	0.017
0.792	0.003

Parameters:

Y = 1 Mt $V_{line} = 10$ mph $D_{line} = 2$ sq mi/day
 D = 10 miles $V_{transverse} = V_{line}$ $D_{transverse} = D_{line}$

Listing 2: The program FALOUT.BAS.

```

30 REM FALOUT - A NUCLEAR FALLOUT CALC PROGRAM
40 REM (C) JOHN R. FANCHI, JULY 1985
50 REM MICROSOFT BASIC ON CP/M-80 OPERATING SYSTEM
60 REM CHR$(26) CLEARS SCREEN
70 PRINT CHR$(26)
80 PRINT " FALOUT - ESTIMATING THE DISTRIBUTION OF NUCLEAR
  FALLOUT"
90 PRINT
100 PRINT "(C) J.R. FANCHI, JULY 1985
110 PRINT: PRINT: PRINT
120 PRINT "ESTIMATING RADIATION DOSAGE"
130 PRINT
140 INPUT "ENTER THE YIELD OF THE NUCLEAR BLAST IN MEGATONS:
  ", Y
150 PRINT
160 INPUT "ENTER YOUR DISTANCE FROM THE BLAST IN MILES: ", D
170 PRINT
180 REMS=250*(1000*Y)/(16*3.1416*D*D)
190 PRINT "ESTIMATED RADIATION DOSAGE IN REMS: ",REMS
200 PRINT
210 PRINT: PRINT: PRINT
220 PRINT "ESTIMATING FALLOUT DISTRIBUTION"
230 PRINT
240 PRINT "THE DISTRIBUTION OF FALLOUT IS TREATED AS A
  RANDOM WALK PROCESS"
250 PRINT "SIMILAR TO BROWNIAN MOTION."
260 PRINT
270 INPUT "ENTER THE LINE-OF-SIGHT WIND SPEED (MPH): ",VPAR
280 VPAR=VPAR*24!
290 PRINT
300 INPUT "ENTER THE LINE-OF-SIGHT DISPERSION (SQ MILES/D):
  ",DPAR
310 PRINT
320 INPUT "ENTER THE TRANSVERSE WIND SPEED (MPH): ",VTRANS
330 VTRANS=VTRANS*24!
340 PRINT
350 INPUT "ENTER THE TRANSVERSE DISPERSION (SQ MILES/D):
  ",DTRANS
    
```

(continued)

expression for the fallout distribution as a function of time at the observer's location, as seen in figure 3. This equation represents an instantaneous distribution of fallout. Fallout effects on biological material are cumulative. If you want an estimate of radioactive dosage at the observer's location, integrate the equation in figure 3 with respect to time.

A major source of uncertainty in using this or any other fallout model is the determination of the constant U_0 . This constant depends on the number and type of nuclear detonations. A superposition principle can be applied for multiple blasts since the convection-dispersion equation is a linear partial differential equation. For my purpose here, it is sufficient to evaluate the ratio $U(D,0,t)/U_0$ for a single blast. The equation in figure 3 specifies the spatiotemporal fallout distribution and can be used to estimate both the time and duration of fallout for a specified observer's location. An application of this equation is presented in table 2. In that example the peak fallout from a 1-megaton blast reaches an observer 10 miles away in about 40 minutes. Listing 2, FALOUT.BAS, is a program that performs the fallout distribution calculation. It is written in Microsoft BASIC for the CP/M-80 operating system. Additional information about fallout is presented in reference 13. [Editor's note: BLAST.BAS and FALOUT.BAS are available on disk, in print, and on BIX. See the insert card following page 320 for details. Listings are also available on BYTEnet; see page 4.]

NUCLEAR WINTER

One of the more controversial issues to be debated in recent years is the prediction of significant climatic temperature declines resulting from an increase of atmospheric particulates following a nuclear exchange (references 16, 17, and 18). The predicted temperature decline would generate wintry conditions, hence the phrase "nuclear winter." The essence of the ideas upon which these predictions are based, as well as the ideas of the opponents of the nuclear winter theory, is laid bare by the simple

(continued)

Unlock your desktop with Publisher's Paintbrush.™

Finally, a paint package designed for desktop publishing! When you create or scan a 300 dpi page, you'll get a 64-screen computer image. That's why Publisher's Paintbrush lets you zoom out and work on the big picture. So you get ultra-sharp resolution without ultra-tedious labor.

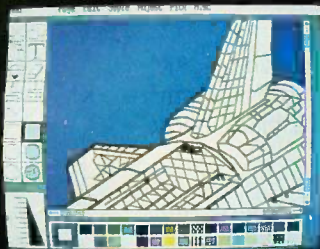

One screen of a 64-screen image.

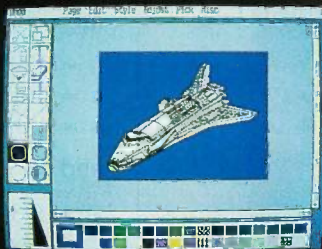

Shrink down to a manageable size.



Next, cut-and-paste . . .



A few edits later, . . . VOILA!

New typography frontiers: continuously adjustable point sizes, text slope, line and character spacing, extended and condensed type, and letter slant.

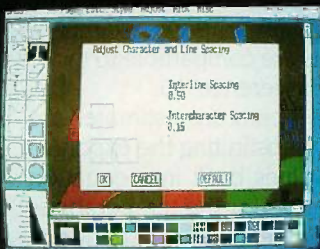

Easy-to-use menus.

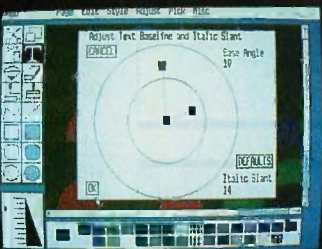

Slant and angle text 1° - 359°.



4⁺ to 250-point type.



Adjustable everything!

Publisher's Paintbrush adapts to most scanners with absolute simplicity. Scan in existing art, logos and diagrams to save many hours of work!

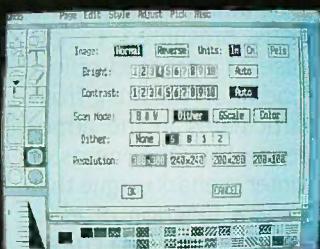

Full use of scanner features.

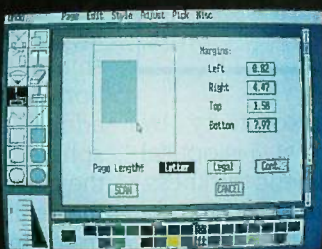

Scan all or part of a page.



Combine art and type . . .



. . . from several sources!

Publisher's Paintbrush is a quantum leap in power beyond our top-selling PC Paintbrush®. In fact, it's the dawn of a new era for desktop publishing. With it, you can produce pictures of super-high resolution (many times sharper than your screen!) and marry them into text pages. With it, you can take full advantage of desktop publishing packages, laser printers and image scanners. Without it, you're stuck with ragged edges and tedious multi-screen editing.

Publisher's Paintbrush supports major-brand image scanners and hundreds of printers and video display boards. And most desktop publishing packages have built-in links to Publisher's Paintbrush.

Say goodbye to the old boundaries. Say "Show me" to your ZSOFT dealer. Or call our corporate offices for more information.

Publisher's Paintbrush is a trademark and PC Paintbrush is a registered trademark of ZSoft Corporation. Dover Clip-Art Series is a registered trademark of Dover Publications, Inc.

Z-SOFT

1950 Spectrum Circle, Suite A495, Marietta, Georgia 30067, (404) 980-1950

Optical depth depends on weather conditions. An estimate of the exponential factor can be easily obtained by rewriting equation 10 in the form

$$e^{(-\delta x)} = [\sigma T^4] / [I_s(1-A)\epsilon]. \quad (13)$$

Values of the constants in equation 13 are

$$I_s = 1340 \text{ watts/m}^2 - \text{ }^\circ\text{K}^4$$

$$\sigma = 5.67 \times 10^{-8} \text{ watts/m}^2 - \text{ }^\circ\text{K}^4$$

$$\epsilon = 1.0 \text{ for a black body,}$$

and

$$A = 0.39 \text{ (reference 19).}$$

In these units, T must be in degrees Kelvin. Substituting these constant values into equation 13 and solving for different values of T corresponding to different weather conditions yields estimates of the exponential factor. Table 3 presents two examples. These results are comparable to those reported in reference 16.

Surface temperature estimates are obtained by substituting the exponential decay values back into equation 12. Expressions for the temperatures in degrees Fahrenheit for a sunny day and a cloudy day are given in equations 14 and 15, respectively:

$$T_s = (173.6 \text{ }^\circ\text{F})[(1-A)\epsilon]^{1/4}, \quad (14)$$

$$T_c = (150.9 \text{ }^\circ\text{F})[(1-A)\epsilon]^{1/4}. \quad (15)$$

In the nuclear winter scenario, the factor $(1-A)\epsilon$ is presumed to get smaller because of increased reflection of solar radiation resulting from additional particulates in the atmosphere (reference 16). Opponents of the nuclear winter scenario argue that the emissivity is a function of electromagnetic wavelength. As a consequence, the greenhouse effect may tend to increase emissivity and the surface temperature of the earth would not change significantly (reference 17). Insufficient information is presently available for knowing which scenario is more likely. Efforts are underway to resolve the controversy (reference 18). ■

REFERENCES

1. Sartori, L. "Effects of Nuclear Weapons." *Physics Today*, March 1983, pages 32-41.
2. Levi, B. G. "The Nuclear Arsenals of the U.S. and the U.S.S.R." *Physics Today*, March

```

360 PRINT
370 REM
380 PRINT "RADIATION DOSAGE AT YOUR LOCATION AS A FUNCTION
OF TIME"
390 PRINT "DAYS", "REMS", "NORM", "HRS"
400 REM
410 ALPHA=D*D/(4*DPAR)
420 BETA=-2*D*VPAR/(4*DPAR)
430 GAMMA=VPAR*VPAR/(4*DPAR) + VTRANS*VTRANS/(4*DTRANS)
440 TFAC=SQR(1+4*ALPHA*GAMMA)
450 TYMMAX=(1+TFAC)/(2*GAMMA)
460 FACMAX=((D-VPAR*TYMMAX)^2)/(4*DPAR*TYMMAX)
470 FACMAX=FACMAX+VTRANS*VTRANS*TYMMAX/(4*DTRANS)
480 FOR I=1 TO 20 STEP 1
490 TYM=TYMMAX*(1-.02*(10-I))
500 FACPAR=0! : FACPER=0!
510 DISPAR=D-VPAR*TYM
520 DISPER=VTRANS*TYM
530 FACPAR=DISPAR*DISPAR/(4! *DPAR*TYM)
540 IF DTRANS<>0! THEN FACPER=DISPER*DISPER/(4! *DTRANS*TYM)
550 FACTOR=FACPAR+FACPER
560 COEF=TYMMAX/TYM
570 EFFREM=REMS*COEF*EXP(FACMAX-FACTOR)
580 NORM=EFFREM/REMS
590 TYMHR=TYM*24
600 PRINT TYM, EFFREM, NORM, TYMHR
610 NEXT I
620 END
    
```

Table 3: Estimate of optical depth.

Conditions	Temperature	Exponential factor
Sunny day	100°F (311°K)	0.648
Cloudy day	80°F (300°K)	0.560

Parameters:

$$A = 0.39 \quad \epsilon = 1.00$$

climatic temperature model depicted in figure 4. It consists of an incident electromagnetic energy source (the sun), a single absorbing layer of material (the atmosphere), and a black body (the earth). The amount of energy reaching the surface of the earth is the amount of solar energy transmitted (not absorbed or reflected) by the atmosphere. This transmitted energy is assumed to be responsible for the temperature of the earth's surface. Geothermal sources are neglected in the present simple model. Given these assumptions and performing an energy balance at the earth's surface yields

$$I_0 \epsilon e^{(-\delta x)} = \sigma T^4, \quad (10)$$

where I_0 is incident solar radiation, ϵ

is emissivity (or absorptivity by Kirchhoff's radiation law), δ is optical depth, x is the atmospheric thickness, σ is Boltzmann's constant, and T is absolute temperature of the earth's surface. Stefan's law—an exponential absorption law (references 19 and 20)—and an emissivity of 1 for a black body were used to derive equation 10. Solving equation 10 for surface temperature yields

$$T = [I_0 \epsilon / \sigma]^{1/4} e^{(-\delta x / 4)}. \quad (11)$$

The incident solar radiation is a function of the solar constant I_s and the albedo A , which is the fraction of solar radiation reflected by the atmosphere (reference 19):

$$I_0 = I_s(1-A). \quad (12)$$

1983, pages 43-49.

3. York, H. F. "Arms-Limitation Strategies." *Physics Today*, March 1983, pages 24-30.

4. Schroer, D. "Teaching About the Arms Race." *Physics Today*, March 1983, pages 52-59.

5. Hafemeister, D. W. "Science and Society Test VIII: The Arms Race Revisited." *American Journal of Physics*, March 1983, pages 215-225.

6. Fanchi, J. R. "Nuclear War Simulation." *Physics Today*, December 1984, page 15; see also the *Denver Post*, June 12, 1985, page 3; the *Detroit News*, October 16, 1985, page 1; the *San Francisco Examiner*, October 2, 1985, page E1; and the *Rocky Mountain News*, September 26, 1985, page 13-S.

7. Dyson, F. *Weapons and Hope*. New York: Harper and Row, 1984.

8. Wyden, P. *Day One—Before Hiroshima and After*. New York: Simon and Schuster, 1984.

9. Bunn, M., and K. Tsipis. "The Uncertainties of a Preemptive Nuclear Attack." *Scientific American*, November 1983, pages 38-47.

10. Steinbruner, J. "Launch Under Attack." *Scientific American*, January 1984, pages 37-47.

11. Yegorov, P. T., I. A. Shlyakhov, and N. I. Alabin. *Civil Defense—A Soviet View*. Superintendent of Documents, U.S. Government Printing Office, Washington, D.C., 1970.

12. Kearny, C. H. *Nuclear War Survival Skills*. NWS Research Bureau, P. O. Box 1144, Coos Bay, OR, 1982.

13. Glasstone, S., and P. J. Dolan, eds. *The Effects of Nuclear Weapons*. Superintendent of Documents, U.S. Government Printing Office, Washington, D.C., 1977.

14. Chandrasekhar, S. "Stochastic Problems in Physics and Astronomy" in *Noise and Stochastic Processes*, ed. by N. Wax. New York: Dover Publishing, 1954. Especially pages 16-20.

15. "APS Study Group on Severe Accidents at Nuclear Power Plants." *Reviews of Modern Physics*, July 1985, pages S78-S79.

16. Turco, R. P., O. B. Toon, T. P. Ackerman, J. B. Pollack, and C. Sagan. "The Climatic Effects of Nuclear War." *Scientific American*, August 1984, pages 33-43; also see the discussion in the Letters section of *Science*, January 28, 1985, volume 227.

17. Teller, E. "Widespread After-effects of Nuclear War." *Nature*, August 23, 1984, pages 621-624.

18. Levi, B. G., and T. Rothman. "Nuclear Winter: A Matter of Degrees." *Physics Today*, September 1985, pages 58-65.

19. Haymes, R. C. *Introduction to Space Science*. New York: John Wiley and Sons, 1971.

20. Eisberg, R. M. *Fundamentals of Modern Physics*. New York: John Wiley and Sons, 1967.

You've seen the rest. Here's your chance to buy the best.



Intelligent Backup™ from Sterling Software. The best data insurance you can buy.

With as few as two keystrokes per day, Intelligent Backup™ backs up your disks quickly, simply, and inexpensively, providing insurance against data loss due to disk crashes.

Intelligent Backup is the most complete backup system there is. And thanks to advanced technology, it is incredibly flexible and easy to use.

Unlike other backup systems, Intelligent Backup completely automates the backup process. Because it's intelligent enough to figure out which level of backup you need, it not only saves you time, it takes the uncertainty out of using a hard disk.

And Intelligent Backup is easy. With over 300 context-sensitive HELP screens, you'll probably never even need to use our easy-to-read manual.

You can backup to floppy disk, hard disk, disk cartridges, and other

disk devices. What's more, it works with IBM, Compaq, Tandy, AT&T, Leading Edge, and all compatibles and clones.

But Intelligent Backup is more than just a superior backup system. Thanks again to advanced technology, file management and manipulation are easy—even for beginners.

So don't take chances when it comes to your valuable data. Get the best data insurance you can buy. Get Intelligent Backup for only \$149.95.

TO ORDER, CALL TOLL-FREE TODAY. Outside Texas call 1-800-843-3879. In Texas call 214-250-0577. Or write to the address below. (When ordering, please add \$4.00 for shipping and handling. Texas residents add 6.125% sales tax.)

Intelligent Backup™
The intelligent choice.

INTELLIGENT BACKUP
2611 Westgrove Drive, Suite 104
Carrollton, TX 75006

Intelligent Backup is a trademark of Software Labs, Inc. Backup and TakeTwo are trademarks of InfoTools and United Software Security, respectively. Fastback is copyrighted by Fifth Generation Systems. IBM, Compaq, Tandy, AT&T, Leading Edge, and Microsoft MS-DOS are registered trademarks of International Business Machines Corp., Compaq Computer Corp., Tandy, Inc., AT&T Computer Systems, Leading Edge Products, and Microsoft Corp., respectively.

Quality

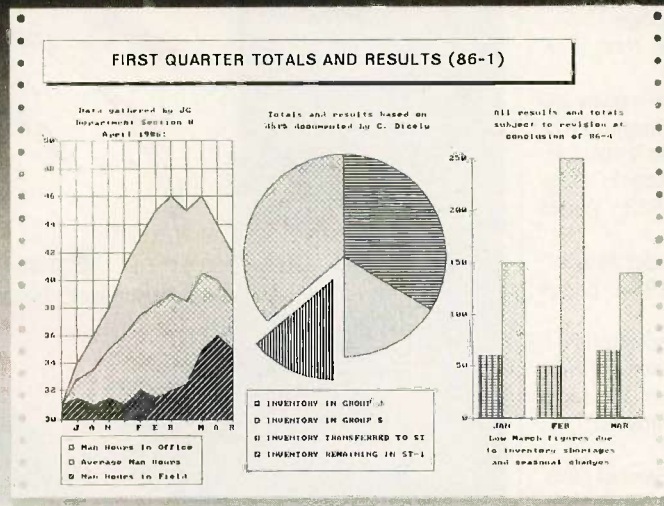

Quality in Star's line of advanced printers begins with the exceptional appearance of their letter quality printouts. They're crisp. Professional. The images sharp. And true letter quality is fast and quiet. But whether it's a spreadsheet, graphics, or a letter, all our printers give you Star quality output, because of Star's quality input.

We design our printers. We make our own precision parts. In fact, we even make the machines that make the parts. But what good is quality without control?

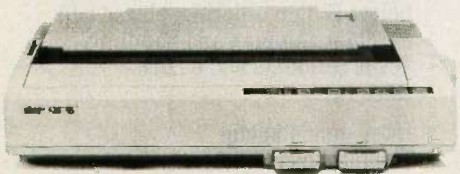

NB-15 The top of the line 24-wire business printer. 300 cps draft 100 cps true letter quality.

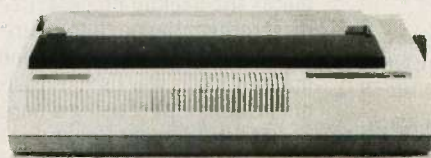

SR-10/SR-15 The high speed printers for home or office. 200 cps draft 50 cps near letter quality.

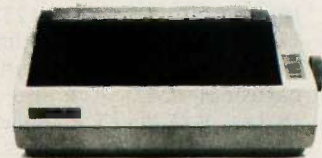

SD-10/SD-15 The no-nonsense printers that are flexible and affordable. 160 cps draft 40 cps near letter quality.

Control

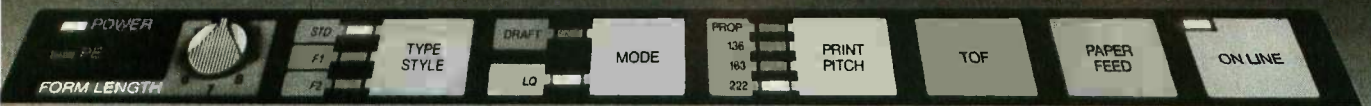

Control begins with the convenient front panel. With advanced features at your fingertips you'll find touch control throughout the entire line of Star printers.

Our premiere printer, the 24-wire NB-15™, lets you select draft or letter quality at a touch. Choose type style—either standard, or any two of five optional fonts. Print pitch—pica, elite, standard or proportional. And you can also feed in single sheets of paper automatically.

Star's line of printers also has standard memories ranging up to a 16K buffer that can expand to 32K. Draft speeds as fast as 300 characters per second (cps). True letter quality as fast as 100 cps. And of course, there's compatibility with all major personal and business computers.

Discover the quality and control of Star's entire printer line at participating ComputerLand and other computer products retailers.



NX-10/NX-15 The economical printers that combine speed and convenience. 120 cps draft. 30 cps near letter quality.

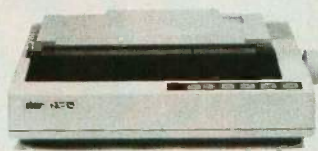

NL-10 The versatile printer with interchangeable interface cartridges. 120 cps draft. 30 cps near letter quality.

star 

MICRONICS

200 Park Avenue
New York, NY 10166 Inquiry 344

Regional Offices:

Atlanta, GA (404) 441-3126
Chicago, IL (312) 773-3717
Irvine, CA (714) 768-7203



Graphics Algorithms

HENON MAPPING WITH PASCAL by Gordon Hughes	161
ABSTRACT MATHEMATICAL ART by Kenneth E. Perry	181
THE TMS34010 GRAPHICS SYSTEM PROCESSOR by Carrell R. Killebrew Jr.	193
PLOTTING THE MANDELBROT SET by Peter B. Schroeder	207
GRAPHING QUADRIC SURFACES by George Haroney	215
FREE-FORM CURVES ON YOUR MICRO by Steve Enns	225

THE WORD GRAPHICS, derived from the Greek *graphikos*, to write, can be loosely defined as the process of representing a three-dimensional entity on a two-dimensional surface using mathematical rules of projection. The latest generation of personal computers, such as the Amiga, Atari, Macintosh, and advanced workstations, all emphasize the use of graphics. Business, engineering, medicine, and the arts have all reaped benefits from advances in the art of computer-generated images.

Programmers are continually searching for better methods, or algorithms, for representing these three-dimensional entities on computer displays. The quest for more speed, animation, and better color and realism in computer-generated graphics continues unabated.

Our December Theme articles present some interesting and innovative algorithms involving a wide range of applications. Gordon Hughes's "Heron Mapping with Pascal" demonstrates how to map complex mathematical functions that describe the behavior of dynamic systems such as asteroids, satellites, and charged particles.

The use of graphics does not always have to serve a specific application, however. We'll explore the domain of purely free-form recreational graphics. In "Abstract Mathematical Art," Kenneth E. Perry uses a BASIC program to produce cellular automata, the mathematical relatives of the Game of Life, and Peter B. Schroeder's "Plotting the Mandelbrot Set" examines the fractal geometry of nature in stunning displays on the Amiga personal computer.

The advent of high-performance, dedicated graphics microprocessor chips will provide the thrust for the next generation of graphics-oriented personal computers. Carrell R. Killebrew Jr. provides an inside look at the Texas Instruments TMS34010 Graphics System Processor. In the very near future the new generation of graphics engines will endow desktop machines with capabilities previously limited to large mainframe computers.

Engineers and scientists have a longstanding interest in plotting mathematical equations in three dimensions. "Graphing Quadric Surfaces" by George Haroney includes short BASIC routines that generate three-dimensional plots of equations in multiple colors. Steve Enns's "Free-Form Curves on Your Micro" explains how your personal computer can produce Bézier and B-spline curves that are normally confined to CAD/CAM and other high-end design applications.

All but one of the Theme articles include source code so you can experiment with these algorithms on your own personal computer and experience firsthand the fascination of computer graphics.

—Charles Weston, Technical Editor

Introducing OptiLab™

The Complete Microprocessor Development Toolbox.

You need the right tools to speed completion of your project and improve its quality.

That's why we created the OptiLab toolbox. The tools you want for beginning-to-end development and optimization of microprocessor code. OptiLab's fully-integrated, PC-based system lets you debug, analyze, modify, optimize, and test code in a seamlessly integrated environment. You can add your own cross-assembler, too.

The star of the OptiLab is Program Performance Analysis that helps you uncover invisible bugs, eliminate unneeded code, and cure program inefficiencies. OptiLab runs in real-time, is non-intrusive, and gives you outstanding performance at a remarkably low price.

There's more. OptiLab's 48-channel analyzer lets you track bus state activity and trap bugs fast. Monitor your software as it executes in real time with

the full-featured 8/16-bit In-Circuit Emulator. Send test patterns with the Input Stimulus Generator and observe their effects. With the built-in EPROM Programmer, you can program devices without leaving OptiLab.

Orion offers you ready support for more than 150 different microprocessors. MicroTargets™ allow you to run and test your software even before you have working hardware. And our crack team of

Applications Engineers is standing by if you need assistance.

But here's the real news. OptiLab is priced under \$7,000. Or, you can start with a basic Orion system for as little as \$2,995 and add capabilities as you need them.

Call now for complete information on OptiLab or other Orion microprocessor development tools. All Orion products are sold with a 15-day money-back guarantee.

	WRITE
Analyzer	OptiLab™
In-Circuit Emulator	
Line-by-Line Assembler	
Debug Package	
Performance Analyzer	
Stimulus Generator	
EPROM Programmer	ASSEMBLE
	DEBUG
	TEST
	OPTIMIZE
	SHIP

Everything from assembly to final optimization of your software can be done with the OptiLab toolbox.

OptiLab presents a graphical display of actual program performance.

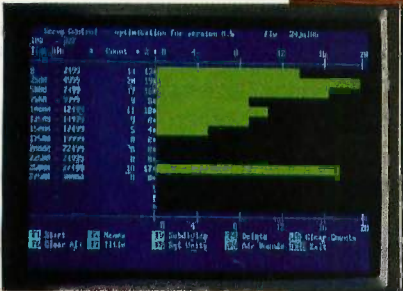

ORION
INSTRUMENTS, INC.

Call Toll Free: 1-800-245-8500
In California: (415) 361-8883

Orion Instruments, Inc., 702 Marshall Street, Redwood City, California 94063, U.S.A. Telex: 530942

HENON MAPPING WITH PASCAL

BY GORDON HUGHES

A window on the world's endless complexity

IN 1968, MICHEL HENON of the Institute for Astrophysics in Paris proposed a simple quadratic mapping of the plane as a model for the study of dynamical systems such as the motion of asteroids, satellites, or charged particles in an accelerator. Henon's mapping (see the text box "Creating a Henon Mapping" on page 170) is based on George Birkhoff's discovery in 1917 that you can reduce the study of conservative systems with two degrees of freedom to the study of area-preserving mappings of the plane. Thus, Henon set out to find an area-preserving mapping that was simple in nature but retained all the characteristics of more complicated mappings.

Although the mapping Henon proposed is easy to describe and program, it yields results of great complexity. Since Henon mappings simulate the behavior of physical systems, they indicate that many such systems are more complex than previously imagined. Mathematicians and physicists are only beginning to understand the nature of this complexity and what it says about physical systems such as the asteroid belt. In a series of results during the years

1954 to 1963, mathematicians A. N. Kolmogorov, V. I. Arnold, and J. Moser provided a partial explanation for the strange behavior of such systems. These results are now known as the KAM theorem. It is an important theorem in modern physics and has aroused a great deal of interest.

WHAT IS THE KAM THEOREM?

The KAM theorem explains mathematically what happens when a small external force disturbs a stable dynamical system, such as a satellite in orbit around Earth. One such disturbance that satellites regularly undergo is the uneven pull of gravity due to Earth's bulge at the equator. For the planets and the asteroids orbiting the sun, the chief disruptive force is the pull of Jupiter. It causes a perturbation in their orbits so that the orbits are not precisely elliptical. The question that the KAM theorem addresses is whether these slight irregularities have long-term effects leading to eventual instability.

The theorem shows that under small disturbances a stable system undergoes changes but remains stable except for microscopically small bands of potential instability

corresponding to "resonances" between the original system and the disturbance. With an asteroid disturbed by Jupiter, such a resonance will occur if the ratio of their periods is a rational number: For example, a 2/5 resonance occurs if two orbits by Jupiter take the same amount of time as five orbits of the asteroid. The KAM theorem proves that as long as the disturbances remain small the relative size of these resonance bands is insignificant and stability is assured.

Figure 1 is a Henon mapping that simulates a system undergoing successively larger disturbances. The inner curves represent a system's reaction to small disturbances and show that the system is altered slightly but remains stable. (The microscopic resonance bands are much too small to be visible in this scale.)

However, if the disturbance in-

(continued)

Gordon Hughes is a professor of mathematics at California State University. He worked as an engineer in the early Polaris program. He has a B.A. in physics from Brown University and a Ph.D. in mathematics from the University of California. He can be reached at the Department of Mathematics, California State University, Chico, CA 95926.

creases in magnitude past a certain threshold value, some of the resonance bands will suddenly widen. In figure 1, for example, the first noticeable widening is the resonance band with six "islands," indicating a $1/6$ resonance. An asteroid with a period $1/6$ that of Jupiter would find itself on such a resonance band.

With even higher disturbances, the resonance bands might dominate the system's behavior, as indicated by the outer band of seven large islands. The scattered dots around these islands indicate areas of instability. Similar areas exist between the islands of each resonance band. An asteroid caught in one of these regions could experience erratic behavior and even be thrown from its orbit, as indicated by the faint dots escaping around figure 1. Such resonances are believed

to cause the Kirkwood gaps in the asteroid belt.

Scientists have known for some time that resonances between two interacting forces can lead to instability in the form of erratic or extreme behavior. In electrical circuits, such resonances are sometimes exploited to amplify selected signals. But the KAM theorem shows that, at least for small interactions, the resonances don't lead to abrupt changes in behavior. The system "stretches" smoothly and doesn't break.

EXTENDING THE KAM THEOREM

Although the KAM theorem is a landmark result in the study of stability, it is concerned entirely with very small disturbances. Thus, it doesn't address the question of the sudden widening of the bands, nor does it attempt to

explain the exact nature of the resonance bands. The KAM authors knew that these regions would be very complex in nature due to the buildup of resonances. The close-up in figure 2 gives some hint of the complexity involved. The pointed region at the center is an unstable hyperbolic fixed point that always exists between stable islands. You can see two thin resonance bands just to the left of this point. At the top and bottom are the edges of the large islands. The smaller islands are secondary resonances of the large islands. These in turn generate third-order resonances and the process continues forever with endless chains of smaller and smaller islands extending into the chaotic center region. The central region appears to be a scattering of random points but is actually a complex interweaving of tiny islands and their corresponding hyperbolic points.

As far back as 1892, Henri Poincaré predicted the possibility of chaotic behavior in certain celestial motions due to these resonances. Since then, a number of prominent physicists and mathematicians have wrestled with the question. George Birkhoff invented an elaborate code called "symbolic dynamics" to represent the structure of these regions. Recent studies by mathematicians such as Stephen Smale center on using mathematical topology, an outgrowth of geometry.

These questions are not just theoretical. The KAM theorem applies to a wide range of ordinary physical systems. Therefore, the study of resonance thresholds and the resonance bands has a number of practical ramifications for items in the physical world, from atomic particles to galactic clusters. At the 1985 NATO conference on the stability of the solar system (see Szebehely in the bibliography), a number of results centered on the KAM theorem and its consequences for the stability of the planets and satellites. Because stability is concerned with a system's long-term behavior, many years may pass before scientists observe any effects. The solar system's long-range stability is still an open question. For asteroids, satellites, and charged particles in an

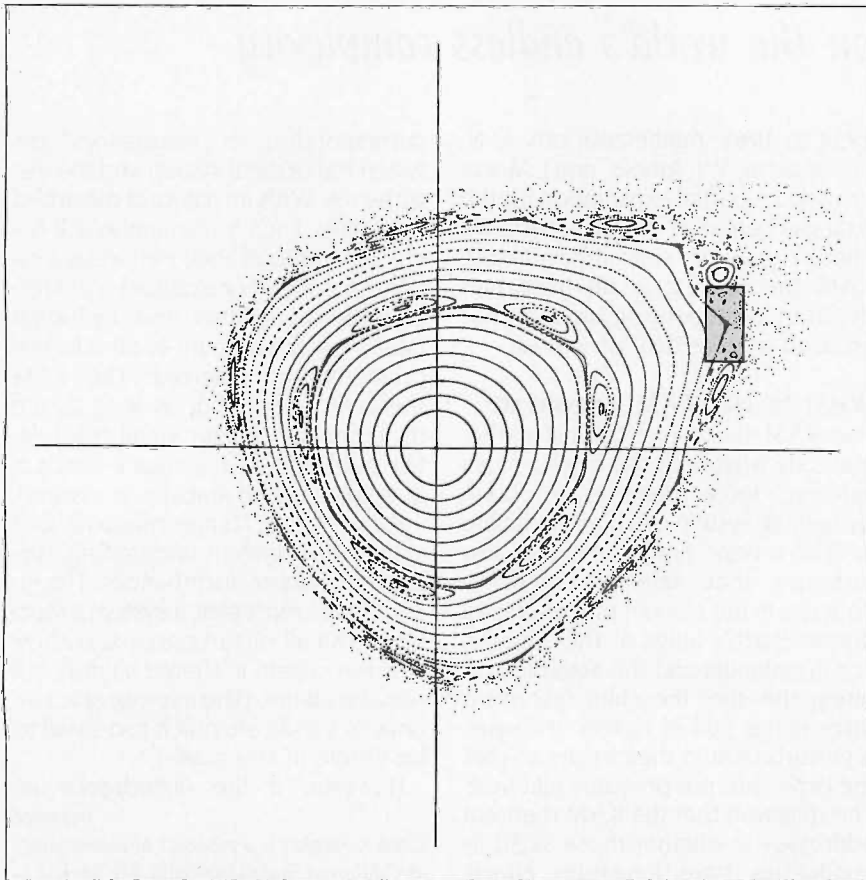

Figure 1: A Henon mapping with phase angle $A = 1.111$ radians. The scale is -1.2 to 1.2 on both the x and y axes. Thirty-eight orbits are shown, each consisting of 700 iterations of a single starting point. The outlined area is enlarged in figure 2. (Use the parameter file A111P.01 with HENON2.COM or the values above with HENON1.COM to create this mapping.)

accelerator, the effects of any instability are magnified either by their relatively small size or by their high energies. These provide good test cases for the KAM theorem.

COMPUTER SIMULATION

Among the most useful tools for investigating the behavior of physical systems is computer simulation. Typically, such simulations are complex and require extensive numerical integration. Even on large-scale computers, these simulations can take hours. However, almost any micro-computer can carry out an iterative simulation such as the Henon mapping in a matter of minutes. Using Turbo Pascal on an IBM PC, you can generate the mapping in figure 1 in about 50 seconds. Listing 1, HENON1.PAS, contains a short Henon mapping program. [Editor's note: Turbo Pascal source code listings for HENON1.PAS and HENON2.PAS (a longer, more comprehensive Henon mapping program) are available on disk, in print, and on BIX; see the insert card following page 320 for details. Listings are also available on BYTENet; see page 4.]

Such simulations provide insight into the structure of resonance bands and the possible mechanisms for their widening. For example, simulations conducted by Joseph Ford at Georgia Tech seem to indicate that widening is brought on by neighboring resonances combining together. L. Jackson Laslett at the Lawrence Berkeley Laboratory devised an iterative mapping similar to Henon mapping to show the side effects of resonances between a beam of charged particles and the guiding electrical field.

The amount of detail available on a Henon mapping is more a function of software than of hardware. The difference between a display at 640 by 200 pixels and one at 320 by 200 is not significant if you can magnify the area of interest sufficiently. However, accurate magnification of a Henon mapping requires speed and precision. At high magnification, you may need to generate 10,000 points to get one within the region of interest. Since the mapping is iterative, you

(continued)

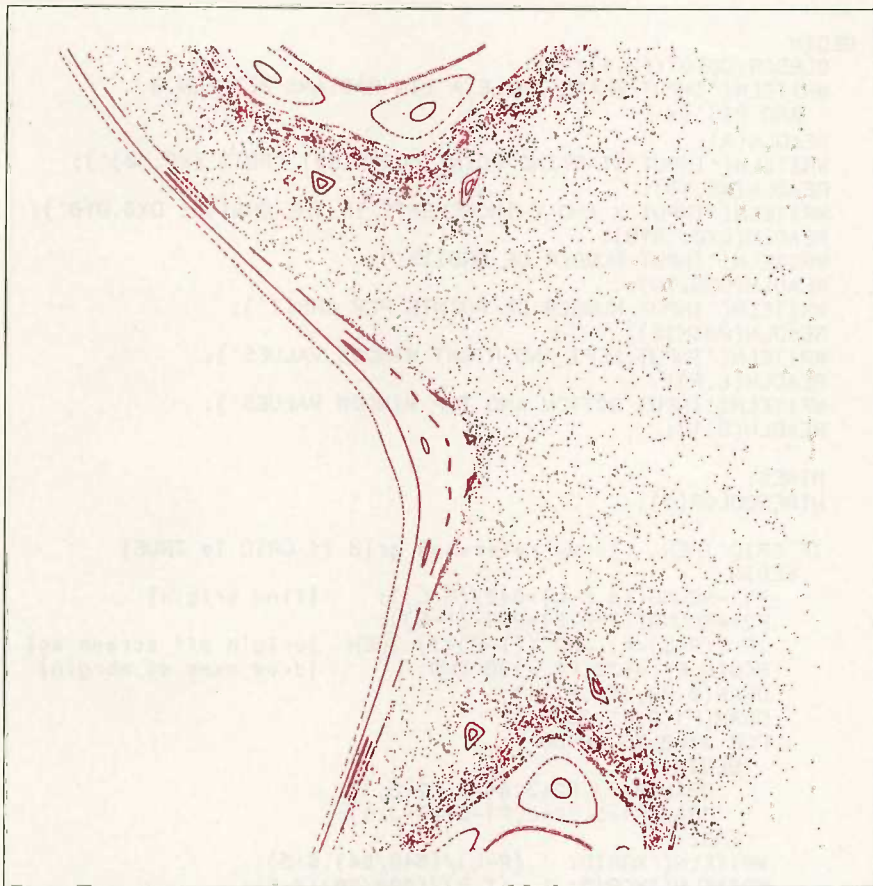

Figure 2: An enlargement of the outlined area in figure 1. This mapping also has a phase angle $A = 1.111$ radians. The scale is 0.74 to 0.95 on the x axis and 0.27 to 0.48 on the y axis. Thirty-two orbits are shown, each consisting of 10,000 points. (Due to the number of points per orbit, this particular Henon mapping is quite time-consuming to produce. Its parameter file is A111P.02. However, you can save time by using the stored screen file A111.02 with HENON2.COM.)

Listing 1: HENON1.PAS, a short Pascal program for generating Henon mappings. This is written in Turbo Pascal for 640- by 200-pixel resolution on an IBM PC. To see a sample plot, use the defaults by pressing Return when asked for data. (Note: Both HENON1.PAS and HENON2.PAS are written to be executed as .COM files.)

```
PROGRAM HENON1; {short version of Henon mapping program}
CONST
  MAXREAL: REAL = 1E+10;
VAR
  I, J, P1, P2, ORBITN, POINTS, RESPONSE: INTEGER;
  R, L, T, B, A, XOLD, YOLD, XNEW, YNEW, X0, Y0, DX0, DY0, XSCALE, YSCALE,
  COSA, SINA: REAL;
  GRID: BOOLEAN; {set this to FALSE to turn off the grid}
BEGIN
  GRID:=TRUE; A:=1.111; L:=-1.2; R:=1.2; B:=-1.2; T:=1.2;
  X0:=0.098; Y0:=0.061; DX0:=0.04; DY0:=0.03; ORBITN:=25;
  POINTS:=500;
  WHILE RESPONSE <> 2 DO      {quit when RESPONSE is 2}
```

(continued)

```

BEGIN
  CLRSCR;GOTOXY(2,1);
  WRITELN('INPUT PHASE ANGLE A (IN RADIANS BETWEEN 0
    AND PI)');
  READLN(A);
  WRITELN('INPUT STARTING POINT FOR FIRST ORBIT (X0,Y0)');
  READLN(X0,Y0);
  WRITELN('INPUT X AND Y INCREMENTS IN THE ORBITS: DX0,DY0');
  READLN(DX0, DY0);
  WRITELN('INPUT NUMBER OF ORBITS');
  READLN(ORBITN);
  WRITELN('INPUT NUMBER OF POINTS PER ORBIT');
  READLN(POINTS);
  WRITELN('INPUT LEFT AND RIGHT WINDOW VALUES');
  READLN(L,R);
  WRITELN('INPUT BOTTOM AND TOP WINDOW VALUES');
  READLN(B,T);

  HIRES;
  HIRESCOLOR(3);

  IF GRID THEN {draw reference grid if GRID is TRUE}
  BEGIN
    P1:=ROUND((0.0-L)*640/(R-L)); {find origin}
    P2:=ROUND((T-0.0)*200/(T-B));
    IF ((R-L)<R) AND ((T-B)<T) THEN {origin off screen so}
    BEGIN P1:=630;P2:=190 END; {draw axes at margin}
    DRAW(0,P2,640,P2,1);
    DRAW(P1,0,P1,200,1);
    FOR J:=0 TO 20 DO
      BEGIN
        DRAW(64*J,P2+3,64*J,P2-3,1);
        DRAW(P1+5,20*J,P1-5,20*J,1);
      END;
    WRITELN('XGRID: ',(R-L)/(640/64):6:5);
    WRITELN('YGRID: ',(T-B)/(200/20):6:5);
  END;

  GOTOXY(1,1); {display plot parameters}
  WRITELN('A = ',A:6:5);
  WRITELN('X0 = ',X0:6:5,' Y0 = ',Y0:7:6);
  WRITELN('DX0 = ',DX0:7:6);
  WRITELN('DY0 = ',DY0:7:6);
  WRITELN('X SCALE: ',L:6:5,' TO ',R:6:5);
  WRITELN('Y SCALE: ',B:6:5,' TO ',T:6:5);
  WRITELN(' ');
  WRITELN(' ');
  GOTOXY(1,22);
  WRITELN('ORBITS CAN BE ADVANCED MANUALLY BY PRESSING ANY
    KEY');

  COSA:=COS(A);SINA:=SIN(A);
  XOLD:=X0;YOLD:=Y0; {starting point for first orbit}
  XSCALE:=640/(R-L);YSCALE:=200/(T-B);
  FOR J:=1 TO ORBITN DO {main loop, J is orbit number}
  BEGIN
    GOTOXY(1,19);
    WRITELN('Orbit #',J, ' of ', ORBITN);
    WRITELN('Current X0,Y0 = ',XOLD:6:5,' ',YOLD:6:5);
    I:=1;
    WHILE I <= POINTS DO {WHILE allows easy abort}
    BEGIN
      IF (ABS(XOLD)<MAXREAL) AND (ABS(YOLD)<MAXREAL) THEN
      BEGIN
        XNEW:=XOLD*COSA-(YOLD-XOLD*XOLD)*SINA; {Henon map}
        YNEW:=XOLD*SINA+(YOLD-XOLD*XOLD)*COSA;
        IF (ABS(XNEW-L)<MAXINT/XSCALE) AND
          (ABS(T-YNEW) < MAXINT/YSCALE) THEN
          BEGIN

```

(continued)

cannot skip intermediate points in the calculations. This slows things down considerably.

Also, at high magnification, the points plotted may differ only by the 10th or the 15th decimal place. You can't ignore any of these digits because the intermediate points—those outside the region of interest—must all be generated with high precision. Therefore, extended precision is necessary to allow good magnification. You can obtain reasonable results with Pascal and extended precision (11 decimal places). The extra speed and precision of 8087 support would be welcome for high magnifications.

INTERPRETING HENON MAPPINGS

Because Henon mappings simulate dynamical systems undergoing disturbances, you can use them to illustrate the workings of the KAM theorem. But a Henon mapping does not represent a physical picture of the system's motion. Rather, it is a cross section of that motion in terms of a phase plot. For planetary motion, this phase plot may resemble an actual orbit, but there are some important differences.

A phase plot is a graph where one axis is the rate of change, or derivative, of the other axis. For example, in figure 1 the horizontal axis represents position, and the vertical axis, velocity. Such phase plots are common for studying a physical system's long-term behavior.

PHASE PLOTS FOR TWO PHYSICAL SYSTEMS

Figure 3 shows the phase plot for a pendulum. It has one degree of freedom since the only motion is angular. The horizontal axis is the angular position θ (in radians), and the vertical axis is the angular velocity $d\theta/dt$ (in radians per second). If you raise the pendulum slightly and let it go, it oscillates back and forth forever (ignoring friction). During each oscillation, there is a smooth and continuous trade-off between the velocity and the position, that is, between kinetic energy (KE) and potential energy (PE). On the phase plot this shows up as a rotation around one of

(continued)

NEW

PhotoMetric 200™

THE LEADING DESK TOP SLIDEMAKER



Unretouched PhotoMetric image.

TERRIFIC SLIDES FROM POPULAR SOFTWARE.

Use any popular graphics package like Lotus Freelance™, Microsoft Chart 2.0™, Ashton-Tate Chart-Master™, our popular PictureIt™ and many more. Call for the list.

2000 x 2000 RESOLUTION SLIDES IN 1000 BRILLIANT COLORS.

Everything you need: PhotoMetric 200 Desktop Film Recorder, PC Board and PhotoMetric software. All for \$5995.

FIND OUT ABOUT IT. Call 1-800-556-1234, Ext. 533. In California, call 1-800-441-2345, Ext. 533. Or write 1250 Ninth Street, Berkeley, CA 94710.

General Parametrics Corporation

the makers of VIDEOSHOW™

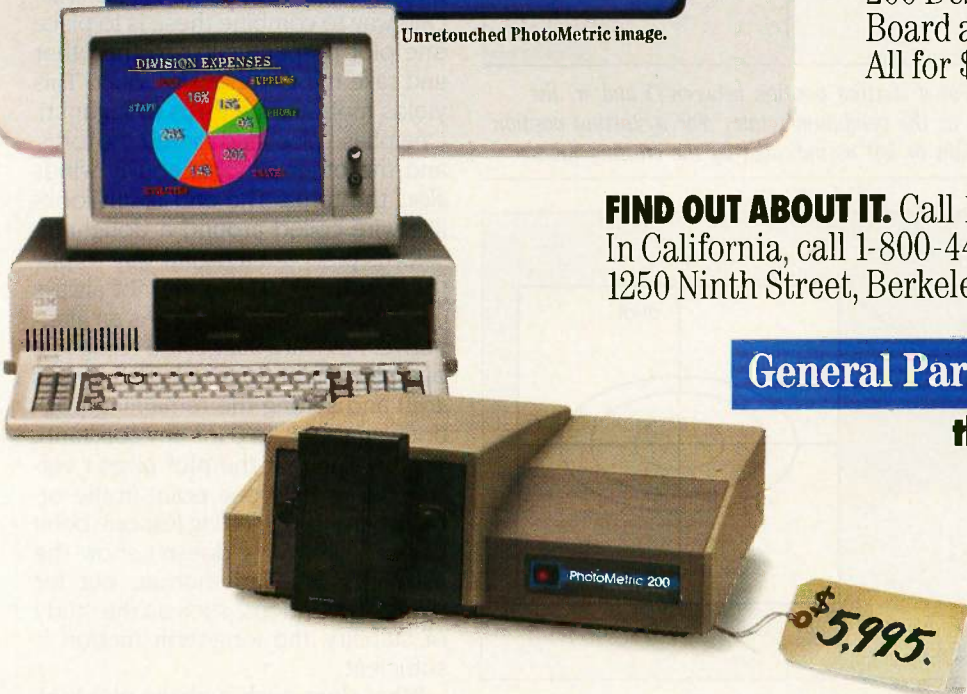

Also available: PhotoMetric 200VS for use with VideoShow 160.

VideoShow, PhotoMetric and PictureIt are trademarks of General Parametrics Corporation. Freelance and Lotus are registered trademarks of Lotus Development Corp. Chart 2.0 is a trademark of Microsoft. ChartMaster is a trademark of Ashton-Tate. IBM is a trademark of International Business Machines Corp.

```

P1:=ROUND((XNEW-L)*XSCALE); {scale new point}
P2:=ROUND((T-YNEW)*YSCALE);
PLOT(P1,P2,1);
END;
XOLD:=XNEW;
YOLD:=YNEW;
END;
IF KEYPRESSED THEN I:=POINTS+1 ELSE I:=I+1;
END; {WHILE I. End of orbit plot}
XOLD:=X0+J*DX0; {next starting point}
YOLD:=Y0+J*DY0;
END; {for J}
GOTOXY(1,22);
WRITELN('SELECT ONE: (1) NEW PLOT (CARRIAGE RETURNS WILL
REPEAT CURRENT DATA)');
WRITELN('                (2) QUIT');
READLN(RESPONSE);
END;
END.
    
```

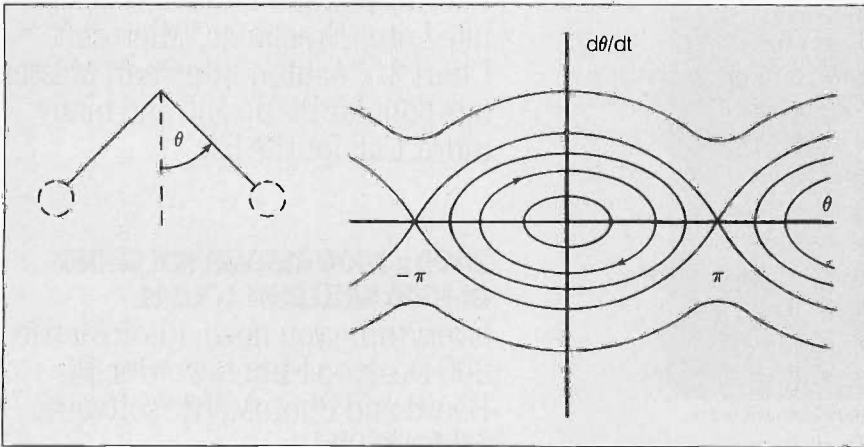

Figure 3: Phase plot of a pendulum. For a starting position between 0 and π , the phase plot will follow one of the ellipses as the pendulum rotates. For a starting position at π or $-\pi$, the pendulum could fall right or left as indicated by the crossing lines.

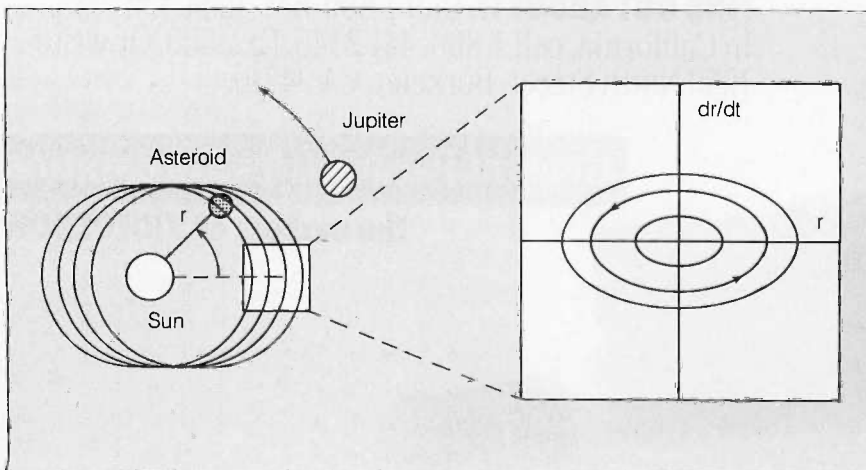

Figure 4: Phase plot for an asteroid under the influence of the sun and Jupiter. Though there are two degrees of motion, angular and radial, only the radial motion is shown in the phase plot.

the ellipses. The actual ellipse depends on the pendulum's starting position and starting velocity. For small oscillations, these ellipses are nearly circles. In a nonconservative system where frictional forces are allowed, the ellipses become spirals indicating a slowing of the pendulum. Since Henon mappings deal with conservative systems, no such spirals are seen. If you assume that the pendulum is on a rigid bar and is given sufficient push (large initial angular velocity), it might become a rotor and not oscillate at all. This scenario is represented by the wavy lines at the top and bottom of figure 3.

The phase plot in figure 4 is a Poincaré cross section that represents motion with two degrees of freedom, such as an asteroid orbiting the sun. The asteroid's orbit is assumed to lie in a plane, so the two possible motions are angular and radial. You can describe the asteroid's position in polar coordinates as (r, θ) . Note that the orbit shown in figure 4 is not quite closed. This is due to the disruptive pull of Jupiter (and, to a lesser extent, the other planets).

There are now two possible phase plots: r versus dr/dt and θ versus $d\theta/dt$. One way to combine these is to place one plot perpendicular to the other and take the Cartesian product. This yields motion on a torus (doughnut). One phase plot winds around the torus, and the other simultaneously winds along the torus. The end result looks like wire coiled around a doughnut.

Torus plots are a useful way to picture motion, but they are not always easy to draw or interpret. As an alternative, Poincaré suggested using just one phase plot (for example, r versus dr/dt) and setting the remaining position variable, θ , to 0 (or any constant). This means that the plot gives r versus dr/dt at only one point in the orbit: when $\theta = 0$. Plotting just one point per orbit certainly doesn't show the asteroid's detailed motion, but for many applications, such as the study of stability, the long-term motion is sufficient.

What does such a phase plot look like? If the orbit is a perfect ellipse (without the pull of Jupiter), all you

(continued)

EGAWONDER™

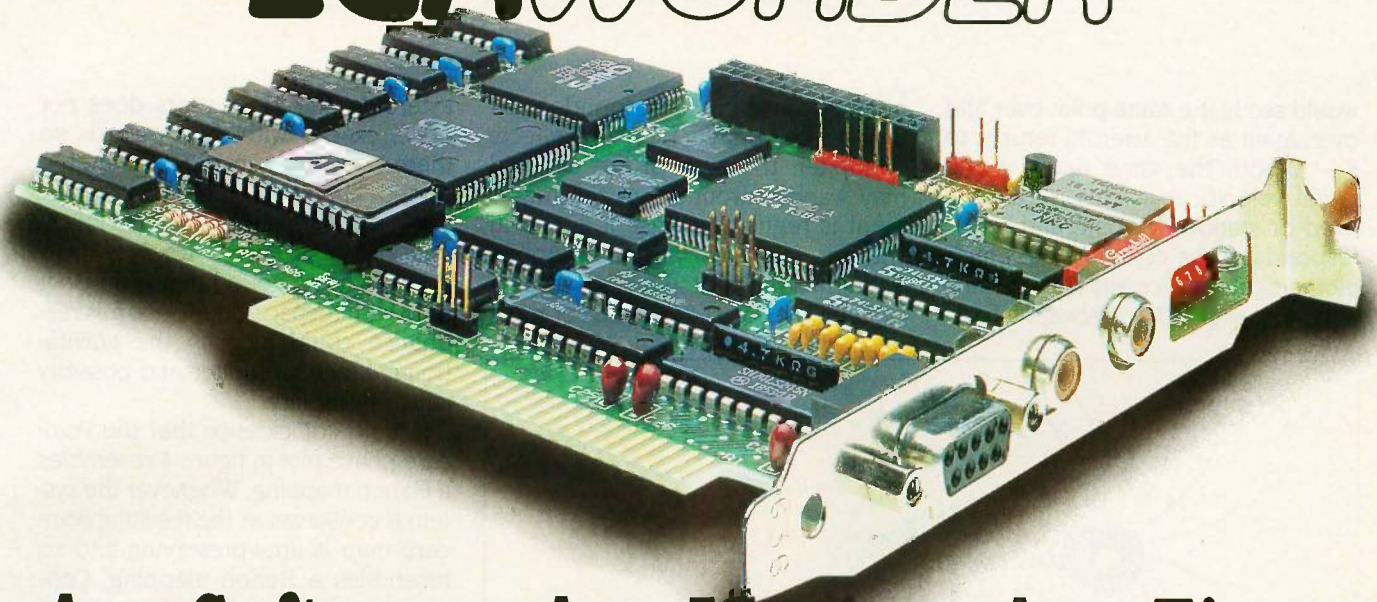

Any Software. Any Monitor. Any Time.

EGA Software

Hercules Software

EGA Software

Hercules Software

EGA Software

Hercules Software

ATI Technologies Inc.

ATI Technologies Inc.

ATI Technologies Inc.

ATI EGA Wonder is an EGA breakthrough. In the past, most video cards have been limited to either Hercules software or the IBM Portable P.C. software. The ATI EGA Wonder brings the design philosophy of the breakthrough to that it now allows all of the major software standards from IBM, Hercules, and the IBM Portable P.C. to be used on the same monitor. It also runs 132 columns.

ATI EGA Wonder is an EGA breakthrough. In the past, most video cards have been limited to either Hercules software or the IBM Portable P.C. software. The ATI EGA Wonder brings the design philosophy of the breakthrough to that it now allows all of the major software standards from IBM, Hercules, and the IBM Portable P.C. to be used on the same monitor. It also runs 132 columns.

ATI EGA Wonder is an EGA breakthrough. In the past, most video cards have been limited to either Hercules software or the IBM Portable P.C. software. The ATI EGA Wonder brings the design philosophy of the breakthrough to that it now allows all of the major software standards from IBM, Hercules, and the IBM Portable P.C. to be used on the same monitor. It also runs 132 columns.

ATI EGA Wonder is an EGA breakthrough. In the past, most video cards have been limited to either Hercules software or the IBM Portable P.C. software. The ATI EGA Wonder brings the design philosophy of the breakthrough to that it now allows all of the major software standards from IBM, Hercules, and the IBM Portable P.C. to be used on the same monitor. It also runs 132 columns.

CGA Software

132 Column Software

CGA Software

132 Column Software

CGA Software

132 Column Software

EGA Monitor

EGA Wonder runs EGA, CGA, MDA, Hercules and 132 Columns on an Enhanced Graphics Display. CGA text is improved to 8x14 and graphics are double scanned for a high quality display.

TTL Monochrome Monitor

EGA Wonder runs EGA, CGA, MDA, Hercules and 132 Columns on a TTL Monochrome Monitor. Colors of EGA and CGA are converted into shades, graphics are full screen and no pre-boot drivers are required.

RGB, *Composite Monitors, and the IBM Portable P.C.

EGA Wonder also runs EGA, CGA, MDA, Hercules and 132 Columns on an RGB Monitor, *Composite Monitor, and the IBM Portable P.C. in 64 colors (shades). EGA and Hercules software are interlaced for high resolution text and graphics.

*Composite Monitor and PC Portable display not shown

Features	ATI EGA Wonder	Paradise Auto Switch	Quadram and Video 7
Compatible to EGA, CGA, MDA, Hercules	✓	✓	✓
256K Video Memory	✓	✓	✓
Automatic Switching Between EGA and CGA Color Modes and Among EGA, MDA, and Hercules Modes	✓	✓	
Runs EGA, CGA, MDA, Hercules and 132 Columns on an EGA Monitor	✓		
Runs EGA, CGA, MDA, Hercules and 132 Columns on an RGB Color Monitor	✓		
Runs EGA, CGA, MDA, Hercules and 132 Columns on a TTL Monochrome Monitor	✓		
Runs EGA, CGA, MDA, Hercules and 132 Columns on a Composite Monitor	✓		
Runs EGA, CGA, MDA, Hercules and 132 Columns on an IBM Portable P.C.	✓		
Warranty	2 Yrs	1 Yr	1 Yr
Suggested List Price	\$399	\$595	\$599

EGA — Enhanced Graphics Adapter MDA — Monochrome Display Adapter
CGA — Color Graphics Adapter

* Trademarks: Paradise, Auto Switch — Paradise Systems Inc; Quad EGA+ is a trademark of Quadram Corp.; Video-7, Video-7, Incorporated; IBM PC Portable — IBM — International Business Machines.

** Any software. Any monitor. Any time.** Applies to IBM compatible graphics standards, monitors, software.

Upgrade to EGA Without An EGA Monitor

The ATI EGA Wonder goes far beyond software compatibility. It is the result of intensive development by one of the most revolutionary technology companies today — ATI Technologies Inc.

The ATI EGA Wonder is not just better technology. It is the solution for upgrading to EGA without an EGA monitor.

Only the ATI EGA Wonder displays EGA, CGA, MDA, Hercules and 132 column software on an Enhanced Graphics Monitor, an RGB Color/Graphics Monitor, a TTL Monochrome Monitor, a Composite Monitor, or the internal monitor of the PC Portable.

Only the ATI EGA Wonder provides upward compatibility to EGA and downward compatibility to CGA, MDA, and Hercules on your present monitor — EGA, RGB, TTL, Composite or PC Portable.

At ATI we have developed a better graphics card for you. Call us today at (416) 477-8804 for more information.



Inquiry 36

TECHNOLOGIES INC.

Technology you can Trust.

would see is the same point over and over again as the asteroid returns to $\theta = 0$ with the same radius r and radial velocity dr/dt . This is called a fixed or stationary point, and it corresponds to the center of the phase plot in figure 4. (For any Henon mapping, the origin (0,0) is always a fixed

point because this corresponds to an undisturbed system.) With the effects of Jupiter, the path of the asteroid may wander around, but the movement is regular because it is tied in with the 11.86-year period of Jupiter. Therefore, the motion tends to repeat on multiples of 11.86 years. For most

asteroids, the 11.86 years does not mesh exactly with their periods so there is no resonance. These are the closed curves in the phase plots. Theoretically, an asteroid could follow one of these curves forever. If an asteroid has a period that is an even ratio with respect to Jupiter's, this resonance could magnify the gravitational effects of Jupiter and possibly cause instability.

It is no coincidence that the Poincaré phase plot in figure 4 resembles a Henon mapping. Whenever the system is conservative, the resulting Poincaré map is area-preserving and so resembles a Henon mapping. Conversely, you can regard every Henon mapping as a phase plot of a physical system. For example, the two Henon mappings in figures 5a and 5b simulate phase plots for different physical systems.

ADVANTAGES OF A PHASE PLOT

Even though a phase plot sometimes makes it difficult to visualize the actual motion of a particle, the final picture provides a record of the overall behavior for extended periods of time. Generally, a smooth closed curve indicates a regular periodic, or almost periodic, motion, while a scattering of points indicates irregular motion. The islands in figure 1 represent stable orbits that have "locked on" to the particular resonance. The area between the islands is the source of irregular behavior.

From a purely practical standpoint, it is often easier to obtain a phase plot than to solve for the complete equations of motion. Even for the simple pendulum in figure 3, obtaining θ as a function of time involves evaluating an elliptic integral—a process you can do only by approximation. For example, if you assume the oscillations are small, then $\theta(t)$ is approximately a cosine curve.

A CLOSER LOOK

The center of figure 1 corresponds to an undisturbed, stable system, such as to an asteroid in an undisturbed orbit around the sun. It is a fixed point because the asteroid always returns to this point at the end of each revolu-

(continued)

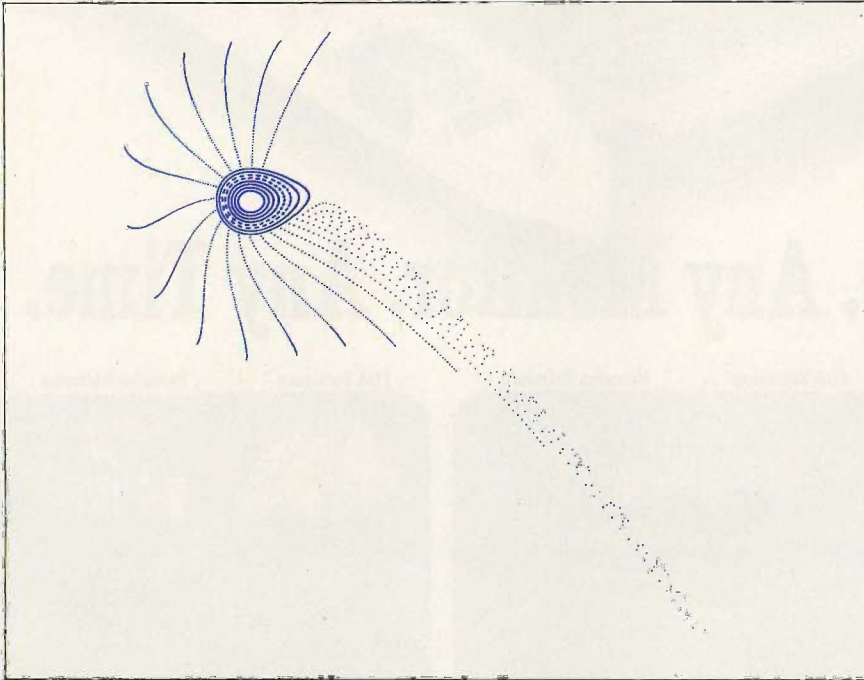

Figure 5a: A Henon mapping of the phase angle A , where $A = 0.264$ and the scale is -1.2 to 1.2 with 25 orbits and 300 points per orbit. The powerful hyperbolic point at the tip of the figure is responsible for the "aura" of points around the figure. (The parameter file is A0264P.01.)

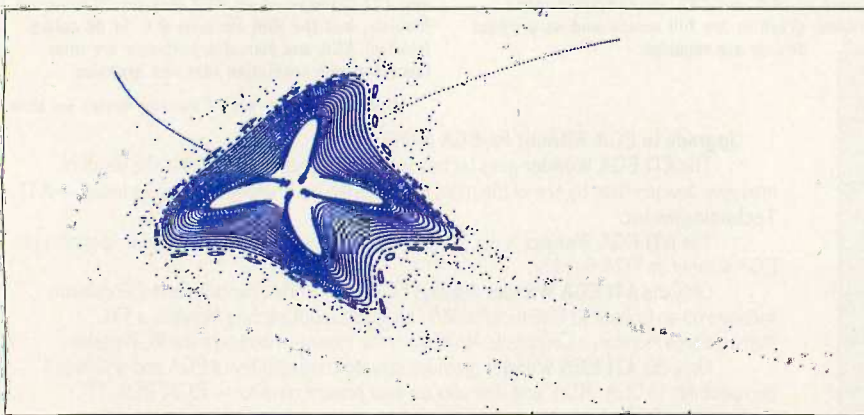

Figure 5b: A Henon mapping of the phase angle A , where $A = 1.5732$ and the scale is -3.0 to 3.0 with 70 orbits and 400 points per orbit. In this "sea creature," A is close to 90 degrees with the result that the inner orbits are dominated by four fixed points. This causes the early breakdown into the four islands. (The parameter file is labeled A15732P.01. Two other mappings are available in parameter files A2012P.01 and A2075P.01.)

THE BAD NEWS ISN'T THE PRICE.

Okay, you could have saved thousands with Ability™, the \$99 integrated program that does everything your armload of programs does.

But maybe even more importantly, you could have saved tons of time and hassle.

Because we've combined six high-powered PC productivity tools into a single, simple package.

You get full-featured wordprocessing with no exotic codes to learn, and what-you-see-is-what-you-get formatting.

Spreadsheets larger than Symphony, with all the powerful math and business functions you need and the ability to import Lotus 1-2-3 files (and formulas where possible).

A forms-oriented database that's easier to use than pfs:file.

Professional business graphics from your spreadsheets and databases with just a few keystrokes.

Ability: \$99.

Menu-driven, Migent Pocket Modem™ and Hayes-compatible communications.

Even "slide shows" with sound on your PC!

And smooth, seamless integration like nothing you've ever seen before.

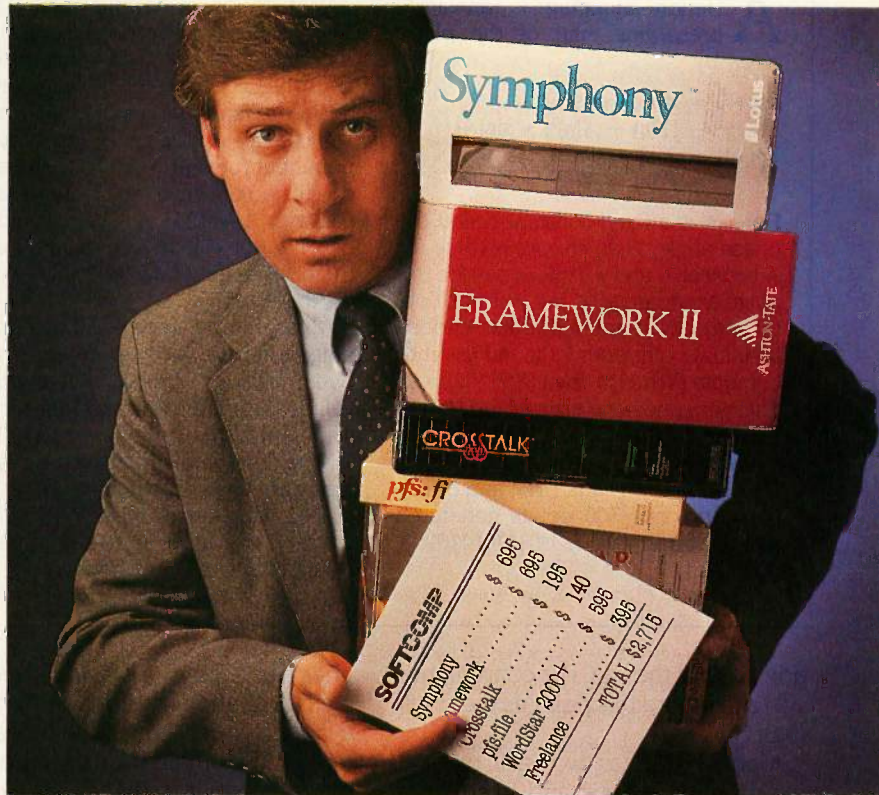

Because with Ability, the table and graph you see in the letter aren't just copies pasted in—they're live.

So if you change the table in the letter, the changes are made in the linked spreadsheet or database that contains the underlying data. Or change the spreadsheet and the letter is updated at the same time. And the graph is automatically redrawn to reflect the changes, either way. (Perfect for those weekly and monthly reports.)

And anybody can do it with no programming at all, because Ability is menu-driven and uses the same instructions in all six applications.

At just \$99, Ability could even pay for your PC if you don't already have one.

Check it out at your local computer store or contact: Migent, Inc., P.O. Box 6062, Incline Village, NV 89450. (702) 832-3700.

MIGENT™

©Migent, Inc. 1986 Ability and Pocket Modem are trademarks of Migent, Inc. Other names and products trademarked by others.

Inquiry 235

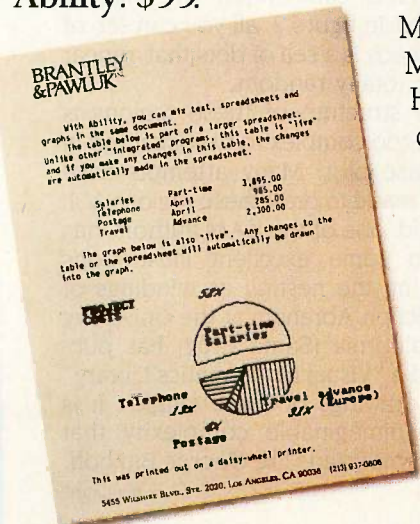

CREATING A HENON MAPPING

A Henon mapping is an area-preserving map of the plane given by

$$\begin{aligned} X(n+1) &= X(n) * \cos(A) \\ &\quad - (Y(n) - X(n)^2) * \sin(A) \\ Y(n+1) &= X(n) * \sin(A) \\ &\quad + (Y(n) - X(n)^2) * \cos(A) \end{aligned}$$

Here, A is a fixed constant called the phase angle. First, choose a value for A between 0 and π . (Values outside this range are acceptable, but you won't obtain any new mappings.) Next, choose an initial point $(X(0), Y(0))$ and use it to compute $(X(1), Y(1))$, then $(X(2), Y(2))$, etc. This generates one orbit of the Henon mapping. Typically, it will resemble a closed curve after a few hundred iterations. In figure 1, A is 1.111, and the inner curve has 700 points generated with a starting value of $(X(0), Y(0)) = (.098, .061)$.

Next, choose a starting point $(X(0), Y(0))$ for the second orbit and continue. A typical mapping might contain 15 to 20 orbits, depending on the detail desired. Figure 1 contains 38 orbits. You can use any value for the starting point, but for $X(0) > 1/\sin(A)$, the successive points grow rapidly. For example, with $A = 1.111$, any starting point beyond $X(0) = 1.116$ grows quickly, and the orbit degenerates to a few points on the screen.

A program to generate these mappings will have two nested loops: the outer loop to choose the starting values $(X(0), Y(0))$, and the inner loop to generate the orbit (see listing 1).

Note that the mappings have a symmetry about a line that makes an angle of $A/2$ with the positive X axis. For figure 1, this angle is $1.111/2$ radians, which is about 32 degrees.

tion around the sun. For convenience, you can regard this point as the origin $(0,0)$.

A phase plot has two basic types of fixed points: elliptic and hyperbolic. This center point, or origin, is an elliptic fixed point because the nearby curves are ellipses. An elliptic fixed point is naturally stable; a small error in position or velocity is not disastrous—the system remains on an elliptic curve close by. For example, the center of the phase plot in figure 3 is an elliptic fixed point, and it corresponds to a stationary pendulum. It is a stable point; if you make a small mistake in positioning the pendulum, it doesn't cause much change in the orbit.

By contrast, if the pendulum is on a rigid bar and is moved all the way to the "high noon" position ($\theta = \pi$, $d\theta/dt = 0$), this would also be a fixed point but it would be extremely unstable. This is called a hyperbolic fixed point because the curves near it are hyperbolic, $(y - c) = 1/(x - d)$. They are the crossing lines seen in the phase plot in figure 3. Relationships of this type are inherently unstable

near the central point, (c,d) , because a small change in either x or y yields a large change in the other. For a pendulum, the smallest error in position would cause it to fly off on one side or the other. In stability theory, these hyperbolic fixed points are the "bad guys," and they show up in the resonance bands.

THE RESONANCE BANDS

In figure 1, the two major resonance bands are the band of six and the outer band of seven. These two bands appear to be different in character, but they are actually similar. Because the outer band is so wide, more detail is visible, but the tiny islands and the "fuzzy" scattering of points are part of every resonance band. If you enlarged the islands in the band of six, you would find a similar structure.

The small islands represent secondary resonances. They are the *bands of the bands*. These secondary resonances occur because each of the large islands represents a new stable fixed point just like the origin. Therefore, according to the KAM theorem, these islands also stretch and then

break to form resonance bands. This is an endless process as the new islands spawn even smaller islands corresponding to higher resonances that resemble the harmonics of a piano string, but in two dimensions.

The scattering of points visible in the outer band is caused by dense accumulations of hyperbolic fixed points. To see how these hyperbolic "bad guys" got here, recall that the resonance bands are formed from the remnants of rational orbits. These are the orbits that mesh exactly with the disruptive force; for example, a 2/5 resonance indicates that two orbits by Jupiter match exactly five orbits of the asteroid. These rational orbits are the ones destroyed to form the resonance bands. (The widening is the result of the rational orbit absorbing nearby orbits.) When these rational orbits are deformed into the bands, the islands are formed. But according to the Poincaré-Birkhoff Fixed Point theorem, these stable islands must alternate with hyperbolic fixed points. The islands and the hyperbolic points have the same origin. They are both created when the rational orbit is deformed by the disturbance.

Since any resonance band has an infinite number of islands, it also has an infinite number of hyperbolic points. These stable and unstable points are interwoven in a complex nesting pattern. To make matters worse, the curves joining these hyperbolic points (called *separatrices*) are turned into incredible jumbles of zigzags, known as *tangles*. This means that each of the islands is surrounded by rings of tangles. In figure 2, all you can see of this chaos is a sea of dots that appear to be totally random.

The structure of these regions is much too complex to be visualized in a phase plot. Many attempts have been made to draw these regions. V. I. Arnold, one of the KAM authors, has drawn some excellent illustrations showing the nesting as windings of tori. Ralph Abraham at the University of California (Santa Cruz) has published a "Visual Mathematics Library" with drawings of some tangles. It is this unimaginable complexity that mathematicians like George Birkhoff,

(continued)

Expanding your display horizons has never been easier.

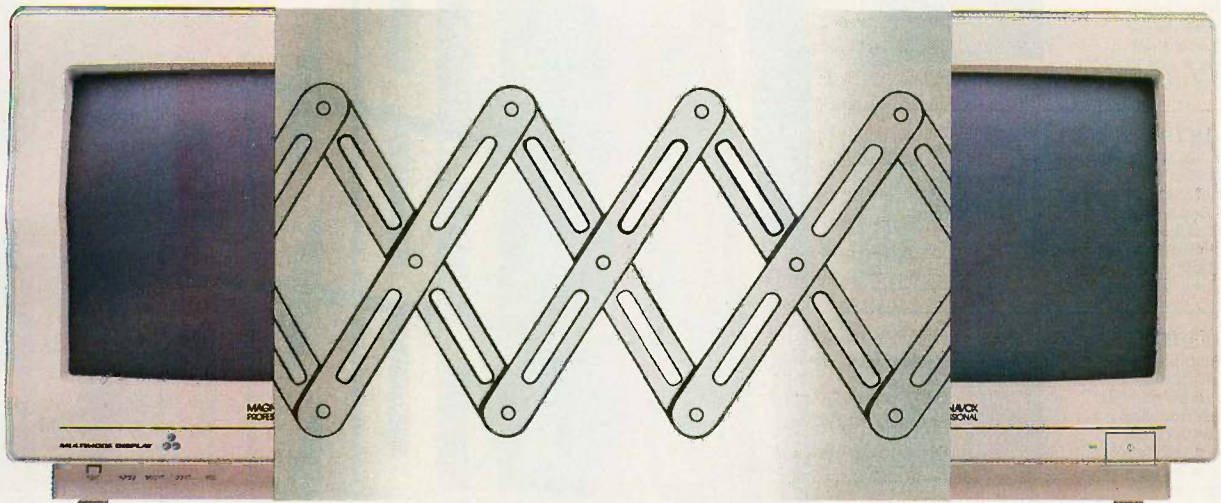

Introducing the Magnavox Professional Color Display System

The Multimode Color Display

Now you can own a single color display that will function with virtually *any* graphics board, in any computer now on the market, automatically. The Magnavox 8CM873 Multimode Display.

The Multimode is a new breed of color display that can adapt itself to a wide range of video signal types providing you maximum flexibility for future expansion. (The Multimode supports vertical resolution up to 580 lines [34kHz] and accepts your system's digital [TTL] or analog video outputs.)

So whether you're into CGA, EGA, ATT, or PCG we're sure you'll have the same opinion of the Multimode. TNT.

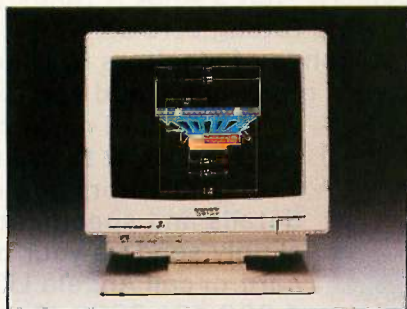

Maximum flexibility. Single sourced.

Nobody puts it together like MAGNAVOX.

© 1986 N.A.P. Consumer Electronics Corp. A North American Philips Company

The Multigraph Display Card

The Multimode Display is only as good as the video adaptor that drives it. And we have one of the best. The 8AV480 Multigraph expanded function EGA Display Card for IBM PC/XT and AT computers and compatibles.

The Multigraph Card is part of a new generation of video controllers which employ customized integrated circuits to pack maximum firepower in minimum space. And with a minimum of parts producing a minimum of life-sapping heat.

The System — With the Multigraph Card and our Multimode monitor you can now get full EGA performance plus 640 × 480 (and 752 × 410) 16/64 color graphics for the price some

people charge for the graphics card alone. Plus you get complete backwards compatibility with virtually all software written for the PC/XT and AT.

It's a dynamite combination.

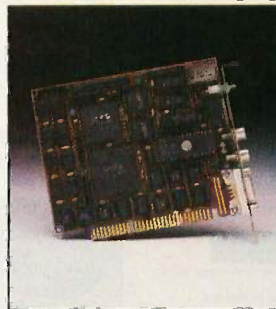

CM-1376

PGA compatible 13" RGB Analog Super High Resolution monitor. 4,096 color display with 640 x 480 lines of resolution.

**CM-1370**

Persyst "BOB"™ or Sigma 400L™ card compatible 13" RGB Super High Resolution monitor. 16 color display with 800 x 400 lines of resolution.

**CM-1370A**

AT&T 6300™ and 6300 Plus™ compatible 13" RGB Super High Resolution monitor. 16 color display with 800 x 400 lines of resolution.

**CM-1365**

CGA compatible 13" RGB High Resolution monitor. 16 color display with 640 x 200 lines of resolution. Five position color display switch.

**CM-1360**

CGA compatible 13" RGB High Resolution monitor. 16 color display with 640 x 200 lines of resolution. Three position color display switch.

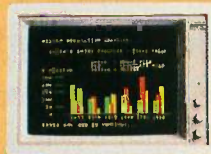
**MM-1422G/A**

MDA or Compaq™ compatible 14" High Quality Monochrome monitor. Amber or green display with 800 x 350 lines of resolution.

**MM-1225G/A**

Apple™, Atari™ or Commodore™ compatible 12" High Quality Monochrome monitor. Amber or green display with 800 x 350 lines of resolution.

**MM-1222G/A**

MDA compatible 12" High Quality Monochrome monitor. Amber or green display with 800 x 350 lines of resolution.

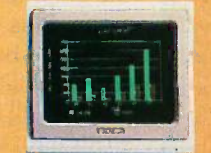

Persyst "BOB" is a registered trademark of Persyst, Personal Systems Technology, Inc.
Sigma 400L is a registered trademark of Sigma Designs, Inc.
AT&T 6300 & 6300 Plus are registered trademarks of AT&T Information Systems.
Compaq is a registered trademark of Compaq Computer Corporation.
Apple is a registered trademark of Apple Computer, Inc.
Atari is a registered trademark of Atari Corporation.
Commodore is a registered trademark of Commodore Business Machines, Inc.

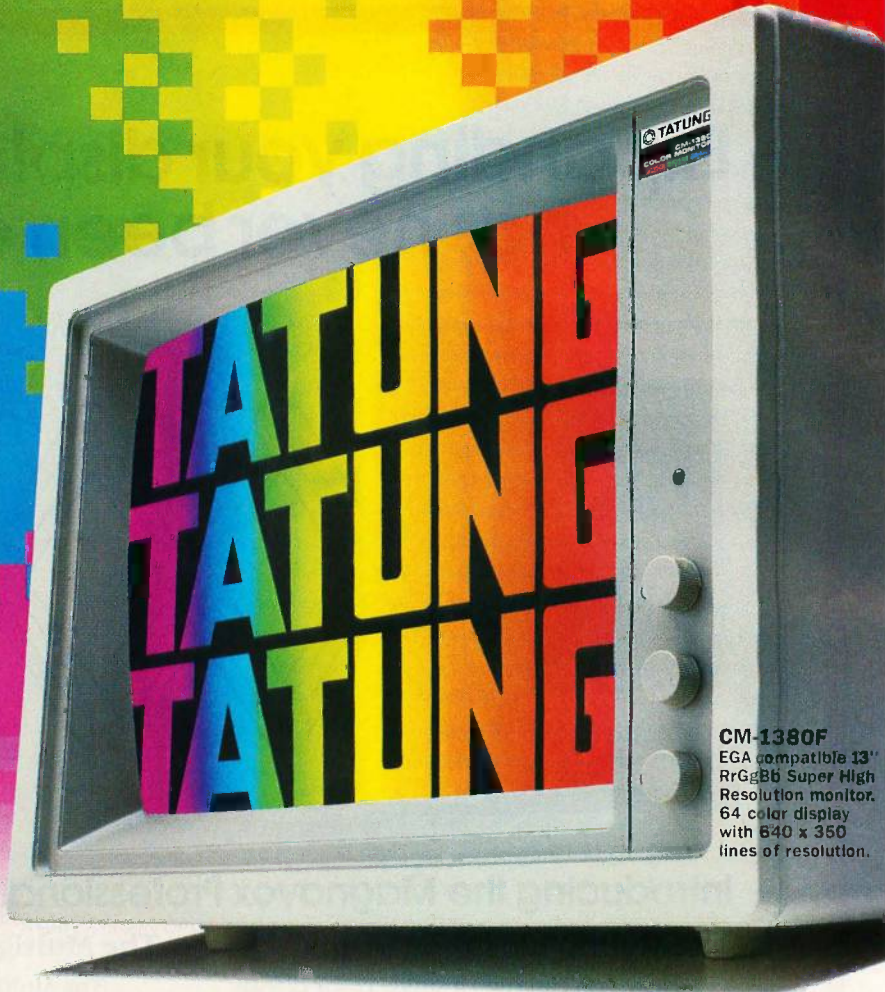

CM-1380F
EGA compatible 13" RrGgBb Super High Resolution monitor. 64 color display with 640 x 350 lines of resolution.

TATUNG MONITORS.

We want to be number 1.

That means we have to have a better product.

We do. Better, brighter image quality. Compatibility. The best value you'll find. A guarantee you'll never have to use. And choice...the chance to choose the monitor that meets your needs precisely. That's what it takes to be Number 1. That's just what Tatung offers.

No one gives you a wider range of monitors to choose from. No one offers more quality, more value, and service. That's

Tatung Quality Monitor Peripherals & Accessories: TEGA-22 Card, Cable-70, 12"MB-12 and 13"MB-13 tilt & swivel bases.



why more and more computer systems show their stuff on Tatung Monitors. For complete details and specifications, simply send us your business card, or call Angela Liu toll free: 1-800-421-2929 (Outside CA) (213) 979-7055 (In CA).



TATUNG

Inquiry 349 for End-Users.
Inquiry 350 for DEALERS ONLY

Tatung Company of America, Inc. 2850 El Presidio St., Long Beach, CA 90810
In Northern California Call: Tatung Science and Technology, Inc., 708 Charcot Ave., San Jose, CA 95131 (408) 435-0140

HENON MAPPING

Jurgen Moser, Stephen Smale, and others have been attempting to unravel. It is the key to the nature of the resonance bands and, therefore, crucial to the question of stability.

RATIONAL VS. IRRATIONAL

Since the rational orbits are deformed into the resonance bands, the remaining curves must correspond to irrational orbits. Here there is no buildup due to resonances, so the status quo is maintained and the overall motion is stable. For example, Earth seems to follow a peaceful irrational orbit with respect to Jupiter. The gravitational pull of Jupiter does cause perturbation of Earth's orbit, but there is no apparent buildup of forces as there could be with a resonance.

Not all irrational orbits are safe. If it happens to be too close to a rational orbit, the irrational orbit can be absorbed into the resonance band. For small disturbances, this absorption is minimal, and the irrational orbits dominate the behavior. Paradoxically, there are many more irrational numbers than rational ones, so if you pick an orbit at random (by choosing a starting point (x,y) or (r,θ)), it will almost certainly correspond to an irrational orbit. This is why the KAM theorem works: The rational resonance bands, even with the neighboring rationals and irrationals, are still insignificant for small disturbances. The end result is a stable system where the irrational orbits dominate and the resonance bands have no appreciable effect. At higher energies though, these rational orbits absorb many more nearby orbits and become a significant factor.

ORBIT WATCHING WITH PASCAL

When you watch an individual orbit in slow motion on the computer, the successive points are rotations by a fixed angle called the *winding number*. For an irrational orbit, this angle never comes out even, so the points never repeat. They wind forever, either clockwise or counterclockwise. For a rational orbit, the points eventually repeat and a resonance occurs. Think of the successive points as the path of the asteroid, and the total curve as

(continued)

THE ATARI
TEN COMMANDMENTS

IV

"We shall create a computer that lets consumers choose what's right for them." *Jack Trammell*

Some of our competitors insist that you do things their way. IBM®, for example, forces you to use command keys. And Apple®, forces you to use a mouse.

The revolutionary 1040ST™ Computer gives you both.

If you feel more in command with command keys and a professional keyboard, the ST™ has them. If you feel more comfortable with the immediate response of a mouse, the ST Computer has that also.

The 1040ST takes 16-bit, 68000 technology to its limit. It is two to four times more powerful than the

Macintosh™ or the PC AT™ And far faster as well.

And you get all the power and performance of the ST for an incredible \$999.

Which is why more and more people are choosing the ST Computer everyday.

The ATARI 1040ST is at your computer retailer now.



ATARI®

© 1986, Atari Corp. ATARI, ST, & 1040ST are TM's or reg. TM's of Atari Corp. Apple is a reg. TM of Apple Computer, Inc. IBM & AT are TM's or reg. TM's of International Business Machines Corporation. Macintosh is a TM licensed to Apple Computer, Inc.

Run Your Software 2 to 10 Times Faster!

No Additional Hardware (Cards or Chips) Required.

Introducing PolyBoost™ The Software Accelerator™

PolyBoost, a set of 3 memory-resident programs, speeds information flow to & from your computer's processor. 1, 2 or all 3 programs can be in loaded in memory. Operation is totally automatic & transparent. Only PolyBoost speeds up all three processor input/output (I/O) paths:

Requires DOS 2.0 or higher

For the IBM PC, XT, AT & Compatibles

Boost Disk Speed

A memory-buffer (disk cache) automatically speeds up hard or floppy disks by storing in RAM the data your software uses most often. You can set the cache size from 5K to 500K. Caches of up to 4 Megabytes each can reside in Expanded or Extended Memory. Unlike a RAM Disk, PolyBoost immediately writes all changed data to your physical disk to prevent data loss.

Boost Display Speed

Text scrolling & screen updates are FAST! You select the speed. Eliminates flicker in CGA cards. Also works with monochrome, EGA, & Hercules cards. (Uses only 4K RAM.)

Faster & Enhanced Keyboard

Adjust repeat rate for cursors & other keys. Increase size of type-ahead buffer. Optionally generate key clicks. Recall, edit & execute DOS commands. (Uses only 3K RAM.)



60 Day Money Back Guarantee

\$79.95 + \$5.00 S/H

VISA/MC ORDERS
1-800-654-5301
In CA (213) 493-2471 ext. 200
POLYTRON Corp.
Berkeley, CA 94706
(Sales & Reg. C.S.S.I.)

80386 ST \$3195.

ST/286-12™ MOTHER BOARD

ST for Superior Technology

\$1295. 12 MHz
One Year
Warranty Against
Manufacturers Defects

- Standard with Intel 80286
- Optional Upgrade to Intel 80386
- Up to 640K Ram on Board
- Clock/Calendar with Battery Back-up
- Complete with Enhanced Set-up Software
- Documentation Included
- Fits XT and AT Cases
- Supports AT and XT Boards
- Runs All Major Software Written For the IBM PC, PC/XT and PC/AT
- Available for Immediate Delivery
- Made in the U.S.A.

**80386
UPGRADE
only \$800**

CCI ST/286-12™

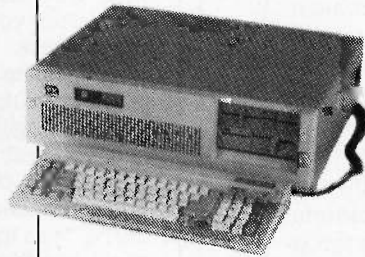

\$2395.

One Year
Warranty Against
Manufacturers Defects

**12 MHz
STANDARD**

**80386 UPGRADE
only \$800**

INCLUDES: ST/286-12™ Mother Board, 640K of Ram, 1.2 Meg Floppy Drive, Western Digital Combined Floppy and Hard Disk Controller Card, AT Keyboard, 192 Watt Power Supply, Clock/Calendar with Battery Back-up, Intel 80286 Processor, Diagnostic and Enhanced Set-up Software, Documentation.

HARD DISKS

20 MEG SEAGATE KIT for XT Western Dig. Controller, Cables, Software, Mounting Hardware	\$445
30 MEG SEAGATE KIT for XT Adaptec Controller, cables, Software, Mounting Hardware	\$505
20 MEG SEAGATE for AT 40 MS Voice Coil, Cables and Rails	\$569
30 MEG SEAGATE for AT 40 MS Voice Coil, Cables and Rails	\$675
40 MEG SEAGATE for AT 40 MS Voice Coil, Cables and Rails	\$799
60 MEG PRIAM for AT 28 MS Voice Coil, Cables and Rails	\$1475
86 MEG TOSHIBA for AT 23 MS Voice Coil, Cables and Rails	\$1695

10 MHz

CCI ST/286™

ST for Superior Technology

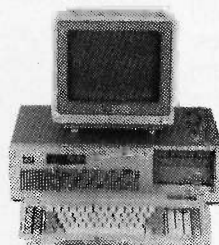

\$1495.

One Year
Warranty Against
Manufacturers Defects

INCLUDES: ST/286™ Mother Board, 1 Meg of Ram, 1.2 Meg Floppy Drive, Western Digital Combined Floppy and Hard Disk Controller Card, AT Keyboard, 220 Watt Power Supply, Clock/Calendar with Battery Back-up, 80286 Processor, Documentation, Phoenix BIOS and Phoenix SETUP Software.

No charge for UPS ground shipping. No surcharge for MasterCard or Visa. Add 5% sales tax if a Florida resident.

Warranty work requires proof of purchase and return authorization number. Merchandise returned for credits subject to a 15% restocking fee.

COMPUTER CLASSIFIEDS, INC.



Sales Calls Outside Florida **1-800-331-5150**
17830 State Road 9 • Miami, Florida 33162



Sales Calls From Anywhere in Country **(305) 651-5853**
Technical Support Calls **(305) 651-0073 - Telex 510-600-7725**

Intel, Hercules, Atronics, Western Digital, Seagate, Priam and Toshiba are trademarks of their respective companies. IBM, PC, IBM XT, IBM AT are trademarks of IBM Corporation. Some quantities may be limited. Computer classifieds reserves the right to substitute equivalent items. All prices are subject to change without notice.

HENON MAPPING

the period of Jupiter. There is a resonance when these two mesh exactly (in time, not physically). On the screen it looks as if the points are stationary.

However, it is unusual to see perfectly stationary points, because these are the orbits that will bifurcate into bands. The orbit is "trying" to be stationary, but the disturbance won't let this happen. The stationary points are distorted into islands just as in figure 1.

Remember, for the purposes of computer simulation all numbers must be rational, since they are stored only to a limited number of digits. This is not a problem, because the KAM theorem is really a matter of degree: There is a hierarchy of rational numbers, from the major resonances such as 1/1, 2/3, 1/5, etc., down to the essentially irrationals represented by numbers such as 78438166/1677743295. Note that in the Henon mappings the major resonances give the wide bands. These are the most powerful resonances.

THE FATE OF A PHYSICAL SYSTEM

There are two broad types of behavior for a physical system on one of these resonance bands: stability and chaos. The islands represent regions of relative stability, and the area between the islands represents potential chaos. If a system locks on to the resonance and follows the islands, it behaves in a regular fashion. For example, if an asteroid followed the seven islands in figure 1, it would have a period of 1/7 that of Jupiter (i.e., every seven revolutions, it would repeat itself). If it were on the outer edge of the islands, it would still be regular but would not quite repeat itself.

If the system is on one of the small islands corresponding to higher resonances, it travels a more varied path, but the overall behavior is still regular. For example, an asteroid that starts out on one of the eight smaller islands is still tied to the seven large islands, but there is a secondary winding, or perturbation, as it visits the eight islands. The overall motion is similar to that of the seven islands. For the

(continued)

THE ATARI
TEN COMMANDMENTS

V

"We shall create a computer that gives consumers Power Without the Price." *Jack Trammell*

Our amazing 1040ST™ Computer is the world's first PC to cost less than \$1. per kilobyte.

How does that stack up against the competition? You'll pay over \$2. per kilobyte for the Macintosh™ Plus. More than \$7. per kilobyte for the Amiga™. And the PC AT™ kilobyte weighs in at a whopping \$18. That's why the 1040ST brings new meaning to the word "value."

For a revolutionary \$999., the ST™ Computer gives you a megabyte of memory. It's a complete package, with CPU, drive, monitor, and mouse. Its keyboard is packed with

function keys and a numeric keypad. Expandability is a built-in bonus. There are industry-standard ports for printers, modems, and many other peripherals.

The ATARI 1040ST is a megabyte of muscle. And it's at your nearby computer retailer today.



ATARI®

©1986 Atari Corp. ATARI, ST, & 1040ST are TM's or reg. TM's of Atari Corp. Amiga is a TM of Commodore-Amiga, Inc. AT is a TM of International Business Machines Corporation. Macintosh is a TM licensed to Apple Computer, Inc. Prices are manufacturers' suggested prices, August 1986. Actual retail prices may vary.

New from Lifeboat:

MULTI-TASKING
C++
LINKER

ADVANTAGE C++ Take advantage of object-oriented programming. Add resiliency and flexibility to your code without sacrificing the standardization of C. Build large and sophisticated programs more productively. C++, developed by AT&T, has many enhancements over C, yet maintains full compatibility with existing C programs.

ADVANTAGE Link Fastest, most powerful linker available for PC-DOS, and the first overlay linkage editor to fully utilize extended memory. Supports memory caching, object file merging, overlays and more. Generates optimized command files for fastest possible link times.

TimeSlicer Create multi-tasking and real-time applications in C with this library of useful tools and services. Optimizes processor usage and transparency. Brings multi-tasking into your application rather than interfacing with the operating system, allowing for more efficient and portable programs.

To order or to obtain complete specification sheets call:

1-800-847-7078

In NY: 914-332-1875

LIFEBOAT

The Full-Service Source for Programming Software.

Swap Up

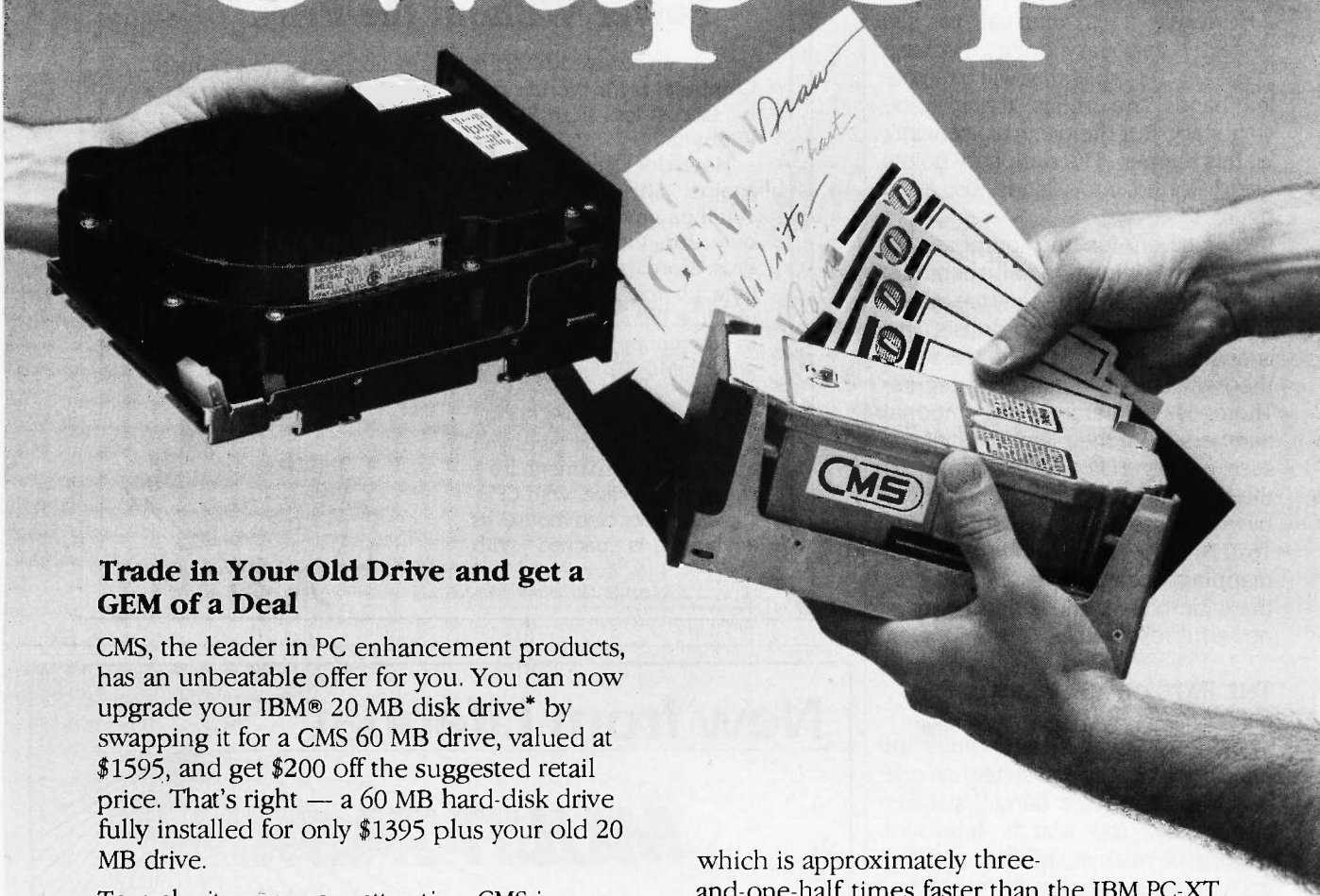

Trade in Your Old Drive and get a GEM of a Deal

CMS, the leader in PC enhancement products, has an unbeatable offer for you. You can now upgrade your IBM® 20 MB disk drive* by swapping it for a CMS 60 MB drive, valued at \$1595, and get \$200 off the suggested retail price. That's right — a 60 MB hard-disk drive fully installed for only \$1395 plus your old 20 MB drive.

To make it even more attractive, CMS is bundling Digital Research's® GEM DESKTOP™ application software with each drive — absolutely free. And if you act before January 31, 1987, you'll get four coupons worth \$50 each toward the purchase of DRI's® popular applications software packages. That's a \$250 software value — free.

Today's data storage requirements are expanding so rapidly that you may have already outgrown your PC's 20 MB capacity. With this special offer, you can not only expand your capacity, but also upgrade performance with the most advanced hard disk drive on the market today. The CMS Model K-60 has an average access time of 22 to 28 milliseconds

which is approximately three-and-one-half times faster than the IBM PC-XT drive access time!

So don't delay — upgrade your PC and get in on this terrific program. For the location of the nearest CMS dealer and a copy of our full product catalogue, **Contact CMS at (714) 549-9111.**



**Best Performance
Best Price**

3080-A Airway Avenue
Costa Mesa, CA 92626
(714) 549-9111 Telex (023) 371-8711
Fax (714) 549-4004

*Offer valid on original IBM PC-XT/286 model drives only. No substitutes will be accepted. IBM and IBM PC are registered trademarks and PC-XT is a trademark of IBM Corporation. Digital Research and DRI are registered trademarks of Digital Research Corporation.

HENON MAPPING

microscopic islands, the many levels of windings cause a great deal of small variation, but the motion is still bound to the large islands. The real danger, especially with the higher resonances, is that a very small change in conditions, such as a minor collision or the pull of Earth, Mars, or Saturn, would tend to disrupt this rather delicate stability. Surrounding these islands are regions dominated by unstable hyperbolic points.

If a physical system didn't lock on to the resonance, it could exhibit erratic behavior as represented by the regions between the islands. If it got too near a powerful hyperbolic point, it could be thrown out like a slingshot. If it got too near one of the tangles, the system would experience a localized chaos as it followed an "orbit" that was a maze of zigzags.

THE KIRKWOOD GAPS

Using the asteroids as a guide, the stable phenomenon of "following the islands" or "orbit-locking" seems rare. In fact, the asteroids are conspicuously missing from the resonance bands. These gaps were first observed in 1886 by Daniel Kirkwood, a U.S. mathematician and astronomer, who suspected that the gaps correspond to resonances with Jupiter. Recent calculations by M. V. Berry at the Wills Physics Laboratory in Bristol, England, indicate that indeed these gaps coincide closely with the major resonances between the asteroid's orbit and Jupiter's. Instability has been the dominant factor causing asteroid ejection. Calculations by Andrea Milani and Anna Nobili at the University of Pisa indicate that secondary disturbances caused by the slight eccentricity of Jupiter's orbit might have speeded this up, making the delicate orbit-locking unlikely. (They did, however, find a possible orbit-locking between Jupiter and Uranus.)

Where do the ejected asteroids go? Wandering asteroids with erratic behavior have been observed, but it is difficult to trace their paths back in time to determine whether this is due to resonances or not. Some astronomers believe that a few of these erratic asteroids join the cloud of

(continued)

THE ATARI
TEN COMMANDMENTS

VI

"We shall create a computer that's as powerful in the music studio as it is in the office." *John Trammell*

Atari was among the first in the personal computer business to do something for music.

With a built-in Musical Instrument Digital Interface (MIDI), you can turn the 1040ST™ into a multitrack recording studio by connecting it directly to keyboards, drum machines, and synthesizers. No other PC has MIDI built in—not IBM®, not Amiga™, not Macintosh™.

The 16-bit ST™ also contains a sound chip with three programmable voices. One more reason why the ST Computer is at the top of the charts.

The ST is one of the finest

68000-based PC's you can own. It also features an array of expansion ports for your synthesizer, printer, and other important peripherals.

The 1040ST gives you all this for \$999—which we think will be music to your ears.

Available at fine computer and music dealers.



ATARI®

1986 Atari Corp.
ATARI ST & 1040ST are TM's or reg. TM's of Atari Corp. Amiga is a TM of Commodore Amiga, Inc. IBM is a reg. TM of International Business Machines Corporation. Macintosh is a TM licensed to Apple Computer, Inc.

Silent Nights.



Tempers flare. Tantrums rage. And both sides come out fighting. It's the battlefield known as life with anyone 5 to 18 years old. Get Mind Over Minors!™ And discover the sweet sound of silence. You'll learn the best ways to manage and motivate your young person, based on their personality and yours.

Mind Over Minors. It's a program to transform the war zone into silent nights, and happier days. Call 1-800-624-5227 (In California, 1-800-824-7325). Separate editions for parents and teachers. IBM/Apple/Commodore.

Mind Over Minors™
From The Makers Of Mind Prober™

MicroCom Systems
OUTSTANDING SOFTWARE
 For IBM PC's and Compatibles

\$350 PER DISK
 SMALL QUANTITIES

\$300 PER DISK
 FOR TEN OR MORE

\$1 OFF 5 DISKS OR MORE WITH THIS COUPON

- CAD 1** — Altamira, a four color object oriented drawing program. Color gr. req'd.
- COMM 3** — Compression/decompression and archival utilities for telecommunications.
- DATABASE 1,2** — (2 disks) PC-File III, Version 4, a user friendly database system.
- DATABASE 3** — The pBASE relational database manager with query language.
- EDUCATION 1** — Interactive DOS tutorial for new PC users. Makes learning DOS painless.
- GAMES 1** — Chess, 3-D Packman, Kong, Spacewar, JanitJoe, and more. Color gr. req'd.
- GAMES 2** — Qubert, Pango, Centipede, Monopoly, Zoorre, and more. Color gr. req'd.
- GAMES 3** — Blackjack (you set rules), Arm Chair QB, and Empire (war game).
- GAMES 4** — Castle, Star Trek, and the original Colossal Caves ADVENTURE.
- GAMES 5** — The HACK adventure game from the universities. Like Rogue.
- GAMES 6** — Pinball, Othello, Dragons, Sopwith (fly one), and more. Color gr. req'd.
- GAMES 7** — Round42 (16 color graphics), Backgammon and more. Color gr. req'd.
- LANGUAGE 2** — The renowned SMALL-C compiler and a C interpreter!
- LANGUAGE 5** — Turbo Pascal interactive debugger, pop-up help, formatters, etc.
- LANGUAGE 7** — Pascal interpreter/compiler. Great for learning Pascal!
- MUSIC 1** — Many clever tunes, and an excellent color graphics music editor.
- ORGANIZER 1** — DeskMate, a Sidekick clone, and the Judy calendar program.
- ORGANIZER 3** — The PC-Outline windowing outline editor/thought organizer.
- PICTURES 2** — High res digitized graphics pictures. Color graphics required.
- PINUP 2** — Provocative high res digitized graphics pinups. Color graphics required.
- PRINTER 1** — Font and sideways utilities, spoolers, banner makers, and more.
- UTILITIES 1** — A collection of invaluable general purpose DOS utilities. A must!
- UTILITIES 2** — More invaluable DOS utilities. Too many to list here!
- UTILITIES 3** — A comprehensive set of debugging and diagnostic utilities.
- WORD 1** — PC Write 2.6, a powerful and complete word processing system.
- WORD 3** — The PC Style writing analysis program and FOG complexity index finder.

— NEW RELEASES —

- BUSINESS 1** — EZ-Forms business form generation, completion, and printing program.
- CAD 2** — An advanced 2D/3D drafting program. 640k required. Color gr. req'd.
- COMM 1,2** — (2 disks) Version 2.2 of the ever-popular QMODEM communications prog.
- COMM 4,5,6,7** — (4 disks) Latest RBBS Bulletin Board System 14.1D.
- COMM 8,9** — (2 disks) PROCOMM 2.4, an exc. modem program with terminal emulation.
- INFO 1,2** — (2 disks) Cooking recipes database with keyword/ingredient retrieval prog.
- LANGUAGE 1** — PDProlog 1.9v, 5th generation language for artificial intelligence.
- LANGUAGE 3** — A86, a full featured 8086/8088 macro assembler.
- LANGUAGE 8** — Xlisp 1.7, the standard for Artificial Intelligence programming languages.
- LANGUAGE 9** — The ICON string and structure oriented programming language.
- MUSIC 2,3** — (2 disks) PianoMan Ver 3.0 polyphonic music recording & playback prog.
- WORD 4** — The Speller spell-checking program. Includes customizable dictionary.

Catalog available, add \$2. 3.5" format add \$1/disk.

Cost of items _____
 CA Res 7% Tax _____
 Ship/Handling _____ Domestic \$1./Foreign \$5.
 Total Enclosed _____

MicroCom Systems
 (415) 325-6000
 P.O. Box 51657, Palo Alto, CA 94303

HENON MAPPING

*Halley's comet could
 be an asteroid
 that suffered
 the fate of a
 KAM resonance.*

comets at the extremes of the solar system. Halley's comet could be an asteroid that suffered the fate of a KAM resonance.

THE RINGS OF SATURN

The rings of Saturn have gaps similar to the gaps in the asteroids. The rings are composed of thousands of rocks and ice particles that are influenced by the gravitational pull of Saturn's satellites, most notably Mimas, and the major resonances here are between the period of the particle and the period of Mimas. The important

BIBLIOGRAPHY

Abraham, Ralph, and Christopher Shaw. "Dynamics: The Geometry of Behavior" from the Visual Mathematics Library. Santa Cruz, CA: Aerial Press, 1983.

Arnold, V. I. "Proof of a Theorem of A. N. Kolmogorov on the Preservation of Conditionally Periodic Motions under a Small Perturbation of the Hamiltonian." *Russian Math Surveys*, vol. 18, 1963, pages 9-36. Translated from Russian.

Berry, M. V. "Regular and Irregular Motion." *Topics in Nonlinear Dynamics*. American Institute of Physics, Proceedings no. 46, 1978.

Birkhoff, G. *Dynamical Systems*. American Mathematical Society, Colloquium Publications, vol. 9, 1966.

Franklin, F. in *The Rings of Saturn*, Palluconi and Pettingill, eds. NASA, SP-343, 1974.

Grayson, H. W., and J. Ford. "Amplitude Instability and Ergotic Behavior for Conservative Nonlinear Oscillator Systems." *Physical Review*, vol. 188, no. 1, 1969, pages 416-431.

Henon, M. "Numerical Study of Quadratic Area Preserving Mappings." *Quarterly of Applied Mathematics*, vol. 27, October 1969, pages 291-312.

Holmes, P. J., and J. E. Marsden. "Dynamical Systems and Invariant Manifolds." *New Approaches to Nonlinear Problems in Dynamics*. Society of Industrial and Ap-

plied Mathematics, 1980.

plied Mathematics, 1980.

Kolmogorov, A. N. "Preservation of Conditionally Periodic Movements with Small Change in the Hamilton Function." *Doklady Akademii Nauk (Report of the Academy of Sciences) SSSR*, vol. 98, 1954, pages 527-530. In Russian.

Laslett, L. Jackson. "Some Illustrations of Stochasticity." *Topics in Nonlinear Dynamics*. American Institute of Physics, Proceedings no. 46, 1978.

Milani, Andrea, and Anna Nobili. "Resonance Locking between Jupiter and Uranus." *Nature*, vol. 310, August 1984, pages 753-755.

Moser, Jurgen. "On Invariant Curves of Area Preserving Mappings of an Annulus." *Nachrichten Akademie Wissenschaften*. Göttingen, Math. Phys. Klasse, no. 1, 1962, pages 1-20.

Poincaré, J. Henri. *Les méthodes nouvelles de la mécanique céleste*. 3 vols. Paris: Gauthier-Villars, 1892-99. Reprinted by Dover in 1957.

Smale, S. "Differentiable Dynamical Systems." *Bulletin of American Mathematical Society*, 73, 1967, pages 747-817.

Szebehely, Victor, ed. "Stability of the Solar System and Its Minor Natural and Artificial Bodies." *NATO Advanced Science Institute Series*. Boston, MA: Reidel Publishing Co., 1985.

SUMMARY

The theoretical study of stability is one of the more difficult fields of mathematics, and results such as the KAM theorem are of a highly technical nature. Yet, through the medium of computer simulation using iterative mappings such as the Henon mapping, you can gain significant insight into the nature of these studies. This visual insight can be a powerful tool. Most of the laws of physics were obtained through keen observation followed by mathematical analysis. Now anyone with a microcomputer has a window from which to observe some of the more exotic behavior that underlies the world. ■

Get the Courier HST™ 9600-bps modem. Then watch the rest of the world play catch-up.



USRobotics new high speed technology delivers over 1,000 characters/second on more dial-up phone lines. For less than \$1,000.

The new Courier HST (High Speed Technology) dial-up modem combines four great ideas that add up to a new standard for personal computer data communications.

It's full-duplex, with high speed (9600-bps) and low speed (300-bps) channels—automatically assigning the high speed channel direction. This asymmetrical solution avoids the problems of echo-cancelling technology or inefficient half-duplex schemes.

The most powerful data signalling technique—Trellis Encoded Modulation—lets Courier HST achieve maximum speed over a much wider range of phone line conditions than other 9600-bps modems.

A unique error- and flow-control method allows Courier HST to send up to 1,100 characters a second over long distance phone connections.

It's familiar as any 2400- and 1200-bps modem. Same features, commands and, in most cases, the same software. In fact, Courier HST automatically falls back to 2400, 1200 and 300-bps, connecting you with nearly all modems.

High speed. High accuracy. High value. And a two-year parts and service warranty. Get the USRobotics Courier HST, priced under \$1,000. And watch the rest of the world play catch-up.

**CALL 1-800-DIAL-USR
In Illinois (312) 982-5001**

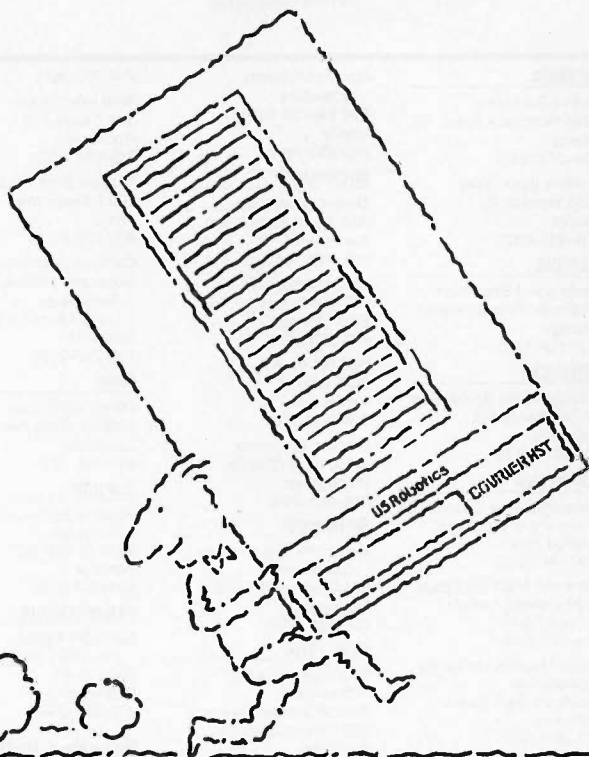

Yes, please send me your FREE 8-page book explaining the new Courier HST and today's new high speed technology.

Name _____

Title _____

Company _____

Address _____

City _____ State _____ Zip _____

Business Phone () _____

12/86-BY-HST

USRobotics™

The Intelligent Choice in Data Communications.
8100 McCormick Blvd., Skokie, Illinois 60076.

10 Distinctive Guides From Prentice-Hall

1 FOURTH GENERATION LANGUAGES

James Martin

Three information-packed volumes make this a complete package of Fourth-Generation Languages—

1. VOL. I.: (An exploratory overview of 4GLs.)

1985, cloth, 432 pp., 0-13-329673-3

2. VOL. II.: Representative 4GLs.

1986, cloth, 512 pp., 0-13-329749-7

3. VOL. III.: 4GLs from IBM.

1986, cloth, 304 pp., 0-13-329764-0

—with
Joe Leben,
The Arben
Group, Inc.

2 RECOMMENDED DIAGRAMMING STANDARDS FOR ANALYSTS AND PROGRAMMERS

James Martin

Confidently step into the new, exciting era of diagramming with this complete guide to diagramming standards. Learn to create more precise diagrams on a workstation screen.

1986, cloth, approx. 352 pp., 0-13-767377-9

3 DIAGRAMMING TECHNIQUES FOR ANALYSTS AND PROGRAMMERS

James Martin

Survey all diagramming techniques in common computer use and clarify thinking and communication when exploring these widely-used structured diagramming techniques.

1984, cloth, 416 pp., 0-13-208794-4

4 THE DESIGN OF THE UNIX OPERATING SYSTEM

Maurice J. Bach

Gain a better understanding of UNIX with the sophisticated workings of the UNIX kernel and these detailed descriptions of internal algorithms and structures.

1986, cloth, 544 pp., 0-13-201799-7

5 ADVANCED UNIX PROGRAMMING

Marc J. Rochkind

Cover UNIX system calls easily, wisely, and portably. Explore how, when, and why system calls are used in UNIX's most important versions to interface user subroutines and commands with kernel facilities.

1985, cloth, 224 pp., 0-13-011800-1

6 THE UNIX C SHELL FIELD GUIDE

Gail Anderson and Paul Anderson

Learn to use this powerful interface effectively and take full advantage of the practicality of the C Shell features. 1986, paper, 400 pp., 0-13-937468-X

7 CRAFTING C TOOLS FOR THE IBM PCs

Joe Campbell

Write powerful C programs to reach inside the IBM PC and into individual hardware devices. Interface with the 8086 assembly language and write system-level functions that help detect and process the "special" keys on the IBM PC keyboard.

1986, paper, 448 pp., 0-13-188418-2

8 ARTIFICIAL INTELLIGENCE IN BUSINESS, SCIENCE AND INDUSTRY

Wendy B. Rauch-Hindin

Provides programmers and managers with a practical overview of AI in business and includes specific methods for implementing new AI technology.

1. VOL. I.: Fundamentals 1986, cloth, 331 pp., 0-13-048893-2

2. VOL. II.: Applications 1986, cloth, 348 pp., 0-13-048901-8

9 ALGORITHMS AND COMPLEXITY

Herbert S. Wilf

Ideal for programmers who want to write more efficient algorithms and programs, this guide explores several families of algorithms and emphasizes analysis of complexity rather than data structures.

1986, cloth, 240 pp., 0-13-021973-8

10 MC68000 8-/16-/32-BIT MICRO-PROCESSORS Programmer's Reference Manual, 5th Edition

Motorola, Inc.

Motorola, Inc., brings you the latest, authorized developments on the MC68000 family of chips.

1986, paper, 256 pp., 0-13-541475-X

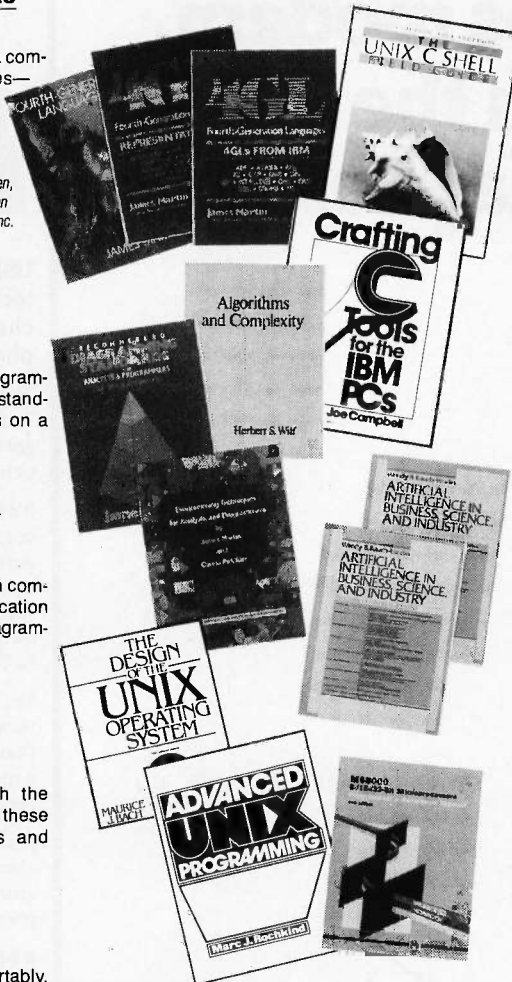

Available at these dependable bookstores:

ALABAMA

Madison Books & Computers
8006 Madison Pike
Madison
205-772-9250

CALIFORNIA

Stacey's
581 Market Street
San Francisco
415-421-4687
Stacey's
219 University Avenue
Palo Alto
415-326-0681
Stacey's
383 Sacramento St.
San Francisco
415-397-7935
Cody's Books
2424 Telegraph Avenue
Berkeley
415-845-7852
Op Amp Technical Books
1033 N. Sycamore Avenue
Los Angeles
214-464-4322
Computer Literacy
520 Lawrence Expressway
#310
Sunnyvale
408-730-9955
Stanford Bookstore

Stanford University
Palo Alto
415-327-3680
San Diego Technical Books
8290 Vickers Street
San Diego
619-279-4990

COLORADO

McKinze-White
Booksellers
5701 N. Academy Drive
Colorado Springs
303-590-1700
Auraria Book Center
955 Lawrence Center
Denver
303-556-3230
Tattered Cover Bookstore
2930 E. 2nd Ave.
Denver
303-322-7727

DISTRICT OF COLUMBIA

Sidney Kramer Books
1722 H Street, N.W.
Washington, D.C.
202-298-8010

FLORIDA

Heath-Zenith Computer
Electronics
4705 W. 16th Avenue
Hialeah
305-823-2280

GEORGIA

Oxford Bookstore
2345 Peachtree Road, NE
Atlanta
404-262-3332
Borders Book Shop
3655 Roswell Rd.
Atlanta
404-237-0707

ILLINOIS

Kroch's and Brentano's
29 South Wabash Avenue
Chicago
312-332-7500

KENTUCKY

Hawley-Cooke Booksellers
27 Shelbyville Rd.
Louisville
502-893-0133

MARYLAND

University Book Center
University of Maryland
College Park
301-454-3222
Maryland Book Exchange
4500 College Avenue
College Park
301-927-2510
Johns Hopkins University
Bookstore
Charles & 34th Street
Baltimore
301-388-8317

MASSACHUSETTS

Harvard Coop
1400 Massachusetts Ave.
Cambridge
617-492-1000

Boston University
Bookstore
660 Beacon Street
Boston
617-236-7415

MICHIGAN

Borders Bookshop
303 South State Street
Ann Arbor
313-668-7652
Jocundry's Books
210 M.A.C. Ave.
East Lansing
517-332-0856
Schuler Books
2975 28th St.
Kentwood
616-942-2561
Borders Bookshop
31150 Southfield Rd.
Birmingham
313-644-1515

MINNESOTA

University of Minnesota
Bookcenter
231 Pillsbury Drive, S.E.
Minneapolis
612-625-5000

NEW YORK

Syracuse University
Bookstore
Schine Student Center
303 University Place
Syracuse
315-423-4194
Barnes & Noble
University of Rochester
Frederick Douglas Bldg.
Rochester

716-275-4011
Total Information
844 Dewey Ave.
Rochester
716-254-0621
Triangle Book Shop
403 College Ave.
Ithaca
607-272-7111
Campus Connections
Rochester Institute of
Technology
1 Lomb Memorial Drive
Rochester
716-262-2731

OHIO

MicroElectronics
1555 W. Gane Ave.
Columbus
614-481-8041

OREGON

Powell's Technical
Bookstore
32 N.W. 11th St.
Portland
503-273-8123

PENNSYLVANIA

Carnegie Mellon
University Bookstore
Barer Hall
Pittsburgh
412-268-2966

TENNESSEE

Davis-Kidd Booksellers
2185 Green Hills Village
Drive
Nashville
615-385-2645

TEXAS

Texas A & M Bookstore
University Center
College Station
409-845-8651
Brown Book Shop
10290 Westheimer
Houston
713-783-2002
The Micro Store
610 James Street
Richardson
214-231-1096
Bookstop, Inc.
9205 Brown Lane
Austin
512-834-9951
Taylor's Inc.
10495 Olympic Drive
Dallas
214-357-1700

WASHINGTON

Tower Books
20 Mercer Street
Seattle
206-283-6333

Prentice-Hall Publishing Company
(201) 767-5049

CJ-468

ABSTRACT MATHEMATICAL ART

BY KENNETH E. PERRY

*Use a BASIC program to explore the fascinating world
of linear cousins of the Game of Life*

COMPUTER-GENERATED mathematical art is art created by pure mathematics as opposed to other forms of computer graphics. In this article, the mathematical entities are "one-dimensional cellular automata." I have found their study exciting and astounding.

One-dimensional cellular automata are linear versions of the two-dimensional automata whose classic example is John H. Conway's Game of Life. The text box "The Origins of Cellular Automata" on page 182 explains the evolution of the ideas that led to the development of these structures.

This article discusses these automata, elaborates the rules that define them, and presents a program in IBM PC BASIC that you can use to find these hidden structures. You will need a color adapter and color monitor to use the program. See the text box "BASIC Program Notes" by George A. Stewart on page 190.

DEFINING THE AUTOMATON

In the years since its invention, the cellular automaton has not had much exposure in the general scientific press. One exception occurred in 1971, when Martin Gardner in *Scien-*

tific American revealed to the world Conway's Game of Life (reference 1).

Conway's game is a two-dimensional cellular automaton in which each cell can take on one of two states, 0 or 1, and its future depends on its own state and that of all eight neighbor cells, both orthogonal and diagonal (this is known as the "Moore neighborhood" after Edward F. Moore, who first discussed rules using this neighborhood).

In 1984 three articles appeared concerning a new breed, the one-dimensional cellular automaton (see references 2, 3, and 4). Two of the articles were written by Dr. Stephen Wolfram of the Institute for Advanced Study in Princeton, New Jersey, and the other made reference to him.

Although the transition rules for one-dimensional cellular automata are very simple and easy to state, some of these automata can exhibit behavior of astonishing complexity. Wolfram is attempting to gain an analytic understanding of how such automata evolve. Reading these articles (and especially looking at the stunning color reproductions of computer graphics) stimulated in me a strong desire to program these au-

tomata on my own computer. Listing 1 is one of the results.

Interpreted BASIC is much too slow to program two-dimensional cellular automata. However, for one-dimensional automata the case is quite different. The field, instead of being n by n , is 1 by n , and the number of cells is in the tens or, at most, the hundreds. Having said this, I must still admit that this BASIC program is rather slow.

The type of automaton I have programmed consists of a linear row or "field" of cells whose maximum length is dictated by the number of pixels on a horizontal screen line. Each cell can take on one of four different states numbered 0, 1, 2, and 3. The transition rule for the next state of the cell depends on the sum of the states of three cells—the cell itself and its two neighbors. Since the largest possible value of each cell is 3, the greatest possible sum of three cells is

(continued)

Kenneth E. Perry (22 Sedgemoor Rd., Wayland, MA 01778) joined the group that built Howard Aiken's Mark IV computer shortly after World War II, which led to a lifetime career in digital logic and programming. Retired, he's still at it.

9, and the sum can take on any value from 0 to 9. A typical rule can be defined as follows:

Sum	0	1	2	3	4	5	6	7	8	9
Rule	0	2	3	0	0	0	0	0	0	0

This rule is as follows: If the sum is 0, the next state will be 0; if the sum is 1, the next state will be 2; if the sum is 2, the next state will be 3; if the sum is 3, the next state will be 0; and so forth.

The first digit of a rule is usually 0; otherwise, the entire initial array of 0-cells will reverse states in a single

generation. The other nine digits can each take on any one of the four values from 0 to 3. The number of different possible rules is therefore 4^9 , or 262,144.

One advantage of the one-dimensional automaton is that it is possible to display a history of its development on a two-dimensional color display screen (with the states 0, 1, 2, and 3 represented by the colors black, red, green, and blue, respectively), while for the two-dimensional automaton only one generation at a time can be displayed.

The program creates a display of 90 generations of an automaton containing 160 cells (the display density can be increased to show 190 by 255 if desired). The horizontal axis represents space and the vertical axis, time. It is important to keep in mind that although the display is two-dimensional, the automaton is unregenerately one-dimensional.

The evolution of this type of automaton over succeeding generations (or clock ticks) is determined entirely by the rule and the initial state of the

(continued)

THE ORIGINS OF CELLULAR AUTOMATA

The time was the early fifties. John von Neumann (1903-1957) had set himself the task of demonstrating that a self-replicating automaton, a robot that could reproduce itself, was possible in principle using the following approach.

Consider a conceptual robot (there was never any thought of actually building anything) wandering at random about an imaginary warehouse containing elementary spare parts scattered about the premises (a badly managed warehouse, but the robot, to be credible, must get along with a minimum of outside help). The robot identifies the parts it needs and assembles these parts to construct an exact copy of itself. In order to direct its operations and make its decisions, the robot contains a conceptual computer, a "universal computer" capable of computing anything that is computable. Such a conceptual universal computer had been invented in 1936 by Alan Turing, and if there was one thing about which von Neumann had no doubt whatever, it was that his self-replicating automaton would contain a Turing machine.

Von Neumann had made some progress with this "kinematic" approach, but he was not satisfied with it. He found it difficult to develop a set of rules of operation that was simple enough to be enlightening. Additionally, the idea of moving pieces of hardware around did not seem to have any place in a fundamental mathematical theory.

Then one day a colleague, Stanislaw M. Ulam, had a bright idea that he

passed along to von Neumann. Consider a large array of rectangular cells (a very large checkerboard some hundreds of cells on a side). Each cell can take on, at any one time, one of a certain number of states numbered 0, 1, 2, 3, 4, and so on (in the simplest case only two states are provided for, labeled 0 to 1). The zero state (also called dead, passive, or quiescent) is always one of the allowed states, and initially all cells are in the zero state. Every cell in the array is allotted the same number of possible states.

Each cell has a rule (the transition rule) based on the states of some of its near neighbors, and perhaps on its own state as well, that specifies at time t what its state will be at time $t+1$; all cells change state simultaneously (in computer terms that would be called a clocked synchronous system). Every cell obeys this rule.

To start the automaton, a certain number of cells are placed into non-zero states, and then the clock is turned on.

Ulam had invented the two-dimensional cellular automaton, and von Neumann was quick to recognize the merit of the idea. Each cell's dependence, for its future state, on only its immediate neighbors, either orthogonal or diagonal, is the very essence of cellular automata. Unlike in the kinematic example, nothing moves; only information is passed from cell to cell.

Take, as a trivially simple example, the rule that the next state of any cell is dependent only on the neighbor cell that shares its northern border. The cell will take on at time $t+1$ the state of this

neighbor at time t . All cells of the array are initially 0, then one cell at the northern boundary of the array is forced into the 1 state. The state of that cell will move, with each tick of the clock, from cell to cell down its column until it reaches the southern boundary. Thus, information has been passed across the array.

When von Neumann seized on the idea, he did it in no small way. The final version of the cellular array took on a size of some hundreds of thousands of cells, each of which could take on one of 29 possible states, that is, the quiescent state plus 28 nonquiescent states. The next state of a cell depended on its own state plus the state of the four neighbor cells with common borders. This is known as the "von Neumann neighborhood." He showed that a Turing machine could be constructed from these cells and that a "constructing automaton" controlled by this machine could send out a "constructing arm" into unoccupied (quiescent) territory of the array. By setting the states of the cell one by one, the automaton would end up with an exact copy of itself.

The result was published posthumously in 1966 as the *Theory of Self-Reproducing Automata*, edited and completed by Arthur W. Burks from von Neumann's unfinished manuscripts (Urbana, IL: University of Illinois Press, 1966). A detailed and quite readable account of von Neumann's automaton is given in the first essay of *Essays of Cellular Automata*, also edited by Arthur W. Burks (Champaign, IL: University of Illinois Press, 1970).

\$25,000 DATAMAT™ APPLICATIONS CONTEST

J

oin us in our first ever contest to find the best application designed by you, the users of DATAMAT™ RELATIONAL DATABASE MANAGEMENT SYSTEM.

Prizes

- One Grand Prize \$10,000.00
One First Prize \$ 5,000.00
Ten Second Prizes \$ 1,000.00 each

Entries may win on any one of the following criteria:

- Creativity
- Utility of Application
- Completeness of Application or
- Clarity of Documentation

The Rules Are Simple:

1. All entries must be postmarked by May 4th 1987.
2. Each entry must be submitted separately with a completed entry form, application disk and documentation.
3. All entries must be made on Version 1.02 or later of DATAMAT™ AMIGA-DOS or MS-DOS. Free up-grades will be provided upon request to registered owners of earlier AMIGA™ Versions of DATAMAT™.
4. No purchase necessary — entrant need not own or buy DATAMAT™.
5. No entry may be copyrighted.
6. All entries will be judged by outside independent reviewers. The winners will be announced by August 31, 1987.
7. Employees or family members of employees of TRANSTIME TECHNOLOGIES CORPORATION are not eligible to enter.
8. ALL WINNING ENTRIES BECOME THE SOLE AND EXCLUSIVE PROPERTY OF TRANSTIME TECHNOLOGIES CORPORATION TO USE IN ANY WAY TRANSTIME TECHNOLOGIES CORPORATION SEES FIT.
9. Non-winning entries will not be returned to the submittor.

Contest winners will be notified by registered mail. A list of winners will be sent upon receipt of request and a self-addressed, stamped envelope.

Grand and First Prizes will be awarded at Fall 1987 Comdex. Transtime Technologies Corporation will pay the hotel and round-trip transportation costs to Comdex for the Grand and First Prize winners or their representative.

Send the completed entry form, application disk and documentation to:

DATAMAT™ CONTEST
Suite 217
3380 Sheridan Drive
Amherst, New York 14226

ENTRY FORM

I have read and understood the contest rules and agree to them.

I am submitting my entry on DATAMAT™:

A-200 _____ MX-200 _____ Serial # _____
A-300 _____ MX-300 _____ Serial # _____

I AGREE THAT SHOULD MY ENTRY WIN, MY ENTRY SHALL BECOME THE SOLE AND EXCLUSIVE PROPERTY OF TRANSTIME TECHNOLOGIES CORPORATION.

I am the owner of the application and documentation that I am submitting. I acknowledge receipt of a copy of the contest rules. I understand TRANSTIME TECHNOLOGIES CORPORATION will not return my entry to me.

I have *not* copyrighted this material.

My application is: _____

Signature: _____

Name: _____

Street Address: _____

City, State, Zip: _____

Area Code, Phone() _____

DATAMAT™ is now available for AMIGA-DOS and MS-DOS.

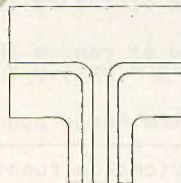

**TRANSTIME
TECHNOLOGIES
CORPORATION**

810 Sheridan Drive
Tonawanda, NY 14150-7871
(716) 874-2010

Inquiry 365

Listing 1: A BASIC version of the one-dimensional cellular automata program written for the IBM PC with color graphics.

```

10 REM One-dimensional cellular automata
20 REM by Kenneth E. Perry
30 REM -----
40 REM Screen setup
50 KEY OFF
60 SCREEN 1,0 :REM Medium resolution (320 x 200)
70 COLOR 0,0 :REM Use color palette 0
80 REM -----
90 REM Initialize variables
100 DEFINT A-Z :REM All variables are integers
110 HRES=320 :REM Number of points horizontally
120 VRES=200 :REM Number of points vertically
130 SF=2 :REM SF=1 for denser graph
140 BY=10 :REM Offset to leave one line blank
150 GN=INT(VRES/SF)-BY
160 MC=INT(HRES/SF) :REM Maximum number of cells
170 IF MC>255 THEN MC=255 :REM Prevent string overflow
180 MI=40 :REM Characters/line in graphics mode
190 BG=0 :REM Color of background
200 NU$="" :REM No spaces inside quotes
210 DIM CL(3), A(MC-1), B(MC-1), RU(9), K$(-INT(-MC/MI))
220 REM Initialize color mapping
230 FOR J=0 TO 3: READ CL(J): NEXT J
240 DATA 0,2,3,1
250 REM -----
260 REM Initialize the rule
270 R$="0000000000" :REM Ten zeros
280 CLS
290 PRINT "Current rule is shown below. The rule"
300 PRINT "must contain exactly 10 digits, using"
310 PRINT "only 0, 1, 2, and 3."
320 PRINT "Move the cursor across the rule, make"
330 PRINT "changes as desired, and press <cr>."
340 PRINT: PRINT R$
350 LOCATE 7,1
360 LINE INPUT RT$
370 IF RT$=NU$ THEN END
380 IF LEN(RT$)<>10 THEN 280
390 OK=(1=1)
400 FOR J=1 TO 10 :REM Make sure the rule is valid
410 RU(J-1)=VAL(MID$(RT$,J,1))
420 OK=(OK AND RU(J-1)>=0 AND RU(J-1)<=3)
430 NEXT J
440 IF NOT OK THEN 280 ELSE R$=RT$
450 REM -----
460 REM Get the number of cells in each generation
470 PRINT USING "How many cells/line (### to ###)";MI,MC;
480 INPUT NC
490 IF NC<MI OR NC>MC THEN 470
500 NL=INT((NC-1)/MI)+1 :REM Lines needed to show 1st gen.
510 REM -----
520 REM Get the initial state of the cellular automaton
530 PRINT
540 INPUT "Initial=predefined or random (P/R)";PR$
550 IF PR$<>NU$ AND INSTR(1,"Rr",PR$)>0 THEN GOSUB 900
ELSE GOSUB 970
560 A(0)=0: A(NC-1)=0 :REM Force boundaries to zero
570 REM -----
580 REM Start the cellular automaton running
590 CLS
600 PRINT "Rule ";R$ :REM Display rule
610 FOR J=0 TO 3
620 LOCATE 1,20+J*4
630 PRINT USING "#=";J
640 NX=168+J*32

```

(continued)

automaton. The simplest initial state consists of all cells in the field zero except the one that we call the "seed."

Let's see what happens with the above rule and a single cell near the middle of the field in state 1. This can be shown as follows:

- | | |
|------------------|-------------|
| 1. Initial state | 00000100000 |
| Sum | 00001110000 |
| 2. Next state | 00002220000 |
| Sum | 00024642000 |
| 3. Next state | 00030003000 |
| Sum | 00333033300 |
| 4. Next state | 00000000000 |

The sums of 3, 4, and 6 all result in next states of 0, and the structure dies out after only three generations. The word *structure* describes the evolution and history of an initial state or seed in a particular automaton. The word *automaton* names the object defined by three things: (1) the field of cells (1 by 160 in this case), (2) the neighborhood (three cells in this case), and (3) the particular 10-digit rule that is selected.

Suppose we change the rule to 0230101000 so that sums of 4 and 6 generate next states of 1. The history of the first few generations, without specifically indicating the successive sums, becomes

- | | |
|----------------|-------------|
| 1. First state | 1 |
| 2. Next state | 222 |
| 3. Next state | 31113 |
| 4. Next state | 10001 |
| 5. Next state | 2220222 |
| 6. Next state | 311111113 |
| 7. Next state | 100000001 |
| 8. Next state | 22200000222 |

It is apparent that this structure will expand forever. The rate at which a structure expands or propagates is called its "speed," and the maximum possible speed is 1 (Conway calls this the "speed of light"), that is, a speed of one cell in each generation. The speed of expansion (in either direction) of the above structure is 2/3, or two cells in three generations.

Another possibility is a structure that neither expands without bound nor dies out but persists in a self-perpetuating state. An example is the rule 0010000000 with initial state 11 (i.e., any two adjacent cells in state 1 with all other cells 0). The first sum will

(continued)

EXTEND YOUR PERFORMANCE

Extend your writing and editing performance with XyWrite III. XyWrite III gives you the flexibility to write everything from a simple memo or letter, to a complex technical or legal document, to a multi-column script. XyWrite III responds instantly to every command to help you stretch your productivity—and your free time.

Extend your imagination and stretch your screen into the ultimate workspace. Touch a key and flip through outline, notes, draft, and daily schedule—up to nine different files in nine windows. Extend your reach: define and redefine every key on your keyboard, or use it as is.



Find out how you can extend your word processing performance with XyWrite III: call (617) 275-4439 today and order our demo disk.

XyQuest

XyQuest, Inc.
3 Loomis Street, Bedford, MA 01730

```

650 LINE (NX,0)-STEP(7,7),CL(J),BF
660 NEXT J
670 FOR Y=0 TO GN-1
680 FOR X=0 TO NC-1
690 IF X=0 OR X=NC-1 THEN V=3 ELSE V=CL(A(X))
700 PSET (X*SF,Y*SF+BY),V :REM Display the point
710 NEXT X
720 REM -----
730 REM Compute new state of automaton
740 FOR X=1 TO NC-2 :REM Don't change boundary cells
750 Z=A(X-1)+A(X)+A(X+1)
760 B(X)=RU(Z)
770 NEXT X
780 REM Copy new values to A() from B()
790 FOR X=1 TO NC-2: A(X)=B(X): NEXT X
800 IF INKEY$<>NU$ THEN Y=GN-1 :REM Exit if key pressed
810 NEXT Y
820 WHILE INKEY$<>NU$: WEND :REM Clear keyboard buffer
830 LOCATE 1,17: PRINT "Continue or quit (C/Q)?";
840 CQ$=INKEY$
850 IF CQ$=NU$ THEN 840
860 WH=INT((INSTR(1,"CcQq",CQ$)+1)/2)+1 :REM wh = 1,2,3
870 ON WH GOTO 840, 590, 280
880 REM -----
890 REM Random initialization of automaton
900 RANDOMIZE
910 FOR J=0 TO NC-1
920 A(J)=INT(RND*4) :REM Random values from 0 to 3
930 NEXT J
940 RETURN
950 REM -----
960 REM Initialize array A() with a preset pattern
970 FOR J=1 TO NL
980 IF NC>=J*MI THEN LL=MI ELSE LL=NC-(J-1)*MI
990 K$(J)=STRING$(LL,".")
1000 CLS
1010 PRINT "Rule is: "; R$
1020 PRINT USING "Cells in range ### to ###: "; (J-1)*MI+1,
(J-1)*MI+LL
1030 PRINT "Move cursor across the field and make"
1040 PRINT "changes as desired. Then press <cr>."
1050 PRINT K$(J)
1060 LOCATE 5,1
1070 LINE INPUT K$(J)
1080 NEXT J
1090 K$=K$(1)+K$(2)+K$(3)+K$(4)
1100 REM Convert string to array values
1110 FOR J=1 TO NC
1120 KK$=MID$(K$,J,1)
1130 IF INSTR(1,"0123",KK$)=0 THEN A(J-1)=BG ELSE A(J-1)=
VAL(KK$)
1140 NEXT J
1150 RETURN

```

be 1221 and the next state will be 0110, and so will all future states. I like to think of this as a cyclically repeating structure with a period of 1 because all of these permanent entities are cyclic and most have periods of 2 or more. The period of a cyclic structure is the number of generations before the cycle repeats. Some have very long periods and are astonishingly complex.

A structure that eventually dies out

is called a "finite structure." Some of these structures can have very long histories before their demise. One shown in the September 1984 *Scientific American* (page 200) had been traced for 1200 generations and was still reproducing and expanding, so whether or not it is indeed finite had not been established. It was generated by the rule 0230011133 and the initial state 11. I programmed the automaton and followed it for hun-

dreds of generations, until it grew too wide for the screen. The fate of such a structure cannot be predicted and can be determined only by simulating it and following it to the end.

These one-dimensional automata are "mathematically irreducible"—there is no shortcut to determine whether a given automaton with a given rule and a given initial state will lead to a cyclic structure of long period, a finite structure of long life, or some other possibility. Therefore, the approach taken by this program is not naive. We are not playing a trivial game whose outcome could be more easily predicted by a more sophisticated mathematical approach.

Of course, a particular outcome can be found much more quickly by expedients such as using a programming language that is inherently faster, a search algorithm that recognizes certain results by techniques more sophisticated than watching the screen, or special hardware that performs the simulation faster than even a computer programmed in machine language.

To find the structures that are shown in this article, I wrote my program in 8088 assembly language. It runs a couple of hundred times faster than the interpreted BASIC program of listing 1. [Editor's note: The author has provided a set of Pascal programs that duplicate the operation of the BASIC program in listing 1, but at a much faster rate. Source listings of these programs with documentation, plus the program in listing 1, are available on disk, in print, and on BIX; see the insert card following page 320 for details. Listings are also available on BYTEnet; see page 4.]

Tables 1 and 2 display examples of various structures. Table 1 shows an automaton that supports three different cyclic structures at periods 6, 2, and 1, each defined by its initial state. Of course, any of the states in the cycle can be the initial state. A "state" of a structure is a sequence of cellular "states" that begins and ends with nonzero (or nonbackground) cells and contains mostly nonzero (or nonbackground) cells.

Table 2 shows two automata that support two different propagating cyclic structures that do not stay in

(continued)

Find out how good Business Class can be.

TWA



TWA AND AMERICAN EXPRESS MEAN BUSINESS.

Discover the peace of mind

that comes with TWA's

Airport Express® service. TWA recommends you reserve and pay for your tickets ahead of time with the American Express® Card, and get your boarding passes even before you get to the airport.

Plus, Business Class travelers enjoy many other special services like priority luggage drop-off and pick-up.

YOUR COMFORT IS OUR BUSINESS.

TWA goes to great lengths and widths to ensure your comfort with extra leg and shoulder room. And on our 747s, Business Class travelers can find themselves sitting in the lap of luxury in our spacious Business LoungerSM—the widest seat in the sky. And all of this special Business Class comfort is available not only across the Atlantic, but also on all TWA widebodies across America.

AMERICAN EXPRESS INTRODUCES GLOBAL ASSIST.

Wherever business takes you, American Express' new Global Assist service provides worldwide emergency referrals. With one call, toll free, 24 hours a day, American Express will help Cardmembers find a lawyer, doctor, dentist, pharmacist, interpreter—or even suggest which visas or inoculations are needed for specific trips. And American

Express has Travel Service Offices

worldwide to help you with any changes in your travel plans.

THE BEST TRAVEL AWARDS FOR FREQUENT FLYERS. Only TWA offers frequent flyers the opportunity to earn a free trip for two, First Class, around the world, as well as free travel to a variety of exciting, exotic places. And members of TWA's Frequent Flight Bonus® program who travel Business Class will earn 25% bonus miles on every flight.

THE IDEAL TRAVEL PARTNERS: TWA AND AMERICAN EXPRESS. There's a new spirit and vitality at TWA and we're determined to make

sure your Business Class travel goes as smoothly and conveniently as possible. To ensure this ease,

TWA gladly accepts the American Express Card with its instant acceptance at TWA

counters worldwide. Don't leave home without it.®



Cards

TODAY'S TWA. FIND OUT HOW GOOD WE REALLY ARE.

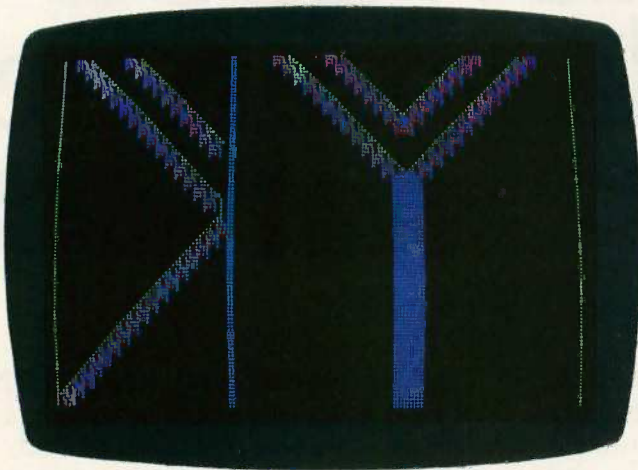

Photo 1: An example of how gliders react when they encounter fixed structures (rule 0020303113).

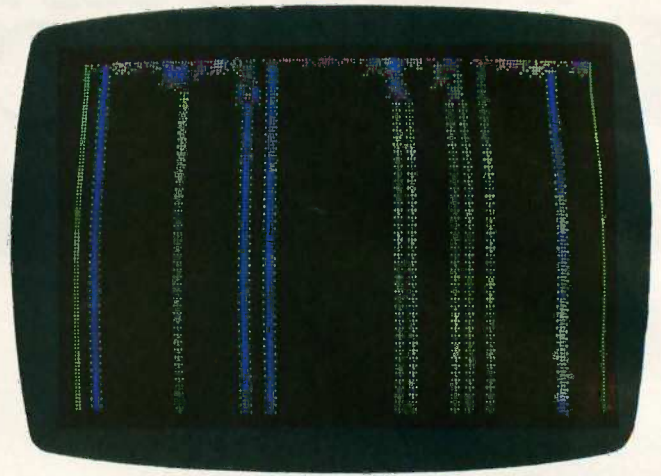

Photo 2: A class 2 automaton showing a pattern of simple cyclic structures of short period (rule 0302003132).

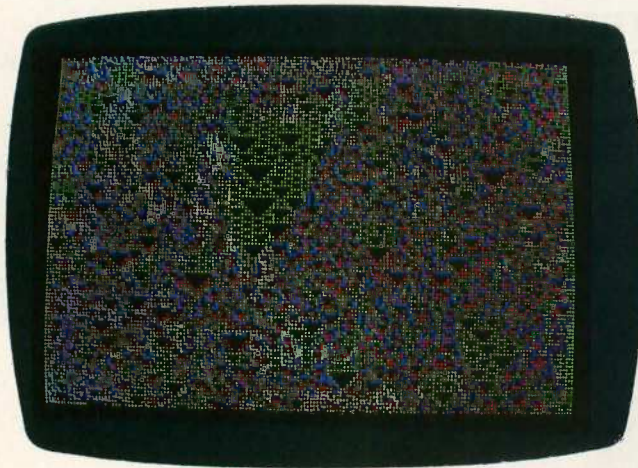

Photo 3: A class 3 automaton exhibiting constantly changing, chaotic behavior (rule 0121230210).

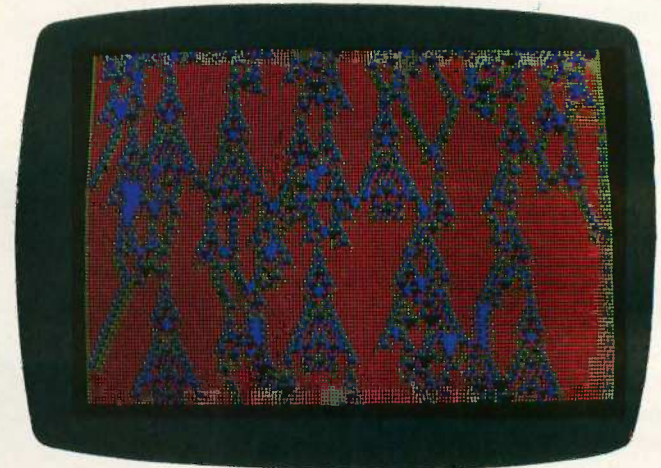

Photo 4: A class 4 automaton that demonstrates the emergence of a nonzero background (rule 0231123003).

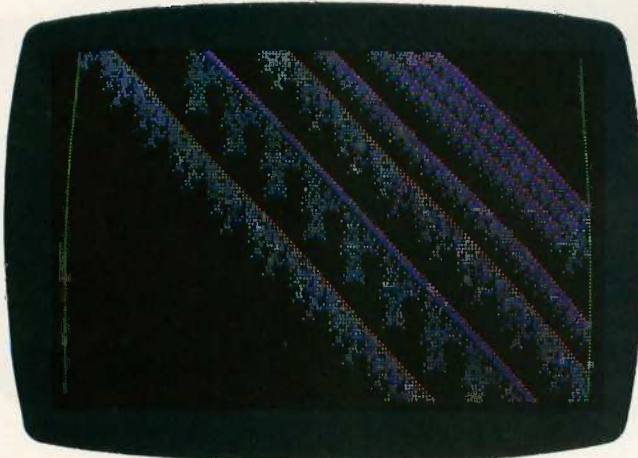

Photo 5: A complex automaton from a random seed, regenerated for display with a nonrandom initial state (rule 0102330312).

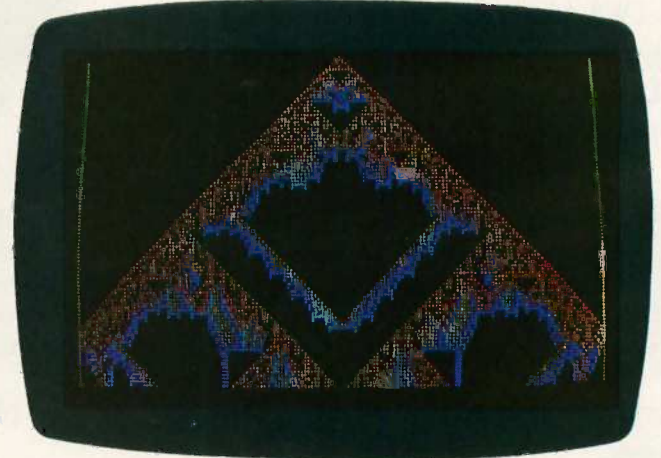

Photo 6: An automaton discovered by initializing the field to a state with one nonzero cell in the center (rule 0120133230).

place as do those in table 1 but travel laterally across the field; I call them "gliders." The first example has a period of 4 and travels with a speed of 1; the second has a period of 2 and a speed of 1/2. You can see that the states of a glider must be asymmetric and that the direction of travel can be changed by reversing the initial state. From this point of view the one-dimensional field can be thought of as a transmission line with structures propagating down it at speeds equal to or less than the "speed of light."

One might ask what happens when a glider encounters a sedentary structure or when two oppositely directed gliders meet each other. Some examples of this are shown in photo 1, an automaton that has the rule 0020303113. In this example, when the glider encounters a fixed structure, it is either stopped and destroyed or "reflected" to travel in the opposite direction. When two gliders collide they either destroy each other or combine to create a new stationary structure. The reason for the alternate behavior is that this glider has a period of 3 and thus consists of three different states; what happens depends on which state first senses the encounter. You can see from this photo that an automaton can contain, at one time, several different structures that evolve independently and do not interfere with each other.

EXTRAORDINARY STRUCTURES

One of the objects of this game is finding complex examples of cyclic structures and very long finite structures.

Photos 2 through 4 show how various automata evolve from random initial states. I have found that the best way to search for interesting rules is to observe how they develop from random initialization. Usually the rule controls the large-scale appearance of the picture on the color monitor screen, while the random initial state affects the detailed or fine-scale appearance. The programmer can generally recognize the "signature" picture of the rule regardless of the random initial state.

Stephen Wolfram has found that all one-dimensional cellular automata of

the type I am describing can be placed into four different classes.

Class 1 contains those automata that, for any random initial condition, evolve in only a few generations to the state where all of the automaton's cells are in state 0 (or possibly all in the same nonzero state). These automata always die out very quickly; the other three classes live a very long time if not forever.

Class 2 automata very quickly reach a state where all that remains is a number of simple cyclic structures of short period (see photo 2).

Class 3 automata never die out and never reach the simple stable state of class 2. Instead, they exhibit a constantly changing chaotic behavior (see photo 3). It has been my observation that of all possible rules, more than half show class 3 behavior. Although class 3 behavior is chaotic, it is not random or even pseudorandom. A close inspection of the photo will show many small-scale structures for which the chance of having been generated by a random process is vanishingly small. About 80 percent of randomly initialized automata will fall into class 3.

The only class that I would recommend as being worth investigating in detail is class 4. Roughly one in 30 or one in 50 of randomly selected rules will generate a class 4 automaton. An example of this class is shown in photo 4.

Regardless of the random initial state, certain structures always seem to evolve within a few states for class 4 automata. One feature of these automata that is entirely controlled by the rule is the background color (black, red, and green, respectively, in these photos). It is clear that, whatever the random initial state, the background specified by the rule very quickly shows itself.

How does the rule specify and force a nonzero background? Here's a hint: Note that for a background of 1 (red) the rule number must have a 1 in the place corresponding to a sum of 3. This is necessary for the background to sustain itself since three 1s equal 3. Likewise, for a green background, the rule must have a 2 opposite the

(continued)

Table 1: The rule defining a one-dimensional cellular automaton supporting three different cyclic structures with periods of 6, 2, and 1. Note: Leading and trailing zeros are omitted.

sum	0	1	2	3	4	5	6	7	8	9
rule	0	2	3	0	3	1	0	1	3	0

state				1	1	1	3			
sum				1	2	3	5	4	3	
state				2	3	0	1	3		
sum				2	5	5	4	4	4	3
state				3	1	1	3	3	3	
sum	3	4	5	5	7	9	6	3		
state				3	1	1	1			
sum	3	4	5	3	2	1				
state				3	1	0	3	2		
sum	3	4	4	4	5	5	2			
state				3	3	3	1	1	3	
sum	3	6	9	7	5	5	4	3		
state				1	1	1	3			

state				3	1	1	0	1	1	3
sum	3	4	5	2	2	2	5	4	3	
state				3	1	3	3	3	1	3
sum	3	4	7	7	9	7	7	4	3	
state				3	1	1	0	1	1	3

state				3	1	1	3			
sum	3	4	5	5	4	3				
state				3	1	1	3			

Table 2: Propagating automata or gliders that move laterally across the field.

sum	0	1	2	3	4	5	6	7	8	9
rule	0	1	0	3	2	2	0	2	3	2

state				2	2	2	2	3		
sum	2	4	6	6	7	5	3			
state				2	0	0	2	2	3	
sum	2	2	2	2	4	7	5	3		
state				2	2	2	3			
sum				2	4	6	7	5	3	
state				2	0	2	2	3		
sum	2	2	4	4	7	5	3			
state				2	2	2	2	3		

sum	0	1	2	3	4	5	6	7	8	9
rule	0	1	3	0	2	2	3	1	3	0

state				3	3	3	2	3		
sum	3	6	9	8	8	5	3			
state				3	0	3	3	2		
sum	3	3	6	6	8	5	2			
state				3	3	3	2	3		

BASIC PROGRAM NOTES

BY GEORGE A. STEWART

The BASIC program for the IBM PC (adapted from Perry's original program) lets you try any rule on a random or predefined cellular automaton. It also lets you specify the size of the automaton; the larger the automaton, the longer the program takes to calculate and display each successive state of development.

Lines 90-240 initialize certain program constants. Some of these you may change for special effects as noted in the remarks. The color codes in line 240 correspond to black, green, red, and brown in IBM color palette 0. Array CL() rearranges the codes to approximate the colors used in the photographs accompanying this article.

Lines 260-440 prompt you to enter the rule. A "dummy" rule is shown so that you can edit or replace it. In any case, you must move the cursor across all 10 digits of the rule, making changes as desired.

Lines 460-500 let you specify the number of cells in each generation,

and lines 520-560 let you select either random or predefined initialization. Subroutines at line 900 and 970 handle the two initialization options.

The program block from 580 to 710 displays a heading and the current state of the automaton. Lines 610-660 print a "color key" to aid in interpreting the progression from one generation to another. The boundary cells are always 0, but the program displays them as color 3 (brown) so they will be visible on the screen (line 690).

Lines 730-810 calculate the next state of the automaton by summing the adjacent cells and applying the rule (lines 750-760). If you press a key while the program is presenting the automaton, a continuation menu appears on the top line, giving you a chance to quit or continue.

Lines 890-940 constitute the random initialization subroutine, and lines 960-1150 make up the predefined state subroutine. The latter subroutine lets you edit the initial state by show-

ing the cell in expanded form. To specify the initial state, you move the cursor across the dots, placing a 0, 1, 2, or 3 as you wish. (The dots will be interpreted as background cells, color 0. To make the dots signify another cell type, change line 190.)

Since the automaton is magnified for editing, it may take several steps to view and edit an entire line. The program displays a maximum of 40 dots or cells at once. Thus a 160-cell automaton will require editing four lines of dots. Remember to move the cursor across all the displayed dots, making changes as you go along. Do not use the delete or backspace key because these will change the length of the input line; instead, use the cursor motion keys and type the desired numbers to make the changes you want.

George A. Stewart is a BYTE technical editor. He can be reached at BYTE, One Phoenix Mill Lane, Peterborough, NH 03458.

Table 3: A list of 100 rules that generate interesting patterns when specified using the BASIC program in listing 1.

#	Rule	#	Rule	#	Rule	#	Rule
1	0 001 033 232	26	0 031 202 120	51	0 131 202 112	76	0 232 320 233
2	0 001 321 021	27	0 031 312 330	52	0 200 213 313	77	0 233 332 230
3	0 001 321 200	28	0 100 023 321	53	0 201 102 332	78	0 300 231 232
4	0 001 330 123	29	0 100 222 313	54	0 201 120 011	79	0 301 220 300
5	0 002 023 330	30	0 100 332 102	55	0 201 220 111	80	0 301 223 033
6	0 002 320 123	31	0 100 332 202	56	0 202 032 321	81	0 302 032 310
7	0 010 212 332	32	0 102 013 322	57	0 202 301 321	82	0 302 033 010
8	0 010 322 003	33	0 102 030 022	58	0 202 330 211	83	0 302 230 132
9	0 010 332 330	34	0 102 323 201	59	0 203 002 120	84	0 302 311 102
10	0 010 332 321	35	0 102 330 023	60	0 203 021 013	85	0 303 023 003
11	0 011 202 122	36	0 102 330 312	61	0 210 033 210	86	0 303 210 023
12	0 012 003 101	37	0 102 330 322	62	0 211 030 031	87	0 310 012 320
13	0 012 011 001	38	0 103 022 021	63	0 211 303 210	88	0 310 021 113
14	0 012 031 221	39	0 103 023 003	64	0 213 102 233	89	0 310 103 220
15	0 012 300 103	40	0 103 202 100	65	0 220 132 200	90	0 310 122 002
16	0 012 322 132	41	0 103 220 011	66	0 221 312 221	91	0 322 202 330
17	0 013 103 112	42	0 103 220 232	67	0 222 100 323	92	0 323 101 303
18	0 020 122 112	43	0 112 322 130	68	0 223 010 033	93	0 330 102 221
19	0 021 312 200	44	0 120 302 230	69	0 223 200 322	94	0 330 102 303
20	0 023 302 220	45	0 120 133 230	70	0 230 011 001	95	0 331 310 203
21	0 030 023 231	46	0 120 203 330	71	0 230 120 333	96	2 000 133 101
22	0 030 210 333	47	0 121 302 210	72	0 230 122 000	97	2 031 013 013
23	0 031 022 131	48	0 130 023 230	73	0 230 210 333	98	2 112 013 330
24	0 031 100 120	49	0 130 203 301	74	0 231 220 233	99	2 120 203 330
25	0 031 123 002	50	0 131 123 000	75	0 231 331 233	100	3 310 013 031

MICROWAY MEANS 8087 PERFORMANCE

FastCACHE-286™

Runs the 80286 at 8.5 or 11 MHz and the 80287 at 5, 6 or 11 MHz. Includes 8 kbytes of 55ns CACHE. Works with more PCs than any other accelerator, including Leading Edge Model D, Compaq, and Turbo motherboards. Includes 8088 Reboot Switch, DCache and Diagnostics. **From \$449**

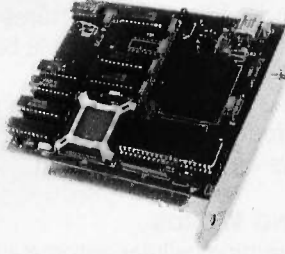

LOTUS/INTEL EMS SPECIFICATION BOARDS

MegaPage™ The only EMS board which comes populated with two megabytes of cool-running, low power drain CMOS RAM installed. Includes RAM disk, print spooler, disk cache and EMS drivers. For the IBM PC, XT and compatibles...**\$549**

MegaPage AT/ECC™ EMS card for the PC AT and compatibles includes Error Correction Circuitry. With ECC, 11 RAM chips cover 256K so the user never encounters RAM errors. Sold populated with 1 megabyte CMOS . . . **\$699** or with 3 megabytes CMOS cool running low power drain RAM . . . **\$1295**. Optional serial/parallel daughterboard. **\$95**

NUMBER SMASHER/ECM™

12 MHz Accelerator
\$1199

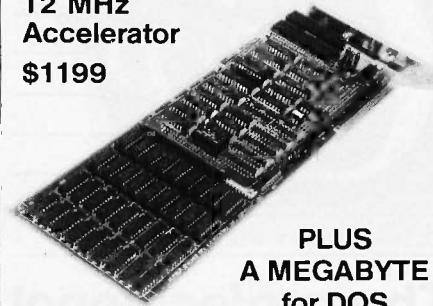

PLUS A MEGABYTE for DOS

For the IBM PC, XT and compatibles
PC Magazine "Editor's Choice"

DATA ACQUISITION and REAL TIME TOOLS

DAL™ - Our new "Data Acquisition Language."

Unkelscope™ - A real time data acquisition, control and process software pkg.

87 FFT and 87 FFT-2

RTOS - REAL TIME OPERATING SYSTEM
A multi-user, multi-tasking real time operating system. Includes a configured version of Intel's iRMX-86, LINK-86, LOC-86, LIB-86, OH-86 and the MicroWay 87DEBUG. Runs on the IBM-PC, XT, PC-AT and COMPAQ. **\$600**

INTEL COMPILERS Available for RTOS
FORTRAN-86, PASCAL-86, PL/M-86 and ASM-86.

287 Turbo™ -10/12

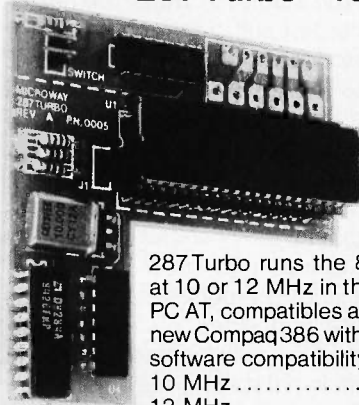

287 Turbo runs the 80287 at 10 or 12 MHz in the IBM PC AT, compatibles and the new Compaq 386 with 100% software compatibility.
10 MHz **\$450**
12 MHz **\$550**

PC Magazine "Editor's Choice"

8087 UPGRADES

All MicroWay 8087s include a one year warranty, complete MicroWay Test Program and accurate installation instructions.

8087 5 MHz **\$114**
For the IBM PC, XT and compatibles

8087-2 8 MHz **\$149**
For Wang, AT&T, DeskPro, NEC, Leading Edge

80287-3 5 MHz **\$179**
For the IBM PC AT and 286 compatibles

80287-6 6 MHz **\$229**
For 8 MHz AT compatibles

80287-8 8 MHz **\$295**
For the 8 MHz 80286 accelerator cards

Call for prices on 64K and 256K RAM

A2D-160™

The Fastest 12 bit A/D Converter

\$1295

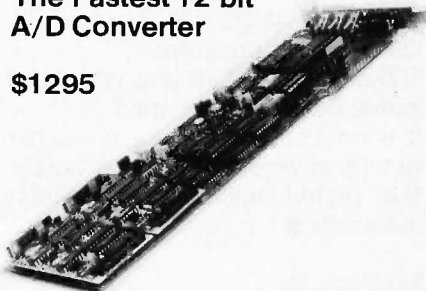

160,000 Samples per second
Pseudo Random Noise Generator/DAC
Optional signal conditioners
AFM-50 Programmable Low Pass Filter Module. **\$225**

MICROWAY SOFTWARE FOR THE 8087

- FASTBREAK for Lotus 1-2-3
- MATRIXPAK
- DCache
- OBJ-ASM
- DFixer
- DOptimizer
- 87 SFL
- 87 BASIC
- 87 MACRO
- 87 DEBUG
- 87 FFT
- 87 FFT-2
- 87 VERIFY
- 87 TEST

287TURBO-PLUS™

Speeds up your AT

Adjustable 80286 Clock 6-12 MHz
10 MHz 80287 Clock
Plus Full Hardware Reset. **\$125**
Optional 80286-10

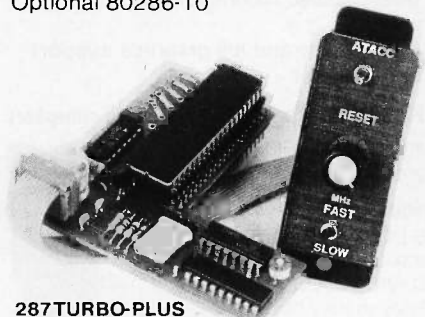

287TURBO-PLUS
With 80287 10MHz **\$529**
With 80287 12MHz **\$629**

CALL FOR OUR COMPLETE CATALOG

MicroWay

P.O. Box 79
Kingston, Mass.
02364 USA
(617) 746-7341

**The World Leader
in 8087 Support!**

MicroWay Europe
32 High Street
Kingston-Upon-Thames
Surrey England KT1 1HL
Telephone: 01-541-5466

#1 C interpreter

The professional C development environment

Your C compiler creates great final code . . . but as a programming tool, it's too, too slow. With C-terp you can edit, debug, and run without the wait. Nothing, but nothing, is faster for developing professional C programs.

Choose the perfect C-terp companion for your C compiler

C-terp/Microsoft	C-terp/XENIX
C-terp/Lattice	C-terp/Aztec
C-terp/Mark Williams	C-terp/C86

Link in all your compiler's functions, your own functions, add-on libraries, assembly routines, and data objects. Get instant access to everything in the C-terp interactive environment.

Only C-terp offers all this and more

- Full K&R with common ANSI enhancements
- Source level interactive debugging
- Software paging for your big jobs
- Complete multi-module support
- Run-time pointer checking
- Unsurpassed reconfigurable screen editor
- Dual display and full graphics support
- Large model ■ Call-in

ORDER C-terp TODAY (specify compiler)

C-terp runs on IBM PC, AT or compatibles.

Price:

MS-DOS 2.x and up - \$298,
Xenix System V 286 - \$498
MC, VISA, COD
30-day money-back
GUARANTEE



Trademarks: C-terp (Gimpel Software), C86 (Computer Innovations), Lattice (Lattice, Inc.), Xenix, Microsoft, MS-DOS (Microsoft, Inc.), Aztec (Mark Software), Mark Williams (Mark Williams Company), IBM (International Business Machines, Inc.)

GIMPEL SOFTWARE

3207 Hogarth Lane, Collegeville, PA 19426

(215) 584-4261

MATHEMATICAL ART

The field of complex systems theory touches on many phenomena, including the growth of a snowflake and complex patterns found in sea shells.

sum of 6, and for blue there must be a 3 at the sum of 9. These are necessary but not sufficient conditions for a rule to force a nonzero background.

Class 4 automata are characterized by the ability to support a number of different, often complex, "persistent structures," as Wolfram calls them, namely stationary cyclic structures and gliders.

It is not easy to know if you have found *all* of the persistent structures that are supported by a rule, particularly if the only method used is the random initial state of the automaton. A structure appears only if one of its states is created by chance, and even then it may be destroyed by interference from nearby structures. Some simple structures will appear almost every time you try a new random initialization, and some complex structures, all of whose states are very long (10 or 20 cells), have such a low creation probability that they are never seen.

Luck and patience are the principal weapons for bagging the big game in this abstract wilderness.

Photo 5 comes from an automaton that supports some rather baroque gliders that, while propagating, sputter off structures of pendant filigree. These gliders were, as usual, found by chance and patience in the random initial state mode, then carefully arranged in the predefined initial state mode to produce the picture shown.

An alternative method of searching for class 4 automata, and one that I used before discovering the random-search method, is to initialize with a

field consisting of a single nonzero cell, preferably in the exact center of the field. This usually displays the automaton expanding at some speed less than or equal to the speed of light and sometimes shows the automaton to best advantage. Photo 6 shows an example of how very complex and enchanting structures can evolve from apparently simple beginnings.

Table 3 is a list of 100 of the rules that I found to produce interesting displays on the color screen.

CLOSING WORDS

Programming cellular automata is an interesting computer pastime and something worth studying for the fun of it. This is a valid approach; to quote from reference 2, "The cellular automaton can be viewed as a 'digital universe' worth exploring for its own sake, quite apart from its utility as a model of the real world."

But the people who make it their business to investigate these things take them more seriously and (as I understand it) believe that the study of complexity in these automata may lead to a better understanding of complexity in nature. This field is called "complex systems theory," and it touches on many phenomena, including the growth of a snowflake, complex patterns found in some sea shells, and perhaps even the development of a single cell into a multicellular adult organism.

The Game of Life is a very good game, but, as I have tried to show, it is only one of an infinite number of undiscovered entities that exist in the digital universe of cellular automata. ■

REFERENCES

1. Gardner, Martin. "On Cellular Automata, Self-Reproduction, the Garden of Eden, and the Game of Life." *Mathematical Games Department, Scientific American*, February 1971.
2. Hayes, Brian. "Computer Recreations." *Scientific American*, March 1984, page 12.
3. Wolfram, Stephen. "Computer Software in Science and Mathematics." *Scientific American*, September 1984, page 188.
4. Wolfram, Stephen. "Cellular Automata As Models of Complexity." *Nature*, October 1984.

THE COMPUTER THAT CONQUERED TIME ALSO CONQUERS SPACE.

Finally: the computers you've been waiting for. Speed. Power. Flexibility. And IBM PC/XT/AT compatibility.

The PC's Limited 286¹⁰ and 286¹² are the most technologically-advanced personal computers ever designed. They run at 10 and 12 megahertz, respectively, providing the fastest processing times of any PC-compatible.

Who needs 12 megahertz speed? *You* do, if you use *dBase* and you're tired of waiting during long sorts and indexes. *You* do, if you're tired of going out to lunch while your compiler finishes its work. *You* do, if you want to see *Microsoft Windows* fly. Or *AutoCAD* or *P-CAD* take off.

The PC's Limited 286s also have the exclusive *SmartVu* panel — an alphanumeric window into the computer that reports on processing speed and provides diagnostic messages in English. It can even help predict hard-disk failures *before* you lose a month's work.

The 286s are also smaller than the other AT-compatibles — more than 25% smaller than the IBM PC-AT, for example. Which means you can find your desk again.

And they're not stripped, Asian wonder-boxes. Designed and built in the U.S., the 286¹⁰ and 286¹² come with 1,024K of fast RAM on the motherboard, 1.2 Mb floppy drive, 200-watt power supply, and an AT-style keyboard.

And every 286 goes through extensive bench-testing and extended burn-in before it leaves our plant.

What more can we say? Except that you can buy the 286¹² for just \$2,695, the 286¹⁰ for \$2,295. Including shipping. Both backed, of course, by PC's Limited's One-Year Limited Warranty and 30-Day Money-Back Guarantee.



Call for latest prices.

* Limited Warranty

FREE SHIPPING in the continental United States via UPS Ground.

PC'S LIMITED 286⁸™ \$1495

High Performance, Competitive Price
 PC Magazine "Editor's Choice" Feb. 25, 1986
 Includes: 80286-based system unit, 1024K on mother board,
 1.2 Meg Floppy Drive, Combined Floppy and Hard Disk Controller Card. AT Style Keyboard, 192W
 Power Supply, 2 Serials and 1 Parallel Port, and Clock/Calendar with Battery Backup.
 Runs all Major Software written for the IBM PC™, PC XT™, and PC AT™. (Processor): Intel 80286 running
 at 8MHZ. (Expansion Slots): 8. Same Bus Configuration as IBM PC AT™
 One Year Warranty*



30 Day
 Money Back
 Guarantee



PC'S LIMITED TURBO PC™ \$795

High Performance, Competitive Price
 Includes: System Unit, 640K on Mother Board, 360K Floppy Drive, AT Keyboard, 130W Power
 Supply.
 Runs all major software written for the IBM PC™, PC/XT™, 40% faster, without
 modifications. Processor: 16-bit 8088—2, 4.77 or 6.66 MHZ Clock Speed. Expansion Slots: 8; 7 are
 available in above configuration.
 One Year Warranty.*

PC'S LIMITED 20 MEG HARD DISK ON A CARD

\$409

- 3½" Tandon Hard Disk
- Software included
- Easy to install
- One Year Warranty



TANDON HARD DISK WESTERN DIGITAL CONTROLLER

Internal \$409

20 MB Hard Disk System for PC™
 Includes Tandon Hard Disk, Western Digital Controller, Cables, Manual, Software, and Mounting
 Hardware. Boots from Hard disk. Our Hard Disk Systems are compatible with the latest versions of
 the following computers: IBM PC, IBM XT, AT&T 6300, Compaq Deskpro, Tandy 1000, Tandy
 1200, PC's Limited Turbo PC, Leading Edge PC (Both Models), Sperry PC, Wyse PC, ITT PC, and
 most other Compatibles.
 PLEASE SPECIFY YOUR COMPUTER TYPE WHEN ORDERING.
 One Year Warranty.*



FLOPPY DISK DRIVE



\$95

Mitsubishi Electronics Half-Height, DS/DD
 Also available for AT™ in gray.

300/1200 BAUD HAYES COMPATIBLE MODEM

Internal \$159 Fits in Short Slot



External \$179

WANGTEK 60 MEG TAPE BACKUP SYSTEM

\$795

- Backs up 5 Megs per minute
- Runs under MS DOS or PC DOS
- Pulse Software Included

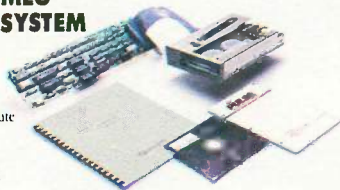

PC'S LIMITED SIX FUNCTION CARD

w/OK \$99 w/384K \$149

- Upgradable to 384K
- Clock/Calendar
- Includes Software
- Parallel Port
- Serial Port
- Game Port
- Two Year Warranty*



PC'S LIMITED MINI I/O

\$99

- Serial port
- Parallel port
- Clock
- Software
- Fits in short slot

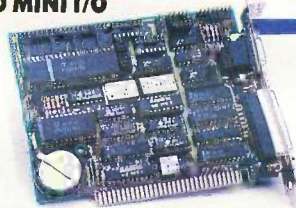

MONO-II

\$129

- 12" flat and compact screen
- TTL signal input
- Built-in swivel and tilt base
- Instant action system
- Low distortion



SEAGATE 20, 30 AND 40 MEG HIGH SPEED 40 MS ACCESS TIME HARD DRIVES FOR AT™ AND NOW — 80 MEG 28 MS ACCESS TIME HARD DRIVE FOR AT™

20 MEG \$579 30 MEG \$699
 40 MEG \$819 80 MEG \$1495

Uses Linear Voice Coil Activator. Heads park automatically
 at power down. Includes Seagate Full Height Hard Disk,
 Cable, and Mounting Rails. Boots from Hard Disk.
 One Year Warranty*



EGAdS! CARD

\$269

- Full IBM EGA compatibility.
- Full 256K Video RAM installed at no extra cost.



EGAdS! MONITOR

\$479

- CGA/EGA compatible
- 13" screen
- .3mm pitch



PC'S LIMITED AT MULTIFUNCTION CARD

\$199 w/OK

- Piggy Back Board \$59 w/OK
- Expandable to 3 MEG (1.5 on Board/1.5 on Piggy Back Board) • Supports 64 or 256K RAMS • Parallel Port • Serial Port (2nd serial option)



UNIVERSAL GRAPHICS CARD II

\$199

- Fully compatible with IBM CGA, Plantronics COLORPLUS, IBM Monochrome, and Hercules compatible graphics modes.
- Includes Parallel Port and fits in a "short" slot.



XT™ POWER 130W

\$99

Solve Your Power Problem.
 Directly replaces Power Supply in PC™
 Fully XT™ compatible.
 One Year Warranty.*



TOTAL SATISFACTION GUARANTEE

WARRANTY

For warranty service, one year limited warranty on PC's Limited products. Contact Technical Support for a Return Authorization Number (RMA). Returns must be accompanied by your RMA, the invoice, and a brief explanation. During the warranty period, PC's Limited will repair or replace items at our option.

30-DAY TOTAL SATISFACTION GUARANTEE

Any item bought from PC's Limited may be returned within 30 days from the date it was shipped for a full refund of your purchase price. Returned items must be as-new, not modified or damaged, with all warranty cards, manuals, and packaging intact. Returned items must be shipped prepaid and insured, and must bear a PC's Limited Credit Return Authorization (CRA) on the shipping label. Call PC's Limited Customer Support Department for CRA. No credit issued after 30 days from date of shipment. Sorry, but we are able to issue credit for new, unopened software only.

CONSUMER TIP

When shopping for PC products, ask our competitors about their refund policies. Mitsubishi, Intel, IBM, Hercules, Plantronics, Seagate, Western Digital, AT&T, Compaq, Tandy, Leading Edge, Sperry, Wyse, and ITT are registered trademarks of their respective companies. IBM PC, IBM XT, IBM AT, are trademarks of IBM Corporation. Leading Edge PC, Sperry PC, Wyse PC, Compaq Deskpro, AT&T 6300, Tandy 1000 and Tandy 1200 are trademarks of their respective companies.

Some quantities may be limited. PC's Limited sells equipment certified to be compliant with FCC Class B standards. All prices are subject to change without notice.

PC'S LIMITED

SALES CALLS OUTSIDE TEXAS, 1-800-426-5150

SALES CALLS INSIDE TEXAS, 1-800-252-8336

1611 Headway Circle, Building 3, Austin, Texas 78754

Sales Calls from anywhere in the country, (512) 339-6962

Technical Support Calls, 1-(800) 624-9896 or PC's Limited BBS (512) 339-4127

Customer Service Calls, 1-(800) 624-9897 or MCI MAIL: PC'S LIMITED

Telex No. 9103808386 PC LTD FAX (512) 339-6721

1-800-426-5150

THE TMS34010 GRAPHICS SYSTEM PROCESSOR

BY CARRELL R. KILLEBREW JR.

*This bit-addressable graphics engine features
an on-chip instruction cache and pipelined architecture*

THE TEXAS INSTRUMENTS TMS34010 Graphics System Processor (hereafter referred to as the GSP) can execute at burst rates of 6 million instructions per second (MIPS) when it is clocked at 50 megahertz. On-chip hardware generates bit-mapped graphics an order of magnitude faster than general-purpose microprocessors. Pipelining enhances the GSP's processing capabilities; during one 160-nanosecond machine-state time, the GSP can read from two registers, write to one register, decode one instruction, execute the current instruction, and initiate or complete a local memory cycle.

The TMS34010 chip achieves this performance through internal parallelism, supported by a 256-byte instruction cache, thirty-one 32-bit registers, variable-width ALUs (arithmetic logic units), single-cycle instructions, a barrel shifter, and mask-merge hardware. The built-in VRAM/DRAM (video RAM/dynamic RAM) interface and display control circuitry simplify interface design. The GSP functions as the host central processor or as a dedicated slave processor via an 8- or

16-bit host port, providing indirect access to the GSP's local memory space.

BASIC ARCHITECTURE

The GSP provides separate interfaces to the graphics display, the host processor, and its own local memory bus. The host interface determines whether the GSP is functioning independently or as a slave to a host processor. When functioning as a slave, the GSP host interface transfers programs, data, and graphics display lists between host memory and the GSP's local memory. In stand-alone applications, the GSP manages its own peripherals via the local memory bus. Display refresh and local memory refresh are performed by the local memory controller at intervals controlled by programming on-chip I/O registers. All instructions and data used by the GSP during program execution come from its local memory.

Instructions are normally fetched from local memory and stored on-chip in the 256-byte instruction cache. When a cache miss occurs, the GSP fetches and loads instructions into the least-recently-used segment of the

cache. Instructions are decoded prior to execution (pipelining). All major data paths, registers, and ALUs in the GSP are 32 bits wide. Pixel sizes are fixed at binary powers of two (1, 2, 4, 8, 16), but data other than pixels can be arbitrarily sized between 1 and 32 bits (programmable field width). Data fields less than 32 bits are extended to 32 bits when loaded into GSP registers. This extension feature is also programmable. Note that data fields can cross word boundaries, but those that do require multiple memory cycles.

The GSP achieves its high graphics operation throughput by processing several pixels in parallel. When the pixel size is programmed, the ALUs

(continued)

Carrell R. Killebrew Jr. is a graphics engineering manager at Texas Instruments. He can be contacted at Texas Instruments, 9901 South Wilcrest, P.O. Box 1443, MS 6410, Houston, TX 77099, or via BIX. A TI-supported BIX conference (*ti.graphics*) is available for additional information.

The author gratefully acknowledges the editorial contributions of Jerry Van Aken (TI) and Chuck Weston (BYTE).

are configured to perform simultaneous Boolean or arithmetic operations upon multiple pixels of that size. (The ALU carry chain is broken at pixel-size intervals, creating a series of smaller ALUs.) Plane masking and transparency are applied concurrently with Boolean or arithmetic operations, thereby increasing graphics parallelism. Photo 1 shows the GSP's 22 pixel-processing operations.

DISPLAY CONTROL

The display control interface provides direct control of display devices (color monitors, laser printers, etc.) and initiates VRAM shift-register load cycles for display refresh. The display control signals consist of a clock input (VCLK), horizontal and vertical synchronization inputs/outputs (HSYNC and VSYNC), and a blanking output (BLANK). HSYNC, VSYNC, and BLANK timing is controlled by values loaded into timers and comparators from the display control I/O registers. As an added capability, software can configure either or both HSYNC and VSYNC as inputs, thus slaving display timing to other devices/systems, such as cameras or multiple GSPs. (Note that VCLK is independent of the GSP processor state clocks and increments the display control timers.)

You can use the display interrupt to synchronize graphics drawing to the display. This GSP internal interrupt ensures that objects move only once per frame interval. The display interrupt occurs whenever the vertical line count equals the value in the display interrupt (DPYINT) register.

Display refresh is accomplished by the VRAM shift-register load cycles, which take place on the GSP's local bus. Display refresh cycles typically occur once per display scan line, consuming approximately 1.5 percent of local memory bandwidth. Display control logic initiates requests for these cycles at programmed intervals.

HOST INTERFACE

Host processors can communicate with the GSP via the host interface at sustained maximum data rates of 5 megabytes per second. The host interface is configurable for 8- or 16-bit slave buses and provides bidirectional pipelined DMA between local memory and the host data register.

The interface is implemented with four host registers and a host communications bus (see figure 1). A 32-bit address pointer into GSP local memory is formed by concatenating two host address registers, HSTADRH and HSTADRL. The host data register

(HSTDATA) contains 16 bits of data from the location in GSP local memory to which the host address registers point. The host control register (HSTCTL) contains two 3-bit message fields (one field for host-to-GSP communications and one field for GSP-to-host communications), 2 bits controlling host-related interrupts, the GSP halt bit, a cache flush bit, 2 bits to control auto-incrementing the host address registers upon HSTDATA read/write, and a bit to control most-significant-byte convention (Intel versus Motorola).

The host communications bus has 16 data lines (HD15-0) and 10 control lines consisting of a chip select (HCS), read and write strobes (HREAD and HWRITE), upper and lower data-byte strobes (HUDDS and HLDS), a transaction-ready signal to the host (HRDY), function selects (HFS0 and HFS1), an interrupt to the host (HINT), and the GSP reset (RESET). Data-drive conditioning by HUDDS and HLDS can force either HD15-8 or HD7-0 to remain tristated during a host interface access.

The GSP powers up halted or free-running depending on the state of HCS when RESET transitions from a low to high state. In the case of a halted power-up, you can load the boot program via the host interface, eliminating the cost of boot ROMs. The GSP, used as the host processor (as in a 32-bit personal computer), would typically use the free-run mode on power-up. All host interface registers are also accessible as I/O registers in GSP local memory space.

LOCAL MEMORY INTERFACE

The GSP interfaces directly to dynamic and video RAMs, supporting instruction fetch and data manipulation at 6 megabytes per second. This local interface consists of 16 triply multiplexed address/data lines (LAD0-15), an input clock (INCLK), two output clocks (LCLK1 and LCLK2), and 12 control signals.

A microcoded memory controller schedules DRAM and display refresh, arbitrates local bus access by all devices, and generates all local memory control signals. In addition to managing the local memory interface,

(continued)

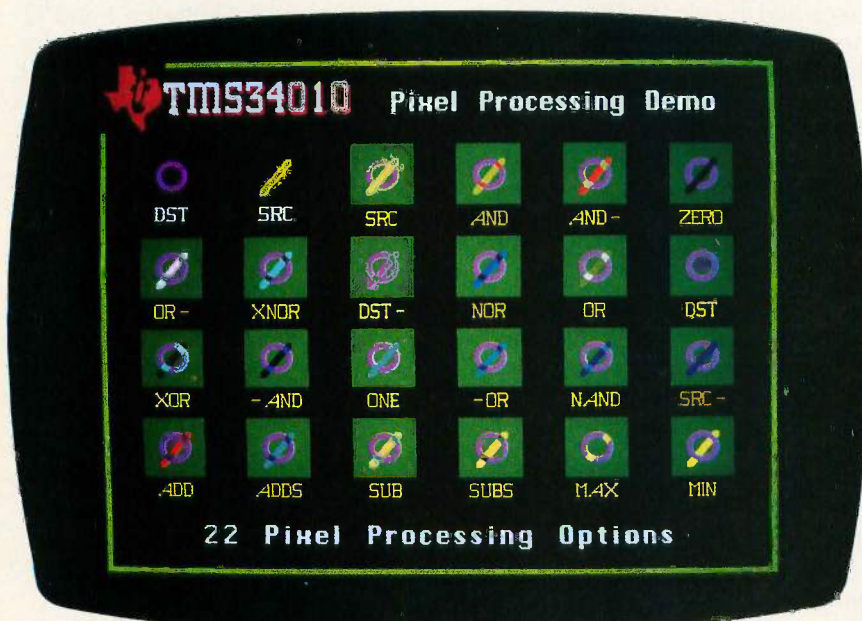

Photo 1: TMS34010 pixel-processing operations, including Booleans and arithmetics.

When You're Looking for Answers, Come to the **Library**



Runs Xenix™
Auto Cad
Novell Network

EGA SYSTEM
\$1895

Basic System
\$795

Chapter 1

**Complete Monographic
10 MHz AT
Compatible System**

- Mono monitor
- Hercules compatible card
- 67% Faster than IBM AT
- 10/8/6 MHz switchable
- 512KB memory
- W.D. HD/Floppy controller
- TEAC 1.2 Floppy drive
- Fully IBM BIOS compatible
- CMOS clock/calendar
- 200 watt power supply

- Operation Manual
- AT style keyboard
- One Year Limited warranty
- FCC class 'B' approved
- Designed, Manufactured and serviced in U.S.A.
- SI Rating 10.3

Free Starter's Kit:

- DOS 3.1
- 3 Diskettes
- Diskette case

Top Ten Bestsellers

Seagate 20MB Subsystem

- Controller
- Cable and hardware
- Software and Manual

\$365

20MB ST-4026 **\$539**
30MB ST-4038 **\$639**
40MB ST-4051 **\$695**
80MB ST-4096 **CALL**

- Cable, rails
- Software and manual

Everex Modem



\$128

- Half-size
- 300/1200 BAUD
- Fully Hayes compatible
- BITCOM communications software
- 2400 BAUD **CALL**

EGA Card



\$228

- Fully IBM EGA compatible
- Color/Mono display
- 16 colors from a palette of 64
- 640 x 350 high res. graphics
- 256K Display memory

Mini I/O Card



\$59

- Parallel/Serial
- Game ports
- Clock/calendar
- Half-size card
- Cables & Software

AT Multifunction



\$175

- Up to 2MB memory
- Selectable memory addressing
- Serial/Parallel/Game ports
- Software

Wangtek Tape Backup



\$727
\$827

INT
EXT

- Backup 5 MB in 1 minute
- Image/file by file
- Mounting hardware
- Software and Tape

Hercules Compatible



\$98

- 720 x 348 pixel graphics
- 64K display memory
- Extended 132 x 44 display
- Parallel printer port

EMS Memory Card



\$139

- Up to 2MB memory
- Selectable memory address
- Lotus/Intel EMS compatible

NEC Multisync



CALL

- EGA, PGA, CGA display
- 800 x 560 Resolution
- Swivel base

Turbo XT \$569



- Fully IBM compatible
- 8088-2 CPU
- 4.77 & 8MHz switchable
- 360K drive w/controller
- 640K memory
- 150 W power supply
- Keyboard

COMPUTER LIBRARY

Sales (415) 659-8784
Tech Support (415) 659-8849

5349 Randall place
Fremont, CA 94538

Quantity Discounts Available
Inquiry 207



Others:

- AT 3MB Memory Expansion card **\$150**
- AT HD/Floppy controller **\$165**
- PC Multifunction **\$94**
- Multifunction/mono card **\$139**
- Expansion chassis **\$428**
- Floppy controller **\$33**
- EVEREX Edge **\$229**
- DOS 3.1 **\$69**
- 150 W power supply **\$79**
- Keyboard AT/XT **\$75**
- Mono & Color Monitors **CALL**
- TEAC 20MB Tape backup **\$580**
- TEAC 360K Floppy Drive **\$99**
- TEAC 1.2M Floppy Drive **\$135**

Items: We accept MasterCard, VISA and Company/Institutional (Certified Funds) and 6.5% sales tax. For California residents add 6.5% sales tax. 15% returns and repairs, call for RMA number. Restocking fee charged on unauthorized returns. Prices are subject to change without notice. IBM, Hayes, Hercules, and IBM are registered trademarks of their respective companies.

Breaking the 640K DOS Barrier:

New version of Alsys PC AT Ada* compiler improves speed, adds application developer's guide, brings seven 80286 machines to latest validation status.



Alsys' landmark Ada compiler for the PC AT, the first to bring Ada to popular-priced microcomputers, has been upgraded to Version 1.2 with significant improvements.

The new version compiles faster than its predecessor, is validated for a full range of popular compatibles using the latest AJPO test suite 1.7, and includes a Developer's Guide in the documentation set. The price remains at \$2,995 for single units, including a 4 megabyte RAM board.

Both the original and the newly upgraded versions utilize the inherent capabilities of the 80286 chip and "virtual mode" to eliminate the 640K limitations of DOS. These techniques permit addressing up to 16 MB of memory, under the control of DOS, without changes to DOS in any way!

80286 machines validated in the new release include HP's Vectra, Compaq's Deskpro 286, Sperry's PC/IT, Zenith's 200 series (including the Z-248), Tandy's 3000 HD, the Goupil/40, and the IBM PC AT. The compiler supports DOS 3.0 or higher. Ada programs compiled on the AT will also run on PCs and XTs supporting DOS 2.1 or higher.



ALSYS, INC.,
1432 Main Street, Waltham, MA 02154
BY1286

ADA NOW. Tell me more about the PC AT Ada compiler.

Name _____

Title _____

Company _____

Address _____

City _____

State/Zip _____

Phone/Ext _____

In the US: Alsys Inc., 1432 Main St., Waltham, MA 02154 Tel: (617) 890-0030

In the UK: Alsys Ltd., Partridge House, Newtown Rd., Henley-on-Thames, Oxon RG9 1EN
Tel: 44 (491) 579090

In the rest of the world: Alsys SA, 29, Avenue de Versailles, 78170 La Celle St. Cloud, France
Tel: 33 (1) 3918.12.44

*Ada is a registered trademark of the U.S. Government (AJPO). Alsys is the trademark of Alsys, Inc. References to other computer systems use trademarks owned by the respective manufacturers.

Inquiry 19

Ada now

organized as four segments of 64 bytes. Each segment may contain a program loop from a different area of memory. Instructions stored in the cache are prefetched without delay. When a cache "miss" occurs (the next instruction is not present in the cache), the four-word block of instructions containing the next instruction is fetched from local memory and loaded into the least-recently-used (LRU) segment. The four-word instruction blocks are known as subsegments. There are eight subsegments in each segment. Cache control logic manages subsegment loading into the LRU segment. An LRU stack indicates which segment has been least recently used.

Software can disable and flush the cache when the cache flush (CF) bit in the host control high-byte (HSTCTLH) register is set to 1. When the cache is disabled, the processor fetches one instruction at a time from local memory for execution. Flushing the cache forces the cache to load new instructions. Resetting CF to 0 enables the cache and causes an immediate cache load. The cache disable (CD) bit of the control register only temporarily disables the cache when set to 1. When CD is reset to 0, instructions retained in the cache are once more available for execution. Both the host and GSP software can manipulate CF and CD.

Instruction cache operation is automatic and transparent to software. Tuning software for the cache is usually unnecessary due to GSP architecture and instruction set synergism. Code loops are smaller because of the specialized graphics instructions, and the large general-purpose register files let operands remain in registers. A number of graphics parameters can be placed in dedicated memory locations (the on-chip I/O registers), which also eliminates the code necessary to move them into and out of registers (see figure 2, the GSP programming model).

MEMORY

Memory size is specified in bits because the GSP is a bit-addressable, field-width-programmable processor. Although the GSP architecture sup-

ports a 4-gigabit (512-megabyte) address space, the first-generation device does not make the most significant 2 address bits available (30 bits of address equals 1 gigabit, or 128 megabytes).

In GSP memory, the least significant bit of data always has the least significant memory address. When accessing memory, the GSP always reads or writes 16 bits of data per bus cycle. Bit-level addressing is transparent to the programmer. The local memory controller initiates the read-modify-write cycles, performs the mask-merge operations, and keeps track of the next bit available for use.

The GSP memory organization consists of traps and vectors at the top of memory, followed by the I/O registers, and then the general-purpose usage at the bottom of memory (see the memory map in figure 2). GSP accesses to the I/O registers are internally decoded, and their addresses are not broadcast on the local bus.

VARIABLE-WIDTH DATA

GSP data is not fixed at discrete sizes (e.g., bit, byte, word, double word) as is common in most processor architectures. The GSP supports four types of data structure: bytes, bit fields 1 and 2, pixels, and two-dimensional pixel arrays.

While the byte size is fixed at 8 bits, sizes of the other data structures are software-configurable. Fields and bytes can start at any bit address. Data-word (16-bit) boundary alignment is not required. Pixels can be 1, 2, 4, 8, or 16 bits and are packed 16, 8, 4, 2, or 1 to a memory word, respectively.

The most common data type is the bit field. The GSP simultaneously supports two independently sized bit fields, each from 1 to 32 bits wide. Since all data paths and registers in the GSP are 32 bits wide, a field-extension bit associated with each field size causes data to be internally extended to 32 bits. Bit-field size and extension are specified in the STATUS register.

Graphics is supported by the pixel data type. Pixel size is specified in the PSIZE register. The GSP supports a "packed-pixel" data format in which

all bits belonging to a pixel are contained in the same memory word. Pixels are constrained to word boundaries in memory. In contrast, a planar-pixel-organized format places each of the bits comprising a pixel in a different region of memory. (See the text box "Packed-Pixel Memory Organization" on page 200.)

REGISTERS

The STATUS register contains the N (negative), C (carry), Z (zero), and V (overflow) flags set according to the results of arithmetic and logical operations. It also contains the interrupt enable bit (IE), the PBX flag (indicating that LINE, PIXBLT, or FILL (indicating that LINE, PIXBLT, or FILL execution was interrupted), and two sets of field-size and field-extension bits (FS0, FE0; FS1, FE1). When the extension bit for a field is set to 0, the field is extended with 0s during register loads. Conversely, data is sign-extended when the extension bit is set to a 1.

The program counter (PC) is 32 bits wide, but the 4 least significant bits are always 0s. Instructions are one or more 16-bit words long and are always aligned to even, 16-bit-word boundaries. The PC can be loaded with immediate data or changed as a result of instruction execution (branches, calls, etc.) and interrupts. The PC always points to the address of the next instruction to be executed.

The stack pointer (SP) points to the word at the top of the system stack. (The system stack grows toward lower memory addresses; therefore, the top of the stack is at the lowest stack address.) The SP is addressable as register 15 in both the A and B register files. The user can implement additional stacks with any of the 30 general-purpose registers.

GRAPHICS REGISTERS

The twenty-eight 16-bit I/O registers are associated with interfaces and graphics functions. The CONTROL register is the most important of the I/O registers associated with graphics and contains bits that control graphics processing. Transparency is enabled by setting the pixel transparency bit (T) to 1. Transparency prevents new

(continued)

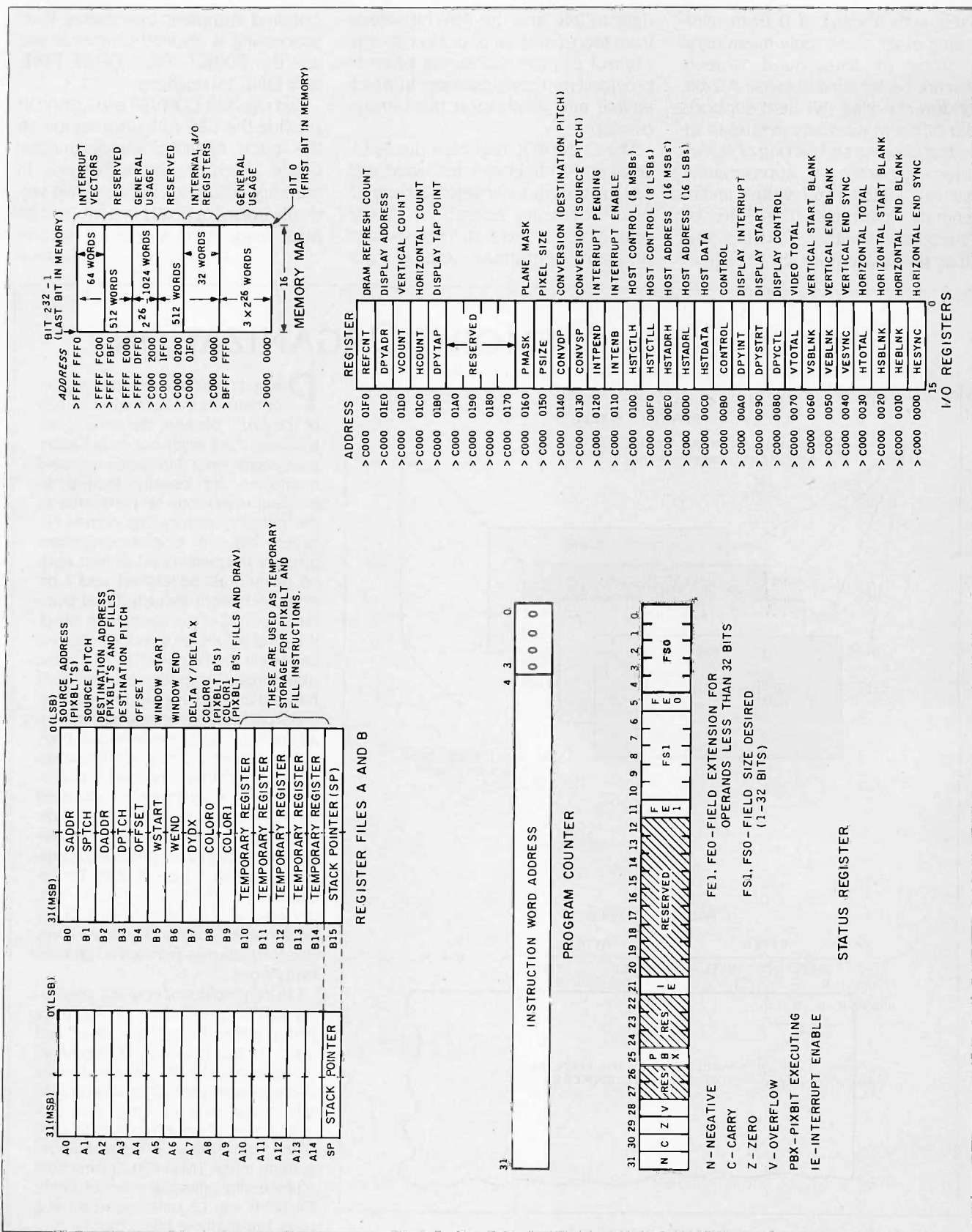

Figure 2: The programmer's model of the TMS34010 GSP.

pixels with a value of 0 from overwriting older pixels (only meaningful portions of foreground objects obscure background objects). A 2-bit, window-checking (W) field supports four different window operations, including clipping and picking of screen objects. By setting W appropriately, you can inhibit pixel writes and/or generate interrupts. The PBH bit determines whether PIXBLTs and FILLS take place from left to right or

right to left, and the PBV bit selects from top to bottom or bottom to top. Control of pixel-processing order is provided for those instances in which source and destination pixel arrays overlap.

The CONTROL register's pixel-processing (PP) field is 5 bits wide and lets the programmer select among 22 pixel-processing operations. These operations include 16 two-operand Boolean operations and 6 two-

operand arithmetic operations. Pixel processing is invoked whenever you use the PIXBLT, FILL, DRAW, PIXT, and LINE instructions.

Two registers, CONVSP and CONVDP, provide the GSP with information on the "pitch" of source and destination pixels. Pitch is the difference in memory addresses between two vertically adjacent pixels in a bit map or pixel map. Pitch is useful for com-

(continued)

PACKED-PIXEL MEMORY ORGANIZATION

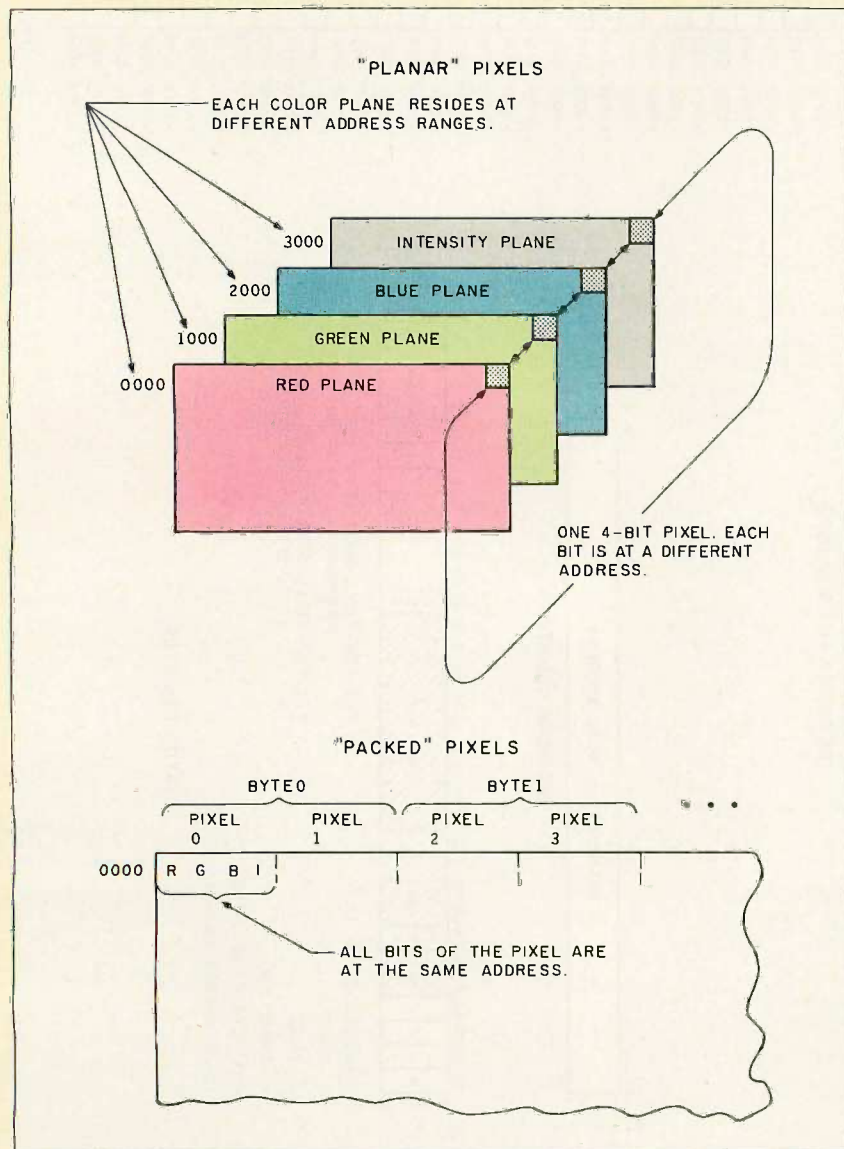

Figure A: Planar- and packed-pixel memory organization.

Packed pixels have an advantage in operations that act upon all bits of the pixel, because the entire pixel is accessed in a single bus cycle. Graphics systems with bit-plane-organized memories are usually limited to Boolean operations on pixels due to the difficulty of handling carries between bits. In bit-plane-organized memory, the memory words from each bit plane must be fetched, and 1 bit from each word extracted and combined with all of the constituent bits of the pixel before arithmetic operations can begin on the pixel. This is a great disadvantage in applications that combine anti-aliased images, for example.

In a packed-pixel-organized memory, all bits comprising the individual pixel are contained within the same word, eliminating the steps needed to manipulate pixels in a planar-pixel-organized memory. Variable-width ALUs allow parallel processing on each pixel (byte) simultaneously (some pixels are actually larger than 1 byte in size). For instance, one 32-bit packed-pixel memory word would contain all eight of the 4-bit pixels shown in figure A. (Only one instruction is required to process every pixel.)

During graphics operations, pixel array size is specified by placing the x and y dimensions in the lower and upper 16 bits, respectively, of general-purpose register B7. Plane masking prevents operations from affecting all bits in a given pixel array, thus providing most of the advantages of a bit-plane organization in a packed-pixel system. In the TMS34010, pixels have a processing advantage over bit fields. Bit fields can be processed one at a time, but multiple pixels can be processed in parallel.

PC TO MAINFRAME COMMUNICATION SO RELIABLE, IT'S LIKE DELIVERING IT YOURSELF.

Get 3780 And 3770 Syn- chronous Communications

Get Remote Job Entry from your PC to a Mainframe, Mini, or another PC, following standard 3780 and 3770 RJE protocols for text, binary, or mixed file transfers containing any type of data.

Automatic Operation

Transfile is easy to use from its menu, or you can activate Transfile from a batch file, or you can call the transmit and receive routines as a transparent subroutine for fully automatic unattended operation. In case of failure or interruption, Transfile will re-boot and resume where communications left off.

Internal Modem Available

Use with your modem with Hayes® or UDS® autodial and receive, or with our internal 2400 or 4800 baud synchronous card and modem.

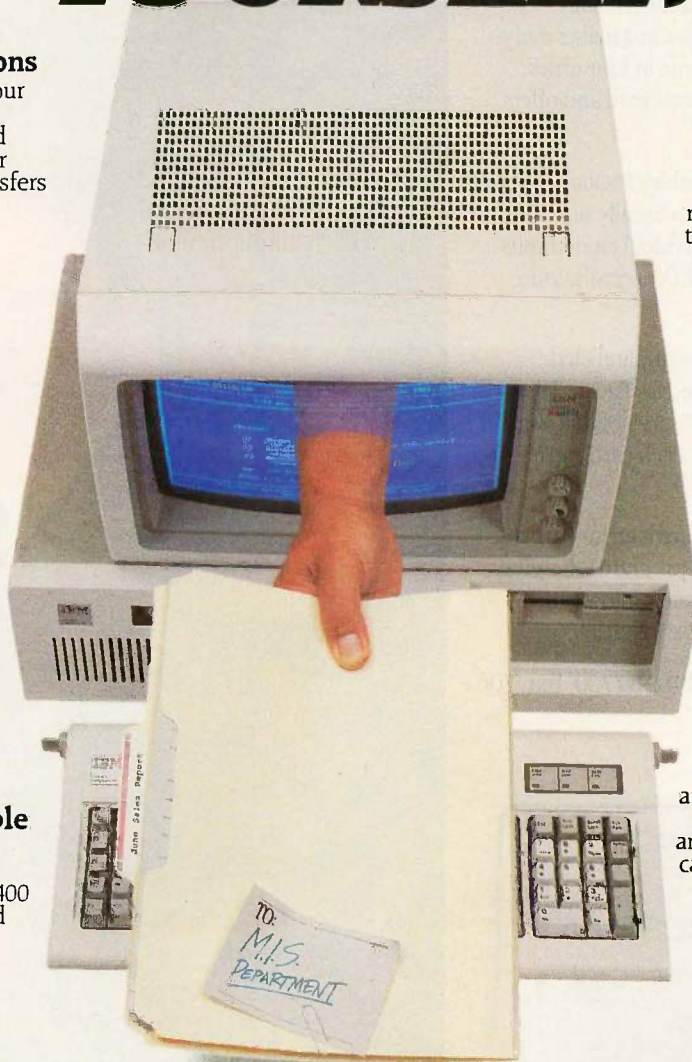

ASCII to EBCDIC Transla- tion And Vice Versa

Transfile features automatic or manual ASCII to EBCDIC translation (and vice versa) with accessible translation tables you can modify to allow for variances in host computer protocols.

Fast And Versatile

Runs from 300 to 19,200 baud. Runs on all IBM® PC, XT, AT, or compatible and works with IBM's Bisync Communications Card. Transfile can be run as a slave or master, and can be configured for auto-receive as well as auto-transmit. And all your communications are logged for a printed summary.

Simply The Best

Plus there's space compression and character expansion for added speed. Automatic error checking and correction, and auto re-start in case of line or equipment failure.

And there's more.

TRANSFILE

Call (800) 826-7839 or (305) 372-9332 in FL today for all the information
TDT Group, Inc. 444 Brickell Ave. Suite 902 Miami, Florida 33131

Master of Possibilities: John E. Hulse

Vice Chairman & CFO
Pacific Telesis Group

Long distance or local, Pacific Telesis gets great reception with the MasterCard BusinessCard.

Pacific Telesis chose the new MasterCard BusinessCard™ because it is consistent with the company's philosophy... progress, intelligently planned. It's a philosophy Pacific Telesis is bringing to life in many ways—from providing quality phone service in California to operating a paging company in Thailand. And, it's a philosophy that warrants the best corporate card program possible.

Whether it's a technician in California or an executive in New York, the BusinessCard makes every employee's work easier. It's welcome in four times more places than any other corporate card and offers cash access at 110,000 locations.

The BusinessCard program enables Pacific Telesis to control business expenses with virtually no administrative effort. It offers individual credit limits and monitoring for each of the 12,000 cardholding employees at Pacific Telesis.

Finally, the BusinessCard offers unparalleled flexibility. The program was tailored for Pacific Telesis by its bank so the company chose services that were right for its business. In addition, each card carries the Pacific Telesis logo.

The distinctive silver BusinessCard is an investment in progress for Pacific Telesis. The program is helping the company live up to its corporate philosophy by keeping it in touch with all the possibilities.

For more information call 1-800-821-7700. Ext. 706



Master
The Business Possibilities™



puting the memory address of data to be accessed in an x,y fashion. Although linear storage (consecutive memory addresses) might be desirable for disk usage, on a display it is more natural to manipulate two-dimensional arrays of pixels and to specify data locations as being offset by x and y displacements from an origin. The GSP uses the CONVSP and CONVDP registers to support windowing computations, to perform x,y -to-linear address conversions, and to adjust the starting corner address for PIXBLTs.

The pixel size (PSIZE) register provides GSP microcode with the bit width of pixels being processed. The microcode uses PSIZE primarily to disconnect the ALU carry chain between pixels so that the ALUs can simultaneously process multiple pixels. Pixel bits (planes) can be protected or masked from pixel-processing operations if you set the appropriate bit in the plane mask (PMASK) register. Plane masking creates effects such as text planes that overlay graphics planes. This is one way of mixing text and graphics on a display without destroying useful information.

CONTROL, PSIZE, and PMASK let GSP graphics algorithms be virtually independent of pixel size and processing. For instance, using one algorithm to draw XORed circles with 4-bit pixels and a different algorithm to draw ORed circles with 8-bit pixels is no longer necessary. A single, robust, circle-drawing algorithm controls pixel processing (transparency, masking, Booleans, and arithmetics) and pixel size by modifying only the CONTROL, PSIZE, and PMASK registers.

Registers COLOR0 and COLOR1 reduce the amount of table area necessary to store multicolored fonts. A 1-bit-per-pixel representation of the font or object is stored in memory, along with two color attributes, a "0" color (in COLOR0) and a "1" color (in COLOR1). Figure 3 shows the expansion of a 4-bit, 1-bit-per-pixel pattern into four 4-bit pixels.

GENERAL-PURPOSE REGISTERS

The GSP has thirty 32-bit general-purpose registers divided into two files,

A and B. General-purpose registers can be used for both address pointers and data, and they are easier for programmers to use, since no special characteristics are associated with any particular register.

Processors with many general-purpose registers are faster for most applications, since time-consuming data swapping between memory and registers is reduced (on-chip registers are faster than main memory). Graphics operations are especially demanding, since many variables must be manipulated during drawing operations.

GRAPHICS OPERATIONS

Graphics operations implicitly use the B register file for operands and temporary storage. This convention allows graphics microcode direct access to operands affecting the graphics operation. Other benefits accrue to this design as well; iterative graphics instructions are interruptible. For example, if a LINE operation violates a window boundary, the operation can be interrupted, a decision made, and the operation restarted or aborted. Graphics instructions can be restarted because the microcode stores temporary variables in registers B10 through B14 when the interruption occurs.

The PSIZE register lets the ALUs process each pixel as an individual entity (the fourth bit of a 4-bit pixel

has no effect upon the first bit of an adjacent pixel). Additional ALU support for graphics includes a single-cycle, 32-bit barrel shifter and mask-merge hardware for changing pixel locations within data words and registers.

For all graphics operations, the least significant pixel address on the display is located at the origin, which is software-configurable to the upper left or lower left corner of the display.

GSP INSTRUCTIONS

The GSP has a complete general-purpose instruction set (127 instructions) with enhancements for floating-point arithmetic, graphics, and windowed environments. The general format for all instructions follows the convention that the first instruction word (16 bits) contains the op code and subsequent words contain immediate data or immediate addresses. Addressing modes include direct register, indirect through a register, indirect through a register with a signed displacement, indirect through a register with pre-decrement, indirect through a register with postincrement, and absolute address.

The GSP executes floating-point operations as fast as floating-point coprocessors by using special instructions and hardware. Floating-point software uses the fast (160-ns) barrel

(continued)

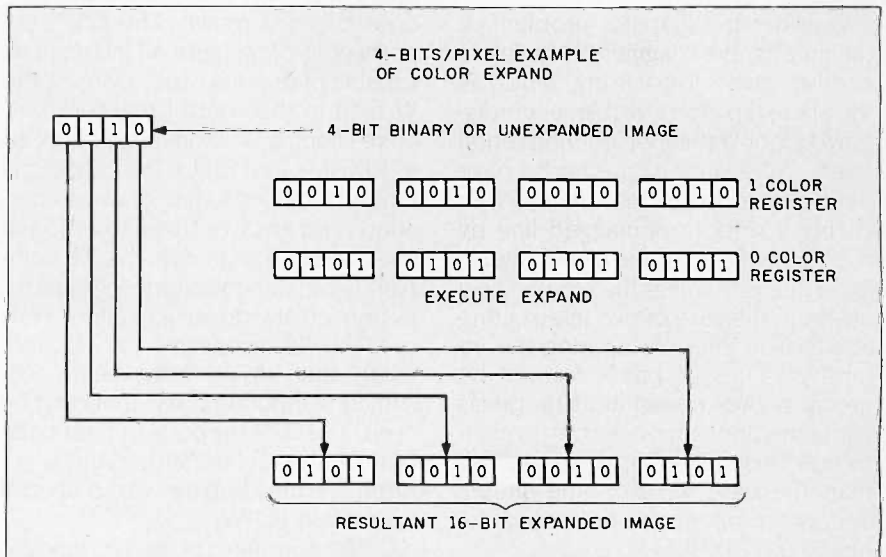

Figure 3: The color expand operation.

shifter and mask-merge hardware to extract exponents and mantissas from floating-point data. After the exponents and mantissas of the multiplier and the multiplicand have been manipulated appropriately, the leftmost one of the resulting mantissa is detected with the LMO (leftmost ones detect) instruction in a single machine state (160 ns). The position of the leftmost one determines how many positions the barrel shifter will rotate the mantissa for normalization. After normalization, the exponent is adjusted, and the exponent and mantissa are spliced back together using the inverse of the sequence that dissected them.

PIXBLT OPERATIONS

The most important graphics instruction is the PIXBLT. This importance is underscored by the fact that most of the graphics microcode is dedicated to the PIXBLT instruction. PIXBLT, or pixel block transfer, is closely related to the BITBLT (bit block transfer), a method for operating on two-dimensional bit arrays with Boolean operators. BITBLT is good for dealing with black-and-white displays but has drawbacks when handling gray-scale and color displays (what does it mean to XOR red with green?). PIXBLT is the concept of the BITBLT generalized to operations on two-dimensional pixel arrays using arithmetic as well as Boolean operators.

Consider the graphics problem of minimizing the "jaggies." Jaggies is another name for aliasing, which is the stair-step effect visible when displaying nonvertical or nonhorizontal lines. Anti-aliasing methods have been developed to fool the eye into seeing a smooth nonjagged line by setting pixels adjacent to the line to lower intensity values than the original pixels. In the case of two intersecting anti-aliased lines, computing the intensity values of pixels formed by merging two lower-intensity pixels with only Boolean operators is much more difficult (perhaps impractical) than the case where some simple arithmetic operators are available; hence the PIXBLT.

The GSP PIXBLT supports all 16 two-operand Boolean instructions, as

well as add (two pixels to each other), subtract (two pixels, one from the other), add-with-saturate (clamp at all 1s), subtract-with-saturate (clamp at all 0s), minimum (compare two pixels, picking the pixel with the minimum value), and maximum (inverse of minimum).

When you invoke PIXBLT, registers B0 through B7 must already contain the source pixel-array address and pitch, destination pixel-array address and pitch, location of the screen origin, window start and end corners, and pixel-array dimensions. Additionally, if you invoke PIXBLTB (PIXBLT with binary expansion), registers B8 and B9 must contain the background and foreground colors, respectively. For all PIXBLTs, the CONTROL, CONVSP, CONVDP, PSIZE, and PMASK registers must also contain the information appropriate to the desired result.

WINDOWING

The GSP supports windowed environments with two types of clipping: post-clipping and pre-clipping. Both prevent drawing operations from altering display memory outside the currently active window, but pre-clipping is faster.

In post-clipping operations, all the computations necessary to draw the pixel are completed, the pixel location is compared to the available window, and if the pixel lies outside the window, it is not drawn. The GSP supports post-clipping for all instructions capable of drawing pixels by using the W field in the control register.

Pre-clipping is automatically applied to PIXBLTs and FILs. Pre-clipping is typically applied to line-drawing operations and involves trivial rejection of lines and line segments that lie completely outside the window. Trivial rejection lets the drawing engine (in this case the GSP) conserve all the bandwidth that would have been consumed computing pixels that can't be seen. The GSP supports implementation of the Cohen-Sutherland algorithm for pre-clipping with a special instruction (CPW).

CPW, compare point to window, generates the clipping data used in the Cohen-Sutherland algorithm. The

GSP hardware generates 4-bit "outcodes" when CPW is used to compare the endpoints of a line or line segment to the active window. If the result of ANDing the two outcodes of a line (segment) is nonzero, that line (segment) lies completely outside the window and no further processing is required. A zero result from ANDing outcodes means a more rigorous test must be applied. This subject is discussed in the book *Fundamentals of Computer Graphics* by James D. Foley and Andries Van Dam (Addison-Wesley, 1982).

ELIMINATING HAND-TUNING

One of the primary objectives of the GSP's architectural specification is to eliminate hand-tuning graphics code to the application, pixel size, and screen resolution. In the current generation of personal computers, hand-tuning is necessary to achieve acceptable graphics performance. Marginal graphics performance makes using graphics standards difficult. Using standard interfaces makes performance even worse.

The use of VRAM frees the drawing engine from competing with display refresh for memory bandwidth. VRAM is, in effect, dynamic RAM that has been modified by the addition of a long shift register, giving separate ports for screen refresh and processor update of the frame buffer. The GSP architecture supports high-performance flexible graphics software, removing the barriers to using graphics standard interfaces (such as CGI and Microsoft Windows). The use of standard graphics interfaces will let more applications come to market, shorten development cycles, and increase applications portability.

Editor's note: As a service to BYTE readers, the TMS34010 Graphics Design Kit will be available in late January for \$340. The kit includes a TMS34010 Graphics System Processor, the TMS34010 User's Guide, and development software. The development software runs on 512K-byte IBM PCs and compatibles and includes the TMS34010 Macro-Assembler, Linker, Archiver-Librarian, Simulator, and a ROM utility. Interested BYTE readers should write Texas Instruments, Dept. SPV04, PO. Box 809066, Dallas, TX 75380-9066. ■



PROTECT ON ORDINARY DISKETTES

- **Extremely safe**
Key diskette cannot be copied by COPYII PC, OPTION BOARD, COPYWRIT
- **2 levels of security**
Key diskette insertion required each time or only after reboot
- **Compatibility**
IBM PC/XT/AT computer and compatibles
- **Easy back-up**
- **Hard disk installable**
- **Standard version \$ 885**
For protection of individual diskettes. Unlimited number of protections (key diskettes)
- **Automatic version \$ 1695**
For mass production of protected key diskettes
- **2-pack version \$ 15**
Contains 2 key diskettes and the Copylock program w/manual. A good appetizer before you invest in the Standard or Automatic version.

COP'S
COPYLOCK

Developed by Link Computer.



PCsoftware, P.O. Box 231499, San Diego, California 92123. Phone: (619) 571-0981
Dancotec, Bakkefaldet 36, DK-2840 Holte, Denmark. Phone: +45 2 80 16 88. Telex: 37913 cotec

APPARAT INTRODUCES THE...

LIMBO*

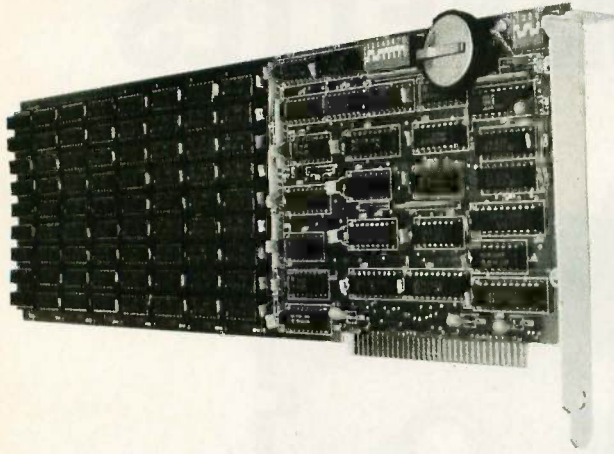

You've got a problem. You have 640K of RAM and you still run out of memory! Go to your favorite computer store. Then ask about expanded memory cards. See the problem? Just too many to pick from. Now, ask to see the **LIMBO™**. No problem. There's only one. Ours. Except you probably don't know a **LIMBO** from a dance step. Maybe you guessed that it is an expanded memory board that supports the Lotus/Intel/Microsoft Expanded Memory Specification (EMS). And that it has a 2 MB capacity and up to 8 MB is supported by the memory management software.

The **LIMBO** includes a clock/calendar and 8 banks for use by either 64K or 256K DRAM. Software includes the EMS memory manager, EMS compatible RAM Disk and print spooler.

The **LIMBO** is manufactured by Apparat in Denver, Colorado, and is covered by Apparat's Exclusive Limited Lifetime Warranty. So you can be confident that you won't find yourself out on a limb. (We've been in business since 1978.)

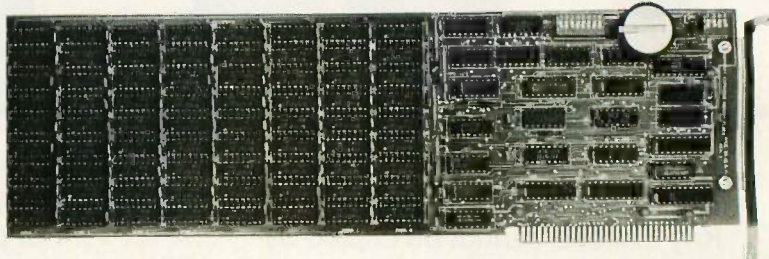

Need an EMS multifunctional board? Ask to see the **LIMBO II**. The **LIMBO II** has a 1.25 MB capacity with a parallel port, a serial port, a clock/calendar, and game-stick adapter. **LIMBO** and **LIMBO II** have flexible starting addresses and can be set to fill system memory to 640K, with the remaining memory to be used for EMS. This eliminates the need for conventional RAM boards.

The **LIMBO** is only \$199 with 64K of RAM installed or \$549 with full 2 MB of RAM installed.

The **LIMBO II** is only \$299 with 256K of RAM installed or \$499 with full 1.25 MB of RAM installed.

Go check out the **LIMBO** at the same store carrying other expanded memory boards. If they don't have the **LIMBO**, have them call us: 800/525-7674. Or write: **Apparat, Inc.**, 6801 South Dayton, Englewood, Colorado 80112, 303/799-0819.

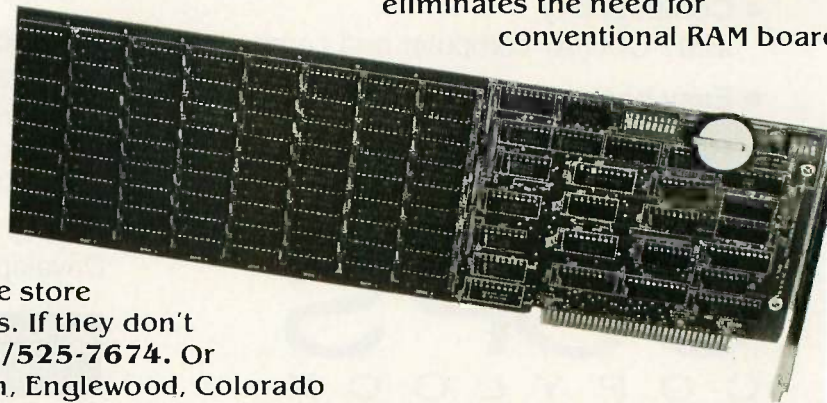

Apparat, Inc.

Inquiry 413

6801 South Dayton, Englewood, CO 80112 — Customer Service 303/799-0819
Retail Outlet in the Chicago area 312/640-0322

* Lotus Intel Microsoft EMS BOa

* Lotus is a registered trademark of the Lotus Development Corporation. * Intel is a registered trademark of the Intel Corporation. * Microsoft is a registered trademark of the Microsoft Corporation.

NOT
The LIMB
boards work gre
with Lotus 1-2
Release

PLOTTING THE MANDELBROT SET

BY PETER B. SCHROEDER

*The more interesting the display, the longer
it takes to generate*

SOME PEOPLE CAN READ a musical score and in their minds hear the music more gloriously rendered than by any orchestra. Others can see, in their mind's eye, great beauty and structure in certain mathematical functions and number systems. Lesser folk, like me, need to hear music played and see numbers rendered to appreciate their structures.

The Mandelbrot set is one of the intriguing mathematical structures you can explore with the Commodore Amiga. In *The Fractal Geometry of Nature* (reference 1), Benoit Mandelbrot defines a fractal as "a set for which the Hausdorff Besicovitch dimension [fractional dimension] strictly exceeds the topological dimension."

You can use fractals to describe the fragmentary aspects of nature. Random fractals can simulate landscapes and objects in nature, such as trees and mountains. Mathematical modelers can use them to simulate shoreline decay and its effect on fisheries. Biochemists can use fractals to characterize the irregularity of protein surfaces and its influence on molecular interactions. You can use them to model climate and predict other apparently random and chaotic

events (reference 2). You can use them to discover order where no order was previously believed to exist. Even processes of ontogeny—the course of an individual organism's development—that have proved elusive might be explorably using fractal geometry.

You need the definitions of complex, real, and imaginary numbers as a starting point. A complex number is any number of the form $a + bi$ where a and b are real numbers, and $i = \sqrt{-1}$. A real number is one in which there is no imaginary part, and an imaginary number is a complex number with b not equal to zero; some definitions require also that $a = 0$.

Engineers and others dealing with vector mathematics find imaginary numbers useful. For example, if vector b can be turned 180 degrees to point in the opposite direction by multiplying it by -1 so b equals vector $-b$, and there is a number, a , that turns the vector 90 degrees, then a^2 will turn the vector 180 degrees and be equal to -1 . Thus, $a = \sqrt{-1}$.

WHAT IS THE MANDELBROT SET?

The Mandelbrot set is a set of numbers $z = c^2 + c$ where c is a com-

plex number of the form $a + bi$ and z iteratively squared never produces a square root of $a^2 + b^2$ larger than 2. Note that since i^2 equals -1 , $(a + bi)^2$ equals $a^2 + 2abi - b^2$, and that the iterative squaring of these numbers produces a jagged, non-differentiable result. If the sum of the squares does grow beyond 4 within a large number of iterations, it will eventually approach infinity and, by definition, not be part of the Mandelbrot set.

If you take a matrix, a by b , and iteratively square every element in it until either the sum of their squares exceeds 4 or you reach 1000 iterations, you can determine a count of the number of iterations that each element in the array requires. Those elements with counts of 1000 are part of the Mandelbrot set; those elements with counts that are very large but still less than 1000 are near the Mandelbrot set; and those with low counts

(continued)

Peter B. Schroeder is president of Biosystems Research Inc. (11550 Southwest 108 Court, Miami, FL 33176). He is a biological consultant specializing in wetland and estuarine environments. He has a Ph.D. in biology from the University of Miami in Coral Gables.

MANDELBROT SET

are far from it. If you assign colors to each count or range of counts and color each pixel of the matrix display accordingly, you can graphically display the Mandelbrot set and its neighboring numbers. In a sense, the varying colors represent the fractal dimension distance from the Mandel-

brot set for particular matrix elements.

SMALLER IS BIGGER

Fractal numbers have funny qualities. If you magnify areas near the Mandelbrot set, you will find minute imperfect replicas of the larger Mandel-

brot set. If you increase the magnification even more, you find even more minute associated replicas, and so on ad infinitum. These components have great beauty and exotic structures, every one varying but always partially replicated at some smaller level.

The magnification you can attain is limited only by your computer's precision. In C, the Amiga stores double-precision floating-point numbers in 64 bits with a precision, therefore, of approximately 2^{63} . It does all its math in double-precision floating-point, and its range for long integers is from $-2,147,483,648$ to $2,147,483,647$ and for double-precision floating-point numbers from $\pm 10.0^{-307}$ to $\pm 10.0^{308}$ with 15 to 16 decimal digits of precision. This precision lets you examine the Mandelbrot set in greater detail than an electron microscope can examine matter. An electron microscope can produce a photo of an object enlarged about 1,000,000 times. You need a magnification between 300,000 to 400,000 times to resolve the facets on the surface of the poliomyelitis virus. If the Amiga were a microscope, its magnification would let you examine the atoms making up those facets.

Areas of interest are those closely associated with the larger Mandelbrot set in photo 1, which represents the numbers from -2.0 to 0.5 on the x axis and from -1.25 to 1.25 on the y axis. Its range is therefore 2.5 along both axes. Photos 2 and 3 are successive enlargements of the small outlined area in photo 1, each with a range $1/20$ that of the preceding photo. The rectangular outlined area in all the photos shows the area enlarged in the succeeding photo.

THE PROGRAMS

A. K. Dewdney provided the algorithm for describing the Mandelbrot set graphically in *Scientific American* (see reference 3). My programs implementing that algorithm are written in Lattice C; they produced photos 1 through 3. While they take a while to run, they seem brisk compared to a BASIC implementation I tried first. [Editor's note: DOSETC and VIEWSETC are available in Lattice C source code on disk, in print, and on BIX; see the insert card

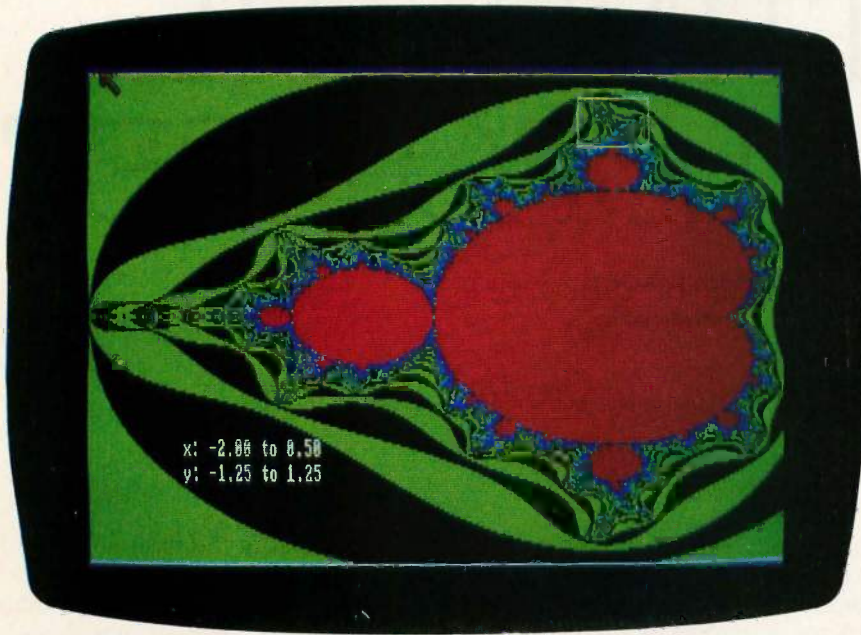

Photo 1: One instance of the Mandelbrot set representing the numbers from -2.0 to 0.5 on the x axis and from -1.25 to 1.25 on the y axis.



Photo 2: An enlargement of the detail in the small box in photo 1.

Listing 1: The program DOSETC, which calculates the Mandelbrot set.

```
#include <stdio.h>
#include <math.h>

main(argc,argv) int argc;char *argv[];
{
  int y,x,count,totct;
  float x_coord,y_coord,range,gap,size,a,b,ac,bc,b1;
  char ct[201][2];
  FILE *OutFile;
  /* Input x-y coordinates and range from keyboard */
  printf("Input X_COORDINATE: ");
  scanf("%f",&x_coord);
  printf("Input Y_COORDINATE: ");
  scanf("%f",&y_coord);
  printf("Input RANGE: ");
  scanf("%f",&range);
  gap = range / 200.0; /* Increment per pixel */
  y_coord += range; /* Start at top of display */
  /* Open output file (default or command line) */
  if(argc<=1) OutFile = fopen("df1:ZOOM.DATA","w");
  else OutFile = fopen(argv[1],"w");
  /* Write coordinates and range to data file */
  fprintf(OutFile,"%7.6f\n",x_coord);
  fprintf(OutFile,"%7.6f\n",y_coord);
  fprintf(OutFile,"%8.7f\n",range);
  /* Calculate count value for each pixel (200X200) */
  for(y=1;y<=200;y++) /* Each row */
  {
    bc = y_coord - y*gap; totct = 0;
    for(x=1;x<=200;x++) /* Each pixel per row */
    {
      ac = x*gap + x_coord;
      a = ac; b = bc; size = 0.0; count = 0;
      while(size < 4.0 && count < 1000)
      {
        /* Do complex-number multiply */
        b1 = 2*a*b;
        a = a*a - b*b + ac;
        b = b1 + bc;
        /* Pythagorean theorem */
        size = a*a + b*b;
        /* Don't need square root */
        count++;
      }
      totct += count;
      /* Code count in two bytes to save disk space */
      ct[x][0] = count/256;
      ct[x][1] = count % 256;
    } /* End x loop */
    /* Show row number and average count to CRT */
    printf("%5d %5d\n",y,totct/200);
    /* Print coded pixel-values this row to data file */
    for(x=1;x<=200;x++)
    {
     putc(ct[x][0],OutFile);
     putc(ct[x][1],OutFile);
    }
  } /* End y loop */
  fclose(OutFile); /* Close data file */
} /* End main */
```

following page 320 for details. You will need Amiga's translator.library, intuition.library, graphics.library, and narrator.device, as well as the Lattice C compiler, to run these programs. Listings are also available on

BYTEnet; see page 4.

DOSETC (listing 1) lets you pick the x,y axis—where you want to begin the display—and supply the distance you

(continued)

EXECUTIVES



Working harder and accomplishing less? This message is for you.

Did you know that more than three million executives and professionals across America now rely on a DAY-TIMER to *organize themselves*—schedule their appointments, prioritize their daily tasks, record their expenses, save substantial tax dollars, and free their minds for important decisions?

Would you like to find out how a DAY-TIMER can do the same for you? For just \$1.00 to defray the cost of postage and handling, we'll send you a specially created 4-month Sampler Kit featuring our most popular pocket-size formats, a conveniently slim wallet to hold the System, and a special introductory audio cassette.

\$1.00 OFFER COUPON

DAY-TIMERS

Dept. 5375

Allentown, PA 18001

Please rush my DAY-TIMER Sampler Kit, including the audio cassette. My \$1.00 is enclosed.

Print Name _____

Firm _____

Address _____

City _____

State _____ Zip _____

E229

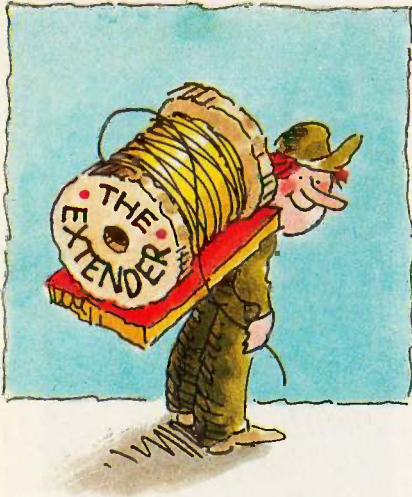

Extend your IEEE-488 network.

With National Instruments Bus Extenders you can connect up to 28 devices to your IEEE-488 port, and connect to instruments as far away as 2,000 meters. One Extender is placed at the source, and one (or more) are placed at the remote location(s). There's no loss of transmission quality, and there's no need to change your application program.



The Extender is compatible with our full line of IEEE-488 interfaces and can incorporate either fiber optic, coax, or parallel cabling.

Find out more about how our Bus Extender can stretch your IEEE-488 network. Call 1-800/531-4742.

NATIONAL INSTRUMENTS
 12109 Technology Blvd.
 Austin, TX 78727
 512/250-9119
 800/531-4742

MANDELBROT SET



Photo 3: An enlargement of the detail in the small box in photo 2.

want to cover. The smaller this distance, the greater the magnification. These programs can take a long time—hours, even days—to generate a display. The closer you are to the Mandelbrot set, the longer it takes.

You should pick an x,y axis near the edge of the Mandelbrot set (colored red in the photos) for further exploration. If you pick a spot totally within the set, the display will seem to take forever—not literally, since the programs stop counting after 1000 iterations at each pixel—and the display will be a solid color. If you pick a spot where each pixel takes the full 1000 iterations (i.e., within the set proper) and you generate a 200- by 200-pixel display, the Amiga has to carry out 40 million iterations. If an iteration does approximately 20 double-precision floating-point operations, that's 800 million double-precision (64-bit) operations. And if each operation requires manipulating all the bits, that's 51 billion bit operations. On the other hand, if you start far away from the Mandelbrot set, you will finish a lot sooner, but you end up with a correspondingly uninteresting display. So choose a display that includes an area alongside, and maybe including a bit of, the set proper.

VIEWSETC creates a 200- by 200-pixel graphics display from the data

file created by DOSETC. If you want to pursue this further, try changing the color separation in the program. With the proper color separation, you can find all sorts of interesting objects: trees, jabberwocks, maybe even a self-portrait—or millions of them. Since the Amiga can show up to 640 by 400 pixels, you can also create high-resolution displays. However, these displays take even longer to generate.

NEW HORIZONS

If you do look into the Mandelbrot set, happy exploring. The going may be slow, but the region is huge and will always remain largely unexamined. Because of the time involved, if you just want to look at the displays I have already generated, I will mail you a disk full of them at my cost (\$10). You may share it as you wish. ■

REFERENCES

1. Mandelbrot, Benoit B. *The Fractal Geometry of Nature*. New York: W. H. Freeman and Company, 1983.
2. Nicolis, C., and G. Nicolis. "Is There a Climatic Attractor?" *Nature*, October 1984, pages 529-532.
3. Dewdney, A. K. "Computer Recreations: A Computer Microscope Zooms in For a Look at the Most Complex Object in Mathematics." *Scientific American*, August 1985, pages 16-24.

POWER PAK!

The Source has the most powerful online communications package anywhere. And a special offer to help you pack more power into every online session.

The Source gives you the power to use each of its communication tools individually. Customize them to perform specific tasks or collect vital information automatically. Or combine them to fill your communication needs.

SOURCEMAIL Acclaimed by experts as one of the best electronic mail systems anywhere. Send electronic mail to one friend or a hundred clients, in minutes. Act on important messages with lightning speed. Eliminate annoying "phone-tag." Send letters to non-Source members via Mailgram® Messages.

PARTI A unique computer conference center. Create productive business, committee or club meetings with an ongoing word-for-word record of the proceedings. Read notes or post your own in hundreds of ongoing discussions on stimulating topics from Jazz Talk to Artificial Intelligence.

POST The Source's international online classified ad space. Post messages that will be read by users all over the world. Buy and sell items or services. Find other members of The Source through the Member Directory. You can even publish your own electronic newsletter. A dynamic, electronic "town square" at your fingertips.

SPECIAL INTEREST GROUPS Available at special low connect rates.* **SIGS** give you and other members with



similar interests an exciting place to meet, share information or exchange software. Dozens of group member directories, bulletin boards, databases and file libraries to choose from. Great for career or social networking.

CHAT Forget CB Simulator and the rest. Our new enhanced version gives you more control over real-time conferencing. CHAT with one person or a dozen. Compose messages of any length without interruption. Our listing of current online members makes it easy to find people to CHAT with. A powerful business tool and great entertainment when you want some time off.

AND MORE! Put these communication tools together with The Source's investor services, news and weather, airline schedules, personal computing information, a complete encyclopedia, games, shop-at-home and all the other features and you've got an online service that really gives you your money's worth. Plus learn The Source with our tutorial, FREE of online charges.

GET THE MOST OUT OF THE SOURCE WITH THIS LIMITED-TIME OFFER Join The Source between now and January 31st, and along with a complimentary SourcePak user's manual, we'll send you *How To Get The Most Out Of The Source* by Charles Bowen and David Peyton—a \$14.95 value—FREE (while supplies last).

It's a great opportunity to get the most out of The Source's powerful online communications features.

*Online rates as low as 10¢/minute. Members subject to a \$10 minimum usage fee each month.

Send no money. To sign up, just mail this coupon. Or call The Source toll-free **800-336-3366**** and give our representative this claim number, **783E330**.

The Source
INFORMATION NETWORK

The most powerful resource any personal computer can have.

MAIL TO: The Source, PO Box 1305,
McLean, VA 22102
Offer expires February 28, 1987

Yes, I want to join The Source, receive my complete SourcePak user's manual and take advantage of your free book offer. Bill my \$49.95 membership fee* and all charges on my account (including monthly fee) to:

Visa MasterCard American Express

Credit card # _____
(must be provided)

Expiration date _____

**In Virginia, call 703-821-6666. *Plus postage & handling

Company Name _____

Name _____

Address _____

City _____ State _____ Zip _____

Signature _____

Mother's maiden name _____
(for online password verification)

PC type _____

Phone (day) _____ (evening) _____

**WHY BUY
OUR \$159
UNIX SYSTEM
FOR YOUR PC/AT
WHEN YOU
CAN GET THE
SAME THING
FOR A THOUSAND
DOLLARS MORE?**

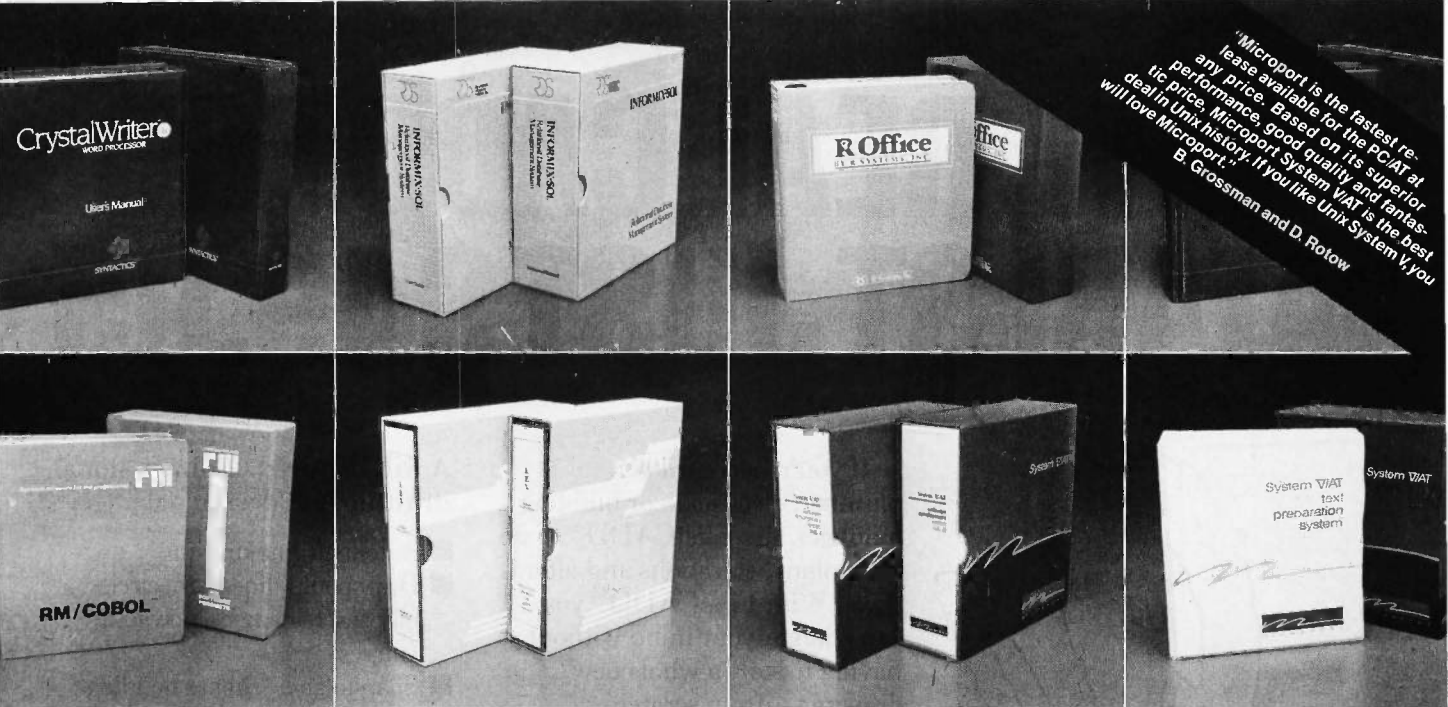

HERE ARE THE REASONS WHY.

Best-price UNIX™ applications software. From the company that made a reality of best-price UNIX operating systems.

Business computing, word processing, database management, text preparation and software development—we've selected, developed and added value to the best. Once you've converted your PC/AT, with our System V, into a true multi-user, multi-tasking machine, you'll demand software that lets you get on with the tasks at hand.

CRYSTALWRITER PLUS

is a comprehensive word-processing system for the multi-user office. It allows concurrent use of files, layouts and printers, as well as supporting a full range of terminals.

INFORMIX SQL

is the relational-database-management system developers will choose for custom applications. It offers relational-database flexibility, interactive-database queries, a flexible design environment, automated functional menus, custom screen design and total format control.

UNIX and DWB are trademarks of AT&T. IBM and IBM PC-AT are trademarks of IBM CORPORATION. SYSTEM V/AT is a trademark of MICROPORT SYSTEMS, INC.

Inquiry 231

R-OFFICE

ties a powerful word processor together with the file-management, table-spreadsheet, report-generation and desktop-management chores common to nearly every modern office.

R/M COBOL

is Ryan-McFarland's GSA certified implementation of the ANSI X3.23 74 standard. R/M COBOL is designed for serious business computing.

LEX

is a standalone system offering complete word processing capabilities, as well as utilities for adapting LEX to any type of video terminal or printer.

SOFTWARE DEVELOPMENT

from Microport. Our package was derived from the extensively-tested Portable C compiler. (The large-model code produced by the compiler is among the densest and fastest available.) These are true 286 compilers, making full and efficient use of the extended 286 instruction set. The package also includes the F77 Fortran compiler.

TEXT PREPARATION

from Microport. This package consists of the complete System V, Release 2 Documenter's Workbench (DWB), and includes both the new troff and the old troff. Drivers for the HP Laser Jet Printer and Apple's LaserWriter are also available.

These are but a few of our available packages. Virtually everything listed in AT&T's catalog can now, or will soon run with our operating system.

Regarding Our SYSTEM V operating system.

More than a look-alike, Microport's System V complies with AT&T's new binary standard and was derived from AT&T's own UNIX System V, Release 2 iAPX286. It thereby contains standard System V features the competitors don't support, such as the powerful symbolic debugger (SDB), the shell-layering job-control facility and the F77 Fortran compiler, as well as programming tools such as ctrace, cflow and bs. Over 200 utilities come standard to let you search and modify files, make use of electronic mail, calculate electronically, convert data and publish.

- 90 day money-back guarantee
- Educational site licensing
- Commitment to AT&T source and binary standards

To order: Call any of our numbers below for today's price and product line quote (be sure to ask about our buy-two-applications-packages-and-get-RUNTIME-free offer).

You really wouldn't want to pay thousands of dollars more, would you?



M I C R O P O R T

MICROPORT SYSTEMS, INC.

4200 Scotts Valley Drive
Scotts Valley, CA 95066
408/438-UNIX or 408/438-8649 (CA)
or 800/PC2-UNIX
TELEX 268/863-3650

NOW, REAL CADD FOR ATARI ST JUST \$49.95



**If You Use This ...
You Need Us!**



FirstCADD™, Now for Atari 520ST & 1040ST, and IBM PC & Compatibles

If you draw, design, draft or doodle use FirstCADD™ to do it faster and do it better.

FirstCADD™ can change the way you do business! If any part of your business calls for putting pencil to paper, then FirstCADD™ is for you.

If you're an executive, use FirstCADD to do flow charts, graphs, presentations. We make it a snap to combine words with pictures.

If you're a contractor, plumber, electrician or building manager, use FirstCADD™ to do floor plans, elevations and alterations. With FirstCADD™ you can change your mind without having to start a whole new drawing— from scratch.

FirstCADD™ is ideal for the architect or interior designer, store owner, developer, graphic designer, engineer, draftsman.

Any time you have to draw with precision. Any time you have to combine drawing with words, FirstCADD™ can help

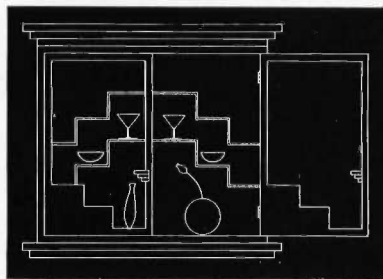

you do it quicker, cleaner and a lot easier.

FirstCADD is so easy to use that all you do is pop in the diskette and you'll be on your way! In minutes you'll be drawing lines, circles, arcs with ease. Plot your work on virtually any popular dot matrix printer.

Don't go another day without FirstCADD™. Call our toll free hot-line today. We'll give you the name of your nearest dealer or have FirstCADD™ in your hands in just a couple of days.

A full featured, 2-dimensional drafting and design package.

- Automatic line drawing
- Draw points, lines, arc, circles, ellipses, rectangles, polygons, Curves
- Snap-to and "rubber banding"
- Two-key commands
- On-screen menus
- User defined menus
- Create your own fonts
- Create libraries of frequently used components
- Zoom
- Edit
- Measure lines, angles, areas
- Drawing size limited only by memory

From the makers of Generic CADD 2.0™ (just \$99.95) the industry's first completely modular, expandable CAD package.

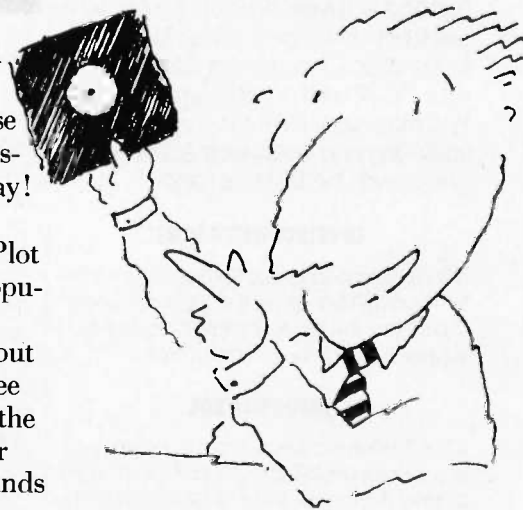

System Requirements:
Atari 520ST or Atari 1040 ST
PC or compatible with 256K RAM min., graphics card and two disk drives.
IBM is a registered trademark of International Business Machines Corp.
Atari ST and 1040 ST is a trademark of Atari Corp.
FirstCADD and Generic CADD 2.0 are registered trademarks of Generic Software, Inc., 8763 140th N.E. Building C, Redmond, WA 98052.

Generic

S O F T W A R E

Inquiry 144 for End-Users.
Inquiry 145 for DEALERS ONLY.

**TOLL FREE
ORDER HOTLINE:
1-800-228-3601**

Dealer inquiries
encouraged

GRAPHING QUADRIC SURFACES

BY GEORGE HARONEY

Methods of simulating 3-D graphics on a color display in BASIC

QUADRIC SURFACES are the graphs of second-degree equations in three variables. The solution set of the equation $x^2 + y^2 + z^2 = \text{radius}^2$, for example, is a familiar quadric surface: a sphere. In this article I present some simple techniques for displaying quadric surfaces. I've also provided a BASIC program as a tool for applying the techniques and exploring the subject of computer graphics and computer art.

The ideal method of plotting three-dimensional points would be on a stack of transparent planes, each filled with multicolored LEDs arranged in rows and columns. The LEDs would be transparent when off, so as not to obscure lighted LEDs on background planes. Such a display would represent illusorily real three-dimensional objects by illuminating selected LEDs on various planes within the structure.

Since such an ultimate system is not available, it is necessary to complicate matters by projecting three-dimensional coordinates onto a two-dimensional system: the computer screen. Nevertheless, it is often helpful to think of real three-dimensional graph-

ics when making pseudo three-dimensional graphics.

PROJECTION TECHNIQUES

As an exercise in projection, draw a cube on a piece of paper, indicating hidden edges with dotted lines. Select a corner of the cube as the origin and label the three lines emanating from that point X , Y , and Z . You now have a system for projecting three-dimensional points onto two dimensions (see the sidebar "3-D Projection Onto 2-D" on page 216). For instance, to locate the point (5,8,3), start at the origin and move 5 units along the X axis. From that point, move 8 units in a direction parallel to the Y axis. Finally, move another 3 units in a direction parallel to the Z axis. By varying the orientation of three axes, you can rotate a projected figure in any way you choose.

To project 3-D data onto a computer screen, you describe the origin point and the axes in terms of the display's native horizontal and vertical coordinate system. The origin is defined by its horizontal and vertical coordinates h_0 and v_0 . Each of the three

axes is defined by the angle it forms with a horizontal line extending from the origin in a positive direction. I'll refer to such angles as A_x , A_y , and A_z .

Using these landmarks and some elementary trigonometry (see the sidebar), it is possible to project any point (x,y,z) onto the display in terms of the display coordinates h and v , as follows:

$$h = x \cos A_x + y \cos A_y + z \cos A_z + h_0$$

$$v = x \sin A_x + y \sin A_y + z \sin A_z + v_0$$

PLOTTING A FUNCTION

Given a projection method, you are ready for some data points. Functions in three variables are a convenient source of data points, generating an unlimited variety of shapes and patterns with a little planning on your part. Unfortunately, there aren't any race car or dinosaur functions; almost all of them are stubbornly abstract.

The general method used is to con-

(continued)

George Haroney is a computer programmer working on software for a parallel computer system. He can be contacted at 2115 Grayson Place, Falls Church, VA 22043.

Ideally, foreground surfaces should cover background surfaces.

sider z as a function of x and y . For instance, given the equation

$$x^2 + y^2 + z^2 = 3$$

you rearrange things to get z as a function of x and y :

$$z = \pm\sqrt{3 - x^2 - y^2}$$

To plot a function, you scan the X - Y plane at regular intervals, selecting values for x and y , and calculate the resulting value for z .

Ideally, foreground surfaces should cover the background surfaces. Complicated hidden-line algorithms can provide this feature, but for the sake of brevity, my program simply draws

the background before the foreground so that it obscures background points. The program also calculates foreground points closer together and assigns different colors to foreground and background surfaces. All of these techniques improve the apparent three-dimensionality of the rendering.

Figures 1 through 6 are the graphs of common second-degree equations in three variables, as found in any calculus text. I produced the images on a Chromatics CG 1999 microcomputer with screen resolution of 512 by 512 pixels.

PROGRAM NOTES

Listings 1 through 6 are Microsoft BASICA programs that will produce similar (but not identical) images on an IBM PC or PC compatible equipped with a color graphics adapter.

The main program (listing 1) starts by asking you to specify the orienta-

tion of the X , Y , and Z axes in degrees. You may enter a positive or negative number, with the understanding that positive angles are rotated counterclockwise around the horizontal axis and negative angles are rotated clockwise.

I created the figures using angles of 15, -15, and 90 for X , Y , and Z , respectively. To render a surface in another orientation, you simply change one or more of the axes. For example, to turn the "saddle" in figure 2 upside down, you specify angles of 195, 165, and 270 for X , Y , and Z .

Line 100 defines the function. The function definition includes two arguments, x and y ; the function returns a value to be used for z .

Lines 110-120 specify the origin in terms of screen coordinates HC and LC . The position is calculated as a fraction of the number of points in each dimension. In listing 1, HC is

(continued)

3-D PROJECTION ONTO 2-D

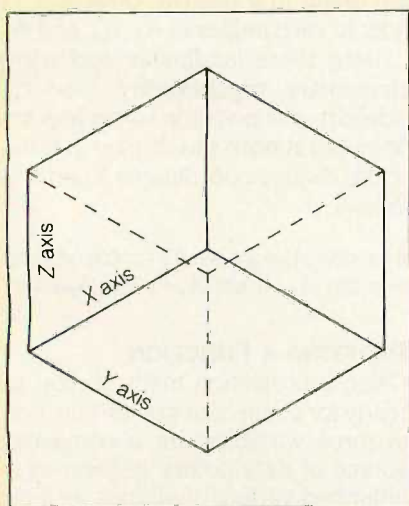

Figure A: Drawing a cube onto a plane gives a system for projecting 3-D points onto a 2-D surface.

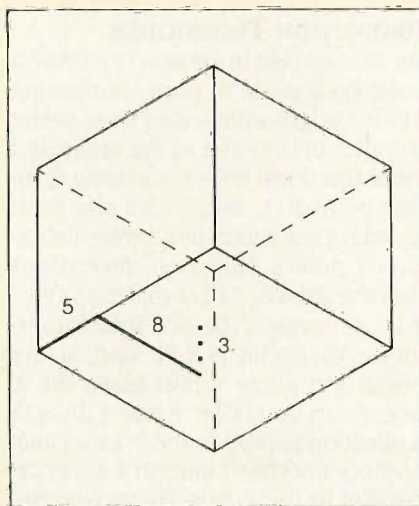

Figure B: Finding the point (5,8,3).

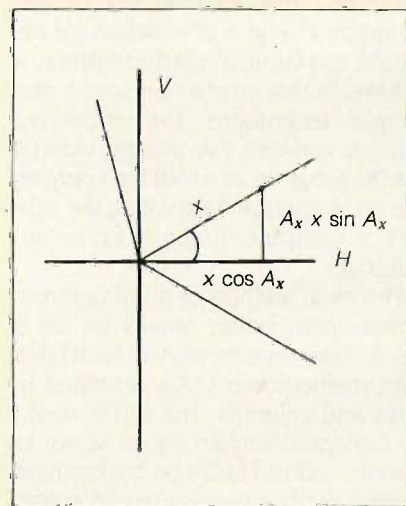

Figure C: Calculating the horizontal and vertical coordinates of a point $(x,0,0)$. When y and z are not zero, they must be calculated similarly using A_y and A_z ; the horizontal and vertical coordinates are summed:

$$\begin{aligned} h &= x \cos A_x + y \cos A_y + z \cos A_z \\ v &= x \sin A_x + y \sin A_y + z \sin A_z \end{aligned}$$

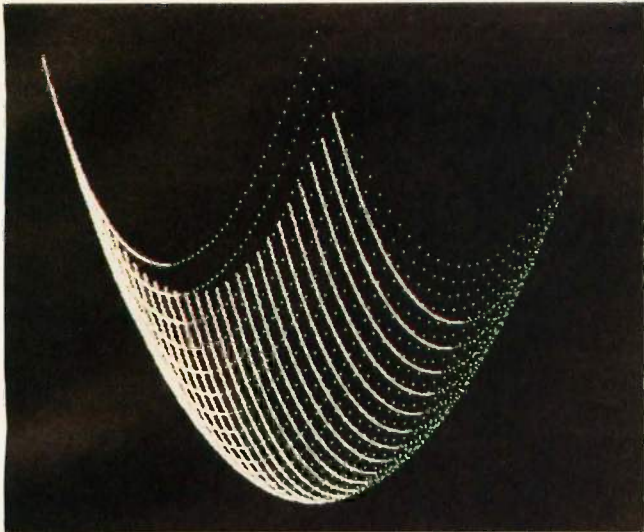

Figure 1: Paraboloid, $x^2/A^2 + y^2/B^2 - Cz = 0$.

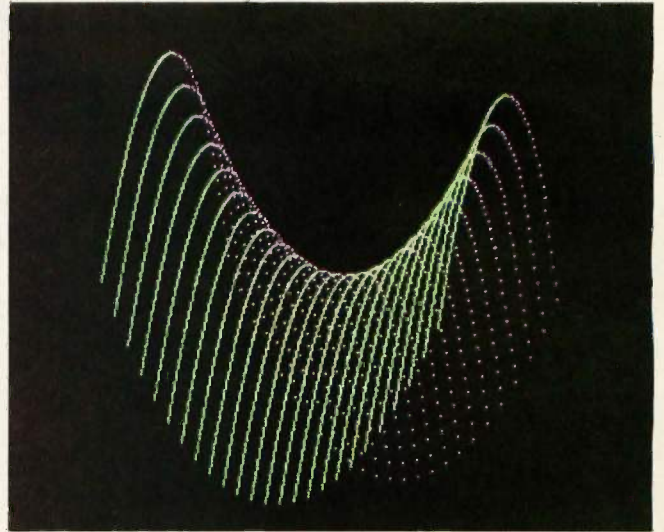

Figure 2: Hyperbolic paraboloid, $y^2/A^2 - x^2/B^2 - Cz = 0$.

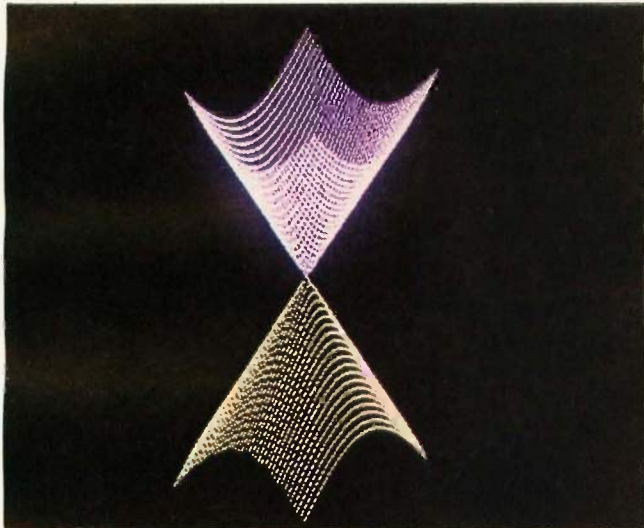

Figure 3: Cone, $x^2/A^2 + y^2/B^2 - z^2/C^2 = 0$.

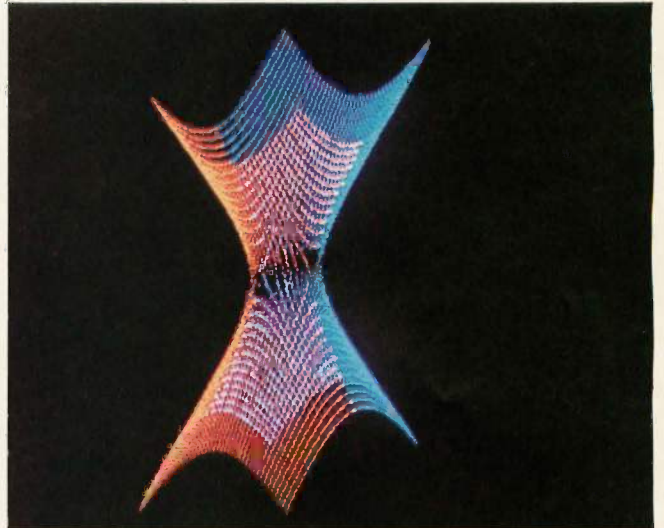

Figure 4: Hyperboloid of one sheet,
 $x^2/A^2 + y^2/B^2 - z^2/C^2 = 1$.

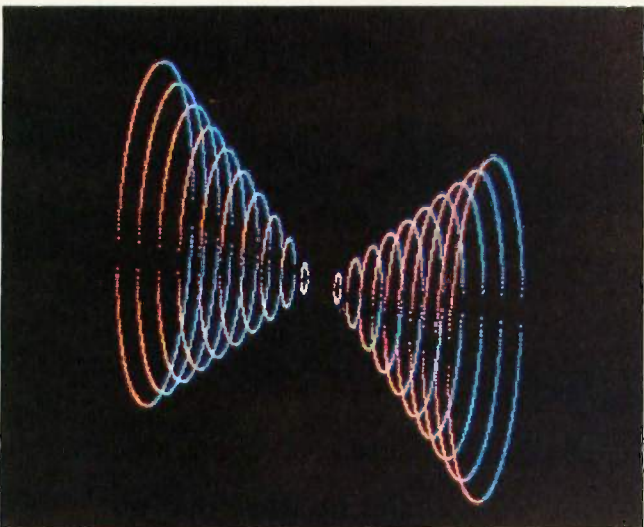

Figure 5: Hyperboloid of two sheets, $x^2/A^2 - y^2/B^2 - z^2/C^2 = 1$.

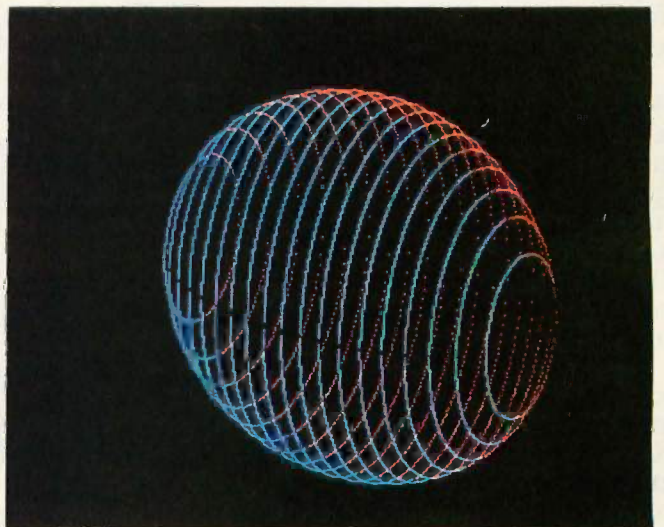
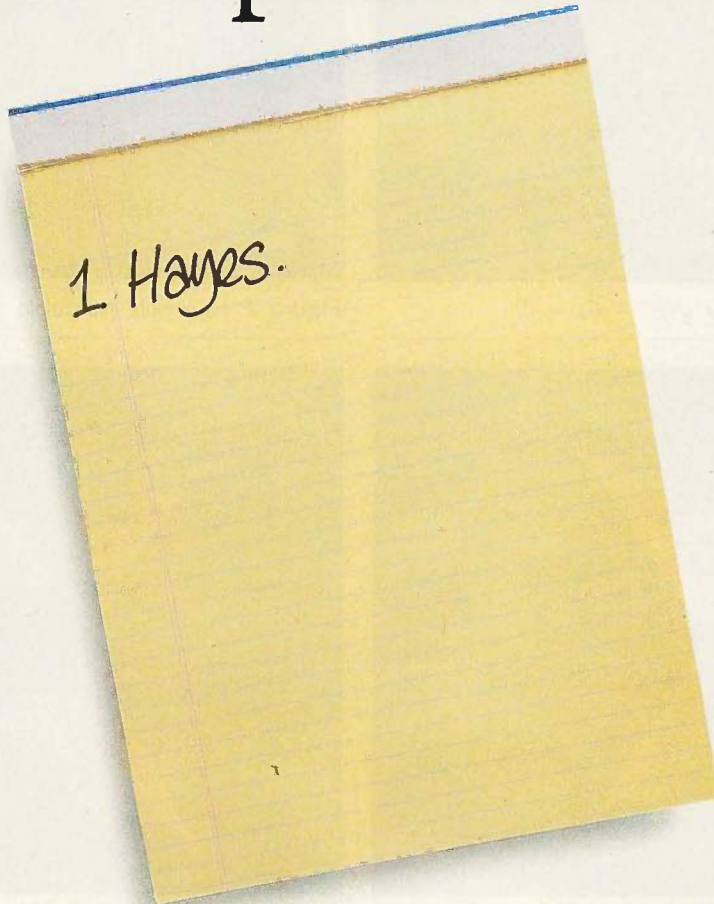

Figure 6: Ellipsoid, $x^2/A^2 + y^2/B^2 + z^2/C^2 = 1$.

A complete list of things to know about 2400 bps modems.



Now that you've memorized that, here's a partial list of why a Hayes® Smartmodem 2400™ is best for you.

1. The Hayes Smartmodem 2400 allows you to communicate with the vast installed-base of 300, 1200 and 2400 bps "Hayes-compatible" modems. The Hayes Standard "AT" Command Set allows you to use Smartcom II® and other software that communicates.

2. Through synchronous/asynchronous technologies, the Smartmodem 2400 permits your PC to access mainframes, minis, and on-line services previously inaccessible through asynchronous-only modems.

3. The Hayes Smartmodem 2400 is efficient...it pays for

itself in just 4 hours of annual use over long distance.

4. The technology of the Smartmodem 2400 allows you to transfer volumes of files with confidence across the city or



across the ocean using Bell and CCITT standards.

5. The new Smartmodem 2400B™—a plug-in board for the IBM PC and compatibles—allows synchronous and asynchronous communication through the same Com port.

6. You will also get the Hayes standard 2-year limited warranty and the opportunity to extend the warranty to 4 years.

Best of all...you get Hayes. And that's all you ever really have to know!

For more information or technical specs, contact your authorized Hayes dealer. Or Hayes directly at (404) 441-1617.

Hayes Microcomputer Products, Inc., P.O. Box 105203, Atlanta, Georgia 30348.



Hayes®

Say yes to the future with Hayes.

Listing 1: The main program (written in Microsoft's BASICA for the IBM PC) generates a paraboloid.

```

10 SCREEN 1 :REM 320 H by 200 V, 3 colors
20 DEFINT H-N
30 PI=4*ATN(1)
40 DR=PI/180 :REM Converts degrees to radians
50 BLUE=1: PURPLE=2: WHITE=3
60 HMIN=0: HMAX=319
70 LMIN=0: LMAX=199
80 HRES=HMAX-HMIN: LRES=LMAX-LMIN
90 REM -----Define function and set parameters -----
100 DEF FNF1(X,Y)=X*X+Y*Y :REM Paraboloid
110 HC=HMIN+INT(HRES/2)
120 LC=LMIN+INT(LRES/20)
130 SCALEH=12
140 SCALEV=2
150 REM -----Find Angles from center to corners -----
160 C1=ATN((LC-LMIN)/(HMAX-HC)) :REM to NE
170 C2=PI-ATN((LC-LMIN)/(HC-HMIN)) :REM to NW
180 C3=PI+ATN((LMAX-LC)/(HC-HMIN)) :REM to SW
190 C4=2*PI-ATN((LMAX-LC)/(HMAX-HC)) :REM to SE
200 REM ----- X Y Z axes -----
210 KOLOR=WHITE
220 INPUT "Angles for x,y,z axes "; DEGX,DEGY,DEGZ
230 CLS
240 DEGREES=DEGX
250 GOSUB 1080 :REM Convert degrees to radians A
260 SINXA=SIN(A): COSXA=COS(A)
270 REM GOSUB 1010: REM Draw the axis
280 DEGREES=DEGY
290 GOSUB 1080
300 SINYA=SIN(A): COSYA=COS(A)
310 REM GOSUB 1010
320 DEGREES=DEGZ
330 GOSUB 1080
340 SINZA=SIN(A): COSZA=COS(A)
350 REM GOSUB 1010
360 REM ----- Plot the surface -----
370 FOR TY=-6 TO 6 STEP .4
380 KOLOR=PURPLE :REM To show points s.t. x>=0
420 FOR TX=0 TO 6 STEP .4
430 TZ=FNF1(TX,TY)
440 GOSUB 1230 :REM Project and scale
450 PSET (MH,MV),KOLOR
460 NEXT TX
470 KOLOR=BLUE :REM To show points s.t. x<0
510 FOR TX=-6 TO 0 STEP .15
520 TZ=FNF1(TX,TY)
530 GOSUB 1230 :REM Project and scale
540 PSET (MH,MV),KOLOR
550 NEXT TX,TY :REM Next point on current tracing
560 END
1000 REM ---- Extend a line through center to borders ----
1010 TANA=TAN(A) :REM Save tangent
1020 GOSUB 1170: H1=HZ: L1=LZ :REM Get one endpoint
1030 DEGREES=DEGREES+180: GOSUB 1080:
1040 GOSUB 1170: H2=HZ: L2=LZ :REM Other endpoint
1050 LINE (H1,L1)-(H2,L2),KOLOR
1060 RETURN
1070 REM -- Converts degrees to radians, 0 <= a < 2*pi ---
1080 WHILE DEGREES<0
1090 DEGREES=DEGREES+360
1100 WEND
1110 WHILE DEGREES>=360
1120 DEGREES=DEGREES-360
1130 WEND
1140 A=DEGREES*DR
    
```

(continued)

800-222-8324

SEASON'S GREETINGS

WOW
What a
Super Special
SAVINGS!

Blowout

SUPER SPECIAL:
Equity I w/ Monitor
640 k memory.
20 meg Hard Drive
\$1095

Win an
Epson LX-86
Printer
FREE.
Details
Below

DK-10 LQ-W/CSP.....\$ 149.00

Epson Guaranteed Lowest Prices	Call	Call
FX-285	Call	LQ-1000
FX-85	Call	LQ-800
LX-86	Call	Call

Equity Series Computers
Equity I w/Monitor from \$699
Equity II w/Monitor from \$899

brother

HR-20	\$399
M-1109	\$199
M-1409	CALL
M-1509	CALL
M-1709	CALL

M1509

Hard Drive Specials

10 Meg \$299	20 Meg \$369	30 Meg \$499
-----------------	-----------------	-----------------

Computers (IBM Compatibles)

	Base	Mono	Color
IDS PC-XT 8088	\$595	795	995
IDS Turbo 8 Mghz			
2 Drives MS-DOS	\$649	895	1095
IDS AT			
1 1.2 Meg Floppy/MS-DOS	\$1495	1695	1895
W/20 Meg Hard Drive	1795	1995	2195

Leading Edge..... Call for Lowest Price
AT&T 6300..... Call for Lowest Price
Epson Equity I, II, III... Call for Lowest Price

SEASON'S GREETINGS

<p style="font-weight: bold; font-size: 0.7em;">MONITORS</p> <p>Samsung Amber TTL 12\$89 Green TTL 12\$85 Green Composite\$79 Amber Composite\$79</p> <p>Mitsuba 51CA TTL Amber\$99 w/Tilt & Swivel Stand 16CA Composite 12\$99 Amber w/Tilt & Swivel Stand</p>	<p style="font-weight: bold; font-size: 0.7em;">Sale on C.I. Accessories</p> <p>Floppy Disks Box of 10 Case of 100</p> <p>TDK ss/dd 8.95 87.50 ds/dd 9.95 97.50</p> <p>Maxell ss/dd 11.99 115.00 ds/dd 14.99 145.00</p> <p>IBM Parallel Cables \$10.00</p> <p>A Full Line of Ribbons. Epson. Brother. Sale on our full line of brand name IBM & compatible Add on Cards - Call for Prices</p>
-------------------------------------------------------------------------------------------------------------------------------------------------------------------------------------------------------------------------------------------------------------------------------------------------------------------------------------------------	-----------------------------------------------------------------------------------------------------------------------------------------------------------------------------------------------------------------------------------------------------------------------------------------------------------------------------------------------------------------------------------------------------------------------

To Enter Contest, Send in a Self-Addressed
Postcard to the address listed below. You
must be 18 years. Winner will be announced
in the February issue of this magazine.

1-800-222-8324

COMPUTERS
INTERNATIONAL

6619 U.S. 1 Miami, FL 33143
IN FLORIDA CALL (305) 667-5936

In Chicago Call:
600 W. Van Buren
Suite 502
Chicago, Illinois 60607
Tel # (312) 235-1272

**Do math
on your PC
as easily as
writing it down**

NEW!

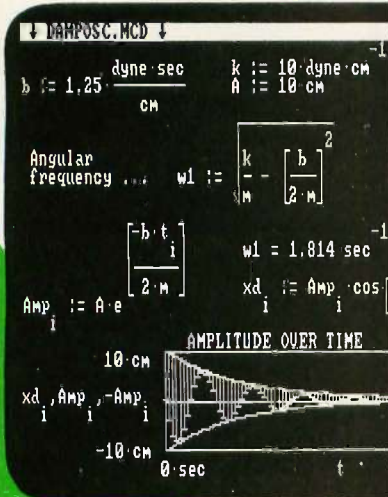

\$189

- Enter and display formulas the way you're used to writing them
- Calculate results instantly as numbers or plots
- Change anything—results are automatically recalculated
- Real and complex numbers, unit conversions, dimensional analysis
- Add text anywhere to document your work
- Print out everything just as you see it

MathCAD

The Engineer's Scratchpad

MathSoft Inc.

One Kendall Square
Cambridge, Massachusetts 02139

1 800 MathCAD or 617 577-1017

QUADRIC SURFACES

```

1150 RETURN
1160 REM Find endpoint (hz,lz) of ray at (hc,lc), angle a
1170 IF A<=C1 OR A>C4 THEN HZ=HMAX: LZ=LC-(HMAX-HC)*TANA:
      RETURN
1180 IF A<=C2 THEN LZ=LMIN: HZ=HC+(LC-LMIN)/TANA: RETURN
1190 IF A<=C3 THEN HZ=HMIN: LZ=LC+(HC-HMIN)*TANA: RETURN
1200 IF A<=C4 THEN LZ=LMAX: HZ=HC-(LMAX-LC)/TANA
1210 RETURN
1220 REM ----- Project tx,ty,tz onto mh,mv -----
1230 PX=TX*COSXA+TY*COSYA+TZ*COSZA
1240 PY=TX*SINXA+TY*SINYA+TZ*SINZA
1250 MH=INT(HC+PX*SCALEH)
1260 MV=INT(LC-PY*SCALEV)
1270 RETURN
    
```

Listing 2: Replacement lines to generate a hyperbolic paraboloid.

```

100 DEF FNF1(X,Y)=Y*Y-X*X :REM Hyperbolic paraboloid
110 HC=HMIN+INT(HRES/2)
120 LC=LMIN+INT(LRES/2)
130 SCALEH=15
140 SCALEV=3.5
370 FOR TY=-5 TO 5 STEP .4
380 KOLOR=PURPLE
390 FOR TX=0 TO 5 STEP .4
400 TZ=FNF1(TX,TY): GOSUB 1230 :REM Project and scale
420 PSET (MH,MV),KOLOR :REM Deleted line 410
430 NEXT TX
440 KOLOR=BLUE :REM To show points s.t. x<0
450 FOR TX=-5 TO 0 STEP .1
460 TZ=FNF1(TX,TY)
470 GOSUB 1230 :REM Project and scale
480 PSET (MH,MV),KOLOR :REM Plot a point
490 NEXT TX,TY
500 END
    
```

Listing 3: Replacement lines to generate a cone.

```

100 DEF FNF1(X,Y)=SQR(Y*Y+X*X)*2 :REM Cone
110 HC=HMIN+INT(HRES/2)
120 LC=LMIN+INT(LRES/2)
130 SCALEH=8
140 SCALEV=4
370 FOR TY=-6 TO 6 STEP .75
380 KOLOR=PURPLE
390 FOR TX=0 TO 6 STEP .5
400 TZ=FNF1(TX,TY)
410 GOSUB 1230 :REM Project and scale
420 PSET (MH,MV),KOLOR :REM Plot a point
430 TZ=-FNF1(TX,TY)
440 GOSUB 1230
450 PSET (MH,MV),KOLOR
460 NEXT TX
470 KOLOR=BLUE
480 FOR TX=-6 TO 0 STEP .2
490 TZ=FNF1(TX,TY): GOSUB 1230
510 PSET (MH,MV),KOLOR :REM Deleted line 500
520 TZ=-FNF1(TX,TY)
530 GOSUB 1230
540 PSET (MH,MV),KOLOR
550 NEXT TX,TY
560 END
    
```

ECOSOFT HOLIDAY SPECIALS



EVERYTHING FOR THE C PROGRAMMER

If you know someone (perhaps yourself!) that wants to learn the C programming language, have we got a deal for you. For a limited time, you get:

Eco-C88 C compiler	\$59.95
CED Program editor	29.95
Developer's Library Source Code	25.00
ISAM File Handler	15.00
Flexi-Graph Graphics Package	39.95
Eco-Lib MSDOS Compatible Librarian	29.95
Ecosoft Windowing Library	29.95
C Programming Guide book (Que Corp)	20.00
C Self Study Guide book (Que Corp)	17.00
C Programmer's Library book (Que Corp)	22.00

Total: \$288.75

Holiday Special: \$175.00

Save Over: \$110.00!!!

The Holiday Special has everything you need for your C programming needs. Eco-C88 is a full K&R C compiler (less bit fields), with over 200 library functions, source code to our cc and mini-make utilities, and generates code rivaling compilers costing 10 times as much. You also get the source code to our library, an MSDOS-obj compatible librarian, one of the neatest graphics packages around, an easy-to-use windowing package plus a library of books to teach you the C language. An unbelievable package at an unbeatable price of only \$175.00.

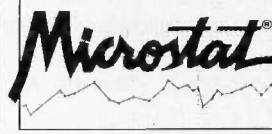

Microstat Statistics Package

Since 1977, Microstat has been one of the most popular statistics packages available for microcomputers. Just some of its features include:

Data Management Subsystem	Multiple Regression (with Stepwise)
Data transformations	Correlation Analysis
Convert External data (e.g. Lotus, Dbase II, etc.)	Time Series Analysis
Descriptive Statistics	Nonparametrics
Hypothesis Testing	Probability Distributions
Crosstabs and Chi-Square	Scatterplots
ANOVA	Factorials, Permutations

Holiday Special: \$250.00

plus many other unique and easy-to-use features. Microstat is available for all MSDOS machines or any CP/M80 system using a Z80 CPU.

The regular price is a bargain at \$375.00. At the Holiday Special price of \$250.00, it's a steal!

To take advantage of these special prices, we must have your order in our offices by Jan. 15, 1987.

To order, call or write:

1-800-952-0472 (for orders)

or

1-317-255-6476 (tech. info.)



Ecosoft Inc.
6413 N. College Ave.
Indianapolis, IN 46220



Trademarks: Ecosoft; Microstat; Eco-C88; Microsoft; MSDOS; New Orleans General Data Services; Flexi-Graph

Listing 4: Replacement lines to generate a hyperboloid of one sheet.

```

100 DEF FNF1(X,Y)=SQR(Y*Y+X*X-2)*2 :REM HB of 1 sheet
110 HC=HMIN+INT(HRES/2)
120 LC=LMIN+INT(LRES/2)
130 SCALEH=8: SCALEV=7 :REM Deleted line 140
370 FOR TY=-4 TO 4 STEP .5
380 FOR TX=-4 TO 4 STEP .2
390 IF TX*TX+TY*TY<2 THEN 460 ELSE TZ=FNF1(TX,TY)
400 GOSUB 1230 :REM Project and scale
410 IF TX<0 THEN KOLOR=BLUE ELSE KOLOR=PURPLE
420 PSET (MH,MV),KOLOR :REM Plot a point
430 TZ=-TZ: GOSUB 1230 :REM Deleted line 440
450 PSET (MH,MV),KOLOR
460 NEXT TX,TY
470 END
    
```

Listing 5: Replacement lines to generate a hyperboloid of two sheets.

```

100 DEF FNF1(X,Y)=SQR(Y*Y-X*X-1) :REM HB of 2 sheets
110 HC=HMIN+INT(HRES/2)
120 LC=LMIN+INT(LRES/2)
130 SCALEH=3: SCALEV=3 :REM Deleted line 140
370 FOR TY=-20 TO 20 STEP 2
380 FOR TX=-20 TO 20 STEP .3
390 IF TX*TX+1>TY*TY THEN 460 ELSE TZ=FNF1(TX,TY)
400 GOSUB 1230 :REM Project and scale
410 IF TX<0 THEN KOLOR=BLUE ELSE KOLOR=PURPLE
420 PSET (MH,MV),KOLOR :REM Plot a point
430 TZ=-TZ: GOSUB 1230 :REM Deleted line 440
450 PSET (MH,MV),KOLOR
460 NEXT TX,TY
470 END
    
```

Listing 6: Replacement lines to generate an ellipsoid.

```

100 DEF FNF1(X,Y)=SQR(1-X*X-Y*Y) :REM Ellipsoid
110 HC=HMIN+INT(HRES/2)
120 LC=LMIN+INT(LRES/2)
130 SCALEH=50: SCALEV=50 :REM Deleted line 140
370 FOR TY=-.99 TO 1 STEP .15
380 KOLOR=PURPLE
390 FOR TX=.01 TO 1 STEP .03
400 IF TX*TX+TY*TY>=1 THEN 460 ELSE TZ=FNF1(TX,TY)
410 GOSUB 1230 :REM Project and scale
420 PSET (MH,MV),KOLOR :REM Plot a point
430 TZ=-TZ
440 GOSUB 1230 :REM Project and scale
450 PSET (MH,MV),KOLOR :REM Plot a point
460 NEXT TX
470 KOLOR=BLUE
480 FOR TX=-1 TO 0 STEP .015
490 IF TX*TX+TY*TY>=1 THEN 550 ELSE TZ=FNF1(TX,TY)
500 GOSUB 1230
510 PSET (MH,MV),KOLOR
520 TZ=-TZ
530 GOSUB 1230
540 PSET (MH,MV),KOLOR
550 NEXT TX,TY
560 END
    
```

All this—and only 15 pounds!

Power for performance:

- IBM PC AT compatible
- 80286 processor, running at 8MHz
- MS-DOS™ 2.11* operating system

More storage for more applications:

- 640KB RAM, extendable to 2.6MB
- Built-in 10MB hard disk
- Built-in 720KB 3½" diskette drive

The display with clear advantages:

- High-resolution gas plasma display
- IBM Color Graphics Adapter (CGA) compatible
- 80 x 25 character display
- 640 x 400 bit-mapped graphics display

Interfaces to make connections a snap:

- RGB color monitor port
- Parallel printer port
- RS-232C serial port

Built-in convenience:

- Full-sized 81-key keyboard
- 110/220 VAC switch-selectable power supply
- Only 12.2" W x 3.1" H x 14.2" D

Important extras included:

- SideKick® and SuperKey® software
- Attractive carrying case

"Big" system expansion options:

- Internal 300/1200 bps Hayes®-compatible modem
- Internal 2MB extended memory card
- 15-key numeric keypad
- External 5¼" 360KB diskette drive
- Floppy Link to desktop 5¼" diskette drive
- Expansion chassis with five IBM-compatible slots

The T3100. So powerful—and so portable— it's like being able to take your whole office wherever you work.

*MS-DOS 3.2 operating system available Fall, 1986.

TOSHIBA

14" x 12" x 10MB x 80286*



AT Power, Toshiba-Style.

Until now, working away from your office meant having to settle for lesser computers—or no computer at all.

Toshiba ends that compromise. The T3100 delivers the power of an IBM® PC AT™ in a lean, 15-pound computer that you can take with you. With a full-sized keyboard and advanced gas plasma display that give you equal comfort and clarity on your desk—or on the road.

Don't let its size fool you.

The T3100 is less than a third the size of the COMPAQ® Portable II,™ yet offers the power and expandability of a full-function IBM compatible desktop system. You get the speed and

ease of a built-in hard disk, communications and expansion options, and more—including dual-voltage power that lets you plug in and go to work just about anywhere in the world.

*Okay, we exaggerated. It's actually 14.2" x 12.2". But you really get a 10.6MB built-in hard disk.

See the system that has all of the industry experts so excited. Call: **1-800-457-7777** for your nearest Toshiba computer and printer dealer.

In Touch with Tomorrow

TOSHIBA

TOSHIBA AMERICA, INC., Information Systems Division



Trademarks: PC AT—International Business Machines Corporation; Portable II—COMPAQ Computer Corporation; MS-DOS—Microsoft Corporation; Registered Trademarks: IBM—International Business Machines Corporation; Hayes—Hayes Microcomputer Products, Inc.; SideKick, SuperKey—Borland International, Inc.; COMPAQ—COMPAQ Computer Corporation.



Figure 7: *Wavy paraboloid.*

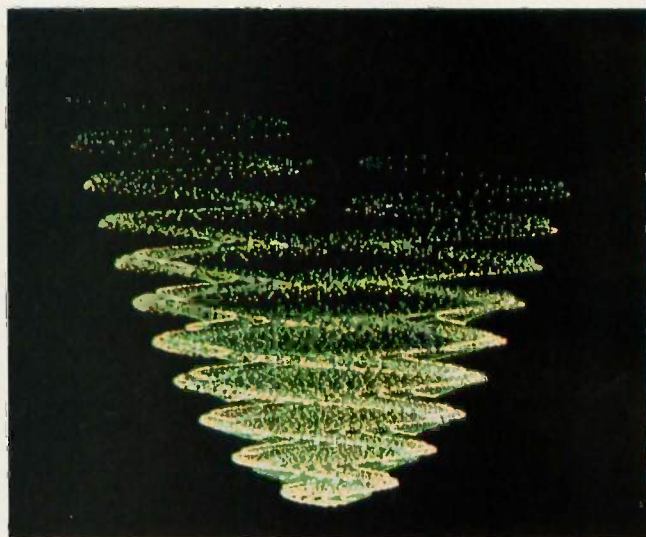

Figure 8: *Swirlid.*



Figure 9: *Comet.*



Figure 10: *Bubbling paraboloid.*

halfway across the screen ($HRES/2$) and $19/20$ of the way down the screen ($19 \cdot VRES/20$).

Lines 130–140 set the horizontal and vertical scaling factors, which you can use to scale a surface so that it fits within the plotting area.

Lines 270, 310, and 350 draw the axes on the screen; in the listing, they are made inoperative by the `REM` keyword. To make the program draw the axes, simply remove the first `REM` from these three lines.

Lines 360–560 make up the plotting routine. The program steps through a domain of x and y values, calculates a z for each x and y , and plots the

point. The program changes colors for points for which x is negative; this helps in the simulation of three-dimensionality.

You might find it interesting to tinker with the plotting domains for X and Y and with the increments used to step through these domains. You might also change the function definition, the screen center point, and the scaling factor.

In general, graphing a different function will require minor changes to lines in the ranges 90–140 and 360–560. Listings 2 through 6 consist of all the changes that you will need to make to listing 1 to generate figures

2 through 6.

You can further explore computer-generated art by using quadric shapes as building blocks and combining and intersecting them to produce intricate figures. Figures 7 through 10 illustrate some of the possibilities. The general idea is to apply an extra transformation to one or more of the coordinates before each point is plotted (for example, multiply a coordinate x by $\sin x$).

Editor's note: The program listings in this article are available on disk, in print, and on BIX; see the insert card following page 320. Listings are also available on BYTENet; see page 4. ■

This Size Fits All.

In today's rapid-paced world in which the movers and shakers prevail, it's nice to have a computer that can move with you. And that's why Logisoft offers a full line of personal laptop computers that are powerful, yet portable. Compact, and convenient.

Take the Toshiba T1100 PLUS, for example. Eleven pounds of power that includes: 640K RAM, two built-in 720K 3.5" disk drives, a high-resolution 80 character x 25 line LCD display (also built in), an 80C86 microprocessor, and runs on rechargeable batteries or an AC adapter (also included). The Toshiba has the ability to handle a host of peripherals, and is fully IBM-compatible. So that it fits any business need, as well as it fits any businessman's lap. Best of all, you can order the Toshiba T1100 PLUS today and get it tomorrow at a great price, from Logisoft.

Logisoft is the world's leading distributor of name-brand computer hardware and software products. We offer free installation on most systems, as well as on-site service contracts.

Our custom leasing programs are designed to make your purchase fit your budget. And through our offices in Amsterdam, we can easily handle your overseas corporate needs.

So, when you're moving up the ladder, take the computer that's fit for the top rung, yet fits in a briefcase...

the Toshiba T1100 PLUS from Logisoft.

The Largest Direct Distributor
of Software and Hardware Products
...in the World.

LOGISOFT

1-800-645-3491

NY STATE: 1-800-235-6442 (516) 249-8440

Customer Service: 1-800-431-9037 NYS: 516-249-8440

FAX # 516-249-5289

CANADA: 800-433-6235 EUROPE: 020-83-4864

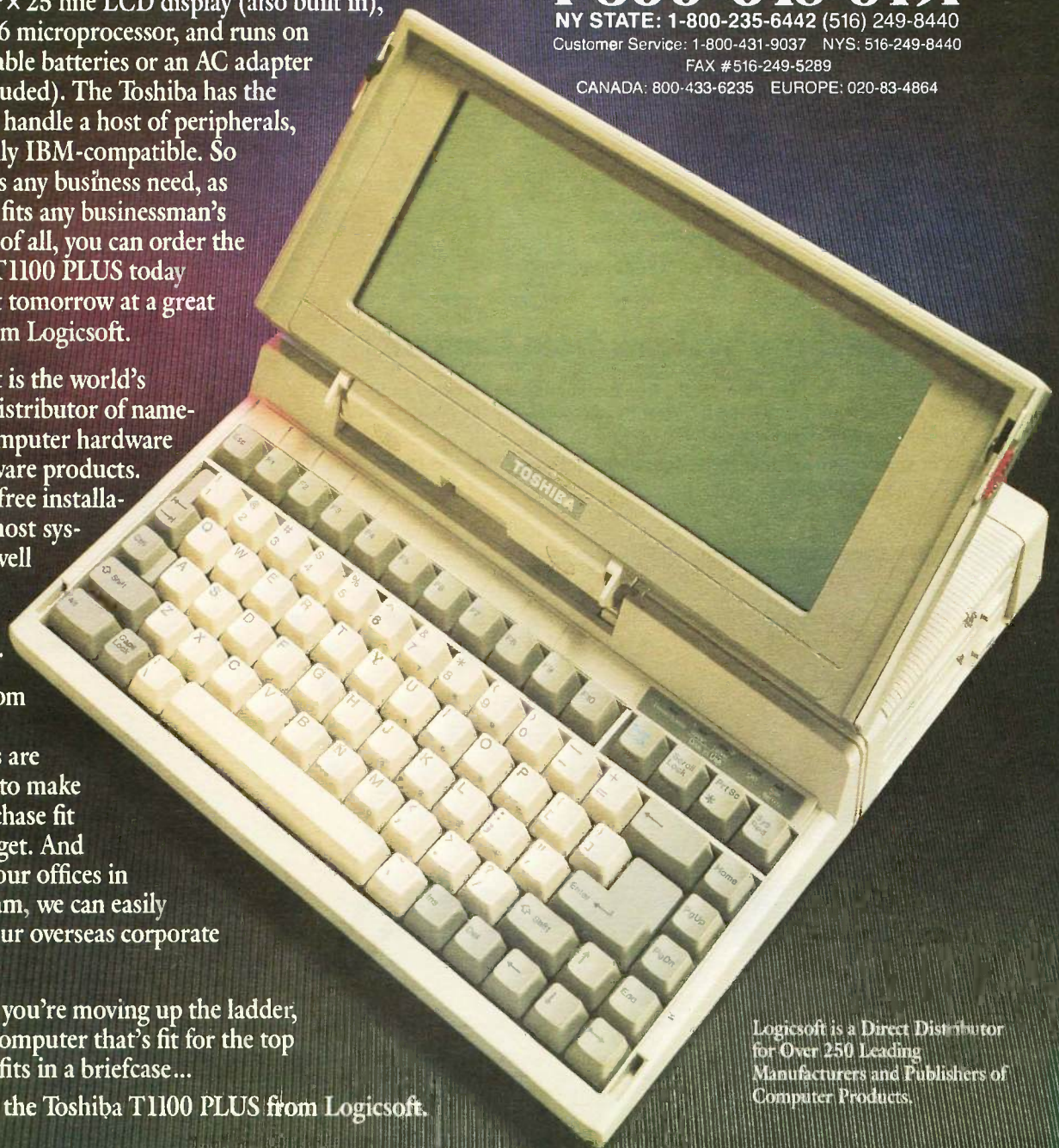

Logisoft is a Direct Distributor
for Over 250 Leading
Manufacturers and Publishers of
Computer Products.

Free on-site installation



New IBM AT-30 Mb

- 8 MHz • 512K • 30 Mb IBM Hard Drive (Full Height, w/controller) • 1.2 Mb Half/Height Floppy • Eight Expansion Slots • IBM Enhanced PC Keyboard • Serial/Parallel Adapter • Free 90-day, On-Site Service Contract • Color or Monochrome Monitor Available as Option.

• **Purchase Price: \$4,299**

Lease For **\$171** per month



New IBM XT 286—20 Mb

- 6 MHz • 80286 Based CPU • Zero Wait States • 640K • 1.2 Mb Half/Height Floppy • 20 Mb Full/Height Hard Drive • Serial/Parallel Adapter • Eight Expansion Slots- (5) 16-Bit, (3) 8-Bit • IBM PC Enhanced Keyboard • Free 90-Day, On-Site Contract • Color or Monochrome Monitor Available as Option.

• **Purchase Price: \$3,199**

Lease For **\$126** per month



IBM XT—20 Mb

- 512K • 20 Mb IBM Full Height Hard Drive • 360K Floppy Drive Half/Height • Eight Expansion Slots • IBM Enhanced PC Keyboard • Asynchronous Communications Adapter • Free 90-day, On-Site Service Contract • Color or Monochrome Monitor Available as Option.

• **Purchase Price: \$2,299**

Lease For **\$98** per month



AT&T 6300

- 640K RAM Memory • One 360K Floppy Drive • Seven Expansion Slots • AT&T Keyboard • High-Resolution Monochrome Graphics Card • High-Resolution Monochrome Graphics Monitor • Serial & Parallel Ports • GW Basic and MS. DOS. Free 90-Day, On-Site Service Contract. Color Monitor Optional.

• **Purchase Price: \$1,829**

Lease For **\$78** per month

Lease or purchase systems from Logisoft

A Logiclease of any system entitles you to free installation and 90-day service contract at your place of business! Outstanding flexibility plus possible tax benefits. We'll process your lease application in 24 hours!

A purchase of any system entitles you to installation for only \$99, and free service for 90 days at your place of business.



ON-SITE SERVICE

Trained technicians are ready to respond to your needs within an average of 4 hours from any of our 96 authorized service centers, located in most major metropolitan areas throughout the United States.



Logic AT

- FCC Class B Approved.
- 8 MHz • 512K RAM Memory • 80286 Based CPU □ ROM BIOS 32K (Includes auto system test when power is turned on) • 1.2 Mb High Density Floppy Drive • Eight Expansion Slots • Enhanced Keyboard • (1) Serial Port • (1) Parallel • Clock/calendar • Graphics Card • Programmable Speaker • Automatic Lock/Unlock Mechanism • Monochrome or Color Monitor Available as Option. Hard Drive Options Available.

• **Purchase Price: \$1,595**

Lease For **\$68** per month

100% Burn-In and Testing.

All systems undergo a 48-hour configuration, testing and burn-in period. We configure system boards, set DIP switches, format hard drives, perform memory diagnostics and check system with monitor.



• No surcharge for MasterCard, VISA, American Express, C.O.D., money order, check or PO's (please call for price verification) • No sales tax on orders shipped outside N.Y. State • Please add 2% for insurance and handling (\$3.00 minimum) (int'l orders add 1) • We do not bill until we ship. All products covered by mfg's warranty. Defective merchandise may be returned for repair or exchange only. We do not guarantee compatibility. Any goods returned for credit are subject to a 15% restocking charge. All prices and policies subject to change without notice.

*FREE OVERNIGHT DELIVERY—available on orders totaling over \$100. Shipped UPS, FREE, if under \$100 (within Cont. U.S.). Due to weight restrictions, printers and monitors & some misc. bulk items are also shipped UPS, FREE.

LOWEST PRICE GUARANTEE—If you find a lower price (bonafide advertisement or quote) we'll beat it by \$10. On items under \$100, American Express or terms orders we will meet any lower price. We reserve the right to request a current written price quote.

FREE-FORM CURVES ON YOUR MICRO

BY STEVE ENNS

Implement Bézier and B-spline curves for interactive graphics

EVEN THOUGH microcomputer graphics have become increasingly sophisticated, free-form curves have been largely confined to mini- and mainframe computers. Yet some microcomputer graphics applications seem to cry out for a method of creating free-form curves.

You could, of course, create several types of curves using an x,y coordinate system. But most microcomputer displays tend to be of the $y = f(x)$ type. For those systems the y coordinate is determined by some operation on the x coordinate. These curves are best suited to the mathematical sciences, where the graph or curve of the function is usually not as important as its numerical properties. In your graphics applications you may be more concerned with what the graph looks like than whether it has, say, a vertical asymptote at $x = 3$. Fortunately, there are ways of accessing free-form curves on your microcomputer.

Two types of curves that are particularly well suited to computer graphics and that you can define visually are Bézier curves and B-splines. You can

define either with a small set of points, and you can intuitively discern their appearance from the positions of these defining points.

THE BÉZIER FORM

The French engineer Pierre Bézier developed the curves that bear his name for the car designers at Renault. Cubic parametric Bézier curves are defined by a set of four control points P_1 , P_2 , P_3 , and P_4 . The curve contains the first and last control point and traces a smooth path between the intervening points (see figure 1). The curves can be shown in matrix form as

$$C(t) = [t^3 \ t^2 \ t \ 1]B \begin{bmatrix} P_1 \\ P_2 \\ P_3 \\ P_4 \end{bmatrix}$$

where

$$B = \begin{bmatrix} -1 & 3 & -3 & 1 \\ 3 & -6 & 3 & 0 \\ -3 & 3 & 0 & 0 \\ 1 & 0 & 0 & 0 \end{bmatrix}$$

The parameter t varies from 0 to 1. At

$t=0$, the curve is on point P_1 . As t is increased in small increments, the curve approaches and passes points P_2 and P_3 , ending at P_4 when $t=1$ (see figure 2). The curve will always remain within the convex hull formed by joining the four control points (figure 3). Different choices for points P_2 and P_3 result in more gentle or more severe curves (figure 4). The shape of the resulting curve becomes predictable after a little experience. This predictability, along with the relative speed at which the curves can be calculated, makes Bézier curves a popular choice for interactive design applications.

Going from the general matrix equation above to a method for plotting the curve in two or three dimension is not difficult. Depending on whether you're using two or three dimensions, each P_i is defined in terms of (x,y) or (x,y,z) coordinates. Matrix multiplication from the preceding equation gives one polynomial

(continued)

Steve Enns is a research assistant in mathematics at the University of Saskatchewan. He can be contacted at 2425 Haultain Ave., Saskatoon, Saskatchewan, Canada S7J 1R2.

equation for each of the coordinates. For instance, the x coordinates of the Bézier curve are given by:

$$x(t) = (-t^3 + 3t^2 - 3t + 1)P_1^x + (3t^3 - 6t^2 + 3t)P_2^x + (-3t^3 + 3t^2)P_3^x + t^3P_4^x.$$

(The notation P_i^x represents the x coordinate of point P_i .) The equations for the y and z coordinates are the same, except that P_j^y and P_j^z are substituted for P_j^x .

Any number of control points could be specified for a Bézier curve, but this requires the calculation of

polynomial functions of higher degree.

THE B-SPLINE FORM

The B-spline is another popular curve form that is slightly more versatile than the Bézier form. The B-spline tends to follow the control points more closely. And while the Bézier description above used only four control points to describe a single curve, the B-spline form lets you use an arbitrary number of control points. (You can, of course, join several curve segments together to produce one

larger curve, using either type.)

Mathematically, the cubic-parametric B-spline resembles the Bézier form. Given n control points, the curve around each control point is defined:

$$C(t) = [t^3 \ t^2 \ t \ 1]B \begin{bmatrix} P_{i-1} \\ P_i \\ P_{i+1} \\ P_{i+2} \end{bmatrix}$$

where $2 \leq i \leq n-2$ and

$$B = \frac{1}{6} \begin{bmatrix} -1 & 3 & -3 & 1 \\ 3 & -6 & 3 & 0 \\ -3 & 0 & 3 & 0 \\ 1 & 4 & 1 & 0 \end{bmatrix}$$

The curve is calculated around each of the points P_2 to P_{n-2} , letting t range from 0 to 1 for each control point.

Matrix multiplication gives a parametric equation for each coordinate (x,y) or (x,y,z). Here's the equation for x coordinates around the point P_i :

$$x(t) = (-\frac{1}{6}t^3 + \frac{1}{2}t^2 - \frac{1}{2}t + \frac{1}{6})P_{i-1}^x + (\frac{1}{2}t^3 - t^2 + \frac{3}{2}t)P_i^x + (-\frac{1}{2}t^3 + \frac{1}{2}t^2 + \frac{1}{2}t + \frac{1}{6})P_{i+1}^x + \frac{1}{6}t^3P_{i+2}^x.$$

The B-spline winds among the control points in a fashion similar to the Bézier—it will not usually pass through any of them but will curve close to them, producing a smooth curve as opposed to an exact but less than "regular" fit (see figure 5). Like Bézier curves, you can change the influence that a particular point has on the overall B-spline. If the same control point is used twice, for example, the curve will be more attracted to that position.

IMPLEMENTING FREE-FORM CURVES

The actual implementations of the Bézier and B-spline forms are very similar to their mathematical descriptions. In fact, the process involves little more than evaluating the polynomial equations at the given control points using each value of the increasing parameter t (see listings 1 and 2).

The only differences in the two algorithms are the number of control points used to produce each segment of the curve (the first loop in each

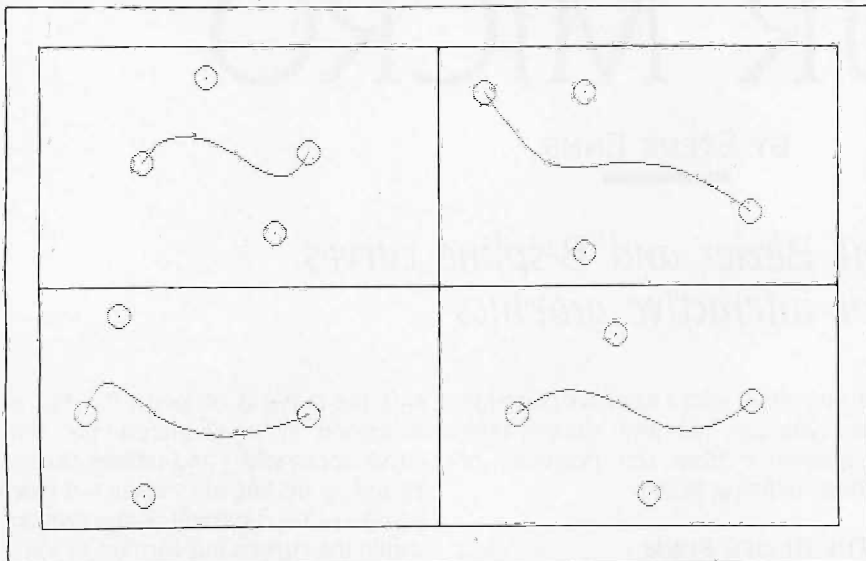

Figure 1: Various Bézier curves and their corresponding control points.

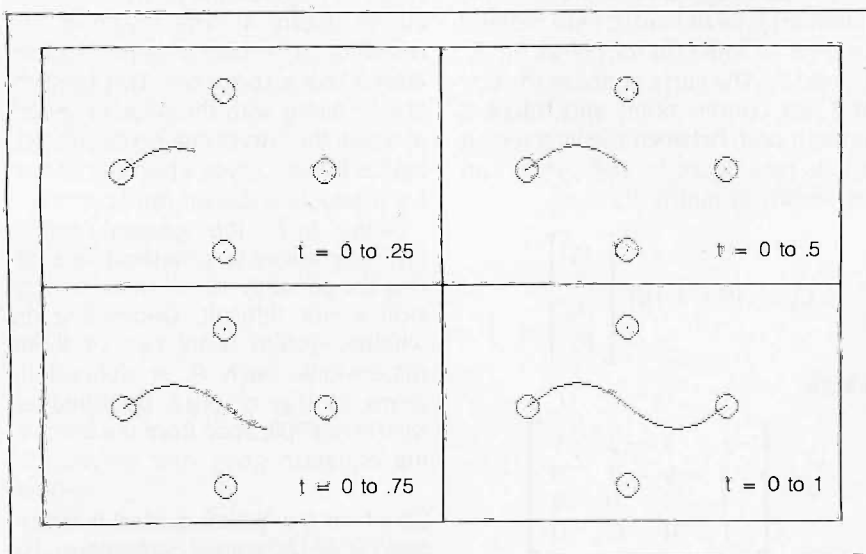

Figure 2: A Bézier curve at various values of the increasing parameter, t .

FREE-FORM CURVES

algorithm) and the type of polynomial calculated (the third step in each case). Listings 3 and 4 are direct implementations of the algorithms as BASIC subroutines.

Let's say you need to create some rolling hills for the background of a graphic display. To produce gently rolling hills, choose four points (more if you use the B-spline routine) that describe the curve. To make the hills two-dimensional, set XBS23 to 0 so that the program calculates only x and

y values. To have the curve drawn directly on the screen, set XBSDR to 0. Store the control points you've chosen in the arrays XC and YC.

Since these are the only control points you are using, set XNC (the index of the control points) to 1 and XNB (the number of points used) to 4. If this is the only curve you will be calculating, the points can occupy the first space in the curve storage arrays (X and Y), so set XNP to 1. To get a

(continued)

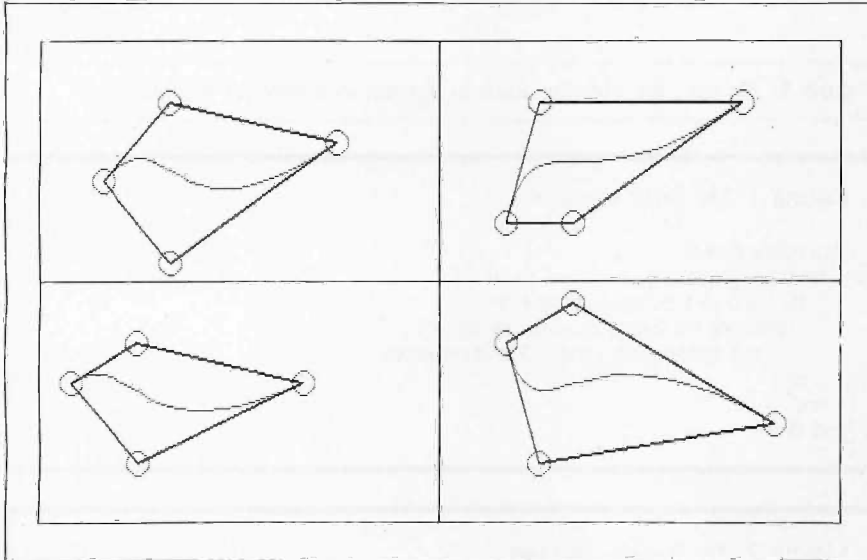

Figure 3: Various Bézier curves and the corresponding "convex hulls" formed by connecting the curves' control points.

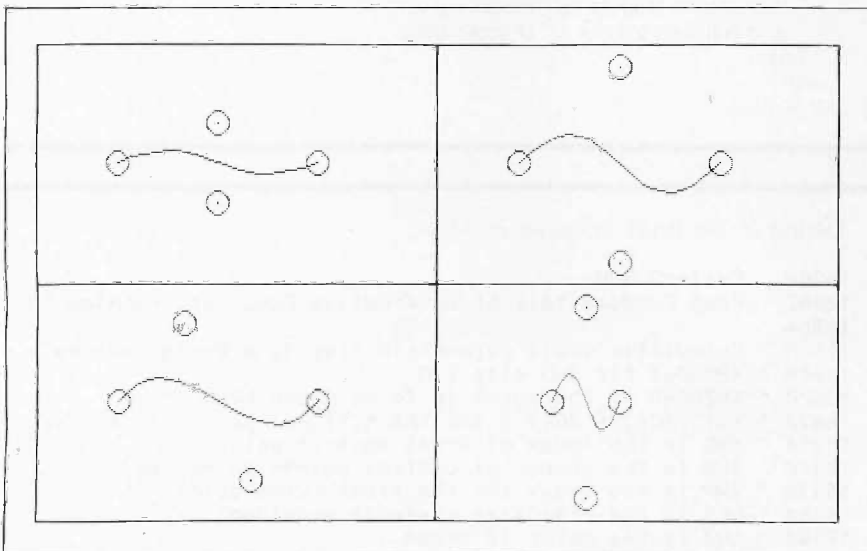

Figure 4: Different choices for the two intermediate (disconnected) control points result in more gentle or more severe curves.

Try It. Then Buy It. PC-Write.™

A fast, full-featured word processing package for only \$16. Complete. You get a quick reference guide and tutorial on disk, 45 help screens, choice of function keys or menus, mail merge, spelling check, advanced formatting, and support for over 350 printers including the HP LaserJet Plus.

Try PC-Write for only \$16. Then register for \$89 to get:

- o Latest diskette pair
- o Hardbound manual
- o Two updates
- o Phone support
- o Newsletter

Plus, your registration fee supports our development of new PC-Write features.

Shareware means you can freely copy and share the PC-Write diskette.

Register only if you decide to use it. No risk!

Byte Magazine
Dec 1986



New Version 2.7

50,000 word Spelling Checker, resident Screen Clip, space to tab conversion and back again, time and date insert macros, plus much more.

Order PC-Write Today.
Satisfaction Guaranteed.

Quicksort™

(206) 282-0452

219 First N. #224y
Seattle, WA 98109



LOOKING FOR "NET" RESULTS?

EARTH COMPUTERS
has the
solution
to your
Networking
problems.



EARTHNET-PC.™

EARTHNET-PC is the most flexible networking card on the market. It has been designed for high performance and maximum functionality.

EARTHNET-PC is fully compatible with SMC networking cards and runs popular networking software such as NOVELL's NETWARE, ViaNet, and TurboDOS, all of which support the new LAN Standard and DOS 3.1 record locking.

EARTHNET-PC's 5-1/2 inch card fits in any short slot of an IBM-PC/XT or compatible system and uses advanced Token-Passing technology. Data transfers are made at 2.5 Megabytes per second.

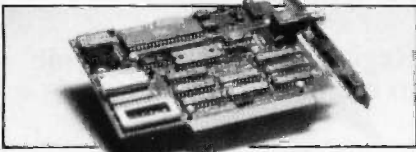

YOU CAN STOP SEARCHING...**EARTHNET-PC** IS THE SOLUTION TO YOUR NETWORKING PROBLEMS! Order your **EARTHNET-PC** today! Call **EARTH COMPUTERS**, the company that's setting the standard for LAN standards.

ATTENTION DEALERS! If you've been searching for ways to increase your Networking profits, call **EARTH COMPUTERS** and find out about our attractive, profit-generating dealer program.

EARTHNET-PC is a trademark of **EARTH COMPUTERS**
NETWARE is a trademark of Novell
ViaNet is a trademark of Vianetix, Inc.
TurboDOS is a trademark of Software 2000
IBM-PC/XT is a trademark of International Business Machines, Inc.



EARTH COMPUTERS

P.O. Box 8067, Fountain Valley, CA 92728
TELEX: 910 997 6120 EARTH FV

(714) 964-5784

Ask about **EARTH COMPUTERS'** other fine PC and S-100 compatible products.

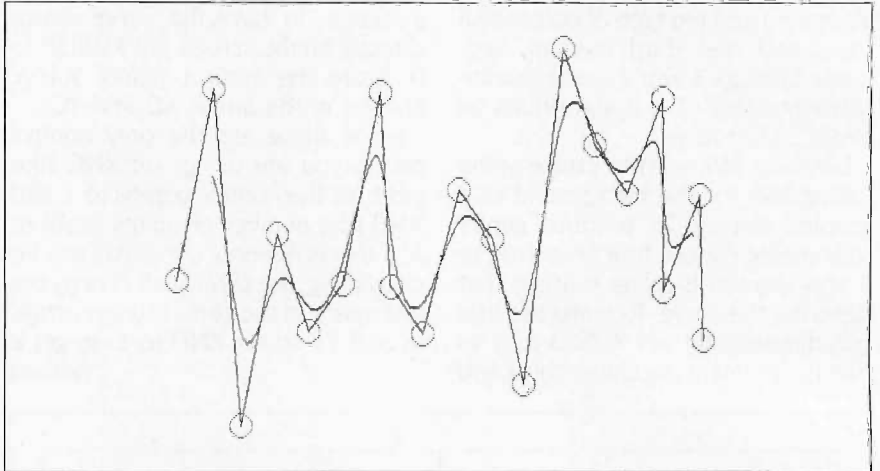

Figure 5: An exact but irregular graph as opposed to a smoother B-spline curve.

Listing 1: The Bézier algorithm.

```
Procedure Bezier
  for each group of four control points do
    for t = 0 to 1 by an increment do
      evaluate the Bezier polynomials x(t),y(t)
        and optionally z(t) (for a 3-D application)
    end
  end
end Bezier.
```

Listing 2: The B-spline algorithm.

```
Procedure B-spline
  for each of the control points do
    for t = 0 to 1 by an increment do
      evaluate the B-spline polynomials x(t),y(t)
        and optionally z(t) (for a 3-D application)
    end
  end
end B-spline.
```

Listing 3: The Bézier subroutine in BASIC.

```
16960 * Bezier2.SUB
16962 * From Fundamentals of Interactive Computer Graphics
16964 *
16966 * Calculates cubic parametric free-form Bezier curves
16968 * XBS23=1 for 3-D else 2-D
16970 * XBZDR=0 if the curve is to be drawn (2-D only)
16972 * XC(),YC(),[ ZC() ] are the hull points (4 per curve)
16974 * XNC is the index of first control point
16976 * XNB is the number of control points to be used
16978 * XNP is the index for the first curve point
16980 * NBS is the step size (default provided)
16982 * QBZ is the color if drawn
16984 * Returns X(),Y(),[ Z() ] as the points
16986 * Returns XNS as the index of the last curve point
16988 *
```

```

16990 IS=XNP:XXS=XNC+XNB-1
16992 IF NBS=0 THEN NBS=.1
16994 IF XBS23 THEN 17016
16996 FOR IIS=XNC TO XXS STEP 4
16998   FOR T=0 TO 1+NBS STEP NBS
17000     T2=T*T:T3=T2*T
17002     NC1=1-3*T+3*T2-T3:NC2=3*T3-6*T2+3*T:NC3
           =3*T2-3*T3:NC4=T3
17004     X(IS)=NC1*XC(IIS)+NC2*XC(IIS+1)+NC3*XC(IIS+2)
           +NC4*XC(IIS+3)
17006     Y(IS)=NC1*YC(IIS)+NC2*YC(IIS+1)+NC3*YC(IIS+2)
           +NC4*YC(IIS+3)
17008     IS=IS+1
17010   NEXT
17012 NEXT
17014 GOTO 17036
17016 FOR IIS=XNC TO XXS STEP 4
17018   FOR T=0 TO 1+NBS STEP NBS
17020     T2=T*T:T3=T2*T
17022     NC1=1-3*T+3*T2-T3:NC2=3*T3-6*T2+3*T:NC3=3*T2
           -3*T3:NC4=T3
17024     X(IS)=NC1*XC(IIS)+NC2*XC(IIS+1)+NC3*XC(IIS+2)
           +NC4*XC(IIS+3)
17026     Y(IS)=NC1*YC(IIS)+NC2*YC(IIS+1)+NC3*YC(IIS+2)
           +NC4*YC(IIS+3)
17028     Z(IS)=NC1*ZC(IIS)+NC2*ZC(IIS+1)+NC3*ZC(IIS+2)
           +NC4*ZC(IIS+3)
17030     IS=IS+1
17032   NEXT
17034 NEXT
17036 XNS=IS-1
17038 IF XBZDR THEN 17048
17040 PSET(X(XNP),Y(XNP)),QBZ      ' Pixel at x,y color QBZ
17042 FOR II=XNP TO XNP+XNS
17044   LINE -(X(II),Y(II)),QBZ    ' Line from last X,Y to
17046   NEXT                       ' X1,Y1 color QBZ
17048 RETURN
    
```

Listing 4: The B-spline subroutine in BASIC.

```

16850 ' BSpline.SUB
16852 ' From Fundamentals of Interactive Computer Graphics
16854 '
16856 ' Calculates cubic parametric free-form splines
16858 ' XBS23=1 for 3-D else 2-D
16860 ' XBSDR=0 if the curve is to be drawn
16862 ' XC(),YC(),[ ZC() ] are the control points
16864 ' XNC is the index of first control point
16866 ' XNB is the number of control points to be used
16868 ' XNP is the index for the first spline point
16870 ' NBS is the step size
16872 ' QBS is the color if drawn
16874 ' Returns X(),Y(),[ Z() ] as the points
16876 ' Returns XNS as the index of the last spline point
16878 '
16880 IS=XNP:XXS=XNC+XNB-3:NSA=1/6:NSB=2/3
16882 IF XBS23 THEN 16904
16884 FOR IIS=XNC+1 TO XXS
16886   FOR T=0 TO 1 STEP NBS
16888     T1=T/2:T2=T*T:T2A=T2/2:T3=T2*T:T3A=T3/2
16890     NC1=-NSA*T3+T2A-T1+NSA:NC2=T3A-T2+NSB:NC3
           =-T3A+T2A+T1+NSA:NC4=NSA*T3
16892     X(IS)=NC1*XC(IIS-1)+NC2*XC(IIS)+NC3*XC(IIS+1)
           +NC4*XC(IIS+2)
16894     Y(IS)=NC1*YC(IIS-1)+NC2*YC(IIS)+NC3*YC(IIS+1)
           +NC4*YC(IIS+2)
    
```

(continued)

Z-NIX

TECHNOLOGY EVERYONE CAN AFFORD!

AT-286 SYSTEM

- 80286 Processor
- 512K RAM on mother board
- Clock/Calendar with battery backup
- Color Graphics Printer Card or Monochrome Graphics Printer Card
- Floppy Disk Controller/ Hard Disk Controller
- 1.2 MB Floppy Disk Drive
- AT Compatible Keyboard
- MS DOS 3.1 included

\$1395

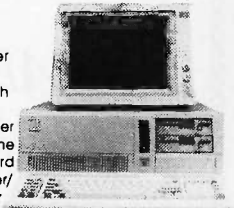

TURBO BAREBONE

- Four-layer Turbo Board with 256K RAM on board
- Four-layer Monochrome Graphics Card with Printer Port
- Four-layer Floppy Disk Controller Card
- One TEAC floppy drive
- 135 Watt Power Supply
- One year warranty (Storage Peripherals not included)
- MS DOS 3.1 optional \$49

\$539

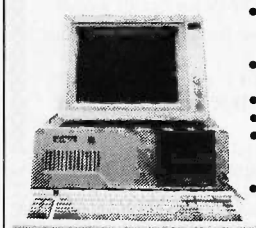

NAKAI MOUSE

- Input speed higher than any devices
- No traditional gridded pad required
- Without using power supply adaptor
- No operating space limit
- Mouse System Mouse Compatible
- Software optional

\$69

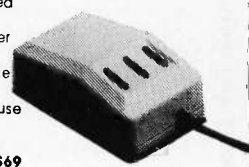

4 LAYER BOARD PERIPHERAL

Mother Board w/256K	\$179
Turbo Board w/256K	\$189
Color Graphic Card	\$ 76
Multi I/O Card	\$103
Monochrome Graphic Printer Card	\$ 84
Disk Controller Card	\$ 39

2LAYER BOARD

Mother Board OK Memory	\$ 89
Turbo Board OK Memory	\$109
Color Graphic Card	\$ 53
Multi I/O Card w/Floppy Controller	\$ 69
Monochrome Graphic Card	\$ 59
Disk Controller Card	\$ 28
EGA Card	\$229
Basic System (Case, KB-5160 KB, 150W P/S)	\$143
TEAC Drive	\$ 95
Fujitsu Drive	\$ 90
ASSEMBLY & TESTING FEE	\$ 35

NAKAI COMPANY, INC.

10527 Humboldt Street,
Los Alamitos, CA 90720

Manufacturer Representative Wanted
Information

(213) 493-2516
To Order Toll Free
1-800-331-6083

**MAKE YOUR PC
SEEM LIKE AN AT!**

**MAKE YOUR AT
SEEM LIKE A
DREAM MACHINE!**

ANSI-tm CONSOLE

The Integrated Console Utility™
**FAST, POWERFUL
ANSISYS REPLACEMENT**

For the IBM-PC, AT, and clones

New Version 2.00 is **MUCH FASTER!**
Now blink free scrolling on CGA!

Now uses EMS/EEMS for Scroll Recall
New Menu Program for Changing Options

**GET A BOX FULL OF UTILITIES!
MAKE LIFE EASIER FOR ONLY \$75!**

- Speed up your screenwriting 2-6x
- Extend your ANSYS to full VT100
- Add many more escape sequences
- Scroll lines back onto screen
- Save scrolled lines into a file
- Add zip to your cursor keys
- Free your eyes from scroll blinking
- Easy installation
- Get a 43 line screen w/EGA
- Get a 50 line screen w/CGA
- No more annoying typeahead beep
- Prevent screen phospher burnin
- Control many programs' use of color
- Generate breakpts from keyboard
- Shorten that annoying bell
- Over 50 other useful options

"The psychological difference is
astounding"
—Lotus June 85 pg 8.

"So many handy functions rolled into
one unobtrusive package"
—PC-World Feb 86 pg 282.

"The support provided by the
publishers is extraordinary"
—Capital PC Monitor May 86 pg 25.

"... the best choice for improving your
console..."
—Capital PC Monitor June 86 pg 26.

460p Manual (w/slip case) & disks \$75.

**Satisfaction Guaranteed!
Order Yours Today!**

HERSEY MICRO CONSULTING
Box 8276, Ann Arbor, MI 48107
(313) 994-3259 VISA/MC/Amex

DEALER INQUIRIES INVITED



FREE-FORM CURVES

```

16896      IS=IS+1
16898      NEXT
16900 NEXT
16902 GOTO 16924
16904 FOR IIS=XNC+1 TO XXS
16906      FOR T=0 TO 1 STEP NBS
16908          T1=.5*T:T2=T*T:T2A=.5*T2:T3=T2*T:T3A=T3/2
16910          NC1=-NSA*T3+T2A-T1+NSA:NC2=T3A-T2+NSB:NC3=-T3A
          +T2A+T1+NSA:NC4=NSA*T3
16912          X(IS)=NC1*XC(IIS-1)+NC2*XC(IIS)+NC3*XC(IIS+1)
          +NC4*XC(IIS+2)
16914          Y(IS)=NC1*YC(IIS-1)+NC2*YC(IIS)+NC3*YC(IIS+1)
          +NC4*YC(IIS+2)
16916          Z(IS)=NC1*ZC(IIS-1)+NC2*ZC(IIS)+NC3*ZC(IIS+1)
          +NC4*ZC(IIS+2)
16918      IS=IS+1
16920      NEXT
16922 NEXT
16924 XNS=IS
16926 IF XBSDR THEN 16936
16928 PSET(X(XNP),Y(XNP)),QBS      * Set pixel, x,y color QBS
16930 FOR II=XNP TO XNP+XNS-1
16932     LINE -(X(II),Y(II)),QBS * Line from last X,Y to
16934     NEXT                       * X1,Y1 color QBS
16936 RETURN
    
```

very smooth curve you'll need a small increment for t , so set NBS to .05. The last variable to set is QBZ (for color), which you can set to 2. The subroutine is now initialized and can be called by the main program.

I've also written a curve-fitting practice program, called CURVTEST.BAS, that allows you to choose control points on your computer display with a cross-hair cursor. The program then uses either BEZIER.SUB or BSPLINE.SUB to calculate and draw the curve on the screen, letting you compare the Bézier and B-spline curves. The program will give you the feel of how placement of the control points determines the shape of the curve. The program and the subroutines are written in Microsoft BASIC for the Texas Instruments Professional Computer. To work with another computer or language, you will probably have to add a graphics screen initialization routine and so forth. [Editor's note: CURVTEST.BAS, which includes listings 3 and 4, is available on disk, in print, and on BIX; see the insert card following page 320. It is also available on BYTEnet; see page 4.]

THE TRADE-OFFS

As opposed to calculating the points on a straight line, curves take a relatively long time to calculate. The

points on a simple line can be calculated with only a few adds and compares, without any floating-point arithmetic. At best, using mathematical techniques that have been ignored here, the calculation of any free-from curve of this type involves many floating-point multiplications. The most effective use of Bézier and B-spline curves involves interaction and several calculations of the same curve, and using a personal computer, you'll have to be patient.

You can use several methods to speed things up. If you are interactively designing and require a particular curve, set the increment for t to a larger value for the initial curves. When you are fine-tuning the curve, the increment can be reset to a smaller value, for a smoother curve. An assembly language implementation that made use of a numeric co-processor would squeeze more performance from a small computer. ■

BIBLIOGRAPHY

- Foley, James D., and Andries Van Dam. *Fundamentals of Interactive Computer Graphics*. Reading, MA: Addison-Wesley, 1982.
- Goloi, W. K. *Interactive Computer Graphics Data Structures, Algorithms, Languages*. Englewood Cliffs, NJ: Prentice-Hall, 1978.
- Pavlidis, Theo. *Algorithms for Graphics and Image Processing*. Rockville, MD: Computer Science Press, 1982.

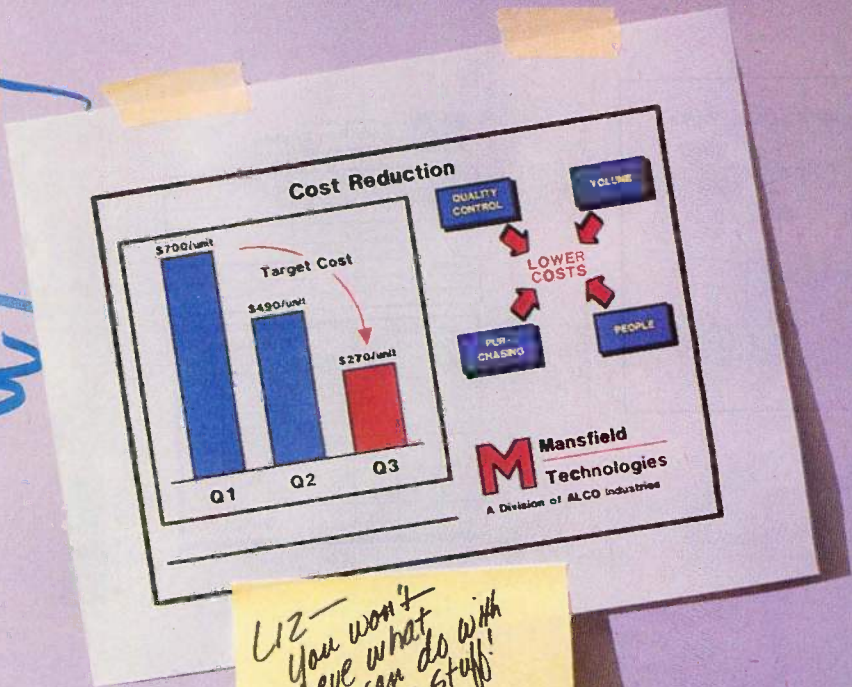

LIZ - You won't believe what you can do with this stuff!

Target Cost

Q1: 700/unit
Q2: 490/unit
Q3: 270/unit

Lotus



The Report Card on Alpha Corporation

- People
- Products
- Recognition
- Distribution
- Growth
- Profits

Customer Service Dept.
 Metro Manufacturing Group, Inc.
 2501 W. Shawmut Blvd.
 Chicago, IL 60649

Bulletin for March/April 1986

New Phone System

After getting the new system installed, we will be receiving a major benefit in the way we handle our growing number of phone calls. This is due to the fact that our new system will allow us to handle more calls at the same time. This means that our customers will receive faster service and we will be able to handle more business.

New Supervisor

A new supervisor will be starting work in our office. This person will be responsible for the supervision of the staff. This person will be responsible for the supervision of the staff. This person will be responsible for the supervision of the staff.

Good Work!

For the month of March and April, we have received a lot of compliments on the way we have handled our business. We are proud of the way we have handled our business. We are proud of the way we have handled our business.

SAMPLE KEYBOARD

FUNCTION KEYS

TYPEWRITER KEYBOARD

TRAINING GUIDE, Figure 2

One Program
 charts, symbols
 diagrams, etc., etc.

*Overheads
 + Slides, too.*

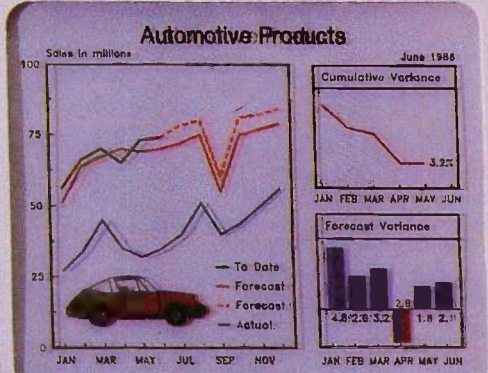



Pollock

Reviews

REVIEWER'S NOTEBOOK	
<i>by Jon Edwards</i>	237
FOUR IBM PC AT CLONES	
<i>by Wayne Rash Jr.</i>	239
THE HERCULES GRAPHICS CARD PLUS	
<i>by Rich Malloy</i>	249
23 MODEMS	
<i>by Stephen Satchell</i>	255
PASCAL FOR THE IBM PC	
<i>by Namir Clement Shamma</i>	265
STELLA	
<i>by Stephen B. Robinson</i>	277
FLASH-COM	
<i>by Brock N. Meeks</i>	281
REVIEW FEEDBACK	285

WAYNE RASH JR. has reviewed four IBM PC AT clones: the Epson Equity III, the Western AT, and the Zenith Z-241 and Z-248. All are fast and relatively easy to use, but Wayne shows that the differences are important and well worth considering.

Rich Malloy examines the Hercules Graphics Card Plus, which may set a new standard for monochrome graphics. Its enhanced text graphics will allow you to use alternative character sets far more easily than before. The board also enhances the performance of a number of applications including Lotus 1-2-3 and Microsoft Word.

Stephen Satchell has compared 23 modems. The evaluation tests were extensive; the results are fascinating. The AT&T Model 4024 and the Ven-Tel 2400 Plus fared well, although many of these modems can well serve your needs. Stephen welcomes your comments on his testing methods.

Namir Clement Shamma surveys four Pascal implementations for IBM PC compatibles: Microsoft's MS-Pascal, Pecan Software Systems' UCSD Pascal, Pro Pascal from Prospero Software, and MetaWare's Professional Pascal. The comparative tables also bring in the results from Mark Bridger's February review of Turbo Pascal 3.0. As you might expect, there is a tremendous range in terms of price and performance. Perhaps of these compilers will meet your exact needs.

This month we present two applications software reviews. Stephen B. Robinson examines STELLA, an unusual application that provides what some might call a graphic spreadsheet. This modeling and simulation program allows you to build structural diagrams. With it you can gain tremendous insight into how organizations function and how various subsystems act and interact.

Finally, Brock N. Meeks reviews Flash-Com, an electronic mail and communications software system. The software is powerful and its uses are diverse, but Brock reveals that the application is not without its troubles.

MICRO CAP and MICRO LOGIC put your engineers on line... not in line.



MY OWN WORKSTATION

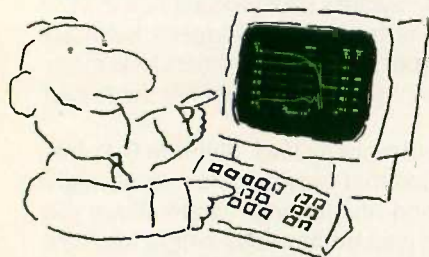

How many long unproductive hours have you spent "in line" for your simulation? Well, no more. MICROCAP and MICROLOGIC can put you on line by turning your PC into a productive and cost-effective engineering workstation.

Both of these sophisticated engineering tools provide you with quick and efficient solutions to your simulation problems. And here's how.

MICROCAP: Your Analog Solution

MICROCAP is an interactive analog circuit drawing and simulation system. It allows you to sketch a circuit diagram right on the CRT screen, then run an AC, DC, or Transient analysis. While providing you with libraries for defined models of bipolar and MOS devices, Opamps, transformers, diodes, and much more, MICROCAP also includes features not even found in SPICE.

MICROCAP II lets you be even more productive. As an advanced version, it employs sparse matrix techniques for faster simulation speed and larger net-

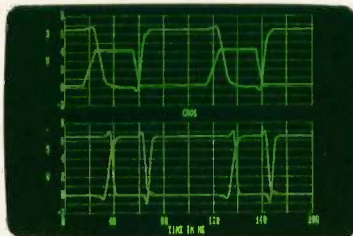

"Typical MICROCAP Transient Analysis"

works. In addition, you get even more advanced device models, worst case capabilities, temperature stepping, Fourier analysis, and macro capability.

MICROLOGIC: Your Digital Solution

MICROLOGIC provides you with a similar interactive drawing and analysis environment for digital work. Using standard PC hardware, you can create logic diagrams of up to 9 pages with each containing up to 200 gates. The system automatically creates the netlist required for a timing simulation and will handle networks of up to 1800 gates. It provides you with libraries for 36 user-defined basic gate types, 36 data channels of 256 bits each, 10 user-defined clock waveforms, and up to 50 macros in each network. MICROLOGIC produces high-resolution timing diagrams showing selected waveforms and associated delays, glitches, and spikes—just like the real thing.

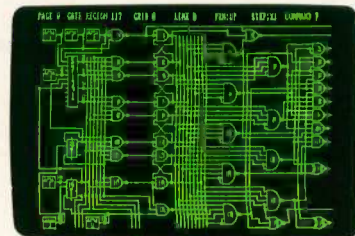

"Typical MICROLOGIC Diagram"

Reviewers Love These Solutions

Regarding MICROCAP... "A highly recommended analog design program" (PC Tech Journal 3/84). "A valuable tool for circuit designers" (Personal Software Magazine 11/83).

Regarding MICROLOGIC... "An efficient design system that does what it is supposed to do at a reasonable price" (Byte 4/84).

MICROCAP and MICROLOGIC are available for the Apple II (64k), IBM PC (128k), and HP-150 computers and priced at \$475 and \$450 respectively. Demo versions are available for \$75.

MICROCAP II is available for the Macintosh, IBM PC (256k), and HP-150 systems and is priced at \$895. Demo versions are available for \$100.

Demo prices are credited to the purchase price of the actual system.

Now, to get on line, call or write today!

Spectrum Software

1021 S. Wolfe Road, Dept. B
Sunnyvale, CA 94087
(408) 738-4387

Inquiry 340

R·E·V·I·E·W·E·R'S N·O·T·E·B·O·O·K

IBM's new PC XT 286 certainly caused its share of excitement here. It was immediately obvious that the case is too small to accommodate conventional IBM PC AT expansion boards, and it appears to be more difficult than usual to install an 8087 co-processor, owing to the location of the socket. At least one company will benefit from the size of the XT 286's case, however. Trade Ventures (512A Herndon Parkway, Herndon, VA 22070, (703) 435-3800) claims to have the only EMS memory board that will fit in the XT 286. [Editor's note: At least two other manufacturers have just released EMS boards for the XT 286. CSS Laboratories ((714) 540-4141) has TurboRAM, and Boca Research ((305) 997-6227) has BOCARAM.]

The benchmarks all ran quickly. The Calculations test took 21 seconds; the Sieve took 60. The Disk Write and Read tests took 25 and 26 seconds, respectively. The keyboard is IBM's new standard; it will take some getting used to.

I always enjoy looking at ways to enhance my working environment. This month I tried RapidWriter from Quixote (One East Wacker Dr., Chicago, IL 60601, (312) 467-6755). This special keyboard/software combination for IBM PC compatibles allows you to input commonly used words, phrases, and sentences by typing "chords" on the special keyboard. After loading in the sample dictionary, for example, you can press the *s* and *y* keys simultaneously to get the phrase *sincerely yours*.

In addition, you can create nested chords in which you can enter new text in the middle of a predefined macro. Pressing the Shift key with a chord will capitalize the first letter of the definition. Pressing Caps Lock will capitalize all the characters in the definition. Dictionaries can store up

to 250 chords, with up to 16,000 characters of text per chord.

It is fairly easy to define new chords. I also found it comfortable to type chords, and the product worked with all the nonresident applications I tried. Unfortunately, RapidWriter is incompatible with Borland's SuperKey and SideKick, and Revolution Software's Cruise Control would not function with it, either. You may find the only other disadvantage to be the keyboard itself, which is slightly non-standard. The function keys are located across the top, and the Alt, Ctrl, and backslash keys are only a few that are in nonstandard locations.

Another tool is Word for Word (formerly Mirrors/PC) by Mastersoft (4621 North 16th St., Suite A-108, Phoenix, AZ 85016, (602) 277-0900), a utility for IBM PC compatibles that allows you to convert files from one format to another without requiring much cleanup. Version 1.0 supports WordStar 3.30 and 3.31, WordPerfect 3.0 and 4.1, Volkswriter, PFS:Write version C, MultiMate 3.3, IBM Writing Assistant, and straight ASCII. Word for Word reports all items that do not convert to the target format.

Two new products tap the color graphics capabilities of the Amiga and the Atari STs. We were obviously impressed by Aegis Animator (see the review in the November BYTE) by Aegis Development (2210 Wilshire Blvd. #277, Santa Monica, CA 90403, (213) 392-6445), and I am much more impressed now that it has introduced the Aegis Art Pak, a series of utilities that, when used in conjunction with Aegis Animator, will allow you to create desktop videos much more easily.

The Art Pak contains a variety of backgrounds and objects, all created with the same color palette to facilitate your cutting and pasting. Aegis

Development also supplies a player that allows you to distribute your videos with no copyright infringements. Even if you don't plan to get an Amiga, it is worth going out of your way to see the Art Pak's introductory video.

For the Atari ST, Activision (P.O. Box 7287, Mountain View, CA 94039, (800) 633-4263) has released Audio Light Incorporated's Paintworks, an elaborate paint program. The user interface is effective, and the program has three individual drawing screens. With them, you can cut and paste more effectively or expand the scope of your painting. There are over 70 features, including three levels of magnification, fine *x,y* coordinate control, and color-cycling animation. You can also incorporate music created with Activision's Music Studio for elaborate slide presentations. Unlike many of the other similar applications for the ST, you can create Paintworks pictures in all three ST modes. Files are compatible with both DEGAS and NEOchrome.

Last month I promised to report on WildFire from Software Wizardry (1106 First Capitol Dr., St. Charles, MO 63301, (314) 946-1968). WildFire is a speed kit for the Zenith Z-151/152/-161. Stan Wszola and I installed the new chip set in my Zenith Z-151. The installation procedure was very simple, but we were unable to get the computer to boot. We were disappointed, particularly because Zenith users on BIX have reported excellent results. I suspect that the problem has to do with the dated BIOS on my Zenith. I'll discuss this problem in more detail in the future.

Next month I plan to report on Fall COMDEX, the largest show of the year.

—Jon Edwards
Senior Technical Editor, Reviews

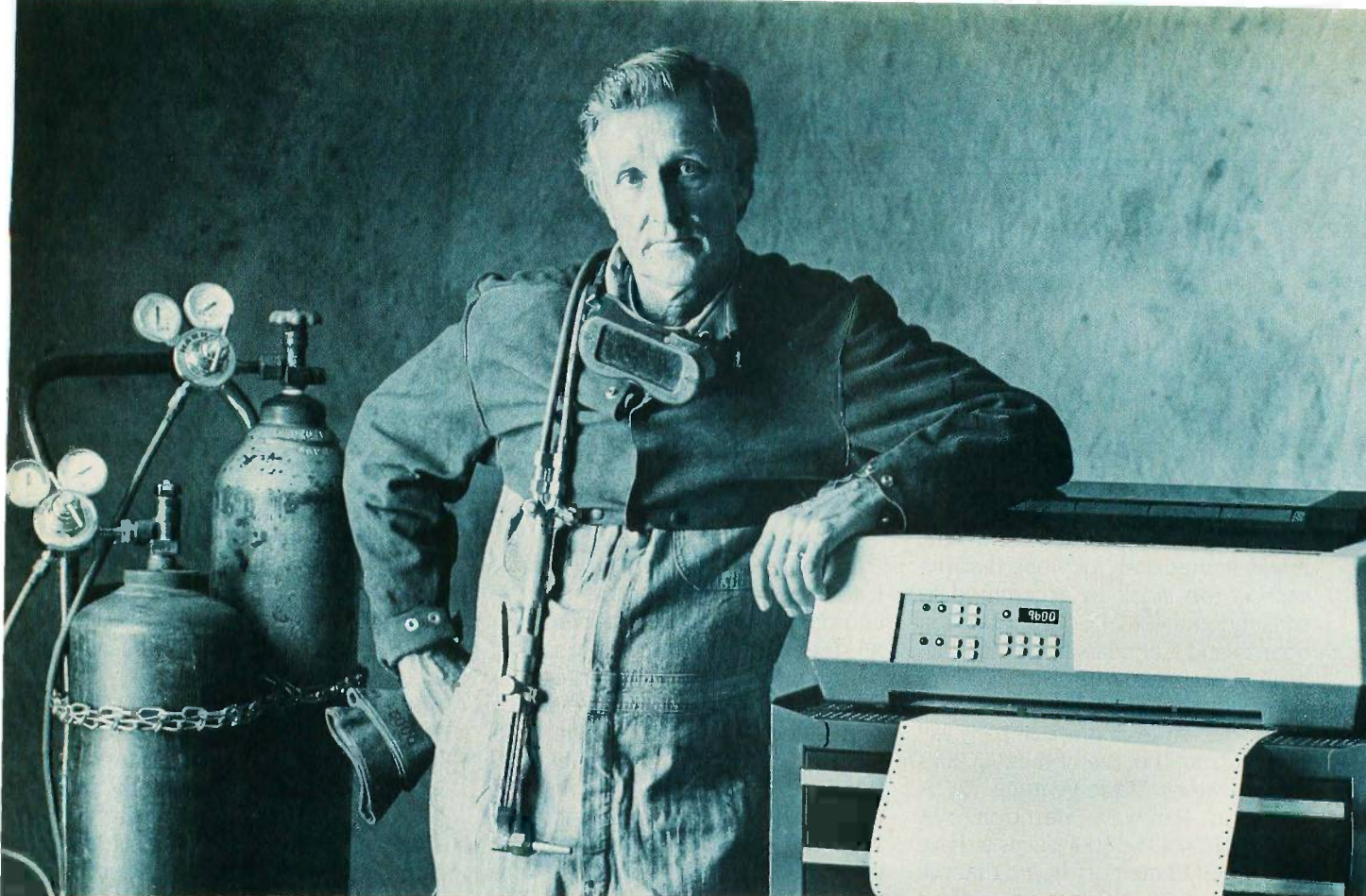

INDUSTRIAL STRENGTH.

The Datasouth High Performance Matrix Printers.

Tough customers demand tough printers. The kinds of printers that go where the work is, and get the job done. Printers built to work three shifts a day—all week, all month, all year—and never take vacations. Printers so solid and durable you'd think they were drop-

forged. Printers like the Datasouth DS 180 and DS 220.

That kind of industrial-strength performance comes from knowing what a tough customer needs: rugged medium-speed printers that combine outstanding performance with the strength to pound

out multipart forms up to 6 layers thick. Printers that put all the controls right on the front panel, so they're easy to use. And printers that offer a choice between a 180 cps draft mode printer, and a 220 cps multimode that produces Near Letter Quality text at 45 cps.

And at Datasouth we practice what we preach. The DS 180 and DS 220 work side-by-side with the hard-working people who build them right here in our Charlotte, North Carolina plant.

Put an industrial-strength printer to work for you. To find your nearest Datasouth distributor, call us at 1-800-222-4528.



Datasouth
AMERICA'S HIGH PERFORMANCE
PRINTER COMPANY



FOUR IBM PC AT CLONES

BY WAYNE RASH JR.

*These machines
offer good value but may also
present problems*

Most IBM PC AT work-alikes promise combinations of greater speed, more functionality, and lower price than the PC AT. With these claims in mind, I evaluated four PC AT clones: the Epson Equity III, the Western AT, and the Zenith Z-241 and Z-248. [Editor's note: The photo does not show the Z-248, which is identical in appearance to the Z-241. For the original IBM PC AT review by Alan Finger, see the May 1985 BYTE.]

I tested the computers with a variety of IBM PC business software and other software commonly used to test compatibility. I also tried each unit with a variety of multi-function boards and peripherals. The systems that I reviewed were all off-the-shelf models—they were identical to what a purchaser would receive. BYTE did, however, request that each manufacturer install a video board, even if one is not normally included.

THE ZENITHS

Both of the Zenith Z-240 series computers that I reviewed follow the Zenith practice of not having a motherboard. The entire computer exists on plug-in boards that attach to a system bus. The Z-241 and the Z-248 both include a serial and parallel port as standard equipment. The enhanced versions, which I tested, also have a 20-megabyte hard disk drive, a 1.2-megabyte high-capacity floppy disk drive, and 512K bytes of RAM. Zenith's version of MS-DOS 3.1 was included with each machine.

The Z-248 comes with an enhanced graphics adapter card and Microsoft Windows. The EGA card will support

special high-resolution monitors in addition to standard color graphics and monochrome monitors.

Both Zenith machines are notable for their speed. The Z-241 runs at 6 MHz, and the Z-248 runs at 8 MHz. Unlike the other two PC AT clones that I reviewed, neither machine has a wait state added to slow its operation. A wait state is a period of time during which the computer waits before it executes another instruction. This slows the computer down to allow the use of slower, less expensive peripherals such as memory boards.

The absence of wait states means that the 6-MHz Z-241 carries out operations at about the same speed as most 8-MHz machines, while the Z-248 is much faster than most other 8-MHz machines. You can anticipate

the computing time of the Z-248 to be about half that of the IBM PC AT.

The extra speed also means that some peripherals may not work unless you slow the Zenith machines down. The expensive but fast Cheetah multifunction and memory cards were the only ones I found that were guaranteed to keep up with the Z-248.

EPSON EQUITY III

The Epson Equity III is a dual-speed machine. A high/low switch lets you select 6-MHz operation for maximum compatibility with peripherals and software or 8 MHz for maximum computing speed. To change the microprocessor speed you turn the system off, flick the high/low switch, and turn the computer on again.

In other respects, Epson has designed this computer along traditional lines. The motherboard resembles the one on the IBM PC AT and has the same number of expansion slots.

Two areas in the construction of the Equity III concerned me. One is the power supply cable, which exits from the supply itself through the unprotected edge of the sheet-metal power supply shield. Although the cable has an extra layer of insulation, it does not have the heavy grommet of the other systems' power supplies.

The other area of concern is that

(continued)

Wayne Rash Jr. is a member of the professional staff of American Management Systems Inc. (1777 North Kent St., Arlington, VA 22209), where he consults with the federal government on microcomputers.



REVIEW: FOUR IBM PC AT CLONES

Epson Equity III

Company

Epson America Inc.
OEM Division
23600 Telo St.
Torrance, CA 90505
(800) 421-5426

Size

6½ by 21½ by 17 inches

Components

Processor: Intel 80286, switchable between 6 and 8 MHz

Memory: 640K bytes, expandable to 16 megabytes

Mass storage: One half-height 1.2-megabyte 5¼-inch floppy disk drive or one 360K-byte floppy disk drive and one 20-megabyte hard disk

Display: 12-inch amber or green monochrome or EGA or RGB color; 80 characters by 25 lines

Keyboard: 84 keys; 10 function keys; indicator lights on Caps Lock, Scroll Lock, and Num Lock keys

Expansion: Eight slots; three IBM PC-compatible

Communications: One serial and one parallel port

Software

MS-DOS 3.2; GW-BASIC

Documentation

User's guide; MS-DOS operator's guide; GW-BASIC manual

Price

With one floppy disk drive:	\$2495
With one floppy disk drive and hard disk:	\$3195
Color monitor:	\$549
Monochrome monitor:	\$149

Western AT

Company

Western Computer
1381 Warner Ave.
Warner Corporate Park, Suite B
Tustin, CA 92680
(714) 553-1611

Size

6½ by 21¼ by 16½ inches

Components

Processor: Intel 80286, switchable between 6 and 8 MHz

Memory: 2 megabytes, expandable to 16 megabytes

Mass storage: One half-height 1.2-megabyte 5¼-inch floppy disk drive or one 360K-byte floppy disk drive and one 30-megabyte hard disk

Display: 12-inch amber or green monochrome or EGA or RGB color; 80 characters by 25 lines

Keyboard: 84 keys; 10 function keys; indicator lights for Caps Lock, Scroll Lock, and Num Lock keys

Expansion: Eight slots; three IBM PC-compatible

Communications: One parallel port

Software

None

Documentation

User's and service manual

Price

\$2395

Zenith Z-241

Company

Zenith Data Systems
1000 Milwaukee Ave.
Glenview, IL 60025
(312) 699-4800

Size

6½ by 21 by 16¾ inches

Components

Processor: 6-MHz Intel 80286

Memory: 512K bytes, expandable to 16 megabytes

Mass storage: One half-height 1.2-megabyte 5¼-inch floppy disk drive or one 360K-byte floppy disk drive and one 20-megabyte hard disk

Display: 12-inch amber or green monochrome or EGA or RGB color; 80 characters by 25 lines

Keyboard: 84 keys; 10 function keys; indicator lights on Caps Lock, Scroll Lock, and Num Lock keys

Expansion: Ten slots; three IBM PC-compatible, four Zenith-compatible (expanded PC AT), and three PC AT-compatible

Communications: One serial and one parallel port

Software

MS-DOS 3.11

Documentation

Owner's manual; MS-DOS manual

Price

With one floppy disk drive:	\$3499
With one floppy disk drive and hard disk:	\$4499

REVIEW: FOUR IBM PC AT CLONES

SYSTEM FEATURES

Zenith Z-248

Company

Zenith Data Systems
1000 Milwaukee Ave.
Glenview, IL 60025
(312) 699-4800

Size

6½ by 21 by 16¾ inches

Components

Processor: 8-MHz Intel 80286

Memory: 512K bytes, expandable to 16 megabytes

Mass storage: One half-height 1.2-megabyte 5¼-inch floppy disk drive or one 360K-byte floppy disk drive and one 20-megabyte hard disk

Display: 12-inch amber or green monochrome or EGA or RGB color; 80 characters by 25 lines

Keyboard: 84 keys; 10 function keys; indicator lights on Caps Lock, Scroll Lock, and Num Lock keys

Expansion: Ten slots; three IBM PC-compatible, four Zenith-compatible (expanded PC AT), and three PC AT-compatible

Communications: One serial and one parallel port

Software

MS-DOS 3.11; GW-BASIC; Microsoft Windows

Documentation

Owner's manual; MS-DOS manual; GW-BASIC operator's guide; Microsoft Windows user's guide; Microsoft Windows user's guide

Price

With one floppy disk drive:	\$2999
With one floppy disk drive and one 20-megabyte hard disk:	\$4399
With one floppy disk drive and one 42-megabyte hard disk:	\$5699

MEMORY SIZE (K BYTES)



HARD DISK STORAGE (M BYTES)

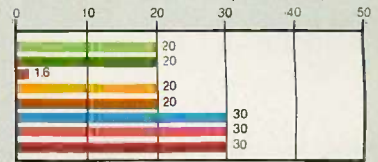

DISK ACCESS IN BASIC (IN SECONDS)

WRITE

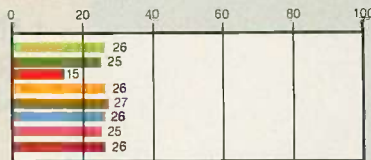

READ

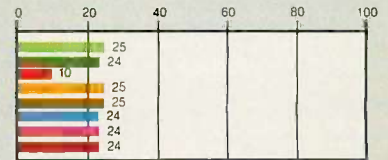

BASIC PERFORMANCE (IN SECONDS)

SIEVE

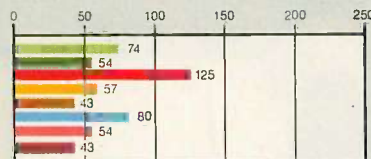

CALCULATIONS

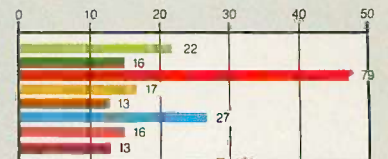

SYSTEM UTILITIES (IN SECONDS)

40K FORMAT/DISK COPY



40K FILE COPY

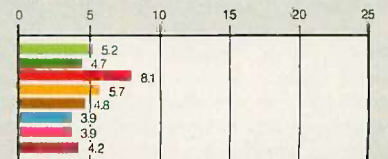

SPREADSHEET (IN SECONDS)

LOAD

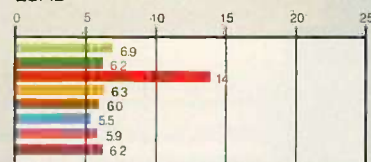

RECALCULATE



■ EPSON EQUITY III (6 MHz) ■ EPSON EQUITY III (8 MHz) ■ MAC PLUS
■ ZENITH Z-241 ■ ZENITH Z-248 ■ IBM AT
■ WESTERN AT (6 MHz) ■ WESTERN AT (8 MHz)

The Memory Size graph shows the standard and optional memory available for the computers under comparison. The Disk Storage graph shows the capacity of the hard disk available with each system. The graphs for Disk Access in BASIC show how long it takes to write and then read a 64K-byte sequential text file to a blank floppy disk. (For the program listings, see *BYTE's Inside the IBM PCs*, Fall 1985, page 195.) The Sieve graph shows how long it takes to run one iteration of the Sieve of Eratosthenes prime-number benchmark. The Calculations graph shows how long it takes to do 10,000 multiplica-

tion and 10,000 division operations using single-precision numbers. The System Utilities graphs show how long it takes to copy a 40K-byte file using the MS-DOS COPY command. The Format/Disk Copy test was omitted since all four systems were single floppy disk systems. The Spreadsheet graphs show how long it takes to load and recalculate a 25- by 25-cell spreadsheet in which each cell equals 1.001 times the cell to its left. The spreadsheet used was Microsoft's Multiplan. All BASIC benchmark programs were run using GW-BASIC.

OMNI-READER™

NOW YOUR COMPUTER CAN READ.
A REVOLUTION IN TAKING WORDS FROM
PAGE TO COMPUTER.

PC MAGAZINE
PRODUCT OF '85

WORD PROCESSOR AND COMPUTER COMPATIBILITY.

The OMNI-READER can read text into most word processors, micro and personal computers. It attaches through a Serial RS232C interface as easily as a modem.

The OMNI-READER is a revolutionary new text reader. It reads the printed word and translates it into an electronic signal capable of being recognized and loaded into most computers and word processors. The need for slow and tedious retyping of already printed data is eliminated.

TYPEFACE QUALITY.

OMNI-READER has the ability to read letter quality text that has been printed on a letter quality printer or type writer in one of the four following typefaces.

TYPEFACE RECOGNITION.

The OMNI-READER can read four of the most commonly used typefaces: Courier 10, Courier 12, Letter Gothic and Prestige Elite.

MANUAL OPERATION.

Alpha or numeric print is scanned line by line by moving the reading head along the text. Capable of scanning both forwards and backwards, the reading head can be used to input all or selected portions of text.

GUIDE RULE. (pat. applied for)

A specially engineered guide rule makes it easy to align text. Because of the unique clock track, the reading head can be moved at variable speed and still read text. Scan time 2-3 seconds a line.

Each OMNI-READER comes with I.B.M. PC/Compatible or Apple Macintosh software - at no extra charge. Interface Cable available for \$16.⁰⁰ extra. Specify I.B.M. or Macintosh.

30 Day UNCONDITIONAL Replacement
Warranty.

TO ORDER PLEASE CALL
TOLL FREE 1-800-523-4898
IN TEXAS 1-800-722-6013
TECH. ASST. 817-589-0313

Accepting major credit cards - C.O.D.:
Visa, Master Card, and American
Express or send money order or check to:

G.A.S. INTERNATIONAL, INC
P.O. BOX 1282, EULESS, TEXAS 76040

Inquiry 406

WAS \$799
NOW \$199*

*** LIMITED TIME ONLY**
FREIGHT PREPAID ANYWHERE
IN THE CONTINENTAL U.S.A.



most of the integrated circuits, including the memory chips, are soldered onto the motherboard. While this method reduces the original cost of the unit, it increases the cost of replacing an integrated circuit. IC sockets are preferable.

WESTERN AT

Like the Epson Equity III, the Western AT is a dual-speed machine. A toggle switch on the back of the case allows you to set the speed for 6 or 8 MHz while the computer is turned off.

The Western AT that I reviewed was equipped with a 30-megabyte hard disk—the largest of the four. Like the Equity III, the Western AT has eight expansion slots. The Western AT is supplied with 2 megabytes of memory, also the largest in this group.

Two points about the Western AT concerned me during the course of the review. The first is the front-panel lock, which locks the case and the keyboard. This lock seemed to be of low quality, and it moved in its mounting when the key was turned.

The second item of concern is the video card that was supplied with my review machine. Although this card is an option, it should still work properly. The card is said to emulate the Hercules card and to provide graphics capability on a monochrome monitor. It is supplied with a special version of BASIC for this purpose. I could not get this version of BASIC to work at all, nor could I get the machine to display graphics using GW-BASIC graphics commands.

SETTING UP

IBM PC AT-compatible computers generally require a more involved setup routine than do earlier microcomputers. This is because of a wider selection of equipment configurations, disk drives, memory, and the like. As a result, you have to know more about your computer than before to get things started.

Normally you have to know the technical details of the hard disk such as the size of the drive and the number of sides to perform an initial formatting. This information is not always readily available. Once you get the information you need, you run a

setup program that stores it in a battery-powered section of memory in which the clock and calendar information is also stored.

With the two Zenith computers I reviewed, the low-level format was already done and the proper parameters were recorded in the section of memory reserved for the setup information. A setup program is contained in the Zenith machines' extensive

ROM diagnostics, eliminating the need to run the setup program from disk.

Setup is a little more involved on the Equity III than on the Zenith machines. You must run the disk-based setup routine before you can prepare the hard disk. Fortunately, Epson's instructions are clear and the appropriate choices for most users are in-

(continued)

Write Right with RightWriter[™]
 For Your IBM PC
THE Intelligent Grammar and Style Checker

RightWriter is a new tool to help you produce lean, powerful BUSINESS WRITING. RightWriter uses advanced artificial intelligence technology to flag errors in GRAMMAR, STYLE, USAGE, and PUNCTUATION. RightWriter is the first office automation package aimed at producing better writing, not more writing.

- **Messages are Inserted** — directly into text to point out possible errors and problem areas.
- **Easy to Use** — only one command to learn, your word processor does the rest.
- **Works with Leading Word Processors** — including WordStar[®], Volkswriter[®], PFS:write[®], MultiMate[®], WordPerfect[®] and others.
- **Readability Index** — measures the reading grade level of the document using the D.O.D. standard Flesch-Kincaid formula.
- **Uncommon Word List** — lists misspelled, slang, and uncommon words.
- **Recommends** — never decides. RightWriter is a writing aid. The final decision is always left to you.

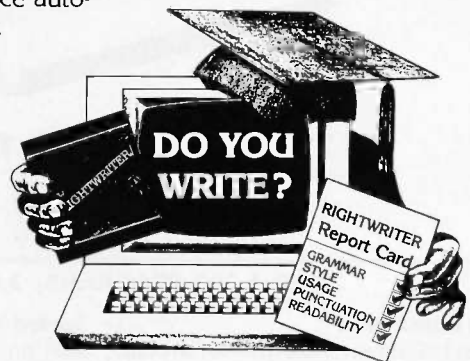

"... RightWriter is an idea whose time is long overdue."
 Phil Wiswell — PC Magazine

"RightWriter is an excellent, low-cost, eye-opening software package..."
 Inside Word Management

"The documentation is among the best I have seen."
 Jim Pile, Soft Sector

Price \$95.00

Available from your local dealer or:
 DECISIONWARE, INC./RightSoft Division
 2033 Wood St. • Suite 218
 Sarasota, FL 33577
Phone Orders Call: 1 (800) 992-0244
 Add \$4 for shipping and handling.
 VISA & MASTERCARD accepted
30 Day Money Back Guarantee

RightWriter is a trademark of DecisionWare, Inc., WordStar is a trademark of MicroPro International Corporation, MultiMate is a trademark of MultiMate International, PFS:write is a trademark of Software Publishing Corporation, Volkswriter is a trademark of Lifetree Software, Inc.

licated. Once you have run the setup program, you can proceed to run the low-level format program. This takes about 20 minutes.

The Western AT, by contrast, should not be set up by the faint of heart. You can change the configuration of this system only by running DEBUG and loading an address from ROM. Other setup steps depend on the details of the version of MS-DOS you purchase.

The operating system is not included with the Western AT.

USING THE CLONES

All of these machines are a pleasure to use. They run quietly and much more quickly than the IBM PC clones that preceded them. Since any of these machines can be ordered with essentially the same video equipment, about the only individuality is

in the four systems' keyboards.

The Western AT follows the IBM PC AT layout closely, even down to the bezel-mounted LEDs. The Epson Equity III is nearly the same, although the LEDs are located on the keys themselves. The two Zenith keyboards closely resemble those on other Zenith products. The primary difference between any of the keyboards is the location of the Escape key. Epson and Western place this key above the 7 on the keypad; Zenith places it in the more traditional location above the Tab key.

Operating these machines is straightforward. Since they are all equipped with a hard disk, you need only turn them on and they run. The Western AT and the Epson Equity III display the amount of memory present while they perform their memory checks. The two Zenith computers perform the checks, but the screen remains blank.

Once MS-DOS is loaded, you will be told the status of the RAM disk if there is one. Any RAM in excess of the 640K bytes used by MS-DOS can be used as a RAM disk. Since the 80286 microprocessor in the PC AT clones can address up to 16 megabytes of memory, you can have a very large RAM disk. Later versions of MS-DOS are supposed to make all this memory available to programs. The latest version of Concurrent PC DOS already does this.

Most of the popular business-related software will run very nicely on any of these machines. The only types of programs that I encountered problems with were ones that looked specifically for the IBM ROM and ones that were copy-protected. PC Focus, for example, would not work on either of the Zenith machines until the copy-protection scheme was changed.

COMPATIBILITY

All 80286-based computers including the IBM PC AT have some compatibility problems with products developed for the IBM PC and other 8086-based machines. Many programs simply will not run, or they will not run properly. The most notable is one of

(continued)

SYMMETRIC
COMPUTER SYSTEMS

THE 375 - A SOFTWARE DEVELOPER'S DREAM



THE BEAUTY AND THE BSD

\$4,995*

OVER 1,000 PROGRAMS, 3,000 FILES !

<p>Full 4.2BSD UNIX™ Each 375 comes standard with a complete configurable 4.2BSD UNIX system. We don't skimp on software. And we can even give you EMACS, INGRES, TEX and SPICE for those special applications.</p>	<p>Loaded With Languages Turn on your 375 and start developing your own applications. It's that easy. C, FORTRAN, PASCAL, BASIC, APL, Assembler, LISP and PROLOG: they all come standard on every 375.</p>
--------------------------------------------------------------------------------------------------------------------------------------------------------------------------------------------------------------------------------	-----------------------------------------------------------------------------------------------------------------------------------------------------------------------------------------------------------------------

Loaded With Standard Features

<ul style="list-style-type: none"> ★ 50MB Winchester Disc Drive ★ 1MB 5¼" Floppy ★ 2MB RAM (8MB optional) ★ Integral SCSI & ST506 Interfaces 	<ul style="list-style-type: none"> ★ 4 RS232 Ports (up to 36 optional!) ★ Parallel Printer Port ★ External Winchester and Floppy Ports ★ Series 32000, 10MHz, VM, FPU
--------------------------------------------------------------------------------------------------------------------------------------------------------------------------------------------	-----------------------------------------------------------------------------------------------------------------------------------------------------------------------------------------------------------------

Also Available: 10 Mb ETHERNET, up to 280MB disk memory, streaming tape, and more !

A Portable Computer for the Serious User

At last, a powerful, portable (22lbs) scientific computer for all your serious work. The 375 combines the advantages of a VAX™ with the size, versatility, and price of a micro. All the software tools are there. It's even small enough to leave on your desktop or take wherever you need it. **And it's available direct to you right now !**

CALL US TODAY (408) 279-0700

SYMMETRIC COMPUTER SYSTEMS - 1620 Oakland Rd. Suite D200 - San Jose, CA 95131

* Prepaid. Sales tax and Shipping Costs not Included.
UNIX is a registered trademark of AT&T Bell Labs.
VAX is a trademark of Digital Equipment Series 32000 is a trademark of National Semiconductor Corp.

Lycy Computer Marketing & Consultants

PRINTERS ★ PRINTERS

SEIKOSHA		CITIZEN	
SP-1000 A centronics	185	120-D	179
SP-1000 VC (E-64)	765	MSP-10	CALL
SP-1000 IBM	185	MSP-15	CALL
SP-1000 AS RS-232	185	MSP-20	325
SP-1000 AP. AP/IC	185	MSP-25	485
BP-1300	469	Premier 35	449
BP-5200	649	"While they last!"	
BP-5420	999		
Color Kit	119		
BP-5420 ribbon	12.50		
SP-1000 ribbon	8.50		
		LEGEND	
		808	159
		1080	199
		1380	229
		1385	289
SILVER REED			
EXP 420 P	209		
EXP 600 P	489		
EXP 800 P	649		
EXP 770	740		
		PANASONIC	
		1080I	199
		1091I	269
		1092	CALL
		3131	249
		1092	309
		1592	419
		1595	549
		3151	SAVE
BROTHER			
HR-15XL-P	335		
1509	409		



NX-10 219
with purchase of interlace

**LYCO'S WAREHOUSE
PROVIDES YOU
ACCESS TO THE
NATION'S LARGEST
INVENTORY**

Panasonic

1080 I 199

PRINTERS ★ PRINTERS

STAR MICRONICS		OKIDATA	
NX10c	NEW	Okimate 20	199
LV12-10 (New)	175	292	499
NL-10	259	293	599
NX10	219	120 NLO	205
NB15	CALL	182	CALL
SG-15	367	192	348
SD-15	438	193+	549
SR-10	469		
		DIABLO	
JUKI		D25	549
Juki 6100	CALL	P-32 CQ1	699
RS-232 serial board	55	635	1029
6100 tractor	119	D-80 1F	2395
6100 sheet feeder	209		
5510 Juki	CALL		
Juki 6300	CALL		
		EPSON	
		LX86	229
		FX85	369
		DX10	CALL
		EX800	NEW
		EX1000	NEW
		HS80	CALL
		FX286	489
		LQ800	CALL
		LQ1000	CALL
TOSHIBA			
321 P/S	479		
351 sheet feeder	529		
P 341P	669		
P 341S	699		
P 351+	999		

MODEMS HAYES

Micromodem IIe	139
Smartmodem 300	133
Smartmodem 1200	377
Smartmodem 120CB	347
Smartmodem 2400	598

VS ROBOTICS

Password 1200	189
Courier 2400	395

ANCHOR

Volkmodem 12	135
--------------	-----

CHRISTMAS SPECIAL!
ATARI
1040 Mono System
with
Seikoshu SP-1000A Printer
\$975

DISKETTES

MAXELL	5 1/4	3.5
SSDD	9.99	16.99
DSDD	12.99	23.99
BONUS		
SSDD	6.99	—
DSDD	7.50	—
SKC		
SSDD	8.50	14.99
DSDD	9.50	19.99
DSHD 96TP1	19.50	—

THOMPSON

365 12 RGB	Call
Monochrome from	89
Composites from	249
HI RES RGB Available!	

TEKNIKA

MJ-22	249
MJ-305 RGB	309

NEC

Multisync	CALL
-----------	------

COMMODORE

1902 color	289
------------	-----

MONITORS

HITACHI

MM-1218 12" Green	99
MM-1220 12" TTL Amber	129
CM-14000 13" Color w/cable	179
CM-1216 D 12" RGB	385
CM-1455 S 13" 720x350	525
CM-1457 A 13" RGB 720x460	679

ZENITH

ZVM 1220	85
ZVM 1230	85
ZVM 1240	145

PANASONIC

TR-122 MYP 12" Amber TTL	139
TR-122 M9P 12" Green TTL	139

PRINCETON GRAPHICS

MAX-12 Amber	175
HX-12 RGB	458
SR-12 RGB	575

EPYX

World Games	24.75
Winter Games	24.75
Karate Champ	24.75
Rouge	19.75

INFOCOM

Leather Goddess	24.75
Moonmist	24.75
Trinity	24.75

IBM SOFTWARE

BRODERBUND

Bank St Writer	48.95
Print Shop	34.95
Graphics Lib. EA	22.95
Ancient Art of War	22.95
Karateka	22.95
Toyshop	39.95
Print Shop paper	12.95

ACTIVISION

Hacker II	24.95
Music Studio	29.95
Pebble Beach Golf	29.95
Shanghai	24.95

UNISON WORLD

Printmaster	35.95
Art Gallery	24.95

SUBLOGIC

Jet Simulator	34.95
Scenery disks EA	14.95
Set 1-6	69.95

MICROLEAGUE

Baseball	24.75
General Mgr	24.75
Team Disk	14.75
Stat Compiler	18.75

DISK STORAGE

Flip-N-File 10	2.49
Flip-N-File 25 Lock	10.95
Flip-N-File 50 Mini	10.95
Flip-N-File 50 Lock	15.95
Flip-N-File ROM	7.99

TOLL FREE 1-800-233-8760

IN PA 717-494-1030

CUSTOMER SERVICE 717-494-1670

or send to

Lycy Computer
P.O. Box 5088
Jersey Shore, PA
17740

Inquiry 206



HOURS

Mon-Thur 9 AM-8 PM
Fri 9 AM-6 PM
Sat 10 AM-6 PM

Risk Free Policy

In-stock items shipped within 24 hrs of order. No deposit on C.O.D. orders. Free shipping on prepaid cash orders within the continental U.S. Volume discounts available. PA residents add sales tax. APO, FPO and international orders add \$5.00 plus 3% for priority mail. Advertised prices show 4% discount for cash, add 4% for Master Card and VISA. Personal checks require 4 weeks clearance before shipping. We cannot guarantee compatibility. We only ship factory fresh merchandise. Ask about UPS Blue and red label shipping. All merchandise carried under manufacturer's warranty. Return restriction applicable. Return authorization required. All items subject to change without notice.

the favorites of compatibility testing, Microsoft's Flight Simulator. The program would start running, but it would always lock up on all four machines shortly after loading.

Most of the other compatibility problems I encountered had to do with copy protection. A variety of copy-protection schemes seem to have trouble with the faster microprocessor speed of most of the PC AT

clones and with the high-capacity disk drives. However, many of the software companies I spoke with during the course of this review said that their copy-protection schemes will be changed to work with most IBM PC AT-compatible machines.

High-capacity disk drives can also cause disk compatibility problems between PC AT clones and other MS-DOS computers. All the manufac-

turers warn that the 360K-byte disks written by these drives may prove to be illegible to computers using standard double-density drives. The reason for this is the very narrow track created by the head of the high-capacity drive.

Nevertheless, I had no such problems when I created disks with each of these computers and attempted to read them with a variety of double-density drives.

Nearly any circuit board designed to function within an IBM PC AT will work in the clones that run at 6 MHz with one wait state, but faster machines may have problems. For instance, some memory boards will not work with the Zenith Z-241 unless you remove a jumper to make the machine add a wait state to its operations.

The 8-MHz machines had even more problems with speed-sensitive hardware. This was most noticeable in the Zenith Z-248, which requires a very fast board for things to run properly.

DOCUMENTATION

The manuals for these systems range from awful to excellent. The manual for the Western AT was clearly the worst of the lot and is one of the worst system manuals I've seen in some time. On the other hand, the Epson and Zenith manuals are quite good, although they are quite different.

The Western AT manual appears to be photocopied from the manual for another machine. The words *Western AT Turbo* were apparently pasted in prior to the copying process. The photographs are of such poor quality that they are virtually useless. The manual has no index.

Once you get past this unfortunate production quality, you may find some useful information in the Western AT manual. Complete configuration instructions are included as well as items such as a description of the system's memory map, error trapping, and physical arrangement. The manual even provides such rare information as I/O port addresses, timer channels, and interrupts.

Epson includes a nicely written hardware user's guide and MS-DOS

Do You Ever Get the Feeling That No One Speaks Your Language?

Arity/Prolog. The Language That Spans the Generation Gap.



Arity listens to what you ask for. You want a serious, versatile language that will go the distance for you. There are two very good reasons for you to use Prolog—to do your work smarter and faster. That's exactly what the Arity/Prolog development environment will help you do. Our powerful tools, based on the general purpose programming language Prolog, will significantly reduce your development time and allow you to solve a wide range of application problems.

No translation required Our development environment for the IBM PC family and all MS-DOS compatibles includes the Arity/Prolog Compiler and Interpreter, the Arity/Expert System, and Arity/SQL. And you can tie them all together. You can interface with several other programming languages and build extensions to your existing applications. You'll be truly multilingual—what better way to span the generation gap?

It can take you to new places You'll discover amazing speed, power, and flexibility using the Arity/Prolog programming environment, with its one gigabyte of virtual memory and fast, compact compiled code, for conventional applications. And if you're working in new territories, like expert systems or sophisticated database management systems, you'll be speaking the native tongue.

Speak it freely Our products are not copy protected and we charge no royalties, so you can use them in as many end-user applications as you'd like. Why keep the language of solutions all to yourself?

Join the thousands of assembly and C programmers who already use Arity/Prolog—the language of solutions.

Call 1-800-PC-ARITY Today.

Massachusetts residents call 617-371-1243.

Software that roars.

ARITY CORPORATION
30 Domino Drive, Concord, MA 01742 U.S.A.
1-800-722-7489 or in Massachusetts call 617-371-1243

REVIEW: FOUR IBM PC AT CLONES

operator's guide in a single binder along with a manual for GW-BASIC in another binder. The user's guide is clearly written and has excellent line drawings for illustration. The normal choices for factory-installed equipment are indicated, which allows you to make an intelligent selection when setting up the computer.

The Epson MS-DOS guide is an improvement over the standard Microsoft offering that most manufacturers use. Epson has rewritten the explanations and added examples of screens.

Zenith has continued in the company tradition of having the most complete manuals in the business. The hardware owner's manual resembles the Epson manual in the use of drawings and clear explanations. It continues beyond the Epson manual, however, in its descriptions of advanced items such as disk drive and memory installation.

Zenith's MS-DOS manual is easily twice as thick as any other that I've used. This is partially because Zenith adds a number of utility programs to its MS-DOS disks. Most of the increased length is due to the expansion of the description for each command and utility program.

BENCHMARKS

All of these machines are fast (see page 241). All except the Epson Equity III running at 6 MHz were faster than the IBM PC AT by a significant margin. The Zenith Z-248 was nearly twice as fast in computing speed. The difference is due mostly to the higher microprocessor speeds of the four machines. Some of the difference can be assumed to stem from slightly faster hard disk drives. The floppy disk drive benchmark times were about the same as those for the IBM PC AT.

The benchmarks show the importance of wait states in the speed of operation. For example, the Sieve calculation time for the 6-MHz Zenith Z-241 was nearly the same as for the Western AT at 8 MHz. The difference is that the Zenith Z-241 has no wait states while the Western AT has one.

CONCLUSIONS

As is always the case, deciding which of these computers is best for you

Deciding which of these computers is best for you depends greatly on your specific requirements.

depends greatly on your specific requirements. You may have to consider cost as the primary factor. If performance is the primary factor, however, the Zenith Z-248 is the obvious front-runner. This machine is significantly faster than the competition and is well built and well supported.

Of course, all that speed is not without a price. Add-on memory boards will cost more than they otherwise would, and some may not work at all because they cannot keep up with the machine. In addition, the higher speed may prevent some software, notably programs with copy-protection schemes, from working. Selecting the slower Z-241 will overcome some of these speed-related problems.

The Western AT and Epson Equity III, with their choice of speeds, give you the best of both worlds. If you have software that will not operate at 8 MHz, you simply throw a toggle switch and it runs at 6 MHz. This should satisfy the requirements of almost any software. Unfortunately, support for the Western AT in your area may be limited. Support for the Equity III should generally be more widely available. In addition, Epson computers are frequently discounted and should be quite inexpensive. However, the soldered-in memory chips and the power supply construction could present problems.

All of these machines are fast and highly compatible with the IBM PC AT. Based on features and price alone, all of them give more value than the IBM computer that they emulate. Provided the dealer and service arrangements satisfy you, any of them should provide satisfactory use. ■

**ORDER TOLL FREE
24 HOURS EVERY DAY
800-662-2686**

HARDWARE

COMPUTERS

IBM COMPATIBLES 256K Ram, Keyboard, 1 yr. war.
w/1 Floppy. . . 459 Plus 20MB Hard Disk . . . 869

PANASONIC Business & Executive Partners . . . CALL

ATARI ST COMPUTERS . . . CALL

MODEMS, BOARDS, DRIVES

Anchor Lighting 2400 . . . 329	AST Rampage AT . . . 439
Evercom 1200 Internal . . . 129	Flashpak Turbo Board . . . 319
Hayes Modems . . . CALL	SixPakPlus 384K . . . 209
Practical Modem 1200 . . . 135	SixPak Premium 512K . . . 359
Genoa Spectra . . . 319	Intel Above Board PC . . . 225
Genoa Spectrum . . . 199	Above Board PS . . . 289
Hercules Graphics + . . . 189	Above Board AT . . . 355
Mono Graphics Card . . . 89	Tallfree I-Ram 3 . . . 189
Sigma Turbo EGA! . . . 589	3AT . . . 249
STB EGA Plus . . . 289	Practical 1200 Multiboard.269
Taxon 560 EGA . . . 375	Seagate 20MB Kit . . . 399
Teomar EGA Master . . . 285	Seagate 30MB Kit . . . 469
Video 7 Vega Deluxe . . . 399	Seagate ST4026 . . . 499
384K RAM Card . . . 99	Filecard 20MB . . . 609
AST Advantage . . . 339	Hardcard 20MB . . . 679
AST Rampage . . . 239	Drivecard 30MB . . . 839

PRINTERS, PLOTTERS & MONITORS

EPSON-All Models . . . BEST	Houston Inst DMP-29 . . . 1799
LX/FX/EX/LQ . . . PRICES	NEC 1280 TTL Mono . . . 129
Citizen 120D . . . 195	NEC 1401 Multi-Sync . . . 649
Citizen Premiere 35 . . . 499	Samsung TTL . . . 89
Panasonic 1080 I . . . 209	Sony KV1311 RGB/TV . . . 429
Panasonic 1091 I . . . 269	Sony 1302 Multi-Sync . . . 629
Panasonic 1092 . . . 315	Taxon 630/640 . . . 449/519
Panasonic P3131 . . . 265	Taxon 760 EGA . . . 539
Roland DXY-800 Plotter . . . 409	Thompson 36432 RGB . . . 309

SOFTWARE

ACCOUNTING — WORD PROCESSING

BPI Accting/Mod . . . from 309	Volkswriter 3 . . . 149
BPI Enterprise/Mod . . . 429	Microsoft Word 3 . . . 249
Peachtree/Module . . . 259	Word Perfect 4.1 . . . 209
Complete Bus. Acing . . . 159	PFS: First Choice . . . 89
DAC EZ Accounting . . . 42	PFS: Pro Write . . . 115
Open Systems V3/Mod . . . 429	Multimate Advantage . . . 309
	Turbo Lightning . . . 59

DATABASE

dBase III Plus . . . 409	
Clipper . . . 359	
Javelin . . . 459	
Paradox . . . 449	
Powerbase . . . 199	
R Base System V . . . 359	
Reflex . . . 83	
Revelation . . . 529	
PFS: Pro File . . . 145	
Q & A . . . 239	

SPREADSHEETS

Lotus/Symphony . . . CALL
Framework II . . . 419
Supercalc 4 . . . 269
Open Access II . . . 289
Ability . . . 61
Smart SW System . . . 449
Mosaic Twin . . . 57

UTILITIES

Alice Pascal . . . 59
Microsoft C . . . 269
Macro Assembler . . . 90
Quick Basic . . . 60
Turbo Pascal Ver 3 . . . 59
Turbo Prolog . . . 59
Desquiew . . . 59
Windows . . . 60
Carbon Copy . . . 117
Fastback . . . 97
Inset . . . 87
Norton Commander . . . 44
Pop-Up Deskset . . . 43
SOZ . . . 56
Xtree . . . 31
Statgraphics . . . 449

800-662-2686 orders only
for Ca. Orders, Tech Support, Price Quotes, info
415-668-9350 9-5 pacific time, m-f
Call or Write for Free Catalog

PAYMENT: (No Fee For Credit Cards) Visa, MasterCard, Cashier's Checks, Personal Checks with 2 week hold, Qualified P.O.'s. California residents add sales tax.
SHIPPING: UPS ground-2% per order, \$5 min. FREE for SW orders over \$1000, UPS Blue-3% per order, \$7 min. FREE for SW orders over \$1500. Printers, Monitors, Disk Drives, Computers — Call for charges.

All Products New with full warranties.
Price & availability subject to change without notice.

THE BEST PRICES



THE BEST SERVICE

**THE BAY
Express
COMPANY**

584 CASTRO ST., SUITE 487 SAN FRANCISCO, CA 94114
a division of MCSS, Inc. Computer & Software specialists since 1981



The PC User's Edge

NOW! TRANSFER DATA – PROGRAM TO PROGRAM WITH SOFTSTRIP®.

Now you can move data between programs quickly and easily using SOFTSTRIP data strips.

Using the Softstrip System, you can move data between computers and such programs as WordStar and MacWrite, dBASE and AppleWorks, Lotus 1-2-3 and Excel and ReadySetGo and many others.

We've created a series of several dozen Application Notes on Softstrip data strips. These lead you through simple steps to make the file transfer as easy as possible, adding even more versatility to your personal computer when you purchase the SOFTSTRIP SYSTEM. The advanced system you've been hearing so much about.

All you need to move data between programs is STRIPPER™ software at \$19.95 and the Softstrip System Reader at \$199.95.

For a complete list of Application Notes, contact your dealer or call Cauzin.

DECEMBER CASE HISTORY



A small manufacturer solved a knotty internal communications problem using the SOFTSTRIP SYSTEM.

The manufacturer uses personal computers in various departments. The problem was that most were not linked with others, and that different, incompatible computer makes were in use; predominantly IBM PC's and Apple Macintoshes.

Because of compatible media, virtually all internal communication was in hardcopy form. It was necessary for document recipients to key in the information if it was to be used in the local computer. Data included sales statistics, engineering reports, and sales materials. Especially time-consuming was the rekeying of brochure and sell-sheet drafts created on IBM PC's with wordprocessors, but later edited and composed with Pagemaker and the Macintosh and Laserwriter.

By equipping all computers with the SOFTSTRIP SYSTEM READER and STRIPPER, each station can now reduce all reports to data strip form. These are photocopied and sent to appropriate departments for reentry through the SOFTSTRIP READER. Using Cauzin's Softstrip System and Application Notes, the problem of moving information between dissimilar computers and programs was solved.

Users' Groups: Call for Special User Group Discounts.

ACT NOW! Don't delay. See your local Softstrip dealer or call us at 1-800-533-7323. In Connecticut: 203-573-0150.

CAUZIN

835 South Main Street
Waterbury, CT 06706
(203) 573-0150

For Europe and Asia Contact:
Softstrip International, Ltd.
53 Bedford Square
London, WC1 B3DP England
01-631-3775 Telex: 263874SOFTST G



Softstrip

This data strip contains IBM2MAC, a utility that runs on the IBM and converts an IBM file to Macintosh format.



THE HERCULES GRAPHICS CARD PLUS

BY RICH MALLOY

An inexpensive general-purpose display card for the IBM PC

The Hercules Graphics Card (see the review by Tom Wadlow in the December 1983 BYTE) quickly became the standard for monochrome graphics. Hercules has now replaced its popular Graphics Card with its new Graphics Card Plus. In addition to having its predecessor's 720-by-348-pixel monochrome graphics capability and a lower price (\$299), it also has enhanced text capabilities. With this board and the software that comes with it, you will be able to use alternative character sets and enhance the performance of applications such as Lotus 1-2-3 and Microsoft Word.

HARDWARE AND INSTALLATION

The Graphics Card Plus is only 10 inches long. Such a small size is possible because Hercules combined the functions of many of the chips from the old card into a smaller number of chips. For example, the entire logic circuitry for the parallel printer interface now fits on one chip. The board's short length would seemingly make it suitable for use in the Tandy 1000. However, Hercules informed me that unfortunately there is no way to disable that computer's internal display adapter. It should, however, work with the new Tandy 1000 SX.

The back panel of the Graphics Card Plus has two connectors: one for the IBM monochrome display (or compatible) and one for a parallel printer. The printer port appears to be hardwired as LPT1. If this designation con-

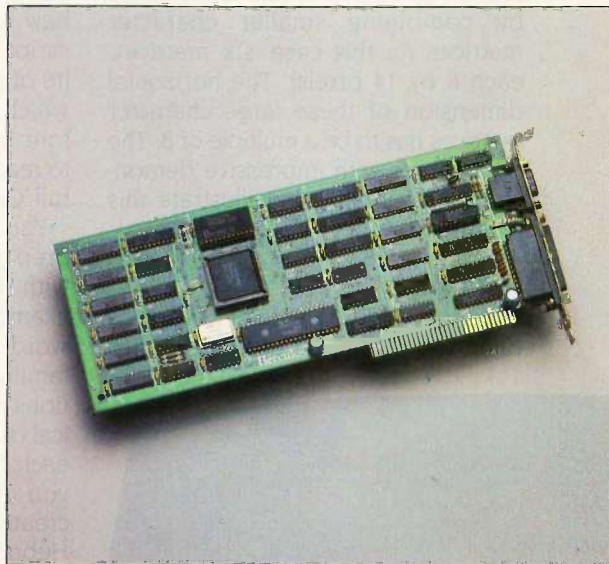

flicts with another printer port, you must either rename the other port or remove the Hercules port by pulling the chip. That will most likely be your only inconvenience during installation, since there are no DIP switches or jumpers to set on the board itself. If your IBM PC is already set up for a monochrome display adapter, all you need to do is pull out the IBM board and insert the Graphics Card Plus.

RAMFONT

RamFont is a unique hardware feature that allows you to use one or more alternate character sets in the display adapter's text mode. On the old

Graphics Card, as well as on the original IBM monochrome display adapter, the only way to change the character set was to install a new ROM chip. Some programs like Microsoft Word instead used the graphics mode to draw characters. Unfortunately, graphics mode did not include certain text-oriented capabilities such as line-by-line scrolling. In many cases, the result was very slow performance.

With RamFont you can completely and easily replace the text characters used in text mode with a new character set. RamFont thus combines a good part of the flexibility of graphics mode with the fast text-handling capabilities of text mode.

RamFont comes in two forms: 4K and 48K bytes. In 4K RamFont mode, a new character set replaces the standard character set. This mode seems to be compatible with almost all existing text-based software, and it allows you to use, for example, italic letters with your spreadsheet or mathematical symbols with your word processor.

In 48K RamFont mode, a program can access a total of 12 character sets. To do this, Hercules uses four of the bits in the attribute byte of each screen character to indicate which set is being used. The other four bits in-

(continued)

Rich Malloy is a senior technical editor for BYTE. He can be reached at BYTE/McGraw-Hill, 1221 Avenue of the Americas, New York, NY 10020.

Graphics Card Plus

Type

Combination text/graphics display adapter for the IBM PC

Company

Hercules Computer Technology
2550 Ninth St.
Suite 210
Berkeley, CA 947210
(415) 540-6000

Features

720- by 348-pixel resolution
Downloadable text fonts

Price

\$299

dicating attributes. To use the 48K RamFont mode, software has to be specially coded.

RamFont's capabilities are impressive, but the board cannot display proportionally spaced text as, for example, the Macintosh or Microsoft Windows Write can. Also, the size of the text is variable, but only within certain limits. The standard IBM character is drawn inside a 9- by 14-pixel matrix that includes all the intercharacter spacing. On the Graphics Card Plus, you can vary the vertical dimension of this matrix from 14 pixels to 1 pixel. The horizontal dimension, however, is limited to either 8 or 9 pixels. Thus, the maximum number of characters per line is 90.

Note that a larger character matrix (e.g., 24 by 28 pixels) can be simulated by combining smaller character matrices (in this case, six matrices, each 8 by 14 pixels). The horizontal dimension of these large character matrices has to be a multiple of 8. The card comes with impressive demonstration programs that illustrate this technique.

SOFTWARE

Like the older Hercules Graphics Card, the Graphics Card Plus comes

with several programs. HBASIC allows you to write BASIC graphics programs that can access the Hercules screen. Another program, HGC, permits you to dump the Hercules graphics image to an Epson printer, and it helps to avoid wearing out the screen phosphors by blanking out the screen after a specified time. Programmers who want to access the graphics screen and control RamFont can order an optional set of assembly language routines.

USING DIFFERENT FONTS

My favorite feature of the Graphics Card Plus is its ability to use a number of prepared fonts with most software (see photo 1). In addition to the standard IBM monochrome font, the board comes with approximately 15 new fonts including italic, sans serif, script, and a medieval font. My favorite of the prepared fonts is "bigserif," which is similar to the standard IBM font but is slightly larger and easier to read. Another interesting font is the full Greek alphabet.

You can easily modify any of these prepared fonts or create a new font with Hercules' FontMan program. For example, I altered the letters in the word "BYTE" to make it look like the familiar logo. More practical applications might involve special mathematical or scientific symbols. You can map each of the IBM keys to the characters you create. You could, for example, create fonts for phonetic Japanese, Hebrew, or Arabic. (For more information about implementing foreign languages on the Graphics Card Plus, contact Max Weinryb, S&B Electric, 2415 Grant St., Berkeley, CA 94703.)

PRINTING RAMFONT CHARACTERS

RamFont's new characters will appear on the screen, but your printer will still see them as the standard characters. Fortunately, some printers provide the capability for handling downloadable fonts. Others offer plug-in font cartridges. You could also use software packages such as Fontrix or Fancy Font that allow you to change the look of printed characters. Unfortunately, Hercules does not provide drivers to print out RamFont characters on stan-

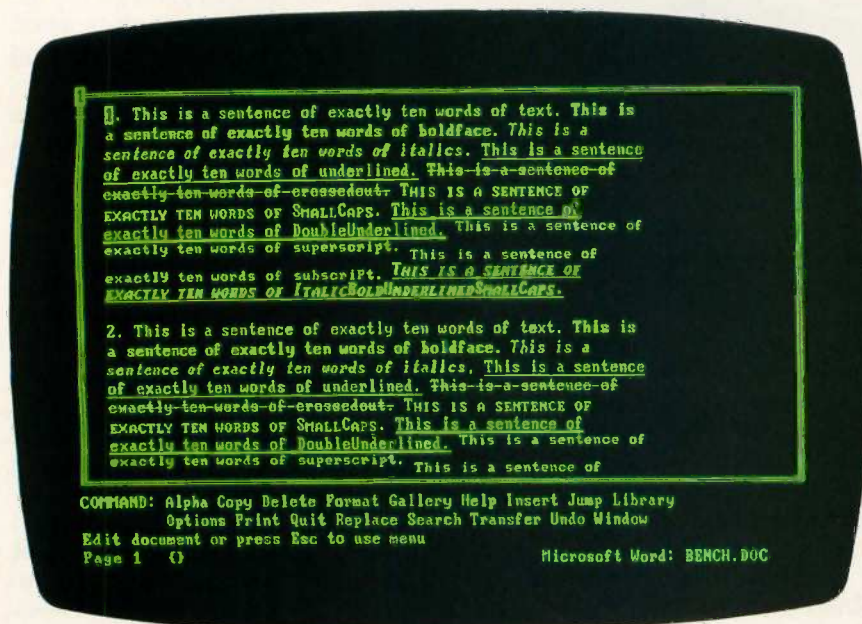

Photo 1: A Microsoft Word screen showing a sample of the fonts that are included with the new Hercules driver for Word.

dard printers. This would have enhanced the value of the Graphics Card Plus considerably.

USING 1-2-3 AND WORD

The board enhances the performance of Lotus 1-2-3 (release 2.0) and Microsoft Word. I tested these programs with the new board using both the standard Hercules drivers and the new RamFont drivers. Scrolling speed increased within both programs, and it increased dramatically with Word (see tables 1 and 2). The new driver scrolls through 50 lines of Word text approximately 70 percent faster than the old driver.

In 90-character-per-line mode, comparisons between the two drivers for Word are a little complicated. The older Microsoft driver displays 43 lines of text; the new RamFont driver displays only 35 lines. Screen repainting, measured by the time required to page down two screens, was 33 percent faster for the new driver, but, naturally, that driver had to display fewer lines during each repainting. After adjusting the time for an equal number of lines, I found that the new RamFont driver was still 17 percent faster.

Not apparent in the timings is the very readable quality of the characters produced by these versions of 1-2-3 and Word. In addition, with 1-2-3, the board allows you to display graphics in a window on the same screen as the spreadsheet. Of course, the graph is fairly small and is drawn at a fairly low resolution (probably 320 by 200 pixels). Symphony and Framework also provide special drivers. Hercules will not produce drivers for any other programs. It hopes that software developers will provide their own, as was done with the older Graphics Card.

PROBLEMS

The user's manual includes a pamphlet that lists approximately 100 compatible graphics software packages. It also states that the card works with all text-only IBM PC software. However, I had trouble with Borland's SuperKey. When I called SuperKey while using the special drivers for 1-2-3 and Word, I had unpredictable

Table 1: Test results of Lotus 1-2-3 release 2.0 running on an IBM PC. The spreadsheet used was a standard 25- by 25-cell spreadsheet in which each cell equaled 1.001 times the cell to its left. The first test involved moving the cursor from column A to column Y. The second test was a simple recalculation. Note that in the 90-character-per-line mode, 1-2-3 appears to buffer cursor keystrokes and then jump to the final desired position.

	Move 25 columns	Recalculate
80- by 25-line mode		
Standard Lotus driver	35.70	4.03
New RamFont driver	33.70	3.99
Improvement (percent)	5.60	1.00
90- by 38-line mode		
Standard Lotus driver	45.60	5.27
New RamFont driver	42.70	4.56
Improvement (percent)	6.40	13.50

Table 2: Tests results of using the Graphics Card Plus with Microsoft Word with both the standard Microsoft driver and the new Hercules driver. The benchmark document consisted of 10 paragraphs of 10 sentences containing 10 words each in 10 various character formats. To ensure that a standard number of scroll-down keystrokes was used, a SuperKey macro was used with the smallest delay possible.

	Scroll down 50 lines	Page down 5 pages
80- by 25-line mode		
Microsoft driver	24.60	14.30
New RamFont driver	7.21	9.47
Improvement (percent)	70.70	33.80
90- by 43-line mode		
Microsoft driver	7.41	20.50**
New RamFont driver*	6.52	13.70**
Improvement (percent)	12.00	33.10

*Note that the new RamFont driver for Microsoft Word's 90-character-per-line mode supports only 35 lines, not 43 lines as in the original driver.

** The time for five page-downs was extrapolated from the time for two page-downs.

results. Sometimes the attributes of various characters would be shifted, and occasionally the system locked up. I would advise caution until perhaps a new version of SuperKey appears.

If you use a graphics program that is not on the list of compatible software, you may run into a problem. For example, I loaded a RamFont font and then used a graphics program to draw

a graph. When I returned to text mode, everything suddenly went blank. To get the screen back, I had to leave the graphics program, go to the appropriate subdirectory, and cancel RamFont, all of which is pretty hard to do when the screen is blank.

RamFont stores its text information in page 0 of the Hercules graphics mode. I suspect that if a program uses

(continued)



FOCUS Computers

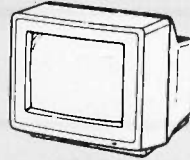

• **COMPUTERS** •

FREE INSTALLATION OF ANY ADDITIONAL BOARDS

SHARP PC 7000

Lightweight transportable that's also a desktop.

- Illuminated crystal display
- Built in dual 5 1/4" floppy drives
- 320 KB RAM expandable to 704 KB

SPECIAL FREE BONUS SHARP CASE WITH PURCHASE

CALL FOR THE LOWEST PRICE

SUPER PRICE BREAK APPLE IIC COMPUTER

NOW ONLY 49950*

*WHEN PURCHASED WITH MONITOR SCRIBE PRINTER, AND APPLE WORKS

ORIGINAL IBM PC with 256K two IBM 360K disk drives, keyboard

IBM PRICED TOO LOW TO PRINT

• **MODEMS** •

Hayes Smartmodem 1200B / IBM	299.95
Hayes Smartmodem 300	129.95
Hayes Smartmodem 2400/RS 232	569.95
Hayes Micromodem IIe/Smartcom	129.95
Hayes Smartmodem IIc (Apple) with Smartmoem software	149.95
Amazing Modems 1200 3aud internal with software	98.45
Amazing Modems 2400 Baud internal with software	196.95
General Electric 3-8200 AC/DC Modem Direct/acoustic full two year warranty	69.95

• **MONITORS** •

Amdtek color 730 RGB/Analog/ Extra hi res. PGA Compat	749.95
Can't mention the name 13" RGB hi res. mfg. by Hitachi List	699.95
Now only	279.95
NEC multi sync everything all in one monitor EGA/PGA/CGA/ NEW LOW	
Xtron hi res T.T.L. monitor w/tilt base	4109.95
Princeton Graphics HX12 hi res color RGB	398.95

• **PRINTERS** •

PANASONIC (2 year warranty)	
KXP 1080i NLO laser (120 cps)	188.50
KXP 1091i top rated (160 cps)	239.50
KXP 1092i super fast (240 cps)	299.50
KXP 1595 15" carr (240 cps)	529.95
EPSON	
LX86 New (120 cps)	232.50
FX286 New	NEW LOW PRICE
NEC	
3550 Spinwriter LQ	789.95
OKIDATA	
OKI 182P 120 cps (80 column)	199.95
OKI 292 200 cps NLO	LOW PRICE
OKI 293 15" carr 200 cps	SPECIAL
OKI 2410 Pacemark 350 cps	CALL



PC-10 Compact	479.50*
New PC 14	549.50*
PC-20 Auto Paper Feed	609.50*
PC-25 Deluxe Makes Legal Size Can Enlarge & Reduce	789.50*
Black Cart	56.35
4 Black Cart	219.50
Color Cart	59.95
Copier Stand	89.50
*WHEN PURCHASED WITH COLOR CARTRIDGE 39.50	

Focus Computers, 1303 46th St., Brooklyn, N.Y. Tel. (718) 871-7600. Open Mon.-Thurs. 10-7, Sun. 10-6, Fri. 10-3. Most orders shipped within 24 hours. Master Card, VISA, American Express gladly accepted. All prices in this ad reflect cash discount. New York State orders must add local sales tax. All merchandise available while supplies last. Price guaranteed subject to verifiable suppliers increases. Money back guarantee if returned within 14 days in mint condition with all papers and packing material intact. No returns accepted on open software.

Call Toll Free 1-800-223-3411

REVIEW:
GRAPHICS CARD PLUS

Until faster processors become more prevalent, the RamFont approach may be the only way to display a large number of text styles and fonts.

page 0 for graphics, it will blank out this information. Programs using page 1 should not have this problem, and as more drivers are written for the Graphics Card Plus, the problem will diminish. Even Hercules' own program, HBASIC, uses page 0 and is not compatible with RamFont.

Another potential problem is that you cannot use the Hercules board while an IBM Color Graphics Adapter (CGA) card, or almost any other CGA card, is also in the system. You can, however, have a Hercules CGA card present.

CONCLUSIONS

Perhaps the best way to represent text is via a bit-mapped display, as on the Macintosh. But until faster processors become more prevalent for the IBM family, the RamFont approach may be the only really workable way of displaying a large number of text styles and fonts.

The Graphics Card Plus accomplishes well what it attempts to do. The card does an excellent job of handling Hercules-style graphics, displaying new custom character sets, and enhancing programs such as Lotus 1-2-3 and Microsoft Word. I advise caution due to the card's lack of complete compatibility with some older Hercules-compatible software and the lack of any easy way to print out RamFont characters. But at only \$299, I recommend it as a very competitive general-purpose display card. For anyone involved in multilingual work or certain scientific applications, it may be indispensable. ■

Hot Tips

Turn to the Inmac catalog for helpful hints and problem solving advice from our engineers. And for over 2,400

computer supplies and accessories displayed and described in detail. All have our exclusive 45-day trial and minimum 1-year guarantee.

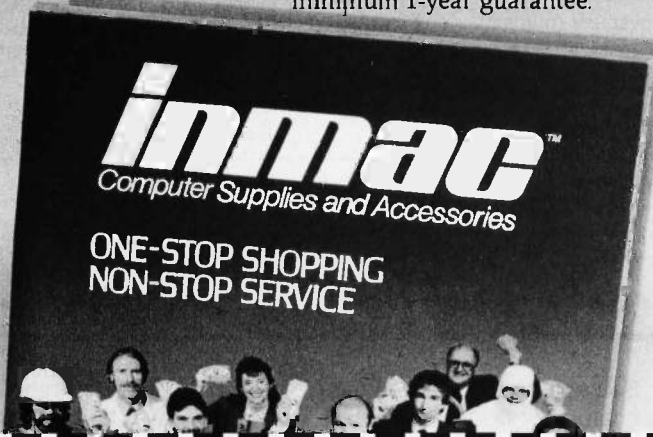

FREE!

Call or write today. Yes... rush me your catalog today.

800-547-5444

inmac™

Name _____
 Company _____
 Address _____
 City _____ State _____ Zip _____
 Phone () _____
 2465 Augustine Drive, Santa Clara, Ca. 95054

5077

Personnel Computing

What you ought to be doing.

Think of the reasons you bought yourself a PC, then apply those same principles to everybody else in your office. Couldn't they benefit from today's personal computer technology, too?

Until recently, such an undertaking would have been too expensive, but now with the ►Kimtron KT-7/PC¹ Terminal as part of a "multiuser solution," you can give your personnel the computing power they need — at a fraction of the cost of purchasing individual PCs.

What this means is while you're using dBase III² to look at the big picture, your secretary could be using WordStar³, while finance reviews purchasing's work with 1-2-3⁴ — all at the same time!

Trademarks: ¹Kimtron Corp. ²Ashton-Tate ³MicroPro Intl. ⁴Lotus Development Corp. Copyright 1986, Kimtron Corp.

Plus you'll have the added benefits of electronic file sharing, and the convenience of having everyone share the same printer, modem, and peripherals.

And it's so easy to install! Just purchase multiuser operating software, some connecting cables, and the number of terminals you need. Hook 'em together — and away you all go on keyboards styled just like the IBM AT's!

That's why we call it Personnel Computing! The ►Kimtron KT-7/PC. It's the difference between personal computing — and what you ought to be doing.

For more information, or the name of your nearest ►Kimtron dealer, send us our coupon, or call **408-436-6550** today. Toll Free: 800-828-8899. TWX: 910-338-0237.

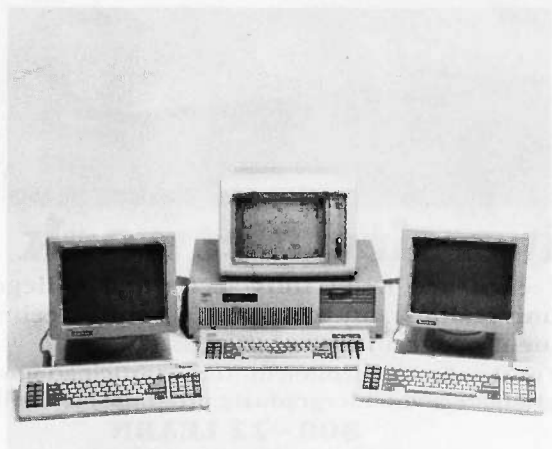

Kimtron

Inquiry 182 for End-Users. Inquiry 183 for DEALERS ONLY.

Mail to:
Kimtron Corp.
1709 Junction Ct., Bldg. #380
San Jose, CA 95112-1090
 End User Reseller 12345678

Name _____

Title _____

Company _____

Address _____

City _____

State _____ Zip _____

Phone # _____

My marketing class meets when I want it to!

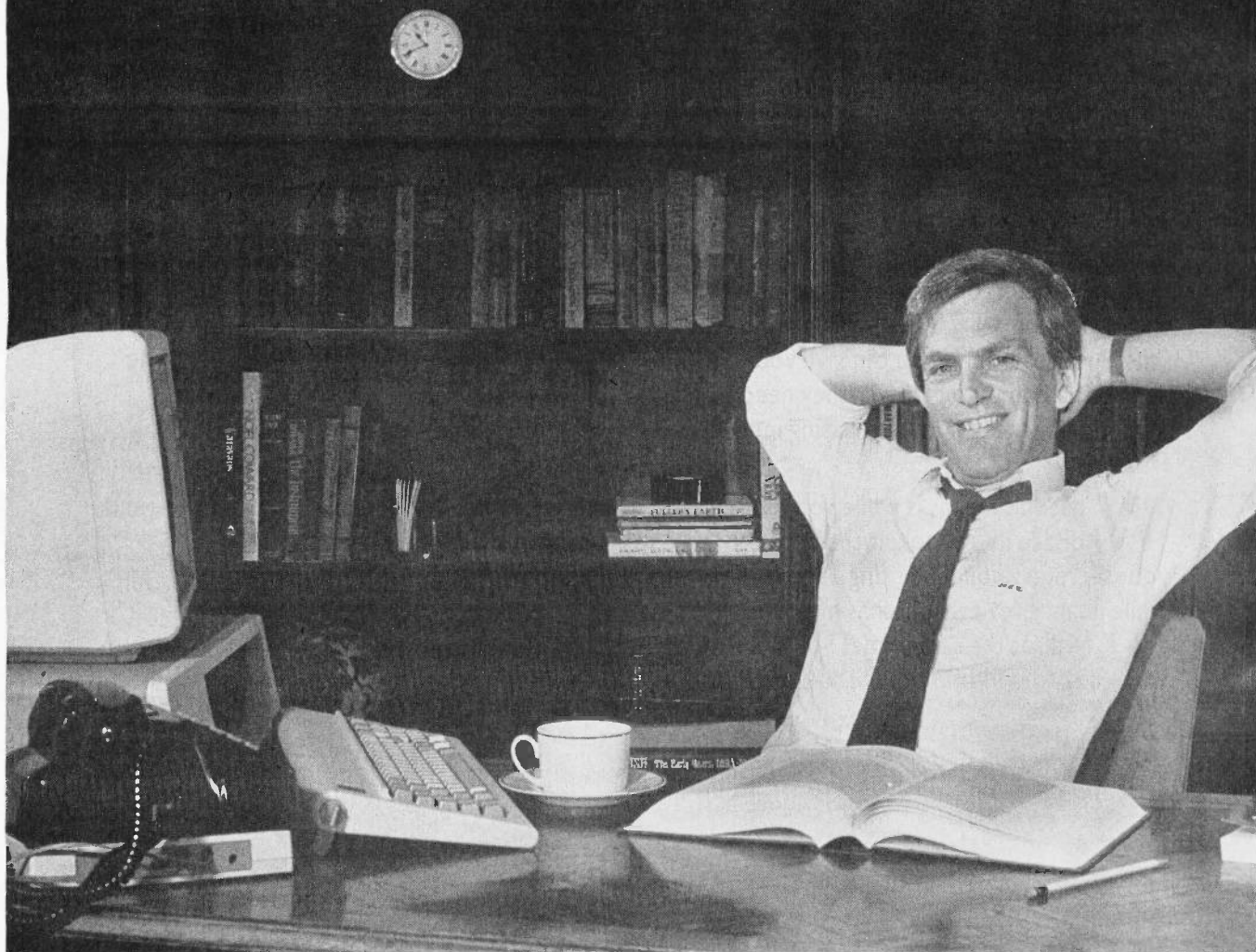

The Electronic University Network

For some time I've wanted to take some courses to fine-tune my strategic marketing skills. But with a job, a family, a hectic schedule, finding the time to go back to a campus just isn't practical.

The convenience of the Electronic University Network makes it possible for me to take courses when I have the time—even go back for my MBA! Although I study with my personal computer and modem, no real computer knowledge is required.

Through the Network, I'm learning with a marketing expert—one-on-one—and since the units

I earn are from fully-accredited colleges and universities, my company's tuition reimbursement program covers the costs.

For details on enrollment, fees, participating schools, graduate and undergraduate programs, call toll free:

800 - 22 LEARN

800 - 44 LEARN

in California

or send \$5 for a 1986-87 catalog to
The Electronic University Network
505 Beach Street, San Francisco, CA 94133



23 MODEMS

BY STEPHEN SATCHELL

An evaluation of modems and their ability to handle impairments

All modems are not the same. To find out how much the current crop of modems differ from one another, I took 23 modems from 16 manufacturers and tested them head to head.

MODEM BASICS

The word *modem* stands for modulator demodulator. At one end a modem accepts signals and converts, or modulates, them to a form suitable for transmission. At the other end, the modem takes the modulated signal and converts it back to the original signal.

The modems I tested for this review convert digital signals to specific tone patterns, send them over an audio (telephone) channel, and reconstruct the digital signal at the other end. All the modems included here are full-duplex modems; that is, they can send information in both directions at the same time. This is done by splitting the available audio channel bandwidth in half; one modem generates tones in the lower half and the other generates tones in the upper half.

Depending on the modulation method, the modem takes 1 to 8 bits of information and modifies the carrier tone in some specific way. Each group of bits is called a symbol. The data rate is defined as the number of symbols transmitted per second. Note that the true data rate of a modem is some percentage of the bit rate, since a symbol can contain several bits.

The three modulation methods currently in use with asynchronous modems are the Bell 103 standard (0-300 bps), the Bell 212 standard (1200 bps), and the CCITT V.22bis standard (2400 bps).

The Bell 103 method uses frequency-shift keying to send up to 300

bits per second in each direction. This system sends two tone frequencies: a lower-frequency tone for a one bit and a higher-frequency tone for a zero bit. The data rate is equal to the bit rate and can be any speed from 0 bits to 300 bits per second. The bit rate may differ in each direction, although this is unusual.

The Bell 212 method uses differential phase-shift keying to send 1200 bits per second. Each symbol consists of 2 bits. For each symbol, the carrier wave is shifted four different amounts for each of the four possible dibit (2-bit) values: 00, 01, 10, and 11. The data rate is fixed at 600 symbols per second, or 1200 bps.

The CCITT V.22bis method uses quadrature amplitude modulation to send 2400 bits per second. Four bits define each symbol, and the system uses both 12 values of phase shift and three amplitude levels to encode a symbol. As with the Bell 212 method, the data rate is fixed at 600 symbols per second and the bit rate is 2400 bps.

WHAT GOES WRONG

Almost all modems work without error when the communications channel makes no changes to the modulated signal. Unfortunately, no telephone line is absolutely perfect. Moreover, the farther the signal has to travel, the greater the possibility of transmission imperfections. How modems cope with these imperfections separates the good modems from the not-so-good ones.

A number of specific imperfections, called impairments by the telephone industry, have been identified, and methods have been developed to measure their magnitude. Impairments introduce errors by making the

receiving modem's job of decoding the correct symbol difficult (or impossible). As the symbols become more complex, symbol corruption becomes easier. Thus, a connection that passes 300-bps data without error can completely destroy 2400-bps data.

To understand the source of particular impairments, you must take a look at the telephone connection. When you make a call to a phone in the same or a neighboring telephone exchange, a simple circuit is created. The connection between the two phones and the telephone company's central office consists of a single pair of wires from each phone to the switches inside the central office.

When you have to call a significant distance—100 miles or more—the telephone company will split your call in two. Instead of carrying both sides of the conversation on one pair of wires, the call goes on two pairs of wires. This simplifies amplifying the signal and improves the quality of long connections. Also, the two halves of the connection can be sent via long distance coaxial, microwave, satellite, or fiber optics with far fewer technical difficulties.

Since the call is split, it is possible to have defects in one direction and not the other. This is especially true with calls that get routed into trans-

(continued)

Stephen Satchell (Satchell Evaluations, 16 Searing Ave., Morristown, NJ 07960) has been active in computer product development and evaluation since 1971.

mission systems that multiplex many calls into one very high-speed channel. Digital transmission systems alleviate the problem a bit, but they introduce problems of their own.

The main problem with modem testing in this type of environment is that you cannot depend on getting exactly the same call routing from call to call. Thus, it is virtually impossible to apply exactly the same test conditions to each modem that you are testing. Even if you could, that does not help someone else decide which modem to buy, since they might have a completely different set of impairments with which to contend.

To combat this problem, I built a telephone connection simulator using a Bradley Telcom Corporation 2A/2B line simulator, a reference modem (an AT&T Dataphone II Set 2224B modem in loopback mode), a Hewlett-Packard 4437A attenuator, passive hybrid splitters, and a Ramsa 8210 recording mixer (used to synthesize two line amplifiers). I generated test data using a BASIC program running on a Compaq Portable (see figure 1).

By using the impairment generators in the 2A/2B line simulator and checking for errors on the Compaq, I was able to stress the modems to discover just how much impairment they could take. For each modem, I took 79 measurements per speed supported; that's 237 measurements for a 2400-bps modem. The results are summarized in figures 2, 3, and 4. [Editor's note: Figures 2, 3, and 4 use numbers to denote the 23 modems tested. See the box on page 257 for the product name, company name, and price of each modem.] As a final check, I used the 1982/83

End Office Connection Study (*AT&T/Bell Laboratories Technical Journal*, volume 63, number 9, November 1984) to set up a reasonable worst-case connection that would test how the modems handled a mixture of impairments.

Modem companies use equipment like this to check out new modem designs. According to applications notes provided by Bradley Telcom, you loop back the modem through the 2A/2B line simulator during testing so that the modem is sending itself data. No one really uses a modem this way, so a more realistic condition was to duplicate the user/server relationship, with the server being an AT&T 2224B modem.

For impairments involving frequency, I focused on 20 Hz, 60 Hz, and 120 Hz in the tests. The most common frequency used by telephone operating companies to ring the telephone bell is 20 Hz. The power-line frequency in the U.S. is 60 Hz, while 120 Hz is the frequency you get from a 60-Hz power line after you convert it to pulsating DC using a full-wave rectifier, as many electronic appliances do. (If I wanted to be international in scope, I would have also used 50 Hz and 100 Hz.)

I conducted each impairment series four times. The first three times I used no filtering and three different signal levels: -5 dBm (decibels referenced to 1 milliwatt), -15 dBm, and -25 dBm. The fourth time I used a great deal of filtering at -5 dBm. The tests are described below.

SENSITIVITY

Sensitivity indicates the signal level required for the modem to recognize

the initial connection protocol and to make an error-free connection on a clean line (i.e., one with no impairments). The results are shown in figures 2a, 3a, and 4a. The lower the result, the better; that means the modem can maintain the connection with a weaker signal.

PHASE MODULATION

If you look at an oscilloscope displaying a sine wave that is experiencing phase modulation, the waveform will wiggle back and forth. Moderate amounts of phase modulation should not affect 300-bps operation. Since a 1200-bps or 2400-bps symbol uses phase offsets, however, a certain amount of jitter will cause symbols to be decoded incorrectly.

In this test I measured the amount of phase modulation that the modem could tolerate before it began introducing errors. I performed the test at the impairment frequencies of 20 Hz, 60 Hz, and 120 Hz and recorded the minimum and maximum tolerances (see figures 2b, 3b, and 4b). In this case (and in all the following tests except Error Count), a modem with high ratings was able to tolerate greater amounts of phase modulation before introducing errors. (In this test and the following test, the maximum modulation that the line simulator could produce was 90 degrees.)

AMPLITUDE MODULATION

Amplitude modulation tests how the modem rejects periodic fluctuations in signal level. It is the same as turning the volume control on the signal back and forth at a specific frequency. I checked how far I could go at the three frequencies of 20 Hz, 60 Hz, and 120 Hz and recorded the minimum and maximum tolerances, as shown in figures 2c, 3c, and 4c. A modem with high ratings could tolerate more amplitude modulation without introducing errors.

WHITE NOISE

White noise is the hiss you hear on long-distance telephone calls. As this gets louder in relation to the signal, the receiving modem may confuse the noise for part of the signal. I

(continued)

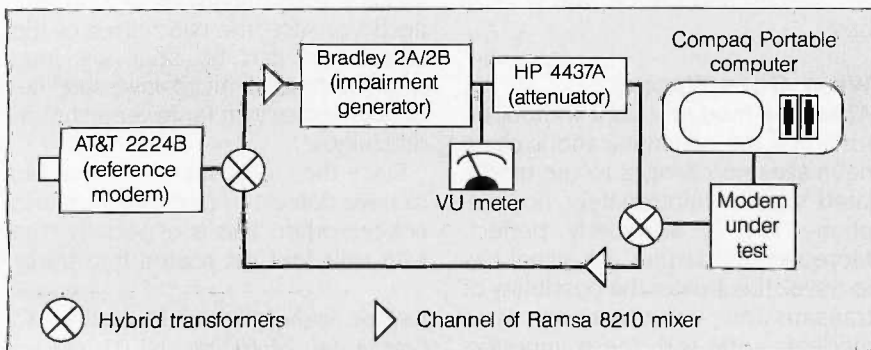

Figure 1: The setup of test instruments used in this review.

REVIEW: 23 MODEMS

PRODUCT INFORMATION

The numbers preceding the products correspond to the numbers in figures 2, 3, and 4. All modems are 300/1200 bps except those marked with an asterisk, which also support 2400 bps.

- | | | | |
|--------------------------------------------------------------------------------------------------------------------|-------|------------------------------------------------------------------------------------------------------------------------------|-------|
| *1. Model 2233
Codex Corp.
20 Cabot Blvd.
Mansfield, MA 02048
(800) 446-6336 | \$445 | *12. Courier 2400
USRobotics Inc.
8100 McCormick Blvd.
Skokie, IL 60076
(312) 982-5010 | \$699 |
| 2. 212AHC | \$295 | 13. Rainbow 1200SA
INCOMM Data Systems Inc.
115 North Wolf Rd.
Wheeling, IL 60090
(312) 459-8881 | \$199 |
| 3. 212AH* | \$295 | *14. Model 2400V
Racal-Vadic
(See address at number 7.) | \$595 |
| CTS Fabri-Tek Inc.
Datacomm Products Division
6900 Shady Oak Rd.
Eden Prairie, MN 55344
(800) 328-6104 | | 15. OZ Guardian Model 533
Tri-Data
505 East Middlefield Rd.
Mountain View, CA 94043-4082
(415) 969-3700 | \$750 |
| 4. FasTalk 1200
Universal Data Systems Inc.
5000 Bradford Dr.
Huntsville, AL 35805
(800) 663-2252 | \$450 | 16. IntelliModem EXT
BIZCOMP Corp.
532 Mercury Dr.
Sunnyvale, CA 94086
(408) 733-7800 | \$499 |
| 5. KM1200S
Kyocera International Inc.
8611 Balboa Ave.
San Diego, CA 92123
(800) 235-1222 | \$299 | *17. Smartmodem 2400
Hayes Microcomputer Products
(See address at number 6.) | \$899 |
| 6. Smartmodem 1200
Hayes Microcomputer Products
P.O. Box 105203
Atlanta, GA 30348
(404) 441-1617 | \$599 | *18. MultiModem224E
Multi-Tech Systems Inc.
(See address at number 8.) | \$749 |
| 7. Maxwell 1200V
Racal-Vadic
1525 McCarthy Blvd.
Milpitas, CA 95035
(800) 482-3427 | \$295 | 19. OmniTel 1200
OmniTel Inc.
5415 Randall Place
Fremont, CA 94538
(800) 654-2785 | \$299 |
| 8. MultiModem | \$399 | 20. Model 4000 | \$499 |
| *9. MultiModem224
Multi-Tech Systems Inc.
82 Second Ave. SE
New Brighton, MN 55112
(800) 328-9717 | \$699 | *21. Model 4024
AT&T Information Systems
225 Littleton Rd.
Morris Plains, NJ 07950
(800) 247-1212 | \$750 |
| 10. Smart-CAT Plus
Novation Inc.
20409 Prairie St.
Chatsworth, CA 91311
(818) 996-5060 | \$495 | 22. Cermetek Security Modem
Cermetek Microelectronics Inc.
1308 Borregas Ave.
Sunnyvale, CA 94088
(800) 862-6271 | \$595 |
| *11. 2400 Plus
Ven-Tel Inc.
2342 Walsh Ave.
Santa Clara, CA 95051
(408) 727-5721 | \$695 | *23. 2424AD
CTS Fabri-Tek Inc.
(See address at number 2.) | \$395 |

* Since this review was completed, the manufacturer has discontinued this model.

DRIVE INN

Enclosures
& power
supplies for
**FLOPPY,
WINCHESTER,
TAPE DRIVES,
SINGLE
BOARD
COMPUTERS**

**S-100
SYSTEMS.**

8 inch
5 inch
3 inch

**CUSTOMIZING
AVAILABLE**

Call or write
for free
catalogs
and
application
assistance.



INTEGRAND

RESEARCH CORPORATION
8620 Roosevelt Ave. • Visalia, CA 93291
209/651-1203

TELEX 5106012830 (INTEGRAND UD)
EZLINK 62926572

We accept BankAmericard/VISA
and MasterCard

Figure 2: Results of the tests performed on the 23 modems operating at 300 bps. See text for description of the tests. Generally, the higher the rating, the better, except for the Sensitivity and Error Count tests, in which the better modems have the lowest ratings.

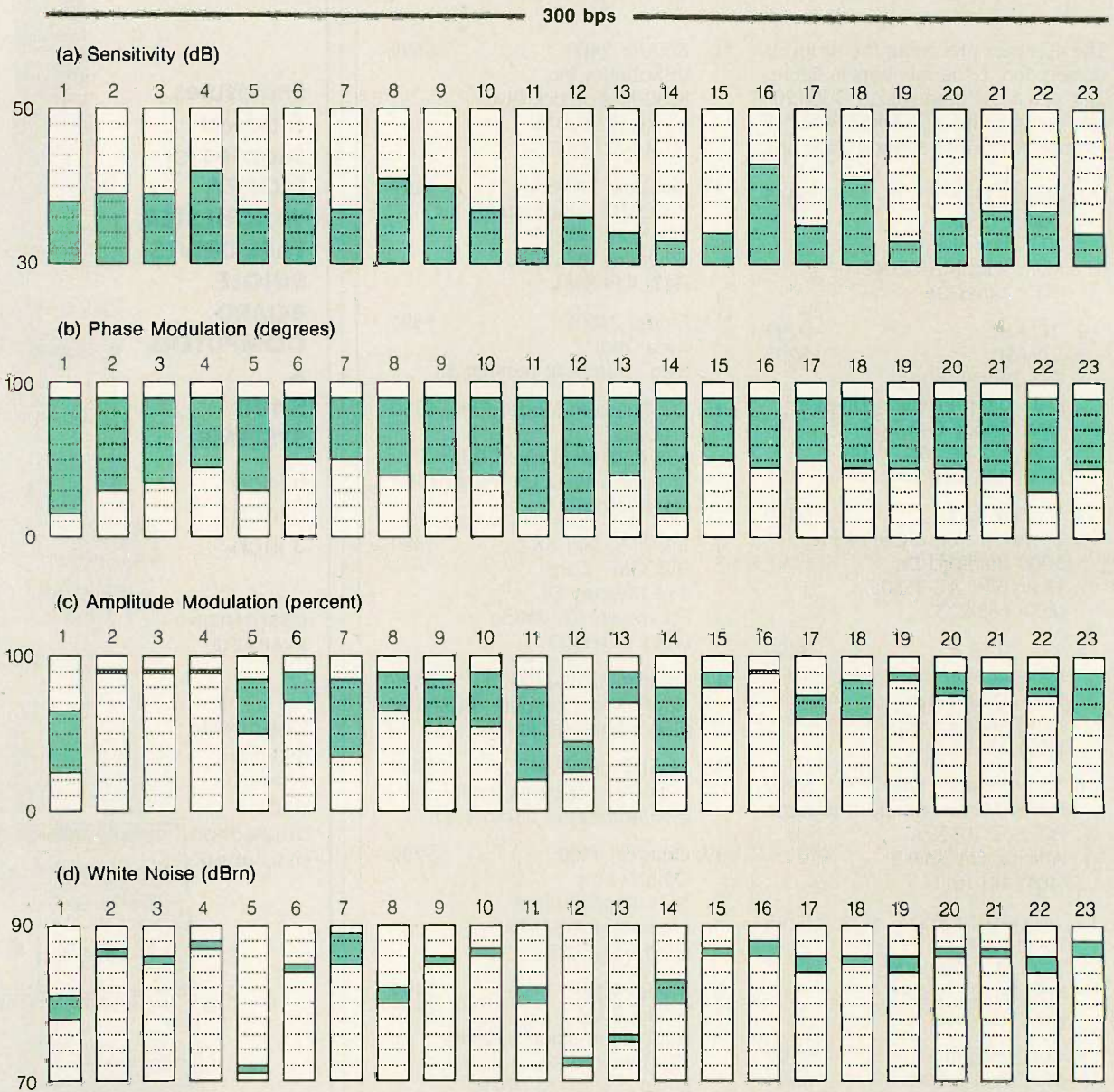

tested how much white noise each modem could tolerate at the various signal levels and recorded the point at which the modem began introducing errors. The results are shown in figures 2d, 3d, and 4d. A modem with high ratings could tolerate white noise better than one with low ratings.

IMPULSE NOISE

Impulse noise is a transient pulse or spike caused by lightning, relays, or

repairs, among other causes. You hear this as a short "pop" on long-distance calls.

I generated an impulse 5 times per second and measured the impulse level the modem could tolerate at the various signal levels. The test results are shown in figures 2e, 3e, and 4e. Once again, the higher the rating, the better. Note that 100 dBrn (decibels above reference noise) is the maximum that the 2A/2B can gener-

ate. This measurement is equal to 10 dBm.

GAIN HIT

A gain hit is a change in the level of the received signal for anywhere from 4 milliseconds up to hours. On a long-distance call, a gain hit sounds like someone has turned down a volume control and (maybe) brought it back up. I measured the maximum dip the modem could stand before it began

300 bps

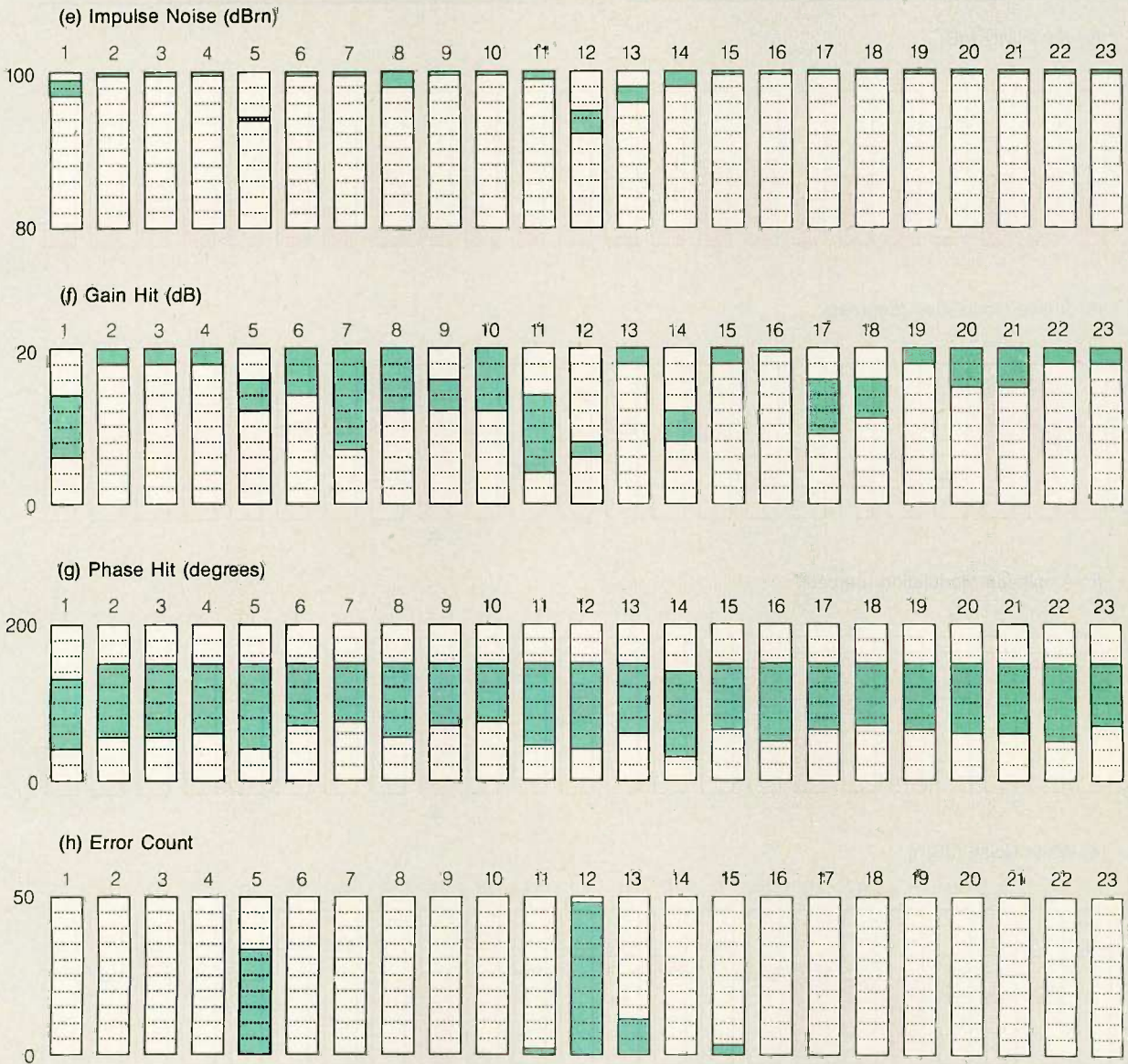

introducing errors by using two different rates of change in gain. In the first test I effected the gain change in 20 milliseconds; in the second I took 2 milliseconds to go from one level to another. Duration of the hit was 100 milliseconds, and I started a hit every 200 milliseconds.

The results are shown in figures 2f, 3f, and 4f. The maximum gain hit that the 2A/2B could generate was 20 dB (decibels). Modems that rate highly in

this test are more likely to continue working reliably in situations where gain hits are common.

PHASE HIT

A phase hit is a change in the phase of the received signal, similar to the change in level of a gain hit. I used the same intervals as in the tests for gain hit and recorded the maximum and minimum amount of phase shift that the modem could stand before intro-

ducing errors (see figures 2g, 3g, and 4g). The maximum phase hit that the 2A/2B could generate was 150 degrees.

ERROR COUNT

Error count is the number of errors recorded for each speed the modem supports. I set up the line simulator for filtered frequency response, a signal level of -15 dBm, 10 degrees

(continued)

REVIEW: 23 MODEMS

Figure 3: Results of the tests performed on the 23 modems operating at 1200 bps. See text for description of the tests. Generally, the higher the rating, the better, except for the Sensitivity and Error Count tests, in which the better modems have the lowest ratings. An asterisk indicates that a modem was unable to maintain a connection at some impairment levels, as reflected in the minimum value reported.

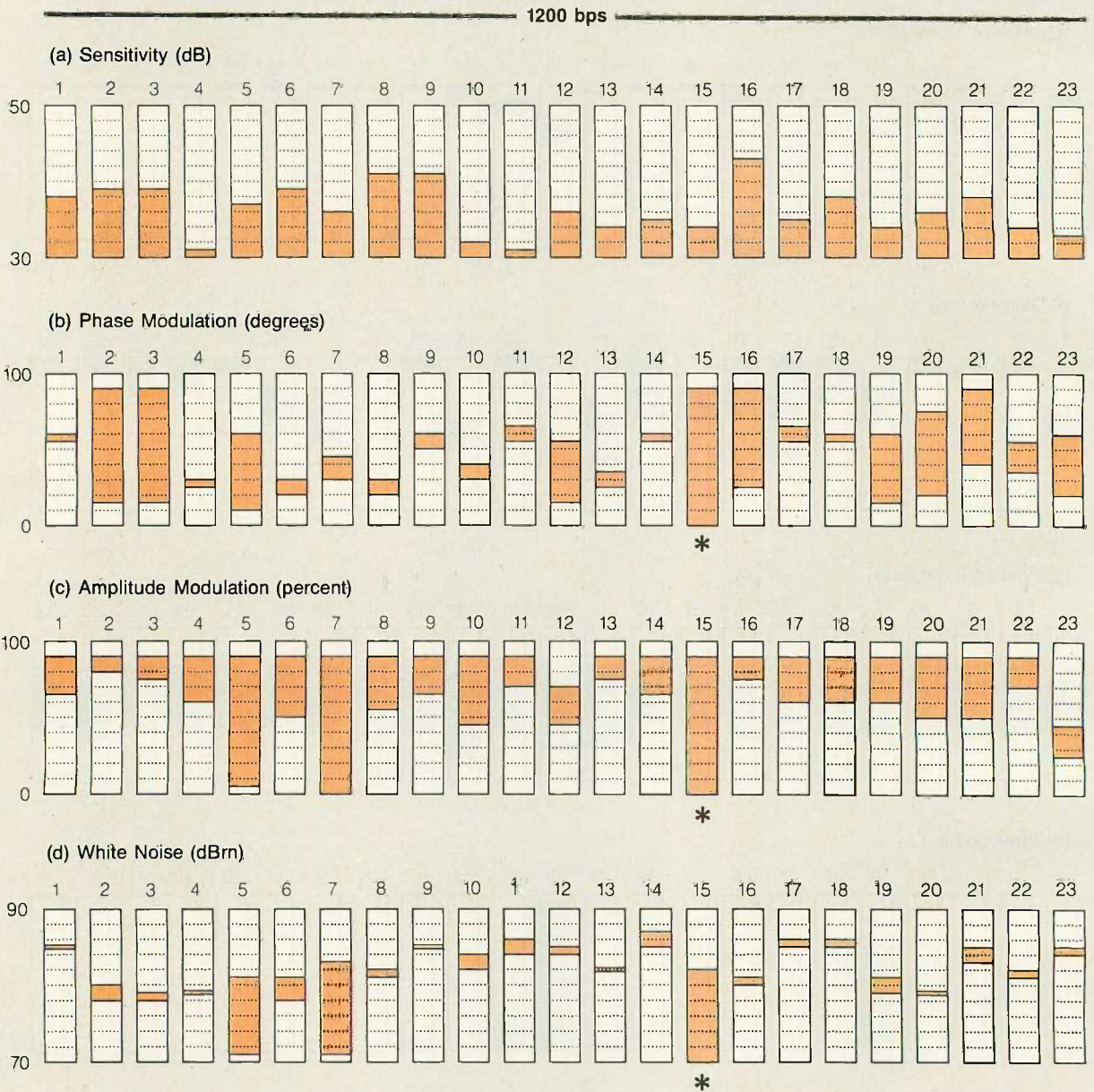

of phase modulation at 60 Hz, 2 percent (-33 dB) of second- and third-order harmonic distortion, white noise output of 55 dBrn (a signal-to-noise ratio of 35 dB), and gain hits of 2 dB and phase hits of 10 degrees at 5-second intervals with a 2-millisecond rise and a 100-millisecond duration. I counted errors for 2 minutes. When an error occurred, the test program stopped and waited for no bits

for about 1/2 second before resuming pattern transmission. This ensured that the modem had recovered from the last error. The results are shown in figures 2h, 3h, and 4h. In contrast to most of the other tests, the lower the rating here, the better.

CONCLUSIONS

The rigorous testing I employed revealed differences between modems

that simple "use testing" did not find. For example, when I tested the USRobotics Courier 2400 modem for another publication, I didn't perceive that 300-bps operation was more sensitive to line impairments than 1200-bps operation. This proved to be true for four other modems I tested.

The AT&T Model 4024 stood out clearly as the top modem. Although

1200 bps

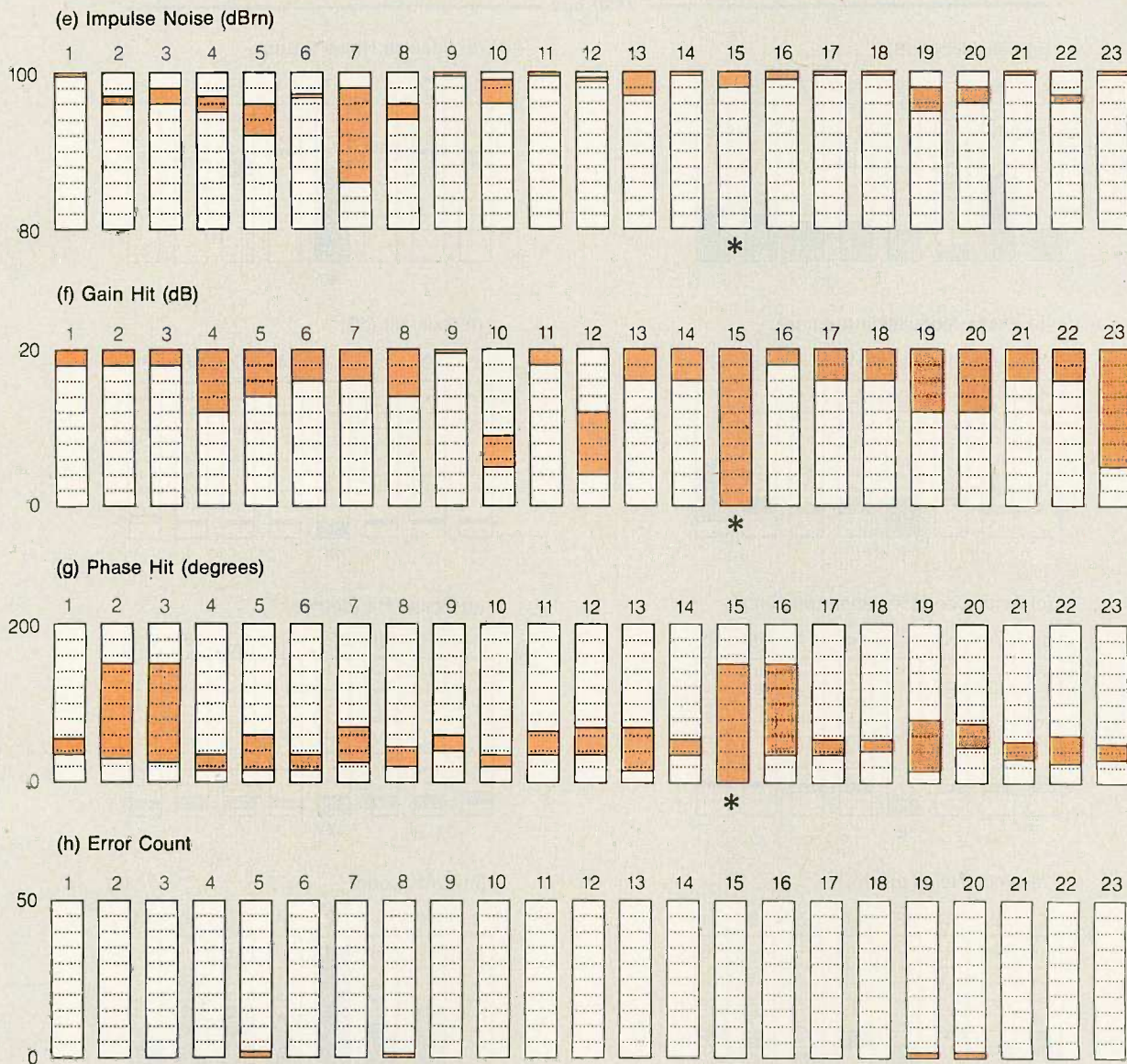

the Model 4024 fared well in most of the tests, the bottom line in data transfer is the error count, and the Model 4024 showed the lowest error count at 2400 bps, as shown in figure 4h. The Ven-Tel 2400 Plus came in with the next lowest error count.

At 1200 bps, a number of modems ignored the simulated bad connection and had no errors at all (see figure 3h). I then looked to see how each

modem stood up to impairments. On this basis, I selected these as the top five modems for 1200-bps transfers: the AT&T Model 4024, the Ven-Tel 2400 Plus, the AT&T Model 4000, the Multi-Tech MultiModem224E, and the IntelliModem EXT. All five modems were able to withstand the more severe impairments and excelled at ignoring at least one.

The error count results also add fuel

to the controversy over whether CCITT V.22bis (2400-bps) modems can work. According to my test setup, the CCITT V.22bis modems performed miserably. (The CTS 2424AD, for example, could not make a clean connection at 2400 bps with any attenuation of the signal.)

Still, users report having good luck using these modems at 2400 bps over

(continued)

Figure 4: Results of the tests performed on the 23 modems operating at 2400 bps. See text for description of the tests. Generally, the higher the rating, the better, except for the Sensitivity and Error Count tests, in which the better modems have the lowest ratings. An asterisk indicates that the modem was unable to maintain a connection at some impairment levels, as reflected in the minimum value reported.

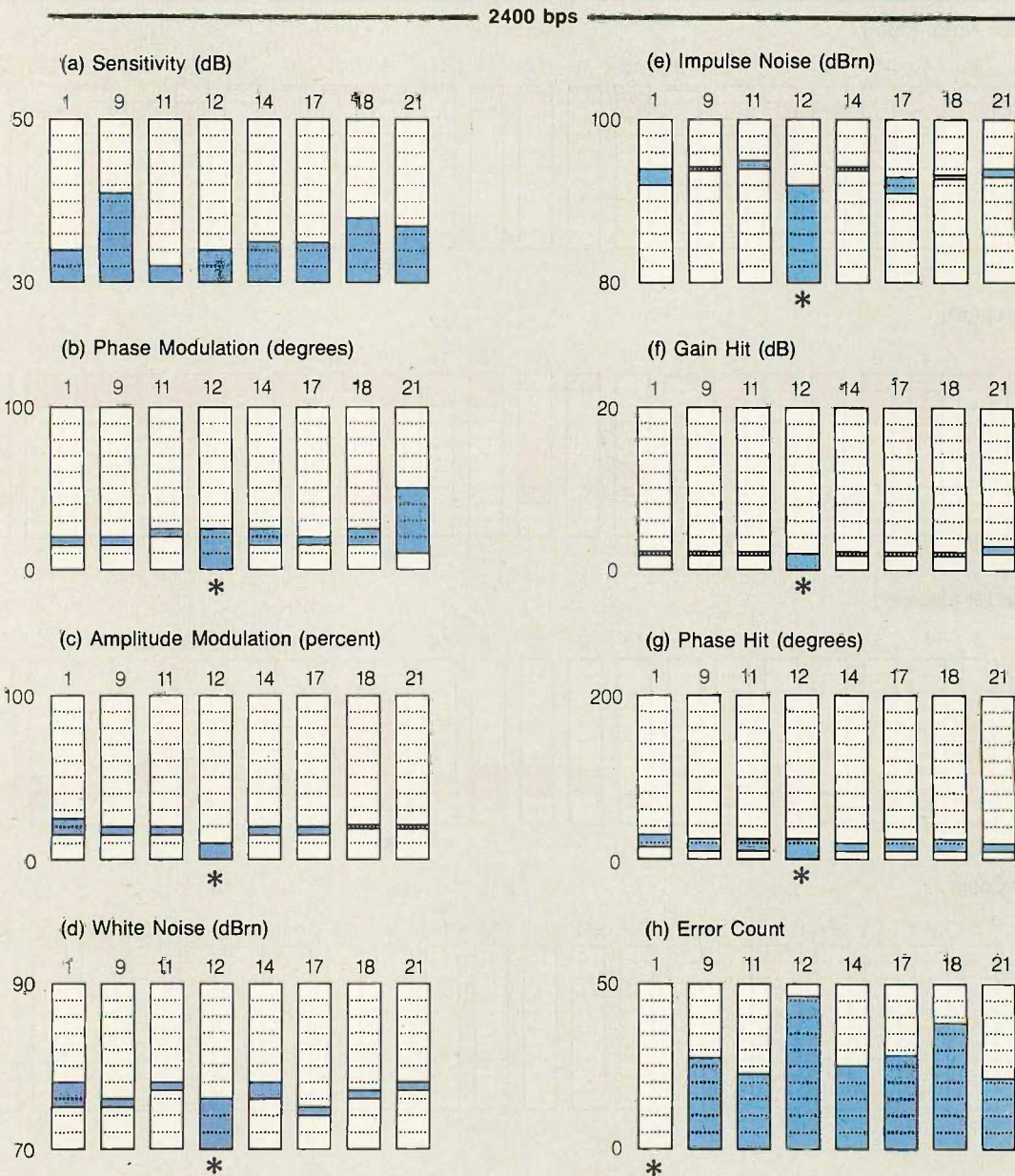

significant distances. The 1982/83 End Office Connection Study, upon which I based the worst-case Error Count test, analyzed 6500 directly dialed long-distance calls among 20 locations. In that study, over 95 percent of the medium-distance connections had better measurements (i.e., fewer impairments) than my setup.

Had I selected values such that 50

percent of the connections showed better measurements, I suspect the 2400-bps modems would have had lower error counts. This conclusion is based on the single-impairment stress tests.

This survey did not test sensitivity to radio frequency interference (RFI) from AM, FM, TV, CB, and other transmitters. Depending on how bad the

RFI problem is, it can be extremely tedious trying to trace down an intermittent problem.

I make no claim that this is the perfect evaluation for modems. I welcome advice from all quarters to improve my methods.

Editor's note: If you would like more details on the setup of these tests, please send all comments and questions directly to the author. ■

We've got a FileClerk™ for Lotus 1-2-3®

She loves filing and quickly finding your spreadsheet files.



She works closely with accountants, bookkeepers, managers, and others.

She files Lotus 1-2-3 spreadsheets on a hard disk, simply organized in its own file drawer. The drawer holds your folders and files ... all in a comfortable office environment that lets you think about your work -- and not about DOS. She helps you file and find massive amounts of company, division and department spreadsheet data on a hard disk ... eliminating the floppy maze.

She effortlessly opens, inspects, copies, moves, erases, renames and prints files.

She is faithfully,
your FileClerk

TRANSEC FILECLERK™

Not copy protected

TO ORDER: 1-800-423-0772 \$74.95 plus \$5 s/h
IN FL: 1-305-276-1500 VISA/MC

UNLOCK™ Removes Copy Protection

Produces Unprotected Backup Copies

RUNS YOUR SOFTWARE ON ANY HARD DISK

UNlock "copying" disk allows you to make "unprotected" DOS copies of popular original program disks. **Unprotected backup copies** perform perfectly, as do copies of these copies. UNlock copies run on any hard disk, including Bernoulli Boxes. No original

required in drive "A." Run on a RAM disk simply and conveniently. Also, copy DOS 5¼" programs to 3½" diskettes. For IBM® PC, XT, AT, compatibles, 256K or more, DOS 2.1 or higher. Choice of the critics!

Guaranteed to work only with programs below:

UNLOCK™ ALBUM "A" PLUS

\$69.95

(Plus \$4 ship/handling. Foreign orders \$10)

- dBASE III & dBASE III PLUS™
- FRAMEWORK I & II™
- CHARTMASTER™ (6.1)
- SIGNMASTER™ (5.1)
- FASTBACK™ (5.3)
- HARVARD TOTAL PROJECT MGR.™ (1.10)
- THINKTANK™ (2.0, 2.1)
- LOTUS 1-2-3™ (1.A-2.0)
- IBM WRITING ASSISTANT™ (1.01)
- IBM FILING ASSISTANT™ (1.0)
- IBM REPORTING ASSISTANT™ (1.0)
- GRAPHWRITER™ (4.3, 4.31)
- REALIA COBOL™ (1.2, 2.0)
- MULTILINK ADVANCED™ (3.02, 3.03)
- DOLLARS & SENSE™ (2.0)

UNLOCK™ ALBUM "B" PLUS

\$69.95

(Plus \$4 ship/handling. Foreign orders \$10)

- SYMPHONY™ (1.1)
- CLIPPER™
- LOTUS 1-2-3 REPORT WRITER™ (1.0)
- DOUBLEDOS™
- smARTWORK™ (1.0 Rev. 8 thru 10 & 1.1)
- DISK OPTIMIZER™
- MANAGING YOUR MONEY™ (1.5, 1.51, 2.0)
- MICROSOFT WORD™ (1.15, 2.0, 2.01)
- PFS: ACCESS™ (1984 Ed.)
- PFS: PLAN™ (B)
- PFS: GRAPH™ (B)
- PFS: WRITET™ (1.01, C)
- PFS: REPORT™ (B, C)
- PFS: FILE™ (B, C)
- DATABASE MANAGER II—THE INTEGRATOR™ (2.0, 2.02)

SPECIAL OFFER

"Best of UNLOCK" ALBUM "D" PLUS

\$74.95

(Plus \$4 ship/handling. Foreign orders \$10)

- dBASE III & dBASE III PLUS™
- FRAMEWORK I & II™
- CLIPPER™
- FASTBACK™ (5.3)
- CHARTMASTER™ (6.1)
- SIGNMASTER™ (5.1)
- DOLLARS & SENSE™ (2.0)
- LOTUS 1-2-3™ (1.A-2.0)
- SYMPHONY™ (1.1)
- LOTUS 1-2-3 REPORT WRITER™ (1.0)
- DOUBLEDOS™
- HARVARD TOTAL PROJECT MGR.™ (1.10)
- MANAGING YOUR MONEY™ (1.5, 1.51, 2.0)
- THINKTANK™ (2.0, 2.1)
- MICROSOFT WORD™ (1.15, 2.0, 2.01)

UNLOCK™ FLIGHT/JET #202

\$29.95

• FLIGHT SIMULATOR™ • JET™ • SCENERY DISKS (Plus \$4 ship/handling. Foreign orders \$10)

CHOICE OF THE CRITICS!

PERSONAL COMPUTING "UNlock has two particularly endearing characteristics: it works, and works simply. I was able to quickly produce unprotected copies of Lotus 1-2-3 release 2, Symphony 1.1, Microsoft Word 2.0, dBase III 1.1, and Framework II. These copies performed flawlessly, as did copies of these copies."
Christopher O'Malley

PERSONAL COMPUTING, April '86



"Because copy protection can interfere with the ability to back up a hard disk, business-oriented users may prefer programs like TranSec's UNlock series."

Winn L. Rosch, PC MAGAZINE, May 27, 1986

BYTE "UNlock 4.7 defeats the latest Prolok and SuperLock type of copy protection scheme. It's menu-driven and works fine on the programs it's supposed to work on: Lotus 1-2-3, dBase III, Framework, Symphony, Paradox, and several others."

Jerry Pournelle, BYTE, Feb. '86

Recommended by the editors of:



ORDER TODAY TOLL FREE:
1-800-423-0772
IN FLORIDA: 1-305-474-7548



TRANSEC UNLOCK™

TranSec Systems, Inc., 220 Congress Park Drive, Delray Beach, FL 33445

Trademarks are the sole property of their respective owners. UNlock is for use only to improve the useability of legally acquired and operated software.

Microprocessor Development Systems & In-Circuit Emulators



SA2000

Complete universal development system and in-circuit emulator for latest micro controllers.

- Cross assembler, Linker, Editor standard.
- Powerful software debugger plus Real-Time ICE.™

SA700-68000

Dedicated in-circuit emulator for 68000 Microprocessor.

- Most transparent 68000 emulation.
- Over 1/2MByte emulation Ram.
- Command files for software/prototype/production test.



PROCESSOR (16bit)		PKG	SA710M	SA700-68000
INTEL	8086/88	DIP40P	○	
	80C86/88	DIP40P	○	
	80186/188	LCC/PGA	○	
NEC	μPD70108/116 (V20/30)	DIP40P	○	
	μPD70208/216 (V40/50)	PGA	○	
MOTOROLA	MC68000	DIP64P,PGA68P		○
PROCESSOR (8bit)		PKG	SA2000	
ZILOG	Z80CMOS (Z80, Z80A, Z80C)	DIP40P	○	
	Z80H (Z80, Z80A, Z80B, Z80H)	DIP40P	○	
	Z8 (Z8601/03/11/13-12R)	DIP40P	○	
	SUPER-8 (Z8310-33)	DIP40/48P	○	
INTEL	80C85, 8085AH-2	DIP40P	○	
	8048 (8035/39/40/49/50AH)	OIP40P	○	
	8051 (8031/51AH, 80C51)	DIP40P	○	
MOTOROLA	MC6801 (6801/03-1)	DIP40P	○	
	MC6809 (68A09, 68809)	DIP40P	○	
	MC6809E (68A09E, 68B09E)	DIP40P	○	
HITACHI	MC68HC11	DIP48P	○	
	HD6301V/6303R, HD63701V	DIP40P	○	
	HD6301X/6303X, HD63701X	SDIP64P	○	
	HD6301Y/6303Y, HD63701Y	SDIP64P	○	
	HD6305U/V, HD63705V	DIP40P	○	
	HD6305X/Y	SDIP64P	○	
	HD6305Z, HD63705Z	FLAT80P	○	
	HD6309E	DIP40P	○	
HD61810B (HSP)	DIP40P	○		
NEC	μPD7807/08/09	SDIP64P,QUIP64P	○	
	μPD7810H/11/14/16	SDIP64P,QUIP64P	○	
	μPD78C10/11	SDIP64P,QUIP64P	○	
MITSUBISHI	M50734SP	SDIP64P	○	
	M50745	SDIP64P	○	
	M50747	SDIP64P	○	
ROCKWELL	R6502, 65C02	DIP40P	○	



SA710M

16-bit universal system analyzer and in-circuit emulator.

- Symbolic features include local variables, arrays, structures.
- Start/Stop trace without breaking.
- Stand-alone or Host operation.

*In U.S. SA2000 & SA710M with Zilog chip support can be purchased through Zilog or Sophia sales channel.

*ICE™ is a trademark of Intel Corp.

*No.3 universal MDS manufacturer in the world.

Call toll-free 1-800-824-9294 (outside CA.)
1-800-824-6706 (in CA.)

Sophia
systems™

U.S. & European Headquarters: Sophia Computer Systems, Inc., 3337 Kifer Road, Santa Clara, CA. Tel.(408)733-1571 Fax.(408)749-8172 95051.
Corporate Headquarters: Japan, Sophia Systems Co., Ltd. NS Bldg. 2-4-1, Nishishinjuku, Shinjuku-ku, Tokyo 163. Tel.(03)348-7000.



PASCAL FOR THE IBM PC

BY NAMIR CLEMENT SHAMMAS

Which one you choose depends on your specific needs and experience

In this review I will survey four Pascal packages for the IBM PC: Microsoft's MS-Pascal, Pecan Software Systems' enhanced version of UCSD Pascal, Prospero Software's Pro Pascal, and MetaWare's Professional Pascal. Information on Borland's Turbo Pascal is taken from "Turbo Pascal 3.0" by Mark Bridger (February BYTE) and is included only in the comparative tables and in the benchmarks.

MS-PASCAL

The three-pass MS-Pascal version 3.31 compiler from Microsoft lets you include compiler directives in the source program or type them on the DOS command line while invoking the first pass. There is no built-in editor in the system. The second and third passes are invoked from DOS without any parameters and use files created by previous passes. You can initiate the compile and link process from a DOS batch file.

The current versions of Microsoft's C, FORTRAN, and Pascal compilers allow the interlinking of object code files among them. The linker comes with its own set of directives that affect such linking and code-generation processes as memory allocation, overlay manipulation, and the use of a default library name. If you are linking programs that have considerable floating-point operations, you can select from a number of floating-point support libraries to consistently use or avoid the 8087 chip, the IEEE floating-point standard, or an alternative representation (see table 1).

MS-Pascal supports the standard data types (boolean, char, integer, and real). It has five integer subtypes: short integer (-127 to 127), byte (0 to 255), standard integer (-32,768 to

32,767), the unsigned integer word (0 to 65,535), and the long integer4 (from minus to plus 2 billion). Floating-point types include the standard real, the explicit single-precision real4, and the double-precision real8.

The single and multidimensional super array data types have undefined upper bounds. When you declare a variable in the var section, you must specify the upper array bound. Pointers to super arrays, however, might delay specifying the upper limit until the new() procedure is called. This procedure allocates dynamic data structures and should define the upper array limits. The predefined functions upper() and lower() allow program access to these limits.

There are two types of strings: string variables, which may vary in length from 1 to 32K bytes (no default), and lstring variables, which may contain up to 256 characters. The difference between them is due to their internal data structures: a string is simply an array of characters, while an lstring contains a length field followed by a string of characters.

Numeric constants in MS-Pascal can be of any base from 2 to 36, enabling the use of binary, octal, decimal, and hexadecimal constants. You can also define constants by using expressions that involve other previously declared constants or as array or record structures (see table 2).

MS-Pascal also implements the value section, a program area in which you can initialize defined vari-

ables and assign each of them one or more attributes to instruct the compiler on how to handle and store them and how to define their status between routine calls.

The compiler supports the standard Pascal for . . . do,

while, and repeat . . . until loop constructs as well as two additional loop control statements. The break statement provides an exit from the current loop, while cycle lets you skip the rest of the current loop iteration and resume processing at the next iteration.

MS-Pascal also supports the standard if and case constructs, and case is extended by the catch-all otherwise clause. Conditional (Boolean) expressions are evaluated sequentially. The tested expression is written as a series of and then or or else subtests. Once an and then subtest is found to be false, the remaining subtests are not evaluated. Similarly, once a subtest in an or else clause is found to be true, further evaluation is terminated.

Functions and procedures can contain attributes that direct compiler-generated code. These include forward (for forward referencing), extern and public (for external referencing), origin (for subprogram addressing), fortran (for multilanguage interfacing), interrupt (for hardware interfacing), and pure (for optimizing). MS-Pascal also contains a large library of functions and procedures that provide such services as data-file system access, dynamic variable allocation, data conversion, mathematical functions, extend- and system-level intrinsics, string manipulation, heap man-

(continued)

Namir Clement Shammass (4814 Mill Park Court, Glen Allen, VA 23060) is a freelance writer and columnist for several microcomputing magazines.

agement, and semaphore routines. There are no routines to support high-resolution graphics, cursor and screen control, or windows, but such support is available elsewhere.

MS-Pascal version 3.31

Type
Language compiler

Company
Microsoft Corporation
16011 Northeast 36th Way
P.O. Box 9097017
Redmond, WA 98073-9717
(800) 426-9400

Format
Two double-sided, double-density 5¼-inch disks

Computer
IBM PC, PC XT, or PC AT with PC-DOS 2.0 or later, 256K bytes of memory, and two floppy disk drives; 8087 math coprocessor chip optional

Documentation
Two three-ring manuals: a 359-page user's guide and a 392-page reference guide

Price
\$300

The language supports readable ASCII and binary data-file structures. MS-Pascal has three file access modes: sequential, direct (random access), and terminal (similar to sequen-

UCSD Pascal version 4.2.1

Type
Language compiler and environment

Company
Pecan Software Systems Inc.
1410 39th St.
Brooklyn, NY 11218
(800) 637-3226 (outside NY)
(800) 457-3226 (NY only)

Format
Three double-sided, double-density 5¼-inch disks; PC-DOS 2.0-compatible disk format

Computer
IBM PC, PC XT, or PC AT with a minimum of 128K bytes of memory, two double-sided disk drives, monochrome or color display, graphics adapter, and PC-DOS 2.0 or later; 8087 math coprocessor chip optional

Documentation
594-page bound manual

Price
\$99.95

tial but used with printers and terminals).

MS-Pascal provides support for modular program development through modules (programs that have no body but contain functions and procedure declarations) and units (more evolved libraries composed of the interface and implementation sections). The interface section declares the exported routines by the unit. It also contains the constants, types, variables, procedure and function headings, and optional unit initialization. The implementation section contains the complete routine's definition as well as those of local routines (see table 2).

UCSD PASCAL

UCSD Pascal version 4.2.1, with its environment and operating system, runs on top of the MS/PC-DOS operating system. You use the PSYSTEM.COM file to boot the p-System; however, the MS-DOS DIR command won't catalog the contents of p-System volumes. The environment consists mainly of the built-in editor, compiler, linker, filer, DOS files, assembler, debugger, monitor, and program driver.

The Edvance editor is a single-file built-in editor. Beyond the normal cursor movement, text modification, and text formatting capabilities, the editor has two buffer-management commands to extend the file buffer and write parts of it to a disk file. The editor lets you create a new function or macro by recording a sequence of keystrokes. Moreover, the program can read such functions from the text. Nested editing is also permitted.

The UCSD Pascal compiler translates source code into either p-code (by default) or native code (by using a compiler directive). You can include a number of directives in the source code to permit actions such as conditional compilation, I/O checking, index range checking, determination of single- or double-precision floating-point representation, or quiet compilation to prevent displaying compilation progress information. Other versions of the compiler produce code using the 8087 chip and a library that supports BCD math. When the compiler detects an error, you can choose

Pro Pascal version 2.14

Type
Language compiler

Company
Prospero Software
190 Castelnau
London SW13 9DH, U.K.
Telephone: 01-741 8531

Format
Two double-sided, double-density 5¼-inch disks; PC-DOS 2.0-compatible disk format

Computer
IBM PC, PC XT, or PC AT with a minimum of 80K bytes of memory and 200K bytes of disk storage; 8087 math coprocessor chip optional

Documentation
220-page three-ring manual

Price
\$390

Professional Pascal version 2.5

Type
Language compiler

Company
MetaWare Inc.
412 Liberty St.
Santa Cruz, CA 95060
(408) 429-6382

Format
Seven double-sided, double-density 5¼-inch disks

Computer
IBM PC, PC XT, or PC AT with 227K bytes of memory, a minimum of 1.5 megabytes of hard disk storage (2.5 megabytes recommended), and PC-DOS 2.0 or later; 8087 math coprocessor chip optional

Documentation
500-page three-ring manual

Price
\$595

from a number of alternate courses of action such as resuming compilation to catch more possible errors, halting the compiler, invoking the editor to point to the offending text location, and sending the error messages to the printer.

The linker enables you to link assembly language routines into a UCSD Pascal compilation. You can also link native code routines together. When you compile a source program into executable code, you need not explicitly invoke the linker; the compiler will automatically call it (see table 1).

The standard scalar data types (boolean, char, integer, and real) are supported. Long integers are available and can be defined as integer[*n*], where *n* is an unsigned integer representing the number of digits to a maximum of 36. You can use real data types as single- or double-precision numbers, depending on the compiler directive invoked. UCSD Pascal also has predefined string data types with default and maximum lengths of 80 and 255 characters, respectively (see table 2).

Procedures and functions can use the forward attribute for forward referencing, passing parameters by value or reference. The language supports conformant single- and multidimensional arrays. The lower and upper range of each array dimension is assigned to variables whose type is indicated after the range expression in the form array [*low* . . . *high*; *type*] of *type*. Within the functions and procedures, you access the array limits through the upper() and lower() special variables. The language also implements loops and decision-making constructs without language extensions.

UCSD Pascal supports single micro-processor pseudoconcurrent processes. These processes must be global to the program and cannot be declared within other procedures and functions; nested processes are not allowed. You use the procedure start to initialize each concurrent call. Each process triggered must have a processid, priority, and stack size assigned to it. Process synchronization is carried out by using the predefined

Table 1: General information about the four compilers discussed, as well as Borland's Turbo Pascal.

	MS-Pascal	UCSD Pascal	Pro Pascal	Professional Pascal	Turbo Pascal
Version	3.31	4.2.1	2.14	2.5	3.0
Native code	Yes	Yes	Yes	Yes	Yes
P-code	No	Yes	No	No	No
Number of passes	3	1	3	1	1
Linker	Yes	Yes	Yes	No	No
Assembler	No	Yes	No	No	No
Debugger	No	Yes	Yes	Yes	No
Built-in editor	No	Yes	No	No	Yes
Syntax-oriented editor	N/A*	No	N/A*	N/A*	No
Requires hard disk to run	No	No	No	Yes	No
Price	\$300	\$99.95	\$390	\$595	\$69.95

*Not applicable.

type semaphore and a number of predefined procedures. A semaphore monitors the number of processes waiting in a queue and an integer count. The seminit procedure initializes the semaphore and the count number. You use the procedures signal and wait for interprocess synchronization; both take a semaphore as an argument. A concurrent process can associate hardware interrupts with a semaphore using the procedure attach.

The compiler allows both sequential and random access binary-formatted I/O operations, but only sequential ASCII-formatted file structures are permitted. Untyped file I/O is supported, block I/O is performed through blockread and blockwrite, and device I/O is also implemented.

UCSD Pascal contains five units that perform a variety of important tasks including advanced screen control, I/O redirection and program chaining, turtle graphics, accessing IBM PC hardware features, PC-DOS file access, and data segment access.

PRO PASCAL

Of the four packages reviewed, Pro Pascal version 2.14 adheres most closely to the ISO standard Pascal, but with a number of language extensions. The main package components include a compiler, linker, symbolic debugger, and librarian; the compiler's components include two utility programs, a cross-reference gen-

erator, and a configurator. It has no built-in editor.

To select a library for inclusion in a compilation, you must first make a copy of it and name that copy PASLIB.OBJ. The three-pass Pro Pascal compiler automatically chains to the linker if it finds the PASLIB.OBJ library. Otherwise you must explicitly link the object code file with a selected library. You use a linker switch to perform selective linking with only those routines that are referenced in the program. You can invoke the linker—or the compiler—in its interactive mode by not entering an object filename. In addition to prompting for the object filename, the linker will also ask you a number of questions concerning stack size, creation of a module map, a public and external routines map, a segment map, and overlays. The four available run-time libraries correspond to the four possible combinations of supporting small or large memory models and running with or without 8087 support (see table 1).

Pro Pascal supports the following basic data types: boolean, char, integer, real, long real, and string. The integers are implemented as long integers with values ranging from minus to plus 2 billion. Long reals have a wider value range (1.1^{-308} to 3.6^{308}) and use 16-digit precision; reals have 7-digit precision and range from 5.9^{-39} to 6.8^{38} ; strings have a maximum size

(continued)

Table 2: A comparison of the various available data types, program components, and special features.

	MS-Pascal	UCSD Pascal	Pro Pascal	Professional Pascal	Turbo Pascal
Binary constants	Yes	No	No	Yes	No
Octal constants	Yes	No	No	Yes	No
Hexadecimal constants	Yes	No	Yes	Yes	Yes
Structured constants	Yes	No	No	No	Yes
Short integers					
(-127 through 127)	Yes	No	No	No	No
byte (0 through 255)	Yes	No	No	No	Yes
Unsigned integers					
(0 through 65,535)	Yes	No	No	Yes	No
Long integers	Yes	Yes	Yes	Yes	No
address	Yes	No	Yes ¹	Yes ¹	Yes ¹
Absolute variables	Yes	No	No	Yes	Yes
Double-precision reals	Yes	Yes	Yes	Yes	No
8087 support	Yes	Yes	Yes	Yes	Yes ²
BCD reals	No	Yes	No	No	Yes ²
Extended reals	No	No	No	Yes	No
Enumerated types	Yes	Yes	Yes	Yes	Yes
Subrange types	Yes	Yes	Yes	Yes	Yes
Set types	Yes	Yes	Yes	Yes	Yes
Open arrays	Yes	Yes	No	No ³	Yes ⁴
Conformant arrays	Yes	No	No	No	No
Procedural types	No	No	No	Yes	No
Functions return					
structures and arrays	No	No	No	Yes	No
Maximum string size	32K	255	255	64K	255
Bit/byte manipulation	Yes	No	No	Yes	Yes
Byte/character					
manipulation	Yes	No	No	Yes	Yes
case with else clause	Yes	No	Yes	Yes	Yes
Concurrent processes	No	Yes	No	No	No
DOS call	Yes	No	Yes	Yes ⁵	Yes
High-resolution graphics	No	Yes	No	No	Yes
Iterators and extended					
for loops	No	No	No	Yes	No
In-line machine code	No	No	No	No	Yes
Interrupts	Yes	No	No	Yes	Yes
Labeled loops	No	No	No	Yes	No
Macro preprocessor	No	No	No	Yes	No
Procedure/function					
parameters	Yes	Yes	Yes	Yes	No
Screen/cursor control	No	Yes	No	No	Yes
String manipulation	Yes	Yes	Yes	Yes ⁵	Yes
User-definable operators	No	No	No	Yes	No
Window support	No	Yes	No	No	No
64K-byte code/data limit	No	No	No	No	Yes
Chaining	No	Yes	Yes	No	Yes
Export abstract data					
types	No	No	No	Yes	No
Modules	Yes	No	No	Yes	No
External routines	Yes	Yes	Yes	Yes	Yes
include files	Yes	Yes	Yes	Yes	Yes
Overlays	Yes	No	Yes	Yes	Yes
Segmentation	No	Yes	Yes	Yes	No
unit libraries	Yes	Yes	No	No	No

¹ As a function.

² Option available through a special version.

³ Feature available through pointers.

⁴ Limited to strings.

⁵ Imported from external available libraries.

of 255 characters. Pro Pascal uses the usual string-manipulation routines and supports the FORTRAN-like common declaration to make variables available to other segments (see table 2).

Functions and procedures follow ISO standard Pascal. Thus, you can pass parameters by value or by reference; Pro Pascal also supports functional and procedural parameters. The compiler contains the forward and extern directives and has additional procedures and functions including routines to chain programs, link overlays, PEEK, and POKE. It also supports standard loops and decision-making constructs. The case statement allows the otherwise clause.

A special library of external routines performs port I/O, makes calls to the operating system, and lets you perform error handling. The compiler has procedures that help a "parent" program start executing a "child" program. While the child program is running, the parent program is on hold. When the child program terminates, the parent program can resume execution. You can have nested child processes, and there are procedures to terminate those processes and free the memory space they used.

Like other Pascal implementations, Pro Pascal supports ASCII and binary file structures and has random and sequential access for binary-formatted files and sequential access for text files. It also allows an applications program to append data to the end of an existing sequential file. Other routines let an applications program rename and delete a file, return a file's file-control-block address, and verify a filename.

PROFESSIONAL PASCAL

Professional Pascal version 2.5 has some interesting language extensions influenced by Ada and Modula-2. It supports the 8087 chip and includes a number of utilities to handle various tasks such as console I/O, heap management, interrupts, sorting, string-manipulation procedures, and operating system services. It requires a hard disk and has no built-in editor.

You can choose from five memory

(continued)

Family Affair

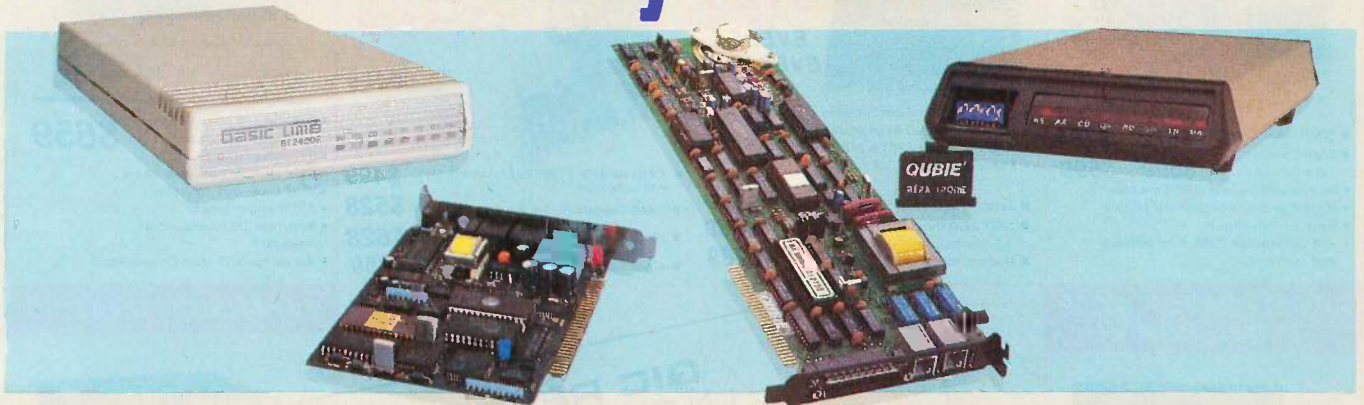

Choose from a family of 4 modems -- the 1200 baud modems at \$139 & \$149, and the 2400 baud modems at \$299 -- that offer unbelievably great performances and make you wonder why everyone else charges so much!

2400 Band Modems

Internal Modem: Modular Phone Cable, Mounting Bracket, COM1 or COM2, Asynchronous Communications
External Modem: AC Power Adapter, Stand Alone Enclosure, Status Indicator LEDs, Asynchronous Or Synchronous Communications
Both Units: Hayes Compatible Command Set, CCITT V.22/V.22 bis and Bell 212A Compatible, 110/300/600/1200/2400 bps Operation, Automatic Adaptive Equalization, IBM PC Hardware Compatible, Two RJ-11C Jacks (Alternate Voice/Data Communication)

1200 Band Modems

Internal Modem: Two Jacks, Line Input and Phone Jack, RS-232 Port COM1 or COM2, Speaker with Volume Control
External Modem: 8 Status Indicator Lamps, Snap Off Front Switch Panel, Speaker with Volume Control
Both Units: Bell 103/212A 300/1200 Baud, Fully Hayes "AT" Command Set Compatible, Modular Phone Cord, PC-TALK III Software

Pedigree

You can be sure that the Qubie' family of modems are of good stock. Our latest editions, the 2400I Internal Modem Card and 2400E External Modem are proof positive what good breeding can accomplish. These state-of-the-art modems are CCITT V.22/V.22 bis, Bell 212A Compatible, and 2400/1200/600/300/110 bps.

Our modems are fully compatible with all Hayes software commands. Software packages such as Crosstalk, Smartcom II, and Sidekick will work flawlessly. Both the 2400I and 2400E are equipped with Automatic Adaptive Equalization which automatically adjusts to the telephone line and increases performance and decreases the error rate.

The 2400I Internal Modem Card fits into any expansion slot, as it is a compact half-card modem. It's designed specifically to operate in the IBM Personal Computer PC/XT/AT family and compatible computers. The rear panel has two RJ-11C modular telephone jacks for the telephone line and the telephone set. The modem can be set for COM1 or COM2. The 2400I modem allows asynchronous communications with remote computers and other data terminal equipment over standard voice grade telephone lines. The 2400E External Modem offers the user asynchronous or synchronous communications. The 2400E is en-

No Risk Guarantee

If you are not completely satisfied with your purchase, you may return it within 30 days of purchase for a complete refund, including the cost to send it back. If you can get any dealer or competitor to give you the same **No Risk Guarantee**, buy both and return the one you don't like.



For fastest delivery, send cashier's check, money order, or order by MasterCard/Visa. Personal Checks allow 18 days to clear. Company purchase orders accepted, call for prior authorization. California residents add 6% sales tax.

closed in a slimline plastic enclosure. The front panel displays the eight modem status indicator lights. It works on any computer or terminal with an RS-232C serial port.

Siblings

Not to be forgotten are our 300/1200 baud modems. The Internal Modem Card is designed for the PC, PC/XT and most compatibles; it occupies one full length slot and the internal speaker lets you know the call progress. An RS-232 serial port is standard, COM1 or COM2; you can use the port for other peripherals when the modem is not being used. Our External stand alone modem can be used with any computer or terminal which utilizes an RS-232C serial port. It also comes with 8 status indicator lamps and a snap off front panel that allows for quick setting of the switches for all types of communication packages. At \$139 and \$149, these are the best price/performance modems for most communications.

What's In A (Sur)Name?

Everything, if it's a Qubie' supported product. We at Qubie' stand behind what we sell. Our 30-Day "No Risk Guarantee", our one year warranty and 48 hour turnaround on warranty repairs are proof that our products are of the highest quality.

QUBIE'

Department B
 507 Calle San Pablo
 Camarillo, California 93010

Inside California
 805-987-9741

Outside California
 800-821-4479

London (01) 223-4569
 Paris (01) 321-5316

Sydney (02) 579-3322
 Canada (403) 434-9444

Hours: M - F 8 am - 5 pm PTZ Sat 8 am - 12 am PTZ

Inquiry 298

TAPE BACKUP

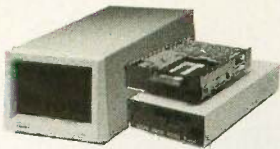

- | | | |
|-----------------------------|--------------|--------------|
| | External | Internal |
| ■ 60MB Tape Backup | \$879 | \$794 |
| ■ 20MB Cassette Tape backup | \$699 | \$599 |
- Backup 20MB in less than 5 minutes
 - Image/file-by-file backup and restore
 - Menu driven software
 - Interchangeable DMA, port address and interrupt

MODEM

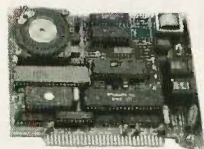

\$128
EVEREX EVERCOM

- Comes with Bit-Com Software
 - 1/2 size 300/1200 Baud Modem
 - Fully Hayes, Bell 103 & 212 compatible
 - Supports Com 1, 2, 3, & 4
- | | |
|------------------------------------------|--------------|
| ■ External 300, 1200 Baud | \$189 |
| ■ 1200/2400 Baud internal 1/2 size modem | \$289 |
| ■ Modem, multifunction card | \$289 |

HARD DISK

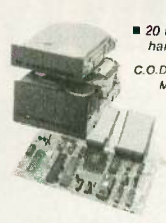

■ 20 MB Seagate 1/2Ht. hard disk (with controller)
C.O.D. VISA MC only **\$369**

Company Terms **\$429**

- | | |
|---------------------------------------------------------|--------------|
| ■ 30MB seagate 1/2Ht. hard disk (65 Ms) with controller | \$499 |
| ■ 20MB Seagate full Ht. hard disk (40 Ms) | \$528 |
| ■ 30MB Seagate full Ht. hard disk (40 Ms) | \$628 |
| ■ 40MB Seagate full Ht. hard disk (40 Ms) | \$759 |

TURBO XT

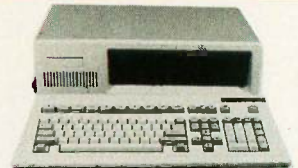

- 8088 CPU (4.77 and 8 MHz keyboard switchable)
 - 8 Expansion slots
 - 640K Memory on Motherboard
 - 360K Drive with controller
 - 150 W power supply
 - Keytronic 5151-compatible keyboard
 - Socket for 8087 Math Co-processor
- \$659** FCC Class 'B'

ACCELERATOR 80286 TURBO BOARD



- Runs with IBM PC, XT and compatibles FCC Class 'B' Made in USA
 - With the Turbo card, your PC will run 7 times faster than IBM, PC, XT or 33% faster than 6 MHz IBM AT
 - 16 bit 80286 design
 - Accepts optional 80287 Math Co-processor
- \$399**

AT MULTIFUNCTION



- QIC multifunction AT (OK)
 - Hold up to 2 MB (64K or 256K)
 - 1 parallel, 2 serial and 1 game port
 - Come with chip tester, RAM disk and spooler program
- \$179** FCC Class 'B' Made in USA

PC/XT MULTIFUNCTION



- Serial port
 - Software
 - Game port
 - Expandable to 384k
 - Clock/Calendar
 - Parallel port
- \$95**

HD/FLOPPY CONTROLLER



- Western Digital Chipset
 - Control 2 hard disks and 2 floppy drives
- \$169** FCC Class 'B' Made in USA
- AT Version (16 bit) **\$149**

FLOPPY DRIVE



- Teac/Fujitsu/Toshiba
 - 1/2 Ht. size
 - High Reliability
 - Low Power Consumption
- 1.2 MB **\$135**
- 360K **\$95**

CHIPS



- 256K RAM (150 ns) **\$27**
- 64K RAM (150 ns) **\$9**

KEYBOARD



- Keytronic 5151 style keyboard
 - IBM PC/XT, AT compatible
 - 95 keys keyboard • LED lights
- \$88**

QIC EGA



- IBM EGA compatible
 - 640 x 350, 16 colors
 - 720 x 348 mono
 - 640 x 200 color
- \$249**

EMS BOARD



- Expandable up 2MB
 - Compatible with IBM, PC/XT
 - Fully socketed with parity check
 - Lotus/Intel/Microsoft compatible
- \$139**

MONO & I/O CARD



- Hercules compatible graphics
 - Monochrome high resolution 720 x 348
 - Parallel printer port • Game port
 - Serial communication port
- \$139**

POWER SUPPLY



- PC, XT compatible 135W **\$79**
- 4 Power leads for drives 150W **\$89**
- Reliable



QIC RESEARCH INCORPORATED

QIC-286-QT

INCREDIBLE MACHINE

INCREDIBLE PRICE

Thousands of systems installed proven reliable



Made in the U.S.A.

\$1125

Quality is what we stand for.

Special dealer and corporate discount.

- Fully IBM AT compatible, runs all major software
- 80286 CPU, 6/8 MHz clock calendar
- 512K RAM on mother board, expandable to 1024K
- 1.2MB or 360K floppy disk drive
- Combined floppy/hard disk controller
- AT style keyboard
- 192W power supply
- 8 Expansion slots
- Clock/calendar with battery backup
- Documentation and setup program
- FCC Class 'B' approved

EXPANSION CHASSIS



- \$429** FCC Class 'B' Made in USA
- Compatible with AT, XT and PC
 - 0 wait state, work with any video display card and multifunction card
- | | |
|--------------------------------------|--------------|
| 3 sizes | Power supply |
| • Full size, 8 slots | 130W |
| • 1/2 size, 4 slots | 75W |
| • slimline, 3 long and 1 short slots | 70W |

QIC MONOGRAPHIC



- 720 x 348 Resolution
 - Hercules compatible
 - Runs Lotus 123 Graphics
 - Printer Port
- \$95**

QIC COLOR CARD



- IBM Color Card compatible
 - 16 colors, 640 x 200 resolution
 - RGB and composite output
 - Parallel Printer Port
- \$95**



QIC RESEARCH INCORPORATED
753 Ames Ave.
Milpitas CA 95035

800-843-0806 (Sales)
(408) 942-8086 (CA)
Tech support (408) 942-0856
Dealer and Quantity discount are available

QIC Research of Chicago
1926 Waukegan Rd., Suite 3A
Glenview IL 60025
(312) 998-8903

Seagate, Tandon, Hercules, Hayes, Bell, IBM are trademarks of their respective companies

Policy:
Returned items must be as-new, not modified or damaged, with all warranty cards, manuals and packaging intact. Returned items must be shipped prepaid and insured, and must bear a QIC return Authorization (RA) on the shipping label. Call QIC Customer Support Department for RA. No credit issued after 30 days from date of shipment

models of the compiler, depending on the size of your source programs. You can invoke compiler directives either directly from the DOS level or as Ada-like pragmas (directives embedded in the source text). Professional Pascal has no linker of its own and uses Microsoft's; however, a macro preprocessor is available (see table 1).

Professional Pascal supports all the standard Pascal data types as well as the following scalar types: cardinal, or unsigned integer (inspired by Modula-2), long integer, and long and extended real. Thus, three floating-point types are provided. While their actual precision is machine-dependent, it can be expressed as real \leq longreal \leq extreal. Strings have a maximum size of 65,535 characters. When you declare string variables, you must define their corresponding sizes in parentheses. This requirement is dropped when you declare string-typed parameters in the formal argument lists of procedures and functions. Thus, routines can handle strings of varying lengths.

Numeric constants can be represented in nondecimal bases: The available range is from 2 to 16, thus enabling the use of binary, octal, and hexadecimal in addition to decimal and constants. You can also use constant expressions wherever constants are expected (see table 2).

You can initialize variables in a value section, which is similar to MS-Pascal's. The compiler offers typecasting, a C feature, to direct the data type of an expression. It is useful for controlling the results of expressions involving different types of integers. You can retype variables with an external pseudofunction that helps to get around Pascal's strong typing. Expressions can contain the assignment operators, thus permitting multiple assignments such as $x := y := 1.23$ among compatible types. There are also many operators for pointers and addresses including addition, subtraction, and a set of logical comparison operators ($=, <, >, <=, >=, <=$). The declaration block is borrowed from Ada and allows you to declare temporary variables inside the body

(continued)

The Great Expanse

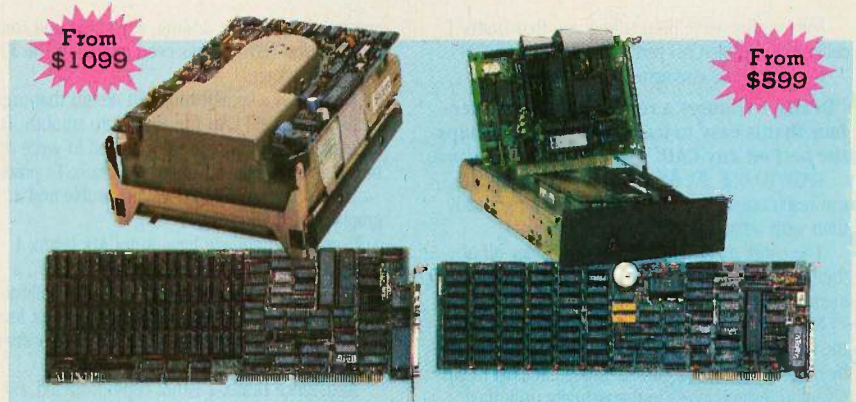

Turn Your Basic PC Or XT Into A Powerhouse With A Qubie' XTKit. Our 1-2 Punch Lets You Create The Ultimate (And Affordable) Enhanced AT.

AT Enhancement Kits

ATK-1 BT42 & AT4X4Plus (512K) \$1099
ATK-2 BT42 & AT4X4Plus (1Mb) \$1199
ATK-3 BT42 & AT4X4Plus (2Mb) \$1299
 42 Megabyte Drive, Runs All The Popular AT Software, 40 Msec. Access Time, Voice Coil Driven Heads With Closed Loop Servo Positioning, Full-Height Unit, Heads Automatically Retract

XT Enhancement Kits

XTK-1 PC20 & BT6Plus (384K) \$599
XTK-2 PC42 & BT6Plus (384K) \$1199
 BT6Plus With 384K Memory, Serial And Parallel Ports, Clock/Calendar, BTDRIIVE And BTSPool Software, 5.25" Controller, 20 Or 42 Megabyte Hard Disk, Cables, 1dir Software And User's Manual

IMMENSE

Your AT is no toy -- it's a serious piece of computing equipment which requires the finest in peripherals to unleash its power and potential. Qubie' ATKits are the solutions to turning an unenhanced IBM AT or compatible into a supercharged system which will run circles around the IBM "Enhanced" Models.

A powerful AT needs a hard disk with the capacity and the speed to supply data fast. Our BT42 hard drive has a formatted capacity of 42 megabytes and 30 msec. access time. Also included is the "Dreamboard" -- the AT4X4Plus. It has up to 4 megabytes available, a parallel and serial port standard, with 3 more serial ports optional.

SCOPE

Savvy buyers have long been aware that they can save money by buying a single-drive PC or XT and add their own

multifunction card and hard disk. Now you can get the power you need at a price you can afford. The BT6Plus has all the features you expect of a multifunction card; 384K of memory, serial and parallel ports, battery-powered clock/calendar and optional game port (\$20). You also get print spooling and RAM disk software. The Qubie' PC20 hard disks offer the best available combination of performance, ease of installation, and reliability. 1dir software completes the kit.

DISTANCE

We really go the distance for you at Qubie'. But don't just take our word for it. Our exclusive **30-Day No Risk Guarantee** speaks for itself. Our top notch technical support staff is here to answer any questions you might have during installation or operation. With our one year warranty, your satisfaction is assured; but if anything should breakdown, our 48-Hour turnaround on warranty repairs will have you back up in no time.

No Risk Guarantee

If you are not completely satisfied with your purchase, you may return it within 30 days of purchase for a complete refund, including the cost to send it back. If you can get any dealer or competitor to give you the same **No Risk Guarantee**, buy both and return the one you don't like.



For fastest delivery, send cashier's check, money order, or order by MasterCard/Visa. Personal Checks allow 18 days to clear. Company purchase orders accepted, call for prior authorization. California residents add 6% sales tax.

QUBIE'

Department B
507 Calle San Pablo
Camarillo, California 93010

Inside California
805-987-9741

Outside California
800-821-4479

London (01) 223-4569 Sydney (02) 579-3322
Paris (01) 321-5316 Canada (403) 434-9444

Hours: M-F 8am - 5pm PTZ
Sat 8am - 12pm PTZ

Drafix 1: The experts agree.

For months we've been telling you that Drafix 1 delivers incredible CAD performance for only \$295. Now someone else agrees — the experts.

"Drafix 1 features a remarkable user interface that is easy to learn and use — perhaps the best on any CAD."

-PC Magazine

EASY TO USE. We designed Drafix 1 so anyone can reach one-to-one productivity far more quickly than with other CAD software.

The entire menu hierarchy is on display all of the time so there's no searching, backtracking or memorizing required.

Snap-mode options are continually shown on the left screen border and can be selected on the fly by mouse or single keystroke. And roll-down menus give you instant access to the virtually unlimited drawing, display and editing options.

"Drafix 1 is more than most people will ever need and costs an order of magnitude less than a full copy of AutoCAD (\$2,750)."

-PC Magazine

POWERFUL FEATURES. Feature for feature, Drafix 1 offers all the 2-D CAD capabilities of the expensive programs such as AutoCAD 2.5. In fact, many features which were recently added to AutoCAD such as multiple colors and linetypes per layer, drawing ellipses and polygons, exploding a

symbol and rotating, scaling, stretching and trimming objects have always been offered in the \$295 Drafix 1 package.

Drafix 1 is a breakthrough in design that organizes sophisticated CAD functions into smooth, fast, accessible operations. You don't need to write or buy macros to take advantage of Drafix 1's power.

If you have an IBM PC or compatible and a graphics card you're ready to go.

Even if you already have AutoCAD, Drafix 1 is still a smart buy because we offer "OTTO", a Drafix/AutoCAD file exchange utility. This allows you to expand your design capacity for a lot less money and take advantage of applications software providing the DXF format.

And, since Drafix 1 is not copy protected, no special hardware locking devices are required.

"Undeniably the best CAD buy in town."

-PC CADD, A Buyer's Guide

NEW DOTPLOTTER OPTION. Drafix 1 is even a better buy with the new Drafix DotPlotter utility which eliminates the need for expensive pen plotters.

It allows you to use your dot matrix printer or laser printer for high resolution hard copy output. You can print to fit or to scale, in landscape or portrait orientation and can even print a large drawing from multiple pages.

For the cost of a copy of AutoCAD, Drafix 1 with the new DotPlotter option gives you an entire workstation.

"At \$295 Drafix 1 is a steal."

-Architectural Technology

A NO-RISK, TOTAL SOLUTION. Thousands of users have tried us and agree. And you can get an even better bargain by taking advantage of our low-cost Drafix CAD-Kit with options.

Buy the Drafix 1 with mouse for just \$395. Or choose the digitizer solution you need and get the entire package for as low as \$595. Our Kurta Series One pads offer an integrated power supply and exceptionally small footprint with active areas ranging from 8 1/2"x11" to 12"x12" to 12"x17".

Whatever you decide you can't lose with our 30-day money back guarantee.

Use our toll-free number and any major credit card to order your copy of Drafix 1 today.

The experts call us the "best bet for affordable CAD." All it takes is \$295 to draw your own conclusions.

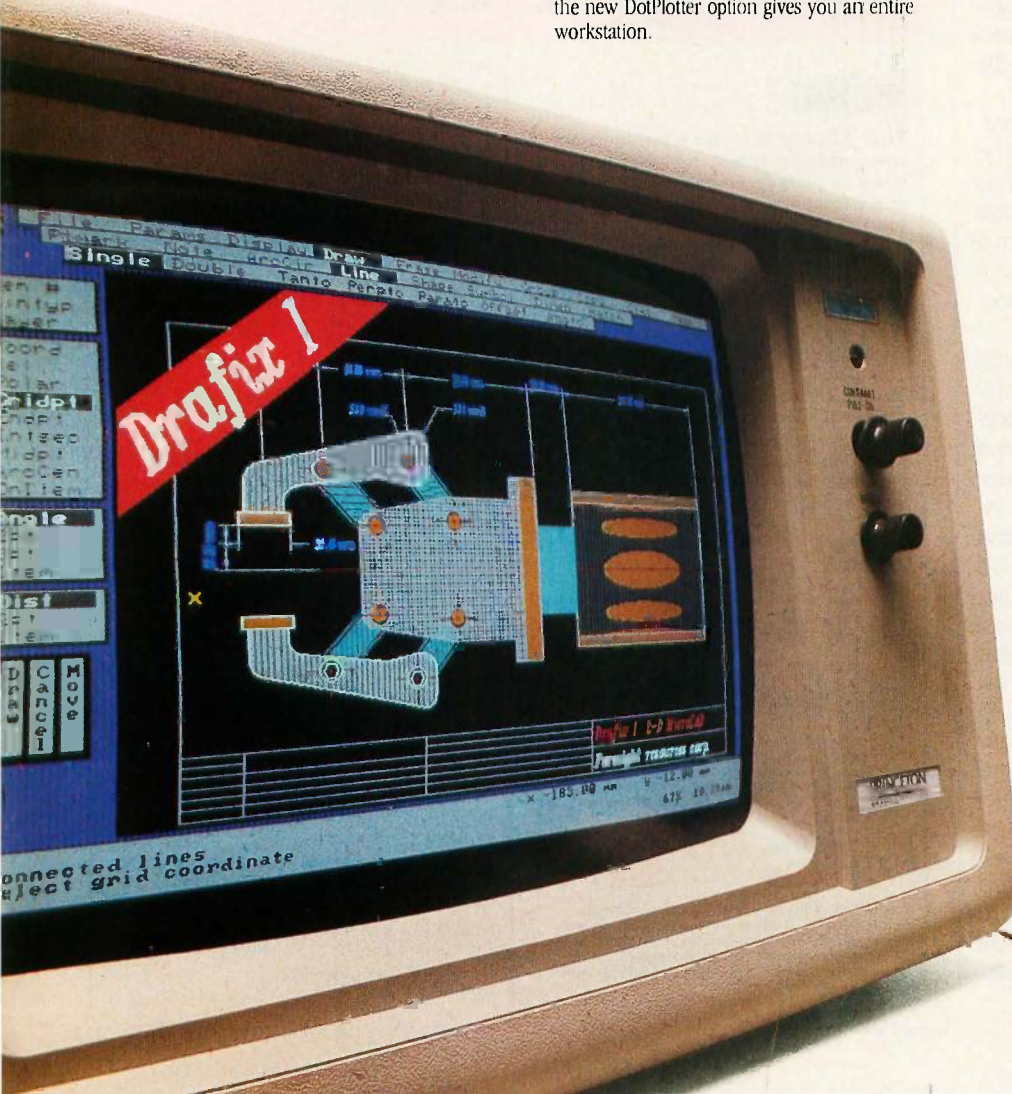

Order Now! Call Toll-Free!
1-800-231-8574
Ext. 150

- Drafix 1** \$295
- Drafix 1 with Mouse**
Systems Field Mouse \$395
- Drafix 1 plus Kurta digitizer**
Kurta 8 1/2 x 11 Series 1 \$595
Kurta 12x12 Series 1 \$795
Kurta 12x17 Series 1 \$895
- Drafix DotPlotter**
(high resolution
graphics dot matrix
printer output) \$ 45
- Drafix 1 Large Plot**
(D & E size plotting
capability) \$150
- OTTO** (AutoCAD file
exchange utility) \$ 95
- Symbol Libraries**
Architectural \$ 80
Mechanical \$ 80
Engineering \$ 80

Check, money order, Visa & MasterCard accepted. Dealer inquiries welcome.

FORESIGHT
RESOURCES CORP.

932 Massachusetts
Lawrence, KS 66044
913/841-1121

Inquiry 135 for End-Users.
Inquiry 136 for DEALERS ONLY.

REVIEW: PASCAL FOR THE IBM PC

of the program or routine.

Professional Pascal supports standard Pascal loops and two loop-control statements. The first statement, cycle, is used in the for, while, repeat, and iterator loops to bypass the remaining portion of the loop and continue with the next iteration. The second, break, is used to exit a loop altogether. Loop and block statements can have names that may follow the break statement to indicate where the program resumes. This is useful in providing nested loops with a single exit.

The case construct is similar to standard Pascal's except that it can contain the otherwise clause. You use the and then construct in sequential logical tests so that the right operand is not evaluated unless the left one is true. By contrast, the or else construct does not evaluate the right operand unless the left is false. You can use these operators to avoid error-prone expressions; for example, $i < > 0$ and then $j/i > 5$ avoids the division-by-zero problem.

The compiler implements a powerful Ada-like feature: user-defined unary and binary operators. A set of symbols lets you create a new operator symbol; it can include as many symbols as you wish. Professional Pascal also introduces a new kind of routine called the iterator, which is a very powerful extended for loop.

The language supports the Modular 2 procedure type and allows functions to return any data type. It has a special syntax to distinguish between intermediate function values appearing on the right-hand side of an assignment and recursive function calls. It also performs parameter association during routine calls by using either positional association or the Ada-like named-parameter association. Procedures and functions can handle arrays of varying sizes. To accomplish this, Professional Pascal uses a different approach than that of the other packages reviewed: Procedures and functions access the arrays with pointers.

Professional Pascal supports all the standard Pascal intrinsics except pack and unpack in addition to the

(continued)

The Only EGA

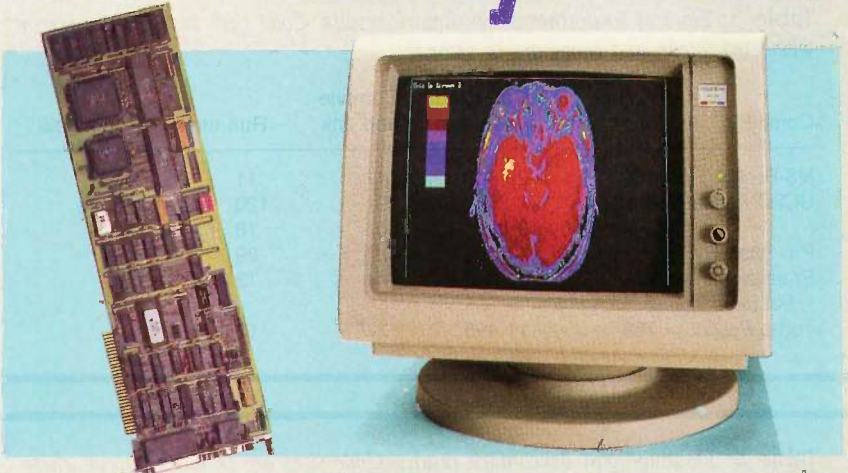

A fully compatible 256k EGA card with a parallel port for only \$259. If you buy any display card: Color, Monochrome, Hercules, or EGA, without reading this ad, you're probably throwing away a lot of money.

BT/EGA Enhanced Graphics Adapter: 256k of memory, and parallel printer port. Works with all standard IBM displays, and compatible displays.
5150 Monochrome Display: Both text and 640x350 bit mapped graphics.

5153 Color Display: 640x200 and 320x200.
5154 Enhanced Display: Color 640x350 16 simultaneous colors from a palette of 64.

A Clear Upgrade Path

This really is the only display board you may ever need. Regardless of what monitor you buy today, this card is a clear upgrade path for the future, and the best choice today, even if you are only going to use a Monochrome Display. This means one board today does monochrome 640x350 bit mapped graphics and text, and provides a clear upgrade path to 640x350 Enhanced Color Display with no change of display board. It also runs with the 640x200, 320x200 Color Display.

Killer Features

All boards come with a full 256k of memory, and a parallel printer port. That means no extras for later, and 16 simultaneous colors displayed from a palette of 64 colors, and crisp clear text on both Mono-

chrome and Enhanced Color Displays - features or options that are not available on other EGA boards. Since all your current software will run, you're set for today, and prepared for the standard of the future.

The Display Deal

Of course many of you will want to take advantage of the EGA card right away, so we are offering a special deal when you buy the board together with a Basic Time HR 31-350 monitor - you get both for just \$749, or the card only for \$259. This means that you can equip all your PC's now and in the future with displays and EGA cards and get the Qubie "No Risk Guarantee", our one year warranty, and 48 hour turnaround on warranty repairs. The price is the whole price, there are no extras for freight, insurance, or credit cards.

No Risk Guarantee

If you are not completely satisfied with your purchase, you may return it within 30 days of purchase for a complete refund, including the cost to send it back. If you can get any dealer or competitor to give you the same No Risk Guarantee, buy both and return the one you don't like.



For fastest delivery, send cashier's check, money order, or order by MasterCard/Visa. Personal Checks allow 18 days to clear. Company purchase orders accepted, call for prior authorization. California residents add 6% sales tax.

QUBIE'

Department B
507 Calle San Pablo
Camarillo, California 93010

Inside California
805-987-9741

Outside California
800-821-4479

London (01) 223-4569 Sydney (02) 579-3322
Paris (01) 321-5316 Canada (403) 434-9444

Hours: M-F 8am - 5pm PTZ
Sat 8am - 12pm PTZ

Table 3: Sieve of Eratosthenes benchmark results. Code sizes are in bytes (except where indicated), and times are in seconds.

Compiler	Source code size	Compiled code size	Compile and link	Run time	Comments
MS-Pascal	768	29,600	54	11	
UCSD Pascal	4 blocks	2 blocks	19	129	p-code
		3 blocks	50	18	native
Pro Pascal	768	11,008	42	29	
Professional Pascal	768	21,646	74	12	
Turbo Pascal	768	11,495	2.7	13	

Table 4: Floating-Point benchmark results. Code sizes are in bytes (except where indicated), and times are in seconds.

Compiler	Source code size	Compiled code size	Compile and link	Run time	Comments
MS-Pascal	384	36,894	64	4	PASCAL.LIB
with 8087		29,708	63	4	8087.LIB
		36,878	66	4	MATH.LIB
MS-Pascal	384	31,946	65	12	ALTMATH.LIB
without 8087		29,954	65	10	DECMATH.LIB
UCSD Pascal	4 blocks	2 blocks	17	36	p-code
		3 blocks	43	4	8086/8087
Pro Pascal	384	5120	43	4	code
		5888	47	10	with 8087
Professional Pascal	384	16,782	75	2.5	without 8087
		21,566	86	18	with 8087
Turbo Pascal	384	10,334	2.0	7	without 8087
		11,485	2.6	33	with 8087

Modula-2 increment, decrement, and set-include and -exclude procedures. The maximum and minimum functions can take more than two arguments. The lower and upper bounds of an array are returned by the lowest and highest functions, respectively. These functions also work with types and sets.

The compiler supports both ASCII and binary-file structures and allows random and sequential access for binary files but only sequential access for ASCII files. The random access record-seeking procedure permits long integers to be used as record numbers, thus extending the range of allowable records from 65,535 to 2 billion.

Professional Pascal implements Ada-like library units, called packages, which can export constants, data

types, variables, procedures, and functions to other programs. You can export abstract types in which the detailed structures are kept hidden from other programs, a feature from Ada and Modula-2. There is a special syntax to specify the items exported, thus localizing all others. Client programs (those being exported to) can also be selective of the items they import, just as in Modula-2.

BENCHMARK TESTING

I carried out the Sieve and Floating-Point standard BYTE benchmarks on all four Pascal compilers using an IBM PC XT with a 10-megabyte hard disk, 512K bytes of memory, an 8087 chip, and PC-DOS 3.1. I used batch files to compile and link those implementations running under PC-DOS, except Turbo Pascal, and timed them accord-

ingly. All compile and run times, except those for UCSD Pascal, were based on using a hard disk; UCSD Pascal was run on floppy disks. All the compilers processed the benchmark programs without error. (Some minor listing modifications were made.)

Pro Pascal generated the smallest fully compiled programs, followed by Turbo Pascal; MS-Pascal yielded the largest programs, with Professional Pascal in second place. UCSD Pascal generated a very small amount of code, which may be attributed to the presence of I/O routines in the UCSD kernel.

In compile and link speed, Turbo Pascal maintained a marginal lead. UCSD Pascal, while producing tight p-code, is the second fastest—and on floppy disks, not a hard disk like the others. Professional Pascal was the slowest.

The execution speeds indicate the strong and weak points in the compilers examined. MS-Pascal is fastest in the Sieve, with Professional Pascal and Turbo Pascal a close second and third, respectively (see table 3). In the Floating-Point test with the 8087 chip, Professional Pascal comes in first, with Turbo Pascal last (see table 4).

CONCLUSION

As you can see, there is no single best choice among these compilers: They all have their merits. As with most choices in the computer industry today, it all depends on your needs and on your skill level. MS-Pascal is suitable for large software projects and for intermediate and advanced programmers; UCSD Pascal puts program execution speed at practical and desirable levels. Pro Pascal's adherence to the ISO standard makes it easy to learn and use for novices and intermediate-level users; Professional Pascal appeals to language fans who enjoy features from other languages and it is suitable for large software projects. Turbo Pascal, even with its 64K-byte limitation, is practical and attractive to programmers at all levels of expertise. The comparative tables within this review can help you to weigh the options and determine which of these compilers is the best one for you. ■

PRINCETON LS-300— LET YOUR PC SCAN NEW HORIZONS

Scan text, images and graphics into your IBM PC or compatible as fast as 12 seconds per page at full 300 dpi resolution.

The compact Princeton LS-300 Scanner is versatile, easy to use and appropriate for desktop use. You can also team the LS-300 Scanner with the new Princeton LM-300 Print Preview Monitor and save time by viewing a full page before you print.

A Wide Range of Applications The LS-300 helps you increase productivity in a variety of applications. With hardware dithering for gray levels, you can combine photographs and illustrations with reports or proposals. You can produce desktop publishing materials with extra visual impact. And, because the LS-300 reads virtually any page, you can scan in documents that can be sent at full 300 dpi resolution for facsimile transmission, or stored for future use.

To convert typewritten pages into editable text, an OCR option is available.

A High Resolution Image Scanning at 300 dpi, the LS-300 gives you the same resolution as the output of a quality desktop laser printer. It also maintains compatibility with your EGA software and display.

IBM Compatibility, Princeton Reliability The Princeton LS-300 is designed for use with your IBM PC/XT/AT or compatible... its attractive price includes adapter card, cable and software. What's more, you can depend on the LS-300 to keep on working because it features built-in Princeton quality and durability.

See Your Dealer for a Demonstration

If you're ready for a versatile desktop scanner that can help you increase your productivity, see your Princeton Dealer today for a demonstration. Or call for more information.

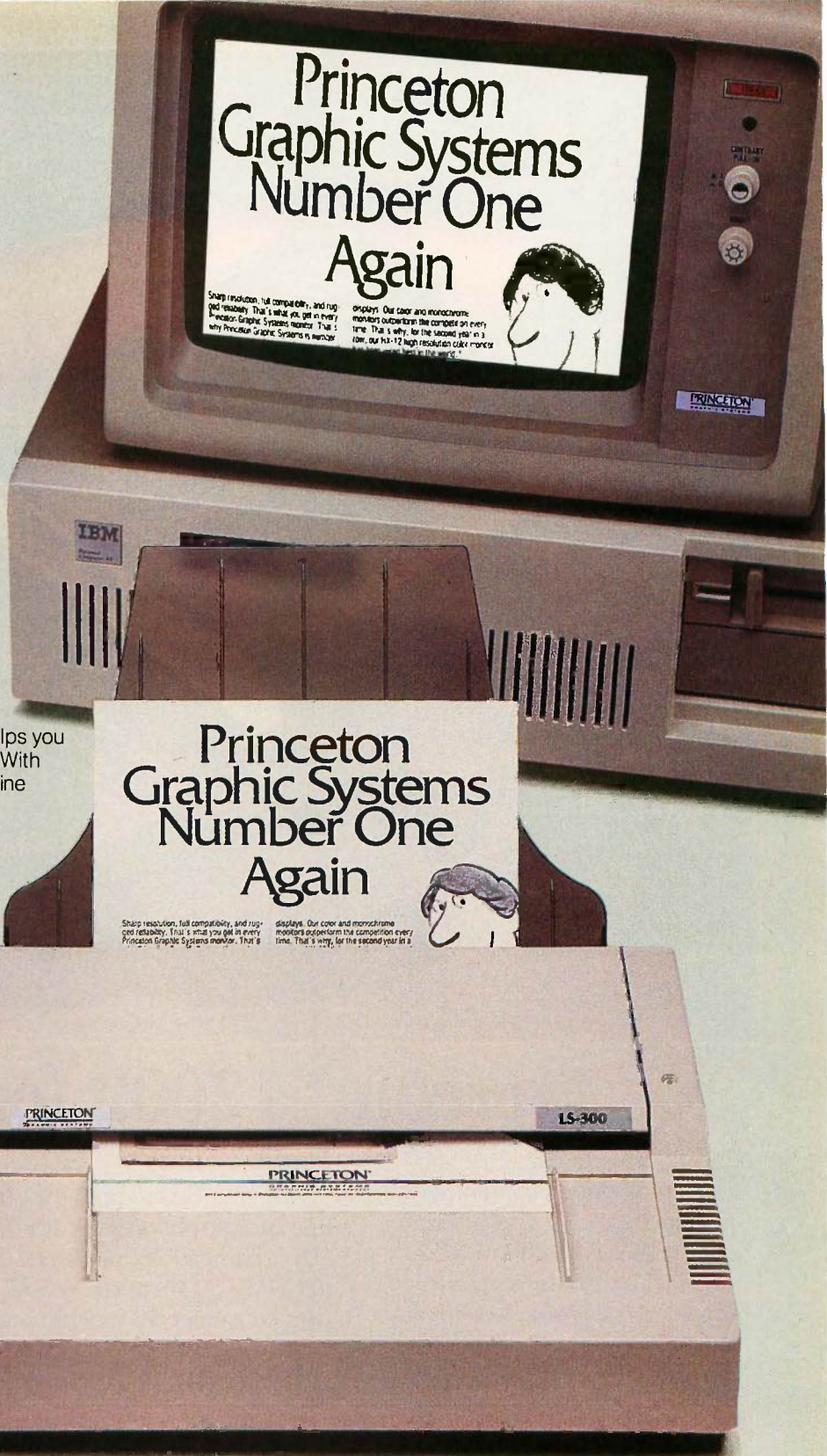

PRINCETON®

GRAPHIC SYSTEMS
AN INTELLIGENT SYSTEMS COMPANY

601 Ewing Street, Bldg. A, Princeton, NJ 08540.
800-221-1490 (Extension 80), 609-683-1660 (NJ only), Telex 821402 PGS PRIN.

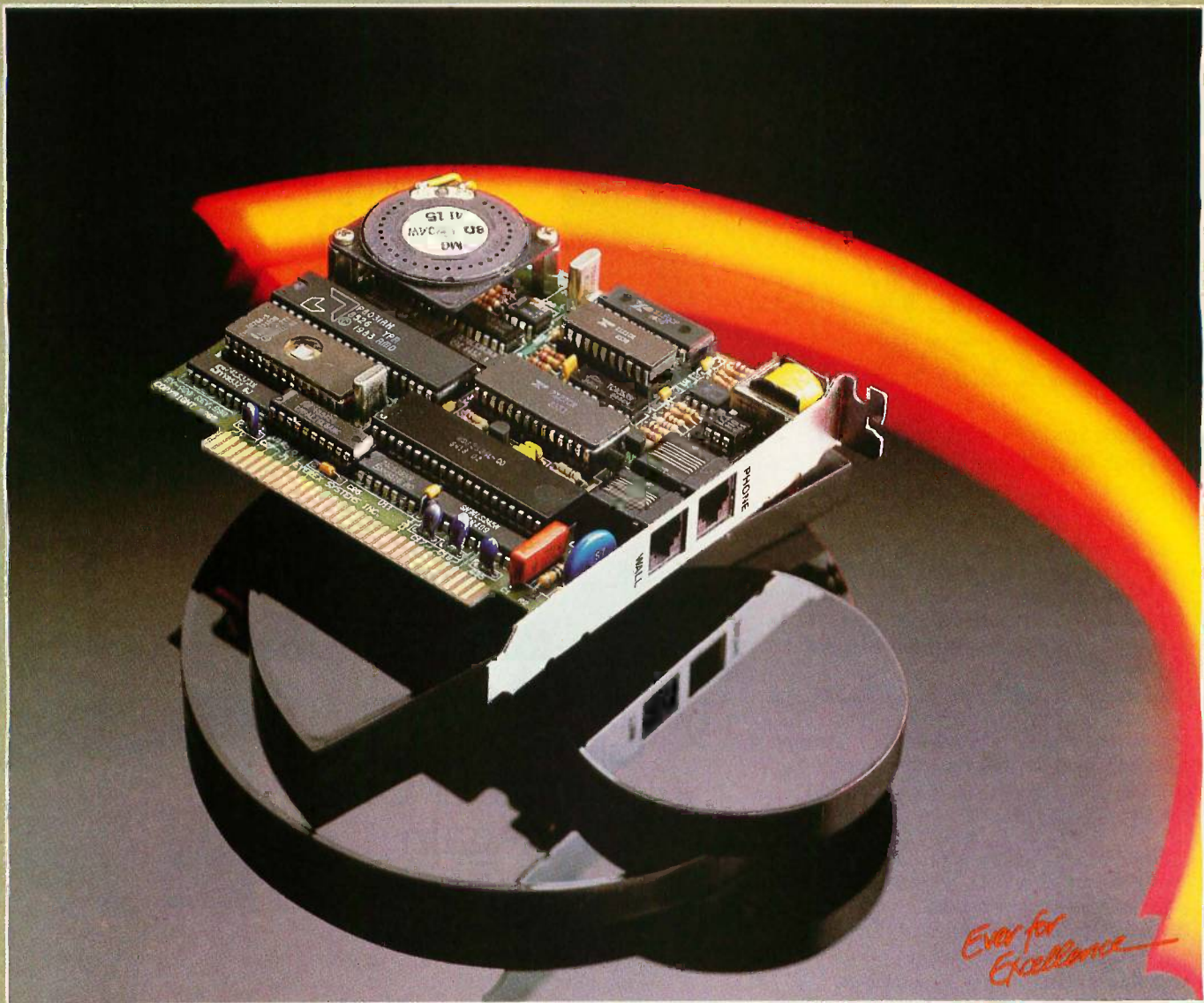

Evercom™ 1200B for Every PC!

Innovative engineering and state-of-the-art technology have produced a winner from Everex! Evercom is now a household item with thousands of satisfied customers enjoying its benefits.

Features Plus

It connects to both the phone line and the phone itself. It is fully Hayes compatible and can be set to COM1-COM4 ports. Various user conveniences include auto-

matic receiver "off-hook" detect, call progress monitoring and auto data-to-voice switching.

The Software Partner

Bitcom™, a powerful menu-driven communications program remembers up to 32,000 phone numbers. Call us today for the name of your local Everex dealer.

Before you buy a modem, check these features:

	EVEREX LEADING EDGE	
	EVERCOM	MODEL "L"
• Hayes AT compatible	YES	YES
• 300/1200 baud	YES	YES
• Software Volume control	YES	NO
• Simplex communication for noisy lines	YES	NO
• Automatic data-to-voice switching	YES	NO
• Telsset off-hook detect	YES	NO
• ROM test on command	YES	NO
• Speed mismatch message	YES	NO
• DTMF timing control	YES	NO
• Works in slot 8 of XT	YES	NO
• Runs with all versions of Smartcom II	YES	NO

1-800-821-0806

in California

1-800-821-0807

EVEREX
EVER for Excellence

48431 Milmont Dr. Fremont CA 94538
(415) 498-1111



STELLA

BY STEPHEN B. ROBINSON

Modeling and simulation software for use with the Macintosh

STELLA is a modeling and simulation program for the Macintosh developed by High Performance Systems Inc. STELLA, which stands for Structural Thinking Experiential Learning Laboratory with Animation, lives up to its name in an outstanding manner.

STELLA allows you to take your ideas about the way something works and make these ideas concrete, understandable, and testable. The program transforms general thoughts into a simple, logical, structural diagram. The user's guide refers to STELLA as a conceptual Lego set, which is an accurate description.

You can easily test and modify models in a variety of ways to obtain more refined models as well as a better understanding of the models. In this sense, STELLA is better than a Lego set because the model doesn't have to be torn apart to be tested and improved.

STELLA's Animation feature allows you to watch the parts of a structural diagram change and develop during a test run. This gives you a good feel for how the parts work in relation to each other. STELLA also has useful graphing features. The graphs, tables, and animation provide you with a variety of ways for gaining an understanding and intuition for a model.

FEATURES

STELLA is designed to model and simulate dynamic systems, that is, systems that move or change with passing time. This includes a very broad range of problems, particularly in the physical and social sciences. Some examples might include epidemics, soil erosion, effects of management policies, and population growth. One example included in the user's guide that I found particularly interesting

because it dealt with some abstract concepts in very concrete terms was a case study in which a previously successful company was losing its most talented managers to competing firms. Using STELLA, the firm was able to recognize the contributing factors and make changes that encouraged and retained talent. In this situation, STELLA's abstract concepts, called converters, were used to build an accurate model of the company and its policies.

AUDIENCE

You don't have to be a mathematician or a programmer to create a useful model with STELLA because the program handles all the difficult mathematics on its own.

STELLA is menu-driven and is no more difficult to use than MacWrite or MacPaint. The commands are straightforward, and only the most technical commands require a complete explanation in the user's guide.

STELLA models are quite lucid. If one user develops a good system model, then it is easy for other users to understand and test that model. The logic of the structural diagram and the visual appeal of the graphs and animations make a model very easy to follow. In this sense, STELLA is a wonderful tool for workbooks, lectures, or presentations. Just as a word processor can enhance productivity, STELLA can help you deal with problems more productively by fleshing out a useful working model of a dynamic system.

Unfortunately, the current version of STELLA will not let you export structural diagrams, tables, graphs, or equation lists for use in other applications. With these features, STELLA would attract a more general audience. [Editor's note: A preliminary version of a STELLA update has these features. In the future, therefore, it may be possible to use tables in your spreadsheet programs or transport structural diagrams to MacPaint. High Performance Systems also plans to add more built-in features to future versions. These may include net present value, delay, integer, linear projection, percent, and other statistical functions.]

MODELING AND SIMULATION

STELLA has four basic building blocks: stocks, flows, converters, and input links. The stocks and flows represent the skeleton of a structural diagram. Stocks represent places where items accumulate, and flows determine how quickly items pass into and out of a stock.

Imagine a model of population growth in America. You might start with one stock and two flows: The stock would represent people, the inflow would represent the birthrate and immigration into the U.S., and the outflow would represent the death rate and emigration out of the U.S.

Converters and input links provide the logical connections that complete a structural diagram. Converters represent factors that might affect flows, while input links are simply arrows that show how the other building blocks are related. Using the population-growth model, two useful

(continued)

Stephen B. Robinson (2874 South Palisades Ave., Santa Cruz, CA 95062) is a graduate student at the University of California at Santa Cruz.

STELLA 1.1

Type

Modeling and simulation software

Company

High Performance Systems Inc.
13 Dartmouth College Highway
Lyme, NH 03768
(603) 795-4122

Format

Two 3½-inch disks (one program disk and one example disk)

Computer

512K-byte Macintosh or Macintosh Plus

Documentation

A User's Guide to STELLA, 115 pages

Price

\$200

verters might be Average__Family__Size or Average__Lifetime. If Average__Lifetime is determined by the number of people and available resources, then there should be an input link from the stock, People, to the converter, Average__Lifetime, and an input link from Available__Resources to Average__Lifetime.

STELLA makes very good use of the Macintosh system to draw these structural diagrams. Using the mouse, you can easily move and connect the parts of a simple or complex diagram in various ways. Several useful features help with the picture-making. Pinning helps keep input links from crossing other parts of the diagram. Using this feature is similar to using pushpins and yarn on a map. Ghosting is another helpful feature. You can create a ghost image of an important model part, move it to a less cluttered area, and enhance the structural diagram around the model part.

After drawing the structural diagram, you must define the basic relationships between diagram parts. STELLA will then arrange the more difficult computational mathematics in the background. You can define

relationships in several ways: You can draw them on a graph, write them in an equation, or define them using conditional statements with IF, THEN, ELSE, AND, OR, or NOT as keywords. STELLA even checks to make sure that the definitions are consistent with the structural diagram that you draw. For example, in the population-growth model, Death Rate might be defined as People/Average__Lifetime. Before allowing this definition, STELLA would require that you draw input links from People and Average__Lifetime to Death Rate. If you draw an input link from Available__Resources to Death Rate, then STELLA requires you to include Available__Resources in the definition of Death Rate. This definition could be refined as you understand the system better and take more factors into account.

The combination of a structural diagram and the basic definitions of its parts constitutes a complete model. Now you are ready for simulation and testing.

The first step, creating graphs and tables, isn't difficult. All you have to do is choose the variables to be graphed, set the scale or approximate limits of the graph values, and then run the simulation. Any one or several of the variables can run against time or each other.

STELLA has several very helpful features for simulation. Autoscale puts the model through all or part of a test run to determine the best limits for values on a graph. In the Specs menu, the Computation Method and Simulation Time features let you adjust accuracy and speed according to the needs of the model.

Also in the Specs menu is Animate What. This feature allows you to select which parts of the structural diagram will be animated. Setting the scale for the animation is identical to setting it for a graph. Animated stocks look like tubs that fill and empty as items flow in and out at different rates. The other animated model parts resemble dials with little arrows that move inside the model part as values change. Watching these during a test run is helpful, although the graphs are more reliable for exact information.

To test the stability and realistic

qualities of a model further, the Built-Ins list has features such as Pulse and Step. These features let you introduce disturbances in the model to see how it will react. For example, in the population-growth model, if in one particular year the U.S. had an influx of one million unexpected war refugees, how would that affect future population? Also, what if the government decided to double the immigration limit permanently? These would be Step increases. These testing features make STELLA a versatile and powerful laboratory for testing your model.

The process of building, testing, and modifying a model has two major results. First, the model can become an increasingly accurate and sensitive tool. Second, you gain an extended intuition and understanding of the system.

LEARNING STELLA

Learning to use STELLA well is mostly a matter of practice. Fortunately, STELLA's manual, *A User's Guide to STELLA*, is reasonably well written and provides an opportunity for sufficient practice. It contains a handful of good modeling workshops; guidelines for conceptualization, equation formation, and testing; a list of useful generic flow structures (basic model shapes that are used frequently); and some friendly advice. For me, learning to use STELLA became a short course in systems dynamics.

CONCLUSIONS

With practice and ingenuity, STELLA can become a remarkably flexible tool. STELLA's writers even mention not having used some of STELLA's built-in functions for defining relationships between model parts, but they were included for those interested modelers who may one day need them.

I expect that STELLA will become a valuable tool in a variety of situations for businesses and organizations that want to understand and improve their own operations, for education as a laboratory and a workshop for ideas, and for users with good ideas that they want to test and improve upon. ■

It's not just *having* 640K... it's what you can *do* with it.



Better
BASIC

More than simply accessing full memory, BetterBASIC expands the *usefulness* of BASIC. Comparing it to other BASICs, Ted Mirecki of PC Tech Journal wrote, "*BetterBASIC promises the best of all possibilities: near-total compatibility with BASICA, plus advanced enhancements that depart from BASIC's simplicity but give the language many of the capabilities of PASCAL and C.*" ©PC Tech Journal, June 1986, Ziff Communications Company

See for yourself. Simply run your GW-BASIC or PC-BASICA programs in BetterBASIC, or create new ones, and get the power, structure and flexibility you'd expect only from C or PASCAL, yet still in familiar BASIC syntax. BetterBASIC also gives you over 150 statements beyond standard Microsoft syntax.

On your IBM-PC or true clone, define your own modules for specific applications, such as Industry Dependent Functions, Hardware Drivers, Data Acquisitions, Robotics, etc., and define keywords in your own language.

BetterBASIC also makes your job easier with its on-screen editor, de-bugging capabilities which include all TRON commands, and a break-and-continue option. It supports IEEE Math, Graphics, Sound Statements, Interrupts, and many other functions.

Optional modules expand BetterBASIC even further: Virtual Memory Manager takes Array Memory to 4 Giga-Bytes; Runtime System creates stand-alone EXE files; 8087/80287 Math Chip Support increases math speed; Btrieve™ Interface permits building sophisticated data-base files; and, Decimal Math supports financial and accounting applications.

As we said, it's not just *having* 640K, it's what you can *do* with it.

For your convenience, BetterBASIC is not copy protected, and technical support and a bulletin board are available for all registered users.

BetterBASIC	\$199
Virtual Memory Manager	99
Runtime System	250
8087/80287 Math Chip Support	99
Btrieve Interface	99
Decimal Math	49
Sample Disk with Tutorial	10

Ask your dealer
or call to order: **1-800-225-5800**
In Canada, call 416-469-5244

Better
BASIC

BetterBASIC is a registered trademark of Summit Software Technology, Inc. IBM, PC, are registered trademarks of International Business Machines Corp. Microsoft is a registered trademark of Microsoft Corp. Btrieve is a registered trademark of SoftCraft Inc.

Summit Software Technology, Inc.™
106 Access Rd. Norwood, MA 02062



TGA mode (640 x 400)

Buy one. Get two free.

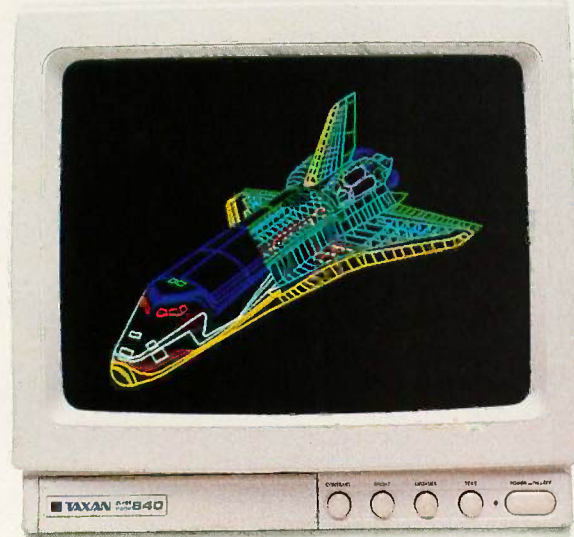

EGA mode (640 x 350)

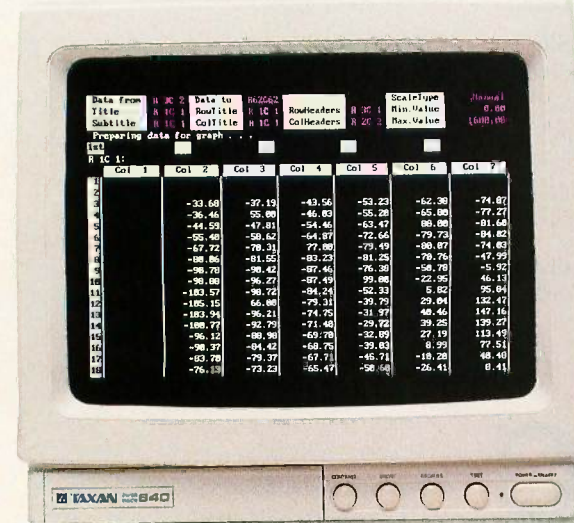

Improved CGA text mode

Sometimes life gives you less than you bargained for. Taxan would like to even that out a bit by giving you more than you'd expect—our Multi-Resolution System.™

Our display products not only give you EGA software compatibility, but also switch modes to CGA or TGA (640x400). This eliminates the hassles of swapping adapter cards or resetting internal switches. And, at the same time, it gives you three modes for the price of one.

Because of its ability to automatically switch modes, the Taxan Gold Card™ graphics adapter allows you to add new programs, with different display standards, to your software library without the worry of compatibility.

The Taxan Gold Card is also equipped with a built-in serial port. Making it easier to use mouse-driven software, like Windows, without buying a separate board or giving up valuable expansion slots in your PC.

Best of all, the Taxan Gold Card is designed to complement our high performance RGB monitors. Like the new large-screen model 840 or the improved models 635 and 650. The higher-than-industry standard horizontal scan rate of 25 KHz, and a doubled line count of 640x400 combine to give you sharp, clean text. Bright, clear colors. And crisp chart titles. All without annoying flicker.

Taxan's Multi-Resolution System is fully compatible with popular IBM and IBM-compatible PCs, including the AT&T 6300 and 6300 Plus.

Give us a call at your regional Taxan office for performance data on the Multi-Resolution product family. And remember that the best things in life are free.

Graphics Mode	
TGA	Ultra-high resolution (640 x 400)
EGA	IBM standard (640 x 350)
CGA	Double-scanned, high-quality image

RGB Monitor Applications	
Model 840	16-inch, large-screen CAD/CAM graphics. 0.39 mm dot pitch
Model 635	Superior text display and business graphics
Model 650	Personal CAD/CAM graphics. 0.28mm dot pitch

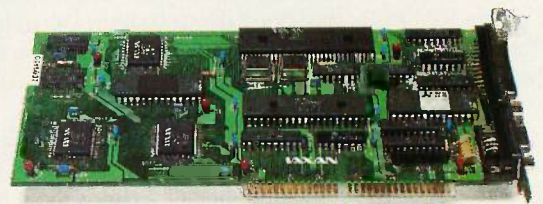

TAXAN

18005 Cortney Court, City of Industry, CA 91748
 Taxan East (201) 769-6500, Taxan Central (214) 550-1244,
 Taxan Midwest (312) 299-1060, Taxan West (818) 810-1291.

Multi-Resolution System and Taxan Gold Card are trademarks of Taxan USA Corporation.

Inquiry 408 for End-Users. Inquiry 409 for DEALERS ONLY.



FLASH-COM

BY BROCK N. MEEKS

An electronic mail and telecommunications software system

Flash-Com by Omni Computer Systems is an electronic communications system that contains four separate applications modules and two utilities. The program is copy-protected, but you can copy it and run it from a hard disk. The only requirement is that a master disk must always be in drive A.

The program's four applications are communications, a mailing list manager, a Store and Forward module, and a forms manager. The two utilities consist of a group of conversion programs for creating Flash-Com-compatible files and a large range of prepared business forms and form letters. For users who don't do much on-line work, this program seems over-qualified. It is more suitable for a corporate setting.

OPERATION

Once you boot Flash-Com's main disk, you can run all its functions from the main menu.

You handle all setup procedures with menus, prompts, and function keys. Novice users will appreciate the extensive use of menus, but advanced users may find them annoying. There is no way to shortcut these menus; no command mode is provided. Once you overcome the menu hurdle, you must get past the program's slow built-in "sloth" mode.

You must sit through a long wait after choosing any function from the main menu until the application appears on the screen. For example, Flash-Com took a full 12 seconds to enter the communications module from the main menu on my floppy-disk-drive-based system.

However, once the desired function is on-screen, the program shines. Flash-Com wasn't built for speed; it

was instead built to be a workhorse, which it does well.

COMMUNICATIONS

Flash-Com's emphasis is on electronic mail (E-mail) transfer. The program comes configured for use with many electronic message transfer systems including MCI Mail, EasyLink, The Source, Delphi, CompuServe, Instant Yellow Pages, and more. For most of these services, Flash-Com runs you through a step-by-step procedure for setting up what it calls a dialogue file, which stores all your unique information such as passwords and ID numbers. By using these dialogue files, your computer and modem execute an automatic log-on procedure.

For services that don't come pre-installed, such as Lockheed's Dialog, Flash-Com lets you set up a custom dialogue file. You can also define custom macro files. These macros permit the program to automatically manipulate the desired service in several ways, and they are an excellent means of handling redundant on-line tasks. For example, if you always read the same conferences on BIX, you could set up a dialogue file to first get you logged onto BIX. Then you could set up macros to automatically download all your BIX mail and any new comments that have been added to conferences you belong to. In addition, Flash-Com lets you send prepared text to these same services with its Post Batch Mail mode.

The Post Batch Mail mode is perhaps the most sophisticated ap-

plication of Flash-Com. After creating your text in batches (following a special format outlined in the documentation), you then assign a specific time when each batch-mail file is to be delivered. You can also stack batch mailings for delivery to several different on-line services.

At the appropriate time Flash-Com dials the service, starts the log-on procedure, and proceeds to deliver your batch mail. If you want to immediately deliver your batch-mail files, Flash-Com handles this as well. To send batch-mail files, your computer must be powered up for the entire time.

You can also set Flash-Com to a Receive Messages mode. In this mode your computer will accept incoming calls from a remote computer while it waits to send your batch-mail files. However, Flash-Com has no security measures for its mail modes. No passwords or account ID numbers are necessary.

The program's Traffic Log monitors all incoming and outgoing message activity and stores the results on disk. A quick scan of the Traffic Log confirms delivery of your batch-mail files and notifies you of any incoming E-mail.

If you don't need all this high-powered E-mail management, Flash-Com also offers a Terminal mode. This mode lets you interact with any type of system just as if you were using a generic telecommunications program. From Terminal mode you can download and upload files or type in comments from the keyboard. Both ASCII

(continued)

Brock N. Meeks (8383 Center Dr., Suite C, La Mesa, CA 92041) is a contributing editor for Profiles magazine. He is the winner of a Computer Press Association award for outstanding writing.

Flash-Com

Type

Electronic mail and telecommunications package

Company

Omni Computer Systems Inc.
Hearthstone Plaza
P.O. Box 162
Chestnut Hill, MA 02167
(617) 522-4760

Format

Three 5¼-inch floppy disks

Computer

IBM PC, XT, AT, or compatible

Features

Automated send/receive electronic mail, mass-mailing manager, forms generator, report generator, telecommunications package

Documentation

111-page hardbound user's manual

Price

\$299

and XMODEM transfers are available.

A curious hitch in the communications module is Flash-Com's inability to handle transfer rates above 1200 bits per second. My calls to Omni Computer Systems to confirm this were never answered. Transfer rates above 1200 bps are not discussed in the user's manual.

STORE AND FORWARD

The Store and Forward module sets up all the correct header and address information for your batch-mail files.

Because telex and E-mail formats differ from service to service, formatting messages for several different services can be confusing. One mistake in syntax could cause your whole batch file to bomb. Flash-Com eases the confusion by providing input templates for setting up message headers for the services it is configured for.

You can prepare text using either your regular word processor or Flash-Com's built-in word processor. A limited text editor is also available for use with each input template. This editor allows you to enter text in small amounts: up to 60 lines with up to 68 characters per line.

Flash-Com defines three different message files: an address message (SAM), a common text message (COT), or a text-insertion message (TIM). A SAM is a message that you write for one person only. A COT is a message designed for mass mailings; each addressee receives the same letter with information you insert that is personal for that individual. A TIM allows you to insert variables into the common text of a letter designed for mass mailings; this is useful for form letters.

MAILING LIST MANAGER

The Mailing List Manager module gives you a versatile way to handle several different mailing lists. You can use it with any previously created mailing list, or you can use it to create your own. An extensive data-entry template included for creating new mailing lists contains all the standard features of list management such as Add, Edit, Browse, Delete, and Sort.

A useful tool of the list manager is the Extract feature. Using Extract, you can pull out all the names from your master mailing list that meet a certain search criteria, for example, names in a particular zip code. You can store the resulting file to disk as a unique mailing list. You can then use this list with batch mailings that you set up with the Store and Forward module.

FORMS MANAGER

The Forms Manager lets you create forms that you can merge with text or send separately. Using the keyboard, you can draw horizontal and vertical lines or insert graphics characters with

a few keystrokes. Forms can be up to 150 lines with a maximum of 80 characters per line.

You can set up forms with data fields, such as account numbers or invoice numbers. You can merge the created forms with an existing database using a utility function. This allows you to send out filled-in forms without having to enter the data by hand.

UTILITIES

The program's utilities can process any prepared text into Flash-Com format (an ASCII file), merge unlimited document and data files to form a single file, convert existing mailing lists to Flash-Com-compatible format, and create reports.

Most of these utilities are simple to use. Instructions are included for handling data files from dBASE II, Lotus 1-2-3, PFS:File, and more. I easily transformed dBASE III files, although this is not mentioned in the user's manual. Flash-Com also easily handles combining different files into a single one.

Another handy feature is the program's ability to generate reports either from forms filled in via the Forms Manager or from any of the Flash-Com data files. Reports are limited to a single format and have no tabulation features. You can, however, specify report width and column titles and designate the order of column headings. This feature might be used by field representatives sending sales forms to the home office via modem. After the forms were received at the home office, someone could compile the results taken directly from the forms into a report format for quick perusal.

FORMS AND LETTERS

Flash-Com comes with over 30 different forms and letters on disk. You get everything from a client billing estimate letter to a Valentine's Day card. Each of these forms can be customized with your word processor or with the Forms Manager.

DOCUMENTATION

Flash-Com's documentation is sketchy in most places, disorganized, and not

REVIEW: FLASH-COM

well written. Only the barest of details are given for most applications. Although a hard-core telecommunicator shouldn't have any trouble making sense of the material, the package doesn't belong in the hands of a novice.

PROBLEMS

Here's a list of some of Flash-Com's problems:

- Although this program is great for batch-mail functions, it is less than desirable as a stand-alone communications package.
- To handle the various functions, you really need a hard disk. Using a floppy-disk-based system requires a disk caddy just for all the work disks required.
- Omni Computer Systems' telephone technical support, which costs \$100 to register for, is handled poorly. When I talked to the technical support people, I couldn't make any sense out of their answers. It seemed like they were bothered by the whole process and simply wanted to get off the telephone as soon as possible.
- The program's learning curve is steep. To build a well-oiled E-mail machine, you have to do some pretty extensive planning and experimenting. The payoff for your efforts, however, is tremendous.
- Error trapping was acceptable, but not fantastic. During one run my modem wasn't connected, and when the program was informed of this it simply locked up, refusing to recognize the modem. I couldn't break out and reset; a cold boot was necessary.

CONCLUSION

Flash-Com doesn't promise to make your communications problems disappear overnight. However, in the right hands and under the right set of applications, this program can do great things for a company or organization (and, in limited cases, an individual) that wants to make the best of the benefits of electronic message transfer systems. Although Flash-Com requires more investment in terms of your time than other communications packages, your efforts are well rewarded. ■

UNIX is a trademark of AT & T Bell Laboratories.

M680UX Series



A HARD ACT TO FOLLOW

SORD's M680UX Series sets a new standard in performance.

- * Operable with UNIX™
 - * Astonishing speed: use of 32-bit Motorola 68020 CPU
 - * Easy expansion: VME bus architecture.
- Also available on OEM basis.

SORD®

SORD COMPUTER CORPORATION
 Kyobashi K-1 Bldg., 2-7-12 Yaesu, Chuo-ku, Tokyo 104 Japan
 (03) 281-8130 New York: (212) 759-0140
 London: (01) 631-0787 W. Germany: (02161) 66-3077

For IBM® PC's, XT's, AT's and other DOS machines. This is the one you've heard so much about—with faster compile times than many COBOL compilers costing hundreds of dollars more! It's based upon ANSI-74 standards. Now comes standard with source code programs demonstrating full screen, cursor control, color, reverse video, etc., another program shows how to even reprogram your keyboard and much more.

Don't let our mail order prices fool ya! This is a new improved version of our best selling COBOL compiler previously offered at \$300.00 a copy. Look at the December 1979 issue of Byte Magazine for one of our first COBOL ads!

Other outstanding values at \$39.95 are: Utah FORTRAN, Utah BASIC, Utah PASCAL, Utah PILOT and Utah EDIT. Used by 50,000 professionals, students, and teachers in 40 countries.

To order:
 (702) 827-3030

IBM is a registered trademark of International Business Machines.

SINCE 1977
ELLIS COMPUTING™

Ellis Computing, Inc. • 5655 Riggins Court, Suite 10 • Reno, Nevada 89502

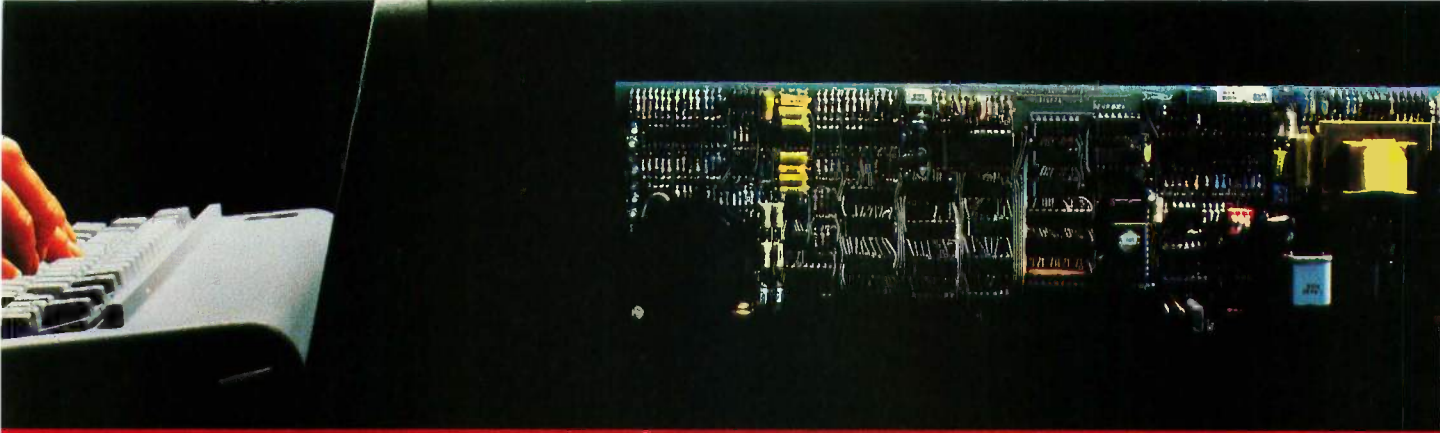

Error-Correcting 2400 bps Modems from Multi-Tech Systems:

When it has to be as good as it is fast

- Dial-up 2400 bps modems have arrived. More datacomm users are upgrading from 1200 to 2400 than ever before. But there can be a flip side to increased speed: More transmission errors.
- That's why our MultiModem224E™ offers MNP™ error correction. Available in our 2400 bps desktop, internal and rack-mounted modems, MNP gives you 100% error-free transmissions. No matter how bad the phone line. And MNP does it without the speed degradation of the less efficient, software-based protocols.
- Another important point: MNP Class 3 has emerged as an industry standard. It's now in the public domain, and has been implemented in virtually all 2400 bps modems that offer error-correction.

● So, why buy error-correcting modems from Multi-Tech? There are lots of good reasons, including:

1. Multi-Tech modems are 100% Hayes-compatible (more so than Hayes' own 2400 bps modems*). And our MultiModem224E with error-correction costs less than a Hayes Smartmodem 2400™ without error-correction.
2. Bonus features, like speed conversion. Both synch and asynch operation. And battery-backed option settings and phone number memory.
3. Versatility. The auto-dial/auto-answer Multi-Modem224E modems run at 2400, 1200 or 300 bps, with or without error-correction, and do so automatically.
4. A two year warranty that means something. Since Multi-Tech modems are designed and manufactured at our Minnesota headquarters (as they have been for the last sixteen years), you know we'll be here when you need us.

● Please call us toll-free, at **1-800-328-9717**, to get the rest of the reasons. And get a modem that's as good as it is fast.

**InfoWorld-8/5/85-reprints available*

Trademarks: MultiModem and the Multi-Tech Systems logo:
Multi-Tech Systems Inc. • MNP: Microcom Inc.
Smartmodem: Hayes Microcomputer Products, Inc.

MultiTech Systems

Inquiry 239 for End-Users.
Inquiry 240 for DEALERS ONLY.

The right answer every time.

Multi-Tech Systems, Inc. • 82 Second Avenue S.E. • New Brighton, Minnesota 55112 U.S.A.
1-800-328-9717 • 1-612-631-3550 • TWX 910-563-3610 (Domestic) • Telex 4998372 MLTTC (International)



TURBO PROLOG

Namir Clement Shammass's delight as a Pascal programmer with the typing of variables in his review of Turbo Prolog (September) does not change the fact that a typed Prolog can hardly be called a Prolog at all, for at least two reasons. First, the unification algorithm is the very heart of the language, and the typing of variables reduces that mechanism to a somewhat glorified value assignment. Second, and even more important, the basic idea of Prolog is the implementation of first-order logic as a programming language.

To do this, you somehow must deal with quantification. The Prolog solution is to assume universal quantification for all clauses and to substitute the existential quantifier by a naming convention called the Skolem function. Evidently, this works only if every variable can be instantiated with an arbitrary logical function of any item that is allowed as its value. Eliminating this possibility, Borland succeeded in implementing a logic without existential quantification.

This is only one of several severe faults with Borland's attempt to hack up some scraps and pieces of its Pascal implementation to some fifth-generation contraption, for example, the impossibility to assert rules, or the introduction of a clumsy string type instead of Prolog's elegant manner of representing strings as character lists.

If you or Borland should object to my calling this product "hacked up," I know of no other expression appropriate for a language implementation that hides the more interesting parts of its messages beyond the limits of a tiny window.

PETER SCHNUPP
Munich, West Germany

LEADING EDGE MODEL D PC

I own a Leading Edge Model D PC with a 20-megabyte hard disk drive and, for the most part, I agree with everything that Stan Miastkowski mentioned in his review (September).

Unfortunately, I have discovered a darker side to Leading Edge Hardware Products Inc. that is not mentioned in the review.

I agree that the company has produced

a good machine at a superb value. The problem is that the company's infrastructure is set up for sales with little time for service or support. It is perhaps misleading to point out that the company has an impressive 15-month warranty when minor repairs such as replacing a clock/calendar battery can take over two months.

There is more to a product than simply its hardware and software features. As I said in a letter to Leading Edge, I am using my Leading Edge Model D, but I fear the day that I have another hardware problem with my computer.

ROBERT S. WEBB
Providence, RI

FIVE LABORATORY INTERFACING PACKAGES

The review "Five Laboratory Interfacing Packages" by Patricia Wirth and Lincoln E. Ford (July) overlooks some of the capabilities of both Labtech Notebook and ILS.

Labtech Notebook is identified in table 2 as having no data manipulation or statistics capabilities, yet version 2.5 can perform both to some degree. An FFT option in the main menu will perform forward and inverse fast Fourier transforms on stored data. A curve-fit option allows the user to fit discrete data to linear, polynomial, exponential, and trigonometric models.

The table also indicates that only one graphics channel can be displayed at a time by the ILS package. In truth, data from several channels can be displayed simultaneously in separate windows as long as the data for each channel is available in sequentially numbered files.

NANCY A. WINFREE
Ann Arbor, MI

EXPEROPS5

Thank you for the review of ExperOPS5 (July). I thought that it was well written and accurate, given that it reviewed a 13-month-old version of the program. Most of the problems that William Jacobs mentioned were corrected in the August 1985 version of the program. For example, ExperOPS5 now offers standard use of the (^) operator, availability of ppwm and matches, time tags with wm, and the full

functionality of the strategy command. In addition, ExperOPS5 now has the build function.

ExperOPS5, as Mr. Jacobs states, is implemented on top of ExperLISP by Expertelligence Inc. Mr. Jacobs correctly points out that the version of ExperOPS5 with ExperLISP that he reviewed was incapable of supporting large expert systems. This shortcoming was due to a limit of 32K bytes of print-name and string space in earlier versions of ExperLISP; with version 1.51 of ExperLISP and the new large-memory Macintoshes, ExperOPS5 can indeed support large expert systems. Since ExperOPS5 uses the Rete algorithm, run-time performance remains acceptable for systems with large numbers of production rules.

As with most artificial intelligence tools, ExperOPS5 is under continuous development. A version of ExperOPS5 that is now being tested supports the development of distributed expert systems using multiple Macintoshes and a local area network; synchronously executing expert systems can add facts to the working memory of other expert systems. This version of ExperOPS5 also supports multiple working memory areas called perspectives; an expert system's production rules can reason with uncertain data by creating and maintaining separate hypothetical data areas.

MARK WATSON
La Jolla, CA

SPERRY PC/IT

I was truly impressed with Frederick D. Davis's review of the Sperry PC/IT (August). I was particularly impressed with the PC/IT's benchmark results. After reading the review, I became convinced that the Sperry PC/IT was the system for me. Kudos to Sperry, BYTE, and Mr. Davis for a job well done.

J. D. MILLER
Bath, ME ■

REVIEW FEEDBACK is a column of readers' letters. We welcome responses that support or challenge BYTE reviews. Send letters to Review Feedback, BYTE, One Phoenix Mill Lane, Peterborough, NH 03458. Name and address must be on all letters.

Backup reasons
for buying the
data cartridge
backup system
now.





You may or may not know the primary, basic reasons for choosing data cartridge technology for your backup.

It's easier to handle than big disks or boxes of floppies.

It stores more than any other method on your PC. Up to 150 megabytes in 5¼ inches of space.

It costs less per formatted megabyte of storage than any other removable mass storage for the PC user.

And most importantly, data cartridges have unsurpassed reliability over other media.

Relying on a second hard disk to do your backup, for example, is putting your faith in a medium that is famous

for losing data. Whether it's caused by operator error (of which there are many) or the fickle finger of fate, crashing is what hard disks do — what created the problem in the first place.

The tough plastic cover protects the tape from problems that can occur with floppies.

A metal plate prevents tape alignment problems that can cause slipping and jamming. A problem that can cause data loss in cassettes.

But if you act before December 31, 1986, there are some other, alternative reasons for joining the data cartridge club:

A free cartridge from 3M if you buy your hardware from one of the participating manufacturers.

And your choice of a wide range of rebates or other special offers from those manufacturers.

For a free 16-page buyers guide detailing these offers, you can call (800) 835-2246 ext. 260. (In Kansas call (800) 362-2421 ext. 260.)

Or better still, just amble on down to your computer products retailer to see who's offering what.

And get your backup system while the gettin's good.





Kernel

COMPUTING AT CHAOS MANOR: THE FINAL FRONTIER <i>by Jerry Pournelle</i>	291
ACCORDING TO WEBSTER: SEASON'S GREETINGS <i>by Bruce Webster</i>	305
APPLICATIONS ONLY: STOCKING STUFFERS <i>by Ezra Shapiro</i>	321
BYTE U.K.: THE U-MAN POTENTIAL <i>by Dick Pountain</i>	329

JERRY POURNELLE ENDED UP having another normally busy month. This one was highlighted by his involvement in the preliminary discussion of an academy for space cadets. BIX was a major component in this discussion. Jerry also paid a visit to Silicon Valley, where he saw the latest CompuPro equipment. What CompuPro is doing may enable Jerry to link up a number of computers and be able to run both IBM PC and CP/M software. This could help him solve the problem of computer proliferation at Chaos Manor.

Bruce Webster experienced a feeling of disorientation writing his Christmas column in August. But the lack of snow didn't stop him. He persevered and came up with a column in which he looks at some products for the Amiga: the Alegra memory expansion box, the MAS-20 hard disk, and Instant Music. Bruce also begins a periodic review of public domain/shareware programs and makes some gift suggestions.

Ezra Shapiro's mission this month is clearly spelled out in the title of his column ("Stocking Stuffers"). He looks at a number of programs that would make good gifts. These programs are not too expensive and are nothing you can't live without, but they are all great fun. This does not mean that they aren't useful products. Being fun to use doesn't mean a program is frivolous.

In BYTE U.K., Dick Pountain returns to his beginning as an organic chemist. He discusses the U-MAN 1000, a computer built around the 68000 micro-processor that is targeted at scientific and engineering users and designed for high-performance I/O. Dick borrowed the U-MAN to look at CHEMMOD, a color, three-dimensional molecular modeling system of a power that until recently would have been available only on a mainframe.

ARE YOUR DOCUMENTS

ALIEN?

If capturing text or images from paper documents is alien to you, our **SCANNING CONNECTION** is your best plan of attack.

In less than one minute, an image of your document can be read, stored, retrieved, processed, and output to a laser printer.

A version of Halo DPE® is provided for processing images. Photographs, books, articles, and drawings can be scanned and saved in compressed form.

The saved images can be combined with text in a wide variety of fonts and sizes. The completed document can be reproduced on a laser printer.

Images can be processed with our OCR software to produce text documents. Enhanced matrix matching is used for accurate character recognition. After the system is trained for each new typestyle, the matrix pattern is saved and reused.

A text editor is used to locate and correct scanning errors. The final document is stored in IBM DCA format with tabs, margins, indents, and line ends. The IBM DCA format can be read by most popular word processing programs.

We specialize in conversion systems and can transport your documents or images to most computer, typesetting, or word processing systems.

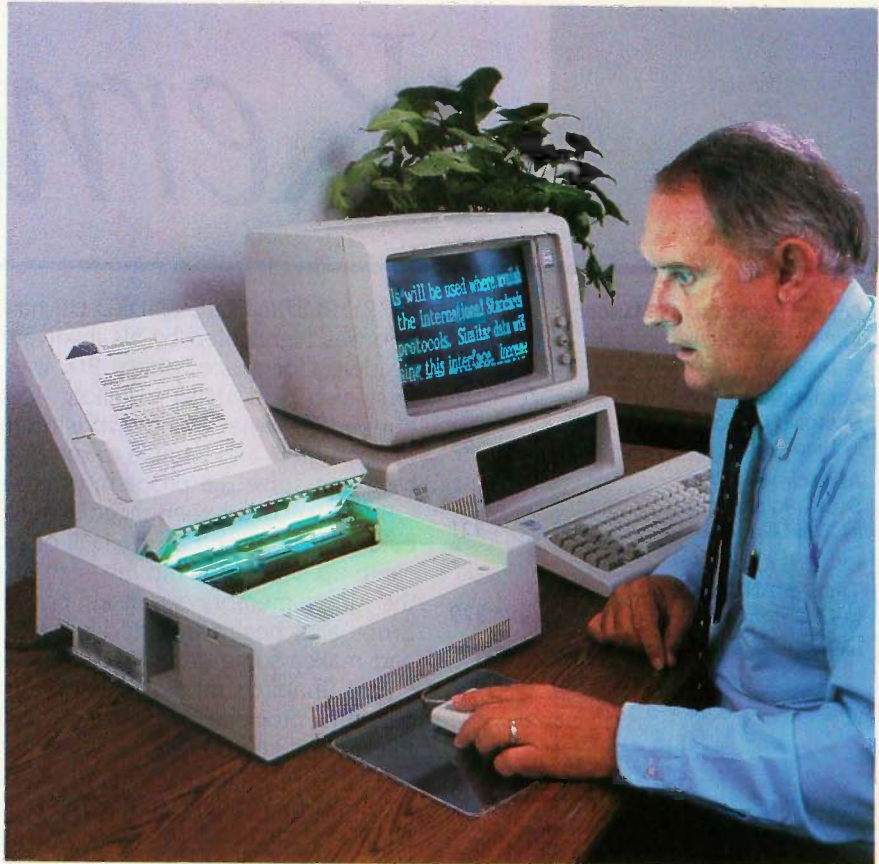

With our **DISKETTE CONNECTION** system you can read and write most 8", 5¼", and 3½" diskettes using a PC. We support systems from CPT, LANIER, NBI, WANG, XEROX, HONEYWELL, DG, DEC, and IBM.

Our **TAPE CONNECTION** system can read and write most 9-Track magnetic tapes using your PC. We can supply tape drives in several models at 800, 1600, or 6250 BPI. Tapes can be labeled and multivolume.

The price for a Canon IX-12 scanner, controller card, cable, and image software is **\$1195**. The optional OCR software is **\$595**. The price for an IBM 3117 flat bed scanner, controller card, and image software is **\$1395**. The price for an 8" diskette drive, controller card, cable, and utility software is **\$1195**. The optional software for word processing conversion is **\$695**. The price for a 9-Track 1600 BPI tape drive, controller card, cable, and software is **\$3495**.

Flagstaff Engineering

1120 W. Kaibab • Flagstaff, AZ
86001 • 602-779-3341 • telex 705609

In Europe contact Compusol
12 Rue Rosenwald • 75015 Paris
tel 530.07.37 • telex 205431F

Since 1982, we have installed thousands of diskette and tape conversion systems at customer locations around the world. We have written hundreds of software programs and designed dozens of hardware products to meet our customer's conversion requirements. We support our products because we developed them. Call us today for help in solving your conversion problems.



THE FINAL FRONTIER

BY JERRY POURNELLE

BIX is the scene for a discussion of an academy for space cadets

Every month I start with reasons why this wasn't a normal month. I suppose one day I'll admit there *are* no normal months—or rather, that even in a normal month something unusual happens to consume my time. Not, you understand, that these activities aren't important. This month it was the Space Academy conference, and that might be the most important thing I've done this year.

The Space Academy is another idea from General Daniel O. Graham's Project High Frontier shop. The notion is to investigate the possibility of setting up an academy whose mission is to do for the space frontier what West Point did for the settlement of the west: to produce the engineers and technicians and officers capable of making the frontier inhabitable. There are, however, two major differences from the early West Point of Superintendent Sylvanus Thayer: Graham conceives this as nongovernmental, and it will admit women from the beginning.

The notion looked worth investigating, anyway; so General Graham set up a conference to include academics, space enthusiasts, journalists, and financiers. We couldn't all get together in the same city, so we used electronics: there are conference rooms linked by television. Meetings would take place in Los Angeles, Colorado Springs, and Melbourne, Florida, with Dr. David Webb of the National Commission on Space participating by telephone from the University of North Dakota. This was all arranged through a commercial electronic conferencing service.

Next thing I knew, I was supposed to chair and organize the Los Angeles part of the meeting, while G. Harry Stine was to do the Colorado Springs

part of the job. The instant I heard that, an idea came: let the commercial TV conference people do their thing, but simultaneously link up through BIX as well.

BIXING THE SPACE ACADEMY

BIX, for those who tuned in late, is the BYTE Information Exchange, a computer-assisted conferencing system that I truly believe is the first step into what will be the normal communications pattern of the future. No doubt you'll find more about it, including how to sign up, elsewhere in this issue.

BIX has several different kinds of computer-assisted conferences. Most are open, meaning that anyone can find them and join up. Others are closed: you have to be invited in. A few are hidden, meaning that you can't find them even if you're looking for them; and of course you'd have to be invited to join if you did stumble across one of those. The Space Academy conference is like that, not because there's anything to hide, but to keep the chatter down to a minimum; most of the people involved in this have about 90 other things to do. Eventually we'll bring all the information out to a public conference. Meanwhile, we used BIX to plan and set up the televised conference.

It all went well. Barry Workman and my son Alex brought Barry's ancient CP/M Lobo computer; Barry still finds it both versatile and reliable. They connected to BIX with MITE, the com-

munications software package I used to use and may go back to. Barbara Clifford (bjc on BIX) came down from Silicon Valley to serve as moderator and editor. With all that help I could concentrate on the conference essentials, and indeed we got a lot done.

Now that the TV conference is over, the discussion continues on BIX. It will be interesting to see what comes of it. With luck, the whole world will see the results.

100 PERCENT COMPATIBLE

Another reason I was away from my desk this month was a trip up to Silicon Valley. The actual reason I went was to confer with Dr. Stefan Possony about the new edition of *Strategy of Technology* we're writing with Barbara Clifford's editorial assistance; but while I was up there I spent a day with Bill Godbout finding out the latest about Viasyn's CompuPro equipment.

There's a lot going on.

First, they were all excited about the new service contracts they've signed with Sperry. You remember Sperry? It's odd how many old-timers look puzzled when you ask if they remember Sperry. If you say Univac, their eyes light up. Anyway, Sperry is providing service support for CompuPro systems. Coincidentally, about the time you read this, I'll be in the south of France giving a talk to a group of managers of the European divisions of Sperry. Tough duty. . .

Anyway, I've always had mixed emotions about CompuPro systems. There's a sense in which CompuPro has no competition: they have just

(continued)

Jerry Pournelle holds a doctorate in psychology and is a science fiction writer who also earns a comfortable living writing about computers present and future.

about the best (microcomputer-based) development hardware packages on the market today. CompuPro is always out at the edge of technology, always pushing the envelope of state-of-the-art "small systems." The Golem, my big CompuPro 286/Z80 Dual Processor system, is still the most powerful machine I have.

That's the good part.

The bad part is that you'd better know what you're doing or have a darned good dealer handy. CompuPro equipment is adequately documented for technoweenies, but there's still a tendency to think "support" means reading the spec sheets, very slowly, over the telephone. With the right dealer that doesn't matter. For example, Steve Rose, a systems distributor on Maui in the Hawaiian Islands, always prefers to install CompuPro because, done right, the systems are trouble-free and the customers are happy. However, if you don't have a good dealer and you don't know much about small computers, you might have your work cut out.

Another problem with CompuPro systems is IBM PC compatibility. Dr. Godbout always had mixed emotions about that. To get real PC compatibility would require compromises in hardware performance and speed, and of course performance and speed are CompuPro's main selling points.

I'm pleased to say that CompuPro has solved those problems. You can get 100 percent PC compatibility, plus multiuser capability, plus file sharing, plus the enormous speed of a CompuPro system. You can not only have SideKick and SuperKey and Ready!, you can share your SideKick calendar and phone dialer files with another user a hundred feet away.

They achieve this in the simplest possible way: CompuPro recommends that you use cheap PClones as workstations. Since you can get a minimum clone for less than a thousand dollars, you aren't paying much for the compatibility: any decent terminal will run you at least half that much. Of course, you can also attach normal terminals to the CompuPro system.

The purpose of the clone is to run memory-resident software. Big jobs, like multiuser database applications, are done in the central CompuPro unit, which operates at speeds considerably higher than an AT.

The clones are networked through Arcnet. CompuPro provides cable, network boards for the clone, and the network board for the CompuPro system. Inside the CompuPro box they follow Pournelle's rule: "One user, at least one CPU." Each user has a block of memory and a CPU, all internally linked, in addition to the CPU in the workstation clone.

The result is something wonderful: at least, I saw it work something wonderful. Steve Rose demonstrated a big CompuPro system linked with three PClones, a TeleVideo terminal, and a Wyse terminal. Big spreadsheets are calculated in the CompuPro at lightning speed. Results can be called up by other users. SideKick files and suchlike are callable in the workstation but are kept in the CompuPro so that other users can get at them when needed.

It all looked wonderful, but now comes the usual note of caution: I saw this in Hayward. As always, I reserve final judgment for when I have things operating here at Chaos Manor. That happens next month. They tell me I'll be able to link up Zeke II, the ancient CompuPro Z80 I'm writing this on; the Golem; Big Kat, the Kaypro 286i PC AT clone; Lucy Van Pelt, our old fussy-budget genuine IBM PC; and the Zenith Z-150, all working together with the new CompuPro; and then I'll be able to run both PC and CP/M software.

There are terrific advantages to this. For one, I can save text from any station onto the Golem's 8-inch floppy disk drives. This is important because I don't think anything is truly safe until it has been saved on two separate 8-inch disks, and one of those disks is no longer in the house. Tapes, hard disks, small disk drives, are all very well, but I don't, deep down in my heart, trust anything but those 8-inchers. That may change in future, but it hasn't yet.

We'll also be able to share printers and hard disks. All stations will be

able to shuffle stuff off for archiving on the Golem's tape backup unit. And so forth.

CompuPro tends to use me as a test site for new stuff. I've promised to keep a log of any problems. Moreover, I'm beginning to collect neat tricks to use in networking PClones; when I'm done, Barbara Clifford is going to edit the stuff into a manual of user tips that CompuPro will ship with the networking systems.

When I left CompuPro, Bill Godbout, Mark Garetz, and Steve Rose were arguing: what is a fair statement of the actual speed of a system that has many CPUs all going at once? Just how many MIPS (millions of instructions per second) does this system execute? It's a good question. Anyway, I'm sending my CompuPro systems up to Hayward in the morning; and I can hardly wait to try this. Maybe, just maybe, I'll have solved the problem of computer proliferation at Chaos Manor.

ELECTRONIC MUSIC

A couple of issues back I talked about the coming revolution in electronic music. Bill Godbout saw that column and sent me some copies of a magazine, *Electronic Musician*, that has some claim to be the BYTE of the electronic music world. Formerly called *Polyphony*, *EM* specializes in MIDI (musical instrument digital interface).

There's a reason for Godbout's interest in the magazine: it was one of the first products of desktop publishing, and Craig Anderton, *EM*'s editor, has always been a big CompuPro fan. The magazine is now produced on a large multiuser (one user, at least one CPU) CompuPro machine, which produces IBM-compatible disks that go directly to the typesetter.

Electronic Musician (2608 Ninth St., Berkeley, CA 94710) is organized like a thinner issue of *BYTE*, with reviews, how-to articles, columns, what's new, and lots of ads. The ads were the most interesting part for me: it's amazing what you can buy, from keyboards and mixers to programs with a wide variety of synthesized sounds. Me, I'm not very musical, and my wife is oriented to classical opera and thus

(continued)



PSSST...

JANUS/Ada

for \$99.95!!

PRESENTING THE NEW JANUS/Ada C-PAK!!

1. Janus/Ada Compiler
2. Janus/Ada Linker
3. Janus/Ada Libraries
4. Janus/Ada Example/
Programs
5. Janus/Ada User Manual

AND THESE ADDED FEATURES!!

1. Free User's Group
2. \$99.95 Discount on
the Janus/Ada D-Pak
3. No License!!
4. No Copy Protection!!
5. Customer tested for
over 3 years!!!

This is the introductory Ada™ package you've been waiting for . . . over three years of actual field use, specifically on microcomputers, by the government, Fortune 500 businesses and major universities. Realistically priced, at \$99.95, so you can afford the most popular Ada implementation used on microcomputers!

The new "C"-Pak is available for most microcomputers running MS-DOS, including the IBM PC AT™, as are all the other fine Janus/Ada programs. Call us or an authorized distributor for your copy today!

We offer you the most flexible, cost efficient means of introducing your programming staff to the Ada Language. **You** can choose the level of Support **you** need, when you need it! These Janus/Ada packages are customer-tested and available now . . .

(C-Pak) Introductory Janus/Ada Compilers
(D-Pak) Intermediate Janus/Ada Systems
(S-Pak) Advanced Janus/Ada Systems
(P-Pak) Janus/Ada Language Translators

Janus/Ada "Site" Licenses
Janus/Ada Source Code Licenses
Janus/Ada Cross Compilers
Janus/Ada Maintenance Agreements

!!!!USE OUR TOLL FREE NUMBER FOR YOUR ORDER OR BROCHURE: 1-800-722-8248

CP/M, CP/M-86, CCP/M-86 are trademarks of Digital Research, Inc.
ADA is a trademark of the U.S. Department of Defense
MS-DOS is a trademark of Microsoft

©Copyright 1984 RR Software



SOFTWARE, INC.

P.O. Box 1512 Madison, Wisconsin 53701
(608) 244-6436 TELEX 4998168

specialists in state of the art programming

Inquiry 309

ACTUAL SIZE.



ACTUAL PRICE.

Introducing The Turner Hall™ Card. The lowest priced complete 256K memory expansion board you can buy.

We made it so inexpensive by using the very latest 256K RAM chips instead of four times as many 64K chips.

That same technology makes the Card fit in a half-length PC/XT™ slot. And the reduced chip count increases reliability, so we can offer a 30-day money-back guarantee and 1-year warranty.

The Card comes with a clock/calendar with replaceable battery backup, illustrated Owner's Manual, and software including clock, print spooler, and disk emulator.

That's everything the most popular

multifunction boards have. Except a couple of extra ports and a lot of extra cost.

IBM® or Compaq® owners will find the Card remarkably easy to install. And if you have any questions after you buy, call our Help Hotline.

The Turner Hall Card is just \$99.95,* plus \$2.00 shipping (\$12.00 outside of U.S.A.).

Order by phone. We accept MasterCard or Visa. Or send us a check or money order with your business card attached.

Turner Hall Publishing
10201 Torre Ave., Cupertino, CA 95014

not terribly interested in things you can synthesize; but I found it intriguing to go through the dozen sample copies Bill Godbout sent me. I'm more convinced than ever that small computers are going to do at least as much for music as they have done for writing.

FASTREAD

Years ago, for my sins, I was a professor in a fairly good college. One thing I consistently noticed about my students: they didn't seem to be as widely read as my generation had been. Perhaps it was television. Whatever the cause, they had a lot of reading to do to catch up to what I thought was an acceptable level.

Many of them had trouble doing that. They just couldn't read fast enough. After giving that some thought, I encouraged the slower ones to take the Evelyn Wood Reading Dynamics course. I'm not sure how I selected that particular course; it may be that outfit offered our college a special deal, or just that their institute was close by. Anyway, I kept some statistics on performance of students who I thought read too slowly and who did or didn't take the course, and I continued to recommend it.

There may be a better way. Note I said "may."

Fastread is a program designed to teach you to read faster. It runs on an IBM PC, XT, AT, or close clone, and it works by running the cursor across the text at a speed you can control with the + and - keys. While it's doing that, it counts how fast you're reading. At least sort of: the count is apparently keyed to the speed of your computer, and the program documents warn you that the absolute speed as reported may not be accurate. Anyway, you turn on Fastread, adjust the cursor speed to a bit faster than you're comfortable with, and practice reading.

That's about all there is to the program. The documents consist of a folded sheet of paper, but that's all you need to make things work. In the lessons themselves are some hints and tips on fast reading, but the program isn't really long on theory: the

1-800-556-1234 x526.

(In CA 800-441-2345 x526).

*CA residents add 7% sales tax (\$7.00). Requires IBM PC, PC/XT, Portable PC, or Compaq with at least 256K of memory. Turner Hall is a trademark of Turner Hall Publishing. IBM is a registered trademark, and PC/XT is a trademark of International Business Machines Corp. Compaq is a registered trademark of Compaq Computer Corp.

CHAOS MANOR

authors clearly think the best way to learn to read faster is to do it, and the most interesting stuff for you to read are files you load on yourself through your word processor.

Whether that will teach you to read faster or not is debatable; certainly it can't hurt, and I have some reason to believe it would help. Indeed, there is a lot to like about this program.

There's also considerable to hate. For one thing, it has a miserable user interface. It starts with one of those menus in which you pick numbers to tell the system what you want to do, including exit the program. At every other level you type a "Q" to exit to the previous menu, but here the program just beeps at a "Q"; it wants a number and nothing else. If, in fury, you type several irrelevant commands, you can fill the type-ahead buffer with them, and thus get a long and perfect cacophony of beeps.

You're supposed to use your own files for most of your lessons. The instructions don't say what kind of files it will accept. I was going to try some downloaded from BIX, but the silly program runs only from the A drive—naturally it's copy-protected—and if you try to give it a subdirectory name from your hard disk, it won't take it. Filenames must be eight letters or fewer; anything more than that gets the dreaded beeps. I don't keep BIX files on the root directory of my hard disk, and I wasn't really in much of a mood to transfer some over there just to accommodate this program. Also, Fastread has no provision for getting a directory of files from inside the program: you'd have to write down the exact names of candidate files before invoking this program.

Fastread, in other words, is one of those programs that might be fun to play around with, but it would be a lot more useful if the publishers had done more testing and editing and hadn't been so paranoid. I'd probably have put it on the hard disk for more attention if they hadn't copy-protected it. As it is, I doubt I'll ever see it again. Pity.

Sometimes we win one, though. Fifth Generation systems has announced that they've dropped all

(continued)

"BRIEF is the most incredible editor I have ever seen.
Programs seem to effortlessly flow from my mind to the screen."
 — Glenn Ehrlich, Systems Engineer
 International Anasazi, Inc.

Tailor Program Editing to Your Style

- A high-level, readable Macro Programming Language - allows customization for programming languages . . . Complete, unlimited variables, etc.
- Edit multiple files of unlimited size (2 Meg is OK)
- Multiple Windows on screen with different or same file, fragments, etc.
- A bona-fide UNDO stack (up to 300) of all operations; deletions, reading files, search, translate, more.
- Reconfigurable keyboard
- Full "regular expression search" - wild cards, complex patterns
- Adjustable line length - up to 512.
- Keystroke macros - for common typing sequences
- Suspend BRIEF to execute, exit to DOS - run another program (like a compiler, dir, XREF, DIFF, or DEBUG) then resume BRIEF session
- Compiler-specific support like auto indent, syntax check, compile with-in BRIEF

Only \$195
 Call 800-821-2492

Solution Systems™

335-B Washington St.
 Norwell, MA 02061
 617-659-1571

Full Refund
 if not satisfied
 in 30 days.

Survey Data

- 88% of survey respondents were more productive with BRIEF than other editors.
- 50% were more productive with BRIEF than their previous editor in 5 hours or less.
- 72% were performing all operations in 2 hours.

For PC, AT, compatibles.

A **CROSSTALK**®
 XVI

SuperKlone™



SOFTKLONE™
 The Age of KloneWare Has Arrived

1210 E. Park Ave. • Tallahassee, FL 32301
 For information call 1-904-878-8564
 TLX: 6714280 KLON

Shipping/handling 5.00
 (COD orders add \$3.00)
 International shipping/handling 18.00
 Florida residents must add 5% sales tax

To Order Call (904) 878-8564

Distributed in Canada by:
 Saragusty Software Distributors,
 Telephone: (416) 923-1500

Distributed in Scandinavia by:
 UNC, (Norway),
 Telephone: 02 38 39 10

Distributed in the UK by:
 Management Data Processing (Int),
 Telephone: (0225) 60491
 Itacoff Ltd, Telephone: (0629) 3021

Distributed in Australia by:
 Delta Computer Systems Pty. Ltd.,
 Telephone: (02) 633 4055
 P.O. Telstra Pty. Ltd.,
 Telephone: (02) 319-2155

MIRROR™ provides:

- Crosstalk XVI compatibility
 - Background communications
 - Built-in text editor
 - Learn-mode for automatic script file generation
 - Transaction log
- AND MUCH MORE...

MIRROR™
\$69.95

Site Licensing Available
 60-Day Money-back Guarantee
 Not Copy Protected

MIRROR is available for the IBM PC/XT/AT and compatibles running MS-DOS 2.0 or higher. MIRROR™, SuperKlone, KloneWare and SoftKlone are trademarks of SoftKlone Distributing Corporation. Crosstalk XVI and Microsoft are registered trademarks of Microsoft, Inc.

copy protection on Fastback (no relation to Fastread), a hard disk backup program I talked about in July.

POURNELLE'S LAW

I can see a church by daylight, although I may be a bit slow. That is: I log on to BIX a lot, and after months of doing that, it came to me that I didn't need to sit here waiting for the phone to ring, answer, get the local

net prompt, respond to that, get the BIX prompt and respond, enter my password. . . Crosstalk, after all, has a script command capability that will take care of everything from dialing to entering my password. Or so I was persuaded.

Doing it was another matter. The Crosstalk manual tells all; but it does it without examples. Actually, it's worse: many of the critical commands

have examples, but the examples are ambiguous or even wrong. Now what I mean by "wrong" is that if you use the example, as shown in the book, it will *not* produce the result you're after. That's because they have inserted or omitted some key item like a quotation mark in the document text. It's not a real example, it's a virtual example. I hate virtual examples.

Some of the descriptions of what the commands do are masterpieces of minor deception, too.

The only salvation is that they do supply you with a few workable scripts on the disk that the program comes with. Examining those while studying the manual will, eventually, produce enlightenment.

All in all, I'm still satisfied with Crosstalk, and I still use it for communications despite having a dozen or more competitors around. That's partly inertia, of course, but it does say I have no serious complaints about the program, except that I wish they'd followed the rule: "You can't have too many examples, but the examples must *work*." On the other hand, I wish *everyone* would follow that rule.

DATA ACQUISITION: Get system capability at a board-level price. The System 570 is a personal computer based Data Acquisition Workstation with the extensive signal capacity you need: **32** analog inputs (or 16 differential), **2** analog outputs, **16** digital inputs, **16** digital outputs, **16** power control lines. The price is only **\$1425**, complete with our powerful **Soft500 software**, an extension of advanced BASIC that provides foreground/background architecture, array and memory management, disk access and storage, and over 45 additional commands.

An expansion slot lets you extend your System 570's capabilities by selecting from an extensive library of optional input/output modules. And you can use the 570 with other data acquisition software such as DADiSP, ASYST™, and Labtech Notebook.

For complete information, a demonstration, or applications assistance, call toll free:

1-800-552-1115

(In Ohio call 216-248-0400.)

32
2
16
16
+ 16

\$1425

KEITHLEY

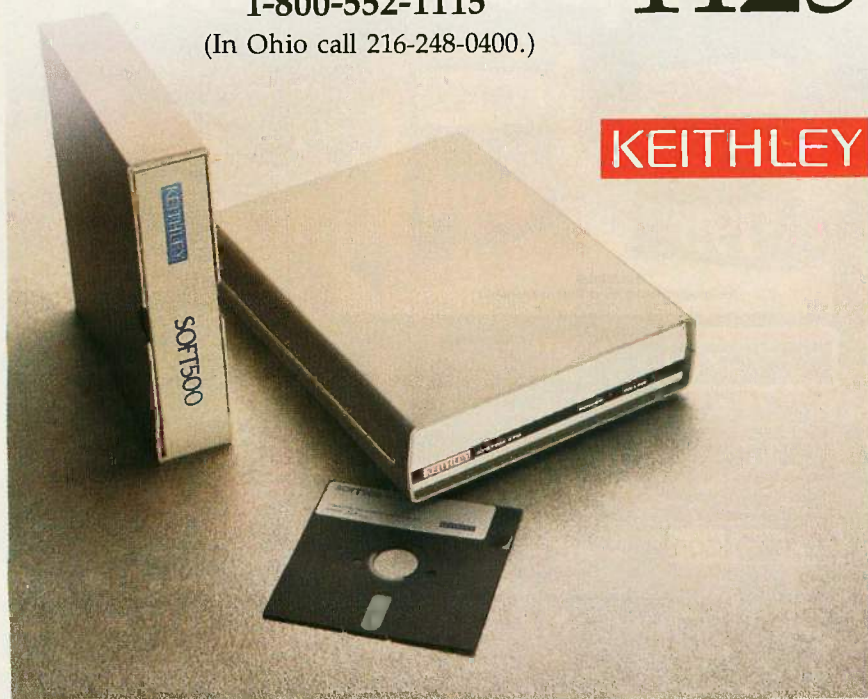

INTERIM REPORT

I have a lot of memory-resident utilities in Big Kat. I don't want to give any up, but I'd sure like to get some of them up into extended memory. I've been trying to install the Orchid EC-CELL error-correcting extended/expanded memory board in Big Kat.

I'm still trying.

My first attempts failed. I called Orchid, was asked what version of the installation software I had, and was asked to wait until a new version came. That arrived promptly, but by then I was off on trips. When I returned I started in again.

It all seemed clear. I went through the installation program, *setting the system* so that it would have both RAM disk and expanded memory. Some of the options didn't seem very clear, so I used my best guesses on them. Finally I rebooted the machine.

Blooy.

Big Kat trundled for a moment, then reported that I didn't have a valid

(continued)

THE PROGRAMMER'S SHOP

helps save time, money and cut frustrations. Compare, evaluate, and find products.

RECENT DISCOVERY

Tom Rettig's Library - adds 140 functions to dBASE III Plus for arrays, character and date control, screen, new logical expressions, number manipulation, and much more. Full source (in C, assembler, and dBASE), no royalties. Use with Clipper. PC \$ 89

AI-Expert System Dev't

Arity System-incorporate w/C. MS \$ 279
 Experteach-Improved, samples PC \$ 399
 EXSYS - Improved. Debug, file & external program access. PC \$ 339
 Insight 2+ - dB2, language MS \$ 389
 LPA MicroProlog Intro w/ APES MS \$ 149
 LPA MicroProlog Prof. w/APES MS \$ 595
 Others: ESP (\$839), Expert Choice (\$449)

AI-Lisp

BYSO - Common, MacLISP compatible 250+ functions, fast. PC \$ 150
 Microsoft MuLisp 85 MS \$ 199
 PC Scheme LISP - by TI. SCHEME has simple, "orthogonal" syntax. PC \$ 95
 TLC LISP - classes, compiler. MS \$ 225
 TransLISP - Good for learning MS \$ 85
 Others: IQ LISP (\$155), UNX LISP (\$59), IQCLISP (\$269), WALTZ LISP (\$149)

AI-Prolog

APT - Active Prolog Tutor - build applications interactively PC \$ 65
 ARITY Standard - full, 4 Meg Interpreter - debug, C, ASM PC \$ 350
 COMPILER/Interpreter-EXE PC \$ 739
 With Exp Sys, Screen - KIT PC \$1250
 LPA MacProlog - Complete incremental compiler and an interpreter MAC \$ 295
 LPA MicroProlog - intro MS \$ 99
 LPA MicroProlog Prof. - full memory MS \$ 359
 Prolog-86 - Learn Fast MS \$ 89
 Prolog-86 Plus - Develop MS \$ 229
TURBO PROLOG by Borland PC \$ 69
 Others: Prolog-1 (\$95), Prolog-2 (\$839)

Editors for Programming

BRIEF Programmer's Editor - undo, windows, reconfigure PC Call
 EMACS by UniPress - powerful, multifile, MLISP. Source: \$929 \$ 299
 Epsilon - like EMACS PC \$ 169
 Kedit - like XEDIT PC \$ 109
 Lattice Screen Editor-multiwindow multi-tasking Amiga \$100 MS \$ 109
 PC/VI - Custom Software PC \$ 129
 PMATE - power, multitask PC \$ 149
 SPF/PC - fast, virtual memory PC \$ 139

FEATURE

Unishell - Bourne UNIX shell script compiler translates to C and runs faster. Portable, hand optimizable code. Use as C program generator. PC \$ 349

Compare Products Use Product Specialists

The Programmer's Shop is much more than the supplier of the largest selection of programmers' software. Trained programming consultants will answer your questions. Ask "product specialists" about Cross Assembler, Translators, Debuggers, or compilers.

Our Services:

- Programmer's Referral List
- Compare Products
- Help find a Publisher
- Evaluation Literature FREE
- BBS - 7 PM to 7 AM 617-826-4086 National Accounts Center
- Dealers Inquire
- Newsletter
- Rush Order
- Over 700 products

C Support-Systems

Basic-C Library by C Source MS \$139
 C Sharp - well supported, Source, realtime, tasks PC \$600
 C ToolSet - DIFF, xref, source MS \$ 95
 The HAMMER by OES Systems PC \$179
 Lattice Text Utilities PC \$ 95
 Multi-C - multitasking PC \$149
 PC LINT-checker. Amiga \$89, MS \$119
 SECURITY LIB - add encrypt to MSC. C86 programs. Source \$250 PC \$125

Fortran & Supporting

Forlib+ by Alpha - graph, comm. \$ 59
 MACFortran by Microsoft - full '77 \$229
 MS Fortran link to C \$209
 No Limit - Fortran Scientific \$119
 RM Fortran - enhanced "IBM Ftn" \$395
 Scientific Subroutines - Matrix \$149

MultiLanguage Support

BTRIEVE ISAM MS \$199
 BTRIEVE/N - multiuser MS \$469
 CODESIFTER - Execution PRO-FILER. Spot bottlenecks. MS \$ 99
 Dan Bricklin's Demo Program PC \$ 65
 HALO Graphics - 115+ device interfaces, rich, printer. Specify language interface PC \$219
 Microsoft Windows Software Development Kit PC \$399
 PANEL - data validation, no royalties Xenix \$539, MS \$229
 Pfinish Performance Analyzer MS \$249
 PLINK-86 - a program-independent overlay linker to 32 levels. MS \$249
 PLINK-86 PLUS - incremental MS \$369
 PolyLibrarian MS \$ 85
 PVCS Version Control MS \$329
 Screen Sculptor - slick, thorough PC \$ 99
 ZAP Communications - VT 100, TEK 4010 emulation, file xfer. PC \$ 95

Atari ST & Amiga

We carry full lines of Manx, Lattice, & Metacomco.

Call for a catalog, literature and solid value

800-421-8006

THE PROGRAMMER'S SHOP™

128-B Rockland Street, Hanover, MA 02339

Mass: 800-442-8070 or 617-826-7531 10/86

RECENT DISCOVERY

Pascal-2 - Perhaps tightest compiler for MSDOS. Mainframe background & power. MS compatible. Complete environment. Turbo translator. Get detailed specs. PC \$ 329

C Language-Compilers

AZTEC C86 - Commercial PC \$ 499
 C86 by CI - 8087, reliable MS \$ 299
 Datalight C - fast compile, good code, 4 models, Lattice compatible, Lib source. Dev's Kit PC \$ 79
 HOT C - new, intriguing PC \$ 85
 Lattice C - from Lattice MS \$ 299
 Mark Williams - w/debugger MS \$ 399
 Microsoft C 4.0 - CodeView MS \$ 279
 Wizard C - full, fast. MS \$ 389

C Language-Interpreters

C-terp by Gimpel - full K & R MS \$ 239
 C Trainer by Catalytix PC \$ 89
 INSTANT C - Source debug, Edit to Run-3 seconds, .OBIs MS \$ 389
 Interactive C - interpreter, editor PC \$ 225
 Introducing C - learn C quickly PC \$ 109
 Run/C Professional - MS \$ 189
 Run/C Lite - improved MS \$ 109

C Libraries-General

Blackstar C Function Library PC \$ 79
 C Essentials by Essential PC \$ 85
 C Food by Lattice-ask for source MS \$ 109
 C Scientific Subroutines-Peerless MS \$ 139
 C Tools Plus (1&2) PC \$ 139
 C Utilities by Essential - Comprehensive screen graphics, strings. Source. PC \$ 139
 C Worthy Library MS \$ 269
 Entelekon C Function Library PC \$ 119
 Greenleaf Functions-portable, ASM \$ 139
 PforCe by Phoenix - objects PC \$ 299

C Libraries-Files

FILES: C Index by Trio - full B + Tree, vary length field, multi compiler /File is object only MS \$ 89
 /Plus is full source MS \$ 349
 CBTREE - source, no royalties MS \$ 99
 CTree by Faircom - no royalties MS \$ 339
 dbQuery - ad loc, SQL based MS \$ 159
 dbVISTA - full indexing, plus optional record types, pointers, Network. Object only - MSC, LAT, C86 \$ 159
 Source - Single user MS \$ 429
 Source - Multiuser MS \$ 849
 dBASE Tools for C PC \$ 79
 dbc Isam by Lattice MS \$ 199

FEATURE

Baby 34.36 RPG II by California Software - complete mini RPG environments for PC include compiler, editor (SEU), OCL processor. Screen gen., sort, data exchange, workstation I/O. Separate products for compatibility w/IBM System /38, /36, /34. PC \$1250

Note: All prices subject to change without notice. Mention this ad. Some prices are specials. Ask about COD and POs. Formats: 3" laptop now available. plus 200 others. UPS surface shipping add \$3/item.

maxell

This is the disk that meets or exceeds every standard of quality.

Not all floppy disks are created alike. Some are better than others. To find what's best for you, look for the Gold Standard seal. It's your assurance that Maxell disks meet or exceed every definition of quality. For every computer and that specifically includes yours. Each is backed by a lifetime warranty. **Maxell. Accepted everywhere, without reservation.**



What separates us from our competition? Simply a combination of the best service in the industry, highly competitive pricing, and an ever widening range of products. Above all we care about our reputation and we are willing to work on a lower margin while delivering what others only claim—and we do it all on a day-in day-out basis.

Every subscriber to **Byte** will receive our New 96-Page Winter Spring 1986/87 Catalog over the next few months. We hope to be your source for computer supplies & accessories. **Now with 15 pages of consumer/industrial products.**

Lyben Computer Systems

WATCH FOR OUR NEW 1986/87 CATALOG

1050 E. MAPLE RD. • TROY, MI 48083
(313) 589-3440



Copying diskettes will never be easier than pushing one button.

While your computer is busy doing other things, your Victory Duplicator can be making as many as eight copies of a diskette at once — producing up to 400 copies in an hour. DualMaster™ models can even make multiple copies of two different diskettes simultaneously. Just insert the diskettes and press one button.

Copy different formats, flawlessly.

An automatic format analysis program makes it possible for the Victory Duplicator to

copy virtually any 5¼, 3½ or 8-inch diskette. The system tests for quality and accuracy at every stage of the process.

It practically services itself.

Each drive has a separate controller to maximize uptime. Simple diagnostics to verify drive alignment and industry standard drives allow you to maintain your system without waiting for outside service.

All at an attractive price.

Victory Duplicators offer fast copying, serialization,

copy protection, a communications port, a four-month warranty and much more—all for one low price.

Call 1-800-421-0103.

Call today for more information. (In Texas, call 512-450-0801.)



VICTORY ENTERPRISES

Technology, Inc.

8910 Research Blvd., Suite B2
Austin, Texas 78758

CHAOS MANOR

command processor file; and nothing I could do would change that. Furthermore, since I couldn't bring the system up at all (maybe I could if I'd removed the board?), I couldn't even get at the file to edit out the CONFIG.SYS file that the ECCELL installation procedure had generated and put on my hard disk.

Fortunately Big Kat, like most clones, will boot off a floppy disk if there's a floppy in drive A. I got out the original IBM PC-DOS disk. Then I called Orchid.

I can't say I'm totally fond of Orchid Technology's documents, although they are much improved from a year ago, and the company listens; but I sure am impressed with the technical support people. It took an hour of careful step-by-step logical procedure, but eventually we found the problem. It seems that something in the Kaypro ROM BIOS and the Orchid installation procedure have a fatal clash. Once the symptoms were all noted, the Orchid people went to work; I'm told they'll have the problem fixed in a few days, and I'll get yet another copy of the installation software.

I have no doubt that the board will eventually work. ECCELL (the name is symbolic of the board's standout feature, error-correcting code capability, meaning that if you get a memory error it not only warns you but fixes it) works fine on a genuine PC AT; at least, I know half a dozen colleagues who've made theirs work. There's no reason why it won't work on the Kaypro.

When it does, I'll set it up with the optional parallel port, so that I can finally put in an EGA color card; at the moment, my only parallel port is on the Hercules Graphics Card, but the Orchid ECCELL has both serial and parallel ports if you want them.

PARADISE

Last month I reported that I had a problem with the Paradise Hi-Res Graphics Card. This is a card that is said to give you the highest resolution your system can use. It's capable of both monochrome and color (you have to throw a switch on the card to change over) and has a parallel port

(continued)



Achieve the next dimension in computer excellence. Experience MAXX™

Imagine sitting in the cockpit. Hands on the yoke. Diving. Spinning. You pull out. Bank to the left and slide across the screen. The control tower passes on the right.

Maxx™ lets you experience the thrill of flight. At home. Or in the office. Wherever you decide.

Icon is pleased to announce Maxx™. The first in a series of Computer Interface Peripherals (CIPs). CIPs bring real-time cockpit simulation to the computer.



Maxx™ is positioned front & center and allows easy keyboard access.

First, the keyboard.

Whether your interest is in F-16 jets, Cessnas, auto racing, tank operations or



A contour handle provides the "feel" of a real yoke.

space flight, Maxx™ excels. Maxx™ is currently compatible with IBM's PC, XT and AT models through the fifteen-pin game port. And with Apple Computer's IIc, IIe and II GS series through the nine-pin game port.

Then, the mouse.

Designed to the specifications of the traditional aircraft control yoke, Maxx™ looks, feels and performs realistically.

Strategically placed buttons are located atop each arm of the yoke. And a centrally located slide throttle controls airspeed.

Maxx™ is easy to use. Boot-up the selected software disk, calibrate Maxx™

to the system and experience desk-bound reality.

Maxx™ comes fully assembled, ready to use. A true plug-and-play Computer Interface Peripheral (CIP).

And now, MAXX™

Flight maneuvers are a breeze with the "feather-touch" of Maxx™. Action buttons are strategically placed.

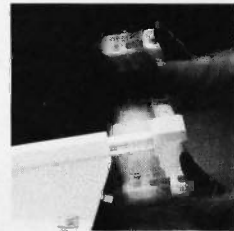

For more information, or to order, call 1-(206) 451-9082 or mail \$129.95 plus \$5.00 for shipping and handling to Icon Incorporated, 1611-116th Avenue NE, Bellevue, Washington 98004.

ICON
INCORPORATED

COMPUTOUGH

"Anyone
who wants to win MegaWars
has to dominate
entire planetary systems.
And me."

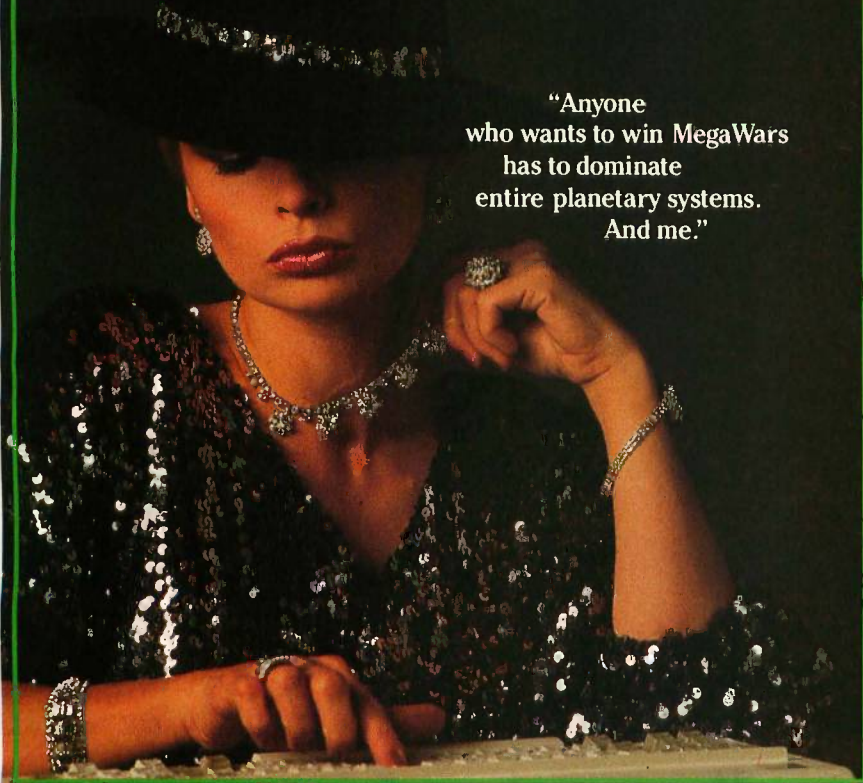

COMPUFUN

"I'm into world events and trivia.
And I can play right here
in the living room!"

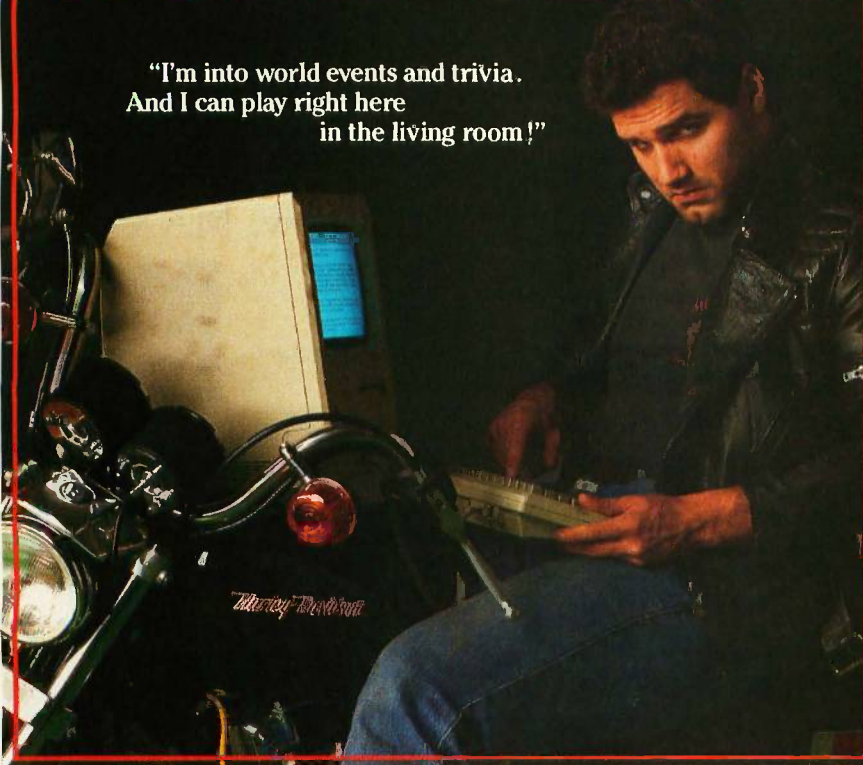

on it. It looked like what I needed.

The problem I had was that all the text was jammed over against the left side of the Zenith 19-inch High Resolution Color Monitor I use with Big Kat.

After I wrote that, two things happened: Paradise sent another board, and Ken Sheldon, my technical editor at BYTE, told me that one of the other editors had asked why I didn't try the MODE command in MS-DOS. MODE, it seems, can shift the image over to the right by a space or two.

I tried both. First, the new board: it had the same problem. Since that board seems to work fine on Lucy Van Pelt, I can only conclude that there's some interaction with either the Kaypro AT or the Zenith monitor. Whatever it is, I remember when they'd have put a horizontal control on either the board or the monitor, or both. One tweak would have solved the problem.

Instead, though, they seem to be relying on MODE.

The MODE command, I discover from reading the fine print in MS-DOS manuals and books, not only tells your machine whether you're using monochrome or color and 40 or 80 characters per line, it will also, in theory, shift the screen image over, thus accomplishing what you'd want from a horizontal control.

In theory. In fact, it doesn't, at least not on a Kaypro 286i. What it does is lock things up to the point where you have to reset the machine. I haven't the foggiest notion why. I don't have a genuine IBM PC AT, so I can't tell if MODE CO80,R would do the job on that. I do know that MODE CO80 or MODE CO40 will work on the Kaypro as advertised, changing the display from color 80 columns to color 40 columns; but if you add the shift, or try to invoke the "T" for test pattern feature of MODE, you'll shortly after reset a Kaypro 286i.

Consequently, I'm back to the Hercules Graphics Card, which has always worked fine. MODE shift doesn't work with it, either, but it doesn't have to.

I find it all pretty discouraging. In order to save about five dollars' worth of parts on the video board, they're relying on software that will probably

have to be invoked every time you reset the machine or turn it off. That makes no sense at all.

SHORT SHRIFT TIME AGAIN

I'm always looking for something new to write about. Believe me, it's no problem. Alas, books, programs, and hardware pour in here much faster than I can keep up. I've had to be pretty ruthless: if something can't get my attention in a couple of minutes, it goes. As late as last year I might have kept it around, but that clearly won't do any longer: there's just no room for it all.

Some stuff can go immediately. Things like silly games that arrive with neither documentation, packaging, nor cover letter, and turn out to be written in BASIC with a "choose a number" user interface; clearly hopeless stuff like that goes into the big barrel with a permanent magnet from an old telephone magneto. Eventually I reformat the disks. But even after eliminating the absurd I find the stacks grow higher all the time.

I'll never clear it all out; but much of it deserves mentioning. Thus, it's short shrift time again.

INTEL MATH CHIP

Some weeks ago Intel sent me one of the 80287 math chips for the PC AT and clones. The chip comes in a lovely box with extensively detailed instructions. If you have a genuine IBM PC AT, I can't imagine anything simpler than installing it.

I had a bit more of a problem with the Kaypro 286i, but the relentless application of logic—there's only one slot on Big Kat's board that would take that chip, and all the notches face the same way—solved the problem. If you have a 286 machine and you do any number crunching, you *must* get a 287 math chip. It speeds up calculations something wonderful, and with most programs you don't have to do anything to get that extra speed. Much recommended for those who crunch numbers.

EXCEL

On the subject of number crunching: as I've said before, if I had to do much

(continued)

COMPU CRAZY

"Ready for an adventurous challenge?
We're a team. And Nellie
doesn't horse around."

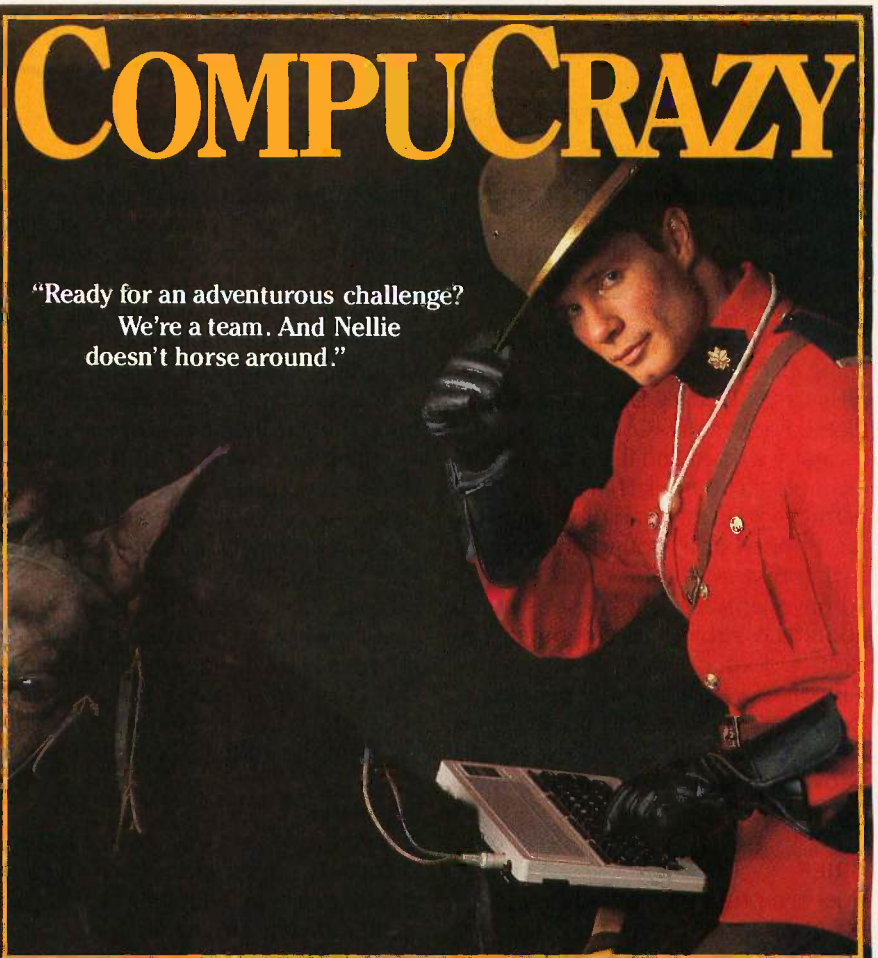

COMPU SERVE GAMES

You never know
who you'll be up against
when you go online
with CompuServe.

To buy your CompuServe Subscription Kit,
see your nearest computer dealer.
Suggested retail price \$39.95.

To request our free brochure or order direct,
call or write: **800-848-8199**
(In Ohio, call 614-457-0802)

CompuServe[®]

5000 Arlington Centre Blvd.
Columbus, OH 43220

detailed spreadsheet work, I'd buy a Macintosh just so that I could use Microsoft's Excel. That is simply the most elegant and versatile spreadsheet I've encountered.

Comes now a really good book on using Excel.

Hands-On Excel by Danny Goodman (Scott, Foresman & Company, \$21.95) is clearly written and filled with useful examples. The book is in an informal narrative style, the kind of writing I try for; I hope I don't sound arrogant by saying that much of it reads the way I'd have written it if I knew as much about the subject as Goodman obviously does.

If you're wondering why people get excited about Excel, this book will tell you; and if you use Excel, I expect this book will save you a lot of time. Recommended.

BRIEF

Brief is a programming editor for the PC. It was written by a company called

UnderWare, which may or may not explain the name. It's extremely popular among hackers, and for good reasons.

Brief isn't all that simple to learn, but then no programming editor is. There are about a zillion commands, including, I suppose, Control-meta-cokebottle and Alt-coffeecup. The main thing is that it will do just about anything you want it to. It has windows—boy, does it ever have windows!—a good search and replace, macros, automatic indenting, buffers, and a partridge in a pear tree.

For the last few months, every time I've mentioned text editors I've got a raft of mail urging me to try Brief. Now that I've tried it I see why. If you need a general-purpose programming editor, look no further. Recommended.

SOLARSIM

Longtime readers will know of my addiction to *Star Fleet I* from Cygnus (now known as Interstel). If you like games based on *Star Trek*, you'll like

that one, which is frankly better than the *Star Trek* game I wrote.

The latest from Interstel is *Solarsim*, "The Solar System Simulation Program." This PC program is a real gem for science fiction writers. You can get a simulation of the positions of the major bodies in the solar system—including about 200 asteroids—for nearly any given date. Find out what constellations will be in the sky, also for any given date and time. Look at the planets' positions as if viewed from earth. And so forth.

There's also a complete, if pretty dry, account of the theory, including Euler's method for approximations.

Recommended for astronomy buffs, science fiction writers, and anyone who likes to play around with computer simulations.

IT'S GENERIC

I've mentioned this program before, but it's more than worth bringing up again; they're always improving it. If

BACK ISSUES FOR SALE

	1985	1986
Jan.	\$4.25	
Feb.	\$4.25	\$4.25
March	\$4.25	\$4.25
April	\$4.25	\$4.25
May	\$4.25	
June	\$4.25	\$4.25
July		\$4.25
Aug.	\$4.25	\$4.25
Sept.	\$4.25	\$4.25
Oct.	\$4.25	\$4.25
Nov.	\$4.25	\$4.25
Dec.	\$4.25	

SPECIAL ISSUES and INDEX

BYTE '83-'84 INDEX	\$1.75
BYTE 1985 INDEX	\$2.00
1984 SPECIAL GUIDE TO IBM PCs (VOL. 9, No. 9)	\$4.75
1985 INSIDE THE IBM PCs (VOL. 10, No. 11)	\$4.75

Circle and send requests with payments to:

BYTE Back Issues
P.O. Box 328
Hancock, NH 03449

VISA MasterCard Check enclosed

Payments from foreign countries must be made in US funds payable at a US bank.

CARD # _____ EXP. DATE _____

SIGNATURE _____

The above prices include postage in the US. Please add \$.50 per copy for Canada and Mexico; and \$2.00 per copy to foreign countries (surface delivery). Please allow 4 weeks for domestic delivery and 12 weeks for foreign delivery.

NAME _____

ADDRESS _____

CITY _____ STATE _____ ZIP _____

you have a PCompatible and any interest at all in CAD, you need Generic CADD. While not quite as elegant as Autodesk's AutoCAD, Generic CADD will, I'd guess, do about 75 percent as much, for 10 percent of AutoCAD's price. It's not copy-protected, either; and the license agreement makes sense. They don't guarantee it will work, but if you don't like it you have a 60-day period during which you can get your money back. How can you go wrong?

Generic CADD comes with a thick, well-written manual (the writing style is informal, and the language is simple English; quite refreshing after all the documentese I've had to digest lately). Not only is it easy to understand, but it's complete, with both analytic table of contents and lengthy index.

In other words, it's pretty hard to find anything to criticize. This is one heck of a program.

Generic CADD works with a PC or close compatible, including the Kaypro 286i AT. It will work without a mouse, but you're better off having one. If you want a paper copy of your designs, you'll need a plotter. Generic CADD supports all the popular microcomputers. You can also get Generic CADD through Logitech, bundled with the LogiMouse. Works fine, and the documents are better bound.

If you've been wondering what CAD is all about, here's your chance to find out at a reasonable cost. You may never need any other CAD program. Highly recommended.

DESKTOP PUBLISHING

Tony Bove and Cheryl Rhodes are near geniuses at making complex ideas understandable. Now they've done it again.

The Art of Desktop Publishing (Bantam, 1986, \$20.95) shows Wes Thomas, a "High tech PR Man," as formal co-author and three more people as contributors, but it's not hard to see the hand of Bove and Rhodes all over the book. It's clearly written and doesn't assume you know much.

I like this book, and it isn't out of line with the industry standards, but I sure don't understand why it costs so much. This book has illustrations,

glossary, and a good index, but it's only 300 pages of large type in a "trade paper" binding; why the daylight should it cost more than, say, the hardbound edition of Niven and Pournelle's *Footfall*, which ran more than 1000 manuscript pages? The fact is, though, computer books *do* cost that much, and there doesn't seem to be anything to be done about it. It sure isn't Tony and Cheryl's fault.

If you're at all interested in desktop publishing and you're looking for a survey of what can be done with existing hardware and software combinations, this is the book to start with. On the other hand, things *flow* in the micro world; the book is almost up to date now; will be a little out of date by the time you read this; and by next year one hopes they'll have a new edition.

POLYNOMIAL

Polynomial is a PC program designed to let you play about with polynomial functions. Take any polynomial function, plug it in, and out comes a graph. Not the kind of program everyone needs, but more useful than you

might think: I wish it had been available when I took high school algebra. By taking the tedium out of numerical calculations, programs like this can make it fun to play with math, so that you can get a feel for just what complicated mathematical functions model. Just what shape is a fifth-order polynomial curve, anyway? Now you can find out, painlessly.

ONE SCREWY NEWSLETTER

I have for months been intending to mention *DTACK Grounded*. This is billed as a "junk mail flyer" from Digital Acoustics, 1415 East McFadden, Suite F, Santa Ana, CA 92705; and it consists of the sometimes outrageous and surprisingly often well-reasoned opinions of an odd composite personality who can't decide whether he's real or fictional. If you've no interest in 68000+ systems, don't bug the man; but if you have a passionate interest in what's going on in that part of the computer world, you don't hate compiled BASIC, and you believe that assembly language is better than Pascal, then by all means write and

(continued)

ITEMS DISCUSSED

BRIEF\$195 Solution Systems 335 Washington St. Norwell, MA 02061 (617) 659-1571	INTEL 80287 MATH COPROCESSOR CHIP\$217 to \$385 Intel Corporation 3065 Bowers Ave. Santa Clara, CA 95051 (408) 987-8080
COMPUPRO COMPUTERSVarious Viasyn prices 26538 Danti Court Hayward, CA 94545 (415) 786-0909	LITTLE COMPUTER PEOPLE ..\$35-\$50 Activision P.O. Box 7287 Mountain View, CA 94039 (415) 940-6044
FASTREAD\$59.95 Achievement House 103 Great Plain Rd. Danbury, CT 06811 (203) 748-0277	POLYNOMIAL\$27.50 Computer Services RR 1 Wolfville, Nova Scotia Canada B0P 1X0 (902) 542-5253
GENERIC CADD\$99.95 Generic Software 8763 148th Ave. NE Redmond, WA 98052 (206) 885-5307	SOLARSIM\$29.95 Interstel Corporation P.O. Box 57825 Webster, TX 77598 (713) 333-3909

beg for a copy.

DTACK Grounded used to be available by subscription. Now it's available at the whim of its editor, FNE, who is sometimes known as Hal W. Hardenbergh. You can't bribe him. Try pleading. It's probably worth the effort.

WINDING DOWN

I'm out of space, and just about out of time: day after tomorrow I'm off to

Atlanta for the World Science Fiction Convention, where *Footfall* has been nominated for a Science Fiction Achievement Award, otherwise known as a Hugo. By the time you read this, we'll all know if Larry Niven and I won, but just now I don't.

The book of the month is *The Education of Julius Caesar, A Biography, A Reconstruction* by Arthur D. Kahn (Schocken Books, 1986). The flyleaf

says he was 12 years writing it, and I believe that. He sure doesn't like Cicero much.

The computer book of the month is Jeff Duntemann's *Complete Turbo Pascal* (Scott, Foresman & Company, 1986). This is about the best introduction to the Pascal language I've yet seen. It's keyed to Borland's Turbo Pascal and has complete, specific, and compilable programs. If you've been thinking of learning Pascal, this is probably the most painless way to start.

The game of the month has to be Activision's *Little Computer People*. That's not strictly a game, but it sure has consumed all the game time around here this month. We had *Little Computer People* running on both the Amiga and the Atari ST. The Amiga's graphics are preferable. I also learned something about multiple-screen systems: there's no easy way to handle error messages, because where do you display them? The program you're running may have covered up the "workbench" screen. That's Amiga's explanation for what happened, which was that the program blew sky-high whenever it tried to write to a disk with the write-protect window open. The programmer is supposed to handle such problems.

I've been pondering that, and we'll look at the problem next month. It isn't a simple one, but I don't think the current version of Amiga's operating system has the answer.

I've been playing with Activision's *Music Studio* program, and all I can say to that is wow! again. It's sure fun to play around, spraying notes about, then listening to what I "composed." If I'd had an Amiga and this program back when my parents were making me take piano lessons, who knows, maybe I'd have learned something. Anyway it's fun.

There's no point in your wishing me luck in Atlanta. See you on BIX. ■

Jerry Pournelle welcomes readers' comments and opinions. Send a self-addressed, stamped envelope to Jerry Pournelle, c/o BYTE, One Phoenix Mill Lane, Peterborough, NH 03458. Please put your address on the letter as well as on the envelope. Due to the high volume of letters, Jerry cannot guarantee a personal reply.

WHAT'S THE SECRET DEBUGGING WEAPON USED BY EVERYBODY FROM BORLAND TO ORACLE? FREE 44-PAGE ANSWER FROM ATRON.

"WE COULDN'T HAVE DONE IT WITHOUT ATRON'S HARDWARE-ASSISTED SOFTWARE BUGBUSTERS."

This is the city saved by the Atron bugbusters. Your city. Full of wizards, with hundreds of millions of dollars invested in wringing every ounce of intelligence and performance out of your PC. It used to be plagued with the toughest software bugs known to mankind.

PLAGUES OF BIBLICAL PROPORTIONS

The first and most difficult plague was impossible to trap with software debuggers. These were carnivorous bugs which randomly overwrote programs, data, even the debugger. Nastiest were the ones that slipped in once every few hours, or changed their behavior after each new compile. Forty days and forty nights of recompiling, trying something else, caused many a would-be resident of the city to run screaming into the wilderness, never to be heard from again.

Second came the plague of not knowing where the program was, or where it had recently been. This compounded the first plague: How could anyone know what caused the random memory overwrites? Add to this random interrupts and timing dependencies, and you begin to understand *The Fear* that gripped the city.

Then came the last plague, which brought the wizards to their knees before they even started debugging. Their towering programs consumed so much memory, there wasn't enough room for their symbol table, let alone debugging software. Even if they could get past the first two plagues, this one killed their firstborn software.

ENTER THE HARDWARE-ASSISTED SOFTWARE BUGBUSTERS

The Atron solution came as a revelation: Monitor every memory reference and every instruction executed, by adding a hardware board to the AT or PC with an umbilical probe to the processor.

The result? Wham! The PC PROBE™ and the AT PROBE™ saved civilization as we know it. The first plague was cured with PROBE'S hardware-assisted breakpoint traps on reading, writing, executing, inputting and outputting. These could be done on single or ranges of addresses, and could include particular data values. All in real time. For a mere software debugger to attempt this, a 1-minute program would take 5 hours to execute.

The second plague, not knowing from whence you came, was cured with PROBE'S real-time trace memory. The hardware of program execution is saved on-board, in real time. Once a hardware trap has occurred,

CCM ASP AMD ARG
ANS ASI Research ATRON
Accret Software Accret
Technology Acquirer Active
Technology Active
Virus Activator Allen Adaptive
Atron Standard Allen Bradley Allen Com
puter Alphas Alphas Alternative
Amber Systems American Airlines American
Computer Products Boeing Bomber Bostons
Bankers Binary Systems Barber Coleman Business Data Foods Beckman
Instruments Bell Communication Bell Northern Research Bentley Sys
tems Bentley Graphics Bitcomp Blue Box Boeing Borland International
Holder Future Group Federal Communications Board Soft Bunker
Ramo Palma Oetzer CNA Insurance Tech Circle Gullinet CMI
Giles Gene Ginkley Campbell Software Canadian Pacific Railway Carnegie
Well as Chevron Ciba Corning Clinical Data Creditcard Cluhsak Coopers
Cohesive Colson Compaq Comshare Comshare Computers Comshare
System Corvus Crandell Development Custom Cubicom Custom Cyborg Data General
Data Translation Datability Digital Equipment DRUM Green Hill Dan Pylaris Data Corp Data
ID Data Labs Datability Datalogics DataSentry Decision Resources Department of Defense
Design Innovations Desk Dispatch Designers Designers Digital A Digital Communica
tions Digital Research Digital Signatures Dimensional West Diogenes Display Data Death B
President Eastman Kodak Edec Design Edizon Electronic Arts Edision Information
Etrus & Wilmett Evers Exolon Express Laser Labs IBM Amdahl Palomar Federal Aviation
Administration Federal Express Hughes Inala Force Communications Force Data Systems
Rarus Fox Research Friendly Software Funck Software Gould GTE Communica
tions General Electric General Motors Olivetti Goldman Sachs Gould Gull
Himes & Ready Hammer Computer Lattner Howard Hayes Microcomputer Hewlett
Packard Honeywell Hughes Aircraft Human Interface IBM IDE Associates Irwin Magnus
ITT Counter Index Technology InfoSoft Informatic Information Builders Information
Resources InfoSoft Intelligent Controls Interactive Data Interactive Training Systems Inter
Interface Intertec Ionics Johnson Johnson Johnson Johnson Johnson Johnson Johnson
Lockheed Locus Computer Leonardo Logitech Lorax Lotus Development Lynx Robotics M
Chiswell Mentor Graphics Memorex Micro Focus MIT Manufacturers Hanover Trust M
Electronics McCormick & Dodge McDermott Douglas Hamilton Mentor Graphics Meridian
Meridian Meridian Meridian Meridian Meridian Meridian Meridian Meridian Meridian
MicroPhonics MicroPro MicroSoft MicroWare Microbeam MicroVare Microway Mills Labora
tory Mindscape Mitre Mitsubishi Molecular Design Monolith Weber Montano Micrad
MicroData Mouse Systems Multimate Multitech NASA NEC Comen National Instruments
National Research Council National Software Research Lab Novell Air Development Comm
Naked Systems Netat Network Research New York Times New York University New
Information Systems Northwestern Mutual Life Insurance Novel OemTEK Oton Research
Olivetti Olivetti Olivetti Olivetti Olivetti Olivetti Olivetti Olivetti Olivetti Olivetti
Oracle Oracle Technology Oxycom Computing Fibredata Oracle Pacific Bell PC Power
Technologies Koda Technology Kinetics Lab Lanier Laser Line Sleight Living Video Teac
Telebit Perkin Elmer Perovt Phoenix Software Associates I Photon PC Software
Pitney Bowes Polaroid Poligon Software Primatronics Primatronics Primatronics
Puritan Bennett Quadram Quorum Quorum Quorum Quorum Quorum Quorum Quorum
Pulsar Systems Raskin Bell Research Systems Research Systems Research Systems Research
Rohm-Rohlf SAS Institute SSI Sensors
Sherry Summa Four Second Norwalk Lab Sen
The Simplex Time Record
Soviet Air Software On
Computing LTD Space Lab
Software Technology Sun
Tandy M Telebit Trans
Technics Christian Eidel
Theater Associated Ther

FREE 44-PAGE DEBUGGING BIBLE COULD MAKE YOU A PROPHET, AND YOUR COMPANY A PROFIT.

We've written a complete tutorial on state-of-the-art debugging. And it's yours, free for the asking. Full of examples and illustrations, it will show you how the wizards work their magic. If you're tired of suffering the wrath of program bugs, call Atron today. You could be busting bugs, and sales records, tomorrow.



20665 Fourth Street • Saratoga, CA 95070 • 408/741-5900

Copyright © 1986 by Atron Corp. PC PROBE™ and AT PROBE™ Atron. The other fine companies mentioned throughout this advertisement own numerous trademarks. Adv. by TRBA.

DOING IT RIGHT!

A SIMPLE FORMULA FOR SUCCESS FROM THE IBM OF THE MAIL ORDER BUSINESS

When we founded PC Network, our goal was to create the IBM of our Industry.

In three short years, we have grown to an annual sales volume of over \$75,000,000 employing over 200 people! We have served over 200,000 members. We ship over 7,000 orders per week.

We have become the world's largest PC Mail Order Firm.

We are often asked how we did it by the Editors of Computer and Business Magazines, Newspapers, Computer Manufacturers and Fledgling Entrepreneurs.

Our answer is our philosophy.

Price computer products at what they're worth, not the most you can get. For us that became our wholesale +8% pricing applied to over 30,000 products, not just the "Grabbers".

The customer is the most important person in the universe!! Treat him or her well and your business will grow and prosper.

10 Day hardware returns, software rentals, a 24 hour bulletin board with over 20,000 FREE software programs yours for the picking, and numerous other benefits are only the tip of the iceberg in translating this philosophy into practice.

These commitments all cost money. A lot of money. But we firmly believe that for every dollar we spend on YOU our customer, we will receive many in return.

We are told we should be proud of our accomplishments, and we are. But we realize that they all come from working for you, giving you exceptional value and good service.

That means at PC Network, the Customer will always come first!



FLIGHT
SIMULATOR
\$27.00*



HAYES MACH III
JOYSTICK
\$30.25*



CITIZEN PRINTER
120-D 120CPS/80COL
PARALLEL
\$169.00*



MICROSOFT
MOUSE
\$107.00*



ANY TITLE
ABOVE
\$20.00*



William R. Stankiewicz
Warehouse Manager

Richard A. Koril
Vice President

Stephen A. Dukker
President

PC Network
(800) 621-SAVE

Simply put: THE™ highest quality and value in computer products anywhere.

THE™ commitment to our customers is compatibility, quality, value, service and support

THE™ backs every product with a **45 DAY MONEY BACK GUARANTEE**

and a **FULL 1 YEAR PARTS AND LABOR WARRANTY**

THE™ MULTI 384

This multi-function card features 0-384K memory, a serial port for communication, a parallel printer port, a clock/calendar with battery backup, and a software bonus which includes RAMdisk and other utilities.

Retail Price \$90.00*

\$67.00*

Special Wholesale Price



BEST BUY
Functional Clone of AST™ SixPackPlus

THE™ H720 MONO

This monochrome graphics card with printer port features 100% IBM™ and Hercules™ compatibility, at a fraction of their prices.

Retail Price \$91.25*

\$69.00*

Special Wholesale Price



BEST BUY
Functional Clone of Hercules Graphics Card

THE™ MODEMS

100% Hayes™ compatible

THE™ 1200 COM EXTERNAL

This self-testing 1200 BPS modem comes with auto answer, auto dial, auto re-dial and a built-in speaker. Retail Price \$161.25*

Special Wholesale Price

\$119.00*



THE™ 1200 COM INTERNAL

Features auto answer, dial and re-dial, with a built-in speaker, RS 232-C serial port and PC Talk III. Retail Price \$148.75*

Special Wholesale Price

\$109.00*

THE™ 2400 COM EXTERNAL

Eight times the speed of a 300 BPS unit makes this 2400 Baud modem truly affordable, and we've made it truly compatible. With auto answer, auto dial, auto re-dial, and a built-in speaker with volume control. Retail Price \$346.25*

Special Wholesale Price

\$259.00*

THE™ 2400 COM INTERNAL

Features auto answer, auto dial, auto re-dial, a built-in speaker and Free PC Talk III. Retail Price \$332.00*

Special Wholesale Price

\$197.00*

THE™ COLOR CARD

100% compatible with IBM™ color card with display modes of 320x200 graphic and 80x25 alphanumeric, w/printer port. Retail Price \$75.00*

Special Wholesale Price

\$60.00*

TM—AST Research/AutoCAD/Hayes/Hercules IBM/Lotus/Microsoft.

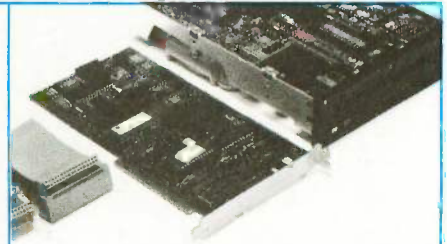

THE™ 20MB HARD DISK

Featuring a half-height IBM™ PC compatible internal 20MB disk drive, controller card, connecting cables and installation manual.

Retail Price \$458.75

Special Wholesale Price

\$357.00*

THE™ MULTII/O

Feature for feature, THE™ matches the AST™ I/O + and comes up a winner, with serial/parallel and game ports standard, (a second serial port optional), a clock/calendar, RAMdisk and print spooler. Retail Price \$75.00

\$60.00*

Special Wholesale Price



BEST BUY
Functional Clone of AST™ I/O +

THE™ EGA PLUS

With 256K standard this 100% IBM™ EGA and Hercules Graphics compatible card is ideal for high resolution graphics display of Microsoft™ Windows, Lotus™ and AutoCAD™. Retail Price \$300.67

Special Wholesale Price

\$220.00*

THE™ 2MB EMS RAM

Intel™/Lotus/Microsoft specs. Features up to 2MB of RAM. Retail Price \$172.00*

Special Wholesale Price

\$99.00*

THE™

Thompson, Harriman and Edwards Computer Products Company, Ltd.

\$444.00*

THE™ PC + 256K/360K DRIVE, TURBO SPEED, 'AT' KEYBOARD
STYLE



"THE™ PC+ is well built and has enough company support behind it to make it a very attractive alternative to higher priced competition."

PC WORLD

"THE's bottom line? The PC+ is a highly compatible clone worthy of consideration..."

Computer Dealer

"...the unit became the preferred computer in our office, which has several name brands as possible alternatives..."



HOW CAN THE PC➔ COST SO LITTLE?

There's no reason why an IBM™ can't sell for \$500! today's costs of floppy drives, chips and all other components which make up the units are a fraction of their costs from a few years past. Advanced high volume production techniques combine with low material costs to make this low price possible.

Why then don't IBM™ PC's and many compatibles sell for \$500? It's simply a question of pricing. Do you go for the most you can get or charge what the product should reasonably bring?

THE™ doesn't have to worry about dropping the price on an existing product 50-80% and then wonder how to make ends meet when they do.

THE™ doesn't have to worry about selling \$800 typewriters in competition with \$500 computers.

You Can Buy	OR	the Same Money Buys
1 \$1,995 IBM™ PC		4 THE™ PC+
1 \$1,495 Leading Edge 'D'		3 THE™ PC+
1 \$999 Tandy 1000		2 THE™ PC+
1 \$795 IBM™ Selectric		1.5 THE™ PC+

And you get more with THE™ PC+! Great strides have been made since the introduction of the IBM™ PC. THE™ personal computers have incorporated the best of them in design.

THE™ PC+	
System Memory	256K/640K
Compatibility	100% IBM™ PC Compatible
Expansion	8 I/O Slots
Power Supply	135 Watt
Floppies	1/360K Drive
System Speed	4.7Mhz/8Mhz
Keyboard	'AT' Style
Price	\$444.00*

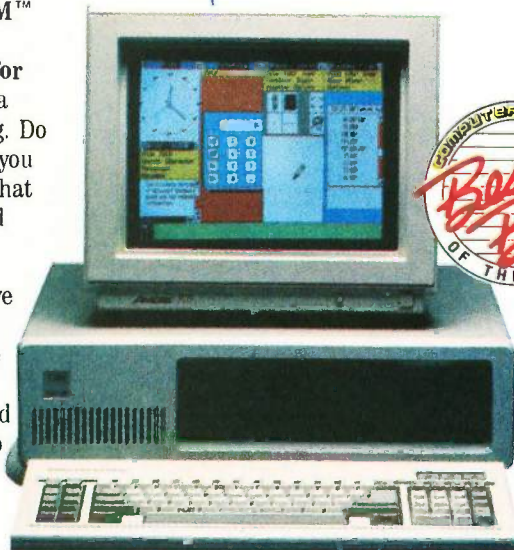

THE™ offers support in more ways than one with these guarantees:
45 Day Returns—If you're not fully satisfied send it back for a full refund within 45 days of purchase.
1 Year Warranty on parts and labor.
Technical Support—Through your dealer or direct from THE.™

*Members pay 8% over wholesale
Prices subject to change without notice

PC Network

(800) 621-SAVE

BUY HARDWARE AND SOFTWARE AT WHOLESALE + 8%, AND GET 14-30 DAY SOFTWARE RENTALS†...

Listed below are just a few of the over 30,000 products available at our EVERYDAY LOW PRICES! The Network carries products for Apple, IBM, CP/M and most other popular computer families.

GAMES & EDUCATIONAL SOFTWARE FOR YOUR APPLE II & MACINTOSH

(Please add \$1 shipping and handling for each title ordered from below.)

Wholesale	Wholesale
Arrays Home Act Financial Plan...Mac \$69.00*	Midecape Crossword Magic/The Halley Project \$26.50*
Bluechip Baron/Millennium/Tycoon 23.99*	Polarware Mac Type-Mac Only 27.50*
Broderbund Logo Runner, Choplifter 17.25*	Polarware Graphics Magician 28.97*
Broderbund Print Shop 24.75*	Polarware Pensale/Xyphus-Transylvanite-Mac Only 13.17*
Broderbund Dazzle Draw 30.25*	Priority Software Forbidden Quest 21.00*
Counterpoint The News Room 26.97*	Scarborough Master Type 19.75*
Davidson Speed Reader II 31.00*	Scarborough Run for the Money 26.00*
Davidson Math Blaster or Word Attack 21.50*	Simon & Schuster Typing Tutor III 28.25*
Edu-Ware Algebra 1,2,3 or 4 23.95*	Sir-Tech Wizardry 26.97*
Electronic Arts One On One 15.97*	Sir-Tech Knight of Diamonds or Rescue Raiders 18.97*
Epyx Summer Games III/Temple of Apshe/Triology 20.00*	Sprinaker Alphabet Zoo, Face Maker, 15.97*
Epyx Winter Games 20.00*	Sprinaker Rhymes & Riddles, Story Machine 20.77*
1st Byte Smooth Talker-Mac Only 44.00*	Sprinaker Amazing Thing/Delta Drawing 24.97*
Hayden Sargon III 24.75*	Sprinaker Delta Drawing 24.97*
Infocom Deadline or Suspended 24.00*	Sublogic Flight Simulator II 27.25*
Infocom Enchanter, Planetfall, 20.00*	Sublogic Jet for Apple or Mac 29.50*
Cuthroths, Witness, Zork I, or Trinity 20.00*	Sublogic Night Mission Pinball 20.00*
Infocom Hitchhiker's Guide or Sealstalker 20.00*	T/Maker Click Art-Mac Only 25.00*
Infocom Suspect, Sorcerer, Indiana, Zork II or III 22.00*	Virtual Combinatics Micro Cookbook 17.50*
Microprose F-15 Strike Eagle, Silent Service 18.50*	
Miles Computing Mac Attack-Mac Only 20.50*	
Mindscape The Mist/View to a Kill/1st Blood Pt. 2 21.00*	

BUSINESS SOFTWARE FOR YOUR APPLE II & MACINTOSH

(Please add \$2.50 shipping and handling for each title ordered from below.)

Wholesale	Wholesale
Apple Apple Works \$165.00*	Microsoft Word/Field/Multiplan for Macintosh \$97.50*
Beagle Brothers Macro Works 19.00*	Microsoft Excel for Macintosh 197.50*
Borland International Reflex for the Mac 59.00*	Microsoft Basic for Macintosh 75.00*
Borland International SideKick w/phonelink 48.00*	Microsoft Chart for Macintosh 62.50*
Borland International Turbo Pascal 37.50*	Monogram Dollars & Sense for Apple II 55.00*
BPI GL, AP, AR, PR or INV 205.00*	Monogram Dollars & Sense for Macintosh 71.99*
Broderbund Bank Street Writer 35.25*	Odesta Double Helix 282.00*
Central Point Copy II Plus or Copy II Mac 16.25*	Provue Overview-Mac Only 130.00*
Funx Software Sideways - Pro Dos Ver. 35.00*	Satellite Software Word Perfect 72.00*
Funsoft Macasm 60.00*	Sensible Software Sensible Speller IV 67.50*
Haba Habazed 40.00*	Softcraft Fancy Fonts 125.00*
Haba Mac Manager 29.95*	Soltech Microsystems UCSD Pascal 37.00*
Human Edge Mind Prober 24.00*	Software Publishing PFS: File, Write, or Graph 61.00*
Human Edge Sales Edge 47.00*	Stoneware DB Master-Mac Tool 145.00*
Human Edge Communication Edge 45.00*	Telos Television for Mac 85.00*
Living Videotext ThinkTank-Mac Tool 65.00*	True Basic Inc. True Basic for Mac 79.00*
MECA Managing Your Money 98.00*	Warner Desk Organizer 52.00*

HARDWARE FOR YOUR APPLE II & MACINTOSH

(Please add shipping and handling charges found in italics next to price.)

DISK DRIVES	MODEMS
Apple IIAC 800KB External Drive \$283.95* (7.50)	Hayes Micromodem Ite w/Smartcom \$125.00* (2.50)
Apple 20MB SCSI HD for Ite or Mac \$24.00* (19.95)	Novation Apple Cart II 174.15* (3.50)
AST A5T-2000 Mac 20/20 20MB HD 1885.00* (40.72)	Prometheus 1200 A 253.00* (6.00)
w/20MB Tape	Low Cost 1200 Baud Internal Modem for Apple II 12.00*
PC Systems 20MB SCSI Hard Drive 650.00* (14.04)	Prometheus/Promodem 1200/MacPack 299.00* (6.00)
IOmega Microvulli 5MB Removable Drive for Macintosh 998.00* (21.58)	Prentice Popcom MacPack 219.00* (2.50)
IOmega Dual 10MB Bernoulli for Mac with SCSI Port 1,800.00* (38.88)	1200 Baud Modem, Cable, Straighttalk
IOmega 20MB SCSI Bernoulli Box 2199.00* (47.50)	
Paradise Mac 10MB Hard Drive 525.00* (11.34)	
Hard Drive Subsystem	
Paradise Mac 20MB Hard Drive 745.00* (16.09)	
Hard Drive Subsystem	
PC Network 800KB Mac External Drive 185.00* (4.00)	
PC Network 140K External Drive 95.00* (2.00)	
for Apple Ite	
PC Network 140K Drive for Apple Ite 95.00* (2.05)	

BOARDS AND BUFFERS

AST Multi-IO-2 Serial/Clock \$155.00* (2.50)	Kennington Dust Cover for MAC or ImageWriter 1.50* (1.50)
AST MegaRAM Plus 4K/1MB 120.00* (2.50)	Kennington Surge Protector 27.75* (2.50)
Microsoft Premium Softcard Ite 243.67* (2.50)	Kennington System Saver Fan 56.97* (3.00)
Microtek Dumping/GX+ 55.00* (2.50)	Koala MacVision 144.50* (3.00)
Orange Micro Grappler + 66.00* (2.50)	Koala Keolapad Touch Tablet 74.97* (1.50)
Orange Micro Serial Grappler 66.00* (2.50)	PC Network Cooling Fan with Surge Protector & Dual Outlets 25.00* (2.50)
PC Network 280 Card 35.00* (2.50)	PC Network SSD Diskettes (Box of 10) 6.95* (1.00)
Quadram E RAM-50 88.00* (2.50)	PC Network Macintosh Diskettes 12.50* (1.50)
Quadram Multicore-1 Parallel 140.00* (2.50)	Includes Free File & File Case
1 Serial/Clock Expandable to 256K	These Diskettes are Guaranteed for Life! No Generals!
Thunderware Thunderclock 104.00* (2.50)	PTI Datasheet S95 45.00* (1.50)
Titan Technologies Accelerator Ite 207.35* (4.48)	PTI Datasheet S100 52.00* (1.50)
	Sony 3.5 Diskettes (Box of 10) 19.00* (1.50)
	Thunderware ThunderScan 155.00* (3.35)

MEMORY CHIPS

(All Memory Chips Guaranteed for Life!)

Wholesale	Wholesale
64K Memory Upgrade Kits (9 Chips) 57.75* (1.00)	Amdek Video 300G Composite Green \$110.00* (3.00)
Quantity Discounts Available!	Amdek Video 300A Composite Amber 120.00* (3.00)
64K Dynamic Ram Chips (Each) 1.00* (1.00)	Amdek Video 310A IBM Type Amber 130.00* (3.00)
256K Dynamic Ram Chips (Each) 2.99* (1.00)	Amdek Color 600 NEW! High Res RGB 365.00* (7.88)
128K IBM Mother Board Chips (Each) 3.50* (1.00)	Amdek Color 722 Enhanced Graphics 424.00* (9.16)
Intel Co-Processor 99.50* (2.15)	Magnavox 12" TTL IBM Type Amber 79.00* (5.00)
	A great looking performing monochrome Monitor, 640 x 240 250.00* (5.00)
	NEC JC-1401 Multisync RGB 530.00* (11.45)
	Princeton HK-12 RGB Monitor 369.00* (7.97)
	Princeton HX-12E CGA or EGA Monitor 430.00* (9.29)
	Princeton IAAX-12e 138.00* (5.00)
	Works with Color or Mono Card
	Quadram ED 13" Enhanced Graphics 430.00* (9.29)
	Taxan 630 High Res RGB Monitor 383.00* (8.27)
	Taxan 640 Highest Res (720x400) 439.00* (10.69)
	Currently Available - Works with Persyst BOB Card & the ATRT Computer

EXTERNAL MODEMS

Anchor Signalman Express \$205.00* (5.00)	
Anchor Lightning 2400 309.00* (2.50)	
Hayes Smartmodem 300 125.00* (5.00)	
Hayes Smartmodem 1200 340.00* (5.00)	
Hayes Smartmodem 2400 525.00* (5.00)	
Prometheus Promodem 1200 247.00* (6.00)	
U.S. Robotics Courier 2400BPS Modem 345.00* (5.00)	
U.S. Robotics Password 172.00* (5.00)	
ALL THE™ MODEMS ARE 100% HAYES COMPATIBLE	
THE™ 1200 Com External 119.00* (2.57)	
THE™ 2400 Com External 259.00* (5.59)	

MONITORS

Apple Macintosh Base System \$355.00* (7.67)	
Apple Ite and Ite Compatible	
ATAT 6300 2DR 640K, KB, DOS Mono Monitor 1,725.00* (38.34)	
COMPAQ DeskPro w/256K 1,775.00* (38.34)	
1 Floppy/20MB Hard Disk	
Citizen MSP-10 NEW! \$259.00* (5.59)	
160CPS 80CPL/Fric + Trac 329.00* (7.34)	
Citizen MSP-15 NEW! 340.00* (7.34)	
160CPS 132CPL/Fric + Trac 299.00* (6.88)	
Citizen MSP-20 NEW! 435.00* (8.40)	
160CPS 80CPL/Fric + Trac 420.00* (9.07)	
Citizen MSP-25 NEW! 440.00* (9.50)	
160CPS 132CPL/Fric + Trac 440.00* (9.50)	
Citizen MSP-28 NEW! 519.00* (11.21)	
160CPS 132CPL/Fric + Trac 699.00* (15.10)	
Citizen MSP-35 NEW! 519.00* (11.21)	
160CPS 132CPL/Fric + Trac 699.00* (15.10)	
Citizen MSP-40 NEW! 519.00* (11.21)	
160CPS 132CPL/Fric + Trac 699.00* (15.10)	
Citizen MSP-45 NEW! 519.00* (11.21)	
160CPS 132CPL/Fric + Trac 699.00* (15.10)	
Citizen MSP-50 NEW! 519.00* (11.21)	
160CPS 132CPL/Fric + Trac 699.00* (15.10)	

TERMS & CONDITIONS

PC NETWORK - Members pay just 8% above the wholesale price, plus shipping. All prices reflect a 3% cash discount. Minimum shipping \$2.50 per order. International orders call for shipping & handling charges. Money orders, personal and company checks please allow 10 working days to clear. All prices subject to change without notice!

†RENT BEFORE YOU BUY - Members are eligible to join the NETWORK'S Business and Game software Rental Libraries and evaluate products for a full 14 (Regular) or 30 (VIP) days to see if it meets your needs. And THE NETWORK'S rental charges are far less than other software rental services - just 20% OF THE MEMBER WHOLESALER PRICE. Rental titles available in IBM/Apple/MAC and CP/M Formats. Hardware price highlighted by ▶ reflect recent major price reductions.

GAMES & EDUCATIONAL SOFTWARE FOR YOUR IBM

(Please add \$1 shipping and handling for each title ordered from below.)

Wholesale	Wholesale
ATI Intro to PC DOS Vol. I, II or BASIC \$27.50*	Microsoft Flight Simulator \$27.00*
Bluechip Millionaire/Oil Baron or Tycoon 28.99*	Mindscape The Mist/View to a Kill/1st Blood Pt. 2 21.00*
Broderbund Logo Runner 17.25*	Systems Mates PC Paint - Turn your PC into A Color Macintosh! 59.95*
Comprehensive Intro to Personal Computing 32.00*	
Davidson Math Blaster, Word Attack 21.50*	Pinpoint Publishing Micro Cookbook 21.00*
Davidson Speed Reader II 36.00*	Scarborough Master Type 19.75*
Edu-Ware Algebra 1,2,3 or 4 23.95*	Sierra On-Line King's Quest II 24.75*
Electronic Arts One On One 15.97*	Spectrum Holobyte GATO 18.00*
Electronic Arts Music Construction Set 15.97*	Sprinaker Alphabet Zoo, Kinder Comp, Story Machine, Face Maker, Hey Diddle, Diddle, Rhymes & Riddles 15.97*
Hayden Sargon III 26.00*	Sprinaker Delta Drawing or Most Amazing Thing 20.75*
Individual Professor DOS 29.75*	Sublogic Jet 27.50*
Infocom Zork I or Witness 19.95*	Sublogic Night Mission Pinball 20.00*
Infocom Deadline or Suspended 24.00*	
Microprose F-15 Strike Eagle/Silent Service 18.50*	

BUSINESS SOFTWARE FOR YOUR IBM

(Please add \$2.50 shipping and handling for each title ordered from below.)

Wholesale	Wholesale
Ansa Paradox \$445.00*	MicroRim RBase 5000 \$215.00*
Ashlon-Tate DBase III+ or Framework II 365.00*	Microsoft C Compiler 230.00*
Borland SideKick (Unprotected) 42.00*	Microsoft Word - Latest Version 3.0 229.00*
Borland SuperKey 34.50*	Microsoft Multiplan 98.00*
Borland Turbo Pascal 35.00*	Microsoft Mouse 107.00*
BPI GL, AR or AP 275.00*	Migent Ability 55.00*
Breakthrough Timeline 203.00*	Monogram Dollars & Sense 85.00*
Central Point Copy II PC 20.00*	Multimate Advantage 270.00*
Computer Associates Supercalc IV, Super Project+ 239.95*	Multimate Multimate (Latest Version) 190.00*
DAC Easy Accounting 39.80*	Norton The Norton Commander 36.00*
Entertronics Energraphics 2.0 147.00*	Norton Norton Utilities 3 43.00*
FGS Fastback 85.00*	Orion Systems P/O Sales A R INV G L ea.395.00*
Funx Software Sideways 32.00*	AP Team Mgr. - Ver. 3.X
Harvard Total Project Manager 250.00*	Roseoft ProKey Version 4 65.00*
Hayes Smartcom (New VT100 Emulator 68.00*	Ryan McFarland RM COBOL (Dev. System) 520.00*
Human Edge Mind Prober 45.00*	Sanna Word + 340.00*
Infocom Cornerstone 65.00*	Satellite Software Word Perfect 185.00*
Lotus Freelance Writer III 126.50*	Soft Logic Solutions Disk Optimizer, Double DOS 29.00*
Lotus Development Lotus 1-2-3 285.00*	Software Group Enable 293.00*
Lotus Development Symphony 385.00*	Software Publishing PFS: File, Write, Graph 68.00*
MDBS KnowledgeManager 229.00*	Software Publishing PFS: Professional File 132.00*
Meca Managing Your Money 92.00*	Software Publishing PFS: Professional Write 105.00*
MicroPro Wordstar 2000 210.00*	Software Publishing PFS: Report 59.50*
MicroPro Wordstar 2000+ 259.00*	Symantec Q & A 230.00*

HARDWARE FOR YOUR IBM

(Please add shipping and handling charges found in italics next to price.)

DISK DRIVES	MODEMS
IBM 360K DS DD Full HI Disk Drive \$85.00* (1.84)	Hayes Smartmodem 1200B 315.00* (2.50)
IOmega Bernoulli Box 1,710.00* (36.94)	with New Smartcom II VT100 Emulator
Dual 10MB Drives	Hayes Smartmodem 2400B 478.00* (2.50)
PC Network 10MB INTERNAL 1/2 289.00* (6.46)	THE™ Internal 2400 2400BPS Modem 259.00* (2.50)
Height Autoload Drive: New low price!	THE™ Internal 1200 1200BPS Modem 109.00* (2.50)
PC Network 10MB Tape Backup 335.00* (8.94)	Lowest Cost Hayes Compatible w/FREE PC Talk III
Same unit used in Compaq's DeskPro!	
PC Network 42MB Internal HD 1,050.00* (24.95)	
35MS Access Time-Comes Complete	
PC Network 20MB Tape Backup 520.00* (11.23)	
Half Height Internal w/controller	
PC Network Half Height DS/DD Drives 75.00* (1.68)	
THE™ 20-20 Combo Kit 20MB HD 699.00* (15.10)	
20MB Tape	
THE™ 20MB Internal 1/2 Height 357.00* (7.71)	

MULTIFUNCTION CARDS

Apparat AT Ram Expansion Card \$139.00* (2.50)	
AST SixPakPremium™ 2MB Multi/DK 315.00* (2.50)	
AST SixPakPlus™ with 64K 139.00* (2.50)	
AST™ I/O Mini 1 Ser./Clock/Short Slot 107.00* (2.50)	
AST™ Advantage for AT™ 325.00* (2.50)	
Orchid Conquest 0K 2MB/1S/1P EMS 220.00* (2.50)	
Orchid Turbo 286 Short Slot 399.00* (2.50)	
Orchid PCTurbo 286 w/1MB RAM 720.00* (2.50)	
Tecmar Captain Multi Card w/DK 109.00* (2.50)	
THE™ 576K Plus Memory Board w/DK 35.00* (2.50)	
THE™ Multi 384 A functional clone 67.00* (2.50)	
Includes up to 384K of expansion memory, 1 serial, 1 parallel, 1 game port, a clock/calendar and 3 software standard	
THE™ Multi IO Plus II Clone 60.00* (2.50)	
Ser/Par./Game/Clock standard	

COMPLETE SYSTEMS

Apple Macintosh Base System \$355.00* (7.67)	
ATAT 6300 2DR 640K, KB, DOS Mono Monitor 1,725.00* (38.34)	
COMPAQ DeskPro w/256K 1,775.00* (38.34)	
1 Floppy/20MB Hard Disk	
COMPQA Hard Disk Portable \$1,800.00* (38.88)	
20MB Hard Disk/1 Floppy/256K	
IBM PC Base System 2SD/DF/OC/256K 1,025.00* (22.14)	
IBM PC Professional Hard Disk 1,337.00* (28.88)	
IBM PC AT Base System - 1.2MB 2,204.00* (62.10)	
Floppy/256K	
IBM AT Professional System CALL	
1.2MB Floppy/20MB Hard Disk/1 Ser/1 Par/512K	

PRINTERS

NEC 2050 20CPS Letter Quality \$570.00* (13.00)	
NEC 3530 33CPS LO Parallel \$888.00* (19.18)	
NEC 3530 33CPS LO 940.00* (14.90)	
NEC 8880 55CPS 699.00* (20.50)	
NEC P 216-180/65CPS 10" Par 415.00* (8.96)	
NEC PinWriter P-7 180CPS/32C 535.00* (11.56)	
Okidata Lotus 20 80CPS 100+ CALL	
Colors/IBM/Integrates & More (Requires Interface)	
Panasonic KX-1091 120/75/22CPS 220.00* (4.75)	
Panasonic KX-1092 180CPSw/Tractor 329.00* (7.11)	
Panasonic KX-P1592 180/38CPS 15" w/Tractor 406.50* (8.78)	
Panasonic KX-P1595 240/51CPS 574.00* (12.40)	
ParSer w/Trac 15K Built	
Epson FX 286 New 440.00* (9.50)	
Epson LX 800 180/60CPS 80CPL/Par 519.00* (11.21)	
Epson LX 1030 NEW! 699.00* (15.10)	
80CPS 80CPL/Par	
Epson LX 86 120/60CPS 8.5" Par 219.00* (4.73)	
NEC 2030 20CPS LO Parallel 605.99* (13.05)	

IBM PC BASE SYSTEM

IBM PC w/256K
Floppy Drive Controller
2 Double Sided Double
Density Disk Drives
Mix and Match with
your Favorite Monitor
and Printer!

\$1,025.00*



CUSTOM CONFIGURATIONS WELCOME

IBM PC HARD DISK SYSTEM

IBM PC w/256K
Floppy Drive Controller
1 Double Sided Double
Density Disk Drive
Half Height Hard Disk

w/20MB
\$1,337.00*

CALL FOR LATEST IBM ANNOUNCEMENTS

PORTABLE HARD DISK SYSTEM

256K/1 Floppy/20MB Hard Disk



COMPAQ™

\$1,800.00*

DESKPRO SYSTEM

256K CPU/1 Floppy/Hard Disk



\$1,775.00* w/20MB



LASER 128

128K RAM, 1 Internal Drive
Apple IIe/IIc Compatible
Parallel & 2 Serial Ports Included

\$355.00*

MACINTOSH
512K
ENHANCED
AND
1.2MB SYSTEMS

CALL



PRICES TOO LOW TO PRINT

Starting
Nov. 1
Mon.-Fri.
7 am-9 pm
CST

**CALL TOLL FREE
1-800-621-S-A-V-E**

(Orders Membership and Advice!!)

In Illinois (312) 280-0002

Your Membership Validation Number is **BBZ6**
You can validate your membership number and, if you wish, place your first money saving order over the phone by using your VISA, MASTERCARD or AMERICAN EXPRESS card. Our knowledgeable sales consultants are on duty Monday - Friday 8:00AM to 7:00PM, Saturday 9:00AM to 5:00PM CST.



PC Network, Incorporated
320 West Ohio Street
Chicago, Illinois 60610

Call now... Join the PC Network and start saving today!
For Customer Service and Order Status call (312) 280-1567
Starting Nov. 1 8:00 AM to 8:00 PM, Mon. - Fri. CST



IBM PC MEMORY EXPANSION KITS

Quantity Discounts Available.

Guaranteed for Life!



Set of
9 Chips **\$7.75***

1/2 HEIGHT DS/DD DISK DRIVES

The Network buys direct and makes fantastic deals with manufacturers like MPI/Tandon/CDC/Shugart/Quime/TEAC and others to bring you fantastic prices on Name Brand drives for your PC/AT/XT/jr/Compatible.

\$75.00*

Quantity Discounts Available

INTERNAL PC HARD DISK

Low Power/Automatic Boot. Works on standard PCs and Compatibles. Includes drive/controller/cables/mounting hardware and instructions.

Full one year warranty!



10MB
\$299.00*

20MB
\$357.00*

Quantity Discount Available



\$285.00*

WordPerfect

\$185.00* ea.

EPSON FX-286 PRINTER

132CPS/200CPS
Letter Quality



\$440.00*

Epson EX-800 NEW! 80COL/Par/Matrix	\$445.00*
Epson EX-1000 132COL/Par/Matrix	629.00*
Epson FX-85 160CPS 10" Par	355.00*
Epson FX-286 200CPS/40CPS NLQ	440.00*
Epson LQ-800 180COL/46CPS Par	519.00*
Epson LQ-1000 180CPS/60CPS NLQ	699.00*
Epson LQ-2500 180CPS/132COL Par/Ser	995.00*
Epson LX-86 120/16CPS 8.5" Par	219.00*

MAGNAVOX 12" RGB MONITOR

\$250.00*



Amdek Video 310 Amber TTL	\$130.00*
Amdek Color 722 NEW! Enhanced	424.00*
Magnavox Amber IBM Type TTL	79.00*
Nec JC-1401 Multisync RGB Color	530.00*
Princeton HX-12 RGB	369.00*
Princeton Max-12E Mono or RGB	138.00*
Taxan 630 High Res RGB	383.00*
Taxan 640 Highest Res (720x400)	439.00*

Members pay 8% above this wholesale price plus shipping.

CALL TOLL FREE 1-800-621-S-A-V-E (orders and memberships)

In Illinois call (312) 280-0002 Validation code:

Customer Service and Order Status (312) 280-1567 **BBZ6**

TM & R - Registered trademarks of IBM/COMPAQ/APPLE/AST Research/LOTUS/Multimate Int./IOMEGA.

FULL HOUSE

BUY THE WORLD'S #1 PRINTER FROM THE WORLD'S #1 SOURCE

It's an unbeatable combination. We're the nation's largest mail order source for everything in computing. Epsos are the nation's best-selling family of printers...and for good reason. Epsos are unmatched in speed, versatility, choice of fonts, letter and correspondence quality, and are backed by the strongest local service network in the nation. So we stock them in tremendous volume, ready for immediate shipment...at the kind of prices that helped make us #1. Epson printers, as well as 30,000 other products are priced at Wholesale + 8%. Also, when you join the Network you get our catalog, our own periodical newsletter, a vast software rental library, free phone consultation, our 10 day money-back guarantee and more! Watch your benefits stack up.

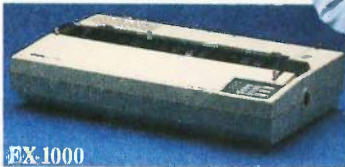

EX-1000

Introducing the EX-800 and EX-1000, for highspeed throughput, at 300 COL draft mode, 60 CPS Near Letter Quality mode.

THOUSANDS IN STOCK READY FOR IMMEDIATE SHIPMENT



EPSON

PC NETWORK
(800) 621-SAVE

In Illinois Call (312) 280-0002



SEASON'S GREETINGS

BY BRUCE WEBSTER

New products for the Amiga highlight Bruce's Christmas column

I find that it's strange to be writing a Christmas column in late August, but such are the vagaries of a three-month lead time. At least I am finally settled into my new office in my new home: boxes are unpacked, papers sorted (more or less), desk organized.

Most of the products discussed this month are for the Amiga. I didn't plan it that way; that's just how it happened to work out. But the Mac and the Atari ST are well represented, so there is something for just about everyone. What? You say there are folks out there who own other machines? Hmm, I'm going to have to look into this.

MEMORY FOR THE AMIGA

When the Amiga made its appearance last year, I—like many others—commented favorably on its open architecture and the free space (8.5 megabytes) in the memory map. Unfortunately for Amiga owners and Commodore, the third-party manufacturers have been slow to release reliable products that take advantage of those features. I would guess that as of this writing, less than 1 percent of all Amigas have more than 512K bytes of RAM. Since the Amiga is a graphics-intensive machine—even more so than the Mac—it eats up RAM quickly and that 512K bytes disappears fast. So the ideal peripheral for the Amiga would be a cheap RAM expansion box, and I expected to see them flooding the market within weeks of the Amiga's introduction.

No such luck. Some RAM boxes have come out, but they've been expensive and often unreliable. To be fair to the manufacturers, part of the problem is the expansion bus itself. In order to pass the bus through for other peripherals, you've got to deal with a number of headaches, including the protection of your own components should the next box down the line do things wrong.

Access Associates decided that the simplest solution was not to pass the bus through at all, and that's how they built their Alegra memory expansion. The unit is a slim grayish-brown box. It's about ½-inch wide and hugs the side of the Amiga. The top, bottom, and rear of the box are flush with the Amiga's main unit, and the front starts about ¼ inch back from the second mouse/joystick port. Installation is simple, though not necessarily easy. I found the best way to get the box to sit firmly on the expansion bus was to stand the Amiga on its side and push down on the Alegra.

The Alegra comes with 512K bytes of RAM, implemented using 256K-bit dynamic RAM chips. On boot-up under version 1.2 of the operating system, the RAM is automatically added to the memory map; you

don't have to worry about anything. For systems running version 1.1, Alegra has supplied the necessary utilities for system configuration—but if you're still running 1.1, shame on Commodore! The Alegra's DRAM sockets are set up so that you can pull all the 256K-bit DRAMs and replace them with 1-megabit DRAMs. That gives you 2 megabytes of extra RAM, instead of just another 512K bytes.

Does the extra 512K bytes make the Amiga nicer? Very much so. First, you can now use more RAM for your RAM disk. My boot disk copies all the command files (in directory DF0:C/) into RAM:C/, then assigns that as the command directory (ASSIGN C: to RAM:C). That way, both floppy disk drives are free for work disks, and I avoid the eternally annoying "Please replace volume WHAZIT in any drive" messages. It also speeds up system response significantly.

Second, applications can now run in the "fast RAM" memory space, that is, memory outside the bottom 512K bytes (which is known as "chip RAM"). Running your program in fast RAM has two advantages. First, it frees up more space for bit planes (graphics images) and any other data that has to be read by the Amiga's custom chips, since those chips can access only chip RAM. Second, it prevents bus contention from slowing down your application. Admittedly, you'd have to be doing a lot of chip work (high resolution with multiple bit planes, etc.) in order to cause bus contention, but it's nice not having to worry about it.

Not passing the bus through isn't as much of a limitation as you might think. If you want to add other expansion-bus peripherals to the Amiga, you simply unplug the Alegra, plug in the peripheral, then plug the Alegra into the peripheral that we're assuming does pass the expansion bus through. If it doesn't, then you're out of luck.

What's the cost of the Alegra? As of mid-July, it was \$379. It might be cheaper by the time you read this. Even at \$379, though, it's worth the price for the added power.

(continued)

Bruce Webster, a consulting editor for BYTE, can be reached *clo* BYTE, P.O. Box 1910, Orem, UT 84057, or on BIX as *bwebster*.

NEW PRODUCTS FROM GTEK

The Model 9000 Eprom programmer is the newest addition to our line of programming equipment. Faster than a speeding bullet, the 9000 can program a 2764A in 8 seconds. More powerful than a locomotive, it can program megabit parts such as the 27010/27210 and exotic devices such as the 87C51.

\$749.00



The Model 2010 Single Board Control Computer features massive power in a small package. Available in a variety of configurations, the 2010 has an 8031H or 8032AH MPU running at 11 Mhz, 64K or 256K bytes of ram, up to 64K bytes of Eprom or EEPROM, RS232, onboard regulator, 40 "bit" programmable I/O lines and, an expansion interface. Languages include Assembly, Basic, C, and Fourth. Call us for help determining a configuration to meet your control or data logging needs.

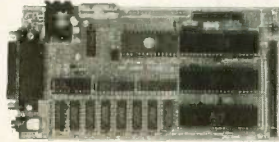

Size 3.5" x 7.0"

GTEK also manufactures and distributes a complete line of development products such as PAL and GANG programmers, Support Software, Erasers, Macro Cross Assemblers and Simulators, CPM-Z80 Emulators, Programmable Parallel Printer Switches and Buffers.

GTEK

INC.

DEVELOPMENT HARDWARE & SOFTWARE
DRAWER 1346, BAY ST. LOUIS, MS 39520 USA
PHONE (601) 467-8048 TELEX 315814 (GTEK UD)

METACOMCO

The quality source for Atari ST & Amiga software

CAMBRIDGE LISP



THE SYMBOLIC LANGUAGE
FOR ATARI ST and AMIGA

An interpreter/compiler providing a complete
LISP development environment for \$199.95.

—also available—

- Macro Assembler - Professional development system ST - \$ 79.95
Amiga - \$ 99.95
 - BCPL - NEW! Full standard BCPL compiler - ST \$149.95
 - Lattice 'C' - The well known Lattice 'C' compiler - ST & Amiga \$149.95
 - Cambridge Lisp - The interpreter/compiler - ST & Amiga \$199.95
 - MCC Pascal - Fast ISO/ANSI standard compiler - ST & Amiga \$ 99.95
 - Metacomco MAKE - NEW! UNIX-like MAKE utility for the ST ... \$ 69.95
 - MENU + - Best selling ST MENU generator \$ 29.95
 - Metacomco SHELL - NEW! Amiga's intelligent programming shell .. \$ 79.95
 - Metacomco TOOLKIT - Smartest tools available for the Amiga \$ 49.95
- Cambridge LISP is also available for CPM-68K. Call for Sinclair QL products. Languages come with full documentation, libraries & screen editor. ST languages include MENU+ and provide full interfaces to GEM VDI and AES functions. Metacomco provides experienced technical support and keeps its customers informed of new products and upgrade releases.

METACOMCO

5353 #E Scotts Valley Dr.
Scotts Valley, CA 95066

Contact your local dealer or call:
Tel: (US) 800-AKA-META (CA) 800-GEMETA
BIX: mhll Compuserve: 73247.522
Add 6 1/2% tax if CA resident

Registered trademarks: Lattice - Lattice, Inc; Atari ST - Atari; UNIX - Bell Labs; Amiga - Commodore Amiga.



ACCORDING TO WEBSTER

I know that I'm hooked; I don't think I could stand a 512K-byte Amiga now.

MICROBOTICS MAS-20 HARD DISK

The other peripheral the Amiga has lacked is a fast, cheap hard disk. Unfortunately, cheap hard disks may be slow in coming for the Amiga, just as they were for the Mac. Two problems crop up here: first, the bugaboo of the expansion bus again; and second, the perception by manufacturers of a small, soft marketplace. The former has already been discussed; the latter means that manufacturers aren't willing to commit to produce more than, say, a thousand units (into an installed base of about 90,000 Amigas as of mid-August). Because of that, the manufacturers can't get a great price on the drives, and that keeps the price relatively high.

However, high-quality hard disks are finally coming out for the Amiga. One such drive is the MAS-20 (20 megabytes) from MicroBotics. The unit is about 2 inches high by 5 inches wide by 12 inches long, and it is the same beige shade as the Amiga. The MAS-20 avoids the problems of the expansion bus by plugging into the parallel port. This allows you to place it wherever is comfortable (within the reach of the cable, of course).

The first time you set up the MAS-20, you must format it and create a boot disk. To do this, you make a copy of your regular Workbench or CLI boot disk, since the setup program will modify portions of the disk (like the Startup-Sequence file). You then run the setup program (provided with the MAS-20). This updates the boot disk with the proper drivers, creates the needed start-up file, and does the formatting (which takes about 40 minutes). After that, you use your modified boot disk when you start up or reset, and the MAS-20 does the rest. All the command files (your C directory) were copied onto the hard disk during the setup process, so commands operate more quickly; likewise, setup copies the device and library files to the hard disk.

Having a hard disk on the Amiga was nice; as was the case with the extra RAM, it spoiled me. It makes a big difference in what I accomplish when I have Aztec C, Lattice C, CSI MultiFORTH, and TDI Modula-2 all on-line at the same time. Twenty megabytes, while not as much as it sounds (about equivalent to 23 floppy disks), still can go a long way. And the access time—about three times faster than a floppy disk—helps a lot, too.

I didn't have time to really wring out the MAS-20. MicroBotics has just started shipping them and could lend me a unit for only a week or so. During that period, though, the unit was trouble-free: no crashes, no lost files, no mysterious happenings. The only major grievance I've heard is that printing and disk accessing tend to interfere with each other since both are using the parallel port. Unfortunately, I don't have a printer cable for my Amiga, so I haven't been able to verify how much of a problem this is.

My only complaint with the MAS-20 is its price: \$1495. Unfortunately, the dynamics of the Amiga marketplace will keep that price up for quite a while. I'm not sure if that

(continued)

AT jr. NOW \$599.



FREE! A \$185.00 VALUE.
With any order of \$1,000 or more, AMT will send you, absolutely FREE, a *Micro* brand dress wristwatch. Finest precision Japanese quartz movement. Specify male or female size.

LAUGH, CLONE, LAUGH! Who would guess that our AT jr. has more on the ball than his big brother?

AT jr. not only delivers fantastic features at fabulous prices, but gives you top quality in design, components, materials, and construction!

And for reliability, every AT jr. is burned-in at the factory prior to shipment.

No IBM® compatible system gives you more capability and value for your dollar than our incredible AT jr.

AT jr. \$599. This feature-packed model is based on an Intel 8088-2 (or NEC V20-8) CPU, running at 4.77 MHz or 8 MHz, selectable; handles PC DOS®, MS DOS®, XENIX®, and other operating systems, plus a full range of IBM-compatible software.

The standard system has a "0" wait state on memory, and operates many times faster than the IBM PC/XT®. Offers 640 KB of RAM on

the motherboard; 360 KB floppy disk drive; eight expansion slots; LED indicator for the turbo mode; AT-style keyboard; 135-watt integral power supply; and security key lock. Optional features include a 40 MB hard disk (38 ms), EGA, and an 8087-2 math co-processor.

LAP TOP. \$1699. AMT's compact Lap Top system gives you full IBM compatibility in less than 12.2 pounds of high-powered computer.

Features an 80C86 microprocessor, giving you twice the speed of IBM's lap top; 640 KB of memory; two 720 KB, 3.5-inch disk drives; an 80-by-25 LCD display with 640 x 200 resolution; RGB and printer ports; and a 1200 baud internal modem, optional.

AMT-286. \$1199. AMT's top-of-the-line AT system outperforms the IBM PC AT® at a fraction of the

price. Tagged "Best Priced" by PC Week, March 1986 issue.

Our phenomenal AT has a 16-bit Intel 80286 CPU running at 8 MHz (10 MHz or 12 MHz optional); 640 KB of RAM, expandable to 1 MB; 1.2 MB floppy disk drive; accommodations for 20, 30, or 40 MB hard disk drive; a socket for an Intel 80287 math co-processor; and a "0" wait state on memory, optional.

DON'T WAIT—CALL NOW

Pick up your phone now and get full details or place your order.



AMERICAN MICRO TECHNOLOGY

14751-B Franklin Avenue

Tustin, California 92680

Phones: (714) 731-6800;

in LA call (213) 477-6320;

in Bay area call (415) 490-7967

TWX 5106003265 AMT USA

*Prices and availability subject to change without notice. Dealer inquiries accepted.

®Registered Trademarks—IBM, IBM PC, IBM PC/XT, IBM PC AT, PC DOS: International Business Machines Corporation; MS DOS, XENIX: Microsoft.

10 MHz

New Quantum 286 Turbo

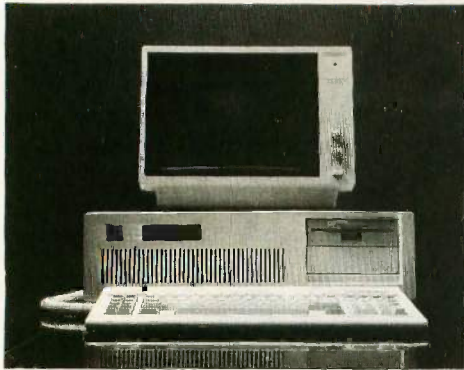

Finally Performance that Exceeds Demand!

Full IBM PC-AT™ Compatibility

Both the Quantum Turbo™ and the Quantum XT Turbo™ incorporate all the hardware developments of yesterday while maintaining the vital link of total software compatibility through the Phoenix BIOS.

Quantum 286 Turbo 10MHz

Features:

- Quantum 286 Turbo Mother Board (made in U.S.A.)
- 10-8 MHz Clock Speed
- **Phoenix BIOS**
- 512K up to 1 MB onboard
- 1-RS-232 (Expandable to 2 onboard)
- One Parallel Port onboard
- 1.2 MB Floppy Drive
- Floppy/Hard Disk Controller
- Keyboard
- One-Year Warranty

\$1395.00

Quantum XT Turbo 8MHz

Features:

- Quantum XT Turbo Mother Board (made in U.S.A.)
- 8-4.77 MHz Clock Speed
- 640K onboard
- **Phoenix BIOS**
- 1 360K Floppy Drives
- FDC w/Clock Calendar
- RS-232 Port & Parallel Port
- Game Port
- AT Keyboard
- One-Year Warranty

\$745.00

IBM AT is a trademark of International Business Machines Corp.

AFTON COMPUTER INC.

(714) 863-6951

24825 Calle El Toro Grande

El Toro, California 92630

Customer Service (714) 553-1701

Telex 756731

Prices, Configurations and Deliveries Subject To Change.

We provide *instant* response to TIPS.

You call, We call! See page 440.

ACCORDING TO WEBSTER

price is low enough to entice someone who has already spent \$2000 or so on the Amiga system to buy a hard disk. But if you can afford it, the MAS-20 is a great addition to the Amiga.

PRODUCT OF THE MONTH: INSTANT MUSIC

Speaking of power, a new package from Electronic Arts shows off the capabilities of the Amiga. Instant Music, written by Robert Campbell, truly provides "the triumph of technology over talent" (to quote BYTE's Gregg Williams). Briefly put, Instant Music turns the Amiga into an intelligent electronic instrument that even an untalented hack like me can play. It allows me to jam by moving the mouse up and down and pressing the button. What's more, it plays three other voices while I jam, forming the musical background for the piece. And what comes out sounds like real music.

The secret is in the "musical intelligence" of the program. By moving the mouse up and down, I pick the relative pitch of the music I want to play, and Instant Music generates accompanying chords. This can be limiting at times—it's disconcerting to hold the mouse button down and get only occasional notes or chords—but the result is pleasing to the ear (usually).

To play, you select the piece of music you want to hear. There are more than 40 different selections from 4 to 24 measures long, ranging in style from rock to classical. A given piece has four voices, though often only three (the ones the computer usually plays) are actually scored. Each voice represents an instrument: electric guitar, flute, organ, and so on. A total of 19 instruments are available, including a "DoVoice" instrument that allows "do wah" vocals for songs. You start the piece and play your part while the computer plays the others. A graphical display shows the entire piece, so you can see what each voice will be doing. You can switch voices and take over another part; you can change instruments; you can change the tempo; you can even make the program do less for you and gain greater control over chords and rhythm.

Once you've gotten comfortable with all that, you can start creating and editing pieces of your own. Composition is almost as easy as playing; in fact, it's just like playing. First, decide how many measures long the piece will be (up to 64). Second, pick the instruments for each of the four voices. Then pick a given voice and use the mouse and button to play what you want the track to be. Pick the next voice and lay down the next track. When you're done, you can play back your composition. You can also "step in" for a given voice and play it yourself.

My only complaint with Instant Music is that it's copy-protected. True, it's the key disk method, which does allow for installation on a hard disk, and, also true, you can buy an unprotected version for another \$20, but it's still a pain. Copy protection seems to be a dying trend in the industry; maybe Electronic Arts will see that and follow the other firms that are dropping protection from their products.

I've enjoyed having Instant Music to use, and my kids have been fascinated by the ability to sit down and play

(continued)

AMT-286: MORE THAN AN IBM® LOOK ALIKE.



**AMT-286.
\$1199.**

The IBM PC AT® laid the foundation. AMT accepted the challenge, and put its AMT-286 into orbit. Now you can get the best of both worlds at a fraction of IBM's price!

Speed. The AMT-286 cruises at 8MHz, with optional clock rates of 10MHz and 12MHz. That's 30% to 40% faster than the IBM PC AT.

Main Memory. User-friendly programming takes lots of RAM. The AMT-286 comes with 640K, but can be expanded to an incredible 6 MB. IBM can't say that.

Mass Storage. Up to 60,000 pages of words and numbers—a full 120 MB of storage—can be crammed into the AMT-286 hard disks. That's twice what the IBM PC AT can handle.

Other Goodies. Intel's fabulous 80286 16-bit microprocessor chip on an American-made motherboard. 1.2 MB floppy disk; and accommodations for an 80287 math co-processor. The system runs all software and accepts all hardware designed for the IBM PC AT.

For \$1199, how can you lose?

**AT jr.
\$599.**

This feature-packed model has an Intel 8088-2 running at 4.77MHz or 8MHz, selectable—many times faster than the IBM PC/XT®. Also has a "O" wait state on memory, and provides 640 KB of RAM on the motherboard. Offers eight expansion slots, an LED indicator for the turbo mode, and a security key lock. Optional features include a hard disk, up to 40 MB (38 ms), EGA, and an 8087-2 math co-processor.



**FREE
A \$185 Value.**

Case style may vary from photograph.

With any order of \$1,000 or more, AMT will send you, absolutely FREE, a Micro brand dress wristwatch. Finest precision Japanese quartz movement. Specify male or female size. Only one watch per customer.

REACH FOR YOUR PHONE.

An AMT-286 or AT jr. is yours by dialing one of our convenient numbers. All orders filled immediately, following complete systems checkout and 72-hour factory burn-in.



AMERICAN MICRO TECHNOLOGY

14751-B Franklin Avenue
Tustin, California 92680

Phones: In Orange County call (714) 731-6800
In LA call (213) 477-6320
In Bay area call (415) 490-7967
TWX 5106003265 AMT USA

*Dealer inquiries accepted
*Prices and availability subject to change without notice

®Registered trademarks IBM, IBM PC/XT, IBM PC AT:
International Business Machines Corporation

NEW 10 MHz

TIME IS MONEY...

10 MHz IS FAST!!!

FULL IBM PC-AT* COMPATIBILITY

IF YOU ARE TIRED OF WAITING FOR A 'SOMEDAY' PRODUCT OR YOU DON'T WANT TO BUY YESTERDAY'S TECHNOLOGY, THEN TREAT YOURSELF TO THE PERFORMANCE & FEATURES OF THE "WESTECH 286 TURBO™" 10 MHz

PHOENIX BIOS - THE MISSING LINK IN SOFTWARE COMPATIBILITY - ON BOARD

LOWEST COST 10 MHz AVAILABLE

COMPLETELY DESIGNED, MANUFACTURED, ASSEMBLED AND TESTED IN U.S.A.

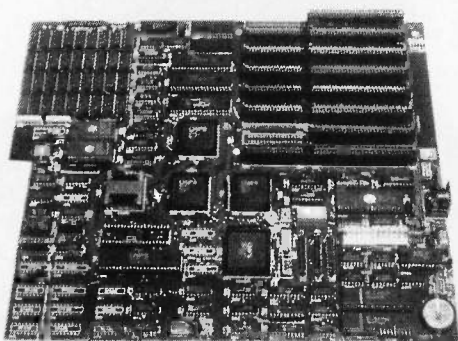

- 8 I/O Slots
- Parallel Port
- Up to 2 RS-232 Ports
- 1 RS-232 Included
- Phoenix BIOS
- Up to 1 MB Onboard
- 512K Included 120ns
- 4 Layer Mother Board
- Onboard Battery
- CMOS Clock Calendar
- Standard Power Connector
- Low Power Circuitry
- 10 MHz 80286
- Socket for 80287
- One-Year Warranty

HIGH SPEED INDUSTRIAL GRADE COMPUTER FOR:

- Industrial
- Medical
- Scientific
- Engineering
- University/Education
- Artificial Intelligence

QUANTITY DISCOUNTS AVAILABLE FOR QUALIFIED DEALER, OEM, UNIVERSITY AND CORPORATE ACCOUNTS.

\$599.00 OEM Quantity Price

Call for other pricing

Westech, Inc.

(714) 474-6022

17781 Mitchell, Irvine, CA 92714

FAX (714) 553-0236 • TELEX 756731

Answer Back: Western Comp

We provide *instant* response to TIPS.

You call, We call! See page 440.

Prices and availability subject to change.
*IBM AT is a trademark of International Business Machines Corporation
Westech 286 Turbo is a trademark of Westech, Inc.

Inquiry 382 for End-Users.

Inquiry 383 for DEALERS ONLY.

real music without much effort. It's an outstanding program, and Robert Campbell should be commended.

THE HACKERS CORNER

Every few weeks, I receive some piece of software that a solitary programmer working long hours has feverishly pieced together. Sometimes the programmer sends it to me; sometimes I get it by other means (downloaded from bulletin boards, etc.). In either case, the software itself is either public domain (i.e., free) or it's shareware (i.e., free unless your conscience bothers you enough to compel you to send some amount of cash to the author). I plan to periodically review some of the PD/shareware programs out there, calling attention to the fine efforts of kitchen-table hackers everywhere.

The two programs I'd like to mention this month are, at first glance, frivolous, but both illustrate the strengths of the computers they run on. The first is a public domain desk accessory for the Macintosh, known simply as Talking Moose. It was written by Steve Halls, a doctor in Canada, who apparently had a great deal of fun putting the program together. When you activate the desk accessory, it installs itself in the system heap, then allows you to go back to whatever you were doing. However, if an interval of time (user-adjustable) goes by with no activity, a small window with a moose's head in it appears near the upper left corner of the screen. The moose then makes some smart-aleck remark, usually (but not always) having to do with your lack of work, and the window goes away. The moose head—somewhat reminiscent of Bullwinkle—is animated while it talks, moving its eyes, ears, nose, and mouth.

At any time, you can bring up the desk-accessory window again, which allows you to adjust the rate and pitch for the voice, as well as the delay between comments. You can also click a box to remove the moose from the system, in which case the moose appears and makes some sort of plea or threat ("Oh, no! Don't do that!"). If you then turn the moose back on, it replies with some expression of gratitude ("Splendid decision!"). The desk accessory requires two support files: MacinTalk, Apple's speech synthesizer program; and Moose Phrases, a resource file full of comments converted to MacinTalk phonetics.

Halls was offering the assembly language source code for the price of a disk and postage (or for a disk with sufficient return postage). I don't know if the offer is still in effect; you might want to write him (with a self-addressed envelope and money for postage) to find out. The last address I have for him is Steve Halls, M.D., 11135 50 Ave., Edmonton, Alberta, Canada T6H 0J1.

The other program is for the Amiga, and it arrived in the mail with a pair of the old red-and-blue three-dimensional movie glasses. The program, 3-D Breakout, was written by Tim Kemp of Columbus, Ohio. As you might guess, it's a variant of the old Breakout game in which you keep bouncing a ball off a paddle back toward a group of bricks. In this version, the "bricks" (one layer thick) line the ceiling and three walls of a room, with the screen forming

(continued)

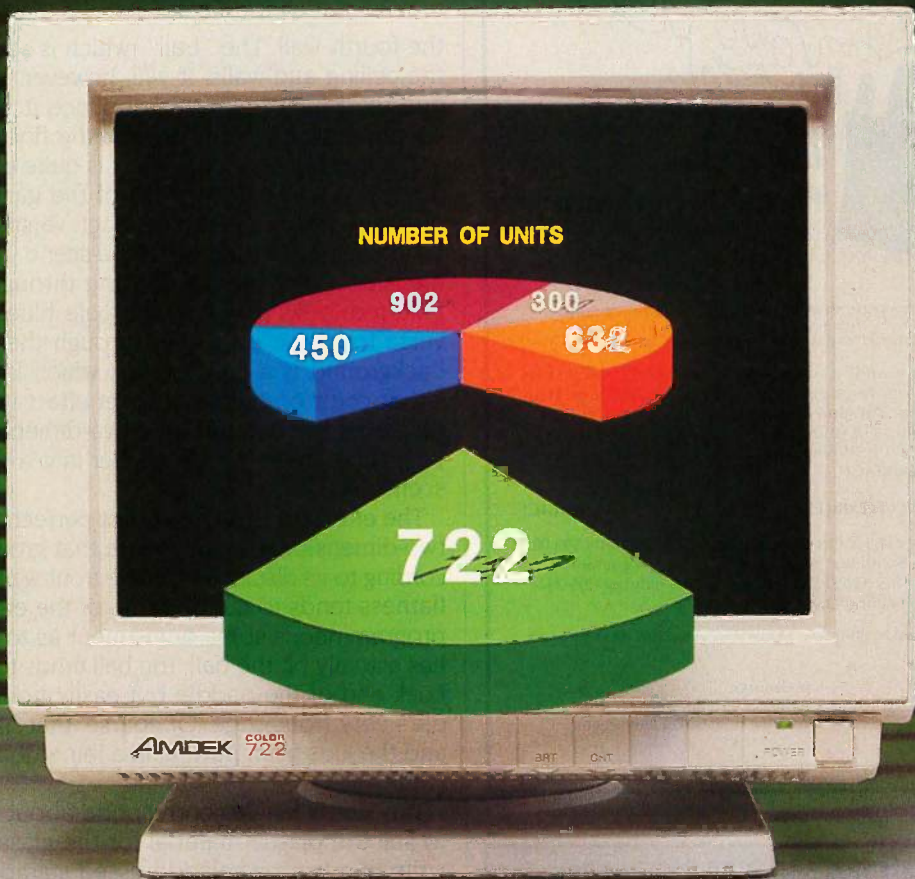

Enhanced graphics without an enhanced price. The Amdek 722 EGA monitor.

The Amdek 722 high performance color monitor is ideal for all enhanced graphics applications. Amdek engineered the 722 monitor to fully support *both* the IBM Enhanced Graphics Adapter (EGA: 640 x 350 lines resolution), and the IBM Color Graphics Adapter (CGA: 640 X 200). In the EGA mode, you can use any combination of 16 colors from a 64-color palette.

The result is an EGA monitor specifically designed to give you the ultimate in high resolution performance for a wide range of business graphics, engineering, educational purposes, and similar applications.

Other advanced design features include a high quality

etched glass, non-glare screen, and a 3-position switch that allows you to choose green, amber or full-color text.

Ask your computer dealer to show you some of the enhanced features of the Amdek 722 EGA monitor. And then ask to see the *best* feature of all—the price! The Amdek 722 EGA is more monitor for the money. And it's backed by more warranty for your peace of mind—*three years* on the CRT, and *two years* on all other parts and labor.

Once you compare the quality and price, you'll focus your attention on the best monitor for enhanced graphics—the Amdek 722 EGA monitor.

AMDEK

Clearly the finest in monitors.

NEW!



turboMAGIC™ turns your ideas into state-of-the-art programs.

Your productivity increased, or your money back!

Let your imagination run wild! It's easy with turboMAGIC, the slickest code generator available for Turbo Pascal. Input forms. Report forms. Help windows. Pop-up menus. Pull-down menu systems. And more! turboMAGIC will turn 15 minutes of your time into code that would take you hundreds of hours to write. Whether you're a professional or just a beginner, you need turboMAGIC.

It's **POWERFUL!** It's **FLEXIBLE!** It's **FAST!** It's **MAGIC!**

Wouldn't you like some magic? Order turboMAGIC today. Only \$99.00. You have nothing to lose with our 30-day full money-back guarantee. CALL NOW! 1-800-225-3165 (Outside Alabama, orders only) or 205-342-7026 (VISA & MC welcome, no PO, no COD)

Requires: Turbo Pascal 3.0 and an IBM PC/XT/AT or compatible 256k-RAM minimum

Not copy protected.



Sophisticated Software Inc.
6586 Old Shell Road
Mobile, AL 36608
(205) 342-7026

Trademarks:
Turbo Pascal — Borland International
WordStar — MicroPro International

**THE GENERAL DATACOMM
1200 Bps SUPER ACCURATE
ACCULINE PC MODEM**

**AT COMPATIBLE • FULL FEATURED •
TWO YEAR WARRANTY**

40% OFF

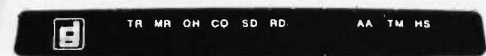

**\$226⁰⁰ Including Software
Call 1-800-523-1737**

**Order now and receive a FREE
IntroPak Subscription to COMPUSERVE.**

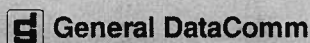

Offer valid through December 31, 1986.

ACCORDING TO WEBSTER

the fourth wall. The "ball" (which is square) bounces off the ceiling and walls. It will, however, sink into the floor and disappear unless you bounce it off your paddle: a square that you move around the floor with the mouse.

The three-dimensional effect is quite good. The program actually draws two versions of the game on the screen, one in red and one in blue. Each version corresponds to what each eye would see if the scene were truly three-dimensional. For the eye looking through red plastic, the pale red looks gray and the pale blue looks black; vice versa for the eye looking through the blue plastic. The background is a light purple, which looks gray through either color of plastic. The net effect is that the left and right eyes see two different two-dimensional images and your brain fuses them together into a three-dimensional scene.

The effect, while good, is not perfect. The "ball" is only two-dimensional, a flat square that grows and shrinks according to its distance from the front wall (the screen). That flatness tends to nullify some of the effect. Likewise, the program needs some adjustment as to when the paddle has actually hit the ball; the ball tends to sink through the back end of the paddle but easily bounces off the paddle's very front edge. Of course, that hasn't stopped me and the kids from putting in a fair amount of time on the game.

Tim was willing to correspond about the program and to sell the plastic material for the glasses. I suggest you write him (with a self-addressed stamped envelope and sufficient money to cover his time and effort) at Tim Kemp, P.O. Box 23101, Columbus, OH 43223.

STOCKING STUFFERS

By the time you read this, there won't be too many more shopping days until Christmas, and you may be wondering what to get for the computerphile in your life (even if that's just you). I don't talk much about games in this column, but I hope you won't mind too much if I make some recommendations for your last-minute Christmas shopping. Since computer games are something of a passion in this household, we've had a fair amount of experience.

My favorite game this year has been Major Motion, written by Philip MacKenzie and Jeffrey Sorenson for the Atari ST and published by Michtron. It was inspired by the video arcade game Spy Hunter and involves car-to-car combat. Your mission is to travel as far as you can, destroying enemy (blue and/or black) cars and helicopters as you go along while avoiding injury to civilians. Your car starts out armed with just guns, and they work only against some of the enemy. As you drive along, a red semi appears from time to time; if you drive into it, you come out with a new weapon (oil, smoke screen, repulsor, missiles for the helicopter, or turbo boost). Each new weapon is good for only three attempts, and you lose one of those weapons each time you crash. You start out with six cars and get a new one for each 10,000 points.

The enemy, of course, is not idle during all of this. One

(continued)

Limited time offer!
Trade up to TAS-Books and save \$30!

TAS-Books VS. Dac-Easy



	DAC	TAS-Books
Full price including Payroll, G/L, A/R, A/P, Sales order/Invoicing/P/O/Inventory & Tutorial	\$159.75	\$99
Written using 4th generation language	NO	YES
Source code included/modifiable	NO	YES
Easy-to-change file structures	NO	YES
Report generator	NO	YES
Multi-user option available	NO	YES
On-line help messages	NO	YES
3-yrs. GL data by month	NO	YES
Create mail/merge files	NO	YES

Feature for feature, dollar for dollar, TAS-Books wins, hands down!

TAS-Books gives you more for your money.

Before you buy DAC Easy accounting software (or if you already have), you should know what you could have instead.

You could have software that changes — easily — to fit your accounting system, instead of the other way around. You could have a program that includes payroll and a full-featured data base at no extra charge.

If you've already bought DAC Easy, you can still trade up to TAS-Books, and get an additional \$30 off the price!

TAS-Books adapts to fit your business.

Accounting systems are not all alike. That's why TAS-Books is written using the popular TAS-Plus 4th generation language/relational data base, with source code included. So you can easily customize TAS-Books to fit your business.

TAS-Books does so much, so easily.

TAS-Books gives you full audit trails and integrated modules, with sales and purchase histories updated automatically. You can review up to 3 years of GL data by month. Plus all the usual accounting functions. And you get a tutorial, and on-line help messages in each field.

Here's what TAS-Books offers you:

- General Ledger**
 - 3 years of data by month
 - Full audit trails
 - Post to previous periods and reclose
 - Budgeting by month
 - Flexible financial statement setup/printing
 - Accounts Receivable**
 - Open item
 - Mailing labels and rolodex cards
 - Detailed history of sales, costs, and net
 - Statements
 - Ageings
 - Accounts Payable**
 - Easy to enter invoices/vouchers
 - Enter checks written by hand and/or print out checks automatically
 - Mailing labels and rolodex cards
 - History of purchases
 - Payroll**
 - Easy to run
 - Produces all necessary information
 - Prints W-2 forms
 - Allows for employee reimbursement without tax
 - Inventory**
 - Averages cost and records last cost
 - Adjusts physical quantity
 - Uses fractional quantity
 - Keeps track of non-inventoried items
 - History of sales, cost, and net
 - Adjust cost
 - Each item can have its own SALES and COGS GL account
 - Invoicing/sales order**
 - 99 items per order
 - Description lines added easily
 - Credits may be mixed on same order
 - Discount for any line
 - Ship to may be loaded from customer file
 - Purchase order**
 - 99 items per order
 - Description lines added easily
 - Credits may be mixed on same order
 - Discount for any line
 - May order non-inventoried items
- Plus many reports and other features too numerous to mention!**

Full-featured database gives you real versatility.

No need to buy an expensive data base to interface with TAS-Books: it's included at no extra charge! So you can easily generate customized reports and create mail-merge files. No need to preallocate files. TAS-Plus does all the hard work for you! And if you're already using DAC Easy, TAS-Books will translate your current files.

Order today 1-800-648-6258.

Call our Toll-Free Hotline. Use your VISA, MasterCard or American Express to order today. For information or Washington residents call 1-206-644-2015.

TAS-Books is available for the IBM PC/XT/AT and fully compatible computers.

Money-back guarantee!

Try TAS-Books for 30 days. If it's not exactly what you've been looking for in accounting software, just send it back. You'll get a full refund (less \$15 handling fee).

TAS+™

NOT COPY-PROTECTED

Trade up to TAS-Books.

Send us the title page from your DAC Easy manual. We'll send you TAS-Books at an additional \$30 off its money-saving price. Limit one discount copy per customer. Offer ends January 1, 1987.

YES! I want powerful, user-friendly accounting software, with easy-to-customize coding and its own full-featured data base. And I want to save money over programs that offer me a lot less. Rush me TAS-Books now!

Quantity _____ Subtotal _____
 @ \$99 ea.
 Shipping: \$8 U.S. \$25 outside U.S.A.
 Trading in DAC? Subtract \$30!
 WA residents add 8.1% sales tax.
 TOTAL _____
 (U.S. funds only)

Name: _____
 Shipping address: _____
 City: _____
 State: _____ Zip: _____
 Telephone: _____
 Payment (circle one): VISA MC AMX Check
 Credit Card Expiration Date: _____
 Card Number: _____
 Name on Card: _____

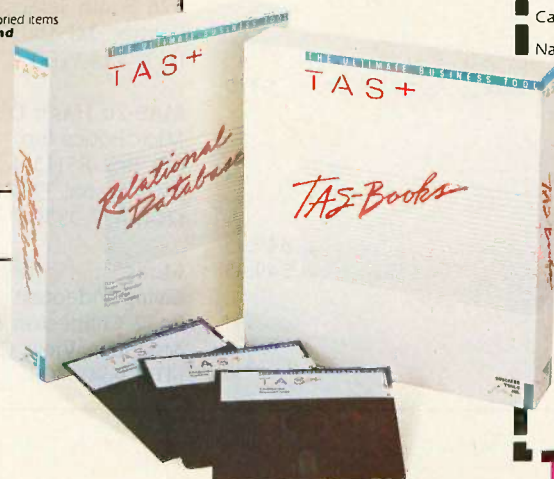

BUSINESS TOOLS INC.



4038-B 128th Ave. S.E.
 Suite 266
 Bellevue, Washington 98006
 (206) 644-2015



The following are registered trademarks of these companies: TAS-Plus, The Accounting Solution, TAS-Books, Business Tools, Inc.; IBM PC/XT/AT, International Business Machines Corp.; Dac-Easy, Dac Software, Inc.

© 1986 Business Tools, Inc.

type of enemy car is equipped with tire slashers; if it bumps into your side, you're gone. Other enemy cars will try to run you off the road while the enemy helicopters drop oil spots in front of you. If you go far enough, you'll encounter your "evil twin"; if you get past him, you'll soon run into two of them. Somewhere past that you'll find the bridge is out, but...well, that would be telling.

The car, controlled by the mouse, handles very nicely, and the graphics are smooth and colorful. Also, the game plays background music (themes from *James Bond*, *Batman*, etc.) from time to time as you drive; a nice touch. The game has other features, like an abort key, pause and music toggles, and the ability to reassign the weapons keys. And, best of all, it keeps a "Top Ten" list that provides solid documentation for bragging rights.

I'm not sure why I like this game more than the others I've played. I think it has to do with the way I drive or, more precisely, the way I'd like to drive. And Major Motion had one welcome feature over the other two: it is not copy-protected. That helps, because my kids have already creamed one working disk, and it took me just a few minutes to make a new working disk from the master. I'd hate to think what would happen if they messed up the master disk for one of the other games.

Nevertheless, those two other games gave Major Motion serious competition. Both are superior in one way or another; I just didn't happen to get as hooked playing them. One is *Time Bandit*, written by Bill Dunlevy and Harry Lafnear for the Atari ST and also published by Michtron. This is easily the finest all-around arcade game to come out on a home computer to date. It is actually a collection of 16 different arcade games, 15 of which follow the same basic pattern: Once you get into it, you can't get out until you find the key(s) and unlock the gate(s) that bar your way. In the meantime, of course, all sorts of nasty creatures are trying to kill you by running into you. You can run, fire, or fire as you run. In an interesting

twist, the points you get for each creature you destroy vary according to your "bravery": If you just sit in a corner and blast away, the points-per-creature value drops; if you run at the things, the PPC value goes up. Each game has 16 levels, which get tough fairly quickly.

Interwoven into all this is an adventure game that lets you solve puzzles, find (and use) objects, and generally work toward an eventual goal. This adds a depth to the game that holds your interest even when the arcade elements grow old. Other features include a pause function (press P) and a "Time Lord" list that keeps track of the top six scores—the top five, actually, since it includes "Krazy Kev," who (allegedly) racked up more than 500,000 points. The only complaint I have is that there is no "Save Game" function, which is a significant shortcoming given the time it would take to completely solve the game. Even so, all the great features, as well as the outstanding graphics, make this game a must if you have an Atari ST (with color monitor).

The other competitor to Major Motion is *Marble Madness*, written by Larry Reed for the Amiga and published by Electronic Arts. This is a licensed port of the Atari video arcade game, and the graphics are really amazing. The basic theme is guiding a marble through a downhill maze. You have so many seconds to complete each maze; any time left over is then added to the time you have for the next maze. Various obstacles and enemies confront you as you proceed, the mazes get tougher, and the time for each maze gets shorter. You can use either the mouse or a joystick; for that matter, the game is designed to let you use a trackball if and when one becomes available for the Amiga.

I do have some gripes with *Marble Madness*. There's no pause function, so once you start a game, there's no way of stopping even for a second until the game is over. Even less forgivable, there is no "top scores" list, and once

(continued)

ITEMS DISCUSSED

ACTA	\$59.95	MAJOR MOTION	\$39.95
Symmetry Corporation		TIME BANDIT	\$39.95
761 East University Dr.		Michtron Inc.	
Mesa, AZ 85203		576 South Telegraph	
(602) 844-2199		Pontiac, MI 48053	
		(313) 334-5700	
ALEGRA MEMORY EXPANSION BOX	\$379	MAS-20 HARD DISK DRIVE	\$1495
Access Associates		MicroBotics Inc.	
491 Aldo Ave.		P.O. Box 85115	
Santa Clara, CA 95054		Richardson, TX 75085	
(408) 727-0256		(214) 437-5330	
INSTANT MUSIC	\$49.95	MORE	\$295
MARBLE MADNESS	\$49.95	Living Videotext	
Electronic Arts		2432 Charleston Rd.	
1820 Gateway Dr.		Mountain View, CA 94043	
San Mateo, CA 94404		(415) 964-6300	
(415) 571-7171			

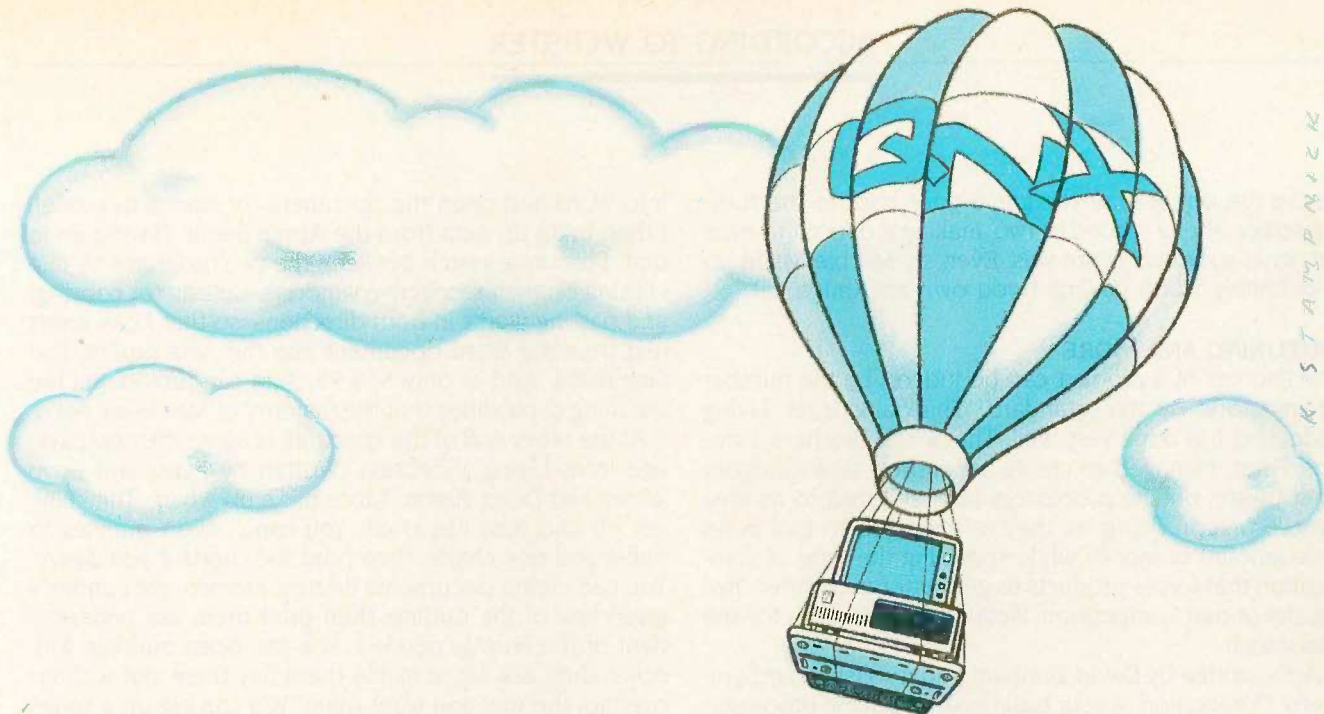

QNX: Other operating systems may never lift the PC to such heights.

QNX was the first operating system with multi-tasking, multi-user capabilities for the IBM PC and compatibles (1982). QNX was first to achieve the same capabilities for the IBM AT and compatibles. Then, in 1984, QNX achieved integrated networking capability, something no other multi-user, multi-tasking operating system has achieved, or is likely to achieve, on IBM personal computers.

QNX consistently beats competitive operating systems to each new height in PC performance. Unlike other multi-user, multi-tasking operating systems, QNX is *not* UNIX-based. Being rigid and monolithic, UNIX architecture is difficult to adapt. By contrast, QNX is modular, based on message-passing, and easy to adapt. UNIX developers have had to preoccupy themselves with merely getting UNIX to work on the personal computer, while QNX, designed specifically for this environment, has enjoyed rapid and continuous growth.

QNX's superb performance and compact size is the result of one dedicated design team with a

common purpose and complete understanding of both the software and the environment in which it must run. Quick and efficient on a PC, QNX soars on an AT.

Of all multi-user, multi-tasking operating systems, only QNX provides unrestricted communications among all tasks anywhere on the network. Therefore, only QNX can implement true distributed processing, distributed file systems, and distributed devices, with no need for central file servers.

No one wants to abandon the tremendous amount of DOS software available. QNX does not force that choice. DOS 2.1 and 3.1 run as single-user tasks under QNX, even on the AT in protected mode.

With over 22,000 systems installed worldwide, QNX remains unsurpassed in PC performance.

End Users, VAR's, OEM's and Software Developers – ask us how QNX can add value to your products!

Multi-User	10 serial terminals per PC, AT.	C Compiler	Standard Kernighan and Ritchie.
Multi-Tasking	40 (64) tasks per PC (AT).	Flexibility	Single PC, networked PC's, single PC with terminals, networked PC's with terminals. No central servers. Full sharing of disks, devices and CPU's.
Networking	2.5 Megabit token ring, 255 PC's and/or AT's per network, 10,000 tasks per network. Thousands of users per network.	PC-DOS	PC-DOS runs as a QNX task.
Real Time	2800 task switches/sec (AT).	Cost	From US \$450. Runtime pricing available.
Message Passing	Fast intertask communication between tasks on any machine.		

For further information or a free demonstration diskette, please telephone (613) 726-1893.

The only multi-user, multi-tasking, networking, real-time operating system

QNX for the IBM PC, AT and compatibles.
By Quantum Software.

Unix is a registered trademark of AT&T Bell Labs. IBM PC, AT, and PC DOS are trademarks of IBM Corp.

Quantum Software Systems Ltd., Moodie Drive High Tech Park, 215 Stafford Road, Ottawa, Ontario, Canada K2H 9C1

you've run out of time, the game goes back to the starting screen after a second or two, making it difficult to even see what your final score was. Even so, Marble Madness is definitely worth having if you own an Amiga.

OUTLINING AND MORE

The success of a product can be judged by the number of imitators. By that standard, ThinkTank from Living Videotext has done very well. The Winer brothers, Dave and Peter, managed to create an entirely new category of software: outline processors (also referred to as idea processors). In doing so, they've managed to pull in no little amount of money while spawning the type of competition that forces products to get better and better. Two results of that competition: Acta and More, both for the Macintosh.

Acta, written by David Dunham and published by Symmetry Corporation, is your basic no-frills outline processor. "No frills" doesn't mean limited, though: You can quickly create outlines, rearrange the topics, add and delete items, cut and paste text, and generally do most of what you'd want to do with an outline.

What makes Acta different—dare I say unique?—is that it's not an application: It's a desk accessory. Once you've installed it in your system file, you can call it up from within any application that supports desk accessories, which is to say 95 percent of all Mac applications. You can be working in, for example, MacProject, Excel, or Microsoft Word, and you can pull down the Apple menu, select "Acta," and there you are. Acta brings up its own window and appends its menu to the end of the current menu bar. You then create a new outline or load in an existing one. You can change it as you please, then save it out in one of three formats: Acta, MacWrite, or Text. And if you're using it within Microsoft Word or MacWrite, you can copy (or cut) part of the outline, exit Acta, and then paste it into your document, where it will appear properly indented and with bullets at the start of each line.

Acta is larger than most desk accessories—about 37K bytes—but smaller than you'd expect for a program this complete. I've found it very useful for doing outlines of documents that I'm writing using Microsoft Word. I get

into Word and open the document (or start a new one). I then bring up Acta from the Apple menu. Having done that, I can now switch between the two programs by just clicking on their respective windows. Cutting (or copying) and pasting works in both directions, so that I can insert text from my Word document into the Acta outline and vice versa. And at only \$59.95, Acta can provide all the outlining capabilities that the majority of Mac users need.

At the other end of the spectrum is More, the new package from Living Videotext. Written by Peter and Dave Winer and Doug Baron, More picks up where ThinkTank left off and runs like crazy. You can convert outlines to bullet and tree charts, then print the charts if you desire. You can create documents (letters, memos, etc.) under a given line of the outline, then print them out (independent of the line) as needed. You can open multiple windows, then ask More to tile them (lay them out with no overlap) the way you want them. You can set up a series of screens as items in a "flip chart"-style presentation. You can have More do math for you, time-stamp text, and sort entries. In short, you can do just about anything you'd like (or expect) to be able to do.

More has features and aspects that you may never use; on the other hand, its capabilities may lead you to try things you might never otherwise attempt. The price is somewhat full-featured, too—\$295—but if you have any serious outlining needs, More may well be the way for you to go.

IN THE QUEUE

You would think that I'd learn not to predict what I'm going to cover next month, since I'm so often wrong. Well, I'm a slow learner. Next month, I hope to review the predictions for 1986 made in last January's column and make some new predictions for 1987. I'll also pick some products of the year. These are meant more to reflect my personal preferences than any objective standards of what the most significant products of 1986 were. I'll also have a first look at the Apple IIGS, the newest offering from Cupertino, as well as whatever additional software products I can squeeze in. Until then, Merry Christmas, and I'll see you on the bit stream. ■

The 3d Wave's R₂ for File Maintenance.

The 3d Wave's Disk Doctor Utility Package is the cure for the problems of file protection and maintenance for IBM PC compatibles. The 3d Wave's prescription for the recovery of erased files and files from damaged disks, the Disk Doctor carefully examines every byte and bit with TLC. At a price which makes the competition look sick.

Other SW Packages

- * Magic Key—Runs color graphics SW on Monochrome Monitors
- * Easy Graphic Arts—Electronics CAD
- * OR—Operations Research/Statistical Analysis
- * GAME SOFTWARE.
- * Computer Go—From the Co-Sponsor of the World's Richest Computer Go Prize.

OVERSEAS
DISTRIBUTORS
WANTED



The Third Wave PUBLISHING CORP
A Division of MSC International
977, MIN SHEN E. ROAD, TAIPEI 10581,
TAIWAN, R.O.C.
TEL: (02)7630052(10 lines)
TLX: 29336 THIRDWVE

●本公司擁有一系列之中文電腦書籍·企業用·家庭用及遊戲用軟體 徵求代理商

Aztec C ... The Best C

Frees the genius in you

You've got a great idea . . .

. . . you're ready to write your programs.

You don't want to be sidetracked by all the paperwork. With Manx Aztec C and the ingenious **make** function, your creative processes won't get bogged down in program administration and housekeeping. Manx Aztec C has the most sophisticated, hardworking program administrator available to you. Once you've described your project, adding new features or enhancements is simple. You never have to concern yourself with the repetitive, tedious task of rebuilding your systems.

The development process moves quickly. Compiles, assemblies, link edits . . . all finish in record time.

Manx Aztec C is the fastest, most efficient C development system in the industry. Benchmarks show it . . . reviews commend it . . . users praise it.

You're ready to test the program. You're ahead of schedule. The Manx Aztec C Source Level Debugger shows you the exact C language statement giving you a problem. You fix the problem quickly . . . you're still ahead of schedule.

You've got some time for fine tuning. The Manx Aztec C Profiler examines your program, tells you where the slow spots are and validates your test procedure. A few changes and it's exactly what you wanted.

You've made it!

Aztec C is available for MS-DOS/PC DOS. Call for details on Macintosh, Amiga, Apple II, CP/M-80, CP/M-86, TRS-80, ROM and others.

To order, or, for information

Call Today

1-800-221-0440

In NJ or outside the USA call
(201) 542-2121

30-day satisfaction guarantee. Special Discounts are available to professors, students, independent developers, and on a "trade-in" basis. Site licenses.

MANX

Manx Software Systems
One Industrial Way
Eatontown, NJ 07724

" . . . a superb linker, a profiler, an assembler, and a set of development utilities are only the beginning of this package . . . performed admirably on the benchmarks, with short compile times and the best link times in this review . . . includes the most professional make utility . . . documentation is clear and complete. There is no doubt that this is a valuable and powerful programming environment." **Computer Languages Feb. '86**

" . . . execution times are very good, close to the best on most tests . . ." **PC Tech Journal Jan. '86**

" Easily one of the fastest compilers overall . . . library provides a lot of flexibility . . . generates small .EXE files." **Dr. Dobbs Journal Aug. '85**

C'Prime (Compiler, Assembler, Linker)	\$ 99.
Aztec C 86-d Developer's System	\$299.
Aztec C 86-c Commercial System	\$499.
PC ROM (8086, 68000, 8080, or 6502)	\$750.

Third Party Software for Aztec C: HALO, PHACT, C-tree, PRE-C, Windows for C, PC-lint, PANEL, Greenleaf, db Vista, C-terp, Plink-86, FirsTime, C Util Lib, and others.

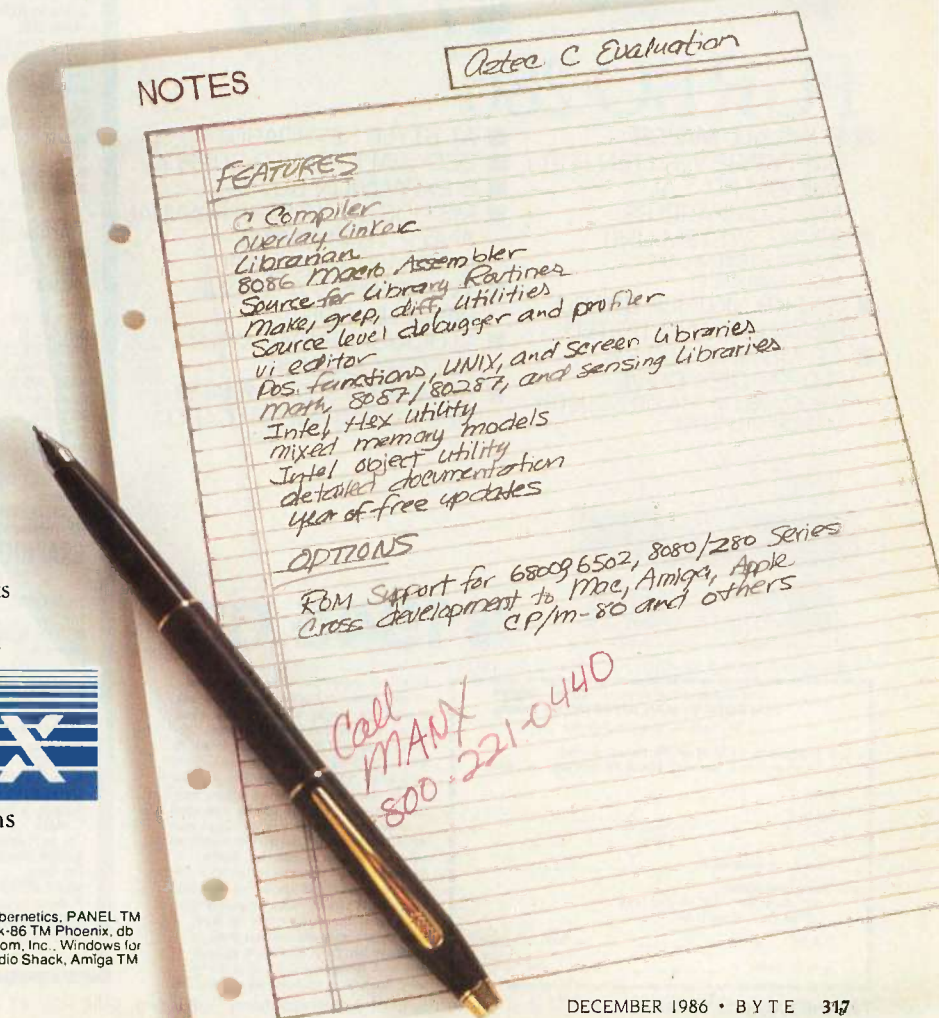

MS is a registered TM of Microsoft, Inc., CP/M TM DRI, HALO TM Media Cybernetics, PANEL TM Roundhill Computer Systems, Ltd., PHACT TM PHACT Assoc., PRE-C, Plink-86 TM Phoenix, db Vista TM Raima Corp., C-terp, PC-lint, TM Gimpel Software, C-tree TM Faircom, Inc., Windows for C TM Creative Solutions, Apple II, Macintosh TM Apple, Inc., TRS-80 TM Radio Shack, Amiga TM Commodore Int'l.

CALL TOLL FREE 1-800-382-2242

NORTHEASTERN SOFTWARE

WE WILL BEAT ANY PRICE

7 Trap Falls Rd. Shelton, Connecticut 06484 (See Below)

Inquiry 416

TURBO PC™

- RUNS ALL MAJOR SOFTWARE WRITTEN FOR THE IBM PC,™ XT,™ AND COMPATIBLES.
- DUAL SPEED SYSTEM UNIT. (RUNS AT 4.77 OR 7.4 MHZ, KEYBOARD SELECTABLE)
- 640 KB MOTHER BOARD INSTALLED AND TESTED.
- 360 KB FLOPPY DISK DRIVE (PRODUCED BY MAJOR INDUSTRY MANUFACTURERS)
- AT STYLE KEYBOARD.
- 135 WATT POWER SUPPLY, UL APPROVED.
- 8 EXPANSION SLOTS (FLIP TOP COVER PROVIDES EASY ACCESS TO EXPANSION SLOTS).
- MS DOS 3.1,™ USERS MANUAL AND 2 YEAR LIMITED WARRANTY INCLUDED.
- ADDITIONAL CONFIGURATIONS AVAILABLE.



\$775.00

TURBO 286™

- RUNS ALL MAJOR SOFTWARE WRITTEN FOR THE IBM PC,™ AT,™ AND COMPATIBLES.
- 8 MHZ SYSTEM UNIT. (8 MHZ SYSTEM UNIT ALSO AVAILABLE).
- 640 KB MOTHER BOARD INSTALLED AND TESTED.
- 1.2 MB AND 360 KB FLOPPY DISK DRIVE. (PRODUCED BY MAJOR INDUSTRY MANUFACTURERS)
- AT STYLE KEYBOARD.
- 200 WATT POWER SUPPLY.
- 8 EXPANSION SLOTS
- MS DOS 3.1,™ USERS MANUAL AND 2 YEAR LIMITED WARRANTY INCLUDED.
- TWO SERIALS AND ONE PARALLEL PORT.
- CLOCK/CALENDAR WITH BATTERY BACKUP.
- COMBINED FLOPPY/HARD DRIVE CONTROLLER CARD

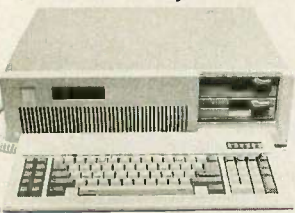

\$1945.00

WITH PURCHASE RECEIVE AN ADDITIONAL 2% DISCOUNT ON ANYTHING ELSE WE SELL FOR A FULL YEAR

Send coupon and list of items desired to
DISCOUNT BY MAIL DEPARTMENT
 7 Trap Falls Rd. Shelton CT 06484

To be eligible for the \$1.50 per item discount you must:
 1. Fill out all items. 2. Send in our ad with the items you have ordered.

Name _____
 Address _____
 City _____ State _____ Zip _____
 Phone No. at above address _____

Check form of payment
 Visa MasterCard C.O.D. Personal Check
 Certified Check Money Order

Card No. _____ Exp. Date _____
 Computer Model _____

Personal and company checks allow 3 weeks to clear. For faster delivery, send cashier's check, certified check or money order. Shipping—Software (\$3.00 minimum). Shipping—Hardware (please call 203-375-3860). COD—Add an additional \$2.00. Alaska, Hawaii, Canada, P.O. APO, and FPO \$5.00 minimum. Foreign orders—\$15.00 minimum and 15% of all orders over \$100. MasterCard and Visa (please include card no. and expiration date). Connecticut residents add 7.5% sales tax. Prices subject to change without notice. All returns must have a return authorization number. Call 203-375-3860 to obtain one before returning goods for replacement. Defective merchandise replaced with same item only. We do not guarantee compatibility. All sales are final. "Comparable advertised price" does not include typographical errors on the part of other vendors or prices that do not reflect higher shipping costs, credit card charges, or membership fees. The \$1 off offer only applies to items where Northeastern's price is not already the lowest. Final judgment remains with the manager on duty.

IBM

BACKUP/DESKTOP SOFTWARE

CENTRAL POINT	
Copy II PC or PC Tools	18.50
Copy II PC Option Board	77.00
QUAID	
Copywrite	40.00
FIFTH GENERATION SOFTWARE	
Fastback	94.00
TRANSEC	
Transac Module 0	65.00
BOURBAKI	
1 Dir	49.00
BORLAND	
Sidekick Non-Protected	47.00
EXECUTIVE SYSTEMS	
X Tree	27.50
MICROSOFT	
Windows	61.00
PETER HORTON	
Norton Utilities 3.1	51.00
ROSE SOFT	
Pro Key	74.00
SOFT LOGIC	
Disk Optimizer or Double DOS	29.00

ACCOUNTING PACKAGES

BPI	
General Acc./AR/AP or Payroll	283.00
CHANG LABS	
Rags to Riches Each	59.00
GREAT AMERICAN SOFTWARE	
One-Write Plus	150.00
PEACHTREE	
Back to Basics	184.00
COMPUTER ASSOCIATES/MS	
AR/AP/VT	295.00
MECA	
Managing Your Money	115.00
MONOGRAM	
Dollars & Sense W/Forecast	99.00

DATABASE SOFTWARE

ASHTON TATE	
D Base III Plus	425.00
BORLAND	
Reflex	86.00
FOX & GELLER	
Quick Code III	145.00
INNOVATIVE SOFTWARE	
Smart Software System	415.00
MICRO DATA BASE SYSTEMS	
KnowledgeMan II/2	285.00
MICRORIM	
RBase 5000	265.00
NANTUCKET	
Clipper	345.00
POWERBASE SYSTEMS	
Powerbase	188.00
SOFTWARE PUBLISHING	
PFS: Professional File	155.00

GRAPHICS SOFTWARE/MICE

BRODERBUND	
Print Shop	35.00
DECISION RESOURCES	
ChartMaster	225.00
ELECTRONICS	
Energistics W/Plotter Option	228.00
LOTUS DEVELOPMENT CORP.	
Free Lance	195.00
HARVARD SOFTWARE	
Presentation Graphics	235.00
MICROSOFT	
Mouse (Bus or Serial)	129.00
SPRINGBOARD	
Newsroom or Certificate Maker	34.00
T-MAKER	
Click Art Publisher	105.00
UNISON WORLD, INC.	
Print Master	31.00
MOUSE SYSTEMS	
PC Mouse W/Point & Ready	129.00
SUMMAGRAPHICS	
Summa Sketch 12 X 12	349.00

PROGRAMMING LANGUAGES

TRUE BASIC	
True Basic W/3-D Graphics	89.00
BORLAND	
Turbo Pascal	40.50
Turbo Lightning	56.00
Graphics or Database Toolbox	39.95
Turbo Prolog	58.00
LIFEBOT	
Latitica C Compiler	249.00
MICROSOFT	
Quick Basic Compiler	65.00
C Compiler	287.00
Macro Assembler	96.00
SUMMIT SOFTWARE	
Better Basic	118.00
SPREADSHEET/WORD PROCESSING	
FUNK SOFTWARE	
Sideways	36.00
PAPERBACK SOFTWARE	
VP Planner or VP Info	52.00
COMPUTER ASSOCIATES	
Supercalc IV	277.00
LIFETREE SOFTWARE	
VolksWriter Deluxe III	144.00
MICROPRO	
Wordstar 2000+	285.00
MICROSOFT	
Word	320.00
MULTIMATE INTERNATIONAL	
Multimate Advantage	320.00
SATELLITE SOFTWARE	
Word Perfect	219.95
SIMON AND SCHUSTER	
Webster's Spelling Checker	34.50
SOFTWARE PUBLISHING	
PFS: Professional Write	119.00

EDUCATIONAL SOFTWARE

BARRONS	
Computer SAT	55.00
BIBLE RESEARCH	
The Word 1.0 (KJV or NIV)	155.00
EDUWARE	
Algebra I, II or III	21.00
HARCOURT BRACE JOVANOVIICH	
Computer SAT	47.00
INDIVIDUAL SOFTWARE	
Tutorial Set	60.00
SIMON AND SCHUSTER	
Typing Tutor III	31.00
GAMES	
ACCOLADE	
Mean 18	30.00
ACTIVISION	
Shanghai	25.00
BLUECHIP	
Baron, Millionaire, Squire	35.00
BRODERBUND	
Ancient Art of War	25.50
HAYDEN	
Sargon III or Holy Grail	25.00
INFIDCOM	
Hitchhiker's Guide or Zork I	24.00
Leather Goddess of Phobos	24.00
Timity or Foolbrlitzky	28.00
Zork II or III	26.00
MICROPROSE	
F-15 or Silent Service	20.50
MICROSOFT	
Fight Simulator (New Version)	32.00
MINDSCAPE	
Balance of Power	29.00
ORIGIN SYSTEMS	
Ultima III	35.50
PC SOFTWARE	
Armchair QB or Blackjack	24.00
SIERRA-ON-LINE	
King's Quest I or II	29.00
WIZ-TECH	
Siryard	37.00
SPECTRUM HOLDBYTE	
Gato or Orbitor	22.00

STRATEGIC SIMULATIONS

STRATEGIC SIMULATIONS	
Battle for Normandy	
SUBLOGIC	
Jet	
PRINTERS	
BROTHER	
HR 35	56.00
CITIZENS	
MSP-25 (200 CPS)	58.00
EPSON	
All Epsons	249.00
JIUKI	
6100 (15 CPS)	65.00
NEC	
P 760	96.00
OKIDATA	
All Okidata	118.00
PANASONIC	
KXP-3151	96.00
SILVER REED	
EXP 550P	36.00
STAR MICRONICS	
NX-10 (120 CPS)	52.00
TOSHIBA	
351 Por Only	277.00
BOARDS	
AST	
Six Pack Premium S12K	144.00
INTEL	
Above Boards	285.00
PERYSST	
Bob Board	320.00
QUADRAM	
EGA+	219.95
HERCULES	
Color Graphics Card	34.50
PARADISE SYSTEMS	
Autoswitch EGA Card	119.00
STB	
The Chauffeur	31.00
Ega Plus	25.00
TECMAR	
Graphics Master	21.00
MONITORS	
AMDEK	
Video 310A Amber	21.00
NEC	
Multisync	47.00
PRINCECTON	
All Monitors	60.00
MODEMS	
ANCHOR AUTOMATION	
Volksmodem 1200	31.00
HAYES	
Smartmodem 1200 (External)	30.00
NOVATION	
Halt-Cord 2400 W/Software	25.00
PROMETHEUS	
Promodem 1200	35.00
VENTEL	
PC Modem 1/2 Card W/Talk	25.50
DRIVES	
ARCHIVE	
60MB Cartridge Backup Int	24.00
PRIMA	
60MB for AT (Internal)	28.00
SEAGATE	
20MB Half Height for XT Int	26.00
MAXTOR	
120MB for AT Int	20.50
SPECIALS	
123	
Compuserve Starter Kit	29.00
Cristallo or Remote	35.50
Framework II	24.00
Intel 80287 Math Co-Processor	24.00
KB 5151 Deluxe Keyboard	29.00
Masterpiece Plus	37.00
Ruby Surge Suppressor	22.00
Superproject Plus	
Symphony	
ThinkTank 2.0	

Northeastern Software Turbo PC is a trademark of Northeastern Software. IBM PC, XT IBM PC, AT are trademarks of IBM Corporation.

NORTHEASTERN

ANY COMPARABLE ADVERTISED PRICE BY \$1

APPLE **MACINTOSH** **AMIGA**

WORD PROCESSING PROGRAMS/BOARDS	18.00
Plus II/II+7/IE	40.00
6.0	56.00
BUSINESS ELECTRONIC SYSTEMS	27.00
ing. AR. APGL. PAY PRO DO	208.00
BUND	40.00
et Writer Series Co.	40.00
ARRAYS SOFTWARE	38.00
constant IIC or IIE	38.00
US	73.00
ks' Programs	73.00
Your Money	104.00
RAM	68.00
Sense IIE or IIC	68.00
REE	101.00
Basics	101.00
IT PUBLISHING	34.50
or Spelling Checker	34.50
gler or Catalyst IIE	58.00
WAGNER PUBLISHING	71.00
rite	71.00
TE SOFTWARE	83.00
ect	83.00
E SOFTWARE	64.00
or Sensible Speller	64.00
Grammar	54.00
ER ASSOCIATES	98.00
3A	98.00
RE PUBLISHING	68.50
ph or Write	68.50
& Report	72.00
SOFTWARE	78.00
ress (DOS or PRODOS)	78.00
MATION/GRAPHICS SOFTWARE	35.00
BUND	28.50
ow	28.50
on or Print Shop	23.50
Companion	23.50
Library 1, 2 or 3	14.50
ANSFORMS	51.00
BOARD	20.50
oard, Vol. 1 or 2	20.50
Expander	23.00
	31.00
ILITY SOFTWARE/LANGUAGES	15.00
hronic or Front Mach	15.00
tra X or Triple Dump	20.50
ics or Beagle Basic	18.00
or Pronto DOS	14.75
	38.00
WAGNER	56.00
EDUCATIONAL	35.00
SAT	35.00
UND	35.00
olkit	35.00
A ASSOCIATES	26.00
or Spell It	26.00
der II	36.00
ck, Mathblaster	26.00
	41.00
E/Peachtree	20.50
2, 3, or 4	20.50
IT BRACE JOVANOVICH	44.50
G COMPANY	28.50
ats or Robot Odyssey	28.50
UGH SYSTEMS	23.00
's New and Improved	23.00
igo	51.00

ENTERTAINMENT	19.50
ACCOLADE	19.50
Dam Busters or First Night	19.50
Hardball	19.50
ACTIVISION	28.50
Alter Ego or Golem-maker	28.50
BLUE CHIP	35.00
Millionaire, Baron or Tycoon	35.00
BRODERBUND	23.00
Where... is Carmen San Diego	23.00
ELECTRONIC ARTS	35.00
Autoduel or Hoebius	35.00
Bar's Tale	30.00
Ultima II or IV	33.00
Chessmaster 2000 or Skyfox	24.00
EPYX	23.00
Summer I or II or Winter Games	23.00
Temple of Asphai Trilogy	23.00
HAYDEN	29.00
Sargon III	29.00
INFOCOM	25.00
A Mind Forever Voyaging	25.00
Ballyhoo or Zork I	22.50
Spellbreaker or Trinity	22.50
Feobility or Wishbringer	27.00
Zork II or Zork III	26.00
Moon Mist	CALL
Leather Goddess of Phobos	23.00
MICROPROSE	20.00
F-15 or Silent Service	20.00
MICRO LEAGUE SPORTS	23.00
Micro League Baseball	23.00
MINDSCAPE	23.00
Steven King The Mist or Rambo	23.00
ONE STEP SOFTWARE	29.00
Golf's Best Pinehurst	29.00
POLARWARE	20.00
Crimson Crown or OO-TOPOS	20.00
SIERRA ON LINE	29.00
King's Quest I or II	29.00
SIR TECH	28.00
Wizardry I	28.00
Wizardry II or III	22.00
SPECTRUM HOLOBYTE	20.00
Gato	20.00
STRATEGIC SIMULATIONS	34.00
North Atlantic 86	34.00
Under Fire	33.00
War in Russia	46.00
ACCESSORIES/BOARDS	32.00
CH HAYES	32.00
Hayes Mach III	32.00
KOALA TECHNOLOGIES	71.00
Kaola Pad	71.00
KRAFT	24.00
Kraft Joystick IIC or IIE	24.00
SWEET MICRO	113.00
Mockingboard C	113.00
Mockingboard D	123.00
APPLIED ENGINEERING	CALL
Tran Warp Accelerator	CALL
Ram Works III	CALL
Viewmaster or Z-80+	107.00
Timemaster or RGB Option	99.00
ORANGE MICRO	69.00
Grapple+	69.00
STREET ELECTRONICS	154.00
Business Card Parallel	154.00
MODEMS	132.00
HAYES	132.00
Micromodem IIE	132.00
INATION	349.00
212 Applenet	349.00
PROMETHEUS	CALL
Prometheus Internal IIE/II+	CALL
SPECIALS	36.00
FUNK	36.00
Sideways Pro DOS	36.00
BEAGLE BROTHERS	30.50
Beagle Graphics	30.50
KENSTON MICROWARE	58.50
System Saver	58.50
SPINMAKER SOFTWARE	29.00
HomeMaker Helper Math/Writing	29.00
SUB LOGIC	30.50
Flight Simulator II	30.50

DESK ACCESSORY PROGRAMS	28.00
BATTERIES INCLUDED	28.00
Battery Pack	28.00
BORLAND	58.00
Sidekick with Phone Link	58.00
GRAPHICS SOFTWARE	35.00
ALTSYS	129.00
Fantastic	129.00
CRICKET SOFTWARE	59.00
Cricket Graph	59.00
ENABLING TECHNOLOGIES	149.00
Easy 3D	149.00
INNOVATIVE DATA DESIGN	103.00
Mac Draft	103.00
MANHATTAN GRAPHICS	257.00
Ready Set Go	257.00
SUMMAGRAPHS	27.00
Mac Tablet 9 X 6	27.00
T HAEER	45.50
All Click Art	45.50
Click On Worksheet	45.50
ACCOUNTING SOFTWARE	248.00
CHANG LABS	83.00
Rags to Riches Three Pack	248.00
MUNOGRAM	89.00
Dollars & Sense	89.00
PALANTIR	210.00
GLAR or Invent	210.00
PEACHTREE	44.00
Back to Basics GLAR/AP	44.00
BUSINESS SOFTWARE	275.00
AEGIS	125.00
Doug Clapp's Word Tools	125.00
BLYTH SOFTWARE	179.00
Omnis III+	179.00
BOSTON SOFTWARE	54.00
Mac Publisher II	54.00
BRAINPOWER	104.00
Stat View S12	104.00
CREIGHTON SOFTWARE	32.00
Mac Spell +	32.00
FORETHOUGHT	15.00
Filemaker	15.00
GREENE, JOHNSON INC.	150.00
Spellswell	150.00
HABA SYSTEMS	299.00
Haba Window Orlar	299.00
LIVING VIDEOEXT	93.00
Think Tank 512K	93.00
MARF	239.00
LOTUS DEVELOPMENT	239.00
Jazz	239.00
MEACOM	71.00
Mac + II	71.00
MICROSOFT	114.00
Excel	114.00
Chart	120.00
File	120.00
Word	169.00
Fortran	85.00
Basic	85.00
NLO LEGAL SOFTWARE	299.00
Will Writer	299.00
ODESTA	148.00
Double Helix	148.00
PROVUE DEVELOPMENT	74.00
Overvue	74.00
SATORI SOFTWARE	58.00
Bulk Mailer	58.00
EDUCATIONAL SOFTWARE	26.75
CAMDE	36.00
Nutricalc	36.00
DAVIDSON AND ASSOCIATES	39.00
Math Blaster	39.00
Speed Reader II	39.00
GREATWAVE SOFTWARE	26.00
Concertwaver +	26.00
PALANTIR	24.00
Mac Type/Word Play/Math Flash	24.00
SCARBOROUGH	58.00
MasterType	58.00

ENTERTAINMENT	35.00
ACTIVISION	26.00
Alter Ego—Male or Female	35.00
Hacker or Shanghai	26.00
BLUE CHIP SOFTWARE	34.00
Squire, Baron or Tycoon	34.00
BRODERBUND	26.50
Ancient Art of War	26.50
ELECTRONIC ARTS	31.00
Deluxe Music Construction Set	31.00
One on One or Skyfox	26.00
EPYX	23.50
Temple of Asphai Trilogy	23.50
Writer Games or Rogue	23.50
HAYDEN SOFTWARE	28.00
Sargon III	28.00
HEADRON ASSOCIATES	20.00
Real Faker	20.00
INFOCOM	25.00
A Mind Forever Voyaging	25.00
Hitchhiker's Guide	23.00
Leather Goddess of Phobos	24.00
Moon Mist	22.00
Planetfall or Zork I	22.00
Zork II or Zork III	25.00
MILES COMPUTING	26.00
Harrier Strike Mission	26.00
MINDSCAPE	23.00
A View to Kill or Rambo	23.00
Balance of Power or Bratocus	29.00
Deja Vu	32.00
Stephen King's The Mist	23.50
ORIGIN SYSTEMS	37.00
Ultima III	37.00
BULLSEYE SOFTWARE	34.50
Fokker Triplane	34.50
POLARWARE	23.00
Crimson Crown or Xiphos	23.00
PSION	30.50
Pison Chess	30.50
SIERRA ON LINE	23.50
Championship Boxing	23.50
SILICON BEACH SOFTWARE	20.50
Enchanted Scepters or Airborne	20.50
SIR TECH	35.00
Wizardry I	35.00
SPECTRUM HOLOBYTE	26.00
Gato or Orbiter	26.00
ACCESSORIES	60.00
ENVIRONMENTAL SOFTWARE	55.00
Covers	55.00
MAC BUFFER 256K, 512K or 1MB	17.00
INNOVATIVE CONCEPTS	17.00
Flag N File II/Micro	17.00
KALMAR DESIGNS	20.00
Microcabinet-Double	20.00
KENSTON	21.50
Swivel/Tilt-Kensington	21.50
Control Center-Kensington	18.50
Disk Case or Drive Clean Kit	59.00
KOALA TECHNOLOGIES	15.50
Mouse Cleaning Kit W/Package	15.50
MAC VISION	167.00
NEW IMAGE TECHNOLOGIES	275.00
Magic Digitizer	275.00
THUNDERWARE	174.00
ThunderScan	174.00
SPECIALS	60.00
AFFINITY MICROSYSTEMS	55.00
Tempo	60.00
ANN ARBOR SOFTWARE	139.00
Full Point	139.00
GREAT AMERICAN SOFTWARE	59.00
Mac One Write Master or Pay	59.00
BORLAND	198.00
Reflex	198.00
TELOS	89.00
Business Flevision	89.00
TRUE BASIC	32.50
True Basic	32.50
SIMON & SCHUSTER	34.00
Typing Tutor II	34.00
PRACTICAL COMPUTER APPLICATIONS	73.00
Mac Golf	73.00
ERGOTRON	24.00
Mac Tilt	24.00

BUSINESS SOFTWARE	289.00
B.E.S.T.	245.00
Best Business Mgt Software	289.00
BYTE BY BYTE	105.00
Integrated Accounting System	245.00
CHANG LABS	33.00
GL, AR or AP	33.00
HARVSOFT	25.00
Intabase	25.00
MICROSMITHS INC.	27.00
1x Ed	27.00
DESKTOP SOFTWARE	45.00
DIGITAL CREATIONS	27.00
Digital Link	45.00
DISCOVERY SOFTWARE	27.00
Grabbit	27.00
ELECTRONIC ARTS	48.00
Maxi Desk	48.00
MAXI COMM	38.00
COMPUMED	38.00
The Mirror	38.00
GRAPHICS/MUSIC SOFTWARE	39.00
ACTIVISION	119.00
The Music Studio	119.00
AEGIS	130.00
Draw	130.00
Impact	130.00
HOME/FINANCE SOFTWARE	82.00
OLAMIC SYSTEMS	95.00
Z+2 Home Mgt System	82.00
PAR SOFTWARE	50.00
Par Biz I or Par Real I	95.00
Par Home I	50.00
EDUCATIONAL SOFTWARE	19.00
ACADEMY SOFTWARE	36.00
Typing Tutor/Word Invaders	19.00
FIRST BYTE	44.00
Kid Talk	44.00
Speller Bee	44.00
QUEUE INTELLECTUAL SOFTWARE	44.00
Comprehensive Grammar I or II	44.00
French Grammar I	44.00
Spanish Grammar I, II or III	44.00
US GEOGRAPHY ADVENTURE I	44.00
World Geo Adv I, II, III or IV	44.00
American History Adventure	44.00
World History Adventure	44.00
Pract Comp I, II, III, IV or V	44.00
College Aptitude Reading Comp	44.00
Reading Adventure I, II or III	44.00
Starting a New Business	44.00
Vocabulary Adv I, II or III	44.00
Practical Vocabulary	44.00
Vocabulary Adv I, II or III	44.00
MICRO ILLUSIONS	30.00
Discovery Spelling	30.00
Discovery Math	30.00
HAYDEN	32.00
Halley Project	32.00
Keyboard Jockey	27.00
ENTERTAINMENT SOFTWARE	24.00
ACCESS SOFTWARE	12.00
Leader Board	24.00
Tournament Disk #1	12.00
Tenth Frame	24.00
ACTIVISION	27.00
Borrowed Time or Hacker	27.00
Mindshadow	27.00
ELECTRONIC ARTS	27.00
Adventure Construction Kit	27.00
Arctic Fox	27.00
Chess Master 2000	32.00
Deluxe Point	55.00
Deluxe Point Art Disk	27.00
Deluxe Print or Deluxe Video	60.00
Deluxe Print Art Disk	27.00
Golden Oldies	23.00
One on One	27.00
7 Cities of Gold or Skyfox	27.00
SPECIALS	99.00
ELECTRONIC ARTS	36.00
Maxiplan	36.00

Six great reasons to join **BIX** today

● **Over 140 microcomputer-related conferences:**

Join only those subjects that interest you and change selections at any time. Take part when it's convenient for you. Share information, opinions and ideas in focused discussions with other BIX users who share your interests. Easy commands and conference digests help you quickly locate important information.

● **Monthly conference specials:**

BIX specials connect you with invited experts in leading-edge topics—CD-ROM, MIDI, OS-9 and more. They're all part of your BIX membership.

● **Microbytes daily:**

Get up-to-the-minute industry news and new product information by joining Microbytes Daily and What's New Hardware and Software.

● **Public domain software:**

Yours for the downloading, including programs from BYTE articles and a growing library of PD listings.

● **Electronic mail:**

Exchange private messages with BYTE editors and authors and other BIX users.

● **Vendor support:**

A growing number of microcomputer manufacturers use BIX to answer your questions about their products and how to use them for peak performance.

What BIX Costs. .How You Pay

ONE-TIME REGISTRATION FEE: \$25

Hourly Charges: (Your Time of Access)	Off-Peak 6PM-7AM Weekdays Plus Weekends & Holidays	Peak 7AM-6PM Weekdays
BIX	\$9	\$12
Tymnet*	\$2	\$6
TOTAL	\$11/hr.	\$18/hr.**

* Continental U.S. BIX is accessible via Tymnet from throughout the U.S. at charges much less than regular long distance. Call the BIX helpline number listed below for the Tymnet number near you or Tymnet at 1-800-336-0149

** User is billed for time on system (i.e., 1/2 Hr. Off-Peak w/Tymnet = \$5.50 charge.)

BIX and Tymnet charges billed by Visa or Mastercard only.

BIX HELPLINE

(8:30 AM-11:30 PM Eastern Weekdays)

U.S. (except NH)—1-800-227-BYTE
Elsewhere (603) 924-7681



We'll
Send
You a

BIX User's Manual and Subscriber Agreement
as Soon as We've Processed Your Registration.
JOIN THE EXCITING WORLD
OF BIX TODAY!

JOIN BIX RIGHT NOW:

Set your computer's telecommunications program for full duplex, 8-bit characters, no parity, 1 stop bit OR 7-bit characters, even parity, 1 stop using 300 or 1200 baud.

Call your local Tymnet* number and respond as follows:

Tymnet Prompt

Garble or "terminal identifier"
login:
password:
mhis login:
BIX Logo-Name:

You Enter

a
byteneti <CR>
mgh <CR>
bix <CR>
new <CR>

After you register on-line, you're immediately taken to the BIX learn conference and can start using the system right away.

FOREIGN ACCESS:

To access BIX from foreign countries, you must have an account with your local Postal Telephone & Telegraph (PTT) company. From your PTT enter 310600157878. Then enter bix <CR> and new <CR> at the prompts. Call or write us for PTT contact information.

BIX

ONE PHOENIX MILL LANE
PETERBOROUGH, NH 03458
(603) 924-9281



STOCKING STUFFERS

BY EZRA SHAPIRO

Time for a little holiday cheer. This month I've put together a batch of programs that would make terrific gifts. Nothing too expensive, nothing that you can't live without, but all great fun. That's not to say that they aren't useful products; they are—some of them spectacularly so. Being fun to use doesn't mean a program is frivolous. I'd argue that *all* software should be as entertaining as the packages in this collection.

If I weren't receiving this stuff because I write this column, I'd be hoping that someone would catch the spirit of the season and gift-wrap the lot for me.

NOT A JOKE

ComicWorks (Mindscape, \$79.95) is yet another giant step in the evolution of Macintosh art. The program starts from the basic toolbox offered by MacPaint, then adds object orientation, sophisticated airbrush and masking techniques, text handling, and layout options that make it a topflight illustrator's kit. Although the name and the promotional literature suggest the program is merely a toy for cartoonists, you can do some amazing—and serious—things with ComicWorks.

Object orientation lets you build a painting piece by piece and then overlay the pieces into a finished work. In a pixel-based program like MacPaint or FullPaint, once a section of art or text is moved into position, it obliterates anything underneath. With ComicWorks, you create each section on a separate layer, so you can edit and rearrange to your heart's content. This strategy is the basis for many CAD programs; it's new in a paint package. You can construct a scene the same way you would decorate a

Some simulations, a paint program, a mouse, and even a game

room or dress a Barbie doll.

A ComicWorks object can be a graphics image or a block of text (usually enclosed in a border, like the standard speech balloon in comics). You can work either on an opaque background or on a transparent plane that lets you see what's underneath. When you're through, you can decide whether the overlay should mask the lower layer, or you can add to it, reverse the color of the underlying pixels, and so on.

Most of the MacPaint tools have been preserved in this package; a couple have been enhanced. FatBits (blowing up a section to edit it a pixel at a time) has become SmallBits, MediumBits, and LargeBits, so you can zoom in step by step down to the pixel level. ThinBits is an editable full-page view that allows easy repositioning of objects.

The airbrush tool is a thing of wonder; you can adjust its diameter from 1 to 96 pixels in 1-pixel increments, control the rate of spray, and toggle between black and white by pressing the Backspace key. Coupled with the masking options, you can use this electronic tool much as you would a real airbrush.

Layout and nomenclature are geared to the comic-book artist—you build "balloons" (text) and "easels" (graphics) in "panels" located on "pages"—but I can see no reason why you should be limited to producing comic art. The program comes with three disks, of which two are libraries of comic-book objects. However, the

authors have also snuck in some eye-opening teasers: two greeting cards, a restaurant menu, a newsletter, and a blank TV storyboard for advertising people. Mindscape is currently talking about releasing a companion product, sold only through the

mail, called GraphicWorks. It will come with libraries of business art (whatever that is) instead of spaceships and monsters. The basic program will be the same, as will the price.

You can work on only one file at a time, but because of the structure, that file can include many individual pictures. A browse option lets you scan other files for objects you might want to import to your current project. Finished illustrations can be stored as ComicWorks files (which preserve the independence of objects) or as MacPaint files for exporting to other programs.

The program takes a while to learn. It's complex and not intended for the weekend doodler. And several things annoyed me. First, text attributes were hard to control, as they were in the early days of MacWrite. Second, when I had half a dozen panels open on the screen, each with a few easels, screen updating was disconcertingly slow. Mindscape's technical support person commented that ComicWorks was pushing the Mac's poor 68000 to its limit, and I'm sure he was right. (This should be better on 1987's Macs.) Finally, I missed the enhancements of FullPaint (see September's Applications Only), like free rotation, precise mouse control, and exotic distortions.

But on the whole, I was enchanted with this program. At a price of

(continued)

Ezra Shapiro is a consulting editor for BYTE. He can be reached at P.O. Box 170040, San Francisco, CA 94117-0040.

\$79.95. ComicWorks is worth the money it costs.

MEDICAL MARVEL

Surgeon (ISM, \$60) is an excellent graphics simulation for the Macintosh that lets you operate on a "patient" to remove an aortic aneurysm and replace the defective artery with a length of Dacron tubing. You start by diagnosing and prepping the patient.

then you perform the surgery using a mouse to select and manipulate icons representing various instruments. An EKG scope in the upper left corner of the screen tracks the patient's vital signs.

Deviation from correct medical procedure is dangerous. If you make a mistake, or leave out a step, or use the wrong medication, or cut in the wrong place, the program informs you in a

polite dialog box; you can attempt to repair the damage, but this is delicate surgery and errors are costly. When the trace on the EKG goes flat, you know you've blown it. I suppose **Surgeon** has to be considered a game, but it's scary in its accuracy and detail (it was designed by a physician), and there's only one way to win: successfully completing the operation.

It takes half an hour, or less, to play **Surgeon** through to its conclusion, but the experience is unusually compelling; it's impossible not to take the operation seriously. This is not a program for the squeamish—you're as close to the heart as you can get without calling it "open-heart surgery"—and for once I'm glad the current Mac lacks color.

Surgeon could be a magnificent teaching tool; think what it could have meant in your high school health or biology class. And it sure beats the cryptic explanations you sometimes get from the medical community when someone you know is having similar surgery. I'd love to see hospitals and doctors using the program to educate, and calm, patients and their families. The people at ISM are currently thinking about turning **Surgeon** into a whole line of programs, each dealing with a different condition. I hope they do; there's a real need for software like this that demystifies the subjects of our darkest fears.

BOP ON THE PC

Good news for any geopolitical wizards out there—**Balance of Power** (Mindscape, \$49.95) is now available for IBM PC-compatible machines. When I first wrote about it in March, I was ecstatic. I commented that Chris Crawford's simulation of superpower diplomacy and confrontation was the best game I had ever seen on any computer. But it was a Macintosh product, period.

Well, it's still the best game around, and owners of MS-DOS computers no longer need sigh longingly. The new version is one of the first software packages to use the Microsoft Windows interface as a way to achieve a Mac-like environment, and it's pretty

(continued)

Expand Your Horizons



with the Messenger 1200™ modem

External RS-232 or Internal Halfcard Models Available

- ✓ Upgradeable to 2400 Baud
- ✓ Asynchronous and Synchronous Data Formats
- ✓ Voice and Data Communications
- ✓ Switched or Leased Line Operations

- 100% Hayes Compatible
- Bell 103/212A Compatible
- 300-1200 Baud Rates
- Full Hayes AT™ Command Set
- Auto Dial/Auto Answer
- Powerful Communications Software
- Full 1 Year Warranty
- 30 Day Money Back Guarantee

Other Products Available:

INTELECOM PLUS™ 1200 Baud Security Modem
DESTECH™ Data Security System

Dealer inquiries welcome
To place your order call: *Inside California:*
(800) 334-5255 (818) 709-6581

Aicon®
SYSTEMS
8968 FULLBRIGHT AVENUE, CHATSWORTH, CALIFORNIA 91311
AICON SYSTEMS, INC.



South Seas Shipping Company

November 20, 1986

Ms. Cathy Lyons
Import Officer
Botanical Research Ltd.
56 Wavak Road
Morabai, Papua, New Guinea

Re: Palm Fruit Research

Dear Ms. Lyons:

This letter confirms the agreement we reached at our meeting last week in San Francisco. Botanical Research, Ltd. will recommend the optimal conditions for shipping palm fruit and palm oil.

Some important issues for consideration are: temperature during shipping and length of time between shipping.

To be completed by June 1, 1987.

South Seas Shipping Company
Corporate Organizational Chart

PRESIDENT
Trevor Cardinal

INVESTOR'S UPDATE

SHIPPING GOES WILD IN SOUTH PACIFIC

South Seas is causing the shipping world to tually every other company. South Seas has managed to maintain its growth despite the strong dollar and lower-than-ever freight rates. For the first quarter ending on March 31, South Seas turned in a record \$117.1 million profit on sales of \$1.1 billion. President Trevor Cardinal cited several reasons for this record-breaking quarter. First of all, by expanding operations into specialized, price insensitive commodities like palm oil and rum, South Seas has been relatively unaffected by the strong dollar and unfavorable exchange rates.

Competitive Factors

One of the primary factors in South Seas success has been the company's ability to identify new market opportunities and then to establish the dominant position in that market. The palm oil trade is a prime example of this successful strategy. Since entering the market in 1977, South Seas has become the prime player in the specialty shipping market.

However, LBC Ltd. is expected to become a more aggressive player. The Singapore concern had concentrated its efforts on short-haul container freight in the Indian Ocean. Last year, LBC purchased the ailing Barton Lines. This tanker capacity. Several of these mid-sized tankers have been refitted for the palm oil trade and are expected to enter service by mid-1986. So far, the LBC has been unsuccessful in winning any of South Seas customers. In the future, increased competition can be expected to depress both prices and margins, but for the short-term, South Seas contracts with most of the palm oil industries largest producers should insulate it.

Joint Ventures Considered

Another growth strategy South Seas is exploring is to establish joint ventures with several of these commodity producers of these commodities. These ventures would be similar to the TransPac/South Seas cooperative, in that South Seas would offer its shipping capabilities to the other party in exchange for a share of the venture. As this type of venture is holding preliminary talks with many export firms. Another possibility would be to join with a company interested in a joint venture with South Seas. MountainView has set its products growth in the Japanese market. This demand, MountainView begin to strengthen the

SHARE OF PALM OIL TRADE (1985)
DOLLAR VOLUME

SOUTH SEAS
64%

MORABAI EXPORTS
16%

LBC LTD.
1%

ALL OTHERS 19%

Outlook for Sales

Spectacular sales for the first quarter will set the pace for what industry analysts expect will be a record year for South Seas. "South Seas will be the industry leader by 1990," says Michael Wong, a vice-president at Donovan, Kroll & Co. "Their growth strategy is sound and their balance sheet gives them the financial muscle to continue to grow even during the current slump in the shipping industry."

JOB INVOICE

SOLD TO: MANHATTAN EXPORTS
ATTENTION: (57-41)

YOUR PHONE NO.

DATE: 04/15/86

INVOICE NO.: 0210

JOB NO.: 2108

MODE: AMOUNT:
\$10,267.50

TH SEAS SHIPPING COMPANY
TILY SALES TRANSACTIONS
BY CUSTOMER

Ext. Price
\$7,000.00
\$1,750.00
\$5,250.00

Cost
\$1,530.00

Ext. Price
\$6,720.00

Representative No: 54

What if...

YOU COULD PRINT EVERYTHING ON THIS DESK FROM A BUSINESS PC?

The world's best-selling desktop laser printer has something in store for just about every business that's ever dealt with the printed word.

Because the Hewlett-Packard LaserJet Printer is the only printer of its kind specifically designed to work with over 300 software programs. And since it hooks up to almost any business PC, it's right for all kinds of users—not just the art department. So you can print everything on this desk—from simple memos to your life's memoirs. And get high-quality, professional-looking output.

Combined with our very fast, very versatile HP Vectra PC (it's IBM PC/AT compatible) and the software of your choice, the HP LaserJet is the cornerstone for a complete desktop publishing solution. One your whole company can easily use.

Of course, the HP LaserJet also works with IBM PC's and compatibles. As well as software like Lotus 1-2-3, WordStar and d:BASE II. And, for around \$3,000, it's the laser printer you can afford.

We can't print all the reasons our HP LaserJet is the printer of choice. But if you stop by an authorized HP dealer or call us at 1 800 367-4772, Dept. 276G for the one nearest you, we'll show you why HP quality printing makes very good business sense indeed.



HP Vectra PC

Print samples produced on a LaserJet Plus with the following software packages: Studio Software, Spellbinder® Desktop Publisher, MicroPro WordStar 2000®, Lotus 1-2-3® and FormMaker II™. HP Vectra PC is a trademark of Hewlett-Packard. IBM PC is a registered trademark of International Business Machines Corp. Lotus 1-2-3 is a registered trademark of Lotus Development Corp. WordStar is a registered trademark of MicroPro International. d:BASE II is a registered trademark of Ashton Tite. © 1986 Hewlett-Packard Co.



HP LaserJet



HEWLETT
PACKARD

Business Computing Systems

inquiry 158

PG601BTY

good. You get three disks that enable you to install Balance of Power and Windows on either a floppy disk or a hard disk (you can make only one copy, but you can uninstall it if you want to make changes to your system). Of course, if you already have Windows running, you can avoid most of the installation procedure.

The MS-DOS version is a bit of a pain after using the program on a

Mac. With a CGA card, the graphics are pretty rough-looking; they're better with an EGA card. You also have to take extra steps that you can avoid with the Mac. You can't just select a country on BOP's world map by pointing the mouse and clicking; you have to choose a continent from a menu bar and then pick the country from a pull-down menu. And I was surprised that the MS-DOS program

seems no faster than the Mac version, even though it makes use of four times the memory (512K bytes versus 128K bytes).

Anyhow, I'm still raving about Balance of Power. If you've got an MS-DOS machine and a Macintosh, buy the Mac version of BOP. But by all means, get the program.

RAT REPORT

This isn't strictly software, but if you want to play Balance of Power, you'll need a good mouse, even if they tell you it's "optional." For the past month and a half, I've been testing mouse-based MS-DOS software using the LogiMouse C7 (Logitech, \$99), and it has made my life a lot easier. On the hardware side, the C7 is an opto-mechanical rodent that uses CMOS technology to get rid of the transformer module; you just plug the thing into your serial port and go. (Anything that cuts down on the jungle of wiring around my system is a real boon.) And resolution seems sharper than that of the optical mouse it replaced.

On the software side, the LogiMouse comes with a driver that doesn't interfere with most other resident software, a mouse driver compiler that's as good as anybody else's, and interfacing routines for BASIC, C, Modula-2, and Turbo Pascal. For an additional 20 bucks you can get Logitech's Plus package, which adds an excellent menu builder (with useful examples), a fast windowing text editor, and an outstanding Lotus 1-2-3 interface. Logitech also sells the mouse bundled with a variety of application programs, including PC Paintbrush, Reflex, and Generic CADD. Any one is a bargain.

Note that there are two models of LogiMouse, one with traditional mouse buttons and one that has three little raised bars in place of buttons. I got the mouse with the strange ribbed thingies. Beware—go with the standard-style buttons!

PRACTICAL PLAY

The last time anyone tried to teach me something about the way of the world was in my eighth-grade math class.

(continued)

CONSIDER THIS JUST A BRIEF AUDITION.



ACTOR™ is a new, interactive programming system, the first with Microsoft® Windows. You have Windows when you write a program, and users have Windows when they run it.

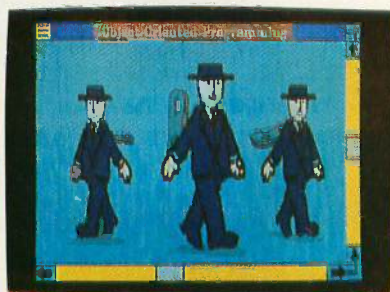

Moreover, ACTOR is a new, object-oriented programming language. Winding objects up and turning them loose is a lot easier, more productive, and more fun than old-fashioned programming.

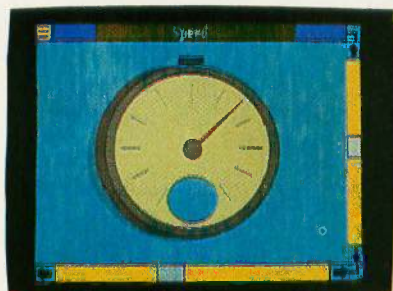

Thanks to a new method of "incremental garbage collection," ACTOR never has to slow down to clean up memory like other advanced languages. You can even use it for real-time control. It's that fast.

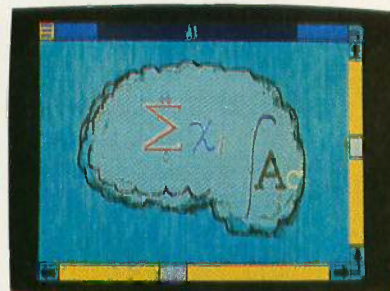

ACTOR offers all the features of an ideal artificial intelligence language, but in a familiar, Pascal-style syntax. Which makes artificial intelligence programming easier. And what could be smarter than that?

From a brief audition like this, you really can't see how much better it is programming with ACTOR. ACTOR is more than just a research tool. It's an effective language for developing real applications. For more information, write us at the address below or call 312-491-2370. It'll help you appreciate the performance.

The Whitewater Group[®]
Technology Innovation Center
906 University Place, Evanston, IL 60201



9 Red Hot Reasons To Get A Free Avis Wizard Number.

Reason#1 Avis Express Services.

You save time every time you reserve with the exclusive computerized Wizard® reservation system. That's because Wizard is your passkey to Avis Express®, Rapid Rental™ and Rapid Return™. These red hot Avis services let you bypass the lines when you're checking in and out of airports, to get you in and out of your car and onto business—fast!

Take a minute now to get a Wizard number and you can save hours down the road.

Reason#2 Lowest Available Rates.

Whenever there's a red hot rate or discount, the Wizard computer system finds it for you. It always gives you the lowest applicable price on your rentals. Automatically.

Reason#3 Your Car Group Preference.

You're assured of renting from the car group you want, whenever available, because Wizard records your preference and matches it with car availability. Again, it's automatic!

Reason#4 No Cost. No Obligation.

An Avis Wizard® number is absolutely free, regardless of the frequency of your car rental needs.



5 FREE AVIS UPGRADES

Avis features GM cars, Pontiac GrandAM.

Reasons#5 Through#9 A Free Book of 5 Avis Car Rental Upgrades.

Your free Wizard number starts with a complimentary book of five upgrade passes. Each one of these upgrades lets you rent one car group higher than the one you reserved to give you extra comfort at no extra cost. That's five additional red hot reasons to get a time- and money-saving Wizard number. This offer expires January 31, 1987, so apply right away. Simply mail the coupon to your right or call Avis toll free at 1-800-831-8000 today!

Offer expires January 31, 1987.

Wizard Application Request

Mail to: Avis Distribution Center
P.O. Box 8116
Trenton, NJ 08650



Please send me more information and an application for a free Avis Wizard® number.

Name BYT 1
Name of Company
Address
City State Zip
()
Business Phone

Mail today or get an instant Wizard number by phone. Call
1-800-831-8000
and ask for Elizabeth.

Red hot

Mr. Kebles took a couple of weeks to explain stocks, bonds, and how checking accounts are managed by banks. Since then, I've had to negotiate the

minefield of personal finance entirely on my own, and there have been many moments when I've wished I knew more about what I was doing.

The first Blue Chip simulation I encountered was Millionaire. It's a stock-market model, and I played it on a CP/M-86 machine with 8-inch drives I'd rather forget. But I learned a lot about market trends, stock options, and portfolio strategy. You track performance of a particular stock, its industry, and the overall market by watching charts and graphs; read the business news; and invest accordingly. On my copy, the graphs were built out of standard text characters, but they were effective. A few years later, Millionaire became the first razzle-dazzle simulation on the Mac by using spreadsheet-like grids and full graphics.

Millionaire is still available from Blue Chip, as are Tycoon (commodities) and Baron (real estate), on a wide range of machines. MS-DOS and Mac versions cost \$59.95; Apple II versions are \$49.95; and Commodore 64 versions are \$29.95. The newest offerings are Squire (MS-DOS and Mac)

ITEMS DISCUSSED

BALANCE OF POWER \$49.95
COMICWORKS \$79.95
 Mindscape Inc.
 3444 Dundee Rd.
 Northbrook, IL 60062
 (312) 480-7667

BLUE CHIP SIMULATIONS
 MS-DOS and Macintosh ... \$59.95
 Apple II \$49.95
 Commodore 64 \$29.95
 Blue Chip Software
 6744 Eton Ave.
 Canoga Park, CA 91303
 (818) 346-0730

DARK CASTLE \$49.95
 Silicon Beach Software Inc.

9580 Black Mountain Rd.
 Suite E
 San Diego, CA 92126
 (619) 695-6956

LOGI MOUSE C7 \$99
 with Plus software \$119
 Logitech
 805 Veterans Blvd.
 Redwood City, CA 94063
 (415) 365-9852

SURGEON \$60
 ISM
 2936 Paper Mill Rd.
 Phoenix, MD 21131
 (301) 666-2672

Flick this switch and go beyond IBM compatibility

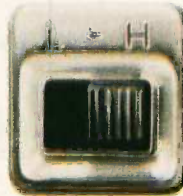

and Managing for Success (MS-DOS only).

Squire is a simulation of investing for retirement. You can choose among stocks, bonds, money-market funds, real estate commodities, tax shelters, and so on. The game period is 20 years; you get to reassess your portfolio monthly, for a total of 240 "turns." As with the other games, you watch charts, graphs, and news reports. The standard game is pretty dull. Being an overview, it lacks the richness and complexity of the other Blue Chip products. However, it does offer one significant plus: a "reality" mode that lets you configure the program for your own situation: age, current portfolio, cash flow, retirement age, etc.

This can be depressing. I fed in my personal statistics, went through the game, and was informed that I would spend my retirement years "leeching off relatives" (the program's words, not mine). Though any simulation of this

sort is necessarily going to have to make some assumptions that hurt its long-term validity, Squire does make you think. Note that the Macintosh port doesn't make use of the Mac interface like the other Blue Chip programs; after clicking the game icon, you're dealing with characters only.

Managing for Success (originally sold as American Dream) is aimed at the professional business manager. You're the CEO of a manufacturing firm, facing decisions on personnel, marketing, production, R&D, materiel, sales, finance, and so forth. It's two disks of exhaustive stuff, far more sophisticated than the rest of the Blue Chip line. I wouldn't suggest it for an evening's entertainment; this baby is tough. However, if you've got aspirations in management, this one will force you to do some hard thinking.

DARK CASTLE

While I'm on the subject of fun software, I'm going to break from my stan-

dard policy and say a few words about an unabashed, honest-to-goodness *game* for the Macintosh. Set in medieval times, Dark Castle (Silicon Beach, \$49.95) is a variation on the tried and true Lode Runner/Donkey Kong theme; you have to pilot your hero through 14 screens of obstacles, traps, monsters, and villains to an eventual confrontation with the extremely nasty Black Knight. There's nothing new about the basic concept, but the execution is impressive. Dark Castle is a wonderland of slick animation and realistic digitized sound. You're constantly confronting squeaking rats, clanking chains, cracking whips, sizzling lightning bolts, and the like.

The program comes on two 400K-byte disks and will really put any of the 512K Macs through its paces. Dark Castle is a perfect way to fritter away those long winter evenings when you should be doing something productive. ■

The Canon A-200 II lets you choose the speed you need.

Our dual speed switch processes data at either the standard 4.77 MHz or the superfast 7.16 MHz — and that's only the beginning. With the Canon Personal Computer A-200 II Series you can custom design the perfect PC.

For starters, choose either floppy disk or 20 megabyte hard disk. Then select either the standard PC layout keyboard or our special word processing keyboard. Next, pick your ideal monitor, either monochrome, color or full-page high resolution for word processing.

And when you want to spread out, you have six PC-compatible expansion slots to work with, three for high-speed processing.

Whatever combination of Canon components you choose, you can use the thousands of programs designed for the IBM PC/XT.

And your customized Canon PC will perform perfectly with Canon peripherals, including the laser beam and bubble-jet printers and our newly introduced image scanner. For more information about the Canon Personal Computer A-200 II Series call 1-800-441-2626. (In UT, 1-800-922-3131.)

Find out what lies beyond compatibility.

Canon
PERSONAL COMPUTERS
Beyond Compatibility

Canon, U.S.A., Inc., Systems Division, P.O. Box 619865,
Dallas/Fort Worth Airport, TX 75261. © 1986 Canon U.S.A., Inc.



COMPUTER WAREHOUSE

CALL TOLL FREE **1-800-528-1054**

FREE **FEDERAL EXPRESS**
Air Express Shipping
See Details Below

NOW **BEST PRICES**
No Charge for Bank Cards

HARDWARE

PRINTERS

Brother All Models	Call
Citizen MSP-10	\$260
MSP-15	\$379
MSP-20	\$319
MSP-25	\$475
Premier 35	\$475
Diablo D-25	\$469
635	\$765

EPSON	
All Printer Models	Call
IBM Proprinter	\$399
NEC	
3510, 3550	\$729
8810, 8850	\$1039
P5	\$959
P6	\$429
P7	\$609

OKIDATA	
All Printer Models	Call
Panasonic 1080 I	\$195
1091 I	\$259
1092	\$295
1592	\$409
3131	\$245
3151	\$385

STAR MICRONICS	
All Printer Models	Call
Toshiba 321 Parallel & Serial	\$455
341 Parallel	\$575
P351 Parallel & Serial	\$929
Laser Printer	Call

DISKETTES	
Maxell M2 S (Qty 100)	\$85
Sony MD/2 (Qty 100)	\$85

MONITORS

Amdex All Monitors	Call
NEC All Monitors	Call
Princeton Graphics	Call
Zenith All Models	Call

VIDEO TERMINALS

Qume QVT Green 101	\$299
QVT Amber 101	\$314
Wyse 30	\$299
50	\$419
75	\$559
Wyse 85	\$439
Wyse 350	\$859
Zenith Z-22	\$455
Z-29A	\$559
Z-49	Call

MODEMS

Anchor Automation	
Signalman Express	\$185
Practical Peripherals	
Practical 1200 Baud	\$124

HAYES	
All Modems	Call
Prometheus All Models	Call
US Robotics Courier 2400	\$349
Password 1200	\$165
Microlink 2400	\$349

DISK DRIVES

Iomega Bernoulli 10 meg	\$1195
Bernoulli 20 meg	\$1595
Bernoulli 40 meg	\$2325

SEAGATE	
20 meg w/Western I/O	\$385

BOARDS

AST Advantage	\$329
Rampage AT	\$445
Rampage PC	\$239
Six Pack Plus	\$159
Hercules Color Card	\$149
Graphic Card	\$179
Intel Above Board PC (1110)	\$239
Above Board AT (2010)	\$329
Above Board PS/AT (2110)	\$369
Paradise Five Pak	\$99
Plus Development	
Plus Hard Card 20 Megabyte	\$599
Quadram Tiny Turbo 286	\$355
Quadlink	\$329
Quad EGA+	\$359
Tec Mar Graphics Master	\$445
Captain No Memory	\$169

FCC Approved

\$449



MIT Turbo PC/XT

256 Memory, One 360K Brand Name Floppy Drive • 135 Watt Power Supply, Slide Case, AT Style Keyboard • 8 MHz Clock Speed, (Keyboard Selectable), 8 Expansion Slots

COMPUTERS

IBM	
PC 1 Drive 256K	\$1199
XT 1 Drive 256K	\$1729
XT 1 Drive 20 Meg 640K	\$2169
AT/68	\$2849
AT/339	\$4449

COMPAQ	
Portable II-2 Drive	\$1649

PANASONIC	
Business Partner Dual Drive	\$979
Sr. Partner Dual Drive	\$1169
Exec. Partner Dual Drive	\$1699
Other Models	Call

TOSHIBA	
T-1100	\$1299
T-1100 Plus	Call
T-3100	Call

Zenith Computer Products	
SAVE Up to 50%	
All Models	Call

PLOTTERS

Epson HI-80	Call
-------------	------

KEYBOARDS

Keytronics 5151	\$159
-----------------	-------

COPIERS

Canon «PC»



Canon PC-25 \$939

SOFTWARE

IBM PC and 100% Compatibles

TRAINING

Flight Simulator	\$28
PC Logo	\$75
Typing Instructor	\$28
Typing Tutor III	\$28
MS Learning DOS	\$28

LANGUAGES

C Compiler (Microsoft)	\$249
Fortran Compiler (Microsoft)	\$195
Lattice C Compiler	\$236
Macro Assembler (Microsoft)	\$84
Pascal Compiler (Microsoft)	\$166
Quick Basic 2	\$55
Run C Interpreter	\$59
Turbo Pascal w/8087 & BCD	\$55
Turbo Database Tool Box	\$38

PROJECT MANAGEMENT

Harvard Total Project Manager	\$262
Microsoft Project	\$219
Super Project Plus	Call
Timeline 2.0	\$209

COMMUNICATIONS

CompuServe Starter Kit	\$19
Crosstalk XVI	\$92
MS Access	\$139
Mirror	\$35
Remote	\$92
Smartcom II	\$83

INTEGRATIVE SOFTWARE

Enable 1.1	\$319
Framework II	Call
Smart Software System	\$389
Symphony	Call

GRAPHICS

Chartmaster	\$199
Diagram Master	\$185
Energraphics 2.0	\$269
In-A-Vision	\$249
Microsoft Buss Mouse	
w/PC Paintbrush 3.0	\$106
Microsoft Chart	\$164
Microsoft Serial Mouse	\$119
Newsroom	\$31
PC Buss Plus Mouse	
w/Paint Plus	\$115
PC Draw	\$199
Click Art Personal Publisher	\$99
PC Mouse w/Dr. Halo II	\$99
PC Paint w/Mouse	\$115
Printmaster	\$29
Sigmaster	\$132
Turbo Graphix Tool Box	\$38

WORD PROCESSORS

Leading Edge Word Processor	On Special
Leading Edge W/P	
w/Spell & Mail	On Special
Lightening	\$55
Microsoft Word 3.1	\$249
Multimate Advantage	Call
PFS: Write w/Spell Checker	\$75
Wordstar w/Tutor	\$152
Wordstar Pro Pack	\$233
PFS: Professional Write	\$108

Word Perfect (Ver.4.1)	\$199
Wordstar 2000 + 2.0	\$278

SPREADSHEETS

Lotus 1-2-3	Call
Multiplan	\$108
Spreadsheet Auditor 3.0	\$82
VP Planner	\$48

Supercalc 4	Call
-------------	------

MONEY MANAGEMENT

Dollars & Sense w/Forecast	\$94
Tobias Managing Your Money	Call

UTILITIES

Copy II PC	\$19
1 DIR Plus	\$46
Fastback	\$86
Norton Utilities 3.1	\$48
Printworks	\$36
Sidekick	\$30
Sidekick (Unprotected)	\$47
Travelling Sidekick	\$39
Turbo Prolog	\$54
Sideways 3.1	\$34
Superkey	\$39

DATA BASE MANAGEMENT

Clipper	\$329
Cornerstone	\$56
dBase II	Call
dBase III Plus	Call
Extended Report Writer	Call
KnowledgeMan II	\$249
PFS: File	\$76
Quickcode	\$138
QuickReport	\$138
Reflex	\$82
Think Tank	\$91
PFS: Professional File	\$135

R:Base 5000 System V	Call
----------------------	------

Many other titles available.

Inquiry 90 for MS DOS Products. Inquiry 91 for all others.

COMPUTER WAREHOUSE

Order Line: 1-800-528-1054
Order Processing: 602-224-9345
2222 E. Indian School Rd.
Phoenix, Arizona 85016
602-954-6109

Store Hours: Mon-Fri 10-5:30
Saturday 9-1
Order Line Hours: Mon-Fri 7-5:30
Saturday 9-1
Order Processing Hours: Mon-Fri 10-3

Product shipped in factory cartons with manufacturer's warranty. Please add \$6.00 per order for UPS ground shipping on orders up to 10 lbs. Orders 10 lbs. and under you pay for ground service, receive air service at no extra charge. Available on orders 11-30 lbs. \$17 for air service. Prices & availability subject to change without notice. Send cashier's check or money order...all other checks will delay shipping two weeks.



THE U-MAN POTENTIAL

BY DICK POUNTAIN

A computer for scientific users and a molecular modeling system

1985 and 1986 have been appalling years for Britain's mass-market microcomputer manufacturers. All the big names of the early 1980s are either gone or survive in greatly reduced circumstances, with the exception of latecomer Amstrad. In the U.K., though, a number of smaller computer manufacturers never went after the volume market. Firms like Comart, Positron, and MicroConcepts found themselves niche markets, often in the scientific and technical arena, and in the main they thrive regardless of the cold winds blowing above.

I've recently been looking at a machine from one such firm called U-Microcomputers, U-Micro for short. The computer, the U-MAN 1000, is built around the 68000 microprocessor. It's targeted at scientific and engineering users and designed for high-performance I/O in applications like data logging and instrument and process control, while still retaining the capabilities of a general-purpose personal computer.

U-Microcomputers was founded in 1979 at Warrington by Dr. Bill Unsworth, who has a Ph.D. in chemistry, and it became one of the first Apple dealers in the U.K. Like many pioneering Apple dealers, U-Micro got into the business of designing and selling its own add-on boards that, given Unsworth's background, tended to be A/D converters and other I/O devices. This led to a series of full-scale Apple II-compatible desktop computers and finally to the U-MAN 1000. Recently, U-Micro has become part of the large VG Instruments Group of scientific instrument makers (U-Microcomputers Ltd., Winstanley Industrial Estate, Long Lane, Warrington, Cheshire WA2 8PR, United Kingdom, (0925)-54117; in the U.S.: VG

Instruments Inc., 300 Broad St., Stamford, CT 06901, (203) 325-4090).

INSIDE THE 68000 BOX

At first sight, the U-MAN looks much like any of the Stride-style multiuser 68000 machines that have sprung up in the business sector in recent years: a featureless box with a separate monitor and keyboard. The U-MAN, however, differs from the average business box in that it comes with bit-mapped color graphics. In addition to a 10-megahertz 68000 microprocessor, it contains a 6809 microprocessor to handle I/O and drive what amounts to a built-in graphics terminal. The two microprocessors communicate via a dedicated 4K-byte area of dual-ported static RAM.

Architecturally, the U-MAN is a clean machine. The standard model comes with 1 megabyte of no-wait-state RAM, which can be expanded to 5 megabytes of contiguous, linearly addressed memory internally and to 15 megabytes externally. The only firmware consists of a boot ROM that can discriminate between the various operating systems available, plus the operating firmware for the 6809 I/O microprocessor. The 6809's operating firmware doesn't reside in the 68000's address space and need not concern programmers (unless they are into heavyweight system building and want to modify it). Up to 512K bytes of user ROM can be supported if required.

The video subsystem provides 27 lines of 85 characters in 16 colors (or

gray scale), along with flashing, underline, and reverse-text attributes. Bit-mapped graphics are supported at 680 by 288 pixels, but the number of colors in graphics mode is hard to summarize conveniently

because of limitations on permitted color combinations in adjacent cells due to the way the video microprocessor works. Basically, you can put 16 colors on the screen—but not just anywhere you like. Two 32K-byte pages of RAM controlled by the 6809 are devoted to video and I/O buffers, and a standard character font is downloaded from EPROM into one of these buffers at boot-up time. Soft fonts (up to 16) can be stored here, and text can be mixed with graphics on the same screen. Any of this memory that's not being used for video or fonts (in text mode, that means most of it) gets allocated for print spooling and other I/O buffering.

The standard U-MAN includes a formidable array of I/O devices. In addition to two buffered serial ports (150 to 38,400 bits per second) and a Centronics printer port, the U-MAN has twin 8-bit general-purpose parallel ports and timers (controlled by a 6522 chip), four channels of 10-bit A/D conversion, a four-slot expansion system that brings out the full 68000 bus and an Apple-compatible bus, and a sound generator and speech synthesizer based on the Texas Instruments TMS5220. Apple cards can be used on the expansion bus, but, of course, any ROM software in 6502 code will not run on the 68000.

These goodies are packed into a

(continued)

Dick Pountain is a technical author and software consultant living in London, England. He can be contacted c/o BYTE, One Phoenix Mill Lane, Peterborough, NH 03458.

seemingly bombproof alloy case with a 100-watt power supply, two 800K-byte floppy disk drives, and the option of hard disks with 20- to 80-megabyte capacities. The keyboard is an OEM version of the Key Tronic KB 5151, and you supply your own monochrome or RGB monitor.

A number of add-on boards are provided for scientific I/O applications. A floating-point coprocessor

board using the National Semiconductor 32081 fits piggyback-style into the 68000 socket and is supported by many of the compilers supplied by U-Micro. A 48-line IEEE-488 parallel interface is available, as is a serial expansion card containing eight RS-232C ports. For high-speed parallel data logging, a 16-bit parallel board operates at the full 10-MHz bus speed and can be configured as one to three

channels depending on the protocol required. This board can acquire a 16-bit word of data in 500 nanoseconds. The system's A/D conversion capabilities can be enhanced with a range of 12-bit A/D and D/A boards with up to 16 channels. Finally, being a relatively small company, U-Micro will build special single-unit U-MAN configurations to order, with extra RAM or other features.

The prices for U-MAN 1000 systems start at £2760 for a machine with twin floppy disk drives and 1 megabyte of RAM and go up to £9250 for a 5-megabyte machine with an 80-megabyte hard disk.

A VARIETY OF OPERATING SYSTEMS

The biggest problem faced by any 68000-based system is that no single dominant operating system has emerged for the chip in the way that CP/M dominated the 8-bit Z80 world and that MS-DOS dominates the Intel 8086 family. UNIX enthusiasts might claim the chip as their own, but in truth the UNIX takeoff still hasn't happened, and applications are few by CP/M or MS-DOS standards. On an installed-units basis, the Apple Macintosh operating system could claim to be more important than UNIX, but it's supported only by one vendor and on one machine. Atari and Commodore have managed to further divide the market by choosing two other operating systems.

None of this is crucial to a specialized firm like U-Micro. It is not chasing the user of packaged business software; typical U-MAN users will probably write their own software, in FORTRAN, Pascal, C, or LISP. Alternatively, they may want to buy scientific packages like the Reduce 3 symbolic math system. Accordingly, U-Micro has chosen to offer no less than four operating systems for the U-MAN, none of which is UNIX!

The two basic operating systems offered are the UCSD p-System and Digital Research's CP/M-68K, both of which are single-user, single-tasking systems. In addition, the Mirage operating system (multiuser, multitasking, networking) and OS-9/68000 (real-

(continued)

IMAGINE WHAT YOUR COMPUTER COULD SAY WITH PC DIAL/LOG™



PC DIAL/LOG™ consists of an expansion card, software and a cable that connects a Touch Tone® telephone directly to your computer. When installed the PC Dial/Log™ automatically dials and answers the phone, saves and sends telephone messages and stores and forwards telephone calls.

IT'S SIMPLE, with direct installation and a menu-driven program. These features make PC Dial/Log™ convenient and easy to use.

UNPARALLELED VOICE QUALITY made possible by the Votrax® voice digitization process enables PC Dial/Log™ to deliver the best low-cost voice reproduction.

VOTRAX®'S SOFTWARE INTERFACE PROGRAM, THE TOOL KIT, created especially for the developer whose application includes PC Dial/Log™, will help save valuable programming time.

- Other Votrax® Products**
- Personal Speech System™
 - Type-N-Talk™ Stand-Alone Devices
 - IBM, Apple II, Commodore 64
 - Plug In Board Synthesizers
 - Votrax® Speech Chips

APPLICATIONS including appointment scheduling, telemarketing, marketing surveys, financial updates, inventory status reports, dispatching and order entry are just some of the many ways that PC Dial/Log™ can be used.

WE WELCOME DEALERS AND DISTRIBUTORS to contact Votrax® regarding our complete line of products. Our reputation has been built on quality products and outstanding customer service that are sure to satisfy you.

AN UNBEATABLE PRICE at only \$495*, PC Dial/Log™ is the lowest priced digital board available today. Please contact Votrax® directly for additional information.

* Plus shipping and handling.



VOTRAX/CMC Int'l, Inc.
"Technology That Talks"
 1394 Rankin, Troy, MI 48063
 1-800-521-1350
 In Michigan 313-588-0341
 TWX-8102324140 Votrax-TRMI
 For a voice demonstration call
 313-588-2926

Avocet puts you in the chips!

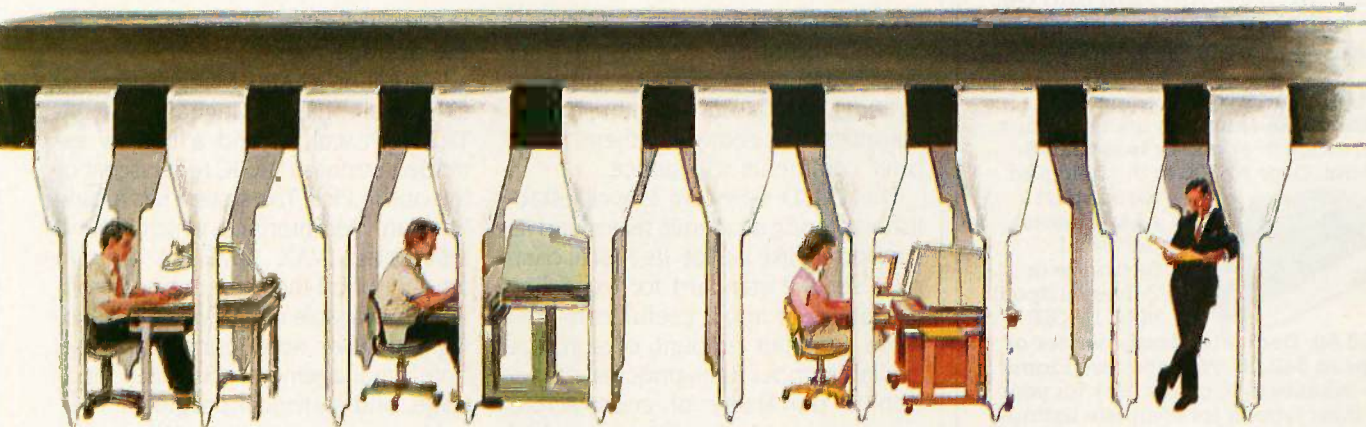

Now you can use your PC or VAX to develop software for virtually any microprocessor. Quickly. Easily. Inexpensively.

Avocet Macro cross-assemblers, simulators, emulators and EPROM programmers will help put your design ideas into more chips than any other software development system on the market. You don't need a dedicated system. All you need is a PC or VAX, a good idea... and Avocet. It's as simple as that.

Avocet has been creating tools for software development since 1979 to help design engineers find easier and more productive ways to develop software for virtually any microprocessor — *without switching development systems.*

Our customers turn ideas into real products. From data entry through assembly, debugging and final EPROMs, Avocet has everything you need to transform your personal computer into a fully integrated development system.

Cross-assembler capabilities.

No matter what the application, our AVMAC™ family of macro cross-assemblers runs on any computer with DOS or VAX™/UNIX™ and processes assembly language for most microprocessors.

AVMAC is fast and loaded with features that make your development job easier. You get a powerful macro facility, relocatable

code, linker and librarian, cross reference by line and procedure, plain English error messages and much more.

AVMAC Macro Cross-Assemblers		
MSDOS™ PCDOS™		\$349
XMAC68K (68000/68010)		\$595
NEW XMAC68K2 (68020)		\$750
VAX/UNIX (AVMAC)		\$995
VAX/UNIX (XMAC)		Call
Target Microprocessor Families Supported:		
6804	6502/65C02	Z8
6805	6800/01,6301	Z80
6809	HD64180	68H11
1802/1805	8085	68020
8048/8041	8051	68000/68010
NEW 8096	TMS32010	TMS32020

Taking the bugs out.



Avocet's new debugging tools will eliminate "crash and burn" from your vocabulary in two ways.

First, AVSIM™ software simulator/debuggers allow you to test program modules on your PC. No special hardware is required for executing your target code interpretively in a crash-proof, interactive environment. AVSIM's full screen display lets you see at a glance what your program is doing.

When you're ready to test your program in a working model, Avocet's TRICE™ in-circuit emulators allow you to examine target memory and register, set break-points, single-step, trace and more. A standard serial interface lets you control emulation and download code from your PC.

Progressive EPROM programming.

Avocet AVPROM™ programmers work with over 37 different devices including EPROMs through 27512, DMOS and E²PROMS, and MPU/EPROM combos using fast "adaptive" algorithms. These intelligent, self-contained units work with any personal computer using Avocet's GD_X driver software.

Made to order.

You don't have to come to Maine to get Avocet products (unless, of course, you want a really great lobster dinner).

Just call, toll-free,

1-800-448-8500

(in the U.S. except Alaska)

and we'll rush out your order, send out more information, or, if you want, talk about some of your great ideas. Avocet Systems Inc., P.O. Box 490-BB, Rockport, Maine 04856. (207) 236-9055, Telex: 467210 AVOCET CI

AVOCET SYSTEMS INC.®

®Signifies manufacturer's trademark

A Christmas gift?

Choose from the following **COMPUTER FRIENDS** winners. **SPECIAL CHRISTMAS OFFER.** Buy one item and get 15% discount on any other item or supply accessory.

MAC INKER™, Automatic Ribbon Re-inker. Re-ink any fabric cartridge or spool for **less than 5 cents.** Over 70,000 in the field and

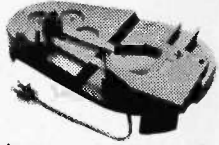

we support **ALL** printers. Universal Cartridge or Universal Spool **MAC INKER**

\$68.50. Dedicated Imagewriter or Epson \$42.00. We have cartridges re-inkable in 10 colors. Ask for your printer type or for complete listing. Bottle ink \$3.00/each. Shipping \$3.00.

PROTEUS™, the 'Siamese' Buffer.

It is a **Data Switch** with buffer on both ports. Switch manually or via software. Saves time, space and money. Or ask about our **MAC MASTER** line of Universal Buffers and Printer Controllers (serial or parallel up to 1 MEG).



PROTEUS 64 K-199.00

256 K-299.00 Shipping \$4.00.

Of course we have **Data Switches**, serial/parallel, 2 way, 4 way, crossed etc., at most competitive prices (all lines switched).

MERCURY MODEM. Really 100% Hayes* Compatible. 300/1200 baud, speaker, full status light display and 2 years warranty. Includes

QUICK LINK, easiest and most reliable Comms Software (available for IBM PC or Macintosh). **\$205.00** Shipping \$4.00.

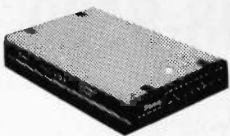

*Hayes is a trademark of Hayes Microproducts.

MAC THE RIPPER. Our newest, original and welcome printer companion. Pulls off paper perforations and tears the sheets apart. Takes little space and will pay for itself almost immediately in saved time and tedium. Ask for brochure. Introductory Price **\$299.00.** Shipping \$10.00.

Order Toll Free.

Call or write for free brochure.

1-800-547-3303

In Oregon 503-626-2291 (24 hour line)

Computer Friends®

14250 N.W. Science Park Drive
Portland, Oregon 97229 Telex 4949559
Dealer inquiries welcome.

BYTE U.K.

time multitasking) are offered. I haven't the space, nor would I tax your patience, to describe all these systems in detail, let alone the myriad compilers that come with them. Some brief comments will suffice.

The UCSD p-System is well established among academic users, and its supporters like it a lot. Its Pascal compiler set the standard for extending the language into a useful form, and there is a fair amount of software available under it. Its principal attraction is portability of code across microprocessor families; its chief drawback is the slow speed of interpreted p-code (though you can choose native code and lose the portability).

CP/M-68K was Digital Research's attempt to repeat its Z80 success on the 68000. But it didn't quite come off. CP/M-68K looks much like 8-bit CP/M version 2.2, which is to say that it's crude and old-fashioned, but simple to program under and reasonably quick. U-Micro offers the high-quality SVS Pascal and SVS FORTRAN 77 from UniPress Software Inc. plus the C Compiler from Whitesmiths as development languages. Using CP/M-68K reminded me how awkward it is to manage a large hard disk without the benefit of a hierarchical directory structure; it has only "user areas," just like 8-bit CP/M. However, CP/M-68K is quite suitable for putting up quick-and-dirty one-time programs. U-Micro has written its own screen-oriented editor for CP/M-68K (called USE) that is powerful, easy to learn, and supports all the U-MAN's video options; it's almost a full-blown word processor.

Mirage was developed by the U.K. software house micro-APL, originally as a vehicle for the firm's APL compiler on 68000-based supermicrocomputers. It's a business-oriented, multiuser, multitasking system that features an indexed sequential-access method filing system with full file and record locking. Written in assembly language, it's small and fast, occupying only 40K to 60K bytes of RAM and requiring no memory management hardware. Mirage can also run CP/M-68K as a task. One of its strongest points is that system configuration

is easy, well within the capabilities of the average user.

In addition to APL, Mirage supports, as development languages, FORTRAN, Pascal, C, and a heavily extended business BASIC reminiscent of the one in Pick. The system has a fairly Spartan user interface, which I found resembled VAX VMS. A certain amount of off-the-shelf business software is available under Mirage, including multiuser accounting, database, hotel management, currency arbitrage, and statistical programs.

An interesting extra to Mirage that I tried successfully is a package called MITS/PC. This program runs on an IBM PC and enables it to serve as a Mirage terminal via its standard RS-232C port. MITS is a memory-resident program. Thus, when you hit Ctrl-Shift, a SideKick-style window pops up in the middle of your current PC application screen, and you can access a multiuser database or run programs on the U-MAN under Mirage. Another keystroke and you're back to what you were doing before.

It's also possible to upload and download files between the Mirage system and the PC, to spool PC files to the U-MAN printer, and to access an IBM mainframe via Mirage. MITS/PC could provide a cheap and satisfactory way to share a moderately used database in a small office while keeping all the advantages of using individual IBM PCs and avoiding expensive network cabling. It might not be adequate for heavy sharing, like a travel bureau application, but since I have only one PC, it wasn't possible to test the package's real capacity.

OS-9, an operating system originally written for the 6809 microprocessor, inspires almost fanatical devotion among its followers; U-Micro put it onto the U-MAN in response to requests from users. It's a full 68000 version and doesn't run on the U-MAN's 6809. OS-9 provides many of the features of UNIX (indeed, its shell is almost indistinguishable from UNIX's), including multitasking and multiuser operation. However, OS-9 is capable of responding to peripherals in real time, a feat that UNIX's virtual memory system completely precludes;

(continued)

YOUR #1 CHOICE

Technoland™

Order Toll Free:
(800) 222-3978

5830 E. Washington Blvd.
City of Commerce, CA 90040

We used to be PC 1,
We're still your #1 Choice!

In California: (213) 724-2781
Technical Support: (213) 724-1684
Customer Service: (213) 724-1685

Basic System

- 8088-2 CPU — Runs at 4.77 or 7.4 MHz
- 640K RAM
- 360K Half-Height Floppy Drive w/Controller
- Runs All Major PC-DOS Software
- AT™ Style Keyboard
- 135 Watt Power Supply
- System Manual
- MS-DOS 3.10
- Full 18 Month Warranty



\$659



AT™ System

- 80286 Processor (Switchable 6/8 MHz)
- 512K RAM (1024K Optional)
- 1.2 MB Half-Height Floppy Disk Drive
- Floppy/Hard Disk Controller Card
- Clock/Calendar w/Battery Backup
- Runs All Major PC-DOS Software
- 200 Watt Power Supply
- AT™ Style Keyboard
- System Manual
- MS-DOS 3.10
- Full 18 Month Warranty

\$1259

Monochrome System

- Basic System Plus...
- Monochrome Graphics Adapter
- 12" TTL Monochrome Monitor

XT \$859
AT \$1459

Color System

- Basic System Plus...
- Color Graphics Adapter
- 13" RGB Color Monitor (640 x 200)

XT \$1059
AT \$1659

EGA System

- Basic System Plus...
- Enhanced Graphics Adapter
- 13" High-Res RGB Color Monitor (640 x 350)

XT \$1339
AT \$1939



\$99

Turbo Speed Hard Disk Controller

- 1:1 Interleave Lets Hard Drive Run at Full Speed
- Up To 6 times Faster Than Standard Controller
- No Hardware Setup Required



\$475

Tiny Turbo Card

- High-Speed Accelerator for PC and PC/XT
- Replaces 8088 with 80286
- Socket for 80287 on Board
- Short Card



\$148

Hayes Compatible Modem

- 300 & 1200 BPS
- Short Card
- Fully Hayes Compatible



\$79

Enhanced Keyboard

- Separate Cursor & Numeric Pads
- Keys in Standard Locations
- LED Status Indicators
- Keytronic 5151 Compatible

Citizen High Speed Dot Matrix Printer

MSP-20 (80 Column) **\$329**
MSP-25 (136 Column) **\$489**

- 200 CPS Draft / 50 CPS NLQ
- IBM, Epson Compatible
- Centronics Parallel Interface



\$169

AT Multifunction Card

- Expandable to 3 MB — 1.5 MB on Board, 1.5 MB on Piggyback Board (OK Installed)
- Supports 64K & 256K RAM Chips
- Parallel, Serial and Game Ports

AT Mini I/O Card

- Parallel, Serial and Game Ports **\$89**



\$139

XT Multifunction Cards

- 384K RAM
- Optional FDC
- Parallel, Serial and Game Ports
- RAM Disk & Printer Spooler Software

XT Mini I/O Card

- Parallel, Serial and Game Ports **\$89**



\$90

135 Watt Power Supply

- XT Compatible
- UL Recognized (UR)
- Extra Power for Hard Drives

Hard Disk Kit

20 MB - **\$399**

- Boots from Hard Disk
- Instruction Manual
- Cables & Mounting Hardware
- Hard Disk Controller



Hard Disk Card

20 MB — **\$408**

- 3 1/2" Hard Card
- Easy Installation
- Formatted and Tested
- Boots From Hard Disk
- IBMXT Compatible

AT Type Hard Disk Drives

20 MB - **\$549**
30 MB - **\$629**
40 MB - **\$759**

- Boot from Hard Disk
- Instruction Manual
- Cables & Mounting Rails
- Works w/AT Hard Disk Controller



Expansion Box

\$150

- Room for 3 Half-Height Drives
- 120 Watt Power Supply
- 5 Slot Bus

Host Bus Interface Cards w/Cable — \$119

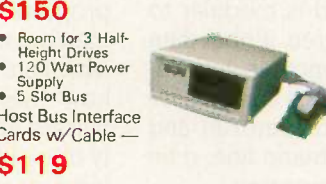

Floppy Disk Drive

Half-Height
DS/DD — 360K
Name Brands — TEAC, Panasonic, Mitsubishi, Sanyo, Etc.

\$90



Fast Tape Backup

20 MB — **\$449**
60 MB — **\$725**

- Easy Loading Tape Reels
- Responds to Standard DOS File Handling Commands
- Cables, Mounting Hardware and Tape Cartridge Included
- Software Included

"IBM's Brother" Monochrome Monitor

- IBM Lookalike **\$119**
- 12" Screen
- Amber or Green

High Resolution RGB Color Monitor

- 13" Screen **\$339**
- 640 x 200 Resolution
- RGB — 16 Colors

EGA Compatible Color Monitor

- 31" mm Dot Pitch
- 13" Screen **\$449**
- 640 x 350 Resolution
- RGB — 16 Colors



Mono-Graphics Adapter

- Hercules™ Compatible
- Parallel Port

\$99



Color Graphics Adapter

- 80 x 25 Character Text Mode
- 640 x 200 Dot Graphics Mode
- Fully IBM Compatible

\$89



EGA Card

- EGA, CGA, MDA & Hercules™ Compatible
- Flicker-Free Display Short Card - Add \$10

\$249

Technoland's Policy:

We accept Master Card and VISA (no surcharge), money order, cashier's check, personal check (please allow 10 days to clear), company / institutional PO's and wire transfers. We pay shipping (UPS ground — faster shipping available at additional charge) in continental US. We pay applicable sales tax.

Any item bought from Technoland (including software if unopened) may be returned for a full refund within 30 days of the date it was shipped if for any reason you are not 100% satisfied. All Technoland products carry Technoland's one year limited warranty. Some products also carry manufacturer's warranty. Selected Technoland products may carry additional warranties. Warranty policy requires that you submit proof of purchase and obtain an RMA number from us by telephone.

IBM, Hercules, Compaq, ATT, Panasonic, TEAC, Mitsubishi, ARC, Sanyo, Western Digital and Seagate are trademarks of their respective companies. MS-DOS is a trademark of Microsoft Corporation. IBM PC, IBM XT and IBM AT are trademarks of IBM Corporation.

Quantity Discount Available!

5 Days Guaranteed Shipping
Next Day Delivery Available
30 Day Money-Back Satisfaction Guarantee
California Residents — We'll Pay Your Sales Tax!

Mon. — Sat. 8:00 a.m. to 5:00 p.m.

14 Intensive On-Line Users At Same Time?

Accessing a Common Data Base?
No Waiting At The Terminal?
No Performance Degradation?

YOU BET!

With CompuPro's Multi-Processor
MP14™

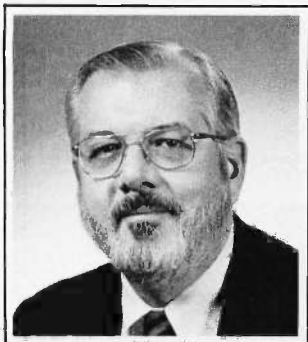

*Bill
Godbout,
architect
of the
CompuPro
MP14,
says,*

"The only way to get this kind of performance is to build it in, chip by chip. That's what we've done. The MP14 contains 8 separate 10 MHz Intel 286 and 186 CPUs, all processing at the same time. It has 6.5 megabytes of high-speed no-wait-state RAM. And it has 80 megabytes of buffered high-speed hard disk storage."

Here's the best part: With the same operating system, the same application software, you can start with the \$5,995 **CompuPro 10 Plus™** (4 intensive users at the same time), move up to the \$18,995 **CompuPro MP14**, and go way beyond that to the **CompuPro MP42™** (42 intensive users on-line at the same time, 24 separate 286 and 186 CPUs, 19.5 megabytes of RAM, no waiting, no performance degradation, \$49,995!).

These superb multi-processor systems are completely tested, are operating today at customer sites, and will be shipped 23 days after receipt of order. The MP14 is available through **CompuPro's** 127 dealers. Third party maintenance is available through Sperry Corp.

The MP14 could be the answer to your hardware problems. Call today, (415) 786-0909, for the complete story of this remarkable multi-processor system, and the telephone number of your nearest **CompuPro** dealer. OEMs and VARs who wish to port their applications to the MP14, please contact Bill Godbout.

CompuPro™

Trademarks: MP14, MP42, 10 Plus, CompuPro: Viasyn Corporation.

334 BYTE • DECEMBER 1986

BYTE U.K.

*OS-9 is completely
structured, the source
code looking much
like Pascal, and is
modular to an
extraordinary degree.*

under UNIX you can never be sure that the servicing routine hasn't been swapped out in favor of another task. This feature makes OS-9 ideal for scientific applications where, for example, a background task might be continuously monitoring an instrument while the user runs programs to process and display the results in the foreground.

I had never played with OS-9 before and was pleasantly surprised at how nice it is to use. It provides all the better features of UNIX, like pipes, filters, and redirection (rather like a grown-up version of DOS 2.0), and includes a remarkable language called BASIC09. This is to Microsoft BASIC as Robert de Niro is to Sylvester Stallone (i.e., it approaches things with rather more finesse). It's completely structured, the source code looking much like Pascal, and is modular to an extraordinary degree, global data being forbidden altogether. Individually named procedures can be separately compiled and even run and tested from the command line, then called from a main program.

It's perfectly possible to have all four of these environments present on the same U-MAN hard disk. Booting without a floppy disk in the default drive gives you CP/M, and putting in a boot disk for the other operating systems causes them to be booted instead. Some fairly tricky code in the boot ROM was required, since they don't all share the same directory format.

CHEMMOD

The main reason I borrowed the U-MAN was to look at a remarkable

molecular modeling system called CHEMMOD, for like Bill Unsworth I started out as an organic chemist. CHEMMOD is a color, three-dimensional molecular modeling system of a power that until recently would have been available only on a mainframe, and it makes all the other microcomputer systems I've ever seen look like toys.

For those of you who are not chemists, I should explain what a molecular modeling system does. It's in effect the research chemist's equivalent of a word processor, but it manipulates three-dimensional pictures of molecules instead of words. You will remember from school chemistry that molecules are represented by formulas like H₂O and NH₃. Nowadays, organic chemists work with models that depict the actual arrangement of the atoms of a molecule in space, known as its *conformation*. The atoms are represented as balls whose radius represents the comparative size of the atoms. To make large, complex molecules easier to recognize, arbitrary colors are assigned to different types of atoms; for example, oxygens might be white and hydrogens red.

When I was at college, we used to make these models out of colored plastic balls held together by bendy springs whose lengths represented the chemical-bond lengths. It's possible to learn things about the chemical properties of a substance simply by manipulating such a model, to see which atoms are near each other and how they collide as the model is twisted and rotated. This is especially true of large molecules found in living systems, like protein enzymes and peptide hormones; the biological actions of such molecules are largely determined by their shape.

Chemists in universities and pharmaceutical company laboratories spend much of their time manipulating computer models of molecules. In this way it's possible to investigate the probable properties of, say, a new drug molecule that hasn't even been synthesized yet. You can take the structure of a drug that does exist (and whose properties you do know) and modify it on-screen, just like cutting and pasting in a word processor.

CHEMMOD is a system of this sort that runs on the U-MAN computer under CP/M-68K and costs around £15,000 for the hardware and software. The U-MAN's built-in graphics are not capable of the required performance, so a separate raster-graphics processor, manufactured by Digisolve, is supplied in a slim box that sits under the monitor. This gives 512-by-512-pixel graphics in 64 colors and can write 1.5 million pixels per second. A separate high-resolution monitor is supplied to display molecular models, with all normal operating system output going to the U-MAN's text monitor.

The user interface to CHEMMOD is driven entirely by a light pen or mouse, and you need the keyboard only for entering the names of the files containing model descriptions. The version I used had a light pen, but a mouse might actually perform better. You choose options from on-screen menus by pointing with the pen, as you do with a professional CAD/CAM system. There are 20 pre-defined atom types (4 types of carbon, 5 types of nitrogen, etc.), 20 pre-defined amino acid molecules, and 20 ring structures to choose from, as well as a disk library of whole molecules.

You can add new components of any sort (e.g., a new atom type) by building parameter tables using an ordinary ASCII editor.

Molecules can be shown either as stick models or fleshed out as colored balls (see photo 1); the transformation is accomplished by one command and happens almost instantly. The stick version makes it easier to see the whole molecule, whereas the ball version gives a feel for the actual molecular shape. Depth can be conveyed by making elements that are farther from the observer appear dimmer. If that still isn't realistic enough, you can display a red-and-green three-dimensional picture that's viewed through cardboard spectacles like those that used to be given away in comics.

Molecules can be rotated in any dimension, either as a whole or internally by using chosen bonds as axes, and can be edited by moving bits from one place to another or adding extra atoms. CHEMMOD scales the models automatically to make them fit the screen; you can also zoom them and pan across them. More than one molecule can be displayed at a time, but screen and model sizes will impose some limits here.

(continued)

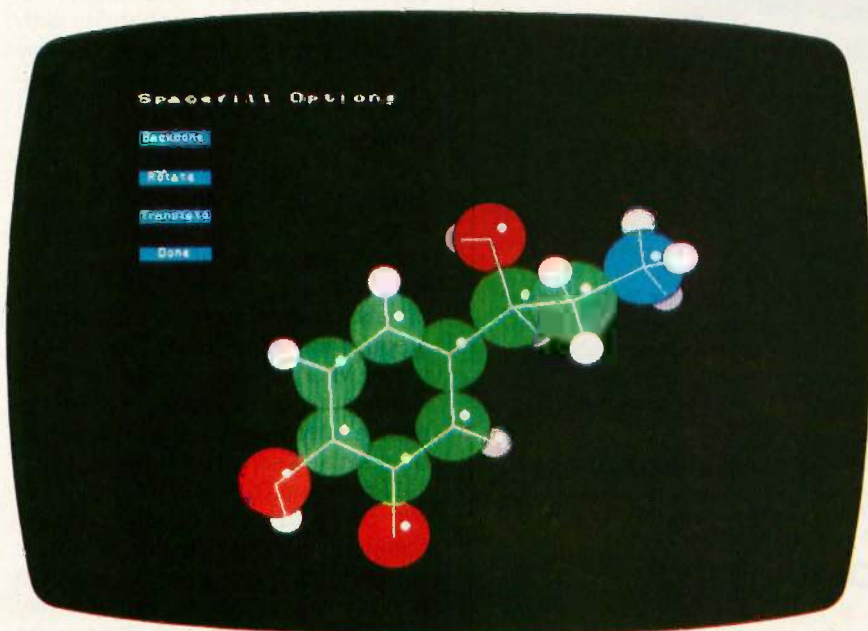

Photo 1: As shown in this model of noradrenalin, CHEMMOD displays molecules as three-dimensional colored balls that can then be manipulated.

C & PASCAL PROGRAMMERS

Blaise Computing provides a broad range of programming tools for Pascal and C programmers, with libraries designed for serious software development. You get carefully crafted code that can be easily modified to grow with your changing needs. Our packages are shipped complete with comprehensive manuals, sample programs and source code.

C TOOLS PLUS

\$175.00

NEW! Full spectrum of general-purpose utility functions; windows that can be stacked, removed, and accept user input; interrupt service routines for resident applications; screen handling including EGA 43-line text mode support and direct screen access; string functions; and DOS file handling.

PASCAL TOOLS/TOOLS 2

\$175.00

Expanded string and screen handling; graphics routines; easy creation of program interfaces; memory management; general program control; and DOS file support.

VIEW MANAGER

\$275.00

Complete screen management; paint data entry screens; screens can be managed by your application program; block mode data entry or field-by-field control. Specify C or IBM/MS-Pascal.

ASYNCH MANAGER

\$175.00

Full featured asynchronous communications library providing interrupt driven support for the COM ports; I/O buffers up to 64K; XON/XOFF protocol; baud rates up to 9600; modem control and XMODEM file transfer. Specify C or IBM/MS-Pascal.

Turbo POWER TOOLS PLUS

\$99.95

NEW! Expanded string support; extended screen and window management including EGA support; pop-up menus; memory management; execute any program from within Turbo Pascal; interrupt service routine support allowing you to write memory resident programs; schedulable intervention code.

Turbo ASYNCH PLUS

\$99.95

Complete asynchronous communications library providing interrupt driven support for the COM ports; I/O buffers up to 64K; XON/XOFF protocol; and baud rates up to 9600.

RUNOFF

\$49.95

NEW! Text formatter written especially for programmers; flexible printer control; user-defined variables; index generation; and general macro facility. Crafted in Turbo Pascal.

EXEC

\$95.00

Program chaining executive. Chain one program from another even if the programs are in different languages. Shared data areas can be specified.

ORDER TOLL-FREE 800-227-8087!



BLAISE COMPUTING INC.

2560 Ninth Street, Suite 316 Berkeley, CA 94710 (415) 540-5441

OUR PLUG-IN CARD GIVES YOU PLUG-IN CONTROL.

PC \leftrightarrow 488 allows your IBM PC/XT/AT or compatible to control IEEE-488 instruments.

With **PC \leftrightarrow 488**, you can:

- Plug-in to BASIC, C, FORTRAN, or Turbo Pascal™
- Emulate hp controllers,
- Use Tek Standard Codes and Formats,
- Run IBM's IEEE-488 software, and much more.

Just \$395 for the complete hardware and software interface.



Capital Equipment Corporation
10 Evergreen Avenue
Burlington, MA 01803
Call tortay (617) 273-1818

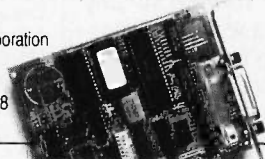

Turbo Pascal is a trademark of Borland International

Before now,
CHEMMOD's modeling
and computation features
were available only
on systems like a VAX
with Tektronix terminals.

Most important to the serious chemist, though, are the computational facilities offered. It's possible to have CHEMMOD compute the minimum energy conformation of a molecule and to get an on-screen plot of the potential energy as a molecule rotates around various bond axes. Bond lengths, torsion angles, and interatomic distances can be measured. Vibrational energy levels can be displayed as a Ramachandran map using colored contours. The distribution of electric charge over a molecule can be computed, and steric congestion can be measured. This last measure is an extremely important one; it shows how the different atoms get in each other's way as the molecule bends and twists and can predict the probability with which reactions will occur. Hard copy of all these measurements can be obtained on a variety of plotters and printers.

£15,000 might sound like a lot of money to nonchemists, but the features offered by CHEMMOD have hitherto been available only on systems like a VAX with Tektronix terminals, for which you are talking hundreds of thousands of pounds. What's more, when several people are time-sharing on such a system, the performance is probably a lot slower than on a single-user CHEMMOD system.

Of course, a CHEMMOD system can still be used as a general-purpose computer. It's possible that someone somewhere might even want to do hotel management during the day and design enzymes in their spare time! It almost makes me wish I were a chemist again. I hated those plastic balls and bendy springs. ■

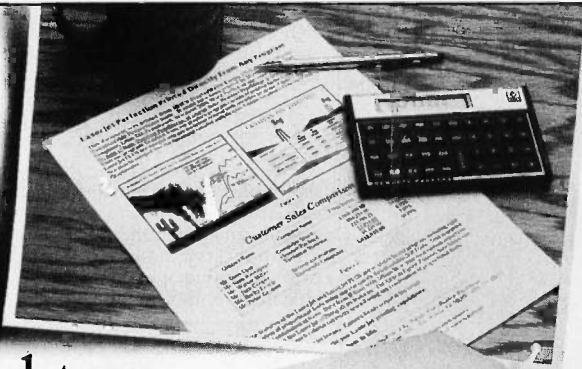

Desktop Publishing.

\$149⁰⁰

Hewlett-Packard's LaserJet created desktop publishing. *Ram-Resident PrintMerge* brings it to life. It does true proportional spacing and justification. With any font combination. You can merge text with screen or output graphics from other programs. Draw lines or boxes. Align proportional tab columns. Only *PrintMerge* offers these unique capabilities. You print directly from virtually any program including: dBase, DisplayWrite3, Lotus 1-2-3,



combination. You can merge text with screen or output graphics from other programs. Draw lines or boxes. Align proportional tab columns. Only *PrintMerge* offers these unique capabilities. You print directly from virtually any program including: dBase, DisplayWrite3, Lotus 1-2-3,

Multimate, WordStar. You've already spent 90% of what's

needed for a powerful personal publishing system with your *current* software and LaserJet. Just a bit more for *Ram-Resident PrintMerge* will bring it to life.

Call 800/338-5943 (In CA 800/231-3531)

Toll-Free for *Ram-Resident PrintMerge* Ordering Information for IBM PC/ATs and 100% compatibles. 30-day no-risk money back guarantee.

POLARIS
SOFTWARE

310 Via Vera Cruz, Ste. 205
San Marcos, CA 92069 619/471-0922

Conducted by Jerry Pournelle

MIND MINE NO LONGER

I've been informed that Mind Mine, which had a clock and a memory upgrade for the Atari ST (October, page 288), is bankrupt. I have also heard from—and alas lost the letter from—the actual designers of the memory upgrade and clock kit furnished to me by Mind Mine.

Mind Mine no longer exists; I will do my best to find the real source of the products I recommended in the column. Apologies.—Jerry

FASTBACK

Dear Jerry,

Regarding "painless" copy protection à la Fastback (Computing at Chaos Manor, July, page 325): No! It has continually been shown that a quality product at a reasonable price is its own guarantee against excessive loss of revenue by illegal copying. Borland is the most obvious example, but I believe that Satellite Software International is another good example with WordPerfect. SSI has shown that its support is desirable to the user, so that no one wants to have an illegal copy and forego support.

Another problem, although perhaps not with this particular product, is speed. Hard disks were considered to be fast, but with the inexpensive price of expanded memory boards, I now dump all programs requiring repeated disk access to a logical drive in expanded memory and run them from the logical drive. Any copy-protection scheme that requires access to a floppy disk becomes a bottleneck to such a system.

And lastly, may I point out that you appear to be giving up when the battle is almost won? I took the pledge several years ago not to buy protected software, and, apparently, so did a significant number of others. If Fastback is a good idea, there shall soon be a competing product—and probably one without copy protection. Besides, as a proud owner of many floppies that eventually became garbage, I will not tolerate the time, effort, and delay involved in replacing a failed copy-protected original when the underlying

ing premise for such protection is an affront to my integrity.

MARTIN E. VON LINDENBERG
Baltimore, MD

Fastback is no longer copy-protected. I may or may not have had anything to do with it; last time I talked to the Fastback people I was not polite regarding withdrawing the "send in for a non-protected update" offer they used to have.

Theirs was not the worst copy-protection scheme I encountered, but all copy protection is a bad solution to a real problem.—Jerry

Dear Jerry,

I am sympathetic with your Fastback problems. After similar and worse (did you know that the old copy-protection scheme refused to allow you to restore on a machine with a different A drive?), we switched to DS Backup from Design Software and are delighted. The cost is a quarter that of Fastback, it is not copy-protected, it can handle all types of files (system, hidden), it uses the archive bit intelligently, and the publisher gave us a site license. DS Backup is 10 to 20 percent slower, but so what? Try it, you'll like it. The address is Design Software, 2 North 520 Prince Crossing Rd., Suite 16, West Chicago, IL 60185, (312) 231-4540.

HARVEY H. BUNDY III
Chicago, IL

Now that Fastback isn't copy-protected, speed and data recovery are the most important factors. I like Fastback for both of those.—Jerry

NEW COMMUNICATIONS NOT SO NEW

Dear Jerry,

While Donald L. Stoner's petition to create the Public Digital Radio Service (May, page 393) is attractive on the surface, his petition to the Federal Communications Commission fails to take into account several facts.

In the first place, a method for computers to be linked via radio already exists. Amateur radio operators have been work-

ing for a number of years with packet radio, to the point that most major metropolitan areas have one or more packet repeaters on the air. Direct computer-to-computer communication is also common. Many of the hams who operate radio teletypewriters are using computers to do so.

A second point is that the "under-utilized" section of the 6-meter band that he proposes is currently designated for repeater service, including packet radio. As to lack of growth and utilization, I cite the American Radio Relay League's reply to the FCC. In 1971, there were 58 repeaters listed in this segment. In 1978, there were 169, and in the 1986 repeater directory, 250 were listed. This looks like utilization and growth to me. It should be noted that direct comparisons of numbers of repeaters in the other bands in which repeater operation is authorized is not applicable, due to the different propagation characteristics of the 6-meter band.

A third point is that the ham radio community has the technical capability and expertise and already has in place the structure and discipline to ensure the long-term growth of digital communications.

Since you presented his side of the argument, I would appreciate your making the opposite viewpoint also known. Ham radio operators have provided leadership in exploring new fields of communications and electronics. I invite you and anyone else so inclined to get in touch with a ham radio operator and find out more about this interesting hobby. Licensing requirements are minimal and information is readily available through your local club, on CompuServe (GO HAMNET), or through many of your local bulletin boards.

WILLIAM E. BUOY JR.
Houston, TX

Thank you. I have no strong views on the subject. I do think it would be nice to have a "computer CB," but I confess I haven't thought much about how hard/easy that would be to implement, nor even what I'd do with it if it existed. I use BIX a lot, and I presume that any decent computer communications system is go-

(continued)

ing to require that someone invest in a pretty big host machine and expensive software.—Jerry

Dear Jerry,

Mr. Stoner's intention is noble, and one not familiar with FCC actions might be enthused about reaching the status of a Rulemaking docket (RM-5241), but it's not an item to get ready to make use of next month—or even next year—or maybe ever. Reason: The radio spectrum is far more

crowded than many "outsiders" might know at virtually all except its highest reaches. It is "open frontier," where ranges are short and technologies are expensive, even to give you short ranges.

Further, the FCC is not sovereign about controlling uses of radio frequencies, because whatever we do must be in accord with international treaty, which the FCC cannot make; that's the job of the State Department. Virtually every square inch of frequency allocation has been

planned out and has to go around a loop from the FCC to international "suggestion," then be approved by the State Department before we can get licenses.

Finally, there are already uses of frequencies for data in Part 90, subpart K of the FCC rules. Indeed, some makers of radio modems have fielded products that claim up to a 37-mile range. Under such circumstances, one will have to convince the FCC that there is some overriding public need to do better than that, and if you want more range, you can bet the phone companies will be all over the case hollering that they can fill what small public need they say there is. One always has the phone industry to contend with, for they are *sure* everything is theirs!

As to amateur radio operators, they are not authorized to use ASCII code, so one way to get use of those nice, crowded (on HF, somewhat on VHF) frequencies is just to get a ham ticket and go to it! Remember that casual contact radio operations will probably do 100 bps maximum. Takes a while to transmit a 500K-byte file that way—and the longer you're on the air, the longer you expose your traffic to getting "hit" by somebody else. Transmitting data files by radio is a real trip!

There *must* be people doing it, for if you look in the appendices of Hayes manuals, you'll find a section on how to use the Hayes modems on radio—just be forewarned that it's not for the faint-at-heart Sunday dabbler.

DONALD E. KIMBERLIN
Safety Harbor, FL

Advising hackers to get a ham ticket is fine, but it requires that they learn the dreaded Morse code. Now, you and I and everyone else know that the only real reason the FCC requires Morse for a ham ticket is to limit the number of amateur licenses. I don't really complain about this; I suppose there needs to be some kind of limit, and the Morse requirement has been around a long time, so it might as well be that. On the other hand, thanks to the Army, I learned Morse a long time ago, and it wouldn't take me all that long to brush up on it.

Most hackers find Morse cruel and unusual punishment.—Jerry

Dear Jerry,

Concerning Donald L. Stoner's letter on the so-called Public Digital Radio Service, such a service already exists. It allows the direct or indirect connection of computers via the airwaves using a variety of codes such as ASCII, AMTOR, or even Baudot with baud rates up to 19.6 kilobaud! The

(continued)

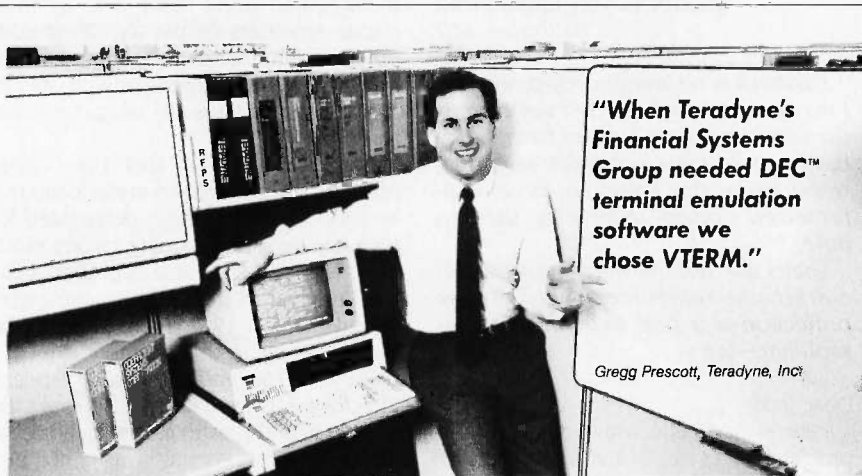

VTERM/220 Quality makes all other DEC terminal emulators obsolete

Over 35,000 demanding professionals, like Teradyne's Gregg Prescott, have recognized VTERM's superior quality.

Now this same VTERM quality is available in Coefficient's powerful new emulator, VTERM/220.

Features include:

- Plug compatible VT220 emulation with 132-column support and optional Tektronix™ 4010/4014 graphics.
- Extensive file transfer system offering KERMIT, XMODEM and our VTRANS protocol with VMS™, RSX 11 M/M+,™ RSTS/E™ and UNIX™ software.
- Host data capture on PC with conversion to Lotus® 1-2-3®, Symphony® and dBase®
- "Hot Key" toggle between host session and PC DOS.

Call us today at 212-777-6707 ext. 403.



Coefficient

The Leader in DEC Emulation Software

Coefficient Systems Corporation
611 Broadway, New York, N.Y. 10012

Trademarks: DEC, VMS, RSTS/E, RSX 11 M/M+, Digital Equipment Corp.; Tektronix, Tektronix, Inc.; Lotus, 1-2-3, Symphony, Lotus Development Corp.; dBase, Ashton-Tate, UNIX, AT&T, Bell Laboratories.

AT performance at an XT price.



Introducing the TeleCAT-286. \$2995. Complete.

With TeleVideo, you always settle for more.

For some time, you've known exactly what kind of PC you could get with a mid-range budget.

But now, you can settle for a whole lot more. With the new TeleCAT-286; from TeleVideo.

It starts you off with everything you need. Including a high-resolution 640 x 400 monitor. 512K RAM. A 20MB hard disk. A 1.2MB floppy. And an Intel 80286 CPU that runs at either 6 or 8 MHz. All standard.

To make even better use of internal space, we socketed the TeleCAT-286 for one MB of RAM, and also included serial and parallel ports on the motherboard. As a result, we can still give you three extra expansion slots.

And we didn't stop there. We've also designed more ergonomic features into the TeleCAT-286. Including sculptured keycaps on a high-quality keyboard. LEDs right on top of the three critical locking keys, where they won't get covered up by overlays. And a footprint that's 28% smaller than the IBM AT's. So you get

more of your desk back, too.

There's a lot more we could say about the TeleCAT-286. But it's even better to get your hands on it. So call (800) TELECAT, Dept. 299, and we'll tell you where you can try one.

The TeleCAT-286. Our 20MB version is \$2995; 30MB, \$3495. For high performance at a low price, don't settle for less.

 **TeleVideo**[®]
Settle for more.

TeleVideo Systems, Inc. 1170 Morse Avenue, Sunnyvale, CA 94088-3568 (408) 745-7760

Inquiry 431

IBM is a registered trademark of International Business Machines, Inc.

© 1986 TeleVideo Systems, Inc.

STOP SOFTWARE PIRACY

With our Copy Protection Products. They really work and do not burden the honest user. . .

For Hard Disk Protection

- HDCOPY

For Disk Security

High Level Security

- PADLOCK II DISK
- SAFEGUARD DISKS
- COUPON DISKS

Low Level Security

User Installable Protection

- PC-PADLOCK

The market is filled with copy protection products which burden the user or simply don't work. We have over 1500 satisfied software firms utilizing our systems. The high-level fingerprint has not required an update in over 2 years.

Why should your valuable data or useful software program become available in the Public Domain?

Call or write for more information.



GLENCO

ENGINEERING INC.

SERVING THE SOFTWARE INDUSTRY

3920 Ridge, Arlington Hts., IL 60004
(312) 392-2492 Telex 493-7109

CHAOS MANOR MAIL

service has also created Packet Radio, an integrated data communication system that allows local, regional, and even global communication using fairly simple radio equipment and computer interfaces. There are on-the-air bulletin boards, automatic relay stations ("digipeaters"), relay satellites, and even a message-delivery service that operates free of charge!

Best of all, this digital radio service is public-service-oriented, allowing even those not directly using the system to benefit from it. Groups and organizations that don't have the money for computer systems can still be helped by those many individuals who use the system for public service events and for emergency message handling during disasters. The service even allows the use of non-digital communication modes (just in case your system is down or your fingers get tired).

What does this service cost? At present, there is a one-time fee of about \$5 for a special exam that the FCC requires to make sure that the user knows enough about the radio aspect of things so as not to cause interference to other users or the general public. The exam also requires the user to know a primitive code used for emergencies and for weak signal conditions. I got through the exam before I knew much about computers, so anyone who has mastered something as complicated as hooking up an RS-232 cable the right way can probably pass the test.

If you haven't guessed what the real name of this service is by now, go find the nearest amateur, and ask him or her about the Technician License. Better yet, how about doing an article in a future issue of BYTE on this fascinating digital communication service? If you need more information, write The American Radio Relay League, 225 Main St., Newington, CT 06111. Mention that you are interested in digital communications. I think you will find that most of the users will go out of their way to help you.

PS—A citizens band for personal computers would probably end up just like the present CB has, namely, a mess!

DAVID KNISELY
Beatrice, NE

Thanks. Since the Technical License does not require the dreaded Morse, it should serve for the computer-hacker types who want to play with remotes.
—Jerry

V20 PROBLEMS

Dear Jerry,

In your June column, there was a lot of discussion about the merits of the NEC

V20 chip and its compatibility, so the following may be of interest:

I installed a V20 in place of the 8088 in the IBM PC XT and attempted to copy a write-protected disk with the CopyWrite 2 program. Instead of the usual copy, I received an abort message with some remark about a batch file. After a quick switch under the hood to the original 8088, everything was working properly again. It seems that write-protected programs and the programs intended to copy them are very sensitive to the speed of the microprocessor. My machine had an 8087 coprocessor installed, but I doubt that this affected the results. It is, however, possible. I am sure other users can tell us more about this matter.

KEN AFFIAS
New York, NY

The major difficulties I've heard about the V20 are Z80 code and copy-protected software.

Z80 code can only be run by software emulation; the V20 chip does only hardware emulation of the 8080. Software emulation on the best PC gives about the equivalent of a 2-MHz Z80. Ezekial, my friend who happened to be my first computer, was a 2-MHz machine, but alas, I've learned to expect better since those days.

Copy protection is another matter. You go by trial and error. Worse, something that usually works may not always work. This is the case with both CP/M software and, worse, PC-DOS software that worked with the original 8088 chip but won't work with the V20. Short of breaking the protection scheme entirely, I have no sure remedy.—Jerry

THE RIGHT TOOL

Dear Jerry,

I would like to speak for what I think is probably a large number of your readers. While the creativity-versus-structure debate will undoubtedly continue (Chaos Manor Mail, March and June), I'm convinced that the point is moot. With the software firms going in their current direction (i.e., falling prices and innovative language implementations), it is becoming practical for hackers to own and utilize several different languages, each suited to different tasks.

For large tasks, or those requiring a great deal of "polish," I use Modula-2. It allows me to break tasks down into small chunks that I can concentrate on. This frees me from having to keep track of organizational skills, thus allowing a greater deal of creativity.

(continued)

GET SERIOUS



...ABOUT ANALYZING YOUR DATA.

You might be spreading your spreadsheet a little too thin. Or maybe you're starting from scratch. But if you're serious about data analysis, you're ready for SPSS/PC+™ — a full software family that brings you six high-powered ways to complete any data analysis task.

Enter it. SPSS/PC+ Data Entry™ takes the effort out of entering and correcting data.

Analyze it. The SPSS/PC+ Base Package provides a powerful array of statistical and reporting procedures.

Examine it. SPSS/PC+ Advanced Statistics™ lets you get more serious with your data.

Table it. SPSS/PC+ Tables™ produces presentation-ready tables instantly.

Chart it. SPSS/PC+ Graphics™ featuring Microsoft® Chart creates show-stopping graphs and charts.

Map it. SPSS/PC+ Mapping™ featuring MAP-MASTER™ — our latest option — creates maps where vast amounts of data can be summarized and presented in one, simple picture.

SPSS/PC+ products are being put to productive use by serious fact finders in business, government and education. For countless purposes such as market research. Wage and salary studies. Survey analysis. And quality control. Plus each product is superbly documented and supported by SPSS Inc., a leader in statistical software for nearly 20 years.

So if you're serious about data analysis, step up to SPSS/PC+. For details, contact our Marketing Department.

CALL 1/312/329-3630

SPSS inc.

SPSS Inc. • 444 North Michigan Avenue, Suite 3000 • Chicago, Illinois 60611

In Europe: SPSS Europe B.V. • P.O. Box 115 • 4200 AC Gorinchem, The Netherlands • Telephone: +31183036711 • TWX: 21019

SPSS/PC+ runs on IBM PC/XT/ATs with hard disk. Contact SPSS Inc. for compatible microcomputers. SPSS/PC+, SPSS/PC+ Data Entry, SPSS/PC+ Advanced Statistics, SPSS/PC+ Tables, SPSS/PC+ Graphics and SPSS/PC+ Mapping are trademarks of SPSS Inc. for its proprietary computer software. Chart and Microsoft are trademarks of Microsoft Corporation. MAP-MASTER is a trademark of Decision Resources. © 1986, SPSS Inc.

On the other hand, if I need to knock off a quick Lagrange polynomial, I do it in FORTRAN (gasp!) because it is well suited to the "off the top of my head" style I use when I need something *now*. This lack of structure also helps my creativity flow.

It seems to me that the "best tool for the task at hand" approach is what the micro revolution is all about. While any group will have its factions, I think it is important to remember what we bought the little buggers for: They help us solve prob-

lems and allow us a little fun at the same time.

TIM NOLAN
Ypsilanti, MI

Oh, I have to agree. The Great Languages Debate began, after all, back when few of us knew much about computers and even less about what to do with them; and in those times, there were no decent Pascal or FORTRAN compilers. Also, most of us learned BASIC and then

wondered what to do next.

With all the tools available now, the problem is to choose a couple; nobody can learn all the languages, or at least no one but a real computer professional, which I, at least, am not.

I still tend to use BASIC for my "quick and dirty, run it once" programs. I have a fascination with APL; I keep thinking I really ought to learn it, but I have never made the required modifications to my hardware so I could use it with its odd squashed boxes and bent arrows and other symbols. I may get to it Real Soon Now. I may not.—Jerry

CP/M ISN'T DEAD

Dear Jerry,

I read with delight your June column "Color and CP/M." For numerous reasons, I rely on a CP/M-based computer as my primary system. I have accumulated thousands of dollars worth of really good CP/M software that I couldn't bear to part with or afford to replace.

Last November, I put together an SB180-based system as featured in Ciarcia's Circuit Cellar starting with the September 1985 BYTE. I have found it to be very fast and powerful, and 100 percent compatible with all my existing CP/M software. It is very compact in size and efficient in its use of electricity.

It comes with Echelon's ZCPR3/Z-System operating system, which is CP/M upward-compatible, coded in Z80 (not 8080) assembly language, and configurable to handle different peripherals. It comes with dozens of powerful, useful utilities, and has fast, powerful, user-configurable video-oriented shells for operating system functions. You can easily bypass these, via Control-C, should the desire strike.

The whole system is greater than the sum of its parts. The added speed and the integral RAM disk, coupled with the flexibility and power of Echelon's operating system, make what I perceive as a superior tool compared to the Ampro boards that you've mentioned. It functions just like we always knew it was supposed to when we first started messing around with these machines.

I love demonstrating my little box to the MS-DOS crowd, mostly average first-time computer buyers who learn just barely enough about their machines to keep from crashing too often. They are jealous of the speed and ease of use. Even the MS-DOS whizzes are impressed. I suppose the moral goes something like: It's not so much what you use that matters, but how you use it.

I recently received a 44-page catalog

(continued)



Announcing 2 New BYTE Collector Prints by Robert Tinney.

Limited Edition Classics

We are proud to announce the annual release of two new 16" x 20" BYTE Magazine Cover Art reproductions by renowned BYTE artist Robert Tinney. Only 1,000 of these flawless Collector Edition Classics will be produced, on acid-free 100% cotton fiber stock to ensure that they will keep their brilliance and quality over the years without cracking or yellowing. The color separations for these sumptuous prints are made *directly from the original paintings*, guaranteeing absolutely faithful reproduction of every subtle nuance present in the originals. Each is individually inspected, signed and numbered by the artist, and accompanied by a handsome Certificate of Authenticity (also signed and numbered). The plates are then destroyed, and no future editions of any size or number will ever be published.

The price of these magnificent limited editions is just \$55, or \$45 each if you order two or more. Your prints will be shipped flat by UPS Blue Label (2-day delivery) and carry an unconditional 30-day guarantee. Order today!

Order Form

Please send me the following Limited Edition BYTE Collector Prints at \$55 (\$45 each for 2 or more):

Qty.	Title	Amount
_____	_____	\$ _____
_____	_____	\$ _____
\$4 Postage & handling (\$15 overseas)		\$ _____
TOTAL:		\$ _____

I enclose my check money order payable to Robert Tinney Graphics, or, bill:

MasterCard VISA American Express card

_____ Expires: _____

NAME _____

ADDRESS _____

CITY _____ STATE _____ ZIP _____

Please send me your FREE color catalog.

VISA, MasterCard or American Express orders, call 1-504-272-7266

ROBERT TINNEY GRAPHICS

1864 N. Pamela Drive Baton Rouge, Louisiana 70815



Thomson Is About To Increase Your Workload. By 65%.

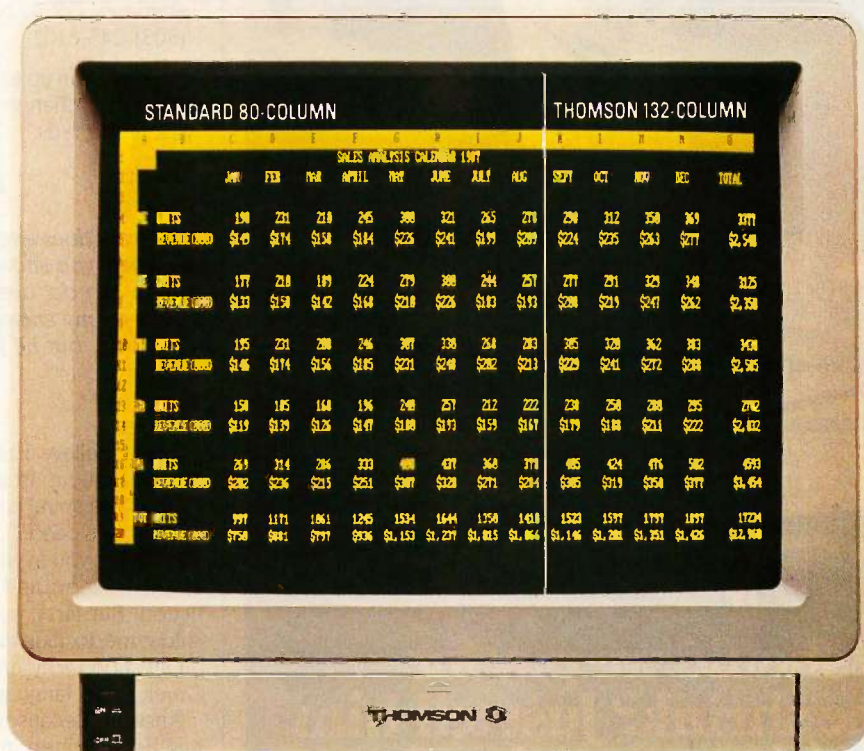

But more workload means less work.

Because our new 14" flat face monitor lets you see 132 columns of your application *all at once—with 80-column quality.*

Which means 65% more spreadsheet. More windows. More detail. Along with less scrolling. Less wasted time. And less frustration.

High-resolution monitor. The 450A is a high-resolution TTL monochrome monitor. Which means 80-column text is larger and easier to read. Graphics are easier to edit. And eyestrain becomes a thing of the past.

And speaking of graphics, you can have

an inexpensive, crystal-clear alternative to color monitors by using any IBM CGA or compatible graphics adapter. Which means more beautiful shades of amber. And at \$250, a lot more green in your pocket.*

How's that for color from a monochrome monitor?

Call 1-800-325-0464 (in Calif.

1-213-568-1002) to find out more about increasing your workload, the name of a dealer near you, and a list of compatible adapters.

THOMSON 
A Sight For Sore Eyes.™

©1986 Thomson Consumer Products Corporation

5731 W. Slauson Avenue, Suite 111, Culver City, CA 90230

*Suggested retail price. Thomson is a trademark of Thomson S.A. IBM is a registered trademark of International Business Machines Corp.

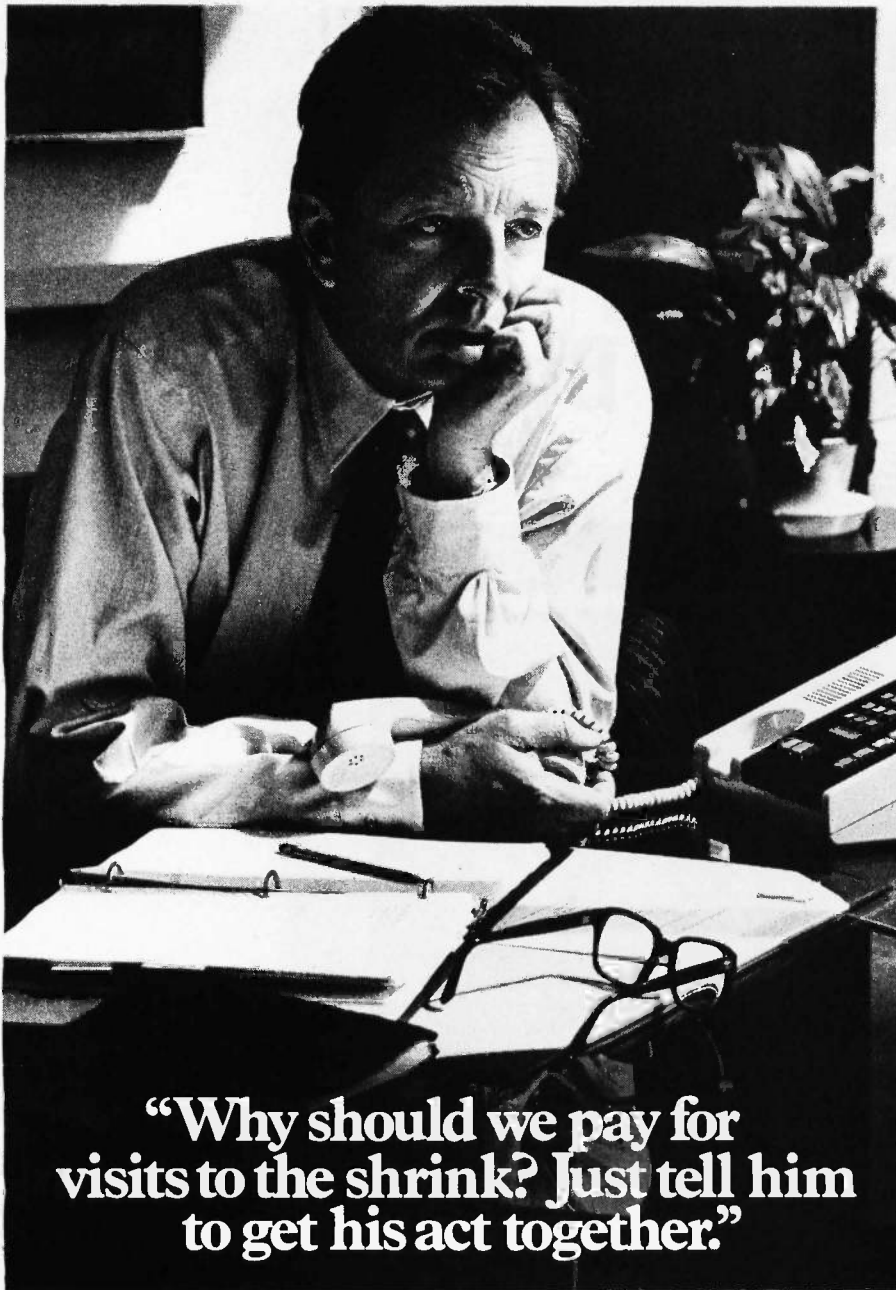

“Why should we pay for visits to the shrink? Just tell him to get his act together.”

In companies where professional treatment for mental illness is still viewed negatively, everybody suffers.

The employee, fearing how it will look on his record, suffers by not seeking treatment.

And the company suffers. From increased absenteeism and loss of productivity.

But you can help change all that. By recognizing that mental illness is a medical illness that requires medical treatment. And by looking into medical insurance coverage that encourages employees to seek professional treatment without fear or hesitation.

Today, many companies have successfully improved employee performance by structuring their health plans to include long and short term treatment.

Learn more. For an informative booklet, write: The American Mental Health Fund, P.O. Box 17700, Washington, D.C. 20041. Or call toll free: 1-800-433-5959. In Illinois, call: 1-800-826-2336.

Learn to see the sickness. Learning is the key to healing.

THE AMERICAN MENTAL HEALTH FUND



from Spite Software. These folks are dedicated to supporting the not-insubstantial installed base of CP/M systems. They have brought together hundreds of programs and a dozen or so vendors in an informative and tempting format. Everyone who plans to be productive with CP/M should be in contact with these folks:

Spite Software
4875 Southwest 19th Drive
Portland, OR 97201
(503) 245-8102

All this adds up to the fact that I see no reason to change computers just to “follow the fads.”

R. SCOTT TRUESDELL
Corona Del Mar, CA

It always does amaze the MS-DOS people when you show what a good CP/M system can do, doesn't it? I say this as I write on my ancient Z80. Zeke may be a bit tired, but he hasn't failed me yet.
—Jerry

Dear Jerry,

I can't believe I read what I think you wrote! I quote from the June issue of BYTE: “The spiral is deadly [to CP/M]” and “CP/M isn't dead.”

I respect you as an author. I enjoy your science fiction and your scientific non-fiction. But Jerry, you have a blind spot! Allow me to illustrate:

Question: Why are Latin and Classical Greek dead languages?

Answer: Because no original thought has been written in these languages for at least a thousand years.

Question: Why haven't Italian and modern Greek become *the* languages of the modern world?

Answer: Because Italy and Greece haven't been the center of entrepreneurial innovation.

CP/M is dead because little or no new and original software is being written for the CP/M environment. CP/M is dead because the center of entrepreneurial innovation is MS-DOS and/or UNIX based. Jerry, recant!

There is a spectrum of microcomputer users from white-eyed new users to seasoned veterans who eat tech manuals for breakfast without salt. You (and I) are pretty far out on the latter end of the spectrum. Do not assume that because you write for a living and are farsighted that the whole spectrum will see the light about CP/M with the emergence of V Weapons.

The availability of mass-produced books did not resurrect Latin or Classical Greek. Until new and commercially innovative

software is written for the CP/M environment, nothing can save CP/M!

CHARLES H. PORTER
Bothwell, WA

Well, we've had the other view too. . . . I'm sure you're right, CP/M will slowly vanish; but it will be useful for a long time anyway, and some will continue to love it. —Jerry

Dear Jerry,

I own two Radio Shack TRS-80s, a Model 4D and a 4P. Recently, I acquired a CP/M 2.2 operating system for them, so I could run KAMAS and Out-Think, by KAMASOFT. Previously I used Radio Shack's TRSDOS 6.2 exclusively, and I have a substantial number of TRSDOS applications.

I must comment that CP/M as an operating system reeks when compared to my TRSDOS 6. I have found it to be very hostile to both users and programmers. (Perhaps I'm biased because TRSDOS lets me take more control of my hardware.) I know of ZCPR3, but this still doesn't stack up to TRSDOS. I know what you're thinking—TRASHDOS! The Model 4 seems to have inherited this reputation from Models I and III—undeservedly, I'll add. TRSDOS 6 was written by Logical Systems, unlike versions 1 and 2, which were rather poorly done by Radio Shack. TRSDOS 6 compares quite favorably with anything else, including MS-DOS. Logical Systems has even published the commented source code to it. You'll never see Micro-soft do that!

Anyway, what's the deal with CP/M these days? Can you steer me toward more CP/M users groups or newsletters?

JEFF JOSEPH
Minot AFB, ND

I suppose that some day I'll forget TRASHDOS and the millions of "zaps" to patch it, but it won't be soon. I also remember LDOS, which is much better, and which, I gather, became TRSDOS 6. I recall Logical was an easy outfit to deal with and I was pretty impressed with what they were trying to do; that was in the days when I was still hoping to make something of my TRS-80 computer (which now gathers dust in a garage.)

A good place to start picking up CP/M software is from Workman and Associates, 112 Marion Ave., Pasadena CA 91106. I haven't heard from the CP/M User Group for a while but there are several of them still going. Software Toolworks (14478 Glorietta Dr., Sherman Oaks, CA 91423, (818) 986-4885) also publishes low-cost CP/M stuff. —Jerry ■

PCCB Has Super Values
Overnight Delivery Available. Call In Your
Toll FREE Order Today 1-800-245-4122

HARD DRIVES & HARD CARDS

- 20 Meg Seagate ST 225 w/controller *388**
- 30 Meg Seagate 403B *578**
- Hard Card Plus 20 *588**
- Tandon 20 Meg Hard Card *388**
- Call for any other models

FLOPPY DRIVES & CARDS

- Mitsubishi, Fujitsu or Matsushita—your choice *85**
- Teac 360K *89**
- Call for any other models

MONITORS & MONITOR CARDS

- Sony RGB Monitor w/Sony Trinitron 13" Color TV ... *488**
- Samson Amber TTL *78**
- Amdek 310A TTL *148**
- PGS Max 12 TTL *158**
- Mitsubishi Color RGB *338**
- Epson Color RGB *378**
- Amdek 600 RGB *428**
- PGS HX-12 RGB *428**
- Taxan 620 RGB *388**
- Quadram CH B420 RGB *158**
- IBM 5153001 Color RGB *538**
- PGS 12E EGA *528**
- Amdek 722 EGA *528**
- Quadram Quad Color EGA W/stand *528**
- NEC multi sync EGA w/stand *578**
- Hercules Graphics Card *188**
- Hercules Compatible Card *88**
- Color Graphics Card *88**
- IBM EGA Card CALL
- IBM Compatible EGA *338**
- Call for other models. Call for PGA cards & monitors.

MULTI-FUNCTION CARDS

- AST 6 pac w/side kick *188**
- AST 6 pac compatible *118**
- AST RAM Page for AT *438**
- AST Compatible RAM Page *288**
- Call for any other models

MODEMS

- Hayes 1200B *308**
- Hayes Compatible IN 1200 w/software *148**
- 1200 BAUD w/software *148**
- 2400 BAUD w/software *288**
- Call for any other modems

RAM CHIPS & MATH COPROCESSORS

- 64K RAM Chips * 88 Ea.
- 256K RAM Chips *2** Ea.
- 8087 Math Coprocessor *138**
- 80287 Math Coprocessor for AT *288**
- Call for any other chips

SOFTWARE

- Call for best prices on all software for MS DOS
- Lotus 1 2 3 *338**
- Word Perfect *258**

SURGE PROTECTORS & ACCESSORIES

- 6 outlet w/6 ft. cord *14**
- Dust covers for all models CALL
- DISKS DS/DD Box of 10 w/purchase *8**
- Call for any other accessories

PRINTERS IN STOCK NOW. CALL FOR PRICES.

- NEC 3550 • Toshiba P321 • IBM Pro Printer
- Okidata 192P • Okidata 2410P • Panasonic KXP 1092
- Panasonic KXP 1592

LX-86

List *349**

\$229**

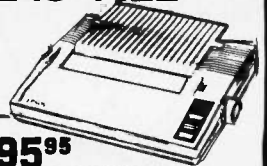

420i

List *1995**

\$995**

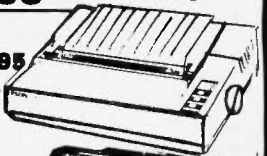

FX-85

List *599**

\$369**



FX-286

List *799**

\$499**



FREE

Stand With Purchase

of any Epson Printer

at P.C. Computer

LQ-800

List *799**

\$499**

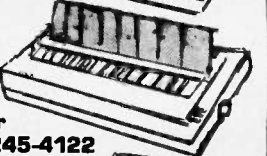

LQ-1000

List *1095**

\$709**

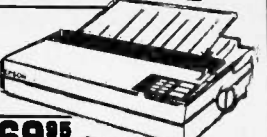

EX-800

List *799**

\$499**

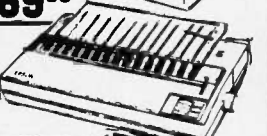

HI-80

List *369**

\$369**

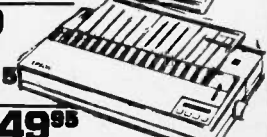

EX-1000

List *995**

\$649**

LQ-2500

List *1595**

\$1089**

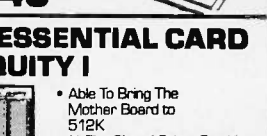

DX-35

List *649**

\$649**

Bus Extender Board For Equity I

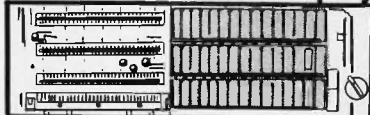

- Expands Mother Board to 640K
- Real time clock/calendar
- Print spooler
- Ram Disc
- 1 yr. warranty

\$189**

Brand New

The Most ESSENTIAL CARD For The EQUITY I

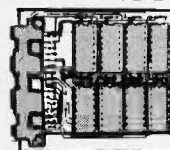

- Able To Bring The Mother Board to 512K
- 1/2 The Size of Other Cards
- 3 Year Warranty
- Save Up to \$70.00

\$99**

These Prices Good For Mail Order Dept. Only. Prices Subject To Change Without Notice.

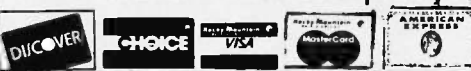

Add 2.9% For Use Of Visa, M/C & Choice & Discover Add 5% For Use of American Express

P.C. Computer Brokers Inc.
3879 East 120th Ave., Thornton, CO
80233 (303) 450-6727

Call Toll FREE 1-800-245-4122

Share info.

MFB



Spreadsheet
database
communications

Acctg/Finance



Spreadsheet
graphics
comm.

Sales/mktg

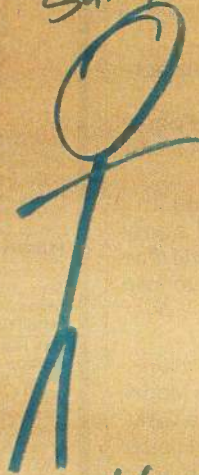

Spreadsheet
graphics
wd. process
comm.

personnel



wd. process
graphics

Symphony
works
For Everyone



R+D
Stick figure
Spreadsheet
database



you can't
outgrow
it

Symphony® is the one software product no business person can afford to be without. Based on the 1-2-3® spreadsheet technology, Symphony pulls together five key functions in one program. Functions that help a marketing manager work smarter. Give a financial analyst a clearer picture. Run an entire company more effectively.

Symphony is designed to stay ahead of your expanding needs. Its five functions can handle a wide range of business requirements. But should you have more specialized needs, you can incorporate Lotus® add-in products, or any of the more than 250 applications created by independent software developers.

Symphony. Business software you'll never outgrow.

Lotus Symphony

A complete general-purpose software tool built around the world's leading spreadsheet technology.

© 1986 Lotus Development Corporation. Lotus, 1-2-3 and Symphony are registered trademarks of Lotus Development Corporation.

**ORDER
LINE
800-354-7330**

LOWEST PRICES NO SURCHARGE ON BANK CARDS SILICON SPECIALTIES

ZENITH COMPUTERS
Always the
lowest prices.
Call us for
a quote.

PRINTERS

Brother All Models	Save
Citizen MSP-10	\$260
MSP-15	\$379
MSP-20	\$319
MSP-25	\$475
Premier-35	\$475
Diablo D-25	\$469
635	\$765

EPSON

All Printer Models	Save
IBM Proprinter	\$399
NEC	
3510, 3550	\$729
8810, 8850	\$1039
P5	\$959
P6	\$429
P7	\$609

OKIDATA

All Printer Models	Save
Panasonic 1080 I	\$195
1091 I	\$259
1092	\$295
1592	\$409
3131	\$245
3151	\$385

STAR MICRONICS

All Printer Models	Save
KEYBOARDS	
Keytronics 5151	\$159

Toshiba

321 Parallel & Serial	\$455
341 Parallel	\$575
P351 Parallel & Serial	\$929
Laser Printer	Save

DISKETTES

Maxell M25 (Qty 100)	\$85
Sony MD/2 (Qty 100)	\$85

MONITORS

Amdex All Monitors	Save
NEC All Monitors	Save
Princeton Graphics	Save
Zenith All Models	Save

VIDEO TERMINALS

Qume QVT Green 101	\$299
QVT Amber 101	\$314
Wyse 30	\$299
50	\$419
75	\$559
Wyse 85	\$439
Wyse 350	\$859
Zenith Z-22	\$455
Z-29A	\$559
Z-49	Save

DISK DRIVES

Imagica Bernoulli 10 meg	\$1195
Bernoulli 20 meg	\$1595
Bernoulli 40 meg	\$2325

SEAGATE

20 meg w/Western I/O	\$385
----------------------	-------

HARDWARE

MODEMS

Signalman Express	\$185
Practical Peripherals	
Practical 1200 Baud	\$124

HAYES

All Modems	Save
Prometheus All Models	Save
US Robotics Courier 2400	\$349
Postward 1200	\$165
Microlink 2400	\$349

BOARDS

AST Advantage	\$329
Rampage AT	\$445
Rampage PC	\$239
Six Pack Plus	\$159
Hercules Color Card	\$149
Graphic Card	\$179
Intel	
Above Board PC (1110)	\$239
Above Board AT (2010)	\$329
Above Board PS/AT (2110)	\$369
Paradise Five Pak	\$99

Plus Development

Plus Hard Card 20 Megabyte	\$599
Quadram TinyTurbo 286	\$355
Quadlink	\$329
Quad EGA+	\$359
Tec Mar Graphics Master	\$445
Captain No Memory	\$169

SOFTWARE

IBM PC AND 100% Compatibles

TRAINING

Flight Simulator	\$28
PC Logo	\$75
Typing Instructor	\$28
Typing Tutor III	\$28
MS Learning DOS	\$28

LANGUAGES

C Compiler (Microsoft)	\$249
Fortran Compiler (Microsoft)	\$195
Lattice C Compiler	\$236
Macro Assembler (Microsoft)	\$84
Pascal Compiler (Microsoft)	\$166
Quick Basic 2	\$55
Run C Interpreter	\$59
Turbo Pascal w/8087 & BCD	\$55
Turbo Database Tool Box	\$38

PROJECT MANAGEMENT

Harvard Total Project Manager	\$262
Microsoft Project	\$219
Super Project Plus	Save
Timeline 2.0	\$209

COMMUNICATIONS

CampuServe Starter Kit	\$19
Crosstalk XVI	\$92
MS Access	\$139
Mirror	\$35
Remote	\$92
Smartcom II	\$83

INTEGRATIVE SOFTWARE

Enable 1.1	\$319
Framework II	Save
Smart Software System	\$389
Symphony	Save

GRAPHICS

Chartmaster	\$199
Diagram Master	\$185
Energraphics 2.0	\$269
In-A-Vision	\$249
Microsoft Buss Mouse	
w/PC Paintbrush 3.0	\$106
Microsoft Chart	\$164
Microsoft Serial Mouse	\$119
Newsroom	\$31

PC Buss Plus Mouse

w/Point Plus	\$115
Click Art Personal Publisher	\$99
PC Mouse w/Dr. Halo II	\$99
PC Paint w/Mouse	\$115

Printmaster

Signmaster	\$132
Turbo Graphics Tool Box	\$38

MONEY MANAGEMENT

Dollars & Sense w/Farcast	\$94
Tabliss Managing Your Money	Save

WORD PROCESSORS

Leading Edge Word Processor	On Special
Leading Edge W/P w/Spell & Mail	On Special
Lightening	\$55
Microsoft Word 3.1	\$249
Multimate Advantage	Save
PFS: Write w/Spell Checker	\$76
Wordstar w/Tutor	\$162
Wordstar Pro Pack	\$233
PFS: Professional Write	\$108

Word Perfect (Ver.4.1) \$199
Wordstar 2000 + 2.0 \$278

SPREADSHEETS

Lotus 1-2-3	Save
Multiplan	\$108
Spreadsheet Auditor 3.0	\$82
VP Planner	\$48

Supercalc 4 \$ave

COMPUTERS

IBM	
PC 1 Drive 256K	\$1199
XT 1 Drive 256K	\$1729
XT 1 Drive 20 Meg 640K	\$2169
AT/68	\$2849
AT/339	\$4449

COMPAQ

Portable II - 2 Drive	\$1649
-----------------------	--------

PANASONIC

Business Partner Dual Drive	\$979
Sr. Partner Dual Drive	\$1169
Exec. Partner Dual Drive	\$1699
Other models	Save

TOSHIBA

T-1100	\$1299
T-1100 Plus	Save
T-3100	Save

Zenith Computer Products
SAVE Up to 50%

All Models	Save
------------	------

PLOTTERS

Epson Hi-80	Save
-------------	------

UTILITIES

Copy II PC	\$19
1 DIR	\$46
Fastback	\$86
Norton Utilities 3.1	\$48
Printworks	\$36
Slidekick	\$30
Slidekick (Unprotected)	\$47
Travelling Sidekick	\$39
Turbo Pralag	\$54
Sideways 3.1	\$34
Superkey	\$39

DATA BASE MANAGEMENT

Clipper	\$329
Cornerstone	\$56
dBase II	Save
dBase III Plus	Save
Extended Report Writer	Call
KnowledgeMan II	\$249
PFS: Professional File	\$135
PFS: File	\$76
Quickcode	\$138
QuickReport	\$138
Reflex	\$82
Think Tank	\$91

R:Base 5000
System V Call



mi **TURBO**
Turbo PC/XT \$449

256 Memory, One 360K Brand Name + Floppy Drive
135 Watt Power Supply, Slide Case, AT Style Keyboard
8 MHz Clock Speed, (Keyboard Selectable), 8 Expansion Slots

**FCC
APPROVED**

SPECIAL
Over \$200 worth of
Paperback Software Programs
\$39 with each system

Turbo PC/XT w/256K & 1 Drive	\$449
Turbo PC/XT w/640K & 1 Drive	\$499
Turbo PC/XT w/640K & 2 Drives	\$599
Turbo PC/XT w/640K, 1 Drive & 20MG	\$929
MS DOS 3.2 W/GW Basic	\$ 75
MonGraphics Card with Software and Parallel Printer Port	\$ 75
Color Card with Parallel Print Port	\$ 69
Multilinkin Card w/Software	\$ 79
Amber Monitor (TTL)	\$ 95
Amber Monitor w/Swivel Tilt	\$105
Color Monitor (RGB)	\$289
Sega Enhanced Graphics Card	\$235
I/O Card (Serial/Parallel)	\$ 39
I/O Card (Serial/Clock Calendar)	\$ 41
5151 Clone Keyboard	\$ 79



SILICON SPECIALTIES
2034 WEST SOUTHERN
MESA, ARIZONA 85202
602-969-0909

Product shipped in factory cartons with manufacturer's warranty. Please add \$10.00 per order for UPS shipping. Prices & availability subject to change without notice. Send cashier's check or money order... all other checks will delay shipping two weeks.

Inquiry 321 for MS DOS Products. Inquiry 322 for all others.

BIX is the BYTE Information Exchange, BYTE's full-time computer conferencing system. The messages shown in this section are only a small sample of the thousands of messages posted on BIX each month. This month, Best of BIX features messages from the Amiga, Atari ST, IBM PC, Macintosh, Apple II, and Graphic Display conferences. For information on joining BIX, see the advertisement on page 320.

AMIGA

The Amiga window begins with a question on how to rescue a disk that suddenly reads "unvalidated." Next is a discussion of a possible bug in the Trackdisk routine. Finally, there is a look at the possibilities within the Resident command.

UNVALIDATED DISK PROBLEMS

amiga/main #4488, from greggw (Gregg Williams, Senior Technical Editor, BYTE)

Help! During a normal disk access, something went wrong and now I have an unvalidated disk, which AmigaDOS won't recognize in any way. This is not the first time this has happened. I thought the file structure was robust enough to recover from such things. I've lost 880K of data!

Are there any programs or techniques to repair a disk that's been declared "not validated"? Surely AmigaDOS is not this fragile? Any help would be appreciated. Thanks.

(FYI--I was trying to "chop" a downloaded file using 'fixobj', which reads the file and writes to a new one. The disk was less than half full.)
--greggw

amiga/main #4489, from Inoland (Leslie Noland)
a comment to message 4488

There is a program called DiskSalvage (some places shortened to DiskSalv) that can rescue much, if not all, of your data. I believe it is in Listings, but if it isn't, BIXmail me and I'll put a copy up there.

It isn't a perfect program - sometimes it seems to recover data from past versions of a file and include those in the new file, or something like that. That's not too critical in a text file, but it could probably mess up an object file pretty badly. But it usually does a pretty good job.

There is an old Metacomco program (the name of which escapes me at the moment) that allows one to manually rescue the disk, but that is an abhorrent task. It's rumored that they've produced a new program, called DiskDoctor, which may well work better than DiskSalvage but it is probably only available to developers.

The big question is why your disk failed to begin with. The only disks I've ever trashed myself were ones I popped out of the disk drive before it had finished writing to the disk. I've heard of Marauder (at least early versions) being capable of trashing a disk - but that obviously isn't your problem. If you aren't being a bit too quick to pop the disks from the drive, and you're consistently getting this problem, you may want to have your drive checked.

- Les Noland

amiga/main #4490, from jim_kent (Jim Kent)
a comment to message 4489

Software crashes during a write can also do this. It happened to my hard disk the other day in fact. But I still don't know if it was AmigaDOS or Aztec, or ... something else.

amiga/main #4491, from cheath (Charlie Heath)
a comment to message 4490

But odds are pretty good it was AmigaDOS, one way or another. I'd guess that 98% of disk crashes are caused by AmigaDOS, or perhaps Intuition in interaction with AmigaDOS. Argghhh.

amiga/main #4492, from rsimonsen (Redmond Simonsen)
a comment to message 4491

Does this mean that no matter what one does nor how skilled one is (editors, programmers, designers) that AmigaDOS [AmigaDOS] blows you away eventually if you put a disk in its path?

Eeewwwwhhhhhh!

--Redmond

amiga/main #4493, from cheath
a comment to message 4492

Well, I'd qualify that by saying I just got bit (had a disk get zapped). So I'm not in a particularly forgiving mood re: AmigaDOS. My disk got zapped after reading a file into TxEd. The disk was still spinning, I brought up an Open requester, and *bang*. Suffice it to say I am fairly familiar with the code being executed and there is nothing I could have done using published specs (and probably nothing I could have done, period) to avoid a disk crash. Most likely there is something happening at interrupt level which kills either Trackdisk or AmigaDOS.

amiga/main #4494, from cheath
a comment to message 4493

Also qualify that by two factors:
1) I was using V1.1 of DOS.
2) I have an old machine.

amiga/main #4496, from jim_kent
a comment to message 4493

I know I just WON'T have any other processes going while I'm compiling/linking anymore, 'cause this makes disaster happen about 10 times as often. Shouldn't be memory either, 'cause my favorite was to run my little itty bitty terminal program on BIX while compiling. Now I use the ST to communicate while programming on the Amiga and vice versa. Oh well, you're all quite tired of my AmigaDOS flames even if most of them are true.

amiga/main #4498, from althoff (Thomas Althoff)
a comment to message 4496

When I reboot the system, I have a habit of typing the date, time, and a program name just as soon as the window is ready to take text. I just typed Manx's DB and, as the drives were churning (20 meg MAS20 and DF0:), got "DHO:not validated." After about 30 seconds of hard disk activity, everything seemed normal again. Next time I say anything about disk problems, I'm going to "knock on wood"!

(continued)

A BUG IN TRACKDISK

amiga/softw.devlpmt #2541, from sjones (Scott Jones)

There seems to be a bug with the IOTDF_INDEXSYNC flag not working for ETD_RAWREADs from the Trackdisk device. I have been able to read in a track, but the track is read in starting at a random location. The flag doesn't seem to do anything at all. The way I understand it, in a synchronized read, the buffer should be filled in with undecoded data starting somewhere in the pre-index gap (before the software index address mark). I've been able to find and decode the index address mark, the sector I.D. fields, and the data fields from an IBM-format disk (it's not at all the same as Amiga format...), but the buffer is filled with data starting in a random location in the track (not sync'd to anything, apparently!). Can any insiders at Commodore-Amiga shed some light on this? (I am a registered developer - with 1.2 beta 4 software. (Where's my beta 7??)) Is this just a bug in beta 4? Thanks!
Scott Jones

amiga/softw.devlpmt #2543, from jdow (Joanne Dow)
a comment to message 2541

This is normal with all raw track reads. The sync has a several-byte slop in it due to interrupt service time lags and sweep time and some other factors. Commodore-Amiga can account for all but 3 microseconds of it, they think (at least that's what the docs say).
<^~>

amiga/softw.devlpmt #2544, from sjones
a comment to message 2543

There is much more than a "several-byte slop." I haven't been able to see any difference between using and not using the IOTDF_INDEXSYNC flag. The slop is often 1/2 to 3/4 of a track. That is NOT 3 microseconds! (More like 1500 microseconds!) This is NOT sync'd. This is a bug. [Please C-A, if you haven't fixed this, fix it before you go ROM wild.]
Scott

amiga/softw.devlpmt #2545, from jdow
a comment to message 2544

Perhaps the TD_RAWREAD is the correct one to use with the INDEXSYNC request. The slop should be anywhere from a minimum of about 135 to 200 microseconds. 55 is software-interrupt service, 66 is one horizontal line as reads and writes are sync'd to this, and the last is the partial scan line to achieve the scan-line sync. This leaves 15 microseconds unaccounted for, unfortunately.

Oh - you are using IOTDF?? The flag is IOTDB_INDEXSYNC. I wonder how the IOTDF got by the compiler?
<^~>

amiga/softw.devlpmt #2546, from sjones
a comment to message 2545

Sorry, but IOTDF_INDEXSYNC should be the right one. As with all other flags used in the ROM Kernel, there are 2 defines, one to define the bit POSITION (IOTDB_, or MEMB_) and another to use to actually test or set the bit flag (IOTDF_, or MEMF_). This is a standard convention that Commodore-Amiga has followed in all of the include .h and .i files. Sorry, Joanne - this is still a bug!
Scott

amiga/softw.devlpmt #2547, from jdow
a comment to message 2546

Let's check your value for IOTDB_INDEXSYNC. (I agree re: IOTDB/IOTDF convention - was grasping at straws and have head cold mashing my ability to think clearly.) My includes have IOTDB_INDEXSYNC as 4 and the "F" as (1<<4). Let me check the .i file for funsies...It agrees. Make sure your version agrees. Also, are you applying it to IO_FLAGS field? Refresh me which version of the Kickstart, Workbench, and includes you are using, please. (I wonder if anyone at Commodore-Amiga is having fun watching me semi-flounder here?)
<^~>

amiga/softw.devlpmt #2548, from snow (Vic Wagner)
a comment to message 2547

Recently I found out from a nice person named Bob Burnes (who used to work for Commodore-Amiga) about
(continued)

AC/FORTRAN™ **AMIGA**

Mainframe quality, full feature ANSI FORTRAN 77 compiler includes: **Debugger**, Linker, Library Manager, Runtime Library, **IEEE** math, and **C** interface. Supports **Complex** numbers, **Virtual** arrays, **Overlays** and Dynamic Linking. Not copy protected. Available now \$295. Turbo Amiga version also available.

AC/BASIC™ - Coming Soon

From the authors of **Microsoft BASIC** compiler for Macintosh, comes AC/BASIC for the Amiga. Comparison compiler to the **Amiga BASIC** interpreter. Has more features and includes a **Debugger**, includes **BLOCK IF**, **CASE** statement, and **STATIC** keyword extensions and executes up to **50x** faster. AC/BASIC is the new BASIC reference for MCG8000 based personal computers. Not copy protected. \$295.

Telephone orders welcome

absoft

Scientific/Engineering Software
4268 N. Woodward, Royal Oak, MI 48072, (313) 549-7111
Amiga trademark of Commodore Amiga.
Microsoft trademark of Microsoft Corp.

ATARI

Inquiry 2

GFK **MEMORIES**

**ADD-IN BOARDS
PIN-FOR-PIN COMPATIBLE
EASY INSTALLATION**

**HP 150
HP 1000
HP 3000
WANG PC**

GFK
Amandastr. 60, 2000 Hamburg 6
West Germany

Phone **Telex**
(40) 4301051 **2162272**

Dealers are invited

US Distributor:
HyPoint Technology (216) 526-0323

Inquiry 146

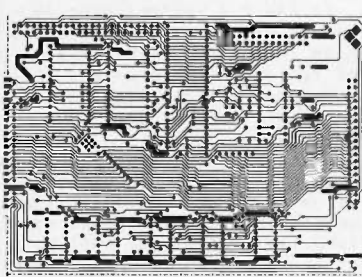

PCLO™
Printed Circuit Layout For The Amiga™

- High performance
- Semi-automatic routing
- Trace yield
- 28" sq - 2 layers
- Full silkscreen
- Utilizes color
- Area relation
- Magnification (zoom)
- Surface stretch
- Dot matrix checkplot
- Camera copy, vid. plotter
- Powerful workspaces operations
- N-layer capability
- Object Libraries
- Multiple pad types
- OSO centers
- Block operations
- Abs., rel & local measurement
- Editing, move copy, delete
- Global trace following
- Supports hard drive

System price - \$1024 / Functional sample disc \$75 (credit towards purchase)
PCLO © Softcircuits, Inc. / Amiga © Commodore, Inc.
FIRST IN A SERIES OF ENGINEERING WORKSTATION PRODUCTS FROM
SOFT CIRCUITS, INC., 401 S.W. 75TH TERRACE
N. LAUDERDALE FL 33068, (305) 721-2707

Inquiry 324

The American Success Story:

Once upon a time, America lead the world in innovation, quality, engineering, and manufacturing with names like Edison, Ford, and Bell . . .

Once again America returns:

\$1125



CLUB AT Inc. Model 1800 out-performs the foreign AT-Compatible machines with...

PRICE...QUALITY...PERFORMANCE

- * **Made in U.S.A.**
- * **A reputable manufacturer**
- * **Service in U.S.A.**
- * **Uses the latest version of Intel parts**
- * **48 hours burn-in**
- * **Same day shipping**

10 MHz, zero wait state
SI Rating 11.7 (version 3.00)

\$1495

Features:

- * 6/8/10 MHz, selectable with 8 MHz CPU
- * 10MHz option available
- * 1 MB of inboard memory (with 512K standard)
- * 8 I/O expansion slots
- * 1.2 MB floppy disk drive
- * 195 watt power supply, 110V/220V switchable
- * Touch-type keyboard
- * Fully compatible BIOS (written in U.S.A.)
- * Full documentation, operation manual with binder
- * Full one year warranty

Dealers and Corporate inquires are welcome
See pages 56 and 57.

CLUB AT INC.

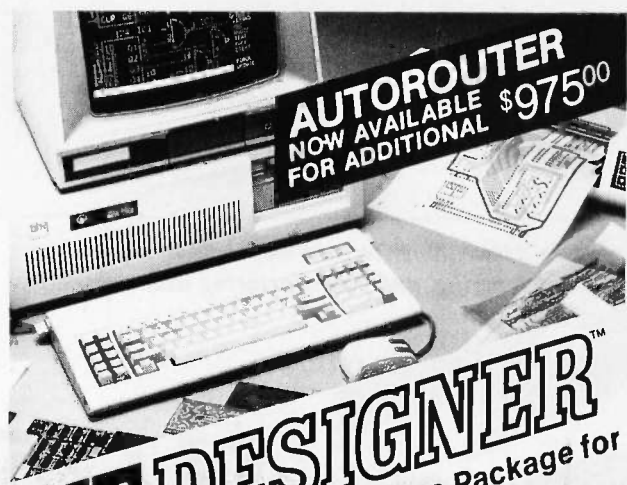

EE DESIGNER™
 CAE/CAD Integrated Software Package for
 IBM PC, XT or AT

At only \$975, no electrical engineer can afford to be without this end-to-end circuit design, simulation and PCB layout tool. You can pay up to 15 times more and still not get all the features offered by EE Designer—Schematic Capture...Circuit Simulation...PCB Layout. 30 day money back guarantee. Full purchase price refunded if not completely satisfied. Call 1-800-225-5669 today to order your package. Bank cards welcome.



**IBM PC AT performance!
 PCjr price!**

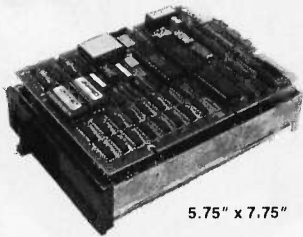

5.75" x 7.75"

- ★ **AMPRO LITTLE BOARD/186**
 - 8Mhz 16 Bit 80186 CPU
 - 512K RAM— No Wait-States
 - 2 Serial Ports 50-38.4K Baud
 - Parallel Printer Port
 - 4 Drive Mini/Micro Floppy Controller
 - SCSI Bus Hard Disk Interface
 - DOS Compatible ROM-BIOS
 - Boots PC DOS 2.x, 3.x
- Computer Board Assembled & Tested w/Tech Manual & DOS Utilities \$489.
- ★ MS DOS 3.2 & GW BASIC \$89.
- ★ DRI CONCURRENT DOS 4.1 Multi-User O/S \$319.
- ★ 512K EXPANSION BOARD (1Mb Total) 8087 Socket, Clock, 2 Channel RS232/422, Buffered Expansion Bus & More from \$149.
- ★ **AMPRO LITTLE BOARD (Z80)** same as 80186 Board but Z80A CPU, 64K RAM, 16K EPROM, CPM 2.2, ZCPR3 & Manuals \$239. With SCSI Hard Disk Interface \$279.
- ☆ ENCLOSURES w/POWER SUPPLY from \$99.
- ☆ 5.25" DS 360K FLOPPY DRIVE \$99.
- ☆ 3.5" DS 720K MICRO FLOPPY DRIVE \$139.
- ☆ XEBEC OWL 10Mb SASI DRIVE w/Built-In Controller \$449.
- ☆ SEAGATE ST225N 20Mb SCSI Low Power 1/2 Ht Drive \$599.
- ☆ WYSE & KIMTRON TERMINALS from \$395.

Complete technical support. Complete systems available. Write or call for more information. Most orders shipped same day.
 VISA, Mastercard, Money Order, COD. Checks allow two weeks. Purchase Orders welcome. Prices FOB Buffalo Grove, IL.

IBM PC AT, PCjr, PC DOS are trademarks of International Business Machines Corporation. Little Board is a trademark of Ampro Computers, Inc. Concurrent DOS is a trademark of Digital Research, Inc.

DISKS PLUS, INC. • 356 Lexington Drive • Buffalo Grove, IL 60089-2312
 (312) 537-7888 • TLX: 650 249 2139 MCI UW.
DISKS PLUS Microcomputers and Accessories

this IOTDF_INDEXSYNC problem. It seems that DoIO is really the culprit. It clears some flags. What you gotta do is

```
BeginIO/WaitIO
```

It works fine for me on both the 3.5 and 5.25 disks.

THE RESIDENT COMMAND

amiga/softw.devlpmt #2411, from cheath

Has anybody tried using the Resident command in v1.2? It is supposed to work with all the AmigaDOS CLI-type commands - but should also work with any programs that adhere to a couple of rules -

- 1) Code segment should not be modified.
- 2) Data segment must be addressed by relative addressing.

Apparently, it is possible to do this with Manx-compiled programs, at least most of 'em. Has anybody tried this? (Also, it would work with Lattice programs if their new linker will support relative addressing - which Alink doesn't.)

amiga/softw.devlpmt #2413, from w.volkaegis (William Volk, Aegis Development Inc.)
 a comment to message 2411

Does Resident make the program stay in memory? This could be GREAT!

amiga/softw.devlpmt #2414, from cheath
 a comment to message 2413

Resident loads the program into memory and then allows multiple invocations of the program to use the same code. So even if you run the program multiple times it only needs one copy to be loaded.

amiga/softw.devlpmt #2428, from jgoodnow (Jim Goodnow, Manx Software Systems)
 a comment to message 2414

Bad news for the Resident hopefuls! The Resident command seems to work okay on Aztec-compiled programs. However, the CLI-resident version of the CLI doesn't make a copy of initialized data segments. This means that programs share both CODE and DATA. This means that if I have any initialized data that later gets changed, the next time you run it you get the last value before exiting.

Even worse, two invocations will use the same variables.

On the bright side, this is fixable in two ways. First, I can have some special start-up and exit code that allocates some memory and copies the data. Even better would be if I could know that the program is resident and, if so, only do the copy. The second way is to use a CLI replacement that is smart enough to make a copy of the data. Question: Doesn't BCPL have initialized data? Or does it always make a copy before using?? (Stay tuned to this station....)

amiga/softw.devlpmt #2443, from tking (Tim King, Metacomco)
 a comment to message 2428

Let me explain what Resident does. It simply loads your program into memory using LoadSeg and then the Resident CLI uses that copy if it can find one in memory. If you write code that is both reentrant and reusable, then

(continued)

"I ♥ American"

COMPU-BRUSH™ EGA/CGA GRAPHICS CONTEST

American MOUSE



TWO CHANCES TO WIN
A GRAND PRIZE OF
\$2,000 + American 286-A
PERFECT SYSTEM WITH MONITOR

FREE
90 day
On-site
Service*



FREE SOFTWARE!

Introducing Compu-Brush—an electronic paintbrush program which allows you to capture any graphic screen of another program to enhance its presentation with a variety of colors, text styles and fonts. Create your own library of frequently used graphics and save it with the SMALL command using 50% to 90% less disk storage space. Additionally, you may develop a computerized "slide presentation" for a professional and effective demonstration.

Compu-Brush will be included in every American computer system or other American hardware products, including the American Mouse—FREE!

\$35,000 IN CASH AND PRIZES! Create a design using the "I ♥ American" slogan with your Compu-Brush software and you could win a grand prize of \$2,000 and an American 286-A (AT compatible) Perfect System with a color monitor. Other prizes include American (IBM AT/XT® compatible) systems with color monitors.

DOUBLE YOUR CHANCES! Phase One of the "I ♥ American" graphics contest concludes at Comdex/Spring '87 in April. Keep the creative flow going and enter Phase Two of the "I ♥ American" contest to conclude at Comdex/Fall '87 in November.

Look for specially marked packages of American systems and American hardware products and create winning graphics with your FREE Compu-Brush!

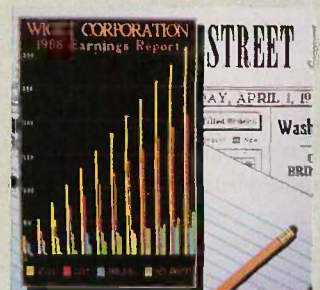

CRT (EGA) DISPLAY USING COMPU-BRUSH

American
COMPUTER & PERIPHERAL, INC.

Corporate Office: 2720 Croddy Way, Santa Ana, CA 92704 USA
Tel: (714) 545-2004 • Fax: (714) 545-2146 • TELEX: 3710523 AMERICAN
Northeastern Office: 830 Busch Court, Columbus, OH 43229 USA
Tel: (614) 846-5433 • Fax: (614) 846-7656

Contest rules and entry forms may be obtained from AC&P.
Deadlines for receipt of entries are April 1, 1987 for Phase One and November 1, 1987 for Phase Two.
Void where prohibited, licensed or taxed by law.
® IBM AT and XT are registered trademarks of International Business Machines Corporation.
*On all American 88 and 286. Effective October 1, 1986. Subject to Intellogic Trace geographic restrictions and regulations.

Inquiry 23 for End-Users. Inquiry 24 for DEALERS ONLY.



Why Electronic Arts is Committed to the Amiga, Part II

THE CLASS OF '86



Last year, we challenged our best software artists with the audio-visual horsepower of the Amiga. They responded.

DeluxePaint is now the standard in personal computer graphics. DeluxeVideo is making "desktop video" a reality. Marble Madness is the first arcade game you can take home in your shirt pocket.

And that's just the beginning.

Brian Fargo
The Bard's Tale

The best new dungeon fantasy of 1986, impressively redesigned for the Amiga. See how ugly an ogre can be.

R. J. Mical (seated)

Co-designer of the Amiga has a top-secret game in the works. Can he really make the Amiga stand on its head?

Glenn Tenney
Adventure Construction Set

Build your own adventures. Or let the computer make them. Or play the nine built in.

Larry Reed
Marble Madness

Race marbles through wildly-colored 3-D mazes. Amaze your friends.

Rick Koenig (seated)
Grand Prix

See pixels fly at 250 mph. Hear the turbos whine. Taunt tailgaters in your rear-view mirror.

Damon Slye
Arcticfox

Tanks at war. Arctic storms with lightning. 3-D smart opponents. Rumble.

Eddie Dombrower (seated)
Earl Weaver Baseball

The crack of the bat. The voice of the seams on the ball.

Moses Ma

Next generation typing instruction. Artificial intelligence gives your fingers



John Rosenberg
DeluxePrint
Full-color greeting cards, stationery, cards, and more. What you see is what you print.

John MacMillan (seated)
DeluxeMusic
Top music publishing. From keyboard to pop music in minutes.

Dan Silva
DeluxePaint II
A feast for the eyes. With perspective, pattern fill, stencil, anti-aliasing and much more.

Tom Casey (seated, without co-designer Mike Posehn)
DeluxeVideo
Special effects. Slide shows. Animatics. Rock videos. The sky's the limit.

Bob Campbell
Instant Music
Jam with digitized instruments. All music, no mistakes.

Mike Wallace
Return to Atlantis
A 3-D undersea "interactive movie." Water-tight animation.

Anne Westfall, Jon Freeman
Archon II: Adept
An action-strategy classic. With panning hi-fi stereo.

Adventure Construction Set, Arcticfox, The Bagel's Tale, DeluxeMusic, DeluxePaint, DeluxePrint, DeluxeVideo, Earl Weaver Baseball, Instant Music, Return to Atlantis and Electronic Arts are trademarks of Electronic Arts. Amiga is a trademark of Commodore-Amiga, Inc. Marble Madness is a registered trademark of Atari Games Corporation. For more information about these products or to order direct, call 800-245-4525 (in California call 800-562-1112). For a complete product catalog, send 50¢ and a stamped self-addressed #10 envelope to Electronic Arts Catalog Offer, 1820 Gateway Drive, San Mateo, CA 94404. Thanks for your support.



ELECTRONIC ARTS™

Inquiry 122 for End-Users.
 Inquiry 123 for DEALERS ONLY.

this works fine (BCPL does this, which is why it works). If you are writing in C, then you must use PC-relative addressing and use a startup sequence that allocates a memory area for your BSS; you must not use any static initialized data because that makes your code nonreusable. Local variables are allocated on the stack; you get one of these for each invocation. If you don't use any global data then your code is OK; otherwise, you must use a compiler that can handle PC-relative addressing. [There is a big problem here in that the current version of ALink does not cope with the Xref(A5)-style of addressing so that Lattice users, at least, cannot use the two options that cause the compiler to produce position-independent code.]

If you think the problem through you will realize that simply copying the data area will, of course, not work because there are essentially absolute references in the code (created by the relocating of the code) to areas within the data segments. And altering these would mean that the code could still be used by only one user at a time.

The entire area of producing pure code on a 68K is complex; some systems (e.g., OS-9) require that all programs are position-independent, which I find very hard to take because the XXX(An) addressing mode limits one to 64K address bounds, which sounds a little too much like the dreaded 808x for me.

amiga/softw.devlpmt #2451, from jgoodnow
a comment to message 2443

Unfortunately, very few serious programs that do anything with windows or graphics can get by without some initialized data structures. That's what Crunch's gadget editor is all about.

amiga/softw.devlpmt #2455, from Inoland
a comment to message 2451

Though I know this is messy at best: How about if the initialized data were stored as a separate file, loaded by the program with LoadSeg and addressed via pointer de-reference. It's an awful way of doing things because it throws any concept of data hiding completely out the window, requires cooperation amongst all programmers on a project to a degree that goes beyond what is reasonable, and requires the programmers and compiler to perform a function that ought to be performed by the linker and loader. It would, however, enable one to write code that could be used with the resident feature and, hence, would be much more valuable to the user. Just a thought.

- Les Noland

amiga/softw.devlpmt #2458, from jdow
a comment to message 2455

Lattice is experimenting with residency using standard Amiga methods. Perhaps some day soon. (BLINK seems to perhaps handle the necessary linking formats.)
<^_^>

amiga/softw.devlpmt #2476, from jmackraz (Jim Mackraz, Commodore-Amiga, Inc.)

a comment to message 2451

Question: If you don't _change_ your initialized data, isn't it OK to use it by multiple invocations? Intuition has a reference copy of each system gadget, which it copies to a dynamically allocated gadget when it creates a window/screen. The only big-time reason for initialized data in Intuition users is probably image planes, and copying them to dynamically allocated chip-mem isn't all bad (unless their size is too large

to duplicate). I think you can share image data that isn't going to change.
ramble ramble ...

amiga/softw.devlpmt #2460, from afinkel (Andy Finkel, Commodore)
a comment to message 2443

Actually, one user at a time is *fine* for compilers and editors, and... (the stuff you've been putting in your RAMdisks). Not keeping two copies around (one in RAMdisk, and one executing) is a win by itself (at least for me!). So only the static data has to go, right?

andy

ATARI

This month's look at the Atari ST conference begins with a thread of double-buffered animation techniques. The section continues with a question on controlling the RS-232 (serial) port and concludes with a comparison of graphics techniques for the Atari 8-bit and 16-bit computers.

DOUBLE-BUFFERING TECHNIQUES

atari.st/tech #706, from jim_kent (Jim Kent)

I was running some double-buffered animations on the ST, switching screens with Setscreen. This seemed to work pretty well except for a glitch that happened every minute or two. I wanted to clear this up without resorting to a wait for vertical blank, which could slow down the frame rate quite a bit. Well, if you make the high-order word of the start address the same for both screens (both screens in same 64K block of memory) then you don't get the glitch, which is apparently from the video register being half-updated when it latches. I had to shuffle around my memory management, but it seems to work, and no waits!

atari.st/tech #720, from cheath (Charlie Heath)
a comment to message 706

Ah, good idea. So you just store the low word?

atari.st/tech #732, from jim_kent
a comment to message 720

Actually, I still call Setscreen, but if you were talking to the chip yourself you'd just store the low word.

atari.st/tech #740, from mmallett (Mark E. Mallett)
a comment to message 732

Does the ST have memory reserved for an alternate screen buffer? The Abacus documentation sort of implies that it does, because its examples show default values for a current and an alternate page. If not (Jim), how did you go about allocating two 32K chunks of memory that were both within the same 64K block, and not waste some memory?
-mm-

atari.st/tech #744, from jim_kent
a comment to message 740

As far as I know, the ST doesn't have a reserved second screen. What do I do? Well, there are some routines I

(continued)

The PC Tech Board Room Presents:

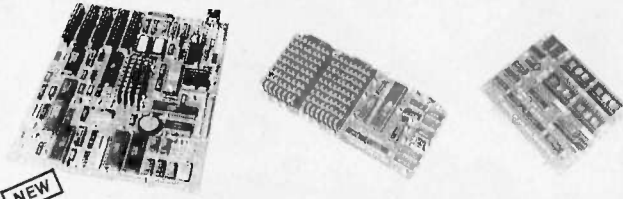

NEW

THE X16B NOW FEATURES 8 or 10 MHz operation with the 80186 CPU, 1 Megabyte of memory with no wait states, a real time clock, floppy disk controller for 4 drives - 360K/720K/1.2M. On board options: SCSI port, two serial ports, and 8087-2.

..... Price Reduced!! \$599.00
OEMs Note: Customs boards and ROM BIOS available.

NEW

Monochrome system w/ 2 floppies, 1 serial port, 135W P.S., keyboard, mono card w/ printer port, mono monitor \$1,345.00

NEW

THE 4 MEGGER BOARD is new leader in EMS boards. This 2/3 length card contains 4 megabytes of EMS memory which works with Symphony, MS-Windows, and others. It is supplied with a fast memory disk driver and works with the X16 or IBM PC/XT

..... Introductory Special!! \$850.00

THE MEMORIES BOARD has four universal byte-wide sockets which can accept RAMs, EPROMs, and EEPROMs up to 256K total. Also has optional Hex displays for diagnostics and status. Suggested uses are in diskless workstations, networked systems, diagnostics and customization of any PC..... \$95.00

More To Come!!! We also sell systems, drives, power supplies, keyboards, etc. Call or write for complete list.



Customization Welcomed!!

(612) 345-4555

904 North 6th Street Lake City, MN 55041

New Quark®/PC Single Board Computer



Base model 5.75" x 8"

Only \$395.
 Reg. Price ~~\$495~~

Quantity discounts available

- IBM PC® compatible single board computer mounts to 5 1/4" drive
- Includes Floppy Disk & Color Graphics CRT Controllers plus more

Also includes: Legal BIOS • Boots MSDOS® 3.0 • Printer Port • 2 Serial Ports • 256K RAM • Clock Speed at 4.77 MHz • Alpha numerics and Graphics Modes for Color Video Controller • Standard IBM® Keyboard Port.

Options include: 512K RAM • Piggyback I/O channel OEM Expansion Board • XT-Compatible Hard Disk SCSI interface • Real Time Clock with battery-back-up • Clock speed of 9.5 MHz (twice as fast as a PC)

The Megatec Quark/PC is for OEM and end user applications that require PC compatibility in a compact single board computer. The Quark/PC BIOS will run most IBM PC® software including Flight Simulator and Lotus®. To meet your specifications a set of options let you add memory, speed and XT-compatible hard disk interface. Not only does it quickly mount to a 5 1/4" drive, it also comes with floppy disk and CRT color graphics controllers — all for just \$395.

To order or enquire call us today. Dealer enquiries welcome. Megatec Computer Technologies (416) 745-7214 150 Turbine Drive, Weston, Ontario M9L 2S2 Telex: 065-27453 U.S. Address: 1051 Clinton St., Buffalo, N.Y. 14206 Distributors: NCS Electronics Varese, Italy • SES Electronics Noralngen, Germany • Perdic Microtronics Biggin Hill, U.K. • Microcomputing Ghent, Belgium • Asp Microcomputers Melbourne, Australia

Quark is a registered trademark of F. and K. MFG. CO. LTD., IBM, IBM PC and PC DOS are registered trademarks of International Business Machines Corp. Lotus is a registered trademark of Lotus Development Corp. MSDOS is a registered trademark of Microsoft Corp.

megatec

posted in listings - alloc and mfree - that I use for my memory management. Basically I use Malloc((long)-1) to see how much memory is there. I leave 32K for GEM, and malloc the rest of it for myself. Then I play some games to extract two screens in the same 64K block out of the big continuous chunk Malloc has given me, and put what's left back on my free list. It is a bit of a pain 'cause you can't use the start-up screen (in high memory) as one of your double buffers. When Deluxe Eggbeater ST crashes, it means that GEM thinks the screens are in the middle of the memory that Megamax uses for a stack. Scrolling the stack for a printf isn't a good idea. So I have to reboot after crashing when I use this memory method. However, now that I've got it to work, I went back to the old way for development.

Anyway, if you're very interested I can post the source. It is a little kinky, but worth it not to put waits into my draw loop!

atari.st/tech #747, from mmallett
 a comment to message 744

No, I was just interested in whether you had some really elegant way of getting aligned allocated memory. I've had to use the same method that you described for other things as well.
 -mm-

atari.st/tech #749, from sgrimm (Steven Grimm)
 a comment to message 740

You can point the screen anywhere on the ST by using Setscreen(). Just allocate 32K (I think it has to be on a 512-byte boundary) and away you go!

atari.st/tech #770, from jruley (John Ruley)
 a comment to message 749

Does that work with GEM (i.e., can you change the screen pointer after GEM starts)?

atari.st/tech #777, from jim_kent
 a comment to message 770

Yep, Setscreen works fine with GEM so long as you don't change resolution.

atari.st/tech #778, from jruley
 a comment to message 777

Many thanks, Jim. That may just come in handy!

atari.st/tech #782, from mmallett
 a comment to message 778

Does that imply that you cannot change resolutions in a GEM application, programmatically speaking? Why can you not do a Setrez, followed by appl_init, etc.? What happens? Doesn't this seem like a major deficiency? So what else is new?
 -mm-

atari.st/tech #784, from jim_kent
 a comment to message 782

Nope, can't change resolution with GEM about. It js maybe the biggest deficiency in this machine.

(continued)

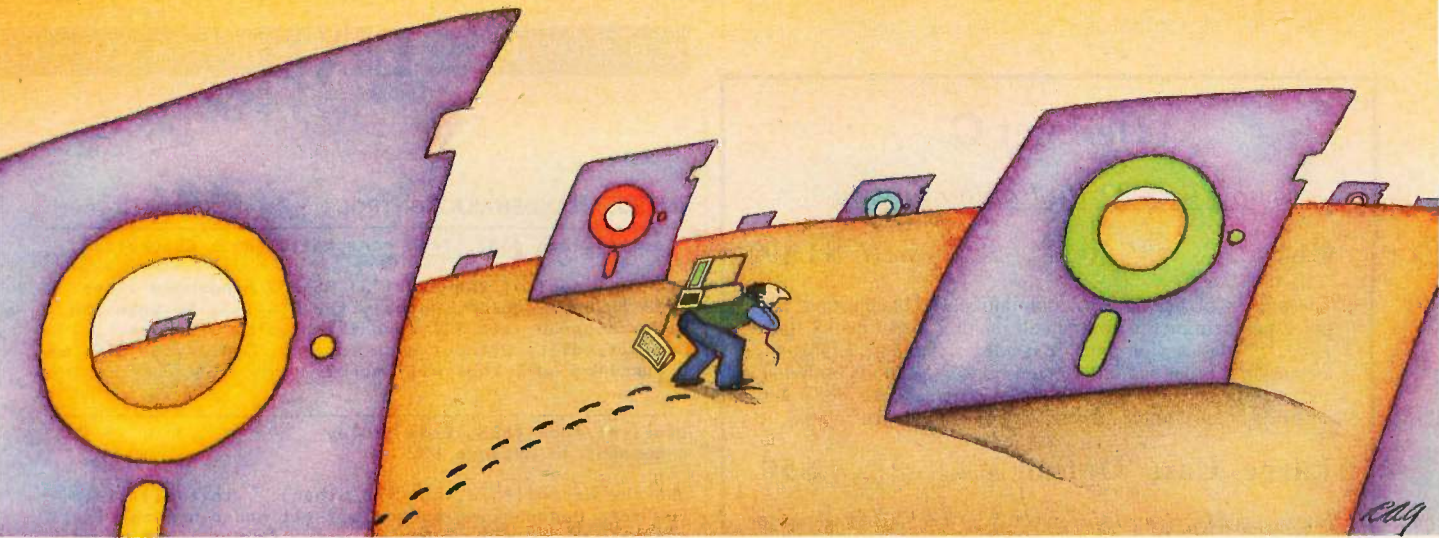

PROBLEM: There's just no easy way to move from one software program to another.

THE SOFTLOGIC SOLUTION: Software Carousel

Now you can keep up to 10 programs loaded and ready to run.

Hard to believe, but some people are happy with just one kind of PC software. Well, this is not a product for them.

But if you're someone who depends on many packages, all the time—someone who'd use several programs at once if you could, well now you can. With Software Carousel.

Why call it "Software Carousel"?

In some ways, Software Carousel works like the slide projector you're used to. You load a handful of pictures, view one at a time, then quickly switch to another. A simple idea, with powerful possibilities for computing.

Here's how it works. When you start Software Carousel, just tell it how much memory you have, load your software and go to work.

Need to crunch numbers? Switch to your spreadsheet. Need your word processor? Don't bother saving your spreadsheet file. Just whip over to your document and do your work. Snap back to your spreadsheet, and it's just like you left it.

With up to ten different programs at your fingertips, you'll have instant access to your database, communications, spelling checker, spreadsheet, word processor, RAM resident utilities, languages, anything you like.

Reach deep into expanded memory.

This could be the best reason ever for owning an expanded memory card, like the Intel Above Board, AST RAMpage, or any

card compatible with the L/1/M Extended Memory Standard.

Software Carousel puts programs into this "high-end" memory for temporary storage when they're not in use. And

switches them back out when you want them. It's fast, efficient, and easy.

If you want, Software Carousel will even use your hard drive for swapping. Just allocate a portion for storage, and go to work.

Sidekick, Superkey and Ready. All at the same time.

You know what happens if you try loading two or more RAM resi-

dent utilities at once. You get crashed keyboards, frozen screens, all kinds of interference between programs fighting for control.

With Software Carousel, you can have as many accessories and utilities on-tap as you want. Just load different ones in different Carousel partitions. Since they can't see each other, they can't fight.

The easy way to maximize PC power.

With all this power, you might think Software Carousel is complicated and difficult to use. Not so. Set it up once, and it will remember forever. Better still,

Carousel will look for the programs you use most often, and optimize them for the quickest access.

Special holiday offer – free* SoftLogic software.

As a special holiday bonus, you can get another SoftLogic Solutions product free when you buy Software Carousel and Disk Optimizer – the software that speeds up your disk by cleaning up your files.

Take your choice of either Cubit or DoubleDOS.

See the coupon below for details. But don't wait. This offer expires December 31, 1986. SoftLogic Solutions products are available at your software dealer. Or by calling SoftLogic Solutions at 800-272-9900 (603-627-9900 in NH).

	4X	8X	12X	16X
Word Star	■	■		
1-2-3	■	■	■	■
BPI	■	■	■	■

With Software Carousel running in RAM, you can load a program and retrieve a file up to 15 times faster. Test conducted on an IBM XT



Free Holiday Offer!

Buy Software Carousel and Disk Optimizer and get your choice of either Cubit – the software that packs more data onto less disk space – or DoubleDOS – the software that lets you and your computer work on two different tasks at once.

Enclose proof of purchase for Software Carousel and Disk Optimizer, both registration cards, this coupon, and \$5.00 (check or money order) for shipping and handling (UPS). Offer expires Dec. 31, 1986. Allow up to four weeks for delivery.

YES! Please send my free copy of DoubleDOS Cubit (check one)

Name _____
 Address _____
 City _____ State _____ Zip _____

SoftLogic Solutions, Inc.
 530 Chestnut Street
 Manchester, NH 03101
 (800) 272-9900
 (603-627-9900 in NH)

SOFTLOGIC SOLUTIONS

 **Software Carousel \$49^{95*} #64**

*plus \$5.00 shipping and handling.

DeSmet C

now with 32-Bit Pointer Option

C88.....still \$109

The editors' choice for fast compilation and execution. The price/performance winner in all major C benchmarks since 1983. Includes Compiler, Assembler, Binder, Librarian, Execution Profiler and Full Screen Editor. Supports both disk and memory resident Overlays. Contains both 8087 and Software floating point support. Full STDIO library.

Large Case Option.....\$50

Makes a great C Compiler even better. Adds 32-Bit Pointers to C88 so you can utilize all of your PC. Groups scalar and static data for fast access. Supports the D88 debugger.

D88.....\$50

Gain most of the benefits of an interpreter while losing none of the run-time speed of the C88 compiler. Display C source and variable contents during execution. Set breakpoints by function name or line number. Examine and set variables by name using C expressions.

order direct from:

C Ware Corporation

505 W. Olive, Suite 767, Sunnyvale, CA 94086 U.S.A.
(408) 720-9696 — Telex: 358185
We accept VISA, MasterCard & American Express

RS-232 HANDSHAKE CONTROL

atari.st/tech #802, from rchecketts (Rick Checketts)

How do I control the Atari ST RS-232 handshake lines from an application, notably the RTS line to make the modem hang-up, etc.? I have tried using Giaccess, Ongibit, etc., without much success. Can anyone give me a function call that will work?

atari.st/tech #805, from Jruley
a comment to message 802

Use the Rsconf(this,that,the_other)... this will let you turn handshaking on and off (it has a handshaking parameter) and will give you very tight control using the MFP registers. Hope that helps! --- John ---

atari.st/tech #811, from rchecketts
a comment to message 805

I have looked up Rsconf and, while I can see how to set it up to do the handshaking for you, I still cannot see how to control the lines myself. How, for instance, do I turn DTR on or off? Thank you in advance. --Rick--

atari.st/tech #812, from sgrimm
a comment to message 811

To turn DTR on:
Ongibit(0xffef);

and off:
Ongibit(0x10);

You have to #include <osbind.h>, of course.

8-BIT-TO-ST GRAPHICS

atari.st/tech #831, from stevesmith (Steve Smith)

As an avid fan of the old Atari 8-bit computers and a possible future owner of the new, I am particularly interested in the machine's graphics capabilities. I know basically that hi-res color is 640x200 with 4 colors, and that lo-res has 320x200 with 16 colors, but what else is there? Is any of the older hardware carried over, such as player/missile (sprite) graphics, etc.? Is there a 16-bit Antic display processor? How is the display memory configured? At a fixed location (like IBM) or can it be moved around anywhere in memory, like the old 800?

Please forgive all the ignorant questions, but I'm basically a video-game programmer who's been locked up in a Mess-DOS world for the last two years!

Any insightful comments would be most appreciated.

atari.st/tech #832, from bwebster (Bruce Webster, Consulting Editor, BYTE)
a comment to message 831

Steve:

I'm certainly not the most experienced ST graphics programmer (OK, guys, stop snickering), but I can probably give you the basics. No, there is no hardware assist (missile graphics, display processor) for graphics. There *are* a series of low-level graphics routines that you can call, which may save you the hassle of writing them yourself. Display memory can be configured on any 256-byte boundary and always takes up 32K. The graphics mapping is an interesting interlace approach. For hi-res (640x400x2), each bit represents one pixel on the screen, starting in the upper left corner and going across and down, i.e., the first 80

It's
Time
To

NEW SLIM DESIGN and a LIFETIME WARRANTY, . . .

Two great reasons to make the switch. Only 1/2" high, but still with the same high quality features you have come to expect from DATA SPEC Switch Boxes:

- Reinforced printed circuit boards
- Full shielding

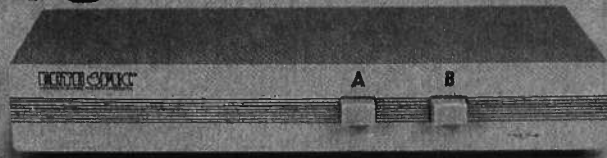

Switch
Boxes

- Durable metal construction
 - Gold-plated contacts
 - All pins switched
- And now, backed by a lifetime warranty. Visit your local DATA SPEC dealer and see our full line of slim style data switch boxes and other computer accessories.

DATA SPEC[®]
A DIVISION OF ALLIANCE RESEARCH CORPORATION

THE ULTIMATE IN COMPUTER ACCESSORIES

20120 Plummer Street • P.O. Box 4029 • Chatsworth,
CA 91313 • (818) 993-1202

In Japan: Call Data Spec Japan LTD., Tokyo, Japan, Tel. (03) 774-7741

(continued)



BALANCE OF POWER.

Introducing the new power in AT-class personal business computers. The NEC Advanced Personal Computer IV.

You're the kind of person who's very serious about personal computers. The kind of person who will never settle for just a powerful machine. Or just a compatible machine. Because you want them both. You're a Power User.

And the NEC APC IV™ is the one machine that strikes a perfect balance between compatibility and power.

Because the APC IV offers both 6 MHz and 8MHz processing speeds.

So you can run all the industry standard software. Like Lotus 1-2-3.™ dBase III.™ Multiplan.™ Windows.™ You name it.

Plus the APC IV has the power of NEC behind it. The \$10 billion leader in computers and communications. So you never have to worry about support. The new NEC APC IV. Because sooner or later, you're going to have to take it to the limit. For more information, call NEC at 1-800-343-4419 (in MA 617-264-8635). NEC Information Systems, Inc., Dept. 1610, 1414 Massachusetts Avenue, Boxborough, MA 01719.

Take it to the limit.

NEC

NEC Information Systems, Inc.

bytes represent the first row. The very first pixel (upper left) is the high-order bit of the first byte. For med-res (640x200x4), each pair of words represents 16 pixels; corresponding bits in those two words represent pixels. Confused? Well, if the screen is located at, say, \$78000, then the upper left pixel is represented by the high-order bit of the words at \$78000 and \$78002. Those two bits yield a total of four values, which are looked up using a color table. For lo-res (320x200x16), groups of four words are used; the upper left pixel is represented by the high-order bits of the words at \$78000, \$78002, \$78004, and \$78006.

..bruce..
(Did I get it right, guys? Huh? Did I? :-)) ..bfw..)

atari.st/tech #833, from jim_kent
a comment to message 831

Yes, we have no sprites, or no hardware sprites at least. There's no real equivalent of the Antic display processor. You can set up horizontal blank interrupts and do some of that stuff with the processor. Basically, the ST is just a real solid 68000 machine with 16 colors out of 512.

The display memory can be put on any 256-byte boundary. You can double-buffer. Scrolling is a little harder; in fact, you can only scroll horizontally 16 pixels at a time and vertically about 5 pixels at a time (or is it 8?). This is without moving data in memory. The 68000 will scroll vertically by moving memory at about 100 frames/sec, though.

The screen layout is "interleaved bitplanes." In 16-color mode this means that a pixel will be a bit in each of 4 consecutive words, 16 pixels in 4 words, the next 16 in the next 4 words. The color selection is 16 colors out of 512. The way this works is 8 levels each of red, green, and blue. Try to check out Neochrome and a couple of video games at a computer store.

atari.st/tech #834, from jsan (Jez San)
a comment to message 833

Jim -
How on earth do you hardware-scroll *ANY* amount on the ST!?

You say that you can scroll 16 pixels at a time, and vertical 5 pixels at a time?

I know how to do it in assembly code, but are you saying there is a hardware function that scrolls the screen!?

-- Jez.

atari.st/tech #835, from jim_kent
a comment to message 834

Jez, I am sleepy. Come to think of it you can't scroll horizontally without moving memory, and even then you can only do it quickly 16 pixels at a time. To scroll vertically you have to figure out the least common multiple (or is it greatest common denominator) of 80 (bytes per line in the screen) and 256 (the screen alignment BS) and just set the screen pointer where you want. If I hadn't been up all night I'd figure out if this was 5 pixels or not.

atari.st/tech #836, from jim_kent
a comment to message 835

Actually in a color mode it's 160 bytes/line. $8 * 160 = 1280 = 16 * 16 * 5 = 256 * 5$... so moving the screen pointer 8 lines down will also be on a 256-byte boundary, 16 lines in monochrome. Sort of course scrolling, but not much overhead. Lets see, $200 / 8 = 25$... so 25 steps to scroll off the screen. If you timed it so it took less than a second it'd probably look pretty smooth even.

atari.st/tech #837, from mpack (Don Milne)
a comment to message 835

Aw, and I hoped you were going to give me a hardware method. Is there any quick way to scroll portions of the screen (i.e., without moving every word yourself)? Restricting it to byte or word boundaries is no problem.

--Don Milne.

atari.st/tech #841, from chriskuku (Christoph Kukulies)
a comment to message 837

There is no way to scroll by hardware on the ST. You have to do it all by yourself (MOVEMs) or use the appropriate GEM or bitblt line-A functions. See earlier discussions in this topic. There is also a way to manipulate the video controller register, but I haven't gone happy with that. You cannot scroll portions by this means and screen wraps are difficult to handle. I've written a VT100 emulator that also emulates the single- and double-width characters, three different fonts (one copied directly from the VT100-character ROM), and I did all scrolling, full screen and partial (in windows), by hand, by using assembler mixed with GEM, line-A and AES functions. The resulting scrolling in the windows still doesn't look overwhelming, so I wished we had a hardware scroll, too.
Chris

atari.st/tech #866, from dmichael (DeCorte Michael)
a comment to message 831

If you are into games, wait a little while until a bigger selection comes out. By then the prices may come down some more and there will be a bigger selection from programmers that have had the benefit of hacking on the ST for a year or two and can teach it to do some really nice things. (To see what I mean take a look at the old Atari 800 games, then look at the newer ones. There is a big difference, right? It comes from hacking a long time on a computer.)

atari.st/tech #869, from jimomura (Jim Omura)
a comment to message 866

We!!!!. It also comes from the fact that memory got cheaper so more people started to buy bigger computers. Some of the early stuff for many of the early home computers were actually quite amazing when you look at them in detail. Just a couple of examples that I don't feel have *ever* been surpassed within the confines of the hardware they were designed for are the original Star Raiders, Tandy's Skiing for the Color Computer, and Tandy's DinoWars, also for the earliest Color Computer.

IBM PC AND COMPATIBLES

The IBM section begins with an unusual problem: A user finds that his IBM isn't compatible with his clones! BIXen quickly come to his rescue. The section continues with a look at the issue of "parking" the heads of hard disks. An assembly language program for parking heads, with instructions on compiling it from Debug, is included.

THE CLONE WARS

ibm.pc/hardware #1137, from jsprowl (Jim Sprowl)

I ran into an interesting headache today. A program that has been running happily for several weeks on

(continued)

LOGITECH MODULA-2/86 HOLIDAY PACKAGE



\$89 Price

\$199 Special Holiday Offer

- Separate Compilation
- Native Code Generation
- Large Memory Model Support
- Multitasking
- Powerful Debugging Tools
- Comprehensive Module Library
- Available for the PC and the VAX

Use LOGITECH MODULA-2/86 to decrease your overall development cycle and produce more reliable, more maintainable code.

Step up to the power of LOGITECH MODULA-2/86 at a saving of nearly \$100 off our usual low prices! We're offering a complete tool set including our compiler with 8087 support (for use with or without an 8087), our Turbo to Modula-2/86 Translator, Run Time Debugger, and Utilities in one holiday package at a special price!

WINDOW PACKAGE \$49

Build windows into your programs. Features virtual screens, color support, overlapping windows and a variety of borders.

MAKE UTILITY \$29

Figures out dependencies and automatically selects modules affected by code changes to minimize recompilation and relinking.

CROSS RUN TIME Debugger and ROM Package \$199

Still available at an introductory price!

TURBO PASCAL to MODULA-2 TRANSLATOR \$49

"Turbo Pascal... is a very good system. But don't make the mistake of trying to use it for large programs."

*Niklaus Wirth**

Our Translator makes it even easier for Turbo users to step up to Modula-2/86. It changes your Turbo source code into Modula-2/86 source, solves all the incompatibilities, and translates the function calls of Turbo into Modula-2/86 procedures. Implements the complete Turbo libraries!

Call for information about our VAX/VMS version, Site License, University Discounts, Dealer & Distributor pricing.

30 Day Money Back Guarantee!
To place an order call our special toll free number:

800-231-7717
in California
800-552-8885

LOGITECH MODULA-2/86 \$89

Includes Editor, Run Time System, Linker, 8087 Software Emulation, Binary Coded Decimal (BCD) Module, Logitech's comprehensive library, Utility to generate standard .EXE files. AND more!

LOGITECH MODULA-2/86 with 8087 Support \$129

LOGITECH MODULA-2/86 PLUS \$189

For machines with 512K of RAM. Increases compilation speed by 50%.

RUN TIME DEBUGGER (Source level!) \$69

The ultimate professional's tool! Display source, data, call chain and raw memory. Set break points, variables, pinpoint bugs in your source!

UTILITIES PACKAGE \$49

Features a Post-Mortem Debugger (PMD). If your program crashes at run-time the PMD allows you to analyze the status of the program and locate the error. Also includes a Disassembler, Cross Reference Utility, and Version that allows conditional compilation.

LIBRARY SOURCES \$99

Source code now available for customization or exemplification. Inquiry 193

YES I want to step up to LOGITECH MODULA-2/86!

Here's the configuration I'd like:

- Special Holiday Package \$199
- Logitech Modula-2/86 \$89
 - with 8087 support \$129
 - Plus Package \$189
- Turbo to Modula Translator \$49
- Run Time Debugger \$69
- Utilities Package \$49
- Library Sources \$99
- Window Package \$49
- Make Utility \$29
- ROM Package \$199

Add \$6.50 for shipping and handling. Calif. residents add applicable sales tax. Prices valid in U.S. only.

Total Enclosed \$ _____

Visa MasterCard Check Enclosed

Card Number _____ Expiration Date _____

Signature _____

Name _____

Address _____

City _____ State _____ Zip _____

Phone _____



Logitech, Inc.
805 Veterans Blvd.
Redwood City, CA 94063
Tel: 415-365-9852

In Europe:
Logitech SA, Switzerland
Tel: 41-21-879656

In Italy: Tel: 39-2-215-5622

*as reported in Micro Cornucopia, August-September 1985. Turbo Pascal is a registered trademark of Borland International.

Compaqs (8088 and 80286 models) and Zeniths (Z-151s and Z-158s) suddenly bombed at one point when tested on an IBM PC XT. The program accesses the screen exclusively through ROM BIOS interrupt 10h, doing such things as positioning the cursor, writing character + attribute, scrolling, and clearing windows (by using scroll and setting the number of lines to zero). Are there any "traps for the unwary" in INT 10h that might be tripping me up on the true-blue product but permitting me to run on the clones? I shall be tackling this one on Friday, and would welcome any suggestions.

ibm.pc/hardware #1138, from dmick (Dan Mick)
a comment to message 1137

One that comes to mind quickly, Jim, is the hardware scrolling of the Zeniths; but I don't know if the Compaqs do that or handle it gracefully or what. Make sure the "set scroll mode" isn't called, is all I can say (AH=100), though the IBM BIOS looks like it'd just ignore that call. Otherwise you got me.

ibm.pc/hardware #1141, from dondumitru (Donald Dumitru)
a comment to message 1137

It seems to me that there was a problem with the BIOS scroll function trashing the BP register. I haven't run into it personally 'cause I use Fansi-Console (which completely replaces the BIOS video functions). It should be easy to verify whether BP gets trashed or not from the BIOS listing in the Tech Ref.

Donald

ibm.pc/hardware #1145, from jsprowl
a comment to message 1141

>INT 10h problems on IBM PC
So scroll may clobber BP, eh? That is where C instructs me to save a pointer to the stack that is restored as the stack pointer after an assembly language program runs. That could very well be the problem. Thanks for the tip. I shall begin by checking for a clobbered BP register whenever the "scroll the window clear" function is called.

ibm.pc/hardware #1146, from dondumitru
a comment to message 1145

If you will look in the Tech Ref BIOS listing (for the older XT), you will see around line 3356 a bunch of pushes to save registers (BP being noticeably absent). Then around line 3858 (in a procedure that gets called by both scroll_up and scroll_down) you see BP getting stuffed with something useful (which gets used when the procedure returns to its caller). Nowhere is BP saved (or restored) by the scroll_up and scroll_down routines.

Oops.

Donald

P.S. This is particularly insidious because high-level languages almost always use BP to keep track of variables on the stack. If you trash BP, it will point to a "random" place in your stack segment. Just think how long it could take to figure out what's going on...

ibm.pc/hardware #1151, from dmick
a comment to message 1146

Yeah, I'd heard of this. Someone (perhaps even on BIX) wrote a little routine to intercept INT 10h and save BP locally, then pass on the call. Was that you, Don? Good idea for IBMs, anyway, it would seem, in particular if you're using some kind of driver anyway. I wonder if ANSI.SYS contains a BP save to isolate me from problems? I've used ANSI on the XTs almost since we unpacked them..

ibm.pc/hardware #1155, from jsprowl
a comment to message 1146

>BP clobbered by IBM PC INT 10h bug
Sure enough -- that was the problem. Today I simply went through all the assembly language listings and searched for all calls to "int 10h." I simply inserted "push bp" ahead of "int 10h" and inserted "pop bp" following "int 10h" everywhere, and my IBM PC and XT problems disappeared completely.

This one "tip," which probably saved me 4 to 6 hours of debugging and testing, has more than paid me back for all the time I have spent helping others on BIX. I am really grateful for this assistance. Thanks to all of you.

(continued)

EPROM PRODUCTION EFFICIENCY: \$995.00

14 DAY FREE TRIAL
OFFER



GANGPRO-8 - meets time-critical production needs. This upgraded unit simultaneously programs eight EE/EPROMs with speed, reliability, and accuracy. Non-technical personnel can efficiently learn to operate GANGPRO-8 within 30 minutes.

- Programs 2716-27512, 27513 (incl. A versions), 68764 & 87C64/128
- Verifies at 4.75, 5.00, and 5.25 VCC margins
- Isolates and displays the location of any failures

- Fast, intelligent algorithms
 - RS232 option for up/download to any computer/ includes IBM PC software
- Compare features, compare price; then make the Logical choice.

IT'S LOGICAL

For details, write or call:
1321 NW 65th Place
Fort Lauderdale, FL 33309;
(305) 974-0967;
toll free 800-331-PROM
TELEX 383142

LOGICAL DEVICES INC.

LOGIMOUSE HOLIDAY GRAPHICS PACKAGE

\$99

LOGIMOUSE C7



\$219

NEW LOGIPAIN-&-DRAW

To place a credit card order call our special toll-free number:

800-231-7717

Call toll-free in California:

800-552-8885

Just for the holidays we've wrapped up LOGIMOUSE and its Plus Software with Generic CADD and PC Paintbrush into the graphics package of the year. LOGIPAIN-&-DRAW is the complete graphics toolkit for combining freehand and technical drawing.



LOGICADD—Generic CADD 2.0 and Dot Plot

Generic CADD is the sensational, new CADD package that offers the features and performance of high-priced at an unbelievably low price. The package also includes DotPlot, the add-on utility that turns your dot matrix printer into a plotter.

Use LOGIPAIN-&-DRAW to design your holiday greeting, enhance your spreadsheets, graphs and memos, or create and personalize a map or mechanical. Just create your CADD drawing, import it into PC Paintbrush, and embellish it with paint sketches and fancy fonts.

At a saving of almost \$50 off our usual low prices, LOGIPAIN-&-DRAW is a holiday package you can't afford to pass up.

LOGIPAIN—PC Paintbrush

PC Paintbrush is the most advanced paint set available for the PC. It's the preferred choice of professional users, but with its icon menus for both graphics and text it's easy and fun for beginners as well. It offers complete graphic capabilities as well as 11 type fonts and a palette of 16 colors.



LOGIPAIN-&-DRAW includes:

LOGIMOUSE C7 with Plus Software

LOGIMOUSE is the high resolution (200-dot-per-inch) mouse that is ideal for CADD and paint. It connects directly to the serial port of any IBM PC/XT/AT or compatible, with no pad or external power supply required. The Plus Package is our top-of-the-line mouse software featuring a pop-up menu system, an automatic mouse configurator, a unique mouse interface for Lotus 1-2-3, and a mouse based text editor.

LOGIMOUSE \$199 with Borland's Reflex

Reflex, Borland's amazing database management program, flies with LOGIMOUSE! We offer Reflex with LOGIMOUSE and the Plus Package Software at a very special price!

YES I want to add the power of LOGIMOUSE to my holidays!

- LOGIPAIN-&-DRAW **\$219**
- LOGIMOUSE w/Driver 3.0 **\$99**
- LOGIMOUSE w/Plus Software **\$119**
- LOGICADD w/Logimouse & Plus Software **\$189**
- LOGIPAIN w/Logimouse & Plus Software **\$169**
- REFLEX w/Logimouse & Plus Software **\$199**

For my computer model: _____
 30-Day Money-Back Guarantee
 VISA MasterCard Check Enclosed
 Add \$6.50 for shipping and handling. Calif. residents add applicable sales tax. Prices valid in U.S. only.

Card Number _____ Expiration Date _____

Signature _____

Name _____

Address _____

City _____ State _____ Zip _____

Phone _____

DEALER INQUIRIES WELCOME



Logitech, Inc.
 805 Veterans Blvd.
 Redwood City, CA 94063
 Tel: 415-365-9852

In Europe:
 Logitech SA, Switzerland
 Tel: 41-21-879656

In Italy: Tel: 39-2-215-5622

Inquiry 194

LOGIMOUSE is a registered trademark of LOGITECH. Lotus and 1-2-3 are trademarks of Lotus Development Corp. Reflex is a trademark of Borland-Analytica. Generic CADD is a trademark of Generic Software, Inc. PC Paintbrush is a registered trademark of ZSoft Corp.

PC/VI

Full Screen Editor for MS-DOS (PC-DOS)

Looking for an Ultra-Powerful Full-Screen editor for your MS-DOS or PC-DOS system? Are you looking for an editor FULLY COMPATIBLE with the UNIX*VI editor? Are you looking for an editor which not only runs on IBM-PC's and compatibles, but ANY MS-DOS system? Are you looking for an editor which provides power and flexibility for both programming and text editing? If you are, then look no further because **PC/VI IS HERE!**

The following is only a hint of the power behind **PC/VI**: English-like syntax in command mode, mnemonic control sequences in visual mode; full undo capability; deletions, changes and cursor positioning on character, word, line, sentence, paragraph or global basis; editing of files larger than available memory; powerful pattern matching capability for searches and substitutions; location marking; joining multiple lines; auto-indentation; word abbreviations and MUCH, MUCH MORE!

The **PC/VI** editor is available for IBM-PC's and generic MS-DOS based systems for only \$149. For more information call or write:

Custom Software Systems
P.O. Box 678
Natick, MA 01760
617-653-2555

The UNIX community has been using the VI editor for years. Now you can run an implementation of the same editor under MS-DOS. Don't miss out on the power of **PC/VI!**

*UNIX is a trademark of AT&T Bell Laboratories.

A PARKING PROBLEM

ibm.pc/drives #367, from amaib (Andy Maib)

I was under the impression that the Seagate ST225 parked the heads properly on power-down and that this would not be a problem. Am I correct? If not, what would be a good way to park the heads before the system is turned off?

Thanks.
Andy

ibm.pc/drives #368, from barryn (Barry Nance)
a comment to message 367

Andy, the following assembler program will park the head of drive "C." You can enter it via Debug (do you need the procedure?) or you can assemble it with MASM.

```

;
; copyright (c) 1985 Barry Nance
;
code    segment para
        assume cs:code, ds:code
        org    100h           ;will be a .com file via
                                ;exe2bin

parkit  proc    far
;
start:  mov     ax, 1100h ;ah 11 = recalibrate
        mov     dx, 0080h ;select first hard drive
        int     13h      ;do the recalibration
        mov     ax, 0800h ;ah 08 = get disk parms into
                                ;CX/DX

        int     13h
        mov     ax, 0C00h ;ah 0C = seek
        mov     dx, 0080h ;select first hard drive
                                ;CX still contains max cyl,
                                ;max sector from get-disk
                                ;-parms
        int     13h      ;do the seek
        int     20h      ;all done...exit
;
parkit  endp
code    ends
        end    start
    
```

ibm.pc/drives #369, from mhaas (Mark Haas)
a comment to message 367

You might also try TIMEPARK.COM in the archive file called HAASUTIL.ARC in the IBM.ARC section of Listings. It'll park your drive's head automatically after a specified number of minutes (i.e., TIMEPARK 5 takes 5 minutes) of inactivity.

ibm.pc/drives #370, from petewhite (Pete White)
a comment to message 367

There are numerous programs available to park the heads on an ST225. If you have a problem, BIXmail me and I'll send you a few. What system? (Say "Leading Edge.")

ibm.pc/drives #371, from petewhite:
a comment to message 369

Just be a bit careful on TIMEPARK. It says it doesn't interfere, but it could cost you keystrokes in certain applications if the timing is right. But use it with "TIMEPARK 1" and wait a minute. I like barryn's better.

ibm.pc/drives #372, from bbrown (Bob Brown)
a comment to message 370

Pete, I'd be interested in a discourse on head parking, in theory and in practice, as it applies to the ST225. My early experience is with mainframe-type drives, which unload the heads (i.e., move them completely off the disk surface and out of the way) when power is

(continued)

NOVAS BEYOND IBM COMPATIBILITY MORE POWER PLUS RELIABILITY

NOVAS TURBO 286 MOTHERBOARD

- Fewer ICs For Greater Reliability— Only 36 Compared to IBM's 131
- Dual Speeds—6 & 8 MHz—Keyboard or Jumper Selectable (10 MHz opt.)
- 4 Serial and 1 Parallel Ports On Board Option
- Expandable to 1 Megabyte RAM
- Complete with Setup Program
- AWARD BIOS
- Socket for 80287
- Rechargeable Battery On Board for Clock
- 0, 1 Wait State. Jumper Selectable. Hardware reset port.

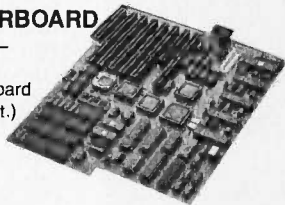

\$495 OEM

NOVAS 1000 EGA BOARD

- Supports EGA, CGA, MDA
- 640 x 350 Pixels EGA
- 640 x 200 Pixels Color
- 320 x 200 Pixels Color
- 720 x 350 Pixels Monochrome
- Parallel Port on Board
- 256K RAM on Board



\$195 OEM

NOVAS TURBO 286 10 MHz SYSTEM..... \$1395

Includes: 640K, 8/10 MHz Turbo Speed, 1 S/1 P, 1.2 Meg. Dr., W. D. Controller

NOW AVAILABLE: XT SIZE

NOVAS TURBO 286 MOTHERBOARD

Quantity: 1-\$495; 2-5-\$435; 6-10-\$425;
11-25-\$395; 26-up-\$390.

W. D. Controller for AT ... \$180 192 W Power Supply .. \$95
AT look-alike Case \$75 Keyboard for AT \$65

COMPUTRADE COMPANY

780 Trimble Road, Suite 605 Tel: (408) 435-2662
San Jose, CA 95131 Fax: (408) 435-5458

* IBM & AT are trademarks of International Business Machines Corp.

New GPS Series: Tek sets the pace with SmartCursors™ and push-button ease.

Work faster, smarter, with two new general purpose scopes from Tektronix. The four-channel, 100 MHz 2246 and 2245 set the new, fast pace for measurements at the bench or in the field. They're easy to use and afford, by design.

On top: the 2246 with exclusive integrated push-button measurements. Measurements are accessed through easy, pop-up menus and implemented at the touch of a button. Measure peak volts, peak-to-peak, \pm peak, dc volts and gated volts with new hands-off convenience and on-screen readout of values.

SmartCursors™ track voltmeter measurements in the 2246 and visually indicate where ground and trigger levels are located. Or use cursors in the manual mode for immediate, effortless measurement of waveform parameters.

Both scopes build on performance you haven't seen at the bandwidth or prices. Lab grade features include sweep speeds to 2 ns/div. Vertical sensitivity of 2 mV/div at full bandwidth for low-level signal capture. Plus trigger

Features	2246	2245
Bandwidth	100 MHz	100 MHz
No. of Channels	4	4
Scale Factor Readout	Yes	Yes
SmartCursors™	Yes	No
Volts Cursors	Yes	No
Time Cursors	Yes	No
Voltmeter	Yes	No
Vertical Sensitivity	2 mV/div	2 mV/div
Max. Sweep Speed	2 ns/div	2 ns/div
Vert/Hor Accuracy	2%	2%
Trigger Modes	Auto Level, Auto, Norm, TV Field, TV Line, Single Sweep	
Trigger Level Readout	Yes	No
Weight	6.1 kg	6.1 kg
Warranty	3-year on parts and labor including CRT	
Price	\$2400	\$1875

sensitivity to 0.25 div at 50 MHz, to 0.5 div at 150 MHz.

Accuracy is excellent: 2% at vertical, 2% at horizontal. And four-channel capability includes two channels optimized for logic signals.

Best of all, high performance comes with unmatched convenience. You can see it and feel it — in the

responsive controls and simple front-panel design, in extensive on-screen scale factor readouts, and in simplified trigger operation that includes Tek's Auto Level mode for automatic triggering on any signal. Start to finish, the GPS Series saves steps and simplifies tasks.

Get out in front! Call toll-free today to order, to get more details or a videotape demonstration.

1-800-433-2323

In Oregon, call collect 1-627-9000

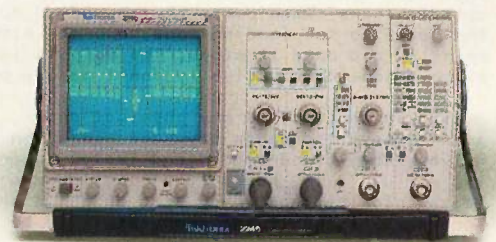
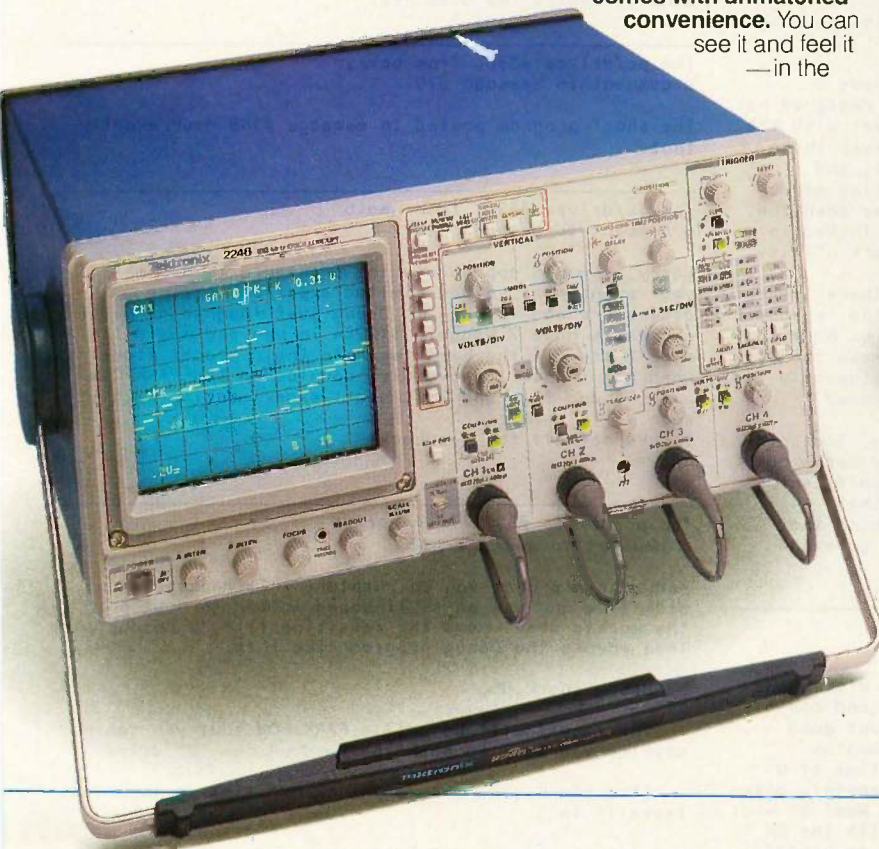

Featuring four channels, flexible triggering, extensive CRT readouts and push-button ease of use, the new Tek 2246 (left) and 2245 (above) bring high-quality, low-cost analysis to diverse applications in digital design, field service and manufacturing.

Tektronix
COMMITTED TO EXCELLENCE

Inquiry 356

removed. I think there are micro-sized hard disks that do this, too, but I think the ST225 isn't one of them.

As I understand "parking," it means moving the head assembly to a "landing area" on the disk so that when power is removed, the heads touch down there instead of wherever they happened to be. Does the ST225 have a dedicated landing area? If not, isn't it better to let the heads land in a random (more or less) place instead of in the same track every time?

ibm.pc/drives #374, from petewhite
a comment to message 372

There is a dedicated parking area. Leading Edge has a "park" program that handles several drives (believe it or not, "color coded" by a dot on the rear of the system). But they also had the "park" capability when they had the older systems, which were almost exclusively Seagate. Seems I remember seeing a "Debug" park command also. But let's not get too carried away with parking heads; it's usually necessary only when you're going to move a drive or move the system where it might get a bump. The "voice coil" drives park themselves on power-off, some by backing the heads to a platform so the heads NEVER come near the platter (and let's not play with the definition of "near"). I make it a habit to park the heads on two of my systems all the time as they are the ones most likely to be ripped apart at a moment's notice to test a board that "dropped by." I don't like the "did I or didn't I?" feeling when I have to backhand the sucker to get the cover off!

ibm.pc/drives #375, from skluger (Sigi Kluger, Definicon Systems Inc.)

Just thought I'd add my 5 cents' worth to the parking subject (insert nickel, turn knob).

Most low-cost Winchester drives do not have a landing zone or head retractors. They were designed not to get damaged when the head comes in contact with the surface due to power-down. High-quality drives these days have automatic head retractors, brakes, and spindle locks. When power is removed, a spring moves the heads to the landing zone, a brake slows down the spindle, and once it stops, the spindle is locked in place. Those drives clearly don't need a park utility.

If you don't cause any physical shock, there is no need to move the heads anywhere since, on the "cheaper" drives, they are designed and tested to do no harm to the media. It is, however, a good idea to move the heads into the least-used area on the disk (usually the innermost track) if the computer is to be moved.

As far as TIMEPARK and such utilities go, I'd rather see them all 'mv'ed to /dev/null since they serve no practical purpose other than to cause a significant delay in access time after they have done their evil deed. Harmless or not, I'd be wary of anything that installs itself in RAM and once in a while goes and moves the heads.

ibm.pc/drives #376, from mhaas
a comment to message 375

I think there may be some merit to parking disk heads if you leave your computer on all the time and don't want to worry about power glitches wiping out good data. I have been using TIMEPARK for many months without problems. I set it to the maximum time of 9 minutes. That way, if I'm doing anything remotely disk-intensive, it doesn't degrade performance. Most of what I do is not disk-intensive, even less so with the 2K buffer on the controller, so it's nice not to have to

remember to move the heads manually every time I get up from the machine.

ibm.pc/drives #377, from mhaas
a comment to message 376

Let me clarify one thing about TIMEPARK. It parks the heads after n minutes of inactivity. Thus, TIMEPARK 9 will park the heads after 9 minutes of no accesses. If you haven't accessed your disk in 9 minutes, then the short delay to "unpark" the heads should not matter to you. If you do access the disk more often than once in 9 minutes, the heads will never park and you will not be inconvenienced.

ibm.pc/drives #378, from nickbaran (Nick Baran)
a comment to message 375

I know that the parking program I use with my Microscience 20-Mb drives parks the head on cylinder 639, which is the next-to-last cylinder on the inside track. The problem with generic parking programs is whether they can tell which track number is the inside track since this varies with different disk drive models. For example, the first program I used was parking my heads on track 305, which is fine if you have a 10-Mb drive but is right smack in the middle of my 20-Mb drive.

ibm.pc/drives #379, from geary (Michael Geary)
a comment to message 378

A park program that doesn't check the disk size is just sloppy programming. All it has to do is issue the "Request Drive Parameters" BIOS call and find out how many cylinders the disk has!

ibm.pc/drives #380, from barryn
a comment to message 379

The short program posted in message #368 does exactly that.

ibm.pc/drives #390, from amaib
a comment to message 368

Barry, I would appreciate the procedure to assemble your program. I've had limited experience using assemblers and the one in Debug just laughed at me. I currently have 7 Seagate ST225s in use and would feel much better if the heads were in their proper place when not in use. I have also downloaded TIMEPARK.COM and the doc file and will start experimenting with it soon.
Thanks for all the feedback!
Andy

ibm.pc/drives #392, from barryn
a comment to message 390

Andy, here's what you do. Capture this message as a disk file and use an ASCII-based editor to "cut out" the marked area. Name the resulting file "park.dbg". Then invoke the Debug program like this:

```
debug <park.dbg
```

The result will be a file PARK.COM that you can run anytime you want to park the head on the "C" drive.

(The blank line before the "R CX" line is important; leave it in.)

```
----- cut here -----  
N PARK.COM
```

(continued)

We Put More Printers In Business Than Anyone Else.

High Resolution 24-Pin Printer Sales, 1982-1985

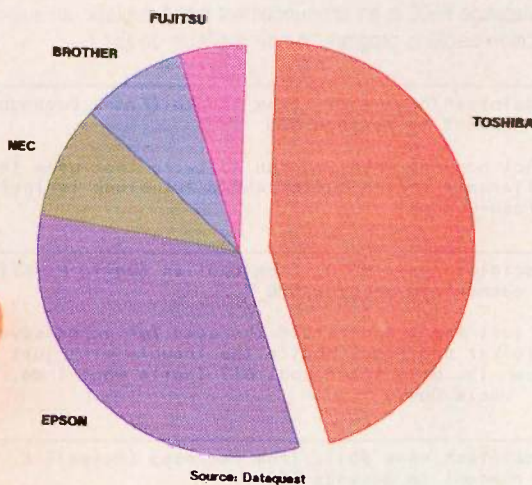

Sales of 24-pin dot matrix printers have increased substantially over the past several years. Dot matrix printers account for over 60 per cent of the total printer industry sales. TOSHIBA has the largest percentage of all the industry's 24-pin print head printer sales.

There are more Toshiba 24-pin dot matrix printers installed in major corporations, as well as in medium and small companies, than any other brand.*

More than Epson¹ More than NEC²
More than Brother³ More than Fujitsu⁴
That's because Toshiba gives you more.

Our P351's printhead, for instance, lasts up to four times longer than anyone else's.



The P351



The P351C (used to print sample shown)

And during its long life it will give you letter quality printing at 100 CPS, drafts at 288 CPS and picture-perfect dot-addressable graphics.

The P351 emulates Qume Sprint 11⁵ and IBM Graphics⁶ and most major software packages utilize its expanded command set. Plus, you can add over 40 downloadable type fonts on both disks and plug-in cartridges.

The P351 is compatible with the IBM PC⁷ family and goes about doing its job in the quietest manner possible.

If you need color graphics capability, there's the new P351C. The 24-pin printhead we pioneered and perfected produces high-resolution presentation graphics on paper for reports and on transparencies for projection.

The P351C will also create multicolor transparencies for all software compatible with the IBM Color Printer⁸ and can output graphics from Microsoft Chart⁹.

So when it comes time to select a printer for your office, why not consider the Toshiba P351 or the new P351C. They're both good for business.

For the name of the Toshiba dealer nearest you, call 1-800-457-7777.

*Installed base figures from Dataquest. 1. Epson is a registered trademark of Epson Corporation. 2. NEC is a registered trademark of Nippon Electric Corporation. 3. Brother is a registered trademark of Brother International Corporation. 4. Fujitsu is a registered trademark of Fujitsu America, Inc. 5. Qume 11 is a registered trademark of Qume Corporation. 6, 7, 8. IBM Graphics, IBM PC and IBM Color Printer are registered trademarks of International Business Machines Corporation. 9. Microsoft Chart is a registered trademark of Microsoft Corporation.

In Touch with Tomorrow
TOSHIBA

Toshiba America, Inc., Information Systems Division
Inquiry 363

```
A 100
mov ax,1100
mov dx,0080
int 13
mov ax,0800
int 13
mov ax,0C00
mov dx,0080
int 13
int 20
```

```
R CX
64
W
Q
```

----- cut here -----

ibm.pc/drives #393, from cdanderson (C. David Anderson) a comment to message 392

Can this program be made to park the "D" drive as well?

ibm.pc/drives #394, from barryn a comment to message 393

Sure. For a "D" drive parker (I've named it "PARK-D.COM" below), just give the following Automatic Response File to Debug, as outlined in message 392:

----- cut here -----

```
N PARK-D.COM
A 100
mov ax,1100
mov dx,0081
int 13
mov ax,0800
int 13
mov ax,0C00
mov dx,0081
int 13
int 20
```

```
R CX
64
W
Q
```

----- cut here -----

ibm.pc/drives #395, from cdanderson a comment to message 394

Thanks very much. Two questions. First, why does it take so much longer to execute the second time you invoke the program (1 second vs. 10 seconds). Second (I may be pressing my luck), can one version do both drives at once?

ibm.pc/drives #396, from barryn a comment to message 395

1. It takes so long because the program does a "recalibrate" operation before actually sending the heads out to the last cylinder. Sometimes it's necessary to do the recalibrate; sometimes not. It's safer to leave it in.

2. Sure, one program could park the heads of all the drives. In fact, one of the drive parameters returned (the second call to Interrupt 13) is the "number of consecutive acknowledging drives attached..." So adding a little code to the program would make it work for any number of drives. (It already works for any size drive, (10 Meg, 20, or whatever.) It always sends the heads to

the last cylinder, regardless of how many cylinders are on the device.)

THE MACINTOSH/ APPLE II

The Macintosh/Apple II window opens with a discussion of the effects (and desirability) of screen-blanking programs for the Macintosh. Moving into the Apple II world, the BI command parser and a problem with MouseWrite are discussed. Finally, there is a brief tutorial on communications programming.

SCREENBLANKERS

[Message #506 is an announcement that Autoblack, an automatic screen-blanking program, is now available on BIX.]

macintosh/news #507, from frankb (Frank Boosman) a comment to message 506

What happens when you run software that uses the alternate screen buffer while Autoblack is installed? Crash-0-Rama?

macintosh/news #510, from dpallen (David P. Allen) a comment to message 506

I just don't understand the need for screensaver/blanker programs. What's the trouble with just turning down the brightness control? That's what I do. Uncle David

macintosh/news #511, from rschnapp (Russell L. Schnapp) a comment to message 510

The same reason we have spring-closed doors: Why should you have to remember to do it? The computer can figure out when to blank the screen quite nicely. I've used a screen blanker on my (shudder) PC clone for years. ...Russ

macintosh/news #512, from tom_thompson (Tom Thompson, Technical Editor, BYTE) a comment to message 510

What happens is this: I'm working away at my Mac when someone needs some tech help (usually a MacBinary download or something). I go help them, and someone jumps me about a desk accessory. That leads to someone I need to check a tech ref with on a manuscript, and... I've been away from the Mac for one-half to two hours. I had not planned to be away that long! No matter: the Mac's taken care of itself by neatly blacking away five minutes of activity. That's what screensavers are for. ---tom

macintosh/news #513, from tom_thompson a comment to message 507

I don't know. Only thing I know that uses the alternate buffer is Megaroids. I'll try it out and see. (Hey guys, I use my Mac for serious work! :-)) ---tom_thompson

macintosh/news #514, from dpallen a comment to message 512

(continued)

NOW YOUR DEALER CAN BEAT THE MAIL-ORDER HOUSES!

WITH PRICE, QUALITY, SERVICE, FEATURES —

INTRODUCING THE **MITAC 160T** "TURBO XT"

\$599 SUGGESTED RETAIL PRICE

WITH INCREDIBLE FEATURES

- 640K RAM—INSTALLED
- REAL TIME CLOCK with battery backup
- 4.77/8 MHz, software switchable
- FLOPPY DRIVE CONTROLLER ON BOARD (So you save a slot!)
- 360K FLOPPY DRIVE
- IBM PC/XT COMPATIBLE
- 8088-2 PROCESSOR
- 8087-2 COPROCESSOR SOCKET
- MS-DOS 3.2
- PHOENIX BIOS
- 16K ROM, expandable to 64K
- 4-CHANNEL DMA
- DETACHABLE 84-KEY "AT" STYLE KEYBOARD

Mitac has been building quality computers for some pretty famous computer companies for years. Now we're ready to build one for you!



HERE'S EGA COLOR AND MUCHO MEGABYTES! ENHANCED 160T "TURBO"

IN ADDITION TO ALL THE FEATURES IN THE TURBO ABOVE, YOU GET ALL THIS:

- PRINTER I/O PORT
- EGA BOARD
- EGA COLOR MONITOR
- 20 MB HARD DISK W/ CONTROLLER
- REAL-TIME CLOCK W/ BATTERY BACKUP

\$2199 Suggested retail

mitac

When reliability is a decisive factor

American Mitac Corp. 3385 Viso Court, Santa Clara, CA 95054. Phone (800) 321-8344 (408) 988-0258 in California.

Mitac International Corp. 585 Ming Sheng East Road, Taipei, Taiwan, R.O.C. Phone: (02) 501-8231; 501-2679. Telex: 20261 MECTAC, 11942 TAIAUTO; FAX: 886-2-501-4265.

IBM, PC/XT and EGA are registered trademarks of International Business Machines Corporation. MS-DOS is a trademark of Microsoft Inc. Phoenix is a trademark of Phoenix Technologies Ltd.

My observation is that the fear of screen burn is vastly overblown, especially in black and white. I can remember, when I first got into this business thirty years ago, that the old Vidicon film chain would sit there for hour after hour on the same I.D. slide. We would comment how amazing it was that it did not burn in ... not in the monitor screen, but on the target of the Vidicon. We were real used to the sticky image Orthicon, which would burn in very badly in only a few seconds on a high-contrast scene. But I never recall ever seeing any significant after-image retention on a Telecine monitor.

I sometimes go off and leave the Mac on the same image for hours and have yet to see any sign of after-image. In the old days if you had after-image it was generally from the pick-up tube and not the monitor screen. The remedy was to defocus the camera on a high-brightness flat field for a couple hours. That would generally erase the image.

I am not denying raster burn on a picture tube; however, that takes years to produce and results from a general deterioration of the picture tube phosphor.
Uncle David

macintosh/news #515, from dwiner (Dave Winer, Living Videotext Inc.)
a comment to message 514.

But monochrome PC screens are a different story. I have a PC that had ThinkTank left on so many nights that the two white bars at the bottom of the screen have become permanent. Now we just keep the monitor on a BBS machine and leave it turned off most of the time.

I've gotten into the habit of turning off monitors at night before I leave, but, like you, I don't worry about it during the day.

macintosh/news #516, from ccrawford (Chris Crawford)
a comment to message 514

My Lisa, which has automatic screen-dim as part of the hardware, clearly shows the menu bar for the editor when in other programs. My original Mac also shows the Apple, "File," and "Edit" items from the standard menu bar in just about every application that doesn't otherwise cover that section of the screen.

Of course, the mere fact that such burn is visible does not make it a problem.

PRODOS BI COMMAND PARSER

apple/software #302, from jtierney (John Tierney)

I have been trying to use the BI (BASIC Interpreter) from machine language and have run into a problem I can't explain. For example, let's say I want to do a catalog from assembly thru the BI. These are the steps that I thought I should follow:

1. Put the command 'CATALOG'+\$8D in the input buffer (\$200)
2. JSR to BI command parse (\$BE03)
3. Check \$BE0F for error (00 = no error)
4. CLC and RTS

The steps outlined above do actually produce a catalog but then I get a "Syntax Error" (sometimes two). Is there something else I must do before RTS? \$BE0F is returning \$00, so the error is after the routine is finished. Anybody have any insight on this problem?
John

apple/software #303, from mdavis (Morgan Davis)
a comment to message 302

I was going to plop onto my II+ to try out what you explained. I've done that exact same thing before, and successfully. But I did it from a BASIC program. Something like this:

```
CMD$ = "CATALOG"
BE03 = 48643
FOR I = 1 TO LEN(CMD$)
POKE 511+I,ASC( MID$(CMD$,I))
NEXT
POKE 511+I,13           ;REM put C/R in there at end
CALL BE03
```

It worked just fine. The "Syntax Error" that you get is telltale. What this usually means is that Applesoft's text pointer has fallen upon something that it doesn't like. If, say, your routine that puts "CATALOG" into the input buffer and calls DOSCMD (\$BE03) is at location 768 (\$300) in memory, and you typed

```
]CALL 768
```

from immediate mode in order to execute it, guess where the text pointer is? Right, it is pointing right after the 768 (which is in the input buffer). BASIC happily goes out and jumps to \$300 to execute your routine. Now, when your routine stuffs "CATALOG" into the input buffer, it just trounced the "CALL 768" (or even a 3000 from within the monitor!), and probably the null terminator that BASIC puts at the end of your immediate mode command so that it knows when to stop parsing instructions. Also, if you have a clock card, ProDOS will poll it before each DOS command and stuff 17 bytes (or is it 16?) into the input buffer starting at \$200 -- this would also munge your command and anything that followed it.

After the catalog is displayed, Applesoft returns to continue parsing commands at its text pointer which (if in immediate mode) is pointing somewhere inside the input buffer. Of course, you can guess the results: SYNTAX ERROR.

Try doing the call to your routine from deferred mode:

```
]10 CALL 768
]RUN
```

See if that works. If so, your problem is solved. And you might want your routine to save the first n bytes of the input buffer before calling \$BE03, and then restoring them when done so that immediate mode usage is okay.

Of course, this was all "on-the-fly" speculation. So I could be very, very wrong about all this. But I've had this sort of thing happen before with DOS calls and such.

apple/software #304, from jerryh (Jerry Hewett)
a comment to message 303

You might also want to try sending low-order ASCII (bit 8 clear, including the C/R) to the input buffer -- BI or ProDOS might be fussy about that.

apple/software #305, from jtierney
a comment to message 304

I think you are right about the problem in the immediate mode. I still had a problem in the deferred mode and solved it by putting a 00 in \$BE0F before calling DOSCMD. Thanks for your help.

apple/software #307, from mdavis
a comment to message 305

(continued)

SQUEEZE 10 TIMES AS MANY SPREADSHEETS ON A DISK. \$79.95.

Spreadsheets are wonderful tools, but they have three major drawbacks: they take up a lot of disk space, they take a lot of time to load and to save, and they're expensive to send electronically.

Introducing SQZ!™ from Turner Hall Publishing, the spreadsheet compaction utility that reduces the amount of disk space needed for

Lotus 1-2-3® and Symphony™ spreadsheets by 80%-95%. And cuts retrieve/save time for floppy users.

SQZ! takes up less than 30K of RAM and runs co-resident in memory with DOS and the Lotus program. It works easily with popular memory-resident programs like Note-It™ and Sidekick™. In RAM, the spreadsheets remain the original size. Spreadsheets are automatically squeezed and unsqueezed during normal file saving and retrieving without loss of content.

SQZ! features a communications option that reformats spreadsheets so they can be sent over electronic mail services that normally only accept text files. And since the files are sent in compressed form, you can save 80%-90% in transmission time

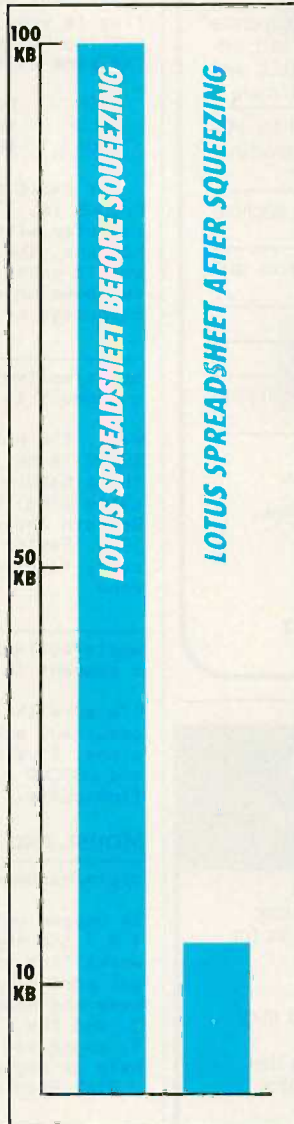

on your phone bill. And a password feature lets you encrypt files to protect them from unauthorized use.

SQZ! is simple to use. It's not copy-protected so hard disk users can install it easily. The user interface mimics Lotus'. You can even customize the defaults.

SQZ! runs on the IBM® PC, XT,™ AT,™ and 100% compatibles with any release of 1-2-3, Symphony and VP Planner.™ It's compatible with EMS memory expansion boards. Every package comes with a complete User's Manual, the program diskette, a Help Hotline number, and a 30-day money-back guarantee.

We also publish Note-It, the 1-2-3 documentation utility. Which, we're proud to say, was named 1985 runner-up Product of the Year by Infoworld.

Remember, when you're up to your ears in data, there's only one thing you can do. SQZ!

SQZ!

THE DATA SQUEEZER FOR LOTUS.

HOW TO ORDER.

Order SQZ! by phone. We accept MasterCard or Visa. Or fill out the coupon at the right and send it to us with a check or money order. Include \$2 shipping (\$12 outside USA). CA residents add \$5.60 sales tax. SQZ! comes with a 30-day, money-back guarantee.

Turner Hall Publishing
10201 Torre Ave., Cupertino, CA 95014

1-800-556-1234 x527.

(In CA 800-441-2345 x527.)

SQZ! is also available at better dealers.

Please send me _____ copies of SQZ! at \$79.95, plus \$2.00 for shipping (\$12 outside USA). CA residents add \$5.60 sales tax. I enclose _____. Please charge my MasterCard or Visa.

Card # _____ Exp. Date _____

Name _____

Company _____

Address _____

City _____ State _____ Zip _____

Phone (_____) _____

BYT12086

SQZ! and Note-It are trademarks of Turner Hall Publishing. Lotus and 1-2-3 are registered trademarks, and Symphony is a trademark of Lotus Development Corp. Sidekick is a trademark of Borland International. IBM is a registered trademark of, and IBM XT and IBM AT are trademarks of International Business Machines Corp. VP Planner is a trademark of Paperback Software International. Program copyright Synex Systems Corp.

Z80 Turbo Modula-2

Created by Borland International!

Complete programming environment features WordStar-like editor, automatic invocation of editor when compiler detects programming errors, and extensive function library

Turbo Pascal programmers will love it because: separate compilation for large programs makes development fast, advanced capabilities for linking assembly language REL and object files, passable open array parameters, and much more

Easy to use: includes extensions like Turbo Pascal for I/O, string handling, multidimensional arrays, and error handling, makes use of Modula-2 much less complicated

Includes multiprogramming facilities for advanced applications, I/O redirection to and from files and devices

Outperforms "C" compilers for speed of compilation and speed of execution

500-plus page Turbo Modula-2 manual included

Price: \$69.95

Requires Z80-compatible microprocessor and CP/M compatible operating system

Dealer and Distributor Inquiries Invited.
 Visa/Mastercard accepted. Add \$6.00 shipping/handling in North America, actual cost elsewhere. Specify disk format.
 Trademarks: Turbo Modula-2, Turbo Pascal, Borland International; WordStar, MicroPro; CP/M, Digital Research; Z80, Zilog.



Echelon, Inc.

885 N. San Antonio Road • Los Altos, CA 94022
 415/948-3820 (Order line and tech support)

Instrumentation

- Engineers
- Technicians
- Maintenance
- Designers

Nowadays, there is absolutely no need to do wiring and terminal schedules by hand. The same applies for lists: terminal boxes, splice boxes, cables, field equipment, etc.

The wildest, most complex wiring configuration may be recorded with the W2 wiring program. For example, you can have up to 13 jumpers within the same box. Even pair and tracer colors are recorded.

Every entry is verified for error, continuity, availability, etc. There is even an auto-command where you need only to enter the first box, and bingo! the remaining cables and boxes are selected right up to the control room. Fantastic! Not really. And we are not even talking about ease of use, windows, menus, etc.

This program has been extensively field tested. It is ready to go now, complete with a 90 page instruction manual. You can of course develop your own. At least 500 hours will be needed, and a lot of sweat. At \$403, the W2 wiring program costs less than \$0.60/hour. Can you do better?

W2 INDUSTRIAL WIRING PROGRAM, \$403
 (version 1.2)

No quotation please. Use this add, price is valid for 60 days. Delivery, immediate and conditional on acceptance of license agreement. U.S. Currency. Net 30 days. 90-day warranty.

Send purchase order to :

TECHNO-SOFT, 3555 Berri #1007,
 Montreal, Canada. H2L 4G4

That's interesting. I don't think the contents of \$BE0F should be significant prior to making the call. If, however, you are testing that location after the call to DOSCMD, it would be. But I don't think you ought to do it that way. From what I've read about it, the carry flag is your indicator of an error occurrence after calling DOSCMD. That would make sense since ProDOS does the same thing. You might want to try:

```
JSR    DOSCMD
BCC    NO_ERROR
LDA    $BE0F           ;A-reg now has error code
```

If BASIC.SYSTEM is as consistent with errors as ProDOS is, I'll bet you don't even need to load the A-register with \$BE0F after a JSR DOSCMD. If an error happens, the carry should be set, and the accumulator should contain the error code for you. (Might help to cut down on some of the code in your program to take advantage of this circumstance.)

apple/software #308, from jtierney
 a comment to message 307

Well, I'm not sure, but I am beginning to think that \$BE0F is not reset after an error occurs. Putting a 00 there before the call works fine. I will look into the carry flag. My primary source of info on this is Beneath Apple ProDOS (by Don Worth and Pieter Lechner, 1984, Reston Publishing) and they don't mention the carry flag to detect an error. Makes sense though.
 John

apple/software #309, from mdavis
 a comment to message 308

I'm sure that \$BE0F will change *ONLY* if an error occurred, otherwise BASIC.SYSTEM probably leaves it alone. I've always used the carry flag status after MLI and DOSCMD calls to indicate an error. It seems to work flawlessly.

MOUSE AND MOUSEWRITE

apple/hardware #497, from rbracken (Rick Bracken)

Is anyone out there using MouseWrite? I have version 1.5.7 and the revision C of the Apple Mouse. Everything works fine except printing. When I go to print I only get part of my document prior to MouseWrite crashing. I have the Mouse in slot 4, a Super Serial Card in slot 2, and the FingerPrint Plus parallel interface in slot 1, connected to a Panasonic dot-matrix printer. Any help or suggestions would be appreciated.
 Rick Bracken

apple/hardware #498, from jerryh
 a comment to message 497

The problem might be the FingerPrint Plus card -- I was recently talking to a developer who was having trouble getting this card to work correctly with his program. You might want to try it with another card (borrow one from a friend, or try it at your local computer store) and see what happens.

apple/hardware #499, from mdavis
 a comment to message 498

Right. I could not get my version of MousePaint to print through Apple's parallel printer interface, though it worked great with the SSC and Imagewriter.

(Does it have a printer-install option or anything like that?)

(continued)

Light a fire under your database.



We've been carrying a torch for dBASE for years.

So we're pleased to announce Quicksilver™, our totally new dBASE III Plus compiler.

Quicksilver produces native assembly code which runs dBASE applications like wildfire, faster than anything else on the market.

It also supports all the programming commands of dBASE III Plus, including multi-user syntax and memo fields. It includes a faster SORT and INDEX. And it uses the same data, index and

other files as dBASE.

For greater flexibility, Quicksilver lets you create your own User-Defined Functions. It also supports "dBASE Tools For C," and lets you link in your own C code for complete control of your database applications. (Our own powerful HOT C™ compiler is available for just \$99.)

With Quicksilver you can even create your own windowing environment, because we've added a full set of dBASE-like commands that give you up to 99 crisp, quick

windows without any other software.

And Quicksilver speed, power and compatibility are all yours for just \$599.

To order, call the WordTech Systems, Inc. HOTline at (415) 254-0900. But do it today. Because we all know that the race goes to the quick.

QUICKSILVER™
by WORDTECH

apple/hardware #500, from rbracken
a comment to message 498

I can get MousePaint to function properly with my Panasonic printer and the FingerPrint Plus card but still no go with MouseWrite. I am borrowing an alternate card tomorrow.

apple/hardware #501, from rbracken
a comment to message 498

Back again. I think I have the solution to the FingerPrint card problem. Evidently the FingerPrint Plus does not handle interrupts properly. I'm going to call Thirware Computers about a possible fix that I heard about. Will let you know.
Rick B

PS: MouseWrite worked great with a Grappler card.

apple/hardware #503, from mdavis
a comment to message 501

MouseWrite requires interrupts in order to print text?!? (hooo! heee! haaww! ooo! har har har!!!)
Strike another point for old Roger.

You ought to ask them why MouseWrite's pull-down menus kind of "crawl" down the screen... "It's because we wanted to give the impression of the menus actually being pullllllllled down the screen, so we put in some false delay loops to slow them down."

Jiminy Crickets, that's rich!

apple/hardware #524, from rbracken
a comment to message 501

Back again. Short update on my FingerPrint problem. Called Rafael Landers at Thirware; he sent out a new ROM - no charge.
Rick B

apple/hardware #525, from jerryh
a comment to message 524

Did they tell you what the problem was in the first place? A brief description of the situation and what steps Thirware took to correct it might help someone else down the road. ("Oh yeah! I remember seeing a solution to that on BIX!")

ACIA 6551 TECHNICAL INFORMATION

apple/long.msg #2, from jemurray (John Murray)

Writing communications programs for the Promodem 1200A

For anyone interested in writing a terminal program for the 1200A (Super Serial Card compatible) internal modem, here is a brief description of the 6551 ACIA used in the 1200A and Super Serial Card. In the following description, it is assumed that the 1200A is in slot 2. In register descriptions, bit 7 is the most significant bit.

The 6551 has 5 registers, which are mapped to 4 Apple memory locations. To write a program to control the 1200A, it is necessary to directly read and write these registers:

Receive/Transmit Data Registers: location: \$C0A8

These registers contain the characters sent to and received from the modem. Writing to this location writes data into the Transmit Data register and reading from it reads from the Receive Data register.

Status Register: location: \$C0A9

This register contains status information about the 6551. Bit 4 is set at 1 when the Transmit Data register is empty and cleared and at 0 when data is written into the Transmit Data register. Bit 3 is set when the Receive Data register has received data and cleared when the data is read from the Receive Data register.

Command Register: location: \$C0AA

This register controls various transmit/receive functions. Normally, bits 0 and 3 should be set and bits 2 and 4 cleared. Bit 1 enables receiver interrupts and is set to disable interrupts and cleared to cause an IRQ' interrupt when a character is received. Bits 5-7 control parity checks as follows:

Bit 7 6 5
 - - 0 No parity
 0 0 1 Odd parity
 0 1 1 Even parity
 1 0 1 Mark parity
 1 1 1 Space parity

Control Register: location: \$C0AB

This register sets the mode of the 6551. Bit 4 should normally be set. Bit 7 selects the number of stop bits, set for 2 stop bits and clear for 1 stop bit. Bits 5 and 6 control word length as follows:

Bit 6 5
 0 0 8 bits
 0 1 7 bits
 1 0 6 bits
 1 1 5 bits

Bits 0-3 set the baud rate as follows:

Bit 3 2 1 0
 0 1 1 0 300 baud
 1 0 0 0 1200 baud

I hope this is helpful to anyone writing a terminal program for the 1200A
 - John.

APPLE IIGS

The IIGS section of the Apple conference has received a great amount of traffic from the day the IIGS was announced. The following are excerpts covering resets, sound, graphics and assembly language programming.

RESET INCONSISTENCIES

apple/gs.compat #27, from rbradford (Rex Bradford)

Does anyone know why my OpenApple-Control-Reset only works some of the time? I cannot detect any pattern. Although usually if I bang on it a dozen times it seems to catch. This is on my Product Validation Unit; I don't know if this is me or real or what. Any comments from the guys at Apple?

apple/gs.compat #28, from ericeldred (Eric Eldred)
a comment to message 27

Yes, same thing happens in my PVU. I was told it is in programs that do not allow interrupts (the Control-Command-Escape uses an interrupt to call the classic Desk Accessory and won't work in a lot of programs in DOS 3.3, and even in one under the new ProDOS I saw today). But I thought that was hard-wired more than that in the IIe for copy protection reasons. (??)

apple/gs.compat #29, from gs.softteam (Apple Computer)
a comment to message 27

(continued)

The Diconix 150. So light it's the one
PC printer you can take lightly. Anywhere.

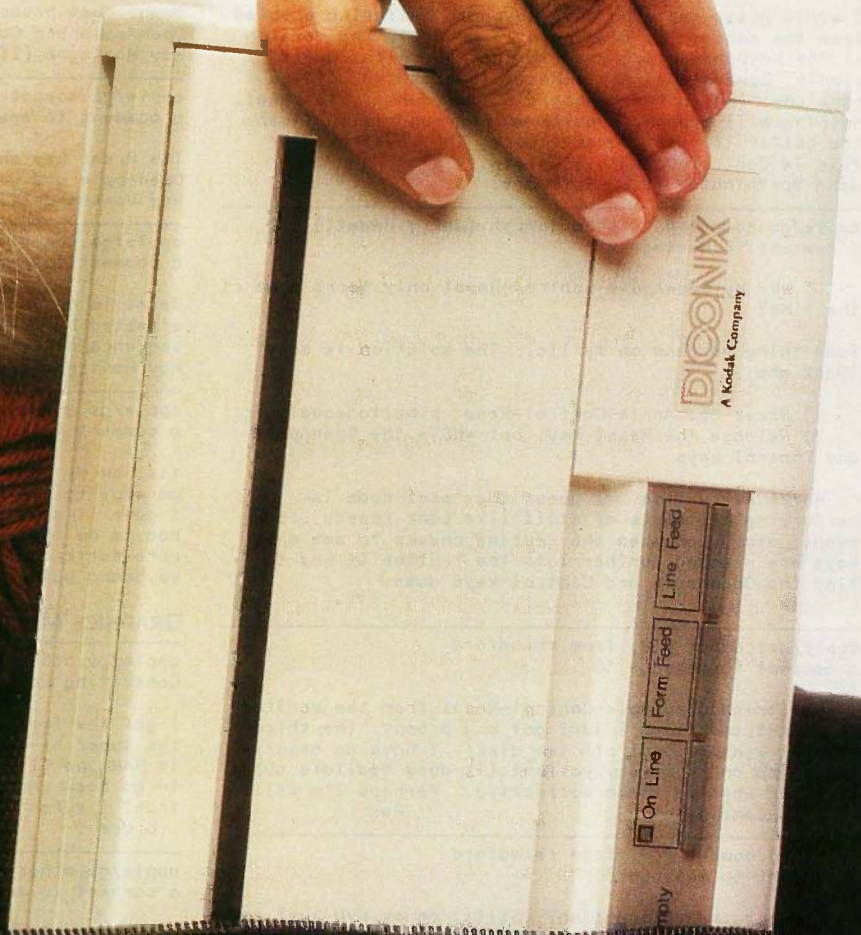
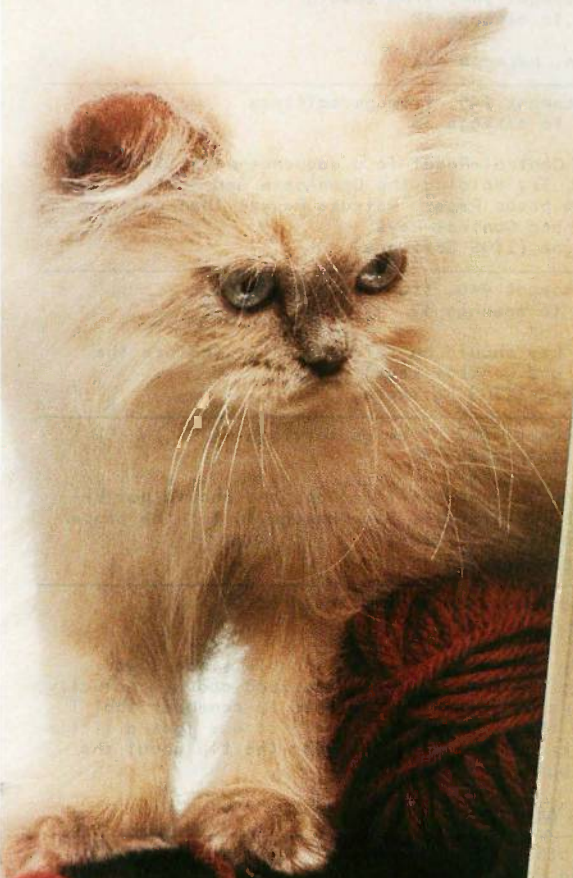

DICONIX
A Kodak Company

3100 Research Boulevard
Dayton, Ohio 45420.

For the dealer nearest you, call
1-800-DICONIX Telex: 288-280

If you have a 1-meg memory expansion card, OpenApple-Control-Reset will cause all RAM not configured as a RAM disk to be zeroed. This takes some time. If you hit the reset again, it restarts the zero process. If this is the problem, be patient. If not, bring it up again and we'll try to find an answer.

R. Montagne (IGS software)

apple/g.s.compat #30, from gs.softteam
a comment to message 28

It is true that programs that disable interrupts also disable access to the control panel via OpenApple-Control-Escape. OpenApple-Control-Reset is not an interrupt, and should always work. See my comment to message 27.

R. Montagne (IGS software)

apple/g.s.compat #31, from gs.softteam
a comment to message 27

I would guess that you have keyboard buffering enabled from the control panel. There is a bug in the version of the keyboard micro used in the PVU units. Quite simply, Control-OpenApple-Reset is buffered. If you have anything in the keyboard buffer and try to reset, nothing will happen. A quick work-around is to flush the buffer if reset doesn't work. The keystroke for this is Control-OpenApple-Delete.
John Worthington (IGS Software)

apple/g.s.compat #32, from Jerryh (Jerry Hewett)
a comment to message 27

> ...why my OpenApple-Control-Reset only works some of the time?

Same thing happens on my IIC. The solution is easy, thank gh... .

- 1) Press OpenApple-Control-Reset simultaneously.
- 2) Release the Reset key, but *NOT* the OpenApple and Control keys

Works every time. I guess the reset code is performing all sorts of stuff like bank resets, code swaps, etc., and when the routine checks to see what keys are pressed further into the routine it has to find the OpenApple and Control keys down.

apple/g.s.compat #38, from rbradford
a comment to message 30

I just tried OpenApple-Control-Reset from the Monitor. The first two times I just got a] prompt; the third time it went to boot off the disk. I have no memory expansion and was very patient (it does hesitate about a second when it works correctly). Perhaps I'm still missing something...
Rex

apple/g.s.compat #39, from rbradford
a comment to message 31

Thanks for the information. Still, on my PVU just now I was inside a game called H.E.R.O. I hit Control-OpenApple-Delete followed by Control-OpenApple-Reset, and it took a few times. Perhaps the buffer-flusher keystroke is itself buffered or locked out?

apple/g.s.compat #40, from rbradford
a comment to message 32

GREAT SCOTT!! It's true! Pressing OpenApple-Control-Reset and releasing the Reset before other keys makes it reset every time. Rex Bradford

apple/g.s.compat #42, from mdavis (Morgan Davis)
a comment to message 27

Make sure you release the Open-Apple key *last* when doing a Ctrl-OA-Reset sequence. If you don't, the reset routine is called and it sees that the OA button is not down, and causes just a standard reset.

apple/g.s.compat #43, from cheath (Charlie Heath)
a comment to message 39

H.E.R.O uses interrupts to synchronize the display - perhaps somehow the interrupt servicing is interacting with the reset function?

apple/g.s.compat #44, from cheath
a comment to message 40

Then again, perhaps not.

apple/g.s.compat #45, from gs.softteam
a comment to message 38

OpenApple-Control-Reset is a sequence-sensitive operation. Try holding the OpenApple and Control keys down. Then press Reset. Release Reset. Then release OpenApple and Control keys.
Ray Montagne (IGS Software)

apple/g.s.compat #46, from gs.softteam
a comment to message 42

The Reset key should be released first (before the OpenApple and Control keys).
Ray Montagne (IGS Software)

apple/g.s.compat #47, from gs.softteam
a comment to message 43

Reset is an independent function, and should not be affected by interrupts. See message 45 for the proper sequence of keys to reset.
Ray Montagne (IGS Software)

apple/g.s.compat #48, from ericeldred
a comment to message 47

Yes, on my PVU, I have had no trouble since I was careful to use the sequence described above. Actually, I gave it some thought and seemed to remember that I had to do that on my IIE as well; it was just a little more noticeable here. Thanks for the tip about the keyboard buffer disable.

GRAPHICS MAPPING

apple/g.s.other #82, from webster (Bruce Webster, Consulting Editor, BYTE)

I got the impression from Gregg-and-Rick's preview that the super hi-res graphics screen is in a fixed location in RAM and (I may be misremembering, but I'm too lazy to go back and look) that there's only one. Is this true? I sure hope not.
..bruce..

apple/g.s.other #94, from rbradford
a comment to message 82

It appears from my reading of the docs that indeed graphics memory is fixed in memory. It's a shame because display double-buffering was invented (on micros anyway) in the Apple II. The display interrupts are helpful in synchronizing screen updates, but it's just not the same.

I am beginning to think that the 256 on-screen colors (with some layout limitations) from a palette of 4096 will make for quite nice displays. Has anyone seen the AT&T board that has resolution of only 256 by 256 but produces stunning displays because of its 32,000 colors?

Also, the byte layout (pixels contained within

(continued)

High-Speed Animation on Your IBM PC!

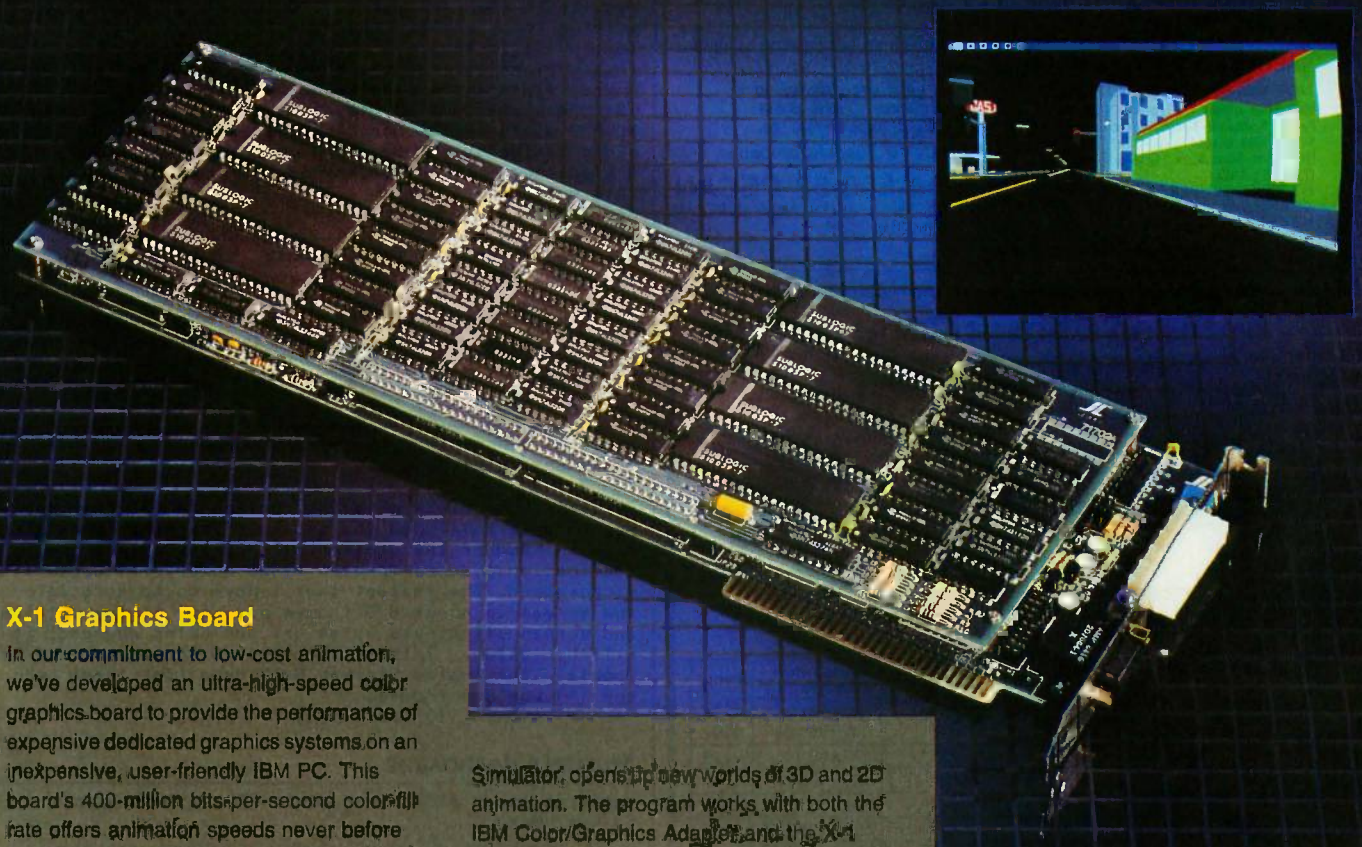

X-1 Graphics Board

In our commitment to low-cost animation, we've developed an ultra-high-speed color graphics board to provide the performance of expensive dedicated graphics systems on an inexpensive, user-friendly IBM PC. This board's 400-million bits-per-second color fill rate offers animation speeds never before available on a PC plug-in board (the X-1 is 10 times as fast as any other PC graphics card we've seen). The low-cost, high-performance X-1 Graphics Board opens up entirely new applications for microcomputer-based graphics.

3D Graphics Software for use with the Standard IBM Color/Graphics Adapter or X-1 Graphics Board

Our 3D Graphics software, the graphic drivers behind Jet and Microsoft Flight

Simulator, opens up new worlds of 3D and 2D animation. The program works with both the IBM Color/Graphics Adapter and the X-1 Graphics Board, so you can update your hardware at any time and maintain software compatibility.

Specs: The X-1 Graphics Board is available for \$2890, and requires an IBM PC or PC-compatible computer with minimum 128K RAM, PC-DOS or MS-DOS Version 2.0 or newer, and an X-1 compatible RGB display monitor.

The 3D Graphics software is available for \$985, and requires an IBM PC or PC-compatible computer with minimum 256K RAM, PC-DOS or MS-DOS Version 2.0 or newer, and either an IBM Color/Graphics Adapter or the X-1 Graphics Board.

See your dealer for details and a special hardware/software demonstration, or call SubLOGIC directly for more information.

IBM is a registered trademark of International Business Machines Corp.

subLOGIC

Corporation
713 Edgebrook Drive
Champaign IL 61820
(217) 350-6482 Telex: 206995

Order Line: (800) 837-4883
(except in Texas, Alaska, and Hawaii)

Inquiry 345

PECAN™ SuperPower Compatibility

The POWER SYSTEM™ from PECAN has set a new standard for comprehensiveness in program development environments that you won't find anywhere else:

PORTABILITY: Whether you're an ardent beginner or a seasoned pro, THE POWER SYSTEM lets you design software that can run on virtually any mini or micro without having to rewrite the program. The program you write on the computer will operate on another—even if the two hardware systems are incompatible. Your software never becomes obsolete—even if your hardware does.

INTEGRABILITY: The versatility and flexibility of THE POWER SYSTEM enables different users to exchange program modules freely with one another, even though the modules may be written in different programming languages.

LANGUAGE INTERCHANGEABILITY: THE POWER SYSTEM lets you customize the modules of your application in the most appropriate of Pecan's powerful languages including UCSD PASCAL, BASIC, FORTRAN-77, ASSEMBLER, or MODULA-2. Once you're created your multi-language program, the modules are linked automatically. The application then runs as if you'd written it all in one language.

THE POWER SYSTEM Only \$99.95

For PC-DOS, MS-DOS, AMIGA, ATARI ST, MACINTOSH, RAINBOW, TANDY, STRIDE, as well as most popular 8/16/32 bit systems. Also available in VAX, UNIX, PDP-11 OS's & others.

THE POWER SYSTEM includes the language of your choice: UCSD PASCAL, MODULA-2, BASIC, ASSEMBLER and FORTRAN-77. Choose an additional language for only \$79.95. Buy three and we will send you a fourth one FREE!

ATTENTION CORPORATIONS: Call and ask about our training seminars.
SCHOOLS: Special Educational Discounts

NOT COPY PROTECTED

Mail Your Check Or Money Order To:
Pecan Software Systems, Inc.
1410 - 39th Street
Brooklyn, New York 11218



(718) 851-3100 Credit Card Orders **1-800-63-PECAN**
ITT TELEX NUMBER: 494 8910 Call Toll Free
COMPUERVE CODE: 76703,520 (NYS) 1-800-45-PECAN

Please add \$2.50 for shipping with the U.S. Foreign orders add \$10.00 and make payment by bank draft payable in U.S. dollars on U.S. bank. New York residents add appropriate sales tax.
UCSD Pascal is a trademark of The Regents of University of California.

Expansion Chassis/Tape Back-up

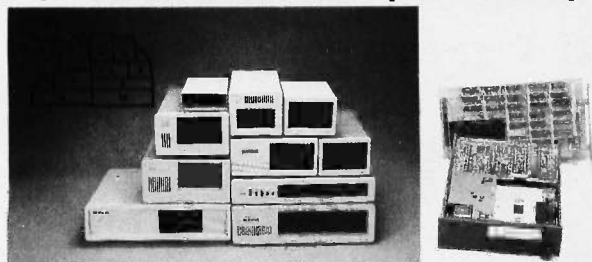

Specification

Model No.	No. of Slot	Space for 1/2 Height Drive	Power Supply (Watts)	Dimension DXWXH(cm)	Price
M-1*	0	1	50	30x15x6.5	\$139
M-2	3	3	100	42x25x16	\$299
M-3	5	3	100	39x30x15	\$239
M-4	12	2	100	40x49x14	\$299
M-5	0	2	45	39x18x15	\$149
M-6	0	1	50	26.5x18x13.5	\$169
M-7	5	2	100	38.5x30x13.5	\$299
M-8	0	2	45	39.5x18x13.5	\$149
M-9	0	2	60	38.5x49x9	\$249
M-10	8	4	135	43x49x14	\$239

* Extra space for a stand alone controller

EXT and RCV Adapters (Interfacing Computer & Chassis With Slots)...\$149

Tape Back-up (With Controller & Cable)...\$499

ORDER TOLL FREE: (800) 826-0267
In California Call (408) 434-0877
SOURCE ELECTRONICS CORP.

2380 Qume Drive, Suite E
San Jose, CA 95131

Telex: 279366

Fax: (408) 434-0539

bytes) is much better for software than bitplane displays. Bitplanes are popular in high-end systems because fancy graphics hardware can cope with bitplanes easily, but software has a dickens of a time updating pixels which are spread across several bytes. Not too much fast animation seen on the Atari ST yet, for instance.

Rex Bradford

apple/gs.other #100, from cheath
a comment to message 94

Say it ain't so! A single video display area, in an 8-meg address space?

How fast can the 65816 copy an entire display screen? Make that: What is the fastest way to move a 16-bit word from one indexed location to another?

apple/gs.other #154, from rbradford

TITLE: Coping with the single video bank
Since the IIGS has only one hardware bank of display memory in super hi-res mode, it is of interest to know about writing to an off-screen "bank" and copying the results to the real screen. Quickdraw II does support writing to a "screen" anywhere in memory; next task is to copy it to the real screen memory. The MVN and MVP instructions will do block moves at 7 cycles per byte moved; since the screen is 32,000 bytes, this is 224,000 cycles. At 2.8 cycles per microsecond, this is 80,000 microseconds, or 80 milliseconds. This is 5 video fields at 60 Hz, which does not exactly make for a clean screen update. Anybody have any thoughts on this matter?

Rex Bradford

apple/gs.other #155, from cheath
a comment to message 154

That sounds about like the speed to copy a screen on the original IIGS, except of course the IIGS does have an alternate bank. That is about five times *slower* than Atari ST and Amiga's; and both of them *do* allow bank switching.

apple/gs.other #163, from gs.softteam
a comment to message 154

Actually, the block move instruction is not the best way to move data onto the screen. The block move does a false read of the destination address. Since the destination address is slow video memory, it costs 1 microsecond. The fastest that I have moved data onto the screen is about 8.5 frames per sec. If the palette and screen brightness bytes are not being changed, it will be faster. I think that over 9 frames per sec is doable. The Empire Strikes Back demo (for those who saw it) was 8.5 frames.
Rich Williams (IIGS Software)

MULTIPLE KEYBOARDS

apple/gs.other #151, from dbetz (David Betz, Senior Editor, BIX)

Does anyone know if software on the IIGS can tell which of several keyboards a keystroke originates from? Can I hook up two keyboards and have my program treat keystrokes from each keyboard individually or are they indistinguishable?
David Betz

apple/gs.other #152, from cheath
a comment to message 151

Interesting idea. I've often wished, when multitasking, for alternate sources of input without having to select a new window or something. Drives me batty when I start typing and the data goes into the

(continued)

10 MHz 286 TURBO™



The Code of the West

The Good

Western 286 Turbo™

Western Computer Corp. has built a strong reputation in the Micro-computer Industry by sticking to a few basic principles. We call it the "Code of the West" and it goes something like this:

MAKE IT BETTER.

with added features like 8-10 MHz switchable, 512K of RAM expandable to 1MB, Standard RS-232, Parallel Ports and 1 year Warranty on parts and labor.

MAKE IT NOW.

it doesn't matter how good a deal you make if you have to wait forever to get it!

MAKE IT CHEAPER.

and pass the savings on to the Buyer.

MAKE IT COMPATIBLE.

we can't think of anything worse than getting a good deal on a new system, but not being able to run your favorite Software! By the way, we use Phoenix Bios for total compatibility.

MAKE IT IN AMERICA.

Please!

The Bad

\$5295⁰⁰

What could a Personal Computer with fewer standard features, actually do for you that would compel you to part with an additional \$3,300.00. Will it pick-up the kids from school, wash the car or walk the dog? Think about it!

& The Ugly

Regardless of what you pay for it, a Foreign Import can be one big gamble, with no guarantees of compatibility, service, or support.

Western Computer Corp. has a full line of personal computers and peripherals designed around your needs and your budget including: **WESTERN COMPUTER XT TURBO™**, **WESTERN CARRY-ON™** and...

...Coming soon—**WESTERN 80386™**

Call one of our salespersons at (714) 553-1611 to find out how to hang-on to more of your money!

Western Computer

17781 Mitchell St., Irvine, CA 92714 USA

Phone (714) 553-1611

Customer Service Only (714) 533-1705

Telex: 7566731

Answer Back WESTERN COMP

FAX (714) 553-0236

Western Computer Australasia Limited

4-82 Abbot Street, Ascot Brisba

Queensland, Australia 4007

#(07) 268-6589 - Telex: AA144746

FAX: #(07) 2685256 - Answer Back MCGUIR

Western Computer Spain

Diputacion, 238-6° Despacho 8

08007 Barcelona, Spain

Tele: 317 7128

Western Computer Greece - Busisoft Ltd.

102 Syngrou Ave., Athens 11741, Greece

Tele: 902 4248 - TLX: 210364

We provide *instant* response to TIPS.
You call, We call! See page 440.

wrong window! What do you want to use multiple keyboards for, David?

apple/g.s.other #153, from dbetz
a comment to message 152

Game programs. I thought it would be interesting to design a game program for the GS that would allow two (or more) players to interact with the machine (and each other) at the same time. I suppose that multiple independent keyboards could be useful for educational software also. The teacher could be the copilot ready to take over the controls but also have some command options that the student doesn't have access to.
David Betz

apple/g.s.other #161, from gs.softteam
a comment to message 151

By talking to the keyboard micro you can tell which keyboard is sending the keystroke. We had a game going in the lab with 6 keyboards. Everyone would type faster to make their character win a race.
John Worthington, (IIGS Software)

SOUND CAPABILITIES

apple/g.s.graphsound #6, from nightlight (Patrick Murphy)

Saw the IIGS today...pretty neat. Questions about the sound:

The Ensoniq chip that runs the sound provides 15 voices (oscillators). I presume that these are digitized waveforms.

1) What are the limitations on the waveforms? A fixed number of bytes per waveform, or fixed total of bytes for all 15, or something else?

2) Why is there 64K of RAM for the sound chip? Is it a convenience (a scratchpad) or a limitation (only 64K of samples total)?

3) The sound is mono, but a company makes a stereo board which seems to demultiplex the mono. How does this work?

4) This question is crucial to my interest, which is in running laser light shows with the IIGS: Is it possible to get two or more non-demultiplexed outputs from the chip? For example, if I open it up, are all 15 of those voices/oscillators coming out of the chip, or are they mixed internally? (Mono would be useless; the more fully independent digitized waveforms, the better.) Thanks for any info on the IIGS sound capabilities.

--Patrick Murphy

apple/g.s.graphsound #8, from robmoore (Rob Moore, Manager, IIGS Hardware Design Group, Apple Computer)
a comment to message 6

The Ensoniq DOC includes 32 oscillators. Our sound tools use these in pairs and reserve one pair to generate time slice interrupts so we end up with 15 voices. With the right software you could do 32 voices.

Waveforms are stored in a dedicated 64K section of RAM and start on page boundaries. They can be up to 32K long.

Stereo or multi-channel sound is possible and stereo cards have been built. Each oscillator can be specified to be assigned to a particular channel number (0-15) and the least significant 3 bits of this channel number are available on the little DOC connector on the board. So an 8-way analog mux [multiplexer] etc. will let you have 8-channel sound.

-- Rob M

apple/g.s.graphsound #20, from nightlight
a comment to message 8

So to get eight independent sounds I would have to get the channel number off the DOC, and switch the signal coming from the D/As into the channel I desire, correct? Does this mean that all signals must run at the same speed (or by only grabbing every nth signal at no more than 8 (15?) multiples of a given speed)?

apple/g.s.graphsound #21, from robmoore
a comment to message 20

You're approximately correct - the channel number is used to vector the unfiltered output to the selected channel circuitry. The DOC generates outputs for 32 oscillators (if 32 are enabled) and two dummy refresh cycles. It steps through the oscillators at about 7/8 MHz, so with all oscillators enabled it takes 34 cycles to complete a pass through the oscillators. This works out to about a 26.4-kHz sample output rate, so the max frequency that can be generated with 32 oscillators enabled is about 13.2 kHz. The output step rate is constant, so enabling fewer oscillators increases the max sample rate and output frequency.

apple/g.s.graphsound #24, from gs.softteam
a comment to message 6

1. The Ensoniq chip has 32 oscillators available for waveform playback. The architecture of the Sound Tools has linked adjacent pairs of oscillators into "Generators." The reason there are only 15 generators instead of 16 is that Apple is reserving the last pair. The Sound tools are broken down into four main sections: free-form sound, note synthesis, sound sequencer, and speech tools. Within the free-form tools the waveform can be up to 16 megabytes wide. The firmware will take care of moving data as needed into the 64K of DOC RAM. The smallest waveform that can be played by the free-form tools is one page (256 bytes).

2. The DOC chip requires memory that can be accessed directly. The chip can access up to 128K of RAM but due to cost constraints some limitations had to be made. This memory can be used by an application program to load waveforms which any of the generators can reproduce.

4. The DOC chip time-domain multiplexes the output from each of the oscillators depending on the number of oscillators enabled, it will cycle through all of the oscillators.

apple/g.s.graphsound #27, from rbradford
a comment to message 24

I have seen several references to the 64K sound chip RAM. Where does this exist? Can any 64K area (or part of 64K) be allocated to it? I assume it doesn't have its own 64K RAM hanging around, does it? On the subject of memory, how much of the 256K is actually available? My cursory reading of specs makes me believe that after sound RAM, graphics RAM, shadow RAM, tiny isolated pieces that are a pain to make use of, etc., are all accounted for (not to mention ProDOS itself and Finder and all), precious little is actually usable. Is Apple repeating the mistake all computer manufacturers (including Apple) have made in the past-- great stuff crammed into a closet?

GLU HELP

apple/g.s.graphsound #26, from sgrant (Steven Grant)

HELP!! If I can get my boss details of the sound GLU quickly, he'll sign the check for a GS! What he wants is a description of the memory locations and registers used by the sound GLU chips. I've already looked at what's been posted re: the sound chips and maybe that will be enough. What he asked for specifically was

(continued)

"Double Strength" Solution delivers a high performance computer *and* power graphics!

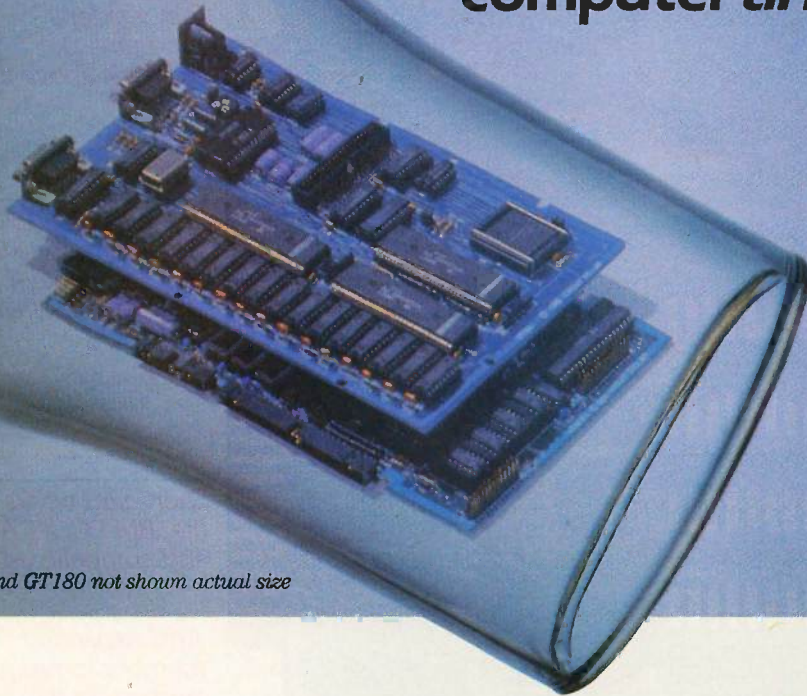

SB180FX and GT180 not shown actual size

You've needed a computer that's smaller, faster and packs more memory. And you've wanted the best of today's graphics. Well, now you can have both affordably. Micromint brings you its newest single board computer, the SB180FX and its piggy-back color graphics board the GT180. Now with this "double strength" combination you can take industry standard Z-80 compatible software and add colossal graphics like the ones you see on this page. That's right—graphics like these with your Z-80 software!



The GT180 has 38 commands including 23 graphics drawing commands: line, rectangle, polyline, polygon, circle, ellipse, arc, ellipse arc, filled rectangle, paint, pattern and copy.

Resolution of the GT180 is 640x480x16 colors with a palette of 4096.

The SB180FX is only 5.75" x 8". It gives you a Z-80 compatible CPU running at 6, 9 or 12 mHz. You also can get 512K bytes of RAM, up to 32K bytes of ROM, two 38.4K baud serial ports, a parallel

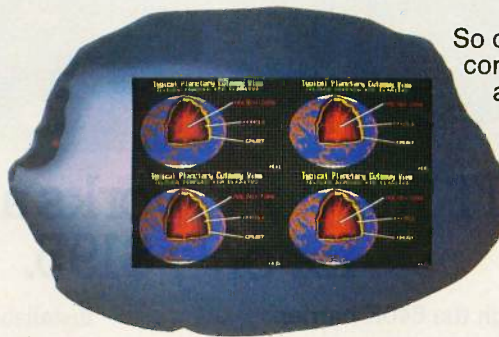

Three horizontal split screens and one window screen. Size and position fully programmable.

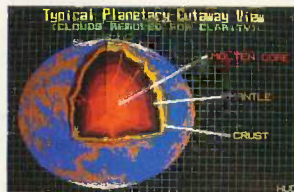

Software: Modula 2 by Borland International including SB180/GT180 Graftix Toolbox.

port, a peripheral expansion bus, three bi-directional parallel ports and an industry standard 765A-compatible disk controller for up to four disk drives (any combination of 3 1/2", 5 1/4" or 8" drives). An on-board SCSI expansion bus lets you connect directly to a hard disk drive or additional computers.

So don't wait any longer for the computer size, speed, memory and graphics you've been waiting for. The SB180FX and GT180 team not only gives you the latest features you're looking for, you can have them for a great low price.

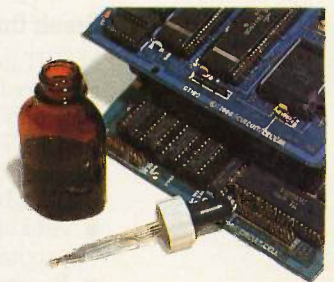

SB180FX* . . . starting at \$409.00
 GT180 \$395.00
Borland International
 Turbo Modula 2 \$69.00
 Modula 2 Graftix Toolbox . \$89.00

*minimum configuration: 256K bytes of RAM and ROM monitor.

To order or for technical information call

1-800-635-3355

In Connecticut call: 1-871-6170



Micromint, Inc. 4 Park Street Vernon, Connecticut 06066 TELEX: 643331

info from the technical reference manual. We are certified (but not registered) developers at the University of Delaware, if that helps.
...Steve

apple/g.s.graphsound #42, from robmoore
a comment to message 26

The info on the sound GLU IC is available to developers but we're trying to discourage people from talking directly to it. We have provided some very low-level, fast-access entry points in the sound tools to access the DOC sound chip and would really prefer that people use them. Otherwise it will be really tough to ever improve that stuff in the future without losing compatibility. In other words, IF YOU TALK DIRECTLY TO THE NEW HARDWARE, YOU WILL PROBABLY NOT BE COMPATIBLE WHEN WE COME OUT WITH A NEW MACHINE.

apple/g.s.graphsound #43, from robmoore
a comment to message 27

The sound chip (the DOC) has its own dedicated 64K of RAM which is separate from the system RAM.

apple/g.s.graphsound #51, from sgrant
a comment to message 42

OK, fair enough. But could you briefly describe what tools are available and how they are used? Also what is the sampling rate, i.e., bandwidth, for sound output and input, and can the voices be combined?

apple/g.s.graphsound #74, from robmoore
a comment to message 51

The DOC includes 32 uncommitted oscillators that tend to be most usable when used in pairs per voice. With 32 oscillators enabled, the output sample rate is about 26.4 kHz giving a max output freq of 13.2 kHz or so - higher with less osc enabled. Voices and/or oscillators can be combined in numerous ways depending upon the software.

BRA LIMITS

apple/g.s.developmt #18, from sgrant

The biggest problem I see is the limits on the branch instructions. If they are limited to a 64K bank, and wrap around on an overflow, does this mean that all program modules are limited to exactly 64K? This could be a real problem for compiler writers, and a real nasty kludge for assembly programmers. Or maybe I am missing something here? I mean how can you be sure that your code will not cross a 64K boundary and what do you do if it does?
...Steve

apple/g.s.developmt #20, from sglass (Steve Glass, Apple Computer)
a comment to message 18

Indeed a single segment of code is limited to 64K bytes since it cannot cross a bank boundary. This does not, however, limit an application to 64K bytes. Applications can be segmented and using the new development environment, tools and OS, this is very easy to do. The development environment for the IIGS is more powerful than anything we've had on the Apple II in the past. Code can be assembled and linked in multiple segments that are loaded by the system loader on an as-required basis. Intersegment references are resolved as segments are loaded. The loader calls the memory manager to find an appropriate-sized piece of memory for any segment being loaded.
Steven Glass, IIGS Software

apple/g.s.developmt #24, from g.s.softteam
a comment to message 18

You're right about the branch instructions. All of the short branch instructions are still limited to 1 byte. BRL takes a 2-byte operand. This can make things messy, but not too bad, since a code segment can't be larger than 64K. I don't know of many compilers that try to do branches between segments.
John Worthington, IIGS Software

apple/g.s.developmt #32, from sgrant
a comment to message 20

I still don't see how dealing with a segment of code that turns out to be 68K in length can be handled without major problems.

apple/g.s.developmt #33, from sgrant
a comment to message 24

So how do you make sure before you get deep into your code, that it won't require a branch across segments? And if it does, is it back to the drawing board?

apple/g.s.developmt #34, from cheath
a comment to message 33

```
bra go_further
...
go_further: jmp where_I_Really_wanted_to_go
```

apple/g.s.developmt #38, from mdavis
a comment to message 33

If the GS has any kind of decent assembler system, it should be able to report 64K boundary crossings for you. This would let you know where you should place a JML (in order to change the code segment) to the next 64K segment.

GRAPHICS

In this thread from the Graphic Display conference, requirements for a IBM PC-based graphics system and possible upgrade paths for current IBM PC owners are discussed.

grafic.disp/other #42, from mhaas (Mark Haas)

Robert, I'd be very interested in hearing what your criteria for a graphics system are. What do you expect from the software? The hardware?

grafic.disp/other #43, from rtlnney (Robert Tinney, BYTE cover artist)
a comment to message 42

In answer to your question, Mark (keeping in mind that I'm not describing the ULTIMATE system; merely one with usable features and moderate price based on today's "state of the art"):

- * 256 simultaneous colors, minimum;
- * 600 x 400 res, or thereabouts;
- * PC Paintbrush-type functions: various zoom levels, brushes, the ability to easily save the metamorphosing stages of a piece, etc. More sophisticated functions, such as pixel averaging, would be nice, but may rely on having many more colors available.
- * The ability to produce a disk that is readable by color separation equipment. (This is generally already true of IBM PC-type systems, via third-party services such as ImageSet in San Francisco.)

Anyway, this is a good start; obviously this list will be quite obsolete in 2 (1? 1/2?) years, insofar as system capabilities are concerned (it already is if you have an AT and about \$5000). But from another perspective, the system described above is very capable of producing genuinely moving artwork, in the right hands. And, of course, at some point during the march

(continued)

into the future one has to jump off the continuum and taste the fruit of what already exists, even if the stop is only a temporary one, before moving on.

grafic.disp/other #44, from mhaas
a comment to message 43

I think you'll be seeing a lot of boards coming on the market in the next 6 to 12 months that have anywhere from 640 by 480 with 256 colors to 1280 by 1024 with 256 colors (out of 16 million). Prices will probably start off high, though. And monitor prices seem a lot more sluggish than board prices. Figure on about \$3 per K byte for the board and monitor for the higher resolutions and colors. My suspicion is that for your work, the number of colors is more important than the resolution. I would think 640 by 480 with 256 colors would be OK.

grafic.disp/other #46, from billn (Bill Nicholls)

My current system is a nice piece of equipment, and if I was not programming, it would probably not need an upgrade. Recently I have been using MS Windows extensively and have finally figured out how to use multitasking. It only took six weeks of daily use. What are the other things I want to do? For starters, run more tasks under Windows and more concurrently. This requires a faster CPU and a larger display of higher resolution. But the higher-res display itself will take more cycles to refresh and this reduces system performance. One solution would be to wait for the new displays supported by the new graphics processors from Intel and TI. (I'll be doing some analysis on these chips in grafic.disp shortly.) But that will be an expensive solution for another year or so. Unless I win the lottery, that solution will have to wait too long. Meanwhile, here is a rough feel for the graphics-refresh problem:

IBM CGA:	640 x 200 x 1 = 16K bytes
Herc monographic:	720 x 348 x 1 = 32K bytes
IBM EGA:	640 x 350 x 4 = 112K bytes
Wyse/Amdek 700:	1280 x 800 x 1 = 128K bytes

To get the resolution I would like to have (Wyse 700) would mean eight times as many pixels to refresh (for full screen). This is not to say eight times slower. One big unknown is the speed/efficiency of pixel access. It may be that the Hercules is no slower than my CGA and the W700; much less than eight times slower. But until I test it or get info from the graphics display code writers, there is no way to tell. This is one part of the dilemma, and an important one.

Another part of the dilemma is the imminent appearance of 386-based machines. To upgrade now to an AT-class system (8-12 MHz) would be an obvious choice except that those machines will be quickly surpassed by 386-based systems, ESPECIALLY in multitasking. Finally, there's the imminent appearance of MS-DOS 5.0, the full MT system. What will be the required hardware configuration? Will it run as is on current ATs? If I move before it appears, I risk not being able to run full MT without another upgrade. AAAARRRGGGHHH!!! If I wait for DOS 5.0, will the 386 machines be close enough to wait for them? GAK! If I add much more to my current system, it will slow to the point of being unacceptable. But I need to do something! [Sound of ARGH! echoing around inside of head.]

I hope that the above explanation will begin to convey the dilemma I face. Another aspect, well known to me, is that waiting for the latest (and greatest) stuff can be an infinite wait process as time and technology march on. One must take a stand somewhere and say "Hold, enough." I have a fairly good idea of where I want to be but what is the "best" upgrade path? More on this later. Keep in mind that a good display is an essential part of the solution.

Billn

grafic.disp/other #51, from billn

TITLE: Finding the Right Upgrade Path, Part 2

Given the series of linked dilemmas mentioned in my prior message, what might be done about it? One of the key but unstated issues here is user interface. Controlling multitasking (MT) needs some kind of ability for the user to "see" (in some sense) what is happening.

Under MS Windows, the method required is to have a tiled (non-overlapping) window active for each task with enough data showing so that the user can figure out what is going on. In my case (a CGA 640 x 200), a one-quarter screen is about the smallest practical size, either a quadrant or a narrow horizontal slice. Since most of my work requires the equivalent of 80 columns of text for comprehension, I usually slice the screen horizontally and move the boundary of the part I am using down until it has 75% of the screen.

This has two implications. Since a full screen is often needed for easy comprehension, working on 3/4 can be a minor problem. More importantly, I can really only run two programs effectively with my current display. The upgrade path referred to above *must* address the display capability as top priority since that will be the limiting factor in the human-machine interface for multitasking.

Now that we have wandered around the barn in discussion, we can get to the question of "What Display?" Given the above explanation, my desire for a 1280 x 800 screen may now be better understood. That is four times the horizontal and twice the vertical resolution I currently use. Unfortunately, resolution has its price - \$1500 and slower refresh. How much slower? Hard to tell until I can experiment or get speed reports from other (reliable) sources. Since resolution and speed are both issues, let's look at the remaining two display options that illustrate the difficulty in making a decision. In this process, I assume that other people are like me and have limited funds for upgrades.

The two remaining choices are Hercules and EGA. The difference in resolution is small enough that we can ignore that for the moment. The big difference is the advantage of color vs. the performance cost of almost four times as many bytes to update. A second issue is the dollar cost difference, both controller and display. A Herc clone and display will set you back around \$250 to \$300, an EGA clone and display will cost around \$800 to \$1200, with most of the difference in the display cost. Another option is the EGA controller and a monochrome graphics display (about \$400 to \$500). There is a patch to run Windows on the EGA with Herc resolution. Given these three options, how can we choose between them? Right off the bat, one of these is NOT going to be acceptable for any PC- (8088) based system. That is the color EGA.

Between the number of pixels and complex updating code required, EGA will simply be too slow. Based on CGA performance on my 8-MHz PC clone, EGA would be slower by two to four times, even allowing for not waiting for retrace to avoid snow. Even twice as long is too long for me, regardless if the window is bigger.

(These estimates are not based on experiments - just estimates.)

There is another reason an EGA is not recommended for PCs. That is the potential compatibility problems between some speed-up boards and separate EGA controllers. Since multitasking will take as much performance as you can get at least some of the time, it makes no sense to further slow the system with

(continued)

THE DAWN OF A NEW ERA

intronics

12 MHz



MASTER SERIES AT/12

The time has come for high-performance personal computers. Introducing - Intronics Computer Corporation's MASTER SERIES, America's Premium Quality, High-Performance IBM AT Compatible Computers. Lead by the powerful AT/12 and AT/10, the MASTER SERIES is the fastest group of IBM Compatible computers available from one manufacturer. The MASTER SERIES is built here

in America, where Quality, Performance, and Reliability are the standards. Intronics will provide you with anything from a single floppy based computer to one with 128 megabytes of high-speed storage. All this backed by an unsurpassed money-back guarantee. The Dawn Is Here. INTRONICS Computer Corporation MASTER SERIES Computers. Get One.



800/422-3366

For more information and a color brochure call or write
Intronics Computer Corporation
5433 Linda Vista Rd. Suite C,
San Diego, CA 92110

IBM Registered Trademark
International Business Machines Corp.
Inquiry 411



MASTER SERIES AT/10 Mini



MASTER SERIES AT/10

excessive display overhead. Adding an EGA board and 80286 board makes little sense if all you net is a fancier display (at the cost of a base AT system!). Given that, even the EGA controller/monochrome display may not be the choice for 8088 systems.

By logically eliminating 2 of 3 choices, it looks like the test to run is the Herc card and monochrome display for better MT display. But the key advantage will be based on whether the display will allow greater than 80 x 25 effective size thru the use of smaller character size. I'll try to line up a borrowed Herc card and display to run that test along with some comparative display speed tests. Stay tuned for the next episode of "As the Display Turns." :-) BillIN

grafic.dlsp/other #66, from billn

TITLE: Finding the Right Upgrade Path, Part 3

While I line up the Herc/monochrome test, there are a few other issues. The two primary ones are disk storage and processor speed. While these problems affect everyone to a greater or lesser degree, multitasking (MT) and large graphic displays create the largest loads. Let's take a brief look at the long view to see where we're headed.

Clearly, MT systems will be based on both 286 and 386 processors. The larger demands will migrate to 386 systems while smaller may stay on fast 286 systems. With the advent of 16-MHz 286 systems (and with 20- and 24-MHz systems in development), there is more potential life in the 286 than was apparent at first. The 386 will overlap the high-end 286 and take off from there. A 16-MHz 286 runs five to ten times as fast as a standard PC, twice as fast as a standard AT, enough for three or four tasks with minimal delays.

Also, in the longer view are graphics processors such as the Intel and TI chips that will offload graphics refresh and update from the main processor, allowing better performance even for current (slow) 8-MHz ATs. Until they arrive, graphics update will continue to burden the main processor.

To the rescue for disk performance and capacity come two relatively new tools. Disk caching is a way to reduce access time to repeated files on disk. Run-length encoding will add 50% to the capacity of disks that have quality-plated media. And CORE has a very (expensive) high-performance 250-Mb disk that uses a custom controller. These developments will converge into a new set of higher-performance disk hardware and software that will become available in the near future.

In the future, then, all of our problems will be solved, right? Well, most of our current ones anyway. But there will be new challenges then to keep things from getting dull. [Who's that I hear screaming in the back "Whaddoo I do NOW?" I'm getting to that.] After the above, an 8-MHz AT doesn't look so hot anymore, does it? Based on memory speeds, the 20- and 24-MHz versions, when available, will have to use either cache memory or static RAM, both of which will raise the cost.

So it is likely that the 16-MHz version will be the most cost-effective system with large memory for the near future. Since the first one of those is now becoming available from PC's Limited (this is not a plug), that may be an optimum option for the next two years or so. The processor option for the short term looks to be something like the breakthrough 286, an 8-MHz half-length board with 16K cache that runs at approximately three to six times the speed of the PC.

With the Compaq 386 just announced, let's look at the range of options available:

System type	Processor clock	Memory (ns)	Cost (base system)	Performance ratio (approx)	Cost/Perf ratio
IBM PC	8088/4.77	200	\$600-800	1.0	600
Turbo PC	8088/8.00	150	\$800-1000	1.6	500
Basic AT	80286/6.00	150	\$1200-1400	2.0	600
Std. AT	80286/8.00	150	\$1400-1600	2.5	560
Brk 286	80286/8.00	cache	\$400	2.5	160 *
Turbo286	80286/8.00	120	\$900	3.0	300 *
AT - 10	80286/10.0	120	\$2300	3.1	740
AT - 12	80286/12.0	100	\$2700	3.7	720
AT - 16	80286/16.0	70	\$3000	5.0	600
CQ 386	80386/16.0	100 +	\$6500	8.0	700

Note:

* Marks expansion cards for PCs, one short, one long. + Static memory

Some interesting things appear from the above table. Except for the expansion cards, the cost/perf ratio is *remarkably* constant in the range of 500 to 740 over a very broad range of systems. Though not quite as surprising when you consider that costs involved in newer products offset some of the economy of scale/higher integration used.

Another surprise - a base or turbo PC plus a short expansion card (\$400) gives the best cost/perf ratios of 400-480. This does overlook other issues but appears valid for a first cut. Note that the PC ratio improves by 200 but the turbo PC only by 20. So an inexpensive 286 card will help my performance but not my cost/performance, while it helps both if you have a standard PC.

Finally, if you gotta have performance, the Compaq 386 is a buy, but costly to expand (static memory). Otherwise, an AT at 16 MHz looks good. For upgrades, if you have a PC, get an inexpensive 286 speed-up card. For turbo PCs and basic ATs that cannot be speeded up, the 16-MHz AT represents a big jump at a reasonable cost.

One last warning. As I said some months ago, 1986-87 will be similar to 1981-82 in the amount of change/new products that we see. The dam has broken on 386 products, the flood will be here soon.

This information is as accurate as I can put together right now. I'll update this periodically; meanwhile it's food for thought. Stay tuned for more on the upgrade path question. BillIN

COMMUNICATIONS PROGRAMS FOR BIX

One of the most common questions asked of the BIX staff concerns communications programs that work with BIX. The following list, compiled by George Bond, Executive Editor of BIX, shows some of the programs that, according to people using BIX, work for uploading and downloading with BIX.

bix.business/tips #5, from gbond (George Bond, Executive Editor, BIX)

This is a list of telecommunications programs that BIX users have reported work reliably for file transfers to and from BIX.

- Work OK
- Crosstalk XVI
- *PC-Talk
- MEX
- *Mini Term (sometimes)
- *RedRyder
- *TICOMM
- Access
- MITE (Framework II version, at least)
- * = in listings area
- PC/BIX
- Ascii-Pro
- MDM740
- *1RD
- *Procomm
- Mack
- *FastTerm
- *QModem

This list is not exhaustive. If you are using a program not listed here to upload and download from BIX, please send BIXmail to sysmgr so that the name of your program can be added to this list.

FORTRON CORPORATION
 3225 Seldon Court
 Fremont, CA 94538

Information & CA Res. (415) 490-8171
 Technical Support (415) 490-8403

Orders Only (800) 821-9771

FORTRON PRESENTS THE DEPENDABLE ONES

While some power supply importers reduce their selling prices by using cheaper and fewer materials, we at Fortron do not jeopardize our discriminating customer's faith in our standards of quality by such compromises.

Here are some visible differences Fortron uses:

- **Burndy (U.S. made) connectors** which provide error-free connections from power supply to CPU board and peripherals.
- **A shielded power cord** insures minimum AC line interference.
- **Built-in EMI filter** maintains a conductive emissions level specification to greater than 6 dB/uV below **FCC Class B.**
- **All U.L. recognized materials and circuit layout** to ensure complete safety.

In addition to our high quality materials, our testing facility in the U.S. and our technical support from five full time power supply and system application engineers has made Fortron's PC/XT and AT power supplies tops in their field.

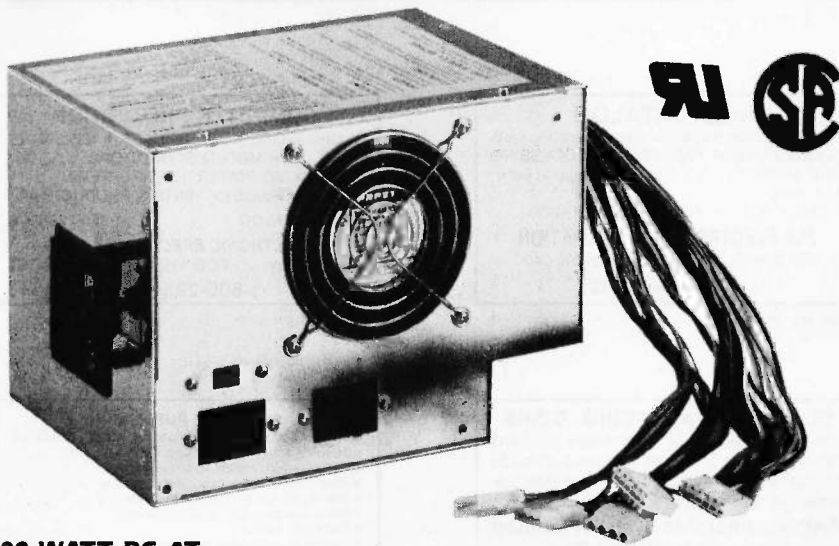

200 WATT PC AT

- U.L. recognized, CSA pending
- OVP, OCP, short circuit protection
- Meets European safety requirements
- MTBF 34,000 hours
- Four drive connectors
- One full year warranty

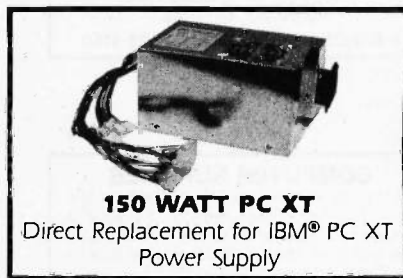

150 WATT PC XT

Direct Replacement for IBM® PC XT Power Supply

DEALERS & SYSTEM INTEGRATORS INQUIRIES INVITED

We have also carefully selected a full line of high quality parts and peripherals to make a complete system.

• CPU Mother Boards

XT, 4.7 mhz	90.00
XT, 4.7/8 mhz	95.00
AT, 6/8 mhz	480.00

• Keyboards

PC XT, AT	55.00
PC XT, 515I	65.00
PC AT, Enhanced	70.00
PC XT, Maxi Switch	59.00

• XT, AT, Add-On Card

Mono/Graphic/Printer	65.00
XT, I/O Floppy	69.00
AT, I/O	69.00
XT, Clock/Calendar	44.00
AT, Multifunction Card	129.00

• Disk Drives

20 MB ST-225 Kit	350.00
JVC 360K Floppy Drives	75.00
Teac 55 BV	82.00

• TTL Amber Monitor

	68.00
--	-------

• Computer Cabinets

XT, Identical	35.00
AT, Identical	69.00
AT, New Front Panel	72.00
XT, Flip-Top, AT Look-Alike	35.00

• Memory Chips

256K DRAM (150 ns)	2.25 each
256K DRAM (120 ns)	call
256K DRAM (100 ns)	call

Too many to list. Please call for more information and a free catalog.



• **DEALER QUANTITY PRICE ONLY.**

Inquiry 137 for End-Users. Inquiry 138 for DEALERS ONLY.

ACCESSORIES

FREE CATALOG

Outstanding prices on computer accessories for your computer and workstation. Our catalog features a wide selection of quality products to meet all your accessory needs. Call or write today to receive your free catalog.

LINTEK COMPUTER ACCESSORIES

426 North Park N.E., Grand Rapids, MI 49505
(616) 361-6644

Inquiry 702.

FREE CATALOG

Thousands of parts and new surplus electronic parts at super low prices. **FAST ORDER PROCESSING AND SHIPPING** (95% of all orders shipped within 48 hours).

CALL OR WRITE FOR A FREE CATALOG.

ALL ELECTRONICS CORPORATION

POB 20406, Los Angeles, CA 90006-0406
1-800-826-5432

Inquiry 651.

SOFTWARE PACKAGING, DISKS

Cloth binders & slips like IBM's. Vinyl binders, boxes, and folders—many sizes. Disk pages, envelopes, & labels. Low qty. imprinting. Bulk & branded disks. Much More! Low prices. Fast service. Call or write for **FREE CATALOG**.

Anthropomorphic Systems Limited

376-B East St. Charles Road
Lombard, IL 60148

1-800-DEAL-NOW (312) 629-5160

Inquiry 653.

COMPUTER SUPPLIES

• Printer Paper • Diskettes • Printer Labels • Anti-Glare Screens • Printer Ribbons • Storage & Accessories • Surge Protectors • Cleaning & Maintenance Products. Send for our Free price list and Check our prices before you Buy. Call or Write

CALIFORNIA SUPPLY CENTER

POB 143, Dept. 7, Elk Grove, CA 95624
(916) 689-3037

Inquiry 662.

Self-Inking Printer Ribbon

For users of **Okidata** and other open spool ribbon printers. Controlled Printout Devices are a new kind of printing ribbon that re-ink themselves, and will last 15 times longer than the ribbon you are now using. For further information please call or write.

CONTROLLED PRINTOUT DEVICES, INC.

POB 869, Baldwin Rd., Arden, NC 28704
(704) 684-9044

Inquiry 667.

FABRIC DUST COVERS

Our 5th year protecting computers and peripherals with heavy poly/cotton covers.

BEST QUALITY — American made, custom work
BEST SELECTION — 6 colors, 1300 styles
BEST SERVICE — Fast, Toll Free, MC/Visa
BEST PRICES — \$8.95-\$36.95, Shipped Free
BEST VALUE — Monogram or Screening available

COVERS UNLIMITED

POB 381076 • Germantown, TN 38183-1076
800-821-7709 or 901-754-4465

Inquiry 668.

ACCESSORIES

LOWEST PRICES ON DISKETTES

5¼" DSDD 39¢, High Density \$1.25.

3½" SSHD \$1.35, DSHD \$1.45.

- Lifetime warranty
- 100% error free
- Finest quality
- Boxed Products
- Includes tyvek sleeves
- Reinforced hub ring
- Labels & write protect tabs
- Same day shipping

Add 300 shipping per 100. Minimum 100 diskettes.

Send check or call. CA residents add 6½% sales tax.

Data Bureau Inc. 213-479-0345

1633 Westwood Blvd., Ste. 120, Los Angeles, CA 90024

Inquiry 671.

COMPUTER PROTECTION

- UPS • LINE CONDITIONERS • ISOLATORS
 - MODEM PROTECTORS
 - AC POWER INTERRUPTERS
- HUNDREDS OF HINTS & PRODUCTS —

FREE CATALOG 1-800-225-4876

ELECTRONIC SPECIALISTS, INC.

171 So. Main St., POB 389, Natick, Mass 01760
1-800-225-4876

Inquiry 679.

...SOFTWARE PUBLISHING...

GDS offers a wide variety of services that will help get your software to the market. Address your needs with GDS

- IBM style cloth/vinyl 3-ring binders/slips
- Labels, sleeves, disk pages, bulk diskettes
- Disk duplication with 100% verification
- Shrink wrapping and product assembly
- Quick turn-around

A well packaged product can make the difference in making a sale. Call us now! VISA/MC

GLENCO DEVELOPMENT SYSTEMS(312) 392-2492
3920 Ridge Ave., Arlington Hts. IL 60004

Inquiry 686.

► COMPUTER PROTECTION ◄
PREVENTIVE MAINTENANCE KIT COMES COMPLETE WITH:

- CRT anti-static/glare cleaner
- Contact cleaner
- Air blaster for keyboards/printers & more
- 5¼" Disk head cleaner
- Non-abrasive cloths
- Simple How-To-Booklet w/diagrams for:

IBM'S, COMPATIBLES, TANDY, APPLES.

\$39.95 + \$4 S/H COD/M.O./CHK

T & W COMPANY (213) 426-4595
226 Euclid Ave., #B, Long Beach, CA 90803

Inquiry 736.

Quality PC Accessories!

Our NEW Catalog includes every Accessory ANY PC USER might want! We have it All, from PC Stands to Monitor Pedestals, Travel Cases to Data Bank Watches, Switches/Cables to Chocolate Floppys, and even a PC Toolkit! Simply call or write for a complimentary copy of our latest catalog. Our products, service, and guarantees are simply the finest.

Tipz Direct, Inc. Simply Call 1-800-TO-ASK-US

PO. Box 690, San Francisco, CA 94101-0690
1-800-862-7587 or 415-567-4067

Inquiry 739.

• RIBBONS •
— OVER 300 AVAILABLE —

	BLACK	COLORS
APPLE IMAGEWRITER	\$2.25	\$2.75
DIABLO HT 2 m/s	2.40	n/a
EPSON MX-RX 70/80	2.25	2.75
OKIDATA 80-82-92	.85	1.25

Nationwide **1-800-331-6841**

In Ohio **1-513-865-0947**

MC/VISA/AMEX DEALER SUPPLIES

Inquiry 781.

ACCESSORIES

DATA CABLES & PARTS

EIA RS232-C Data Cables - standard, extended distance, Teflon Assemblies. Also Centronics (parallel), Coaxial (RG59U, RG62A/U, Dual Wang, Twin-axial), Ethernet, Ribbon, IBM, DEC Compatible cables, AB switches, connector parts, bulk cable; tools & hardware (wall plates). Send for Catalog.

Communication Cable Co.

POB 600-B, Wayne, PA 19087
215-644-1900

Inquiry 788.

FREE CATALOG

Diskettes & Acc • Dust Covers • Furniture • Data Cartridges • Plotter Pens • Clean'g Supl • Tapes & Acc • Ribbons • Printers • Computer Paper • Copier Supplies • Surge Prot • Cables & Acc • Print Wheels • MUCH MORE!

Call, write or circle inquiry card for a FREE, 80 page Catalog

GAAN COMPUTER SUPPLIES

186 B East Sunnyoaks, Campbell, CA 95008
(800) 523-1238, In Calif. (408) 370-6747

Inquiry 792.

ASSEMBLY LANGUAGE

FREE 8088 TUTOR Monitor

Learn 8088 assembly language using the new book, *IBM PC-8088 Assembly Language Programming*, by Richard E. Haskell. Order the book for \$25 plus \$3 S/H and get the powerful TUTOR monitor software free. Load and examine any disk file, disassemble any 8088 code, debug EXE files. Satisfaction guaranteed.

REHI Books

54 N. Adams, Suite 130-Y, Rochester Hills, MI 48063
(313) 853-1941

Inquiry 722.

BAR CODE

DATA INPUT DEVICES

Bar Code & Magnetic Stripe Readers for microcomputers & terminals, including IBM, DEC, AT&T, CT, Wyse, Wang. All readers connect on the keyboard cable & are transparent to all software. Low cost bar code print programs & magnetic encoders are also available.

TPS Electronics

4047 Transport, Palo Alto, CA 94303
415-856-6833 Telex 371-9097 TPS PLA

Inquiry 741.

PRINT BAR CODES ON PC

Print Bar Codes and Large Text Labels on PC with Epson/Okidata/IBM Printers - Code 39, 12of5, UPC/EAN, MSI, DOD-LOGMARS, AIAG. Text up to 1" tall. File input. Menu driven \$49-299. 8K Ram-Resident program prints bar codes from any user program or even word processor — \$179, (\$239 with large text).

Worthington Data Solutions

130 Crespi Court, Santa Cruz, CA 95060
(408) 458-9938

Inquiry 748.

BAR CODE READERS

Program-transparent, Keyboard interface Bar Code Readers for IBM PC, AT and compatibles-\$385. Other wedge readers for IBM 3180, 3178, 3278, 5251, 5291, and RS-232 terminals. Portable Bar Code Readers from \$325. Programmable Hand-Held Portables-\$1350. Free PC print program with reader purchase. 30 day money-back guarantee on all products.

Worthington Data Solutions

130 Crespi Court, Santa Cruz, CA 95060
(408) 458-9938

Inquiry 748.

THE BUYER'S MART

COMMUNICATION

VT102/52 TEK4014 VT220

Our terminal emulators turn your PC/AT/jr into a full featured terminal. Features include: local printing, ASCII & KERMIT file transfer, softkeys, DOS key, ANSI COLOR, 4014 graphics support. Guaranteed compatibility. Call today for free info packet.

General Micro Systems

P.O. Box 5330, Hopkins, MN 55343-1553
(612) 944-0593

Inquiry 685.

MULTI-USER BBS (PC AT)

TEAMate—a mainframe quality BBS. A mini COMPU-SERVE. Full screen cursor-controlled interface, topic outline structure, public and private topics, audit trails, XMODEM, integrated mail, content retrieval and more. Requires XENIX. From \$495. MS-DOS Demo \$29.95

MMB Development Corporation

753 Deep Valley Drive, Rolling Hills Estates, CA 90274
213-541-4504

Inquiry 710.

COMPUTER DIGITIZERS

VIDEO IMAGE PROCESSING

- STORE VIDEO PICTURES ON DISK
- CAPTURE & PRINT REAL-WORLD IMAGES
- Custom Applications Include:
 - Video Databases
 - Desktop Publishing
 - PC Based Video Telephones
 - Color/B&W T-Shirt Systems
- Digitizers (Computer Eye, Chorus, etc.)
- Video Toolkits for DBASE III, LOTUS 123, etc.

See HAL SYSTEMS below

Inquiry 785.

HAL SYSTEMS

Image Processing Specialists

674 Route 202-206N
Bridgewater, NJ 08807

1-800-227-0158

(in NJ 201-218-1818)

201-469-0049 (24 hr. BBS/Modem)

"A picture is worth a thousand words"

Inquiry 785.

COMPUTER FURNITURE

MOBILE PC WORKSTATIONS

The new *Mobile-Station* series of computer workstations add wheels to your computer system. Position it next to your desk like a typewriter or take it from room to room. Several models in wood or laminates. Call or write for catalog and more information.

MicroLand Furniture Co., Inc.

11 Madrone Ave. — San Anselmo, CA 94960
415-485-9758

Inquiry 709.

COMPUTER INSURANCE

COMPUTER OWNERS INSURANCE

Call toll free for coverages and premiums

- COMPUTERS OVERSEAS
- COMPUTERS YOU LEASE
- COMPUTERS YOU LEASE TO OTHERS

SAFWARE

The Insurance Agency Inc.

1-800-848-3469

IN OHIO (614) 262-0559

Inquiry 760.

CROSS-ASSEMBLERS

ASSEMBLERS & TRANSLATORS

Over 20 high quality, full function, fast relocatable and absolute macro assemblers are available immediately. Source language translators help you change microcomputers. Call for info about MS/DOS, CPM80, ISIS versions.

RELMS™

P.O. Box 6719
San Jose, California 95150
(408) 265-5411
TWX 910-379-0014

Inquiry 723.

DATA/DISK CONVERSION

DISK AND TAPE CONVERSIONS

High quality conversion services for Dedicated Word Processors, Mini and Microcomputers. Over 600 3½", 5¼", and 8" formats. Also 800-1600BPI tape. Included: Wang, NBI, CPT, DEC, Vydec, Lanier, OS/6, Xerox, IBM Sys/34/36/38/5520, Mac, Victor, TRS, Apple, NSTAR, IBM PC/AT, HP, and most of the other microcomputers. We can convert directly into word processing software such as: DW3, WP, MS/WRD, WS, Samna, MM, PFS, and many others.

DATA FORMATS, INC. (408) 972-1830

Inquiry 673.

CONVERT TAPE TO DISK

We will transfer data from any ½" 9-track magnetic tape recorded at 1600 or 3200 bpi to 5¼" IBM PC floppies. Diskettes included. Quantity and repeat customer discounts. Fast turnaround. Disk to tape transfers also available. *Competitive Rates!*

Micro Data Services

5 Town and Country Village, Suite 774 • San Jose, CA 95128
(408) 980-7203

Inquiry 705.

AMERICA'S MOST ADVANCED DATA CONVERSION FACILITY:

1,000 formats.
Tape, disk,
mailing
lists, wp, opt.
scanning
& custom
reformatting.

Data Conversion Laboratory
(718) 939-4921

Inquiry 672.

Disk/Disk • Tape/Disk

Over 600 formats! 3½, 5¼, or 8 inch disks; 9 track mag tape; 10 MB Bernoulli cartridge. Data base and word processor translation specialists.

Computer Conversions, Inc.

9580 Black Mountain Rd., Ste J
San Diego, CA 92126
(619) 693-1697

Inquiry 665.

CONVERSION SERVICES

Convert any 9 track magnetic tape to or from over 700 formats including 3½", 5¼", 8" disk formats & word processors. Disk to disk conversions also available. Call for more info. Introducing OCR Scanning Services.

Pivar Computing Services, Inc.

165 Arlington Hgts. Rd., Dept. #B
Buffalo Grove, IL 60089 (312) 459-6010

Inquiry 754.

DATA/DISK CONVERSION

CONVERT CP/M <—> MS-DOS

Read, write and format CP/M diskettes on an IBM PC or compatible. Over 115 CP/M formats on the menu and you can add your own. Use Convert to copy text and data files (such as WordStar and Dbase II) between CP/M and MS-DOS. Or use it to manufacture CP/M diskettes.

Only \$69 from Selfware, Inc.

3545 Chain Bridge Rd., Suite 3
Fairfax, VA 22030
703-352-2977

Inquiry 751.

DOCUMENTATION

COMPUTER ASSEMBLY MANUALS

BIG BLUE SEED for IBM™ BUILDERS: Parts list, placement diagrams, instructions for assembling 75 bare cards. Now includes 640K, Turbo & AT MthBds. \$17.95.
APPLE™ BUILDERS NEED APPLE SEED: Instructions for assembling 85 Apple-compatible bare cards including the popular 6502 II+ and IIe MthBds. \$14.95.
Both for \$30. Bare cards available. Check/MO/ISA/MC:

NuScope Associates*, Dept B

P.O. Box 790 • Lewiston New York • 14092
*A Division of Kosmic MicroTech Inc.

Inquiry 751.

DUPLICATING SERVICES

DUPLICATION SOLUTIONS

MEGASOFT has the answer to your Diskette Duplication needs no matter what the volume. We provide *DUPLICATION *COPY PROTECTION *TECHNICAL SUPPORT *PACKAGE ASSEMBLY & DISTRIBUTIVE SHIPPING. We supply *AUTOLOADERS *BULK DISKETTES. We guarantee *QUALITY *100% SATISFACTION *FAST TURN AROUND.

MegaSoft

P.O. Box 710, Freehold, NJ 07728

1-800-222-0490 201-462-7628 (in NJ)

Inquiry 751.

100% Guaranteed Copies

Protect your reputation with top-quality duplication. We copy 3½", 5¼", 8" media (48 TPI, 96 TPI and high density). We offer 24-hour delivery of 50 to 5,000 copies. Also drop shipping and free warehousing. We collate, label, serialize, copy protect, package and shrink wrap.

WESTERN TRANSDATA, INC.

1701 E. Edinger Ave. A-4, Santa Ana, CA 92705
714/547-3383 (Collect)

Inquiry 747.

BLANKET SERVICES

Diskette duplication • Packaging • Stocking/Drop shipping • 48 hour delivery • SUPERLOK copy protection • No mastering fee • No charge for standard labels • Place a blanket order with releases as you need them for any quantity at a fixed price.

Star-Byte, Inc.

2564 Industry Lane, Norristown, PA 19403
215-539-4300 800-243-1515

Inquiry 755.

FLOW CHARTS

FLOW CHARTING II HELPS YOU!

Precise flowcharting is fast and simple with Flow Charting II. Draw, edit and print perfect charts: bold and normal fonts, 24 shapes — 95 sizes; fast entry of arrows, bypasses & connectors; Fast Insert Line; shrink screen displays 200-column chart; 40 column edit screen for detail work, much more!

PATTON & PATTON

340 Lassenpark Circle, San Jose, CA 95136

1-800/672-3470, ext. 897 (CA residents)

1-800/538-8157, ext. 897 (Outside CA)

408/629-5044 (Outside the U.S.A.)

Inquiry 719.

THE BUYER'S MART

HARDWARE

68020 COMPUTERS

Up to 14.5 Mbyte RAM, 258K ROM, 30 users. DMA floppy and SASI (SCSI), calendar/clock w/bat. backup, timer, real time multi-tasking, multi-user op. sys., basic assembler, screen editors, spreadsheet. Fits PC type cabinet. Mem. Prot. option, more.

From \$2195.00.

Other 68XXX computer systems from \$995.00.

AAA Chicago Computer Center

120 Chestnut Lane - Wheeling, IL 60090

(312) 459-0450

Inquiry 650.

??? PC WON'T TALK ???

If your IBM-PC or compatible won't say a word, it needs a Mouthpiece, the synthesized-speech development system!

- half-slot plug-in synthesizer
- menu driven software
- text-to-speech capability

Introductory price: \$119

DWK Research

22458 Ventura Blvd Suite E
Woodland Hills, CA 91364
805-584-8123

Inquiry 677.

MEGABYTES OF MEMORY

Lowest Prices Guaranteed in US. Dealer Inq. Invited
Fully Populated 2MB Memory Boards
TALLTREE SYSTEMS — JRAM BOARDS

JRAM 2	\$134	OPEN 7
JRAM 3 Aboveboard	183	DAYS A WEEK
JRAM AT	183	M-F 9-8
JRAM AT Aboveboard	239	S-S 9-6
JDISKETTE	135	VISA, MC, AE, CHOICE
JLASER I	275	703-847-4740
JMODULES	CALL	800-642-2395

Information and Technology Services, Inc.

EPROM/EEPROM PROG. \$250

Programs 2716-27512, 25xx and 68764/66 eproms via RS-232. Also 874x micros and 28xxA & 52Bxx EEPROMs. Automatic baud rate select, built in help menus. no personality modules!

16 BIT I/O MODULE \$75

Low cost control via RS-232. Expands to 512!

INTELLITRONICS

P.O. Box 3263, Tustin, CA 92680
(714) 669-0614

Inquiry 696.

PC WHOLESALE CENTER F.C.C. APPROVED BASIC KIT

* 640K Mother Board (OK)	\$94.00
* 5150 Keyboard	\$46.00
* 150W Power Supply	\$56.00
* Case	\$34.00
* Disk I/O Card	\$70.00
* Color Graphic Printer Card	\$60.00
ALL FOR \$230.00, CALL FOR OTHER ADD-ON CARD.	
* TTL Monitor	\$80.00
	MGP \$60.00

SANFORD INC. (713) 879-0068
10413 Rockley Rd., Houston, TX 77099

Inquiry 725.

USED APPLES & IBM's

Laser 128 (new) — \$385.00

Apple II+ and IIe — call

Imagewriter I — \$275.00

Motherboards & accessories — call

We buy, sell, & horsetrade — Apple, IBM, & CBM.

SHREVE SYSTEMS

845 Lark Ave., Shreveport, LA 71105
318-865-6743 4-9 p.m. C.S.T. VISA/MC

Inquiry 729.

HARDWARE

SANYO 550/555 USERS

TURBO BOARD-7.2 MHZ	\$ 95.00
20 MEG EXTERNAL HARD DISK SYSTEM	\$749.95
SANYO VIDEO BOARD (ORIGINAL)	\$174.95
RS-232 BD	\$ 49.95
HARD DISK CONT W/CABLES & SOFT (ST-506)	\$249.95
768K MEM. CLK. & EXPANSION BD.	
(FREE RAMDISK, SPOOLER, & SOFTVIDEO-RUNS IBM PROGRAMS)	\$199.95

TAMPA BAY DIGITAL

1807 Gulf-to-Bay Blvd., Clearwater, FL 33575
813-443-7049

Inquiry 737.

Z80™ / 64180/CP/M™ CO-PROCESSORS

Plug-in co-processors for PC, PC/AT.

Blue Thunder (5 mhz)	\$199.50
Blue Lightning (9 mhz)	\$595.00
D64180 w/SBX Connectors	\$445.00

Run CP/M software on PC as if MS-DOS software. Diskette conversion included. Can run Intel ISIS software. We have cards for PDP-11 and VAX too.

Z-WORLD 408-980-1678

2065 Martin Ave. #110, Santa Clara, CA 95050

Inquiry 750.

CHIP CHECKER

- 54/74 TTL & CMOS
 - 14/4000 CMOS
 - 9000 TTL
 - 14-24 Pin Chips
 - Two 24 Pin ZIF sockets
 - 3" and 6" IC widths
- Tests/identifies chips with ANY type of output in seconds. Inexpensive software updates will be offered as new chips become available. For C128 and C64. \$129 plus \$3.50 s+h.

DUNE SYSTEMS

2603 Willa Dr., St. Joseph, MI 49085
(616) 983-2352

Inquiry 756.

LOAD CELL INPUT & CONTROL

Local/remote control of plant processes via multi-drop bus from single serial port; compatible with all computers. Basic software included.

- Load cell input
- 8 channel AC output
- 24 channels AC/DC I/O
- Count up/down/dispense

SCALE-TRON INC.

P.O. Box 424, Lachine, Quebec, H8S 4C2 Canada
(514) 634-7032

Inquiry 776.

PANASONIC PRINTER Connection

*** Panasonic printers offer a two year warranty ***

New KX-P 1080-I	\$239.00	KX-P 1092	\$315.00
KX-P 1592	\$450.00	KX-P 1595	\$615.00
KX-P 3131	\$270.00	KX-P 3151	\$395.00

C.C.C.C., Inc.

CHERRY CAPITAL COMPUTER CONNECTION, Inc.
336 E. Front St. Traverse City, MI 49684
(616) 947-7275

Inquiry 664.

HARDWARE ADD-ONS

DIGITAL SIGNAL PROCESSOR

The Model 10 coprocessor board for IBM PC/XT/AT is based on the 16/32 bit TI TMS 32010 and is designed for applications in communications, speech, instrumentation, and numeric processing. A 1K complex FFT takes under 90ms. Offered with onboard 12 bit A/D and D/A. Includes all utility and applications software. \$650 — \$850.

DALANCO SPRY

Suite 241 2900 Connecticut Ave NW
Washington, DC 20008
(202) 232-7999

Inquiry 670.

HARDWARE ADD-ONS

APPLE COMPATIBLE PRODUCTS

IIe RAM/80 Column Boards, 64K \$39. 256K \$109. 512K \$139. 1.0MEG \$238. 256K-1.0MEG includes XMe PLUSWORKS Sfwr. II+ 80 Col Bd \$49. IIe Keypad w/16 Keys \$39. II+ 1/2 Cooling Fan w/surge protect \$29.95. Add \$3 Shipping. Write for complete list.

NEXO DISTRIBUTION

914 East 8th St., Ste. 109, National City, CA 92050
(619) 474-3328

Inquiry 713.

PC I/O BOARDS

- Four Port RS-232 w/software \$349.00
- RS-422/485 Serial \$149.00
- RS-232/422 with 24 Parallel I/O \$199.00
- RS-422 Synchronous \$299.00
- EPROM/RAM \$199.00
- A/D & Digital I/O \$299.00

Call About Custom Designed Boards

Sealevel Systems Inc.

P.O. Box 1808, Easley, SC 29641
(803) 855-1581

Inquiry 727.

HARDWARE/BLDG. CONTROL

POWERLINE MODEM

CASH REGISTERS, ELECTRONIC SIGNS, PC'S communicate over POWERLINE

RS232C, GE/EIA Consumer Electronic Bus Protocol, Hayes Compatible, 64,000 units on network. Data Compression, 1000 bps (Homenet™ spec), 40 powerline commands, User Programmable Client Layer \$395.

AISI RESEARCH CORPORATION

Discovery Park, University of Victoria 3771A Haro Rd.
Victoria BC CANADA V8W 2Y2
(604) 477-1415

Inquiry 771.

HARDWARE GRAPHICS

HOUSTON INSTRUMENTS PLOTTERS

Houston DMP-40/418/42: A-B/C-D-size \$966/\$2577
Holine LP3700 A-E size: 1 pen \$4175

DIGITIZERS

Summagraphics MM1201, pow. cable \$374

GTCO MD7-1212 complete \$602

Hitachi HDG-1111B Tiger II w/stylus \$735

GRAPHICS BOARD/MONITOR COMBOS

Orchid TurboEGA & NEC Multisync \$1220

Artist 1 & Mitsubishi 19" monitor \$3113

Large corp & institutional PO's accepted O.A.C.

ARDEN SYSTEMS, INC. (213) 479-6707 ext.29
12335 Santa Monica Bl. #240, Los Angeles, CA 90025

Inquiry 655.

LANGUAGE TRANSLATOR

INTERCHANGE HEWLETT PACKARD FILES ON IBM PC

LIF Utility for the IBM PC allows IBM PC's and compatibles to read and write files written by Hewlett Packard Series 70, 80, 200, 300, 1000, 9000 computers. Call for data sheets, config diagram, pricing. Oswego Software Inc. specializes in HP disk file copying, program translators.

Oswego Software Inc.

507 North Adams Street, Oswego, Illinois 60543 USA
(312) 554-3567 TELEX 858757

Inquiry 718.

MACHINE TRANSLATION

The TurboTranslator

Chinese <=> English. Eng/Pinyin in. Chinese/Eng/Pinyin out. Edit (char needs mouse)/export/import dict. 350+ (chars hi qual, 6200+ (2.3Mb) lo. No copy prot. IBM/Herc/etc graph card. IBM-PC & compat, 256K, 2 floppies. AUST \$85 (+\$10 overseas). AMEX/MC/VISA.

SAVAGE SOFTWARE

Box 81, East Caulfield 3145,
Victoria, Australia

Inquiry 726.

THE BUYER'S MART

MAILING LISTS

Professional List Management

ArcList — mainframe mailing list management for the PC/XT/AT. Capacity 20 million names, automatic zip and state verification, print any label, custom charts and reports, merge-purge with excellent near-duplicate recognition, match codes, postal presorting, Nth sampling, much more. \$595. Demo disk available. Take control of your list. Call for free brochure.

Arc Tangent, Inc.

232 Anacapa St., POB 2009, Santa Barbara, CA 93120
800-843-5928 (in CA. 805-965-7277)

Inquiry 654.

SOFTWARE ACCOUNTING

dBASE BUSINESS TOOLS

- * General Ledger
- * Accounts Recvbl.
- * Order Entry
- * Sales Analysis
- * Purch Ord/Invntory
- * Accounts Payable
- * Job Costing
- * Job Estimating

\$99 EA. + s&h w/dBASE 2, 3 or 3+ SOURCE CODE

dATAMAR SYSTEMSSM Cred. Card-Check-COD

6809-B Convoy Court, San Diego, CA 92111
800-223-9963/CA 800-221-9964/(619) 278-8222

Inquiry 674.

SOFTWARE/A.I.

EXPERT SYSTEM LANGUAGE

If you can use a spreadsheet, you can use KNOWOL, the Knowledge Oriented Language, to guide people in solving problems.
KNOWOL+ (Complete) \$99.95
KNOWOL (Introductory) \$39.95

Intelligent Machine Company

1907 Red Oak Circle, New Port Richey, FL 33553
(813) 844-3262

PROGRAM GENERATORS

WINDOW.LIB

\$99.

An easy to use complete windowing system for programmers and writing in

- * BASIC IBM, M.S. CB86
- * COBOL M.S. RMF
- * FORTRAN M.S. RMF
- * C LATTICE, M.S.
- * PASCAL M.S. TURBO
- * dBase Clipper

Window editor included. Create callable pop-up menus, help screens. The line selector features auto reverse highlighting and cursor control. No royalties. Ask about our BIOS/DOS, LIB/VIS/AMC

GLENCOE ENGINEERING (312) 392-2492
3920 Ridge Ave., Arlington Hts., IL 60004

Inquiry 687.

1986 TAX PREPARATION

Fast, easy to use package prepares and prints 1986 Federal Income tax returns using form 1040. Fully interactive, menu driven. Follows IRS forms. Supports 28 forms plus multiples. Fully integrated MS/PC-DOS, 86 Prof. \$349, Pers. \$59, 85 Prof. \$30.

Dunphy Systems, Inc.

P.O. Box 326, Worthington, OH 43085-0326
614-431-0846

Inquiry 676.

SOFTWARE/BASIC

FINALLY! MODULES

Add class to your compiled BASIC programs with FINALLY! MODULES. Use pull-down WINDOWS, horizontal menus, pop-up help screens, input screen and directory managers. For use with FINALLY! library and QuickBASIC 2.0 or IBM Compiler 2.0. 30 Day Money-Back Guarantee. VIS/AMC/Check/MO FINALLY! MODULES is \$99.00 + \$4.00 S&H

KOMPUTERWERK, INC.

851 Parkview Blvd., Pittsburg, PA 15215
(412) 782-0384

Inquiry 700.

PUBLIC DOMAIN

IBM, CP/M, MAC SOFTWARE

Over 2500 disks covering IBM/PCDOS/MSDOS, CP/M and Macintosh. All major public domain user groups represented. Priced from \$6 (US) disk (even lower in quantity). Fast service, shipped around the world. Call or circle inquiry #663 for our FREE 32 page minicatalog of highlights.

CANADA REMOTE SYSTEMS LIMITED

(1-800-387-1901) (1-416-231-2383)

Inquiry 663.

INCOME TAX SOFTWARE

TAXWORKSSM software to enter, calculate, and print Federal Form 1040 and 17 supporting schedules. 1986 marks 4th year of production. Free telephone support. For IBM, MS-DOS, CPM-80. Federal \$400. California \$100.

TAXWORKSSM

881 Alma Real Dr., Suite T-2
Pacific Palisades, CA 90272
(213) 459-2746, in Calif. (800) 232-1040

Inquiry 692.

SOFTWARE/BUSINESS

PC-WriteSM Shareware Ver. 2.7

Fast, powerful word processor/text editor for IBM PC. Spelling checker, screen clip, mailmerge, split screen, ASCII files, macros. Supports proportional printing, laserJet, 300+ printers. \$16 for all software, tutorial/guide on diskette. OK to copy. Register for manual/support, \$89. Full 90-day guarantee.

Quicksoft (206) 282-0452 Visa/MC
219 First N. #224J, Seattle, WA 98109

Inquiry 789.

SOFTWARE FOR PENNIES

GET BEST AND LATEST PC-DOS, CPM-80 AND CP/M-86 PUBLIC DOMAIN PROGRAMS FOR BUSINESS, PERSONAL, EDUCATION, SOFTWARE DEVELOPMENT, MODEMING, SCIENCE, AND MORE. AT LOW COST OF COPYING. 3-1/2, 5-1/4 AND 8" DISK FORMATS ARE SUPPORTED. SEND \$5.00 FOR CATALOG.

MULTIPATH, INC.

Box 395, Montville, NJ 07045
(201) 575-5880

Inquiry 711.

TIME & BILLING

400 clients/20 partners/80 job & 40 out of pocket categories/20 areas of practice/fix'd fee or hourly/more! Prints billings/statements/aged rec's/more! Free phone support. \$149 (VISA/MC/AMEX). MS-DOS/CPM-80. Other original software.

FREE catalogue.

MICRO-ART PROGRAMMERS

614 Alameda Padre Serra, Santa Barbara, CA 93103
(805) 962-0922 (24 hours)

Inquiry 704.

PC-File IIISM Version 4

Search, sort, browse, global changes, macros, mailing labels, format reports with selection & calculations, sub-totals, totals, averages, encryption. Exchange data with 1-2-3, WORD, WordStar. Over 190,000 users. \$59.95 + \$5 s/h. For IBM PC.

ButtonWare, Inc.

P.O. Box 5786, Bellevue, WA 98006
1-800-J-BUTTON

Inquiry 658.

THE BEST OF THE BEST!

Public Domain & User Supported Software for IBM PC or compatible. Word Processing, Database, Spreadsheets, Utilities, Games, Accounting, etc! 50 disk package \$205.00, or rent 2 wks. \$75.00. Info & Super Sampler Disk \$6.50, Deluxe Word Processor \$6.50, both \$12.00. MC/VISA

BLUE CIRCLE GROUP, INC.

Box 23502, Minneapolis, MN 55423
(612) 823-4111

Inquiry 772.

CUSTOM PAYROLL

All systems have multiple pay categories, calculation of all taxes, user defined deductions, 401(k) handling, many reports, paychecks, W-2 forms, and much more. Custom features are available. Prices start at \$695 for system, manual, and PC Basic source code.

Datasmith, Inc.

Box 8036, Shawnee Mission, KS 66208
(913) 381-9118

Inquiry 765.

PC-File/RSM

All the power of PC-File III plus: Relational link to other databases, integrated letter writing & mailmerge, context sensitive pop-up help windows. New binary search retrieves data hundreds of times faster. \$149.95 + \$5 s/h.

ButtonWare, Inc.

P.O. Box 5786, Bellevue, WA 98006
1-800-J-BUTTON

Inquiry 659.

PUBLIC DOMAIN SOFTWARE

50 AMIGA DISKETTES — \$8.50 each, 25 ATARI-ST DISKETTES — \$8.50 each, 490 IBM DISKETTES — \$4.25 each, 60 SANYO 550/555 DISKETTES — \$4.25 each. SAMPLE DISKETTE & CATALOG: AMIGA or ATARI-ST \$8 ppd. IBM or SANYO \$5 ppd. All prices include FREE SHIPPING! Visa/MC - No Extra Charge! 48 hr. Turnaround! Phone Orders Welcome! Quality Media Used!

Computer Solutions

P.O. Box 354 - Dept. B, Mason, Michigan 48854
1-800-874-9375 (M-F 10-5 EST) 1-517-628-2943

Inquiry 666.

1986 INCOME TAX PROGRAM

PC-TAX-MASTER, the complete 1986 Federal Income Tax preparation program for IBM-PC, XT, AT, PCjr and compatibles for only \$95. Form 1040 with 22 schedules and forms. Menu driven, fast, integrated, easy to use. Prints forms. Free telephone support. Yearly updates, and 15 day money back guarantee. Free pop-up scientific calculator with order.

VISA, M.C. C.O.D. call: 1-800-628-2828 Ext 820
Questions and info call: 1-718-417-0165

DATAX

1923 Linden Street, Ridgewood, NY 11385

Inquiry 779.

DATA ENTRY SYSTEM

Heads-down data entry with two-pass verification for the PC/XT/AT & compatibles. Loaded with features like: Auto dup & skip, verify bypass, range checks, & table lookups. Fully menu driven only \$395. Call for free 30 day trial period.

COMPUTER KEYES

21929 Makah Rd., Woodway, WA 98020
(206) 776-6443

THE BUYER'S MART

SOFTWARE/BUSINESS

dFELLER Inventory

Business inventory programs written in modifiable dBASE source code.

dFELLER Inventory **\$150.00**

Requires dBASE II or III, PC-DOS/CPM

dFELLER Plus **\$200.00**

with History and Purchase Orders
Requires dBASE III or dBASE III Plus (For Stockrooms)

Feller Associates

550 CR PPA, Route 3, Ishpeming, MI 49849
(906) 486-6024

Inquiry 683.

LP88-LINEAR PROGRAMMING

A powerful menu-driven system for solving linear programs w/ up to 510 constraints & 2510 variables. Features include interactive & batch operation, spreadsheet-style input & editing, storage of problems & bases, Simplex Algorithm restart, report generator, sensitivity analysis. Req. IBM PC, 192K, \$99 w/8087 support, user's guide. VISA/MC.

EASTERN SOFTWARE PRODUCTS INC.

P.O. Box 15328, Alexandria, VA 22309

(703) 549-5469

Inquiry 678.

OFFICE AUTOMATION SOFTWARE

Order Entry, Inventory \$49.95 each. Independent or interactive. Fast, accurate. Database sizes: 150 to 1000. Monitor up to 15 whse. Other configs avail. Order acknowledgment forms, inventory listings, & reorder level listings printed. Min. req: IBM PC or compatible, 1 DSDD 360K drive, 128K RAM memory, DOS 2.10 or later. MC/VISA, free shipping in continental U.S.

FutureSoft (216) 753-1336

P.O. Box 23005, Cuyahoga Falls, OH 44223-1100

Inquiry 684.

SAVE LEGAL FEES

157 time tested legal forms on disk, complete with menu driven system and editing and printing capability. Free copy of PC-Write word processor included. Forms written by a noted attorney and applicable nationwide. **\$129.95 plus \$7.50 shipping and handling.**

LegalEase™ HDG Software, Inc.

54 Whitney St., Sherborn, MA 01770

617-651-1881

800-628-2828 x 706 for credit card orders

Inquiry 690.

DOWN TO EARTH SOFTWARE

AutoDos (\$34.50) works from a menu to run programs and DOS functions. OmniTask (\$99.50) is a word processing system. Does autoform, mail merge, reports, etc. CorpForm, GenForm (\$74.50 ea)—form corporations and legal documents. Free information.

TSC

P.O. Box 872687, Wasilla, AK 99687

(907) 745-6267

Inquiry 774.

SOFTWARE/CHURCH

Church Package

Parishioner Time, Talent and Treasure System program is written in modifiable dBASE source code.

- Contributions • Disbursements • Ledger
- Names with mailing labels
- Personal information database.

Requires dBASE II or III, PC-DOS/CPM-80 \$200.

Feller Associates

550 CR PPA, Route 3, Ishpeming, MI 49849
(906) 486-6024

Inquiry 682.

SOFTWARE/CHURCH

ROMAR CHURCH SYSTEMS™

Membership-61 fields plus alternate address; labels, letters, reports any field(s). Offering-256 funds; optional pledge; statements; post to 255 x/year. Finance-G/L with budget: up to 500 sub-totals & 99 depts: month & YTD reports anytime for any month. Size 2000 people/floppy. 25000/10 meg. Ad too short! Write!

Romar Church Systems, Attn: BMB

P.O. Box 4211, Elkhart, IN 46514

(219) 262-2188

Inquiry 752.

SOFTWARE EDUCATION

Best Christmas Gift

Our exciting Math Games is designed to make your kid **THE TOP MATH STUDENT** in his class. Send Check/MO, specify **IBM PC** or **APPLE IIC/IE**. \$21.50 ea. + \$2 S/H.

**BLACK BELT-ADDITION -SUBTRACTION
-DIVISION -MULTIPLICATION**

ROBIN SOFTWARE

P.O. Box 1053, Cupertino, CA 95015

(408) 255-7458

Inquiry 724.

SOFTWARE/GENERAL

—SOFTWARE ORGANIZER—

CYBER_CAT will catalog all those disks for You. —FAST and EASY to use! —MENU SCREEN driven! —Catalogs Floppy and Hard disk Root & Sub-dir. —Prints neat attractive Diskette Labels. —Finds any file in seconds. MS-DOS 2.0 2 DRV. **\$24.95 + 5%** tax in Florida. Visa/MC or Check.

CYBER_WARE Corp.

4411 Bee Ridge Rd. Suite S251, Sarasota, FL 33583

1-800-237-8400 x86 In FL 1-800-282-1469 x86

Inquiry 669.

NEW Turbo Pascal™ Programs

Outstanding software. Full source code included! **KEYMASTER, DESKMASTER:** Pop Up desk organizers. Editor, macros, alarms, addr book/dialer, calculator, more! **\$49.95 + \$2 s&h** each. IBM PC & Comp. **DICTIONARY TOOLBOX:** Library to produce/manage bit compressed dict. **\$39.95.** Any MS-DOS Comp. **CHESTER:** Full featured Chinese checkers game using heuristic search. **\$22.00** IBM-PC & Comp. Visa/MC

A. I. SOFTWARE 512-928-2009

2200 Rogge Ln., Austin, TX 78723

Inquiry 764.

FREE FIRSTUP MENU PROGRAM

Simplify your MS-DOS system with FIRSTUP. Complete program. You configure FIRSTUP to do all the commands necessary to start your programs. FIRSTUP then works as a Menu Interface to access your applications with a single key. Includes FREE demo (disk #1) of our other products. Specify IBM-PC, DEC Rainbow or Zenith Z-100. \$4.99 s&h.

Newline Software

P.O. Box 289, Tiverton, RI 02878

(401) 624-3322

Inquiry 782.

FREE CHECKBOOK PROGRAM

Let Check Processor balance your checkbook. Complete program to maintain your checkbook and credit card accounts. Classify entries into 1 of 31 categories. Print reports on entire checkbook or individual categories. On-disk docs. Includes FREE demo (disk #2) of our other products. Specify IBM-PC, DEC Rainbow or Zenith Z-100. \$4.99 s&h.

Newline Software

P.O. Box 289, Tiverton, RI 02878

(401) 624-3322

Inquiry 783.

SOFTWARE/GENERAL

FREE DISK CATALOG PROGRAM

Let DISKombobulate keep track of your disks. Complete program. On-line database keeps track of all your files by file names, sizes, dates and times. Display, print, or store reports of all or selected files in alphabetical or disk order. Includes FREE demo (disk #3) of our other products. Specify IBM-PC, DEC Rainbow or Zenith Z-100. \$4.99 s&h.

Newline Software

P.O. Box 289, Tiverton, RI 02878

(401) 624-3322

Inquiry 784.

PRO FOOTBALL/BASKETBALL

POINTSPREAD ANALYZER database-software includes all NFL games since 1978, with won-loss stats and pointspreads. Basketball version has all NBA games since 1963. In seconds, see stats and patterns. Developed by Ph.D. statisticians. **\$50** each. IBM PC, compatibles. MC/VISA.

BEST BET SOFTWARE

3104 Shattuck Ave., Berkeley, CA 94705

(415) 540-5072

Inquiry 786.

US\$6 . . . INCLUDING DISK

Over 2,900+ software titles for IBM-PC, Apple II, Macintosh, Latest titles. Lots of hi-quality manuals. **VOLUME DISCOUNTS.**

- IBM-PC Light Pen c/w software: **\$65**
- 640K motherboard c/w full RAM: **\$200**
- PC mouse compatibles: **\$65**

Lots of bargains, ram chips, etc. . . . Specify your computer type with \$1 note for our air-mailed catalog to:

MICRO-WORLD, Dept BYTE

Towner POB 310, Singapore 9132

REPUBLIC OF SINGAPORE

Inquiry 770.

GREAT SOFTWARE, CHEAP!

Absolutely Smashing User Supported Software **\$4.95** per disk. PC-Outline, PC-Write, DOSmatic, Commercial Unprotect, File Express, Cheap Assembler, Chess, utilities galore, many more. Money-back guarantee. IBM PC, PC Jr, or compatibles. **FREE CATALOG.**

PLUS SOFTWARE

33495 Del Obispo, Suite 160 M,

Dana Point, CA 92629

Inquiry 768.

NEW INTEGRATED ENVIRONMENT AI FOR THE IBM PC

TOPSI IS A FULL VERSION OF **OPS6** WHICH RUNS UNDER MS-DOS, UNIX OR CPM. A FAST, EFFICIENT EXPERT SYSTEM DEVELOPMENT TOOL

PROTOTYPING: **\$125** PRODUCTION: **\$250**
PROFESSIONAL: **\$375** SHIPPING, ADD \$5

DYNAMIC MASTER SYSTEMS

POB 566456, Atlanta, GA 30356

(404) 565-0771 Telex #282923

Inquiry 762.

SOFTWARE/CHURCH

Church Package

Parishioner Time, Talent and Treasure System program is written in modifiable dBASE source code.

- Contributions • Disbursements • Ledger
- Names with mailing labels
- Personal information database.

Requires dBASE II or III, PC-DOS/CPM-80 \$200.

Feller Associates

550 CR PPA, Route 3, Ishpeming, MI 49849
(906) 486-6024

Inquiry 682.

BIBLIOG2

Software for the accessible library. The technology explosion has made journals a major source of information. **BIBLIOG2** makes that information accessible. Easy to use. Quick to retrieve. Especially made for the IBM PC and IBM PC compatibles. MS-DOS 2.0. Price **\$49.50** Check/MC/VISA

MICRO-DYNAMICS OF TEXAS

P.O. Box 40691, Houston, TX 77240

713-886-8957

Inquiry 759.

THE BUYER'S MART

SOFTWARE/GENERAL

SongWright III

Music Processor for IBM Compatibles
Prints quality lead sheets, songs, scores with text and symbols, multiple staves; transposes to any key; plays tunes. Screen graphics editor; IBM/Epson/Star printers. Send \$49.95, \$2 s&h or write for free sample output.

SongWright Software

Box 61107, Cherry Creek, CO 80206

(303) 691-4573

Inquiry 733

CONTROL YOUR PROJECT!

Describe the work. **MicroGANTT**® project management system calculates the schedule and budget. Optimize the schedule and resource loading interactively. Customize the reports, including Gantt Chart and Network Diagram. Buy only the modules you need. MS-DOS, PC-DOS & CP/M-80. Free catalog.

Earth Data Corporation

P.O. Box 13168, Richmond, VA 23225

(804) 231-0300

Inquiry 793

SOFTWARE/GRAPHICS

TI PRO + TURBO + GRAPHICS

TI_{Graphics} = graphics, turtlegraphics, music, scr and curs controls, + more. Use basic pacs w/o reprog. Source & doc included. TI_{Graphics} \$89.95, + TURBO w/8087 & BCD \$169.95. NEW—TURBOFIX patches IBM TURBO 3.01A to run on TI windows, plot & draw \$39.95 or with TI_{Graphics} or TURBO \$30.00. Specify IBM or MS DOS TURBO.

ProWare, Inc.

1023 SE 36th Ave., Portland, OR 97214

VISA/MC/CHECK 7AM-7PM MON-FRI

(503) 233-4465

Inquiry 720

FAST! 3D GRAPHICS EDITOR

Rotate 4000 planes in 3 secs. Mouse/keybd. Enter planes, swept surfaces, spline curves/surfaces. Multiple views. Copy, mirror, rotate, translate, scale. DOS-like hierarchy. Hidden surface removal. Read/write to disk, much more. \$39.95

Graphics lib for DOS lattice c \$99.95

Money-back guarantee, HERC/CGA

SOFT VISIONS

609 Trowbridge, Santa Rosa, CA 95402

(707) 579-2871

Inquiry 732

SOFTWARE/LANGUAGES

MACINTOSH DEVELOPERS

Dramatically decrease development time. Elegantly crafted compiled library routines for easy implementation of Mac interface. Graphics scrolling and printing, text editing, zooming windows and much more!

PASCAL EXTENDER™ \$89.95

C EXTENDER™ \$129.95

INVENTION SOFTWARE CORPORATION

P.O. Box 3168, Ann Arbor, MI 48106

313-996-8108

Inquiry 698

BASIC => C, PASCAL

Accept Apple, TI, IBM BASICA, etc. Transform spaghetti code to structured statement (REPEAT, WHILE, IF, CASE) by rearranging the statement sequence. Scoped, indented modules at top-down fashion. Generate many vendor's C, PASCAL. All automatic. MS-DOS. \$85 each.

GOTOLESS CONVERSION

P.O. Box 50068, Denton, TX 76206

PH (214) 221-0383

Inquiry 699

SOFTWARE/GRAPHICS

POPULAR HGRAPH™

SCIENTIFIC 2D & 3D graphic routines for IBM PC. Powerful, easy to use. Multiple fonts, device independence. Uses max resolution. Support for most popular devices. Links with MS-Pascal, FORTRAN; Logitech Modula-2. Support for Turbo Pascal. \$189.

HeartLand Software, Inc.

234 S. Franklin, Ames, IA 50010

(515) 292-8216

Inquiry 691

SCIENTIFIC GRAPHS

SCI-GRAPH produces high-res graphs (1680 x 1712 pixels) on Epson or IBM graphics printers. Supports log/linear scales, error bars, overlays, batch-mode operation. Very flexible data entry from disk or keyboard. User customizable. Requires DOS 2 or 3, 256K

\$99.95 (Sorry, no credit cards)

Microcomputer Systems Consultants

32 West Anapamu, Suite 190, Santa Barbara, CA 93101

(805) 963-3412

Inquiry 767

SCREEN PROGRAM GENERATOR

SPG I creates BASIC program code quickly and easily. Design your screen directly and SPG I will generate the BASIC program code to handle the display and input of data. Controls use of color, editing, graphics, cursor movement and function keys. Generated code easy to modify / merge

IBM PC & compatibles 128K

\$75 + \$3.00 S&H (CA + tax)

Treebeard Software

5901 Warner Avenue, Suite 428

Huntington Beach, CA 92649

(714) 840-6939

Inquiry 742

GRAPHICS PRINTER SUPPORT

AT LAST! Use the *PrintSc* key to make quality scaled B&W or color reproductions of your display on any dot matrix, inkjet, or laser printer. **GRAFPLUS** supports all versions of PC or MS-DOS with IBM, Tecmar, and Hercules graphics boards. \$59.95.

Jewell Technologies, Inc.

4302 SW Alaska St., Suite 207, Seattle, WA 98116

(206) 937-1081

Inquiry 699

THE DGI SIGNMAKER

creates presentation quality text signs and overhead transparencies using your IBM or APPLE II computer and most plotters. It provides automatic or manual selection of character size, pen selection, starting location and Normal or Italic letters. Data can be saved, retrieved, edited and plotted in a matter of minutes. \$75.

DECISION GRAPHICS, INC.

P.O. Box 2776-B, Littleton, Colorado 80161

(303) 796-0341

Inquiry 675

HYPER C COMPILERS/TOOLS

Apple II ProDos Professional compiler, CDOS compiler, ProDos entry level compiler, 65C02 Assembly Language Dev. System, Macintosh compiler, full source code for both Apple II and Macintosh programming tools.

For further information/catalog contact:

WSM GROUP, INC. (602) 298-7910

P.O. Box 32005, TUCSON, AZ 85751

Inquiry 749

FORTRAN PROGRAMMER?

Now you can call 2-D and 3-D graphics routines within your FORTRAN program.

GRAFMATIC: 75 callable routines for screen output. \$135.

PLOTMATIC: Pen plotter driver. \$135. For the IBM PC, XT, AT and compatibles. We support a variety of compilers, graphics boards and plotters.

MICROCOMPATIBLES

301 Prelude Drive, Dept. B

Silver Spring, MD 20901

(301) 593-0683

Inquiry 706

MetaWINDOW™/TurboWINDOW™

Advanced graphics toolkit provides Xerox Star/Apple Macintosh style graphics on your IBM PC. Supports most popular graphics cards. Allows you to create pop-up menus, windows & icons; use proportionally spaced fonts; rubberband & rag lines, text or bitmap images; supports mouse-cursor tracking. Tightly optimized for use with Turbo Pascal, IBM Pascal, C, Fortran. MetaWINDOW™/TurboWINDOW™ awarded as PC Tech Jnl's Product of the month.

Metagraphics Software Corp.

4575 Scotts Valley Dr., Scotts Valley, CA 95066

(408) 438-1550

Inquiry 780

NEW LOGO FOR PC'S

- ZLOGO features advanced turtle graphics
- LISP-like equivalence of data and code
- Numeric, string, and list objects
- The command sequences of the built-in editor are user-definable
- There are over 130 commands
- ZLOGO can be easily converted to other languages such as French

192K 565 S&H \$3

COLORWORKS™ (602) 323-9674

Dept. BE 867, 5337 E. Bellevue, Tucson, AZ 85712

Inquiry 791

FORTRAN GRAPHICS LIBRARY

MicroGlyph/SciPlot™ provides (MS/IBM Pro/77L) FORTRAN graphics on any IBM PC/XT/AT. Features lin/log axes, labels, Hershey fonts, hi res plots on (IBM/Epson/Apple LaserWriter) printers, or graphics on (IBM color/EGA/Hercules/mono/Tecmar/GM) displays. \$69.95 plus \$3.00 shipping.

MicroGlyph Systems

P.O. Box 474, Lexington, MA 02173

Inquiry 708

SOFTWARE/LANGUAGES

Minnesota SNOBOL4 Language

Powerful string & data handling facilities. Interpreter compatible with mainframe SNOBOL4. 32K strings, 32 bit integers, 8087 for float & large memory model. Sample pgs include ELIZA. For > 128K IBM PC & DOS or equivalent. Definitive "green" book by Griswold at all available.

Guide + 5 1/4" 5.25DD diskette. \$44.95

Guide + diskette + "green" book. \$59.95

"Green" book only. \$26.95

Postpaid in USA. In NY add tax. VISA/MC (914) 271-5855

BERSTIS INTERNATIONAL

POB 441, Millwood, NY 10546

Inquiry 656

SOFTWARE/SCIENTIFIC

MATRIX 100

Perform multiple regression, solve simultaneous equations, invert matrices, etc. in BASIC or Fortran. Very sound numerically, very powerful and very easy to use. — *OR/MS Today* 2/85 "Stanford Business Software deserves congratulations" — *PC Mag*, 5/14/85. Price \$80. 8087 support \$125; compiler support \$250. Fortran library \$175 (\$4 s&h)

STANFORD BUSINESS SOFTWARE, INC.

2672 Bayshore Parkway, Ste. 304

Mountain View, CA 94043

To Order Call (415) 424-9499

Inquiry 734

THE BUYER'S MART

SOFTWARE/SCIENTIFIC

DATA ACQUISITION ANALYSIS

New from Lotus MEASURE for data acquisition. Attaches to 123 FOURIER PERSPECTIVE II with graphics for analysis. FFT/FT and 30 more linear calculations in 1 & 2D. PRIME FACTOR FFT, a precise subroutine library. Use with your application program written in any language including Turbo Pascal, C, Fortran, and Basic. Borland's TURBO PASCAL and Lotus MANUSCRIPT, a technical word processor also available. Call for prices/package deals.

Alligator Transforms Scientific Software
P.O. Box 11386, Costa Mesa, CA 92627
(714) 662-0660

Inquiry 652.

SOFTWARE/SCIENTIFIC

MATRIX CALCULATOR v.2.0

Matrix manipulations, Linear Programming, Sensitivity, System of Eqns, Multilinear Regression, Diff Eqn Solver, Programmable, Spread Sheet Like Editor/Printer w/built-in Calculator, w/160+ pg. manual at \$59.95. Turbo Pascal source add \$60.

SoftTech Inc.
14640 LaBelle, Oak Park, MI 48237
1-313-544-8544

Inquiry 730.

SOFTWARE/SYSTEMS

CPM-80 LIVES on your PC

CP/Mulator puts a 4mbz 8 bit CP/M emulator in your IBM-PC for \$99. (\$3 s+h).
- A great 8 bit development system
- Saves expensive CPM-80 applications
- Increases PC speed 10% for 8088 programs
- Priced less than most software only products
- Uses no valuable board slots

Source Information
P.O. Box 2974, Warminster, PA 18974
VISA Phone (215) 441-8178 MIC

Inquiry 773.

SOFTWARE/TOOLS

STOP BURNING PROMS

Burn n' Learn is out... The ROM Simulator is in. Plugs into your PC development system and simulates the 27xxx series ROMs. Features allow you to (A)ssemble, U(n)assemble and E(n)ter changes to code under dev. directly in your system, trap and locate execution addresses. No need to burn ROMs, code executes in RAM. The best low-cost dev. tool you will ever buy. Use with any microprocessor or microcontroller. Increase debug productivity 10 times or more. DEBUG utilities avail. for all microprocessors. Pays for itself the first time you use it. Order now at only \$695.00.

Protostar Instruments (714) 662-7910
749 Grayling Bay, Costa Mesa, CA 92626

Inquiry 787.

Affordable Engineering Software
CALL OR WRITE FOR FREE CATALOG
Circuit Analysis • Root Locus • Thermal Analysis • Plotter Drivers • Graphics • Signal Processing • Filter Design • Report Proofreader • Transfer Function Analysis.

BV Engineering
2200 Business Way Suite 207, Riverside, CA 92501
(714) 781-0252 VISA/MC

Inquiry 611.

ORDINARY/PARTIAL DIFFERENTIAL EQN SOLVER

FOR THE IBM PC & COMPATIBLES

MICROCOMPATIBLES INC.
301 Prelude Dr., Silver Spring, MD 20901
(301) 593-0683

Inquiry 707.

CROSS ASSEMBLERS for VAX VMS and PC/MS DOS New Low Prices

Relocatable Macro Cross Assemblers, Linkers, Librarians
Targeted to almost all Microprocessors

ENERTEC, INC.
BOX 1312, Lansdale, PA 19446
215-362-0966 MC/VISA

Inquiry 680.

ELECTRONIC CIRCUIT ANALYSIS

Has AC, DC, Transient and Fourier. Includes worst-case, Monte-Carlo, component sweeping, Macro models, transmission lines.

Electronic Circuit Analysis \$450.
EC-Ace \$95.

TATUM LABS
POB 698, Sandy Hook, CT 06482
(203) 264-3755

Inquiry 738.

PC-Type +

The ultimate tool for writing! PC-Type+ comes equipped with the essentials, PLUS many advanced features—Mail Merge, 100,000 word spelling checker, & a Labels program. Works hand in hand with PC-File and PC-File. Open up to 10 files simultaneously! \$69.95 + \$5 s/h. For IBM PC.

ButtonWare, Inc.
P.O. Box 5786, Bellevue, WA 98006
1-800-J-BUTTON

Inquiry 660.

Computer-Aided Circuit Design

CompDes is a menu-driven electronic circuit design program that has selections from basic electricity to circuit design. The program will calculate values of circuits for attenuators, amplifiers, active and passive filters, power supplies, etc. It has calculators for resistance, resonance, reactance, dB ratio's, VSWR, and more. Design manual included. IBM and DEC Rainbow compatibles. \$49.95

Esoft Software
P.O. Box 072134, Columbus, OH 43207
(614) 491-0832 Visa/MC

Inquiry 611.

FINITE ELEMENT ANALYSIS

Full-featured SAPIV finite element program for 3D static structural analysis. All original elements—beams, plates, 2D plane, 3D solids, etc. Solves up to 700 nodes. IBM/PC or compatible. Complete for only \$295! Try the 70 node/3D frame version—\$39.

Applied Science & Development, Inc.
Suite 141, 169 Southeast Cary Pkwy, Cary, NC 27511
(919) 467-4614

Inquiry 761.

MODULA-2

REPertoire is the latest selling M2 toolkit. New release includes DBMS, screen system, editor, & much more. \$19 for all LNKS & SYMS; \$89 with full (440K) source and 250p printed manual. MC/VISA/AMEX/COD. Call for free demo & manual on disk.

PMI 4536 SE 50th, Portland, OR 97206
(503) 777-8844 (24 hrs); BIX: pmi
In Europe: +47-6-97-00-40

Inquiry 757.

POP UP SCI CALCULATOR

COMPLEX is everything sci. calculator can hope for plus complex algebra, integer & bit manipulation, Boolean Logic, Polynom, eqn, FFT transform, computer graphics, curve fitting, extensible language like FORTH. w/50 pg. manual \$25. Turbo Pascal source add \$60.

SoftTech Inc. 1-313-544-8544
14640 LaBelle, Oak Park, MI 48237

Inquiry 730.

► SCIENTIFIC CALCULATOR ◀

Memory resident emulation of the HP-11C plus direct insertion of results in foreground program, graphically presented, decimal, hex, binary, & octal operations, boolean functions and more. Mouse support. 8087 or Standard versions \$49.95 + 3.00 s&h.

K SOFTWARE HOUSE

Rt. 2, Box 83B1 Unionville, TN 37180
(615) 294-5090

Inquiry 763.

dBDOCGEN™

dBASE™ DOCUMENTATION GENERATOR
dBASE owners easily document your dBASE applications. Documents .DBF (with structure and field names), .NDX (with index), .CMD, .FRM, and .FMT files. Only \$99.50 + \$4 UPS and or + \$6 Blue S&H VISA/MC

CALL TODAY (503) 233-8676
TOP PRIORITY Data Products, Inc.
1731 S.E. 55th Ave., Portland, OR 97215-3396

Inquiry 740.

SOFTWARE/SORT

OPT-TECH SORT/MERGE

Extremely fast Sort/Merge/Select utility. Run as an MS-DOS command or CALL as a subroutine. Supports most languages and filetypes including Btrieve and dBASE. Unlimited filesizes, multiple keys and much more! \$149.

(702) 588-3737

Opt-Tech Data Processing
P.O. Box 678 - Zephyr Cove, NV 89448

Inquiry 716.

forMath® text-formatter

- Equations, matrices, ratios, integrals, diagrams
- Macros, fonts, Greek/math symbols
- Hyphenation, secn/eqn/fret numbering
- Indexes, table of contents, footnotes
- Dot-matrix, daisywheel, laser printers, all monitors \$400. \$50 for demo

SHANTHA SOFTWARE INC.
50 West 97th St. Room 11N, New York City 10025
(212) 222-SNIP
Touchtone toll free: 950-1088-walt-FORMATH

Inquiry 728.

STATISTICS

SL-MICRO

Tabulate survey results or analyze experimental data using SL-MICRO. It has Frequencies with statistics, Crosstabs, Anova, Multiple Regression & Correlation. Data Editor & PC-DOS, MS-DOS or CP/M

Only \$250 for PC-DOS, MS-DOS or CP/M
QSC, Box 778, East Lansing, MI 48823
(517) 641-4428

Inquiry 753.

THE BUYER'S MART

STATISTICS

NUMBER CRUNCHER STAT SYS

Menu-driven. Multiple & stepwise regression, ANOVA, time series, discriminant cluster and factor analysis, principal components, scatter plots, histograms, t-tests, contingency tables, non-parametrics. Import export data. Spreadsheet, sort, join, merge. \$79. IBM PC/Macintosh. Quantity discount.

NCSS-B

865 East 400 North, Kaysville, UT 84037
(801) 546-0445

Inquiry 712.

STATISTICS CATALOG!

If you need statistics for IBM PC or Apple II, call us and let our technical advisors help you find the statistics programs you need. Write or call now to get a FREE catalog of statistics and quality control software.

HUMAN SYSTEMS DYNAMICS

9010 Reseda Blvd., Ste. 222
 Northridge, CA 91324

(800) 451-3030 (818) 993-8536 (CA)

Inquiry 693.

STATISTIX™

\$75 - Satisfaction guaranteed

A comprehensive, powerful, yet easy-to-use statistical analysis system for IBM PC/XT/AT's, Apple II's, and MS DOS machines. Clear 200p manual. Write for information.

NH ANALYTICAL SOFTWARE

801 West Iowa Ave., St. Paul, MN 55117
(612) 488-4436

Inquiry 714.

RATS! Version 2.0

RATS, the best selling Econometric software package, now includes daily and weekly data, a new easier to use 500 page manual, and many advanced features. Use RATS for time-series and cross-section regression, including OLS, ARIMA, VAR, logit, and probit. IBM PC or compatible. \$200. MC/VISA. Call for brochure.

VAR Econometrics, Inc.

P.O. Box 1818, Evanston, IL 60204-1818
(312) 864-1910

Inquiry 745.

The Statistician

includes: Multiple Regression (Stepwise, ridge, all subsets, backward elimination)

- Time series analysis • descriptive statistics
- transformations • survey research • nonparametrics
- X-Y plots • ANOVA • random samples • data base
- data editor • search & sort • hypothesis tests

For IBM, MS-DOS, XENIX, CPM, TRS-DOS.

QUANT SYSTEMS

Box 628, Charleston, SC 29402
803-571-2825

Please call
TOLL FREE
1-800-334-0854
 (Ext. 814)

Inquiry 721.

TERMINAL/EMULATORS

DataTerm 8220

Now you can connect your PC with any Datapoint computer. Full 8220 emulation. File transfer, with DOS or RMS, under user or host control. Supports 50 to 19.2K baud, directly to MPCA or modem. Requires only an IBM compatible with an async comm adaptor. **\$179.95** Visa/MC. Datapoint 8242 or 3600 terminal emulator & 8086 Assembler source is also available.

LAN Comp Systems

14524 I.H.R., Issaquah, WA 98027
206/391-3725

Inquiry 790.

TYPESETTING

DESKTOP PUBLISHING

Laser Printer composition software to drive Cordata L300 with 76 PS Ints \$495. With add 14 PS Lndscp fonts \$695. For Canon LBP-8 A2, NCR, or HP LaserJet+ with 41 PS Pnt or Lndscp Ints \$495. H & J, merge graphics, mix face & pt. size anywhere on any line, mult tab & col justification. Boxes & Rules.

Micro Print-X, Inc.

P.O. Box 581, Ballinger, TX 76821
(915) 365-2343

Inquiry 766.

UTILITIES

SOURCE CODE LIBRARIAN & REVISION CONTROL SYSTEM

TLIB™ keeps ALL versions of your program in ONE compact library file, even with hundreds of revisions.

- 5 times faster than SCCS • LAN compatible
- Free public domain MAKE (with source) by L. Dyer

BURTON SYSTEMS SOFTWARE

POB 4156, Cary, NC 27511
(919) 469-3068

Inquiry 777.

EditingTools

An elegant DOS shell with a superb text editor. Load multiple directories in table format as menus. Edit multiple files circularly. Many innovative features and only 38K in size. Incredible value at \$10 with 36 page manual. Add \$25 for source code in Turbo Pascal. Add \$2 for s/h.

Dr. Jiann Jou

P.O. Box 460969, Garland, TX 75046
214-495-8862

Inquiry 775.

MEDIA MASTER PLUS

READ, WRITE, and FORMAT over 150 CP/M disks and run most CP/M-80 programs on your IBM PC! Two program package includes ZP/EM, a CP/M-80 emulator program that transforms your IBM PC into a 1-2 MHz CP/M 2.2 computer. \$59.95 + \$3.00 S/H (CA 6%)

INTERSECTING CONCEPTS, INC.

4573 Heatherglen Ct., Ste. 10
 Moorpark, CA 93021
(805) 529-5073

Inquiry 697.

Automenu™ version 4.0

Create one menu system to run all your programs, batch files & DOS commands. "Insulates" novices; many options for power users. On-screen help, password protection, user-defined prompts. Written in assembler. 16K size. Over 8,000 satisfied users. Money back guarantee. \$46 + \$4 s/h. Chk/Visa/MC. Call or write for brochure.

Magee Enterprises

Dept. B13, 6577 Peachtree Industrial Blvd,
 Norcross, GA USA 30092-3796
404/446-6611

Inquiry 703.

PADLOCK/PADLOCK II DISKS

PADLOCK furnishes the user with a method for providing protection against unauthorized duplication from DOS commands \$99. PADLOCK II disks come preformatted with finger-print and serialization. PADLOCK II disks offer superior protection. Ask about our HARD DISK protection with uninstall capability. MC/VISA.

GLENCO ENGINEERING

3920 Ridge Ave., Arlington Hs., IL 60004
(312) 392-2492

Inquiry 688.

UTILITIES

CONCURRENT DOS BACKUP

BackPack™ runs like BACKUP/RESTORE and supports DOS and CP/M media as well as users. Backs up and restores up to 1000K/min. on an AT and 360K/min. on an XT. Supports release 4.1. Also available on CP/M-80 and CP/M plus. \$150.

Bright Light, Inc.

520 Fellowship Rd. #C301, Mt. Laurel, NJ 08054
(609) 778-0772

Inquiry 657.

WARP-TEN or RAMback - 9.95

WARP-TEN is a programmable disk cache that speeds up your PC disk access's. RAMbak automates the saving of new or changed RAM disk files to floppy disks and/or hard disk subdirectories. PC, XT, AT, compatibles with 256K DOS 2.0+. Introductory price is only 9.95 each. (MN Res. + 6%). Visa/MC/CHK

Software Brewing Company

P.O. Box 12094, St. Paul, MN 55112
612-636-2727

Inquiry 758.

?WHAT DOESN'T IT DO?

Resides under any software, print multi-fonts to any dot matrix & daisy wheel (Epson, Toshiba, etc.), a pop up 10 mem calculator, DOS services, printable calendar, date/time note pad, help pages, all user modifiable, 70Kb \$60 and IBM PC.

LCS

(514) 279-5678

P.O. Box 956, Outremont, Quebec
 Canada, H2V 4R8

Inquiry 701.

HANDS OFF THE PROGRAM™

- Locks Hard Disk. - Restricts Floppy Use.
- Protects Subdirectories.
- Normal Use of DOS Commands and Application Software.
- IBM PC, XT, AT and True Compatibles.
- DOS V2.0 and Higher. Hard Disk System.
- Keep Other People HANDS OFF Your System

-\$89.95

VISA/MC/MO/CK

SYSTEM CONSULTING, INC.

314 Canterbury Dr., Pittsburgh, PA 15238
(412) 963-1624

Inquiry 735.

IBM - TOSHIBA PRINTER INTERFACE

- all extended capabilities of the TOSHIBAS available
- bit mapped graphics supported
- Prints all IBM extended ASCII characters.
- screen dumps in text and graphics
- escape sequences supported
- popular software supported directly
- "Sideways" and "Pixel Visuals" support
- dealers welcome \$79.95 (\$2.50 S&H)

Integrated Data Technologies, Inc.

4775 Bunchberry Lane, Colorado Springs, CO 80917
303-597-5547 MC/VISA

Inquiry 694.

PAL FOR SIDEKICK!

Personal Appointment Locator automatically shows coming appointments, searches your file, maintains to-do list, automatically repeats appointments, examines multiple files. Resident alarm too! Only **\$49.95**. Cheap at twice the price!

PAL SOFTWARE

Ste. 12B 110 Green St., New York, NY 10012
212-334-9172 1-800-541-0900
 (In CA.) 1-800-334-3030

Inquiry 769.

Compu\$ave

Call Toll Free: 1-800-624-8949

A DIVISION OF ADLANKO CORPORATION

PRINTERS

Citizen 120D . . . 179	Alps P2100 . . . 1199
Citizen MSP10 . . . 275	Canon A60 . . . 469
Citizen MSP15 . . . 375	Canon Laser . . . 1935
Citizen MSP25 . . . 472	NEC P6 . . . 439
Cordata Laser . . . 2159	NEC P7 . . . 599
Panasonic 1080i . . . 199	NEC CP6 . . . 549
Panasonic 1091i . . . 269	NEC CP7 . . . 729
Panasonic 1092 . . . 299	Okidata 192 . . . 306
Panasonic 1592 . . . 415	Okidata 192 + . . . 365
Panasonic 1595 . . . 565	Okidata 193 + . . . 549
Toshiba: All . . . CALL	Star LV1210 . . . 179
Diconix: 150 cps/Portable/4 Lbs. . . 339	
Fujitsu 2100: Color/220 cps/Amiga . . . 475	
CIE/Data Products/Diablo/Epson . . . CALL	
Genicom/Juki/Tally/Televideo/T1 . . . CALL	
Buffers/Cables/Sheet Feeders . . . SAVE	
Stands/Switch Boxes/Tractors . . . SAVE	

MONITORS

Aydin 19" EGA . . . 1995	Amdek 310A . . . 143
Mitsubishi 6920 . . . 1995	Amdek 730 . . . 719
NEC Multisynch . . . 579	PGS SR12 . . . 499
Samsung TTL . . . 89	PGS MAX12 . . . 155
Teco 14" EGA . . . 439	Taxan 760 . . . CALL
Wyse 700 W/Card . . . 709	Wyse 640 . . . 525
Zenith 1230 . . . 92	Roland RGB . . . 289
Hitachi/Nanaco/Thomson/Tatung . . . CALL	

COMPUTERS

AT&T 6300: 640K/ 1 Drive . . . 1295
Cordata 400: Port. & Desk/2 Drives . . . 899
Cordata 400XT: Port. & Desk/20M . . . 1465
Cordata AT: Port./20M Drive . . . 2265
Corvus PC: 640K/2 Drives/Monitor . . . 845
Laser 128: Apple IIE Compatible . . . 382
Sharp PC7000: Portable/2 Drives . . . 1125
Sharp AT: 6 & 8 MHz/20M Drive . . . 1949
Sperry IT: 512K/1.2M Drive . . . 1965
Sperry IT: 512K/44M Drive . . . 2799
TeleCat 286: 512K/20M Dr/Monitor . . . 2249
Toshiba 1100 + & 3100 Portables . . . CALL
Wyse Turbo PC: 256K/1 Drive . . . 799
Wyse 286: 10 MHz/640K/20M Drive . . . 2149
Wyse 286: 10 MHz/640K/40M Drive . . . 2699
Zenith 181: Portable 512K/2 Drives . . . 1675
Altos/NEC/Olivetti/Others . . . LOW PRICES

TERMINALS

IBM 3164 Color . . . 899	Altos IV . . . 355
Kimtron KT7 . . . 435	Ampex 232 . . . 485
Liberty Freedom I . . . 385	Wyse 30 . . . 289
Qume 101G . . . 293	Wyse 50 . . . 369
Televideo 905 . . . 285	Wyse 60 . . . 469
Televideo 955 . . . 399	Wyse 85G . . . 432
Televideo 9220 . . . 452	Zenith 49 . . . 565
Adds/DEC/Hazeltine/Link/Visual . . . CALL	

PLOTTERS

Houston Instruments DMP 51/52 . . . 3295	
Houston Instruments DMP 56 . . . 4195	
HP 7570 . . . 4495	Roland 880 . . . 899
HP 7475 . . . 1595	Roland 980 . . . 1175
Roland 800 . . . 375	Ioline 3700 . . . 3895
Amdek/Calcomp/Taxan/Others . . . CALL	

DIGITIZERS

Houston: All Models . . . THE LOWEST PRICES	
Kurta Penmouse . . . 185	Hitachi 11x11 . . . 589
Kurta 8.5x11 . . . 299	GTCC: All . . . CALL
Summa Mac 12 . . . 349	Summa 12x12 . . . 355
Summa Mouse . . . 82	Summa 12x18 . . . 699
Mice: Microsoft/Mouse Systems/Etc. . . SAVE	

MODEMS

Anchor Volksmodem 12 . . . 119
Anchor Lightning 2400: W/Software . . . 299
Anchor Volks I: 1200 W/Software . . . 119
Hayes Smartmodem 1200 . . . 349
Hayes 1200B: W/Software . . . 325
Hayes Smartmodem 2400 . . . 555
Hayes 2400B: W/Software . . . 505
Incomm 2400: Upgradeable 4800 + . . . 295
Prometheus Promodem 2400G . . . 345
Prometheus Promodem 1200A: Apple . . . 185
Prometheus Promodem 300C: Apple . . . 75
Racal-Vadic 2400V & PC . . . 399
UDS 208 A/B: 4800 Baud . . . 935
US Robotics Courier 2400 . . . 378
AST/Codex/Practical/Rixon/Zoom . . . CALL

BOARDS

Artist I: 1024 x 768 (Interlaced) . . . 1449
Artist I + : 1024x768 (Noninterlaced) . . . 1795
AST Rampage: PC-XT/256K . . . 242
Hercules Monochrome Graphics . . . 188
Orange Grappler + : Apple . . . 69
PC 576K RAM Board: OK . . . 55
PC Monochrome Graphics Card . . . 85
PC Multifunction Card . . . 79
Photon: Graphics/800 x 600 . . . 799
Sigma 400L: Graphics . . . 395
Tecmar EGA: Graphics . . . 265
Video 7 Vega Deluxe . . . 365
Intel/Microtek/Orchid/Practical . . . CALL
Persyst/Quadram/STB/Taxan/Vutek . . . CALL

WE ALSO CARRY MANY OTHER PRODUCT LINES & MODELS, CABLES, SOFTWARE CHIPS, KEYBOARDS, POWER DEVICES

DISK DRIVES

Apple Drives . . . 112	Teac 55B . . . 95
Maxtor 140M . . . 2995	CDC 40M . . . 1145
IOMEGA Dual 20M Bernoulli + 80M . . . 3995	
Miniscribe 20M Drive & 10M Controller . . . 440	
Seagate 20M Hard Drive & Controller . . . 372	
Tandon 20M Hard Card (#1 Rated) . . . 449	

OTHER FLOPPY AND HARD DRIVES

Alloy • CMS • Corvus • Fujitsu • Irwin
Maynard • Mitsubishi • Mountain
Pram • Rodine • Sanyo • Talgrass • Teac
Tecmar • Toshiba • Western Digital

**HOURS: MON - FRI 7AM - 6PM/SAT 9AM - 2PM
IN ARIZONA CALL (602) 437-4855**

CompuSave: 4207 S. 37th St., Phoenix, AZ 85040/Prices Reflect Cash Discounts And Subject To Change Without Notice. Major Credit Cards And Selected PO's Are Accepted. We Cannot Guarantee Compatibility.

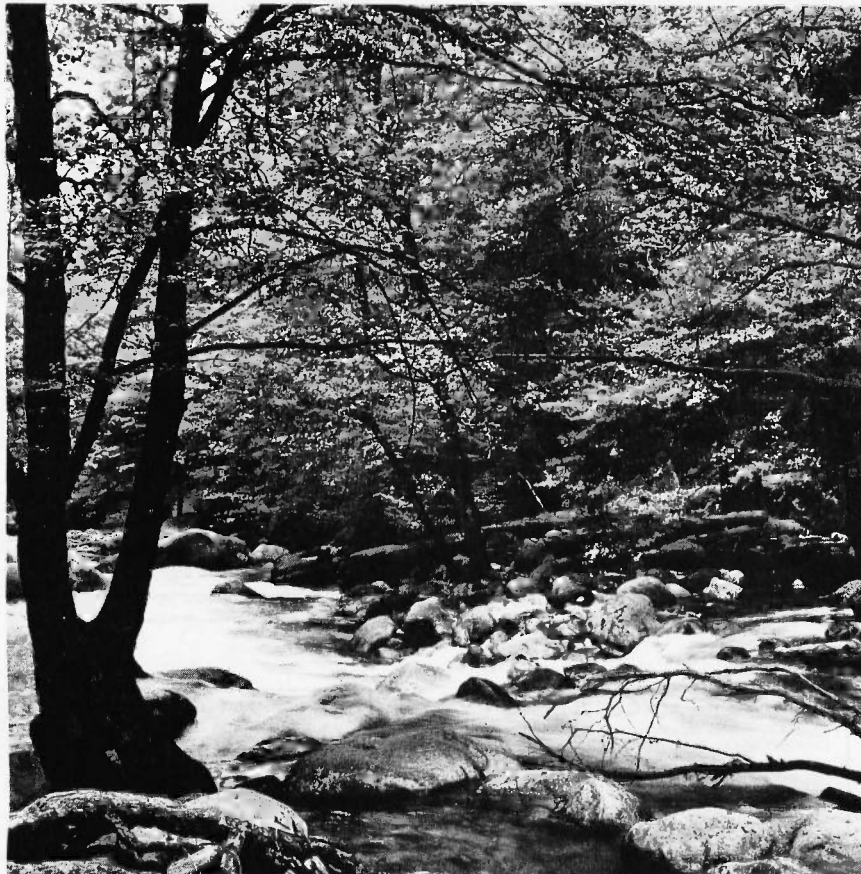

Bruce Barnbaum

To Explore, Enjoy, and Protect

You and I share a great love of this earth.

The ocean's pounding surf, Spring covering the earth with that season's newness, a bird's song reaching out. . . and we are moved.

We enjoy the earth's beauty, its grandeur. The endless sweep of colors, and sounds, and everywhere, the excitement of life.

And we of the Sierra Club join together to protect the earth.

We invite you to join with us. To explore, to enjoy. To protect this wondrous earth. For all of us. . . forever.

For membership information, write Sierra Club, 530 Bush Street, San Francisco, CA 94108, (415) 981-8634.



Sierra Club

8MHz SUPER TURBO SYSTEMS

SUN-ST MONO SYSTEM

\$795



Dealers and Computer Groups
CALL FOR SPECIAL PRICE

- Two 360KB Disk Drives
- 640K RAM
- Hercules Compatible Mono Graphic Card (720x348)
- 12" High-Resolution TTL Mono Monitor
- 135W Power Supply
- AT Style Keyboard
- 4 Layer 8MHz CPU Board
- Keyboard Switchable to 4.77MHz
- Parallel Printer Port
- FCC Approved
- Fully Assembled & Tested
- 1 Year Limited Warranty (Parts & Labor)

SUN-EGA SYSTEM \$1325

- 2 Disk Drives
- 135W Power Supply
- 640K RAM
- AT Style Keyboard
- EGA Card (CGA+EGA+MDA)
- 14" R.G.B. EGA Monitor (EGA+CGA)

SUN-ST BASIC \$465

- 8MHz Turbo CPU
- 1 Disk Drive
- 135W Power Supply
- 256K RAM
- AT Style Keyboard

(Call for other configurations)

SUN-ST COLOR SYSTEM \$1059

- 2 Disk Drives
- 135W Power Supply
- Color G Card
- 640K RAM
- AT Style Keyboard
- 13" R.G.B. Color Monitor

SUN-286 SYSTEM \$1295

- AT Compatible 6&8MHz CPU
- 640K RAM
- 1.2MB FDD (1/2 HT)
- HDD/FDD Controller w/Cable
- 200W Power Supply
- Keyboard 5151 Compatible
- Assembled & Tested

SPECIAL SALE!!

- SUN-ST CPU (8MHz) \$165
(4 Layers, Switchable to 4.77MHz)
- Multi I/O Plus Card \$95
(Serial, Parallel, Clock, Calendar, Game Port, RAM Disk, Spool)

- EGA PACKAGE \$649 Qty. of 2 or more
- EGA Card (EGA + CGA + MDA) w/250K Display Buffer, 14" R.G.B. EGA Monitor (640x350, 0.31mm Dot Pitch)



SUNTRONICS, INC.
12603 Crenshaw Blvd. Hawthorne, CA 90250

1-800-421-5775
(orders only)
213-644-1140

STORE HOURS
MON-FRI 9:00am - 6:00pm
SATURDAY 10:00am - 5:00pm
Dealer & OEM Inquiries Invited

TERMS: VISA, MasterCard (No Surcharge), C.O.D. Cash on Certified Check (VISA or MC Ref. Required), Finance & Gift Certificate P.D. required. Shipping & H.C. \$3.00 for 3 lbs. plus \$3.00 for each additional lb. CA residents add CA Sales Tax \$10.00/Mo. Order WARRANTY: 90 Days Warranty, Labor, Parts, Replacement Only. IBM is a registered trademark of International Business Machines.

BYTE CONNECTION INC. (714) 778-6496

BOTTOM LINE PRICE BUSTERS! - "Who you gonna call?"

★ ★ ★ PERSONAL COMPUTERS ★ ★ ★

UBM ★ I (IBM XT Comp.), w/640K 2 Drives, K.B. Graph Card, Monitor.....	\$ 825
UBM ★ IV (IBM AT Comp.), w/8 MHz 640K, 1.2 MB Floppy, 20 MB HD, Graph Card, Monitor & Keyboard.....	\$1995
IBM PC XT, w/640K, 360 K Floppy, 20 MB HD, Enhanced K.B., Graph Card, Monitor.....	\$2349
IBM PC AT, w/512K, 1.2 Fl., 20 MB HD....	\$3150
IBM PROPRINTER XL.....	\$ 599
IBM PC AT #339, 512K, 1.2 Floppy, IBM 30MB HD.....	\$4375
COMPAQ PORTABLE PLUS, w/256K, 2 Drives.....	\$1695
COMPAQ PORTABLE II with 640K, 80286 Processor, 360K Floppy, 20 MB HC.....	\$2795
COMPAQ PORTABLE 286, with 640K, 1.2 Drive, 20 MB HD.....	\$3749
COMPAQ DESK PRO 286, with 640K, 1.2 Fl., 20 MB HD, Graph Card, Monitor.....	\$3495
LEADING EDGE, 1 Drive, 30 MB, Graphics Card, Monitor & S/W.....	\$1749
AT & T 6300 PC, w/640 K, Two 360 Drives, AT & T Graphics Card & Monitor.....	\$1795
SHARP PORTABLE, w/320K, Two 360K Floppies, DDS.....	\$1149
SPERRY PC-IT, with 640K, 1.2 MB Floppy, 40 MB, K.B., 80287, DOS.....	\$2995
VICTOR V 286, w/640K, 1.2 Floppy, K.B., 20 MB HD, DOS.....	\$2475

★ ★ ★ PLOTTERS ★ ★ ★

CALCOMP 1043 (A - E).....	\$7359	CALCOMP 1044 (A-E, Roll).....	\$11099
HI DMP 56 (A - E).....	\$4575	HI DMP 51/52 (A - D).....	\$3575
HI DMP 42 (A - D).....	\$2575	HI DMP 695 (A - B, 4 Pen).....	\$ 649
HP Color Pro 7440 (A, B).....	\$ 995	HP 7475 (A - B, 6 Pen).....	\$1659
HP Data Pro 7570.....	\$4475	HP 7580B (A - D, 8 Pen).....	\$8395
IO LINE 3700 (A - E).....	\$3895	Western Grop GP 9001 (A-E).....	\$5295

★ ★ ★ DIGITIZERS ★ ★ ★

CALCOMP 12 x 12.....	\$ 709	CALCOMP 44 x 60.....	\$5099
HITACHI 11 x 11.....	\$ 825	HITACHI 15 x 15.....	\$1425
Houston Ins. TG 1011.....	\$ 549	Houston Ins. 8017.....	\$1299
KURTA 12 x 12.....	\$ 580	KURTA 12 x 17.....	\$ 675
SUMMAGRAPHSICS 12x12.....	\$ 475	SUMMAGRAPHSICS 12x17.....	\$ 735

★ ★ ★ GRAPHIC CONTROLLERS & MONITORS ★ ★ ★

Mitsubishi C6920LPAG & Artlist I, (1024 x 768).....	\$2995
Mitsubishi 8918NB & Verticom H-16, (1024 x 768N).....	\$5095
Samsung CD1452 EGA, Monitor Vega EGA.....	\$ 720
Mitsubishi 1341 & Sigma 400 (640 x 400).....	\$ 995
BNW 151 (1024 x 1024).....	\$1245
Artist 10 (1024 x 1024N).....	\$2275

★ ★ ★ SOFTWARE ★ ★ ★

AUTOCAD 2.5 (ADE3).....	\$2195	T & W VERSACAD.....	\$2099
COMPUTER ASSOCIATE (IVS) A/R, A/P, G/L, I/G.....	EACH \$ 385		
CYMA ACCOUNTING A/R, G/L, A/P, I/L.....	EACH \$ 349		
CYMA Medical, Chiropractic, Orthodontic, Dental Package.....	\$1625		
Wordstar & Correct, Mailmerge.....	\$ 295	Wordstar 2000 +.....	\$ 329
d:BASE III +.....	\$ 439	LOTUS.....	\$ 339
IBM Doctor Officer Manager II.....	\$2950		

SPECIAL OF THE MONTH - CAD System, Sperry IT, 640K, 40 MB HD, 80287 M.C., EGA Card, NEC 1401, Auto CAD, Summagraphics, HI DMP 40..... \$6985

★ ★ ★ PRINTERS ★ ★ ★

BLAZER LASER PRINTER.....	\$1995
CITOH LQ24.....	\$ 899
CITOH 8510 SP.....	\$ 399
CITIZEN PREMIER 35.....	\$ 515
CANON LASER PRINTER.....	\$2050
DIABLO 635.....	\$ 950
DIABLO LASER.....	\$3795
HEWLETT-PACKARD LASER JET.....	\$2250
HEWLETT-PACKARD 500 Plus.....	\$4150
NEC P560.....	\$ 995
FUJITSU DL 2400.....	\$ 959
OKIDATA 193 +.....	\$ 549
TOSHIBA P351.....	\$1095

★ ★ ★ HARD DRIVES & BACK UP SYSTEMS ★ ★ ★

BERNOULLI BOX 10 + 10 / 20 + 20.....	\$1595/\$2195
SEAGATE 4038.....	\$ 695
SEAGATE 4096, 96 MB.....	\$1595
TEAC 20 MB Tape B/U.....	\$ 595
ARCHIVE 60 MB Tape B/U.....	\$ 850

CALL FOR WHAT IS NOT LISTED, WE GUARANTEE THAT YOUR CALL WILL NOT BE A WASTE. LEASING AVAILABLE.

No charges for testing and configuring equipment. Prices and availability subject to change without notice.

Open 9 - 6 PST (714) 778-6496

167 West Cerritos Ave., Anaheim, CA 92805

U.S. POSTAL SERVICE
STATEMENT OF OWNERSHIP, MANAGEMENT
AND CIRCULATION
(Act of August 12, 1970, Section 3685, Title 39,
United States Code)

1. Title of publication: BYTE
2. Date of filing: September 9, 1986
3. Frequency of issue: Monthly
- 3A. Number of issues published annually: 13
- 3B. Annual subscription price: \$21.00
4. Location of known office of publication: One Phoenix Mill Lane, Peterborough, NH 03458-9979
5. Location of headquarters or general business offices of the publisher: 1221 Avenue of the Americas, New York, NY 10020

6. Names and addresses of publisher, editor, and managing editor: Publisher, Harry L. Brown—One Phoenix Mill Lane, Peterborough, NH 03458; Editor, Philip Lemmons—One Phoenix Mill Lane, Peterborough, NH 03458; Managing Editor, Frederic Langa—One Phoenix Mill Lane, Peterborough, NH 03458

7. Owner: McGraw-Hill, Inc., 1221 Avenue of the Americas, New York, NY 10020. Stockholders holding 1 percent or more of stock: Donald C. McGraw, Jr.; Harold W. McGraw, Jr.; John L. McGraw; William H. McGraw; June M. McBroom; Elizabeth McGraw Webster; all in care of McGraw-Hill, Inc., 1221 Avenue of the Americas, New York, NY 10020; College Retirement Equity Fund c/o Bankers Trust Company, 280 Park Avenue, New York, NY 10015; Public Employees Retirement Systems of Ohio, 277 East Town Street, Columbus, OH 43215; Northern Trust Company c/o Kray & Company, 50 South LaSalle Street, Chicago, IL 60675; Teachers Retirement System of Texas, 1001 Trinity Street, Austin, TX 78701; New Jersey Division of Investment c/o First Fidelity Bank N.A., 570 Broad Street, Newark, NJ 07192.

8. Known bondholders, mortgagees, and other security holders owning or holding 1 percent or more of total amount of bonds, mortgages, or other securities: None

9. Not applicable.

10. Extent and nature of circulation:

	Average No. Copies Each Issue During Preceding 12 Months	Actual No. Copies of Single Issue Published Nearest to Filing Date
A. Total No. Copies Printed	496,625	500,000
B. Paid Circulation		
1. Sales through dealers and carriers, street vendors and counter sales	95,703	187,177
2. Mail subscriptions	307,894	298,752
C. Total Paid Circulation	403,597	485,929
D. Free Distribution by Mail, Carrier or Other Means; Samples, Complimentary, and Other Free Copies	5,674	5,847
E. Total Distribution	409,271	491,776
F. Copies Not Distributed		
1. Office use, left over, unaccounted, spoiled after printing	13,796	8,224
2. Return from news agents	73,558	none to date
G. Total	496,625	500,000

11. I certify that the statements made by me above are correct and complete.

—Harry L. Brown, Publisher

Flow Charting II™

FAST. SIMPLE. SPECIFIC.

Now build, update and print process flow and organizational charts easily, confidently.

- Readjust chart immediately after addition or deletion
- Travel quickly across a 120 or 200-column screen
- Move a single character or half a chart - instantly.

Present the true, current picture. Use Flow Charting II on your IBM® PC compatible system. General Motors, Bechtel, Touche Ross, Fairchild and 500 other major US corporations use it.

1-800/672-3470, ext. 897 Calif.
1-800/538-8157 ext. 897 National
408/629-5044 International

PATTON & PATTON

340 Lassenpark Circle
San Jose, CA 95136

IBM is a registered trademark of International Business Machine Corp.

Inquiry 264

DATAFLEX™

- Multi-user Database!
 - Powerful!
 - Multiple Operating System Compatibility!
 - Attractive Dealer Pricing!
 - Full Dealer Support!
- Datallex is a trademark of Data Access
Dealer Inquiries Invited

COGITATE

24000 Telegraph Road
Southfield, Michigan 48034 USA
(313) 352-2345

Inquiry 76

FORMATTED DISKS

Ready to use in your
IBM PC or compatible.



ALF formats brand-name factory certified disks, and double-checks them for defects. You save the time and hassle of formatting disks yourself, and pay no more than for ordinary blank disks!

Call today, toll-free, for complete information:
1-800-321-4668

in Colorado: 303-234-0871

ALF Formatted Disks on these fine brands:

Nashua 3M
ALF 1315 F Nelson St.
Denver, CO 80215

Inquiry 17

Get the whole
story on graphics
terminal emulation.



To find out more about software that lets your PC emulate TEKTRONIX™ 4105/6/7/9 and DEC VT100™ terminals, call or write:

GRAFPPOINT

4340 Stevens Creeks Blvd., Suite 280,
San Jose, CA 95129 (408) 249-7951

Inquiry 151

PC/XT USERS!

- /// COGTREE Utilities by Cogitate \$129.95
- /// LYNC by Norton-Lamber.... \$199.95
- /// DATAFLEX by Data Access... Varles
- /// RMICOBOL by Ryan/McFarland Varles
- /// Universe by Omnitrend..... \$ 98.50
- /// Blue MacI by Cogitate..... \$599.00
- /// CadPower+ by Trilex..... \$995.00
- /// Softext Teaching Aids..... \$ 95.00
- /// PrintSet by Cogitate..... \$ 79.95
- /// CogITAPE by Cogitate..... CALLII
- /// Anti-Static Products..... Varles
- /// Uninterruptible Power Backups..... Varles
- /// TeleVideo Software..... CALLII

COGITATE

"A Higher Form of Software"
24000 Telegraph Road
Southfield, MI 48034
(313) 352-2345/Telex 386581

VISA/MASTERCARD ACCEPTED
Dealer Inquiries Welcomed

Inquiry 77



Real-Time Multitasking Executive

- No royalties
- Source code included
- Fault free operation
- Ideal for process control
- Timing control provided
- Low interrupt overhead
- Inter-task messages
- Language Interfaces: C Pascal PL/M Fortran
- DOS File Access: CP/M-80 IBM PC DOS

Options:

- Resource Manager
- Buffer Manager
- Integer Math Library

AMX is TM of KADAK Products Ltd.
CP/M-80 is TM of Digital Research Corp.
IBM, PC DOS are TM of IBM Corp.

AMX for 8080 \$ 800 US
8086 950
6809 950
68000 1600
Manual (specify processor) 75

KADAK Products Ltd. (604) 734-2796
Telex: 04-55670
206-1847 W. Broadway, Vancouver, B.C., Canada V6J 1Y5

Inquiry 180

ATARI

SCRATCH & DENT SALE

COMMODORE

520ST SYSTEM

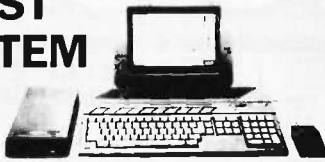

Includes 520ST computer with modulator, disk drive, mouse, Basic, Neochrome, and monochrome or color monitor.

Monochrome **\$599** Color **\$779**

COMPUTERS

Atari 520ST Computer.....	\$339.00
Apple Macintosh 128K.....	1099.00
Apple IIc Computer.....	499.00
Apple IIe 128K CPU.....	499.00
Amiga 1000 Computer.....	749.00
Commodore 32K/40 col.....	199.00
CBM Super Pet.....	299.00
Commodore 16.....	69.00
Commodore Plus 4.....	49.00
Compaq Portable 2 DD.....	1299.00
Compaq Portable 286, I.....	3099.00
Eagle PC-1.....	399.00
Epson PX-8 Geneva.....	649.00
IBM PC 256K, 2 DD, KBD.....	799.00
ITT 256K, 2 DD, P, S, KBD.....	699.00
Kaypro PC 256K, 1 DD, P/S w/Soft.....	799.00
Sperry IT 512K, 1.2 DD, 44.6.....	2799.00
Zenith 138 256K, 2 DD, 7" mono.....	1099.00
Zenith 148 256K, 2 DD.....	929.00
Zenith 162 Port, 2 DD.....	1249.00

AMIGA SYSTEM PACKAGE



Includes: Amiga 1000 CPU, 512K, Mouse, Amiga RGB Monitor, Amiga DOS Basic, Tutorial, Kaleidoscope, and Voice Synthesis Library.

SYSTEM PRICE \$1199

Peripherals for ATARI

800 XL Computer.....	\$79.99
65 XE Computer.....	89.99
130 XE Computer.....	139.00
1050 Disk Drive.....	129.00
1020 Color Printer.....	29.99
1025 Dot Matrix Printer.....	149.00
1027 Letter Quality Printer.....	109.00
Atari XM801 XL/XE Dot Matrix.....	189.00
Atari XM804 ST Dot Matrix.....	199.00
Epson Homewriter 10 w/PIC.....	149.00
Multi-Tech 13" Color Monitor.....	159.00
NAP 12" Green Monitor.....	79.99
Atari XM301 Modem.....	39.99
Atari 835 Modem.....	29.99
Anchor Volksmodem.....	59.99
Supra 1200 AT Modem.....	159.00
Supra 1200 ST Modem.....	159.00
Supra 1150.....	49.99
ICD PR Connection.....	59.99
Atari 850 Interface.....	109.00
Atari 20 Meg Hard Drive for ST.....	729.00

Peripherals for COMMODORE

Commodore 128 Package: CB128, CB1571 Drive, Magnavox 8562 RGB/Comp. Monitor.....	\$759.00
Commodore 64C.....	199.00
Commodore 64 Package: CB64, CB1541 Drive, Taxan 220 Color Monitor.....	479.00
Amiga 1020 5 1/4" External.....	199.00
Amiga 1010 3 1/2" External.....	229.00
Magnavox RGB/Comp.....	289.00
NEC 1216 12" RGB.....	299.00
CBM 1660 (C-64).....	59.99
CBM 1670 (C-128).....	179.00
Okidata Okimate 10 Printer.....	199.00
Star SL10C Printer.....	219.00
PPI Printer Interface.....	34.99
Xetec 8K.....	69.99
Micro R&D MJ350.....	44.99
Commodore 1541C.....	199.00
Commodore 1541 Drive.....	199.00
Commodore 1571 Drive.....	249.00

MONITORS

Atari 124 Hi Res Mono (ST).....	169.00
Amdek 310A Amber TTL.....	109.00
Amdek 300G Green Composite.....	89.00
AT&T Monochrome.....	179.00
BMC 12" Green Composite.....	59.00
Commodore 1902 RGBI 13".....	249.00
Compaq Dual-Mode Green.....	179.00
IBM PCjr. Color RGB Monitor.....	299.00
ITT 14" Amber TTL.....	109.00
Magnavox 8562 RGB/Composite.....	239.00
Quadram Quadchrome 8400 RGB.....	399.00
Quadram Amberchrome 12" TTL.....	129.00
Taxan RBG I Monitor.....	299.00
Zenith 1230 Green 12" Composite.....	79.00

SCRATCH & DENT PRINTERS

Atari 820 Printer.....	\$10.00	Hush 80 Printer.....	49.00	Sanyo 5000 Letter Quality.....	199.00
Axiom GP 550 Parallel NLQ.....	89.00	IBM Quietwriter "R" Mod-2.....	910.00	Silver Reed 550 LQ Parallel.....	259.00
CBM 132 Column Printer.....	199.00	Juki 6000 LQ Daisywheel.....	179.00	Toshiba 1340 Printer.....	279.00
Diablo 620 Serial Printer.....	299.00	Juki 6100 LQ Daisywheel.....	389.00	Toshiba 1351 Printer.....	339.00
Epson FX-85 NLQ, 160 cps.....	299.00	Mannesmann Talley 180L P/S.....	399.00	C.ltoh A10-30SP.....	229.00
Epson HI-80 4 Pen Plotter.....	329.00	Okidata 192 Parallel.....	249.00	C.ltoh 1550 BCD.....	419.00
Epson JX-80 Color Printer.....	229.00	Okidata 193 IBM P-N-P.....	399.00	C.ltoh F10-40 Parallel 40 cps.....	729.00
Epson LX-80 NLQ.....	199.00	Okidata 92 IBM P-N-P.....	299.00	C.ltoh F10-55 Parallel 55 cps.....	979.00
Comrex CR-220 Atari Printer.....	59.00	Star SG-15 Dual Mode.....	339.00	C.ltoh 7500P.....	149.00
ES600 Six-Shooter 6 Pen.....	599.00	Star GRAF II Apple.....	59.00		

HEWLETT-PACKARD CALCULATORS

18C Bus Consultant.....	\$139.95	15C ADV Scientific.....	74.99	11C Slim Scientific.....	44.99
12C Slim Financial.....	74.99	41CX ADV Feature.....	199.00	16C Prog Scientific.....	92.99



COMPUTER MAIL ORDER

When you want to talk computers. When you want to talk price.

Call toll-free: 1 800 233-8950

Outside the U.S.A. 717 327-9575 Telex 5106017898

Educational Institutions call toll-free 1 800 221-4283

CMO. 477 East Third Street Dept. A114, Williamsport, PA 17701

All major credit cards accepted.

POLICY: Add 3% (minimum \$7.00) shipping and handling. Larger shipments may require additional charges. Personal and company checks require 3 weeks to clear. For faster delivery use your credit card or send cashier's check or bank money order. Pennsylvania residents add 6% sales tax. All prices are subject to change and all items are subject to availability. Defective software will be replaced with the same item only. Hardware will be repaired or replaced at our discretion within the terms and limits of the manufacturer's warranty. We cannot guarantee compatibility. All sales are final and returned shipments are subject to a restocking fee.

7400

Part No.	1-9	10+	Part No.	1-9	10+
7400	29	19	7485	65	55
7402	29	19	7486	45	35
7404	35	25	7489	2.05	1.95
7405	39	29	7490	49	39
7406	39	29	7493	45	35
7407	39	29	74121	45	35
7408	35	25	74123	59	49
7410	35	25	74125	55	45
7414	49	39	74126	75	65
7416	45	35	74143	4.05	3.95
7417	45	35	74150	1.35	1.25
7420	35	25	74154	1.35	1.25
7430	35	25	74158	1.59	1.49
7432	39	29	74173	85	75
7438	39	29	74174	65	55
7442	55	45	74175	65	55
7445	79	69	74176	99	89
7446	69	59	74181	1.95	1.85
7447	89	79	74189	2.05	1.95
7448	2.05	1.95	74193	79	69
7472	75	65	74198	1.85	1.75
7473	45	35	74221	99	89
7474	45	35	74273	2.05	1.95
7475	39	29	74365	69	59
7476	45	35	74367	69	59

74LS

Part No.	1-9	10+	Part No.	1-9	10+
74LS00	29	19	74LS165	75	65
74LS02	29	19	74LS166	99	89
74LS04	35	25	74LS173	59	49
74LS05	35	25	74LS174	49	39
74LS06	1.09	99	74LS175	49	39
74LS07	1.09	99	74LS189	4.59	4.49
74LS08	29	19	74LS191	59	49
74LS10	29	19	74LS193	79	69
74LS14	49	39	74LS221	69	59
74LS27	35	25	74LS240	79	69
74LS30	29	19	74LS243	79	69
74LS32	35	25	74LS244	79	69
74LS42	49	39	74LS245	99	89
74LS47	99	89	74LS259	99	89
74LS73	39	29	74LS273	99	89
74LS74	35	25	74LS279	49	39
74LS75	39	29	74LS322	4.05	3.95
74LS76	45	35	74LS365	49	39
74LS85	59	49	74LS366	49	39
74LS86	35	25	74LS367	49	39
74LS90	49	39	74LS368	49	39
74LS93	49	39	74LS373	79	69
74LS123	59	49	74LS374	79	69
74LS125	45	35	74LS383	89	79
74LS138	49	39	74LS590	6.05	5.95
74LS139	49	39	74LS624	2.05	1.95
74LS154	1.09	99	74LS629	2.29	2.19
74LS157	45	35	74LS640	1.09	99
74LS158	45	35	74LS645	1.09	99
74LS163	59	49	74LS670	1.09	99
74LS164	59	49	74LS688	2.05	1.95

74S/PROMS*

74S00	29	74S188*	1.29
74S04	35	74S189	1.69
74S08	35	74S196	2.49
74S10	29	74S240	1.49
74S32	35	74S244	1.49
74S74	45	74S253	79
74S85	1.79	74S287*	1.49
74S86	35	74S288*	1.49
74S124	2.95	74S373	1.49
74S174	79	74S374	1.49
74S175	79	74S472*	2.95

74ALS

74ALS00	35	74ALS138	89
74ALS02	35	74ALS174	89
74ALS04	35	74ALS175	89
74ALS08	39	74ALS240	1.49
74ALS10	39	74ALS244	1.49
74ALS27	39	74ALS245	1.49
74ALS30	39	74ALS373	1.69
74ALS32	39	74ALS374	1.69
74ALS74	49	74ALS573	1.69

74F

74F00	39	74F139	89
74F04	39	74F157	95
74F08	39	74F193	3.95
74F10	39	74F240	1.39
74F32	39	74F244	1.39
74F74	49	74F253	39
74F86	59	74F373	1.39
74F138	89	74F374	1.39

CD-CMOS

CD4001	19	CD4081	25
CD4011	19	CD4082	25
CD4013	29	CD4093	35
CD4015	29	CD4094	35
CD4017	55	CD40103	2.49
CD4018	59	CD4503	35
CD4020	59	CD4510	69
CD4024	49	CD4511	69
CD4027	35	CD4515	89
CD4030	35	CD4518	75
CD4040	65	CD4520	75
CD4049	29	CD4522	79
CD4050	29	CD4538	79
CD4051	59	CD4541	69
CD4052	59	CD4543	69
CD4053	59	CD4544	39
CD4059	3.95	CD4555	79
CD4060	65	CD4566	2.49
CD4066	29	CD4572 (MC14572)	39
CD4069	25	CD4583	89
CD4070	35	CD4584	39
CD4071	35	CD4585	89
CD4072	25	MC14411P	8.95
CD4076	65	MC14490P	4.49

COMMODORE CHIPS

Part No.	Price	Part No.	Price	Part No.	Price
SI-3052P 5V Rts. Ret. 2A	5.95	6545-1 CRTC.	2.49	8701 Clock Chip	9.95
6502 MPU w/Clock	2.25	6551 ACIA	3.29	8721 PLA	14.95
6504A CPU	1.95	6560 VIC-I	10.95	8722 MMU	9.95
6507 CPU	4.95	6567 VIC-II	14.95	25110-04 Kernal ROM	10.95
6508 MPU w/RAM & I/O	8.95	6569 VIC PAL	14.95	325572-01 Logic Array	24.95
6510 CPU	9.95	6572 VIC PAL-N	14.95	82S100PLA (90614-01)	13.95
6520 PA	1.75	6581 SID	4.95	901225-01 Chat ROM	11.95
6522 VIA	2.95	8360 Text Editing	10.95	901228-01 BASIC ROM	11.95
6525 TP	7.95	8501 MPU	10.95	901227-03 Kernal ROM	11.95
6526 CIA	14.95	8502 MPU	7.95	901229-05 Upgrd. ROM	15.95
6529 SP	4.95	8563 CRT Contr.	15.95	*No spec. avail. 8721 and 82S100PLA	
6532 128x8 RAM, I/O, Tim Ar	6.49	8564 VIC	15.95	**NOTE: 82S100PLA = U17 (C-64)	

NEC V20 & V30 CHIPS

Replace the 8086 or 8088 in Your IBM-PC and Increase Its Speed by up to 40%!

Part No.	Price
UPD70108-5 (5MHz) V20 Chip (Replaces the 8088)	\$ 9.95
UPD70108-8 (8MHz) V20 Chip (Replaces the 8088-2)	\$ 11.95
UPD70116-8 (8MHz) V30 Chip (Replaces the 8086 or 8086-2)	\$ 14.95
UPD70116-10 (10MHz) V30 Chip (Replaces the 8086 or 8086-2)	\$ 34.95

MICROPROCESSOR COMPONENTS

MICROPROCESSOR CHIPS		8000 SERIES CONT.	
Part No.	Price	Part No.	Price
D765AC	4.49	8031	2.95
CDP1802CE	4.95	8032 1BH	14.95
2661-3	5.95	8035	1.49
		8073	29.95
		8080A	2.49
		8085A	2.99
		8086	6.95
		8086-2	8.95
		8087 (5MHz)	125.00
		8087-2 (8MHz)	159.95
		8088	6.49
		8088-2	8.95
		8116	4.95
		8155-2	2.49
		8156	2.49
		8202	9.95
		8203	14.95
		8212	1.49
		8224	2.25
		8228	2.49

DYNAMIC RAMS

Part No.	Function	Price
4116-15	16,384 x 1	89
4128-20 (Piggyback)	131,072 x 1	4.49
4164-150	65,536 x 1	1.15
4164-200	65,536 x 1	95
TMS4416-12	16,384 x 4	4.25
8118	16,384 x 1	69
41256-150	262,144 x 1	2.95
50464-15	65,536 x 4	4.95

STATIC RAMS

2016-12	2048 x 8	1.69
2102	1024 x 1	89
2102-2L	1024 x 1	1.95
2114N	1024 x 4	99
2114N-L	1024 x 4	1.09
2114N-2L	1024 x 4	1.05
2114N-2L	1024 x 4	1.49
21C14	1024 x 4	4.95
2149	1024 x 4	4.95
5101	256 x 4	1.95
6116LP-2	2048 x 8	2.95
6116P-3	2048 x 8	1.89
6116LP-3	2048 x 8	1.95
6264P-12	8192 x 8	3.89
6264LP-12	8192 x 8	4.25
6264LP-15	8192 x 8	3.69
6514	1024 x 4	3.75
43256-15L	32,768 x 8	24.95

PROMS/EPROMS

1702A	256 x 8	6.95
TMS2516	2048 x 8	4.95
TMS2532	4096 x 8	5.95
TMS2564	8192 x 8	8.95
2708	1024 x 8	4.95
TMS2716	2048 x 8	9.95
27C16	2048 x 8	3.75
2732	4096 x 8	4.95
2732A-20	4096 x 8	4.25
2732A-25	4096 x 8	3.95
2732A-45	4096 x 8	4.95
27C32	8192 x 8	7.49
2764-20	8192 x 8	4.25
2764-25	8192 x 8	3.75
2764-45	8192 x 8	4.25
27C64	8192 x 8	5.49
27128-25	16,384 x 8	4.25
27128A-25	16,384 x 8	7.95
27C128-25	16,384 x 8	5.95
27256-25	32,768 x 8	5.95
27C256-25	32,768 x 8	8.95
27512-25	65,536 x 8	19.95
68764	8192 x 8	15.95
68766	8192 x 8	16.95
745387	256 x 4	4.95
745471	256 x 8	4.95
N82S123	32 x 8	2.49

SATELLITE TV DESCRAMBLER CHIP

The MM5321 is a TV camera sync generator designed to supply the basic sync functions for either color or monochrome 525 line/60Hz interlaced and camera video recorder applications. COLOR BURST GATE & SYNC ALLOW STABLE COLOR OPERATION

MM5321N \$11.95

74HC HI-SPEED CMOS

Part No.	Price	Part No.	Price
74HC00	25	74HC175	6.95
74HC02	25	74HC221	9.95
74HC04	29	74HC240	7.95
74HC08	29	74HC244	7.95
74HC10	29	74HC245	8.95
74HC14	49	74HC253	5.95
74HC30	29	74HC259	6.95
74HC32	29	74HC273	7.95
74HC74	39	74HC373	7.95
74HC75	39	74HC374	7.95
74HC76	45	74HC383	7.95
74HC85	79	74HC595	11.95
74HC86	39	74HC688	7.95
74HC123	89	74HC400	8.95
74HC125	49	74HC409	5.95
74HC132	49	74HC4050	14.95
74HC138	49	74HC460	7.95
74HC139	49	74HC451	1.29
74HC154	1.19	74HC4514	1.19
74HC163	65	74HC4538	8.95
74HC174	69	74HC4543	1.19

74HCT - CMOS TTL

74HCT00	29	74HCT139	5.95
74HCT02	29	74HCT157	6.95
74HCT04	29	74HCT163	7.95
74HCT08	29	74HCT175	6.95
74HCT10	29	74HCT240	5.95
74HCT32	29	74HCT244	5.95
74HCT74	49	74HCT245	5.95
74HCT76	49	74HCT373	11.95
74HCT138	59	74HCT374	11.95

UPDATE: Our 1987 Product Selection Guide is Here! 94 Pages of Components, Peripherals & More!

Mail Order Electronics • Worldwide
Jameco
 ELECTRONICS

COMMODORE® COMPATIBLE ACCESSORIES

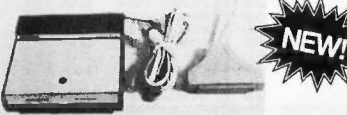

HESWARE 300 Baud Modem For VIC-20 and C-64

• Connects directly to User Port • Manual Answer/Dial • Function keys defined for convenience • Includes Midwest Micro Associates communication software.

CM-1 (For VIC-20 and C-64) \$34.95

RS232 INTERFACE

Allows connection of standard serial devices.

JE232CM (For VIC-20, C-64 & C-128) \$39.95

External Power Supply

CPS-10 (For C-64) \$39.95

Parallel Printer Interface

2K Buffer, Expandable to 10K!

MW-350 (For VIC-20, C-64 & C-128) \$54.95

Input/Output Card

16-Channel Analog Multiplexer

MW-611 (For C-64 and C-128) \$199.95

TRS-80/TANDY® COMPATIBLE ACCESSORIES

E-X-P-A-N-D TRS-80 MEMORY

All kits come complete with documentation

TRS-80 MODEL I, III 16K EXPANSION

TRS-16K3 200ns (Model III) \$5.95

TRS-16K4 250ns (Model I) \$5.49

TRS-80 COLOR AND COLOR II 64K EXPANSION

TRS-64K-2 \$7.95

New models only

TRS-Co-Co-Incl. 2-50464's (41464's) . . . \$10.95

TRS-80 MODEL 4, 4P, & 4D 64K/128K EXPANSION

TRS-64K-2 \$7.95

Expands Model 4 from 16K-64K or Model 4 (Gate Array Version), 4P and 4D from 64K-128K

TRS-64K-2PAL \$14.95

Expands Model 4 (Non-Gate Array Version) from 64K to 128K

TRS-80 MODEL 100 8K EXPANSION

M1008K \$19.95 ea. or 3 for \$54.95

TANDY MODEL 102 8K EXPANSION

M1028K \$9.95

TANDY MODEL 200 24K EXPANSION

M200R \$59.95 ea. or 2 for \$109.95

TANDY 1000 Expansion Memory Half Card

Expand the memory of your Tandy 1000 (128K Version) as much as 640K. Also includes a DMA controller chip.

TAN-EM256K Includes 256K RAM \$ 99.95

TAN-EM512K Includes 512K RAM \$129.95

Options for TAN-EM256K/512K

TAN-C Plug-in Clock option chip (only) \$39.95

TAN-D RAM Disk Printer Spooler Software (only) \$39.95

TANDY 1000 Multifunction Board with Clock Calendar

Expand the memory on your Tandy 1000 (128K Version) to as much as 640K. Complete with an RS232 port, clock/calendar.

RAM Disk Printer Spooler and on-board DMA controller chip.

WTAN-256K Includes 256K RAM \$179.95

WTAN-512K Includes 512K RAM \$209.95

UV-EPROM ERASER

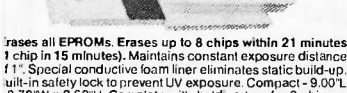

Erases all EPROMs. Erases up to 8 chips within 21 minutes (1 chip in 15 minutes). Maintains constant exposure distance 11". Special conductive foam liner eliminates static build-up. Built-in safety lock to prevent UV exposure. Compact - 9.00" L x 3.70" W x 2.60" H. Complete with holding tray for 8 chips.

VE-4 UV-EPROM Eraser \$69.95

JVS-11EL Replacement Bulb \$19.95

NEW PRODUCTS!



ProModem 1200/300 Baud Half-Card Modems

For IBM PC, XT, AT & Compatibles

• Auto-answer/Auto-dial • Extensive diagnostics • Built-in speaker/vol. control • Auto redial on busy • Ability to access Com-port 3 • Hayes compatible • 2 yr. warranty

PM1200B-2 without software . . . \$129.95

PM1200B-2S w/Mirror™ Software . . \$159.95

2 yr. warranty! ZOOM 300 Baud Modem



for Apple II, II+ and IIe

• Auto-dial/Auto-answer • Hayes compatible • Includes call progress monitor, speaker, Zoom Communications software and manual • Made in U.S.A.

ZM300 \$89.95



ProModem 1200/300 for Apple II, II+, IIe and II GS

Fully Compatible with the NEW APPLE II GS!



• NEW, single card version • Built-in software in ROM • Comes with ProCom-A disk based communications software • Hayes compatible • Compatible with ProDOS • Auto-dial/Auto-answer • Auto redial on busy • Built-in speaker and volume control • 2 phone jacks with exclusion switching • 2-year warranty

PM1200A-2 \$199.95



ProModem 2400/1200/300 Baud Modems

For Any Computer w/RS232 Serial Port

• Hayes command compatible • Call progress tone detection • Auto redial on busy • Internal power supply • Voice/data switching • Second phone jack for voice handset • Auto-answer/Auto-dial • Touch tone and pulse dialing • Speaker with volume control • 8 LED status lights • 1-year warranty



PM1200G (1200/300 baud) \$199.95

PM2400G (2400/1200/300 baud) . . . \$379.95

ProCom-B (Communication Software . . . \$34.95

For IBM PC and Compatibles)



1MByte RAM Card for Apple II, II+ and IIe



PLUS-WORKS™ Supports Appleworks!

BIG BOARD comes complete with RAMDISK software for DOS 3.3, ProDOS, Pascal 1.2, and CP/M for Microsoft's Softcard. A separate driver is available for the AppliCard (StarCard - \$39.95). You can choose the active addressing mode both via a jumper on the BIG BOARD or through software commands.

BIG BOARD-1M 1Meg RAM \$299.95

PLUS-WORKS™ XM (Software for Apple II and II+) . . . \$49.95

PLUS-WORKS™ XME (Software for Apple IIe) \$49.95

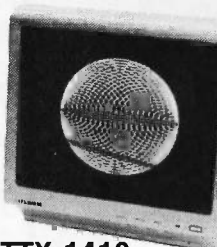

TTX™ 14" RGB Color Monitor

for IBM PC, XT and Compatible Computers

• Input: RGB TTL Level • Scanning Freq.: (Hor) 14.5KHz to 17.8K • Video Bandwidth: 18MHz • Resolution: 640 x 200 • Connector: DB 9-pin (incl.) • Power Consumption: 70W • Size 14.8"H x 15.5"W x 13.6"D • Weight: 27 lbs. • TTX-1410 is compatible with the IBM-ICB and the IBM-EGA Cards (above, right)

TTX-1410 \$299.95

IBM® COMPATIBLE ACCESSORIES

83-KEY KEYBOARD

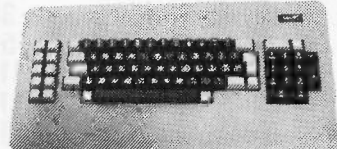

• Identical layout as original IBM PC Keyboard • Highly desirable case with palm rest • Complete with cable and data • JUST PLUG IN!

KB83 SALE \$29.95

Build an IBM PC/XT™ Compatible!

IBM-64K(2) 64K RAM Chips (18) \$ 19.90

KB83 83-Key Keyboard \$ 29.95

IBM-FCC Floppy Controller Card \$ 39.95

IBM-Case Case \$ 39.95

IBM-MCC Monochrome Card \$ 69.95

IBM-PS Power Supply \$ 69.95

FD55B Disk Drive \$109.95

IBM-MON Monochrome Monitor \$ 99.95

IBM-MB Motherboard \$129.95

Regular List \$609.50

IBM™ Special (Incl. 9 items above) . . \$549.95

Additional Add-Ons Available!

IBM-KB 83-Key Keyboard \$ 69.95

IBM-ENH Enhanced Keyboard \$ 89.95

IBM-ICB Integrated Color Board \$ 99.95

IBM-EGA Enh'd. Graphics 256K RAM . . . \$259.95

IBM-20MBK 20MB Hard Disk Drive . . . \$449.95

IBM is a registered trademark of IBM Computers

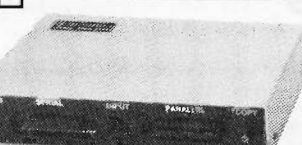
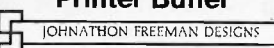

The UBUFFER Universal Printer Buffer is a hi-speed data buffer that accepts data at a high rate, and then outputs this data to your printer. You save valuable computer time. The UBUFFER can be connected to practically any computer or printer. There are four possible combinations: 1) Serial to Serial, 2) Serial to Parallel, 3) Parallel to Parallel, 4) Parallel to Serial. Manual included. Size: 9-1/3" L x 4 1/2" W x 1 1/2" H

UB64K \$199.95

UB256K \$239.95



FD55B Teac 5 1/4" DS 1/2-Height \$109.95

JU-455 Panasonic 5 1/4" DS 1/2-Height . . . \$109.95

TM100-2 Tandon 5 1/4" DS Full-Height . . . \$119.95

DATA BOOKS

30003 National Linear Data Book (82) \$14.95

30009 Intersil Data Book (85) \$ 9.95

30013 Ziog Data Book (85) \$14.95

30032 National Linear Supplement (84) . . . \$ 6.95

210830 Intel Memory Handbook (86) \$17.95

230843 Intel Microsystem Hndbk. Set (86) . . . \$24.95

MUFFIN/SPRITE-STYLE FANS

MUF60 \$9.95

Torin Industries (4.68" sq. 60 cfm)

SU2A1 \$8.95

EG&G Roltron (3.125" square, 20 cfm)

\$20 Minimum Order — U.S. Funds Only
 Shipping: Add 5% plus \$1.50 Insurance

California Residents: Add 6%, 6 1/2% or 7% Sales Tax

Spec. Sheets — 50¢ each
 Prices Subject to Change

Send stamped, self-addressed envelope to receive a Quarterly Sales Flyer — FREE!

12/86



Send \$1.00 Postage for a FREE 1987 JAMECO CATALOG

©1986 Jameco Electronics

1355 SHOREWAY ROAD, BELMONT, CA 94002 • PHONE ORDERS WELCOME 415-592-8097 Telex: 176043

DISK-KING®

Premium Quality Diskettes From the Magnetic Media Kings Incredible Value!

WHY RISK THE UNKNOWN... when you can get premium quality disks from the Leader and Inventor of magnetic media... **for less!!**

- * 100% tested & certified at 65% or higher clipping level*
- * 10 mil sturdy jacket * LIFETIME WARRANTY *

5.25" SS-DD-RH 48 TPI	38¢
5.25" DS-DD-48 TPI	38¢
5.25" DS-DD-RH 48 TPI	54¢
5.25" DS-HD-96 TPI	\$1.29
3.50" SS-135 TPI	\$1.15
3.50" DS-135 TPI	\$1.39

Factory sealed in lots of 25 All 5.25" diskettes are supplied with Tyvek® sleeves, user ID labels, w/p tabs and reinforced hub rings. Multiples of 100, lesser quantities add 10% (*DS-DD-RH in Lots of 125)

FREE! Flip 'n File
with each order, while they last!



FREE! Scotch CX-60 Cassette plus \$2.00 rebate certificate inside each 3M 5 1/4" box.

79¢	5.25"/48 TPI	99¢
\$1.39	3.50"/135 TPI	\$1.99
DS-HD for the "AT"		\$2.05

(Quantities less than 5 bx. add 10%)
The Technology Whose Time Has Come
3M Data Cartridges

DC-100A	\$1.79	DC-300 XL/P ..	\$1.85
DC-1000	\$2.40	DC-600A	\$2.05

BASF **QUALIMETRIC**
FlexDisk **SUPER LOW PRICES**
BASF "Boxed Products"

SS-DD Qty less than 10 BX. add 10%	DS-DD
69¢	5.25"/48TPI-10/reg. cardboard box ... 75¢
\$1.29	5.25"/48 TPI DS-DD 10/plastic storage case ... 79¢
	3.5"/135TPI
DS-HD for the "AT"	\$1.95

UNBELIEVABLE PRICES!
Nashua Boxed

SS-DD Qty less than 20 BX. add 6%	DS-DD
\$5.95	Price per Factory Sealed Box of Ten
	5.25"/48 TPI
DS-HD for the "AT"	\$16.99

COLOR Premium Quality U.S.A. Made Available in Rainbow & many other color options
DISKETTES

LIFETIME WARRANTY	Bulk	Boxed*
5.25" DS-DD 48 TPI	59¢	72¢
5.25" DS-HD 1.6 MB for the "AT"	\$1.75	\$1.99
3.50" DS-135 TPI C-ITOH Rainbow Color ..	\$1.79	\$1.99

*Boxed - pre-packaged 10 to a clear plastic library case. Bulk - Polybagged 25 of a solid color. Includes Tyvek® sleeves, user ID labels, w/p tabs and hub rings. We've got your color.
CALL FOR OUR SUPER LOW PRICES ON WIDE RANGE OF PRINTER RIBBONS, DISK STORAGE, COMPUTER TAPES & DISK PACKS.

ORDER TOLL FREE 1-800-523-9681

TERMS: VISA, MasterCard, American Express P.O.'s accepted from corporations rated 3A2 or better, government and schools on 2% prepaid cash discount. Net 30 basis (minimum order on credit terms is \$100.00). No sales tax outside Utah
Shipping: Add \$3.00 for 100 or fewer diskettes. Diskettes with Flip 'n File add \$3.00 for 50 or fewer disks. C.O.D. orders add \$5.00. AFO, PPO, AK, HI, PR and Canada orders add 10%. Overseas orders please call for exact freight & insurance charges, or add 20% (approx). Orders placed before 4:00 p.m. (Mountain time) shipped via UPS same day.

SATISFACTION GUARANTEED!

Toll-Free Order Line: 1-800-523-9681
Telax: 9102404712
Inquiries Line: 1-801-942-2273

DISK-COTECH

DISKCO TECHNOLOGIES, INC.
2034 E. 7000 So. Salt Lake City, Utah 84121
Hours: 8 AM-6PM (Mtn. Time)-Half day Saturday

9-TRACK MAG. TAPE SUBSYSTEM FOR THE IBM PC/XT/AT AND...

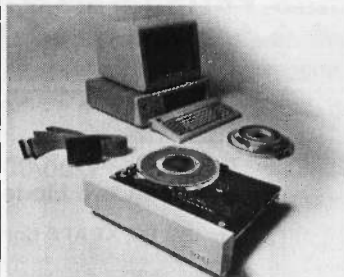

For information interchange, backup and archival storage, IBEX offers a 9-track, IBM format compatible 1/2" magnetic tape subsystem for the IBM PC, featuring:

- IBM format 1600/3200 and 800 cpi.
- Software for PC-DOS, MS-DOS.
- Also for DEC, VAX, VME, S-100, RS-232, IEEE 488.

IBEX

IBEX COMPUTER CORP.
20741 Manilla St.
Chatsworth, CA 91311
(818) 709-8100
TWX: 910-493-2071

Write, phone or TWX for information.

Inquiry 164

NEC PRINTERS

(1 Year Factory Warranty)

Pinwriter P5	\$ 930
Pinwriter P5XL	\$1075
Pinwriter P6	\$ 450
Pinwriter P7	\$ 615
Elf 350/360	\$ 380
3510/15/30/50	\$ 715
8810/15/30/50	\$1040

Optional Forms Handling Devices CALL

QUALITY PRINTERS
8415 Cement City Road
Brooklyn, Michigan 49230
Phone: 517-592-3749

Inquiry 295

BULK DISKETTES MAXELL

5 1/4 DS/DD **59¢**

Price based on quantity of 250
Includes sleeves, labels and tabs

Quantities Limited Call Today!

800-222-0490
(In N.J. 201-462-7628)

Full service duplication facility
24 Hour Shipment

MEGAsoft

P.O. Box 710
Freehold, N.J. 07728

Inquiry 216

DYNAMIC RAMS

41256	100ns	\$4.85
41256	120ns	\$2.95
✓41256	150ns	\$2.69
4164	120ns	\$1.40
✓4164	150ns	\$1.10
4464	150ns	\$3.95

■ PROCESSORS		■ E. PROMS	
8087-2	8MHz \$159.00	27C256	250ns \$6.50
8087-3	5MHz \$115.00	27256	250ns \$5.25
80287-3	6MHz \$169.00	27128	250ns \$3.95
80287-8	8MHz \$ CALL	27C64	200ns \$4.50
V-20	8MHz \$ 12.75	2764	250ns \$3.25
V-30	8MHz \$ 14.00	2732A	250ns \$4.25
■ STATIC RAMS		■ 8000's	
6264LP-15	150ns \$2.95	(Parts in stock)	

I.C. EXPRESS

15358 Valley Blvd., City of Industry, CA 91746
Phone: 818-369-2688 (Mon-Fri • 8-5)

ORDER TOLL FREE
(800) 892-8889 • (800) 882-8181

Outside California Inside California

CALL FOR CURRENT PRICES & VOLUME DISCOUNTS

Price Shown for Cash • MasterCard/VISA add 3% more
Prices are subject to change. Minimum order \$1000
California residents must add 6.5% sales tax
Shipping & Handling: UPS Ground \$5.00, UPS Air \$7.00 (under 1 lb.)
ALL MERCHANDISE IS 100% GUARANTEED

Inquiry 165

ROSE DATA SWITCHES



SHARE computers, printers, any parallel or serial device
ELIMINATE cable swapping
INEXPENSIVE way to network
COMPATIBLE with all computers.

Businesses, Schools, Homes
WE ALSO OFFER:
Data Buffers, Line Drivers, Modems, Protocol Converters, Parallel - Serial Converters, Cables, Computers, Printers, Disk Drives, and more.

AUTOMATIC - CARETAKER is ideal for a business or school to share a printer or modem among many computers. Operation is fully automatic with no software required. Parallel or Serial 4 channels - \$295 8 channels - \$395
MANUAL - HARD SWITCH is operated with the flip of a switch. 2:2 and 2:4 models allow simultaneous communication.
Serial 1:2 - \$59 1:4 - \$99 2:2 - \$109 2:4 - \$169
Parallel 1:2 - \$79 1:4 - \$139 2:2 - \$119 2:4 - \$199
LED and spike protection on serial models add \$20.

CODE ACTIVATED - PORTER connects one computer to multiple peripherals. A software code selects the peripheral. Parallel or Serial 4 channels - \$295 8 channels - \$395
Buffer option 64K - \$100 256K - \$250
REMOTE - TELEPATH connects multiple computers to multiple peripherals. A selector at each computer or terminal chooses up to 4 peripherals and displays busy status.
4:4 - \$495 4:8 - \$795 selector - \$39.

Give a Rose to your computer

ROSE ELECTRONICS (713) 933-7673
P.O. BOX 742571 MC & VISA Accepted
HOUSTON, TX 77274 Dealer Inquiries Invited
CALL US FOR ALL YOUR INTERFACE NEEDS

Inquiry 308



PORTABLE ADDITIONS

DISK DRIVE 3 1/2", 1 1/4 lbs., battery oper. or A/C adaptor (incl.), 100K storage. With TS-DOS software \$229. Drive without software \$179

24K RAM CHIP-Tandy 200 \$65, 2/\$59 ea.

8K RAM CHIP-Model-102 \$9.95

Model-100 & NEC 8201/\$23 3/\$19 ea.

SIDESTAR-NEC Starlet \$399 \$199

128K Ram Disk Cartridge

SIDECAR-NEC PC-8201A \$259

128K cartridge (four 32K banks)

CALL TOLL FREE 1-800-732-5012

Calif: 805-987-4788

Canada: 604-856-8858, Australia: 02-419-8899

PURPLE COMPUTING

VISA MC & AMER.EXP.

420 Constitution Ave., Camarillo, CA 93010

Inquiry 286



FROM THE ACP CIRCUIT SELLER

Advanced 286 \$1395⁰⁰
Advanced PC/XT \$549⁰⁰

Advanced PC/XT

- FCC/UL Approved
- IBM PC/XT™ Compatible
- (1) 360K Floppy
- 256K Expandable to 640K
- Serial, Parallel, LCD
- RGB Color Graphics
- Composite Video
- Mouse & Keyboard
- 10Mb Hard Disk (Add \$300⁰⁰)

HARDWARE

Advanced Cards
Largest Selection!



A210 Color/Printer/Graphics	\$88.00
A220 Color/Graphics/Video/Mouse	95.00
A230 Mono/Color/Graphics/132 Col	149.00
A231 Color/Mono (Runs 2 Monitors)	149.00
A240 Mono/Printer/Graphics	79.00
A250 Mono/Printer/Graphics/132 Col	119.00
A260 Mono/Printer	75.00
A271 EGA/256K RAM - Short Card	229.00
A320 384 Multi-function Card - OK	99.00
A330 Multi-function - Short Card	99.00
A340 Multi-function/Floppy	119.00
A350 640K RAM Card - OK	59.00
A410 Floppy Card - 2 Drives	39.00
A420 Floppy Card - 4 Drives	49.00
A510 Parallel/Serial, Optional Serial	69.00
A520 Parallel Card	35.00
A530 Serial Card	49.00
A610 AT 2Mb Multi-function - OK	139.00
A612 AT 2.5Mb RAM Card	139.00
A620 AT 3Mb RAM Card	159.00
A630 AT Parallel/Serial, Optional Ser	59.00
A640 AT Floppy/Hard Controller	249.00
A650 AT I/O Card - Ser/Par/Clk	55.00
A950 AT Motherboard - OK	499.00
A955 XT Motherboard - OK	119.00
A960 XT Turbo Motherboard - OK	139.00

AST - (1 to 2 Year Warranty)	
AST5251-11	595.00
AST5251-12	495.00
RAMpage Expandable to 2Mb	Call
RAMpage AT Expandable to 2Mb	Call
(Both boards support EMS & EEMS)	
Advantage 128K	365.00

AST SPECIALS	
REDUCED TO MOVE LIMITED SUPPLY	
SixPak Plus w/64K	Only \$166.00
Including Sidekick 1.5 & DESoview	
SixPak Plus 384K	Only 219.00
Combo Plus - OK	Only 66.00
Combo Plus - 64K	Only 79.00
(Makes superior I/O Device)	
Reach Modem 1200 Baud	199.00
AST Colorgraphics Card	99.00
(Original Factory Box)	
HAYES - (2 Year Warranty)	
Smartmodem 1200	\$385.00

HARDWARE

Smartmodem 1200B	349.00
Smartmodem 2400 (Int)	575.00
Smartmodem 2400B	535.00
Hayes Comp. 1200 (Ext)	169.95
Hayes Comp. 1200 (Int) w/SW	149.95
Hayes Comp. 2400 (Ext)	349.00

HERCULES

Hercules Color Card	\$166.00
Hercules Plus Graphics	NEW 239.00

INTEL - (5 Year Warranty)

Above Board PC, AT, PS
FREE OFFER Windows thru 12-31

KEYTRONICS

5150 Keyboard	\$159.95
5151 Deluxe Keyboard	169.95
5153 w/Touchpad	285.00
PC Jr. Numeric Keypad	29.95
NEW 101 Key	Call

MICROSOFT

Microsoft Mouse	\$139.00
Microsoft Bus Version	155.00

MOUSE SYSTEMS - (3 Year War.)

PC Mouse w/Paint Plus	\$138.00
PC Mouse w/Ready & Paint	148.00
ACP Mouse w/Keyboard	SALE 149.00

PROMETHEUS - (1 Yr. Warranty)

ProModem 1200 w/Mite (Int)	\$299.00
ProModem 1200B	259.00
Alphanumeric/Options Processor	79.00

TECMAR CLOSOUTS

Call for Complete List	List	ACP
Speechmaster	\$395	\$195.00
1st Mate w/64K	389	169.00
Voice Recognition	995	269.00
3rd Mate	445	195.00
Powerlink 3270	1099	399.00
Phonagate 2400	695	295.00

PRINTERS

BROTHER

M1109 Dot Matrix	\$249.00
M1509 Dot Matrix	399.00

DIABLO/XEROX

620 Serial LQP	was 1495 now \$299.00
620 D36 (36cps)	399.00
Tractor	was 395 now \$125.00
F-21 Sheet Feeder	was 896 now 199.00
630 Sheet Feeder	219.00
Cable for 620 (to IBM)	29.00
Diablo P-11 or S-11 100cps	129.95
Diablo P-31 or S-31 Wide	199.95

EPSON - (1 Year Warranty)

FX85 160cps NLQ	\$365.00
FX286 160cps Wide	449.00

TOSHIBA

P321 "3 in 1" LQ Printer	sale \$515.00
P351E 24 Pin w/Serial & Parallel	Call
New Toshiba Color Printer	Call

8 PEN PLOTTER - Limited Special

Roland's DXY-800 Flatbed X-Y Plotter.
Formerly sold for \$995.00. While Supply
lasts your price only \$499.00

Inc. Parallel/Serial Interface. IBM Compatible.
DXY 101 Pen Plotter 299.00

MONITORS

Samsung TTL IBM Green	\$88.00
Samsung TTL IBM Amber	98.00
ACP 12" Softwhite TTL IBM	139.00
TECO EGA Monitor	399.00
Roland's CD240 HiRes Color	359.00

PRINCETON GRAPHICS

HX-12 RGB (640x240)	\$445.00
MAX-12E Amber TTL	175.00
SR-12	575.00
HX-12E (690x350)	545.00

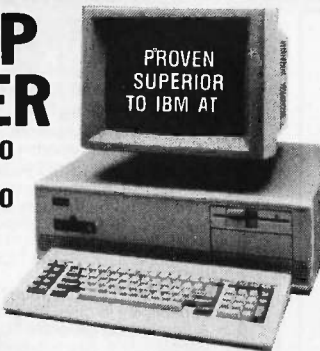

Advanced 286

- FCC/UL Approved
- IBM AT™ Compatible
- 6/8 MHz SW Switchable
- 640K, 200 Watts
- 1.2 Mb Floppy Controller
- Floppy Controller
- Phoenix BIOS
- MS-DOS 3.2 (Add \$85⁰⁰)
- GW Basic (Add \$95⁰⁰)
- 30Mb 35mS HD (Add \$700⁰⁰)

EGA SPECIALS EGA UPGRADE KIT

Includes:
NEC Multisync
ACP/EGA Card **CALL**

NEC Multisync	\$599.00
ACP RGB Color/Teco. Tatumg	399.00
RIX EGA Paint	59.00
Paradise Autoswitch	375.00
Genoa EGA	295.00
Orchid Turbo EGA	585.00
Quad EGA Plus, Quadram	365.00
Advanced EGA, 256K, Short Card	229.00
EGA Mouse	119.00

PGA SPECIALS

IBM Professional, Limited Quantity
IBM PGA Card, Regular \$2995 Sale 1195.00

HARD DISK CARDS

20Mb MEGA Card	\$479.00
----------------	----------

Call for 30Mb Card

BEST BACK-UP

Use same back-up device we use at ACP.
AlphaMicro VCR Back-up Card \$399.00
AlphaMicro VCR 699.00

DISK DRIVES

Toshiba FD04403 3 1/2" w/5 1/4" Bezel	\$129.00
Toshiba ND040 PC, XT 360K	95.00
Toshiba ND04E-G AT, 360K	105.00
Toshiba ND08DE-G 1.2Mb	129.00
TEAC FD-55B	99.00

DISKETTES (Box of 10)

DS/DD for PC/XT (40tpi)	
• ACP Generic	\$6.00
• Verbatim Datalite	16.00
• Maxell MD-2	19.00
• Fujii	16.00
DS/Hi-Density for AT (96tpi)	
• Verbatim	\$32.00
• Maxell	35.00
• Fujii	26.00

SS/DD for Apple II etc.	
• ACP Flippy (Use both sides)	\$6.00
• Verbatim	14.00
• Maxell MD-1	17.00
• Fujii	14.00
Macintosh/IBM Conv. 3 1/2"	
• Maxell MF-2DD	\$62.00
Fujii MF-2DD (135tpi)	52.00
Flip-Sort (75 Disks)	14.00
ACP 5 1/4" Disk Holder	9.00
ACP 3 1/2" Disk Holder	12.00
Head Cleaner 5 1/4" or 8"	9.00
Perfect ComputerCare Kit	29.00



20 Mb Upgrade Package (1 Yr War) \$449
20 Mb Mega card Plug-in 1 Yr War) \$479

SEAGATE FOR AT

(Linear Voice Coil Activator)
20 Mb for AT \$499.00
30Mb for AT \$599.00
40Mb for AT \$799.00
(Inc. Cable & Mounting Rails)

IRWIN TAPE BACK-UP

for AT \$399.00

PC UPGRADE SPECIAL

\$149 ⁹⁵ SET OF (9) 64K RAMS	
\$369 ⁹⁵ SET OF (9) 256K RAMS	
\$1399 ⁹⁵ 8087 COPROCESSOR	
\$1699 ⁹⁵ 8087-2 COPROCESSOR	
\$1999 ⁹⁵ 80287-6	
\$269 ⁰⁰ 80287-8	
\$449 ⁰⁰ 80287-10	

1200 Baud Hayes™ Comp. Modem

List \$299	ACP \$139 ⁰⁰
1200 (Ext.)	\$149.00
2400 Baud (Int.)	\$249.00

10Mb HARD DISK

\$189.00

SYSGEN 20/20



- 20Mb Hard Disk
- 20Mb Tape Back-up
- New/Factory Box
- PC/XT/AT Comp.
- External Complete

Reg. Retail \$3300

ACP Only **\$888**

SEAGATE ST225

20Mb Hard Disk \$349.95

ACP SUPER LOW PRICE

\$299⁰⁰

MS-DOS LAPTOP Sharp PC5000

Formerly sold for \$1995
2800 in stock new in
box w/factory warranty!
Vol. discounts available.

128K Bubble Printer	\$79.00	Supercom	59.00
Modem 300 Baud	\$150.00	Superwriter	88.00
PFS File/Report	\$129.00	Color Plotter	149.00
Soft Carry Case	\$99.00		
Soft Key Plotter SW	\$129.00		
	\$10.00		
	\$35.00		

SEAGATE ST4038-30Mb

Hi-Speed, 40 mS, AT
Compatible Drive **\$599.00**

★ Advanced Computer Products Inc.

TOLL FREE

800-854-8230

CA Residents 714-558-8813

OUR POLICY

- No Surcharge for VISA or Mastercard.
- Volume purchasing agreements available.
- Orders subject to availability. *Supply limited on certain items.
- Pricing subject to change without notice.
- ACP Retail Store pricing may vary. Not responsible for typos.

Inquiry 12

Mail Order: P.O. Box 17329 Irvine, CA 92713
Retail: 1310 B E. Edinger, Santa Ana, CA 92705

**CORPORATE BUYERS - CALL
GILLES, PHIL, MIKE or DAVE**



FULL POWER!



SANYO MBC 4000

FREE SOFTWARE FROM MICROPRO

- 8086 Microprocessor
- Runs MS DOS & CP/M 86
- Floppy disk drive with 640K capacity
- RAM expansion to 640K available
- Utility pack including BIOS & schematics option

\$499

Special pricing for printers

EDUCATIONAL DISCOUNTS

805/393-2247



For our catalog with complete details and prices, send \$2 to:
 Micro Supply Organization, Inc.
 4909 Stockdale Hwy., #180
 Bakersfield, CA 93309

15% Restocking on Returned Orders

Visa & M.C. Accepted

TURBOLINK +

"TURBO Pascal hackers will like this program."

Jerry Pournelle
 Byte Magazine

- Add 512K of TURBO Pascal* to your code
- Call up to 8 memory resident TURBO Pascal modules from programs written in:
 - BASIC, BASICA, Compiled BASIC
 - MS Pascal, C, MS FORTRAN
 - Standard, 8087 and BCD TURBO Pascal
 - TURBO Prolog
- Add TURBO Pascal's 8087, BCD and graphic capabilities to other languages
- Automatically generate TURBO Pascal compatible inline machine code.
- Use all TURBO Pascal variants in a single program
- Add AI capability to your Pascal programs
- For IBM PC and compatible

\$6995

Foreign orders add \$10.00

S&H included

VISA/MC: 1-800-835-2246 x123

KANSAS CALL: 1-800-362-2421 x123

Inquiries and Technical Information (303) 971-0729

PATHFINDER SOFTWARE, INC.
 P.O. Box 43, Littleton, CO 80160

*TURBO Pascal and TURBO Prolog are trademarks of Borland International

Now Add
 TURBO Prolog
 to your Pascal Code!

Inquiry 263

SEAMLESS File Transfer

Softerm PC provides a transparent Micro-to Mainframe link using *Virtual disk drive specifiers* accessible from any DOS application program. Memory resident. Transfers files in background using customizable communications scripts. Includes 32 exact terminal emulations.

For IBM PC/XT/AT, DG, NEC, HP, Wang, TI, Gridcase, Tandy, Zenith
 \$195 - Visa, MC, COD
 Call 800-225-8590 orders/info.



7899 Lexington Dr., Ste 210
 Colorado Springs, CO 80918
 (303) 593-9540 Telex #450236

Inquiry 330

SAVE MONEY EPROM PROGRAMMER



APROTEK 1000 ONLY

\$265.00

COMPLETE WITH PERSONALITY MODULE

117 AC POWER-RS-232 CONNECT
 -6 BAUD RATES - HANDSHAKE TO HOST
ALLOWS READ, WRITE, VERIFY & COPY

Comes complete with IBM-PC, Apple, or CPM (Specify Computer) Driver Program on Disc.

Programs the following 5 Volt 24 or 28 pin devices: 2716 series through 27512, 25xx series, 68764 plus others. Please Specify Personality Module desired with order. Additional Personality Modules only \$15.00 ea. Full 1 year warranty.

TO ORDER: CALL 1-800/962-5800 OR WRITE

APROTEK

1071 A AVENIDA ACASO Add
 CAMARILLO, CA 93010 \$4.00 Shipping-USA
 Info: (805) 987-2454 VISA or MC Add 3%
 We Accept Govt., School & Large Corp. P.O.s

Inquiry 34

6809 Single Board Computer

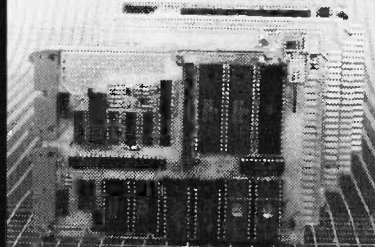

6809 MPU, 2 serial ports, 4 parallel ports, RAM, EPROM, real-time clock, watchdog timer, 44-pin 4.5" x 6.5" PCB
EXPANSION MODULES: RAM, EPROM, CMOS RAM/battery, analog I/O, serial I/O, parallel I/O, counter/timer, IEEE-488, EPROM programmer, floppy disks, cassette, breadboard, keyboard/display.

WINTEK
 Wintek Corp.
 1801 South Street
 Lafayette, IN 47904
 317-742-8428

Inquiry 391

COLOR

VT220 \$150

*plus your PC, XT, AT, or compatible

ZSTEMpc-VT220 Smart Terminal Emulator

Double high/double wide characters

Full line graphics. Smooth Scrolling

2-way file transfers incl. XMODEM & KERMIT

Full keyboard softkeys/MACROS. DOS access

Data rates to 38.4 KB. High throughput

CGA, Hercules, MDA, & EGA support

8-bit mode, downloadable fonts,

user defined keys, full national/multinational modes

ISO and attribute mapped color

ZSTEMpc-VT220 \$150. 4010/4014 option \$99.

Also available VT220 Style replacement keyboard

ZSTEMpc-VT100 \$99. - Choice of the U.S. A/F

30 day money back guarantee. MC/VISA

KEA SYSTEMS LTD.

#412 - 2150 W. Broadway

Vancouver, B.C. CANADA V6K 4L9

Support (604) 732-7411

TELEX 04-352848 VCR

Order Toll Free (800) 663-8702

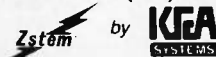

Inquiry 397

American Semiconductor

THE BARE XT TURBO SYSTEM \$399



"Looks, tastes, and acts like an IBM, AND it's 100% compatible."

8087	\$119.00	BABY AT	\$499.00
80287-3	175.00	AT	1100
80287-8	239.00	V-20	14.00
64K	99	FLOPPY DD/DS	75.00
41256K-150	2.39			
41256K-200	1.99			

XT & AT ADD ON CARDS
 For AT, XT, Compaq, & Corona:
 20MB Hard Drive \$299
 30MB Hi-Speed RLL KIT \$449

TO ORDER TOLL FREE CALL 1-800-237-5758, EXT. 819

Inside Florida Technical Line
 813-961-9444 1-813-961-5584
 16520 N. Florida Ave., Lutz, Florida 33549
 Add 3.2% for VISA/MC purchases.

Inquiry 31



COMPUTERBANC



IBM COMPATIBLE HARDWARE

Multifunction card 384K, S, P, CLK	\$139
AT Multifunction card OK-3MB	\$175
MONOCROME graphics card	\$79
Color Graphics card	\$69
ComBo CARD ser, par, clock	\$69
EXPANSION CHASIS 7 slots	\$569
MULTI SERIAL F/D 4 PORT	\$89

DRIVES

20 MB Seagate drive	\$369
30 MB Seagate for XT	\$469
30 MB drive for AT	\$649
360 K Floppy for AT	\$110
Teac 55B	\$109
20MB Hard Card	\$429

TAPE DRIVES

10 MB Irwin	\$379
20 MB Irwin	\$429
Everex Stream 20	\$569
Everex Stream 60	\$899
Peachtree	CALL
Franklin 20MB	\$399
GENOA 20MB	\$AVE

BUSINESS SYSTEMS

IBM SOFTWARE

LOTUS 123	CALL
Symphony	CALL
SPREADSHEET Auditor	89.00
ENABLE	359.00
V P Planner	55.00
ASHTON TATE Framework	CALL
dBASE II	CALL
dBASE III Plus	CALL
REVELATION	499.00
MDBS KnowledgeMan 2	299.00
POWERBASE	199.00
CLIPPER dBASE III Compiler	355.00
LATTICE C COMPILER	265.00
LET'S C Compiler	49.00
SUPERCALC IV	275.00
MULTIMATE	249.00
MULTIMATE ADVANTAGE	269.00
SORCIM SUPERCALC III	199.00
MICROSOFT Multiplan	119.00
EXCEL	245.00
Word	CALL
Windows	65.00
Project	239.00
DO5 3.2 W/GW basic	69.00
MACRO ASSEMBLER	95.00
Quick Basic	65.00
FOX & GELLER Quickcode	149.00
QuickIndex	76.00
dUTIL 3	76.00
BORELAND TURBO PASCAL	42.00
Turbo Pascal W/BCO	60.00
REFLEX	CALL
LIGHTENING	59.00
SUPERKEY	41.00
SIDEKICK (unprotected)	50.00
NORTON UTILITIES	55.00
FASTBACK	95.00
ASCII PRO Comm Software	55.00
CROSSTALK XVI	99.00
MIRROR Comm Software	49.00
PEACHTREE Back to Basics	199.00
BPI GENERAL ACCOUNTING	299.00
OPEN SYSTEMS	CALL
REALWORLD	CALL
ONE-WRITE PLUS	149.00
ACCOUNTING PARTNER	199.00
MONOGRAM DOLLARS & SENSE	99.00
TOBIAS MANAGING YOUR MONEY	99.00
DAC EASY ACCOUNTING	45.00
PFS Professional Write	115.00
PFS Professional File	145.00
Websters New World Writer	79.00
SATELLITE WORD PERFECT	209.00
MICROPRO WordStar PRO	249.00
WordStar 2000 PLUS	299.00
SANNA WORD III	279.00
RBASE 5000	359.00
RBASE System V	370.00
SUPERPROJECT PLUS	255.00

Multitech Accell 900 ... \$1550
6/10Mhz Switchable speeds
89286 AT Compatible

20MB Turbo XT Compatible
\$999.00

2 Floppy XT Compatible
\$699.00

IBM AT 30MB ... \$3200
6MHZ, 512K, Seagate 40MS

IBM XT 20MB ... \$2200
Seagate, 256K, DOS, Monitor

COMPAQ COMPUTERS ... CALL
LEADING EDGE ... CALL
SPERRY IT 44MB ... CALL
LASER 128(11c Compatible) ... CALL
LOCAL AREA NETWORK ... CALL

PRINTMASTER	35.00
BREAKTHROUGH TIMELINE	235.00
DECISION RESOURCES CHRTMSTER	219.00
ENERGRAPHICS w/plotter opt.	289.00
FUNK SIDEWAYS	36.00
LIFETREE VOLKSWRITER 3	149.00
HARVARD TTL PROJECT MNGR	285.00
THINKTANK	110.00

IBM HARDWARE

AST 6 Pack Plus w/384k	215.00
6 Pack Premium	CALL
STB Companion PC 0-2 MB LIMS	189.00
Chauffeur monographics	229.00
EGA - Plus Color Board	279.00
JRAM 3	CALL
JRAM AT3	CALL
HERCULES Mono Graphics Plus	199.00
Color Card	149.00
INTEL Above Board 64K	229.00
ABOVE BOARD for AT	359.00
ORCHID Tiny Turbo	469.00
Turbo 286E W/1 Meg	749.00
Turbo EGA	CALL
QUADRAM EGA +	379.00
PARADISE Modular Graphics Card	199.00
Autoswitch EGA	388.00
Plus Hard Card	CALL
130 WAT Power Supply	79.00
Thesys Fastcard III LIMS 0-2MB	169.00
TALLGRASS W/Tape	CALL
MOUNTAIN	CALL
ALLOY	CALL
GENOA	SAVE
MOUSE SYSTEMS Mouse	119.00
MICROSOFT Mouse w/ sltwr.	117.00
KOALA KAT	137.00

MODEMS

ANCHOR Lightening 2400	299.00
Express 300/1200	199.00
Volkmodem 1200 (5 yr wrnty)	139.00
EXPRESS I 300/1200(INTERNAL)	149.00
HAYES 1200	369.00
1200B	349.00
2400	CALL
PROMETHEUS 2400	379.00
Promodem 1200	245.00
Promodem 1200B	170.00
Promodem 1200A	189.00
Promoden 300 11c	79.00

MONITORS

AMDEK 300A	139.00
310A Hi-Res Amber	149.00
Color 600	389.00
Color 722 RGB 720 X 350	CALL
PRINCETON GRAPHICS HX-12	399.00
HX-12E RGB 720X350	489.00
SR-12	CALL
MAX-12	149.00
TAXAN: ALL MODELS	CALL
PANASONIC	CALL
DT-H103 10" High Res RGB	359.00
IBM COMPATIBLE Monochrome	99.00
Color RGB Monitor (640X200)	299.00

PRINTERS

PANASONIC (2 yr warranty)	SAVE
KX-P1080i	SAVE
KX-P1091i	SAVE
KX-P1092	299.00
KX-P1592	419.00
KX-P1595 240 CPS	CALL
KX-P3131 17cps Daisy	249.00
KX-P3151 22 cps Daisy	385.00
Citizen MSP-10	275.00

MSP-15	389.00
MSP-25	CALL
STAR MICRONICS	CALL
EPSON	CALL
FX-286	for
LO-800	Best
LO-1000	Prices
BROTHER-1509	369.00
M-1409 dot matrix	CALL
M-1109 dot matrix	205.00
HR-20 Daisy wheel	370.00
OKIDATA - All Models	Call
TOSHIBA All Models	CALL
CANNON Laser Printer	1,999.00
HEWLETT PACKARD LASER	2,199.00
HOUSTON INSTRUMENTS Plotters	CALL
Digitizers	CALL

APPLE

LASER 128 Computer	CALL
APPLE Compatible Drive Iie	99.00
11c compatible drive	99.00
MAC Compatible 3 1/2 drive	CALL
MICROSOFT Softcard II	259.00
ASCII XPRESS (Communications)	65.00
APPLEWORKS	215.00
SPELLWORKS	49.00
PRINT SHOP	35.00
Mach III Joystick	35.00
SYSTEM SAVER Fan	69.00
VIDEO 7 11c Enhancer	CALL
VIDEX Ultraterm	165.00
APRICORN (Lifetime Warranty)	
Super Serial Imager	75.00
Graphics Interface	65.00
80 Column/64K	75.00
EXTEND IT 64K	55.00
KOALA SpeedKey	99.00

Call for catalog. Thousands of products available. Volume discounts.



COMPUTERBANC

16783 Beach Blvd., Huntington Beach, CA 92647

Customer Service Call 714-841-6160

Technical Service Call 714-847-BANC



Cash prices indicated. We guarantee all items for 30 days. Within this period, defective merchandise returns must be accompanied by RMA number. All other returns will be subject to a 15% restocking fee. For prepaid orders, there will be a 3% shipping charge; 5% for UPS Blue Label; \$5.00 minimum; all orders outside U.S.A. at 15% shipping. California residents add 6% sales tax.

Prices subject to change without notice.
 ©Copyright 1985 COMPUTERBANC, All Rights Reserved.

Orders Only
 OUTSIDE CALIFORNIA

800/332-BANC

714-841-6160

VAR's OEM's RESELLER'S

Save 20 to 40%
818-889-1256

IBM-PC* Logic Boards

- XT 640k Mother Board **\$78** ³²
(Fully IBM compatible, w/0k RAM)
- XT 640k Super Turbo **\$98** ²²
(Fully IBM compatible, w/0k RAM)
- AT Turbo Mother Board **\$474** ⁸⁶
(6 & 8 MHz AT, w/0k RAM)

IBM-PC* Components (Partial List)

- Mono/Graphics/Printer **\$50** ⁶¹
(Herc. Compatible interface card)
- Multi Disk I/O (2 Floppy **\$57** ²³
Ctrl, Par, Ser, Clk, Cld, Game)
- Hi Res Amber Monito (Tilt **\$66** ¹²
swivel Base & Anti-glare Screen)
- Box/Chassis Flip Top **\$19** ⁰⁷
(IBM Compatible & Look-a-like)
- Power Supply (150w) **\$43** ⁷²
(FCC & UL Std.)
- 5160 Keyboard, AT style **\$48** ⁴⁰
(Hi-quality with great feel)
- Floppy Drive DS/DD **\$59** ⁸⁷
(Hi-quality w/Direct Drive motor)
- E G A Video Card **\$197** ²³
(Now affordable)
- E G A Monitor RGB **\$368** ²³
(720 x350 Multi Sync.)

ACS Imports, specializes in buying custom and standard electronics components to fit your specific needs. We have years of expertise buying and importing components from the Orient.

ACS will solve your sourcing needs.

Call: 818-889-1256

ACS Imports, 5311 Derry Ave.#A
Agoura Hills, CA 91301
TLX 5106018224

*IBM trademark International Business Machines
All prices are FOB Taiwan - Import Quantities

NEW



RAMJET™ Print Buffer

with advanced features!

The RAMJET Print Buffer has the features you will need at a price you will like! Panel buttons allow COPY, CLEAR, BYPASS, PAUSE, RESUME. The RAMJET buffer comes with your choice of 16K, 64K, 256K. User upgradable. Optional card expands to 512K. Special programmable features. Available with Parallel/Parallel, Serial/Serial, or Parallel/Serial ports. Parallel/Serial version can buffer either way. Serial ports independently programmable up to 19,200. Comes with rugged solid aluminum case and reliable power supply. Many more features.

RAMJET 16K - \$169.00	RAMJET 256K - \$269.00
RAMJET 64K - \$199.00	RAMJET 512K - \$399.00

(206) 624-4985

CALL TODAY! Specify Parallel, Serial, or Parallel/Serial. Information requests welcome. Omnitronix, Inc. is an experienced custom hardware/software developer. We welcome inquiries about customized buffers or controllers. Call us about your application.

Omnitronix, Inc.

760 Harrison St. — Seattle, WA 98109

Inquiry 253

HELP IS HERE !!!

Quit wearing out the pages of your software manuals! Mainframe and Mini users quit years ago. Now they use on-line HELP -- so why not step up and see what you've been missing? With **microHELP** you can have on-line access to the description and syntax for all your DOS commands and special programs. Novice DOS users find it a real aid in becoming familiar with DOS commands. Experts enjoy the increased productivity of having command information on-line.

- DOS 2.x and 3.x libraries supplied.
- Disk space requirements reduced using Huffman compression algorithm.
- A utility for adding new subjects to the library or for generating new libraries is provided.
- Complete source code to the access routines enable users to write programs that can access any library generated by **microHELP**. Great for program messages.
- Requires MSDOS or PCDOS 2.1 or later and 256k memory. Hard disk desirable but not required.

ONLY \$60.00 Checks and COD

VITAL SYSTEMS

P.O. Box 61738 • Palm Bay, FL 32906
(305) 723-1808

TRADEMARKS: microHELP (VITAL SYSTEMS),
PCDOS (IBM), MSDOS (MICROSOFT)

Inquiry 378

BAR CODES MADE EASY



PERCON® E-Z-READER™

FAST • ACCURATE • RUGGED

NO SOFTWARE CHANGES with PC/XT/AT, AT&T 6300/7300, TeleVideo 905/955 keyboard, multi-user RS 232 interfaces • Thousands in use

- Free phone support • 2 year warranty
- Bar code printing software available

Details or Questions? Call us
(503) 344-1189
2190 W. 11th Ave. Eugene, OR 97402

A LEADER IN BAR CODE READER ENGINEERING

PERCON®

ZIMCO

INTERNATIONAL, INC.
85-39 213 St., Queens Village, NY 11427

• FOUNTAIN PC/AT Compatible	\$1250
• IBM PC PACKAGE	\$895
• Internal 300/1200 Modem for IBM	\$109
• LOTUS SIGNAL	\$325
▶ BOARDS ◀	
• EVEREX Graphics Edge	\$235
• IRMA PC 3273-79	\$729
• AST 6 PackPlus 64k	\$150
• AST Rampage 256k	\$244
• HERCULES Graphics Card	\$179
▶ DRIVES ◀	
20M. CardDrive \$399	
20Meg. Drive \$345	
Complete w/cont., rails, software, cables	
▶ PRINTERS ◀	
• CANON LaserJet A-1	\$1850
• EPSON FX85	\$359
• OKIDATA 192/193	\$339/459
• IBM PROPRINTER/XL	\$385/609
• IBM/APPLE/HARDWARE/SOFTWARE/ASKUS	
CALL for Catalog & latest PRICES	

1-800-227-6647

For Technical Support & NYS
Call 718-479-7888
FREE SHIPPING! Byte12/86

Inquiry 395

DATA SENTINEL™

SECURITY FOR THE PRIVATE PC USER



- Provides Seal (Encryption) and Open (Reconstruction) of Private Data
- Hardware Key Plugs Into a PC or Compatible Parallel Port: Transparent to Printer Operations
- No Systems Work Necessary; Just and Running in Seconds
- Easy-To-Use Menu Driven Software; No Password Required
- Data Files Encrypted by Des or Rainbow Algorithm
- Compression Feature **K** - Saves Files to 50% of Original Size
- Removal of Data Sentinel. Prevents Access to Sealed Data
- Can be Configured for Corporate Needs

\$195.00

Free Extra Matching Key Included; 30 Day Refund

EVALUATION KIT AVAILABLE

RAINBOW
TECHNOLOGIES, INC.
17971 SKYPARK CIRCLE SUITE E, IRVINE, CA 92714

1-800-380-078
(714)261-0224

Inquiry 305

IEEE 488 (GPIB/HPIB)

- Controllers
- Buffers
- Converters
- Extenders
- Interface Boards



for PCs, Macintosh, HP plotters, instruments, printers, etc.

Call or send for your FREE Technical Guide

LOtech (216) 439-4091

23400 Aurora Road
Cleveland, Ohio 44146

Inquiry 171

YES, YOU CAN!

PC AMERICAN MAKES IT POSSIBLE FOR YOU!

HARDWARE

SOFTWARE

Compatible Computer



Multitech 900 10/6 MHz 1550
1.2 MB Floppy
MS DOS 3.1
One Year Warranty
Serviced by TRW Nationwide
Multitech software + Card 219
Multitech color + Card 359
Multitech EGA + Card 659
Multitech 3 MB RAM Exp OK 219
PCA 8 MHz 640K 20 MB 995
PCA 8 MHz 640K 1 floppy 660

Desktop Computer



IBM PC AT 512K 2675
Compaq Deskpro 286 512K 6195
IBM PC XT 640K 1899
IBM PC 256K 1095

Transportable Computer

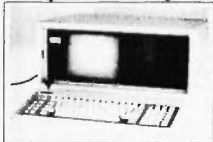

Compaq Portable 286 3100
Compaq Portable Computer 1595
Compaq Port. II Model 4 3895
Compaq Portable Plus 1695

Lap-Size Computer



Toshiba T100 1575
Toshiba T100+ 1795
Toshiba T3100 3595
IBM Portable 1675

Floppy Disk Drive

Teac 556V, 360K 99
Teac FG 12MB 149
Toshiba ND 040, 360K 99
Toshiba ND 080EG, 12MB 149
Fujitsu 360K 85

Hard Disk Drive



Seagate ST225, 26MB Kit 389
Seagate ST238, 30MB Kit 479

Seagate ST4026, 20MB 529
Seagate ST4038, 30MB 629
Radtone 203E, 30 MB 498
Seagate ST4051, 40 MB 729
CDC 9415-86, 80MB 1295
Western Digital WA2 289
Western Digital WAH 139
Disk Manager Software 99

Alternative Mass Storage

Bernaulli Box 20+20+80 3995
Everex Stream 60 ext 695
Everex 60 internal 819
Alloy 60MB external 749
Irwin 10MB Internal 389

Diskettes and Tapes

3M DC-600A cartridge 26
3M DC-100D cartridge 19
Bernaulli 20MB cartridge 72
Maxell MD2-QM 10 disks 19
Maxell MD2-HD 10 disks 35

Color Monitor

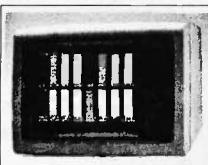

Princeton HX-12 442
Princeton SR-12 539
Princeton SR-12 P 735
Multitech color RGB 269
Toxon 630 450
Toxon 640 515

EGA Color Monitor

Princeton HX-12 E 539
NEC MultiSync 569
Multitech EGA 419
Samsung EGA 399

Monochrome Monitor

Samsung amber/bean/TTL 85
Amdex 310A TTL amber 159
Prinston MAX 12 amber 155
Multitech soft white TTL 119

Printer - Dot Matrix Near Letter Quality



Epson LQ-1000 830
Epson FX-286 569
Epson FX-85 434
IBM Proprinter 415
IBM Proprinter XL 629
Citizen 1200 120 CPS 200
Citizen MSP 10 160 CPS 307
Citizen MSP 15 160 CPS 414
Okidata 182 120 CPS 228
Okidata 192+ 216 CPS 399
Okidata 193+ 216 CPS 595
Panasonic KXP 1091 120 270
Panasonic KXP 1092 180 348
NEC P5 290 CPS 1053
NEC P5 XL 290 CPS 1192
NEC P6 216 CPS 475
NEC P7 216 CPS 665
Nishio 24 wire, 540 CPS 1090
Toshiba P-321 216 CPS 442
Toshiba P-341 216 CPS 699
Toshiba P-351 288 CPS 949
Toshiba P-351 C 288 CPS 1135
CIE 3500 350 CPS 1895

Printer - Letter Quality

Brother HR-15XL 17 CPS 369
Brother HR-25 23 CPS 610
Brother HR-35 35 CPS 895
NEC ELF 18 CPS 410
NEC Spinwriter 3550 799
IBM Quietwriter 1215

Printer - Laser

H P Laserjet 500 3850
H P Laserjet Prof 2350
H P Laserjet Plus 3000
Cannon LSP-8A-1P 2150
Cannon LSP-8A-2P 3000

Plotter



HP 7475 A Plotter 1744
Houston Ins. DPM 56 5169
Roland 860 B pen 966

Input Device

Microsoft Mouse 119
Mouse System Mouse 139

Graphics Board, Monochrome

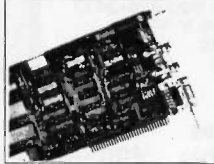

Hercules Graphics Card 194
Everex Edge 238
ATI Mono/color/high/res 238
Clone monochrome graphic 95
Percy's Bob/MG mono/RGB 171

Graphics Board Color

Paradise Mod. Graphics 249
Hercules Color Graphics 149
Clone Color Graphics 85

Graphics Board EGA

Paradise EGA/Auto Switch 359
Video 7 Deluxe/Auto 399
Multitech EGA 239

Modem



US Robotics Direct 1200 149
US Robotics 1200 PC INT 139
US Robotics 2400 PC INT 199
Everex Evercom 1200 139

Memory Expansion

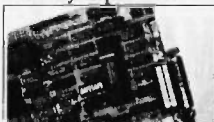

AST SixPakPlus 166
Clone ShPack 89
AST Rompage PC 234
AST Rompage AT 445
Toll Tree J-Rom 3 184
Multitech 0-3MB P/S 238

I/O Board

2 Floppies P/S/C/G/ 89
AT I/O P/S 89

Chips

256K 160 Nano 27
256K 120 Nano 29
64K 150 Nano 9
8087 119
8087-2 158
80287-3 189
80287-8 299

Accounting



Dac-Easy Accounting 45
Accounting Software, BPI 299
Open System, Account Soft 399
PCAmerican Accounting 1685
Time Line + Breakthrough 282

Applications Integrator

Microsoft Windows, Microsoft 65
Desqview, Quarterdeck 65

Communications

Crossstalk XVI, Microstuf 119
Smartcom II, Hayes 89

Data Management



dBASE III Plus, Ashton T 399
R Base 5000, Micromir 308
Reflex, Borland 86
Paradox Anso Software 442
Clipper 349
Ext Report Writer 85
Clout 2 139
OGraph II 149
Quickcode III 145
Quick Report 139

Desktop Management

Sidickick, Borland 29
The Desk Organizer, Warn 65

Education

Study Program for SAT 47
Math Blaster 25
Early Learning Series 33
Newsroom, Springboard 30

File Management

PFS: File, Software Pub 76
PC-File III, Baitonware 69

Financial Modeling

1-2-3, Lotus 305
Javelin, Javelin Software 548

Games

Scenery Disks Western US 72
Flight Simulator, Microsoft 32
Jag, Sublogic Communication 33
Sargon III, Hayden Software 29
Zark I, II, and III, Inf. 29
F-15 Strike Eagle MicroPro 29
Winter Games Epyx 29
Temple Of Apshai Trilogy 29
Movie Master - The Game 29
World's Greatest Baseball 25
Comp Novel Construction Set 29
Black Cauldron, Sierra 29
Silent Service, Microprose 25

Graphics - Business

Charter-Master, Decision Re 220
Microsoft Chart, Microsoft 176
1-2-3, Lotus 305
Freelance Lotus 224
Harvard Presentation Graphics 299

Graphics - CAD

AutoCAD, Autodesk Inc. 2700
ProDesign II, American 173
In-a-Vision, Microsoft 237
Generic CAD, Generic 89
ProDesign II AmericanSBC 179

Integrated



Framework II 399
Symphony, Lotus 425
1-2-3, Lotus 305
Enable, The Software Group 333

Investment

Andrew Tobias's MECA 115
Dow Jones Market Manager 147
Dollars and Sense 107
Market Analyzer, Dow Jones 219
Market Manager Plus, Dow Jones 158
Spread Sheet Link, Dow Jones 156

Micro-to-Mainframe

IRMA, Digital Communications 1499
Crossstalk XVI, Microstuf 119

Outline Processing

ThinkLink, Living Video 99
Ready, Living Video 52

Personal Management

Andrew Tobias's MECA 115
Dollars and Sense, Mono 99

Programming Language

Turbo Pascal, Borland 41
C Compiler, Microsoft 287
Basic Compiler Microsoft 227
Turbo Prolog, Borland 58
Microsoft Quick Basic 72
R-base System V 389
Think Tank 108

Project Management

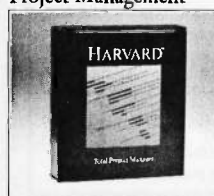

Harvard, Software Pub 299
Microsoft Project 238
Time Line, Breakthrough 235

Spreadsheet



1-2-3, Lotus 305
SuperCalc 3, Computer As 277
Multiplan, Microsoft 111
Lotus Report Writer 119

Tax Planning or Preparation

Tax Preparer, HowardSoft 299
PC/TaxCut, Best Program 85

Training

Professor Dos, Individual 35
Teach Yourself dBASE III 89
PFS: First Choice SP 95
Webster's New World Writer 82
Certificate Maker, Spring 25
Print Shop, Boderbund 52
Typing Tutor III, Simon & Simon 42

Utilities

Norton Utilities, Norton 51
SuperKey, Borland 40
SideKick, Borland 28
Traveling SideKick 41
Carbon Copy, Meridian 130
PC Tool, Central Pnt 39
Copy II PC, Central Pnt 39
1DIR+, Bourbak 53
V Feature, Golden Bow 99
SQZ1 Turner Hall 59
Fast Back, Fifth Generation 94
Xtree, Executive Systems 29

Word Processing



WordPerfect, Wordperfect 219
Microsoft Word, Microsoft 285
Wordstar 2000, MicroPro 277
Easy, MicroPro 75
Multimate Advantage Ashton/T 317

Most Promising Software

Turbo Lighting, Borland 59
Javelin, Javelin 549
Microsoft Windows, Microsoft 65
Q & A, Symantec Corp 299
Generic CAD, Generic 99

The difference between PCAmerican and other suppliers is our service. We guarantee low prices, carry products that are fully backed by manufacturer's warranties and offer customer service and technical support. Yes you can! It's easy to do business with PC American. We offer terms to qualified institutions, accept major credit cards, wire transfers, checks, and cash. Yes you can! Give us a call. Let us make it possible for you.

TERMS: We accept C.O.D., cashier check, Visa, Master Card, 3% extra on American Express, wire transfers, approved P.O.'s. All equipment carries new factory warranty. Prices are subject to change. Any return item must be accompanied by a return authorization number and description. IBM, Compaq, Seagate are registered trademarks of their respective companies.

HOURS - FRIDAY
8:30 - 5:30
SATURDAY
10:00 - 2:00

Marketing, Inc.
17151 Newhope St., Suite 104, Fountain Valley, CA 92708

1-714-557-3903
CUSTOMER SERVICE

1-800-654-5365
SALES HOTLINE

1-714-557-3904
TECHNICAL SUPPORT

DiskMASTER[®]

The Ultimate Diskette Value ...

Discover The Difference ...

2 FOR 1 LIFETIME WARRANTY

- Performance exceeds ANSI specifications by 62.5%
- Each diskette 100% tested and certified error free
- 65% clipping level • Over 10 million passes per track
- Reinforced Hubs • Tyvek[®] (not paper) sleeves
- W/P tabs and ID labels

.49 5 1/4" - 48 TPI DS-DD
1.19 DS-HD 96 TPI IBM-AT Compatible

Simply top Brand-Name Quality, made in the U.S.A. by a leading manufacturer. Factory polybagged in lots of 25.

CenTech[®]

America's Premium Quality Color Diskettes

- ✓ **LIFETIME WARRANTY**
- ✓ Performance exceeds A.N.S.I. specifications by 88%
- ✓ Each disk 100% tested and certified
- ✓ 14 COLORS for data organization
- ✓ Pkgs. of 10, tyvek sleeves, w/p tabs, and ID labels

SS-DD	QTY. 10 BOXES OR 100 DISKETTES	DS-DD
.74	5 1/4" Color, BOXED, 48 TPI	.98
1.39	3.5" Color, BOXED	1.95
.64	5 1/4" Color, BULK, 48 TPI	.88
1.30	3.5" Color, BULK	1.92
	High Density, Color, 1.6mb, IBM AT Compatible	1.95

Includes Tyvek sleeves, w/p tabs, ID labels
 Call for excellent prices on other CenTech products

America's No. 1 Name-Brand Diskettes

- ✓ **LIFETIME WARRANTY**
- ✓ High quality and consistently reliable
- ✓ More rigid jackets than ever before

SS-DD	QTY. 5 BOXES	DS-DD
.74	5.25, 48 TPI	.97
1.35	3.5, 135 TPI	1.90
	DS-HD 96 TPI, IBM AT Compatible	1.95

Call for best 3M prices on head cleaning and data cartridges.

Nashua[™]

Affordable Quality Incredible Value Best Prices Ever!

- ✓ **LIFETIME WARRANTY**
- ✓ Factory Fresh in **BOXES** of 10 with sleeves, w/p tab, ID labels

SS-DD	QTY. 10 BOXES	DS-DD
.54	5.25, 48 TPI, box of 10	.57
1.12	3.5", 135 TPI	1.46
	High Density, IBM PC-AT Compatible	1.50

For every 100 name-brand diskettes **FREE Shipping or a Diskminder for only \$5.99**

- ✓ **LIFETIME WARRANTY**
- ✓ Exceeds ANSI specifications
- ✓ Includes Tyvek sleeves and w/p tab
- ✓ Hub Rings
- ✓ 100% tested and certified
- ✓ Made in USA

BULK MULTIPLES OF 100
5 1/4 DS-DD 35¢

ORDERING INFORMATION

TERMS: Free use of VISA, Mastercard, and American Express. P.O. orders accepted from recognized corporations rated 3A2 or better, government and schools on net 30. **SHIPPING:** Add \$3.00 per 100 diskettes or fraction thereof, add \$5.00 for COD orders.

PRICE PROMISE: We will better any lower delivered price on the same products and quantities advertised nationally.

Toll Free Order Line: **1-800-233-2477** Information Line: **1-801-561-0092**

199 Cottage Avenue
 Salt Lake City, Utah 84070
 Hours: 8am to 5pm (mtn. time)

Computer Affairs, inc.

AT Memory Board

NOW COMPATIBLE WITH 10 MHz ATs

MRB 2010 memory board that expands ATs to run multiple programs for multitasking operations is now capable of running at 10 MHz. These upgraded boards enable AT systems to operate at higher speeds and are compatible with Xenix, Unix, and other multiuser systems.

MRB 2010 features include:

- 2 megabytes per board — use up to 3 boards
- Compatibility with many other memory boards
- 10 MHz operation with IBM ATs
- Installation in less than 10 minutes

Call now for information on how the MRB 2010 can expand the multitasking options of your AT system.

STAR-GATE TECHNOLOGIES, INC.
 33800 Curtis Blvd.
 Eastlake, OH 44094
 (216) 951-5922

Inquiry 343

NO SHIPPING CHARGES

ORDER TOLL-FREE 800-824-3432
 In California Call (916) 341-8833

DRIVES

1/2 Ht. IBM [®] Compatible	89.99
Tandon 100-2	99.99
Tandon 100-4 (96 TPI)	129.99

SYSTEMS

PC/XT Compatible 499.99

- 640K on Motherboard
- Slide-In Case
- 1-1/2 HT. Floppy
- 135 Watt Power Supply
- Mono Card w/Printer Port
- 5150 Type Keyboard

→ **FCC APPROVED** ←

CALL FOR CUSTOM CONFIGURATIONS AT COMPATIBLES — CALL!

We carry a complete line of electronic components. Call or write for our free catalog!

NICORN ELECTRONICS
 10010 Canoga Ave. Unit B-8, Chatsworth, CA 91311

Minimum order \$10.00 — No shipping charges on prepaid orders — C.O.D. add \$3.00 — UPS Ship add \$3.00 — Call, residents add 6 1/2% sales tax. Personal checks held for clearance. VISA - MC

Inquiry 371

PROGRAMMABLE COMMUNICATIONS TRANSLATOR

The PCT-100 is an in-line, user-programmable RS-232 protocol and data translator. It can provide a simple, inexpensive solution to your communications and compatibility problems.

- Terminal & Printer Emulation
- Baud Rate Conversion (50 through 19.2 kbaud)
- Handshake Translations (XON/XOFF CTS/RTS, ENO/ACK)
- Code Conversions (ASCII, Modified ASCII, EBCDIC)
- Bidirectional Manipulation of Data Strings, Bytes, Bits
- User-Programmable
- User Programs are Easily Implemented
- Built-in Compiler, Editor and Debugger
- Programs via any RS-232 ASCII Device
- Only \$495 (single unit quantities)
- User's Technical Manual \$25

Method Systems Incorporated
 3511 Lost Nation Road
 Willoughby, Ohio 44094
 (216) 942-2100 or toll-free Sprint local number, then 666-0212

Inquiry 220

GAT-286 COMPLETE SYSTEM—\$2195⁰⁰

Includes one megabyte memory on board, 6 or 8 MHz, zero wait state, Phoenix BIOS; Disk drive controller with 2 floppy disk drives (1.2 M.B. and 360 K) and one 20 M.B. hard disk; monochrome monitor with adapter, serial/parallel ports; 200 W. power supply, keyboard, case. IBM PC/AT compatible. Certified to comply with FCC. class B standard.

XT COMPATIBLE SYSTEM—\$795⁰⁰

Includes 640K memory on board, 2 floppy disk drives, serial/parallel/game ports, real time clock; monochrome monitor w/adaptor, 150 W. power supply, keyboard; one year warranty.

PC/XT/AT COMPATIBLE PARTS

I/O Card for XT or AT	\$ 70.00
LOGIMOUSE	\$ 85.00
20 M.B. Hard Card	\$425.00
30 M.B. Hard Card	\$475.00
Modem (Internal or External)	\$149.00
Joystick	\$ 20.00

LUCKY COMPUTERS

(214) 690-6110
 1701 Greenville, Suite 602, Richardson, TX 75081

IBM PC/XT/AT are Registered Trademarks of International Business Machines Corp.

Inquiry 204

STAND ALONE MICROCONTROLLERS

For engineers, designers, experimenters, and others!

Omnitronix, Inc. is now offering a self contained stand-alone 8031 based microcontroller package for your applications development. The MSC-8031 Controller features two bi-directional RS232 ports, fully supporting serial pins 1 thru 8, 12, 20, and 22. The serial ports are independently selectable for up to 19,200 baud. Front panel has two on/off buttons (plus power) and two controllable LEDs. The board supports one 2764 EPROM and one 8K SRAM. Internal expansion bus permits additional memory or I/O interfacing. All contained in an attractive solid aluminum case. Controller package includes MSC-8031 controller, 8K SRAM, UL approved wall power supply, schematics, and programming examples. Kit price \$249.00.

Quantity pricing available. Call us at (206) 624-4985. Send for our catalog of peripherals and controllers. Omnitronix, Inc. is an experienced hardware/software developer for microcontroller applications. Call us for your custom programming requirements on our stand alone controllers or other PC based applications.

Omnitronix, Inc.
 760 Harrison St. — Seattle, WA 98109

Inquiry 252

\$79 HARD DISK CONT.

Computer Surplus Store

New Shugart Model 1610 5-1/4" Hard Disk Controllers

Emulates:

- Xebec S1410 (1610-3)
- DTC 510 (1610-1)
- SCSI (1610-4)

Works with:

- Micromint COM 180, SB180
- Wavemat Bullet
- AMPRO All Boards
- Macintosh
- Apple IIe
- ACS 1000

Full 90 Day Guarantee

Manual & Schematic Only \$8

Xebec S1410 HDC\$95
IBM PC Controllers	
• Adaptec 2010A\$150
• Adaptec 2070 (RLI 2-7)\$175
(Shipping & Handling \$5.00)	

222 Phelan Ave. • San Jose, CA 95112
408-280-1740

Inquiry 89

TIMELINE INC.

CALL US FOR ALL YOUR NEEDS!
We have 10 Million I.C.'s in stock!
Minimum I.C. Order: \$200.00

Continental U.S.A. Order Desk (800) 872-8878 Inside California (800) 223-9977 L.A. & Technical Info (800) 217-8912 OEM INQUIRIES WELCOME

INCREDIBLE PRICE BLOWOUT!

MICROSCIENCE
10 Mb 1/2 HEIGHT
HARD DISK DRIVE

SUPER PRICE!
\$135.00 \$235.00
WITH OPTIONAL CONTROLLER CARD



15 Mb System - \$289.00
30 Mb System - \$419.00 Includes:
(2) 1/2 Height drives & Controller card with cables.

WE HAVE A LIMITED STOCK OF THESE BRAND NEW 1/2 HEIGHT DRIVES. WE ARE OFFERING THEM ON A ONE TIME SALE ONLY AT THESE SEVERELY LOW PRICES.

AMDEK 13" Color Composite MONITOR
for Atari, Commodore & Apple Computers
Model: Color-I Plus -
Resolution: 260Hx320V

\$129.95 Only 250 Available!

Input Terminal:
Video In: RCA phone jack
Audio In: Mini phone jack
16 1/2" H x 17 1/2" W x 16 1/2" D

Character Number:
1700 Characters (64 Characters x 25 Rows on 5x7 Dot Matrix)



MOTOROLA 7" DIAGONAL SCREEN HIGH RESOLUTION GREEN SCREEN MONITOR

\$280.00 Factory List \$29.95 4 for \$99.00
MODEL MD-100

- Flat Facplate
- 300 lines at Center 650 lines at corners
- Operates from 12VDC at 1 Amp.
- Vertical input is 47 to 63 Hz
- Horizontal input: 15.7 KHz (18.7 KHz optional)
- Video input signal: Positive white, input termination 470 ohms ±
- 5%, 2.5V to 5.0V P.P.
- Weight: 5lbs.

For split video (ITL) input operation. Not composite video.



INFRARED REMOTE CONTROL KEY BOARD

IBM PC/XT (OR JR.) LIQUIDATION! \$69.95 LIQUIDATION!

We are proud that we have been awarded the opportunity of offering these very unique keyboards. The original factory list was 259.00. We are blowing them out at an incredible price! Also, these are American made and not Taiwan clones. These can be operated by remote or attached to your computer. COMPLETELY IBM COMPATIBLE



TEC MODEL 1550 PRINTER \$279.00

- Centronics parallel and RS232 Serial ports
- 15" carriage
- 120 cps
- Tractor and friction feed
- Graphics



One of the largest manufacturers in the world has 125 of these prestigious printers in their overstock. We are extremely fortunate to be designated as their representative to market them.

ASTECH 65 WATT SWITCHING POWER SUPPLY

Dual input voltage 115/230 VAC - Overvoltage protection - Short circuit protection - Dual isolated +12V - Built-in EMI filter - Very compact size - UL/CSA/VDE approved - 100% thermal cycle & burn-in - High efficiency - Vacuum impregnated transformers - Convection cooling - Open PCB "L" bracket or boxed construction.

Dimensions:
8.0" - Length
4.4" - Width
2.4" - Height

SUPER DEAL! \$29.00

OUTPUTS:
Condition No.1
+5V DC @ 6.0A
+12V DC @ 1.5A
+12V DC @ 2.1A
-12V DC @ 0.25A

Condition No.2
+5V DC @ 5.0A (with two +12V outputs in parallel)
+12V DC (with two +12V outputs in parallel)
@ 3.5A (5.0A surge)
-12V DC @ 0.25A

MODEL No. AC9335-01

PERFECT FOR POWERING:
- HARD DISK DRIVES
- FLOPPY DISK DRIVES
- MINICOMPUTERS
- CRTs

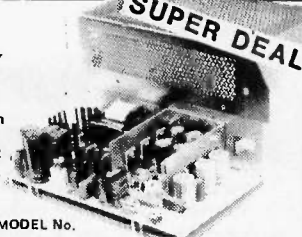

PROGRAMMABLE SYNTHETIC SPEECH GENERATION BOARD

SSB-APPLE **\$59.00**

PLUG COMPATIBLE WITH APPLE II MICROCOMPUTERS. Can be easily controlled by BASIC. Uses TMS5220 for: Low-data-rate LPC encoding, +5V & -5V supplies only - TTL Compatible

INCLUDES: Software and Speaker



EPSON QX-10 MOTHERBOARD WITH VIDEO CARD & YOUR CHOICE OF - ASCII KEYBOARD (ENCLOSED) OR HASCII (BARE)

\$169.95

ONLY 250 SYSTEMS AVAILABLE!
Will work with any IBM compatible disk drive • CPU: PD780AC-1 (280A compatible, 4 MHz) • Memory-RAM: 256K on board; Video RAM: 128K on CRT board; C-MOS RAM: 2K; EPROM: 24/48K (for IPL) Clock - C-MOS real-time clock interface - Serial and Parallel DMA - 7 channels - Interrupt levels: 15, Counter/timer: 6 channels; Card slots: 5 Compatible with any TTL monitor; Weight: 10 lbs with enclosed keyboard, 8 lbs with bare keyboard



KEPCO/TDK SWITCHING POWER SUPPLY

\$39.95

ONLY 250 AVAILABLE!
Model EPX 100T-3 100W • +5V @ 8A • -5V @ 1.5A • +12V @ 2.0A • -12V @ 2.0A • Input Voltage: 100 to 130V a-c or 200 to 260V a-c • 47-440 Hz Single phase • Brownout Voltage: 90V a-c/180V a-c • Fused Input Output protected against short circuit Dim: 9 1/2" x 4 1/4" x 2 1/4" H, Weight: 3 lbs., Spec Included.



Kodak-Teamate HIGH CAPACITY Drive \$129.00

Unformatted: 3.3 Mb Formatted: 2.78
Requires 8" controller and software (both available)
**Amlyn 1865 High Capacity drive : 119.00

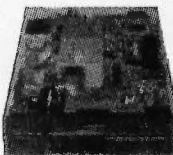

MODEL DM8112CX High Quality - Solid State 12" SANYO MONITOR

MONOCHROME- For use in: Surveillance, Industry, broadcast, education & data display.
AC 117V-60Hz-36W (0.4A)
Re-conditioned & fully tested - Composite video signal, sync. negative

\$49.95

Video amp. bandwidth 18 MHz
Display format 1920 characters max. 80 char. x 24 lines (5 x 7 dot) Scanning Frequency
Horizontal rate 15.78 KHz, Vertical rate 60 Hz
10 1/2" H x 13 1/2" W x 14" D

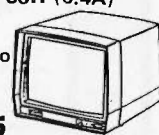

"Spy in the Sky" Fairchild CCD122 1,728 ELEMENT * Linear Image Sensor \$29.95

*The Twilight
* * * * *

Designed for page scanning applications including facsimile, (Optical Character Recognition and other imaging applications which require high resolution and high sensitivity.



TANDON 848-2	199.95
REMEX FD480	59.95
RICOH RP1200 (Daisy Wheel)	349.95
SERIAL MODEM CABLE	7.95
NASHUA Diskettes (box of 10)	8.00
4164-15 (min. 100 pcs.)	.89
TELEPHONE HEADSET	3.95
12V ADAPTER (250mA)	2.50
ULTRASOUND DEVICE	3.95
5" MONITOR (B&W)	39.95

CLASSIC TECHNOLOGY CORPORATION 286 SPEED PAK FOR IBM PC & XT UP TO 10 TIMES PC SPEED \$695.00

10 MHZ

- Increases speed of PC/XT to make it 33% faster than an AT
- 20-30% faster than boards that use cache
- Compatible with IBM Enhanced Graphics Adapter and the Lotus/Intel above board
- Can run programs designed for the AT's and also PC/XT's
- No software patches needed
- Includes native mode
- Made in U.S.A.

3 Year Warranty



**Top 100
Venture Capital
Investment Firms**

We work with the **top one hundred** venture capital investment firms in America. **Ninety eight** percent of the multi-million dollars of investment goes into high-tech, manufacturing and start up companies.

The amount can range from 50,000 to 50 million.

Call today for further information
(916) 362-2731



International Financial Co.

President Rayford R. Roberson
4056 Bairn Dale Way
Sacramento, CA 95826

Inquiry 170

Power Control

110/220 AC by your IBM-PC

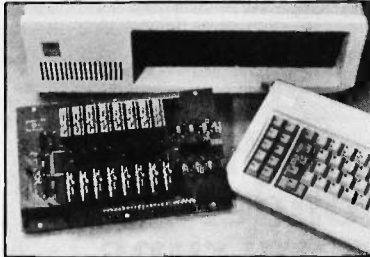

The boards allow you to Control/Monitor high voltage AC/DC power lines with your IBM-PC/XT/AT or compatible while providing optical isolation.

QUA TECH, INC.

478 E. Exchange St. Akron OH 44304
(216) 434-3154 TLX: 5101012726

Inquiry 290

**WAVEFORM
SYNTHESIZER**

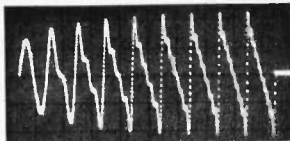

- For IBM-PC/XT/AT and compatibles
- Generates user-definable signal
- Up to 2000 points per envelope

\$795.00

QUA TECH, INC.

478 E. Exchange St. Akron OH 44304
(216) 434-3154 TLX: 5101012726

Inquiry 292

**RS-422
Communications Board**

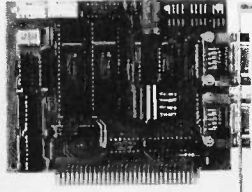

- For IBM-PC/AT/XT and compatibles
- Dual RS-422/RS-485 interface
- Differential drivers to 4000 ft.

Fast Delivery

QUA TECH, INC.

478 E. Exchange St. Akron OH 44304
(216) 434-3154 TLX: 5101012726

Inquiry 289

**MODULAR
DATA ACQUISITION**



- For IBM & Compatibles
- Flexible and Inexpensive
- Money Back Guarantee
- Free Technical Support

Fast Delivery

QUA TECH, INC.

478 E. Exchange St. Akron OH 44304
(216) 434-3154 TLX: 5101012726

Inquiry 291

72 Digital I/O



PXB-721

Parallel Expansion Board

- For IBM-PC & Compatibles
- 72 Digital I/O Lines
- Simple Programming
- Uses One Expansion Slot
- Fast Delivery

\$195

QUA TECH, INC.

478 E. Exchange St. Akron OH 44304
(216) 434-3154 TLX: 5101012726

Inquiry 293

LIFETIME WARRANTY

Verbatim.
Special **12PACK**
* 12 Pack Special 5 1/4" SSDD & DS-DD

5 1/4" Disks	Digital Cassettes	3 1/2" Disks
	S-Side 7.95 D-Den. *	
5 1/4" Disks	T300..... 4.05	8" Disks
	R300... 3.85	
5 1/4" Disks	T450..... 5.55	8" Disks
	DC30... 6.60	
5 1/4" Disks	MI 50... 4.90	HEAD CLEANERS
	HD10... 7.95	
5 1/4" Disks	HEAD CLEANERS	5 1/4" Refills 7.00
		8" Kits... 5.05
5 1/4" Disks	8" Refills 8.00	5 1/4" Disks
	HIGH DEN. 20.95	

Old Reliable **Diskette Connection** • Delaware 1-800-451-1849
• Oklahoma 1-800-654-4058
• Nevada 1-800-621-6221

LIFETIME WARRANTY

3M

Call For Quantity Discounts

5 1/4" Disks	Data Cartridges	3 1/2" Disks
	DC 100A 12.95	
5 1/4" Disks	DC 1000 12.95	8" Disks
	DC 300A 16.60	
5 1/4" Disks	DC 300XL 19.55	HEAD CLEANERS
	DC300XLP 19.85	
5 1/4" Disks	DC 600A 22.00	5 1/4" Disks
	HIGH DEN. 21.95	

Old Reliable **Diskette Connection** • Delaware 1-800-451-1849
• Oklahoma 1-800-654-4058
• Nevada 1-800-621-6221

maxell
FLOPPY DISKS

5 & 10 box Quantity Discounts

SUPER QUALITY

5 1/4" DISKS	3 1/2" DISKS
S-Side 12.95 D-Side 19.00	S-Side 19.95 D-Den. 21.95

LIFETIME WARRANTY

Old Reliable **Diskette Connection** • Delaware 1-800-451-1849
• Oklahoma 1-800-654-4058
• Nevada 1-800-621-6221

PC's & PERIPHERALS

QUANTITY BUYERS ONLY

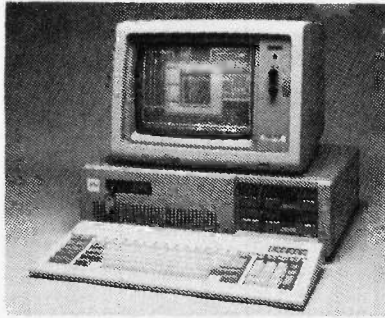

TURBO XT CLONE 64K expandable to 640K, 135 watts P/S, keyboard FDC, 360 K disk drive fully burned & tested.

\$399.00 (3 Units Minimum)

AT CLONE 10/6 MHz switchable, 80286 CPU, 1 MB board U.S. made, 200 watts P/S, AT style keyboard, burned & tested.

\$999.00 (2 Units Minimum)

2400 Baud
Modem **\$189.00** (Qty. Only)

1200 Baud
Modem **\$ 85.00** (Qty. Only)

360 KB
Floppy Drive **\$ 67.00** (Qty. Only)

Color Graphics
Card **\$ 49.00** (Qty. Only)

Printer Cable **\$ 3.59** (Qty. Only)

XT Hard Disk
Cable Set **\$ 2.99** (Qty. Only)

20 MB Hard Disk Sub-
System **\$359.00** (Qty. Only)

All of above prices are C.O.D. cash only.
Prices and availability subject to change
without notice.

CLONE FACTORY

(415) 656-5404
(213) 477-0447
(714) 731-5727
TWX: 5106003265



This ad is for all those who ever wonder why your company runs a United Way campaign.

When it comes right down to it, you're probably the best reason your company has for getting involved with the United Way.

You see, they know almost all of the money given to the United Way goes back out into the community to help people.

So if you, or the people you work with, should ever need any of our services, like day care, family counseling or health care, we'll be right there to help. In fact, there are tens of thousands of United Way-supported programs and services in cities and towns across the country. That means help is nearby wherever you are.

And your company knows that could mean the difference between keeping or losing a valuable employee.

That's why they give. And that's why they ask you to give. Because there may come a day when you need help yourself.



United Way

Thanks to you, it works. for ALL OF US.



A Public Service of This Magazine & The Advertising Council

PC COMPATIBLE SYSTEMS

WE CARRY A WIDE RANGE OF DESKTOP, LAPTOP & PORTABLES DESIGNED TO RUN THE SOFTWARE THAT FUELS TODAY'S BUSINESS.

"BIG BLUE CLONE"

NOT JUST AN ECONOMICALLY PRICED PC - WE'RE DOWN IN THE DIRT ON PRICE! LET'S MUD WRESTLE A DEAL FOR YOU ON A B.B.C. THAT'S "FCC" APPROVED & ONE YR. LIMITED WARRANTY.

BASIC B.B.C.

256-640K, TURBO V20, 8 SLOTS, 360K FLOPPY, 150 W P/S, SLIDE CASE, SPKR, 8 SLOTS \$449

CALL OUR SALES PROFESSIONALS FOR ADDITIONAL OPTIONS



BREAK THE SPEED LIMIT



Rev-up to 10 or 12 MHz with ACS ET-286. ACS ET-286 10 MHz, 1-4Mb, CLK-CAL, 2P & 3S PORTS, CABINET, 200W P/S, KEYBOARD, 8 SLOTS, "FCC", 100% AT COMPATIBLE BIOS, + XENIX READY. **\$1,395**



PC-400 512K, 2 FLYPS, 14" 640x400, 512K \$979
20Mb HARD DISK SYSTEM \$1,369
ATD-8-Q 8MHz 80286, 640K, S, P, 1.2 FLYP \$1,549
ATP-8-Q PORTABLE \$1,629



PC/IT 8MHz 80286 EXPANDED w/1 MbRAM, 1.2 Mb FLYP & 85 Mb HARD DISK DRIVES, 8 SLOTS, MS-DOS 3.1, GW-BASIC, & DIAGNOSTICS \$3,575
PC/IT ENHANCED WITH 1 Mb RAM, 1.2 Mb FLYP & 44 Mb HARD DISK DRIVES & SOFTWARE \$2,949
MICRO/IT BASIC SYSTEM \$1,749

ALTO 1086-50 1 Mb RAM, 50 Mb H.D./TAPES \$10,695
686-25 6 USER, 25 Mb H.D. \$3,395
2086-2 2 Mb RAM, 80 Mb H.D. & TAPE \$14,395



WYPC-286 40 Mb H.D., 10 MHz 80286 \$2,849
WYPC-286 10 MHz 80286, 640K, S, P, CLOCK \$1,875

NETWORKING

CALL FOR DEALER PRICING, INTEGRATION, AND/OR CONSULTATION.

CompuPro HYBRID HUB \$265
EARTH NET/PC ARCNET 1/2 CARD \$295
ALLOY PC-SLAVE/16 1 MB, 8 MHz, V20 \$655
RTNX MSDOS 2.1 \$145
ATNX MSDOS 3.1 \$219

Intra-Continental Micro LAN-PC ARCNET FOR PC's \$369
ACTIVE HUB \$519
PASSIVE HUB \$ 40

NOVELL

ADVANCED NETWORK STARTER KITS, SERVERS, AND SOFTWARE CALL

PC/XT/AT BOARDS

STE RIO GRANDE 128K-1.5 Mb, P&S \$195
CHAUFFER RUNS RGB IN MONO \$189
ATTA-BYTE 0-384K FOR AT&T \$159
TECMAR MAESTRO 0-2.5 Mb, S, P \$295
CAPTAIN OK, S, P, CLK \$155
EXPANSION CHASSIS \$639

AST 6 PACK PLUS \$159
6 PACK PREMIUM \$339
RAMPAGE-AT \$429
ADVANTAGE \$359
3G-PAK EGA CARD, 256K, S, P, CLK \$359

intel PCMB-1120 ABOVE BOARD PS/PC 256K \$319
PCMB-2020 ABOVE BOARD/AT 512K \$419
MACROTECH MSR-AT 0-3 Mb RAM FOR IBM-AT @ 6, 8, 10, & 12 MHz. NO WAIT STATES \$185 - \$625

CAD

CORDATA FASTDRAFT 640x480 w/32 COLORS \$969
ACS GRAPHAX 20/20 x 2000 x 2000 RES., 32 COLORS, 2.5 Mb, AUTOCAD COMPATIBLE \$1,595



DMP 41/42 \$2,449
DMP 51/52 \$3,699
DMP 56 \$4,399
DMP 29 \$1,699
DMP 40 \$899

TRUE GRID DIGITIZERS

TG1005 \$289
TG1011 \$509
TG1017 \$619

POWER SYSTEMS & ACCESSORIES



ALL CABLES SOLD AT DEEP DISCOUNT

S4 CIRCUIT SURGE SUPPRESSOR \$19
S10 6 CIRCUIT SURGE SUPPRESSOR \$29
P15 MONITOR BASE - 5 PLUGS w/SURGE-NOISE & MODEM PROTECTION - DISK STORAGE \$89
U1000 POWER SAVER 1000W U.P.S. (BY TOPAZ) w/4 OUTLETS AND TRUE SINE WAVE CALL
U400 POWER SAVER 400 WATT CALL



BC-425 WATT S.P.S. 30 MIN. \$419
BC-675 WATT S.P.S. 70 MIN. \$625
BC-1000 WATT W/SELF CONTAINED BATT 40 MIN. \$939
SAFE (SAFT) SPS1000 WATT SINE WAVE \$889

MONITORS & TERMINALS

NEC MULTISYNC CALL
TECMAR RGB HI-RES ZVM-1360 \$498
ZENITH ZVM-1240 (IBM) FLAT SCREEN \$149
ZENITH ZVM-1360 640x400 \$498
PRINCETON GRAPHICS ALL MODELS CALL



ONE YEAR WARRANTY - 30 DAY SWAP-OUT
CM-1360 640x200 RGB, 13" G/A SWITCH \$339
CM-1380F EGA 640x350 RES 13" G/A SWITCH \$450
TEGA-22 256K EGA 1/2 CARD WHGC, CGA, MDA \$245
1222A 12" GRN. OR AMB \$109
1422A DUAL FREQ. TLT/SWIVEL, 14", G/A \$139



PC-TERM EMUL WY-50, TVI 925, IBM-AT KB, FOR MULTI-USER PC-SLAVE BOARDS \$425
220 EMULATES DEC VT 220, 100, 52 \$449
WYSE WYSE 30 \$299
WYSE WYSE 50 \$399
WYSE WYSE 60 \$475
LIBERTY FREEDOM ONE \$395

PRINTERS & BUFFERS



M-1109 100-25 CPS P & S, TRACTOR \$199
M-1509 180/45 CPS P & S W/TRAC CALL
M-1409 AS ABOVE 110 COL. PARA CALL
M-1709 240/50 CPS "PAPER PARK" FX-286 & IBM PROPRINTER COMPAT AUTO SHEET LOAD CALL
HR-35 36CPS DAISY, WIDE CARR. \$729
HR-20 20 CPS \$349

CITIZEN™

MSP-10 \$298
MSP-15 \$375
MSP-20 \$339
MSP-25 \$475
120D \$185
PREMIERE 35 \$459
CORDATA LP-300 LASER \$2,175
HANZON BUFFER 64K-256K S-S, S-P, P-S, P-P \$265
STAR MICRONICS SG-15 \$369
TOSHIBA P321 PARA. & SERIAL \$509
TOSHIBA P341 \$899
TOSHIBA PRINTERS CALL



DIABLO D25 \$475

DIABLO 635 \$815
DIABLO D80IF \$1,398
DIABLO 34 LQ \$939
4045 LASER WITH COPIER & 512K RAM \$4,798

SCIENTIFIC/INDUSTRIAL PC BDS.

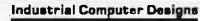

A/D 64-100 \$315
A/D 64-PC \$396
D/A 64-100 \$236
D/A 64-PC \$468
1018-PC 96 TTL INPUT LINES \$446
SCIENTIFIC SOLUTIONS (TECMAR)
IEEE 488 \$239
LAB MASTER \$859

S-100 BOARDS

ONE STOP SHOPPING FOR ALL OF YOUR INTEGRATION AND POST SALE SUPPORT NEEDS. WE HANDLE: CCS, COMPUPRO, DUAL, I.C.M., ILLUMIN. TECH., LOMAS, TELETEK, MULLEN, P&T, INDUST. COMP. DESIGNS, TARBELL, ETC. THIS MONTH'S SPECIALS ARE:

ICM CPS-16/256K-8 MHz \$495
ICM CPZ-186-1 Mb \$995
ICM CPS-186/256K \$949
COMPUPRO DISK DRIVE BRACKETS \$25

HARD DISK & TAPE DRIVES

PC-INSIDER, PC-OUTSIDER & AT-INSIDER HARD DISKS FOR IBM AND COMPATIBLES SET-UP TO BOOT FROM HARD DISK WITH ALL NECESSARY HARDWARE AND PC-STYLE CABINET FOR EXTERNAL DRIVES.

20Mb PC-INSIDER \$399
38 Mb PC-INSIDER ST-238 \$498
51 Mb PC-INSIDER ST-4051 \$888
51 Mb AT-INSIDER ST-4051 \$778
85 Mb AT-INSIDER MC-1325 \$1,195
ALLOY FT-60 60Mb a 1.8Mb/Min. For PC Compat. \$699
IRWIN 10Mb TAPE/PC or CPPO - Requires CDOS \$369
IRWIN 20 Mb TAPE \$469
TECMAR QIC 60 AT INT 60 Mb TAPE \$1,139

BARE WINCHESTER DRIVES

SEAGATE ST-225 \$309
SEAGATE ST-4051 51 Mb, 40mSEC, FH 5 1/4" \$775
QUANTUM Q540 43 Mb, 45mSEC, FH 5 1/4" \$798
MICROPLAT MC-1325 85 Mb, 28mSEC, FH 5 1/4" \$1,198
MAXTOR XT-1140 140 Mb, 30mSEC, FH 5 1/4" \$3,289
MAXTOR XT-2190 190 Mb, 30mSEC, FH 5 1/4" \$3,895

FLOPPY DISK DRIVES

MITSUBISHI 2894 FH 8" \$465
2896 HH 8" \$425
MITSUBISHI MF-501 48TPI \$95
MF-504 96TPI \$129
TEAC FD55BV 48TPI \$89
TANDON TM 50 48TPI \$75

SOFTWARE

WE SELL ALL WELL KNOWN BRANDS. ORDER CORRECTLY!
"OPENED" SOFTWARE IS NOT RETURNABLE!
NEWSTAR NEWWORD 2 \$139
NEWSTAR NEWWORD 3 SPELL CHECKER, INDEXING, CONTENT TABLES, MACROS, SHORTHAND KEYBOARD, MULTI-TASKING WORDSTAR COMPAT. \$225
BD SOFTWARE C COMPILER 8" SSDD 8 BIT \$95
MICROSOFT — ASHTON-TATE -38%
MICROPRO — MULTIMATE — P.F.S. -41%
BORLAND INT'L TURBO PASCAL, ETC. -41%
MOST OTHER PC PROGRAMS -41%

MODEMS



PROMODEM 1200 \$249
PROMODEM 2400 CALL
PROMODEM 1200G \$179
2400G \$339
PROMODEM 1200B W/MIRROR \$139
CTS 2424 ADH ASYNCH/SYNCH. HAYES COMPATIBLE 2400 BAUD \$269



MT224EH MNP ERROR CORREC. \$469
MT224ER RACK MOUNT WEDC \$465
U.S. ROBOTICS COURIER 2400 CALL
U.S. ROBOTICS AUTO DIAL 212A \$285
WITELPAC-MS-DOS \$285



All merchandise new. Authorized prices are cash prepaid only. PO's from qualified firms & AM Express. 95.MC & Visa. 968.COD's (99.55 min fee) with Cashiers Check, MO, Bank Wires & APO's accepted. Shipping minimum \$4 first 5lbs. Tax. AZ RES. ONLY add 6.5% sales tax. All returns subject to 20% restocking fee or credit towards future purchases. All prices & availability subject to change without notice.

ENCLOSURE PRODUCTS

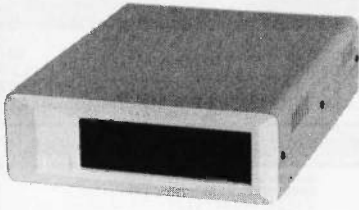

- Tape and Hard Disk Drives Enclosures for all Major Micros.
- Single Board Computer Packages
- Custom Design Available
- Class 'B' Certification Support Can Be Provided
- Call For Pricing and Catalog

Microware Inc.

41711 Joy Road • Canton, MI 48187
(313) 459-3557

Inquiry 233



RS232C IBM PC Compatible Paper Tape Transmitter/Model 612

Stops and starts on character at all speeds, uses manual control or X-on, X-off 90-260 volt, 50-60 Hz power. 50-9600 baud, up to 150 char/sec synchronous or asynchronous; gated internal or external clock, RS 232C, current loop or parallel output, reads 5-8 level tape, 7-11 frames per character, even or odd parity. Desk top or rack mount.

Addmaster Corporation, 2000 S. Myrtle Ave., Monrovia, CA 91016, (818) 358-2395, Telex 674770 Addmaster SGAB

Inquiry 5

DOUBLE THE OPTION CAPACITY OF YOUR IBM PERSONAL COMPUTER

PC-XTRA

- DIRECT EXTENSION OF 8M PC BUS
- NO SOFTWARE CHANGES
- NO HARDWARE MODIFICATION
- STYLING CONSISTENT WITH IBM

Add all these special options that you've been wanting without worrying about filling your Plug-in and back panel space

DEALER INQUIRIES INVITED.

\$549.00* F.O.B. SANTA ANA
*CALIFORNIA RESIDENTS ADD 6% SALES TAX

P C HORIZONS, INC.
1701 E. Edinger, Ste. A6, Santa Ana, CA 92705
(714) 953-5396

Inquiry 257

8051 PASCAL

- * MS-DOS Cross Compiler
- * Generates ROMable HEX files
- * Separate Compilation Includes Linker
- * Two Memory Models On Chip RAM External RAM
- * Access to BITs, PORTs, SFRs
- * Interrupt Routines
- * Compact Run Time Package Source Included
- * Assembler Compatible
- * Only \$395 Complete

SCIENTIFIC ENGINEERING LABORATORIES
104 Charles Street, Suite 143
Boston, MA 02114 Tel 617 262 3903

Inquiry 317

Why waste time?

ACCELERATE with VCACHE™

HARD DISK ACCELERATOR

- Caching eliminates repetitive disk accesses
- Use up to 15 Mb of extended/expanded or 500 Kb of standard memory

DISKETTE ACCELERATOR

SCREEN ACCELERATOR

FAST — FRIENDLY — SAFE

VCACHE

GOLDEN BOW SYSTEMS

\$65

Add \$3 for shipping/handling
California residents add 6% sales tax



2870 Fifth Avenue
Suite 201
San Diego, CA 92103
619/298-9349

Inquiry 150

Incredible!

64K Printer Buffer with cable

Plus \$3 shipping & handling

\$69

30-day money back guarantee plus 1-year warranty

Limited Offer-Order Today

Works with any standard Centronics parallel interface • Reset button • Multiple copy repeat function • Auto diagnostics • Self-test

Order by Check/MO or VISA/MC/AX

CENTRAL
COMPUTER PRODUCTS

Call Toll Free
USA: 800-533-8049
CA: 800-624-5628

330 Central Avenue • Fillmore, CA 93015

Inquiry 420

DATA ACQUISITION TO GO INTERFACE FOR ANY COMPUTER FREE IBM SOFTWARE

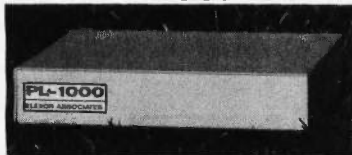

Connects via RS-232. Fully IBM compatible. Built-in BASIC. Stand alone capability. Expandable. Battery Option. Basic system: 16 ch. 12 bit A/D, 2 ch. D/A, 32 bit Digital I/O. Expansion boards available. Direct Bus units for many computers.

(201) 299-1615

P.O. Box 246, Morris Plains, NJ 07950

ELEXOR

Inquiry 124

Set up a complete graphics workstation on your PC for under \$100!

MicroPlot's enhanced PC-PLOT-III graphics emulator software package enables IBM PC and compatibles to appear to a mainframe as a DEC VT-100/VT-52, a Retrographics VT-640, a Tektronix 4010/4014 or a partial Tektronix 4027. Over 12,000 copies are currently in use world-wide at major corporations, educational facilities, research labs and independent consulting firms.

For more information call toll free

1-800-654-1217



659-H Park Meadow Road
Westerville, Oh 43081 614/882-4786

Inquiry 418

LOW COST UNIVERSAL PROGRAMMER KITS

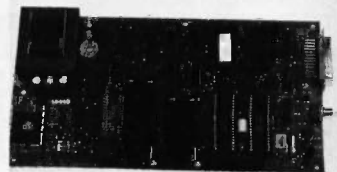

- * NO PERSONALITY MODULES REQUIRED
- * ON LINE HELP AND MENU SELECTION
- * ON BOARD 110/220V POWER SUPPLY
- * FAST PROGRAMMING MODE AT 6V VCC
- * BUILT IN MONITOR FOR I/O DEBUG
- * CAD PCB, SILKSCREEN & SCHEMATIC
- * SOFTWARE DRIVERS FOR MOST PCs
- * SUPPORTS ALL 5V EPROMS, EEPROMS AND INTEL MICROCOMPUTERS

KITS FROM \$125 ASSEMBLED \$295
DRIVERS \$35 SHIPPING \$4
VISA & MASTER CARD ACCEPTED

B&C MICROSYSTEMS

6322 MOJAVE DR. SAN JOSE CA 95120
PHONE (408) 997-7685 TELEX 4995363

Inquiry 418

IT'S A FACT! SOME PC USERS ARE SNOBS!

OVER 600 PIECES OF
IBM-PC COMPATIBLE
SOFTWARE JUST
\$6.00 A DISK!
OVER 500 DISKS FULL
OF PUBLIC DOMAIN AND
USER SUPPORTED PROGRAMS



Some PC users are snobs!

In this day of Young Upwardly Mobile Professionals, some people won't even try our great software because of the status stigmas tacked to it. Why, you ask? Because of some of the same status symbols that make some people want to drive BMW's and wear genuine ROLEX watches. "After all," they reason, "what if some one from the office saw me using a \$6.00 software program instead of the latest version of Star-Word-Perfect-Plus? I might loose my keys to the executive wash room or something."

We're sorry if you have fallen into this status trap. The truth is our modestly priced software is some of the best and most sophisticated you can buy anywhere at any price. Would it make you feel better if we increased our prices 50 times and added a fancy copy protection scheme?

Think big! Dare to be different! Why not tell the other YUPPIE's at the office that you're buying an ounce of gold with the difference you're saving. You may start a new band, and may even corner the gold market the same time!

Still not convinced? Well, here is just a sample of our ever growing library by category:

APPLICATIONS

- ANCESTRAL GENEOLOGY ON DISPLAY (#90)**
- ANCESTRAL GENEOLOGY - FT (#240)** From Pine Cone software.
- LABELMAKER (#146)** Our favorite label file and printer. Menu driven.
- FAMILY HISTORY (#361)** Family history, ancestor and descendant charts. Sample programs.
- FORM LETTERS (#388)** LOTS of samples of the most commonly used business letters. Modify!
- PC-SPRINT (#507)** Detailed instruction on how to double your computer's speed for less than \$50.00.
- MSDOS-CPM/80 INTERFACE (#561)** CPM lovers! This program allows you to transfer information between and emulate CPM and MSDOS.
- NAME GRAM/BREAK DOWN/FOREWARD (#477)** Discover the words inherent in your phone number, and great anagrams.
- THE WORD DIGITIZED (#494, 495, 496)** A cartographer's dream. Locate and display over 100,000 locations.
- 3 LETTERS (#300)** Most commonly used form letters, and business applications at your fingertips.

COMMUNICATIONS

- MODEM (#310)** Without a doubt the fastest and best communications software you can buy at any price.
- TALK (#16)** The classic "Freeware" communication program.
- BS (#212)** Become a SYSOP and start a bulletin board.
- JO NET (#333)** Bulletin Board System. Perhaps the easiest to run.
- OCOMM (#499)** Communication software that makes a hacker's dream come true.

DATABASE

VCR dBASE (#493) Keep track of those favorite VCR tapes that you never can seem to find when you want them.

DATABASE PROGRAMS

- PC-FILE (#5)** Perhaps the granddaddy of user supported database programs from Jim Button.
- NEWBASE (#238)** Menu driven database for the beginner.
- PC-DBMS (#383)** A relational database management system that provides on-line help and screen editing functions.
- CREATOR (#339)** Create, report and sort makes this a super database management system.
- MAIL MASTER (#481)** Easily sort, index, and list your multiple mailing data bases.

EDUCATION

- EQUATOR (#249)** A teaching tool for math, science and finance.
- PC-TUTORIAL (#403)** A first course in computer usage covering various aspects of MS-DOS. Good!
- PC-PROFESSOR (#105)** Learn Basic the easy way. One of the best tutorials on BASIC.
- PC-DOS HELP (#254)** Type "help" for the DOS command you forgot.
- PC PROMPT (#558)** Fascinating on line memory resident DOS helper that also supports BASICA, EDLIN, DEBUG, and TURBO PASCAL.
- PC-SPRINT (#507)** Tutorial on how to triple your PC's speed.

FINANCIAL

- PC-CHECK MANAGER (#275)** Keeps multiple checkbooks in balance.
- TAX FILE DBS (#295)** Tax record keeping system that saves you money on April 15.
- PORTSWORTH PACKAGE (#101)** Evaluates your ever-changing stock portfolios.
- PC-GENERAL LEDGER (#237)** An exceptional accounting system. Used by some CPA's.
- LOAN AMORTIZATION (#399)** For output to screen or printer. Lots of on-line help.
- MR. BILL (#469, 470)** Prepare invoices, client report, audit trail, etc.
- ANALYTIC CALC (#430-432)** 3 disk set. Complete spreadsheet, database, graphics, word processor - fasss!
- PC ACCOUNTING SYSTEM (#559, 560)** General purpose ledger system that includes payroll, depreciation, accounts receivable/payable, inventory, processing 1099's and a good general ledger.
- PC-PAYROLL (#565)** Handle all payroll problems with this complete menu-driven payroll system. Includes taxes, reports, forms, etc.
- SALESEYE (#501, 502)** Never let another prospect or lead get away! Prints memos and letters as well.

GAMES

- TOP GAMES (#274)** The most requested arcade type games.
- ARCADE GAMES (#293)** Another goodie bag of top arcade games.
- PC JR GAMES (#354)** Games that will work only on PC JR. Combat, Dungeons and Dragons, Global Thermonuclear War.

MISC GAMES (#390) Good selection of educational, adventure, and arcade games.

- PINBALL RALLY (#557)** You asked for it! Here are three pinball games that vary in complexity. PINBALL, RAIN, TWILZONZ.
- DND (#567)** Dungeons and Dragons, this uses text characters instead of graphics.
- REFLEX POINT (#487)** Self styled action game similar to ROBOTTECH cartoon series.

GRAPHICS

- PC-KEY DRAW (#344-345)** A small CAD system. Lots of demonstration files.
- PC-PICTURE GRAPHICS (#136)** Drawing package allows you to zoom, color, and store pictures.
- PC-GRAPH (#418)** Allows user to create graphics from PC-File report files.
- PRESENT (#471)** Professional slide shows are a snap with the advanced graphic features of this program. Includes a screen "capture".

LANGUAGE

- CHASM (#10)** Cheap assembler with tutorial.
- XLISP (#148)** Lisp language interpreter.
- PROLOG & UNIFORTH (#417)** Complete with editor and documentation.
- ESIE (#398)** Build and generate an expert system in a flash.
- P-BASIC (#381)** BASICA work-a-like for clones, etc.
- TINY PASCAL COMPILER BUILDER (#540)** Learn to create your own Pascal Compiler and language compiler/savings and investment portfolio. User friendly!
- SCREENCODE (#503)** Build your screen applications and watch SCREENCODE generate the code for DBASE II and III, BASIC, and more.
- VISIBLE PASCAL COMPILER (#510)** Watch your program spig through its routines as you learn to program it in PASCAL.
- EXTENDED BATCH LANGUAGE (#124)** Makes the PC do menial tasks you never thought possible.

MATH AND STATISTICS

- EPISTAT (#88)** Statistical analysis of small to medium-sized data samples.
- STAT-TOOLS (#509)** (1 of 2) Do single size experiments, studentized ranges, calculate the size of specific sample sizes.
- STAT-TOOLS (#509)** (2 of 2) Do calculations that require the entry of original observations, exact randomization tests, mean squares, etc.

MUSIC

- PC-MUSICIAN (#127)** Compose music on your PC, save and play again.
- PIANO MAN (#279)** Play your keyboard like a piano.

PRINTER UTILITIES

- SIDEWAYS (#285, 411)** Prints text sideways on an Epson printer.
- SETPRTR (#79)** Sets up Epson printer from a menu.
- PRINTER UTILITIES (#411)** Smorgasboard of utilities and tools.
- EPSON PRINTER UTILITIES (#326)** Spool, set up routines all designed for Epson codes.
- BANNER (#386)** Make long banners with large letters. Includes MS-FORTRAN source codes.
- WSMMX80 (#526)** Allows Word Star to print more ways than you imagined on an Epson/Compatible

printer. Useful for mathematical and scientific notation.

SPREADSHEET TEMPLATES

- PC-CALC (#199)** Fabulous 123 work-a-like from the author of PC-File.
- LOTUS 1-2-3 TEMPLATES AND MACROS (#406, 414)** Why spend hours writing your macros when these are ready made? Modify them yourself.

TEXT PROCESSING TOOLS

- WORDSTAR AIDS (#375)** Collection of the most useful utilities for the Wordstar user.
- PC OUTLINE (#414)** Create and collapse and outline. Great for plans, essays, etc.
- PC-STYLE (#505)** Better than your high school English teacher! Analyzes your writing ability.
- POLYGLOT & LETTERFALL (#542)** Two educational programs to match sentences, words, and definitions. Q&S's. Typing tutor is great!
- SIDE WRITER (#523)** Print your text files sideways. Allows the 132 column barrier to be broken. Great for large spread sheets.

UTILITIES

- GINACO (#66)** Polished routines written in basic for any beginner or expert. We love it!
- ULTRA-UTILITIES (#133, 245)** Recover lost files, modify sectors, etc. Like Nortons.
- SYSTEMU (#250)** Build a menu driven menu system. Excellent for hard disks.
- PC-DESKMATES (#405)** Better than Sidekick and all of the rest of the memory resident desktop utilities.
- ALIGN (#217)** Disk Alignment tool.
- TOP UTILITIES (#273)** All of the most requested utilities on one disk.
- NUMZAP (#284)** Removes line numbers from BASIC programs.
- UNPROTECT (#414)** Various routines to disconnect protection schemes.
- PATCHES (#376)** Make back up copies of some of the most popular commercial programs with this collection.
- DOSMATIC (#498)** Fabulous task-switching and menuing utility that allows several.
- PC-TOOLS (#536)** Lots of useful utilities with both EXE and ".C" source code. BROWSE, DUMP, MERGE, WORD COUNT, ROFF, GREP, etc.
- DBS-KAT (#537)** Diskette cataloging system for archival purposes. Database can hold up to 9,999 diskettes and 16,000,000 files.
- STILL RIVER SHELL (#481)** An enhancement of the PC-DOS working environment. Faster and uses Key Commands.
- PC-PROMPT (#558)** The on-line mode makes this memory resident utility tops. Great for beginners and advanced users alike.

WORD PROCESSING

- PC-WRITE (#78)** Our most popular full featured word processor that is actually faster than Wordstar.
- DICTIONARY (#378)** Dictionary type spelling checker.
- PC TYPE (#455)** Jim Button's contribution to a full fledged word processor.
- NEW YORK WORD (#528, 529)** Powerful word processor that creates keystroke macros, split screen editing, mail merge and more. Watch out Micro-Soft!

Inquiry 195

ORDER FORM

LONE STAR SOFTWARE, INC. 2100 Hwy. 360, Suite 1204, Grand Prairie, Texas 75050, (214) 647-1010

No COD's or Purchase Orders

U.S. Funds Only

Foreign Orders add \$5.00

to all Shipping/Handling

We Warranty All Disks Against Defects
In Duplication

SHIP TO: _____

CHARGE MY: _____

MASTERCARD VISA

CARD NO. _____

EXPIRATION DATE _____

SIGNATURE _____

TOTAL # _____ * \$6 = _____

DISK DIRECTORY _____ * \$6 = _____
(Explanation of all files & programs)

OTHER _____

SUBTOTAL _____

TEXAS RESIDENTS ADD 6% TAX _____

SHIPPING AND HANDLING _____
(1 @ \$1.00 and 50¢ for each additional disk)

PLEASE ENCLOSE CHECK WITH ORDER

ENTER DISK NUMBERS DESIRED:

- | | |
|-----------|-----------|
| 1. _____ | 13. _____ |
| 2. _____ | 14. _____ |
| 3. _____ | 15. _____ |
| 4. _____ | 16. _____ |
| 5. _____ | 17. _____ |
| 6. _____ | 18. _____ |
| 7. _____ | 19. _____ |
| 8. _____ | 20. _____ |
| 9. _____ | 21. _____ |
| 10. _____ | 22. _____ |
| 11. _____ | 23. _____ |
| 12. _____ | 24. _____ |

Expand your options!

DISK UPGRADE BIOS for ATs

Forget Drive Table Limits!

- Use any Compatible Drive on the AT Controller
- For DOS, UNIX, XENIX . . .
- Plug-in Installation
- Includes set-up and low-level format

DUB-14 GOLDEN BOW SYSTEMS

\$95

\$3 shipping/
handling
California orders
add 6%



2870 Fifth Avenue
Suite 201
San Diego, CA 92103
619/298-9349

Inquiry 149

NEW!



SafeSkin™ KEYBOARD PROTECTOR

Remains in place during keyboard use. Prevents damage from liquid spills, dust, ashes, etc. Fits like a second skin, excellent feel. Available for: IBM-PC, AT, Apple (all), Compaq, Model 100, NEC 8201, C64, Zenith 150, DEC, Kaypro, KB5151, AT&T 6300, WYSE 50 and many others. Send \$29.95, check, M.O., Visa & MC include exp. date. Specify computer type. Dealer inquiries invited. Free brochure avail.

Merritt Computer Products, Inc.
2925 LBJ Fwy. #180 / Dallas, Texas 75234
(214) 339-0753

Inquiry 218

CHANGING SYSTEMS?

What Happens to Your Data? Does JUST Media Conversion Solve Incompatibilities?

WHAT IF . . .

everything is changing, including your software, hardware, operating systems and media? What happens to your **spreadsheet** data and formulas, **database** structures and/or word processing documents and codes?

What do you do, and what is the cost?

We Make Incompatible Data Compatible!

The source can be mainframes, minis, micros, dedicated word processors or typesetters. **ADAPSO** member.

CompuData Translators, Inc. 213-462-6222
6565 Sunset Bl., #301 Hollywood, CA 90028

Inquiry 79

8051 8048

SIMULATORS - CROSS ASSEMBLERS - PROGRAMMERS - SIM51 and SIM48 Software Simulators run on IBM-PC, CP/M-80, MS-DOS. Designed for validation & debugging application software. Simulation includes all on chip functions plus expansion chips. \$250, one year FREE updates. Formats: PC-DOS 2.x DSSD, CP/M-80 8" SSSD, many 5 1/4" formats. Cross Assemblers and EPROM pgmrs also available. Logical Systems Corp. 6184 Teall Station, Syr., NY 13217. (315) 478-0722.

Logical Systems

Inquiry 191

VT100 VT220 TEK 4010/14

Emulation from \$89

GMS emulators turn your PC* into full-featured DEC Color terminals

- True 132 columns. VT100 line graphics
- Softkeys, DOS key
- ASCII and binary file transfer KERMIT
- 38400 Baud, ANSI Color
- Fast, Compact (less than 70k), Efficient
- OPTIONAL 4010/14 GRAPHICS
- CGA, EGA, Herc 6300, 3270 support
- Coming soon: TC/IP support, PC4105

Join thousands who have discovered GMS's
4 year record of
quality emulation software and support.

General Micro Systems

PO Box 5330
Minneapolis, MN 55343-1553 USA
(612) 944-0593

Call for Free Information Package.

*Also runs on XT, AT, 3270 PC, Jr and compatibles.
DEC is a trademark of Digital Equipment Corp.

Inquiry 141



INI-10/AT

PC-AT EXPANSION CHASSIS

- Full 16-bit PC-AT bus
- 10 slots
- 250W power supply
- Two fans
- Direct extension of PC-AT bus
- No software changes needed
- Inexpensive, simple, attractive

Dealer inquiries invited.
List Price \$1,400.00

INI Computer Products

6915 Hightech Drive
Midvale, UT 84047

(801) 561-1100
Contact Mark Jenkins

Inquiry 167

Motion Control & Data Acquisition

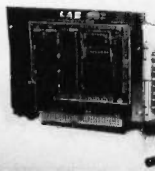

on your IBM PC or Apple II
and all compatibles

Smart 2 Axis Motion Controller: For many types of motors & encoders. New I.C. (from HP) allows changes & monitoring on the fly. Optically isolated. W/SOFTWARE \$350.

Four Axis Stepper Driver: With SOFTWARE & motor for instant automation. \$95.

Fast A/D Board: With programmed gain, 650 KHz, 4 inputs. \$220. Complete Scope hardware & SOFTWARE \$500. Also: 12 Bit A/D, Relay Driver, Real Time Clock. Circuit developers Project Book \$25.

How do you do it? Use our Local Applications Bus, LAB 40. One host adapter (\$150) supports up to 8 boards, like those above, on a 50 ft. ribbon cable.

Please call (415) 755-1978 for free literature.

Computer Continuum

75 Southgate Ave., Suite 6
Daly City, CA 94015

(415) 755-1978

IBM-PC Schematic Design

A professional package enabling you to design, edit, print & plot electronic schematics. Supports "A" — "E" size sheets, over 2000 Unique Library Parts, Auto Panning, Part Rotation, 5 Zoom Levels, Rubberbanding, Powerful Macros, Hi-Res Color & Monochrome Graphics, Much More! \$495 Includes Everything.

Call or Write for Free Demo Disk.

OrCAD Systems Corporation

1049 S.W. Baseline St. Suite 500

Hillsboro, OR 97123

(503) 640-5007

! not only a
printer buffer!
THIS IS THE MOST SOPHISTICATED
PRINTER BUFFER - MULTIPLEXOR - SWITCH

WITH TWO SEPARATE INPUTS (SERIAL AND PARALLEL) AND TWO SEPARATE OUTPUTS (SERIAL AND PARALLEL) CAN BE USED LIKE STANDARD BUFFER. WITH ANY INPUT TO ANY OUTPUT. BUT ALSO YOU CAN CONNECT 2 COMPUTERS TO 1 PRINTER, OR 1 COMPUTER TO 2 PRINTERS, OR 2 COMPUTERS AND 3 PRINTERS. . . AND MORE - 1 COMPUTER TO 3 PRINTERS OR 3 COMPUTERS TO 1 PRINTER
HIGH CAPACITY - 64 KB TO 256 KB AND - 256 KB TO 1 MB (MODELS A AND B). PAUSE, COPY AND RESET FUNCTIONS SERIAL PORTS WITH 7 OR 8 BITS WORD LENGTH, 1 OR 2 STOP BIT, PARITY, XON/XOFF, DTR, RTS

DCB-A-64K \$ 195

DCB-B-266K \$ 255 (**)

(**) Power supply and parallel cables are included.

ALSO, WE HAVE THE MOST COMPLETE DATA CONVERTER UNIT. CONVERTS RS232 SERIAL TO CENTRONICS PARALLEL OR VICE VERSA, JUST BY MOVING JUMPERS. BAUD RATE AND PROTOCOL FULLY PROGRAMABLE FROM 160 TO 19200 BAUDS. INCLUDES: DTR, RTS, XON/XOFF, PARITY, etc.

DCU \$ 80 (***)

(***) Power supply and cables NOT included



serial<>parallel
bi-directional converter



INECTRA Inc. - Dept. 232

2029 TERMINAL BLVD
MOUNTAIN VIEW, CA - 94043

(415) 967-8818 TX 345545

HUNTING FOR A GREAT DEAL?

HARD DISK DRIVE CARDS

Logic Array MegaCard!

NEW!
\$499

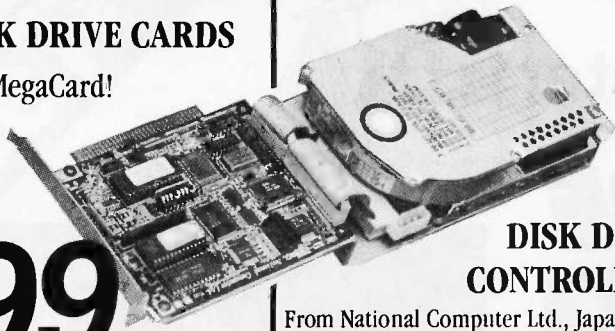

- Hard disk drive on a plug-in card gives PC or compatible the storage capacity of an XT
- Uses NEC technology for high reliability
- Fast, easy installation
- **two year guarantee**—parts and labor

21-Megabyte \$499
30-Megabyte CALL FOR PRICE

HARD DISK DRIVE KITS

(Half height, boots from hard disk—includes controller, cables, manual)

20-Megabyte \$415
40-Megabyte \$599
(with Disk Manager software)
On Track Disk Manager Software sold separately \$65

FLOPPY DISK DRIVES

360-K \$89
1.2 Megabyte, AT-Compatible \$129
1.2 Megabyte, PC-compatible
(enables your PC or XT to read and write AT-formatted diskettes)
was \$299—clearance price NOW \$129



EGA SOFTWARE

Rix EGA Paint \$49

DISK DRIVE CONTROLLERS

From National Computer Ltd., Japan's premier maker of controllers

- These compact AT-compatible controller cards are among the smallest available.
- Co-resident, IBM-COMPATIBLE

NDC 5126 AT Winchester only \$179
(a half card—so small you won't believe it's AT-compatible)
NDC 5125 AT Winchester/Floppy \$189
NDC 5127 XT Winchester only \$79
NDC 3011 SASI Controller \$91
DTC5150CX Data Technology \$99



BOARD LEVEL PRODUCTS FROM MYLEX

Multifunction card
0-K \$82
384-K \$123
Envision I (mono/color/graphics) \$147
Envision II (mono/color/graphics, char. RAM enhanced modes) \$156
Color Adapter I \$77
Color Adapter II \$83
Business Master I (mon/par adapter, enhanced text modes) \$80
Business Master II (high-res. mon graphics, enhanced text modes) \$91
Enhanced Graphics Adapter \$279
(EGA, CGA, MDA, HGC compatible)
Advanced Graphics Adapter I \$345
(high-res. 800 x 600, CGA compatible)
Advanced Graphics Adapter II \$605
(with 80186 multi-processor)

CHIPS

256K D-RAM (set of 9) \$27
64K D-RAM (set of 9) \$9
V-20 (8 MHz) \$10.95

INTEL MATH CO-PROCESSORS

8087 \$125
8087-2 \$179
80287-6 \$225

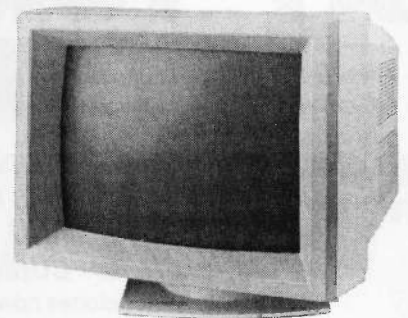

MONITORS

TTL Amber \$98
MultiSync CALL FOR PRICE

HERE'S HOW TO ORDER:

We accept Visa, MasterCard and American Express (no surcharge) and Money Orders. Minimum charge card order \$25. No sales tax outside California. (CA residents add 6%.)

Personal or company checks require three weeks to clear.

We insure all orders.

Shipping and handling minimum \$5 up to 3 lbs. within continental U.S. Call for shipping info on other orders.

Prices and availability may change.

Returns require authorization and are subject to restocking charge.

Normal manufacturers' warranties apply.

Not responsible for typographical errors.

IBM, MultiSync, MegaCard, Mylex EGA Paint and On Track are trademarks of their respective companies.



18017 Skypark Circle, Suite L, Irvine, CA 92714

CALL 800-443-7355
In Calif. Call 800-345-4868
Tech Questions 714-250-3386

MON-FRI 7AM-5PM Pacific Time



**American
Semiconductor®**



**\$256K
\$199!**

THE BARE XT TURBO SYSTEM

\$399.

*"Looks, tastes, and
acts like the IBM,
AND, it's 100%
COMPATIBLE!"*

AT's and portables clones now available



**CALL US FOR THE
COMPLETE PICTURE
TODAY! . . .**

**HOT NEW PRICES!
AT Clones \$1100.**

Portable Compact Clone XT	799.
XT Power Supplies	89.
XT/AT Keyboards	69.
Hayes Compatible Modern 300/1200 INT/EXT	139.
Mini UPS (200W)	335.
Ext. Drive Case with 80W Power Supply	169.

WINCHESTER DRIVES

(5¼" & 3½")

10MB Portable Shock Mount (40g's)	\$250.
20MB Half Height ST225	299.
20MB Portable Shock Mount	325.
30MB RLL XT Compatible Kit	449.
Hardcards Available	499.



**WINCHESTER
DRIVE KITS**

20MB Half Height/CC Shock Mount	\$379.
10MB Portable Shock Mount	379.
20MB 3½ Shock Mount Portables	379.
30MB Half Height (RLL)	449.
30MB Full Height	599.

ALL DRIVE KITS INCLUDE:
CONTROLLER CARD/
CABLES/MANUAL

**HIGH-SPEED
HARD DRIVES
(RT-AT-XT-RLL Compatible)**

20MB AT/Hi-Speed	\$299.
30MB AT/Hi-Speed	499.
50-160MB	499.
60MB PRIAM	\$999.

PERIPHERALS

Composite Monitor	\$ 79.
Color Monitors AS LOW AS	235.
HiRes Monochrome Monitors	119.
IRWIN B/U TAPE SYSTEM	\$449.

ADD-ON CARDS

Monochrome Card III	\$ 79.
Monochrome Graphics III WITH Port Printer	99.
Color Graphics Card V	79.
Printer Port	29.
Multi I.O. WITH FLOPPY CONTROLLER	99.
Multi Function (6-PAK Lookalike) Card 0-384K w/Software	99.
Hard Drive Controller	99.
Hard/Floppy Controller AT	190.
EGA Cards	239.
Floppy Controller w/Cables	49.

FLOPPY DISK DRIVES

Mother Boards (Expandable to 640K) XT Compatible Turbo	\$139.
DSDD 48 TPI-360K Half Height: QUME/TRAK #142	79.

CHIPS

41128	\$ 3.25
41256K-150	2.39
41256K-200	1.99
4164	.99
8087-3	119.00
8087-2	155.00
80287-3	159.00
80287-8	239.00
NEC V-20	14.00

"OURS does what THEIRS does for a whole lot LESS!"...CALL TODAY!



**TO ORDER TOLL FREE CALL
1-800-237-5758
EXT. 1108**

Vendor Line
Inside Florida
813-961-9444

TECHNICAL
SUPPORT
813-961-5584

PRICES SUBJECT TO CHANGE DUE TO AVAILABILITY AND MARKET FLUCTUATIONS.

CALL TODAY FOR ITEMS NOT LISTED AND DEALER PRICING. ADD 3.2% FOR



16520 N. Florida Ave., Lutz, Florida 33549

ATTAK-286™ MODEL 1A

HIGH SPEED 12 MHZ OPERATION 6,8,10, and 12 MHZ! SELECTABLE TO

- FULL IBM PC-AT* COMPATIBILITY!
- FULL MEGA-BYTE RAM CAPACITY!

100% DESIGNED, MANUFACTURED, ASSEMBLED AND TESTED IN USA!

AIT Corporation is a publicly traded company. Majority USA owned and traded on the OTC market under AITC



THOUSANDS SOLD WORLDWIDE!

Keyboard Interface same as PC-AT

FULL TIME PRODUCT SUPPORT AND SERVICE.

UNIQUE FEATURE!
Hardware Reset Switch

NEW!

VOLUME DISCOUNTS AVAILABLE!

0-1 WAIT STATES!

UNIQUE FEATURE!
Complete Set-Up Software in ROM BIOS (No Disk Required for Set-Up)

UNIQUE FEATURE!
Multi-Speed 80287 Numeric Processor Speed-Up Capability (Switch Selectable)

Triple Tested for 100% Quality Assurance!

Complete Documentation Package with Full Schematic Diagrams Included

Highest Quality Industrial Grade AMP Sockets!

ONLY!
\$499⁹⁵

OEM EVALUATION BOARD
Completely Assembled and Tested with all IC's and Components

- ATTAK-286™ MODEL II 24MHZ CALL
- ATTAK-386™ 32 BIT MICRO CALL
- CASES, POWER SUPPLIES, PERIPHERALS, ETC. CALL
- TURBO-SCOPE™ A/D BOARD \$99.95
- ATTAK-286™ MODEL 1A BARE BOARD \$99.95

• **OK RAM**
• **8 MHZ Version, Expansion to 12 MHZ**

100% SATISFACTION GUARANTEED.
10 DAY MONEY BACK GUARANTEE IF NOT COMPLETELY SATISFIED!



ORDER NOW!
SAME DAY SHIPMENT!
(FOR IN STOCK ITEMS)

AiT™ ADVANCED INTELLIGENCE CORPORATION TECHNOLOGY

4100 Spring Valley Road
Suite 400
Dallas, Texas 75244
(214) 490-0344

TELEX 821379
FAX (214) 960-1309

TERMS: We accept cash, checks, money orders and credit cards. Prices and availability subject to change without notice. Shipping and handling charges via UPS ground 50c/lb UPS air \$1.00/lb. Minimum charge \$3.00.

*IBM and IBM PC-AT are trademarks of International Business Machines

© 1986 AIT CORP.

LOWEST PRICES

AT System	\$895
XT Portable	\$795
20 MB Segate w/Controller	\$369
MS DOS 3.2 w/BASIC	\$75
300/1200 Modem (External)	\$89
300/1200 Modem (Internal)	\$99
1200/2400 Modem	\$279
EGA Card	\$219
NEC Multisync	\$559
STAR LV1210	\$179
EPSON FX286	\$495
8087	\$95
8087-2	\$139
80287-6	\$159
80287-8	\$229

COMPUTER MART — Call for items not listed.

1-800-225-0105 ★ 1-512-836-3766

Inquiry 424

controls up to 4 motors from any CRT, terminal or computer



STEPPING MOTOR CONTROLLER

- CHOPPER or R/L drives
- RS232 interface
- acceleration deceleration
- 1-4 axis moves

Standard R/L Version with BASIC \$985
 16K BASIC, R/L, Battery Backup \$1335
 CNC R/L Version \$1950
 Stepping Motor Tips Cookbook \$8
 Users Manuals \$12

CENTROID (814) 237-4535
 Box 739, State College, PA 16804

Inquiry 419

COMMODORE 128 & CP/M Users WORDSTAR[®]

WORDSTAR V. 2.26 or SuperCalc V. 1.12 or WORDPAC (incl. Grammatic and Spellguard) or Fortran with compiler. **\$39.00** each

Wordstar/SuperCalc includes a 763 page Osborne System Manual with extensive CP/M Tutorials as well.

Combination: Any 3 above for \$95.00.
 52 Page IBM PUBLIC DOMAIN \$4.00 List of 13,000 Programs.
 Also Catalog P.D. Software for IBM Apple, C-64, CP/M, MAC, Amiga, CoCo.
Ask about \$25 Special.



800-221-7372 Don Johnson
 PDSC-33 GOLD ST. L3-NYC 10038

Inquiry 423

SOFTWARE SENTINEL™

MUCH MORE THAN JUST PROTECTION

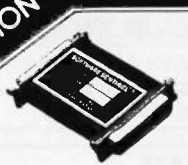

Because its original objective was to protect software from unauthorized use, it's called the SOFTWARE SENTINEL. But maybe we'll change the name to REVENUE GENERATOR, since we've discovered its true value to our customers. But whatever we call it, everyone ends up with numerous benefits from this hardware key with unlimited "locks".

- SOFTWARE DEVELOPER BENEFITS**
- Prohibits unauthorized use of software
 - No need for copy protection
 - Algorithm technique (never a fixed response)
 - Virtually unbreakable
 - Higher level language interfaces included
 - 100 times faster (1ms) than fixed response devices
 - Minimal implementation effort
 - Runs under DOS and Xenix, on IBM PC, AT, XT & compatibles
- SOFTWARE USER BENEFITS**
- Unlimited backup copies
 - No floppy required with hard disk
 - Pocketsize
 - Transparent
 - Transportable

EVALUATION KIT AVAILABLE

RAINBOW logo
 17971 SKYPARK CIRCLE SUITE E, IRVINE, CA 92714 (714)261-0228

Inquiry 306

A MESSAGE TO OUR SUBSCRIBERS

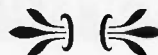

FROM TIME TO TIME we make the BYTE subscriber list available to other companies who wish to send our subscribers material about their products. We take great care to screen these companies, choosing only those who are reputable, and whose products, services, or information we feel would be of interest to you. Direct mail is an efficient medium for presenting the latest personal computer goods and services to our subscribers.

Many BYTE subscribers appreciate this controlled use of our mailing list, and look forward to finding information of interest to them in the mail. Used are our subscribers' names and addresses only (no other information we may have is ever given).

While we believe the distribution of this information is of benefit to our subscribers, we firmly respect the wishes of any subscriber who does not want to receive such promotional literature. Should you wish to restrict the use of your name, simply send your request to the following address.

BYTE MAGAZINE

ATTN: CIRCULATION DEPT.
 ONE PHOENIX MILL LANE
 PETERBOROUGH, NH 03458



Inquiry 101

Super Buffer Bargain!



64K Only 89.00 !!!

Copy, Bypass, Reset... This Buffer does it all!!! Rugged Metal Case with LED's to indicate status!!! Reliable Parallel Operation with Multiple Copies AND Multiple Documents. A Real Bargain!

256K Only \$199.00 !!!

Call (918) 437-2600
 Call for Best Price Cables and Switches!

No minimum. COD's accepted. Checks clear 2 weeks.
 3% surcharge MC/VISA. Shipping and Handling \$5.00
 Prepaids to: POB 690958 • Tulsa, OK 741 69-0958

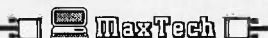

The ADJUSTable + fits your needs - perfectly

Holiday Special \$149

plus UPS and options good until December 31, 1986

- Fits PC, AT, Portables, Macs
- Adjustable Height, Depth, Tilt
- Exceptional mobility w/optional Casters, \$19
- Also: Chairs, Printer Stands, CRT Swing Arms, Copy Holders, Cab's Clips, Task Lights
- Special Package: \$269 for COMFORT chair & ADJUSTable
- Next Day Shipping with VISA/MC
- Thirty Day Money Back Guarantee

NEW OPTIONAL PRINTER SHELF \$49

ORDER TOLL FREE 1-800-822-5301

ACP

In Texas, call collect. (713) 783-3881
6776 Southwest Freeway • Suite 150 • Houston, Texas • 77074
Volume discounts available. Dealer inquiries welcomed.

Inquiry 6

PRINTER SHARING
HERE IS THE ECONOMIC AND THE BEST SOLUTION



- Completely automatic operation
- Eliminates the need for manual switching or cable swapping
- May be used for other peripherals (i.e. plotters)
- Compatible with all computers using a standard CENTRONICS output
- Identifies active computer
- Totally transparent to the user

- Adjustable time-out delay from 1 to 25 seconds between two printings
- Form feed may be inserted (or not) between two successive requests
- Port number associated with requesting computer may be printed or not
- 8 kbyte standard buffer
- 32 kbyte optional buffer
- Z80-A processor
- Six models to choose from:

PMS 606: 2 computers to one printer/
8 kbyte buffer : \$149.00

PMS 607: PMS 606 with 32 kbyte buffer : \$219.00

PMS 610: 4 computers to one printer/
8 kbyte buffer : \$249.00

PMS 611: PMS 610 with 32 kbyte buffer : \$319.00

PMS 615: 8 computers to one printer/
8 kbyte buffer : \$349.00

PMS 616: PMS 615 with 32 kbyte buffer : \$419.00

We are also manufacturing a full line of STD BUS and educational products.
DEALER INQUIRIES INVITED 1-800-361-2572
Visa, M.C. accepted, call toll free:
Protac Micro Systems Inc. 8090A, Tama Canada Hwy. St. Laurent, Qc H4S 1M6
Tel: (514) 335-9855 Fax: 0825134/PROTEC

Inquiry 285

Heritage Systems Corp



HSC-9100
80 By 24
Or 25 Line
Alpha-numeric
Video Terminal
Card

ANSI X3.64/Other Terminal Emulations
50 To 38.4K Baud Serial Port
RS-232 Or TTL/CMOS Versions
IBM PC Compatible Keyboard Input
EEPROM Based On Screen Config
Composite or Separate Video
100 By 100mm Card 5V Only @ 200mA
\$139 TTL/CMOS \$149 RS-232

PO Box 10588,
Greensboro, NC 27404-0588
(919) 274-4818
TLX WVI 6503057397

Inquiry 157

EVSAN Order Toll Free: (800) 443-8853
P.O. Box 2143 Daily City, CA 94017 Tel. (415) 991-1051

V - 20	8mhz	9.50	V - 30	8mhz	11.00
--------	------	------	--------	------	-------

Math Co Processors

C8087	8mhz	142.00	80287	8mhz	275.00
C8087	5mhz	102.00	80287	6mhz	168.00

DYNAMIC RAMS

1 MEG	150/100ns	36.00	27512	250ns	16.75
41256	100ns	4.50	27256	250ns	5.10
41256	120ns	2.85	27256	200ns	6.90
41256	150ns	2.65	27256	250ns	6.40
4464	120ns	4.25	27128	150ns	4.50
4464	150ns	3.78	27128	250ns	3.60
4128	150ns	3.95	2764	200ns	3.60
4164	120ns	1.20	2764	250ns	3.10
4164	150ns	1.00	2564	450ns	7.50
			2532	450ns	4.25
			2716	450ns	2.95
			2708	450ns	2.25

COLOR GRAPHIC CONTROLLER

07220AD	18.50	2708	450ns	2.25
---------	-------	------	-------	------

STATIC RAMS

43256L	120ns	23.50	5268L	150ns	2.85
5565PL	150ns	3.25	5564PL	150ns	5.25
6116L	150ns	1.60	6116P	150ns	1.40
4016	150ns	1.40	2016P	100ns	1.50

FLOPPY DISK DRIVE: TEAC 5L FD558 94.00
FUJITSU 5L M2551 82.00
SEAGATE 20meg 375.00

INTERFACE: 1488 0.32 1489 0.32

TERMS AND CONDITIONS: PRIME PARTS 100% GUARANTEED
1) Prices subject to change, PLEASE CALL for CURRENT & VOLUME PRICING. MINIMUM ORDER \$10.00
2) SHIPPING & HANDLING UPS GROUND \$3.00 ONE POUND CHARGES UPS 2nd DAY \$4.50 California Resident subject to sales tax.
3) 3% SURCHARGE ON CREDIT CARD CHARGES
OFFICE HOURS: MON to FRI 7:30AM to 5:30 PM

Inquiry 129

NEW EPROM PROGRAMMER



\$349

The EP-1 is a great value, here's why:

- IBM PC Software included or RS-232 to any computer
- ASCII Command driven operation; All intelligence in unit
- Reads, Programs, Copies over 150 types from 2716 to 27512
- Optional Intel microcontroller programming head
- Menu-driven Chip Selection; No Personality Modules
- Fast, Slow, Quick-Pulse Programming Algorithms
- Intel (8080 & 8086), Motorola, Tekhex, Straight Hex Files
- Splits Files By Base Address and Odd/Even (16 bit systems)
- Gold Textool ZIF IC Socket
- Over-Current Protection
- Full One Year Warranty
- U.V. Erasers from \$34.95
- Generate & Set Checksums
- 8 Baud Rates 300 to 38,400
- 5, 12.5, 21, 25V Programming

BP Microsystems
10681 Haddington, Suite 190, Houston, TX 77043
(800) 225-2102 (713) 461-9430

Inquiry 56

PUBLIC DOMAIN SOFTWARE

isn't copyrighted. Thousands of useful programs available for most computers from user group libraries.

User Group Libraries	Rent	Buy
IBM PC Blue 220 Disks	\$230	\$450
Capitol-IBM 45 Disks	50	100
Sanyo UG MSDOS 80 Disks	85	165
Authors Showcase (IBM) 35 Disks	40	100
Amiga 75 Disks	80	250
Atari ST 35 Disks	40	125
Macintosh 85 Disks	90	275
CP M UG 92 Disks	45	200
SIG M UG 290 Disks	185	350
CBM 64 Gold 100 Disks	50	100
Apple DDS 120 Disks	65	200

Rental is for 7 days with 3 days grace for return.
Use your credit card, no deposit! Call for free catalog or send Disk for free Directory of programs.

P.D. SIG, INC.
Master 2400 Santa Rita VISA
Card Las Vegas, Nevada 89109
(702) 732-0169

Inquiry 258

Advertise your computer products through **BYTE BITS** (2" x 3" ads)

For more information call Dan Harper at 603-924-6830

BYTE
70 Main St.
Peterborough, NH 03458

Inquiry 426

Quelo® 68000 Software Development Tools

Quelo Assembler Packages are Motorola compatible. Each package includes a macro assembler, linker/locator, object librarian, utilities for producing ROMable code, extensive indexed typeset manuals and produces S-records, Intel hex, extended TEK hex, UNIX COFF and symbol cross references. Portable source written in "C" is available. It has been ported to a variety of mainframes and minis including VAX.

68020 Assembler Package
For CP/M-86, -68K and MS/PC-DOS \$ 750

68000/68010 Assembler Package
For CP/M-80, -86, -68K and MS/PC-DOS \$ 595

68000 "C" Cross Compiler
For MS/PC-DOS by Lattice, Inc.
With Quelo 68000/68010 Assembler Package \$1095
With Quelo 68020 Assembler Package \$1250

Call Patrick Adams today: Quelo, Inc.
2464 33rd W, Suite #173
Seattle, WA USA 98199
Phone 206/285-2528
Telex 910-333-8171

COD, Visa, MasterCard

Trademarks: CP/M, Digital Research; MS, Microsoft Corporation; Quelo, Quelo, Inc.

Inquiry 30J

COMPLETE HIGH END AT COMPATIBLE



FCC CLASS B CERTIFIED
FULL ONE YEAR WARRANTY
\$1095

(IMMEDIATE DELIVERY*)
TO ORDER: CALL OR WRITE CNT MARKETING
(714) 839-3724

System includes:

- AT System Board w/8MHz INTEL 80286 CPU
- 640KB Memory expand to 1MB
- Hard disk and floppy controller
- 1.2 Megabyte floppy drive
- The most compatible BIOS on market
- Case
- 200W Power Supply
- AT Compatible Keyboard
- Battery, Speaker & System Keylock

• Other parts available • Please call for details
• All orders C.O.D.—CA residents add 6% Sales Tax
• U.P.S. Shipping \$25.00

CNT MARKETING
16580 Harbor Blvd., Suite J, Fountain Valley, CA 92708

AT is a Registered Trademark of IBM
All computers are fully assembled and tested in the U.S.A.

Inquiry 73

California Digital

17700 Figueroa Street • Carson, California 90248

Portable FAX Machine



1995
\$559

Just the FAX man! ...Corny, well maybe, but if Sargeant Friday had a DataFax 300 back when doing Dagnet he could have filed his report over his fax machine from any teleph one in the World.
The DataFax 300 is the first truly portable facsimile machine, operating on self contained rechargeable nickel-cadmium batteries. The unit transmits or receives a full 8 1/2" by 11" sheet in less than three minutes. This is a CCITT Group II machine and is capable of communicating with faster Group III fax machines.
The acoustical coupler supplied with the DataFax 300 allows the user to send copy and pictures from the office or even airport payphones without the need of external power. To receive transmissions, simply make voice contact with the sending party and attach the coupler to your telephone hand set.
The DataFax 300 includes a soft sided nylon carrying case along with 100 sheets of electrostatic copy paper. Optional RJ-11 connector jack available.

21 Megabyte Gold Card

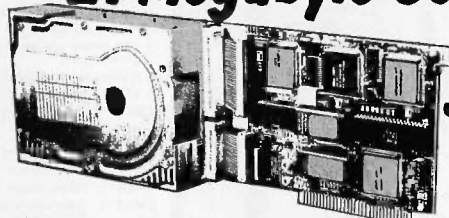

\$479

The fastest, lowest powered, longest warranted, most durable, highest capacity, most reliable, lowest priced HARD-DISK-ON-A CARD available in the world today.

• 65ms Access Time • Fastest Available • Automatic Head Unloading • Protects Heads and Media • 2K Sector Buffer • Increases System Throughput • High Reliability: 28,000 hr. MTBF
No one else even close • 15.5 Watt Power Consumption • Lowest Available • 2 Year Warranty
Longest Available

WERE \$695... GET 'EM WHILE THEY LAST FOR JUST \$559 \$479

IBM 8MHz./XT Compatible

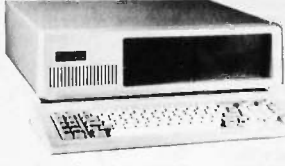

- DOS 3.2 & GW Basic
- Eight Expansion Slots
- 135 Watt Power Supply
- 256K Expandable to 640K on Motherboard
- Double Sided Double Density Disk Drive
- IBM/AT Type Keyboard (with LED Indicators)

\$579

The Eclipse Turbo 16/XT is an outstanding value in IBM Compatible Computers. After careful research and evaluation we found it to be the most reliable XT compatible available.
The computer includes some of the most recent features available, such as the 8 MHz. (software selectable to 4.77 MHz.) multi-layer motherboard with 256K of RAM upgradable on board to 640K. A generous eight expansion slots and 135 Watt power supply give you ample room and power for add-on boards. And our floppy controller supports up to four drives, so as many as three additional drives can be added. The units is complete with manuals, GW Basic and the new version of MicroSoft DOS 3.2 along with the AT style keyboard.
The Turbo 16/XT is FCC and Underwriters Laboratories approved. Finally, each computer is configured and fully tested before sending it to you.
Satisfaction Guaranteed! We're really excited about this new unit, and so sure you will be too... that you may return the Eclipse 16 for a full credit towards an IBM PC if you are not completely satisfied.
20MB Hard Drive w/Controller\$429
30 Megabyte HardCard 459
Additional Drive-Installed99
Irwin 10 Meg. Tape Back up489
Upgrade from 256K to 640K RAM79
8087 Math Co Processor119
Color Graphics Card79
Monochrome Graphics Card99
RGB Color Monitor199
TTL Monochrome Monitor139
Summagraphics SummaMouse ... 139
Upgrade from Floppy Controller to Disk I/O 2 drive controller, clock/ctrl., software parallel, serial, & game ports 79
1200 Internal Modem w/Software 129

NOW YOUR COMPUTER CAN READ!!

Omni-Reader... the first optical character reader designed and priced for the small computer

\$179

COPY:
• Manuscripts • Contracts • Articles
• Forms • Invoices

APPLICATIONS:
• Mailing Lists • Editing • Data Base Management • Transferring information between incompatible systems

Uses a standard RS-232 serial port hookup to interface easily with your computer.

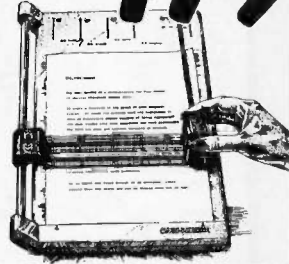

1200 BAUD MODEMS



AVATEX 1200
\$99

This 300/1200 baud modem matches the design specs of the Bell 212A, feature by feature, bringing you reliability, impeccable transmission and easy operation. Hayes Compatible, except for "S" register. Communication software included.
The AVATEX 1200, at \$99, is a steal!



SMARTTEAM 1200
\$159

The Team 212A offers all the features of the Hayes Smart Modem 1200 for a fraction of the price. Now is your opportunity to purchase a 1200 baud modem at the price of a 300 baud modem.



NEC
RACKMOUNT
MODEM
\$69

The NEC N212BR modem is designed for use in a rackmount configuration or may be used stand alone on external power. The Unit is fully 300/1200 Hayes compatible allowing for auto dial, auto log/on password capabilities. This modem is also switch selectable to the special NEC command set, which contain too many features to describe in this limited space.
The NEC212BR originally cost \$595. California Digital has available 500 units which we are offering at only \$69.

ECLIPSE 2400 BAUD MODEM



\$299

• Hayes & Bell 212A/103 Compatible
• CCITT V.22, V.22 bis
The ECLIPSE 2400 modem is a microprocessor-based full or half-duplex modem incorporating the latest in high speed data communications capabilities. It also accommodates computers and terminals equipped with an RS-232 port allowing communication with other computers or timesharing systems either locally or remotely. Compatibility, Versatility and Performance are yours in a configuration designed to provide years of reliable operation.

MODEMS

Eclipse 1200 100% Hayes, with status lamps.	EDP-1200	149.00
Eclipse 1200B internal with software	EDP-1200B	139.00
Eclipse 2400 External, Hayes Compatible	EDP-2400	299.00
AvateX 1200 baud external, Hayes	AVA-1200	99.00
Hayes Smartmodem 2400 baud modem	HYS-2400	599.00
Fujitsu 2400/1200 baud auto everything.	FUJ-1935D	459.00
Team 1200 Hayes Compatible, 300/1200 baud.	TEM-1200	159.00
Smarteam 1200B IBM 1200 baud card	TEM-1200B	159.00
UltraLink 1200 data and voice on same line.	UTL-1200A	99.00
CTS 212AH 1200 baud, auto dial	CTS-212AH	179.00
Terminal software for CTS 212AH	CTS-2125FT	35.00
Prometheus 1200 super features	PRM-1200	289.00
Prometheus 1200B internal PC	PRM-1200B	279.00
Signalman Mark VI, 300 baud internal PC	SGL-MK6	49.00
Hayes Smart Modem 1200 baud, auto dial	HYS-212AD	369.00
Hayes 1200B for use with the IBM/PC, 1200 baud.	HYS-1200B	339.00
Hayes Chronograph, time & date	HYS-CHF232	199.00

Seagate

20 MEGABYTE WINCHESTER HARD DISK DRIVE

\$299

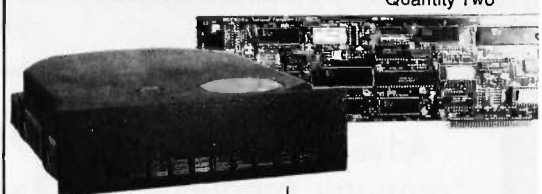

Five Inch Winchester Disk Drives

each two+	● Winchester Controllers for IBM/PC
SEAGATE 225 20 Meg. 1/2 Ht.	XEBEC 1220 with floppy controller
SEAGATE 4026 26 M. 35mS.	OTC 51508X
SEAGATE 4051 51 M. 35mS.	OMTI 5510 half card
FUJITSU 2242 55 M. 35mS.	ADAPTEC 2070 RLL controller
FUJITSU 2243 86 M. 35mS.	ADAPTEC 2010A
RODIME RO-202E 27 Meg.	WESTERN DIGITAL WD/1002
RODIME RO-203E 40 Meg.	● SCSI/SASI Winchester Controllers
RODIME RO-204E 53 Meg.	XEBEC 1410A 5 1/4" foot print
CONTROL DATA 94155-86 M.1829	OMTI 20L
MAXTOR XT1140 140 Meg.	● Winchester Accessories ●
HONEYWELL 85M. 27 mS.	Installation Kit with manual
TOSHIBA MK5670 M. 30mS.	Winchester enclosure and supply
TANDON 502 10 Meg.	Dual 20/34 cable set
	Switching power supply

TOLL FREE ORDER LINE
(800) 421-5041

TECHNICAL & CALIFORNIA
(213) 217-0500

California Digital

17700 Figueroa Street • Carson, California 90248

Great Christmas Gift Dynamics Desk Director



The Desk Director is a management tool engineered to increase the efficiency of any one who spends any time behind a desk. The unit incorporates: a speaker telephone with autodial, clock calendar, calculator and more all into a handsome leather desk pad. You have seen the same product selling at Sharper Image for \$995. While supplies last the Desk Director is available from California Digital for only \$479. Please specify mahogany brown or black leather. Will consider volume trade.

Bernoulli Box



The Bernoulli Box by Iomega, features 10 and 20 megabyte removable cartridges, and delivers reliability, expandability, transportability, security and speed in one versatile subsystem. It lets you transfer megabytes of information safely and swiftly for primary or backup storage. Or combine several software programs onto a single cartridge for easy switching from one to another. Reliable... the Box has incredible resistance to shock and vibration completely eliminating the possibility of head crash. Expandable... grow at your own pace by adding inexpensive cartridges. When security is essential, don't lock up your system... just lock up the cartridges. The Bernoulli Box delivers performance that often exceeds the best of hard disk speed and the convenience of floppy disks. At these prices don't be caught wishing you had one after a loss of irreplaceable data.

	List	Our Price
10+10 Meg.	A2210H	\$3450 1595
20+20 Meg.	A2220H	4540 2095
Bootable Controller		255 159
10 Meg. Cartridge		79 49
20 Meg. Cartridge		99 65

PRINTERS

MATRIX PRINTERS	
NEC/P7 132 col., par'l interface	NEC-760 659.00
Star Gemini NX-15, 300 cps, 135 col. 24 wire head	STRN15
Star Gemini NX-10, 120 cps/30 cps NLO, tractor	STRN10
Citizen MSP110FT 160 char/sec.	CIT-MSP10 259.00
Panasonic KK105 120 cps, draft, 29 NLO tractor & friction.	PANKK105 259.00
Toshiba 351P/S, 240 char/sec, 24 wire head	TOC-351PS 1099.00
Toshiba 341P/S/E, 240 char/sec, 24 wire head	TOC-341PSE 769.00
Okidata 192P IBM parallel 8 1/2" paper	OKI-82P 229.00
Okidata 192A parallel interface, 160 char/sec.	OKI-192A 379.00
Okidata 84P parallel 15" paper	OKI-84P 695.00
Epson LX-80 10" 120 Char/sec.	EPS-LX80 259.00
Epson LQ-800 near letter quality	EPS-LQ800 629.00
Epson FX-85 160 cps, draft 32 cps, NLO, 240 dot/inch.	EPS-FX85 399.00
Epson FX286 132 col., 200 cps, 29 cps NLO, graphics.	EPS-FX286 599.00
Dataproducts B-600-3, band printer 600 LPM	DPS-600 6985.00
Pantronix P300 high speed printer 300 lines per minute.	PTX-P300 3995.00
Pantronix P600 ultra high speed 600 lines per minute.	PTX-P600 5795.00

WORD PROCESSING PRINTERS	
Starwriter F10 (6400) parallel, 40 char/sec.	PRO-F10P 429.00
Same as above but 55 char/sec., 50 pin Diablo interface	PRO-F55P 559.00
NEC9810 55 char/second, serial interface	NEC-9810 1179.00
NEC8830 55 char/sec, par'l interface	NEC-8830 1179.00
NEC3550 popular printer designed for the IBM/PC	NEC-3550 819.00
Silver Reed EXP600, 25 cps, 10/12/15 pitch, serial/par'l.	SRD-EXP600 319.00
Silver Reed EXP600 same as 600 but 40 char/sec.	SRD-EXP600 729.00
Diablo 620, proportional spacing, horz. & vert. tab, 20 cps.	DBL-620 299.00
Juki 6100, 18 char./sec.	JUK-6100 359.00
Juki 6300, 40 char./sec.	JUK-6300 689.00

Quick-Link 300 \$59

The Quick-Link 300 gives you an instant link to any dial up data base. Such as Dow Jones, Western Union or the Source. The Quick-Link has four user programmable log-on keys, allowing the operator, with only one key stroke, to dial the data base, log-in and give the password. All this information is permanently stored in non-volatile RAM. Features include video output to television or monitor, auto dial, auto-log, full sized keyboard, 300 baud modem and 1200 baud auxiliary printer port. All this is available for only \$59.



FOUR PEN COLOR PLOTTER \$159

The manufacturer has asked us not to publish their name. But this four color plotter was produced by one of the Worlds largest makers of personal computers. The 410 color plotter will connect to the serial port of virtually any micro-computer. Simple ASCII commands direct one of the four color pens to draw circles, arcs or ellipses on paper or transparency material up to 11 by 17 inches. The plotter is capable of producing the full upper and lower case alphabet along with seven international character sets. Text can be printed horizontal, vertical or diagonal in sizes from 1/16 to 6 inches, slanted forward or backward to 85 degrees. Enlargements or reductions are achieved through elaborate firmware. Pen travel is four inches per second with .004" pen resolution. Standard pens are available in an assortment of 32 different colors and widths. The ideal plotter for architecture, CAD engineering or graphic design. At \$595 it was a great buy, at \$159 its a steal. Support packages for specific computers available. Manual only \$15 refundable upon purchase or plotter.

PLottERS

Four pen color plotter, 11 by 17 IBM/PC compatible	APL-410	\$159
Sweet "P" 100 (Comrex) 8 1/2 by 12"	COM-C1	\$159
Houston Instruments DMP29, 11 by 17	HOU-29	1779
Houston Instruments DMP40, 11 by 17, B size	HOU-40	959
Houston Instruments DMP41/42 C/D 24 by 36	HOU-41	3779
Houston Inst. DMP51/52MP C/D, 14 pen plotting	HOU-51MP	4859
Houston Instruments DMP56, E size 34 by 44	HOU-56	4795
Houston Instruments PC695, 11 by 17 multi-pen	HOU-695	579
Roland DYS-101 flat bed 11 by 17	ROL-101	419
Roland DYS-800 11 by 17 multi-pen 8 color	ROL-800	899
CalComp 1043GT plotter	CCP-1043	7899

XEROX Sunrise Computer \$299

The Xerox Sunrise 1810 is by far the best value we have ever seen in a micro computer. This is a self contained battery and AC portable. The Sunrise was originally priced at \$2995. Xerox has since elected to drop the computer from their product list. California Digital has purchased all the remaining inventory and is making the unit available at a fraction of its original cost. This portable features a built in 80 column liquid crystal display, 64K of memory along with both RF monitor and television outputs. The internal 300/1200 baud modem includes an auto dial telephone assembly. The unit has both centronics parallel and a serial port programmable to 19,200 baud. The self contained micro cassette is capable of capturing data from the keyboard as well as doubling as an recorder for dictating messages. An optional dual floppy disk drive module, pictured above, is available for only \$219. Also available, for \$59 is an 80 column printer that mounts in the drive module. The Sunrise features a CP/M operating system which allows the operator to use any CP/M program in Xerox 5 1/4" disk format and over 6500 CP/M programs available in public domain.

Dragon Computer \$89

Compatible with most Radio Shack Color Computer software. The world famous Dragon computer is now available in the United States. Manufactured by the Tano Corp. under license of the British Broadcasting Company. The Dragon comes complete with 64K Byte of memory, serial modem port along with a Centronics printer interface. This unique microcomputer features Motorola's advanced 6805E microprocessor and comes standard with Microsoft Color Basic, data base manager, and a complete word processing package. The computer outputs color composite video along with R.F. video that allows the unit to be used in conjunction with any color television. This is the ideal low cost computer to be used with any dial up information system such as the Source, EasyLink or any other time share service.

RGB Color Monitor \$199

The NEC JC-1401D is a 13" medium/high resolution RGB monitor suitable for use with the Sanyo MBC-550/555 or the IBM/PC. The monitor features a resolution of 400 dots by 240 lines. Colors available are Red, Green, Blue, Yellow, Cyan, Magenta, Black and White. The NEC monitor carries the Little-Monroe label and was originally scheduled for use in their "Office of the Future" equipment. A change in Menore's marketing strategy has made those units excess inventory which were sold to California Digital. We are offering these "new" RGB monitors at a fraction of their original cost. IBM/PC compatible NEC-1401/PC Also available 12" Amdex Color 1 composite \$159.

SONY 53W Floppy Disk Drive \$139



5 1/4" DISK DRIVE \$89



	One	Two	Ten
TEAC FD55BV half height	109	99	89
TEAC FD55FV 96 TP, half ht.	119	109	105
TEAC FD55GF for IBM at	169	159	155
PANASONIC 455 Half Height	109	99	89
PANASONIC 465 1/2 Ht. 96TP	139	129	125
TANDON 100-2 full height	129	125	119
MITSUBISHI new 501 half ht.	129	119	109
MITSUBISHI 504A AT comp.	169	159	155
QUME 142 half height	99	89	89
Switching power supply			49
Installation Kit with manual			10
Dual enclosure for 5 1/4" drives			59
34 pin edge connectors			5
Scotch head cleaning kit			19
Flip & File Storage tubs			15

QUME \$119

Eight Inch Single Sided Drives	
QUME 841 single side	129 119 call
SHUGART 801R	359 359 354
SIEMENS FDD 100-8	119 115 109
Eight Inch Double Sided Drives	
QUME 842 "QUME TRACK 8"	189 179 call
SHUGART SA851R	495 485 475
OLIVETTI double sided	189 179 159
REMEX RFD-4000	179 169 159
MITSUBISHI M2896-63 1/2 Ht.	459 449 409
Dual 8" enclosure with power and fan	259
Switching power supply	89
Installation kit with manual	10

Adeus Daisy Wheel \$159



The Adeus CP/2000, is a 22 character per second daisy wheel printer which accepts 96 character Diablo wheels and ribbons. This printer was manufactured by the Olympia Typewriter Company for Cosmo World USA. This unit will print 10, 12 and 15 characters per inch proportionally spaced with increments of 1/120". Bi-directional printing, 2 K/Byte buffer (expandable to 6K) and both serial and Centronics parallel interfacing make the Adeus CP/2000 an exceptional buy at only \$159. Original price \$595.

Shipping: First five pounds \$3.00, each additional pound \$5.00. Foreign orders: 10% shipping, excess will be refunded. California residents add 6 1/2% sales tax. • COD's discouraged. Open accounts extended to state supported educational institutions and companies with a strong "Dun & Bradstreet" rating.



LOOK what's Inside!

5 Complete Systems

XAT TURBO



The **XAT** is out most versatile and powerful system. Using Intel's 80286 processor, the system runs at 6 and 8 MHz with a true 16-bit data bus. Comes standard with a 3 meg Add-On board, 2 parallel & one serial port, monitor, keyboard, DOS 3.1, two 1/2 height 5 1/4 DD 1.2 meg floppies.

XPC TURBO



This standard system is as compatible with IBM as it can be. Featuring a 4-layer motherboard, 8-slot expansion, up to 640K memory on the motherboard, and the 6.67 MHz **TURBO** mode. Also included: DOS 3.1, keyboard, 135 watt power supply, TTL 720 x 348 resolution video card, green or amber monitor, serial & parallel ports. Real Time Clock and software.

XTC TURBO

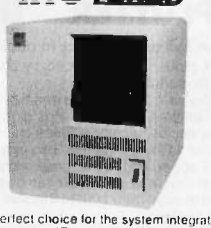

The perfect choice for the system integrator who needs the IBM compatibility, but not in the standard PC cabinet! This model features hinged and removable sides, up to 3 1/2 height peripherals out front, front mount AC switch and rear mount 135 watt power supply. Also makes an ideal "Host" or "File Server" unit in multi-user configurations!

XT Jr.



The **XT Jr.** is only Junior in size! With up to 640K memory on the motherboard and four expansion slots, this stand-alone system is also great for workstations in a networking environment. It can be upgraded to the **TURBO** two speed motherboard and you can also add up to 2 serial & 2 parallel ports or any IBM compatible expansion card. A perfect word processing data entry system.

XPC Compact



This is truly the affordable portable, and we'll build it to your specifications. Need a 20 meg hard disk and 20 meg tape with 640K memory in your portable? No problem! The **XPC Compact** comes standard with a 9" amber TTL monitor, 135 watt P.S. 256K memory, two 360K drives, Real Time Clock/Calendar w/ battery Back-up, serial and parallel ports, and our **TURBO** Motherboard.

Amsterdam ■ 020-45-26-50

24 Add-On Cards

Germany ■

2 MB Expansion Board



This board satisfies the new approach suggested by INTEL and Lotus 1-2-3. Also may be used on our **XT-SBC TURBO** board for memory based at 0K.

Hard Disk Controller

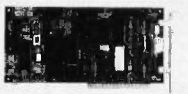

This Western Digital controller handles 1 or 2 drives, 5 to 140 megabytes with minimum software configuration. Features DOS 2.1 & 3.1 compatibility, and ST-506 Interface.

384K Multi-Function

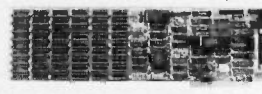

A Multi-Function board featuring Parallel Port, Serial Port, Game Port, Real Time Clock/Calendar with Battery Back-up, Expand to 384K, all Cables, PrintSpooler and RAM Disk Software, and Manuals.

4 Meg Token Ring



Connect your workstation to an existing 4 Megabyte IBM token ring system or build up your own IEEE 802.5 standard system. The lowest possible cost for 100% industry standard compatibility.

AT H.D. & Floppy



This new Western Digital combo board with its Hi-speed VLSI technology will give you a data transfer rate 50% faster than the existing combo board in the AT. Runs both 360K and 1.2 meg floppy disk drives.

Mono & Color Graphics



Supports two levels of graphics and text in composite monochrome or RGB color. Low resolution 320 x 200 pixel, high resolution 640 x 200 pixel.

7 PAK Multi-Function



Features Floppy Controller, Parallel Port, Serial Port (optional 2nd Serial), Game Port, Real Time Clock/Calendar with Battery Back-up, RAMdisk, PrintSpooler, all cables & manuals.

PROM Laser



Hi-speed algorithms will burn 2716, 2732, 2732A, 2764 (in 52 sec), 27128, 27256 EPROMs under software control right in your PC. Zero Force Insertion Sockets, Software, and Manual.

England ■

35 Components

Bombay ■ 357172

Motherboards

XAT TURBO XT-SBC

- RTC Calendar
- 6 & 8 MHz clock
- 8-slot expansion
- Intel 80286
- 4.77 & 6 MHz clock
- Serial & Parallel
- 4-layer PCB design
- RTC Calendar

XPC TURBO XPC-XT

- 4.77 & 6.67 MHz
- 4-layer PCB design
- 8-slot expansion
- up to 640K Memory
- 8088-2 processor
- Standard 4.77 MHz
- up to 640K memory
- 8-slot expansion
- standard 8088 CPU
- 8087 socket avail.

Power Supplies

XT 135 watt XT 150 watt

- 135w switching
- Whisper Fan
- Side AC switch
- +5V-15A -5V-5A
- +12V-4.2A -12V-5A
- Whisper fan
- Hi-output 150 watt
- 4 DC connectors
- +5V-15A -5V-5A
- +12V-5.5A -12V-5A

AT 200 watt XTC 135

- 200 Watt power
- Exterior AC switch
- 4 DC power conn.
- +5V-20A -5V-5A
- +12V-7.7A -12V-5A
- Rear Mount
- Rear On Off switch
- extra AC outlets
- +5V-15A -5V-5A
- +12V-4A -12V-5A

Cabinets

The **XT Jr.** cabinet is only 3" x 16.5" x 15" yet it will hold a standard XT compatible motherboard. Includes a switching power supply. Front panel cut-out for a half-height floppy or hard disk.

Our **XPC-XT** cabinet has an 8-slot back panel with additional cut-outs for two RS-232C I/O ports. Features mounting for up to four half height peripherals.

The right choice for an external add-on cabinet! Add on a floppy, tape back-up or up to 33 meg of hard disk (half-height). Switching power supply is included.

Keyboards

AT

This Keyboard is standard equipment with all of our **XAT** systems, but the layout is so well liked, we're offering it here.

XT

Our volume purchases of these IBM style units allows us to lower the price once again.

5051

Now a fully electric unit at an affordable price. Features a 10-key numeric pad & a separate cursor pad.

Drives

Archive
Irwin
Maxtor
Memtek
Miniscribe
Panasonic
Seagate
TEAC
Tulin

3 Sub-Systems

This full height cabinet will hold a Tape Back-up with full or 1/2 height Hard Disk inside (or two Hard Disks).

A perfect cabinet for Tape or Hard Disk, a nice addition to your PC.

Choose from single 1/2 height, dual 1/2 height, or 1 1/2 height with full height base. All Sub-systems include controllers, cables, software, and manuals.

3 Networks

One way to stay ahead of the competition is by using a Multi-User or Network system configuration from **Micro Products International**. Choose Hi-speed RS-232C, **XOR-NET**, **SDLC** or Token Ring. Data transfer rates up to 4 megabytes second can be obtained.

Cassette Training

What is the Cassette Training concept? Using Interactive Audio Training to combine the advantage of classroom and self-teaching methods.

The Method: One audio track delivers a lecture explaining the program, while the second track emulates the keyboard, clicking running the student's computer. At frequent intervals the tape pauses automatically to allow the student keyboard input, which is monitored for accuracy by the **MITS COED**.

Int/Ext Modems

FCC approved for direct RJ-11 connection. Phone Cable & Power Supply. Finally a price breakthrough on a Hayes compatible external 300/1200 baud modem. Includes driver software.

Runs the popular Hayes communications software.

Q-Modem software included. Also runs XCOM software.

Runs the popular Hayes communications software.

We included every feature you would want in a modem card. It's FCC registered for direct connection to your modular phone jack with the cord included.

DISK/RIBBON WAR

NOW ALL BULK DISKS CAN BE BOXED AT NO EXTRA CHARGE

5.25" DISKS (Minimum 30)	BULK OR BOXED
ss/dd	.44
ds/dd	.49
ds/dd notchless	.59
ds/dd floppy	.59
ds/dd 10 hard sector	.69
ds/dd 16 hard sector	.69
ds/qd 96 tpi	.79
ds/qd 96 tpi 10 hard sector	.99
ds/qd 96 tpi 16 hard sector	.99
ds/hd 1.2mb for AT	1.49

RIBBONS (Minimum 3)	Call if yours is not listed
Apple Imagewriter I, II, Prowriter	2.39
Apple Imagewriter Multicolor	11.99
Commodore MPS 801	3.99
Diablo Hytype II	2.99
Epson LQ 800	6.99
Epson LQ 1000	9.99
Epson LQP 1500, Epson LX 80	2.99
Epson MX/FX/RX 100/185	3.19
Epson MX/FX/RX 70/80/85	2.39
IBM Proprinter	3.99

NEC Pinwriter P1/P2	4.99
Okidata 82/83/92/93/801	.99
Okidata 84/94	2.19
Okidata 182/192	3.99
Panasonic KXP 1090, 91, 92	6.29
Radio Shack LP, VI, VIII	2.99
Radio Shack LPVII	3.99
Star Gemini 10X/15X	.99
Star Radix 10	4.49
Star Radix 15	5.49
Toshiba P 1350	2.99

5.25" COLOR DISKS	BULK OR BOXED
ds/dd color pack	
assortment A, B, or C †	.59
ds/dd color pack	
assortment A floppy †	.69

- † Color pack assortment A: red, orange, yellow, blue, green.
- † Color pack assortment B: maroon, brown, dark blue, silver, gold.
- † Color pack assortment C: pink, med. blue, beige, white, light grey.
- † All colors are available separately, except floppies.

FREE BONUS OFFER

IF YOU ORDER	YOU GET	YOUR CHOICE VALUE
100 DISKS	5 DISKS PUBLIC DOMAIN SOFTWARE FOR IBM/MAC OR APPLE	\$14.95
	OR	
100 DISKS	HEAD CLEANING DISK	\$12.99
150 DISKS	DISK ORGANIZER (Holds over 20 disks, disk file, etc.)	\$19.99
200 DISKS	PRINTER STAND	\$29.99

3.5" DISKETTES	BULK OR BOXED
ss/dd-Blue/Beige or Grey	1.39
ds/dd-Blue/Beige or Grey	1.59
ds/dd color pack A	1.69

8" DISKS	BULK OR BOXED
ss/dd soft sector	1.49
ds/dd soft sector	1.69
ss/dd color pack, asst. A†	1.69
ds/dd color pack asst. A†	1.89

- FREE TYVEC SLEEVES, HUB RINGS, WRITE PROTECTS AND ID LABELS — 10 MIL JACKETS
- MAGNETIC TAPE — DISK PACKS AND CARTRIDGES — BEST PRICES — CALL
- QUALITY & SERVICE OUR #1 PRIORITY — BUY DIRECT — NO MIDDLE MAN — NO MUMBO JUMBO
- ALL ITEMS IN STOCK ALL THE TIME — SAME DAY SHIPPING — DISKS MADE IN THE U.S.A. — 70% CLIPPING

PUBLIC DOMAIN SOFTWARE — IBM COMPATIBLE — ONLY \$2.99 (MINIMUM 5)

- 3408) Still River Shell v. 1.33: Run DOS commands from a menu
- 223) Insults: Generate random insults on screen for the unsuspecting PC user.
- 1501) Chasm: Cheap Assembler
- 302) Q-Modem version 2.87: Fast modem software
- 402) Unprotect Protected Programs Disk: This disk gives you tips.
- 401) 8086, 8087, 8088 disassembler.
- 201) JetSet Flight Simulator: Turn your PC into the pilot's cockpit
- 101) PC-Write: Full screen word processor
- 109) Galaxy: This word processor is command compatible with WordStar but also offers pull down menus for the forgetful or the novice
- 308) ProCOM with random redial capabilities. (Hackers love this one!)

- 2808) PC-Outline version 1.08: Outline your papers, to-do lists, ideas, or strategies. Has an optional memory resident mode.
- 113-114) New York Word: a very powerful word processor that has too many features to list.
- 237) Hack: A display oriented Dungeon and Dragons adventure game. This program was ported from a UNIX system and requires 256K RAM.
- 243) Pinball. This disk has three games which have been created using the program "Pinball Construction Set" by Bill Budge.
- 3425) MSDOS CPM/80 conversion. This program allows you to transfer data between various CP/M and MS-DOS formats.
- 3422) CTRLALT: This RAM resident utility is a must! Too many features to list here!

THE "CARETAKERS"™	
10 disk library case 3.5" or 5.25"	.99
10 disk library case 8"	2.49
40 disk storage case 3.50" w/lock	7.99
50 disk storage case 5.25" w/lock	7.99
100 disk storage case 5.25" w/lock	9.99

ACCESSORIES	
Drive head cleaning disk 3.5/5.25/8"	12.99
Tyvec sleeves white — 100 pk.	5.99
Tyvec sleeves color — 100 pk.	8.99
ID labels/write protect - 100 pk.	1.99
Disk mailer box (3/5.25") — 10 pk.	8.99
Disk mailer box (3/8") — 10 pk.	9.99
Disk organizer	19.99
Printer stand	29.99

... and many more!

Lifetime warranty on disks. Satisfaction guaranteed or money refunded within 30 days. Disks packaged in 10's — Minimum 30 disks. Checks (allow 10 days to clear), money orders, MasterCard, Visa, American Express, C.O.D. (add \$1.90). Purchase orders accepted from qualified public institutions, government agencies and well-rated companies, net 30 days. California residents add 6%. For information, call (619) 942-9998. Call for free catalog.

PRIVATE DEALER LABEL
AVAILABLE AT
NO EXTRA CHARGE

800-992-1992
NATIONAL

ORDER
TODAY

800-992-1993
CALIFORNIA

Over 200
Special Formats for
5 1/4" and 8"
from \$1.99 (Call)

U.S./DISK, INC.

Hours Mon. - Sat.
8:30 am - 4:30 pm
511 - 104 Encinitas Blvd.
Encinitas, CA 92024

JADE TURBO or 286

- 640K of RAM
- 7 MHz turbo mode
- 360K disk drive
- 5151-style keyboard
- 8 expansion slots

\$588



OPTION #1

Two disk drives
Mono graphics card
Parallel printer port
Amdex 310A monitor

TURBO 286
\$898 \$1598

OPTION #2

20 MB hard disk
Mono graphics card
Parallel printer port
PGS MAX-12E monitor

TURBO 286
\$1288 \$1898

OPTION #3

20 MB hard disk
Color graphics card
Parallel printer port
Hitachi hi-res color monitor

TURBO 286
\$1388 \$1998

NO-SLOT CLOCK

\$49

- Uses No Slot
- 20 Year Battery
- Includes Software

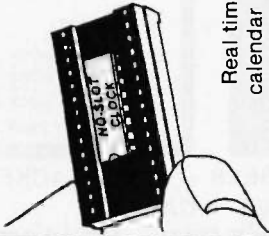

Real time clock/
calendar for your
PC-XT or clone

21 Megabyte Hard Disk ON A Card **\$399**



- 21.3 MB Formatted
- Lowpower, 11 Watts
- Head Park Zone
- Plated Media
- Light 2.4 lbs.

MFG. BY.
Tandon

HARD DISK DRIVE

\$349

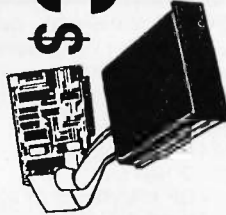

HARD DISK,
CONTROLLER
AND CABLES

10 MB Internal Kit _____ \$349
20 MB Internal Kit _____ \$399

Hi-Performance Hard Disk

FOR
YOUR
AT
\$399

20 MB 1/4 HT 65 MS _____ \$329
20 MB Full HT _____ \$399
30 MB Full HT _____ \$695
40 MB Full HT _____ \$895
70 MB Full HT _____ \$1695
120 MB Full HT _____ \$3395

JADE TURBO or 286

- 640K of RAM
- 8 MHz 80286
- 1.2 MB disk drive
- AT-style keyboard/case
- 8 expansion slots

\$1288

OPTION #3

20 MB hard disk
Color graphics card
Parallel printer port
Hitachi hi-res color monitor

TURBO 286
\$1388 \$1998

OPTION #2

20 MB hard disk
Mono graphics card
Parallel printer port
PGS MAX-12E monitor

TURBO 286
\$1288 \$1898

OPTION #1

20 MB hard disk
Color graphics card
Parallel printer port
Hitachi hi-res color monitor

TURBO 286
\$1388 \$1998

HIGH RESOLUTION COLOR MONITOR

\$269

List Price \$699

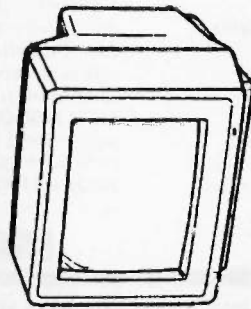

- High resolution 640 x 240
- Excellent dot pitch .38 mm
- 16 true colors, 2000 characters
- Accepts standard RGB input signals
- Non-glare picture tube
- Free PC RGB cable included
- Free tilt & Swivel

Manufactured
by Hitachi
HITACHI

MICROSPEED FAST 88
7 MHz TURBO \$99
CARD FOR YOUR PC

- No wait states
- External switch
- Reset switch

- Uses no slots
- 6.14, 6.67 and 7.37 MHz

80 CPS DAISYWHEEL PRINTER FROM FUJITSU

\$599

List Price \$2295
80 CPS,
Fully Formed
Letter Quality
Characters

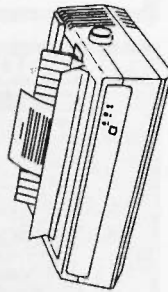

LIMITED QUANTITY

EPSON
DAISYWHEEL
PRINTER

LIMITED QUANTITY

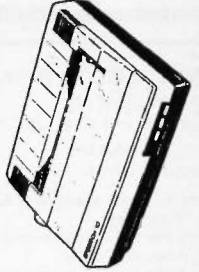

EPSON DX-10, 10 CPS _____ \$169
DX-10 TRACTOR _____ \$39
DX-10 SHEET FEEDER _____ \$49
EPSON DX-35, 35 CPS _____ \$499
DX-35 TRACTOR _____ \$99
DX-35 SHEET FEEDER _____ \$299
DX-35 CABLE _____ \$19

Monochrome Monitors

- Jade green Hi-res TTL _____ \$99
- Jade amber Hi-res TTL _____ \$99
- Amdek 310A amber _____ \$149
- Quimax 14" green T/S _____ \$139
- Quimax 14" amber T/S _____ \$139
- Magnavox green Hi-res TTL _____ \$119
- Magnavox amber Hi-res TTL _____ \$119
- PGS MAX 12E amber _____ \$159

Data General DG/One

DEMO SALE

- DG-1 128K 1 DR _____ \$795
 - DG-1 256K 1 DR _____ \$995
 - DG-1 256K 2 DR _____ \$1295
 - DG-1 Accessories 35% off
- LIMITED QUANTITY

PC Power Supply

- 135 watt power supply _____ \$69
- 150 watt power supply _____ \$79

PC or AT Video Boards

- Hercules Color Graphics _____ \$159
- Jade Color Graphics _____ \$89
- Hercules Mono Graphics Plus _____ \$198
- JADE Monochrome Graphics _____ \$99
- Quad EGA+ _____ \$359
- Video 7 Vega EGA _____ \$339
- JADE EGA+ _____ \$239

High Speed APU Chips

- 8087-3.5 MHz _____ \$119
- 8087-2.8 MHz _____ \$159
- 80287-3.5 MHz _____ \$179
- 80287-8.8 MHz _____ \$269
- NEC V-20 5 MHz _____ \$11
- NEC V-20 8 MHz _____ \$14
- NEC V-30 8 MHz _____ \$16

RGB Color Monitors

- Hitachi 640 x 262 _____ \$269
- Magnavox 640 x 240 _____ \$319
- Quimax EGA 640 x 350 _____ \$489
- NEC Multisync 800 x 560 CALL
- PGS HX-12 640 x 240 _____ \$439
- PGS HX-12E 640 x 350 _____ \$529

DELUXE BACK CHAIR

\$49
List Price \$99

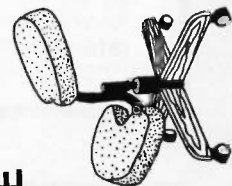

POWER/SURGE PROTECTION

6 socket, UL listed, U.S. made
Power/surge strip

\$1495
List Price \$49

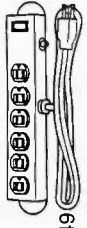

6 button, under-monitor, swivel
Power/surge control center

\$5995
List Price \$129



ISO-Bar

These industrial quality ISO-BAR's contain surge suppression circuitry & built-in noise filters plus a 15 amp circuit breaker.

- 6 socket, 1 filter ISO-BAR _____ \$44
- 4 socket, 2 filter ISO-BAR _____ \$59
- 8 socket, 4 filter ISO-BAR _____ \$69
- 200W standby power supply _____ \$269
- 425W standby power supply _____ \$399
- 675W standby power supply _____ \$599
- 1000W standby power supply _____ \$899

Plotters

- Roland DXY-800 8 pen _____ \$399
- HP 7470 2 pen _____ \$999
- HP 7475 6 pen _____ \$1699
- HP 7550A 8 pen _____ \$3399
- HP Color Pro 8 pen _____ \$1699
- Houston Inst. PC 695 _____ \$599
- Houston Inst. DMP 40P _____ \$949
- Houston Inst. DMP 29 _____ \$1699
- Houston Inst. DMP 41/42 _____ \$2495
- Houston Inst. DMP 51/52 _____ \$3795
- Houston Inst. DMP 56 _____ \$4495

PC Multifunction Cards

- 384K Jade Seven Pak w/OK, P, S, C, G, software _____ \$89
- 384K Jade Seven Pak with 384K installed _____ \$139
- AST Six Pak Plus 64K _____ \$159
- AST Six Pak Plus 384K _____ \$229
- AST Six Pak Premium 512K _____ \$389

64K BUFFER FOR YOUR EPSON

Serial or parallel input. Fits MX, RX, FX printers
Limited Quantity

\$99



Disk Drive For Your Apple IIc

\$11995

- IIc 1/2 high disk drive _____ \$119
- IIc 1/2 high disk drive _____ \$99
- IIe, II+ disk drive _____ \$129
- IIe 64K, 80 column card _____ \$49
- II+ 80 column card _____ \$119
- Grappler printer card _____ \$89
- II+ 16K RAM card _____ \$39
- II+, IIe printer card & cable _____ \$49
- II+, IIe cooling fan _____ \$59

DISK DRIVE

\$79

- Double Sided
- Double Density
- 360K for PC

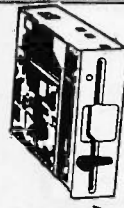

Epson Printers In Stock

EPSON HW-10
100 CPS
Including Free Interface and Cable
\$189

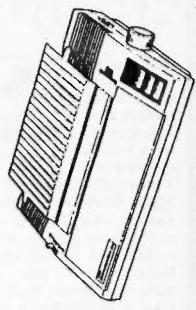

- Citizen 120D 120 cps _____ \$198
- Okidata 192 160 cps _____ \$339
- Epson LX-86 120 cps _____ IN STOCK
- Epson FX-85 160 cps _____ IN STOCK
- Epson FX-286 200 cps _____ IN STOCK
- Epson LQ-800 24 pin _____ IN STOCK
- Epson LQ-1000 24 pin _____ IN STOCK
- Epson EX-800 300 cps _____ IN STOCK
- Epson EX-1000 300 cps _____ IN STOCK
- Epson LQ-2500 324 cps _____ IN STOCK

Microfazer Buffers

- Expands to 64K (Parallel to 512K)
- 8K Parallel in/parallel out _____ \$139
- 64K Parallel in/parallel out _____ \$164
- 128K Parallel in/parallel out _____ \$269
- 512K Parallel in/parallel out _____ \$499
- Your choice: serial in/serial out; parallel in/serial out; serial in/parallel out. 8K _____ \$169 64K _____ \$199



JADE COMPUTER

4901 W. Rosecrans Ave. Box 5046 Hawthorne, CA 90251-5046



PLACE ORDERS TOLL FREE!
Continental U.S.A.
(800)421-5500
Inside California
(800)262-1710

Prices at our six store locations will be higher.
We accept cash, checks, credit cards or purchase orders from qualified firms and institutions. Minimum prepaid order \$15.00. Ca. & Tx. residents add 6 1/2% tax. Prices & availability subject to change without notice. Shipping & handling charges via UPS. Ground 50c/lb. UPS Air \$1.00/lb. Minimum charge \$3.00.

FLOPPY DISK DRIVES

MPI Model 52SA IBM® Compatible

ONLY
\$39.00

AS SHOWN - USED

FULLY TESTED

With Schematics

DS DD 40 TRK - 360K



These Disk Drives are removed from operating machines and tested on a computer before shipping. If you're not completely satisfied, send the unit back to us prepaid within 15 days for a full refund.

We Want You To Be Satisfied

ALL UNITS GUARANTEED 90 DAYS. Repair or Replacement our option. Supplies are limited.

ORDER NOW. DON'T BE LEFT OUT!
ALSO AVAILABLE:
TANDON, CDC, SHUGART, SEAGATE, TEAC,
FUJITSU, NEC, HP

CALL TODAY

617-369-1175 MASS. RESIDENTS
ADD 5% SALES TAX



CARLISLE COMPUTER CORP.

26 OAK KNOLL RD.
CARLISLE, MA 01741

Registered
Trademark

Inquiry 64

Smart Cash Register

\$95

Turns MSDOS computer into complete
RETAIL POS SYSTEM

TURBO PASCAL program 100% dBASE compatible files

All transactions logged to disk

Transfer data to 123. dBASE. BASIC, PASCAL etc

PLU/Inventory Table to 32000 items

4-character DEPT 5-character MFR, PROD

Cashier security Auto/Manual discount, tax

End-Shift summary Custom Receipts 20/40/80 col

HARDWARE SUPPORT: Cash Drawer BarCode Reader

Receipt Printer Function-button Keyboard

ORDER:
915-837-7180

Inquiry 318

EPROM PROGRAMMER

FOR PC **\$129.95**



- 2716 to 1 MEG
- Updateable to 32 MEG
- Programs 2764 A in 10 Seconds
- Menu Driven Software
- External 40 PIN ZIF (PC only)
- 90 Day Warranty
- 10 Day Money Back Guarantee
- Available for APPLE II \$92.50
- For More Information Call



Add 4%

NEEDHAM'S ELECTRONICS

1121 Las Palmas, Sacramento, CA 95815
(916) 924-8037 (M-F) 8 AM to 5 PM PST

Inquiry 249

Printer (Data) switch \$45

Dealers & OEM Welcome

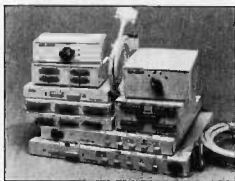

- Metal case, beige color
- Push button or rotary switch
- 2 layer PC board, fully shielded
- Dimension: 1" x 4 1/4" x 8 1/4"
- All pin switched
- 1 year warranty

Switch box	DB25/Centricric	RS232 Miniature	
2 way switch	\$45/\$52	Gender changer M/M, F/F	\$7
2 way cross	\$65/\$79	Null modem	\$10
4 way switch	\$85/\$98	Jumper box, Surge-protector	\$10
RS232 Break-out box	\$55	Mini tester, Mini-patch box	\$15
Power: Central/Center/DB			
Switch/Monitor Swivel	\$99		

Cable (Lifetime warranty) \$10 up

- UL approved, molded, double shielded, beige color
- D type connector with thumb screw (screwless)

Printer Cable (For IBM)	6'/8'/12'	\$12/\$15/\$18
Centronic Cable (male to male)	6'/10'	\$14/\$18
RS232 Cable (male to male)	6'/10'	\$12/\$16
RS232 Cable (male to female)	3'/8'/10'/12'	\$10/\$12/\$16/\$18
(25 line connected ones can be used as modem or extension cable)		
XT Floppy/hard disk cables/AT h/f drive cable		\$7/\$8/\$15

30 Day Money Back Guarantee
Terms: C.O.D. \$190
Handling fee \$3, plus shipping
California residents add sales tax

JACO Enterprises
1478 Poppy Way
Cupertino, CA 95014
TEL: (408) 996-0675

Inquiry 172

TOSHIBA T1100/3100 PORTABLE ENHANCEMENT PRODUCTS

- FLOPPY LINK CARD/CABLE **\$195**
- TEAC/TOSHIBA 3 1/2" FDD **\$195**
(WITH UNIVERSAL MOUNTING KIT)
- EXTERNAL 5 1/4" FDD **\$325**
(INCLUDES POWER SUPPLY)
- EXTERNAL 20MB HARD DISK . . . **\$995**
- EXTERNAL 30MB HARD DISK . . **\$1195**
- 300/1200 BAUD INTERNAL MODEM **\$350**
- DICONIX (KODAK) 150 CPS **\$395**
INKJET PRINTER
(3.75 LBS WITH NI-CAD BATTERIES)
- TAXAN 620 RGB MONITOR **\$395**
- TOSHIBA T1100 PLUS/T3100 . . . **CALL**

VISA - M/C ADD 3% AMEX ADD 5%
- VOLUME DISCOUNTS -

COMPUSALES

16819 S. HAWTHORNE BLVD.
LAWNDALE, CA 90260
(213) 370-3711

Inquiry 80



CREATE A COMPUTER NETWORK for \$299.95

with the MFJ-1294 Super Switch! This switch lets you interconnect 4 RS-232 devices with

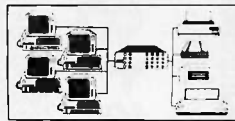

4 other RS-232 devices simultaneously. **All eight devices can be working at the same time!** What you will have is a mini-networking system for the price of other companies' simple switches. And you never have to learn complicated software commands. Reliable and affordable port expansion is as simple as pushing a button. Has LEDs to monitor data lines, MOV surge protectors and transmit-receive buttons that allow 2-way communications. 30 day money back guarantee (less shipping & handling). 1 year unconditional warranty. Add \$6 shipping & handling. Free catalog. call toll-free **800-647-1800**

MFJ MFJ Enterprises, Inc.
921 Louisville Road
Starkville, MS 39759

Inquiry 221



\$1899

FOUNTAIN-XT COMPUTERS

- IBM COMPATIBLE
- 640 k RAM
- SEAGATE 20M HARD DRIVE W/ CONTROLLER
- 2-320 k FLOPPIES
- MULTI-DISPLAY COLOR MONITOR W/CARD
- AT-STYLE KEYBOARD
- 1200 BAUD INTERNAL MODEM
- 72 HOUR BURN IN
- MANUFACTURERS WARRANTY

AT'S & OTHER CONFIGS. AVAILABLE.

H & S SALES, INC.

PO. BOX 795
RAYMORE, MO 64083

(816) 331-3933

PREPAID ORDERS - NO SHIPPING CHARGE
IBM: REGISTERED TRADEMARK OF INTERNATIONAL BUSINESS MACHINES CORP.

Inquiry 421

BlueBox IBM-PC/XT/AT Printer Buffer >>>> Parallel



Short Description:

- ✓ 64 kByte **\$149**
- ✓ 256 kByte **\$399**
- ✓ COPY/CLEAR Button
- ✓ Ready to plug in, including 5 ft. IBM-cable.
- ✓ It's only a small box.

(CA orders add 6.5% tax. Add \$4 for shipping. Price change without notice)

Interfaces, buffers and cables available for most major computer and printer manufacturers:

TecTrans - Guertzen,
6925 Rosemead Blvd.,
San Gabriel, CA 91775
(818) 285-3121

IBM PC/XT/AT are trademarks of Intern. Business Machines
CENTRONICS is a trademark of Centronics Data Comp.

Inquiry 355

THE LATEST IN PC ENHANCEMENT PRODUCTS

ENHANCED GRAPHICS ADAPTOR

100% IBM COMPATIBLE—PASSES IBM EGA DIAGNOSTICS

- * COMPATIBLE WITH IBM EGA, COLOR GRAPHICS ADAPTOR AND MONOCHROME ADAPTOR
- * DISPLAYS 16 COLORS OUT OF 64 COLORS
- * COMES WITH 256K OF VIDEO RAM
- * DUAL SCANNING FREQUENCIES WORKS WITH STANDARD OR EGA TYPE RGB MONITORS
- * LIGHT PEN INTERFACE

NOW ONLY
\$259.95

EGA MONITOR

FULL ONE YEAR WARRANTY

- * EGA AND CGA COMPATIBLE
- * SCANNING FREQUENCIES: 15.75 KHz / 21.85 KHz
- * 14" BLACK MATRIX, NON-GLARE SCREEN
- * RESOLUTION: 640 x 200 / 640 x 350
- * .31 DOT, 25MHz
- * 16 COLORS OUT OF 64
- * TEXT SWITCH-GREEN/AMBER

\$499.95



20 MB HARD DISK SYSTEM

INCLUDES HARD DISK CONTROLLER, CABLES AND INSTRUCTIONS. ALL DRIVES ARE PRE-TESTED AND COME WITH A 1 YEAR WARRANTY.

\$389.95

AT MULTIFUNCTION CARD

\$199.95

ADDS UP TO 3 MEGABYTES OF USER EXPANDABLE MEMORY

- * SHIPPED WITH ZERO K RAM, USER EXPANDABLE TO 1.5 MEGABYTES RAM ON BOARD, UP TO 3 MEGABYTES WITH OPTIONAL PIGGYBACK CARD
 - * USES 64K OR 256K DYNAMIC RAMS
 - * PARALLEL PORT & GAME PORT
 - * SERIAL PORT
 - * OPTIONAL SECOND SERIAL PORT
- PIGGYBACK MEMORY CARD (NO MEMORY INSTALLED) \$49.95**

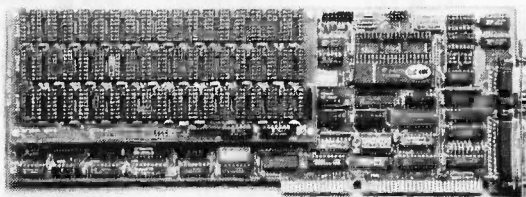

EXPANDED MEMORY CARD

\$199.95

UP TO 2 MEGABYTES OF LOTUS/INTEL COMPATIBLE MEMORY

- * CONFORMS TO LOTUS/INTEL EXPANDED MEMORY SPECIFICATIONS (EMS)
- * SHIPPED WITH ZERO K RAM, USER EXPANDABLE TO 2 MEGABYTES
- * USES 64K OR 256K DYNAMIC RAMS
- * USE AS EXPANDED (EMS) OR CONVENTIONAL MEMORY, RAMDISK OR SPOOLER
- * SOFTWARE INCLUDES EMS DEVICE DRIVERS, PRINT SPOOLER AND RAMDISK

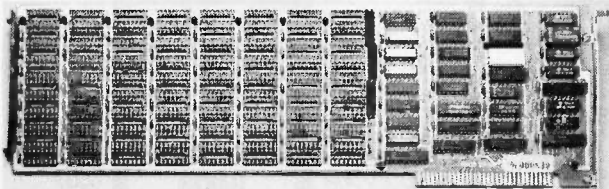

EPROM PROGRAMMER

\$129.95

FOR IBM PC/XT/AT AND COMPATIBLES

- * PROGRAMS 27xxx SERIES EPROMS UP TO 27512
- * MENU DRIVEN SOFTWARE PROVIDED ON DISKETTE
- * AUTOMATICALLY SETS PROGRAMMING VOLTAGE
- * LOADS AND SAVES EPROM BUFFER TO DISK
- * READ, WRITE, COPY, VERIFY OR CHECK BLANK
- * DEBUG STYLE EDITOR FOR EASY MODIFICATION OF PROGRAM
- * SPLITS OR COMBINES EPROMS OF DIFFERING SIZES
- * INTERNAL CARD WITH EXTERNAL CABLE FOR A ZIF SOCKET

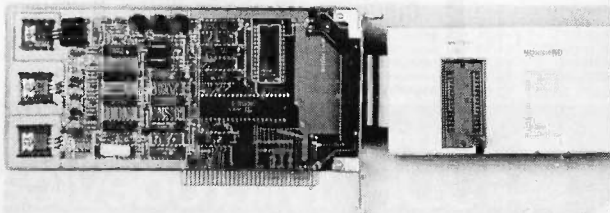

JDR Microdevices

110 Knowles Drive, Los Gatos, CA 95030
Toll Free 800-538-5000 • (408) 866-6200 • FAX (408) 378-8927 • Telex 171-110

Inquiry 176

© COPYRIGHT 1986 JDR MICRODEVICES

THE JDR MICRODEVICES LOGO IS A REGISTERED TRADEMARK OF JDR MICRODEVICES. JDR INSTRUMENTS AND JDR MICRODEVICES ARE TRADEMARKS OF JDR MICRODEVICES. IBM IS A TRADEMARK OF INTERNATIONAL BUSINESS MACHINES.

20MB HARD DISK SYSTEM ONLY \$38995!

STATIC RAMS

2101	256x4	(450ns)	1.95
5101	256x4	(450ns)(CMOS)	3.95
2102L-4	1024x1	(450ns)(LP)	.99
2112	256x4	(450ns)	2.99
2114	1024x4	(450ns)	.99
2114L-4	1024x4	(450ns)(LP)	1.09
2114L-15	1024x4	(150ns)(LP)	1.49
TMS4044-4	14096x1	(450ns)	1.95
TMM2016-150	2048x8	(150ns)	1.95
TMM2016-100	2048x8	(100ns)	1.95
HM6116-4	2048x8	(200ns)(CMDS)	1.89
HM6116-3	2048x8	(150ns)(CMDS)	1.95
HM6116L-4	2048x8	(200ns)(CMOS)(LP)	1.95
HM6116L-3	2048x8	(150ns)(CMOS)(LP)	2.05
HM6116L-2	2048x8	(120ns)(CMOS)(LP)	2.95
HM6264P-15	8192x8	(150ns)(CMOS)	3.89
HM6264L-15	8192x8	(150ns)(CMOS)(LP)	3.95
HM6264L-12	8192x8	(120ns)(CMOS)(LP)	4.49

LP=Low power

DYNAMIC RAMS

4116-250	16384x1	(250ns)	.49
4116-200	16384x1	(200ns)	.89
4116-150	16384x1	(150ns)	.99
4116-120	16384x1	(120ns)	1.49
MK4332	32768x1	(200ns)	6.85
4164-200	65536x1	(200ns)(5v)	1.19
4164-150	65536x1	(150ns)(5v)	1.29
4164-120	65536x1	(120ns)(5v)	1.95
MCM6665	65536x1	(200ns)(5v)	1.95
TMS4164	65536x1	(150ns)(5v)	1.95
4164-REFRESH	65536x1	(150ns)(5v)(REFRESH)	2.95
TMS4416	16384x4	(150ns)(5v)	4.95
41128-150	131072x1	(150ns)(5v)	5.95
TMS4464-15	65536x4	(150ns)(5v)	6.95
41256-200	262144x1	(200ns)(5v)	2.95
41256-150	262144x1	(150ns)(5v)	2.95

5v=Single 5 Volt Supply

REFRESH=Pin 1 Refresh

★★★★ HIGH-TECH ★★★★★

NEC V20 UPD70108 \$1195

REPLACES 8088 TO SPEED UP IBM PC 10-40%

* HIGH-SPEED ADDRESS CALCULATION IN HARDWARE

* PIN COMPATIBLE WITH 8088

* SUPERSET OF 8088 INSTRUCTION SET

* LOW POWER CMOS

8MHZ V20 UPD70108-8 \$13.95

8MHZ V30 UPD70116-8 \$19.95

★★★★ SPOTLIGHT ★★★★★

ORDER TOLL FREE 800-538-5000



EPROMS

2708	1024x8	(450ns)	4.95
2716-1	2048x8	(450ns)(5V)	3.49
TMS2532	2048x8	(350ns)(5V)	3.95
2732	4096x8	(450ns)(5V)	5.95
2732A	4096x8	(450ns)(5V)	3.95
2732A-2	4096x8	(250ns)(5V)(21V PGM)	4.25
2764	8192x8	(250ns)(5V)(CMDS)	5.95
2764-250	8192x8	(450ns)(5V)	3.49
2764-200	8192x8	(250ns)(5V)	4.25
MCM68766	8192x8	(350ns)(5V)(24 PIN)	17.95
27128	16384x8	(250ns)(5V)	4.25
27C256	32768x8	(250ns)(5V)(CMOS)	10.95
27256	32768x8	(250ns)(5V)	7.49

5V=Single 5 Volt Supply

21V PGM=Program at 21 Volts

SPECTRONICS CORPORATION EPROM ERASERS

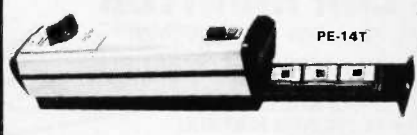

PE-14T

Model	Timer	Capacity Chip	Intensity (uW/Cm ²)	Unit Price
PE-14	NO	9	8,000	\$83.00
PE-14T	YES	9	8,000	\$119.00
PE-24T	YES	12	9,600	\$175.00

8000

8035	1.49
8039	1.95
8080	2.95
8085	2.49
8087-2	169.95
8087	129.00
8088	6.95
8088-2	9.95
8155	2.49
8155-2	3.95
8748	7.95
8755	14.95
80286	129.95
80287	199.95

6500

1.0 MHZ

6502	2.69
65C02(CMOS)	12.95
6507	9.95
6520	1.95
6522	4.95
6526	26.95
6532	6.95
6545	6.95
6551	6.95
6561	19.95
6581	34.95

2.0 MHZ

6502A	2.95
6520A	2.95
6522A	5.95
6532A	11.95
6545A	7.95
6551A	6.95

3.0 MHZ

6502B	6.95
-------	------

CRT CONTROLLERS

6845	4.95
68845	8.95
6847	11.95
HD46505SP	6.95
MC1372	2.95
8275	26.95
7220	19.95
4.0	1.95
4.032	1.95
5.0	1.95
5.0688	1.95
6.0	1.95
6.144	1.95
6.5536	1.95
8.0	1.95
10.0	1.95
10.738635	1.95
12.0	1.95
14.31818	1.95
15.0	1.95
16.0	1.95
17.430	1.95
18.0	1.95
18.432	1.95
20.0	1.95
22.1184	1.95
24.0	1.95
32.0	1.95

CRYSTALS

32.768 KHz	.95
1.0 MHZ	2.95
1.8432	2.95
2.0	1.95
2.097152	1.95
2.4576	1.95
3.2768	1.95
3.579545	1.95
4.0	1.95
4.032	1.95
5.0	1.95
5.0688	1.95
6.0	1.95
6.144	1.95
6.5536	1.95
8.0	1.95
10.0	1.95
10.738635	1.95
12.0	1.95
14.31818	1.95
15.0	1.95
16.0	1.95
17.430	1.95
18.0	1.95
18.432	1.95
20.0	1.95
22.1184	1.95
24.0	1.95
32.0	1.95

74LS00

74LS00	.16
74LS01	.18
74LS02	.17
74LS03	.18
74LS04	.16
74LS05	.18
74LS08	.18
74LS09	.18
74LS10	.16
74LS11	.22
74LS12	.22
74LS13	.26
74LS14	.39
74LS15	.26
74LS20	.17
74LS21	.22
74LS22	.22
74LS23	.23
74LS24	.26
74LS30	.17
74LS32	.18
74LS33	.28
74LS37	.26
74LS38	.26
74LS42	.39
74LS47	.75
74LS48	.85
74LS51	.17
74LS73	.29
74LS74	.24
74LS75	.29
74LS88	.29
74LS83	.49
74LS85	.49
74LS86	.22
74LS90	.39
74LS92	.49
74LS93	.39
74LS95	.49
74LS107	.34
74LS109	.36
74LS112	.29
74LS122	.45
74LS123	.49
74LS124	2.75
74LS125	.39
74LS126	.39
74LS132	.39
74LS133	.49
74LS136	.39
74LS138	.39
74LS139	.39
74LS145	.99
74LS147	.99
74LS148	.99
74LS151	.39
74LS153	.39
74LS154	1.49
74LS155	.59
74LS156	.49
74LS157	.35
74LS158	.29
74LS160	.29
74LS163	.39
74LS162	.49
74LS163	.39
74LS164	.49

CRYSTAL OSCILLATORS

1.0MHZ	5.95
1.8432	5.95
2.0	5.95
2.4576	5.95
2.5	4.95
4.0	4.95
5.0688	4.95
6.0	4.95
6.144	4.95
8.0	4.95
10.0	4.95
12.0	4.95
12.480	4.95
15.0	4.95
16.0	4.95
18.432	4.95
20.0	4.95
24.0	4.95

DISK CONTROLLERS

1771	4.95
1791	9.95
1793	9.95
1795	12.95
1797	12.95
2791	19.95
2793	19.95
2797	29.95
6843	19.95
8272	4.95
UPD765	4.95
MB8876	12.95
MB8877	12.95
1691	6.95
2143	6.95

BIT RATE GENERATORS

MC14411	9.95
BR1941	4.95
4702	9.95
CM8116	8.95
MM5307	4.95

UARTS

AY5-1013	3.95
AY3-1015	4.95
TR1602	3.95
2651	4.95
IM6402	6.95
IM6403	9.95
INS8250	6.95

MISC.

TMS99531	9.95
TMS99532	19.95
ULN2003	7.95
3242	7.99
3341	4.95
MC3470	1.95
MC3480	8.95
MC3487	2.95
IC93	19.95
2513-001 UP	6.95
AY5-2376	11.95
AY5-3600 PRO	11.95

SOUND CHIPS

76477	5.95
76489	8.95
551-263	39.95
AY3-8910	12.95
AY3-8912	12.95
SP1000	39.00

8200

8203	24.95
8205	3.29
8212	1.49
8216	1.49
8224	2.25
8237	4.95
8237-5	5.49
8250	6.95
8251	1.69
8251A	1.89
8253	1.95
8253-5	1.95
8255	1.69
8255-5	1.89
8259	1.95
8259-5	2.29
8272	4.95
8279	2.49
8279-5	2.95
8282	3.95
8284	2.95
8286	3.95
8288	4.95

Z-80

Z80-CPU 2.5 MHz	1.69
4.0 MHZ	
Z80A-CPU	1.79
Z80A-CTC	1.89
Z80A-DART	5.95
Z80A-DMA	5.95
Z80A-PIO	1.89
Z80A-SIO/0	5.95
Z80A-SIO/1	5.95
Z80A-SIO/2	5.95

6.0 MHZ

Z80B-CPU	3.75
Z80B-CTC	4.25
Z80B-PIO	4.25
Z80B-DART	14.95
Z80B-SIO/0	12.95
Z80B-SIO/1	12.95
Z80B-SIO/2	12.95
Z8671 ZILOG	19.95

2.0 MHZ

68800	4.95
68802	5.95
68809E	6.95
68809	6.95
68821	3.95
68845	6.95
68850	2.95
68854	7.95

CLOCK CIRCUITS

MM5369	1.95
MM5369-EST	1.95
MM5817	12.95
MM58174	11.95
MSM5832	2.95

Visit our retail store located at 1256 S. Bascom Ave. in San Jose, (408) 947-8881

JDR Microdevices

110 Knowles Drive, Los Gatos, CA 95030
Toll Free 800-538-5000 • (408) 866-6200
FAX (408) 378-8927 • Telex 171-110

PLEASE USE YOUR CUSTOMER NUMBER WHEN ORDERING

TERMS: Minimum order \$10.00. For shipping and handling include \$2.50 for UPS Ground and \$3.50 for UPS Air. Orders over 1 lb. and foreign orders may require additional shipping charges - please contact our sales department for the amount. CA. residents must include applicable sales tax. All merchandise is warranted for 90 days unless otherwise stated. Prices are subject to change without notice. We are not responsible for typographical errors. We reserve the right to limit quantities and to substitute manufacturer. All merchandise subject to prior sale.

© COPYRIGHT 1986 JDR MICRODEVICES Inquiry 177

THE JDR MICRODEVICES LOGO IS A REGISTERED TRADEMARK OF JDR MICRODEVICES. JDR INSTRUMENTS AND JDR MICRODEVICES ARE TRADEMARKS OF JDR MICRODEVICES. IBM IS A TRADEMARK OF INTERNATIONAL BUSINESS MACHINES. APPLE IS A TRADEMARK OF APPLE COMPUTER.

20MB HARD DISK SYSTEM ONLY \$389.95!

CMOS

4001	.19	14419	4.95
4011	.19	14433	14.95
4012	.25	4503	.49
4013	.35	4511	.69
4015	.29	4516	.79
4016	.29	4518	.85
4017	.49	4522	.79
4018	.69	4526	.79
4020	.59	4527	1.95
4021	.69	4528	.79
4024	.49	4529	2.95
4025	.25	4532	1.95
4027	.39	4538	.95
4028	.65	4541	1.29
4035	.69	4553	5.79
4040	.69	4585	.75
4041	.75	4702	12.95
4042	.59	74C00	.29
4043	.85	74C14	.59
4044	.69	74C74	.59
4045	1.98	74C83	.49
4046	.69	74C85	1.49
4047	.69	74C95	.99
4049	.29	74C150	5.75
4050	.29	74C151	2.25
4051	.69	74C161	.99
4052	.69	74C163	.99
4053	.69	74C164	1.39
4056	2.19	74C192	1.49
4060	.69	74C193	1.49
4066	.29	74C221	2.49
4069	.19	74C240	1.89
4076	.59	74C244	1.89
4077	.29	74C374	1.99
4081	.22	74C905	10.95
4085	.79	74C911	8.95
4086	.89	74C917	12.95
4093	.49	74C922	4.49
4094	2.49	74C923	4.95
14411	9.95	74C926	7.95
14412	6.95	80C97	.95

7400/9000

7400	.19	74147	2.49
7402	.19	74148	1.20
7404	.19	74150	1.35
7406	.29	74151	.55
7407	.29	74153	.55
7408	.24	74154	1.49
7410	.19	74155	.75
7411	.25	74157	.55
7414	.49	74159	1.65
7416	.25	74161	.69
7417	.25	74163	.69
7420	.19	74164	.85
7423	.29	74165	.85
7430	.19	74166	1.00
7432	.29	74175	.89
7438	.29	74177	.75
7442	.49	74178	1.15
7445	.69	74181	2.25
7447	.89	74182	.75
7470	.35	74184	2.00
7473	.34	74191	1.15
7479	.39	74192	1.25
7492	.50	74248	1.85
7493	.35	74249	1.95
7495	.55	74251	.75
7497	2.75	74265	1.35
74100	2.29	74273	1.95
74121	.29	74278	3.11
74123	.49	74367	.65
74125	.45	74368	.65
74141	.65	9368	3.95
74143	5.95	9602	1.50
74144	2.95	9637	2.95
74145	.60	96502	1.95

74S00

74S00	.29	74S163	1.29
74S02	.29	74S168	3.95
74S03	.29	74S174	.79
74S04	.29	74S175	.79
74S05	.29	74S188	1.95
74S08	.35	74S189	1.95
74S10	.29	74S195	1.49
74S15	.49	74S196	2.49
74S30	.29	74S197	2.95
74S32	.35	74S226	3.99
74S37	.69	74S240	1.49
74S38	.69	74S241	1.49
74S74	.49	74S244	1.49
74S85	.95	74S257	.79
74S86	.35	74S253	.79
74S112	.50	74S258	.95
74S124	2.75	74S280	1.95
74S138	.79	74S287	1.69
74S140	.59	74S288	1.69
74S151	.75	74S299	2.95
74S153	.79	74S373	1.69
74S157	.79	74S374	1.69
74S158	.95	74S471	4.95
74S161	1.29	74S571	2.95

VOLTAGE REGULATORS

TO-220 CASE		
7805T	.49	
7808T	.49	
7812T	.49	
7815T	.49	
7905T	.59	
7908T	.59	
7912T	.59	
7915T	.59	
TO-3 CASE		
7805K	1.59	
7812K	1.39	
7905K	1.69	
7912K	1.49	
TO-93 CASE		
78L05	.49	
78L12	.49	
79L05	.69	
79L12	1.49	
OTHER VOLTAGE REGS		
LM323K	5V 3A TO-3	4.79
LM338K	Adj. 5A TO-3	6.95
LMH12K	12V 5A TO-3	8.95

LINEAR

TL066	.99	LM733	.99
TL071	.69	LM741	.28
TL072	1.09	LM747	.69
TL074	1.95	LM748	.69
TL081	.85	MC1330	1.69
TL082	.99	MC1350	1.19
TL084	1.49	MC1372	6.95
LM301	.34	LM1414	1.59
LM309K	1.25	LM1458	.49
LM311	.59	LM1488	.49
LM311H	.89	LM1489	.49
LM317K	3.49	LM1496	.85
LM317T	.99	LM1812	8.25
LM318	1.49	LM1889	1.95
LM319	1.25	ULN2003	.79
LM320	***7900	XR2206	3.95
LM322	1.95	XR2211	2.95
LM323K	4.79	XR2240	1.95
LM324	.49	MPO2907	1.95
LM331	3.95	LM2917	1.95
LM334	1.15	CA3046	.89
LM335	1.79	CA3081	.99
LM336	1.75	CA3082	.99
LM337K	3.95	CA3086	.80
LM338K	6.95	CA3089	1.95
LM339	.59	CA3130E	.99
LM340	***7800	CA3146	1.29
LM350T	4.60	CA3160	1.19
LF353	.59	MC3470	1.95
LF356	.39	MC3480	8.95
LF357	.99	MC3487	2.95
LM358	.59	LM3900	.49
LM380	.89	LM3909	.98
LM383	1.95	LM3911	2.25
LM386	.89	LM3914	2.39
LM393	.45	MC4024	3.49
LM394H	5.95	MC4044	3.99
TL494	4.20	RC4136	1.25
TL497	3.25	RC4558	.69
NE555	.29	LM13600	1.49
NE556	.49	75107	1.49
NE558	1.29	75110	1.95
NE564	1.95	75150	1.95
LM565	.95	75154	1.95
LM566	1.95	75188	1.25
LM567	.79	75189	1.25
NE570	2.95	75451	.39
NE590	2.50	75452	.39
NE592	.98	75453	.39
LM710	.75	75477	1.29
LM723	.49	75492	.79
H-TO-5 CAN, K-TO-3, T-TO-220			

DATA ACQ INTERFACE

ADC0800	15.55	8T26	1.29
ADC0804	3.49	8T28	1.29
ADC0809	4.49	8T95	.89
ADC0816	14.95	8T96	.89
ADC0817	9.95	8T97	.59
ADC0831	8.95	8T98	.95
DAC0800	4.49	DM8131	2.95
DAC0806	1.95	DP8304	2.29
DAC0808	2.95	DS833	2.25
DAC1020	8.25	DS8835	1.99
DAC1022	5.95	DS8836	1.95
MC1408L8	2.95	DS8837	1.69

INTERSIL

ICL7106	9.95
ICL7107	12.95
ICL7660	2.95
ICL8038	4.95
ICM7207A	5.95
ICM7208	15.95

EDGECARD CONNECTORS

100 PIN ST	S-100	.125	3.95
100 PIN WW	S-100	.125	4.95
62 PIN ST	IBM PC	.100	1.95
50 PIN ST	APPLE	.100	2.95
44 PIN ST	STD	.156	1.95
44 PIN WW	STD	.156	4.95

36 PIN CENTRONICS

MALE		6.95
IDCEN36	RIBBON CABLE	6.95
CEN36	SOLDER CUP	4.95
FEMALE		7.95
IDCEN36/F	RIBBON CABLE	7.95
CEN36C	RT ANGLE PC MOUNT	4.95

DIP CONNECTORS

DESCRIPTION	ORDER BY	CONTACTS								
		8	14	16	18	20	22	24	28	40
HIGH RELIABILITY TOOLED ST IC SOCKETS	AUGATxxST	.62	.79	.89	1.09	1.29	1.39	1.49	1.69	2.49
HIGH RELIABILITY TOOLED WW IC SOCKETS	AUGATxxWW	1.30	1.80	2.10	2.40	2.50	2.90	3.15	3.70	5.40
COMPONENT CARRIERS (DIP HEADERS)	ICCxx	.49	.59	.69	.99	.99	.99	.99	1.09	1.49
RIBBON CABLE DIP PLUGS (IDC)	IDPxx	---	.95	.95	---	---	---	---	1.75	2.95

FOR ORDERING INSTRUCTIONS SEE D-SUBMINIATURE BELOW

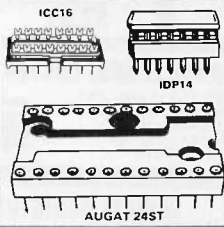

DIODES/OPTO/TRANSISTORS

1N751	.25	4N26	.69
1N759	.25	4N27	.69
1N4148	25/1.00	4N28	.69
1N4004	10/1.00	4N33	.89
1N5402	.25	4N37	1.19
KBPO2	.95	MCT-2	.59
KBUR8A	.65	MCT-6	1.29
MDA990-2	.35	TIL-111	.99
N2222	.25	2N3906	.10
PN2222	.10	2N4401	.25
2N2905	.50	2N4402	.25
2N2907	.25	2N4403	.25
2N3055	.79	2N6405	1.75
2N3904	.10	TIP31	.49

D-SUBMINIATURE

DESCRIPTION	ORDER BY	CONTACTS						
		9	15	19	25	37	50	
SOLDER CUP	MALE	DBxxP	.82	.90	1.25	1.25	1.80	3.48
	FEMALE	DBxxxS	.95	1.15	1.50	1.50	2.35	4.32
RIGHT ANGLE PC SOLDER	MALE	DBxxPR	1.20	1.49	---	1.95	2.65	---
	FEMALE	DBxxSR	1.25	1.55	---	2.00	2.79	---
WIRE WRAP	MALE	DBxxPWW	1.69	2.56	---	3.89	5.60	---
	FEMALE	DBxxSww	2.76	4.27	---	6.84	9.95	---
IDC RIBBON CABLE	MALE	IDBxxP	2.70	2.95	---	3.98	5.70	---
	FEMALE	IDBxxS	2.92	3.20	---	4.33	6.76	---
HOODS	METAL	MHOODxx	1.25	1.25	1.30	1.30	---	---
	GREY	HOODxx	.65	.65	---	.65	.75	.95

ORDERING INSTRUCTIONS: INSERT THE NUMBER OF CONTACTS IN THE POSITION MARKED "x" OF THE "ORDER BY" PART NUMBER LISTED.
EXAMPLE: A 15 PIN RIGHT ANGLE MALE PC SOLDER WOULD BE DB15PR.

MOUNTING HARDWARE \$1.00

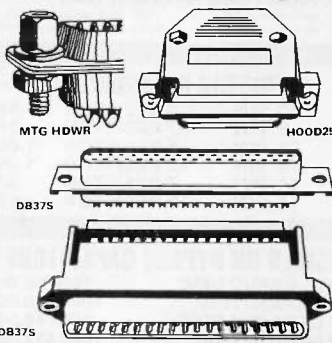

LED DISPLAYS

FND-357(359)	COM CATHODE .362"	1.25
FND-500(503)	COM CATHODE .5"	1.49
FND-507(510)	COM ANODE .5"	1.49
MAN-72	COM ANODE .72"	.99
MAN-74	COM CATHODE .3"	.99
MAN-8940	COM CATHODE .8"	1.99
TIL-313	COM CATHODE .3"	.45

TIL-311	4x7 HEX W/LOGIC	.270"	9.95
HP5082-7340	4x7 HEX W/LOGIC	.290"	7.95

DIFFUSED LEDS

JUMBO RED	T1 1/4	.10	.09
JUMBO GREEN	T1 1/4	.14	.12
JUMBO YELLOW	T1 1/4	.14	.12
MOUNTING HDW	T1 1/4	.10	.09
MINI RED	T1	.10	.09

SWITCHES

SPDT	MINI-TOGGLE ON-ON	1.25
DPDT	MINI-TOGGLE ON-ON	1.50
DPDT	MINI-TOGGLE ON-OFF-ON	1.75
SPST	MINI-PUSHBUTTON N.O.	.39
SPST	MINI-PUSHBUTTON N.C.	.39
SPST	TOGGLE ON-OFF	.49
BCD OUTPUT 10 POSITION 6 PIN DIP		1.95

DIP SWITCHES

4 POSITION	.85	7 POSITION	.95
5 POSITION	.90	8 POSITION	.95
6 POSITION	.90	10 POSITION	1.29

RIBBON CABLE

CONTACTS	SINGLE COLOR		COLOR CODED	
	1'	10'	1'	10'
10				

20MB HARD DISK SYSTEM ONLY \$389⁹⁵!

BARGAIN HUNTERS CORNER

**20 MEG
FULL HEIGHT
HARD DISK DRIVE**
INCLUDES CABLE & CONTROLLER CARD

\$349⁹⁵

SPECIAL ENDS 12/31/86

PAGE WIRE WRAP WIRE PRECUT ASSORTMENT IN ASSORTED COLORS \$27.50

100ea: 5.5", 6.0", 6.5", 7.0"
250ea: 2.5", 4.5", 5.0"
500ea: 3.0", 3.5", 4.0"

SPOOLS

100 feet \$4.30 250 feet \$7.25
500 feet \$13.25 1000 feet \$21.95

Please specify color:
Blue, Black, Yellow or Red

EMI FILTER \$4.95

- MANUFACTURED BY CORCOM
- LOW COST
- FITS LC-HP BELOW
- 6 AMP 120/240 VOLT



6 FOOT LINE CORDS

LC-2 2 CONDUCTOR .39
LC-3 3 CONDUCTOR .99
LC-HP 3 CONDUCTOR W/STD FEMALE SOCKET 1.49

MUFFIN FANS

3.15" SQ ROTRON 14.95
3.63" SQ ETRI 14.95
3.18" SQ MASUSHITA 16.95

WIRE WRAP PROTOTYPE CARDS FR-4 EPOXY GLASS LAMINATE WITH GOLD-PLATED EDGE-CARD FINGERS



IBM-PR2

IBM

BOTH CARDS HAVE SILK SCREENED LEGENDS AND INCLUDES MOUNTING BRACKET

IBM-PR1 WITH +5V AND GROUND PLANE \$27.95
IBM-PR2 AS ABOVE WITH DECODING LAYOUT \$29.95

S-100

P100-1 BARE - NO FOIL PADS \$15.15
P100-2 HORIZONTAL BUS \$21.80
P100-3 VERTICAL BUS \$21.80
P100-4 SINGLE FOIL PADS PER HOLE \$22.75

APPLE

P500-1 BARE - NO FOIL PADS \$15.15
P500-3 HORIZONTAL BUS \$22.75
P500-4 SINGLE FOIL PADS PER HOLE \$21.80
7060-45 FOR APPLE IIe AUX SLOT \$30.00

SOCKET-WRAP I.D.™

- SLIPS OVER WIRE WRAP PINS
- IDENTIFIES PIN NUMBERS ON WRAP SIDE OF BOARD
- CAN WRITE ON PLASTIC, SUCH AS IC #

PINS	PART#	PCK. OF	PRICE
8	IDWRAP 08	10	1.95
14	IDWRAP 14	10	1.95
16	IDWRAP 16	10	1.95
18	IDWRAP 18	5	1.95
20	IDWRAP 20	5	1.95
22	IDWRAP 22	5	1.95
24	IDWRAP 24	5	1.95
28	IDWRAP 28	5	1.95
40	IDWRAP 40	5	1.95

PLEASE ORDER BY NUMBER OF PACKAGES (PCK. OF)

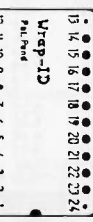

ID WRAP 24

FRAME STYLE TRANSFORMERS

12.6V AC CT 2 AMP 5.95
12.6V AC CT 4 AMP 7.95
12.6V AC CT 8 AMP 10.95
25.2V AC CT 2 AMP 7.95

25 PIN D-SUB GENDER CHANGERS \$7.95



SWITCHING POWER SUPPLIES

PS-IBM \$69.95

- FOR IBM PC-XT COMPATIBLE
- 135 WATTS
- +5V @ 15A, +12V @ 4.2A
- -5V @ .5A, -12V @ .5A
- ONE YEAR WARRANTY



PS-IBM-150 \$79.95

- FOR IBM PC-XT COMPATIBLE
- 150 WATTS
- +12V @ 5.2A, +5V @ 16A
- -12V @ .5A, -5V @ .5A
- ONE YEAR WARRANTY



PS-130 \$99.95

- 130 WATTS
- SWITCH ON REAR
- FOR USE IN OTHER IBM TYPE MACHINES
- 90 DAY WARRANTY



PS-A \$49.95

- USE TO POWER APPLE TYPE SYSTEMS, 79.5 WATTS
- +5V @ 7A, +12V @ 3A
- -5V @ .5A, -12V @ .5A
- APPLE POWER CONNECTOR



PS-SPL200 \$49.95

- +5V @ 25A, +12V @ 3.5A
- -5V @ 1A, -12V @ 1A
- UL APPROVED
- ALUMINUM ENCLOSURE

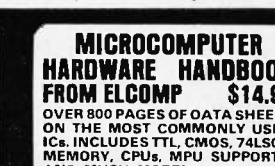

CAPACITORS

TANTALUM

1.0µf	15V .35	35V .45
6.8	15V .70	1.0 35V .45
10	15V .80	2.2 35V .65
22	15V 1.35	4.7 35V .85
.22	35V .40	10 35V 1.00

DISC

10µf	50V .05	680 50V .05
22	50V .05	.001µf 50V .05
27	50V .05	.0022 50V .05
33	50V .05	.005 50V .05
47	50V .05	.01 50V .07
68	50V .05	.02 50V .07
100	50V .05	.05 50V .07
220	50V .05	.1 12V .10
560	50V .05	.1 50V .12

MONOLITHIC

.01µf	50V .14	.1µf 50V .18
.047µf	50V .15	.47µf 50V .25

ELECTROLYTIC

RADIAL		AXIAL	
1/2	25V .14	1/2	50V .14
2.2	35V .15	10	50V .16
4.7	50V .15	22	16V .14
10	50V .15	47	50V .20
47	35V .18	100	35V .25
100	16V .18	220	25V .30
220	35V .20	470	50V .50
470	25V .30	1000	16V .60
2200	16V .70	2200	16V .70
4700	25V 1.45	4700	16V 1.25

DATASEC EPROM ERASER \$34.95

- ERASES 2 IN 10 MINUTES
- COMPACT-NO DRAWER
- THIN METAL SHUTTER PREVENTS UV LIGHT FROM ESCAPING



1/4 WATT RESISTORS

5% CARBON FILM ALL STANDARD VALUES FROM 1 OHM TO 10 MEG. OHM

10 PCS same value .05 100 PCS same value .02
50 PCS same value .025 1000 PCS same value .015

RESISTOR NETWORKS

SIP 10 PIN	9 RESISTOR	.69
SIP 8 PIN	7 RESISTOR	.59
DIP 16 PIN	8 RESISTOR	1.09
DIP 16 PIN	15 RESISTOR	1.09
DIP 14 PIN	7 RESISTOR	.99
DIP 14 PIN	13 RESISTOR	.99

SPECIALS ON BYPASS CAPACITORS

.01 µf CERAMIC DISC 100/\$5.00
.01 µf MONOLITHIC 100/\$10.00
.1 µf CERAMIC DISC 100/\$6.50
.1 µf MONOLITHIC 100/\$12.50

WISH SOLDERLESS BREADBOARDS

PART NUMBER	DIMENSIONS	DISTRIBUTION STRIP(S)	TIE POINTS	TERMINAL STRIP(S)	TIE POINTS	BINDING POSTS	PRICE
WBU-D	.38 x 6.50"	1	100	---	---	---	2.95
WBU-T	1.38 x 6.50"	---	---	1	630	---	6.95
WBU-204-3	3.94 x 8.45"	1	100	2	1260	2	17.95
WBU-204	5.13 x 8.45"	4	400	2	1260	3	24.95
WBU-206	6.88 x 9.06"	5	500	3	1890	4	29.95
WBU-208	8.25 x 9.45"	7	700	4	2520	4	39.95

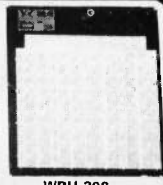

WBU-208

LITHIUM BATTERY AS USED IN CLOCK CIRCUITS

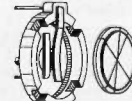

3 VOLT BATTERY \$3.95
BATTERY HOLDER \$1.49

NEW EDITION!

MICROCOMPUTER HARDWARE HANDBOOK FROM ELCOMP \$14.95

OVER 800 PAGES OF DATA SHEETS ON THE MOST COMMONLY USED ICs. INCLUDES TTL, CMOS, 74LS00, MEMORY, CPUs, MPU SUPPORT. AND MUCH MORE!

1986 IC MASTER

THE INDUSTRY STANDARD

\$129.95

Visit our retail store located at 1256 S. Bascom Ave. in San Jose, (408) 947-8881

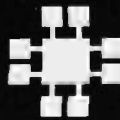

JDR Microdevices

110 Knowles Drive, Los Gatos, CA 95030

Toll Free 800-538-5000 • (408) 866-6200

FAX (408) 378-8927 • Telex 171-110

© COPYRIGHT 1986 JDR MICRODEVICES

Inquiry 178

THE JDR MICRODEVICES LOGO IS A REGISTERED TRADEMARK OF JDR MICRODEVICES. JDR INSTRUMENTS AND JDR MICRODEVICES ARE TRADEMARKS OF JDR MICRODEVICES. IBM IS A TRADEMARK OF INTERNATIONAL BUSINESS MACHINES. APPLE IS A TRADEMARK OF APPLE COMPUTER.

PLEASE USE YOUR CUSTOMER NUMBER WHEN ORDERING
TERMS: Minimum order \$10.00. For shipping and handling include \$2.50 for UPS Ground and \$3.50 for UPS Air. Orders over 1 lb. and foreign orders may require additional shipping charges - please contact our sales department for the amount. CA. residents must include applicable sales tax. All merchandise is warranted for 90 days unless otherwise stated. Prices are subject to change without notice. We are not responsible for typographical errors. We reserve the right to limit quantities and to substitute manufacturer. All merchandise subject to prior sale.



20MB HARD DISK SYSTEM ONLY \$389.95!

DISK DRIVES FOR APPLE COMPUTERS

AP-150
\$99.95

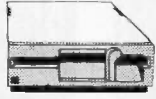

- 1/2 HT. DIRECT DRIVE
- 100% APPLE COMPATIBLE
- SIX MONTH WARRANTY

BAL-500
\$129.95

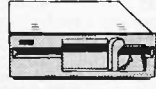

- TEAC MECHANISM-DIRECT DRIVE
- 100% APPLE COMPATIBLE
- FULL ONE YEAR WARRANTY

AP-135
\$129.95



- FULL HT SHUGART MECHANISM
- DIRECT REPLACEMENT FOR APPLE DISK II
- SIX MONTH WARRANTY

DOUBLE SIDED!

MAC535
\$249.95

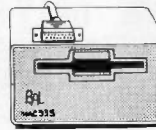

- 3.5" ADD-ON DISK DRIVE
- 100% MACINTOSH COMPATIBLE
- DOUBLE SIDED 800K BYTE STORAGE
- HIGH RELIABILITY DRIVE HAS AUTO-EJECT MECHANISM
- FULL ONE YEAR WARRANTY

AD-3C
\$139.95

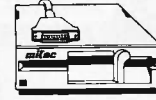

- 100% APPLE IIc COMPATIBLE. READY TO PLUG IN, W/SHIELDED CABLE & MOLDED 19 PIN CONNECTOR
- FAST RELIABLE SLIMLINE DIRECT DRIVE
- SIX MONTH WARRANTY

DISK DRIVE ACCESSORIES

- FDD CONTROLLER CARD \$49.95
- IIc ADAPTOR CABLE \$19.95
- ADAPTS STANDARD APPLE DRIVES FOR USE WITH APPLE IIc

KB-1000 \$79.95

- CASE WITH KEYBOARD FOR APPLE TYPE MOTHERBOARD
- USER DEFINED FUNCTION KEYS
- NUMERIC KEYPAD WITH CURSOR CONTROL
- CAPS LOCK • AUTO-REPEAT

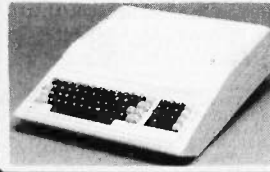

KEYBOARD-AP \$49.95

- REPLACEMENT FOR APPLE II KEYBOARD
- CAPS LOCK KEY, AUTO-REPEAT
- ONE KEY ENTRY OF BASIC OR CP/M COMMANDS

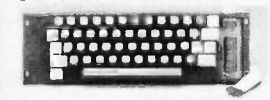

EXTENDER CARDS

- IBM-PC \$45.00
- IBM-AT \$68.00
- APPLE II \$45.00
- APPLE IIe \$45.00
- MULTIBUS \$86.00

APPLE COMPATIBLE INTERFACE CARDS

EPROM PROGRAMMER \$59.95

MODEL RP525



- DUPLICATE OR BURN ANY STANDARD 27xx SERIES EPROM
- EASY TO USE MENU-DRIVEN SOFTWARE IS INCLUDED
- MENU SELECTION FOR 2716, 2732, 2732A, 2764 AND 27128
- HIGH SPEED WRITE ALGORITHM
- LED INDICATORS FOR ACTIVITY
- NO EXTERNAL POWER SUPPLY NEEDED
- ONE YEAR WARRANTY

16K RAMCARD \$39.95



- FULL TWO YEAR WARRANTY
- EXPAND YOUR 48K APPLE TO 64K
- USE IN PLACE OF APPLE LANGUAGE CARD

BARE PC CARD W/INSTRUCTIONS \$9.95

IC TEST CARD \$99.95

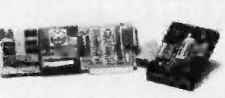

- QUICKLY TESTS MANY COMMON ICs
- DISPLAYS PASS OR FAIL
- ONE YEAR WARRANTY
- TESTS: 4000 SERIES CMOS, 74HC SERIES CMOS, 7400, 74LS, 74L, 74H & 74S

300B MODEM \$49.95

FOR APPLE OR IBM

INCLUDES ASCII PRO-EZ SOFTWARE



• FCC APPROVED

- BELL SYSTEMS 103 COMPATIBLE
- INCLUDES AC ADAPTOR
- AUTO-DIAL
- DIRECT CONNECT

CABLE FOR APPLE IIc \$14.95

JOYSTICK CR-401 \$7.95

FOR ATARI 400, 800, 2600, VIC 20/64 AND APPLE IIc

DISKFILE
HOLDS 70 5 1/4" DISKETTES



3.5" DISKFILE HOLDS 40 \$9.95

POWER STRIP
UL APPROVED 15A CIRCUIT BREAKER \$12.95



2 WAY SWITCH BOXES

- AVAILABLE IN SERIAL OR PARALLEL
- CONNECTS 2 PRINTERS TO ONE COMPUTER OR VICE VERSA
- ALL LINES SWITCHES
- PUSH-BUTTON SWITCHES MOUNTED ON PCB
- 3 FEMALE GOLD-PLATED CONNECTORS



AB-P CENTRONICS PARALLEL \$38.95

AB-S RS232 SERIAL \$38.95

MOLDED INTERFACE CABLES

6 FOOT, 100% SHIELDED, MEETS FCC

- IBM PARALLEL PRINTER CABLE 9.95
- CENTRONICS MALE TO FEMALE 15.95
- CENTRONICS MALE TO MALE 14.95
- MODEM CABLE FOR IBM 7.95
- RS232 SERIAL MALE TO FEMALE 9.95
- RS232 SERIAL MALE TO MALE 9.95
- KEYBOARD EXTENSION (COILED) 7.95
- APPLE II JOYSTICK EXTENSION 4.95

C. ITOH RITEMAN II PRINTER



- 160 CPS DRAFT MODE, 32CPS NLQ MODE
- 9 X 9 DOT MATRIX
- SUPPORTS EPSON/IBM GRAPHICS
- FRICTION AND TRACTOR FEEDS
- VARIABLE LINE SPACING AND PITCH

\$219.95

IBM PRINTER CABLE \$8.95

REPLACEMENT RIBBON CARTRIDGE \$15.95

NASHUA DISKETTES DEALS

5 1/4" SOFT SECTOR DS/DD WITH HUB RINGS

\$9.90 69c ea 59c ea

BOX OF 10 BULK QTY 50 BULK QTY 250

NASHUA DISKETTES WERE JUDGED TO HAVE THE HIGHEST POLISH AND RECORDED AMPLITUDE OF ANY DISKETTES TESTED ACCORDING TO "COMPARING FLOPPY DISKS", BYTE 9/84

DISKETTES

NASHUA 5 1/4"

- N-MD2D DS/DD SOFT \$9.90
- N-MD2F DS/QUAD SOFT \$34.95
- N-MD2H DS/HD FOR AT \$49.95

NASHUA 8"

- N-FD1 SS/DD SOFT \$27.95
- N-FD2D DS/DD SOFT \$34.95

NASHUA 3.5"

- N-3.5SS 3.5" SS/DD FOR MAC \$32.95

VERBATIM 5 1/4"

- V-MD10 SS/DD SOFT \$23.95
- V-MD2D DS/DD SOFT \$29.95
- V-MO110D SS/DD 10 SECTOR HARD \$23.95

BUILD STEVE GIARCIA'S INTELLIGENT EPROM PROGRAMMER

AS SEEN IN BYTE, OCT. 86

- STAND-ALONE OR RS-232 SERIAL OPERATION
- MENU SELECTABLE EPROM TYPES—NO CONFIGURATION JUMPERS
- PROGRAMS ALL 5V 27XXX EPROMS FROM 2716 TO 27512
- READ, COPY OR VERIFY EPROM
- UPLOAD/DOWNLOAD INTEL HEX FILES
- PROGRAMMER DRIVER USER MODIFIABLE

ONLY \$199

KIT INCLUDES PCB AND ALL COMPONENTS EXCEPT CASE AND POWER SUPPLY

5 1/4" FLOPPY DISK DRIVES

- TEAC FD-55B 1/2 HT DS/DD (FOR IBM) \$109.95
- TEAC FD-55F 1/2 HT DS/QUAD (FOR IBM) \$124.95
- TEAC FD-55GFV 1/2 HT DS/HD (FOR IBM AT) \$154.95
- TANDON TM100-2 DS/DD (FOR IBM) \$119.00
- TANDON TM50-2 1/2 HT DS/DD (FOR IBM) \$79.95
- MPI-852 DS/DD (FOR IBM) \$79.95

8" FLOPPY DISK DRIVES

- FD 100-8 SS/DD (SA/801 EQUIV) \$119.00
- FD 200-8 DS/DD (SA/851R EQUIV) \$159.00

DISK DRIVE ACCESSORIES

- TEAC SPECIFICATION MANUAL \$5.00
- TEAC MAINTENANCE MANUAL \$25.00
- 1/2 HT MOUNTING HARDWARE \$2.95
- MOUNTING RAILS FOR IBM AT \$4.95
- "Y" POWER CABLE FOR 5 1/4" FDD \$2.95
- 5 1/4" FDD POWER CONNECTORS \$1.19

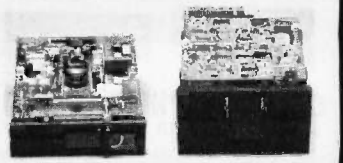

TEAC FD-55

TANDON TM100-2

DISK DRIVE ENCLOSURES

- CAB-1FH5 FULL HT 5 1/4" BEIGE CABINET W/POWER SUPPLY \$89.95
- CAB-2SV5 DUAL SLIMLINE 5 1/4" CABINET W/POWER SUPPLY \$48.95
- CAB-2SV8 VERTICAL DUAL SLIMLINE 8" CABINET W/POWER SUPPLY \$209.95
- CAB-2FH8 HORIZONTAL DUAL FULL HT 8" CABINET W/POWER SUPPLY \$219.95

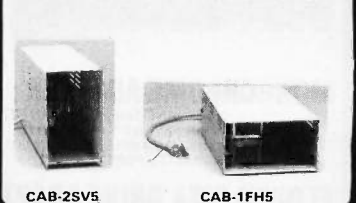

CAB-2SV5

CAB-1FH5

TEST EQUIPMENT FROM JDR INSTRUMENTS

DIGITAL MULTIMETER PEN DPM-1000

AUTO RANGING, POLARITY AND DECIMAL!

\$54.95

- LARGE 3.5 DIGIT DISPLAY
- DATA HOLD SWITCH FREEZES READING
- FAST, AUDIBLE CONTINUITY TEST
- LOW BATTERY INDICATOR
- OVERLOAD PROTECTION



- 20MHZ DUAL TRACE OSCILLOSCOPE MODEL 2000 \$389.00
- 35MHZ DUAL TRACE OSCILLOSCOPE MODEL 3500 \$549.00

FOR MORE INFORMATION ON THE OSCILLOSCOPES, CALL US FOR FREE PRODUCT BRIEFS.

20 MEGA BYTE HARD DISK SYSTEM ONLY \$389.95!

SEAGATE ST-225 20 MB HARD DISK SYSTEM

INCLUDES HARD DISK CONTROLLER, CABLES AND INSTRUCTIONS. ALL DRIVES ARE PRE-TESTED AND COME WITH A ONE YEAR WARRANTY.

\$389.95

XT COMPATIBLE MOTHERBOARD

\$129.95

- 4.77 MHz 8088 CPU, OPTIONAL 8087 CO-PROCESSOR
 - 8 EXPANSION SLOTS
 - 0K RAM INSTALLED, EXPANDABLE TO 640K ON-BOARD MEMORY
 - ALL ICs SOCKETED-HIGHEST QUALITY PC BOARD
 - ACCEPTS 2764 OR 27128 ROMS
- PRO-BIOS \$19.95**

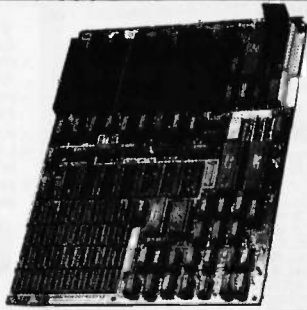

IBM COMPATIBLE INTERFACE CARDS

ALL WITH A ONE YEAR WARRANTY

MULTI I/O FLOPPY CARD

\$89.95

PERFECT FOR THE 640K MOTHERBOARD

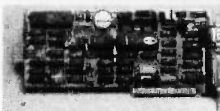

- 2 DRIVE FLOPPY DISK CONTROLLER
- 1 RS232 SERIAL PORT; OPTIONAL 2nd SERIAL PORT
- PARALLEL PRINTER PORT
- GAME PORT
- CLOCK/CALENDAR
- SOFTWARE: CLOCK UTILITIES, RAMDISK, SPOOLER
- OPTIONAL SERIAL PORT \$15.95

MULTIFUNCTION CARD

\$84.95

ALL THE FEATURES OF AST'S 6 PACK PLUS AT HALF THE PRICE

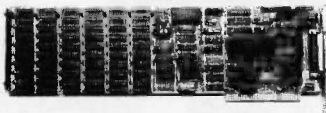

- CLOCK/CALENDAR
- 0-384K RAM
- SERIAL PORT
- PARALLEL PORT
- GAME PORT
- SOFTWARE INCLUDED
- PRINTER CABLE \$9.95
- 64K RAM UPGRADE 9/\$11.61

COLOR GRAPHICS ADAPTOR

\$69.95

FULLY COMPATIBLE WITH IBM COLOR CARD



- 4 VIDEO INTERFACES: RGB, COMPOSITE COLOR, HI-RES COMPOSITE MONOCHROME, CONNECTOR FOR RF MODULATOR
- COLOR GRAPHICS MODE: 320 x 200
- MONO GRAPHICS MODE: 640 x 200
- LIGHT PEN INTERFACE

MONOCHROME GRAPHICS CARD

\$89.95

FULLY COMPATIBLE WITH IBM MONOCHROME ADAPTOR & HERCULES GRAPHICS



- LOTUS COMPATIBLE
- TEXT MODE: 80 x 25
- GRAPHICS MODE: 720 x 348
- PARALLEL PRINTER INTERFACE

MONOCHROME ADAPTOR

\$49.95

ANOTHER FANTASTIC VALUE FROM JDR!

- IBM COMPATIBLE TTL OUTPUT
 - 720 x 350 PIXEL DISPLAY
- PLEASE NOTE: THIS CARD WILL NOT RUN LOTUS GRAPHICS AND DOES NOT INCLUDE A PARALLEL PORT

FLOPPY DISK DRIVE ADAPTOR

\$34.95



- INTERFACES UP TO 4 STANDARD FDDs TO IBM PC DR COMPATIBLES
- INCLUDES CABLE FOR TWO INTERNAL DRIVES
- STANDARD DB37 FOR EXTERNAL DRIVES
- RUNS QUAD DENSITY DRIVES WHEN USED WITH JFORMAT

1200 BAUD MODEMS

HAYES COMPATIBLE, AUTO-DIAL, AUTO-ANSWER, AUTO RE-DIAL ON BUSY, POWER-UP SELF TEST, FULL ONE YEAR WARRANTY

- MODEL 1200B***
- INTERNAL DESIGN
 - 10 INCH CARD
 - SERIAL PORT INCLUDED

\$169.95

*FOR IBM, INCLUDES PC TALK III COMMUNICATIONS SOFTWARE

- MODEL 1200H***
- INTERNAL DESIGN
 - HALF LENGTH (5") CARD
 - INCLUDES SPEAKER

\$149.95

- SMARTEAM**
- EXTERNAL DESIGN
 - WITH POWER SUPPLY
 - LED STATUS INDICATORS

\$169.95

CRT MONITORS FOR ALL APPLICATIONS



LUXOR HI-RES RGB MONITOR
MODEL 190-9528

- DIGITAL RGB-IBM COMPATIBLE
- 14" SCREEN
- 18 TRUE COLORS
- 25 MHz BANDWIDTH
- RESOLUTION > 640 x 262
- 31mm DOT PITCH
- CABLE FOR IBM PC INCLUDED

\$299.95

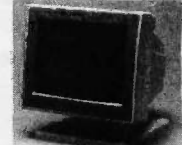

SAMSUNG MONOCHROME
MODEL SM-123F

- IBM COMPATIBLE TTL INPUT
- 12" NON-GLARE AMBER, LOW DISTORTION SCREEN
- RESOLUTION: 720H x 350V
- ATTRACTIVE CASE WITH SWIVEL BASE
- ONE YEAR WARRANTY

\$119.95

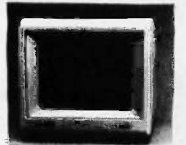

CENTER SYSTEMS MONOCHROME
MODEL KLM-1211

- IBM COMPATIBLE TTL INPUT
- 12" NON-GLARE SCREEN
- P39 GREEN PHOSPHORUS
- VERY HIGH RESOLUTION: 25 MHz BANDWIDTH 1100 LINES (CENTER)
- AMBER VERSION \$109.95

\$99.95

BUILD YOUR OWN 256K XT COMPATIBLE SYSTEM

- XT MOTHERBOARD \$129.95
- PRO-BIOS \$19.95
- 256K RAM \$26.55
- 130 WATT POWER SUPPLY \$69.95
- FLIP-TOP CASE \$39.95
- DKM-2000 KEYBOARD \$59.95
- 1/2 HT TANDON DRIVE \$79.95
- FLOPPY DISK CONTROLLER \$34.95
- MONOCHROME ADAPTOR \$49.95
- MONOCHROME MONITOR \$89.95

TOTAL: \$811.10

MONITOR STAND



TILTS AND SWIVELS

ONLY \$12.95

IBM PRINTER CABLE



- DB25 TO CENTRONICS
- SHIELDED CABLE \$9.95

IBM STYLE COMPUTER CASE

AN ATTRACTIVE STEEL CASE WITH A HINGED LID FITS THE POPULAR PC/XT COMPATIBLE MOTHERBOARDS

- SWITCH CUT-OUT ON SIDE FOR PC/XT STYLE POWER SUPPLY
- CUT-OUT FOR 8 EXPANSION SLOTS
- ALL HARDWARE INCLUDED

\$39.95



IBM COMPATIBLE KEYBOARDS

DKM-2000 \$59.95

IBM-5151 \$79.95



- "5150" STYLE KEYBOARD
- FULLY IBM COMPATIBLE
- LED STATUS INDICATORS FOR CAPS & NUMBER LOCK
- 83 KEY - SAME LAYOUT AS IBM PC/XT KEYBOARD



- REPLACEMENT FOR KEYTRONICS KB-5151"
- SEPARATE CURSOR & NUMERIC KEYPAD
- CAPS LOCK & NUMBER LOCK INDICATORS
- IMPROVED KEYBOARD LAYOUT

POWER SUPPLY



NOW ONLY \$69.95

- FOR IBM PC-XT COMPATIBLE
 - 135 WATTS
 - +5V @ 15A, +12V @ 4.2A
 - -5V @ .5A, -12V @ .5A
- 150 WATT MODEL \$79.95**

DISK DRIVES TANDON TM50-2

\$79.95

- 1/2 HT DS/DD
- IBM COMPATIBLE
- EXTREMELY QUIET!

- TEAC FD-55B D8/DD \$109.95
- TEAC FD-55F D8/QUAD \$124.95
- TEAC FD-55B D8/HD \$154.95
- MOUNTING HARDWARE \$2.95
- AT/RAILS \$4.95

B·O·M·B

BYTE'S ONGOING MONITOR BOX

ARTICLE#	PAGE	ARTICLE	AUTHOR(S)	ARTICLE#	PAGE	ARTICLE	AUTHOR(S)
1	9	Microbytes	staff	12	193	The TMS34010 Graphics System Processor	Killebrew
2	29	What's New	staff	13	207	Plotting the Mandelbrot Set	Schroeder
3	52	Ask BYTE/Circuit Cellar Feedback	Ciarcia	14	215	Graphing Quadric Surfaces	Haroney
4	65	Book Reviews	Unger, Cunningham, Hoffman	15	225	Free-Form Curves on Your Micro	Enns
5	87	Ciarcia's Circuit Cellar: Build the GT180 Color Graphics Board, Part 2: Hardware	Ciarcia	16	239	Four IBM PC AT Clones	Rash
6	102	Programming Project: Using DOS Functions from Turbo Pascal	Yriart	17	249	The Hercules Graphics Card Plus	Malloy
7	113	Programming Insight: A Program for Approximating Integrals	Smith	18	255	23 Modems	Satchell
8	127	Debugging Macintosh Applications	West	19	265	Pascal for the IBM PC	Shammas
9	143	Local Effects of Nuclear Weapons	Fanchi	20	277	STELLA	Robinson
10	161	Henon Mapping with Pascal	Hughes	21	281	Flash-Com	Meeks
11	181	Abstract Mathematical Art	Perry	22	291	Computing at Chaos Manor: The Final Frontier	Pournelle
				23	305	According to Webster: Season's Greetings	Webster
				24	321	Applications Only: Stocking Stuffers	Shapiro
				25	329	BYTE U.K.: The U-MAN Potential	Pountain
				26	349	Best of BIX	BIXen

BOMB Results

PRIZE COMPARISON

"A Comparison of MC68000 Family Processors" is the winning article from September, bringing author Thomas L. Johnson \$100. In second and the winner of \$50 is Adam Brooks Webber for his system software analysis of the two machines. "Amiga vs. Macintosh" Mike Morton's "68000 Tricks and Traps" came

in third in the vote tally for quantity.

And the first place prize for quality of \$50 also goes to Thomas L. Johnson for his coverage of the five MC68000s. Congratulations to all of these Theme authors.

N·E·X·T M·O·N·T·H I·N B·Y·T·E

At press time the following articles are intended for publication in the January issue of BYTE:

Theme:

Next month's theme, Programmable Hardware, includes an overview of the evolution of programmable hardware, an explanation of the theory and physics of programmable logic devices, the merits of microcode versus hard-wiring, general considerations in designing with PALs, how to choose PALs for particular applications, and a programmable hardware construction article.

Features:

Steve Ciarcia concludes his three-part graphics construction project. We have a programming project on hashing, a programming insight or two, and a 68000-related piece on creating and manipulating Macintosh regions.

Hardware Reviews:

We'll feature coverage of 8 multifunction boards for the IBM PC AT, followed by an evaluation of 15 AT clones. We also plan to present reviews of the Data General/One Model 2, the Stride computer, and the Laser 128. Peripheral reviews will include a comparison of 12 graphics boards and the All Card from All Computers.

Software Reviews:

Among the software reviews we have on hand include three Modula-2s for the IBM PC, multitasking BASIC, RuleMaster, Laser Quill, and Scribble!.

Plus columns by Pournelle, Webster, Shapiro, Pountain, and more from the Best of BIX; Book Reviews, What's New, Microbytes, and more.

A COMPUTER PROGRAM DELIVERED VIA SATELLITE!

The Computer Chronicles, a half-hour weekly television series brings you news and information from Silicon Valley and around the world.

Correspondent Stewart Cheifet and Gary Kildall, creator of CP/M cover today's headlines and the stories behind them.

Find out what is, what was and what will be, with the only computer program you're ever going to need. **The Computer Chronicles**, every week on a public television station near you.

(Check local listings for time and channel.)



Produced by KCSM, San Mateo, CA and WITF, Harrisburg, PA with funding from McGraw-Hill's **BYTE** magazine.



BYTE ADVERTISING SALES STAFF:

Dennis J. Riley, Advertising Sales Manager, One Phoenix Mill Lane, Peterborough, NH 03458, tel. (603) 924-9281

NEW ENGLAND
ME, NH, VT, MA, RI,
ONTARIO, CANADA & EASTERN CANADA
Paul McPherson Jr. (617) 262-1160
McGraw-Hill Publications
575 Boylston Street
Boston, MA 02116

ATLANTIC
NY, NYC, CT, NJ (NORTH)
Leah C. Rabinowitz (212) 512-2096
McGraw-Hill Publications
1221 Avenue of the Americas—
39th Floor
New York, NY 10020

Dick McGurk (203) 968-7111
McGraw-Hill Publications
Building A—3rd Floor
777 Long Ridge Road
Stamford, CT 06902

EAST
PA, KY, OH, NJ (SOUTH),
MD, VA, W.VA, DE, D.C.
Daniel Ferro (215) 496-3833
McGraw-Hill Publications
Three Parkway
Philadelphia, PA 19102

SOUTHEAST
NC, SC, GA, FL, AL, TN
Maggie M. Dorvee (404) 252-0626
McGraw-Hill Publications
4170 Ashford-Dunwoody Road—
Suite 420
Atlanta, GA 30319

MIDWEST
IL, MO, KS, IA, ND, SD, MN, WI, NB, IN, MI
Bob Denmead (312) 751-3740
McGraw-Hill Publications
Blair Building
645 North Michigan Ave.
Chicago, IL 60611

SOUTHWEST, ROCKY MOUNTAIN
UT, CO, WY, OK, TX, AR, MS, LA
Kevin Harold (214) 458-2400
McGraw-Hill Publications
Prestonwood Tower—Suite 907
5151 Beltline
Dallas, TX 75240

SOUTH PACIFIC
SOUTHERN CA, AZ, NM, LAS VEGAS
Jack Anderson (714) 557-6292
McGraw-Hill Publications
3001 Red Hill Ave.
Building #1—Suite 222
Costa Mesa, CA 92626

Karen Niles (213) 480-5243, 487-1160
McGraw-Hill Publications
3333 Wilshire Boulevard #407
Los Angeles, CA 90010

NORTH PACIFIC
HI, WA, OR, ID, MT, NORTHERN CA,
NV (except LAS VEGAS), W. CANADA
Mike Kisseberth (415) 362-4600
McGraw-Hill Publications
425 Battery Street
San Francisco, CA 94111

Bill McAfee (415) 349-4100
McGraw-Hill Publications
951 Mariner's Island Blvd.—3rd Floor
San Mateo, CA 94404

**WEST COAST SURPLUS
AND RETAIL ACCOUNTS**
Tom Harvey (805) 964-8577
3463 State Street—Suite 256
Santa Barbara, CA 93105

The Buyer's Mart
Karen Burgess (603) 924-3754
BYTE Publications
One Phoenix Mill Lane
Peterborough, NH 03458

BYTE BITS (2x3)
Dan Harper (603) 924-6830
BYTE Publications
One Phoenix Mill Lane
Peterborough, NH 03458

**Post Card Mailings
National**
Ed Ware (603) 924-9281
Bradley Browne (603) 924-6166
BYTE Publications
One Phoenix Mill Lane
Peterborough, NH 03458

International Advertising Sales Staff:

Mr. Hans Csokor
Publimedia
Reisnerstrasse 61
A-1037 Vienna, Austria
Tel: 222 75 76 84

Mrs. Gurit Gepner
McGraw-Hill Publishing Co.
PO Box 2156
Bat Yam, 59121 Israel
Tel: 3 866 561 321 39

Mr. Fritz Krusebecker
McGraw-Hill Publishing Co.
Liebigstrasse 19
D-6000 Frankfurt/Main 1
West Germany
Tel: 69 72 01 81

Mrs. Maria Sarmiento
Pedro Teixeira 8, Off. 320
Iberia Mart 1
Madrid 4, Spain
Tel: 1 45 52 891

Mr. Andrew Karnig
Andrew Karnig & Associates
Finnbodavagen
S-131 31 Nacka, Sweden
Tel: 8-44 0005

Mr. Alain Faure
McGraw-Hill Publishing Co.
128 Faubourg Saint Honore
75008 Paris
France
Tel: (1) 42-89-03-81

Mr. Arthur Scheffer
McGraw-Hill Publishing Co.
34 Dover St.
London W1X 3RA
England 01 493 1451

Manuela Capuano
McGraw-Hill Publishing Co.
Via Flavio Baracchini 1
20123 Milan, Italy
Tel: 02 86 90 617

Seavex Ltd.
400 Orchard Road, #10-01
Singapore 0923
Republic of Singapore
Tel: 734-9790
Telex: RS35539 SEAVEX

Seavex Ltd.
503 Wilson House
19-27 Wyndham St.
Central, Hong Kong
Tel: 5-260149
Telex: 60904 SEVEX HX

Hiro Morita
McGraw-Hill Publishing Co.
Overseas Corp.
Room 1528
Kasumigaseki Bldg
3-2-5 Kasumigaseki,
Chiyoda-Ku
Tokyo 100, Japan
Tel: 3 581 9811

Mr. Ernest McCrary
Empresa Internacional de
Comunicacoes Ltda
Rua da Consolacao, 222
Conjunto 103
01 302 Sao Paulo, S.P., Brasil
Tel: (11) 259-3811
Telex: (100) 32122 EMBN

R·E·A·D·E·R S·E·R·V·I·C·E

Inquiry No.	Page No.	Inquiry No.	Page No.	Inquiry No.	Page No.	Inquiry No.	Page No.
398 3M COMPANY	286, 287	80 COMPUSALES	430	421 H & S SALES INC.	430	225 MICRO SUPPLY ORGANIZATION	406
2 ABSOFT	350	81 COMPUSAVE	398	* HARMONY COMPUTERS	62	222 MICROCOM SYSTEMS	178
3 ACS IMPORTERS	408	82 COMPUSERVE	300	154 HAYES MICROCOMP. PROD.	218	226 MICROCOMP ACCESSORIES	126
4 ADDISON-WESLEY EDU.MEDIA	62	83 COMPUSERVE	301	155 HERCULES COMPUTER TECH.	82, 83	227 MICROCOMP ACCESSORIES	126
5 ADDMASTER CORP.	416	85 COMPUTER CLASSIFIEDS INC.	174	156 HERCULES COMPUTER TECH.	82, 83	* MICROMINT INC.	383
6 ADJUSTABLE COMPPROD.	423	* COMPUTER CONTINUUM	418	157 HERITAGE SYSTEMS CORP.	423	228 MICRON TECHNOLOGY	134
8 ADV. INTELLIGENCE TECHN.	421	86 COMPUTER DIRECT	129	401 HERSEY MICRO CONSULTING	230	418 MICROPLOT	416
10 ADVANCED COMP. PROD.	49	87 COMPUTER FRIENDS	332	158 HEWLETT-PACKARD	323	231 MICROPORT SYSTEMS INC.	212, 213
11 ADVANCED COMP. PROD.	49	207 COMPUTER LIBRARY	195	429 HUNTER SALES	419	232 MICROPROCESSORS UNLTD.	411
12 ADVANCED COMP. PROD.	405	* COMPUTER MAIL ORDER	64A-D	430 HUNTER SALES	419	* MICROSOFT CORP.	53
13 AFTON COMPUTER	308	88 COMPUTER MAIL ORDER	401	162 I-CON INCORPORATED	299	* MICROSOFT CORP.	100, 101
14 AFTON COMPUTER	308	424 COMPUTER MART	422	404 IBM (ISG) SERVICES	140, 141	233 MICROWARE	416
15 AICON SYSTEMS	322	89 COMPUTER SURPLUS STORE	410	164 IBEX COMP. CORP.	404	234 MICROWAY	86
16 AICON SYSTEMS	322	90 COMPUTER WAREHOUSE	328	165 I.C. EXPRESS	404	* MICROWAY	191
17 ALF PRODUCTS, INC.	400	91 COMPUTER WAREHOUSE	328	166 ILLUMINATED TECHNOLOGIES	134	235 MIGENT SOFTWARE, INC.	169
18 ALPHA MICRO	19	93 COMPUTERBANC	407	167 INI COMPUTER PROD.	418	160 MIND OVER MINORS	177
19 ALSYS LTD.	197	94 COMPUTERS INTERNATIONAL	219	168 INMAC	252	407 MITAC CORP.	371
186 AMAZING THINGS INC.	23	95 COMPUTRADE COMPANY	366	* INTECTRA INC.	418	236 MIX SOFTWARE	99
20 AMDEK CORP.	311	96 CUESTA SYSTEMS	139	169 INTEGRAND RESEARCH CORP.	257	237 MOTOROLA SEMI-CONDUCTOR	411
23 AMERICAN COMP. & PERIPH.	353	97 CUSTOM SOFTWARE SYSTEMS	366	170 INTERNATIONAL FINANCE	413	239 MULTI-TECH SYSTEMS	284
24 AMERICAN COMP. & PERIPH.	353	98 DAC SOFTWARE INC.	45	411 INTRONICS COMPUTER CORP.	387	240 MULTI-TECH SYSTEMS	284
25 AMERICAN MICRO TECH.	307	99 DANCOTEC	205	171 IO TECH	408	241 MULTITECH INDUSTRIAL CORP.	61
26 AMERICAN MICRO TECH.	307	102 DATA SPEC	360	172 IACO ENTERPRISES	430	412 NAKAI CO INC.	229
27 AMERICAN MICRO TECH.	309	103 DATA SPEC	360	173 IADE COMP. PROD.	428, 429	243 NANTUCKET	39
28 AMERICAN MICRO TECH.	309	105 DATADESK INTERNATIONAL	117	174 JAMECO ELECTRONICS	402, 403	244 NANTUCKET	39
29 AMERICAN RESEARCH INC.	77	106 DATADESK INTERNATIONAL	117	175 IDR INSTRUMENTS	111	245 NATIONAL INSTRUMENTS	210
30 AMERICAN RESEARCH INC.	77	108 DATASOUTH COMP. CORP.	238	176 IDR MICRODEVICES	431	246 NEC HOME ELECT.USA	121
31 AMERICAN SEMICONDUCTOR	406	* DAYTIMERS	209	177 IDR MICRODEVICES	432, 433	247 NEC INFORMATION SYS.	CIII
417 AMERICAN SEMICONDUCTOR	420	414 DECISIONWARE INC.	243	178 IDR MICRODEVICES	434, 435	248 NEC INFORMATION SYS.	361
32 AMERICAN SMALL BUSN. COMP.119		415 DECISIONWARE INC.	243	179 IDR MICRODEVICES	436	249 NEEDHAM'S ELECTRONICS	430
33 AMPRO COMPUTERS INC.	70	110 DICONIX	377	180 KADAK PRODUCTS LTD.	400	416 NORTHEASTERN SFTW. CO.	318, 319
413 APPARAT INC.	206	111 DIGITALK INC.	115	397 KEA SYSTEMS	406	253 OMNITRONIX INC.	408
34 APROTEK	406	113 DISKOTECH	404	181 KEITHLEY DAC	296	252 OMNITRONIX INC.	410
35 ARITY CORPORATION	246	114 DISKETTE CONNECTION	413	182 KIMTRON CORP.	253	* ORCAD SYSTEMS CORP.	418
37 ARTEK CORP.	66	84 DISKMASTER	410	183 KIMTRON CORP.	253	427 ORCHID TECHNOLOGY	31
* AST RESEARCH INC.	17	115 DISKS PLUS INC.	352	184 LAHEY COMPUTER SYSTEMS	54	428 ORCHID TECHNOLOGY	31
* AT&T COMMUNICATIONS	132, 133	116 DRESSSELHAUS COMP. PROD.	60	185 LATTICE, INC.	58	255 ORION INSTRUMENTS	160
39 ATARI CORP.	173	117 EARTH COMPUTERS	228	187 LIFEBOAT ASSOCIATES	175	256 PC COMPUTER BROKERS INC.	345
40 ATARI CORP.	175	118 EARTH COMPUTERS	228	189 LOGICAL DEVICES	364	257 PC HORIZONS INC.	416
41 ATARI CORP.	177	119 EASTMAN KODAK CO.	55	190 LOGICAL DEVICES	364	258 P.D. SIG INC.	423
36 ATI TECHNOLOGIES INC.	167	120 ECHELON	374	191 LOGICAL SYSTEMS INC.	418	260 PANASONIC COMPUTER DIV.	71
42 ATRON CORP.	304	121 ECOSOFT	221	400 LOGICSOFT	224A-F	261 PANASONIC COMPUTER DIV.	72, 73
43 AVIS RENT-A-CAR	325	122 ELECTRONIC ARTS	354, 355	193 LOGITECH INC.	363	262 PARFOR SOFTWARE CO.	430
* AVOCET SYSTEMS INC.	331	123 ELECTRONIC ARTS	354, 355	194 LOGITECH INC.	365	263 PATHFINDER SOFTWARE INC.	406
45 B&B ELECTRONICS	411	357 ELECTRONIC UNIV. NETWORK	254	195 LONE STAR SOFTWARE INC.	417	264 PATTON & PATTON	400
* B&C MICROSYSTEMS	416	124 ELEXOR INC.	416	* LOTUS DEVELOPMENT	40, 41	265 PC AMERICAN MARKETING INC.	409
46 BARRINGTON SYSTEMS	25	125 ELLIS COMPUTING INC.	283	* LOTUS DEVELOPMENT	124, 125	78 PC INNOVATIONS	59
47 BAY EXPRESS COMPANY THE	247	127 EVEREX SYSTEMS	276	* LOTUS DEVELOPMENT	144-151	* PC NETWORK	304A-H
48 BAY TECHNICAL ASSOC.	68	128 EVEREX SYSTEMS	276	* LOTUS DEVELOPMENT	231-233	266 PC SIG	20
52 BLAISE COMPUTING INC.	335	129 EVSAN	423	* LOTUS DEVELOPMENT	346, 347	268 PC TECH	358
53 BLAISE COMPUTING INC.	335	130 FILTREX RESEARCH INC.	411	204 LUCKY COMPUTERS	410	* PCS LIMITED	192A-B
54 BORLAND INT'L.	CII, 1	132 FLAGSTAFF ENGINEERING	290	205 LYBEN COMP. SYS.	298	269 PECAN SOFTWARE SYS. INC.	18
55 BORLAND INT'L.	CII, 1	133 FLAGSTAFF ENGINEERING	290	206 LYCO COMPUTER	245	270 PECAN SOFTWARE SYS. INC.	380
56 BP MICROSYSTEMS	423	134 FOCUS ELECTRONICS	252	208 MACMILLAN SOFTWARE	123	* PERCON	408
57 BUSINESS TOOLS INC.	313	135 FORESIGHT RESOURCES CORP.	272	209 MAGITRONIC TECHNOLOGY INC.	76	271 PERSOFT INC.	8
* BUYER'S MART SECTION	390-397	136 FORESIGHT RESOURCES CORP.	272	* MAGNAVOX	171	272 PERSOFT INC.	33
* BYTE BACK ISSUES	302	137 FORTRON CORPORATION	389	210 MANX SOFTWARE SYS.	79	273 PERSONAL TEX. INC.	74
426 BYTE BITS	403	138 FORTRON CORPORATION	389	211 MANX SOFTWARE SYS.	317	276 POLARIS SOFTWARE	336
58 BYTE CONNECTION, THE	399	139 FOX SOFTWARE, INC.	22	212 MARK WILLIAMS CO.	35	277 POLARIS SOFTWARE	336
450 BYTE INFO EXCHANGE (BIX)	320	406 G.A.S. INT'L. ELECTRONICS	242	213 MARK WILLIAMS CO.	37	278 POLYTRON	173
* BYTE PUBLISHER'S STATEMENT	400	140 GENERAL DATACOMM	312	* MASTERCARD INT'L. INC.	202	279 POLYTRON	173
* BYTE SUB. MESSAGE	422	141 GENERAL MICRO SYSTEMS	418	214 MATHSOFT INC.	220	* PRENTICE-HALL	180
* BYTE SUB. SERVICE	112	142 GENERAL PARAMETRICS CORP.	165	* MAXELL DATA PRODUCTS	7	280 PRINCETON GRAPHIC SYS.	14, 15
* C WARE/DESMET C	360	143 GENERAL PARAMETRICS CORP.	165	101 MAXTECH	422	281 PRINCETON GRAPHIC SYS.	275
* CALIFORNIA DIGITAL	424, 425	144 GENERIC SOFTWARE INC.	214	215 MCGRAW-HILL SOFTWARE	384	282 PROGRAMMER'S SHOP	297
61 CANON U.S.A.	326, 327	145 GENERIC SOFTWARE INC.	214	216 MEGASOFT	404	284 PROSOFT	43
63 CAPITAL EQUIPMENT CORP.	336	146 GFK	350	217 MEGATEL COMPUTER TECH.	358	285 PROTEC MICRO SYSTEMS	423
64 CARLISLE COMPUTER	430	147 GIMPTEL SOFTWARE	192	218 MERRITT COMP. PRODUCTS	418	423 PUBLIC DOMAIN SFT. COPYING	422
65 CAUZIN SYSTEMS	248	148 GLENCO ENGINEERING	340	219 METACOMCO	306	286 PURPLE COMPUTING	404
420 CENTRAL COMP. PROD.	416	149 GOLDEN BOW SYSTEMS	418	220 METHOD SYSTEMS INC.	410	287 OW PAGE ASSOCIATES INC.	131
419 CENTROID	422	150 GOLDEN BOW SYSTEMS	416	221 MFJ ENTERPRISES INC.	430	288 OIC RESEARCH	270
68 CLONE FACTORY	414	151 GRAFPOINT	400	223 MICRO DESIGN INT'L.	64	289 OUA TECH. INC.	413
69 CLUB AT	56, 57	153 GTEK INC.	306	425 MICRO PRODUCTS INT'L.	426	290 OUA TECH. INC.	413
70 CLUB AT	57					291 OUA TECH. INC.	413
71 CMS	176					292 OUA TECH. INC.	413
72 CMS	176					293 OUA TECH. INC.	413
73 CNT MARKETING	423					294 QUADRAM CORP.	107
75 COEFFICIENT SYS. CORP.	338					295 QUALITY PRINTERS	404
76 COGITATE	400					296 QUALSTAR CORP.	411
77 COGITATE	400					297 QUANTUM SOFTWARE	315
79 COMPUTADATA TRANSLATORS INC.	418					298 OUBIE	269
* COMPUPRO	334					299 OUBIE	271

.....
 TO GET FURTHER information on the products advertised in BYTE, either pick up your touch-tone telephone and use TIPS (if you are a subscriber), or fill out the reader service card. Either way full instructions are provided following this reader service index which is provided as an additional service by the publisher, who assumes no liability for errors or omissions. *Correspond directly with company.



NEC'S PINWRITER P5XL HAS MADE BLACK A PRIMARY COLOR.

Our Pinwriter® P5XL printer has changed forever the way people look at dot matrix printing.

It's the first 24-pin dot matrix printer to use a letter-quality multistrike film ribbon—the same ribbon used in typewriters and letter-quality printers, such as our Spinwriter®. So for the first time in computer history there is a printer that honestly does everything. A printer that produces

important letters and documents with crisp, black, true letter-quality printing. But with all the speed and graphics capability dot matrix printers are known for.

Fast, black letter-quality printing will be the primary reason many people will buy a P5XL printer. But there are plenty of other good reasons. In fact, it's the most versatile printer ever created for personal computers.

It can use an optional ribbon to print seven other colors plus black. And it has the best graphics resolution of any impact printer you can buy, due in part to our advanced 24-pin printhead. Plus it can print more type faces automatically than any other dot matrix printer. And it's quiet and fast.

You can also expect a P5XL printer to turn out millions of characters before it will need service because it has the highest reliability rating in the industry. And there's a nationwide network of NEC Customer Service Centers to take care of maintenance.

Now, while the Pinwriter P5XL performs a little black magic, you won't have to go in the red to buy it.

The Pinwriter P5XL is the latest addition to the most advanced and extensive family of 24-pin printers available.

See it at your dealer or for an information package that includes actual print samples, call 1-800-343-4418 (in MA 617-264-8635).

Or write: NEC Information Systems, Dept. 1610,
1414 Massachusetts Ave., Boxborough, MA 01719.

**NEC PRINTERS. THEY ONLY STOP
WHEN YOU WANT THEM TO.**

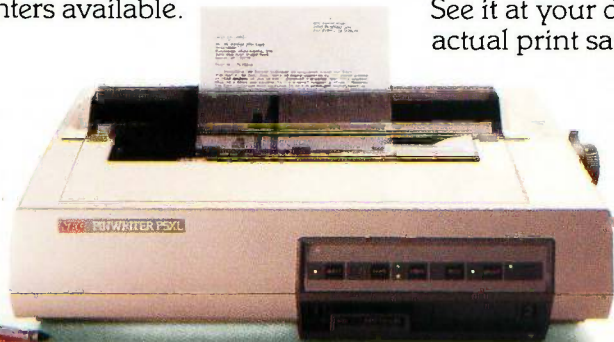

C&C Computers and Communications

The chevrons and serpentine designs are registered trademarks of Binney and Smith Inc., used with permission.

NEC

NEC Information Systems, Inc.

Inquiry 247

Great Christmas Savings from Radio Shack.

The Tandy® 102 Portable

Reg.
\$499⁰⁰

\$399⁰⁰

Save \$100 on our most popular portable.

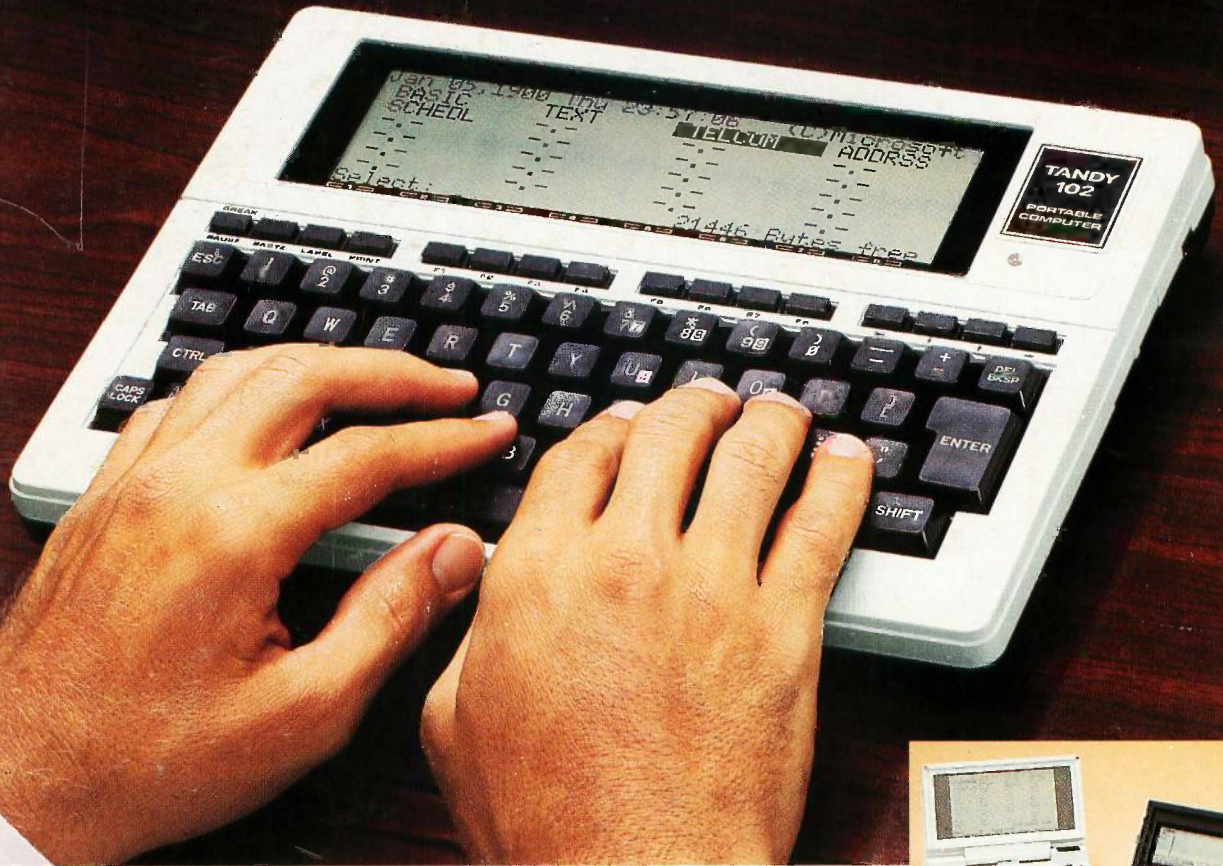

Good things really do come in small packages

Here's the perfect gift for busy executives, students and people on the move. The Tandy 102 provides the performance of a desktop computer in a much smaller—and much more affordable package.

We've redesigned our best-selling portable—the Model 100—into the slimmer, more lightweight Tandy 102. Ideal for businesspeople who travel, the Tandy 102 includes five instant-on programs, an 8-line by 40-character LCD display and a built-in modem. Despite its small size, the Tandy 102 features a full-size typewriter-style keyboard and 24K memory.

Use the Tandy 102 as a personal word processor, address/phone directory, appointment calendar and telephone auto-dialer. Access other computers or national information services by phone with the built-in 300 bps modem and communications program. Or write your own programs in BASIC.

The Tandy 102 includes parallel, RS-232C, cassette and bar code reader interfaces. You can even add a Disk/Video Interface for up to 184,000 characters of disk storage, as well as connection to a TV or display monitor. The powerful little Tandy 102 is a Micro Executive Workstation™ that operates on batteries or optional AC adapter.



Save on our other portables!

The powerful Tandy 200 (26-3860, Reg. \$799.00, Sale \$599) and the professional disk-based Tandy 600 portable computers (26-3901, Reg. \$1599.00, Sale \$999) are available at special holiday savings as well. Stop by your local Radio Shack. We've got the perfect portable for everyone on your list.

Radio Shack®
The Technology Store™
A DIVISION OF TANDY CORPORATION